

**QUANTITATIVE ASPECTS OF RUMINANT  
DIGESTION AND METABOLISM**

**Second Edition**

*This page intentionally left blank*

---

# QUANTITATIVE ASPECTS OF RUMINANT DIGESTION AND METABOLISM

## Second Edition

---

Edited by

**J. Dijkstra**

*Animal Nutrition Group  
Wageningen University  
The Netherlands*

**J.M. Forbes**

*Centre for Animal Sciences  
University of Leeds  
UK*

and

**J. France**

*Centre for Nutrition Modelling  
University of Guelph  
Canada*

CABI Publishing

**CABI Publishing is a division of CAB International**

CABI Publishing  
CAB International  
Wallingford  
Oxfordshire OX10 8DE  
UK

CABI Publishing  
875 Massachusetts Avenue  
7th Floor  
Cambridge, MA 02139  
USA

Tel: +44 (0)1491 832111  
Fax: +44 (0)1491 833508  
E-mail: [cabi@cabi.org](mailto:cabi@cabi.org)  
Web site: [www.cabi-publishing.org](http://www.cabi-publishing.org)

Tel: +1 617 395 4056  
Fax: +1 617 354 6875  
E-mail: [cabi-nao@cabi.org](mailto:cabi-nao@cabi.org)

© CAB International 2005. All rights reserved. No part of this publication may be reproduced in any form or by any means, electronically, mechanically, by photocopying, recording or otherwise, without the prior permission of the copyright owners.

A catalogue record for this book is available from the British Library, London, UK.

A catalogue record for this book is available from the Library of Congress, Washington, DC, USA.

Library of Congress Cataloging-in-Publication Data

Quantitative aspects of ruminant digestion and metabolism / edited by J. Dijkstra, J. M. Forbes, and J. France.--2nd ed.

p. cm.

Includes index.

ISBN 0-85199-814-3 (alk. paper)

1. Ruminant. 2. Digestion. 3. Metabolism. 4. Ruminants. I. Dijkstra, J. (Jan), 1964-II. Forbes, J. M. (John Michael), 1940-III. France, J. IV. Title.

QP151.Q78 2005  
573.3'1963--dc22

2004029078

ISBN 0 85199 8143

Typeset by SPI Publishing Services, Pondicherry, India  
Printed and bound in the UK by Biddles Ltd, King's Lynn

---

# Contents

---

<b>Contributors</b>	ix
<b>1. Introduction</b>	1
<i>J. Dijkstra, J.M. Forbes and J. France</i>	
<b>DIGESTION</b>	
<b>2. Rate and Extent of Digestion</b>	13
<i>D.R. Mertens</i>	
<b>3. Digesta Flow</b>	49
<i>G.J. Faichney</i>	
<b>4. <i>In Vitro</i> and <i>In Situ</i> Techniques for Estimating Digestibility</b>	87
<i>S. López</i>	
<b>5. Particle Dynamics</b>	123
<i>P.M. Kennedy</i>	
<b>6. Volatile Fatty Acid Production</b>	157
<i>J. France and J. Dijkstra</i>	
<b>7. Nitrogen Transactions in Ruminants</b>	177
<i>J.V. Nolan and R.C. Dobos</i>	
<b>8. Rumen Microorganisms and their Interactions</b>	207
<i>M.K. Theodorou and J. France</i>	

<b>9. Microbial Energetics</b>	229
<i>J.B. Russell and H.J. Strobel</i>	
<b>10. Rumen Function</b>	263
<i>A. Bannink and S. Tamminga</i>	
<b>METABOLISM</b>	
<b>11. Glucose and Short-chain Fatty Acid Metabolism</b>	291
<i>R.P. Brockman</i>	
<b>12. Metabolism of the Portal-drained Viscera and Liver</b>	311
<i>D.B. Lindsay and C.K. Reynolds</i>	
<b>13. Fat Metabolism and Turnover</b>	345
<i>D.W. Pethick, G.S. Harper and F.R. Dunshea</i>	
<b>14. Protein Metabolism and Turnover</b>	373
<i>D. Attaix, D. Rémond and I.C. Savary-Auzeloux</i>	
<b>15. Interactions between Protein and Energy Metabolism</b>	399
<i>T.C. Wright, J.A. Maas and L.P. Milligan</i>	
<b>16. Calorimetry</b>	421
<i>R.E. Agnew and T. Yan</i>	
<b>17. Metabolic Regulation</b>	443
<i>R.G. Vernon</i>	
<b>18. Mineral Metabolism</b>	469
<i>E. Kebreab and D.M.S.S. Vitti</i>	
<b>THE WHOLE ANIMAL</b>	
<b>19. Growth</b>	489
<i>G.K. Murdoch, E.K. Okine, W.T. Dixon, J.D. Nkrumah, J.A. Basarab and R.J. Christopherson</i>	
<b>20. Pregnancy and Fetal Metabolism</b>	523
<i>A.W. Bell, C.L. Ferrell and H.C. Freetly</i>	
<b>21. Lactation: Statistical and Genetic Aspects of Simulating Lactation Data from Individual Cows using a Dynamic, Mechanistic Model of Dairy Cow Metabolism</b>	551
<i>H.A. Johnson, T.R. Famula and R.L. Baldwin</i>	

---

<b>22. Mathematical Modelling of Wool Growth at the Cellular and Whole Animal Level</b>	583
<i>B.N. Nagorcka and M. Freer</i>	
<b>23. Voluntary Feed Intake and Diet Selection</b>	607
<i>J.M. Forbes</i>	
<b>24. Feed Processing: Effects on Nutrient Degradation and Digestibility</b>	627
<i>A.F.B. Van der Poel, E. Prestløkken and J.O. Goelma</i>	
<b>25. Animal Interactions with their Environment: Dairy Cows in Intensive Systems</b>	663
<i>T. Mottram and N. Prescott</i>	
<b>26. Pasture Characteristics and Animal Performance</b>	681
<i>P. Chilbroste, M. Gibb and S. Tamminga</i>	
<b>27. Integration of Data in Feed Evaluation Systems</b>	707
<i>J.P. Cant</i>	
<b>Index</b>	727

*This page intentionally left blank*



---

## Contributors

---

- R.E. Agnew, *Agricultural Research Institute of Northern Ireland, Large Park, Hillsborough BT26 6DR, UK.*
- D. Attaix, *Institut National de la Recherche Agronomique, Unité de Nutrition et Métabolisme Protéique, Theix, 63122 Ceyrat, France.*
- R.L. Baldwin, *Department of Animal Science, University of California, Davis, CA 95616-8521, USA.*
- A. Bannink, *Division of Nutrition and Food, Animal Sciences Group, Wageningen University Research Centre, PO Box 65, 8200 AB Lelystad, The Netherlands.*
- J.A. Basarab, *Western Forage/Beef Group, Lacombe Research Centre, 6000 CandE Trail, Lacombe, Alberta T4L 1W1, Canada .*
- A.W. Bell, *Department of Animal Science, Cornell University, Ithaca, NY 14853, USA.*
- R.P. Brockman, *St. Peter's College, Muenster, Saskatchewan S0K 2Y0, Canada.*
- J.P. Cant, *Department of Animal and Poultry Science, University of Guelph, Guelph, Ontario N1G 2W1, Canada.*
- P. Chilibroste, *Facultad de Agronomía, Estación Experimental M. A. Cassinoni, Ruta 3 km 363, CP 60000, Paysandú, Uruguay.*
- R.J. Christopherson, *Department of Agricultural, Food and Nutritional Science, University of Alberta, Edmonton, Alberta T6G 2P5, Canada.*
- J. Dijkstra, *Animal Nutrition Group, Wageningen Institute of Animal Sciences, Wageningen University, PO Box 338, 6700 AH Wageningen, The Netherlands.*
- W.T. Dixon, *Department of Agricultural, Food and Nutritional Science, University of Alberta, Edmonton, Alberta T6G 2P5, Canada.*
- R.C. Dobos, *Beef Industry Centre of Excellence, NSW Department of Primary Industries, Armidale, 2351 Australia.*

- F.R. Dunshea, *School of Veterinary and Biomedical Sciences, Murdoch University, Murdoch, WA 6150, Australia; and Department of Primary Industries, Werribee, VIC 3030, Australia.*
- G.J. Faichney, *School of Biological Sciences A08, University of Sydney, NSW 2006, Australia.*
- T.R. Famula, *Department of Animal Science, University of California, Davis, CA 95616-8521, USA.*
- C.L. Ferrell, *USDA ARS, Meat Animal Research Center, Clay Center, NE 68933, USA.*
- J.M. Forbes, *Centre for Animal Sciences, School of Biology, University of Leeds, Leeds LS2 9JT, UK.*
- J. France, *Centre for Nutrition Modelling, Department of Animal and Poultry Science, University of Guelph, Guelph, Ontario N1G 2W1, Canada.*
- M. Freer, *CSIRO Plant Industry, GPO Box 1600, Canberra, ACT 2601, Australia.*
- H.C. Freetly, *USDA ARS, Meat Animal Research Center, Clay Center, NE 68933, USA.*
- M. Gibb, *Institute of Grassland and Environmental Research, North Wyke Research Station, Okehampton, Devon EX20 2SB, UK.*
- J.O. Goelma, *Pre-Mervo, PO Box 40248, 3504 AA Utrecht, The Netherlands.*
- G.S. Harper, *CSIRO, Division of Livestock Industries, St. Lucia, QLD 4067, Australia.*
- H.A. Johnson, *Department of Animal Science, University of California, Davis, CA 95616-8521, USA.*
- E. Kebreab, *Centre for Nutrition Modelling, Department of Animal and Poultry Science, University of Guelph, Guelph, Ontario N1G 2W1, Canada.*
- P.M. Kennedy, *CSIRO Livestock Industries, J.M. Rendel Laboratory, Rockhampton, QLD 4701, Australia.*
- D.B. Lindsay, *Division of Nutritional Sciences, School of Biosciences, University of Nottingham, Sutton Bonington Campus, Loughborough, Leicestershire LE12 5RD, UK.*
- S. López, *Department of Animal Production, University of Leon, 24071 Leon, Spain.*
- J.A. Maas, *Centre for Integrative Biology, University of Nottingham, Sutton Bonington, Leicestershire LE12 5RD, UK.*
- D.R. Mertens, *USDA – Agricultural Research Service, US Dairy Forage Research Center, Madison, WI 53706, USA.*
- L.P. Milligan, *Department of Animal and Poultry Science, University of Guelph, Guelph, Ontario N1G 2W1, Canada.*
- T. Mottram, *Silsoe Research Institute, Wrest Park, Silsoe, Bedford MK45 4HS, UK.*
- G.K. Murdoch, *Department of Agricultural, Food and Nutritional Science, University of Alberta, Edmonton, Alberta T6G 2P5, Canada.*

- B.N. Nagorcka, *CSIRO Livestock Industries, GPO Box 1600, Canberra, ACT 2601, Australia.*
- J.D. Nkrumah, *Department of Agricultural, Food and Nutritional Science, University of Alberta, Edmonton, Alberta T6G 2P5, Canada.*
- J.V. Nolan, *School of Rural Science and Agriculture, University of New England, Armidale, 2351 Australia.*
- E.K. Okine, *Department of Agricultural, Food and Nutritional Science, University of Alberta, Edmonton, Alberta T6G 2P5, Canada.*
- D.W. Pethick, *School of Veterinary and Biomedical Sciences, Murdoch University, Murdoch, WA 6150, Australia.*
- N. Prescott, *Silsoe Research Institute, Wrest Park, Silsoe, Bedford MK45 4HS, UK.*
- E. Prestløkken, *Felleskjøpet Fôrutvikling, Department of Animal and Aquacultural Sciences, Agricultural University of Norway, PO Box 5003, N-1432 Ås, Norway.*
- D. Rémond, *Institut National de la Recherche Agronomique, Unité de Nutrition et Métabolisme Protéique, Theix, 63122 Ceyrat, France.*
- C.K. Reynolds, *Department of Animal Sciences, The Ohio State University, OARDC, 1680 Madison Avenue, Wooster, OH 44691-4096 USA.*
- J.B. Russell, *Agricultural Research Service, USDA and Department of Microbiology, Cornell University, Ithaca, NY 148531, USA.*
- I.C. Savary-Auzeloux, *Institut National de la Recherche Agronomique, Unité de Recherches sur les Herbivores, Theix, 63122 Ceyrat, France.*
- H.J. Strobel, *Department of Animal Sciences, University of Kentucky, Lexington, KY 40546-0215, USA.*
- S. Tamminga, *Animal Nutrition Group, Wageningen Institute of Animal Sciences, Marijkeweg 40, 6709 PG Wageningen, The Netherlands.*
- M.K. Theodorou, *BBSRC Institute for Grassland and Environmental Research, Aberystwyth, Dyfed SY23 3EB, UK.*
- A.F.B. Van der Poel, *Wageningen University, Animal Nutrition Group, Marijkeweg 40, 6709 PG Wageningen, The Netherlands.*
- R.G. Vernon, *Hannah Research Institute, Ayr KA6 5HL, UK.*
- D.M.S.S. Vitti, *Animal Nutrition Laboratory, Centro de Energia Nuclear na Agricultura, Caixa Postal 96, CEP 13400-970, Piracicaba, SP, Brazil.*
- T.C. Wright, *Department of Animal and Poultry Science, University of Guelph, Guelph, Ontario N1G 2W1, Canada.*
- T. Yan, *Agricultural Research Institute of Northern Ireland, Large Park, Hillsborough BT26 6DR, UK.*

*This page intentionally left blank*

---

# 1 Introduction

J. DIJKSTRA,<sup>1</sup> J.M. FORBES<sup>2</sup> and J. FRANCE<sup>3</sup>

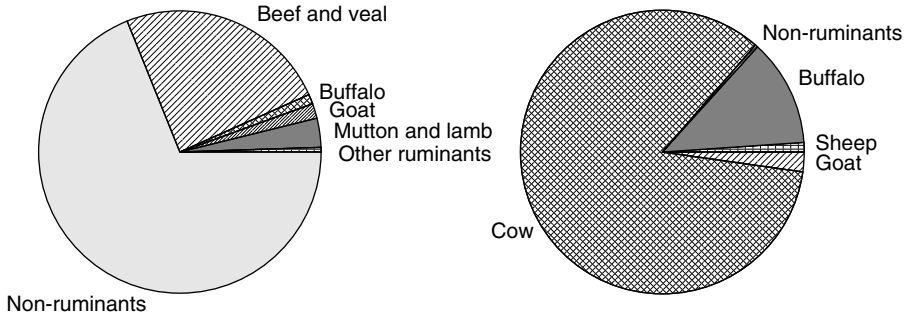
<sup>1</sup>*Animal Nutrition Group, Wageningen Institute of Animal Sciences, Wageningen University, P.O. Box 338, 6700 AH Wageningen, The Netherlands;* <sup>2</sup>*Centre for Animal Sciences, School of Biology, University of Leeds, Leeds LS2 9JT, UK;* <sup>3</sup>*Centre for Nutrition Modelling, Department of Animal & Poultry Science, University of Guelph, Guelph, Ontario N1G 2W1, Canada*

---

## Preamble

Ruminant animals have evolved a capacious set of stomachs that harbour microorganisms capable of digesting fibrous materials, such as cellulose. This allows ruminants to eat and partly digest plants, such as grass, which have a high fibre content and low nutritional value for simple-stomached animals. Thus, animals of the suborder Ruminantia, being plentiful and relatively easy to trap, became prime targets of hunters and, eventually, were domesticated and farmed. Today, ruminants account for almost all of the milk and approximately one-third of the meat production worldwide (Food and Agriculture Organization, 2004) (Fig. 1.1). It is not surprising, then, that a great deal of research has been carried out on the digestive system of ruminants, leading to studies on the peculiarities of metabolism that cope with the unusual products of microbial digestion. The reading list at the end of this chapter gives some of the books in which the biology of ruminants is reviewed.

As qualitative knowledge increased, so it became possible to develop quantitative approaches to increase understanding further and to integrate various aspects. Initially this was achieved by more complex statistical analysis, but in recent years this has been supplemented by dynamic mathematical models that not only summarize existing data but also show where gaps in knowledge exist and where further research should be done. The purpose of this book is to bring together the quantitative approaches, concerned with elucidating mechanisms, used in the study of ruminant digestion, metabolism and related areas. In this introductory chapter, we describe briefly the special features of the ruminant and the potential for quantitative description of ruminant physiology to contribute to our understanding. We also indicate the chapters in which detailed consideration is given to each topic. This chapter is based firmly on Chapter 1 of the previous edition of this book (Forbes and France, 1993). However, all the subsequent chapters in this second edition are



**Fig. 1.1.** Relative contribution of various groups of ruminants and non-ruminants to the production of meat (left graph) and milk (right graph) worldwide in 2003 (Food and Agriculture Organization, 2004).

either major revisions of the old chapters or, in the majority of cases, completely new chapters written either by old or new authors.

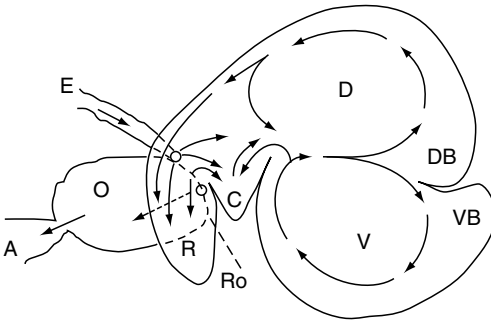
## Special Features of the Ruminant

### *The gastrointestinal tract*

#### *Reticulorumen*

As there is no sphincter between the rumen and the reticulum and they function to a large extent as a single organ, they are usually considered together. Feed, after being chewed during eating, enters the reticulorumen where it is subjected to microbial attack and to the mixing and propulsive forces generated by coordinated contractions of the reticulorumen musculature. This muscular activity results in the pattern of movement of digesta that is shown diagrammatically in Fig. 1.2. It is coordinated not only to mix the digesta but also to allow the removal of fermentation gases by eructation, the regurgitation of digesta for rumination, which is largely responsible for the physical breakdown of digesta particles (see Chapter 5), and the passage of digesta out of the reticulorumen through the reticulo-omasal orifice (see Chapter 3). The rate and extent of degradation in the reticulorumen and developments in techniques to estimate the rate and extent are described in Chapters 2 and 4, respectively.

The microbial activity in the reticulorumen gives the host the ability to eat and utilize forages. Chapters 8 and 9 review the dynamics and energetics of this microbial population. Most of the material digested in the rumen yields short-chain fatty acids, known as volatile fatty acids (VFA), which are absorbed through the rumen wall. Acetic acid is produced in the greatest quantities, around 20–50 moles per day in dairy cows, while propionic acid is usually produced at about one-third of the rate of acetic acid. Butyric acid accounts for around 10% of the total acid production, while valeric and isovaleric acids each



**Fig. 1.2.** Movement of digesta within the reticulorumen, omasum and abomasum: oesophagus (E), reticulum (R), reticulo-omasal orifice (Ro), cranial sac (C), dorsal rumen (D), ventral rumen (V), dorsal blind sac (DB), ventral blind sac (VB), omasum (O) and abomasum (A).

form about 1% to 2%. The ratio of acetic:propionic acids is higher for forage diets than for concentrate diets (see Chapters 6 and 10).

Much of the dietary protein, as well as the urea that is recycled via the saliva, is metabolized to ammonia. Both ammonia and amino acids or small peptides are available for microbial protein synthesis (see Chapters 7 and 10).

#### *Omasum*

Digesta pass from the reticulum to the omasum via a sphincter, the reticulo-omasal orifice. The omasum is filled with about 100 tissue leaves (the laminae), which almost completely fill the lumen. The role of the omasum is not well understood but it is known that water, ammonia, VFA and inorganic electrolytes are absorbed in the omasum and that ammonia and, presumably, some VFA are produced there.

#### *Abomasum*

From the omasum, digesta pass to the abomasum, the compartment equivalent to the monogastric stomach. As in monogastrics, acid and enzymes are secreted in the abomasum and are mixed with the digesta by the muscular activity of the organ. However, whereas in monogastric animals there is a circadian rhythm in this activity associated with the feeding pattern, abomasal motor activity exhibits an ultradian rhythm as a consequence of the relatively continuous passage of digesta from the reticulorumen. Distension of the abomasum inhibits reticulorumen emptying but is the main stimulus for emptying of the abomasum.

#### *The small intestine*

The small intestine comprises three segments: the duodenum, jejunum and ileum. Digesta pass from the duodenum along the small intestine as a consequence of contractions that start at the gastroduodenal junction due to the generation of electrical activity at this junction in the form of migrating motor complexes (MMC). These also show an ultradian rhythm resulting in cyclical variations in flow over periods of 90 to 120 min. The velocity of propagation of MMC in the jejunum of normally fed sheep is 18 cm/min, which is similar to the value of 20 cm/min for the velocity of digesta flow in the jejunum of sheep. The agreement between these measurements confirms the concept that propulsive activity of the small intestine is directly mediated by MMC. The

increases in digesta flow that occur with increasing intake are the result of increases in the amount of digesta propelled per contraction rather than in the number of contractions. Digestion in the small intestine is similar to that in simple-stomached animals.

### *The large intestine*

The flow of digesta to the caecum and proximal colon from the ileum is intermittent and can be followed by periods of quiescence, which may range from 30 min to 5 h. Digesta in the caecum and proximal colon are subjected to both peristaltic and antiperistaltic contractions so that digesta are mixed as well as being moved towards the distal colon. There is further VFA production and absorption in the large intestine but its main function is probably the absorption of water.

The flow of digesta through the distal colon differs between sheep and cattle. In sheep, bursts of spiking activity, which last less than 5 s and do not propagate, result in the segmenting contractions that are responsible for the formation of faecal pellets as the digesta pass through the spiral colon. By contrast, in cattle bursts of spiking activity of long duration propagate along the spiral colon. These occur as several phases of hyperactivity per day and are associated with the propulsion of large volumes of digesta. As a consequence, faeces are voided by cattle as an amorphous mass.

## ***Metabolic adaptations***

The intermediary metabolism of ruminants has adapted to the consequences of the production of VFA in the rumen in a number of ways (see Chapters 11 and 12). Acetate is absorbed into the ruminal venous drainage, some of it being used as an energy source by ruminal tissue, and used throughout the body for fat synthesis, including milk fat, and as an energy source. Propionate, passing from the rumen in the hepatic portal vein, is taken up almost completely by the liver and used, together with amino acids, for gluconeogenesis. The glucose released by the liver is necessary for lactose synthesis in the mammary gland, for fructose synthesis in the placenta and by the nervous system, although the latter can use ketones sufficiently to continue to function with very low blood glucose levels. Butyric acid is, to a large extent, metabolized in the rumen wall, to 3-hydroxy-butyrate.

Rumen fermentation also produces ammonia and that not utilized by the microbes is absorbed and converted in the liver to urea. Much of this is secreted in the saliva, which is produced continuously in copious amounts, or is absorbed through the rumen wall to be available once again for microbial protein synthesis. Protein that escapes rumen degradation is digested and the constituent amino acids absorbed.

Metabolic regulation is discussed in Chapter 17, while metabolic adaptations of ruminants are included in Chapter 13 (fat metabolism), Chapter 14 (protein turnover), Chapter 15 (energy–protein interactions) and Chapter 18 (mineral metabolism). Besides, since all life processes including growth, work and animal production (milk, eggs, wool) use energy, methods to study energy metabolism in relation to dietary changes are reviewed in Chapter 16.



## ***Consequences of ruminant adaptations***

The ability of the ruminant to utilize forages high in fibre is exploited in many agricultural production systems. However, the slow rate of digestion means that feed particles remain in the rumen for long periods and rumen capacity becomes a limiting factor to further intake; the slower and less complete the digestion of a particular feed, the greater is the importance of physical factors, compared to metabolic factors, in the control of feed intake (see Chapter 23). The ability of ruminants to select a balanced diet from imbalanced foods offered in choice has become better established since publication of the first edition of this book and modelling of intake has been extended to food choice in this chapter.

Feeding large amounts of rapidly fermented carbohydrate produces sudden changes in acid and gas production that are sometimes beyond the adaptive ability of the animal. The pH of rumen fluid falls from a normal level of 6.0 to 6.2, causing cessation of motility and reduction in feed intake. Excessive gas production causes bloat, under some circumstances, and a reduced acetate:propionate ratio depresses milk fat synthesis. A consequence of microbial protein synthesis in the rumen is that some of the protein in the diet can be replaced by non-protein nitrogen, typically urea. High-quality protein sources can be protected against ruminal degradation to obtain more benefit from their superior balance of amino acids or to better match the amount of degradable carbohydrates. Moreover, and depending on the starch degradation characteristics, starch sources may be protected against ruminal degradation to avoid low pH levels, or starch degradation may be enhanced to promote energy supply to the microbes in the rumen. The effect of various technological treatments on nutrient digestibility is discussed in Chapter 24.

These adaptations and their metabolic consequences have important effects on productive processes; these are discussed in Chapter 19 (growth), Chapter 20 (pregnancy), Chapter 21 (lactation) and Chapter 22 (wool).

In the developed world, cattle are often kept in automated, intensive systems. In these intensive systems, a much better management control over the environmental effects is achieved. It is therefore important to understand how cattle interact with their environment, in order to optimize the design and management of cattle production systems, and also in view of animal welfare. The topic of animal–environment interaction is discussed in Chapter 25.

Since forages are generally the main part of the ruminant diet, botanical, physical and chemical characteristics of the forage are important in determining the nutritive value for the ruminant. Ruminants will adapt their intake behaviour (in terms of, for example, eating and ruminating time and bite rate and bite mass characteristics) to changes in such forage characteristics. The interaction between the pasture and the animal is discussed in Chapter 26.

Finally, various systems have been developed to evaluate the feeding value of diet ingredients and to predict the animal response to intake of a given set of feed ingredients. The various approaches to the integration of data in feed evaluation systems are discussed in Chapter 27.

## Quantitative Approaches to Ruminant Physiology

Traditionally, quantitative research into digestion and metabolism in ruminants, as in many other areas of biology, has been empirically based and has centred on statistical analysis of experimental data. Whilst this has provided much of the essential groundwork, more attention has been given in recent years to improving our understanding of the underlying mechanisms that govern the processes of ruminant digestion and metabolism, and this requires an increased emphasis on theory and mathematical modelling. The primary purpose of each of the subsequent chapters of this book, therefore, is to bring together the quantitative approaches concerned with elucidating mechanism in a particular area of ruminant digestion and metabolism. Given the diverse scientific backgrounds of the contributors of each chapter, the imposition of a rigid format for presenting the mathematical material has been eschewed, though basic mathematical conventions are adhered to. Before considering each area, however, it is necessary to review the nature and implications of organizational hierarchy (levels of organization), and to review the different types of model that may be constructed.

### Organizational hierarchy

Biology, including ruminant physiology, is notable for its many organizational levels. It is the existence of the different levels of organization that give rise to the rich diversity of the biological world. For the animal sciences, a typical scheme for the hierarchy of organizational levels is shown in Table 1.1. This scheme can be continued in both directions and, for ease of exposition, the different levels are labelled  $\dots, i + 1, i, i - 1, \dots$ . Any level of the scheme can be viewed as a system, composed of subsystems lying at a lower level, or as a subsystem of higher level systems. Such a hierarchical scheme has some important properties:

1. Each level has its own concepts and language. For example, the terms of animal production such as *plane of nutrition* and *liveweight gain* have little meaning at the cell or organelle level.

**Table 1.1.** Levels of organization.

Level	Description of level
$i + 3$	Collection of organisms (herd, flock)
$i + 2$	Organism (animal)
$i + 1$	Organ
$i$	Tissue
$i - 1$	Cell
$i - 2$	Organelle
$i - 3$	Macromolecule

2. Each level is an integration of items from lower levels. The response of the system at level  $i$  can be related to the response at lower levels by a reductionist scheme. Thus, a description at level  $i - 1$  can provide a mechanism for behaviour at level  $i$ .
3. Successful operation of a given level requires lower levels to function properly, but not necessarily vice versa. For example, a microorganism can be extracted from the rumen and can be grown in culture in a laboratory, so that it is independent of the integrity of the rumen and the animal, but the rumen (and hence the animal) relies on the proper functioning of its microbes to operate normally itself.

Three categories of model are briefly considered in the remainder of this chapter: teleonomic, empirical and mechanistic. In terms of this organizational hierarchy, teleonomic models usually look upwards to higher levels, empirical models examine a single level and mechanistic models look downwards, considering processes at a level in relation to those at lower levels.

### ***Teleonomic modelling***

Teleonomic models (see Monod, 1975, for a discussion of teleonomy) are applicable to apparently goal-directed behaviour, and are formulated explicitly in terms of goals. They usually refer responses at level  $i$  to the constraints provided by level  $i + 1$ . It is the higher level constraints which can select combinations of the lower level mechanisms, which may lead to apparently goal-directed behaviour at level  $i$ . Currently, teleonomic modelling plays only a minor role in biological modelling, though this role might expand. It has not, as yet, been applied to problems in ruminant physiology though it has found some application in plant and crop modelling (Thornley and Johnson, 1989).

### ***Empirical modelling***

Empirical models are models in which experimental data are used directly to quantify relationships, and are based at a single level (e.g. the whole animal) in the organizational hierarchy discussed above. Empirical modelling is concerned with using models to describe data by accounting for inherent variation in the data. Thus, an empirical model sets out principally to describe, and is based on observation and experiment and not necessarily on any preconceived biological theory. The approach derives from the philosophy of empiricism and adheres to the methodology of statistics.

Empirical models are often curve-fitting exercises. As an example, consider modelling voluntary feed intake in a growing, non-lactating ruminant. An empirical approach to this problem would be to take a data set and fit a linear regression equation, possibly:

$$I = a_0 + a_1W + a_2dW/dt + a_3D \quad (1.1)$$

where  $I$  denotes the intake,  $W$ , liveweight,  $D$ , measure of diet quality and  $a_0$ ,  $a_1$ ,  $a_2$ , and  $a_3$  are parameters.

We note that level  $i$  behaviour (intake) is described in terms of level  $i$  attributes (liveweight, liveweight gain and diet quality). As this type of model is principally concerned with prediction, direct biological meaning cannot be ascribed to the equation parameters and the model suggests little about the mechanisms of voluntary feed intake. If the model fits the data well, the equation might be extremely useful though it is specific to the particular conditions under which the data were obtained, and so the range of its predictive ability will be limited.

### **Mechanistic modelling**

Mechanistic models, which underlie much of the material presented in this book, seek to understand causation. A mechanistic model is constructed by looking at the structure of the system under investigation, dividing it into its key components and analysing the behaviour of the whole system in terms of its individual components and their interactions with one another. For example, a simplified mechanistic description of intake and nutrient utilization for our growing ruminant might contain five components, namely two body pools (protein and fat), two blood plasma pools (amino acids and carbon metabolites) and a digestive pool (rumen fill), and include interactions such as protein and fat turnover, gluconeogenesis from amino acids and nutrient absorption. Thus, the mechanistic modeller attempts to construct a description of the system at level  $i$  in terms of the components and their associated processes at level  $i - 1$  (and possible lower), in order to gain an understanding at level  $i$  in terms of these component processes. Indeed, it is the connections that interrelate the components that make a model mechanistic. Mechanistic modelling follows the traditional philosophy and reductionist method of the physical and chemical sciences.

Mechanistic modelling gives rise to dynamic differential equations. There is a mathematically standard way of representing mechanistic models called the rate:state formalism. The system under investigation is defined at time  $t$  by  $q$  components or state variables:  $X_1, X_2, \dots, X_q$ . These variables represent properties or attributes of the system, such as visceral protein mass, quantity of substrate, etc. The model then comprises  $q$  first-order differential equations, which describe how the state variables change with time:

$$dX_i/dt = f_i(X_1, X_2, \dots, X_q; S); \quad i = 1, 2, \dots, q \quad (1.2)$$

where  $S$  denotes a set of parameters, and the function  $f_i$  gives the rate of change of the state variable  $X_i$ .

The function  $f_i$  comprises terms that represent individual processes (with dimensions of state variable per unit time), and these rates can be calculated from the values of the state variables alone, with of course the values of any parameters and constants. In this type of mathematical modelling, the differential equations are formed through direct application of the laws of science

(e.g. the law of mass conservation, the first law of thermodynamics) or by application of a continuity equation derived from more fundamental scientific laws.

If the system under investigation is in steady state, the solution to Eq. (1.2) is obtained by setting the differential terms to zero and manipulating to give an expression for each of the components and processes of interest. Radioisotopic data, for example, are usually resolved in this way, and indeed, most of the time-independent formulae presented in this book are derived likewise. However, in order to generate the dynamic behaviour of any model, the rate:state equations must be integrated.

For simple cases, analytical solutions are usually obtained. Such models are widely applied in ruminant digestion studies to interpret time-course data from marker and polyester-bag experiments, where the functional form of the solution is fitted to the data using a curve-fitting procedure. This enables biological measures, such as mean retention time in the rumen prior to escape and the extent of ruminal degradation, to be calculated from the estimated parameters.

For the more complex cases, only numerical solutions to the rate:state equations can be obtained. This can be conveniently achieved by using one of the many computer software packages available for tackling such problems. Such models are used to simulate complex digestive and metabolic systems. They are normally used as tactical research tools to evaluate current understanding for adequacy and, when current understanding is inadequate, help identify critical experiments. Thus, they play a useful role in hypothesis evaluation and in the identification of areas where knowledge is lacking, leading to less ad hoc experimentation. Also, a mechanistic simulation model is likely to be more suitable for extrapolation than an empirical model, as its biological content is generally far richer.

Further discussion of these issues can be found in Thornley and France (2005).

## Acknowledgement

We are pleased to acknowledge Dr Graham Faichney's contribution to Fig. 1.2 and related material.

## Further Reading

### *Textbooks*

- Baldwin, R.L. (1995) *Modelling Ruminant Digestion and Metabolism*. Chapman & Hall, London.
- Blaxter, K.L. (1989) *Energy Metabolism in Animals and Man*. Cambridge University Press, Cambridge.
- Church, D.C. (ed.) (1993) *The Ruminant Animal: Digestive Physiology and Nutrition*. Waveland Press, Inc., Englewood Cliffs, New Jersey.

- Czerkawski, J.W. (1986) *An Introduction to Rumen Studies*. Pergamon Press, Oxford, UK.
- Food and Agriculture Organization (2004) *FAOSTAT Data, 2004*. FAO, Rome.
- Forbes, J.M. (1995) *Voluntary Food Intake and Diet Selection in Farm Animals*, 1st edn. CAB International, Wallingford, UK.
- Getty, R. (ed.) (1975) *Sisson and Grossman's Anatomy of the Domestic Animals*, 5th edn. W.B. Saunders Co, Philadelphia, Pennsylvania.
- Hobson, P.N. and Stewart, C.S. (eds) (1997) *The Rumen Microbial Ecosystem*, 2nd edn. Blackie Academic & Professional, London.
- Hungate, R.E. (1966) *The Rumen and Its Microbes*. Academic Press, New York.
- McDonald, P., Edwards, R.A., Greenhalgh, J.F.D. and Morgan, C.A. (2002) *Animal Nutrition*. Prentice-Hall, Englewood Cliffs, New Jersey.
- Monod, J. (1975) *Chance and Necessity: An Essay on the Natural Philosophy of Modern Biology*. Collins, London.
- Reece, W.O. (ed.) (2004) *Dukes' Physiology of Domestic Animals*, 12th edn. Comstock Publishing, Ithaca, New York.
- Theodorou, M.K. and France, J. (eds) (2000) *Feeding Systems and Feed Evaluation Models*. CAB International, Wallingford, UK.
- Thornley, J.H.M. and France, J. (2005) *Mathematical Models in Agriculture*, 2nd edn. CAB International, Wallingford, UK.
- Thornley, J.H.M. and Johnson, I.R. (1989) *Plant and Crop Modelling*. Oxford University Press, Oxford, UK.
- Van Soest, P.J. (1994) *Nutritional Ecology of the Ruminant*, 2nd edn. Cornell University Press, Ithaca, New York.

### **Proceedings of symposia**

- Baker, S.K., Gawthorne, J.M., Mackintosh, J.B. and Purser, D.B. (eds) (1985) *Ruminant Physiology: Concepts and Consequences*. School of Agriculture, University of Western Australia, Perth, Western Australia.
- Cronje, P. (ed.) (2000) *Ruminant Physiology: Digestion, Metabolism, Growth and Reproduction*. CAB International, Wallingford, UK.
- Dobson, A. and Dobson, M.J. (eds) (1988) *Aspects of Digestive Physiology in Ruminants*. Comstock, Ithaca, New York.
- Kebreab, E., Mills, J.A.N. and Beaver, D.E. (eds) (2004) *Dairying – Using Science to Meet Consumers' Needs*. Nottingham University Press, Nottingham, UK.
- Kebreab, E., Dijkstra, J., Gerrits, W.J.J., Bannink, A. and France, J. (eds) (2005) *Nutrient Digestion and Utilization in Farm Animals: Modelling Approaches*. CAB International, Wallingford, UK.
- McNamara, J.P., France, J. and Beaver, D.E. (eds) (2000) *Modelling Nutrient Utilization in Farm Animals*. CAB International, Wallingford, UK.
- Milligan, L.P., Grovum, W.L. and Dobson, A. (eds) (1986) *Control of Digestion and Metabolism in Ruminants*. Prentice-Hall, Englewood Cliffs, New Jersey.
- Tsuda, T., Sasaki, Y. and Kawashima, R. (eds) (1991) *Physiological Aspects of Digestion and Metabolism in Ruminants*. Academic Press, San Diego, California.
- Von Engelhardt, W., Leonhard-Marek, S., Breves, G. and Giesecke, D. (1995) *Ruminant Physiology: Digestion, Metabolism, Growth and Reproduction*. Ferdinand Enke Verlag, Stuttgart, Germany.

---

# Digestion

---

*This page intentionally left blank*



---

# 2

## Rate and Extent of Digestion

D.R. Mertens

*USDA – Agricultural Research Service, US Dairy Forage Research Center,  
Madison, WI 53706, USA*

---

### Introduction

Digestion in ruminants is the result of two competing processes: digestion and passage. Rate of passage determines the time feed is retained in the alimentary tract for digestive action and the rate and potential extent of degradation determines the digestion that can occur during the retention time. To predict dynamic flows of nutrients or static estimates of digestibility at various levels of performance, the processes of digestion and passage must be described in compatible mathematical terms and integrated. This chapter will focus on the mathematical description or modelling of digestion, especially fermentative digestion in the rumen because it typically represents the largest proportion of total tract digestibility and is the first step in the digestive process for ruminants that influences the processes that follow.

The digestive process involves the time-dependent degradation or hydrolysis of complex feed components into molecules that can be absorbed by the animal as digesta passes through the alimentary tract. Conceptually, digestion and passage can be described as multi-step processes using compartmental models (Blaxter *et al.*, 1956; Waldo *et al.*, 1972; Baldwin *et al.*, 1977, 1987; Mertens and Ely, 1979; Black *et al.*, 1980; Poppi *et al.*, 1981; France *et al.*, 1982). Because feed components do not digest or pass through the digestive tract similarly (Sutherland, 1988), an understanding about the nature of passage in ruminants provides an important framework for developing compatible digestion models.

In ruminants, passage of digesta through the alimentary tract is a complex process that involves selective retention, mixing, segregation, and escape of particles and liquid from the rumen before they pass into and through the small and large intestines. Mechanistically, the reticulorumen, small intestine and large intestine differ in mixing and flow. The rumen operates as an imperfectly stirred, continuous-flow reactor, whereas the small and large intestines act

more like plugged-flow reactors (Levenspiel, 1972; Penry and Jumars, 1987). Furthermore, ruminal contents act as though there were at least three different subcompartments with different flow characteristics: liquid, escapable particles and retained particles. Soluble feed components dissolve and pass out at the rate of ruminal liquids. Ground concentrates and forages pass out of the rumen more quickly than large fibre particles, which are retained selectively and ruminated. Models of digestion must be compatible with these differences in passage rates and processes.

Separate compartments are needed to represent the distinct digestive and passage processes of the reticulorumen, small intestine and large intestine. The unique digestive kinetics of feed components should be described by dividing feed into rapidly digested, slowly digested and indigestible compartments. The variety of compartments needed to model digestion and passage illustrates an important principle. Model compartments are defined by their kinetic properties and may not necessarily correspond to anatomical, physiological, chemical or physical compartments in the real system. Thus, non-escapable and escapable particles should be described as separate compartments, though both are in the ruminal environment. The kinetic property of 'escapability' rather than particle size is used to define particles because small particles trapped in the large particle ruminal mat pass differently from those located in the reticular 'zone of escape' (Allen and Mertens, 1988). Particles are uniquely defined because they have different kinetic parameters and require separate equations to describe the processes of digestion and passage. Similarly, digestible and indigestible matter may be contained in the same feed particle, yet each requires a separate compartment to describe their unique kinetics of digestion and passage.

Current models describe digestion as a function of the mass of substrate that is available in a compartment, i.e. they are mass-action models. Generally, digestion is described as a first-order process with respect to substrate (Waldo *et al.*, 1972; Mertens and Ely, 1979); however, some models describe it as a second-order process that depends on the pools of substrate and microorganisms present in the system (France *et al.*, 1982; Baldwin *et al.*, 1987). Regardless of the model used, it appears that rate and extent of digestion are critical variables in the description of the digestion process. Kinetic parameters of digestion are important because they not only describe digestion, but also they characterize the intrinsic properties of feeds that limit their availability to ruminants.

To be useful, models based on mechanistic assumptions must replicate the real system with an acceptable degree of accuracy. The number of different mechanistic models that can predict a set of observations may be large, perhaps infinite (Zierler, 1981). Thus, accuracy in predicting a specific set of data cannot prove that a model is uniquely valid, but only indicates that it is one plausible explanation of reality. To be universally applicable, models should be valid in extreme situations and under varied experimental conditions, rather than predicting the average accurately, even if it is from a large data set.

The goal of this chapter is to present the theoretical development and use of models for quantifying rate and extent of the digestion process in the rumen.

To accomplish this goal, methods used to collect kinetic data will be analysed, the background of simple models for measuring rate and extent of fermentative digestion will be discussed, mathematical models will be proposed that more accurately describe the methods used to obtain kinetic data, and methods of fitting data to models for estimating kinetic parameters will be reviewed.

## Terminology

Before proceeding, some terminology that will be used in the remainder of the chapter needs to be defined. Considerable confusion results from incorrect or undefined use of terms. Even the most common terms such as rate or extent are often defined or interpreted differently by authors. All too often mathematical formulations used to generate coefficients are not provided explicitly, adding further confusion to the discussion of factors affecting digestion kinetics. For example, in one paper rate may be defined as the starting amount of material minus the ending amount of material divided by the interval allowed for digestion (an absolute rate). In another paper, rate is determined as the fraction of the potentially digestible material that disappears per hour (a fractional or relative rate). Analysing the same data in these two different ways can lead to opposite conclusions about which treatment has the faster rate (Table 2.1). Caution is advised when reviewing literature on digestion kinetics because of non-standardized and ambiguous use of terminology. Valuable time and resources have been wasted in explaining discrepancies that were only a function of fuzzy definitions or contradictions between verbal concepts and models.

**Table 2.1.** Effect of using different definitions of rate (absolute versus fractional) on the comparison of digestion kinetics from two treatments.

Variable	Treatment 1	Treatment 2
Time (h)	Residue remaining (mg)	
0	100.0	100.0
12	63.9	63.0
24	44.1	48.8
48	27.3	41.3
72	22.2	40.2
Absolute rate <sup>a</sup> (mg/h)	2.33	2.13
Fractional rate <sup>b</sup> (per h)	0.05	0.08
Potential digestibility <sup>b</sup> (mg)	80	60

<sup>a</sup>Absolute rate determined by taking the difference in residue weights at 0 and 24 h and dividing by 24.

<sup>b</sup>Fractional rate ( $K_d$ ) and potential digestibility ( $D_0$ ) determined using the model  $R(t) = D_0 \exp(-K_d t) + I_0$ , where  $I_0$  is indigestible residue.

The following are definitions of terms used in this chapter:

- Aggregation*: Combining entities or attributes in a model that have similar kinetic properties to reduce detail and complexity.
- Assumptions*: Implicit or explicit relationships or attributes of a model that are accepted *a priori*.
- Attributes*: Coefficients of parameters and variables used to describe the entities in a model.
- Compartment*: Boundaries of an entity that is distributed in an environment that is assumed to have homogeneous dynamic or static properties. Compartments are typically represented in diagrams by solid-lined boxes.
- Dynamic*: Systems, reactions or processes that change over time.
- Entities*: Independent, complete units or substances that have uniquely defined chemical or physical properties in a system.
- Environment*: Physical location of an entity in a system.
- Extent of digestion*: A digestion coefficient that represents the proportion of a feed component that has disappeared as a result of digestion after a particular time in a specified system. It is a function of the time allowed for digestion and the digestion rate. Units are fractions or percentages. Extent of digestion is a more general term that is not equal to either the potentially digestible fraction or potential extent of digestion.
- Flux or flow*: Amount of material per unit of time that is transferred to or from a compartment. In non-steady-state conditions, fluxes vary over time. Although they may have the same mathematical form in some cases, fluxes are not the same concept as the derivative of the pool size. Fluxes typically are represented in diagrams by arrows.
- Flux ratio*: Proportion of a flux that is transferred to or from a compartment. Flux ratios differ conceptually from fractional rates because ratios partition fluxes, whereas rates are proportions of pools that are transferred. Flux ratios typically are represented in mathematical equations by lower case 'r' with a subscript.
- Indigestible residue*: Residue of feed that remains after an infinite time of digestion in a specified system. It is often approximated by measuring the disappearance of matter after long times of digestion.
- Kinetics, mass-action*: Systems in which material is transferred between compartments in proportion to the mass of material in each compartment.
- Kinetics, Michaelis–Menten* (or Henri–Michaelis–Menten): Kinetics derived from a reversible second-order mass-action system in which the flux of product formation is proportional to the concentration of substrate and enzyme (or microbial mass). With respect to substrate, the reaction varies from zero-order when enzyme is limiting, to first-order when enzyme (or microbial mass) is in excess.
- Models*: Representations of real-world systems. Models do not duplicate the real world because they always contain assumptions about, and aggregations of, components of the real-world system. Mathematical models use explicit equations to describe a system.

- Models, deterministic:* Assume the system can be simulated with certainty from known or assumed principles or relationships.
- Models, dynamic:* Simulate the change in the system over time.
- Models, empirical:* Based on relationships derived directly from observations about the system. These data-driven models are sometimes called black box or input–output models.
- Models, kinetic:* Kinetics refers to movement and the forces affecting it. In chemical and biological systems, kinetic models are related to the molecular movement associated with chemical or physical systems.
- Models, mechanistic:* Are based on known or assumed biological, chemical or physical theories or principles about the system. These concept-driven models are sometimes called white box models.
- Models, static:* Represent time-invariant systems or processes. The steady-state solution of dynamic systems is a specific type of static model.
- Models, stochastic:* Assume that the system operates on probabilistic principles or contains random elements that cannot be known with certainty.
- Order of reaction:* The combined power terms of the pools in mass-action kinetic systems. For example, in first-order systems the flux of reaction is related to the amount or concentration of a single pool raised to the power 1. In second-order systems, flux is related to a single pool raised to the power 2 or the product of two pools raised to the power 1.
- Parameters:* Constants in equations that are not affected by the operation of the model.
- Pool:* Mass, weight or volume of material in a compartment. Pools are typically represented by upper case letters in mathematical equations.
- Potentially digestible fraction:* Inverse of the indigestible fraction ( $1.0 - \text{indigestible fraction}$ ). It is the proportion of feed that can disappear due to digestion given an infinite time in a specified system. The potentially digestible fraction is the same as the potential extent of digestion or maximal extent of digestion.
- Processes:* Activities or mechanisms that connect entities within a system and determine flows or fluxes between compartments.
- Rate:* Change per unit of time, which can be expressed in many different units; therefore, it is important to indicate the specific type of rate being discussed, preferably with a mathematical description.
- Rate, absolute:* Has the units of mass per unit of time. Absolute rates and fluxes are the same, but the term ‘flux’ is preferred because it prevents confusion associated with the unqualified use of the term ‘rate’.
- Rate, first-order:* Fractional rates that are proportional to a single pool.
- Rate, fractional (or relative):* Proportion of mass in a pool that changes per unit of time. This rate has no mass units and is usually a constant that does not vary over time. First-order fractional rate constants are usually represented in mathematical equations by a lower case ‘k’ with subscripts.
- Simulation:* Operation of a model to predict a result expected in the real-world system.

*Sinks*: Irreversible end-point compartments of entities that are outside open systems. Sinks are typically represented in diagrams by clouds with entering arrows.

*Sources*: Initial locations of materials that are supplied from outside open systems. Sources are typically represented in diagrams as clouds with exiting arrows.

*State, quasi-steady*: Occurs when pools within compartments in a dynamic system do not change significantly. Under natural situations, the time needed to attain quasi-steady-state is relative. True steady state cannot be achieved in perturbed systems because small changes are occurring continuously. Quasi-steady-state is sometimes called the steady-state approximation.

*State, steady*: Occurs when pools within compartments in a dynamic system do not change. True steady state is a mathematical construct that occurs when the derivative of a pool with respect to time equals zero.

*Systems*: Organized collections of entities that interact through various processes. Open systems can accept or return material outside the system, whereas all material must originate and be retained in a closed system.

*Time, retention*: Is the average time an entity is retained in a compartment.

*Time, turnover*: Is the time needed for a compartment to transfer an amount of material equal to its pool size.

*Validation*: Evaluating the credibility or reliability of a model by comparing it to real-world observations. No model can be validated completely because all of the infinite possibilities cannot be evaluated. Some modellers prefer the term 'evaluation' rather than 'validation'.

*Variables*: Coefficients that change during or among model simulations. Variables can be external or internal to the model. External or exogenous variables are inputs that affect or interact with the system that is modelled, but are controlled outside of it. Internal or endogenous variables are calculated within the model during its operation.

*Variables, state*: Define the level, mass or concentration within the pools of the system.

*Verification*: Checking the accuracy by which a model is described mathematically and implemented.

## Requirements for Quantifying Rate and Extent of Digestion

Robust quantitative description of the rate and extent of digestion requires three components:

1. Appropriate biological data measured in a defined, representative system using an optimal experimental design.
2. Proper mathematical models that reflect biological principles.
3. Accurate fitting procedures for parameter estimation.

The validity of digestion kinetics depends on data that are accurately collected in a relevant system. Once the biology of the system for collecting data is described,

models should be developed that correctly reflect the system. Only then can a valid fitting procedure be used to accurately estimate rate and extent of digestion.

## Kinetic Data

Accurate biological data, generated by a method that is consistent with the mathematical model and its assumptions, is a necessary first step in quantifying digestion kinetics. Subtle differences among measurements can have substantial effects on the parameterization and interpretation of digestion kinetics. Three characteristics of the data have critical impact on modelling and the interpretation of kinetic properties:

1. The method used to measure kinetic changes.
2. The specific component on which kinetic information is measured.
3. The design of sampling times and replications.

Kinetic data can be collected using either *in vitro* or *in situ* methods, and the component measured can vary from specific polysaccharides to total dry matter (DM). Reported end-point sampling times have varied from as little as 6 h to more than 40 days.

### **Data collection method**

Both *in vitro* and *in situ* techniques use time-series sampling to obtain kinetic data. *In vitro* methods involve the incubation of samples in tubes or flasks with a buffer solution and ruminal fluid or enzymes. *In situ* techniques require the incubation of samples in porous bags that are suspended in the rumens of fistulated cows. Either method may be appropriate for measuring digestion kinetics, depending on research objectives. However, both methods have advantages and disadvantages that influence their suitability for a given application, affect the mathematical model that is needed, and alter interpretation of results. Regardless of the model used to describe digestion, kinetic parameters can be determined only on the assumption that they are constant during the time data are collected, and the component that is reacting can be measured accurately and unambiguously.

#### *In vitro methods*

Models to measure digestion kinetics *in vitro* are less complex than those needed to measure *in situ* kinetics because the environment of the system is easier to control and measurements are not affected by infiltration or loss of materials from the fermentation vessel. However, not all *in vitro* systems used to measure 48-h digestibility are acceptable methods for measuring kinetic data. Many *in vitro* systems fail to include adequate inocula, buffers, reagents or equipment to guarantee that pH, anaerobiosis, redox potential, microbial numbers, essential nutrients for microbes, etc. do not limit digestion during some or all of the time that kinetic data are collected. Furthermore, it is

important that particle size of the sample does not inhibit digestion if the research objective is to measure the intrinsic rate of digestion of chemical components and for this purpose samples are typically ground to pass through a 1 mm screen.

If some characteristic of the *in vitro* system limits digestion, it is obvious that kinetic parameters intrinsic to the substrate are not measured. Besides ensuring that factors affecting rate and extent of digestion do not change significantly during fermentation, any *in vitro* system used for kinetic analysis also must ensure that conditions in early and late fermentation do not limit digestion. Many *in vitro* procedures shock microbes during inoculum preparation or at inoculation because the sample-containing media is inadequately reduced and anaerobic. These systems will cause biased estimates of digestion kinetics because digestion during early fermentation is low. If non-substrate characteristics of the *in vitro* technique limit digestion kinetics, it may be difficult to detect underlying mechanisms or measure differences among treatments. Differences in *in vitro* systems can create a two- to threefold difference in kinetic parameter estimates.

The primary disadvantage of the *in vitro* method for generating kinetic data is that it may differ from the *in vivo* environment. Yet, this deficiency can be an advantage when the research objective is to study intrinsic properties of the substrate. Conditions *in vitro* can be controlled to prevent fluctuations in pH, dilution, fermentation pattern, etc., that occur *in vivo*. In addition, *in vitro* methods can be adjusted to ensure that the characteristic of interest in the substrate is the only factor limiting fermentation. For example, if the intrinsic characteristics of fibre are to be investigated, the *in vitro* method can be modified to ensure that particle size, nitrogen, trace nutrients, pH, etc. are not the factors limiting rate and extent of fibre digestion.

If the goal is to assess effects of extrinsic factors on rate and extent of digestion, the *in vitro* method can be modified to maintain constant fermentation conditions that do not violate assumptions needed to estimate kinetic parameters. For example, pH of the buffer can be varied *in vitro* to determine its direct and interacting effects on digestion kinetics. If the objective is to measure the digestion kinetics of a feed when fed to an animal as the sole diet, the substrate should be fermented in an *in vitro* system that contains no supplemental nitrogen or trace nutrient sources that would not be available by recycling in the animal.

#### *In situ methods*

If the research objective is to determine the combined effects of the intrinsic properties of the feed and the extrinsic characteristics of the fermentation pattern in the animal on digestion kinetics, the *in situ* method may be appropriate, biologically. Justification for using the *in situ* method is based on the concept that dynamic animal–diet interactions are important. Consequently, kinetics of digestion measured *in situ* are valid only when the feed in the bag is also the feed fed to the host animal. However, if *in situ* data are to be used to estimate kinetic parameters, an additional constraint is required. Conditions of fermentation in the rumen must be constant, i.e. the animal must be in



quasi-steady-state to meet the restriction that compartments have homogeneous kinetic properties during the time kinetic data are collected.

Usually, the objective of kinetic experiments is to measure the intrinsic rate and extent of digestion of the test material. In these situations, the *in situ* method has disadvantages that affect the interpretation of rate and extent parameters. Kinetic results obtained under non-steady-state conditions may be biased by the time samples were placed in the rumen because fermentation patterns vary relative to the animal's feeding time. In addition, kinetic parameters may be related more to the type of diet that the host animal is fed (and resulting ruminal conditions) than to the intrinsic properties of the substrate. If rate of digestion varies because of factors that are extrinsic to the substrate, interpretation of kinetic parameters is complex, and their general applicability is questionable. Even if all samples are included in the same animal simultaneously, it is difficult, if not impossible, to attribute differences between treatments to intrinsic differences in substrates, unless interactions between intrinsic and extrinsic factors are known not to exist.

*In situ* kinetic data also is hampered by losses of DM and contamination from incoming material. *In situ* bags are porous to allow infiltration of microbes for fermentation of residues inside the bag. Unfortunately, these same pores allow escape of undigested, fine particles, and infiltration of fine particles from ruminal contents. France *et al.* (1997) suggested models and mathematics for correcting *in situ* disappearance for particle losses and variable fractional rates during the initial period of digestion. However, these models do not account for the possibility that material may also enter bags while they are in the rumen, but not be completely washed out after fermentation. Because much of the fine matter in the rumen is indigestible or extensively digested, influx contamination can result in high estimates of the indigestible fraction, which in turn can bias the potentially digestible fraction and the fractional digestion rate.

An obvious solution to fine particle infiltration is to either physically remove fine-particle mass by washing the bags or arithmetically subtracting an estimate of particle contamination of the residues using blank bags (Weakley *et al.*, 1983; Cherney *et al.*, 1990). The first option has the disadvantage that extensive washing can cause loss of substrate from the bags (especially at early fermentation times) that is not due to digestion. In addition, it is not possible to confirm that the washing technique is adequate without first including blanks. Blank bags probably should contain ground inert material of a mass similar to that of the samples to prevent them from collapsing and preventing the infiltration of fine particles. Alternatively, a model can be developed that represents migration of residues into and out of *in situ* bags. Similarly, models can be developed that account for the initial solubilization of matter that occurs in both the *in vitro* and *in situ* systems.

## **Component**

Determining kinetics of fibre digestion is the least complex of any feed component because fibre should not be affected by initial solubilization or

contamination by microbial debris. Models are often developed to account for initial solubilization of feed components such as DM or protein (Ørskov and McDonald, 1979). However, without careful design of the experiment it is difficult, if not impossible, to separate solubilization from lag phenomena. If kinetic analysis of feed components that solubilize is desired, samples must be taken at zero time to measure solubilization directly.

For compounds that are contaminated by microbial residues, the determination and interpretation of digestion kinetics is more complex. Digestion of DM and protein, uncorrected for microbial contamination, does not represent true digestion kinetics of feed components, rather it represents the kinetics of net digestion, which is analogous to apparent digestibility coefficients. Not only is it uncertain that microbial contamination will be similar in other situations where the kinetic parameters are used, but also the moderating effect of microbial residues on disappearance of DM and protein may mask true differences among feeds. If the goal of the research is to relate digestion kinetics to intrinsic properties of the feed, the use of net residues, contaminated by microbial debris, is questionable.

Theoretically, simple models of digestion are inappropriate for measuring intrinsic kinetic properties of DM or protein. One solution to this problem is to measure and subtract the contamination associated with microbial debris using microbial markers (Nocek, 1988; Huntington and Givens, 1995; Vanzant *et al.*, 1998). Fractional rates of protein degradation were changed dramatically by removing contamination, thereby providing empirical evidence that microbial residues can result in biased estimates of kinetic parameters. Alternatively, the digestion model can be modified to include microbial residues as described later in this chapter. These models can assess potential errors associated with the use of simple models and provide analytical solutions that can estimate more appropriately the intrinsic rates and extents of digestion of DM and protein.

## **Design**

Regardless of the method used to generate kinetic data, the experimental design must be consistent with the objective of obtaining accurate estimates of parameters. Biological, statistical, kinetic and resource management considerations should be used to adequately and efficiently collect kinetic data. Biologically, variation in both *in vitro* and *in situ* experiments is greater between runs than within runs. Therefore, to estimate universally valid kinetic parameters the experimental design should replicate substrate between runs rather than within runs. Replicated measures within a run are repeated measures, like replicated laboratory analyses, and do not qualify as independent measures when doing statistical tests or estimating standard errors. Replicated data from different runs provide additional information about run by substrate interactions and are useful in estimating lack-of-fit statistics.

For most efficient use of resources, more measurements should be made at additional fermentation times instead of replicating measurements at fewer

fermentation times within a run. Statistical concepts indicate that regression coefficients are determined more accurately when the same number of observations are collected once at more times rather than multiple observations collected at fewer times. Deviation from regression is a good estimate of replicate variation, thereby making duplicate sampling at each time statistically redundant. Although there is no statistical rule, experience suggests that there should be at least three observations for each parameter to be estimated in the model. Most digestion models contain three independent parameters, indicating that at least nine fermentation times are needed to estimate parameters of simple digestion models adequately and accurately.

Spacing of fermentation times is important in optimizing the design of kinetic experiments. When nothing is known about the process, it is best to evenly space observations for regression analysis. However, *a priori* information about digestion kinetics can be used to improve the efficiency of regression analysis. In general, variance in kinetic data is proportional to the absolute rate of reaction that occurs between 6 and 18 h of fermentation. Therefore, observations should be taken more often between 3 and 30 h than during other periods of fermentation to offset the greater variation that occurs during this period of rapid fermentation. Optimal and minimal sampling times suggested for collecting kinetic data are given in Table 2.2. Also, it is desirable to record the exact time samples are taken to the nearest 0.1 h because regression analysis assumes that the independent variable (time) is measured without error and inaccurate time measurements can significantly affect results.

**Table 2.2.** Recommended sampling times to obtain accurate parameter estimates for digestion kinetics.

Number of samples		Rapidly digesting component (hours after inoculation)		Slowly digesting component (hours after inoculation)	
Optimal sampling <sup>a</sup>	Minimal sampling <sup>b</sup>	Optimal sampling	Minimal sampling	Optimal sampling	Minimal sampling
1		0		0	
2	1	0	0	0	0
3	2	2	2	3	3
4	3	4	4	6	6
5	4	8	8	9	9
6	5	12	12	12	12
7		16		18	
8	6	20	20	24	24
9		24		30	
10	7	32	32	36	36
11		40		48	
12	8	48	48	72	72
13	9	64	64	96	96

<sup>a</sup>Optimal sampling strategy for digestion models containing three parameters.

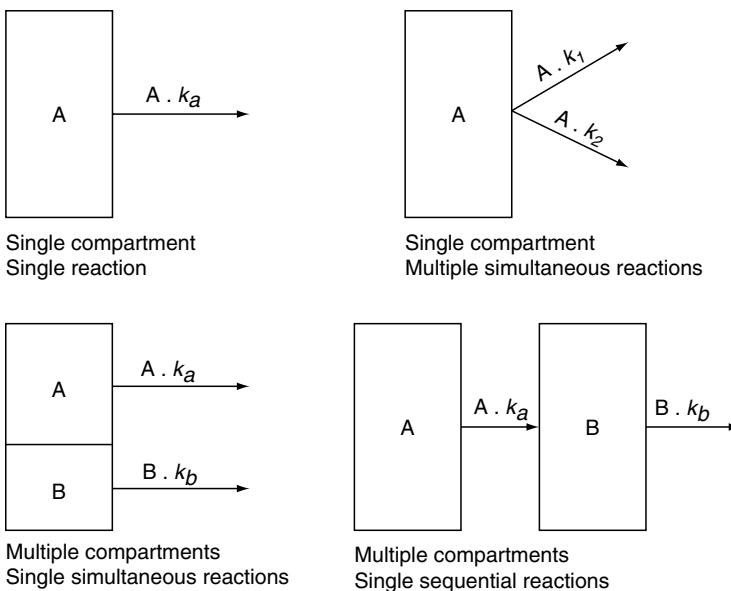
<sup>b</sup>Minimal sampling strategy for digestion models containing three parameters.

Observations at the beginning and end of fermentation also are critical because they establish initial solubilization/lag and potential extent of digestion, respectively. Accurate zero-time measurement is needed to distinguish solubilization from digestion and estimate the lag effect. Thus, it is important to make extra observations during the lag phenomenon and to duplicate measurements when time equals zero. Replicated measurements are also valuable in estimating the potential extent of digestion.

## Models of Digestion

The mathematics for describing first-order dynamic systems is rather simple. Too often it is assumed that rigorous mathematical training is required to model a biological system. Typically, biological conceptualization of the system is the most difficult part of the modelling process. Fear of mathematics has created too much dependence on the selection of equations from those reported in the literature and has inhibited many scientists from formally describing their conceptual model in precise mathematical terms that accurately describe the biological process being investigated. The focus of this section will be the development of simple models that demonstrate the principles of relating biology to the mathematical model and thereby stimulate the reader to generate other suitable models for describing kinetic data.

First-order digestion models can be classified into four types, depending on the number of compartments and the number and type of reactions (Fig. 2.1). In simultaneous systems, flows from compartments occur simultaneously and independently. In sequential systems, flow from some compartments becomes



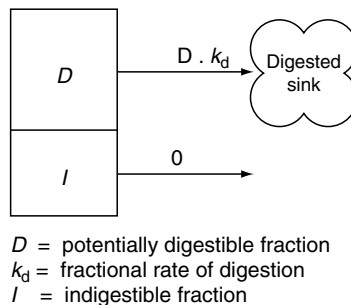
**Fig. 2.1.** Illustrations of the various types of first-order models used to describe digestion.

the input to other compartments, which creates a ‘time dependency’ for the second compartment. Because the models are first-order, they will have an exponential function in the equation for each compartment in the system. Each type of model has a distinct set of linear and semi-logarithmic plots of their differential and integral functions that can be used to identify the type of digestive process being investigated.

Comments about rates of digestion first appeared in the literature in the 1950s, but development of digestion kinetics was hampered by the lack of a biological concept of the digestion process that could be described by a mathematical formula. Description of the process was difficult because digestion curves were non-linear, differed in asymptote and did not appear to fit the kinetics of typical chemical reactions. Waldo (1970) was the first to suggest a conceptual breakthrough that serves as the basis for our current view of digestion kinetics. He suggested that digestion curves are combinations of digestible and indigestible material. His hypothesis that some matter is indigestible was based on the work of Wilkins (1969) who observed that some cellulose was undigested in the rumen after 7 days. Waldo speculated that if the indigestible residue was subtracted, the potentially digestible fraction might follow first-order, mass-action kinetics. Interestingly, nutritionists would have arrived at this same conclusion if they had used classical curve peeling approaches to analyse and interpret digestion curves in which fermentation was extended to more than 72 h.

### **Model 1: Simple first-order digestion with an indigestible fraction**

The concept that all feed components are not potentially digestible not only simplifies the mathematical description of digestion, but also clarifies the biological framework for explaining digestion. However, the problem in describing digestion kinetics is that residues remaining at any digestion time are a mixture of undigested and indigestible matter. The model proposed by Waldo (1970) is illustrated in Fig. 2.2. It assumes that the indigestible residue does not disappear, whereas the potentially digestible residue disappears at a rate that is proportional to its mass at any time. It is intuitive that rates of digestion are only valid for potentially digestible components, i.e. indigestible components have rates of digestion of zero. Equations for this model are:



**Fig. 2.2.** Model 1: Simple first-order model of digestion with an indigestible fraction.

$$dD/dt = -k_d D \quad (2.1)$$

$$dI/dt = 0 \quad (2.2)$$

where  $t$  represents time,  $I$  the indigestible residue,  $D$  the potentially digestible residue and  $k_d$  the fractional rate constant of digestion.

Although derivatives of time describe the system elegantly, we seldom measure fluxes under steady-state conditions, instead we measure amounts or concentrations in a system at specified times. Thus, to describe the data usually collected, the above equations must be integrated over time to derive equations that correspond to observed data. The integrated equations are:

$$D(t) = D_i \exp(-k_d t) \quad (2.3)$$

$$I(t) = I_0 \quad (2.4)$$

$$R(t) = D(t) + I(t) = D_i \exp(-k_d t) + I_0 \quad (2.5)$$

where  $I_0$  and  $D_i$  are the indigestible and potentially digestible residues at  $t = 0$  and  $R(t)$  is the total undigested residue at any time.

The implicit assumptions of this first-order model are:

1. The potentially digestible and indigestible pools act as distinct compartments with homogeneous kinetic characteristics.
2. The fractional rate of digestion is constant and is an intrinsic function of the digestive system and the substrate.
3. Digestion begins instantly at time zero and continues indefinitely.
4. Enzyme or microbial concentrations are not limiting.
5. Flux or absolute rate is strictly a function of the amount of potentially digestible substrate present at any time.

The equation for  $D(t)$  can be transformed into a linear function by natural logarithmic transformation ( $\ln$ ) and substitution:

$$\ln [D(t)] = \ln [D_i] - k_d t \quad (2.6)$$

$$D(t) = R(t) - I_0 \quad (2.7)$$

$$\ln [R(t) - I_0] = \ln [D_i] - k_d t \quad (2.8)$$

By estimating  $I_0$  using long-term fermentations and regressing  $\ln [R(t) - I_0]$  on time, the intercept can be used to estimate  $D_i$  and the slope or regression coefficient estimates the fractional rate constant of digestion ( $k_d$ ), which is described on page 42. The true indigestible fraction can be reached only after infinite time, and any fermentation end-point is an overestimation of the true asymptote. A practical estimate of the asymptote ( $I_0$ ) can be obtained when digestion is >99% complete. The time at which a pool declines to 1% of its original value can be approximated by dividing 4.6 by the fractional rate of the pool. For a rate of 0.10/h it will take 46 h to decline to 1% of its original value compared with 92 h for a fractional rate of 0.05/h.

Van Milgen *et al.* (1992) observed differences in the indigestible acid detergent fibre fraction when measured after 42 days *in situ* when host animals were

fed diets differing in the proportion of concentrate. They concluded that the indigestible fraction is not an intrinsic characteristic of the feed because it was affected by the diet of the animal. However, it could be argued that the intrinsic indigestibility of a feed can only be measured under optimal ruminal conditions that result in maximal digestion. Any perturbation of fermentation that does not allow maximal digestion results in indigestible residues that are contaminated by undigested potentially digestible matter. Although indigestibility may not be a constant intrinsic characteristic of the feed, it may be more appropriate to measure the intrinsic indigestibility of the feed using an optimal system and then modelling the extrinsic factors that cause incomplete digestion, even after long fermentation times, as a function of the fermentation system.

The classical test for the appropriateness of the first-order mass-action model is to plot the natural logarithm of the potentially digestible residue versus time. If the plot is linear, the flux or absolute rate of reaction is constant and proportional to the amount of the potentially digestible pool; therefore the first-order, fractional rate constant model is a plausible description of the digestive process. Although most researchers have used  $R^2$  to assess linearity, the most powerful statistical test is a lack-of-fit test comparing linear and quadratic functions of time using multiple samples each measured once in replicated *in vitro* or *in situ* trials. Several scientists (Gill *et al.*, 1969; Smith *et al.*, 1972; Lechtenberg *et al.*, 1974) evaluated the first-order model for potentially digestible matter, using either 48- or 72-h fermentations as the end-point for estimating  $I_0$ . Their results indicated that first-order, mass-action kinetics with an indigestible fraction was an acceptable model of digestion for neutral detergent fibre (NDF) and cellulose.

### **Model 2: Simple first-order digestion with indigestible and soluble fractions**

For feed components that contain a significant soluble fraction, such as protein and DM, the simple first-order model must be modified to include an additional parameter to describe the digestive process. At the beginning of digestion, there can be disappearance of residue due to solubilization that should not be confounded with rate of digestion (Ørskov and McDonald, 1979). This solubilization is so rapid compared with degradation that it can be considered instantaneous. Except for the instant of solubilization, the differential equations for this model (Fig. 2.3) are:

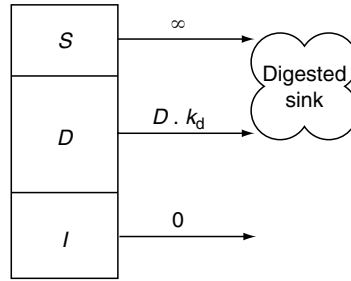
$$dD/dt = -k_d D \quad (2.9)$$

$$dI/dt = 0 \quad (2.10)$$

$$dS/dt = \infty \quad (2.11)$$

where  $S$  is the soluble fraction of the feed component and all other variables are the same as defined for Model 1.

The integral equations for this system are the same as the simple first-order model except:



$S$  = soluble fraction

$\infty$  = infinite fractional rate indicating instantaneous transfer

$D$  = potentially digestible fraction

$k_d$  = fractional rate of digestion

$I$  = indigestible fraction

**Fig. 2.3.** Model 2: Simple first-order model of digestion with soluble and indigestible fractions.

at  $t = 0$ ,

$$S(0) = S_0 \quad (2.12)$$

and

$$R(0) = D(0) + I(0) + S_0 = D_i + I_0 + S_0 \quad (2.13)$$

at  $t > 0$ ,

$$S(t) = 0 \quad (2.14)$$

and

$$IR(t) = D(t) + I(t) = D_i \exp(-k_d t) + I_0 \quad (2.15)$$

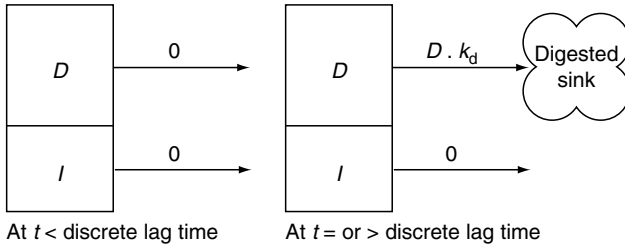
where  $IR(t)$  is insoluble residue at any time  $t$ .

The last equation, similar to that for the simple first-order model, can be used to estimate instantaneous solubilization, assuming no lag effect, by extrapolating the potentially digestible fraction to  $t = 0$  and comparing  $(D_i + I_0)$  to  $R_0$ . If  $(D_i + I_0)$  is less than  $R_0$ , the difference is an estimate of  $S_0$ , assuming no lag. Because the assumption of no lag effect is uncertain, it is necessary to measure insoluble residue at time zero ( $IR_0$ ), which allows estimation of both  $S_0 (= R_0 - IR_0)$  and lag effects.

### **Model 3: Simple first-order digestion with discrete lag time and an indigestible fraction**

The simple first-order model indicates that digestion begins instantaneously at time zero. Mertens (1977) observed that logarithmically transformed digestion





$D$  = potentially digestible fraction  
 $k_d$  = fractional rate of digestion  
 $I$  = indigestible fraction

**Fig. 2.4.** Model 3: Simple first-order model of digestion with a discrete lag time before digestion and an indigestible fraction.

curves typically exhibited non-linearity before 6 h of fermentation, which suggests a lag phenomenon. The potentially digestible pool ( $D_i$ ) estimated as the intercept of the simple model at  $t = 0$  usually exceeded 100% of that possible because the actual potentially digestible pool ( $D_0$ ) at  $t = 0$  must be equal to total residue at time zero minus indigestible residue. Mertens (1977) proposed that the lag phenomenon could be easily quantified by including a discrete lag time in the simple first-order model (Fig. 2.4). Discrete lag time was defined as the time at which the first-order equation derived for a data set equals the actual potentially digestible fraction at zero time. The discrete lag model assumes that no digestion occurs until lag time, when digestion begins instantaneously. After a discrete lag time, the differential equations and integral solutions are similar to Model 1. Differential equations for this model are:

at  $t < L$ :

$$dD/dt = 0 \tag{2.16}$$

and

$$dI/dt = 0 \tag{2.17}$$

at  $t \geq L$ :

$$dD/dt = -k_d D \tag{2.18}$$

and

$$dI/dt = 0 \tag{2.19}$$

where  $L$  is discrete lag time.

The integral equations for the discrete lag model are:

at  $t < L$ :

$$D(t) = D_0 \tag{2.20}$$

and

$$I(t) = I_0 \quad (2.21)$$

$$R(t) = D_0 + I_0 \quad (2.22)$$

at  $t \geq L$ :

$$D(t) = D_i \exp(-k_d[t - L]) \quad (2.23)$$

and

$$I(t) = I_0 \quad (2.24)$$

and

$$R(t) = D(t) + I(t) = D_i \exp(-k_d[t - L]) + I_0 \quad (2.25)$$

At  $t = L$ :

$$R_0 - I_0 = D_0 = D_i \exp(-k_d[L]) \quad (2.26)$$

and

$$L = [\ln(D_0) - \ln(D_i)]/(-k_d) \quad (2.27)$$

This model can be modified easily to incorporate the digestion kinetics of feed components that exhibit initial solubilization (Dhanao, 1988). However, to estimate lag time for these components, there must be a measure of the amount of insoluble residue at  $t = 0$  to provide an estimate of  $IR_0$  that must equal  $(D_0 + I_0)$ . Although the discrete lag model may not adequately describe lag phenomena for use in dynamic simulation models, it provides a simple and quantitative measure of the lag effect that can be used to compare feeds. Although López *et al.* (1999) concluded that discrete lag models are difficult to justify biologically because some digestion occurs before lag time, they observed that the simple exponential model with discrete lag was only ranked below generalized exponential and inverse polynomial models for lack-of-fit, rank of residual mean of squares (RMS) and average RMS when used to describe *in situ* DM, NDF and protein degradation. However, generalized exponential and inverse polynomial models also have difficult biological interpretations.

When the intercept ( $D_i$ ) is greater than  $D_0$  clearly some type of lag phenomenon has occurred (see Fig. 2.9 in the Curve Peeling section). When  $D_i < D_0$ , the discrete lag time  $L$  is negative, which implies that digestion begins before  $t = 0$ , a result that is difficult, if not impossible, to accept biologically. However, there is a biological explanation for negative lag times because they simply indicate that instantaneous solubilization has occurred, which equals  $D_0 - D_i$ . However, both solubilization and lag can occur when initial solubilization is greater than that indicated by the difference between  $D_0$  and  $D_i$ , but their effects cannot be separated unless  $IR_0$  is measured at time zero so that  $D_0$  can be estimated. Setting bounds on discrete lag to prevent it from being less than zero is not appropriate because it eliminates the possibility for detecting solubilization and can result in biased estimates of kinetic parameters.

**Model 4: Sequential first-order reaction for lag and digestion with an indigestible fraction**

Other models of digestion have been proposed that describe digestion as a sequential compartmental process (Allen and Mertens, 1988; Mertens, 1990; Van Milgen *et al.*, 1991). In these models, the digestive process is described by a two-step mechanism (Fig. 2.5). In the first stage, lag is modelled as a first-order process involving the change in the substrate from an unavailable form to one that is available for digestion. Biologically, this step could represent hydration of substrate, removal of digestion inhibitors, or attachment or close association of microorganisms with the substrate. The second stage is also first-order and represents actual degradation of the substrate. This model exhibits a smooth curvilinear transition from no digestion at  $t = 0$  to maximum absolute digestion rate at the inflection point of the digestion curve. Differential equations for this model are:

$$dU/dt = -k_1U \tag{2.28}$$

$$dA/dt = k_1U - k_dA \tag{2.29}$$

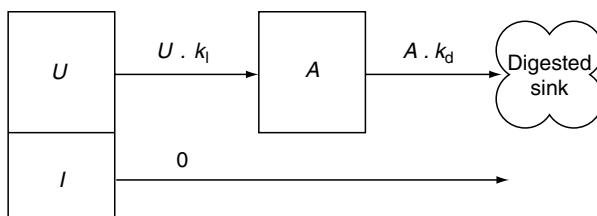
$$dI/dt = 0 \tag{2.30}$$

where  $U$  is the unavailable potentially digestible pool,  $A$  is the potentially digestible pool that is available for digestion,  $I$  is the indigestible residue,  $k_1$  is the fractional rate constant for lag and  $k_d$  is the fractional rate constant for digestion.

The integral equations for this digestive process are:

$$U(t) = U_0 \exp(-k_1t) \tag{2.31}$$

$$A(t) = U_0[k_1/(k_d - k_1)][\exp(-k_1t) - \exp(-k_d t)] \tag{2.32}$$



- $U$  = unavailable potentially digestible fraction
- $k_1$  = fractional rate of availability (lag phenomena)
- $A$  = available potentially digestible fraction
- $k_d$  = fractional rate of digestion
- $I$  = indigestible fraction

**Fig. 2.5.** Model 4: Sequential multi-compartmental model of digestion and lag with an indigestible fraction.

$$I(t) = I_0 \quad (2.33)$$

$$R(t) = U(t) + A(t) + I(t) \quad (2.34)$$

$$R_0 = U_0 + I_0 \quad (2.35)$$

because  $A_0 = 0$  at  $t = 0$

Given

$$R(t) = U(t) + A(t) + I_0 \quad (2.36)$$

at  $t > 0$ :

$$R(t) = [U_0/(k_d - k_1)][k_d \exp(-k_1 t) - k_1 \exp(-k_d t)] + I_0 \quad (2.37)$$

Although this model does not contain a discrete lag, Mertens (1990) observed that a discrete lag term was a necessary addition to the model for it to adequately describe digestion processes with prolonged lag effects.

### **Model 5: Second-order digestion based on substrate and enzyme concentrations**

Previous models assume that rate and extent of digestion are limited only by intrinsic properties of the substrate. However, it may be possible that extrinsic factors, such as microbial mass or enzymatic activity, limit the rate of reaction (France *et al.*, 1982; Baldwin *et al.*, 1987). A more complex model used to describe digestion is based on the Henri–Michaelis–Menten (HMM) kinetics developed for enzyme reactions. The complete model of HMM kinetics is a reversible, four-compartment system with both first- and second-order reactions (see p. 20 in Segel, 1975). Using quasi-steady-state approximation, the series of differential equations used to describe the complete system can be solved as a function of substrate concentration (Segel, 1975). If we assume that microbial mass acts like an enzyme and the substrate is potentially digestible fibre, the final differential equations are:

$$dD/dt = -[V_{\max}/(K_m + D)]D \quad (2.38)$$

$$dI/dt = 0 \quad (2.39)$$

where  $V_{\max}$  is the maximal rate of reaction when all microbial mass is actively digesting substrate,  $K_m$  is proportional to the rates of degradation ( $k_{md}$ ) and formation ( $k_f$ ) of the active complex, i.e.  $(k_f + k_{md})/k_f$ , and other variables as defined previously.

This model assumes that microbial mass can limit digestion instead of assuming, as in all previous models, that only intrinsic properties of the substrate limit digestion. In the HMM model, the fractional rate of digestion relative to the amount of potentially digestible fibre is not a constant, but is proportional to the total amount of microbial mass, which changes throughout fermentation. In a rumen or *in vitro* system with low microbial mass relative to potentially

digestible sites, the order of the overall reaction varies with respect to the concentration of the substrate. Initially, the concentration of substrate is high relative to microbial mass ( $D \gg K_m$ ) and  $dD/dt = -V_{\max}t$ , which is zero-order relative to  $D$ . This occurs because at high substrate concentrations, the absolute rate of reaction is more a function of the amount of microbial mass than of substrate concentration. As potentially digestible substrate is degraded, its concentration decreases relative to microbial mass ( $D \ll K_m$ ) and  $dD/dt = -(V_{\max}/K_m)D$ , i.e. the reaction is first-order with respect to  $D$  with a fractional rate equal to  $(V_{\max}/K_m)$ .

The HMM-type differential equation can be integrated (Segel, 1975) to:

$$V_{\max}t = -K_m \ln(D/D_0) - (D - D_0) \quad (2.40)$$

Although this equation cannot be solved analytically for  $D$  at any time, even if  $V_{\max}$  and  $K_m$  are known, it can be rearranged to a linear form and used to estimate  $V_{\max}$  and  $K_m$  from time-series measurements. A linear form of the integral equation that is useful is:

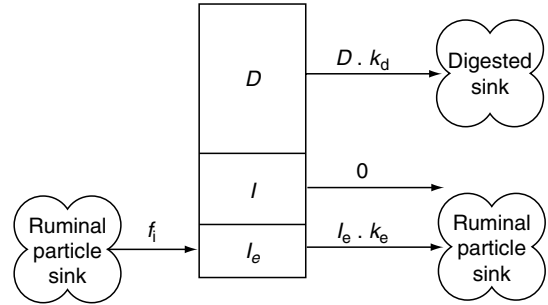
$$(D_0 - D)/t = -K_m[\ln(D_0/D)/t] + V_{\max} \quad (2.41)$$

By regressing  $(D_0 - D)/t$  versus  $\ln(D_0/D)/t$ ,  $K_m$  and  $V_{\max}$  can be estimated from the slope and intercept, respectively. To obtain accurate estimates of parameters, the values of  $D$  should vary from approximately  $0.1 K_m$  to  $10 K_m$ .

After estimates of  $K_m$  and  $V_{\max}$  are determined, the differential form of the HMM-type equation can be integrated numerically to obtain values of  $D(t)$  at any time. Use of numerical integration is only a minor inconvenience with the availability of computers and computer programs. A factor complicating the use of HMM kinetics with microbial systems is that microbial activity increases during the reaction as microbes use substrate for growth. Thus, microbial activity is not constant in a fermentation system like enzyme concentrations are in classical enzyme kinetics. To more accurately mimic HMM kinetics, microbial growth could be inhibited during kinetic measurements or the model could be modified to add microbial growth and then derive a new equation that more accurately describes microbial fermentation of a substrate. Biologically the HMM model is valid only if microbial concentrations limit degradation during the early period of fermentation. Thus, one can never be sure when interpreting HMM results that intrinsic limitations of the substrate are being evaluated because  $V_{\max}$  depends on microbial concentration, and the intrinsic second-order rate constant of substrate disappearance is not estimated.

### **Model 6: Simple first-order model for in situ digestion with influx and efflux of matter**

Previous models assume that no contamination of feed components from outside the fermentation vessel occurs during the collection of data. Porous bags used in *in situ* methods allow entry of particles from the rumen and exit of particles from the bag (Fig. 2.6). Washing bags is often used in an attempt to minimize errors



**Fig. 2.6.** Model 6: Simple first-order model of digestion with an indigestible fraction and influx and efflux of indigestible fine particles in the rumen that can occur when using an *in situ* system.

$D$  = potentially digestible fraction  
 $k_d$  = fractional rate of digestion  
 $I$  = indigestible fraction  
 $I_e$  = exogenous indigestible fine particles  
 $f_i$  = zero-order influx rate of exogenous fine particles  
 $k_e$  = fractional rate of escape of fine particles

associated with the former problem, whereas grinding samples coarsely is sometimes used to minimize the latter. However, washing bags varies substantially among laboratories and it is difficult, if not impossible, to balance the errors between washing out contaminating matter and removing actual sample. Coarse grinding may influence digestion processes and alter digestion kinetics (Michalet-Doreau and Cerneau, 1991). Because neither of these strategies may solve the problems associated with measurement of digestion kinetics *in situ*, it is intuitive that models used for *in vitro* digestion kinetics may not be valid for *in situ* kinetics.

In this model (Fig. 2.6), the number of fine digestible and indigestible particles in the feed and the amount of fine digestible particles in the rumen are assumed to be negligible. Thus, influx and efflux of fine particles is assumed to be only indigestible fibre from ruminal contents. The influx rate is assumed to be zero-order, i.e. is only a function of time, and is probably related to pore size and surface area of bag material. Differential equations describing the digestion of fibre *in situ* are:

$$dD/dt = -k_d D \quad (2.42)$$

$$dI/dt = 0 \quad (2.43)$$

$$dI_e/dt = f_i - k_e I_e \quad (2.44)$$

where  $I_e$  is the pool of escapable indigestible particles from the rumen that are in the bag,  $f_i$  is the zero-order influx rate of particles into the bag and  $k_e$  is the first-order efflux rate of fine, escapable particles from the bag.

The integrated solutions to these equations are:

$$D(t) = D_0 \exp(-k_d t) \quad (2.45)$$

$$I(t) = I_0 \quad (2.46)$$

$$I_e(t) = (f_i/k_e)[1 - \exp(-k_e t)] \quad (2.47)$$

The total residue in the bag at any time  $t$  is:

$$R(t) = D(t) + I(t) + I_e(t) \quad (2.48)$$

$$R(t) = D_0 \exp(-k_d t) + I_0 + (f_i/k_e)[1 - \exp(-k_e t)] \quad (2.49)$$

Because the influx rate is zero-order and has the units mass per unit of time, the residue at any time must be expressed in the same units to estimate the parameters of this model using non-linear regression. Thus  $R(t)$  cannot be expressed as a percentage of the starting sample weight, but must be expressed as mg, g, etc. This differs from first-order Models 1 to 4 that obtain the same fractional rate constants irrespective of the units used to express  $R(t)$ .

If it is postulated that washing fine particles out of bags follows first-order kinetics (the amount washed out at any time  $t$  is proportional to the amount of fine particles in the bag at any time  $[I_e(t)]$ ) and the concentration of fine particles in the wash water is so small that influx during washing is negligible, it can be shown that changes during washing are described by the following equations:

$$dD/d(t_w) = 0 \quad (2.50)$$

$$dI/d(t_w) = 0 \quad (2.51)$$

$$dI_e/d(t_w) = -k_w I_e \quad (2.52)$$

where  $t_w$  is washing time and  $k_w$  is the fractional washout rate of fine particles from the *in situ* bag.

Because the amount of each pool at the time of washing is equal to  $D(t)$ ,  $I(t)$  and  $I_e(t)$ , respectively, it can be shown that after any washing time  $t_w$ :

$$R(t) = D(t) + I(t) + I_e(t) \exp(-k_w t_w) \quad (2.53)$$

$$R(t) = D_0 \exp(-k_d t) + I_0 + [\exp(-k_w t_w)](f_i/k_e)[1 - \exp(-k_e t)] \quad (2.54)$$

If washing time  $t_w$  is the same for all samples, the term  $\exp(-k_w t_w)$  becomes a constant, and when non-linear least squares regression is used to estimate the parameters of the model the term  $[\exp(-k_w t_w)](f_i/k_e)$  will be determined as a single coefficient.

The equation for Model 6 is similar to the simple equation for an *in vitro* system (Model 1) except that an additional term is needed to describe the net accumulation of fine particles in the bag at any time  $t$ . Model 6 predicts that infiltration of fine particles will increase to an asymptote that is equal to the ratio of influx and efflux rates. This indicates that indigestibility will be overestimated *in situ* and suggests that fractional rates and lag times will be biased if simpler models such as Models 1 to 4 are used that do not contain terms for net accumulation of residue in the bag and washing does not remove all influx material.

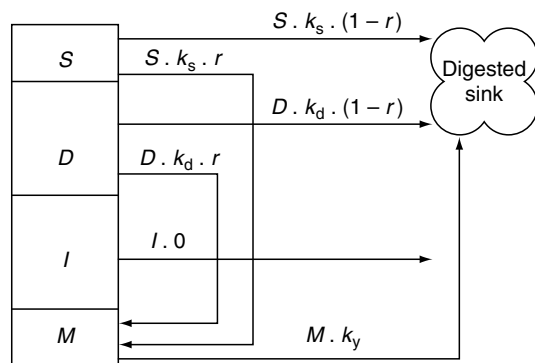
Analysing models derived from the biology of the specific digestion process demonstrates one of the often overlooked uses of models. Once equations are derived, they can be used to detect differences in timing and magnitude

between alternative models and suggest experimental designs that can be used to effectively compare them. Model 6 could be modified to incorporate additional biological processes including losses of fine particles in a more finely ground sample than is assumed in Model 6 or by including a discrete lag time during which influx and efflux occurred, but digestion did not. However, these models require additional terms that cannot be estimated realistically using current data collection and fitting techniques.

### Model 7: Simple first-order model with contamination of residues by microbial matter

The measurement of protein and DM digestion kinetics is complicated by the contamination of these residues by microbial debris. When simple models are used, digestion kinetics of these feed components are actually determined as net coefficients that include true digestion of feed as well as appearance and disappearance of microbial matter. Indirect methods (Negi *et al.*, 1988) and markers (Nocek, 1987; Nocek and Grant, 1987) have been used to estimate the amount of microbial contamination in the residue obtained at each fermentation time. However, microbial growth can be described using several simplifying assumptions to obtain models that estimate the microbial contamination at each time in *in vitro* systems that retain all microbial matter (Fig. 2.7). These models also can indicate the potential errors that will occur in estimating rate and extent of digestion when using simple models such as Models 1 to 3.

If it is assumed that a constant proportion of DM is converted to microbial residues, no recycling of DM through the microbial pool occurs and lysis of microbes is proportional to the amount of microbes in the *in vitro* system at



**Fig. 2.7.** Model 7: Simple first-order model of digestion with soluble and indigestible fractions and contamination of residues by microbial debris that occurs when measuring the digestion kinetics of protein or dry matter (DM) using an *in vitro* system.

$S$  = soluble fraction  
 $k_s$  = fractional rate of soluble matter digestion  
 $D$  = potentially digestible fraction  
 $k_d$  = fractional rate of insoluble matter digestion  
 $r$  = proportion of digested matter converted to microbial mass  
 $I$  = indigestible fraction  
 $M$  = microbial mass  
 $k_y$  = fractional rate of microbial lysis



any time, the following differential equations can be used to describe the digestion of DM:

$$dS/dt = -rk_sS - (1-r)k_sS = -k_sS \quad (2.55)$$

$$dD/dt = -rk_dD - (1-r)k_dD = -k_dD \quad (2.56)$$

$$dI/dt = 0 \quad (2.57)$$

$$dM/dt = rk_sS + rk_dD - k_yM \quad (2.58)$$

where  $r$  is the proportion of digested matter that is converted to microbial DM,  $k_s$  is the fractional rate of digestion of soluble matter,  $k_y$  is the fractional lysis rate of microbial DM,  $M$  is the pool of microbial matter in the *in vitro* vessel at any time and all other variables are defined as for Model 2. In this model, digestion of soluble matter is not assumed to be instantaneous, although this assumption could have been used.

The differential equations can be integrated to obtain the following solutions:

$$S(t) = S_0 \exp(-k_s t) \quad (2.59)$$

$$D(t) = D_0 \exp(-k_d t) \quad (2.60)$$

$$I(t) = I_0 \quad (2.61)$$

$$M(t) = [rk_s S_0 / (k_y - k_s)] [\exp(-k_s t) - \exp(-k_y t)] \\ + [rk_d D_0 / (k_y - k_d)] [\exp(-k_d t) - \exp(-k_y t)] \quad (2.62)$$

To solve for  $M(t)$ , it was assumed that a blank microbial residue was subtracted so that  $M = 0$  at time = 0. If residues are filtered to isolate undigested DM residues,  $S(t)$  will not be measured at any time. Since  $R_0 = S_0 + D_0 + I_0$ , the function  $(R_0 - D_0 - I_0)$  can be substituted into the microbial contamination function to eliminate the  $S_0$  term. The final DM residue function is:

$$DM(t) = D_0 \exp(-k_d t) + I_0 + [rk_s (R_0 - D_0 - I_0) / (k_y - k_s)] [\exp(-k_s t) \\ - \exp(-k_y t)] + [rk_d D_0 / (k_y - k_d)] [\exp(-k_d t) - \exp(-k_y t)] \quad (2.63)$$

Model 7 could be simplified to assume an instantaneous loss of soluble matter and conversion to microbial mass, or it could be made more complex by including recycling of microbial DM and addition of lag phenomena. However, the biological process described for Model 7 and the equations that are obtained can be used to demonstrate the errors inherent in using simple models such as Models 1 to 3 to describe a complex process involving microbial growth when microbial debris contaminates the feed component that is being studied. The equation used to describe Model 7, which includes microbial lysis, indicates that microbial debris increases, then decreases, during fermentation which agrees with data of Nocek (1987). Observations by Negi *et al.* (1988) indicate that microbial nitrogen contamination increased to an asymptote during fermentation; this occurrence could be modelled by assuming that no lysis occurs. Both Nocek (1987) and Negi *et al.* (1988) used an *in situ* procedure to

determine digestion kinetics and additional terms would be needed to describe the influx and efflux of microbial debris that does not occur in the *in vitro* system described by Model 7.

If Model 7 is simulated assuming no lag and the resulting data are fitted to Model 2, two principles can be demonstrated. First, apparent or net fractional rates of digestion are biased estimates of the true fractional digestion rates of the feed. Second, the standard technique for assessing the adequacy of the first-order model of digestion is not sensitive enough to detect model discrepancies associated with production or recycling of microbial mass. The standard test for determining the adequacy of the first-order model is to determine the  $R^2$ , i.e.  $R^2$  near 1.00 are assumed to indicate a good fit of the data to the first-order model. However, it is possible to obtain  $R^2$  greater than 0.9 for residues contaminated with microbial debris, suggesting the simple first-order model is a good fit to the data. Although  $R^2$  can be criticized as a test of model adequacy, even lack-of-fit tests may not detect inadequate models with typical biological variation. Parameters will be biased when a simple model is used to estimate digestion kinetics for components contaminated with microbial debris and it appears that biological justification rather than statistical evaluation is the key to determining the validity of models for use in estimating digestion kinetics.

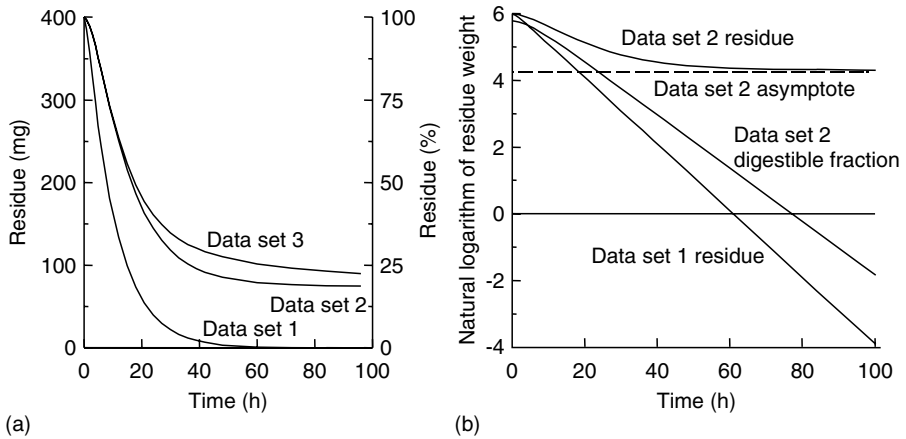
## Fitting Digestion Data to Kinetic Models

### Curve peeling

Although curve peeling has fallen out of favour because non-linear least squares estimation and other computer algorithms are more accurate and less prone to subjective decisions, it is an excellent learning device because it demonstrates graphically the process needed to estimate kinetic parameters. Data in Table 2.3 are typical of kinetic measurements collected using *in vitro* systems and

**Table 2.3.** Example data that can be used to demonstrate the problems in fitting digestion data to first-order models.

Time (h)	Data set 1 (mg)	Data set 2 (mg)	Data set 3 (%)
0	400	400	100.0
3	327	379	94.6
6	244	337	84.1
9	181	292	73.3
12	134	250	63.6
18	73	187	49.3
24	40	145	40.3
30	22	118	34.8
36	12	102	31.4
48	4	85	27.5
72	0	77	24.2
96	0	75	22.6



**Fig. 2.8.** Plots of data from Table 2.3 illustrating the exponential behaviour of data set 1 and the sigmoid and incomplete asymptotic behaviour of data sets 2 and 3 (a), and the natural logarithmic plots for data sets 1 and 2 with and without correction for the asymptotic indigestible residue (b).

can be used to illustrate the fitting of digestion data to alternative kinetic models. Data set 1 represents substrates with simple and complete degradation (Fig. 2.8a), such as sugars or protein (after correction for microbial contamination), which can be described with simple exponential models (Fig. 2.1, upper left model). Data set 2 represents substrates that exhibit sigmoid degradation curves (Fig. 2.8a) that require more complex models to adequately describe degradation, which include multiple pools, discrete lag times, or variable fractional rates (e.g. Models 1 to 5 or the generalized single exponential model of López *et al.*, 1999). Data set 3 represents substrates that have increasing variable rates of degradation during early fermentation and decreasing variable rates during late fermentation. Substrates like data set 3 may require models with multiple exponential pools (Mertens, 1977; Mahlooh *et al.*, 1984; Robinson *et al.*, 1986) or with variable fractional rates (e.g. inverse polynomial, generalized inverse polynomial, logistic, Gompertz, or generalized Von Bertalanffy models as described by López *et al.*, 1999).

The rationale for curve peeling is that pools with rapid first-order rates will decline to near zero at long times of reaction. Thus, at later reaction times the composite curve is primarily a function of pools with slow fractional rates of digestion and the composite curve at long times of reaction can be used to estimate the kinetic parameters of the slowest pool in the system. The first step in graphical curve peeling is to plot the observed data on semi-logarithmic graphing paper with residue as the Y axis (logarithmic scale) and time as the X axis (linear scale). Alternatively, the natural logarithm of the residue can be plotted versus time on linear graphing paper or using a computer spreadsheet (Fig. 2.8b). To identify the slowest pool using graph paper, draw a straight line through the linear portion of the data with the longest times of reaction (in the spreadsheet a regression line between time and the natural logarithm of the last data points can be used to define the slowest pool). After the line or regression

is established, it is peeled from the composite curve by subtracting its actual value (not its logarithm) at each time from the value of the composite line. This leaves a residual line that is the result of other pools in the system. If the residual line is linear, curve peeling is complete; if it is curvilinear, the peeling procedure is repeated on the residual line. The slope of each line is the fractional rate constant of that pool or compartment, whereas the intercept of each line may be the size of the pool or may be undefined, depending on whether the system has sequentially or simultaneously reacting pools. In practice, it is difficult to separate more than three pools unless extremely long times of reaction are recorded and the fractional rates differ greatly. It also is difficult to separate systems in which the fractional rates do not differ by a factor of three or more.

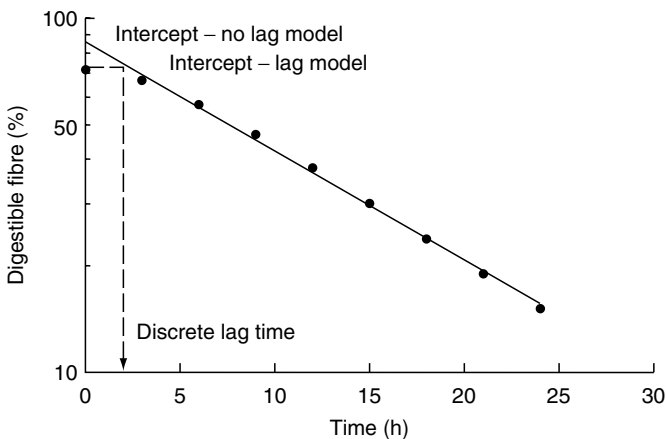
The plot of data set 1 (Table 2.3) is linear with only a slight deviation during initial fermentation (Fig. 2.8b). The linear semi-logarithmic line indicates that a first-order model with a constant fractional rate (equal to the slope of the line) is plausible and a model like that in Fig. 2.1 (upper left model) could be used to describe degradation of this substrate. However, data set 2 (Table 2.3) results in a non-linear semi-logarithmic line that appears to be asymptotic (Fig. 2.8b). An asymptotic plateau indicates a pool with a slope of zero (i.e. an indigestible pool), which corresponds to an indigestible residue that never degrades in the anaerobic system in which feeds are fermented as indicated by Wilkins (1969). Using curve peeling, the indigestible pool, which is typically assumed to be the residue after long (> 72 h) fermentation times, is subtracted from the composite data line to obtain a residual digestible pool or fraction (Fig. 2.8b). The line for the digestible fraction is linear suggesting that it can be represented by a first-order model with a constant fractional rate of digestion except during early fermentation.

Because a fractional digestion rate can only apply to a pool that is digestible, it is crucial that a valid estimate of the indigestible fraction be used to determine the potentially digestible fraction by difference. Mertens (1977) illustrated the consequences of using 48, 72, or 96-h fermentations to estimate the indigestible fibre fraction. If the 48-h observation in data set 3 (Table 2.3) is used to estimate the asymptote of fermentation, the residual plot of the potentially digestible fraction will be concave and shifted to the left, resulting in an overestimation of the indigestible fraction, fractional rate, and discrete lag time compared with the 72-h fermentation end-point. When data sets terminate at 24 or 48 h of fermentation, it is easy to miss the asymptotic nature of the digestion process in anaerobic systems and conclude that degradation can be described by a single exponential pool without an indigestible fraction. This conclusion results in estimates of fractional rates that are low compared with the true fractional rate of digestion because their rates are 'averaged' over both potential digestible and indigestible pools. These results not only cause confusion in the literature, but also they are fundamentally incorrect because they violate two assumptions of kinetic principles. First, the single digestion pool is an aggregate of both digestible and indigestible components and does not represent a pool with homogeneous kinetic properties. Second, the inclusion of the indigestible fraction in a digesting compartment results in the paradox that indigestible residue has a non-zero fractional rate of digestion.

When long times of fermentation ( $>90$  h) are used to estimate indigestible residues, semi-logarithmic plots may become convex and non-linear suggesting that the potentially digestible fraction can be described as the sum of two or more first-order pools with different rates. Robinson *et al.* (1986) confirmed that this model is most appropriate in some situations. Mahlooh *et al.* (1984) carried this approach to its extreme, and proposed that a stochastic model could describe digestion that assumes a population of digestible pools with a gamma distribution of fractional rates. Alternatively, sigmoid mathematical models (inverse polynomial, generalized inverse polynomial, logistic, Gompertz, and generalized Von Bertalanffy) as described by López *et al.* (1999), which have diminishing variable fractional rates toward the end of fermentation, can describe the degradation curve, but these models cannot be parameterized by curve peeling.

Data sets 2 and 3 (Table 2.3) indicate that disappearance of the potentially digestible fraction does not start instantaneously at time 0. Instead, there is a lag period during which digestion occurs slowly or not at all (see Fig. 2.9). Mertens (1977) suggested that the lag phenomenon could be easily described by the addition of a discrete lag time to the simple exponential model (Model 3). Fig. 2.9 indicates that the lag effect is a gradual process with an increasing variable fractional rate. This process can be described as two sequential first-order reactions (Model 4), as sigmoidal mathematical models, or as a generalized single exponential model with time dependency related to the square root of time (López *et al.*, 1999). López *et al.* (1999) observed that this latter model consistently performed the best based on lack-of-fit, residual mean of squares, and ease in fitting for DM, protein and NDF using *in situ* data.

Finally, data sets 1 and 2 (Table 2.3) are provided in mg to demonstrate that the units used to express the data do not affect the estimation of fractional rate constants. To prove this point, express the weight data as a percentage and plot it to show that the same fractional rate (slope of the line) will be



**Fig. 2.9.** Semi-logarithmic graph of digestible fibre illustrating the interpretation of the discrete lag-time model.

obtained whether the data are expressed as mg or percentages. It is often assumed that the data must be expressed as percentages before kinetic analysis because fractional rates are sometimes reported in the literature as %/h. The first-order rate constant is a pure fraction that has no units other than per hour. Expressing fractional rates as percentages or g/kg is confusing and erroneous.

### ***Logarithmic transformation and regression***

Although graphical curve peeling visualizes the process, estimating digestion kinetics using linear regression of logarithmically transformed data is a statistical adaptation of the process for estimating kinetic parameters. In this method, the indigestible residue, typically estimated from the last fermentation point, is subtracted from the measured residues at each fermentation time. The natural logarithm of the resulting potentially digestible residue is regressed on time (see Eq. 2.8). The regression coefficient obtained is an estimate of the first-order rate constant of digestion (if logarithms to the base 10 are used the resulting rate must be multiplied by 2.302). The regression intercept can be used to calculate a discrete lag time (Mertens and Loften, 1980) if a measurement of residue at  $t = 0$  is available (Eq. 2.27). If a lag effect is detected, the fermentations prior to the lag time must not be included because they bias the regression and result in an underestimation of both fractional rate and discrete lag time. The log-transform regression method, when combined with a good approximation of the indigestible residue and elimination of observations prior to lag, can yield reasonably accurate estimates of kinetic parameters.

An implicit assumption of logarithmic transformation is that the random error in the data is multiplicative rather than additive (Mertens and Loften, 1980; Moore and Cherney, 1986), which may be a potential problem in the use of the logarithmic transformation method for estimating kinetic parameters. In effect, log transformation assumes that observations with smaller residues (after long times of fermentation) have smaller errors and effectively gives greater weight to their contribution during regression analysis. However, it is typically observed that variation among replicated measurements is lowest at the end of fermentation when residue amounts are smallest. Therefore, it does not seem that the multiplicative error distribution associated with logarithmic transformation is a significant problem during parameter estimation.

The most serious problem with the logarithmic transformation and linear regression method of estimating kinetic parameters is error in estimating the indigestible fraction. Indigestibility measured at any time other than infinity is an overestimate of the asymptotic indigestible residue. A more accurate estimate of the indigestible residue can be obtained by iteratively assuming the indigestible residue is smaller than the observed end-point of fermentation and recalculating the log transformed linear regression coefficients. As the estimate of the indigestible residue is reduced, the  $R^2$  of regression increases until the indigestible residue that optimizes the  $R^2$  is obtained. The use of fermentation end-points as approximations of the indigestible residue can result in fractional

rates of digestion that are 10% to 15% too high and discrete lag times that are 20% to 30% too long.

### ***Non-linear least squares regression***

Many problems associated with curve peeling and logarithmic transformation-linear regression can be overcome by estimating kinetic parameters using non-linear least squares regression procedures (Mertens and Lofton, 1980; Moore and Cherney, 1986). As with linear regression, non-linear regression determines the values of regression coefficients that minimize the residual sums of squares from regression. Unlike linear regression, non-linear regression cannot calculate parameter solutions directly. Instead the estimates of model parameters are adjusted iteratively from an initial estimate to reduce the squared deviations from regression using numerical or analytical derivatives of the non-linear model. This approach is similar to that accomplished by manual iteration. Iteration continues until a negligible improvement in fit of the data to the model occurs. Several algorithms are used for non-linear regression, including steepest descent, Gauss-Newton, Marquardt compromise and simplex. Each algorithm has advantages and disadvantages that can influence the rate and occurrence of convergence to a solution that minimizes the deviation from regression to an acceptable level. Regardless of the algorithm used, standard errors of parameters derived by non-linear regression are based on linear assumptions and always underestimate the true uncertainty of parameter values.

Because of their ability to use all the data to identify the set of parameter estimates simultaneously, non-linear regression procedures are the method of choice for estimating kinetic parameters of digestion. However, the advantages of non-linear regression are not achieved without cost. In most cases, initial estimates for each parameter should be close to the final solution. In well-behaved models, poor selection of initial estimates will only increase computational time. In other models, poor initial estimates may not converge to a solution, or may arrive at a solution that is not valid. Complex, multi-exponential models can have several solutions that can fit a narrow range of observations with almost equal accuracy. This results from the occurrence of 'local' minima in residual sums of squared deviations from regression that do not correspond to the 'global' minimum that achieves the best fit of the data to the model equation.

To increase the probability that a non-linear solution is the global minimum, it is wise to develop specific algorithms for each non-linear model that derives initial estimates for parameters that are refined by iterative non-linear least squares regression. For example, linear regression after logarithmic transformation can be used to derive initial estimates for the simple models that have been described. Alternatively, several sets of initial estimates can be used for each data set to ascertain if they all converge to the same solution. If so, the kineticist can be reasonably confident that the global solution was obtained for a particular set of data.

The flexibility of multi-exponential models also causes them to be sensitive to variations in single data points when fitted by non-linear regression. It is not unusual for one parameter in the model to change dramatically in an attempt to reduce the deviations associated with an 'outlier' data point. It may be desirable to use weighted rather than unweighted least squares as the best minimization criteria to reduce effects of spurious data points. Choice of weighting factors is somewhat arbitrary, but the most commonly accepted weighting factor is the reciprocal of the variance at each observation time. However, this criterion can be used only when multiple measurements are made at each time. Alternatively, iteratively reweighted least squares can be used in data sets with single observations at each time. This approach attempts to use deviations from regression within the single data set to detect and minimize the effects of outlying data points. Iteratively reweighted non-linear least squares is not a panacea for poor data, but it can be helpful in deriving biologically useful parameter estimates from data with a few apparently outlying data points when used with caution and judgement.

## Conclusions

Quantitative description of rate and extent of digestion depends on:

1. The adequacy of the model in describing the real biological processes of digestion.
2. The appropriateness of the methods and experimental design used to collect kinetic data.
3. The accuracy of the method used to estimate kinetic parameters when observations are fitted to the model.

No single component of the methodology needed to quantify rate and extent of digestion can be ignored. Kinetic parameters are just as likely to be invalid when the data are appropriate, but the model is wrong, as when the model is adequate but the method of fitting it to the data is inaccurate. It is speculated that the first-order kinetic model that is used most often to describe the digestion process is a simplification of the real system. However, it can serve as an appropriate 'defender' model to be used to assess improvements in fitting and understanding associated with the use of 'challenger' models to be developed in the future. Current knowledge about measurement of the dynamic digestion process is adequate to suggest optimal experimental designs for measuring digestion kinetics. It appears that at least three observations are needed for each parameter to be estimated in the digestion model. It is also apparent that a broad range of fermentation times is needed to determine the existence and magnitude of the indigestible component. Greater variation associated with early digestion times and their importance in determining fractional rates and lag effects indicates that observations should be more closely spaced during early digestion. Finally, non-linear least squares regression procedures are the methods of choice for estimating kinetic parameters.



## References

- Allen, M.S. and Mertens, D.R. (1988) Evaluating constraints on fibre digestion by rumen microbes. *Journal of Nutrition* 118, 261–270.
- Baldwin, R.L., Koong, L.J. and Ulyatt, M.J. (1977) A dynamic model of ruminant digestion for evaluation of factors affecting nutritive value. *Agricultural Systems* 2, 255–287.
- Baldwin, R.L., Thornley, J.H.M. and Beever, D.E. (1987) Lactating cow metabolism. 2. Digestive elements of a mechanistic model. *Journal of Dairy Research* 54, 107–131.
- Black, J.L., Beever, D.E., Faichney, G.J., Howarth, B. and Graham, N.C. (1980) Simulation of the effects of rumen function on the flow of nutrients from the stomach of sheep. Part 1: Descriptions of a computer model. *Agricultural Systems* 6, 195–219.
- Blaxter, K.L., McC.Graham, N. and Wainman, F.W. (1956) Some observations on the digestibility of food by sheep and on related problems. *British Journal of Nutrition* 10, 69–91.
- Cherney, D.J.R., Patterson, J.A. and Lemenager, R.P. (1990) Influence of *in situ* rinsing technique on determination of dry matter disappearance. *Journal of Dairy Science* 73, 391–397.
- Dhanao, M.S. (1988) On the analysis of dacron bag data for low degradability feeds. *Grass and Forage Science* 43, 441–444.
- France, J., Thornley, J.H.M. and Beever, D.E. (1982) A mathematical model of the rumen. *Journal of Agricultural Science, Cambridge* 99, 343–353.
- France, J., López, S., Dijkstra, J. and Dhanao, M.S. (1997) Particulate matter loss and the polyester-bag method. *British Journal of Nutrition* 78, 1033–1037.
- Gill, S.S., Conrad, H.R. and Hibbs, J.W. (1969) Relative rate of *in vitro* cellulose disappearance as a possible estimator of digestible dry matter intake. *Journal of Dairy Science* 52, 1687–1690.
- Huntington, J.A. and Givens, D.I. (1995) The *in situ* technique for studying the rumen degradation of feeds: a review of the procedure. *Nutrition Abstracts and Reviews, Series B* 65, 63–93.
- Lechtenberg, V.L., Colenbrander, V.F., Bauman, L.F. and Rykerd, C.L. (1974) Effect of lignin on rate of *in vitro* cell wall and cellulose disappearance in corn. *Journal of Animal Science* 39, 1165–1169.
- Levenspiel, O. (1972) *Chemical Reaction Engineering*, 2nd edn. John Wiley & Sons, New York.
- López, S., France, J., Dhanao, M.S., Mould, F. and Dijkstra, J. (1999) Comparison of mathematical models to describe disappearance curves obtained using the polyester bag technique for incubating feeds in the rumen. *Journal of Animal Science* 77, 1875–1888.
- Mahlooh, M., Ellis, W.C., Matis, J.H. and Pond, K.R. (1984) Rumen microbial digestion of fibre as a stochastic process. *Canadian Journal of Animal Science* (Supplement 1) 64, 114–115.
- Mertens, D.R. (1977) Dietary fibre components: relationship to the rate and extent of ruminal digestion. *Federation Proceedings* 36, 187–192.
- Mertens, D.R. (1990) Evaluating alternative models of passage and digestion kinetics. In: Robson, A.B. and Poppi, D.P. (eds) *Proceedings of Third International Workshop on Modelling Digestion and Metabolism in Farm Animals*. Lincoln University, Canterbury, New Zealand, pp.79–98.

- Mertens, D.R. and Ely, L.O. (1979) A dynamic model of fibre digestion and passage in the ruminant for evaluating forage quality. *Journal of Animal Science* 49, 1085–1095.
- Mertens, D.R. and Loften, J.R. (1980) The effect of starch on forage fibre digestion kinetics *in vitro*. *Journal of Dairy Science* 63, 1437–1446.
- Michalet-Doreau, B. and Cerneau, P. (1991) Influence of foodstuff particle size on *in situ* degradation of nitrogen in the rumen. *Animal Feed Science and Technology* 35, 69–81.
- Moore, K.J. and Cherney, J.H. (1986) Digestion kinetics of sequentially extracted cell components of forages. *Crop Science* 26, 1230–1235.
- Negi, S.S., Singh, B. and Makkar, P.S. (1988) An approach to the determination of rumen degradability of nitrogen in low-grade roughages and partition of nitrogen therein. *Journal of Agricultural Science, Cambridge* 111, 487–494.
- Nocek, J.E. (1987) Characterization of *in situ* dry matter and nitrogen digestion of various corn grain forms. *Journal of Dairy Science* 70, 2291–2301.
- Nocek, J.E. (1988) *In situ* and other methods to estimate ruminal protein and energy digestibility: a review. *Journal of Dairy Science* 71, 2051–2069.
- Nocek, J.E. and Grant, A.L. (1987) Characterization of *in situ* nitrogen and fibre digestion and bacterial nitrogen contamination of hay crop forages preserved at different dry matter percentages. *Journal of Animal Science* 64, 552–564.
- Ørskov, E.R. and McDonald, I. (1979) The estimation of protein degradation in the rumen from incubation measurements weighted according to rate of passage. *Journal of Agricultural Science, Cambridge* 92, 449–503.
- Penry, D.L. and Jumars, P.A. (1987) Modelling animal guts as chemical reactors. *The American Naturalist* 129, 69–96.
- Poppi, D.P., Minson, D.J. and Ternouth, J.H. (1981) Studies of cattle and sheep eating leaf and stem fractions of grasses. III. The retention time in the rumen of large feed particles. *Australian Journal of Agricultural Research* 32, 123–137.
- Robinson, P.H., Fadel, J.G. and Tamminga, S. (1986) Evaluation of mathematical models to describe neutral detergent residue in terms of its susceptibility to degradation in the rumen. *Animal Feed Science and Technology* 15, 249–271.
- Segel, I.H. (1975) *Enzyme Kinetics Behavior and Analysis of Rapid Equilibrium and Steady-State Enzyme Systems*. John Wiley & Sons, New York.
- Smith, L.W., Goering, H.K. and Gordon, C.H. (1972) Relationships of forage compositions with rates of cell wall digestion and indigestibility of cell walls. *Journal of Dairy Science* 55, 1140–1147.
- Sutherland, T.M. (1988) Particle separation in forestomachs of sheep. In: Dobson, A. and Dobson, M.J. (eds) *Aspects of Digestive Physiology in Ruminants*. Comstock Publishing Associates, Ithaca, New York, pp. 43–73.
- Van Milgen, J., Murphy, M.R. and Berger, L.L. (1991) A compartmental model to analyse ruminal digestion. *Journal of Dairy Science* 74, 2515–2529.
- Van Milgen, J., Berger, L.L. and Murphy, M.R. (1992) Fractionation of substrate as an intrinsic characteristic of feedstuffs fed to ruminants. *Journal of Dairy Science* 75, 124–131.
- Vanzant, E.S., Cochran, R.C. and Titgemeyer, E.C. (1998) Standardization of *in situ* techniques for ruminant feedstuff evaluation. *Journal of Animal Science* 76, 2717–2729.
- Waldo, D.R. (1970) Factors influencing voluntary intake of forages. In: Barnes, R.F., Clanton, D.C., Gordon, G.H., Klopfenstein, T.J. and Waldo, D. (eds) *Proceedings of the National Conference on Forage Quality Evaluation and Utilization*. Nebraska Center for Continuing Education, Lincoln, Nebraska, pp. E1–E22.

- 
- Waldo, D.R., Smith, L.W. and Cox, E.L. (1972) Model of cellulose disappearance from the rumen. *Journal of Dairy Science* 55, 125–129.
- Weakley, D.C., Stern, M.D. and Satter, L.D. (1983) Factors affecting disappearance of feedstuffs from bags suspended in the rumen. *Journal of Animal Science* 56, 493–507.
- Wilkins, R.J. (1969) The potential digestibility of cellulose in forages and feces. *Journal of Agricultural Science, Cambridge* 73, 57–64.
- Zierler, K. (1981) A critique of compartmental analysis. *Annual Review of Biophysics and Bioengineering* 10, 531–562.

*This page intentionally left blank*

---

# 3

## Digesta Flow

G.J. Faichney

*School of Biological Sciences A08, University of Sydney, NSW 2006, Australia*

---

### Introduction

The structural carbohydrates that constitute plant fibre represent a major feed resource. Herbivorous animals, unable to produce fibre-degrading enzyme systems of their own, have evolved a range of strategies (Hume and Sakaguchi, 1991) to make use of a consortium of microbes, including bacteria, protozoa and anaerobic fungi, for this purpose. The strategy adopted by the ruminants involves the development of a compound stomach in which the feed eaten can be fermented by the microbes before being subjected to attack by the animal's own enzymes and, finally, to a second fermentation in the hindgut before the undigested residues are voided in the faeces. This strategy suits the domestic ruminants to the utilization of diets of moderate fibre content for the production of food and fibre and the provision of motive power. They are not so well adapted to poor quality diets of high fibre content because the extended time required to break down the fibre for passage out of the stomach severely limits the amount of such diets that can be eaten. Thus a knowledge of digesta flow through the ruminant gastrointestinal (GI) tract, and of the factors that affect it, is important because of its role both in the processes of digestion and absorption and in the expression of voluntary feed consumption.

### The Nature of Digesta

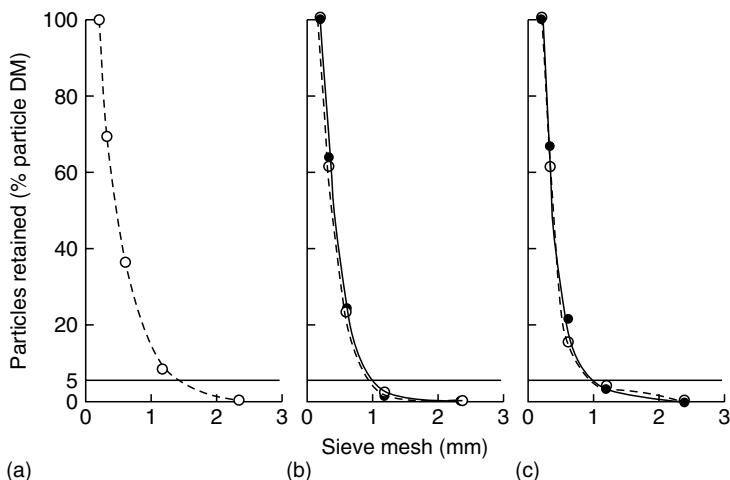
The ruminant GI tract consists of a succession of mixing compartments – the reticulorumen, abomasum and caecum/proximal colon, in which residues from successive meals can mix – and connecting sections in which flow is directional and axial mixing is minimal. Of these latter, the small intestine and the distal colon (consisting of the spiral colon, terminal colon and rectum) are tubular in nature. However, the omasum is a bulbous organ whose lumen is largely

occupied by leaves of tissue (the laminae) so that, although particulate matter may be retained between them, little mixing can occur. The digesta in the GI tract consist of particulate matter, including microorganisms, and water, in which is dissolved a range of organic and inorganic solutes of both dietary and endogenous origin. The relative proportions of these digesta components are different in the different sections of the tract.

The particles exist in a continuous range of sizes from the very small to pieces of plant material up to several centimetres long that can be found in the rumen when a diet of long hay is given. In order to study the characteristics of these particles, various sieving procedures have been devised which divide the continuum of sizes into fractions of defined size range. Both dry- and wet-sieving procedures have been used but it is now generally accepted that a wet-sieving procedure is preferable for digesta particles (Kennedy, 1984; Ulyatt *et al.*, 1986). However, plant particles are generally elongated, often having a length/width ratio in excess of six (Evans *et al.*, 1973), and there remains uncertainty regarding the relative importance of length and diameter in the separations achieved during sieving. McLeod *et al.* (1984) concluded that discrimination in their wet-sieving procedure was mainly on the basis of diameter. However, examination of their data indicates that for three of five fractions, particle diameter was less than the mesh size of the sieve which retained them, and particle length was less than the theoretical maximum (Vaage *et al.*, 1984) for particles passing through the particular sieve. Thus it seems more likely that, with their technique, discrimination between particles was mainly on the basis of length. The technique used by Evans *et al.* (1973) also appeared to discriminate on the basis of length (Faichney, 1986).

Particles that pass a sieve of mesh 150  $\mu\text{m}$  are sufficiently fine to behave like solutes (Hungate, 1966; Weston and Hogan, 1967; Kennedy, 1984) but, in the rumen, only a proportion of them flow in the fluid phase (FP) because many are trapped in the 'filter-bed' of the reticulorumen digesta mass (Faichney, 1986; Bernard *et al.*, 2000). On the other hand, particles above a certain size are retained in the reticulorumen, few if any being found in digesta distal to the reticulorumen (Ulyatt *et al.*, 1986). This has led to the concept of a critical size above which particles have a low probability of passage from the rumen (large particles). Poppi *et al.* (1980) presented evidence to support the use of a sieve of mesh 1.18 mm to define the critical size for both sheep and cattle. Subsequently, Kennedy and Poppi (1984) suggested that different sieve sizes could be used for cattle and sheep on the basis that sieves of, respectively, 1.18 and 0.89 mm mesh would retain 5% of the faecal particulate dry matter (DM). Values of 1.41 mm for grazing cattle and 0.91–1.08 mm for sheep given lucerne hay can be obtained from the data illustrated in Fig. 3.1, and a value of 1.2 mm can be obtained for grazing cattle from the data of Pond *et al.* (1984), supporting the suggestion of a real, albeit small, difference in critical size between cattle and sheep.

It has been claimed that the critical size is not constant but increases when hay is ground and when the level of intake increases (Van Soest, 1982). However, this claim has been challenged (Faichney, 1986) because it was based on an observed increase in faecal mean particle size, a measure that



**Fig. 3.1.** Cumulative particle size distribution in: (a) faeces from grazing cattle; (b) faeces from sheep given chopped (○- - - ○) or ground (●-●) lucerne hay (Van Soest, 1982); and (c) digesta leaving the stomach of sheep given chopped (○- - - ○) or ground and pelleted (●-●) lucerne hay.

gives no information on critical size. The data of Van Soest (1982) for faecal particle size in sheep given chopped or pelleted lucerne hay are plotted in Fig. 3.1b; sieves of, respectively, 0.98 and 0.91 mm mesh would have retained 5% of the particles. For comparison, Fig. 3.1c shows data from the author's laboratory for particles in digesta leaving the abomasum of sheep given 1 kg/day of lucerne hay either chopped or ground and pelleted; sieves of, respectively, 1.08 and 1.06 mm mesh would have retained 5% of the particles. Faichney and Brown (1991) found no significant effect of grinding lucerne hay on critical mesh size and could find no evidence of an increase in critical mesh size as the intake by sheep increased from 20% to 90% of voluntary consumption. In fact, the critical mesh size at the lowest intake (1.12 mm) was higher ( $P < 0.05$ ) than at the higher intakes (0.91 mm). Chewing time during rumination decreases as intake increases (Faichney, 1986) so that it might be expected that the size of particles leaving the reticulorumen would increase as intake increases. However, this does not occur because the efficiency of rumination increases as intake increases (Faichney, 1990). Thus the available data support the conclusion that the critical size of particles for passage from the reticulorumen is relatively unaffected by grinding and pelleting the diet or by the level of feed intake.

Selective retention of particles in the reticulorumen, which is more pronounced in cattle than in sheep and goats (Lechner-Doll *et al.*, 1991), is also affected by the buoyancy, or functional specific gravity (FSG), of the particles (Sutherland, 1987; Kennedy and Murphy, 1988; Lechner-Doll *et al.*, 1991). The FSG of a particle in the reticulorumen is a function of its solid, liquid and gaseous components. Thus recently ingested particles, undergoing rapid

fermentation, tend to have a relatively low FSG. Such particles also tend to be larger because less time has been available for comminution by chewing during rumination so that size and buoyancy are directly related (Sutherland, 1987). For particles of a given size, retention in the reticulorumen decreases as FSG increases (Lechner-Doll *et al.*, 1991). However, retention of particles in the abomasum increases with density (Faichney, 1986), leading to the commonly observed optimum FSG for passage through the stomach of ruminants (Kennedy and Murphy, 1988). As there is no differential passage of fluid and particulate matter distal to the abomasum (Faichney, 1986), this optimum is probably due to selective retention of particles in the abomasum (Faichney, 1975a; Barry *et al.*, 1985) on the basis of their density. Such selective retention may occur because particles in the abomasum must be drawn up, against their tendency to settle, and pumped upwards through the pylorus by antral contractions. Thus, small, dense particles would stay in the abomasum for extended periods as is the case with copper oxide needles used as a slow-release copper supplement (Faichney, 1986).

The microbial population of the reticulorumen digesta consists largely of bacteria, protozoa and anaerobic fungi. The latter colonize plant particles, invading them by hyphal extension of the thallus within the plant tissue, and reproduce by releasing motile zoospores which then colonize new particles (Orpin, 1975). They can contribute 1% to 4% of the non-ammonia nitrogen in the reticulorumen, but may be completely suppressed if free (accessible) lipid exceeds about 4% of the diet (Faichney *et al.*, 1997, 2002). Bacteria and protozoa are found both free-floating and attached to particulate matter. For example, Faichney *et al.* (1997) found 53–62% of the bacterial nitrogen and 61–76% of the protozoal nitrogen in the sheep reticulorumen in the fluid phase. The sheep were given a hay diet on which bacteria contributed 58–62% and protozoa 35–41% of the microbial nitrogen in the reticulorumen or a hay/concentrate diet on which the contributions were 33–40% for bacteria and 57–66% for protozoa. The proportion of the microbial population that is free-floating appears to depend on the diet and the rumen turnover rate (Faichney and White, 1988a).

Distal to the stomach, digesta become progressively more viscous as digestive and mucous secretions are added and water is absorbed. The plant particles that leave the stomach flow together with microbial residues and epithelial cells shed into the digesta, showing no evidence of differential passage (Faichney, 1986), indicating that there is no separating mechanism in the ruminant small intestine and hindgut (Faichney and Boston, 1983).

## Digesta Flow

Digesta flow can be considered in terms of velocity, flow rate or rate of passage (Warner, 1981). Velocity, which has units of distance per unit time, is applicable only to tubular segments of the GI tract where it provides an index of gut motility. Flow rate refers to the volume or mass of digesta passing a point in the GI tract per unit time and its measurement in association with particular



analyses allows estimates to be made of the partition of digestion, i.e. the extent of digestion, absorption and/or secretion occurring in defined segments of the tract.

Rate of passage is a measure of the time during which a portion of digesta is exposed to the processes of mixing, digestion and absorption in the GI tract or a defined segment of it; it is measured as the mean retention time (MRT), which is the ratio of the amount of any component of digesta in a segment to the flow of that digesta component from that segment. Thus the MRT of a digesta component is its time constant of flow. Under steady-state conditions, i.e. with all volumes and flow rates constant, the fractional outflow rate (FOR) of a digesta component from a segment of the GI tract can be calculated as the reciprocal of its MRT. However, there cannot be an FOR for reticulorumen particulate matter and its constituents because large particles cannot leave the reticulorumen until they are reduced in size (see above). For any digesta component, MRTs in successive segments are additive. On the other hand, within a segment of the GI tract, fractional rates applying to a digesta component are additive; thus, in the reticulorumen, the fractional disappearance rate of a digesta component is the sum of its fractional degradation rate and its FOR.

## Measurement of Digesta Flow

### *Surgical preparations*

Measurement of digesta flow requires some degree of surgical modification of the animal. A continuous record of digesta flow can be obtained by implanting an electromagnetic flow probe at the reticulo-omasal orifice (Dardillat, 1987) or the ascending duodenum (Poncet and Ivan, 1984). For the measurement of the flow of digesta components, cannulation of the GI tract is required so that samples can be taken for analysis. Samples from the reticulum are not representative of digesta leaving the reticulorumen because they contain large particles not found distal to the reticulo-omasal orifice (Hogan, 1964). Attempts have been made to sample digesta leaving the rumen by cannulating the omasum (Hume *et al.*, 1970) or by diverting to the exterior the digesta flowing into (Collombier *et al.*, 1984) or from the omasum (Bouchaert and Oyaert, 1954), but these techniques are not in common use. Estimates of rumen outflow have been made from samples taken by aspiration from the omasal canal through a tube passed through the reticulo-omasal orifice via a rumen fistula (e.g. Faichney *et al.*, 1994; Ahvenjärvi *et al.*, 2000). However, most of the studies of digesta flow from the stomach involve either simple cannulas close to the pylorus (in the antrum of the abomasum or the ascending duodenum) or re-entrant cannulas in the duodenum. Similarly, simple or re-entrant cannulas can be used to measure digesta flow at selected points along the small intestine, most commonly at the terminal ileum. Re-entrant cannulas, which divert digesta flow outside the body, allow it to be measured directly by total collection (MacRae, 1975) or by the use of an electromagnetic flow meter (Singleton, 1961). Measurement of digesta flow in animals fitted with simple

cannulas requires the use of markers (see below) or of an electromagnetic flow probe inserted into the cannula (Malbert and Ruckebusch, 1988).

Several workers have examined the effects of these surgical preparations on the animal and its performance. Wenham and Wyburn (1980) showed by radiological observations that intestinal cannulation disrupted normal digesta flow; flow was affected more in the duodenum than in the more distal sites and re-entrant cannulas caused the most disturbance. Poncet and Ivan (1984) reported disturbances in GI electrical activity due to cannulation; these were most marked with re-entrant cannulas. However, MacRae and Wilson (1977) found little difference in voluntary feed consumption, digestibility, marker MRT and several blood parameters in sheep before and after being fitted with simple or re-entrant cannulas in the duodenum and terminal ileum. Thus, in terms of nutrient supply, the sheep appeared not to have been affected by cannulation, but the question of a metabolic effect with the re-entrant preparation remains open because these sheep showed a reduction in wool growth (MacRae and Wilson, 1977).

### ***Re-entrant cannulas and total collection***

MacRae (1975) has reviewed the use of re-entrant cannulas for measuring digesta flow in the small intestine. Diversion of digesta without their return to the distal cannula results in substantial increases in flow due to the reduction in pressure distal to the cannula (Ruckebusch, 1988). Collection procedures involving the diversion, sampling and return of digesta tend to depress digesta flow, necessitating the use of an indigestible marker whose recovery can be used to correct the flow rate. The depression in flow rate may be a consequence of short-term disturbances since, when collections are continued over several days, reduced flow in the first 24 h may be compensated for over the next 48 h (MacRae, 1975).

Automated equipment has been developed to make continuous digesta collections for periods of several days (MacRae, 1975). Although flow measurements made with such equipment should be reliable, it is advisable to maintain the routine use of a marker. With such long-term collection techniques, it would be possible to study the changes in digestive function consequent upon, for example, changes in the quantity or composition of the diet, or even those associated with meals, but no such studies have been reported. However, Malbert and Baumont (1989) have studied the effect of changing the diet on duodenal digesta flow using an electromagnetic flow probe inserted into a simple cannula.

### ***Simple cannulas and the use of markers***

When animals are prepared with simple cannulas in the small intestine, indigestible markers are required to measure digesta flow at the point of cannulation. They can also be used to measure the MRT between the point at which the marker is administered and any point distal to that location at

which samples can be taken, as well as the MRT in cannulated mixing compartments (reticulorumen, abomasum or caecum/proximal colon). From reviews of a variety of markers, the criteria of the ideal marker can be summarized as follows (Faichney, 1975b):

1. It must be strictly non-absorbable.
2. It must not affect or be affected by the GI tract or its microbial population.
3. It must be physically similar to or intimately associated with the material it is to mark.
4. Its method of estimation in digesta samples must be specific and sensitive and it must not interfere with other analyses.

The ideal marker does not exist and care is needed to ensure that the effects of all assumptions, both explicit and implied, regarding marker behaviour are taken into account when interpreting results obtained by their use.

Faichney (1975b) and Warner (1981) have described the methods used for the measurement of digesta flow and rate of passage. The most commonly used method for measuring digesta flow involves administration of markers at a constant rate, either in the diet or by infusion at a point proximal to the points at which flow is to be measured, followed by sampling at that (those) points once equilibrium (steady-state) conditions have been achieved. Steady-state conditions exist when marker pools and flows proximal to the sampling points are constant and are reflected in constant concentrations of markers in the samples when the animal is fed continuously (Faichney, 1975b), or at regular short intervals, or in a repeating pattern of concentrations related to the feeding and/or marker dosing patterns (Faichney, 1980a; Dove *et al.*, 1988). Digesta flow can then be calculated as marker dose rate divided by mean marker concentration in digesta.

This calculation assumes that the concentrations in the sample of all the constituents of digesta, including the marker, are the same as in the digesta flowing past the sampling point. However, as already discussed, digesta consist of a heterogeneous mixture of particulate matter and fluid. When sampling through a simple cannula, it is difficult to obtain samples containing these constituents in the same proportions as are present in the organ sampled or flowing past the cannula (Hogan, 1964; Hogan and Weston, 1967). Similarly, the concentration of any single marker in the sample may differ from that in the digesta and so may introduce errors into the calculated values for digesta flow. For example, although chromium sesquioxide ( $\text{Cr}_2\text{O}_3$ ) is the most commonly used marker for estimating faecal output and is satisfactory for correcting flow estimates made by total collection from re-entrant cannulas (MacRae, 1975), it behaves independently of both the fluid and particulate phases of digesta (criterion 3 above). When samples are taken from simple cannulas, it gives estimates of flow rate that can be grossly in error (Faichney, 1972; Beever *et al.*, 1978) and should never be used for this application, even in association with other markers.

Other markers, used alone, have also been shown to give erroneous flow values (Faichney, 1980a). Hogan and Weston (1967) suggested that, if digesta in forage-fed ruminants were considered to consist of two phases, a particle phase and a fluid phase, two markers could be used to measure digesta flow as

the sum of the two phases. This approach requires that each marker associates exclusively with and distributes uniformly throughout the phase that it marks.

### ***The double-marker method***

To overcome the requirement of exclusive association, Faichney (1975b) proposed a method by which two markers could be used simultaneously to correct for sampling errors so as to calculate the composition and flow of the digesta actually passing a sampling point, i.e. true digesta, and later extended it to the calculation of reticulorumen true digesta content (Faichney, 1980b). This method, called the double-marker method to distinguish it from methods that use markers to measure the flow of different phases of digesta independently (Faichney, 1980a), does not require that each marker associates exclusively with one phase but does assume uniform distribution of the markers within phases.

Thus, given that steady state has been achieved and is maintained by continuous infusion of a solute marker ( $S$ ) and a particle-associated marker ( $P$ ) and that their concentrations are normalized by expressing them as fractions of the daily dose per unit of digesta or its phases, it can be shown (Faichney, 1975b, 1980b) that:

$$R = (P_{DG} - Z \cdot S_{DG}) / (Z \cdot S_{FP} - P_{FP}) \quad (3.1)$$

where  $R$  is the reconstitution factor, i.e. the number of units of FP that must be added to (or removed from) one unit of digesta (DG) to obtain true digesta (TD), and  $Z$  is the marker concentration ratio,  $P/S$ , in TD; when calculating TD passing a point distal to the reticulorumen,  $Z = 1$ .

For these calculations, marker concentrations must be corrected for losses due to absorption and/or leakage from cannulas (Faichney, 1975a,b, 1980b). Similarly,

$$R' = (P_{DG} - Z \cdot S_{DG}) / (Z \cdot S_{PP} - P_{PP}) \quad (3.2)$$

and

$$R^* = (P_{PP} - Z \cdot S_{PP}) / (Z \cdot S_{FP} - P_{FP}) \quad (3.3)$$

$$= -R/R' \quad (3.4)$$

where  $R'$  is the number of units of particle phase (PP) that must be added to (or removed from) one unit of DG to obtain TD and  $R^*$  is the number of units of FP that must be added to one unit of PP to obtain TD (note that  $R'$  is negative when  $R$  is positive and that  $R^*$  is always positive).

Then, for the concentration,  $C$ , of any constituent:

$$\begin{aligned} C_{TD} &= (C_{DG} + R \cdot C_{FP}) / (1 + R) = (C_{DG} + R' \cdot C_{PP}) / (1 + R') \\ &= (C_{PP} + R^* \cdot C_{FP}) / (1 + R^*) \end{aligned} \quad (3.5)$$

Marker concentrations in TD are calculated from Eq. (3.5) and then, for digesta flow,  $F$ , distal to the reticulorumen:

$$F_{TD} = 1/S_{TD} = 1/P_{TD} \quad (3.6)$$

If sampling is continued for at least 24 h after ending the infusion, reticulorumen TD content,  $Q_{TD}$ , can be calculated using uncorrected marker concentrations (Faichney, 1986) in Eqs (3.1)–(3.5) by setting  $Z = MRT_P/MRT_S$ , determined as  $k_S/k_P$  from the disappearance curves  $y(t) = y(0) \exp(-kt)$  where  $y$  is the concentration of marker in TD (using the concentrations in DG will provide a reasonable approximation but the TD values can be obtained iteratively by recalculating the concentrations using the  $P/S$  ratio  $Z_i$  from Eq. (3.11) in Eqs (3.1)–(3.3) and refitting the model; two iterations should suffice). Note that only those markers whose reticulorumen disappearance can be described by this model can be used to calculate  $Z$ .

Then, if MRT is expressed in hours:

$$Q_{TD} = MRT_S/(24S_{TD}) = MRT_P/(24P_{TD}) \quad (3.7)$$

The preparation of the particle-rich (PP) and fluid-rich (FP) subsamples of the digesta sample (DG) must be done at the time of sampling. It may be done by centrifugation but is best done by straining because the filtrate so produced contains fine particles that would be expected to behave like solutes (Hogan and Weston, 1967) in the GI tract.

A sample of TD can be reconstituted physically for subsequent analysis since TD is made up of the two subsamples, PP and FP. Thus a quantity,  $w$ , of TD can be reconstituted from a quantity,  $x$ , of PP and a quantity,  $y$ , of FP from the relationship:

$$w_{TD} = x_{PP} + (R^* \cdot x)_{FP} = (y/R^*)_{PP} + y_{FP} \quad (3.8)$$

However, before doing such a reconstitution, it is important to confirm that the equalities shown in Eq. (3.5) hold. Failure indicates a problem in the analysis of one or other marker either in DG, PP and/or FP. The most likely sources of error are in the analysis of PP for the solute marker and of FP for the particle-associated marker. The values obtained can be compared with the expected values by first calculating the fluid-phase fraction (FPF) as described by Faichney (1986):

$$FPF_{DG} = (DM_{PP} - DM_{DG})/(DM_{PP} - DM_{FP}) \quad (3.9)$$

Then

$$C_{DG} = (1 - FPF_{DG}) \cdot C_{PP} + FPF_{DG} \cdot C_{FP} \quad (3.10)$$

Thus, given the marker concentration in DG and one phase, the concentration in the other phase can be calculated. The FPF in TD,  $FPF_{TD}$ , can be calculated

by substituting  $DM_{TD}$  in Eq. (3.9). It can then be seen that  $R^* = FPF_{TD}/(1 - FPF_{TD})$ .

If marker concentrations are determined in DG, PP and FP for individual reticulorumen samples during the marker disappearance phase, and checked as described above (Eqs (3.9) and (3.10)), the samples can be reconstituted by correcting  $Z$ , the  $P/S$  marker concentration ratio, for marker disappearance (Faichney, 1992a). Thus:

$$Z_i = Z \exp[(k_S - k_P)t_i] \quad (3.11)$$

where  $Z_i$  is the  $P/S$  marker concentration ratio in the reticulorumen sample  $i$ ,  $Z = k_S/k_P$  following termination of a continuous infusion (see preamble to Eq. (3.7)) and  $t_i$  is the time (h) elapsed since the termination of the infusion. After substituting  $Z_i$  in Eqs (3.1)–(3.3) and confirming the equalities in Eq. (3.5), the reconstitution factor  $R_i^*$  (Eq. (3.3)) can be used to reconstitute reticulorumen sample  $i$  (Eq. (3.8)).

Following a single dose of the markers and expressing concentrations as fractions of the dose, samples can be reconstituted as above by substituting the dose ratio,  $Z = 1$ , in Eq. (3.11) and using Eqs (3.1)–(3.5) and (3.8). Then, marker distribution space,  $Q_{TD}$ , can be calculated as:

$$\begin{aligned} Q_{TD} &= 1/S_{TD(0)} = 1/P_{TD(0)} \\ &= \frac{1}{n} \sum_{i=1}^n \exp(-k_S t_i)/S_{TDi} = \frac{1}{n} \sum_{i=1}^n \exp(-k_P t_i)/P_{TDi} \end{aligned} \quad (3.12)$$

The continuous infusion double-marker method is commonly used to measure digesta flow and reticulorumen digesta content when animals are fed continuously or at short intervals. However, it can also be used when animals are given one or two meals daily because the repeating 24-h feeding cycle can be considered to be a steady state (Faichney, 1980a). Samples are taken to represent a sequence of sub-periods within the feeding cycle and mean values of TD flow or reticulorumen TD content for the feeding cycle are obtained. If there are  $n$  sub-periods, estimates of variation in TD flow or reticulorumen TD content between sub-periods can be obtained by calculating the mean values for FP and PP from the mean TD value using the FPF for TD (Eq. (3.9)), assigning corrected values to the sub-periods in proportion to the relative marker reciprocal factors (RMRFs) and summing to obtain the TD values. For any sub-period  $i$

$$RMRF_{FPi} = (1/S_{FPi}) / \left[ \frac{1}{n} \sum_{i=1}^n (1/S_{FPi}) \right] \quad (3.13)$$

and

$$RMRF_{PPi} = (1/P_{PPi}) / \left[ \frac{1}{n} \sum_{i=1}^n (1/P_{PPi}) \right] \quad (3.14)$$

Theoretically, digesta flow can be measured using a single dose of an indigestible marker, provided steady-state conditions apply during passage past the sampling point of the whole dose, because the product of digesta flow and the integral of (or area under) the marker concentration vs. time curve represents the marker dose. Thus, expressing  $C$  as a fraction of the dose,  $F = 1 / \int_0^\infty C dt$ . Although the double-marker method can be applied using the integrals in place of the marker concentrations (Eq. (3.1), etc.), it is probably not a practical approach to flow measurement because of the frequent sampling and the large number of analyses required. However, the principle has a useful application in determining the digestibility of a labelled compound in the small intestine because flow itself need not be determined. Thus, if a labelled compound,  $A$ , and a marker,  $M$ , are given simultaneously into the duodenum and samples are taken from a simple cannula in the terminal ileum:

$$\text{Digestibility of } A = 1 - (\text{AUC}_A / \text{AUC}_M) \tag{3.15}$$

where AUC is the area under the concentration (fraction of dose per kg) vs. time curve. An approximation to this method was used by Ashes *et al.* (1984) to measure the intestinal digestibility of radioactively labelled protein.

### Consequences of variations in marker distribution

In practice, particle-associated markers are not distributed uniformly throughout the particulate matter. For example, it can be seen in Table 3.1 that, in reticulorumen digesta, the concentrations of the particle-associated markers  $^{169}\text{Yb}$  (Siddons *et al.*, 1985) and the phenanthroline complex of  $^{103}\text{Ru}$  (Tan *et al.*, 1971) are higher in the fine-particle DM of the reticulorumen FP than in the larger particle DM of the reticulorumen particle phase. Table 3.1 also shows that this distribution changes when the digesta are exposed to the acid

**Table 3.1.** Concentration<sup>a</sup> (mean and coefficient of variation) of particle-associated markers in the particle and fluid phases of digesta present in the rumen and leaving the abomasum<sup>b</sup> of sheep.

Marker	Rumen digesta			Digesta passing pylorus		
	Particle phase	Fluid phase	Ratio PP:FP	Particle phase	Fluid phase	Ratio PP:FP
$^{169}\text{Yb}$ ( $n = 4$ )	0.776 (25%)	2.001 (11%)	0.4 (44%)	1.584 (7%)	1.774 (18%)	0.9 (11%)
$^{103}\text{Ru-phen}$ ( $n = 4$ )	1.177 (8%)	1.946 (12%)	0.6 (18%)	1.861 (9%)	1.485 (3%)	1.3 (11%)

<sup>a</sup>Fraction of daily infusion rate per kg DM.

<sup>b</sup>Samples taken from the duodenal bulb during intraruminal infusion of  $^{169}\text{Yb}$  chloride (Faichney *et al.*, 1989) and from the pyloric antrum during intraruminal infusion of  $^{103}\text{Ru-phen}$  (G.J. Faichney and H. Tagari, unpublished results).

conditions of the abomasum, but to a different extent for each marker. Thus, while the  $^{169}\text{Yb}$  concentration in FP DM remained relatively high, that of  $^{103}\text{Ru}$ -phen was lower than in particle phase DM.

The consequences of such differences in distribution were discussed by Faichney (1992b) and are illustrated in the sensitivity test shown in Table 3.2. The synthetic data used were based on the author's use of the markers  $^{51}\text{Cr}$ EDTA (solute),  $^{103}\text{Ru}$ -phen and  $^{169}\text{Yb}$  in sheep. Changing the distribution of the particle marker to the extent that might be observed with  $^{169}\text{Yb}$  increased  $R$  from 0.1847 to 0.2380 (29%) relative to the ideal but decreased DM flow by only 3%. Changing the distribution to the extent that might be observed with  $^{103}\text{Ru}$ -phen decreased  $R$  from 0.1847 to 0.1642 (11%) relative to the ideal but increased DM flow by only 1%. When the distribution was biased towards PP (Ru-phen), DM flow was 4% greater than when the bias was towards FP (Yb). Ortigues *et al.* (1990) reported differences of a similar order of magnitude from an experiment with cattle in which they compared Ru-phen and Yb as particle-associated markers in the double-marker system. By contrast with the simulation in Table 3.2, their sampling procedures resulted in negative  $R$  values, so that  $R$  calculated using Yb was 20% less than when Ru-phen was used and DM flow was 5% greater.

However, Ortigues *et al.* (1990) modified the double-marker method by imposing the assumption that their solute marker, CrEDTA, remained totally in solution even though it is known that some CrEDTA does adsorb to particulate matter (Faichney, 1975b). This adsorption leads to a higher apparent concentration of CrEDTA in digesta water than in FP water in samples of abomasal or duodenal digesta. Table 3.2 shows that, when the apparent

**Table 3.2.** Sensitivity of the digesta (DG)/fluid phase (FP) reconstitution factor ( $R$ ), and of calculated water and dry matter (DM) flow, to deviations from uniform distribution of the particle marker throughout the DM of the particle phase (PP) and digesta (DG) and of the solute marker throughout the water of the FP and digesta—simulation of true digesta (TD) flowing to the duodenum of sheep during continuous infusion of markers. Concentrations are fractions of the daily infusion rate per kg.

<i>Synthetic data:</i>						
	DG	PP	FP		TD	
Solute marker (day/kg)	0.0940	0.0700	0.0980	$R = 0.1847$	0.09462	
Particle marker (day/kg)	0.1056	0.5279	0.0352	$R' = -0.02533$	0.09462	
DM (kg/kg)	0.0600	0.3000	0.0200	$R^* = 7.2914$	0.05376	
<i>Simulation:</i>						
	Solute marker (water ratio) DG:FP					
Particle marker (DM ratio) PP:FP	1.0			1.03		
	$R$	Water flow (l/day)	DM flow (g/day)	$R$	Water flow (l/day)	DM flow (g/day)
1.4 ( $^{103}\text{Ru}$ -phen)	0.1642	10.00	574.8	0.1246	9.74	573.2
1.0	0.1847	10.00	568.2	0.1401	9.75	568.2
0.6 ( $^{169}\text{Yb}$ )	0.2380	10.00	552.0	0.1806	9.76	555.6



concentration of the solute marker in digesta water was assumed to be 3% higher than that in FP water, imposing the assumption of complete solution resulted in an increase in  $R$  from 0.1401 to 0.1847 (32%) and an increase of 2.6% in calculated water flow, and increased the difference in DM flow between the particle-associated markers from 3% to 4%. Thus, in using the double-marker method, it is important to: (i) use sampling methods that minimize sampling errors so that errors due to variable distribution of particle-associated markers remain small; (ii) not impose the assumption of complete solution on the solute marker; and (iii) to compare marker concentrations obtained in PP and FP with expected values calculated using Eq. (3.10) so as to confirm the equalities in Eq. (3.5).

### **Conclusions on marker methods**

The assumption that digesta can be considered as two phases, upon which the double-marker method relies, appears reasonable for forage diets. However, for some concentrate and mixed diets, especially those based on maize silage, digesta flowing to the duodenum can be so heterogeneous that this assumption fails and the double-marker method is inappropriate (Faichney, 1993). France and Siddons (1986) have shown that the double-marker method may be extended to the use of three (or more) markers provided that their partition between the notional three (or more) phases is significantly different. This procedure has been used by Ahvenjärvi *et al.* (2000) in cows given silage/barley/oilseed by-product diets. If digesta are so heterogeneous that multiple marker systems cannot be used, total collection procedures must be used if digesta flow measurements are required.

In summary, no single marker can give reliable values for digesta flow. Taking the average of two values obtained using two independent markers (Mambrini and Peyraud, 1994) does not improve reliability and does not correct for sampling errors affecting other digesta constituents. The use of two (Hogan and Weston, 1967) or three (Armentano and Russell, 1985) markers to measure the flow of defined phases of digesta will improve the reliability of digesta flow measurements but suffers from the disadvantage that the assumption of exclusive association of each marker with its phase must be made. On the other hand, the use of two (Faichney, 1975b; this chapter) or more (France and Siddons, 1986) markers which partition differentially between digesta phases does not require the assumption of exclusive association and, by allowing for sampling errors, provides corrected concentrations not only for the markers but also for the other digesta constituents of interest. The reservations regarding the double-marker method expressed by Titgemeyer (1997) appear to be based on the misapprehension that ideal marker behaviour is required. However, his conclusion that complete faecal recovery of markers should be verified confirms the importance of criterion 1 above.

The use of  $\text{Cr}_2\text{O}_3$  with sampling from simple cannulas appears to have increased in recent years (Faichney, 1993; Titgemeyer, 1997). Despite the statement of Firkins *et al.* (1998) that they could find ‘...no definitive

evidence . . . to choose the double-marker technique over  $\text{Cr}_2\text{O}_3$  . . .', there are sound theoretical reasons and good experimental evidence (see above) to exclude the use of  $\text{Cr}_2\text{O}_3$  as a digesta flow marker. Its continued use for this application should be actively discouraged to prevent the accumulation of unreliable data in the literature (Faichney, 1993).

### ***Digesta flow in sheep and cattle***

In Table 3.3, data from the literature on digesta flow in sheep and cattle have been summarized. The data for cattle are limited because few workers who study the partition of digestion in cattle report their digesta flow values. It can be seen that, for sheep on a given diet, digesta flow is a function of feed intake. It occurs through an increase in the amount passed from the reticulorumen per contraction because the total number of contractions per day remains relatively constant and similar for sheep and cattle (Ulyatt *et al.*, 1986). Digesta flow is also influenced by physical and chemical characteristics of the diet and by animal factors. The highest rates of flow of duodenal digesta occur in animals given fresh forage and the lowest rates occur with concentrate diets. The effects of intake and physical form of a lucerne hay given to sheep are illustrated in Fig. 3.2. Grinding a forage (Fig. 3.2) or including concentrates with a forage decreases flow. Thus duodenal flow tends to decrease in the order: fresh forage > dried forage > chopped hay > ground hay and mixed diets > concentrates. Pregnancy and lactation are associated with increased flow and flow appears to be higher in cattle than in sheep. Digesta flow through the terminal ileum is much less than through the duodenum but some of these effects can still be detected.

The coefficient of variation associated with measurement of duodenal digesta flow has ranged from 4% to 20% and, for ileal flow, from 9% to 23% (MacRae, 1975). A range from 6% to 20% was reported for concentrate diets (Faichney, 1975b). The values for the data in Fig. 3.2 range from 7% to 14% (chopped hay) and from 4% to 16% (ground and pelleted hay); the standard deviations increased from 0.2 to 2 kg/day (chopped hay) and 0.7 to 1.3 kg/day (ground and pelleted hay) as intake increased. It is often noted that, within a group of sheep, the ranking of animals on the basis of digesta flow tends to be maintained across diets. This is confirmed by the observation that animal variation usually accounts for more than 50% and can account for as much as 80–90% of the variation in digesta flow (Faichney, 1975b; MacRae, 1975).

### **Measurement of Rate of Passage**

Measurement of the MRT of a digesta component in a segment of the GI tract requires the measurement of the amount of the component in the segment and its flow from that segment. Then, MRT is calculated as (pool/outflow). Turn-over time is calculated as (pool/inflow) so will be less than MRT if the digesta component is digested in and/or absorbed from the segment. Alternatively, the

**Table 3.3.** The flow of digesta through the proximal duodenum of sheep and cattle and the terminal ileum of sheep.

Diet	Organic matter intake (kg/day)	Live weight (W) (kg)	Method <sup>a</sup>	Digesta flow <sup>b</sup>			Reference	
				kg/day	kg/day W <sup>-0.75</sup>	kg/kg OMI		
<b>DUODENUM</b>								
<b>Sheep</b>								
<i>Fresh forage</i>								
Ruanui ryegrass	0.5	42	TC	9.3	0.56	18.6	Ulyatt and MacRae (1974)	
	0.8			14.5	0.88	18.1		
Manawa ryegrass	0.5			17.2	1.04	34.4		
	0.8			22.0	1.33	27.5		
White clover	0.5			13.5	0.82	27.0		
	0.8			21.3	1.29	26.6		
<i>Forage<sup>c</sup> (dried)</i>								
F.M1	0.81		MA	17.9		22.1	Hogan and Weston (1969)	
F.M2	0.81			12.9		16.0		
F.M3	0.48			9.9		20.7		
U.M1	0.86			16.4		19.1		
U.M2	0.78			15.2		19.6		
<i>Hay diets</i>								
Legumes	1.12	37	MA	19.9	1.33	17.8	Kennedy (1985)	
Grasses	1.01			14.2	0.95	14.1		
Chopped	1.05			17.7	1.18	16.8		
Ground and pelleted	1.08			16.4	1.09	15.1		
Orchard grass hay	1.06	54.5	EM	10.5	0.52	9.9	Malbert and Baumont (1989)	
Lucerne hay	1.62			17.2	0.86	10.7		
Lucerne hay	1.02			11.9	0.59	11.6		
Orchard grass hay		62	MA				Bernard <i>et al.</i> (2000)	
10% Ground	1.11			17.6	0.79	15.9		
50% Ground	1.12			16.0	0.72	14.3		
90% Ground	1.13			16.1	0.73	14.3		
Chopped	0.80	64	MA	10.8	0.48	13.4	Faichney <i>et al.</i> (1997)	
+ concentrates	0.75	66		9.8	0.42	13.1		
Alkali-treated straw	0.72		MA	12.7		17	Hogan and Weston (1971)	
	0.44			8.1		18		
	0.31			5.7		19		
Oaten hay	0.39	23.2	MA	6.5	0.61	16.5	Doyle <i>et al.</i> (1988)	
+ concentrates								
low	0.53	25.6		7.7	0.67	14.4		
medium	0.53	24.7		6.9	0.63	13.0		
high	0.60	26.0	7.5	0.63	12.5			

*continued*

**Table 3.3.** *continued.*

Diet	Organic Matter Intake (kg/day)	Live weight (W) (kg)	Method <sup>a</sup>	Digesta flow <sup>b</sup>			Reference
				kg/day	kg/day W <sup>-0.75</sup>	kg/kg OMI	
Lucerne hay	0.65		TC'	17.6		27.0	Mathers and Miller (1981)
+ barley	0.66			15.9		24.2	
Barley	0.67			11.9		17.8	
+ lucerne	0.66			12.0		18.0	
Hay	0.66 <sup>d</sup>	40	TC	8.62	0.54	13.1	Topps <i>et al.</i> (1968)
Concentrates	0.49 <sup>d</sup>			5.99	0.38	12.3	
Concentrates	0.81	48.0	MA	6.40	0.35	7.9	Faichney and White (1977)
Lucerne + oats (pelleted)							
Non-pregnant	0.75	50.5	MA	8.0	0.42	10.7	Faichney and White (1988b)
Late pregnant	0.76	50.8 <sup>e</sup>		9.6	0.50	12.6	
Hay (lucerne + wheaten)							
Non-pregnant	0.88		MA	14.3		16.3	Weston (1988)
Late pregnant	0.88			16.5		18.8	
Lactating	0.88			17.4		19.8	
Cattle (lactating cows)							
Fresh grass	10.0	462	MA	265	2.66	26.4	van't Klooster and Rogers (1969)
	8.9	420		267	2.88	29.9	
Hay + concentrates	11.3	462		203	2.04	18.0	
	10.5	420		175	1.89	16.7	
Fresh herbage (mature)	10.3 <sup>d</sup>		TC	353		34.4	van't Klooster <i>et al.</i> (1972)
	8.4 <sup>d</sup>			226		26.8	
Hay + concentrates	11.9 <sup>d</sup>			288		24.3	
	11.0 <sup>d</sup>			202		18.3	
Cattle (growing steers)							
Grass hay	Ad lib	100	EM	80	2.5		Ruckebusch <i>et al.</i> (1986)
ILEUM							
Sheep							
Fresh forage							
Ruanui ryegrass	0.5	42	TC	2.1	0.13	4.20	Ulyatt and MacRae (1974)
	0.8			3.3	0.20	4.13	
Manawa ryegrass	0.5			3.0	0.18	6.00	
	0.8			4.7	0.29	5.88	
White clover	0.5			2.6	0.16	5.20	
	0.8			4.8	0.29	6.00	

**Table 3.3.** *continued.*

Diet	Organic Matter Intake (kg/day)	Live weight (W) (kg)	Method <sup>a</sup>	Digesta flow <sup>b</sup>			Reference
				kg/day	kg/day W <sup>-0.75</sup>	kg/kg OMI	
Lucerne hay	0.66	32	MA	4.62	0.34	6.95	Dixon and Nolan (1982)
Hay	0.58 <sup>d</sup>	40	TC	5.05	0.32	8.74	Topps <i>et al.</i> (1968)
Concentrates	0.48 <sup>d</sup>			1.37	0.087	2.83	
Dried grass	0.50	38	TC	1.63	0.11	3.24	Goodall and Kay (1965)
Hay + concentrates	0.46			2.88	0.19	6.26	
Hay	0.51			2.74	0.18	5.38	
Concentrates	0.81	48	MA	2.02	0.11	2.49	Faichney and White (1977)

<sup>a</sup>TC, total collection from re-entrant cannula; TC', total collection from simple cannula by balloon occlusion immediately distal to cannula; MA, marker methods; EM, electromagnetic flow meter giving flow in litres (l).

<sup>b</sup>l Indicates values in litres rather than kilograms.

<sup>c</sup>F, fertilized; U, unfertilized; M1, 2, 3, maturity 1, 2, 3.

<sup>d</sup>Assumed 0.9 g OM/g DM.

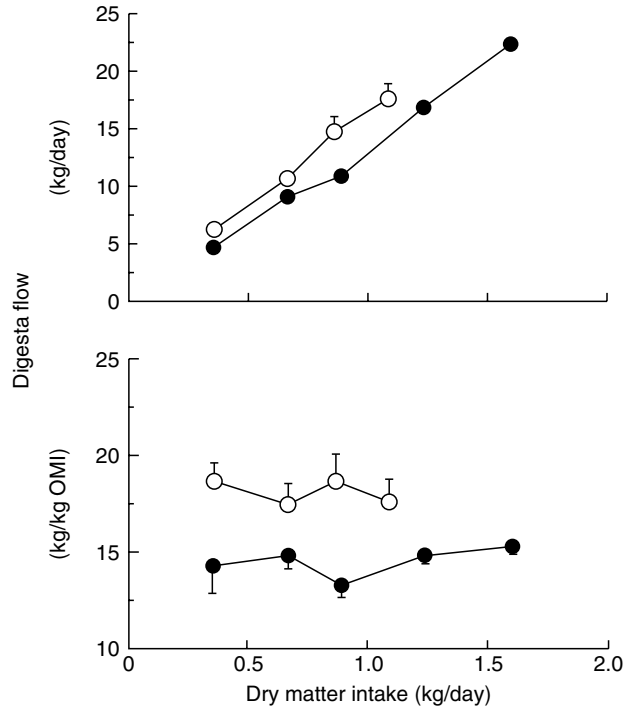
behaviour of markers in the GI tract can be analysed on the basis of a postulated model of the tract and assumptions regarding the equivalence of markers and digesta components. Various combinations of direct measurements and marker techniques have been used and have been reviewed by Warner (1981).

For example, the net MRT of particles in the reticulorumen can be calculated as the ratio of the amount of a relatively indigestible component of the particles, acid-detergent lignin (ADL) (Fahey and Jung, 1983), to the amount flowing out of the reticulorumen. It is essential that reticulorumen outflow be identified for this calculation; for many diets, faecal ADL flow is equivalent to reticulorumen ADL outflow but, because some dietary ADL disappears from the stomach (Hogan and Weston, 1969; Fahey and Jung, 1983), use of ADL intake will underestimate particle net MRT. Failure to distinguish between inflow and outflow in this calculation will lead to the false conclusion that digestible and indigestible constituents of a particle have different MRTs.

**Marker MRT and its interpretation**

*Solutes in the reticulorumen*

Determination of the MRT of solutes requires the use of a marker. Thus, following the cessation of a continuous infusion or a single dose of a solute marker into a mixing compartment, the disappearance of the marker can be described by the model  $y(t) = y(0)\exp(-kt)$  where  $y$  is the amount of marker



**Fig. 3.2.** Relationships between the flow of digesta to the duodenum and dry matter intake in sheep given chopped (○—○) or ground and pelleted (●—●) lucerne hay. Values are means ( $\pm$ SE) for five or six sheep.

present at time  $t$  and  $k$  is the rate constant. Provided the volume remains constant (steady state), the concentration of the marker in fluid from the mixing compartment can be substituted in the equation. The MRT of unabsorbed solutes is then calculated by taking the reciprocal of  $k$  and correcting for any marker absorption that occurred (Faichney, 1986). MRT corrected in this way is the time constant for flow and its reciprocal is the FOR. They apply to both unabsorbed solutes and the water in which the solutes are dissolved; note, however, that the mean residence time of a water molecule in the reticulorumen is an order of magnitude less than its MRT (Faichney and Boston, 1985). Warner and Stacy (1968) examined the effects of ingestion of feed and water on the marker concentration curve and Faichney and Griffiths (1978) showed that a circadian pattern of concentration changes persists in sheep fed continuously. Also, it should be borne in mind that the model assumes that mixing is instantaneous but mixing takes 30–60 min in sheep (Faichney *et al.*, 1994). Thus it is important to make the measurements in such a way that the MRT value obtained applies to the whole daily cycle rather than only a part of it.

In addition to the calculation of solute MRT, this approach is often used to calculate both reticulorumen fluid volume as the marker distribution space ( $Q = \text{dose}/\text{zero time concentration}$ , or  $= \text{MRT} \times \text{infusion rate}/\text{plateau concentration}$ ) and fluid flow from the reticulorumen ( $F = Q \times \text{FOR}$ , or  $= \text{infusion rate}/\text{plateau concentration}$ ). Caution is needed in interpreting these calculations because not all the saliva entering the reticulum mixes throughout the reticulorumen before passing to the omasum (Engelhardt, 1974). Although

estimates of MRT would not be affected, marker concentration in the reticulum and in digesta entering the omasum would be less than in samples taken from the rumen. This is illustrated by the results for two sheep shown in Table 3.4. Marker concentrations in the reticulum averaged 22% less than those in the rumen. However, the reticulum contains less than 10% of the digesta in the reticulorumen of sheep (Weston *et al.*, 1989) so the net concentration would have been no more than 3% below that in the rumen samples. The fluid volume of the reticulorumen would have been underestimated to the same extent if it had been estimated as the rumen distribution volume. By contrast, Poppi *et al.* (1981a) reported that CrEDTA overestimated rumen water volume by 15.8%; this implies that the concentration of CrEDTA in their rumen samples was lower than it should have been. As these workers injected the marker at multiple sites throughout the reticulorumen, it is possible that a significant proportion of the dose was deposited close to the reticulo-omasal orifice and left the reticulorumen before mixing was complete.

Mackintosh (1985) infused two solute markers, one into the rumen and the other into the oral cavity of sheep given their daily water requirement by continuous intraruminal infusion. The rumen concentration of the orally infused marker was significantly less than that of the marker infused into the rumen (0.105 to 0.154 day/l), indicating that some of the orally infused marker, and saliva with which it was swallowed, left the reticulorumen without mixing throughout its contents. Calculation of rumen volume using its concentration would give a spuriously high value. There was no significant difference between the concentrations of the two markers in samples taken from the omasum (0.128 day/l). These were 17% less than the rumen concentrations of the ruminally infused marker, which is consistent with the data in Table 3.4.

A further problem with regard to fluid flow from the rumen is indicated by the observation by Warner and Stacy (1968) that a small proportion of imbibed water may pass directly to the omasum. Such passage of water would not be detected as reticulorumen outflow by rumen or omasal sampling but would affect flow to the duodenum. Thus the difference between measured reticulorumen outflow of water and its duodenal flow may be affected by water by-passing the rumen as well as by omasal absorption and abomasal secretion.

#### *Particulate matter in the reticulorumen*

Values for the MRT of particle-associated markers, such as  $^{103}\text{Ru}$ -phen and rare earths such as Yb, have also been obtained using the single exponential

**Table 3.4.** Concentration (fraction of daily infusion rate per kg) of  $^{51}\text{CrEDTA}$  in fluid samples from stomach compartments in sheep (mean  $\pm$  SE;  $n = 6$ ) (G.J. Faichney and H. Tagari, unpublished results).

	Sheep 1 (day/kg)	Sheep 2 (day/kg)
Rumen	0.0834 $\pm$ 0.0016	0.0944 $\pm$ 0.0026
Reticulum	0.0747 $\pm$ 0.0018	0.0646 $\pm$ 0.0035
Omasal canal	0.0749 $\pm$ 0.0032	0.0711 $\pm$ 0.0047

model. Although MRT values for such external markers are related to particle passage rate, they cannot be interpreted as the rate of passage of particulate matter for three reasons. First, external markers bind in proportion to particle surface area (Faichney, 1986) so that, with relatively more marker associated with smaller particles, their reticulorumen MRTs are biased towards those of smaller particles. Secondly, they may exchange amongst binding sites (Faichney and Griffiths, 1978) and, as a result, they leave the reticulorumen more rapidly than the particles with which they were first associated (Faichney, 1986). Thirdly, they may increase particle specific gravity, either directly or indirectly by inhibiting fermentation and thus the gas production that would cause a decrease in FSG (Sutherland, 1987). Thus the reticulorumen MRTs of  $^{103}\text{Ru}$ -phen (Faichney, 1980b) and  $^{169}\text{Yb}$  (Faichney *et al.*, 1989) were considerably shorter than those of the internal marker, indigestible (*I*) ADL.

When markers are applied to particles within a relatively narrow range of sizes using procedures that bind them strongly enough to prevent exchange (Udén *et al.*, 1980; Ellis and Beaver, 1984), reasonable estimates of the rate of passage of the defined particles can be obtained (Faichney *et al.*, 1989). Although their disappearance from the defined pool within the reticulorumen can be described by a single exponential model, their disappearance from the reticulorumen cannot be so described (Faichney, 1986). However, their reticulorumen MRT can be described as the first moment of the disappearance curve by numerical integration (method PSD of Warner, 1981; Gibaldi and Perrier, 1982).

Thus:

$$\text{MRT} = \int_0^{\infty} C \cdot t \, dt \bigg/ \int_0^{\infty} C \, dt \quad (3.16)$$

A close approximation can be obtained using the trapezoidal rule by manual calculation provided that samples are taken until no marker can be detected or the curve can be extrapolated to infinity.

Then:

$$\text{MRT} = \sum_{i=1}^n C'_i \cdot t'_i \cdot \Delta t_i \bigg/ \sum_{i=1}^n C'_i \cdot \Delta t_i \quad (3.17)$$

where  $C_i$  is the marker concentration at time  $t_i$  after dosing so that  $C'_i = (C_i + C_{i-1})/2$ ,  $t'_i = (t_i + t_{i-1})/2$ ,  $\Delta t_i = t_i - t_{i-1}$ , and  $C_n = 0$ . The smaller  $\Delta t_i$  is, especially where the slope of the curve is changing rapidly, the better the approximation.

#### *Microbes in the reticulorumen*

Protozoal counts in fluid leaving the reticulorumen are lower than those in reticulorumen fluid, suggesting that they may be selectively retained (Weller and Pilgrim, 1974). This has been confirmed by the measurement of protozoal kinetics (Leng, 1982; Leng *et al.*, 1984). Protozoal MRT can be calculated



from the turnover time, i.e. the reciprocal of the rate constant for disappearance, if the flow of labelled protozoa from the reticulorumen is measured at the same time since  $MRT = \text{turnover time} / \text{fraction of disappearance as outflow}$  (Faichney, 1989). This calculation showed that the reticulorumen MRT of protozoa was substantially longer than the estimated net value for particulate matter (Table 3.5), presumably because, being motile and chemotactic, they can move towards and attach to recently ingested feed particles. Faichney *et al.* (1997) reported reticulorumen MRTs of 131 and 352 h for protozoa in two sheep given a hay diet on which particle MRTs were 18.9 and 20.8 h; when concentrates were included in the diet, the values were 169 and 240 h for protozoa and 31.2 and 31.9 h for particles. The MRTs for both liquid-associated- and solid-associated-bacteria, calculated as (pool/outflow), were similar to the particle MRT on the hay diet but, when concentrates were included, that for liquid-associated bacteria was intermediate between particle and solute MRTs for one sheep and similar to solute MRT for the second sheep. These observations indicate that solute MRT cannot be taken as a measure of the passage rate of liquid-associated bacteria.

#### *MRT of specified particle fractions in the reticulorumen*

Faichney (1986) proposed a method by which the net reticulorumen MRT of particles, obtained using the internal marker IADL, could be partitioned amongst particle fractions. When allowance was made for the entrapment of fine particles and for random comminution, values for a defined particle fraction were comparable to those obtained using the external markers Cr and Yb (Faichney *et al.*, 1989). The calculations required are illustrated in Fig. 3.3 using data from one of the sheep studied by Faichney *et al.* (1989). For the particles that would pass the 0.8 mm screen but be retained on the

**Table 3.5.** Mean retention time (MRT) and intraruminal degradation of rumen protozoa (from Faichney, 1989).

Reference	Dry matter intake (g/kg <sup>0.75</sup> /day)	MRT		Rumen protozoa		
		CrEDTA (h)	Particles <sup>a</sup> (h)	TT <sup>*</sup> (h)	MRT (h)	FDR <sup>*</sup> (% per h)
Leng (1982)	49 <sup>b</sup>	11.2	30	19.5	54.6	3.29
Leng <i>et al.</i> (1984)	54 <sup>b</sup>	9.1	25	16.0	45.7	4.06
Control	54 <sup>b</sup>	15.6	42	19.2	83.5	4.01
Monensin	41 <sup>c</sup>	12.8	51	26.5	109.0	2.86
Punia (1988)	60 <sup>d</sup>	10.7	43	29.1	83.6	2.26

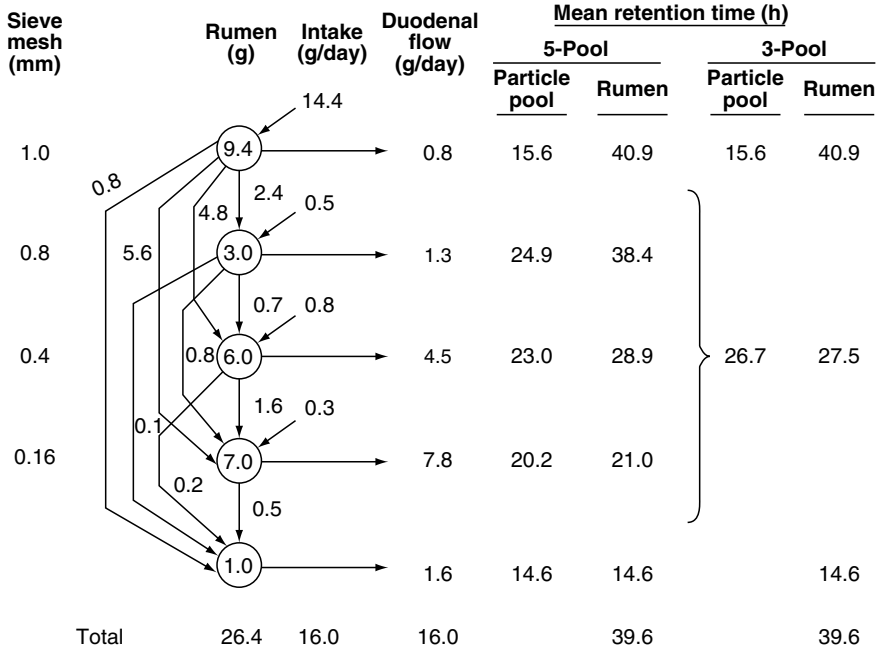
\*TT, turnover time; FDR, fractional degradation rate.

<sup>a</sup>Calculated values.

<sup>b</sup>Four sheep given chopped roughage.

<sup>c</sup>Two sheep.

<sup>d</sup>Two heifers given ground and pelleted lucerne/barley (3/2).



**Fig. 3.3.** Calculation of the partition of particle mean retention time (MRT) in the reticulorumen of a sheep given chopped ryegrass hay using 3- and 5-pool models of the passage of indigestible ADL (Faichney *et al.*, 1989). Pools were defined by reference to the mesh size of sieves used to retain the particles during wet sieving.

0.4 mm screen, the pool MRT (23.0 h) and the reticulorumen MRT (28.9 h) of IADL were similar to the values of, respectively, 21.3 and 29.1 h for the external markers reported by Faichney *et al.* (1989). The small differences could be due to errors in assessing particle reduction during chewing and hence in apportioning IADL intake to particle pools, to the effect of the external markers on FSG or to the bias of the external markers towards the smaller particles in the fraction isolated. The three-pool model in Fig. 3.3 partitions the particles between those having a low probability of leaving the reticulorumen, those having a high probability of leaving the reticulorumen and those that behave like solutes, defined using the 1.0 and 0.16 mm screens (Kennedy, 1984). This model was used by Bernard *et al.* (2000) to study the effect of physical form of the diet on the passage of particulate matter through the reticulorumen of sheep. It should be remembered that reticulorumen net particle MRTs reflect both comminution and outflow. Thus particle FOR cannot be calculated as the reciprocal of net particle MRT.

#### Marker MRT in the GI tract

The total (T) MRT of both solute and particle-associated markers in the whole GI tract, or sections of it defined by the sites of marker administration and

sampling, can be calculated using Eqs (3.16) and (3.17). When the faecal output is collected, Eq. (3.17) can be simplified to:

$$\text{TMRT} = \frac{\sum_{i=1}^n t_i \cdot m_i}{\sum_{i=1}^n m_i} = \sum_{i=1}^n t_i \cdot M_i \tag{3.18}$$

where  $t_i$  is the time elapsed between dosing and the  $i$ th defecation,  $m_i$  is the amount of marker excreted in the  $i$ th defecation,  $M_i$  is the amount of marker excreted in the  $i$ th defecation as a fraction of the total amount of marker excreted, i.e. the dose of marker and  $n$  is the number of defecations required to excrete the whole dose.

In practice, faeces are commonly collected during successive (short) periods;  $t_i$  is then the time elapsed to the notional defecation time, usually taken as the mid-point of the  $i$ th period. The errors introduced by this approximation to the time of defecation were discussed by Faichney (1975a). Equation (3.18) can also be used when total collections are made using re-entrant cannulas. The time required to recover virtually all of the dose may be estimated from the expected TMRT less transit time (the time of first appearance of the marker) using the relationship: fraction remaining =  $\exp[-t/(\text{TMRT} - \text{transit time})]$ . For example, it would take 5.3 times the expected (TMRT–transit time) to recover 99.5% of the dose.

The TMRT of a marker in the whole GI tract can be determined when continuous infusion procedures are being used (Faichney, 1975b). After ending the infusion, faecal concentrations ( $C_i$ ) are expressed as a fraction of the steady-state concentration ( $C_{ss}$ ) and TMRT is calculated as the area under the marker elimination curve.

Thus:

$$\text{TMRT} = \sum_{i=1}^n A_i (T_i - T_{i-1}) \tag{3.19}$$

where  $A_i$  is the ratio  $C_i/C_{ss}$  for the marker concentration in faeces collected at time  $T_i$  after ending the infusion; note that  $C_n = 0$  so that  $A_n = 0$ .

Alternatively, it can be calculated as the area under the complement of the accumulation curve after starting an unprimed infusion of the marker.

Thus:

$$\text{TMRT} = \sum_{i=1}^n B_i (T_i - T_{i-1}) \tag{3.20}$$

where  $B_i$  is  $(1 - C_i/C_{ss})$  for the marker concentration in faeces collected at time  $T_i$  after starting the marker infusion; note that  $C_n = C_{ss}$  so that  $B_n = 0$ .

TMRT may also be determined from total faecal collections, provided that the marker is fully recovered and no re-ingestion is occurring, because there is no retrograde digesta flow between segments in ruminants. TMRT is the sum of

the MRTs for the successive segments; since all marker infused digesta flows through every segment, the sum can be calculated as:  $TMRT = (\text{GI tract marker content}/\text{infusion rate})$ . GI tract marker content is determined as total marker excretion after cessation of the infusion or, alternatively, the difference between the amount of marker infused and the amount excreted between the start of the infusion and the achievement of steady state (constant concentrations in the faeces). The procedure is not valid if there is any loss of marker by absorption or leakage because marker flow would then differ between GI tract segments.

These calculations can provide a way to determine the extent, if any, of marker re-ingestion (RI units per day) that may be occurring. Thus, given TMRT (h) from Eqs (3.19) or (3.20), GI tract marker content (TQ units) and the infusion rate (IR units per day),  $RI = (24TQ/ TMRT) - IR$ .

### **Compartmental analysis**

Data obtained by sampling distal to the site of a marker dose are also amenable to compartmental analysis. This may be accomplished by postulating a model of the GI tract between the sites of dosing and sampling in terms of mixing compartments and flow segments (time delays) and fitting it to the data. Thus Blaxter *et al.* (1956) suggested that the ruminant GI tract could be represented by two mixing compartments and a time delay. Grovum and Williams (1973) used this approach to study faecal marker concentrations in sheep, identifying the mixing compartments as the reticulorumen and the caecum/proximal colon, and Faichney and Griffiths (1978) used a two-pool plus time-delay model to describe marker passage through the stomach (reticulorumen, omasum and abomasum) of sheep. However, although compartment MRTs and the total time delay are calculated, the identity of the compartment to which each MRT applies must be determined either by assumption on the basis of previous experience or by simultaneous direct sampling of one of the compartments.

It has been commonly assumed that reticulorumen MRT is longer than MRT in the caecum/proximal colon on the basis of data such as those of Faichney and Barry (1986) in which the caecum/proximal colon:reticulorumen MRT ratios for  $^{51}\text{CrEDTA}$ ,  $^{103}\text{Ru-phen}$  and IADL were, respectively, 81%, 52% and 21%. However, in some circumstances, the reticulorumen MRT of  $^{51}\text{CrEDTA}$  is often shorter, and that of  $^{103}\text{Ru-phen}$  sometimes shorter, than the caecum/proximal colon MRT (Faichney and Boston, 1983); as a result, compartment misidentification would lead to substantial errors for these markers. Faichney and Boston (1983) used direct estimates of MRT in the reticulorumen, abomasum and caecum/proximal colon and of the time delays in the omasum, small intestine and distal large intestine to simulate the faecal concentration curves to be expected following the administration of markers into the reticulorumen. They analysed these curves using the two-pool plus time-delay model and found that it gave reasonable estimates of pool MRTs but underestimated TMRT because delay time underestimated the transit time and

mixing in the abomasum was ignored; abomasal MRTs are about 10% of those in the rumen (Barry *et al.*, 1985; Faichney and Barry, 1986). France *et al.* (1985) developed a multi-compartmental model which to a large extent, overcomes these problems and have applied it successfully to data from sheep and cattle (Dhanoa *et al.*, 1985). However, the question of compartment identification remains. It should also be remembered that the fitting of such models assumes that flow is continuous; thus intermittent defecation constitutes a source of error when faecal concentration curves are analysed.

A graphical approach to compartmental analysis has been used by Mambri and Peyraud (1994, 1997) to partition TMRT (Eq. (3.18)) and stomach MRT (Eq. (3.17)) between the transit time and the time constants associated with the ascending and descending components of the marker curve. They concluded that the time constant for the descending component of the faecal curve was associated with the escape of feed particles from the rumen and that for the ascending component, calculated by difference, represented the time required for particle size reduction in the reticulorumen together with mixing in the abomasum and caecum.

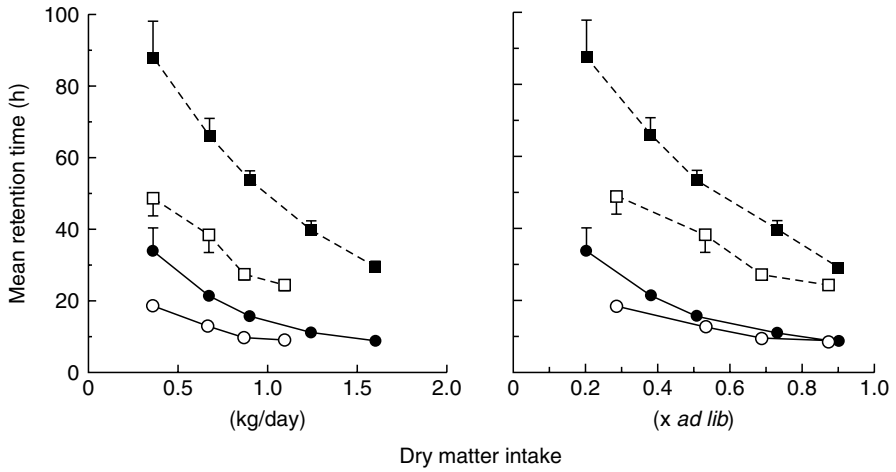
An alternative to these deterministic models is the use of stochastic models to encompass the uncertainties resulting from the independent actions of individual particles. This approach has been proposed by Matis, Ellis and co-workers (Matis, 1972; Ellis *et al.*, 1979; Pond *et al.*, 1988; Matis *et al.*, 1989) and is based on the fact that time-dependent as well as time-independent processes apply to digesta components in the reticulorumen. For example, mixing in the reticulorumen is not instantaneous (an assumption of the deterministic models) and large particles have a low probability of leaving the reticulorumen, requiring comminution before they can readily pass out of this compartment. Matis (1972) proposed the use of a gamma distribution of lifetimes to model the time-dependency of particle passage through the reticulorumen. Ellis *et al.* (1979) and Pond *et al.* (1988) fitted two-pool plus time-delay models to faecal marker data obtained from cattle, introducing time-dependency into the pool with the shorter MRT. Although the models were able to describe the data well, requiring different orders of gamma dependency for the different diets used by Pond *et al.* (1988), all mixing processes in the GI tract, including those in the abomasum and caecum/proximal colon, were encompassed by the two compartments. As already noted, particle MRTs in the abomasum and the caecum/proximal colon can be of the order of, respectively, 10% and 20% of those in the reticulorumen so that interpretation of the parameter estimates for the time-dependent and time-independent compartments is problematic. From a comparison of estimates obtained by fitting the model to both duodenal and faecal data, Pond *et al.* (1988) concluded that the faster turnover rate (the time-dependent compartment) of their two-compartment models of the faecal data reflected compartmental mixing flow in both pre- and post-duodenal segments. This conclusion was confirmed by the studies of Bernard *et al.* (1998), who compared stochastic and deterministic models of marker excretion in sheep. They also found that the models tended to overestimate TMRT relative to its direct determination by numerical integration but concluded that the models provided accurate estimates of

particle MRT in the reticulorumen. However, only the multi-compartmental model (France *et al.*, 1985) provided such estimates for their particle markers. It must be concluded that the analysis of faecal data alone, especially using stochastic models, cannot provide unequivocal descriptions of particle passage through the reticulorumen (Faichney, 1986). Where such information is required, techniques that provide direct estimates of the pool sizes and turnover rates of specified particle size fractions are needed (Kennedy and Murphy, 1988; Faichney *et al.*, 1989).

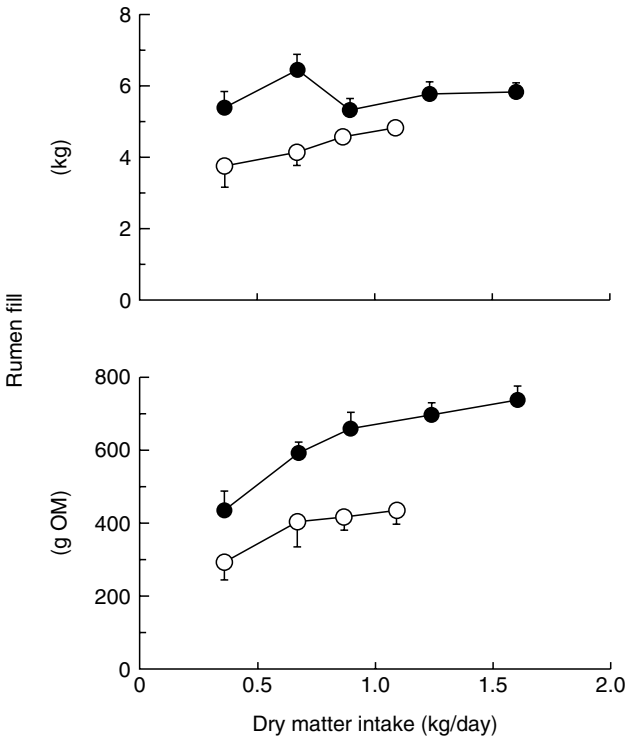
### **Factors affecting MRT**

Rate of passage is affected by dietary, animal and climatic factors (Warner, 1981; Faichney, 1986; Lechner-Doll *et al.*, 1991). Dietary factors include feed intake, the amount of fibre in the diet and its physical form. Thus it has often been observed that reticulorumen MRT decreases with increased intake and that increasing the amount of concentrates in the diet increases MRT (Warner, 1981). Prolonged marker MRTs in the reticulorumen have been reported for concentrate diets (Faichney, 1975a; Faichney and White, 1977). Grinding of hay has been found commonly to increase rate of passage (Thomson and Beaver, 1980; Warner, 1981) but Balch (1950) reported delayed excretion of a ground hay diet and Stielau (1967) found no effect of grinding lucerne hay to different extents on rate of passage in sheep. Bernard *et al.* (2000) reported that particle MRT in the reticulorumen decreased and then reached a plateau as the proportion of ground/pelleted hay in a grass hay diet increased. By contrast, Weston and Hogan (1967) reported an increase in the MRT of a solute marker in the reticulorumen when lucerne was ground, and Faichney (1983) found that grinding and pelleting of a lucerne hay increased the reticulorumen MRT of solutes and of a particle-associated marker. Data for solutes and particles (IADL) from the experiment of Faichney (1983) are shown in Fig. 3.4. At restricted levels of intake, MRTs were longer for the ground hay. However, inspection of the curves shows that, were the sheep fed to appetite, MRTs of both solutes and particles would have been the same for ground and pelleted as for chopped hay; as intake was reduced, MRT increased more rapidly when the hay was ground and pelleted.

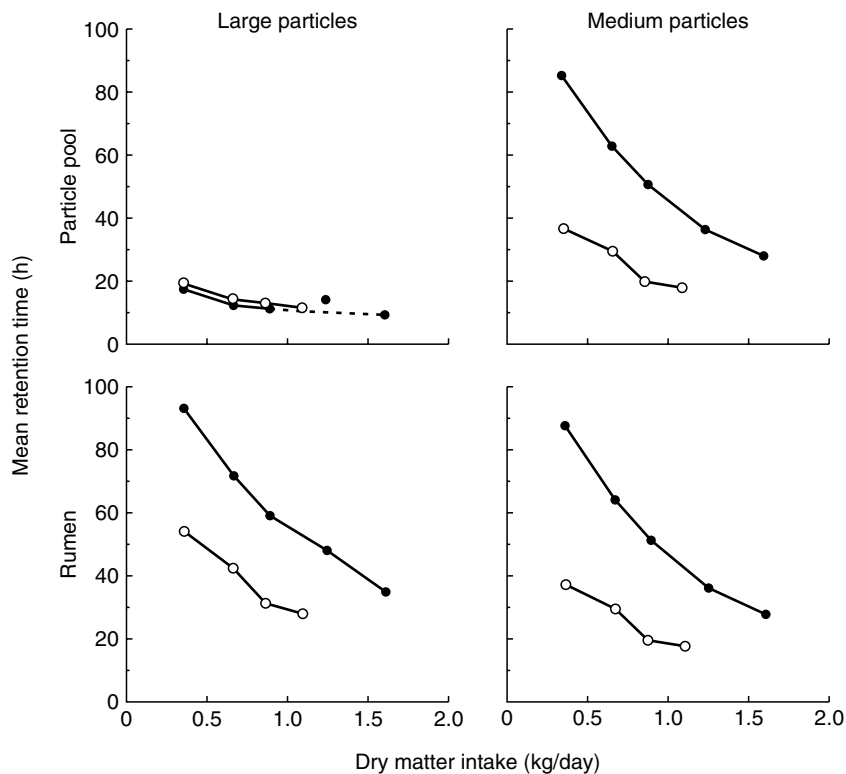
These differences in the response to the grinding of forages are due to variations in the components of MRT. Dietary, animal and climatic factors may affect either reticulorumen volume or digesta outflow, or both. The response shown in Fig. 3.4 was a consequence of an increase in reticulorumen digesta volume and, in particular, reticulorumen organic matter fill (Fig. 3.5), presumably because the smaller particles of the ground lucerne hay were able to pack more closely together in the reticulorumen. There was also a small decrease in digesta flow (see Fig. 3.2). By contrast, Bernard *et al.* (2000) found that DM fill was lower for their grass hay diets that contained more than 10% ground/pelleted hay. Although the components of MRT are not commonly measured, a decrease in reticulorumen MRT when forages are ground would be expected



**Fig. 3.4.** Relationships between the MRTs in the reticulorumen of solutes (○, ●) and particulate matter (□, ■) and dry matter intake in sheep given chopped (○, □) or ground and pelleted (●, ■) lucerne hay. Values are means ( $\pm$ SE) for five or six sheep.



**Fig. 3.5.** Relationships between reticulorumen fill (marker distribution space) and dry matter intake in sheep given chopped (○—○) or ground and pelleted (●—●) lucerne hay. Values are means ( $\pm$ SE) for five or six sheep.



**Fig. 3.6.** Partition of the MRT of particulate matter in the reticulorumen (Fig. 3.4) between large and medium particles within their pools and in the reticulorumen in sheep given chopped (○—○) or ground and pelleted (●—●) lucerne hay.

to be associated with little change or a decrease in reticulorumen content and/or an increase in digesta flow.

Partition of the particle MRTs shown in Fig. 3.4 between large and medium particles is shown in Fig. 3.6. Large particles were those retained on a sieve of 1.18 mm mesh; medium particles passed a 1.18 mm mesh sieve and were retained on a sieve of 0.15 mm mesh. Both for chopped and for ground and pelleted lucerne hay, particles were retained much longer in the medium particle pool than in the large particle pool; MRT in the large particle pool tended to be longer for the chopped hay but MRT in the medium particle pool was much longer when the hay was ground. Retention in the large particle pool is dependent on rumination whereas retention in the medium particle pool is largely a function of pool size and the propulsive activity to which it is subjected. The data in Fig. 3.6 indicated that the proportion of the reticulorumen MRT of particles entering the large particle pool that was accounted for by retention in that pool increased with intake from about 35% to about 40% when chopped lucerne was given; the structural relationship predicted 44% for intake to appetite. When the lucerne was ground and pelleted, the ratio increased from about 18% to about



28%, with 30% predicted for intake to appetite. The value for chopped ryegrass hay from Fig. 3.3 was 38%. These results support the contention that retention of particles in the medium particle pool is a more important determinant of their rate of passage from the reticulorumen than is rumination (Poppi *et al.*, 1981b; Bernard *et al.*, 2000).

It is clear from the range of responses observed that prediction of the effects of dietary changes on MRT is not simple, but will depend on an understanding of their effects on the mechanisms by which reticulorumen fill, particle comminution and the propulsive activities of the GI tract are regulated. Animal and climatic factors modulate these mechanisms. Thus, reticulorumen MRT tends to be shorter in young animals (Faichney, 1986) and is reduced during gestation (Faichney and White, 1988a) and lactation (Weston, 1988). It can be increased by exposure to heat (Warren *et al.*, 1974) and reduced by exposure to cold conditions (Kennedy *et al.*, 1986). Changes in reticulorumen MRT can be compensated for, at least in part, by changes in the distal tract (Barry *et al.*, 1985). Faichney and White (1988a) found that decreased MRTs in the reticulorumen during gestation in sheep were reflected in a decrease in whole-tract MRT for a particle-associated marker but not for a solute marker. The increase in digesta MRT distal to the stomach compensated for the decrease observed in the reticulorumen.

It can be seen from Fig. 3.4 that variation about the diet means for MRT increased as intake decreased. The coefficients of variation for solutes ranged from 8% to 25% (SD 0.7–4.6 h) for the chopped hay and from 14% to 44% (SD 1.3–14.6 h) for the ground and pelleted hay. For particulate matter (IADL) they ranged from, respectively, 14% to 27% (SD 3.4–13.0 h) and 9% to 28% (SD 2.7–24.2 h). This pattern of variation reflects that seen in reticulorumen fill (Fig. 3.5) which is a determinant of MRT. Examination of the individual values confirmed that the ranking of animals on the basis of MRT tended to be maintained across diets and that, within diets, animals with a longer MRT had greater reticulorumen fill. Such a pattern of variation due to animal effects must be borne in mind when interpreting the effects of experimental treatments on MRT and emphasizes the importance of an understanding of the mechanisms involved. The effects of feed intake on MRT illustrated here were a consequence of its effects on reticulorumen fill (Fig. 3.5) and digesta outflow (Fig. 3.2). They were obtained by restricting feed intake and may not be the same as would occur were voluntary feed consumption to vary because the mechanisms by which reticulorumen fill is regulated would not have been fully expressed. The effect of intake on reticulorumen fill, digesta outflow and, hence, MRT needs to be examined in animals fed to appetite.

## Application

It is widely recognized that the traditional systems of feed evaluation for ruminants are inadequate, particularly with respect to protein. As a result, much effort has been put into the development of new systems and of databases to support them (Robards and Packham, 1983; Jarrige and Alderman, 1987). All

the new systems are based on attempts to predict the flow of nutrients to and their absorption from the small intestine in specified animals as a function of the diet and its interaction with the animal. Most of them rely on empirical relationships and it was considered that the additive systems, based on tabulated data and software for personal computers, currently being implemented would remain satisfactory for ration formulation because correction factors could be used in diet formulation or applied to animal requirements (Jarrige, 1987).

However, these systems are totally unsatisfactory for use with grazing animals where they are required to identify limitations to production from pasture and to evaluate strategies to overcome them rather than to formulate rations to achieve chosen rates of production. One approach to this problem is the GRAZPLAN package described by Donnelly *et al.* (2002), which uses a series of empirically based programs to predict pasture growth, feed intake and animal performance. Another approach to representing the interactions between the animal, its diet and the environment was described by Black *et al.* (1982). It depends on the prediction of nutrient supply to the animal using a quasi-mechanistic model of digestive function to describe events in the reticulorumen and the effect on them of animal, dietary and climatic factors.

The early models of reticulorumen function (Sauvant, 1988) are more or less empirical and so have a limited range of application. However, empirical estimates of FOR (e.g. Illius and Gordon, 1991) can introduce serious errors when the model is extrapolated beyond the conditions of their estimation because they confound the determinants of digesta passage. Mechanistic models are needed in which the control of reticulorumen fill and digesta flow are represented; in such models, FORs are not specified but can be derived if desired along with any MRTs of interest.

The GI tract transports the physical components of digesta and hence the chemical constituents that are distributed amongst them. To have general utility, predictions of the digestion and passage of digesta constituents require knowledge of their partition between the physical components of digesta and the processes of comminution, chemical degradation and outflow that apply to those physical components. The development of mechanistic models that take account of these factors depends upon concepts derived from the quantitative study of digesta flow.

## References

- Ahvenjärvi, S., Vanhatalo, A., Huhtanen, P. and Varvikko, T. (2000) Determination of reticulo-rumen and whole-stomach digestion in lactating cows by omasal canal or duodenal sampling. *British Journal of Nutrition* 83, 67–77.
- Armentano, L.E. and Russell, R.W. (1985) Method for calculating digesta flow and apparent absorption of nutrients from nonrepresentative samples of digesta. *Journal of Dairy Science* 68, 3067–3070.
- Ashes, J.R., Mangan, J.L. and Sidhu, G.S. (1984) Nutritional availability of amino acids from protein cross-linked to protect against degradation in the rumen. *British Journal of Nutrition* 52, 239–247.

- Balch, C.C. (1950) Factors affecting the utilisation of food by dairy cows. 1. The rate of passage of food through the digestive tract. *British Journal of Nutrition* 4, 361–388.
- Barry, T.N., Faichney, G.J. and Redekopp, C. (1985) Gastro-intestinal tract function in sheep infused with somatostatin. *Australian Journal of Biological Sciences* 38, 393–403.
- Beever, D.E., Kellaway, R.C., Thomson, D.J., MacRae, J.C., Evans, C.C. and Wallace, A.S. (1978) A comparison of two non-radioactive digesta marker systems for the measurement of nutrient flow at the proximal duodenum of calves. *Journal of Agricultural Science, Cambridge* 90, 157–163.
- Bernard, L., Chaise, J.P., Delval, E. and Poncet, C. (1998) Validation of the main modeling methods for estimation of marker mean retention times in the different compartments of the gastrointestinal tract in sheep. *Journal of Animal Science* 76, 2485–2495.
- Bernard, L., Chaise, J.P., Baumont, R. and Poncet, C. (2000) The effect of physical form of orchardgrass hay on the passage of particulate matter through the rumen of sheep. *Journal of Animal Science* 78, 1338–1354.
- Black, J.L., Faichney, G.J., Beever, D.E. and Howarth, B.R. (1982) Alternative systems for assessing the nitrogen value of feeds for ruminants. In: Thomson, D.J., Beever, D.E. and Gunn, R.G. (eds) *Forage Protein in Ruminant Animal Production*. Occasional Publication No. 6 British Society of Animal Production, pp. 107–118.
- Blaxter, K.L., Graham, N.McC. and Wainman, F.W. (1956) Some observations on the digestibility of food by sheep, and on related problems. *British Journal of Nutrition* 18, 69–91.
- Bouchaert, J.H. and Oyaert, W. (1954) A method of collecting fluid leaving the omasum of sheep. *Nature (London)* 174, 1195.
- Collombier, J., Dardillat, C., Senaud, J., Grolière, C.A. and Jouany, J.P. (1984) Dispositif de collecte de l'effluent du rumen chez le mouton. *Reproduction Nutrition Développement* 24, 855–863.
- Dardillat, C. (1987) Débit réticulo-omasal instantané chez la vache. *Reproduction Nutrition Développement* 27(1B), 231–232.
- Dhanao, M.S., Siddons, R.C., France, J. and Gale, D.L. (1985) A multicompartmental model to describe marker excretion patterns in ruminant faeces. *British Journal of Nutrition* 53, 663–671.
- Dixon, R.M. and Nolan, J.V. (1982) Studies of the large intestine of sheep. 1. Fermentation and absorption in sections of the large intestine. *British Journal of Nutrition* 47, 289–300.
- Donnelly, J.R., Simpson, R.J., Salmon, L., Moore, A.D., Freer, M. and Dove, H. (2002) Forage-livestock models for the Australian livestock industry. In: Ahuja, L.R., Ma, L. and Howell, T.A. (eds) *Agricultural System Models in Field Research and Technology Transfer*. CRC Press, Boca Raton, pp. 9–31.
- Dove, H., Milne, J.A., Sibbald, A.M., Lamb, C.S. and McCormack, H.A. (1988) Circadian variation in abomasal digesta flow in grazing ewes during lactation. *British Journal of Nutrition* 69, 653–668.
- Doyle, P.T., Dove, H., Freer, M., Hart, F.J., Dixon, R.M. and Egan, A.R. (1988) Effects of a concentrate supplement on the intake and digestion of a low-quality forage by lambs. *Journal of Agricultural Science, Cambridge* 111, 503–511.
- Ellis, W.C. and Beever, D.E. (1984) Methods for binding rare earths to specific feed particles. In: Kennedy, P.M. (ed.) *Techniques in Particle Size Analysis of Feed and Digesta in Ruminants*. Occasional Publication No.1, Canadian Society of Animal Science, Edmonton, Alberta, pp.154–165.

- Ellis, W.C., Matis, J.H. and Lascano, C. (1979) Quantitating ruminal turnover. *Federation Proceedings* 38, 2702-2706.
- Engelhardt, W. v. (1974) Radioactive reference substances in gastro-intestinal studies. In: *Tracer Techniques in Tropical Animal Production*. International Atomic Energy Agency, Vienna, pp. 111-124.
- Evans, E.W., Pearce, G.R., Burnett, J. and Pillinger, S.L. (1973) Changes in some physical characteristics of the digesta in the reticulo-rumen of cows fed once daily. *British Journal of Nutrition* 29, 357-376.
- Fahey, G.C. and Jung, H.G. (1983) Lignin as a marker in digestion studies: a review. *Journal of Animal Science* 57, 220-225.
- Faichney, G.J. (1972) An assessment of chromic oxide as an indigestible marker for digestion studies in sheep. *Journal of Agricultural Science, Cambridge* 79, 493-499.
- Faichney, G.J. (1975a) The effect of formaldehyde treatment of a concentrate diet on the passage of solute and particle markers through the gastrointestinal tract of sheep. *Australian Journal of Agricultural Research* 26, 319-327.
- Faichney, G.J. (1975b) The use of markers to partition digestion within the gastrointestinal tract of ruminants. In: McDonald, I.W. and Warner, A.C.I. (eds) *Digestion and Metabolism in the Ruminant*. University of New England Publishing Unit, Armidale, New South Wales, pp. 277-291.
- Faichney, G.J. (1980a) The use of markers to measure digesta flow from the stomach of sheep fed once daily. *Journal of Agricultural Science, Cambridge* 94, 313-318.
- Faichney, G.J. (1980b) Measurement in sheep of the quantity and composition of rumen digesta and of the fractional outflow rates of digesta constituents. *Australian Journal of Agricultural Research* 31, 1129-1137.
- Faichney, G.J. (1983) The effect of physical form of lucerne hay on the passage of markers through the rumen of sheep. *Proceedings of the Nutrition Society of Australia* 8, 186.
- Faichney, G.J. (1986) The kinetics of particulate matter in the rumen. In: Milligan, L.P., Grovum, W.L. and Dobson, A. (eds) *Control of Digestion and Metabolism in Ruminants*. Prentice-Hall, Englewood Cliffs, New Jersey, pp. 173-195.
- Faichney, G.J. (1989) Mean retention time and intra-ruminal degradation of rumen protozoa. *Proceedings of the Nutrition Society of Australia* 14, 153.
- Faichney, G.J. (1990) Effect of level of intake and grinding of lucerne hay on the efficiency of rumination in sheep. *Proceedings of the Nutrition Society of Australia* 5, 147.
- Faichney, G.J. (1992a) Application of the double-marker method for measuring digesta kinetics to rumen sampling in sheep following a dose of the markers or the end of their continuous infusion. *Australian Journal of Agricultural Research* 43, 277-284.
- Faichney, G.J. (1992b) Effect of non-uniform distribution of particle-associated markers on the measurement of duodenal digesta flow by the double-marker technique. *Journal of Agricultural Science, Cambridge* 118, 119-120.
- Faichney, G.J. (1993) Marker methods for measuring digesta flow (Letter to the Editors). *British Journal of Nutrition* 70, 663-664.
- Faichney, G.J. and Barry, T.N. (1986) Effects of mild heat exposure and suppression of prolactin secretion on gastro-intestinal tract function and temperature regulation in sheep. *Australian Journal of Biological Sciences* 39, 85-97.
- Faichney, G.J. and Boston, R.C. (1983) Interpretation of the faecal excretion patterns of solute and particle markers introduced into the rumen of sheep. *Journal of Agricultural Science, Cambridge* 101, 575-581.

- Faichney, G.J. and Boston, R.C. (1985) Movement of water within the body of sheep fed at maintenance under thermoneutral conditions. *Australian Journal of Biological Sciences* 38, 85–94.
- Faichney, G.J. and Brown, G.H. (1991) Critical size of particles leaving the rumen of sheep given chopped or ground lucerne hay. In: *Proceedings of the Third International Symposium on the Nutrition of Herbivores*. Malaysian Society of Animal Production, Serdang, Selangor, Malaysia, p. 29.
- Faichney, G.J. and Griffiths, D.A. (1978) Behaviour of solute and particle markers in the stomach of sheep given a concentrate diet. *British Journal of Nutrition* 40, 71–82.
- Faichney, G.J. and White, G.A. (1977) Formaldehyde treatment of concentrate diets for sheep. 1. Partition of the digestion of organic matter and nitrogen between the stomach and intestines. *Australian Journal of Agricultural Research* 28, 1055–1067.
- Faichney, G.J. and White, G.A. (1988a) Rates of passage of solutes, microbes and particulate matter through the gastro-intestinal tract of ewes fed at a constant rate throughout gestation. *Australian Journal of Agricultural Research* 39, 481–492.
- Faichney, G.J. and White, G.A. (1988b) Partition of organic matter, fibre and protein digestion in ewes fed at a constant rate throughout gestation. *Australian Journal of Agricultural Research* 30, 493–504.
- Faichney, G.J., Poncet, C. and Boston, R.C. (1989) Passage of internal and external markers of particulate matter through the rumen of sheep. *Reproduction Nutrition Development* 29, 325–337.
- Faichney, G.J., Tagari, H., Teleki, E. and Boston, R.C. (1994) Nitrogen transactions in the rumen of sheep given a barley straw diet supplemented with untreated or formaldehyde-treated sunflower seed meal. *Australian Journal of Agricultural Research* 45, 1203–1214.
- Faichney, G.J., Poncet, C., Lassalas, B., Jouany, J.P., Millet, L., Doré, J. and Brownlee, A.G. (1997) Effect of concentrates in a hay diet on the contribution of anaerobic fungi, protozoa and bacteria to nitrogen in rumen and duodenal digesta in sheep. *Animal Feed Science and Technology* 64, 193–203.
- Faichney, G.J., Gordon, G.L.R., Welch, R.J. and Rintoul, A.J. (2002) Effect of dietary free lipid on anaerobic fungi and digestion in the rumen of sheep. *Australian Journal of Agricultural Research* 53, 519–527.
- Firkins, J.L., Allen, M.S., Oldick, B.S. and St-Pierre, N.R. (1998) Modeling ruminal digestibility of carbohydrates and microbial protein flow to the duodenum. *Journal of Dairy Science* 81, 3350–3369.
- France, J. and Siddons, R.C. (1986) Determination of digesta flow by continuous marker infusion. *Journal of Theoretical Biology* 121, 105–119.
- France, J., Thornley, J.H.M., Dhanoa, M.S. and Siddons, R.C. (1985) On the mathematics of digesta flow kinetics. *Journal of Theoretical Biology* 113, 743–758.
- Gibaldi, M. and Perrier, D. (1982) Noncompartmental analysis based on statistical moment theory. *Pharmacokinetics*, 2nd edn. Marcel Dekker, New York, pp.409–417.
- Goodall, E.D. and Kay, R.N.B. (1965) Digestion and absorption in the large intestine of the sheep. *Journal of Physiology* 176, 12–23.
- Grovum, W.L. and Williams, V.J. (1973) Rate of passage of digesta in sheep. 4. Passage of marker through the alimentary tract and the relevance of rate constants derived from the changes in concentration of marker in faeces. *British Journal of Nutrition* 30, 313–329.

- Hogan, J.P. (1964) The digestion of food by the grazing sheep. 1. The rate of flow of digesta. *Australian Journal of Agricultural Research* 15, 384–396.
- Hogan, J.P. and Weston, R.H. (1967) The digestion of chopped and ground roughage by sheep. 2. The digestion of nitrogen and some carbohydrate fractions in the stomach and intestines. *Australian Journal of Agricultural Research* 18, 803–819.
- Hogan, J.P. and Weston, R.H. (1969) The digestion of pasture plants by sheep. 3. The digestion of forage oats varying in maturity and in the content of protein and soluble carbohydrate. *Australian Journal of Agricultural Research* 20, 347–363.
- Hogan, J.P. and Weston, R.H. (1971) The utilisation of alkali-treated straw by sheep. *Australian Journal of Agricultural Research* 22, 951–962.
- Hume, I.D. and Sakaguchi, E. (1991) Patterns of digesta flow and digestion in foregut and hindgut fermenters. In: Tsuda, T., Sasaki, Y. and Kawashima, R. (eds) *Physiological Aspects of Digestion and Metabolism in Ruminants*. Academic Press, London, pp. 427–451.
- Hume, I.D., Moir, R.J. and Somers, M. (1970) Synthesis of microbial protein in the rumen. 1. Influence of the level of nitrogen intake. *Australian Journal of Agricultural Research* 21, 283–296.
- Hungate, R.E. (1966) *The Rumen and its Microbes*. Academic Press, New York.
- Illius, A.W. and Gordon, I.J. (1991) Prediction of intake and digestion in ruminants by a model of rumen kinetics integrating animal size and plant characteristics. *Journal of Agricultural Science, Cambridge* 116, 145–157.
- Jarrige, R. (1987) Situation and perspectives of the modern protein feeding systems for ruminants. In: Jarrige, R. and Alderman, G. (eds) *Feed Evaluation and Protein Requirement Systems for Ruminants*. Office for Official Publications of the European Communities, Luxembourg, pp. 305–326.
- Jarrige, R. and Alderman, G. (eds) (1987) *Feed Evaluation and Protein Requirement Systems for Ruminants*. Office for Official Publications of the European Communities, Luxembourg.
- Kennedy, P.M. (1984) Summary and conclusions from discussion. In: Kennedy, P.M. (ed.) *Techniques in Particle Size Analysis of Feed and Digesta in Ruminants*. Canadian Society of Animal Science, Edmonton, Alberta, pp. 184–186.
- Kennedy, P.M. (1985) Influences of cold exposure on digestion of organic matter, rates of passage of digesta in the gastrointestinal tract, and feeding and rumination behaviour in sheep given four forage diets in the chopped, or ground and pelleted form. *British Journal of Nutrition* 53, 159–173.
- Kennedy, P.M. and Murphy, M.R. (1988) The nutritional implications of differential passage of particles through the ruminant alimentary tract. *Nutrition Research Reviews* 1, 189–208.
- Kennedy, P.M. and Poppi, D.P. (1984) 'Critical particle size' in sheep and cattle. In: Kennedy, P.M. (ed.) *Techniques in Particle Size Analysis of Feed and Digesta in Ruminants*. Canadian Society of Animal Science, Edmonton, Alberta, p. 170.
- Kennedy, P.M., Christopherson, R.J. and Milligan, L.P. (1986) Digestive responses to cold. In: Milligan, L.P., Grovum, W.L. and Dobson, A. (eds) *Control of Digestion and Metabolism in Ruminants*. Prentice-Hall, Englewood Cliffs, New Jersey, pp. 285–306.
- Lechner-Doll, M., Kaske, M. and Engelhardt, W. v. (1991) Factors affecting the mean retention time of particles in the forestomach of ruminants and camelids. In: Tsuda, T., Sasaki, Y. and Kawashima, R. (eds) *Physiological Aspects of Digestion and Metabolism in Ruminants*. Academic Press, London, pp. 455–482.

- Leng, R.A. (1982) Dynamics of protozoa in the rumen of sheep. *British Journal of Nutrition* 48, 399–415.
- Leng, R.A., Nolan, J.V., Cumming, G., Edwards, S.R. and Graham, C.A. (1984) The effects of monensin on the pool size and turnover rate of protozoa in the rumen of sheep. *Journal of Agricultural Science, Cambridge* 102, 609–613.
- Mackintosh, J.B. (1985) Salivation, rumination and passage of digesta through the forestomach of the sheep. In: Baker, S.K., Gawthorne, J.M., Mackintosh, J.B. and Purser, D.B. (eds) *Ruminant Physiology: Concepts and Consequences*. University of Western Australia, Perth, Western Australia, pp. 67–77.
- MacRae, J.C. (1975) The use of re-entrant cannulae to partition digestive function within the gastro-intestinal tract of ruminants. In: McDonald, I.W. and Warner, A.C.I. (eds) *Digestion and Metabolism in the Ruminant*. University of New England Publication Unit, Armidale, New South Wales, pp. 261–276.
- MacRae, J.C. and Wilson, S. (1977) The effect of various forms of gastro-intestinal cannulation on digestive measurements in sheep. *British Journal of Nutrition* 38, 65–71.
- McLeod, M.N., Kennedy, P.M. and Minson, D.J. (1984) Dimensions of particles retained on sieves during a wet sieving procedure. In: Kennedy, P.M. (ed.) *Techniques in Particle Size Analysis of Feed and Digesta in Ruminants*. Canadian Society of Animal Science, Edmonton, Alberta, p. 168.
- Malbert, C.H. and Baumont, R. (1989) The effects of intake of lucerne (*Medicago sativa* L.) and orchard grass (*Dactylis glomerata* L.) hay on the motility of the forestomach and digesta flow at the abomaso-duodenal junction of the sheep. *British Journal of Nutrition* 61, 699–714.
- Malbert, C.H. and Ruckebusch, Y. (1988) Gastroduodenal motor activity associated with gastric emptying rate in sheep. *Journal of Physiology* 401, 227–239.
- Mambrini, M. and Peyraud, J.L. (1994) Mean retention time in digestive tract and digestion of fresh perennial ryegrass by lactating dairy cows: influence of grass maturity and comparison with a maize silage diet. *Reproduction Nutrition Development* 34, 9–23.
- Mambrini, M. and Peyraud, J.L. (1997) Retention time of feed particles and liquids in the stomachs and intestines of dairy cows. Direct measurement and calculations based on faecal collection. *Reproduction Nutrition Development* 37, 427–442.
- Mathers, J.C. and Miller, E.L. (1981) Quantitative studies of food protein degradation and the energetic efficiency of microbial protein synthesis in the rumen of sheep given chopped lucerne and rolled barley. *British Journal of Nutrition* 45, 587–604.
- Matis, J.H. (1972) Gamma time-dependency in Blaxter's compartmental model. *Biometrics* 28, 597–602.
- Matis, J.H., Wehrly, T.E. and Ellis, W.C. (1989) Some generalized stochastic compartment models for digesta flow. *Biometrics* 45, 703–720.
- Orpin, C.G. (1975) Studies in the rumen flagellate *Neocallimastix frontalis*. *Journal of General Microbiology* 91, 249–262.
- Ortigue, I., Oldham, J.D., Smith, T., de Courtney, M.B. and Siviter, J.W. (1990) A comparison between ytterbium acetate, ruthenium phenanthroline and indigestible acid detergent fibre in a double-marker system for intestinal flow measurements in steers. *Journal of Agricultural Science, Cambridge* 114, 69–77.
- Poncet, C. and Ivan, M. (1984) Effect of duodenal cannulation in sheep on the pattern of gastroduodenal electrical activity and digestive flow. *Reproduction Nutrition Development* 24, 887–902.

- Pond, K.R., Tolley, E.A., Ellis, W.C. and Matis, J.H. (1984) A method for describing the weight distribution of particles from sieved forage. In: Kennedy, P.M. (ed.) *Techniques in Particle Size Analysis of Feed and Digesta in Ruminants*. Canadian Society of Animal Science, Edmonton, Alberta, pp. 123–133.
- Pond, K.R., Ellis, W.C., Matis, J.H., Ferreiro, H.M. and Sutton, J.D. (1988) Compartment models for estimating attributes of digesta flow in cattle. *British Journal of Nutrition* 60, 571–595.
- Poppi, D.P., Norton, B.W., Minson, D.J. and Hendricksen, R.E. (1980) The validity of the critical size theory for particles leaving the rumen. *Journal of Agricultural Science, Cambridge* 94, 275–280.
- Poppi, D.P., Minson, D.J. and Ternouth, J.H. (1981a) Studies of cattle and sheep eating leaf and stem fractions of grasses. 2. Factors controlling the retention of feed in the reticulo-rumen. *Australian Journal of Agricultural Research* 32, 109–121.
- Poppi, D.P., Minson, D.J. and Ternouth, J.H. (1981b) Studies of sheep and cattle eating leaf and stem fractions of grasses. 3. The retention time in the rumen of larger feed particles. *Australian Journal of Agricultural Research* 32, 123–137.
- Punia, B.S. (1988) Studies on the role of rumen protozoa in digestion and nitrogen metabolism in cattle and sheep. PhD thesis, University of Sydney, New South Wales, Australia.
- Robards, G.E. and Packham, R.G. (1983) *Feed Information and Animal Production – Proceedings of the Second Symposium of the International Network of Feed Information Centres*. CAB International, Wallingford, UK.
- Ruckebusch, Y. (1988) Motility of the gastro-intestinal tract. In: Church, D.C. (ed.) *The Ruminant Animal: Digestive Physiology and Nutrition*. Prentice-Hall, Englewood Cliffs, New Jersey, pp. 64–107.
- Ruckebusch, Y., Merritt, A. and Poncet, C. (1986) Enregistrement chronique des variations du débit duodénal chez les bovins. *Reproduction Nutrition Développement* 26(1B), 323–324.
- Sauvant, D. (1988) La modélisation de la digestion dans le rumen. *Reproduction Nutrition Développement* 28 (Suppl. 1), 33–58.
- Siddons, R.C., Pdaradine, J., Beever, D.E. and Cornell, P.R. (1985) Ytterbium acetate as a particulate-phase digesta-flow marker. *British Journal of Nutrition* 54, 509–519.
- Singleton, A.G. (1961) The electromagnetic measurement of the flow of digesta through the duodenum of the goat and the sheep. *Journal of Physiology* 155, 134–147.
- Stielau, W.J. (1967) The rate of passage of food particles through the digestive tract of sheep. *South African Journal of Agricultural Science* 10, 753–760.
- Sutherland, T.M. (1987) Particle separation in the forestomachs of sheep. In: Dobson, A. and Dobson, M.J. (eds) *Aspects of Digestive Physiology in Ruminants*. Cornell University Press, Ithaca, New York, pp. 63–73.
- Tan, T.N., Weston, R.H. and Hogan, J.P. (1971) Use of  $^{103}\text{Ru}$ -labelled tris-(1,10 phenanthroline)-ruthenium (II) chloride as a marker in digestion studies with sheep. *International Journal of Applied Radiation and Isotopes* 22, 301–308.
- Thomson, D.J. and Beever, D.E. (1980) The effect of conservation and processing on the digestion of forages by ruminants. In: Ruckebusch, Y. and Thivend, P. (eds) *Physiology and Metabolism in Ruminants*. MTP Press, Lancaster, pp. 291–308.
- Titgemeyer, E.C. (1997) Design and interpretation of nutrient digestion studies. *Journal of Animal Science* 75, 2235–2247.



- Topps, J.H., Kay, R.N.B. and Goodall, E.D. (1968) Digestion of concentrate and of hay diets in the stomach and intestines of ruminants. 1. Sheep. *British Journal of Nutrition* 22, 261–280.
- Udén, P., Colucci, P.E. and Van Soest, P.J. (1980) Investigation of chromium, cerium and cobalt as markers in digesta. Rate of passage studies. *Journal of the Science of Food and Agriculture* 31, 625–632.
- Ulyatt, M.J. and MacRae, J.C. (1974) Quantitative digestion of fresh herbage by sheep. 1. The sites of digestion of organic matter, energy, readily fermentable carbohydrate, structural carbohydrate and lipid. *Journal of Agricultural Science, Cambridge* 82, 295–307.
- Ulyatt, M.J., Dellow, D.W., John, A., Reid, C.S.W. and Waghorn, G.C. (1986) Contribution of chewing during eating and rumination to the clearance of digesta from the ruminoreticulum. In: Milligan, L.P., Grovum, W.L. and Dobson, A. (eds) *Control of Digestion and Metabolism in Ruminants*. Prentice-Hall, Englewood Cliffs, New Jersey, pp. 498–515.
- Vaage, A.S., Shelford, J.A. and Moseley, G. (1984) Theoretical basis for the measurement of particle length when sieving elongated feed particles. In: Kennedy, P.M. (ed.) *Techniques in Particle Size Analysis of Feed and Digesta in Ruminants*. Canadian Society of Animal Science, Edmonton, Alberta, pp. 76–82.
- Van Soest, P.J. (1982) *Nutritional Ecology of the Ruminant*. O and B Books Incorporated, Corvallis, Oregon.
- van't Klooster, A.T. and Rogers, P.A.M. (1969) Observations on the digestion and absorption of food along the gastro-intestinal tract of fistulated cows. 1. The rate of flow of digesta and the net absorption of dry matter, organic matter, ash, nitrogen and water. *Mededelingen Landbouwhogeschool Wageningen* 69–11, 3–19.
- van't Klooster, A.T., Kemp, A., Geurink, J.H. and Rogers, P.A.M. (1972) Studies of the amount and composition of digesta flowing through the duodenum of dairy cows. 1. Rate of flow of digesta measured direct and estimated indirect by the indicator dilution technique. *Netherlands Journal of Agricultural Science* 20, 314–324.
- Warner, A.C.I. (1981) Rate of passage of digesta through the gut of mammals and birds. *Nutrition Abstracts and Reviews, Series 'B'* 51, 789–820.
- Warner, A.C.I. and Stacy, B.D. (1968) The fate of water in the rumen. 2. Water balances through the feeding cycle in sheep. *British Journal of Nutrition* 22, 389–410.
- Warren, W.P., Martz, F.A., Asay, K.H., Hilderbrand, E.S., Payne, C.G. and Vogt, J.R. (1974) Digestibility and rate of passage by steers fed tall fescue, alfalfa and orchard-grass hay in 18 and 32°C ambient temperatures. *Journal of Animal Science* 39, 93–96.
- Weller, R.A. and Pilgrim, A.F. (1974) Passage of protozoa and volatile fatty acids from the rumen of sheep and from a continuous *in vitro* fermentation system. *British Journal of Nutrition* 32, 341–351.
- Wenham, G. and Wyburn, R.S. (1980) A radiological investigation of the effects of cannulation on intestinal motility and digesta flow in sheep. *Journal of Agricultural Science, Cambridge* 95, 539–546.
- Weston, R.H. (1988) Factors limiting the intake of feed by sheep. 11. The effect of pregnancy and early lactation on the digestion of a medium-quality roughage. *Australian Journal of Agricultural Research* 39, 659–669.
- Weston, R.H. and Hogan, J.P. (1967) The digestion of chopped and ground roughages by sheep. 1. The movement of digesta through the stomach. *Australian Journal of Agricultural Research* 18, 789–801.

Weston, R.H., Lindsay, J.R., Peter, D.W. and Buscall, D.J. (1989) Factors limiting the intake of feed by sheep. 14. Comparisons of voluntary feed consumption and various transactions in the alimentary tract between lambs and sheep fed roughage diets. *Australian Journal of Agricultural Research* 40, 625–642.

---

# 4

## *In Vitro* and *In Situ* Techniques for Estimating Digestibility

S. López

*Department of Animal Production, University of Leon, 24071 Leon, Spain*

---

### Introduction

New feeding systems need to be founded on the mechanisms that govern the response of animals to nutrients, dealing with quantitative aspects of digestion and metabolism in the ruminant animal. Digestibility and rumen degradability have been recognized as the main sources of variation of the energy and protein value of feeds, respectively. For the quantitative description of digestive and metabolic processes, appropriate biological data are required and can be obtained using *in vivo*, *in situ* and *in vitro* methods.

Information obtained *in vivo* is the most reliable and should be the reference to evaluate other methods, because it represents the actual animal response to a dietary treatment. However, *in vivo* digestion trials are expensive, laborious, time-consuming and not readily applicable to large numbers of feeds or when only small quantities of each feedstuff are available. *In vivo* results are restricted to the experimental conditions under which measurements are carried out, such as level of feeding and associative affects between feeds (Kitessa *et al.*, 1999). *In vivo* techniques to determine rumen degradability or intestinal digestibility require animals to be surgically modified, and measurements of digesta flows and of microbial and endogenous contributions of nutrients may be needed, resulting in digestibility and degradability estimates subject to large variability and additional errors associated with use of digesta flow rate markers, microbial markers and inherent animal variation. This variation demands use of sufficient experimental replication to obtain reliable results. Therefore, these trials cannot be considered routine in most laboratories, and cannot be carried out for all the possible feeding situations found in practice. Thus, the prediction of feed digestibility or energy values from *in vitro* or *in situ* information has become a necessity in all the feeding systems.

*In vitro* and *in situ* techniques represent biological models that simulate the *in vivo* digestion processes with different levels of complexity. These

techniques allow manipulation of parameters defining the state of the animal and, if properly evaluated against *in vivo* observations, can be appropriate to study the response of the animal when one factor is varied and controlled without the interaction of other related factors, which could conceal the main effect. Thus, *in vitro* and *in situ* techniques may be used to study individual processes providing information about their nature and sensitivity to various factors. Also a number of *in vitro* and *in situ* methods have been developed to estimate digestibility and extent of ruminal degradation of feeds, and to study their variation in response to changes in rumen conditions. Such techniques have been used for feed evaluation, to investigate mechanisms of microbial fermentation, and for studying the mode of action of anti-nutritive factors, additives and feed supplements.

This chapter will review recent developments in feed evaluation, with attention given to the role of *in situ* and *in vitro* methods in combination with mathematical modelling, in predicting digestibility and extent of degradation in the rumen of feeds.

## ***In Vitro* Techniques**

### ***Methods to estimate whole tract digestibility***

An overview of methods in use to estimate whole tract digestibility is presented in Table 4.1.

#### *Solubility*

The objective of separating soluble and insoluble components by simple extractions is to differentiate fractions that are either readily digestible or potentially indigestible, respectively (Van Soest, 1994). This could explain why with some of these techniques and for some feeds, a significant correlation between solubility and digestibility has been observed (Minson, 1982). Nocek (1988) has reviewed some of the solubility techniques used to predict the digestibility of feeds. Different solvents have been used, but with forages the best results have been obtained with the detergent system of fibre analysis (Van Soest *et al.*, 1991), which separates feeds into a combination of uniform and non-uniform fractions. The uniform fractions are the cell contents (or neutral detergent solubles that are essentially completely digestible), and the lignin that can be considered indigestible. The neutral detergent fibre (NDF) and the acid detergent fibre (ADF) have a variable digestibility that depends on multiple factors, but mainly on the lignification (Van Soest, 1994). The detergent system of fibre analysis has been extensively used to study the chemical composition of forages and also to predict digestibility (Van Soest, 1994).

#### *Methods using rumen fluid*

With these methods, digestibility is measured gravimetrically as substrate disappearance when the feed is incubated in the presence of ruminal contents diluted in a buffer solution. According to Hungate (1966), the first reported use

**Table 4.1.** Methods to estimate whole tract digestibility.

Methods	References
1. Using rumen fluid	
<i>Substrate disappearance</i>	
● Incubation in rumen fluid after 24–48 h	Walker (1959); Smith <i>et al.</i> (1971)
● Incubation in rumen fluid 48 h + incubation in HCl pepsin 48 h	Tilley and Terry (1963)
● Incubation in rumen fluid 48 h + extraction in neutral detergent	Goering and Van Soest (1970)
● <i>In vitro</i> filter bag technique	Ammar <i>et al.</i> (1999)
<i>Fermentation end-products formation</i>	
● Gas production after 24 h incubation in rumen fluid	Menke <i>et al.</i> (1979)
<i>Using faecal instead of ruminal inoculum</i>	El Shaer <i>et al.</i> (1987); Omed <i>et al.</i> (2000)
2. Using cell-free enzymes	
● Cellulase	Jones and Theodorou (2000)
● Acid pepsin + cellulase	Jones and Hayward (1975)
● Amylase + cellulase	Dowman and Collins (1982)
● Neutral detergent extraction + cellulase	Roughan and Holland (1977)
● Acid + cellulase	De Boever <i>et al.</i> (1988)
3. Solubility	
● Neutral detergent extraction	Van Soest <i>et al.</i> (1991)

of these techniques was in 1919, but the key progress in this methodology occurred when buffer solutions able to maintain an appropriate pH were used, thus allowing for longer term *in vitro* incubations. Many early *in vitro* systems consisted of a one-stage digestion in rumen fluid to measure *in vitro* digestibility (Donefer *et al.*, 1960; Smith *et al.*, 1971). One of the first comparisons between *in vitro* and *in vivo* digestibility was reported by Walker (1959).

The two-stage method described by Tilley and Terry (1963) is the most extensively used for *in vitro* digestibility. With this technique, a second stage was introduced after incubation in buffered rumen fluid for 48 h, in which the residue is digested in acid pepsin to simulate the digestion in the abomasum. Using a wide range of forages, Tilley and Terry (1963) confirmed the high correlation between *in vitro* and *in vivo* digestibility, with the *in vitro* values being almost exactly the same as the *in vivo* digestibility determined with sheep. To obtain reliable estimates of *in vivo* digestibility, the *in vitro* technique should be calibrated with samples of known digestibility, and then the conversion of *in vitro* digestibility to estimated *in vivo* results can be achieved by using correction factors (Minson, 1998). The *in vitro* digestibility technique led to the development of the concept of forage D value, defined as the content of digestible organic matter in forage dry matter (DM), used widely to predict digestibility and energy value of forages (Beever and Mould, 2000).

Some methodological modifications of the original technique described by Tilley and Terry have been suggested to facilitate scheduling for routine analysis of large numbers of samples. These include modifications in the acidification of the first stage residue, in the filtering system, in the length of the second stage or in the buffer solution composition (Marten and Barnes, 1980; Weiss, 1994). Goering and Van Soest (1970) proposed the use of neutral detergent solution as an alternative for acid pepsin in the second stage. The extraction with the neutral detergent removes bacterial cell walls and endogenous products in addition to protein, and therefore this modification predicts true digestibility rather than apparent digestibility (Van Soest, 1994). Furthermore, the second stage is substantially shortened allowing for large-scale operation.

One recent and promising alternative is offered by an *in vitro* filter bag technique. Small amounts of sample are weighed into polyester bags, which are incubated within a single fermentation vessel placed in revolving incubators (Ammar *et al.*, 1999; Adesogan, 2002). A large number of samples can be analysed at one time, and determinations of DM, NDF and ADF can be carried out on the residue contained in the bag. The system allows for investigating the effects of changes in the rumen environment on the digestibility of feeds, such as the addition of a substance.

Another *in vitro* method to estimate digestibility that has had wide acceptance is the gas measuring technique proposed by Menke *et al.* (1979), based on the close relationship between rumen fermentation and gas production (Van Soest, 1994). Basically, a small amount of feed is incubated in buffered rumen fluid and then the gas produced by fermentation is measured after 24 h of incubation. The volume of gas accumulated is highly correlated with *in vivo* digestibility, and different empirical equations were developed to predict *in vivo* digestibility from chemical composition and *in vitro* gas production (Menke and Steingäß, 1988). Other methods based on measuring the accumulation of volatile fatty acids (VFA) or heat generation during *in vitro* fermentation have been suggested to estimate digestibility.

The *in vitro* rumen fermentation methods are subject to multiple sources of variation, such as the type of fermentation vessels, the composition of the buffer-nutrient solution, the conditions of incubation (anaerobiosis, pH, temperature, stirring), the sample size or the sample preparation (drying, grinding, particle size) (Marten and Barnes, 1980; Weiss, 1994). However, the most important factors are the length of incubation and the inoculum source, processing and amount used. As to the length of incubation, a 48-h incubation period has been suggested for the gravimetric techniques as the overall optimal time for better accuracy of the digestibility estimates, whereas for the gas production method, the best results were observed with incubation times of 24 h. The length of the *in vitro* fermentation, however, can be altered depending upon the objectives of the trial.

The inoculum represents the greatest source of uncontrolled variation in these techniques. The activity and microbial numbers in the inoculum can show significant differences for different animal species, breeds, individuals, and within the same animal from time to time, as well as for the diet of donor animals (Marten and Barnes, 1980; Weiss, 1994). To overcome the

requirement for fistulated donor animals to provide the liquor, the use of faecal samples as an alternative source of fibrolytic microorganisms has been considered (El Shaer *et al.*, 1987; Omed *et al.*, 2000). The inoculum activity is affected by dietary effects to a lesser extent when faecal liquor is used, and the technique seems to be more suitable for free-ranging animals, although the values obtained are somewhat different from those observed with ruminal inoculum (Omed *et al.*, 2000).

### *Enzymatic methods*

The use of enzymes as alternatives to rumen fluid has the advantages of overcoming the need for fistulated animals and anaerobic procedures, simplifying analytical methodology and eliminating the variability in activity of the inoculum (Nocek, 1988; Jones and Theodorou, 2000). The enzyme activities must reflect the digestive process in the ruminant. Cell-wall-degrading enzymes able to digest the structural carbohydrates have been used to estimate digestibility of forages. In most cases these enzymes are commercial and have been obtained from aerobic fungi. In particular, crude cellulases from *Trichoderma* species have generally been found to be the most reliable sources of fibrolytic enzymes (Jones and Theodorou, 2000). Although the main activity of these enzymes is cellulolytic, they can hydrolyse other structural carbohydrates.

Initially, one-stage methods consisting of incubating feed samples for some time in a buffer solution containing the cellulase were used. However, the low substrate disappearance values observed suggested that the enzymes could not remove readily all the soluble constituents of the feed. Hence, different treatments of the samples prior to the incubation in cellulase were suggested, such as incubation in acid pepsin (Jones and Hayward, 1975) or in amylase (Dowman and Collins, 1982), neutral detergent extraction (Roughan and Holland, 1977) or treatment with hot acid (De Boever *et al.*, 1988). The potential of these techniques in feed evaluation depends on the reliability and robustness of the predictive equations derived for *in vivo* digestibility. Results reported seem to indicate that enzymatic solubility can be considered a good estimator of digestibility, with small prediction errors (De Boever *et al.*, 1988; Jones and Theodorou, 2000; Carro *et al.*, 2002). But the values observed with these enzymatic techniques differ to some extent from the actual digestibility coefficients, and the regression equations are affected by forage species, methods of pre-treatment and source of enzyme (Weiss, 1994; Jones and Theodorou, 2000). Nevertheless, when a simple relative ranking of digestibility is the objective, enzymatic digestion is clearly an attractive prospect.

## **Methods for rumen studies**

### *In vitro systems to investigate rumen fermentation*

The direct study of rumen fermentation is difficult, and different systems have been designed to allow rumen contents to continue fermenting under controlled laboratory conditions to follow fermentation patterns (Table 4.2). Several systems have been developed with the aim of attaining conditions

**Table 4.2.** Methods to investigate rumen fermentation.

- 
1. Batch cultures or bulk incubations
    - Short- or medium-term experiments
    - Non-steady-state conditions
  2. Continuous cultures
    - Medium- or long-term experiments
    - Quasi-steady-state conditions
    - Types:
      - 2a. The semi-permeable or dialysis type
      - 2b. The continuous flow type
        - (a) The dual-flow system
        - (b) The single outflow system
      - 2c. The semi-continuous flow type: the Rusitec
- 

approaching those observed within the rumen *in vivo*, with the system design being prompted, to some extent, by the particular objectives of the research. The system will also be different, depending on the type of microbial population to be cultured: isolated pure cultures of either one single species or a group of microorganisms or incubation of mixed rumen contents. Czerkawski (1991) considered some obligatory (temperature and redox-anaerobiosis control, provision for replication, ease of use) and optional (efficiency of stirring, pH control, removal of end-products, provision for gaseous exchanges, sterile conditions) criteria for successful *in vitro* rumen fermentation work. *In vitro* systems have been classified into two main types: bulk incubations (also called batch cultures) and continuous cultures. Within each type it is possible to have open (accumulated fermentation gas is released or gas is circulating through the reaction mixture) or closed (the mixture is incubated under a given volume of gas and the gas produced is somehow collected to be measured) systems (Czerkawski, 1986).

**BATCH CULTURES.** Batch cultures are the simplest and most commonly used *in vitro* fermentation systems, and are very useful for experiments in which a large number of samples or experimental treatments are to be tested ('screening trials'), or when the amount of sample available is very small (Tamminga and Williams, 1998). The main application of these systems is to estimate digestibility or the extent of degradation in the rumen, either by single end-point or kinetic measurements of either gravimetric substrate disappearance or end-products accumulation (Weiss, 1994). VFA production can be measured easily *in vitro* as the accumulation of VFA when the substrate is incubated. Internal (purines) or external ( $^{15}\text{N}$ ,  $^{14}\text{C}$ ,  $^{32}\text{P}$ ) markers are required to measure microbial synthesis (Hristov and Broderick, 1994; Blümmel *et al.*, 1997a; Ranilla *et al.*, 2001). The main drawback of using batch cultures to study rumen fermentation is that only short- (hours) and medium-term (days) experiments are possible and steady-state conditions cannot be reached owing to the microbial growth pattern. After reaching an asymptote, the



microbial population tends to decrease due to the shortening of substrate and the accumulation of waste products, resulting in lysis and death of microbial cells.

**CONTINUOUS CULTURES.** In continuous culture systems or chemostats, there is a regular addition of buffer and nutrients and a continual removal of fermentation products, reaching steady-state conditions, which allow for the establishment of a stable microbial population that can be maintained for long periods of time. The systems allow measurement of fermentation parameters, extent of DM degradation, output of end-products and microbial protein synthesis (Czerkawski, 1986). Thus, these systems simulate the rumen environment closer than batch cultures, and enable the study of long-term (weeks) effects of factors affecting the microbial population and the digestion of nutrients under controlled conditions of pH, turnover rate and nutrient intake (Michalet-Doreau and Ould-Bah, 1992; Stern *et al.*, 1997). However, some time is required after inoculating the culture before steady-state conditions are achieved. Czerkawski (1991) defined three types of *in vitro* rumen continuous cultures or fermenters:

- The *semi-permeable type*, a continuous dialysis system in which the microbial culture is enclosed inside a semi-permeable membrane. This system is very complex, not suitable for routine use, and cannot be fed with solid substrates.
- Continuous cultures in which the fermenter contents are completely mixed up, a liquid buffer-solution containing nutrients is infused continuously, the feed (particulate matter) is dispensed regularly into the vessel, and some of the reaction mixture, containing particles in suspension, is either pumped out or simply allowed to overflow. As the input and output of both liquid solutions and solid feed are continuous, these systems are regarded as *continuous flow type systems* (Czerkawski, 1991). Several fermenters of this type have been described in the literature (Stern *et al.*, 1997). The dual-flow systems (Hoover *et al.*, 1976) incorporate a dual effluent removal system, simulating the differential flows for both liquids and solids. In the single outflow systems a specially designed overflow device is fitted, so the feed particles stratify in the vessel according to density, providing the basis for differential liquid and solid turnover rates as in the rumen (Teather and Sauer, 1988).
- The *Rusitec* (Rumen Simulation Technique), a fermenter (Czerkawski and Breckenridge, 1977) with just a single outflow to control dilution. Both the infusion of the buffer solution into the vessel and the removal of the liquid effluent by overflowing are continuous. However, there are no provisions for continuous feed supply and solid particles outflow from the vessel, so the Rusitec is considered a *semi-continuous flow system*. Despite its limitations, the Rusitec represents a simple and elegant system to simulate the compartmentation occurring in the rumen (Czerkawski, 1986), and kinetic studies are facilitated in comparison with continuous flow systems where the use of markers is required.

Modelling the production and passage of substances in continuous culture systems is simpler than in the rumen because conditions are stable, without confounding effects of endogenous matter, absorption and passage are a single process (removal or outflow), and feed input and outflow rates are constant, regulated and measured directly. Nevertheless, similar to *in vivo* studies, reliable techniques are required for differentiation of microbial and dietary fractions by the use of markers ( $^{15}\text{N}$ , purines).

Rusitec and dual-flow continuous cultures seem to simulate rumen conditions to an acceptable extent (Hannah *et al.*, 1986; Mansfield *et al.*, 1995) and are excellent biological models for studying ruminal microbial fermentation.

#### *Estimation of degradability of feeds in the rumen*

A number of *in vitro* techniques have been described to estimate the degradability of feeds in the rumen (Table 4.3). Specific *in vitro* techniques have been developed to estimate protein degradability.

**METHODS USING RUMEN FLUID.** The *in vitro* technique of Goering and Van Soest (1970) has been used to estimate degradability in the rumen. Substrate disappearance after incubation in buffered rumen fluid followed by neutral detergent extraction is measured at several incubation times, and the degradation curve fitted to various mathematical models to estimate the fractional rate of degradation. This parameter is used with the passage rate to

**Table 4.3.** Methods to estimate the extent of degradation of feeds in the rumen.

Methods	References
1. Organic matter fermentation	
• Kinetics of substrate disappearance after incubation in rumen fluid	Smith <i>et al.</i> (1971)
• Kinetics of gas production after incubation in rumen fluid: the gas production techniques	Reviewed by Schofield (2000) and Williams (2000)
• Kinetics of substrate disappearance or end-products formation after incubation in cell-free enzymes (amylases, cellulases, etc.)	Nocek (1988); López <i>et al.</i> (1998)
2. Protein degradability	
• Kinetics of ammonia production after incubation in rumen fluid: the inhibitor <i>in vitro</i> method	Broderick (1987)
• Kinetics of ammonia and gas production after incubation in rumen fluid	Raab <i>et al.</i> (1983)
• Use of microbial markers <i>in vitro</i>	Hristov and Broderick (1994); Ranilla <i>et al.</i> (2001)
• Kinetics of nitrogen loss after incubation in cell-free enzymes (proteases)	Krishnamoorthy <i>et al.</i> (1983); Aufrère <i>et al.</i> (1991)
• Nitrogen solubility	Nocek (1988); White and Ashes (1999)

estimate the extent of degradation in the rumen (Waldo *et al.*, 1972). The fermentation kinetic parameters may also be derived from the cumulative gas production profile, obtained after measuring gas production at different incubation times, and using non-linear models to estimate the fermentation rate. The cumulative gas produced at different incubation times can be measured on a single, small sample (Williams, 2000).

To measure gas production from batch cultures of buffered rumen fluid at several time intervals, different devices and apparatus have been designed, based on essentially two different approaches: measuring directly the increase in volume when the capacity of the container can be expanded so the gas is accumulated at atmospheric pressure, or measuring changes in pressure in the headspace when the gas accumulates in a fixed volume container (Getachew *et al.*, 1998). Using the first approach, Menke *et al.* (1979) incubated the samples in calibrated syringes so the volume of gas produced could be measured from the plunger displacement. In other similar techniques gas volumes are measured by liquid displacement or by a manometric device.

Theodorou *et al.* (1994) used a pressure transducer to measure the volume of gas accumulated in the headspace of sealed serum bottles. This system has been adapted for computer recording to allow for large-scale operation (Mauricio *et al.*, 1999). Some automated systems have been developed to obtain more frequent readings and a large number of data points (Schofield, 2000; Williams, 2000). Basically the systems consist of computer-linked electronic sensors used to monitor gas production. Some of the systems (closed) record the changes in pressure in the fermentation vessel as gas accumulates in the headspace (Pell and Schofield, 1993), whereas in others (open) the accumulated gas is released by opening a valve when the sensor registers a pre-set gas pressure, so that the number of vents and the time of each one are recorded by a computer (Davies *et al.*, 2000).

The gas production technique can be affected by a number of factors, such as sample size and physical form (particle size), the inoculum source as influenced by animal, diet and time effects, inoculum size, manipulation of the rumen fluid, composition and buffering capacity of the incubation medium, anaerobiosis, pH and temperature control, shaking and stirring, correction for a blank, reading intervals when pressure is increased, etc. (Getachew *et al.*, 1998; Schofield, 2000; Williams, 2000). Some uniformity in the methodology is required to compare results from different laboratories. The gas technique also needs to be validated against comprehensive *in vivo* data to develop suitable predictive procedures (Beever and Mould, 2000).

It is important to understand that the technique assumes that the gas produced in batch cultures is just the consequence of the fermentation of a given amount of substrate, and the major assumption in gas production equations is that the rate at which gas is produced is directly proportional to the rate at which substrate is degraded (France *et al.*, 2000). However, there are some questions relating to this assumption that need further consideration: (i) some gas can be derived from the incubation medium, as CO<sub>2</sub> is released from the bicarbonate when the VFA are buffered in the culture (Theodorou *et al.*, 1998); (ii) some gas production is caused by microbial turnover, especially for

prolonged incubation times (Cone, 1998); and (iii) the partitioning of the fermentable substrate into gas, VFA and microbial mass can be different for each substrate (Blümmel *et al.*, 1997b). Gas production is basically the result of the fermentation of carbohydrates, and the amount of gas produced per unit of fermentable substrate is significantly smaller with protein-rich feeds (López *et al.*, 1998), and almost negligible when fat is fermented (Getachew *et al.*, 1998). Furthermore, the amount of gas produced per unit of fermentable substrate is affected by the molar proportions of the VFA, because a net yield of CO<sub>2</sub> and CH<sub>4</sub> is generated when acetate and butyrate are produced, but not when the end-product is propionate (Blümmel *et al.*, 1997b). Molar proportions of acetate and butyrate are greater when fibrous feeds are degraded, and more propionate is obtained when starchy feeds are fermented, giving rise to a significant variability in the fermentable substrate to gas production ratio. This ratio, also called partitioning factor (Blümmel *et al.*, 1997b), is also affected by the efficiency of microbial synthesis, as the partitioning of ruminally available substrate between fermentation (producing gas) and direct incorporation into microbial biomass may vary depending upon, amongst others, the size of the microbial inoculum and the balance of energy and nitrogen-containing substrates (Pirt, 1975). Therefore, across different feedstuffs there is an inverse relationship between the amount of microbial mass per unit of fermentable substrate and the amount of either gas or VFA produced (Blümmel *et al.*, 1997b). Based on this relationship and the stoichiometry of gas and VFA production, it has been suggested that if the amount of substrate truly degraded is known, gas production may be used to predict *in vitro* microbial biomass (Blümmel *et al.*, 1997b).

*In vitro* techniques to estimate protein degradability by incubating feed samples in rumen fluid are based on measuring ammonia production. However, ammonia concentration in batch cultures will reflect the balance between protein degradation and the uptake of ammonia for the synthesis of microbial protein. The amount and nature of fermentable substrates also affect ammonia concentrations, as uptake by microbes is stimulated to a greater extent than ammonia release in the presence of readily fermented carbohydrates. In order to measure net ammonia release as the main end-product of protein degradation, Broderick (1987) described an *in vitro* procedure using inhibitors of uptake of protein degradation products and amino acid deamination by ruminal microbes (hydrazine sulphate and chloramphenicol), and measuring NH<sub>3</sub> and amino acid concentration in the incubation medium before any uptake by microbes can occur. This procedure has been called the inhibitor *in vitro* method (Broderick and Cochran, 2000) and it gives acceptable estimates of kinetic parameters for protein degradation, as the inhibitors do not affect the proteolytic activity of the microorganisms. However, in the absence of nitrogenous precursors for protein synthesis, microbial growth will be reduced after a few hours of incubation; hence this procedure involves only short-term *in vitro* incubations. Raab *et al.* (1983) proposed an alternative procedure, measuring ammonia concentration and gas production at 24 h when feeds were incubated in rumen fluid with graded amounts of starch or other carbohydrates.

A different approach described by Hristov and Broderick (1994) uses a marker ( $^{15}\text{N}$ ) to distinguish newly formed microbial protein from feed protein remaining undegraded. Similarly, differential centrifugation procedures and markers such as  $^{15}\text{N}$  and purines have been used to estimate the efficiency of protein synthesis in batch cultures (Blümmel *et al.*, 1997a; Ranilla *et al.*, 2001). Alternative approaches estimate microbial N formation from the incorporation of  $^3\text{H}$ - or  $^{14}\text{C}$ -labelled amino acids.

**ENZYMATIC TECHNIQUES.** In these techniques the feed is incubated in buffer solutions containing commercial cell-free enzymes instead of rumen liquor. To estimate the extent of DM or cell wall degradation in the rumen, the techniques used are similar to those already described to predict digestibility. Specific fungal and bacterial enzymes have been used to measure degradation of the different feed carbohydrates, such as amylases (Cone, 1991), cellulases, xylanases, hemicellulases and pectinases (Nocek, 1988). Use of enzymes to simulate ruminal fibre digestion results generally in less DM degradation than with buffered rumen fluid presumably as a result of incomplete enzymatic activity compared with the ruminal environment. Some studies suggest synergism between digesting enzymes, so mixtures of enzymes may be necessary. Enzymatic techniques are usually gravimetric, measuring the disappearance of DM or any other feed component, but the release of any hydrolysis product can be also measured to estimate degradation (López *et al.*, 1998).

A number of different techniques have been reported to predict protein degradability using kinetic or single-point estimates of N loss from feed samples incubated with various proteases (Krishnamoorthy *et al.*, 1983; Aufrère *et al.*, 1991). Enzymes of bacterial, fungal, plant and animal origin have been used, but the reported results seem to indicate that non-ruminal enzymes may be of limited use as they may not have the same activity and specificity (Stern *et al.*, 1997). Protein degradability measurements using enzymatic techniques are affected by factors such as incubation pH, presence of reducing factors, type of protease used and batch-to-batch variability in enzyme activity, pre-incubation with carbohydrate degrading enzymes and the enzyme:substrate ratio. It seems crucial that the enzyme concentration is sufficient to saturate the substrate (Stern *et al.*, 1997). Although with these techniques feeds are ranked roughly in the same order as with other methods, it seems that enzymatic techniques do not provide accurate predictions of protein degradability across all feed types (White and Ashes, 1999).

**SOLUBILITY.** Nitrogen solubility in buffer or in different solvents varying in complexity has been used to predict protein degradability for some feed types (Nocek, 1988; White and Ashes, 1999). Although some results indicate a significant correlation between solubility and degradability, N solubility can be considered a useful indicator of protein degradation when comparing different samples of the same feedstuff, but of limited use for ranking different feedstuffs (Stern *et al.*, 1997). In fact, soluble proteins can be degraded at different rates or even be of low degradability, in contrast with some insoluble proteins that are readily degraded in the rumen (Mahadevan *et al.*, 1980).

## The *In Situ* Technique

In this case, digestion studies are conducted in the rumen of a living animal instead of simulating rumen conditions in the laboratory, hence the term *in situ*. The disappearance of substrate is measured when an undegradable porous bag containing a small amount of the feedstuff is suspended in the rumen of a cannulated animal and incubated for a particular time interval (Ørskov *et al.*, 1980).

The technique is based on the assumption that disappearance of substrate from the bags represents actual substrate degradation by the rumen microbes and their enzymes. However, a number of questions cannot be resolved completely, as not all the matter leaving the bag has been previously degraded, and some of the residue remaining in the bag is not really undegradable matter of feed origin. Furthermore, the bag can be considered an independent compartment in the rumen, with the cloth representing a 'barrier' that on one side allows for the degradation of the feed to be assessed without mixing with the rumen contents, but on the other side implies an obstacle for simulating actual rumen conditions inside the bag. Finally, some methodological aspects require standardization for the technique to be considered precise and reproducible. Many of these questions have been investigated extensively and reviewed in the last 20 years, and a number of technical and methodological recommendations have been made (Ørskov *et al.*, 1980; Setälä, 1983; Lindberg, 1985; Nocek, 1988; Michalet-Doreau and Ould-Bah, 1992; Huntington and Givens, 1995; Vanzant *et al.*, 1998; Broderick and Cochran, 2000; Nozière and Michalet-Doreau, 2000; Ørskov, 2000) (see Table 4.4 for overview of factors).

### *In situ* methodology

#### *Loss of matter from the bag*

Matter contained in the bag has to be degraded to pass through the pores out of the bag. However, complete fermentation is not required, and the particles can be lost once their size is smaller than the pore size. It has been suggested that the particles escaping consist of material potentially degradable during short incubation times (Setälä, 1983). Nevertheless, the particulate matter lost from the bag includes particles that have not been previously degraded, which results in overestimation of both the immediately soluble fraction and the extent of degradation, and likely underestimation of the rate of degradation (Huntington and Givens, 1995).

Loss of particles from the bag can be attributed mainly to the interaction between bag pore size and sample particle size. A standard and appropriate particle size to pore size ratio is desirable to minimize the impact of such loss on the estimate of the extent of degradation. As expected, large pore sizes lead to greater loss of particles and undegraded material. Aperture size of the bag affects significantly the initial rate of degradation, but the extent of degradation is affected to a lesser extent (Huntington and Givens, 1995).

**Table 4.4.** Factors affecting the *in situ* technique.

- 
1. Loss of matter from the bag
    - a. Bag pore size
    - b. Sample particle size
    - c. Degradation rate of the soluble fraction
  2. Recovery of matter of non-feed origin in the incubation residue
    - a. Post-incubation washing procedure
    - b. Microbial colonization of the residue
  3. Confining conditions inside the bag
    - a. Textile fibre, weave structure of the cloth
    - b. Bag porosity (pore size, open surface area)
    - c. Sample size
    - d. Bag position within the rumen
    - e. Basal diet (forage to concentrate ratio, forage type, level of feeding, long fibre)
    - f. Diurnal changes in ruminal activity (frequency of feeding, time to start incubation)
  4. Other procedural considerations
    - a. Animal effects
    - b. Replication (number of animals, bags, repetitions)
    - c. Sample preparation (high-moisture feeds)
    - d. Routine for introducing and withdrawing bags
    - e. Sampling scheme and mathematical modelling
  5. Multiple interactions amongst factors of variation
- 

Prior to incubation, feed samples are usually ground to facilitate handling, to provide more homogeneous and representative material for incubation, and to reduce particle size to simulate the comminution occurring normally by mastication and rumination. In the bag, the reduction in particle size is due to microbial fermentation and rubbing forces driven by the movements of the rumen wall and its contents. Milling also increases the area accessible for microbial attachment and degradation, as damaged and cut surfaces are the primary sites for microbial colonization. Different recommendations have been made about the most appropriate particle size for the *in situ* technique, as coarser particles result in lower and more variable disappearance rates, whereas too small particles are associated with greater mechanical losses of material from the bags (Weakley *et al.*, 1983; Udén and Van Soest, 1984).

Intermediate screen apertures (1.5–3 mm) for grinding have been suggested as the most adequate for the *in situ* technique (Huntington and Givens, 1995; Broderick and Cochran, 2000). Forages should be ground using a larger screen than those used for concentrates to reproduce the effect of chewing. However, simple recommendations cannot deal with other complex questions arising, because the particle size distribution after milling using a standard screen size is different depending upon the proportion of different plant parts (stems and leaves) and the physical properties (brittleness) of the feedstuff, with a significant interaction between milling screen size and feedstuff type (Emanuele and Staples, 1988; Michalet-Doreau and Ould-Bah, 1992). Furthermore, the chemical composition is variable for particles of different sizes

(Emanuele and Staples, 1988). As a mean particle size would be preferable to a grinding screen aperture, the best way to overcome this problem in part would be to establish some degree of uniformity in particle size within major feedstuff categories (Nocek, 1988; Michalet-Doreau and Ould-Bah, 1992), but standards based on particle size distribution seem to be impractical (Vanzant *et al.*, 1998).

Particulate matter loss can be quantified as the difference between the total washout from the bag prior to incubation (disappearance of material attributed to mechanical loss and washing) and the soluble fraction measured by filtration. Using the estimated particulate matter loss, some mathematical approaches have been suggested to correct the disappearance rates, the degradation parameters and the estimates of the extent of degradation (López *et al.*, 1994; France *et al.*, 1997).

Most water-soluble materials disappear from the bag unfermented, just by soaking in an aqueous solution. The assumption that this soluble fraction is instantaneous and completely degraded may not be true since some highly soluble compounds show small ruminal degradability (Messman *et al.*, 1994). This problem cannot be easily tackled by the technique. Some mathematical approximations have been suggested to account for this factor in estimating the extent of degradation (Dhanoa *et al.*, 1999), providing estimates of the degradation rate of the soluble fraction are available.

#### *Recovery of matter of non-feed origin in the incubation residue*

After withdrawal from the rumen, the bags are washed to stop microbial activity and to remove any rumen digesta and microbial matter in the incubation residue or in the bag. A considerable diversity of post-incubation washing procedures have been used, although a significant influence of the rinsing methodology on degradability estimates has been reported (Cherney *et al.*, 1990; Huntington and Givens, 1995). In the first *in situ* experiments, bags were just soaked and rinsed by hand under cold water until the water appeared to be clear. The main flaw of manual washing is that it is highly subjective, introducing a high and undesirable variability to the measurements. Thus, the use of washing machines was investigated as a means to standardize the procedure, offering better repeatability (Cherney *et al.*, 1990). The duration and number of rinses with cold water in the washing machine and the suitability of agitation and spinning have been tested (Madsen and Hvelplund, 1994).

Some influx of small fine particles into the bags allows faster inoculation of the samples. This ruminal matter that has infiltrated the bag is usually removed after mild rinsing (Udén and Van Soest, 1984), but complete removal of the microbial mass attached to the feed particles is far more difficult to achieve. Microbial colonization of the feed is required for degradation, but its presence in the residue can lead to substantial underestimation of the extent of degradation. The degree of microbial contamination of the residues is variable among different substrates. Contamination can have a large impact on the estimates of protein degradability of low-protein forages (Michalet-Doreau and Ould-Bah, 1992), but its influence using other feeds seems to be almost negligible. A number of procedures to facilitate microbial detachment minimizing



contamination of the residues have been suggested (Michalet-Doreau and Ould-Bah, 1992; Huntington and Givens, 1995), and the proportion of microbial matter in the incubation residue can be determined using markers (Michalet-Doreau and Ould-Bah, 1992). The correction for microbial contamination may give variable estimations of protein degradability depending upon the marker used (purines,  $^{15}\text{N}$ ) and the microbial pellet isolated (solid- or liquid-associated bacteria).

#### *Confining conditions inside the bag*

Despite the physical separation of bag contents from ruminal digesta, conditions inside the bag should be as similar to those in the surrounding rumen contents as possible, so the choice of an appropriate cloth seems crucial. Although silk was the first material used, bags are made from artificial or synthetic textile fibres such as polyester, dacron and nylon. The material should be entirely resistant to microbial degradation. The weave structure of the cloth determines the uniformity of the pore size, with the monofilamentous weave showing a more precisely defined pore size and being less distorted during incubation (Marinucci *et al.*, 1992). Due to the changes in that structure during incubation, repetitive use of bags should be prevented.

If the bags are overfilled with sample, the mixing and soaking of bag contents with rumen fluid can be incomplete (Nocek, 1988; Vanzant *et al.*, 1998). Recommended sample size is expressed in terms of optimal sample weight to bag surface area ratio, and values suggested are in the range of 15–20 mg/cm<sup>2</sup> (Huntington and Givens, 1995). Some materials (e.g. gluten) tend to clump when wet, which may impede particle movement and proper mixing with rumen fluid within the bag.

However, the main bag characteristic to be considered is pore size. If the pore is too small the exchange of fluids and microorganisms is restricted. Small pores may be clogged, mainly when viscous substrates are incubated. Inhibited removal of fermentation end-products from bags with small pores that become blocked during incubation can lead to accumulation of gas and acidification of the medium inside the bags (Nozière and Michalet-Doreau, 2000). The exchange of fluids between bag and rumen contents is also determined by open surface area of the bag material (proportion of the total surface area of the bag accounted for by the pores) (Weakley *et al.*, 1983; Vanzant *et al.*, 1998). With bags of small pore size, the microbial population reaching the sample may be significantly different from that present in rumen contents. A minimal aperture size of 30–40  $\mu\text{m}$  is necessary to favour entry of rumen bacteria, anaerobic fungi and some protozoa into the bag (Lindberg, 1985). Therefore, intermediate bag pore sizes (35–55  $\mu\text{m}$ ) have been recommended to allow for a minimal microbial activity in the bags without major loss of fine particles from the feed incubated.

More diverse microbial colonization is possible with larger pore sizes, but even so the type and numbers of microorganisms inside the bag are somehow different from those in the surrounding rumen digesta. The differences between bag contents and rumen digesta for the proteolytic and amylolytic activities seem to be slight, whereas those for the cellulolytic population are larger, with

fibrolytic activity of solid-adherent microorganisms being lower in bag residues than in rumen digesta (Nozière and Michalet-Doreau, 2000).

The diet fed to the animals may have pronounced effects on the whole rumen environment, and consequently interactions between the type of feed assayed *in situ* and the basal diet fed to the animal are prevalent (Lindberg, 1985). To obtain the most accurate measurement of ruminal degradation, the same food incubated in the bag should be contained in the diet fed to the animal. However, this approach cannot be followed in all circumstances, and when the objective is to compare feeds or to develop tabular values, it seems satisfactory to use a general purpose basal diet to minimize the dietary effects (Broderick and Cochran, 2000). In theory, this diet should support optimal growth and metabolic activity of the rumen microbial population, meeting the energy, nitrogen and micronutrient requirements of most microorganisms. Probably, forage-to-concentrate ratio, type of forage and level of feeding have been the diet-related features that have received most attention. Increasing the amount of grain fed to the animals is associated with lower estimates of rate and extent of *in situ* disappearance of forages (Nocek, 1988; Weiss, 1994), but these values are significantly less affected by the type of forage included in the diet. Altered or extreme rumen conditions as well as the deficiency or excess of nutrients due to unbalanced diets can cause the undesirable exclusion of some of the microbial species. Finally, a minimum percentage of long fibre in the diet seems to be required because fibrous rumen contents enhance the circulation of fluid through the bag and its blending with the sample incubated (Huntington and Givens, 1995).

There are significant diurnal fluctuations in digestive ruminal activity, especially in animals fed once or twice daily. Frequent feeding using automatic feeders can reduce this source of variation (Lindberg, 1985), but in most cases feeds are evaluated for use in practical conditions where animals receive one or two meals per day. In this case, the time that bags are introduced into the rumen in relation to animal feeding can influence digestion rates inside the bags. Thus, to minimize this variability, all the bags should be introduced at the same time to be exposed to the same rapidly changing rumen conditions occurring after feeding (Nozière and Michalet-Doreau, 2000).

To facilitate flow of rumen liquor into and out of the bags and mixing with the feed sample, the bags should remain immersed in the liquid phase of the rumen contents, move freely and be squeezed during muscular contractions. Aspects such as length of string along which bags are fastened or use of a carrier weight have been investigated, as these devices can determine, to some extent, the position of the bags and the lack of restrictions for bag mobility during incubation (Huntington and Givens, 1995).

#### *Other procedural considerations*

It is advisable that *in situ* disappearance procedures are standardized to increase precision, as lack of standardization has been reported as the main source of variation in the assay (Madsen and Hvelplund, 1994). As for the animal effects, there may be small but significant differences in the estimates of extent of degradation of feeds if samples are incubated in the rumen of different

ruminant species and breeds (Udén and Van Soest, 1984; López *et al.*, 2001), and ideally the same type of animal for which the information is intended should be used. To improve the precision of measurements, the animal variability needs to be minimized using the same type of animals for each experiment, in the same physiological state and maintained in the same husbandry and environmental conditions (Nocek, 1988; Huntington and Givens, 1995). Provision for adequate replication (number of animals, number of bags per animal, number of incubations to account for day-to-day variation) is also necessary (Weakley *et al.*, 1983; Vanzant *et al.*, 1998). More replicates should be used for short incubation times, when the effects of particle size or host diet are more pronounced. The use of standards has been suggested as a means of accounting for the variation among animals and time periods (Weiss, 1994; Vanzant *et al.*, 1998).

The evaluation of high moisture feeds (fresh herbage and silage) is complicated because grinding is difficult unless the sample is previously dried. Wet grinding or hand-chopping and macerating are probably the best ways to simulate chewing, but these procedures cannot guarantee a uniform particle size distribution, result in some inevitable sewage and it is necessary to incubate the samples immediately after harvesting (Nozière and Michalet-Doreau, 2000). Freeze drying is a better alternative for sample preparation than oven drying (López *et al.*, 1995), but affects the physical properties of the material and thus the particle size distribution after milling.

The routine to be followed for introducing and removing the bags has also been examined. When bags are not machine washed, introducing bags at different times to be removed all at once seems preferable in order to minimize the variation attributed to bag washing technique. Otherwise, it is better to introduce all the bags at the same time and withdraw them at the intended incubation times, so that the samples are subject to the same rumen conditions in all cases. Huntington and Givens (1995) did not detect significant differences between both incubation sequences on DM degradability of feeds.

Finally, the values determined for the soluble, degradable and undegradable fractions, rate, extent and lag time may be also affected by the sampling scheme, the approach (either logarithmic-linear transformation or non-linear fitting) to derive kinetic parameters (Nocek and English, 1986) and the model selected to represent degradation kinetics (Dhanoa *et al.*, 1996; López *et al.*, 1999) (see Chapter 2). Mathematical modelling of degradation kinetics will be discussed in detail later. The incubation times and the number of data points to be recorded for kinetic studies should be established according to the minimum requirement for statistical analysis of the disappearance profiles (Chapter 2) and will depend on the shape of the curve (Michalet-Doreau and Ould-Bah, 1992). More frequent measurements are required in the first 24 h of incubation, the most sensitive part of the curve, to obtain reliable and precise estimates of the lag time and degradation rate. On the other hand, some bags will be incubated for prolonged times, long enough to reach the asymptotic values of disappearance, for the potential extent of digestion to be estimated accurately. These long incubation times vary with type of feed (in general longer for forages and shorter for concentrates).

Maybe the most important feature concerning all these factors of variation is that there are multiple interactions amongst many of them; those standing out involve the feed characteristics (Vanzant *et al.*, 1998). Because of these interactions, not a single standardized procedure seems to be applicable across all feedstuffs, but even so some concordance in the methodology used should be pursued to provide a more reliable, precise and accurate technique. It also seems necessary to assess the relative importance of each methodological factor on the precision and accuracy of degradability estimates, because some of the recommendations for the *in situ* procedures may be not applicable to experimental objectives.

### ***Use of the in situ technique in feed evaluation and rumen studies***

Initially, the technique was set out to predict *in vivo* DM digestibility, mainly of forages. In the late 1970s the technique was used to measure the extent of protein degradation in the rumen (Ørskov and McDonald, 1979). Nowadays, the *in situ* technique is a standard method for characterizing the rumen degradability of protein, given the high correlation and concordance between *in vivo* and *in situ* values (Poncet *et al.*, 1995).

Therefore, the technique has been used to study the digestive processes in the rumen and to predict the degree to which nutrients are made available for the rumen microorganisms and for the host animal (Ørskov *et al.*, 1980). The *in situ* technique is suitable for kinetic studies following the time course of disappearance of an individual feedstuff, and has been used widely to evaluate the rate and extent of degradation in the rumen (Ørskov, 2000). More recently, the technique has been used to estimate the extent of starch degradation in the rumen (Cerneau and Michalet-Doreau, 1991). Rumen degradation kinetics of lipids have been also studied *in situ* (Perrier *et al.*, 1992). Rates of fermentable organic matter and protein degradation can be estimated, and then the synchronization between energy and nitrogen availability for microbial synthesis in the rumen can be evaluated (Nozière and Michalet-Doreau, 2000).

The *in situ* technique has also been used for studying animal (species, physiological state, level of intake) or dietary (additives, diet composition, fat supplementation) factors affecting rumen conditions or microbial activity (mainly the fibrolytic activity of ruminal microorganisms) (Nozière and Michalet-Doreau, 2000; Ørskov, 2000). Due to the interaction between the basal diet and the feed evaluated in the bag, the *in situ* technique appears to be a good method for quantifying the associative effects, especially between forage and fermentable carbohydrates. Finally, based on the relationship between degradation rate and rumen fill, rumen degradation parameters estimated with the *in situ* technique have been used to predict voluntary intake of forages (Hovell *et al.*, 1986; Carro *et al.*, 1991).

Despite all its limitations, this technique is one of the best ways to access the rumen environment, it is fairly rapid and reproducible and requires minimal equipment. Therefore it is one of the techniques used most extensively in feed evaluation for ruminants.

## Methods to Estimate Post-Ruminal Digestibility

Some *in vitro* techniques have been designed to estimate digestibility (mainly of the feed protein) in the small intestine (Calsamiglia *et al.*, 2000). These techniques are based on the use of enzymes to simulate abomasal and intestinal digestion (Stern *et al.*, 1997). The most commonly used technique is a three-step procedure consisting of a ruminal pre-incubation followed by an incubation in acid pepsin and a phosphate buffer–pancreatin digestion (Calsamiglia and Stern, 1995).

An *in situ* mobile bag technique has been used to determine intestinal protein digestion in ruminants (Hvelplund, 1985). Samples of feed or residues after incubation in the rumen are weighed in small polyester bags that are introduced directly into the abomasum or proximal duodenum and subsequently collected either from the ileum or from the faeces. Endogenous or other contaminating materials are removed by washing, and the indigestible residue is determined. This technique is affected by a number of potential sources of variation such as porosity of bag material, sample weight to surface area ratio, animal and diet effects, ruminal pre-incubation, pepsin HCl pre-digestion, retention time, site of bag recovery and microbial contamination of the residue (Hvelplund, 1985). Although loss from the bag may not necessarily relate to protein absorption, the technique seems to be useful in predicting intestinal protein digestibility (Stern *et al.*, 1997).

## Role of Mathematical Modelling in *In Vitro* and *In Situ* Techniques

The goal of most *in vitro* and *in situ* techniques is to estimate total-tract digestibility or rumen degradability. It is very unlikely that values measured *in vitro* are identical to the intended *in vivo* values, and thus mathematical modelling is a useful tool to link the data obtained *in vitro* or *in situ* with the processes occurring *in vivo*. Mathematical models used to estimate digestibility or degradability from *in vitro* measurements can be either empirical or mechanistic.

### *Empirical modelling*

A large number of empirical equations for predicting DM intake, digestibility, DM or protein degradability in the rumen or energy value of forages from *in vitro* and *in situ* measurements is provided in the literature (Minson, 1990; Hvelplund *et al.*, 1995). In most cases, the predictor used is a single end-point measurement determined by one of the *in vitro* techniques described previously. When end-point measurements are used, incubations are usually run for a given time interval, although in the animal the residence time in the rumen depends upon the level of feed intake, type of feedstuff and composition of the diet, and thus no single end-point measurement will be valid for all circumstances.

Using analytical results and actual values determined by feeding trials for a number of standard representative feeds, multiple regression equations can be derived statistically and used to predict the digestibility or degradability of other samples. Most of these equations are based purely on the statistical relationship between the variables and the performance of regression methods facilitated by improved computing facilities, resulting sometimes in equations with little biological meaning. One of the consequences of this empirical approach is that there are a large number of equations available in the literature differing significantly in the predicting variables, in the regression coefficients for the same predictors, and in the estimated prediction error. These empirical prediction equations are a consequence of the specific data sets used for their derivation, and thus have a variable degree of unreliability and are only useful when the situation to be predicted corresponds to the original data set. Despite these criticisms, empirical equations are used widely in feed evaluation systems.

Correlation between *in vivo* and *in vitro* or *in situ* values and statistical goodness-of-fit are the only criteria considered in evaluating these prediction equations. But the accuracy of these methods relies on a proper evaluation of the techniques and empirical models. The starting point of such evaluation would be the systematic measurement of the variable to be predicted using a reference technique (*in vivo* methods) to create a comprehensive database of the actual values against which the *in vitro* and *in situ* values can be challenged. Then, suitable prediction equations can be developed and evaluated following the stages of initial calibration and subsequent validation. New data becoming available can be incorporated into the original database contributing not only to extending its size, but also to making the prediction stronger and valid for a wider range of situations. This is a long-term approach necessary to achieve a satisfactory degree of accuracy in the estimations of digestibility and degradability.

However, many of the *in vitro* and *in situ* techniques described previously are still at a stage of methodological standardization, and thus cannot be considered sufficiently precise. This current lack of precision precludes any discussion about their potential accuracy.

### ***Mechanistic modelling***

Mechanistic mathematical modelling can simulate reality and predict nutrient utilization and availability within the digestive tract by representing quantitatively concepts and mechanisms (Dijkstra and France, 1995). This type of modelling can be used to derive kinetic parameters from data obtained *in vitro* or *in situ*, which can then be incorporated in holistic models to simulate whole system behaviour. It is expected that, in the future, mechanistic models will yield superior predictions of animal performance and will be applicable more generally than empirical models. As feed digestibility is affected to a large extent by rumen degradation and fermentation, mechanistic modelling has focused on representing and quantifying the rate and extent of substrate degradation in the rumen. Modelling of other crucial processes occurring

in the rumen, such as kinetics of VFA production or microbial growth and synthesis are reviewed elsewhere in this book (Chapters 6 and 8, respectively).

#### *Rate and extent of degradation*

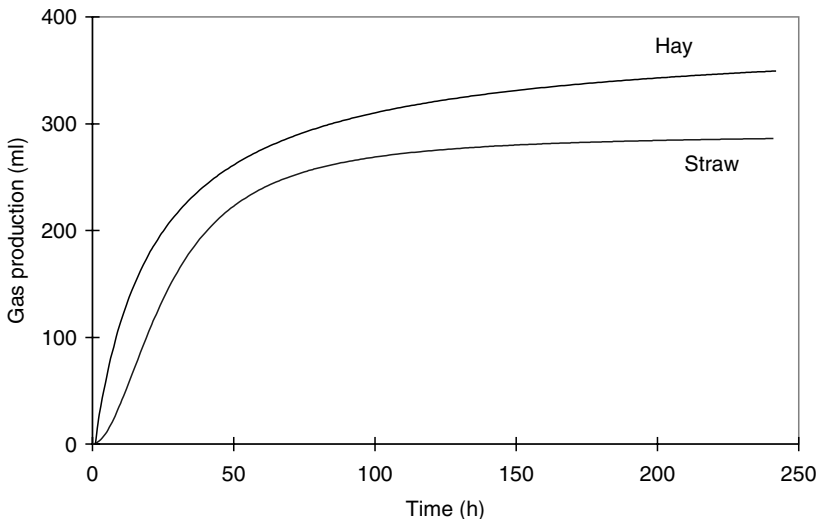
Kinetic degradation parameters are necessary to predict feed digestibility, and thereby the energy available, and also protein degradability in the rumen. The amount of substrate degraded in the rumen is the result of competition between digestion and passage. Several models have been proposed since that of Blaxter *et al.* (1956), in which kinetic parameters for degradation and passage are integrated to estimate the actual extent of degradation of feed in the rumen. Degradation parameters are usually estimated from degradation profiles (Fig. 4.1) obtained using either gravimetric or gas production techniques. To associate disappearance or gas production curves with digestion in the rumen, models have been developed based on compartmental schemes, which assume that the feed component comprises at least two fractions: a potentially degradable fraction  $S$  and an undegradable fraction  $U$ . Fraction  $S$  will be degraded at a fractional rate  $\mu$  (per hour), after a discrete lag time  $L$  (h). The scheme is shown in Fig. 4.2, and the dynamic behaviour of the fractions is described by the differential equations:

$$dS/dt = 0, \quad 0 \leq t < L \quad (4.1a)$$

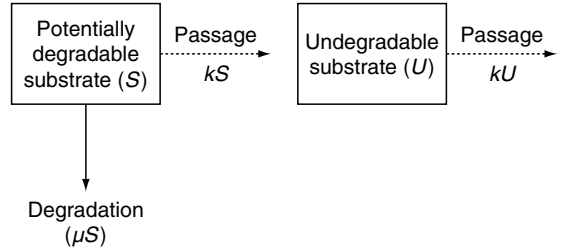
$$= -\mu S, \quad t \geq L \quad (4.1b)$$

$$dU/dt = 0, \quad t \geq L \quad (4.2)$$

Therefore, the parameters to be estimated are the initial size of the fraction  $S$ , the size of  $U$ , the lag time ( $L$ ) and the fractional degradation rate ( $\mu$ ) (Fig. 4.3).



**Fig. 4.1.** Examples of sigmoidal and non-sigmoidal cumulative gas production curves *in vitro*.



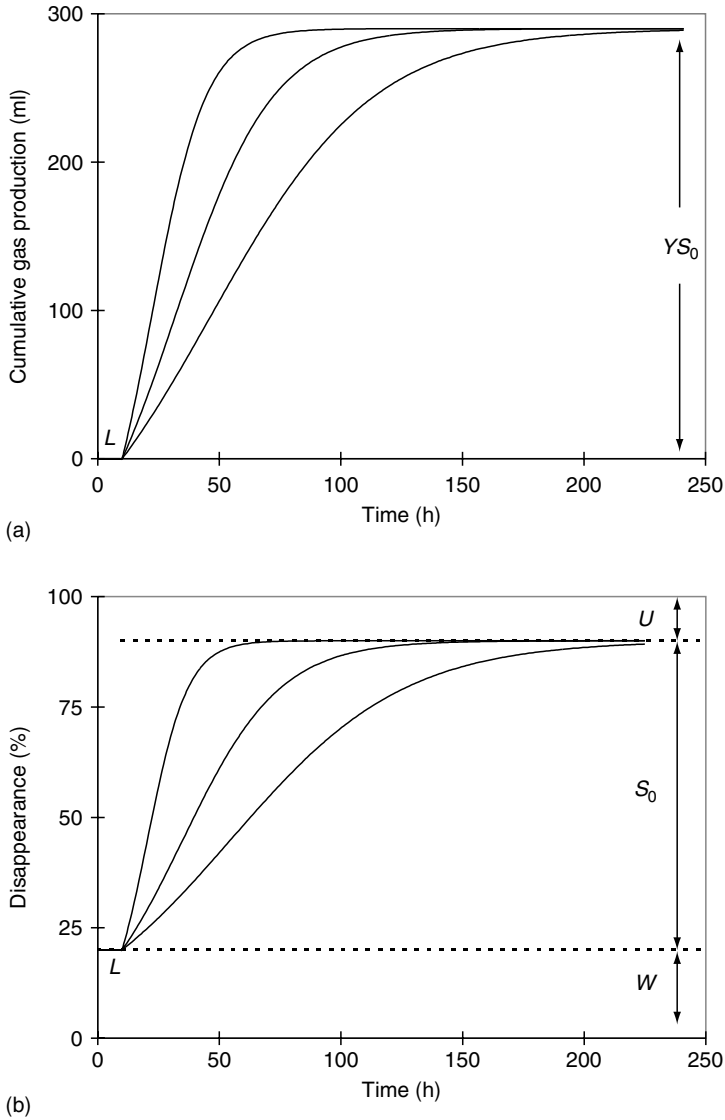
**Fig. 4.2.** The two-compartment model of ruminal degradation. Deletion of the dashed arrows gives scheme for disappearance during incubation *in vitro* or *in situ*.

Precise estimation of  $U$  is critical to accurate description of degradation kinetics because the degradation rate, by definition, applies only to the fraction that is potentially degradable, with the assumption that each pool is homogeneous in its kinetic properties. Fraction  $U$  of protein and fibre components has been measured by long incubations (from 6 days to several weeks) either *in vitro* or *in situ*, or estimated from non-linear fitting of degradation profiles. When degradation profiles are obtained by gravimetric techniques, the non-fibre components are assumed to contain a third fraction that disappears immediately after incubation begins, and is assumed to be degraded instantly in the rumen (called soluble fraction or washout value,  $W$ ). The loss of undegraded particulate matter from polyester bags leads to an overestimation of  $W$ , underestimating the undegradable fraction. Estimation can be improved significantly by measuring the extent of particle loss from the bag and applying mathematical corrections to the parameter estimates (López *et al.*, 1994; France *et al.*, 1997). Using *in vitro* techniques allows degradation profiles with much more data points to be obtained, revealing the existence of multiple pools, which would be degraded at different rates. Some models have been reported that include several degradable pools (Robinson *et al.*, 1986; Groot *et al.*, 1996). Such models contain a considerable number of parameters requiring a large number of data points, complicating satisfactory parameter estimation due to the limitations of the non-linear regression.

The lag phase of the degradation profiles has been described in terms of either a discrete or a kinetic lag (Van Milgen *et al.*, 1993). The initial lag phase is due in part to the inability of the rumen microbial population and its enzymes to degrade the substrate at a significant rate until microbial growth is sufficient for enzymatic production to increase and ultimately to saturate the substrate. Lag may be due to factors other than microbial capacity, such as the rate of hydration of the substrate, microbial attachment to feed particles and nutrient limitations. A discrete lag is not a mechanistic interpretation of the process in the rumen. *In vitro* and *in situ* systems may induce an artificial lag because of experimental procedures, and this parameter is therefore required in the models representing the system from which the degradation profiles are obtained.

The degradation rate of nutrients in the rumen is a key factor in predicting extent of ruminal degradation, because it can have significant effects on both the ruminal microbes and the host. The fractional degradation rate can be considered an intrinsic characteristic of the feed, depending on factors such





**Fig. 4.3.** Representation of the degradation parameters ( $L$ , lag time;  $S_0$ , potentially degradable fraction;  $YS_0$ , asymptotic gas production;  $W$ , 'soluble' fraction and  $U$ , undegradable fraction) in a gas production profile (a) and in an *in situ* disappearance curve (b), showing the differences in shape attributed to the rate parameter (the higher the rate, the steeper the curve).

as chemical composition of the forage, the proportion of different plant tissues as affected by the stage of maturity, surface area and the cell wall structure. Once feed enters the rumen, the degradation rate may also be affected by factors related to the animal, such as rate of particle size reduction, and ruminal conditions (pH, osmotic pressure, mean retention time of the digesta), that

have a profound effect on microbial degradative activity. Associative effects of feeds in the diet can be very important. For example, the depressive effect of easily degradable non-fibre carbohydrates on the degradation rate of forage DM is generally recognized.

An essential aspect of estimating the rate of degradation concerns the kinetics assumed for the process. The most commonly used model (Ørskov and McDonald, 1979) assumes first-order kinetics, implying that substrate degraded at any time is proportional to the amount of potentially degradable matter remaining at that time, with constant fractional rate  $\mu$  (Fig. 4.4), and that only characteristics of the substrate limit degradation. This model has been used extensively owing to its simplicity, but it is not capable of describing the large diversity of degradation profiles (Fig. 4.1), which have been observed (Dhanao *et al.*, 1995), and cannot represent mechanistically the reciprocal influences of substrate degradation and microbial growth.

France *et al.* (2000) postulated that  $\mu$  may vary with time according to different mathematical functions (Table 4.5). From the various functions used to represent  $\mu$ , different models can be derived to describe either *in situ* disappearance (López *et al.*, 1999) or *in vitro* gas production profiles (Dhanao *et al.*, 2000) (Fig. 4.4). Some of these functions are capable of describing both a range of shapes with no inflexion point and a range of sigmoidal shapes in which the inflexion point is variable. Therefore, other models are versatile alternatives to the commonly used simple exponential model for describing degradation profiles. On substituting the function proposed for  $\mu$  and integrating, Eq. (4.1b) yields an equation for the S fraction remaining during the incubation *in situ* or *in vitro* at any time  $t$ , which can be expressed in the general form:

$$S = S_0 \times [1 - \Phi(t)] \quad (4.3)$$

where  $S_0$  is the zero-time quantity of the S fraction,  $\Phi(t)$  is a positive monotonically increasing function with an asymptote at unity (Table 4.5) and  $t$  is incubation time (h). *In situ* or *in vitro* disappearance ( $D$ , g/g incubated) is given by:

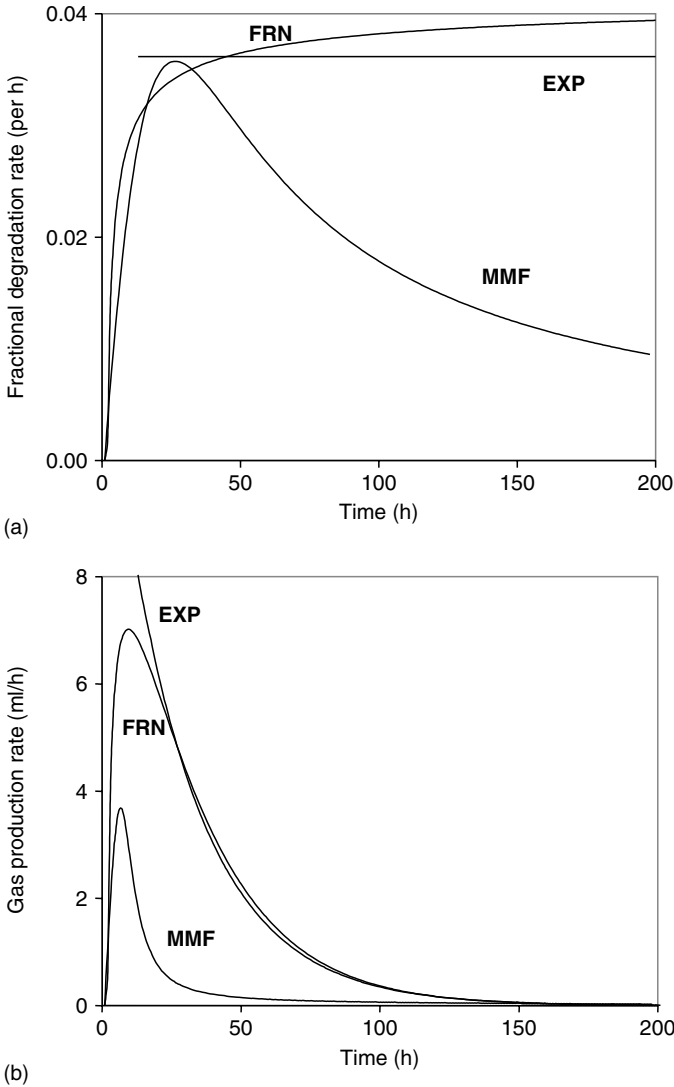
$$D = W + S_0 - S = W + S_0 \times \Phi(t) \quad (4.4)$$

Similarly, gas production profiles observed *in vitro* can be represented by:

$$G = YS_0 \times \Phi(t) \quad (4.5)$$

where  $G$  (ml) denotes total gas accumulation to time  $t$  and  $Y$  (ml gas per g degradable DM) is a constant yield factor. For each function,  $\mu$  could be obtained from Eqs (4.1b) and (4.3) as:

$$\mu = -\frac{1}{S} \frac{dS}{dt} = \frac{1}{(1 - \Phi)} \frac{d\Phi}{dt} \quad (4.6)$$



**Fig. 4.4.** Change in fractional degradation rate (a) and in gas production rate (b) with time as represented by different mathematical models (EXP, exponential; FRN, France; MMF, Morgan–Mercer–Flodin).

This function constitutes the mechanistic interpretation of the degradation processes.

Rates of degradation and passage can be combined to calculate the extent of degradation of the substrate in the rumen (France *et al.*, 1990, 1993). In the rumen, if  $S$  is the amount of potentially degradable substrate remaining that is subjected to both passage and degradation, the rate of disappearance of  $S$  is given by (Fig. 4.2):

**Table 4.5.** Alternative functions for  $\Phi$  in the general equations for the *in situ* disappearance curves and the gas production profiles, with corresponding functions for the fractional degradation rate ( $\mu$ ) of the substrate for each (for the meaning of the constants, which is specific to each model, see France *et al.*, 1990, 2000; López *et al.*, 1999).

	$\Phi$	$\mu$
France	$1 - e^{-c(t-L) - d(\sqrt{t} - \sqrt{L})}$	$c + (d/2\sqrt{t})$
Simple exponential	$1 - e^{-c(t-L)}$	$c$
Morgan–Mercer–Flodin	$t^c / (t^c + K^c)$	$ct^{(c-1)} / (t^c + K^c)$
Logistic	$(1 - e^{-ct}) / (1 + Ke^{-ct})$	$c / (1 + Ke^{-ct})$
Gompertz	$1 - \exp[(b/c)(1 - e^{ct})]$	$be^{ct}$

$$\frac{dS}{dt} = -kS, \quad t < L \quad (4.7a)$$

$$= -(k + \mu)S, \quad t \geq L \quad (4.7b)$$

where  $k$  (per h) is the fractional rate of passage from the rumen, and is assumed constant. To obtain  $S$ , the solutions of these differential equations are:

$$S = S_0 e^{-kt}, \quad t < L \quad (4.8a)$$

$$S = S_0 e^{-kt} (1 - \Phi), \quad t \geq L \quad (4.8b)$$

Using these equations, the extent of degradation in the rumen ( $E$ , g degraded per g ingested) is given by the equations:

$$E = \frac{W + \int_L^\infty \mu S dt}{W + S_0 + U} = \frac{W + kS_0 \int_L^\infty \Phi e^{-kt} dt}{W + S_0 + U} \quad (4.9)$$

for *in situ* and *in vitro* disappearance profiles (López *et al.*, 1999), and

$$E = \frac{\int_L^\infty \mu S dt}{S_0 + U} = \frac{kS_0 \int_L^\infty \Phi e^{-kt} dt}{S_0 + U} \quad (4.10)$$

for *in vitro* gas production profiles.

Although ranking of and comparisons between feeds according to their *in situ* or *in vitro*  $E$  values are similar, the estimates of  $E$  values obtained using the *in situ* technique are numerically greater than those obtained using the *in vitro* gas production method (López *et al.*, 1998, 2000). The first explanation for this bias could be the loss of particulate matter from the bag, as part of this material is lost without being degraded. However, the discrepancies persist when the *in situ* values are corrected for particle loss assuming that passage losses for particulate matter escaping from the bag at zero time are according to the fractional passage rate or assuming that there is no instantly degradable fraction (Dhanoa *et al.*, 1999). The calculation for  $E$  using *in situ* parameters

assumes that there is a soluble fraction ( $W$ ) that is degraded completely and instantly in the rumen, whereas in the gas production technique the soluble and the insoluble but potentially degradable fractions are both degraded at the same rate ( $\mu$ ) and subject to passage, so neither substrate fraction can be degraded completely in the rumen.

Furthermore, fractional rates of substrate degradation ( $\mu$ ) in the *in situ* technique are higher than those estimated from *in vitro* profiles. The differences in fractional degradation rates between *in situ* and *in vitro* techniques are larger with feeds having high protein contents (López *et al.*, 1998). Possible differences in gas yield per unit of substrate degraded are not directly important in the calculation of the extent of degradation  $E$ , as can be seen from the absence of  $Y$  in Eq. (4.10). However, if  $Y$  varies during the course of incubation, then the rate of gas production does not properly reflect the rate of substrate degradation. For example, a low yield at the start of the incubation period (coinciding with a high propionic acid production from rapidly degrading fractions, including the soluble fraction), and a high yield towards the end of the incubation period will underestimate the rate of substrate degradation and consequently  $E$ . The value of  $Y$  might well vary during the course of incubation for a substrate with different chemical entities (e.g. fibre, starch, sugars) because starch and sugars generally have a higher fractional degradation rate than fibre and cause a lower pH in the rumen fluid. Also, during the course of fermentation the amount of substrate becoming available per unit of microbial mass decreases, resulting in an increase in the yield of gas in the later phases of incubation. Other reasons for the discrepancies could be methodological differences between the two techniques. Possibly rumen fluid is less active *in vitro* than *in situ*, and accumulation of end-products may affect long-term fermentation in batch cultures (López *et al.*, 1998).

In conclusion, the equations derived herein provide a general expression for calculating the extent of degradation in the rumen from *in situ* and *in vitro* data, which are applicable to any model expressed in the form of Eqs (4.4) and (4.5). A number of equations have been proposed in the literature to describe the gas production curve without considering the quantitative relationship to extent of degradation in the rumen, thus failing to link the *in vitro* technique to animal performance. Now that expressions for ruminal extent of degradation for various models have been worked out (López *et al.*, 1999; France *et al.*, 2000), testing more flexible models will contribute to enhancing our understanding of degradation and fermentation kinetics, leading to better diet formulation and animal nutrition.

## Concluding Remarks

*In vitro* and *in situ* techniques are used widely to estimate digestibility and rumen degradability, and to study ruminal fermentation. It is difficult to appraise the accuracy of many of these techniques. Only the *in vitro* digestibility technique was developed following calibration and validation of the *in vitro* estimations against the *in vivo* values. Few studies have been conducted to determine

how to obtain more accurate *in vitro* and *in situ* data, mainly because there are few reference data to which comparisons can be made. With this limitation, *in vitro* and *in situ* data are at least useful to detect treatment effects, for relative comparisons of feeds or, in some cases, as intrinsic characteristics of feeds that can be used in diet formulation.

On the other hand, values obtained with most of these techniques are less variable than those measured *in vivo*, although the reproducibility of some techniques needs to be increased substantially by standardizing the experimental procedures. The greatest level of standardization has been attained with the *in vitro* digestibility methods, whereas a large multiplicity of analytical techniques exists for the gas production method. For the *in situ* technique, important agreement has been achieved and a number of recommendations are available in the literature. But not all the variables can be completely standardized, and some flexibility is required for some of them, such as the animal species or the basal diet fed to the animals, to accomplish the research objectives and accommodate the different facilities available in each laboratory. The important point is that results can be interpreted by anyone and, if possible, compared with other reported data.

All the limitations of *in vitro* and *in situ* methods need to be borne in mind when interpreting the results, but there is no point expecting these techniques to give exactly the same values measured *in vivo*. It is possible to design very complex techniques with the aim to improve accuracy, but then many of the inconveniences of the *in vivo* experiments will be prevalent and still there will be discrepancies between estimated and actual values. In this context, mathematical modelling can play an important role, first detecting the bias between estimated and actual values in order to overcome possible methodological weaknesses of the techniques or to introduce mathematical corrections to achieve a better approximation to *in vivo* values. It is important to accept that *in vitro* and *in situ* techniques represent biological models, and hence are just simplifications of reality. The target should be a balance between that simplicity and the accuracy and precision of the values determined. A wide range of techniques is available; each with its advantages and disadvantages, and the final decision should be based on the type of work (number of feeds to be tested and amount of sample), facilities available and research objectives.

## References

- Adesogan, A.T. (2002) What are feeds worth? A critical evaluation of selected nutritive value methods. In: *Proceedings 13th Annual Florida Ruminant Nutrition Symposium*. University of Florida, Gainesville, Florida, pp. 33–47.
- Ammar, H., López, S., Bochi, O., García, R. and Ranilla, M.J. (1999) Composition and *in vitro* digestibility of leaves and stems of grasses and legumes harvested from permanent mountain meadows at different maturity stages. *Journal of Animal and Feed Sciences* 8, 599–610.
- Aufrère, J., Graviou, D., Demarquilly, C., Vérité, R., Michalet-Doreau, B. and Chapoutot, P. (1991) Predicting *in situ* degradability of feed proteins in the rumen by two

- laboratory methods (solubility and enzymatic degradation). *Animal Feed Science and Technology* 33, 97–116.
- Beever, D.E. and Mould, F.L. (2000) Forage evaluation for efficient ruminant livestock production. In: Givens, D.I., Owen, E., Axford, R.F.E. and Omed, H.M. (eds) *Forage Evaluation in Ruminant Nutrition*. CAB International, Wallingford, UK, pp. 15–42.
- Blaxter, K.L., Graham, N.McC. and Wainman, F.W. (1956) Some observations on the digestibility of food by sheep, and on related problems. *British Journal of Nutrition* 10, 69–91.
- Blümmel, M., Steingaß, H. and Becker, K. (1997a) The relationship between *in vitro* gas production, *in vitro* microbial biomass yield and <sup>15</sup>N incorporation and its implications for the prediction of voluntary feed intake of roughages. *British Journal of Nutrition* 77, 911–921.
- Blümmel, M., Makkar, H.P.S. and Becker, K. (1997b) *In vitro* gas production: a technique revisited. *Journal of Animal Physiology and Animal Nutrition* 77, 24–34.
- Broderick, G.A. (1987) Determination of protein degradation rates using a rumen *in vitro* system containing inhibitors of microbial nitrogen metabolism. *British Journal of Nutrition* 58, 463–476.
- Broderick, G.A. and Cochran, R.C. (2000) *In vitro* and *in situ* methods for estimating digestibility with reference to protein degradability. In: Theodorou, M.K. and France, J. (eds) *Feeding Systems and Feed Evaluation models*. CAB International, Wallingford, UK, pp. 53–85.
- Calsamiglia, S. and Stern, M.D. (1995) A three-step *in vitro* procedure for estimating intestinal digestion of protein in ruminants. *Journal of Animal Science* 73, 1459–1465.
- Calsamiglia, S., Stern, M.D. and Bach, A. (2000) Enzymatic and microbial-cell preparation techniques for predicting rumen degradation and postruminal availability of protein. In: Givens, D.I., Owen, E., Axford, R.F.E. and Omed, H.M. (eds) *Forage Evaluation in Ruminant Nutrition*. CAB International, Wallingford, UK pp. 259–279.
- Carro, M.D., López, S., González, J.S. and Ovejero, F.J. (1991) The use of the rumen degradation characteristics of hay as predictors of its voluntary intake by sheep. *Animal Production* 52, 133–139.
- Carro, M.D., López, S., González, J.S., Ovejero, F.J. and Ranilla, M.J. (2002) *In vitro* methods as predictors of voluntary intake and digestibility of hays fed to sheep. *Australian Journal of Agricultural Research* 53, 471–479.
- Cerneau, P. and Michalet-Doreau, B. (1991) *In situ* starch degradation of different feeds in the rumen. *Reproduction Nutrition Development* 31, 65–72.
- Cherney, D.J.R., Patterson, J.A. and Lemenager, R.P. (1990) Influence of *in situ* bag rinsing technique on determination of dry matter disappearance. *Journal of Dairy Science* 73, 391–397.
- Cone, J.W. (1991) Degradation of starch in feed concentrate by enzymes, rumen fluid and rumen enzymes. *Journal of the Science of Food and Agriculture* 54, 23–34.
- Cone, J.W. (1998) The development, use and application of the gas production technique at the DLO Institute for Animal Science and Health (ID-DLO), Lelystad, The Netherlands. In: Deaville, E.R., Owen, E., Adesogan, A.T., Rymer, C., Huntington, J.A. and Lawrence, T.L.J. (eds) *In Vitro Techniques for Measuring Nutrient Supply to Ruminants*, Occasional Publication No. 22. British Society of Animal Science, Edinburgh, pp. 65–78.

- Czerkawski, J.W. (1986) *An Introduction to Rumen Studies*. Pergamon Press, Oxford, UK.
- Czerkawski, J.W. (1991) *In vitro* rumen simulation systems. In: Jouany, J.-P. (ed.) *Rumen Microbial Metabolism and Ruminant Digestion*. INRA Editions, Paris, pp. 353–355.
- Czerkawski, J.W. and Breckenridge, G. (1977) Design and development of a long-term rumen simulation technique (Rusitec). *British Journal of Nutrition* 38, 371–389.
- Davies, Z.S., Mason, D., Brooks, A.E., Griffith, G.W., Merry, R.J. and Theodorou, M.K. (2000) An automated system for measuring gas production from forages inoculated with rumen fluid and its use in determining the effect of enzymes on grass silage. *Animal Feed Science and Technology* 83, 205–221.
- De Boever, J.L., Cottyn, B.G., Andries, J.I., Buysse, F.X. and Vanacker, J.M. (1988) The use of a cellulase technique to predict digestibility, metabolisable and net energy of forages. *Animal Feed Science and Technology* 19, 247–260.
- Dhanao, M.S., France, J., Siddons, R.C., López, S. and Buchanan-Smith, J.G. (1995) A non-linear compartmental model to describe forage degradation kinetics during incubation in polyester bags in the rumen. *British Journal of Nutrition* 73, 3–15.
- Dhanao, M., France, J., Dijkstra, J. and López, S. (1996) Consequences of model choice when analysing the polyester bag data. *British Journal of Nutrition* 75, 142–148.
- Dhanao, M.S., France, J., López, S., Dijkstra, J., Lister, S.J., Davies, D.R. and Bannink, A. (1999) Correcting the calculation of extent of degradation to account for particulate matter loss at zero time when applying the polyester bag method. *Journal of Animal Science* 77, 3385–3391.
- Dhanao, M.S., López, S., Dijkstra, J., Davies, D.R., Sanderson, R., Williams, B.A., Sileshi, Z. and France, J. (2000) Estimating the extent of degradation of ruminant feeds from a description of their gas production profiles observed *in vitro*: comparison of models. *British Journal of Nutrition* 83, 131–142.
- Dijkstra, J. and France, J. (1995) Modelling and methodology in animal science. In: Danfær, A. and Lescoat, P. (eds) *Proceedings of the Fourth International Workshop on Modelling Nutrient Utilisation in Farm Animals*. National Institute of Animal Science, Foulum, Denmark, pp. 9–18.
- Donefer, E., Crampton, E.W. and Lloyd, L.E. (1960) Prediction of the nutritive value index of a forage from *in vitro* rumen fermentation data. *Journal of Animal Science* 19, 545–552.
- Dowman, M.G. and Collins, F.C. (1982) The use of enzymes to predict the digestibility of animal feeds. *Journal of the Science of Food and Agriculture* 33, 689–696.
- El Shaer, H.M., Omed, H.M. and Chamberlain, A.G. (1987) Use of faecal organisms from sheep for the *in vitro* determination of digestibility. *Journal of Agricultural Science* 109, 257–259.
- Emanuele, S.M. and Staples, C.R. (1988) Effect of forage particle size on *in situ* digestion kinetic. *Journal of Dairy Science* 65, 1947–1954.
- France, J., Thornley, J.H.M., López, S., Siddons, R.C., Dhanao, M.S., Van Soest, P.J. and Gill, M. (1990) On the two compartment model for estimating the rate and extent of feed degradation in the rumen. *Journal of Theoretical Biology* 146, 269–287.
- France, J., Dhanao, M.S., Theodorou, M.K., Lister, S.J., Davies, D. and Isac, D. (1993) A model to interpret gas accumulation profiles associated with *in vitro* degradation of ruminant feeds. *Journal of Theoretical Biology* 163, 99–111.
- France, J., López, S., Dijkstra, J. and Dhanao, M.S. (1997) Particulate matter loss and the polyester-bag method. *British Journal of Nutrition* 78, 1033–1037.



- France, J., Dijkstra, J., Dhanoa, M.S., López, S. and Bannink, A. (2000) Estimating the extent of degradation of ruminant feeds from a description of their gas production profiles observed *in vitro*: derivation of models and other mathematical considerations. *British Journal of Nutrition* 83, 143–150.
- Getachew, G., Blümmel, M., Makkar, H.P.S. and Becker, K. (1998) *In vitro* gas measuring techniques for assessment of nutritional quality of feeds: a review. *Animal Feed Science and Technology* 72, 261–281.
- Goering, M.K. and Van Soest, P.J. (1970) *Forage Fiber Analysis (Apparatus, Reagents, Procedures and Some Applications)*. Agricultural Handbook No 379, Agricultural Research Service, USDA, Washington DC.
- Groot, J.C.J., Cone, J.W., Williams, B.A., Debersaques, F.M.A. and Latinga, E.A. (1996) Multiphasic analysis of gas production kinetics for *in vitro* fermentation of ruminant feeds. *Animal Feed Science and Technology* 64, 77–89.
- Hannah, S.M., Stern, M.D. and Ehle, F.R. (1986) Evaluation of dual flow continuous culture system for estimating bacterial fermentation *in vivo* of mixed diets containing various soya bean products. *Animal Feed Science and Technology* 16, 51–62.
- Hoover, W.H., Crooker, B.A. and Sniffen, C.J. (1976) Effects of differential solid-liquid removal rates on protozoa numbers in continuous cultures of rumen contents. *Journal of Animal Science* 43, 528–534.
- Hovell, F.D.DeB., Ngambi, J.W.W., Barber, W.P. and Kyle, D.J. (1986) The voluntary intake of hay by sheep in relation to its degradability in the rumen as measured in nylon bags. *Animal Production* 42, 111–118.
- Hristov, A. and Broderick, G.A. (1994) *In vitro* determination of ruminal protein degradability using [<sup>15</sup>N]-ammonia to correct for microbial nitrogen uptake. *Journal of Animal Science* 72, 1344–1354.
- Hungate, R.E. (1966) *The Rumen and its Microbes*. Academic Press, New York.
- Huntington, J.A. and Givens, D.I. (1995) The *in situ* technique for studying the rumen degradation of feeds: a review of the procedure. *Nutrition Abstracts and Reviews Series B (Livestock Feeds and Feeding)* 65, 63–93.
- Hvelplund, T. (1985) Digestibility of rumen microbial protein and undegraded protein estimated in the small intestine of sheep and by *in sacco* procedure. *Acta Agriculturae Scandinavica* (Suppl. 25), 132–144.
- Hvelplund, T., Andrieu, J., Weisbjerg, M.R. and Vermorel, M. (1995) Prediction of the energy and protein value of forages for ruminants. In: Journet, M., Grenet, E., Farce, M.H., Theriez, M. and Demarquilly, C. (eds) *Recent Developments in the Nutrition of Herbivores*. INRA Editions, Paris, pp. 205–227.
- Jones, D.I.H. and Hayward, M.V. (1975) The effect of pepsin treatment of herbage on the prediction of dry matter digestibility from solubility in fungal cellulase solutions. *Journal of the Science of Food and Agriculture* 26, 711–718.
- Jones, D.I.H. and Theodorou, M.K. (2000) Enzyme techniques for estimating digestibility. In: Givens, D.I., Owen, E., Axford, R.F.E. and Omed, H.M. (eds) *Forage Evaluation in Ruminant Nutrition*. CAB International, Wallingford, UK, pp. 155–173.
- Kitessa, S., Flinn, P.C. and Irish, G.G. (1999) Comparison of methods used to predict the *in vivo* digestibility of feeds in ruminants. *Australian Journal of Agricultural Research* 50, 825–841.
- Krishnamoorthy, U., Sniffen, C.J., Stern, M.D. and Van Soest, P.J. (1983) Evaluation of a mathematical model of rumen digestion and an *in vitro* simulation of rumen proteolysis to estimate the rumen-undegraded nitrogen content of feedstuffs. *British Journal of Nutrition* 50, 555–568.

- Lindberg, J.E. (1985) Estimation of rumen degradability of feed proteins with the *in sacco* technique and various *in vitro* methods: a review. *Acta Agriculturae Scandinavica* (Suppl. 25), 64–97.
- López, S., France, J. and Dhanoa, M.S. (1994) A correction for particulate matter loss when applying the polyester-bag method. *British Journal of Nutrition* 71, 135–137.
- López, S., Hovell, F.D.DeB., Manyuchi, B. and Smart, R.I. (1995) Comparison of sample preparation methods for the determination of the rumen degradation characteristics of fresh and ensiled forages by the nylon bag technique. *Animal Science* 60, 439–450.
- López, S., Carro, M.D., Gonzalez, J.S. and Ovejero, F.J. (1998) Comparison of different *in vitro* and *in situ* methods to estimate the extent and rate of degradation of hays in the rumen. *Animal Feed Science and Technology* 73, 99–113.
- López, S., France, J., Dhanoa, M.S., Mould, F. and Dijkstra, J. (1999) Comparison of mathematical models to describe disappearance curves obtained using the polyester bag technique for incubating feeds in the rumen. *Journal of Animal Science* 77, 1875–1888.
- López, S., France, J., Dijkstra, J. and Dhanoa, M.S. (2000) Models to interpret degradation profiles obtained from *in vitro* and *in situ* incubation of ruminant feeds. In: McNamara, J.P., France, J. and Beever, D.E. (eds) *Modelling Nutrient Utilisation in Farm Animals*. CAB International, Wallingford, UK, pp. 73–86.
- López, S., Frutos, P., Mantecón, A.R. and Giráldez, F.J. (2001) Comparative digestion of herbage by two breeds of sheep: effects of grass maturity stage and level of intake. *Animal Science* 73, 513–522.
- Madsen, J. and Hvelplund, T. (1994) Prediction of *in situ* protein degradability in the rumen. Results of a European ringtest. *Livestock Production Science* 39, 201–212.
- Mahadevan, S., Erfle, J. D. and Sauer, F.D. (1980) Degradation of soluble and insoluble proteins by *Bacteroides amylophilus* protease and by rumen microorganisms. *Journal of Animal Science* 50, 723–728.
- Mansfield, H.R., Endres, M.I. and Stern, M.D. (1995) Comparison of microbial fermentation in the rumen of dairy cows and dual flow continuous culture. *Animal Feed Science and Technology* 55, 47–66.
- Marinucci, M.T., Dehority, B.A. and Loerch, S.C. (1992) *In vitro* and *in vivo* studies of factors affecting digestion of feeds in synthetic fibre bags. *Journal of Animal Science* 70, 296–307.
- Marten, G.C. and Barnes, R.F. (1980) Prediction of energy digestibility of forages with *in vitro* rumen fermentation and fungal enzyme systems. In: Pigden, W.J., Balch, C.C. and Graham, M. (eds) *Standardisation of Analytical Methodology for Feeds*. IDCR/IUNS, Ottawa, Canada, pp. 61–71.
- Mauricio, R.M., Mould, F.L., Dhanoa, M.S., Owen, E., Channa, K.S. and Theodorou, M.K. (1999) A semi-automated *in vitro* gas production technique for ruminant feedstuff evaluation. *Animal Feed Science and Technology* 79, 321–330.
- Menke, K.H. and Steingäß, H. (1988) Estimation of the energetic feed value obtained from chemical analysis and *in vitro* gas production using rumen fluid. *Animal Research and Development* 28, 7–55.
- Menke, K.H., Raab, L., Salewski, A., Steingäß, H., Fritz, D. and Schneider, W. (1979) The estimation of the digestibility and metabolizable energy content of ruminant feeding stuffs from the gas production when they are incubated with rumen liquor. *Journal of Agricultural Science* 93, 217–222.

- Messman, M.A., Weiss, W.P. and Erickson, D.O. (1994) Changes in total and individual proteins during drying, ensiling and ruminal fermentation of forages. *Journal of Dairy Science* 77, 492–500.
- Michalet-Doreau, B. and Ould-Bah, M.Y. (1992) *In vitro* and *in sacco* methods for the estimation of dietary nitrogen degradability in the rumen: a review. *Animal Feed Science and Technology* 40, 57–86.
- Minson, D.J. (1982) Effect of chemical composition on feed digestibility and metabolizable energy. *Nutrition Abstracts and Reviews, Series B* 52, 591–615.
- Minson, D.J. (1990) *Forage in Ruminant Nutrition*. Academic Press, London.
- Minson, D.J. (1998) A history of *in vitro* techniques. In: Deaville, E.R., Owen, E., Adesogan, A.T., Rymer, C., Huntington, J.A. and Lawrence, T.L.J. (eds) *In Vitro Techniques for Measuring Nutrient Supply to Ruminants*, Occasional Publication No. 22. British Society of Animal Science, Edinburgh, pp. 13–19.
- Nocek, J.E. (1988) *In situ* and other methods to estimate ruminal protein and energy digestibility: a review. *Journal of Dairy Science* 71, 2051–2069.
- Nocek, J.E. and English, J.E. (1986) *In situ* degradation kinetics: evaluation of rate determination procedure. *Journal of Dairy Science* 69, 77–87.
- Nozière, P. and Michalet-Doreau, B. (2000) *In sacco* production methods. In: D'Mello, J.P.F. (ed.) *Farm Animal Metabolism and Nutrition*. CAB International, Wallingford, UK, pp. 233–253.
- Omed, H.M., Lovett, D.K. and Axford, R.F.E. (2000) Faeces as a source of microbial enzymes for estimating digestibility. In: Givens, D.I., Owen, E., Axford, R.F.E. and Omed, H.M. (eds) *Forage Evaluation in Ruminant Nutrition*. CAB International, Wallingford, UK, pp. 135–154.
- Ørskov, E.R. (2000) The *in situ* technique for the estimation of forage degradability in ruminants. In: Givens, D.I., Owen, E., Axford, R.F.E. and Omed, H.M. (eds) *Forage Evaluation in Ruminant Nutrition*. CAB International, Wallingford, UK, pp. 175–188.
- Ørskov, E.R. and McDonald, I. (1979) The estimation of protein degradability in the rumen from incubation measurements weighted according to rate of passage. *Journal of Agricultural Science, Cambridge* 92, 499–503.
- Ørskov, E.R., Hovell, F.D.DeB. and Mould, F. (1980) The use of the nylon bag technique for the evaluation of feedstuffs. *Tropical Animal Production* 5, 195–213.
- Pell, A.N. and Schofield, P. (1993) Computerized monitoring of gas production to measure forage digestion *in vitro*. *Journal of Dairy Science* 76, 1063–1073.
- Perrier, R., Michalet-Doreau, B., Bauchart, D. and Doreau, M. (1992) Assessment of an *in-situ* technique to estimate the degradation of lipids in the rumen. *Journal of the Science of Food and Agriculture* 59, 449–455.
- Pirt, S.J. (1975) *Principles of Microbe and Cell Cultivation*. Blackwell Science, Oxford, UK.
- Poncet, C., Michalet-Doreau, B., McAllister, T. and Rémond, D. (1995) Dietary compounds escaping rumen digestion. In: Journet, M., Grenet, E., Farce, M.H., Thériz, M. and Demarquilly, C. (eds) *Recent Development in the Nutrition of Herbivores*. INRA, Paris, pp. 167–204.
- Raab, L., Cafantaris, B., Jilg, L.T. and Menke, K.H. (1983) Ruminal protein degradation and biosynthesis. 1. A new method for determination of protein degradation in rumen fluid *in vitro*. *British Journal of Nutrition* 50, 569–582.
- Ranilla, M.J., Carro, M.D., López, S., Newbold, C.J. and Wallace, R.J. (2001) Influence of nitrogen source on the fermentation of fibre from barley straw and sugarbeet pulp by ruminal micro-organisms *in vitro*. *British Journal of Nutrition* 86, 717–724.

- Robinson, P.H., Fadel, J.G. and Tamminga, S. (1986) Evaluation of mathematical models to describe neutral detergent residue in terms of its susceptibility to degradation in the rumen. *Animal Feed Science and Technology* 15, 249–271.
- Roughan, P.G. and Holland, R. (1977) Predicting *in-vivo* digestibilities of herbages by exhaustive enzymic hydrolysis of cell walls. *Journal of the Science of Food and Agriculture* 28, 1057–1064.
- Schofield, P. (2000) Gas production methods. In: D'Mello, J.P.F. (ed.) *Farm Animal Metabolism and Nutrition*. CAB International, Wallingford, UK, pp. 209–232.
- Setälä, J. (1983) The nylon bag technique in the determination of ruminal feed protein degradation. *Journal of Scientific Agricultural Society of Finland* 55, 1–78.
- Smith, L.W., Goering, H.K., Waldo, D.R. and Gordon, C.H. (1971) *In vitro* digestion rate of forage cell wall components. *Journal of Dairy Science* 54, 71–76.
- Stern, M.D., Bach, A. and Calsamiglia, S. (1997) Alternative techniques for measuring nutrient digestion in ruminants. *Journal of Animal Science* 75, 2256–2276.
- Tamminga, M.K. and Williams, B.A. (1998) *In vitro* techniques as tools to predict nutrient supply in ruminants. In: Deaville, E.R., Owen, E., Adesogan, A.T., Rymer, C., Huntington, J.A. and Lawrence, T.L.J. (eds) *In Vitro Techniques for Measuring Nutrient Supply to Ruminants*, Occasional Publication No. 22. British Society of Animal Science, Edinburgh, pp. 1–11.
- Teather, R.M. and Sauer, F.D. (1988) A naturally compartmented rumen simulation system for the continuous culture of rumen bacteria and protozoa. *Journal of Dairy Science* 71, 666–673.
- Theodorou, M.K., Williams, B.A., Dhanoa, M.S., McAllan, A.B. and France, J. (1994) A simple gas production method using a pressure transducer to determine the fermentation kinetics of ruminant feeds. *Animal Feed Science and Technology* 48, 185–197.
- Theodorou, M.K., Lowman, R.S., Davies, Z.S., Cuddeford, D. and Owen, E. (1998) Principles of techniques that rely on gas measurement in ruminant nutrition. In: Deaville, E.R., Owen, E., Adesogan, A.T., Rymer, C., Huntington, J.A. and Lawrence, T.L.J. (eds) *In Vitro Techniques for Measuring Nutrient Supply to Ruminants*, Occasional Publication No. 22. British Society of Animal Science, Edinburgh, pp. 55–63.
- Tilley, J.M.A. and Terry, R.A. (1963) A two-stage technique for the *in vitro* digestion of forage crops. *Journal of the British Grassland Society* 18, 104–111.
- Udén, P. and Van Soest, P.J. (1984) Investigations of the *in situ* bag technique and a comparison of the fermentation in heifers, sheep, ponies and rabbits. *Journal of Animal Science* 58, 213–221.
- Van Milgen, J., Berger, L.L. and Murphy, M.R. (1993) An integrated dynamic model of feed hydration and digestion, and subsequent bacterial mass accumulation in the rumen. *British Journal of Nutrition* 70, 471–483.
- Van Soest, P.J. (1994) *Nutritional Ecology of the Ruminant*, 2nd edn. Cornell University Press, Ithaca, New York.
- Van Soest, P.J., Robertson, J.B. and Lewis, B.A. (1991) Methods for dietary fiber, neutral detergent fiber, and nonstarch polysaccharides in relation to animal nutrition. *Journal of Dairy Science* 74, 3583–3597.
- Vanzant, E.S., Cochran, R.C. and Titgemeyer, E.C. (1998) Standardisation of *in situ* techniques for ruminant feedstuff evaluation. *Journal of Animal Science* 76, 2717–2729.
- Waldo, D.R., Smith, L.W. and Cox, E.L. (1972) Model of cellulose disappearance from the rumen. *Journal of Dairy Science* 55, 125–129.

- Walker, D.M. (1959) The *in vitro* digestion of roughage dry matter. *Journal of Agricultural Science* 53, 192–197.
- Weakley, D.C., Stern, M.D. and Satter, L.D. (1983) Factors affecting disappearance of feedstuffs from bags suspended in the rumen. *Journal of Animal Science* 56, 493–507.
- Weiss, P.E. (1994) Estimation of digestibility of forages by laboratory methods. In: Fahey, G.C. Jr (ed.) *Forage Quality, Evaluation, and Utilisation*. American Society of Agronomy, Crop Science Society of America and Soil Science Society of America, Madison, Wisconsin, pp. 644–681.
- White, C.L. and Ashes, J.R. (1999) A review of methods for assessing the protein value of grain fed to ruminants. *Australian Journal of Agricultural Research* 50, 855–869.
- Williams, B.A. (2000) Cumulative gas-production techniques for forage evaluation. In: Givens, D.I., Owen, E., Axford, R.F.E. and Omed, H.M. (eds) *Forage Evaluation in Ruminant Nutrition*. CAB International, Wallingford, UK, pp. 189–213.

*This page intentionally left blank*

---

# 5

## Particle Dynamics

P.M. Kennedy

*CSIRO Livestock Industries, J.M. Rendel Laboratory, Rockhampton,  
Queensland, Australia*

---

### Introduction

The success of large ruminants in grassland habitats has been attributed to their fibre-handling ability. In particular, their ability to retain plant particles in the capacious reticulorumen (RR) allows sufficient time for digestion by fibrolytic microbes, while the rumination process stimulates passage of digested particles from the RR. The harvesting of nutrients from forage requires physical processing of large amounts of plant material by the ruminant, with prolonged chewing during eating and rumination. Time required for diet processing is determined by the amount of large particles (LP) in ingested forage, efficiency of their comminution (size reduction) and the related resistance to fragmentation that is determined by the chemical properties and three-dimensional anatomy of plant particles. These factors affect digesta clearance from the RR, and therefore can constrain voluntary intake. This constraint, together with other factors such as palatability, bulk density and rate of digestion, potentially limits the ability of ruminants to satisfy their metabolic capacity to utilize energy. Added to this constraint involving processing of plant residues and clearance of digesta from the RR, is the interplay between the animals' metabolic capacity to use nutrients and the ability of the diet to provide those nutrients (Weston, 1996). An understanding of particle kinetics of digestion and passage from the RR is important in the prediction of yields of microbial protein and substrates providing energy for ruminant tissues, together with adequate representation of nutrient flows in models of rumen function and animal performance.

In this chapter, mastication during ingestion and rumination, the associated processes of particle comminution, hydration, mixing and stratification and effects of particle properties on probability of rumination and passage from the RR and through the post-ruminal tract are discussed. It should be remembered throughout that one of the unique aspects of ruminant physiology is the circuitous route often followed by individual particles in the alimentary

tract. This route is determined by the interplay between individual particle properties, fermentative activities of adherent microbes, the cumulative effects of digesta load and packing of particles within the RR and the mixing and propulsive activities of the RR and post-ruminal tract. The stratification of particles into a floating 'raft' in the dorsal sac of the RR is a feature in some situations and is thought to be important to the preferential retention of newly ingested particles for subsequent fermentation, and to allow enhanced passage of aged particles that have undergone digestion.

Description of these processes, and of salient anatomical features of the ruminant gut, are given by Reid (1984), Sutherland (1988), Poncet (1991) and also in Chapter 3. The physiology of regurgitation has been reviewed by Ulyatt *et al.* (1986).

## Properties of Particles Associated with Rumination and Passage

Particle properties, especially 'size' because of its relative ease of measurement, are integral to discussion of particle movements. Particle size is usually determined by wet or dry sieving techniques, using screens of differing aperture and allowing a sieving time sufficient for all particles to have an opportunity to pass the screen. Particle size is an imprecise term and lack of standardization in its measurement with respect to equipment, sieving time, degree of agitation and mass of particles applied to the sieves can markedly influence the result. Despite this, many methods yield comparable information, although some result in estimates of enhanced median particle size (Murphy and Zhu, 1997). At least a part of the variation between methods results from differences in opportunity for 'end-on' approach of particles to the screen, which allows passage of some particles through screens on the basis of their diameter, rather than length that is the prime determinant of passage in most techniques. The relation of particle length or diameter to the aperture of retaining screen may differ depending on the source of the particles (e.g. faeces vs. RR, McLeod *et al.*, 1990). When reference is made in this review to data derived by sieving, the aperture of the screen that retains the particles in question is termed 'particle size'. More recent methods that offer speed and reliability use a simple separator with screens (Lammers *et al.*, 1996), microscopic image analysis (Luginbuhl *et al.*, 1984) or laser diffraction (Olaisen *et al.*, 2001). Shape information can be obtained using the latter two methods, but not from sieving methods. Classification of particles by size gives no information on the shape (with exceptions noted above), chemical composition or origin of the particles and consequently may be of limited use in the description of pools of uniform kinetic behaviour in the RR. As discussed below, the physical configuration and proportions of plant tissues, principally of vascular structures, will determine the patterns of fragmentation and the shape and rate of digestion of daughter particles (see also Kennedy and Doyle, 1993). There is also heterogeneity of approaches for summary statistics (Kennedy, 1984; Kennedy and Doyle, 1993).

It was recognized early that functional specific gravity (FSG) and size of particles were interrelated and both influenced particle dynamics in ruminants



(King and Moore, 1957; Lechner-Doll *et al.*, 1991). However, measurement of FSG, which includes contributions from gas and fluid components in internal inter- and intracellular spaces as well as from plant structural material, requires maintenance during measurement of fermentative activities of microbes associated with particles. This difficulty has resulted in only particle size being measured in many experiments, and accordingly in an incomplete description of factors affecting particle movements.

In this review, where reference is made to LP, medium particles (MP), small particles (SP), generally these are defined as particles retained on a screen of 1.18 or 1.0 mm aperture (LP), those passing a 1.18 or 1 mm but retained on a 0.5 or 0.6 mm screen (MP) and those passing a 0.5 or 0.6 mm screen but retained on a screen of 0.15–0.05 mm (SP). Fine particles (FP) are those passing the smallest screen. These are indicative sizes, and may differ somewhat between experiments. In much of the literature, division of the particle spectrum is made into large and small only, to designate particle pools that can be cleared from the RR with low and moderate to high probability, respectively. Accordingly with this division, the small particle pool includes MP, SP and FP using the definitions above. In this review when reference is made to these studies, the ‘small’ particles will be referred to as non-LP.

## Ingestion and Effects of Mastication

Time required for ingestive chewing comprises about 40% of total chewing time dedicated to ingestion and rumination (see Wilson and Kennedy, 1996) and is related to diet fibrosity and maturity (Weston, 1985) and therefore to degree of diet selection. The proportions of leaf and stem of available forage, and their respective physical and mechanical properties, affect the ability of animals toprehend and harvest their diets (Ulyatt *et al.*, 1986; Wright and Illius, 1995). The particle comminution that accompanies mastication and insalivation of the feed bolus required for comfortable swallowing is a secondary effect, but it does compromise structural integrity of the leaf and stem components by removal of cuticle, crushing and separation of vascular bundles and other plant tissues, and release of plant cell contents (Ulyatt *et al.*, 1986; Wilson and Kennedy, 1996). Nevertheless, for stems of different lengths, chewing time may be related to length of feed, and the resultant particle distribution of the swallowed bolus may be similar or even of smaller particle size for forage of longer chop length (Gherardi *et al.*, 1992; Pan *et al.*, 2003). These physical changes aid subsequent colonization of the ingested material by fibrolytic microbes when material reaches the rumen (Pond *et al.*, 1984; Pan *et al.*, 2003), while not necessarily increasing rate of digestion (Beauchemin, 1992), with the possible exception of tropical grasses (Poppi *et al.*, 1981a).

A comparison of susceptibility to ingestive comminution of different forages may be made using a ‘chewing efficiency index’ (CI), calculated as:

$$CI = LP_{\text{ingested}}/LP_{\text{feed}} \quad (5.1)$$

where  $LP_{\text{ingested}}$  is the proportion of LP in the ingested bolus and  $LP_{\text{feed}}$  is the proportion of LP in the feed.

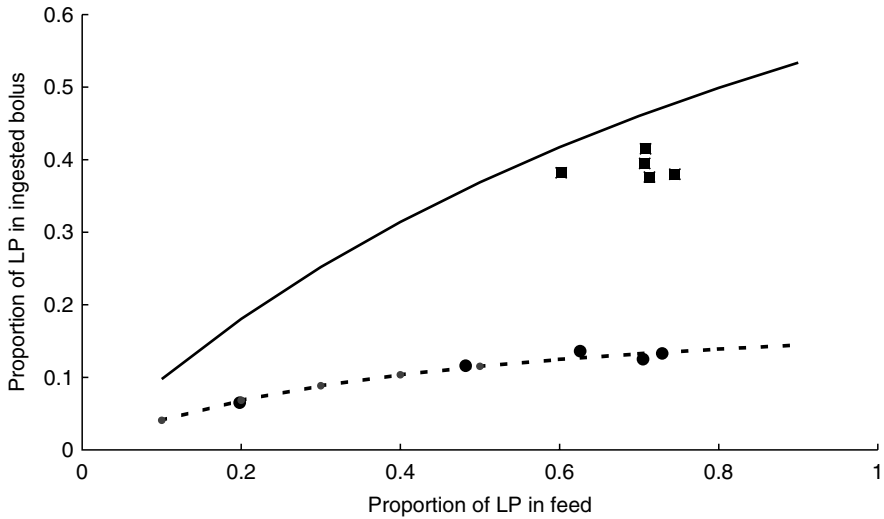
Dryden *et al.* (1995) stated that values for this index for sheep and cattle, using a 1 mm screen to define LP, are usually between 35% and 55% except for a value of 26% for cattle consuming annual ryegrass. With sheep and cattle fed high-quality temperate grass forages, at least 40% of LP are comminuted (CI of 60%) during eating (Gill *et al.*, 1966; Reid *et al.*, 1979; Ulyatt, 1983; Domingue *et al.*, 1991) compared with only 9–39% of LP in tropical forages (Poppi *et al.*, 1981b; Pond *et al.*, 1984; McLeod, 1986). However, Lee and Pearce (1984) concluded that there is no simple relationship between the degree of size reduction and their fibre content, perhaps because the former is also related to level of feed intake (Luginbuhl *et al.*, 1989a). Ulyatt *et al.* (1986) suggested that fresh diets and those of high nutritive value are chewed more effectively than dry ones, or those of lower nutritive value. In contrast, Burns *et al.* (1997) reported that advancing switch grass maturity was associated with reduced LP content of the ingested bolus. Selection of a larger screen to define LP may yield a different ranking when forages are compared (see Grenet, 1989). Sauviant *et al.* (1996) proposed the following relationship between proportions of LP in the ingested bolus and the feed:

$$LP_{\text{ingested}} = 1.21 / (1 + 1.14 / LP_{\text{feed}}) \quad (5.2)$$

This relationship closely described data from ground forages, but there was large variation for long forage. The relationship did not provide a good fit for data of Gherardi *et al.* (1992) for sheep fed diets in which particle size of wheat hay was varied between 4 and 101 mm (Fig. 5.1). When a screen of 2.36 mm aperture was used instead of one of 1.18 mm to define LP, an equation of the same form as Eq. (5.2) provided an adequate fit. This illustrates the utility of the mathematical function employed by Sauviant *et al.* (1996) and at the same time provides a caution concerning the appropriate definition of LP.

The mean particle size in the swallowed bolus declines with time after the start of meal eating (Gill *et al.*, 1966). This decline is associated with an increase in jaw movements per bolus, larger boluses and less rapid swallowing of boluses as the meal progresses. Differences between animals in average particle size of swallowed hay boluses have been observed (Gill *et al.*, 1966; Lee and Pearce, 1984; Ulyatt *et al.*, 1986; Gherardi *et al.*, 1992). Rate of chewing during eating in cattle is slower and is less effective in reducing particle size than in sheep (Ulyatt *et al.*, 1986).

Newly ingested boluses commonly disintegrate in the ventral rumen or the caudal ventral blind sac after 5–15 min, while ruminated boluses break up more readily (Reid, 1984). Individual particles then become susceptible to the various forces that determine their location in the RR and their likelihood of passage from this compartment as described later.

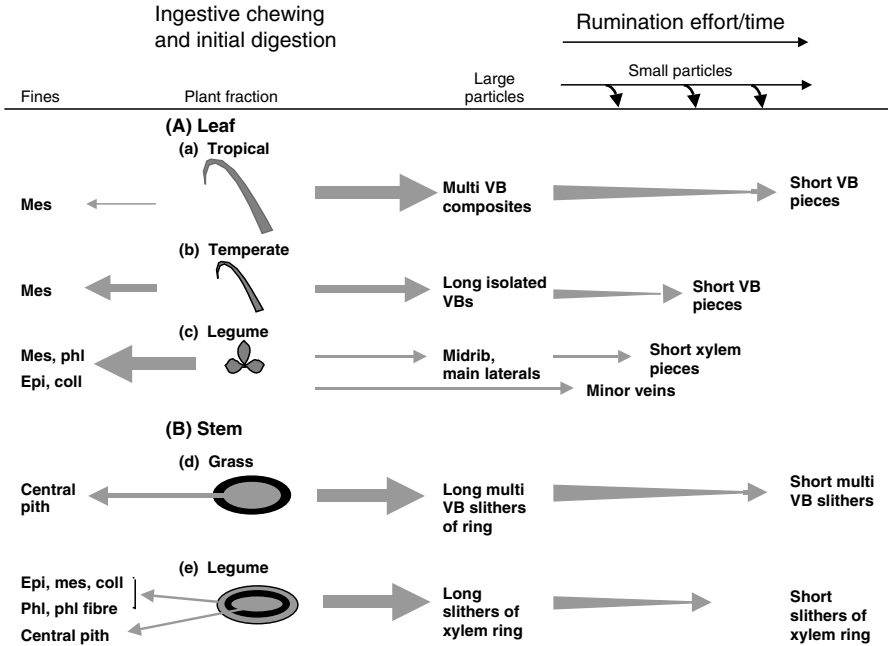


**Fig. 5.1.** Relationship (solid line) proposed by Sauvants *et al.* (1996) to describe change of large particle content (LP, determined by retention on a screen of aperture 1.18 mm) of the ingested bolus with that of the feed, together with data of Gherardi *et al.* (1992) from sheep fed five diets of wheaten hay chopped to lengths from 4 to 101 mm (■). When a screen of 2.36 mm aperture was used to define LP, the latter data (●) was described by an equation of the same form as proposed by Sauvants *et al.* (1996):  $y = 0.212/(1 + 0.419/x)$ .

### **Fragmentation patterns and role of plant anatomy**

During ingestive mastication, plant tissues fragment into particle size categories in a stochastic process (Kennedy *et al.*, 1997), according to constraints provided by epidermal and vascular structures (Fig. 5.2).

Rate of intake of legumes was higher than for grasses and the extent of size reduction of petioles and stems was correspondingly less (Wilman *et al.*, 1996). The greater ease of breakdown of lucerne than of ryegrass has been attributed to differences in fibre content and three-dimensional structure of the lignified supportive tissues, which in the case of lucerne are central xylem tissues compared to the scattered arrangements in ryegrass (Grenet, 1989). For temperate grasses, the fragments that result are long vascular strands, whereas leaf fragments from tropical species generally remain in blocks of vascular bundles due to girder-like structures in the latter (see Wilson *et al.*, 1989b) but with ready detachment of cuticle (Pond *et al.*, 1984). The characteristics that contributed to greater leaf rigidity in the tropical grass were cross-sectional area of thick-walled tissues, a higher vascular bundle frequency per unit leaf width, and lesser amount of densely packed mesophyll (Wilson *et al.*, 1989b). Legume leaves readily fragment due to their lack of girder structures (Wilson and Kennedy, 1996). The degree of longitudinal vs. lateral splitting



**Fig. 5.2.** Conceptual representation of the breakdown process of (A) leaves of tropical and temperate grasses and of legumes, and (B) mature stems of grass and legume, during eating and initial (0–6 h) digestion in the rumen to ‘fines’ or large particles, and subsequent breakdown by rumination to SP. Width of lines approximately represents relative proportions of each fraction. Black in stem = lignified ring; mes, mesophyll; phl, phloem; epi, epidermal fragments; coll, collenchyma; VB, vascular bundle. Reproduced from the *Australian Journal of Agricultural Research* 47 (Wilson and Kennedy, 1996) with permission of CSIRO Publishing.

during chewing of petioles, sheaths and leaf blades can be related to the abundance, thickness and orientation of vascular bundles (Mtengeti *et al.*, 1995). For example, Wilson *et al.* (1989a) reported that ingestive chewing reduced both length and width of fresh leaf blades of a tropical grass (*Panicum maximum*) to a greater extent than for a temperate grass (*Lolium multiflorum*). Reductions in length for the tropical grass were approximately nine- vs. fivefold for temperate leaf, whereas mean width was reduced approximately five- and twofold. Wilson *et al.* (1989a,b) and Wilman and Moghaddam (1998) found that tropical grasses were chewed into particles ‘somewhat smaller’ than the temperate ones, apparently involving slower eating. After chewing, particles of tropical stem were much larger than corresponding leaf particles; 6–10% of total cell wall area was exposed on the outside of chewed particles of legume leaflets and grass leaf blades and sheaths, whereas stem fragments were larger, and only 3–4% of cell wall area was exposed (Wilman and Moghaddam, 1998).

## Rumination and Comminution

### *Chewing behaviour*

Duration of rumination increases with dietary intake and fibre content to a maximum of at least 12 h/day (Weston *et al.*, 1989), although values of 10 h/day for animals at high intake of forage of low feeding value are more common (Dulphy *et al.*, 1980). Coleman *et al.* (2003) reported a close relationship between intake constraint (see Weston, 1996) and ruminating time in goats. Chewing rates during rumination vary with type of animal and forage (Dulphy *et al.*, 1980; Weston *et al.*, 1989). In contrast to comminution during eating, it has been proposed that rumination has the primary function of facilitating clearance of digested particles from the RR by reduction of particle size and positioning of particles in 'zones of escape' (adjacent to the reticulo-omasal orifice), where there is an enhanced likelihood of onward passage (Ulyatt *et al.*, 1986; Waghorn *et al.*, 1986; Ellis *et al.*, 1999). However, there is evidence that the stimulus to outflow of particles from the RR that are 'aged' (having been fermented and comminuted) is less during rumination than during eating (Girard, 1990; Das and Singh, 1999). Reasons for this may include: (i) increased salivary input during eating; combined with (ii) availability and amounts of 'aged', digested particles with high propensity for onward passage; and (iii) force, frequency and duration of contractions of the RR in relation to opening of the reticulo-omasal orifice.

With the exceptions of legume leaf which may be quite fragile (Wilson and Kennedy, 1996) and of very highly digestible forage (Grenet, 1989), most LP present in the RR appear to undergo comminution during ruminative mastication rather than by breakdown through direct microbial action or by friction against other particles during compression of the digesta mass caused by contractions of the RR (see Kennedy, 1985; Ulyatt *et al.*, 1986; McLeod and Minson, 1988; Kennedy and Doyle, 1993). This conclusion applies to reduction in particle length of LP, but less so to width which may be substantially reduced during microbial digestion by splitting between vascular bundles (Wilson *et al.*, 1989a,b). Non-LP are also subjected to comminution during rumination, but this occurs in competition with increasing probability of passage as size decreases. Among particles in the RR from coastal Bermuda grass categorized as non-LP, passage rates may vary by a factor of 2, and probability of comminution may exceed that of passage for particles retained on screens of 0.3 to 1 mm (Ellis *et al.*, 1999). In that study, leaf was twice as likely as stem to either pass from the RR or be comminuted at equivalent particle size, thus illustrating the heterogeneity within pools defined by sieving techniques that do not distinguish tissue type.

For particles containing vascular tissue, there may be a size below which particles are not comminuted. Smith *et al.* (1983) found little comminution in orchard grass particles of size below 0.2 mm. In agreement, Jarrige *et al.* (1973) reported that time spent ruminating sharply increased when diet

particle size increased from 0.2 to 1.0 mm. The effectiveness of rumination in comminution of very small particles may depend on the presence of fractures that may be propagated by further chewing (Kelly and Sinclair, 1989). This suggestion needs further elaboration in relation to plant anatomical structures.

### **Large particle dynamics**

In cattle, estimates of the proportion of ingested LP comminuted by rumination are between 40% and 90% (Ulyatt *et al.*, 1986), 70–84% (Suzuki, 2001) and 90% (Kennedy, 1985). The efficiency of rumination (per hour of chewing) increases with feed intake and LP content of the RR (Faichney, 1990; Bernard *et al.*, 2000). Within a cycle, efficiency is a function of: (i) the ease with which particles are transported to the mouth during regurgitation and the attendant selection of LP requiring comminution; (ii) efficiency of locating particles between the occlusal surfaces of the teeth; (iii) physical properties of particles, especially the inherent resistance to fracture of particles; (iv) the particle size distribution of the swallowed bolus; and (v) time spent chewing.

Rates of breakdown of LP in cattle have been estimated by measurement of LP load by removal of digesta from the RR through a fistula. When frequent feeding is practised to promote steady-state kinetics, a single measurement of LP pool size is required, whereas when feed is available for a restricted period, measurement of the subsequent decline in LP pool in the RR requires two measurements (see Kennedy and Doyle, 1993). Other methods involve collection of bolus traffic from an oesophageal fistula during rumination, or using marker techniques. In a collation of data from a variety of sources and methods, Kennedy and Doyle (1993) found rates of LP breakdown through comminution plus digestion of 5–29% per hour for forages, with values for sheep tending to be 30% greater than for cattle. This difference is associated with higher chewing rates during rumination in sheep than in cattle (80–100 vs. 40–60 chews per min; Ulyatt *et al.*, 1986), but it is not clear if differences in mastication efficiency *per se* are involved. Pertinent studies employing plastic particles showed that 10-mm particles were comminuted at rates of 2–6% per hour for both sheep and cattle (Lechner-Doll *et al.*, 1991), indicative of similar mastication efficiency. It was noteworthy that, while pregnancy and lactation affected intake and passage rate of plastic particles, comminution rate of 10-mm particles was constant at about 6% per hour in sheep (Kaske and Groth, 1997). Whole maize grains that escape ingestive chewing apparently are not available for rumination and pass intact from the RR (Ewing *et al.*, 1986). Leaf is not always comminuted at a faster rate than the corresponding stem, but with cattle consuming coastal Bermuda grass, the difference in rate was substantial (Kennedy and Doyle, 1993). More recent data for that diet confirmed that ruminative comminution occurred at 27% per hour for leaf particles retained on a 3 mm screen, compared to only 12% per hour for equivalent stem particles (Ellis *et al.*, 1999).

### **Bolus traffic**

Regurgitated boluses appear to be derived from the ventral or middle parts of the reticulum of sheep, although it has been suggested that the site of origin in cattle may be the dorsal reticulum or cranial sac (Ulyatt *et al.*, 1986; Luginbuhl *et al.*, 1989b; Suzuki, 2001). In most studies, the ruminated bolus in cattle was found to contain a lower proportion of LP than in the dorsal sac, from where the bolus material was thought to originate (Ulyatt *et al.*, 1986; Suzuki, 2001). Kennedy (1985) reported a contrary result but explanation may lie in the non-exhaustive sieving technique used.

The regurgitated ('up') bolus is followed within a second by swallowing of an unchewed ('tail') bolus that is depleted of LP. After chewing for approximately 1 min, the 'down' bolus is swallowed and the comminuted material deposited in the anterior rumen, in proximity to the reticulo-omasal orifice. Some material is usually swallowed before the end of the cycle; thus the 'down' bolus comprises two parts. A conceptual representation of the time course of particles and LP in the mouth during a rumination cycle is shown in Fig. 5.3. The 'up' bolus may vary in sheep from 54 g wet weight for fresh herbages to 74 g for chopped forages (Ulyatt *et al.*, 1986) and values of 750–824 g were reported for cattle given chopped forages (Kennedy, 1985).

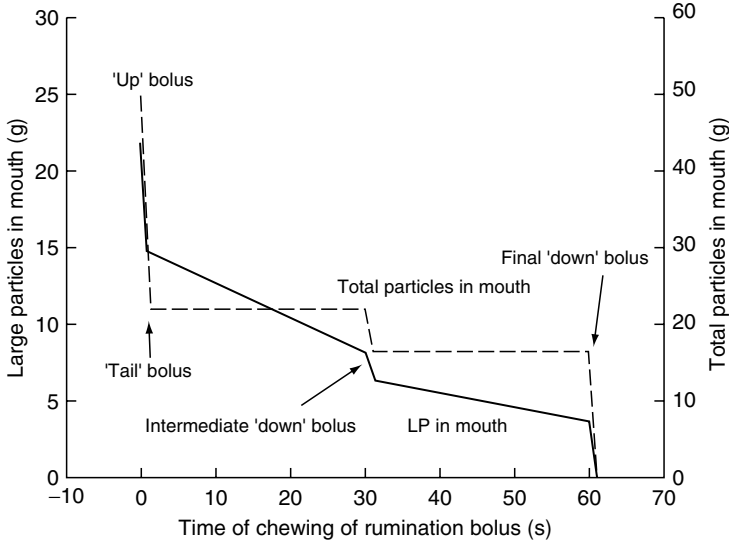
In cattle, as a result of swallowing the 'tail' bolus, LP in the retained bolus was enhanced by 30–47% (Chai *et al.*, 1984; Kennedy, 1985), 15% (Suzuki, 2001) and 8–18% in sheep (Ulyatt *et al.*, 1986). Of LP retained in the mouth after passage of the 'tail' bolus, 57–86% was reduced during a rumination cycle in cattle (Chai *et al.*, 1984; Kennedy, 1985; Suzuki, 2001) and 39–65% for sheep (Ulyatt *et al.*, 1986).

Specific fragility (SF) during rumination describes the efficiency of LP comminution of the 'retained' bolus and is calculated as:

$$SF = LP_{\text{comminuted}} / (\text{chews} \times LP_{\text{retained}}) \quad (5.3)$$

where  $LP_{\text{comminuted}}$  denotes LP comminuted in one cycle of rumination, chews is the number of chews per rumination cycle and  $LP_{\text{retained}}$  is the quantity of LP in the retained bolus at the start of chewing.

SF is affected by time after feeding, with values at 16 h twice those at 4 h after feeding for cattle fed brome grass and lucerne chaff (Chai *et al.*, 1984). This increased SF with time after feeding may be attributable to the digestive weakening, or to changes with time of leaf and stem proportions aspirated to the mouth in the 'up' bolus. Forage effects are important; SF of brome grass was 50% higher than for lucerne, resulting in 21–36% more LP being comminuted per chew at 16 h after feeding (Chai *et al.*, 1984). Data of Suzuki (2001) for cattle fed orchard grass and timothy hay show moderate increases (35–44%) in SF with time post-feeding, attributable to decreases of about 20% in shearing energy of regurgitated stem. In that study, shearing energy of stem was two to three times that of leaf and the majority of regurgitated LP was of stem origin. Accordingly, the proportion of stem particles would largely



**Fig. 5.3.** Depiction of changes in large (solid line) and total particle (interrupted line) content of bolus in the mouth of cattle during ruminative chewing vs. time of chewing.

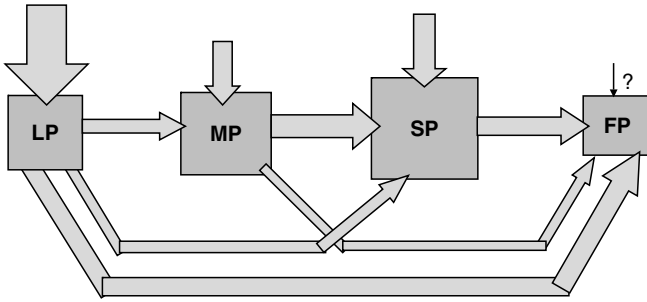
determine the comminution effort required. Chai *et al.* (1984) and Kennedy (1985) observed a close relationship of SF with number of chews per cycle, which led to the suggestion that cycle length during rumination was determined by the relative extent of LP comminution. The data of Suzuki (2001) for low- and high-quality grasses are consistent with this concept.

### ***LP comminution and resultant particle distribution***

Description of the degree of comminution during rumination to daughter pools of different particle sizes is poorly defined, to the detriment of efforts to model particle kinetics (Faichney *et al.*, 1989). The chemical and anatomical determinants of rigidity and brittleness of plant fractions need elucidation (Akin, 1989; Wilson *et al.*, 1989a,b) as does the role of the rumen microbes in digestion and weakening of fibrous plant residues and the resulting impact on fragmentation patterns.

Ueda *et al.* (2001) showed in sheep that comminution from the rumen MP pool was responsible for entry of 2.3 times as much indigestible DM into the SP pool compared to the direct entry to the SP pool from the LP comminution. Conversely, MP comminution was responsible for only 15% of entry into the FP pool, whereas the amounts from LP and SP pools were 46% and 40%, respectively (Fig. 5.4). In experiments reliant on adhesion of external markers to mark defined particle pools, migration of marker may bias accuracy of estimates of particle movements; application of markers using competitive





**Fig. 5.4.** Diagram of RR pools and flows of indigestible dry matter calculated from Ueda *et al.* (2001). Pools are shown with size in proportion to content of indigestible dry matter, and width of arrows connecting pools are in proportion to daily flows of indigestible dry matter. Biases caused by increase in potential digestibility due to comminution *per se* could not be assessed. LP, MP, SP and FP designate large, medium, small and fine particle pools, respectively.

binding is now considered the optimal method (see Worley *et al.*, 2002), but marker migration may still occur (Hristov *et al.*, 2003). Data of Ueda *et al.* (2001) were derived using markers that had been applied by a soak and wash method, which should have reduced marker migration.

Information on net changes of particle proportions during bolus traffic was obtained by Kennedy (1985 and unpublished results) for steers fed four dried forages. The majority of LP in the 'up' bolus were comminuted after one rumination cycle mainly to MP (57–72% by weight), with the remainder appearing in SP (18–30%) and FP (6–21%) fractions in the 'down' bolus. A greater proportion (50%) of LP was comminuted to the MP pool between 4 and 16 h post-feeding, than occurred between 16 and 24 h (17–25%). In another study with steers given separated leaf and stem fractions of *Lolium* and *Medicago*, McLeod (1986) found that 34–40% of comminuted LP appeared in the MP pool, while 19–41% and 13–52% appeared in the SP and FP pools. Leaf of *Lolium* fragmented more to FP than was the case for the other three diets and therefore the potential clearance rate from the RR might be expected to be greater (see later). Such studies of net changes in particle size fractions of boluses do not account for comminution of MP and SP initially present in the retained bolus, i.e. changes in the non-LP pools are attributed solely to input of material from LP fragmentation, unless particles are also marked to determine gross movements between particle pools.

The vascular origin of non-LP produced following rumination indicates the obvious predominance of residual vascular tissue in leaf and stem fragments in the RR. This conclusion differs from the situation on ingestion, which results in more digestible tissue, notably mesophyll in the non-LP. In seeking more quantitative definition of patterns of LP comminution, sampling of bolus traffic during rumination has yielded some insights, but has rarely been accompanied by anatomical characterization of LP that would have facilitated a mechanistic explanation of fragmentation patterns. In one of the few relevant studies, Kelly and Sinclair (1989) concluded after examination of 'up' and 'down' boluses in

sheep that all plant components (leaf, stalk, sheath and cuticle) were broken down at a similar rate for five forage diets. A more accurate evaluation of fragmentation patterns is possible when particle categories are identified using external markers, but it is important that appropriate preparation techniques are used to ensure strong attachment of markers to particles (Bernard and Doreau, 2000). Using markers, Suzuki (2001) identified leaf and stem components of ruminated boluses in cattle fed orchard grass. The data showed that the ratio of stem:leaf in the 'up' bolus progressively increased from about 38:45 at 4–8 h after feeding, to be about 60:35 at 20–24 h. Thus, differences in ruminative comminution rates of leaf and stem may arise from changes in availability of these fractions for rumination with time after feeding, in addition to differences in SF and fragmentation patterns.

Occurrence of substantial breakdown of LP directly to SP, thus bypassing the MP pool, was indirectly supported by evidence of similarity between LP and SP in respect of fibre:lignin ratio and digestible fibre patterns (Waghorn *et al.*, 1986; McLeod *et al.*, 1990) and also by particle distributions after ruminal digestion of forages *in situ* (Nocek and Kohn, 1988). However, because the input of particles to these pools during ingestive mastication is from different and more digestible plant tissues than is the case during rumination, it is probable that the chemical composition of particle fractions cannot be used unequivocally to support conclusions about parent pools. For example, during rumination, the smallest particles are likely to be pieces or slithers of vascular bundle or xylem ring, in contrast to fines derived from initial chewing, which are likely to be derived from mesophyll, epithelial and pith cells (Fig. 5.2).

In order to clarify factors affecting degree of comminution, we require more studies *in vivo* using markers to trace the fate of defined particle groups (e.g. Ellis *et al.*, 1999; Ueda *et al.*, 2001) and *in vitro* employing bench-top equipment to mimic chewing and fragmentation patterns applicable to the *in vivo* situation. Elucidation of different patterns of fragmentation will require description of the plant tissue of origin and composition of bolus material retained in the mouth prior to ruminative chewing.

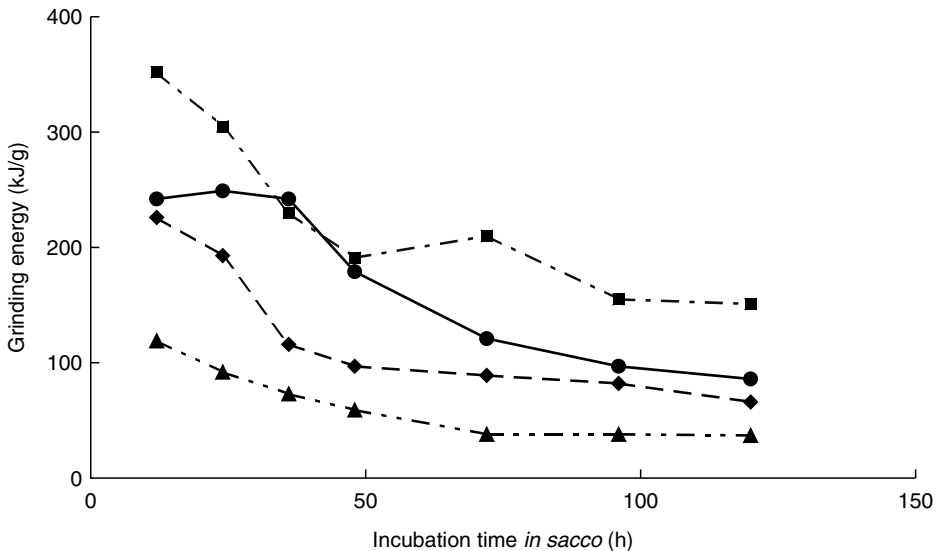
### **Microbial colonization and weakening of particles**

Attachment of fibrolytic bacteria to ingested particles occurs within 10 min, followed by bacterial growth and initiation of digestion (Koiike *et al.*, 2003). Yang *et al.* (2001) and Rodriguez *et al.* (2003) found quadratic increases in microbial biomass attached to ruminal particles as their size decreased to those retained on screens of 0.15 and 0.08 mm apertures, respectively. The high proportion of bacteria associated with the smallest particles is likely to be caused by the predominance of highly digestible plant tissue resulting from direct inputs from the diet (see Rinne *et al.*, 2002; also Fig. 5.2); smaller particles have increased surface area for microbial attachment (Pond *et al.*, 1984; Pan *et al.*, 2003). This suggestion is in accord with calculations by Wilson and Hatfield (1997) that indicate that accessibility by fibrolytic bacteria

decreases as particle size increases, partly owing to reduced opportunity of infiltration into cell interiors through open lumens of cells with chewed ends. Accordingly, the efficiency of microbial synthesis will be directly related to the rate of passage from the RR of the particle material to which the bacteria are attached (Isaacson *et al.*, 1975), and their microbial load determined by extent of fermentation and tissue origin of the particles.

It has been generally assumed that microbial digestion does not significantly affect particle comminution (Ulyatt *et al.*, 1986), but there is evidence that the fungi in the RR are especially effective in the disruption and weakening of LP (Fonty *et al.*, 1999). Moreover, there is evidence that weakening of particles during ruminal fermentation occurs, as illustrated by reduction in grinding energy of chopped dietary material with time of exposure to *in situ* ruminal incubation (Fig. 5.5). In another study, time of immersion in the rumen required to halve initial strength (load to fracture) for ryegrass leaf, hay stem and barley straw stem was measured to be 18, 35 and 60 h, respectively; furthermore, these times were well related to the total chewing effort observed for each diet (Evans *et al.*, 1974). Rate of LP comminution, simulated in bench-top artificial masticators was increased by ruminal digestion (McLeod, 1986; Kennedy *et al.*, 1997).

During digestion of temperate grass, width reduction of the chewed LP was faster than in a tropical grass because the straight-walled intercostal cells of the epidermis were easily separated allowing the epidermis to split, whereas the sinuous walls of tropical grass were resistant to splitting (Wilson *et al.*, 1989a). The linkage of epidermis to vascular bundles via thick-walled bundle sheath cells



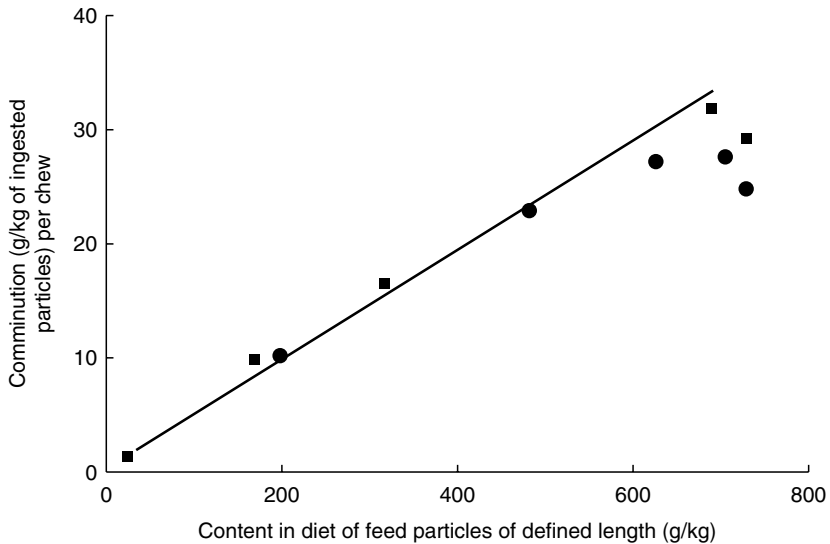
**Fig. 5.5.** Grinding energy of particles of dietary material recovered from dacron bags after various incubation times in the reticulorumen when cattle were fed the same hay diet of either dolichos (■), verano (●), pangola (▲) or sorghum (◆) (data of Kennedy *et al.*, 1993).

contributed to slower width reduction in the tropical grass by causing the epidermis to remain attached for much longer than for a temperate grass. The epidermis of the temperate grass was shed on digestion of thin-walled mesophyll cells, which formed the linkage of epidermis to the vascular bundles (Wilson *et al.*, 1989a). Leaf material of temperate grass was reduced to isolated fibres within 24 h of digestion; this process took more than 48 h in the tropical grass. These fibres all had a high resistance to length reduction by digestion irrespective of their anatomical or species origin.

Although there is presumptive evidence for increased ruminative fragmentation with greater digestion *in vivo* (Chai *et al.*, 1984), whether this weakening contributes to greater comminution rate in the animal is uncertain. Considering the changes in proportions of leaf and stem in boluses mentioned previously (Suzuki, 2001), together with the shearing energy of leaf and stem particles separated from the ruminated boluses, there should have been a net decline with time post-feeding of about 30% in the shearing strength of an average bolus particle. However, as little change in rate of comminution per chew (SF) was evident from the bolus traffic experiments, we may conclude that the biting force exerted by ruminants is sufficient for LP comminution at all stages of the feeding cycle. Tensile breaking strengths of 1–15 N of temperate grass leaves (Henry *et al.*, 1996) are lower than peak biting force exerted by sheep (8–13 N; Hughes *et al.*, 1991), but the higher tensile strength expected for stem material may require several chews for its fracture. Greater forces were required to fracture pseudostem than leaves of grasses and there were no significant relationships with chemical composition (Wright and Illius, 1995). Fragmentation of stems generally requires more energy than of leaf, giving rise to the inverse relationship between ease of fragmentation and mean cell wall thickness (Spalinger *et al.*, 1986).

### **Comminution mechanisms**

Although particle size distributions of swallowed boluses have been reported by various authors, such data provide information about the results of mastication, but do not specifically address the chewing process itself. It seems agreed that translative (grinding or shearing) mechanisms, as opposed to compressive movements, are the dominant mode of breakdown of large plant particles during chewing in ruminants (Nickel *et al.*, 1979). In general, comminution can be viewed as a function of two processes, selection and breakage (Epstein, 1947). The selection of a particle for breakage is likely to depend on: jaw, tongue and cheek movements; the total occlusal surface of the molars; tooth shape; particle size; and the total amount of food or digesta in the mouth. Breakage is thought to depend on tooth shape, the amount and coordination of muscle activity, the rigidity/breaking strength of the particle and its size and shape. Processes of particle selection and breakage during mastication have not been explicitly studied in ruminants, although the results of experiments using humans may prove instructive although not directly applicable because of



**Fig. 5.6.** Relationship between particles comminuted per chew during ingestion and content of those particles in the diet of sheep fed wheaten straw chopped to five lengths between 4 and 101 mm (data of Gherardi *et al.*, 1992). Particles retained on screens of 2.36 (●) and 4.75 mm (■) are plotted. The common regression ( $y = 0.0464x$ ) excludes the three points with highest  $x$  values.

the choice of materials such as carrots in the human studies (e.g. Lucas and Luke 1983a,b; Baragar *et al.*, 1996).

If a quantitative description of the progress of particle fragmentation during comminution was available, our ability to explain the interaction of mastication and plant anatomy would be greatly enhanced. A pertinent approach was made by Murphy and Bohrer (1984). From data for sheep of Gherardi *et al.* (1992) depicted in Fig. 5.6, it appears from the linear relationship that active selection of particles for ingestive chewing did not occur and comminution was determined by dietary LP content, at constant efficiency. The deviation from linearity at high dietary LP content may be due to the increased content of  $>4.75$  mm particles in the  $>1.18$  mm fraction, rather than changes in selectivity or breakage probability.

## Mixing and Stratification of Particles in the RR

Boluses swallowed during eating are deposited in the reticulum or over the cranial pillar into the main rumen sac, depending on the stage of the contraction cycle, whereas those swallowed during rumination are deposited in the dorsal part of the cranial sac of the rumen and swept caudally over the cranial pillar with the next contraction of the reticulum. The contraction sequence of the RR

that determines the movement location in the RR and their likelihood of passage from this compartment have been discussed elsewhere (Waghorn and Reid, 1977; Reid, 1984).

Newly ingested particles, with the exception of large grains, contribute to the floating raft in the RR as they have a low FSG owing to gas-filled voids. Hydration of the voids is rapid and essentially complete for SP within 60 min (Wattiaux *et al.*, 1992, 1993) and the relative change of FSG is greater for larger particles (Hooper and Welch, 1985). After hydration, the FSG of particles may continue to be less than the surrounding fluid, by virtue of gas evolution arising from microbial fermentation (Sutherland, 1988). Stem particles, with their architecture of internal gas-filled voids, are more likely than leaf to be incorporated into raft particles. Sutherland (1988) reported for sheep fed lucerne which was 50% leaf, that the raft came almost entirely from stem. This also applied in cattle fed silages made from timothy–meadow fescue hay harvested at intervals of 1 week and with leaf content declining from 60% to 29% (Rinne *et al.*, 2002), but not to cattle grazing coastal Bermuda grass in which material harvested was of predominantly leaf origin (Pond *et al.*, 1984).

Stratification of particles between pools within the RR may be quantified by the 'distribution coefficient' ( $D$ ) (Sutherland, 1988), for any particle size category as defined by:

$$D = A_{\text{pool1}}/A_{\text{pool2}} \quad (5.4)$$

where  $A_{\text{pool1}}$  and  $A_{\text{pool2}}$  are the concentrations of particles from a size category (g DM/kg wet weight of digesta) sampled from two pools.

As an illustration, if the distribution coefficient of MP between dorsal and ventral sacs (ratio of the MP content of the raft compared to MP in ventral digesta) is greater than 1, it is either indicative of incomplete mixing, heterogeneity of buoyancy, or physical entrapment within the dorsal raft. For both sheep and cattle fed once per day, this dorsal/ventral distribution coefficient was positively related to particle size, and decreased with time after feeding, indicating lessening of stratification (Evans *et al.*, 1973; Sutherland, 1988). Plots of distribution coefficients from data of Evans *et al.* (1973) indicate that MP, but not SP, are susceptible to stratification with a consequent disproportionate representation in the raft (see Kennedy and Doyle, 1993). In another study, with increasing maturity of grass in silage, MP in the RR accumulated due to decreases in passage of MP from the RR (Rinne *et al.*, 2002).

Sutherland (1988) and Pond *et al.* (1987), from evidence of similar sedimentation characteristics of particles from dorsal and ventral sites, proposed that particles were continuously interchanging. In contrast, Poppi *et al.* (2002) suggested that once particles leave the raft, their rate of reincorporation into the raft is low, and probability of passage out of the RR is high. These conflicting reports leave open the possibility that the buoyancy and entanglement characteristics that determine sequestration may be quite variable with different rumen conditions that result from ingestion of forages of

different types, maturities and leaf:stem ratios. In situations in which a distinct raft was not observed and distribution coefficients of particles from the dorsal and ventral sacs were similar, the reticulum appeared to take a major role in the selection of particles for onward passage (Weston *et al.*, 1989). For example, in cattle in which there was no evidence for particle stratification in the dorsal and ventral sacs of the rumen, there was depletion of contents of MP and enhancement of SP in the reticulum relative to the rumen (Ahvenjarvi *et al.*, 2001). In cattle fed a silage-based diet *ad libitum*, higher feed intakes were associated with reduced fibre digestion of the particles from the ventral sac, but raft particles were little affected (Deswysen and Ellis, 1988), indicating stability in probability of particle escape from the raft. This was consistent with a filter-bed effect discussed below and with the suggestion by Poppi *et al.* (2002) that particle movement from the raft controlled residence time of particles in the RR and could be characterized as 'age-dependent'. In contrast, in cattle grazing coastal Bermuda grass, distribution coefficients indicated that relative depletion of MP in the raft occurred with time after feeding accompanied by enhancement of LP but with little change in SP (Pond *et al.*, 1987). Reconciliation of these findings is problematical without information on buoyancy or potential digestibility of the particle fractions, as is interpretation of reports of rapid mixing in the RR with no impediment from a raft (Lirette *et al.*, 1990).

Rinne *et al.* (1997) showed that increased maturity of silage resulted in delay of transfer from the 'lag-rumination' to the escape pools. As intake was restricted below *ad libitum*, raft digesta weight was decreased as a proportion of total RR digesta (Robinson *et al.*, 1987). Poppi *et al.* (2002) found that for cattle eating tropical grass, the raft comprised 77% of the DM in the RR, and that movement of particles from the raft was slower for stem than for leaf particles. Cherney *et al.* (1991) attributed the slower passage rate from the RR of stem than leaf to greater entrapment of stem in the raft, although this effect was confined to oat and barley, and was not found with sorghum-sudan and pearl millet.

Faichney (1986) and Ulyatt *et al.* (1986) considered that the presence of the raft acts as a filter bed whereby non-LP move through the raft with the fluid phase in response to contractions of the RR, and may become entrapped with larger particles. Bernard *et al.* (2000) proposed that the amount of 'free water' in relation to size of the LP pool is a main determinant of movement of particles in the rumen and therefore degree of stratification in a raft. The raft/filter bed is equivalent to the 'lag-rumination' compartment identified by Ellis *et al.* (1999) using marker kinetics. It appears that the raft exerts only a temporary delay to movement of small plastic particles (Welch, 1982; Lechner-Doll *et al.*, 1991) and to dense radio-opaque markers (Waghorn and Reid, 1977). In general, there seems to be little evidence for entanglement of SP in the longer forage particles of the raft and subsequent impedance of SP movement to the reticulum, although such entanglement may occur with larger particles, such as whole cottonseed (Harvatine *et al.*, 2002).

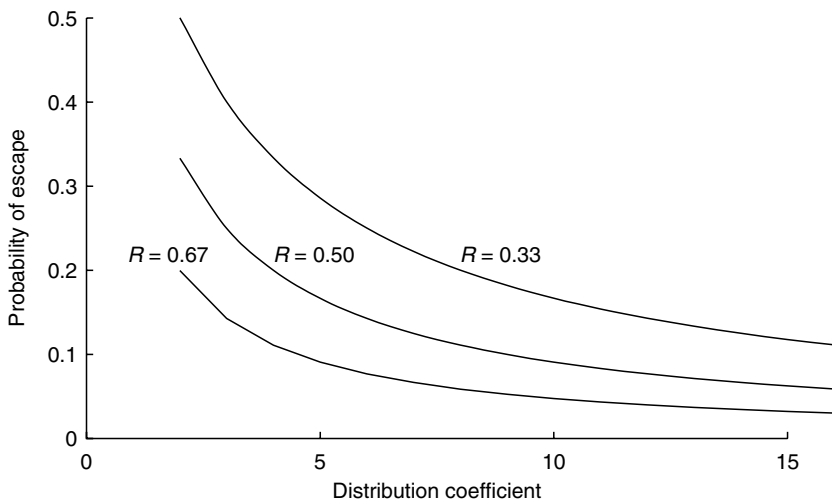
The degree to which particle passage from the ventral sac ( $P_p$ ) is hindered by the presence of the raft may be expressed as a probability of particles

escaping to the reticulum:

$$P_p = (1 - R) / [R \cdot D + (1 - R)] \quad (5.5)$$

where  $R$  is the proportion of the wet weight of rumen contents comprising the raft, and  $D$  is the distribution coefficient expressed as a ratio of concentration of particles in the raft to that in the ventral sac (Sutherland, 1988). This relationship is shown for  $R = 0.33$ ,  $0.50$  and  $0.67$  in Fig. 5.7.

Using concepts developed by Faichney (1986), Bernard *et al.* (2000) produced a model of particle movements that endeavoured to take account of the filter-bed effect. These authors employed an arbitrary method to determine entrapment of SP by larger particles, which involved estimating the proportion of the SP pool that was entrapped with larger particles by use of a filtration method, and subsequent redistribution of entrapped SP to LP and MP pools. Also, they assumed random comminution of LP and MP to smaller particle pools with mass flows determined by the content of indigestible acid detergent fibre in those pools. The assumptions involved are unlikely to be valid for the variety of fragmentation patterns and buoyancy mechanisms that appear to characterize particle comminution and passage. For appropriate accommodation of the filter-bed effect, an improved method to measure entrapment should be developed, which accommodates results of Olaisen (2001). These indicated that increased feed intake leads to increased raft formation, a greater degree of particle packing within the RR and partial inhibition of sedimentation behaviour. It is also of interest that the comminution patterns of lucerne deduced by Ueda *et al.* (2001), by use of marking particle pools with rare earth markers as depicted in Fig. 5.4, do not support the random



**Fig. 5.7.** Relationship between the probability of particles escaping the reticulorumen and their distribution coefficients ( $D$ ) between dorsal sac and reticulum, as described by Eq. (5.5) (from Sutherland, 1988).



comminution assumption used in application of the method of Faichney (1986). Discrimination against particle movement from the ventral rumen to the reticulum also occurs as indicated by distribution coefficients between the two sites, but was removed when the diet of lucerne was ground (Weston *et al.*, 1989). It is possible that a similar lack of particle discrimination and negligible raft formation occurs with some diets such as silages (Ahvenjarvi *et al.*, 2001).

Considerable experimental work will be required to develop a quantitative description of the interaction of the particle properties and microbial fermentation that are responsible for particle buoyancy and movement within the RR. Current evidence indicates that differences in chemical composition and particle anatomy, together with the particle environment in the RR, will also affect particle movements and therefore require characterization.

## Passage from the RR

Passage of digesta from the RR is not only determined by feed properties and/or the amount of digesta in the RR, but also by the degree of motor control by the animal over muscular contractions of the RR that affects propulsion to the omasum of reticular contents. Increased feed intake of forage, and therefore outflow from the RR, results in increased fractional passage rate (FPR) from the RR (Luginbuhl *et al.*, 1989b; Coleman *et al.*, 2003); this is associated with duration and amplitude of reticular contractions, with the duration deemed the more important (Okine and Mathison, 1991). Ulyatt *et al.* (1986) stated that for sheep the amount of digesta flowing from the RR per opening of the reticulo-omasal orifice varied from 0.25 to 0.5 g DM, while for cattle the value is 1.8–3.6 g OM. Sauvant *et al.* (1996) assigned a value for particulate DM that flowed per opening of the orifice of 0.40 g in sheep with a RR volume of 150 ml/kg liveweight. In this model, intake variations were accommodated through their effects on RR volume. It is pertinent to note that the primary response is increased digesta flow from the RR. Whether a corresponding increase in particle FPR occurs will depend on corresponding changes in the amount of particles in the RR (see Chapter 3 for discussion about the relationship of FPR with mean retention time).

Clearance from the RR of digestible plant cell wall occurs at a slower rate than for indigestible cell wall (Rinne *et al.*, 2002), despite the occurrence of both components in each particle. Thus, estimated FPR of dietary cell wall constituents is usually greatest for lignin and least for hemicellulose (Egan and Doyle, 1985). This is a consequence of differential sorting within the RR of particles having undergone differing degrees of digestion and having differing chemical and physical properties. The kinetic validity of calculating FPR from the total RR content of particles is reduced by the existence of sub-pools with restricted interchange. There may be reduced probability of movement of particles relative to water due to sequestration of particles in the raft in the dorsal rumen, discrimination against passage from the ventral rumen to

reticulum, and at the reticulo-omasal orifice. The degree to which movement of particles within the RR are retarded relative to fluid by a series of such processes can be expressed in the form:

$$\text{FPR}_{\text{particles}} = P_1 P_2 P_3 \dots P_n \text{FPR}_{\text{fluid}} \quad (5.6)$$

where  $\text{FPR}_{\text{particles}}$  and  $\text{FPR}_{\text{fluid}}$  are the FPR constants governing outflow from the RR for particles and fluid, and  $P_1$  to  $P_n$  are probabilities of particle passage relative to fluid during each retardation process up to the  $n$ th process (Sutherland, 1988). Close relationships between FPR of water and FPR of non-LP were reported by Cherney *et al.* (1991) and de Vega and Poppi (1997).

The existence of back-flow of LP from the omasum to the RR has been demonstrated (Deswysen, 1987) but is considered to be of little consequence to this discussion, as there appears to be no apparent mechanism to select or reject particles in the omasum.

### ***Effects of particle size on passage from the RR***

FPR from the RR varies inversely with particle size, and seems to be well described in most studies by a negative linear relationship between the logarithm of FPR and screen aperture through which particles pass or are retained (Poppi *et al.*, 1980; Egan and Doyle, 1984; Ellis *et al.*, 1999). Similar relationships were observed with particle length or width (Weston, 1983). The intercept and slope of the logarithmic relationship noted above is dependent not only on the methodology employed to determine particle size, but also on type of forage in the diet and animal age.

The inverse relationship between FPR and particle size, while a common feature in the literature, was not observed in all studies. Passage rate of FP in some cases may be lower than that of SP. For cattle eating a grain:silage diet, within the non-LP particles, passage rate of 0.3 mm particles was fastest, and declined at particle sizes below and above the 0.3 mm size (Olaisen, 2001). A similar relationship was also reported by Dixon and Milligan (1985) for cattle given long and ground grass hay, while Waghorn *et al.* (1989) found in cows similar FPR of particles smaller than 2 mm. It is uncertain if the results would have been obtained if corrections had been made for differential digestion of particles of different size, occurring in transit between the RR and faeces. When FPR from the RR is measured from the appearance of those particles in faeces, its calculation will be biased if the mean weight of the particle that exists in the RR pool differs from those appearing in the faeces as a result of microbial fermentation, mammalian digestion, or simply lysis or detachment from particles of ruminal microbes in the post-ruminal tract. The degree of bias is likely to differ for different particle categories and sources of particles, as determined by use of internal markers (McLeod *et al.*, 1990). Internal markers are preferred for correction of post-ruminal digestion. External markers (especially rare-earth markers) that can be applied to specific particle pools have been used extensively, but use of these markers may still be subject to methodological inadequacies, with the most important concerns being variation in ratio of

marker to particle DM and marker migration from particles and preferential adherence to the smallest particles (Faichney, 1986).

Many authors have proposed a critical particle size above which passage of LP is assumed to occur with very low probability. Critical particle size has often been defined as retention on a screen of 1–2 mm aperture because minor amounts of particles appearing in faeces are retained on a 1mm screen. Such particles are usually several millimetres in length, and faecal particles exceeding 10 mm have been observed (Weston, 1983; McLeod, 1986). The concept of critical particle size may be convenient, but without evidence of a discontinuity in the relationship of FPR with particle size, it is strictly incorrect and seems to lead to the invalid presumption that all non-LP are equally eligible to flow from the rumen. In contrast, Smith *et al.* (1983) and Ellis *et al.* (1999) reported continued comminution and enhanced particle flow as particles decreased in size to approximately 0.2 mm, such that FPR of particles of the largest non-LP particles were 30–40% that of the smallest. When leaf and stem fractions were fed *ad libitum* separately to cattle, intake of leaf was higher than stem (e.g. Poppi *et al.*, 1981a; McLeod *et al.*, 1990) or similar to stem intake (Lamb *et al.*, 2002). In both situations, FPR of leaf was higher than for stem for LP, MP and SP. Additionally, in the report of Lamb *et al.* (2002), FPR for (MP + SP) was higher for leaf than for stem when immature hay was fed, but not when mature hay from the same pasture was fed. Confirmation of faster breakdown and subsequent passage of leaf blades cut to a length of 37 mm, when compared with stem of identical length, was reported by Cherney *et al.* (1991), who marked different morphological fractions of four hays with rare earths in ten sheep diets. Total clearance (breakdown plus passage) from the RR of leaf blade was 5–6% per hour higher for stem for oats and barley, but clearance of those fractions was similar in sorghum-sudan and pearl millet. Rapid leaf loss from rumen contents was reported for legumes, but not for grasses (Kelly and Sinclair, 1989). These differing responses may result from an interaction between tissue type (leaf or stem) with nutrient supply, in which physical factors in some situations imposed a greater constraint (not necessarily maximal) to passage of stem than of leaf (Rafiq *et al.*, 2002). It would be of interest to ascertain if there were distinct rafts in situations where differences in clearance rates of leaf and stem were observed.

Interactions of age and animal species with passage of particles occur. Lambs cleared LP from the rumen much slower than adults, whereas they cleared SP faster when a lucerne diet was ground, but not when it was chopped (Weston *et al.*, 1989). In a comparison of sheep with goats, Hadjigeorgiou *et al.* (2003) reported that clearance of digesta from the RR was similar for goats fed long, medium or short ryegrass hay, whereas a negative relationship between clearance and feed particle length was seen in sheep.

### ***FSG, effects on probability of rumination and passage***

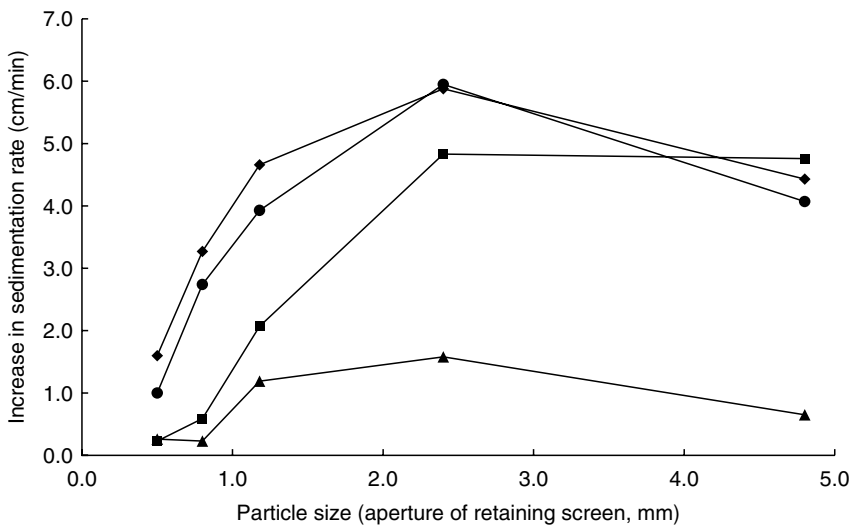
In the absence of fermentation, particle size will vary inversely with specific gravity (Evans *et al.*, 1973) with an upper limit to specific gravity (1.3 to 1.4)

determined by the chemical composition of the ligno-cellulosic matrix (Sutherland, 1988). Shape will also *per se* affect specific gravity as given by Stokes' law which states that sedimentation rate increases proportional to the square of the particle size for particles of equal shape and density. Thus, as formulated by Olaisen (2001):

$$\nu = [K_1gs^2(\rho_p - \rho_1)]/(18\mu) \quad \text{and} \quad K_1 = 0.843 \log[\psi/0.065] \quad (5.7)$$

where  $\nu$  is the sedimentation velocity,  $g$  is the acceleration due to gravity,  $s$  is the 'particle size' (diameter of a sphere of equal volume),  $\rho_p$  is the particle density,  $\rho_1$  is the density of fluid medium,  $\mu$  is the fluid viscosity and  $\psi$  is the sphericity (surface area of a sphere having the same volume as the particle divided by the surface area of the particle).

After hydration of gas-voids in ingested particles and colonization by microbes, gas evolved during fermentation in the RR has a major effect on FSG of particles, which includes contributions from solid, fluid and gas components. Accompanying fermentation, there is accentuation of the negative curvilinear relationship of FSG with plant particle size in RR digesta (Lirette *et al.*, 1990; Kennedy, 1995) that reflects higher buoyancy of LP caused by gas production associated with high digestion rate. In a comparison of cattle fed four forages *ad libitum*, Kennedy *et al.* (1993) found that microbial fermentation of digesta particles was responsible for an increase in buoyancy, which was positively related to particle size (Fig. 5.8), owing to poor architecture of SP for retention of gases derived from microbial fermentation (Sutherland, 1988). Sutherland (1988) mathematically expressed the critical gas volume (the fraction of void

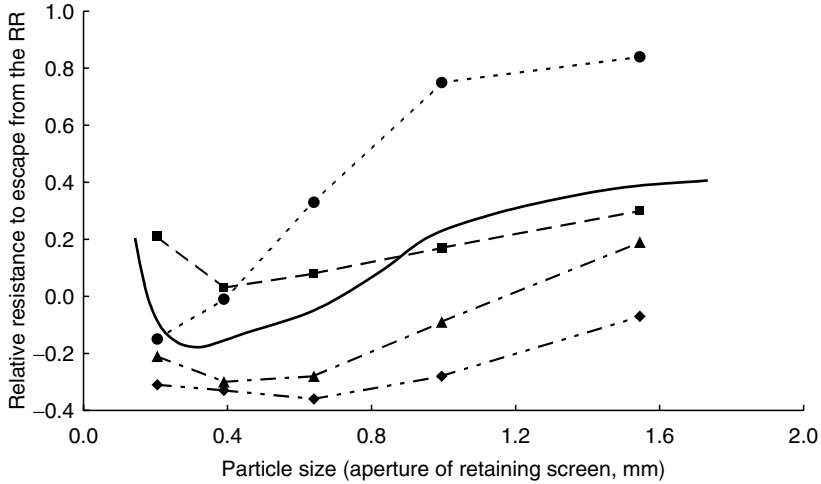


**Fig. 5.8.** Mean increase in sedimentation rate of particles of various sizes, when associated microbial activity is inhibited in ruminal digesta from cattle fed hays from dolichos (■), verano (●), pangola (▲) and sorghum (◆) (data of Kennedy *et al.*, 1993).

space available to liquid but occupied by gas) to achieve a neutral buoyancy, from which it was clear that smaller particles would have to retain relatively much more gas than large particles, but with a poorer architecture for gas entrapment and a high ratio of surface area to volume that facilitates gas loss. Added to this is the lower content of digestible cell wall due to more prolonged retention if the SP were derived from LP by rumination, and it is evident that SP will have a higher FSG than LP during fermentation unless a high proportion of SP are highly fermentable particles derived directly from the ingested bolus.

The importance of FSG in selection of particles for onward passage appears to be related to the pattern of reticulum contraction that propels lighter particles away from the reticulo-omasal orifice before it opens (Reid, 1984; Sutherland, 1988). Lechner-Doll *et al.* (1991), using plastic particles of defined size and FSG, estimated that particle density was twice as important as particle length in determining rate of clearance from the RR. Accelerated particle FPR was observed when FSG of plant particles of defined size was experimentally increased by binding of chromium (Ehle, 1984; Lindberg, 1985). In contrast, efforts to relate buoyancy of particles in RR digesta to their FPR from the RR have been inconclusive (Kennedy, 1995). These difficulties may derive from heterogeneity of the measured particle pools, in which some components may migrate in opposite directions (buoyant vs. sedimenting, see Bailoni *et al.*, 1998).

Problematic observations for the FSG hypothesis were reported by Cherney *et al.* (1991) and de Vega and Poppi (1997). In both experiments, rates of passage from the RR of faecal particles reintroduced into the RR were similar to those of small leaf blades, ground through a 1-mm screen (Cherney *et al.*, 1991) or to dietary MP (de Vega and Poppi, 1997), whereas there would be expected to be large differences in FSG for rumen and faecal particles of equivalent size. However, this presumption remained unproven because FSG was not measured, and the application of markers may have changed passage characteristics. Certainly, in experiments where particles are relatively homogeneous with respect to FSG (Lechner-Doll *et al.*, 1991; Olaisen, 2001), the importance of FSG in clearance rate from the RR is unequivocal. Hristov *et al.* (2003) found that digesta particles with FSG greater than 1.02 contained more indigestible fibre and SP, and passed from the RR faster than particles with FSG less than 1.02. Data of Olaisen (2001), in which particles from the RR and duodenum were characterized into categories defined by sedimentation rate and particle size, are plotted in Fig. 5.9. The resistance to passage from the RR ( $\nu$ -axis) was calculated relative to particles passing a 0.28-mm screen and retained on a 0.13-mm screen (assigned a value of zero). A negative value indicates less resistance to passage than the reference particles, and a value of 1 designates zero particle flow. A significant feature was that the minimum passage resistance across sedimentation rates was for particles of 0.3 mm. The increase in overall resistance above 0.3 mm was a reflection of increases in resistance in all four of the sedimentation groups, while below 0.3 mm, the behaviour of particles sedimenting at 1.2 mm/s contrasted with that of other groups. Consequently the proportion of duodenal particles which sedimented at 0.38 mm/s declined from representing 65% of duodenal particles retained on the 0.038-mm screen, to 5% on the 1.21-mm screen, while the opposite behaviour was observed in the



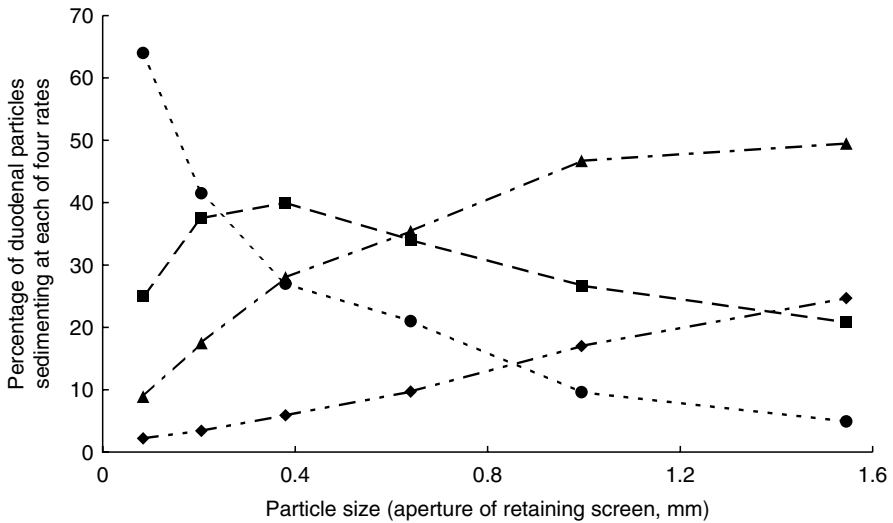
**Fig. 5.9.** Comparison of the relative resistance to escape of particles into the duodenum from the reticulorumen (RR) categorized by size and sedimentation rate, in cattle fed a diet of (60:40) concentrate:grass silage. Particles were separated on the basis of sedimentation rates (mm/s); 0.38 (●), 1.2 (■), 4.9 (▲) and 16 (◆), and subsequently their retention on screens of aperture 0.038, 0.28, 0.50, 0.78 or 1.21 mm, after sieving through a cascade of screens starting with one of 1.88 mm aperture. x-Axis values plotted on mean of apertures of retention screen and the next largest, to facilitate comparison to the relationship for total duodenal particles over all sedimentation rates (solid line). The assumption was made that sedimentation characteristics of particles were not altered by passage through the omasum and abomasum (data of Olaisen, 2001).

two fastest sedimenting groups (Fig. 5.10). The discussion above was based on the assumption that buoyancy of particles collected from the duodenum was not affected during passage from the reticulum.

In general conclusion, it appears that a logarithmic relationship between FPR and particle size is frequently observed but deviations that occur are related to differences in FSG–particle size relationships of components that have different representation in various particle categories. Ration components with obvious different physical characteristics are those of forage and grain, but variation in proportions and behaviour of tissue categories illustrated in Fig. 5.2, also may contribute to anomalies.

When Jessop and Illius (1999) used stochastic methods to model particle movements without reference to discrete particle pools, incorporation of content of indigestible cell wall as an index of FSG into predictions of feed intake noticeably improved goodness-of-fit, especially for slowly digestible forages. In the latter work, different relationships were needed for stem and leaf, in agreement with data of Ellis *et al.* (1999) in which the passage rates of leaf particles were twice that for stem of the same size throughout SP, MP and LP pools.

Despite the current consensus that rates of LP comminution are high enough not to be rate-limiting (see Kennedy and Doyle, 1993), it is not certain if the same conclusion applies to MP. Passage and comminution rate of MP



**Fig. 5.10.** Sedimentation characteristics of duodenal particles of defined size. See legend of Fig. 5.9 for symbols (data of Olaisen, 2001).

were reduced with increasing maturity and stem content of silage, despite increases in LP comminution rate (Rinne *et al.*, 2002). With increasing maturity, fill of the RR increased as a consequence of accumulation of MP, which is likely to be of stem origin. Bosch and Bruining (1995) also noted relatively poor clearance of MP for at least 8.5 h after feeding of silages. Other papers also indicate unexpected features in relative fibre composition of MP (e.g. McLeod *et al.*, 1990; Bernard *et al.*, 2000), but this is not invariably observed (Rinne *et al.*, 2002). It appears that those MP aspirated to the mouth for ruminative chewing are not comminuted to the same extent as LP (Grenet, 1989); lower buoyancy for MP than for LP and SP (Kennedy, 1995) might also reduce efficiency of aspiration into the oesophagus during rumination.

Concentrates may clear faster from the RR than forage LP due to their higher FSG, which reduces the probability of retention in the raft (Poncet, 1991). Maize particles of 0.5–1.0 mm size (determined by sieving) were cleared from the RR 20% faster than larger particles (Turnbull and Thomas, 1987) although a larger differential (100%) was reported by Ewing *et al.* (1986). For ground barley, FPR of MP and LP were similar (Olaisen, 2001) and rumination behaviour also differs in cattle fed maize and barley (Beauchemin *et al.*, 1994). For comparison in forages, FPR of MP may be 500% higher than for LP (Egan and Doyle, 1984).

## Post-ruminal Particle Dynamics

Digesta particle size is reduced somewhat between the omasum and faeces; however, the faecal particle size distribution is considered to reflect that of material passing from the RR (Ulyatt *et al.*, 1986). A size separation

mechanism seems to exist in the proximal colon of some non-ruminants that enhances the concentration of FP (<0.100 mm) in digesta in this compartment compared to that in the distal colon (Bjornhag *et al.*, 1984). Whether or not this occurs in the ruminant colon appears not to have been examined explicitly, although identical excretion curves for fluid and particulate markers (Dixon and Milligan, 1985) suggest such a mechanism may not exist in sheep and cattle.

The possibility that size and specific gravity could affect post-ruminal particle dynamics was examined in two studies using plastic cylinders (Siciliano-Jones and Murphy, 1986; Kaske and Engelhardt, 1990). In the former experiment, faecal appearance of 1, 5 and 10 mm particles having specific gravities of 0.9, 1.17, 1.41 or 1.77 was followed after placement in the abomasum of steers at various times in relation to once daily feeding of a 60% long lucerne hay and 40% grain mix diet. The second study determined the mean post-ruminal retention times for 1 and 10 mm particles with specific gravities of 0.92, 1.03, 1.22 or 1.44 after placement in the omasum of sheep fed hay three times daily. Particle length did not significantly affect post-ruminal passage in either study but both noted an effect of specific gravity. It was found that particles having specific gravities in the 1.03 to 1.17 range passed most quickly, whereas those with values outside this range passed more slowly. The effect was particularly pronounced for specific gravities greater than 1.4, although few digesta particles would normally be that dense. Significant interactions between particle specific gravity and time of dosing in relation to feeding were also noted for post-ruminal passage measures in the first study. This result may be associated with the surge in digesta passage from the RR that normally accompanies meal feeding (Reid *et al.*, 1979).

## Conclusions

Our quantitative understanding of the dynamics of particles in the RR has advanced steadily in recent years. The main features of importance in determining passage probability of particles in the RR have been identified, but more precise linkage of plant anatomy with the effects of mastication during ingestion and rumination and subsequent probability of passage in the ruminant gut, is needed. Particle size and FSG are undoubtedly pre-eminent; however, it may be some time before their direct effects can be separated and the effects of other confounding factors such as sequestration of particles in the raft and the associated filter-bed effects are better defined.

## References

- Ahvenjarvi, S., Skiba, B. and Huhtanen, P. (2001) Effect of heterogeneous digesta chemical composition on the accuracy of measurements of fiber flow in dairy cows. *Journal of Animal Science* 79, 1611–1620.
- Akin, D.E. (1989) Histological and physical factors affecting digestibility of forages. *Agronomy Journal* 81, 17–25.



- Bailoni, L., Ramanzin, M., Simonetto, A., Oblakov, N., Schiavon, S. and Bittante, G. (1998) Effect of *in sacco* fermentation on specific gravity and sedimentation measurements of forage particles. *Journal of Animal Science* 76, 3095–3101.
- Baragar, F.A., Van der Bilt, A. and van der Glas, H.W. (1996) An analytic probability density for particle size in human mastication. *Journal of Theoretical Biology* 181, 169–178.
- Beauchemin, K.A. (1992) Effects of ingestive and ruminative mastication on digestion of forage by cattle. *Animal Feed Science and Technology* 40, 41–56.
- Beauchemin, K.A., McAllister, T.A., Dong, Y., Farr, B.I. and Cheng, K.-J. (1994) Effects of mastication on digestion of whole cereal grains by cattle. *Journal of Animal Science* 72, 236–246.
- Bernard, L. and Doreau, M. (2000) Use of rare earth elements as external markers for mean retention time measurements in ruminants. *Reproduction Nutrition Development* 40, 89–101.
- Bernard, L., Chaise, J.P., Baumont, R. and Poncet, C. (2000) The effect of physical form of orchardgrass hay on the passage of particulate matter through the rumen of sheep. *Journal of Animal Science* 78, 1338–1354.
- Bjornhag, G., Sperber, I. and Holtenius, K. (1984) A separation mechanism in the large intestine of equines. *Canadian Journal of Animal Science* 64 (Suppl.), 89–90.
- Bosch, M. and Bruining, M. (1995) Passage rate and total clearance rate from the rumen of cows fed on grass silages differing in cell-wall content. *British Journal of Nutrition* 73, 41–49.
- Burns, J.C., Pond, K.R., Fisher, D.S. and Luginbuhl, J.-M. (1997) Changes in forage quality, ingestive mastication, and digesta kinetics resulting from switchgrass maturity. *Journal of Animal Science* 75, 1368–1379.
- Chai, K., Kennedy, P.M. and Milligan, L.P. (1984) Reduction in particle size during rumination in cattle. *Canadian Journal of Animal Science* 64 (Suppl.), 339–340.
- Cherney, D.J.R., Mertens, D.R. and Moore, J.E. (1991) Fluid and particulate retention times in sheep as influenced by intake level and forage morphological composition. *Journal of Animal Science* 69, 413–422.
- Coleman, S.W., Hart, S.P. and Sahl, T. (2003) Relationships among forage chemistry, rumination and retention time with intake and digestibility of hay by goats. *Small Ruminant Research* 50, 129–140.
- Das, A. and Singh, G.P. (1999) Effect of different levels of berseem (*Trifolium alexandrinum*) supplementation of wheat straw on some physical factors regulating intake and digestion. *Animal Feed Science and Technology* 81, 133–149.
- Deswysen, A.G. (1987) Forestomach: control of digesta flow. In: Ooms, L.A.A., Degryse, A.D. and van Miert, A.S.J.P.A.M. (eds) *Physiological and Pharmacological Aspects of the Reticulo-rumen*. Martinus Nijhoff, Dordrecht, The Netherlands, pp. 134–154.
- Deswysen, A.G. and Ellis, W.C. (1988) Site and extent of neutral detergent fiber digestion, efficiency of ruminal digesta flux and fecal output as related to variations in voluntary intake and chewing behavior in heifers. *Journal of Animal Science* 66, 2678–2686.
- Dixon, R.M. and Milligan, L.P. (1985) Removal of digesta components from the rumen of steers determined by sieving techniques and fluid, particulate and microbial markers. *British Journal of Nutrition* 53, 347–362.
- Domingue, B.M.F., Dellow, D.W. and Barry, T.N. (1991) Voluntary intake and rumen digestion of a low-quality roughage by goats and sheep. *Journal of Agricultural Science, Cambridge* 117, 111–120.

- Dryden, G. McL., Stafford, K.J., Waghorn, G.C. and Barry, T.N. (1995) Comminution of roughages by red deer (*Cervus elaphus*) during the prehension of feed. *Journal of Agricultural Science, Cambridge* 125, 407–414.
- Dulphy, J.-P., Remond, B. and Theriez, M. (1980) Ingestive behaviour and related activities in ruminants. In: Ruckebusch, Y. and Thivend, P. (eds) *Digestive Physiology and Metabolism in Ruminants*. MTP Press, Lancaster, pp. 103–122.
- Egan, J.K. and Doyle, P.T. (1984) A comparison of particulate markers for the estimation of digesta flow from the abomasum of sheep offered chopped oaten hay. *Australian Journal of Agricultural Research* 36, 483–495.
- Egan, J.K. and Doyle, P.T. (1985) Effect of intraruminal infusion of urea on the response in voluntary food intake by sheep. *Australian Journal of Agricultural Research* 35, 279–291.
- Ehle, F.R. (1984) Influence of feed particle density on particulate passage from rumen of the Holstein cow. *Journal of Dairy Science* 67, 693–697.
- Ellis, W.C., Poppi, D.P., Matis, J.H., Lippke, H., Hill, T.M. and Rouquette, F.M. Jr (1999) Dietary–digestive–metabolic interactions determining the nutritive potential of ruminant diets. In: Jung, H.-J.G. and Fahey, G.C. (eds) *Nutritional Ecology of Herbivores*. American Society of Animal Science, Illinois, pp. 423–481.
- Epstein, B. (1947) The mathematical description of certain breakage mechanisms leading to the logarithmic-normal distribution. *Journal of the Franklin Institute* 244, 471–477.
- Evans, E.W., Pearce, G.R., Burnett, J. and Pillinger, S.L. (1973) Changes in some physical characteristics of the digesta in the reticulo-rumen of cows fed once daily. *British Journal of Nutrition* 29, 357–376.
- Evans, E.W., Burnett, J. and Bines, J.A. (1974) A study of the effect of exposure in the reticulo-rumen of the cow on the strength of cotton, grass, hay, and straw. *British Journal of Nutrition* 31, 273–284.
- Ewing, D.L., Johnson, D.E. and Rimpler, W.V. (1986) Corn particle passage and size reduction in the rumen of beef steers. *Journal of Animal Science* 63, 1509–1515.
- Faichney, G.J. (1986) The kinetics of particulate matter in the rumen. In: Milligan, L.P., Grovum, W.L. and Dobson, A. (eds) *Control of Digestion and Metabolism in Ruminants*. Prentice-Hall, Englewood Cliffs, New Jersey, pp. 173–195.
- Faichney, G.J. (1990) Effect of level of intake and grinding of lucerne hay on the efficiency of rumination in sheep. *Proceedings of the Nutrition Society of Australia* 15, 147.
- Faichney, G.J., Poncet, C. and Boston, R.C. (1989) Passage of internal and external markers of particulate matter through the rumen of sheep. *Reproduction Nutrition Development* 29, 325–337.
- Fonty, G., Chavatot, M., Lepetit, J., Canistro, J. and Favier, R. (1999) Mechanical resistance of wheat straw after incubation in cultures of ruminal cellulolytic micro-organisms. *Animal Feed Science and Technology* 80, 297–307.
- Gherardi, S.G., Kellaway, R.C. and Black, J.L. (1992) Effect of forage particle length on rumen digesta load, packing density and voluntary feed intake by sheep. *Australian Journal of Agricultural Research* 43, 1321–1336.
- Gill, J., Campling, R.C. and Westgarth, D.R. (1966) A study of chewing during eating in the cow. *British Journal of Nutrition* 20, 13–23.
- Girard, V. (1990) Effect of rate of intake on ruminal rate of passage of small forage particles. *Canadian Journal of Animal Science* 70, 243–250.

- Grenet, E. (1989) A comparison of the digestion and reduction in particle size of lucerne hay (*Medicago sativa*) and Italian ryegrass hay (*Lolium italicum*) in the ovine digestive tract. *British Journal of Nutrition* 62, 493–507.
- Hadjigeorgiou, I.E., Gordon, I.J. and Milne, J.A. (2003) Intake, digestion and selection of roughage with different staple lengths by sheep and goats. *Small Ruminant Research* 47, 117–132.
- Harvatine, D.I., Winkler, J.E., Devant-Guille, M., Firkins, J.L., St-Pierre, N.R., Oldick, B.S. and Eastridge, M.L. (2002) Whole linted cottonseed as a forage substitute: fiber effectiveness and digestion kinetics. *Journal of Dairy Science* 85, 1988–1999.
- Henry, D.A., Macmillan, R.H. and Simpson, R.J. (1996) Measurement of the shear strength and tensile fracture properties of leaves of pasture grasses. *Australian Journal of Agricultural Research* 47, 587–603.
- Hooper, A.P. and Welch, J.G. (1985) Effects of particle size and forage composition on functional specific gravity. *Journal of Dairy Science* 68, 1181–1188.
- Hristov, A.N., Ahvenjarvi, S., McAllister, T.A. and Huhtanen, P. (2003) Composition and digestive tract retention time of ruminal particles with functional specific gravity greater or less than 1.02. *Journal of Animal Science* 81, 2639–2648.
- Hughes, T.P., Sykes, A.R., Poppi, D.P. and Hodgson, J. (1991) The influence of sward structure on peak bite force and bite weight in sheep. *Proceedings of the New Zealand Society of Animal Production* 51, 153–158.
- Isaacson, H.R., Hinds, F.C., Bryant, M.P. and Owens, F.N. (1975) Efficiency of energy utilization by mixed rumen bacteria in continuous culture. *Journal of Dairy Science* 58, 1645–1659.
- Jarrige, R., Demarquilly, C., Journet, M. and Beranger, C. (1973) The nutritive value of processed dehydrated forages with special reference to the physical form and particle size. In: Skidmore, C.L. and Plumridge, E. (eds) *Proceedings First International Green Crop Drying Congress*, 99–118.
- Jessop, N.S. and Illius, A.W. (1999) Modeling the influence of buoyancy on particle dynamics in the foregut of ruminants. *The Fifth International Symposium on the Nutrition of Herbivores. Nutritional Ecology of Herbivores: an Integration*. Poster session. Available at: <http://cnrit.tamu.edu/conf/isnh/post-online/post0056/>
- Kaske, M. and Engelhardt, W.V. (1990) The effect of size and density on mean retention time of particles in the gastrointestinal tract of sheep. *British Journal of Nutrition* 63, 457–465.
- Kaske, M. and Groth, A. (1997) Changes in factors affecting the rate of digesta passage during pregnancy and lactation in sheep fed on hay. *Reproduction Nutrition Development* 37, 573–588.
- Kelly, K.E. and Sinclair, B.R. (1989) Size and structure of leaf and stalk components of digesta regurgitated for rumination in sheep offered five forage diets. *New Zealand Journal of Agricultural Research* 32, 365–374.
- Kennedy, P.M. (1984) (ed.) *Techniques in Particle Size Analysis of Feed and Digesta in Ruminants*. Occasional Publication No. 1, Canadian Society of Animal Science, Edmonton, Alberta.
- Kennedy, P.M. (1985) Effect of rumination on reduction of particle size in digesta by cattle. *Australian Journal of Agricultural Research* 36, 819–828.
- Kennedy, P.M. (1995) Intake and digestion in swamp buffaloes and cattle. 4. Particle size and buoyancy in relation to voluntary intake. *Journal of Agricultural Science, Cambridge* 124, 277–287.

- Kennedy, P.M. and Doyle, P.T. (1993) Particle-size reduction by ruminants-effects of cell wall composition and structure. In: Jung, H.G., Buxton, D.R., Hatfield, R.D. and Ralph, J. (eds) *Forage Cell Wall Structure and Digestibility*. American Society of Agronomy, Madison, Wisconsin, pp. 499–534.
- Kennedy, P.M., Gordon, G.L.R. and Hogan, J.P. (1993) Nutritional comparisons between cattle and buffaloes and implications for draught animal power. In: Pryor, W.J. (ed.) *Draught Animal Power in the Asian–Australasian Region*. Australian Centre for International Agricultural Research, Canberra, pp. 66–71.
- Kennedy, P.M., Toscas, P.J., Faddy, M.J. and Minson, D.J. (1997) Use of a multi-exponential model to assess the effect of fermentation in the reticulorumen on particle fragmentability as simulated from artificially macerating leaf and stem fractions of two tropical grasses. *Animal Feed Science and Technology* 66, 111–128.
- King, K.W. and Moore, W.E.C. (1957) Density and size as factors affecting passage rate of ingesta in the bovine and human digestive tracts. *Journal of Dairy Science* 40, 528–536.
- Koike, S., Pan, J., Kobayashi, Y. and Tanaka, K. (2003) Kinetics of *in sacco* fiber-attachment of representative ruminal cellulolytic bacteria monitored by competitive PCR. *Journal of Dairy Science* 86, 1429–1435.
- Lamb, J.B., Adams, D.C., Klopfenstein, T.J., Grant, R.J., Sims, P.L., White, L.M. and Waller, S.S. (2002) Intake and digestive kinetics of leaf and stem fractions. *Journal of Range Management* 55, 57–64.
- Lammers, B.P., Buckmaster, D.R. and Heinrichs, A.J. (1996) A simple method for analysis of particle sizes of forage and total mixed rations. *Journal of Dairy Science* 79, 922–928.
- Lechner-Doll, M., Kaske, M. and Engelhardt, W.v. (1991) Factors affecting the mean retention time of particles in the forestomach of ruminants and camelids. In: Tsuda, T., Sasaki, Y. and Kawashima, R. (eds) *Physiological Aspects of Digestion and Metabolism in Ruminants*. Academic Press, San Diego, California, pp. 455–482.
- Lee, J.A. and Pearce, G.R. (1984) The effectiveness of chewing during eating on particle size reduction of roughages by cattle. *Australian Journal of Agricultural Research* 34, 609–618.
- Lindberg, J.E. (1985) Retention time of chromium-labelled feed particles and of water in the gut of sheep given hay and concentrate at maintenance. *British Journal of Nutrition* 53, 559–567.
- Lirette, A., Milligan, L.P., Cyr, N. and Elofson, R.M. (1990) Buoyancy separation of particles of forage, feces, and ruminal contents and nuclear magnetic resonance examination. *Canadian Journal of Animal Science* 70, 1099–1108.
- Lucas, P.W. and Luke, D.A. (1983a) Methods for analysing the breakdown of food in human mastication. *Archives of Oral Biology* 28, 813–819.
- Lucas, P.W. and Luke, D.A. (1983b) Computer simulation of the breakdown of carrot particles during human mastication. *Archives of Oral Biology* 28, 821–826.
- Luginbuhl, J.-M., Pond, K.R., Russ, J.C. and Tolley, E.A. (1984) Use of micro-computer in feedstuff particle evaluation: a direct approach. In: Kennedy, P.M. (ed.) *Techniques in Particle Size Analysis of Feed and Digesta in Ruminants*. Occasional Publication No. 1, Canadian Society of Animal Science, Edmonton, Alberta, pp. 184–186.
- Luginbuhl, J.-M., Pond, K.R., Burns, J.C. and Russ, J.C. (1989a) Effects of ingestive mastication on particle dimensions and weight distributions of coastal bermuda-grass hay fed to steers at four levels. *Journal of Animal Science* 67, 538–546.

- Luginbuhl, J.-M., Pond, K.R., Burns, J.C. and Russ, J.C. (1989b) Eating and ruminating behavior of steers fed coastal bermudagrass hay at four levels. *Journal of Animal Science* 67, 3410–3418.
- McLeod, M.N. (1986) Physical and biological factors controlling the reduction of feed particles in the ruminant. PhD thesis, The University of Queensland, Brisbane, Australia.
- McLeod, M. N. and Minson, D.J. (1988) Breakdown of large particles in forage by simulated digestion and detrition. *Journal of Animal Science* 66, 1000–1004.
- McLeod, M.N., Kennedy, P.M. and Minson, D.J. (1990) Resistance of leaf and stem fractions of tropical forage to chewing and passage in cattle. *British Journal of Nutrition* 63, 105–119.
- Mtengeti, E.J., Wilman, D. and Moseley, G. (1995) Physical structure of white clover, rape, spurey and perennial ryegrass in relation to rate of intake by sheep, chewing activity and particle breakdown. *Journal of Agricultural Science, Cambridge* 125, 43–50.
- Murphy, M.R. and Bohrer, R.E. (1984) Tenable assumptions about comminution leading to lognormal or Rosin-Rammler (Weibull) particle size distributions. In: Kennedy, P.M. (ed.) *Techniques in Particle Size Analysis of Feed and Digesta in Ruminants*. Occasional Publication No: 1, Canadian Society of Animal Science, Edmonton, Alberta, pp. 93–101.
- Murphy, M.R. and Zhu, J.S. (1997) A comparison of methods to analyse particle size as applied to alfalfa haylage, corn silage, and concentrate mix. *Journal of Dairy Science* 80, 2932–2938.
- Nickel, R., Schummer, A. and Seiferle, E. (1979) *The Viscera of the Domestic Animals* (translated and revised by Sack, W.O.) 2nd (revised) edn. Springer-Verlag, New York.
- Nocek, J.E. and Kohn, R.A. (1988) *In situ* particle size reduction of alfalfa and timothy hay as influenced by form and particle size. *Journal of Dairy Science* 71, 932–945.
- Okine, E.K. and Mathison, G.W. (1991) Reticular contraction attributes and passage of digesta from the ruminoreticulum in cattle fed roughage diets. *Journal of Animal Science* 69, 2177–2186.
- Olaisen, V. (2001) Degradation- and passage kinetics of concentrate particles and solubles in the rumen. Doktor ingenior thesis, Norwegian University of Science and Technology, Trondheim, Norway.
- Olaisen, V., Nesse, N. and Volden, H. (2001) Technical note: use of laser diffraction for particle size distributions in duodenal digesta. *Journal of Animal Science* 79, 761–765.
- Pan, J., Koike, S., Suzuki, T., Ueda, K., Kobayashi, Y., Tanaka, K. and Okubo, M. (2003) Effect of mastication on degradation of orchardgrass hay stem by rumen microbes: fibrolytic enzyme activities and microbial attachment. *Animal Feed Science and Technology* 106, 69–79.
- Poncet, C. (1991) The outflow of particles from the reticulo-rumen. In: Jouany, J.P. (ed.) *Rumen Microbial Metabolism and Ruminant digestion*. INRA Editions, Paris, pp. 297–322.
- Pond, K.R., Ellis, W.C. and Akin, D.E. (1984) Ingestive mastication and fragmentation of forages. *Journal of Animal Science* 58, 1567–1574.
- Pond, K.R., Ellis, W.C., Lascano, C.E. and Akin, D.E. (1987) Fragmentation and flow of grazed coastal bermudagrass through the digestive tract of cattle. *Journal of Animal Science* 65, 609–618.

- Poppi, D.P., Norton, B.W., Minson, D.J. and Hendricksen, R.E. (1980) The validity of the critical size theory for particles leaving the rumen. *Journal of Agricultural Science, Cambridge* 94, 275–280.
- Poppi, D.P., Minson, D.J. and Ternouth, J.H. (1981a) Studies of cattle and sheep eating leaf and stem fractions of grasses. II. Factors controlling the retention of feed in the reticulo-rumen. *Australian Journal of Agricultural Research* 32, 123–137.
- Poppi, D.P., Minson, D.J. and Ternouth, J.H. (1981b) Studies of cattle and sheep eating leaf and stem fractions of grasses. III. The retention time in the rumen of large feed particles. *Australian Journal of Agricultural Research* 32, 99–121.
- Poppi, D.P., Ellis, W.C., Matis, J.H. and Lascano, C.E. (2002) Marker concentration patterns of labelled leaf and stem particles in the rumen of cattle grazing bermuda grass (*Cynodon dactylon*) analysed by reference to a raft model. *British Journal of Nutrition* 85, 553–563.
- Rafiq, M., Dixon, R.M., Hosking, B.J. and Egan, A.R. (2002) Leaf content of straw diets influences supplementation responses by sheep. *Animal Feed Science and Technology* 100, 93–106.
- Reid, C.S.W. (1984) The progress of solid feed residues through the rumino-reticulum: the ins and outs of particles. In: Baker, S.K., Gawthorne, J.M., Mackintosh, J.B. and Purser, D.B. (eds) *Ruminant Physiology – Concepts and Consequences*. University of Western Australia, Nedlands, Western Australia, pp. 79–84.
- Reid, C.S.W., John, A., Ulyatt, M.J., Waghorn, G.C. and Milligan, L.P. (1979) Chewing and the physical breakdown of feed in sheep. *Annales de Recherches Veterinaires* 10, 205–207.
- Rinne, M., Jaakola, S. and Huhtanen, P. (1997) Grass maturity effects on cattle fed silage-based diets. 1. Organic matter digestion, ruminal fermentation and nitrogen utilization. *Animal Feed Science and Technology* 76, 1–17.
- Rinne, M., Huhtanen, P. and Jaakola, S. (2002) Digestive processes of dairy cows fed silages harvested at four stages of grass maturity. *Journal of Animal Science* 80, 1986–1998.
- Robinson, P.H., Tamminga, S. and Van Vuuren, A.M. (1987) Influence of declining level of feed intake and varying the proportion of starch in the concentrate on rumen digesta quantity, composition and kinetics of ingesta turnover in dairy cows. *Livestock Production Science* 17, 37–62.
- Rodriguez, C.A., Gonzalez, J., Alvir, M.R., Redondo, R. and Cajarville, C. (2003) Effects of feed intake on composition of sheep rumen contents and their microbial population size. *British Journal of Nutrition* 89, 97–103.
- Sauvant, D., Baumont, R. and Faverdin, P. (1996) Development of a mechanistic model of intake and chewing activities of sheep. *Journal of Animal Science* 74, 2785–2802.
- Siciliano-Jones, J. and Murphy, M. (1986) Passage of inert particles varying in length and specific gravity through the postruminal digestive tract of steers. *Journal of Dairy Science* 69, 2304–2311.
- Smith, L.W., Weinland, B.T., Waldo, D.R. and Leffel, E.C. (1983) Rate of plant cell wall particle size reduction in the rumen. *Journal of Dairy Science* 66, 2124–2136.
- Spalinger, D.E., Robbins, C.T. and Handley, T.A. (1986) The assessment of handling time ion in ruminants: the effect of plant chemical and physical structure on the rate of breakdown of plant particles in the rumen of mule deer and elk. *Canadian Journal of Zoology* 64, 312–321.
- Sutherland, T.M. (1988) Particle separation in the forestomachs of sheep. In: Dobson, A. and Dobson, M.J. (eds) *Aspects of Digestive Physiology in Ruminants*. Cornell University Press, Ithaca, New York, pp. 43–73.

- Suzuki, T. (2001) Study on mechanism of feed particle comminution during rumination by cattle. PhD thesis, Hokkaido University, Japan.
- Turnbull, G.W. and Thomas, E.E. (1987) Evaluation of rare-earth markers using an *in sacco* ruminal fermentation system and effect of processing method on ruminal turnover of sized corn particles. *Journal of Animal Science* 64, 1835–1841.
- Ueda, K., Ichinohe, T., Okubo, M. and Asahida, Y. (2001) A method for estimating the rate of size reduction, passage and fermentation of ruminal particles of sheep. *Animal Science Journal* 72, 306–314.
- Ulyatt, M.J. (1983) Plant fibre and regulation of digestion in the ruminant. In: *Fibre in Human and Animal Nutrition*. Bulletin 20. The Royal Society of New Zealand, Wellington, New Zealand, pp. 103–107.
- Ulyatt, M.J., Dellow, D.W., John, A., Reid, C.S.W. and Waghorn, G.C. (1986) Contribution of chewing during eating and rumination to the clearance of digesta from the rumenoreticulum. In: Milligan, L.P., Grovum, W.L. and Dobson, A. (eds) *Control of Digestion and Metabolism in Ruminants*. Prentice-Hall, Englewood Cliffs, New Jersey, pp. 498–515.
- de Vega, A. and Poppi, D.P. (1997) Extent of digestion and rumen condition as factors affecting passage of liquid and digesta particles in sheep. *Journal of Agricultural Science, Cambridge* 128, 207–215.
- Waghorn, G.C. and Reid, C.S.W. (1977) Rumen motility in sheep and cattle as affected by feeds and feeding. *Proceedings of the New Zealand Society of Animal Production* 37, 176–181.
- Waghorn, G.C., Reid, C.S.W., Ulyatt, M.J. and John, A. (1986) Feed comminution, particle composition and distribution between the four compartments of the stomach in sheep fed chaffed lucerne hay at two feeding frequencies and intake levels. *Journal of Agricultural Science, Cambridge* 106, 287–296.
- Waghorn, G.C., Shelton, I.D. and Thomas, V.J. (1989) Particle breakdown and rumen digestion of fresh ryegrass (*Lolium perenne* L.) and lucerne (*Medicago sativa* L.) fed to cows during a restricted feeding period. *British Journal of Nutrition* 61, 409–423.
- Wattiaux, M.A., Satter, L.D. and Mertens, D.R. (1992) Effect of microbial fermentation on FSG of small forage particles. *Journal of Animal Science* 70, 1262–1270.
- Wattiaux, M.A., Satter, L.D. and Mertens, D.R. (1993) Factors affecting volume and specific gravity measurements of neutral detergent fiber and forage particles. *Journal of Dairy Science* 76, 1978–1989.
- Welch, J.G. (1982) Rumination, particle size and passage from the rumen. *Journal of Animal Science* 54, 885–894.
- Weston, R.H. (1983) The effect of cold exposure on various aspects of digestion and metabolism in roughage-fed sheep. *Proceedings of the Nutrition Society of Australia* 8, 181–184.
- Weston, R.H. (1985) The regulation of feed intake in herbage-fed ruminants. *Proceedings of the Nutrition Society of Australia* 10, 55–62.
- Weston, R.H. (1996) Some aspects of constraint to forage consumption by ruminants. *Australian Journal of Agricultural Research* 47, 175–197.
- Weston, R.H., Lindsay, J.R., Peter, D.W. and Buscall, D.J. (1989) Factors limiting the intake of feed by sheep. XIV. Comparisons of voluntary feed consumption and various transactions in the alimentary tract between lambs and sheep fed roughage diets. *Australian Journal of Agricultural Research* 40, 625–642.
- Wilman, D. and Moghaddam, P.R. (1998) Volume, surface area and cellular composition of chewed particles of plant parts of eight forage species and estimated

- degradation of cell wall. *Journal of Agricultural Science, Cambridge* 131, 69–77.
- Wilman, D., Mtengi, E.J. and Moseley, G. (1996) Physical structure of twelve forage species in relation to rate of intake by sheep. *Journal of Agricultural Science, Cambridge* 126, 277–285.
- Wilson, J.R. and Hatfield, R.D. (1997) Structural and chemical changes of cell wall types during stem development: consequences for fibre degradation by rumen microflora. *Australian Journal of Agricultural Research* 48, 165–180.
- Wilson, J.R. and Kennedy, P.M. (1996) Plant and animal constraints to voluntary feed intake associated with fibre characteristics and particle breakdown and passage in ruminants. *Australian Journal of Agricultural Research* 47, 199–225.
- Wilson, J.R., McLeod, M.N. and Minson, D.J. (1989a) Particle size reduction of the leaves of a tropical and temperate grass by cattle. I. Effect of chewing during eating and varying times of digestion. *Grass and Forage Science* 44, 55–63.
- Wilson, J.R., Akin, D.E., McLeod, M.N. and Minson, D.J. (1989b) Particle size reduction of the leaves of a tropical and a temperate grass by cattle. II. Relation of anatomical structure to the process of leaf breakdown through chewing and digestion. *Grass and Forage Science* 44, 65–75.
- Worley, R., Clearfield, A. and Ellis, W.C. (2002) Binding affinity and capacities for ytterbium(3+) and hafnium(4+) by chemical entities of plant tissue fragments. *Journal of Animal Science* 80, 3307–3314.
- Wright, W. and Illius, A.W. (1995) A comparative study of the fracture properties of five grasses. *Functional Ecology* 9, 269–278.
- Yang, W.Z., Beauchemin, K.A. and Rode, L.M. (2001) Effect of dietary factors on distribution and chemical composition of liquid- or solid-associated bacterial populations in the rumen of dairy cows. *Journal of Animal Science* 79, 2736–2746.



---

# 6

## Volatile Fatty Acid Production

J. France<sup>1</sup> and J. Dijkstra<sup>2</sup>

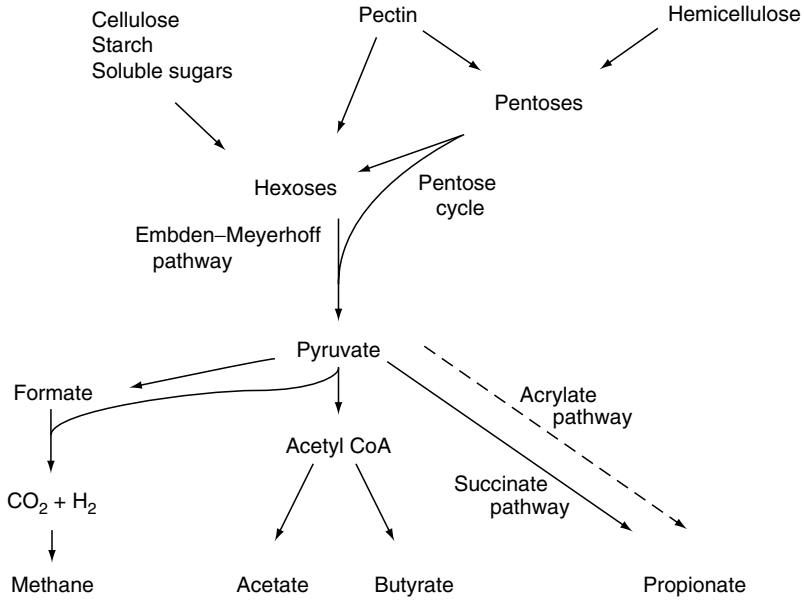
<sup>1</sup>Centre for Nutrition Modelling, Department of Animal & Poultry Science, University of Guelph, Guelph, Ontario N1G 2W1, Canada; <sup>2</sup>Animal Nutrition Group, Wageningen Institute of Animal Sciences, Wageningen University, PO Box 338, 6700 AH Wageningen, The Netherlands

---

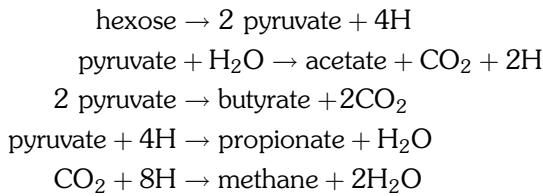
### Introduction

Volatile fatty acids (VFAs), principally acetate, propionate and butyrate but also lesser amounts of valerate, caproate, isobutyrate, isovalerate, 2-methylbutyrate and traces of various higher acids, are produced in the rumen as end-products of microbial fermentation. During the fermentation process energy is conserved in the form of adenosine triphosphate and subsequently utilized for the maintenance and growth of the microbial population. As far as the microbes are concerned the VFAs are waste products but to the host animal they represent the major source of absorbed energy and with most diets account for approximately 80% of the energy disappearing in the rumen (the remainder being lost as heat and methane) and for 50–70% of the digestible energy intake in sheep and cows at approximately maintenance, the range being 40–65% in lactating cows (Sutton, 1972, 1979, 1985; Thomas and Clapperton, 1972).

Dietary carbohydrates, i.e. cellulose, hemicellulose, pectin, starch and soluble sugars, are the main fermentation substrates. They are degraded to their constituent hexoses and pentoses before being fermented to VFA via pyruvate (Fig. 6.1). Pentoses are converted to hexose and triose phosphate by the transketolase and transaldolase reactions of the pentose cycle so that the majority of dietary carbohydrate metabolism proceeds via hexose, which is metabolized to pyruvate almost exclusively by the Embden–Meyerhof glycolytic pathway. Acetyl CoA is an intermediate in the formation of both acetate and butyrate from pyruvate, whilst propionate formation occurs mainly via succinate although an alternative pathway involving acrylate is also operative. The need to maintain redox balance through reduction and reoxidation of pyridine nucleotides (NAD) controls fermentation reactions (review Dijkstra, 1994). Excess reducing power generated during the conversion of hexose to acetate or butyrate is utilized in part during the formation of propionate but mainly by conversion to methane. The overall reactions can be summarized as:



**Fig. 6.1.** A schematic representation of the major pathways of carbohydrate metabolism in the rumen.



In addition to dietary carbohydrates, dietary lipids and proteins also give rise to VFAs in the rumen. The contribution from lipids is very small as lipids normally represent a small proportion of the diet and only the carbohydrate moiety, i.e. glycerol and galactose arising from lipid hydrolysis, and not the long-chain fatty acids, are fermented. Dietary proteins on the other hand may be a significant source of VFA when diets having a high rumen-degradable-protein content are fed. The proteins are hydrolysed to amino acids, which are deaminated before conversion to VFA. Of particular importance in this respect is the formation of isobutyric, isovaleric and 2-methylbutyric acids from valine, leucine and isoleucine, respectively, as these branched-chain VFAs are essential growth factors for certain of the rumen bacterial species (Cotta and Hespell, 1986).

The majority of the VFAs produced in the rumen are lost by absorption across the rumen wall, although a proportion (10–20% in sheep and up to 35% in dairy cattle) pass to the omasum and abomasum and are absorbed from these organs (Weston and Hogan, 1968; Dijkstra *et al.*, 1993). Absorption across the rumen wall is by simple diffusion of the undissociated acids (Stevens, 1970; Dijkstra *et al.*, 1993). It is a concentration-dependent process and therefore

(of the three major VFAs) usually higher for acetate than for propionate and lowest for butyrate, but per unit of concentration the absorption rates of the three acids are quite similar, although at low pH VFA with a higher carbon chain have a higher fractional absorption rate due to their greater lipid solubility (Dijkstra *et al.*, 1993; Lopez *et al.*, 2003). As the  $pK_a$  values of the acids are lower than the pH of rumen contents, they exist largely in the anionic form. A fall in rumen pH is associated with an increase in the proportion in the undissociated form and therefore in the rate of absorption. During passage across the rumen wall the VFAs are metabolized to varying extents so that the amounts entering the bloodstream are less than the quantities absorbed from the rumen (Weigland *et al.*, 1972; Bergman, 1975; Weekes and Webster, 1975). However, recent results in which VFA absorption from the temporarily isolated and washed rumen was compared with the portal VFA absorption indicate that the rumen wall does not metabolize large amounts of acetate, propionate and isobutyrate absorbed from the rumen, though the extensive metabolism of butyric acid during absorption was confirmed (Kristensen *et al.*, 2000).

The concentration of VFA in the rumen at any given time reflects the balance between the rate of production and rate of loss. Immediately after feeding, production exceeds loss and the concentration increases, but subsequently the situation is reversed and the concentration falls. The total VFA concentration may fall as low as 30 mM or be in excess of 200 mM but is normally between 70 and 130 mM. The relative concentrations of the individual acids, commonly referred to as the fermentation pattern, is a reliable index of the relative production rates of the acids when forage diets are given but would appear less reliable with concentrate diets (Leng and Brett, 1966; Esdale *et al.*, 1968; Sharp *et al.*, 1982; Sutton, 1985). The fermentation pattern is determined by the composition of the microbial population, which in turn is largely determined by the basal diet, particularly the type of dietary carbohydrate, and by the rate of depolymerization of available substrate (review by Dijkstra, 1994). High-fibre forage diets encourage the growth of acetate-producing bacterial species and the acetate:propionate:butyrate molar proportions would typically be in the region 70:20:10, whereas starch-rich concentrate diets favour the development of propionate-producing bacterial species and are associated with an increase in the proportion of propionate at the expense of acetate, although acetate is almost always the most abundant of the acids. Under certain conditions, concentrate diets may encourage the development of a large protozoal population and this is accompanied by an increase in butyrate rather than propionate (Williams and Coleman, 1997). If levels of substrate available for fermentation are high, either from increased intake or increased rates of depolymerization, a shift in fermentation pattern from acetic acid to propionic acid occurs to dispose of excess reducing power (Dijkstra, 1994). In addition to the type of dietary carbohydrate, other factors such as the physical form of the diet, level of intake, frequency of feeding and the use of chemical additives may also affect the fermentation pattern (Ørskov, 1981; Thomas and Rook, 1981; Nagaraja *et al.*, 1997). Some examples of the fermentation pattern, VFA concentration and production rate in animals

receiving different diets are shown in Table 6.1. More detailed reviews of the various aspects of VFA production and metabolism are given by Bergman (1990) and Dijkstra (1994).

Within the host animal's tissues absorbed acetate and butyrate are used primarily as energy sources through oxidation via the citric acid cycle. Acetate is also the principal substrate for lipogenesis, whilst propionate is used largely for gluconeogenesis and with most diets is the major source of glucose, since net absorption of glucose from the intestinal tract is usually small. The balance between the supply of the glucogenic propionate relative to that of the non-glucogenic acetate and butyrate influences the efficiency with which the VFAs are used for productive purposes (Ørskov, 1975; MacRae and Lobley, 1982; Sutton, 1985). Thus, not only the total supply of VFA but also the molar proportions are important determinants of feed utilization by ruminants and as such a number of methods have been used to estimate the rates of individual and total VFA production in and removal from the rumen. These may be conveniently divided into two groups:

1. Those methods not employing isotopic tracers (e.g. Barcroft *et al.*, 1944; Hungate *et al.*, 1960; Bath *et al.*, 1962).
2. Those employing tracers and based on the application of compartmental analysis to interpret isotope dilution data (e.g. Bergman *et al.*, 1965; Weller *et al.*, 1967; Morant *et al.*, 1978; Armentano and Young, 1983).

## Non-tracer Methods of VFA Production Measurement

A variety of non-tracer methods of measurement were used in early attempts to quantify VFA production in the rumen, and these are comprehensively reviewed by Warner (1964) and Hungate (1966). They include: the zero-time *in vitro* method, perturbation of the steady state, portal–arterial difference and methane production. Due to interconversions between individual VFA, particularly between acetate and butyrate, the net production rates of the acids (i.e. the amounts lost by absorption and passage) are less than the total production rates (Bergman *et al.*, 1965). In this and subsequent sections of the chapter, the term production is synonymous with net production unless total production is specified.

### *Zero-time in vitro method*

A sample of rumen contents is taken and subsamples incubated *in vitro* under anaerobic conditions. The rate of production of individual or total VFAs is calculated from the increments in acid concentration obtained by incubating the subsamples for different periods and extrapolating back to zero time to give the rate of VFA production per unit volume at the time the sample was removed. Equations for performing the calculation are given by Whitelaw *et al.* (1970). If the rumen volume is known, total ruminal production can

**Table 6.1.** VFA concentration, molar proportions and production rates in the rumen of sheep, steers and cows given various diets.

Animal species	Diet	Intake (kg/day)	Total VFA concentration (mmol/l)	Acetate (molar %)	Propionate (molar %)	Butyrate (molar %)	VFA production (mol/day)	Reference
Sheep	Dried grass	0.89 <sup>a</sup>	106	68	19	13	5.8	Bergman <i>et al.</i> (1965)
	Dried grass	0.73 <sup>b</sup>	87	68	21	11	4.08	Weston and Hogan (1968)
	Dried forage oats	0.78 <sup>b</sup>	100	68	21	11	4.90	Weston and Hogan (1968)
	Dried clovers	0.97 <sup>b</sup>	118	71	19	10	6.32	Weston and Hogan (1971)
	Lucerne silage	0.87 <sup>c</sup>	85	72	22	6	4.50	Siddons <i>et al.</i> (1984)
	Lucerne chaff	0.8 <sup>c</sup>	131	73	18	9	4.97	Leng and Brett (1966)
	Maize:lucerne chaff (2:1)	0.6 <sup>c</sup>	113	63	24	13	3.61	Leng and Brett (1966)
	Maize:lucerne chaff (1:1)	0.6 <sup>c</sup>	73	65	21	14	3.11	Leng and Brett (1966)
Steers	Lucerne hay:concentrate (4:1)	7.99 <sup>a</sup>	103	73	18	9	50.1	Siciliano-Jones and Murphy (1989)
	Lucerne hay:lucerne pellets:concentrate (1:3:1)	8.29 <sup>a</sup>	100	72	18	10	42.4	Siciliano-Jones and Murphy (1989)
	Concentrate:lucerne hay (4:1)	8.56 <sup>a</sup>	108	67	22	12	54.1	Siciliano-Jones and Murphy (1989)
	Concentrate:lucerne hay:lucerne pellets (16:1:3)	8.94 <sup>a</sup>	118	63	26	12	42.3	Siciliano-Jones and Murphy (1989)
	Maize silage:concentrate (1:1)	5.19 <sup>a</sup>	123	55	34	11	14.3	Rogers and Davis (1982a)
	Concentrate:maize silage (3:1)	7.7 <sup>a</sup>	125	57	31	12	48.3	Rogers and Davis (1982b)
	Lucerne hay:maize silage:concentrate (3.6:1:1)	9.0 <sup>a</sup>	92	72	17	11	33.3	Rogers and Davis (1982b)

*continued*

**Table 6.1.** *continued.*

Animal species	Diet	Intake (kg/day)	Total VFA concentration (mmol/l)	Acetate (molar %)	Propionate (molar %)	Butyrate (molar %)	VFA production (mol/day)	Reference
Dairy cows	Whole maize:other (5.25:1)	6.22 <sup>a</sup>	145	49	34	17	51.4	Sharp <i>et al.</i> (1982)
	Ground maize:other (5.25:1)	6.22 <sup>a</sup>	141	41	49	10	42.0	Sharp <i>et al.</i> (1982)
	Lucerne hay:grain (1:1.3)	19.1 <sup>c</sup>	109	67	21	12	37.52	Davis (1967)
	Lucerne hay:grain (1:6.6)	17.27 <sup>c</sup>	121	49	40	11	44.58	Davis (1967)
	Maize silage	3.5 <sup>a</sup>	83	64	19	17	30.9	Esdale <i>et al.</i> (1968)
	Lucerne hay	3.9 <sup>a</sup>	77	73	17	10	26.7	Esdale <i>et al.</i> (1968)
	Ryegrass	12.9 <sup>a</sup>	85	68	19	13	79.8	Sutton <i>et al.</i> (2003)
	hay:concentrate (6:4)							
Ryegrass	12.7 <sup>a</sup>	89	52	38	9	90.0	Sutton <i>et al.</i> (2003)	
	hay:concentrate (1:9)							

<sup>a</sup>Dry matter.<sup>b</sup>Organic matter.<sup>c</sup>Not specified.

then be calculated. As with other *in vitro* techniques, it is important that the sample taken for incubation is representative of whole-rumen contents rather than just the solid or liquid fraction (Hungate *et al.*, 1960). However, the VFA concentrations and molar proportions in *in vitro* systems often do not resemble those *in vivo* (Mansfield *et al.*, 1995; Ziemer *et al.*, 2000). Whitelaw *et al.* (1970), in comparing published experiments, show that the rate of VFA production determined by this method is about 50% lower than the rate obtained using isotope dilution procedures. They attribute the discrepancy to a reduction in the activity of microorganisms brought about by their removal from the rumen.

### ***Perturbation of the steady state***

The rate of total production of an acid (or net production of total VFA) in the rumen in steady state can be calculated from the change in its ruminal concentration when the acid is infused. Let  $P$  (mmol/h) be its rate of production,  $U$  (mmol/h) its rate of disappearance and  $C$  (mmol/ml) its concentration in the basal steady state. Assuming disappearance is proportional to acid pool size, the balance equation may be written as:

$$P = U = kCV \quad (6.1)$$

where  $k$  (per h) is a constant of proportionality and  $V$  (ml) the ruminal volume. Let the basal steady state be perturbed by infusion of a solution of the acid at a constant rate  $I$  (mmol/h) such that a new steady state is reached. If the acid infusion does not alter the basal fermentation, the balance equation in the new steady state is:

$$P + I = U' = kC'V' \quad (6.2)$$

where  $U'$ ,  $C'$  and  $V'$  denote acid utilization, acid concentration and ruminal volume, respectively, in the new steady state. Subtraction of Eq. (6.1) from Eq. (6.2) yields an expression for the constant of proportionality:

$$k = I/(C'V' - CV) \quad (6.3)$$

Substituting for  $k$  in Eq. (6.1) gives the rate of production:

$$P = I/[C'V'/(CV) - 1] \quad (6.4)$$

The steady-state volumes  $V$  and  $V'$  can be determined using one of the methods, based on digesta markers and intraruminal sampling, described in France *et al.* (1991a). This approach of raising the steady-state level was used by Bath *et al.* (1962) though they assumed a constant ruminal volume and expressed the acid concentration relative to that of the other acids. Martin *et al.* (2001) adopted the perturbation of steady-state method with some modifications. They infused VFA

into the rumen at five levels and estimated VFA production using a regression approach. They observed that the VFA production rate obtained with the regression approach was about two-thirds of that obtained with the isotope dilution technique. This difference may be explained to an extent by the use of  $1\text{-}^{13}\text{C}$  propionate because of the labile nature of the carboxyl-C. A critical assumption in the perturbation of steady-state method is that the rate parameter  $k$  is not altered by the acid infusion. However, a change in VFA concentration and other modifications that result from the acid infusion, including a change in pH, affect the fractional absorption rate of VFA (Dijkstra *et al.*, 1993) and consequently  $k$  values may differ.

### **Portal–arterial difference in VFA concentration**

The difference between VFA concentration in venous blood draining the rumen and that in arterial blood provides a measure of the amount entering the blood from the rumen, if the rate of blood flow is known. Vessels normally sampled are the portal vein and the carotid artery. This method was used by Barcroft *et al.* (1944) to demonstrate that acids from the rumen fermentation are absorbed and utilized by the host. Metabolism of VFA in the rumen wall, however, precludes accurate estimation of ruminal VFA production. Bergman (1975) estimated that in sheep receiving a forage diet, approximately 90% of the butyrate, 50% of the propionate and 30% of the acetate produced in the rumen did not appear in the portal blood. These values were generally in good agreement with *in vitro* data on the loss of VFA transported across the rumen epithelium (review Rémond *et al.*, 1995). However, Kristensen *et al.* (2000) observed considerably higher recovery rates of acetate and propionate in the temporarily isolated rumen of sheep. To explain the differences, Kristensen *et al.* (2000) suggested substantial microbial utilization of VFA. Also, measurements of blood flow show considerable variability (Dobson, 1984).

### **Methane production**

Methane production is an index of rumen fermentation, which has been used to obtain indirect estimates of VFA production. Total methane production can be measured in intact, non-fistulated animals using indirect calorimetry (McLean and Tobin, 1987) or the polytunnel method (Lockyer and Jarvis, 1995). Calorimetry and the polytunnel, however, overestimate the ruminal contribution; Murray *et al.* (1976), for example, showed that the production of methane in the rumen of sheep fed lucerne chaff accounted for 87% of the total production. Alternatively, ruminal methane production can be measured with fistulated animals using isotope dilution techniques (Murray *et al.*, 1976, 1978; France *et al.*, 1993). Also, non-isotopic tracer techniques have been developed to measure ruminal methane production in free-moving, intact animals, such as the sulphur hexafluoride ( $\text{SF}_6$ ) method (Johnson *et al.*, 1994). The value obtained for methane production is then multiplied by the



ratio of individual or total VFA produced to methane produced. This ratio may either be determined *in vitro* using rumen samples, or calculated stoichiometrically (Murray *et al.*, 1978), provided the VFA proportions are known. The method relies on a close relationship between VFA and methane produced, based on the need to maintain redox balance in the rumen. However, a number of other factors, including the uptake of hydrogen for biohydrogenation of unsaturated long-chain fatty acids and the uptake or release of hydrogen for microbial protein synthesis, may impair this relationship (Mills *et al.*, 2001).

### Tracer Methods of VFA Production Measurement

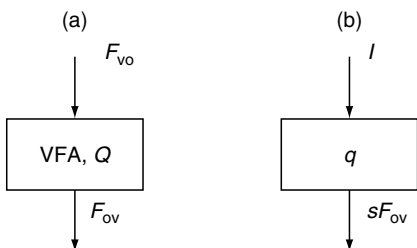
The tracer methods developed in this section are described for radioactive isotopes, though they are equally valid for stable isotopes (see end of section, page 171). For measurement of VFA production by radioactive isotopic tracer techniques, Bruce *et al.* (1987) recommended the use of 1 or 2-<sup>14</sup>C acetate, 2-<sup>14</sup>C propionate and 1-<sup>14</sup>C butyrate. 2-<sup>3</sup>H butyrate may also be used (Leng and Brett, 1966), but 2-<sup>3</sup>H acetate is unsatisfactory (Leng and Leonard, 1965).

#### Single-pool scheme

A relatively simple approach, which assumes steady-state conditions as imposed by continuous feeding, was proposed by Weller *et al.* (1967), whereby total VFA is considered to behave as a homogeneous pool and therefore can be represented as a single-pool model (Fig. 6.2). The isotopic form of any one of the individual VFAs or a mixture of the VFAs is administered into the rumen by continuous infusion at a constant rate,  $I$  ( $\mu\text{Ci}/\text{h}$ ), and the plateau specific activity of the total VFA,  $s$  ( $\mu\text{Ci}/\text{mmol}$ ), is subsequently determined from the isotope concentration ( $\mu\text{Ci}/\text{ml}$ ) and total VFA concentration ( $\text{mmol}/\text{ml}$ ) in rumen liquid. The rate:state equations, based on mass conservation principles, for this steady-state scheme are:

$$\frac{dQ}{dt} = F_{vo} - F_{ov} \tag{6.5}$$

$$\frac{dq}{dt} = I - sF_{ov} \tag{6.6}$$



**Fig. 6.2.** Single-compartment model for estimating VFA production: (a) tracee and (b) tracer. The scheme assumes no re-entry of label into the rumen.  $Q$ , total VFA;  $q$ , quantity of tracer;  $F_{vo}$ , rate of *de novo* VFA production;  $F_{ov}$ , rate of VFA removal;  $s$ , plateau specific activity of total VFA; and  $I$ , infusion rate.

where  $Q$  (mmol) denotes total VFA,  $q$  ( $\mu\text{Ci}$ ) the quantity of tracer,  $F_{\text{vo}}$  (mmol/h) the rate of production *de novo* (i.e. entry into the pool) and  $F_{\text{ov}}$  (mmol/h) the rate of removal. The g carbon can equally well be used instead of the mmol as the unit of mass. On solving Eqs (6.5) and (6.6), the rate of VFA production becomes:

$$F_{\text{vo}} = I/s \quad (6.7)$$

The production rate of the individual VFA is then obtained from their respective concentrations in the rumen liquid by assuming that production is proportional to concentration, e.g.

$$\text{Rate of acetate production} = F_{\text{vo}}C_a/C_v \quad (6.8)$$

where  $C_a$  and  $C_v$  (both mmol/ml) are the concentrations of acetate and total VFA, respectively.

Assuming isotope concentration and total VFA concentrations are measured in a number of samples, then the rate of VFA production may be calculated from Eq. (6.7) using either the mean specific activity or the specific activity of a pooled sample or, alternatively, by multiplying the infusion rate by the mean reciprocal specific activity. Although with steady-state conditions all three procedures should give the same result, Morant *et al.* (1978) found in simulation studies with non-steady-state conditions that estimates obtained using the latter procedure were closer to the true production rates and recommended its use in preference to the other two. (Note: Eq. (4) in Morant *et al.* (1978) should read  $M_R = (I_R/n) \sum_{i=1}^n M_i/I_i$ .)

Weller's method can be adapted for single-dose injection of tracer, rather than continuous infusion. Equation (6.6) reduces to:

$$\frac{dq}{dt} = -sF_{\text{ov}} \quad (6.9)$$

where  $s$  is now the instantaneous specific activity. Integration of Eq. (6.9) with respect to time between time zero and infinity gives:

$$-D = -AF_{\text{ov}} \quad (6.10)$$

where  $D$  ( $\mu\text{Ci}$ ) is the dose injected at time zero and  $A (= \int_0^\infty s dt)$  denotes the area under the VFA specific activity-time curve. As the rate of removal equals that of production in steady state, then:

$$F_{\text{vo}} = D/A \quad (6.11)$$

i.e. the rate of VFA production equals dose over area under the specific activity-time curve.

When the system is not in steady state (i.e. with animals that are not continuously fed), the VFA pool size,  $Q$ , and the production rate will vary

with time. Under these conditions, the instantaneous production rate of the total VFA,  $F_{vo}$ , if it behaves as a single homogeneous pool and the tracer is administered by continuous infusion, is given by:

$$F_{vo} = (I/s) + sQ \frac{d(1/s)}{dt} \quad (6.12)$$

Equation (6.12) is derived using the rate:state equations for Weller's method in non-steady-state (i.e. from Eqs. (6.5) and (6.6) not equated to zero) and eliminating the flow  $F_{ov}$ . It applies from the instant of commencement of infusion.

The instantaneous production rate may be determined by varying the rate of isotope infusion in synchrony with the rate of VFA production so that the specific activity remains constant, and therefore, the differential term in Eq. (6.12) is equal to zero. Gray *et al.* (1966) used this method to measure VFA production in sheep fed twice daily but, since it is dependent on prior knowledge of the rate of VFA production, it is unlikely to be of general applicability.

An alternative approach, proposed by Morant *et al.* (1978), is to infuse the isotope at a constant rate, and monitor the variable liquid volume of the rumen and its isotope and total VFA concentrations (thus permitting determinations of total VFA pool size  $Q$  and its specific activity  $s$  at time  $t$ ). Variable volume can be determined using one of the methods described in France *et al.* (1991a). The differential term in Eq. (6.12) is given by the slope of the curve of inverse specific activity against time. A way of determining this slope is to fit a polynomial of the form:

$$\phi(t) = \sum_{i=0}^n a_i t^i \quad (6.13)$$

where the  $a_i$  denotes constant coefficients, to the serial values of inverse specific activity, and then find the derivative  $\phi'$  by differentiating analytically. The values of  $F_{vo}$ , the rate of VFA production, at the times of ruminal sampling (any time after the start of infusion) can be found by substituting the appropriate instantaneous values for  $s$ ,  $Q$  and  $d(1/s)/dt$  ( $= \phi'$ ) into Eq. (6.12). The rates of production of the individual VFA may be obtained by partitioning  $F_{vo}$  according to their instantaneous molar proportions in rumen liquid as in Eq. (6.8). This non-steady-state approach also applies if the isotope is given as a single-dose injection, but with Eq. (6.12) simplifying to:

$$F_{vo} = sQ \frac{d(1/s)}{dt} \quad (6.14)$$

In non-steady-state, it may not be necessary to monitor changes in rumen volume. Sutton *et al.* (2003), in dairy cattle fed diets with high (90%) or moderate (60%) concentrate levels (air dry basis) twice daily, observed a mean

increase in rumen liquid digesta after feeding of 19% and 21%, respectively. Such differences in rumen volume resulted in only minor differences in estimates of net production rates of VFA obtained by continuous infusion of acetate, propionate and butyrate in a three-pool scheme (next section, this page). This suggests that, in practice, attempts to make accurate measurements of diurnal changes in rumen volume may not be necessary.

### Three-pool scheme

Weller's method has the advantages that only one infusion (or single injection) experiment needs to be undertaken and the specific activities of the individual VFAs do not have to be determined. However, it is dependent on the production rate of the acids being proportionally the same as their concentration in rumen liquid and this may not always be so (Sutton, 1985).

An alternative method for estimating VFA production rates in steady state, which is not dependent on the proportionality between VFA production and concentration and also provides a more detailed description of VFA metabolism in the rumen (thus permitting total rather than just net production to be estimated), is to use interchanging compartmental models to interpret isotopic tracer data. The models may be complete – i.e. exchange between all pools (plus the external environment) included – or incomplete (i.e. exchange between some pools excluded). Tracer is administered into each pool in turn and on each occasion the specific activity of all pools is determined. A unique solution to the model is obtained by deriving a series of  $n$  simultaneous equations (where  $n$  is the number of flows included in the model) to describe the movement of tracer and tracee between pools.

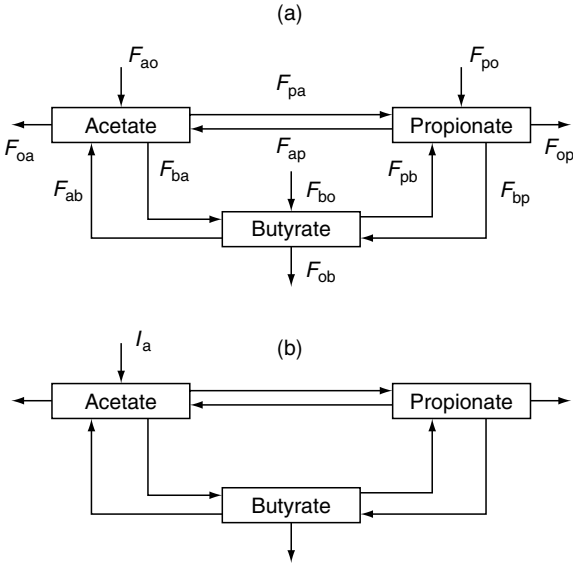
Consider the fully interchanging three-pool model for acetate, propionate and butyrate (Fig. 6.3). This scheme was proposed by Bergman *et al.* (1965) using sheep but with no interconversion between propionate and butyrate (i.e.  $F_{bp} = F_{pb} = 0$ ). Under steady-state conditions, the isotopic form of each VFA in turn is continuously infused into the rumen at a constant rate and for each infusion the plateau specific activity ( $\mu\text{Ci/g}$  carbon) of acetate ( $s_a$ ), propionate ( $s_p$ ) and butyrate ( $s_b$ ) is determined. Since the system is in steady state, the rate:state equations are as follows. The movement of tracee acetate,  $Q_a$  (g carbon), is described by:

$$\frac{dQ_a}{dt} = F_{ao} + F_{ap} + F_{ab} - F_{oa} - F_{pa} - F_{ba} = 0 \quad (6.15)$$

Following the infusion of labelled acetate,  $I_a$  ( $\mu\text{Ci/h}$ ), the movement of label through the acetate pool,  $q_a$  ( $\mu\text{Ci}$ ), is described by:

$$\frac{dq_a}{dt} = I_a + s_p F_{ap} + s_b F_{ab} - s_a (F_{oa} + F_{pa} + F_{ba}) = 0, \quad (6.16)$$

through the propionate pool,  $q_p$ , by:



**Fig. 6.3.** Fully interchanging three-compartment model for acetate, propionate and butyrate production: (a) tracee and (b) tracer. The scheme assumes no re-entry of label into the rumen.

$$\frac{dq_p}{dt} = s_a F_{pa} + s_b F_{pb} - s_p (F_{op} + F_{ap} + F_{bp}) = 0 \tag{6.17}$$

and through the butyrate pool,  $q_b$ , by:

$$\frac{dq_b}{dt} = s_a F_{ba} + s_p F_{bp} - s_b (F_{ob} + F_{ab} + F_{pb}) = 0 \tag{6.18}$$

Similar equations may be derived to describe the movement of tracee propionate and butyrate and the movement of label when labelled propionate and butyrate are infused into the rumen. The resulting 12 simultaneous linear equations may be solved using a simple computational procedure (France *et al.*, 1987).

The method can also be adapted for single-dose injection of tracer. The system is now in non-isotopic steady state so the rate:state equations for labelled material are non-zero. In the three-pool scheme, movement of label through the acetate pool following injection at time zero of a single dose of labelled acetate,  $D_a$  ( $\mu\text{Ci}$ ), is given by:

$$\frac{dq_a}{dt} = s_p F_{ap} + s_b F_{ab} - s_a (F_{oa} + F_{pa} + F_{ba}) \tag{6.19}$$

through the propionate pool by:

$$\frac{dq_p}{dt} = s_a F_{pa} + s_b F_{pb} - s_p (F_{op} + F_{ap} + F_{bp}) \tag{6.20}$$

and through the butyrate pool by:

$$\frac{dq_b}{dt} = s_a F_{ba} + s_p F_{bp} - s_b (F_{ob} + F_{ab} + F_{pb}) \quad (6.21)$$

The  $s$  terms now refer to instantaneous specific activities. Integrating these three equations with respect to time between the limits zero and infinity yields:

$$-D_a = A_p F_{op} + A_b F_{ab} - A_a (F_{oa} + F_{pa} + F_{ba}) \quad (6.22)$$

$$0 = A_a F_{pa} + A_b F_{pb} - A_p (F_{op} + F_{ap} + F_{bp}) \quad (6.23)$$

$$0 = A_a F_{ba} + A_p F_{bp} - A_b (F_{ob} + F_{ab} + F_{pb}) \quad (6.24)$$

where  $A_a$ ,  $A_p$  and  $A_b$  are the areas under the acetate, propionate and butyrate specific activity–time curves, respectively (i.e.  $A_a = \int_0^\infty s_a dt$ , etc.). Eqs (6.22)–(6.24) can be derived for the movement of label when labelled propionate and butyrate are injected into the rumen. The system of equations for single dose is therefore the same as for constant infusion, but with dose and area replacing infusion rate and plateau specific activity, respectively.

The method can also be extended to the non-steady-state. Under non-steady-state conditions and constant infusion, movements of tracee and label in the three-pool model are described by the same set of 12 equations as represented in Eqs (6.15)–(6.18), but with the derivatives not now equated to zero. Instantaneous values of the derivatives may be determined in a similar way as for the single-pool model, by monitoring the variable liquid volume of the rumen and its tracee and isotopic concentrations of acetate, propionate and butyrate. An expression for each derivative term in the equation set is obtained by fitting a polynomial (Eq. (6.13)) to serial data on isotope/tracee pool size and differentiating analytically. Instantaneous values of the flows can then be found by solving the 12 equations using a similar computational procedure to that described in France *et al.* (1987). This approach also works if isotope administration is by single injection rather than constant infusion, but in this case the three infusion rates represented in the equation set (e.g.  $I_a$  in Eq. (6.16)) become zero. However, it does not work if isotope is administered by single continuous infusion and the infusion rate varied, as in Gray *et al.* (1966). This is only applicable to a one-pool scheme because a single infusion cannot generally stabilize the specific activity of more than one pool. The single-pool model (Fig. 6.2) can be derived from the three-pool representation (Fig. 6.3) by assuming that the external flows  $F_{oa}$ ,  $F_{op}$  and  $F_{ob}$  are directly proportional to their respective concentrations in the rumen (France *et al.*, 1991b). The mathematical analysis presented for the three-pool scheme can be extended to any number of pools.

There appear to be no reports of the application of fully interconverting three-pool schemes in dairy cattle, except for that of Sutton *et al.* (2003). In sheep, Bergman *et al.* (1965), the first authors to propose the three-pool scheme, excluded the propionate:butyrate C exchange as being insignificant. Annison *et al.* (1974) and Lebzien *et al.* (1981) obtained results for only two labelled VFAs in dairy cattle. Other authors have used variations of the three-pool scheme (Esdale *et al.*, 1968; Armentano and Young, 1983) or a four-pool

**Table 6.2.** Re-definition of entities in the two- and three-pool models for estimating VFA production when using stable isotopes.

$C_i$ (mmol/l)	Concentration of VFA $i$ in rumen liquid
$D_i$ (mmol)	Pulsed dose of labelled VFA $i$ administered into primary pool at time zero
$F_{ij}$ (mmol/h)	Total flow (labelled plus unlabelled) from pool $i$ to pool $j$ , $F_{i0}$ denotes an external flow into pool $i$ and $F_{0j}$ a flow from pool $j$ out of the system
$I_i$ (mmol/h)	Constant rate of continuous infusion of labelled VFA $i$ into primary pool
$Q_i$ (mmol)	Total quantity (labelled plus unlabelled) of VFA $i$ in rumen liquid
$q_i$ (mmol)	Quantity of labelled VFA $i$ in rumen liquid
$s_i$	Enrichment of pool $i$ ( $=q_i/Q_i$ ): mmol labelled VFA $i$ /(mmol total VFA $i$ )

model (Wiltrout and Satter, 1972; Sharp *et al.*, 1982) with cattle, but in all cases some interconversions were omitted. Generally, a large amount of C exchange between acetate and butyrate is reported. However, whilst several authors observed very little exchange between propionate and butyrate (Bergman *et al.*, 1965; Annison *et al.*, 1974; Sharp *et al.*, 1982), Sutton *et al.* (2003) reported 10–13% of propionate C to be derived from butyrate, whereas 2–4% of butyrate C was derived from propionate. This argues against omitting the propionate:butyrate C exchange from three-pool schemes.

The tracer methods described in this chapter employ radioactive isotopes such as  $1\text{-}^{14}\text{C}$  acetate. Stable isotopes such as  $1\text{-}^{13}\text{C}$  acetate could be used equally well, though they have to be administered in larger amounts in order to bring ruminal enrichments up to detectable levels, and hence their use is more costly. The models presented, together with the associated mathematical formulae (Eqs (6.5)–(6.24)), remain the same for stable isotopes, though minor re-definition of the entities used in the models is needed. These are presented in Table 6.2.

## Conclusions

The fermentation pattern and total supply of VFA are major determinants of feed utilization by the ruminant. Many attempts have therefore been made to estimate the rates of individual and total VFA production in and removal from the rumen. Originally, non-tracer methods such as the zero-time *in vitro* and the perturbation of steady-state methods were employed. These have now been superseded by tracer methods utilizing compartmental analysis to interpret isotope dilution data. The tracer-based attempts generally adopt either a single-pool scheme (total VFA) or a three-pool scheme (acetate, propionate and butyrate), and normally steady-state conditions are assumed and label is continuously administered by constant infusion. The assumption of ruminal steady state particularly is rather restrictive in that it is only likely to apply to

frequently fed animals. The methods, however, can be adapted for non-steady-state conditions and for single injection of label, and extended to any number of pools.

## References

- Annison, E.F., Bickerstaffe, R. and Linzell, J.L. (1974) Glucose and fatty acid metabolism in cows producing milk of low fat content. *Journal of Agricultural Science, Cambridge* 82, 87–95.
- Armentano, L.E. and Young, J.W. (1983) Production and metabolism of volatile fatty acids, glucose and CO<sub>2</sub> in steers and the effects of monensin on volatile fatty acid kinetics. *Journal of Nutrition* 113, 1265–1277.
- Barcroft, J., McAnally, R.A. and Phillipson, A.T. (1944) Absorption of volatile acids from the alimentary tract of sheep and other animals. *Journal of Experimental Biology* 20, 120–129.
- Bath, I.H., Balch, C.C. and Rook, A.J.F. (1962) A technique for the estimation of the ruminal production of volatile fatty acids in the cow. *Proceedings of the Nutrition Society* 21, ix–x.
- Bergman, E.N. (1975) Production and utilisation of metabolites by the alimentary tract as measured in portal and hepatic blood. In: McDonald, I.W. and Warner, A.C.I. (eds) *Digestion and Metabolism in the Ruminant*. University of New England Publishing Unit, Armidale, New South Wales, pp. 292–305.
- Bergman, E.N. (1990) Energy contribution of VFA from the gastrointestinal tract in various species. *Physiological Reviews* 70, 567–590.
- Bergman, E.N., Reid, R.S., Murray, M.G., Brockway, J.M. and Whitelaw, F.G. (1965) Interconversions and production of volatile fatty acids in the sheep rumen. *Biochemical Journal* 97, 53–58.
- Bruce, L.A., Lobley, G.E. and MacRae, J.C. (1987) Measurement of volatile fatty acid production rates in sheep given roughage. *Research in Veterinary Science* 42, 47–52.
- Cotta, M.A. and Hespell, R.B. (1986) Protein and amino acid metabolism of rumen bacteria. In: Milligan, L.P., Grovum, W.L. and Dobson, A. (eds) *Control of Digestion and Metabolism in Ruminants*. Prentice-Hall, Englewood Cliffs, New Jersey, pp. 122–136.
- Davis, C.L. (1967) Acetate production in the rumen of cows fed either control or low-fiber, high-grain diets. *Journal of Dairy Science* 50, 1621–1625.
- Dijkstra, J. (1994) Production and absorption of volatile fatty acids in the rumen. *Livestock Production Science* 39, 61–69.
- Dijkstra, J., Boer, H., van Bruchem, J., Bruining, M. and Tamminga, S. (1993) Absorption of VFA from the rumen of lactating dairy cows as influenced by VFA concentration, pH and rumen liquid volume. *British Journal of Nutrition* 69, 385–396.
- Dobson, A. (1984) Blood flow and absorption from the rumen. *Quarterly Journal of Experimental Physiology* 69, 599–606.
- Esdale, W.J., Broderick, G.A. and Satter, L.D. (1968) Measurement of ruminal volatile fatty acid production from alfalfa hay or corn silage rations using a continuous infusion isotope dilution technique. *Journal of Dairy Science* 51, 1823–1830.
- France, J., Gill, M., Dhanoa, M.S. and Siddons, R.C. (1987) On solving the fully interchanging N-compartment model in steady-state tracer kinetic studies with



- reference to VFA absorption from the rumen. *Journal of Theoretical Biology* 125, 193–211.
- France, J., Siddons, R.C., Dhanoa, M.S. and Thornley, J.H.M. (1991a) A unifying mathematical analysis of methods to estimate rumen volume using digesta markers and intraruminal sampling. *Journal of Theoretical Biology* 150, 145–155.
- France, J., Siddons, R.C. and Dhanoa, M.S. (1991b) Adaptation of compartmental schemes for interpreting isotope dilution data on volatile fatty acid metabolism in the rumen to the non-steady state and for single-dose injection. *Journal of Theoretical Biology* 153, 247–254.
- France, J., Beever, D.E. and Siddons, R.C. (1993) Compartmental schemes for estimating methanogenesis in ruminants from isotope dilution data. *Journal of Theoretical Biology* 164, 207–218.
- Gray, F.V., Weller, R.A., Pilgrim, A.F. and Jones, G.B. (1966) The rate of production of volatile fatty acids in the rumen. III. Measurement of production *in vivo* by two isotope dilution procedures. *Australian Journal of Agricultural Research* 17, 69–80.
- Hungate, R.E. (1966) *The Rumen and its Microbes*. Academic Press, New York.
- Hungate, R.E., Phillips, G.D., Hungate, D.P. and MacGregor, A. (1960) A comparison of the rumen fermentation in European and Zebu cattle. *Journal of Agricultural Science, Cambridge* 54, 196–201.
- Johnson, K.A., Huylar, M., Westberg, H., Lamb, B. and Zimmerman, P. (1994) Measurement of methane emissions from ruminant livestock using a SF<sub>6</sub> tracer technique. *Environmental Science and Technology* 28, 359–362.
- Kristensen, N.B., Gäbel, G., Pierzynowski, S.G. and Danfaer, A. (2000) Portal recovery of short-chain fatty acids infused into the temporarily-isolated and washed reticulo-rumen of sheep. *British Journal of Nutrition* 84, 477–482.
- Lebzien, P., Rohr, K. and Oslage, H.J. (1981) Untersuchungen über die Abhängigkeit der Fettsäureproduktion im Pansen von der Rationszusammensetzung. *Archiv für Tierernährung* 31, 685–696.
- Leng, R.A. and Brett, D.J. (1966) Simultaneous measurements of the rates of production of acetic, propionic and butyric acids in the rumen of sheep on different diets and the correlation between production rates and concentrations of these acids in the rumen. *British Journal of Nutrition* 20, 541–552.
- Leng, R.A. and Leonard, G.J. (1965) Losses of methyl tritium from <sup>3</sup>H acetate in rumen fluid. *Nature (London)* 207, 760–761.
- Lockyer, D.R. and Jarvis, S.C. (1995) The measurement of methane losses from grazing livestock. *Environmental Pollution* 90, 383–390.
- Lopez, S., Hovell, F.D.DeB., Dijkstra, J. and France, J. (2003) Effects of volatile fatty acids supply on their absorption and on water kinetics in the rumen of sheep sustained by intragastric infusions. *Journal of Animal Science* 81, 2609–2616.
- MacRae, J.C. and Lobley, G.E. (1982) Some factors which influence thermal energy losses during the metabolism of ruminants. *Livestock Production Science* 9, 447–456.
- Mansfield, H.R., Endres, M.I. and Stern, M.D. (1995) Comparison of microbial fermentation in the rumen of dairy cows and dual flow continuous culture. *Animal Feed Science and Technology* 55, 47–66.
- Martin, C., Kristensen, N.B. and Huhtanen, P. (2001) Comparison of non-tracer and tracer methods for determination of volatile fatty acid production rate in the rumen of sheep fed on two levels of intake. *British Journal of Nutrition* 86, 331–340.
- McLean, J.A. and Tobin, G. (1987) *Animal and Human Calorimetry*. Cambridge University Press, Cambridge.

- Mills, J.A.N., Dijkstra, J., Bannink, A., Cammell, S.B., Kebreab, E. and France, J. (2001) A mechanistic model of whole-tract digestion and methanogenesis in the lactating dairy cow: model development, evaluation and application. *Journal of Animal Science* 79, 1584–1597.
- Morant, S.V., Ridley, J.L. and Sutton, J.D. (1978) A model for the estimation of volatile fatty acid production in the rumen in non-steady-state conditions. *British Journal of Nutrition* 39, 451–462.
- Murray, R.M., Bryant, A.M. and Leng, R.A. (1976) Rates of production of methane in the rumen and large intestine of sheep. *British Journal of Nutrition* 36, 1–14.
- Murray, R.M., Bryant, A.M. and Leng, R.A. (1978) Methane production in the rumen and lower gut of sheep given lucerne chaff. *British Journal of Nutrition* 39, 337–345.
- Nagaraja, T.G., Newbold, C.J., Van Soest, P.J. and Demeyer, D.I. (1997) Manipulation of rumen fermentation. In: Hobson, P.N. and Stewart, C.S. (eds) *The Rumen Microbial Ecosystem*, 2nd edn. Blackie Academic and Professional, London, pp. 387–443.
- Ørskov, E.R. (1975) Manipulation of rumen fermentation for maximum food utilisation. *World Review of Nutrition and Dietetics* 22, 152–182.
- Ørskov, E.R. (1981) Recent advances in the understanding of cereal processing for ruminants. In: Haresign, W. and Cole, D.J.A. (eds) *Recent Developments in Ruminant Nutrition*. Butterworths, London, pp. 258–267.
- Rémond, D., Ortigues, I. and Jouany, J.P. (1995) Energy substrates for the rumen epithelium. *Proceedings of the Nutrition Society* 54, 95–105.
- Rogers, J.A. and Davis, C.J. (1982a) Rumen volatile fatty acid production and nutrient utilisation in steers fed a diet supplemented with sodium bicarbonate and monensin. *Journal of Dairy Science* 65, 944–952.
- Rogers, J.A. and Davis, C.J. (1982b) Effects of intraruminal infusions of mineral salts on volatile fatty acid production in steers fed high-grain and high-roughage diets. *Journal of Dairy Science* 65, 953–962.
- Sharp, W.M., Johnson, R.R. and Owens, F.N. (1982) Ruminal VFA production with steers fed whole or ground corn grain. *Journal of Animal Science* 55, 1505–1514.
- Siciliano-Jones, J. and Murphy, M.R. (1989) Production of volatile fatty acids in the rumen and caecum-colon of steers as affected by forage:concentrate and forage physical form. *Journal of Dairy Science* 72, 485–492.
- Siddons, R.C., Arricastres, C., Gale, D.L. and Beever, D.E. (1984) The effect of formaldehyde or glutaraldehyde application to lucerne before ensiling on silage fermentation and silage N digestion in sheep. *British Journal of Nutrition* 52, 391–401.
- Stevens, C.E. (1970) Fatty acid transport through the rumen epithelium. In: Phillipson, A.T. (ed.) *Physiology of Digestion and Metabolism in the Ruminant*. Oriel Press, Newcastle-upon-Tyne, UK, pp. 101–112.
- Sutton, J.D. (1972) *In vivo* measurement of energy supply and protein synthesis in the rumen. In: *Tracer Studies on Non-Protein Nitrogen for Ruminants*. International Atomic Energy Agency, Vienna, Italy, pp. 35–42.
- Sutton, J.D. (1979) Carbohydrate fermentation in the rumen – variations on a theme. *Proceedings of the Nutrition Society* 38, 275–281.
- Sutton, J.D. (1985) Digestion and absorption of energy substrates in the lactating cow. *Journal of Dairy Science* 68, 3376–3393.
- Sutton, J.D., Dhanoa, M.S., Morant, S.V., France, J., Napper, D.J. and Schuller, E. (2003) Rates of production of acetate, propionate and butyrate in the rumen of

- lactating dairy cows given normal and low-roughage diets. *Journal of Dairy Science* 86, 3620–3633.
- Thomas, P.C. and Clapperton, J.L. (1972) Significance to the host of changes in fermentation activity. *Proceedings of the Nutrition Society* 31, 165–177.
- Thomas, P.C. and Rook, A.J.F. (1981) Manipulation of rumen fermentation. In: Haresign, W. and Cole, D.J.A. (eds) *Recent Developments in Ruminant Nutrition*. Butterworths, London, pp.157–183.
- Warner, A.C.I. (1964) Production of volatile fatty acids in the rumen: methods of measurement. *Nutrition Abstracts and Reviews* 34, 339–352.
- Weekes, T.E.C. and Webster, A.J.F. (1975) Metabolism of propionate in the tissues of the sheep gut. *British Journal of Nutrition* 33, 425–438.
- Weigland, E., Young, J.W. and McGilliard, A.D. (1972) Extent of propionate metabolism during absorption from the bovine ruminoreticulum. *Biochemical Journal* 126, 201–209.
- Weller, R.A., Gray, F.V., Pilgrim, A.F. and Jones, G.B. (1967) The rates of production of volatile fatty acids in the rumen. IV. Individual and total volatile fatty acids. *Australian Journal of Agricultural Research* 18, 107–118.
- Weston, R.J. and Hogan, J.P. (1968) The digestion of pasture plants by sheep. I. Ruminal production of volatile fatty acids by sheep offered diets of ryegrass and forage oats. *Australian Journal of Agricultural Research* 19, 419–432.
- Weston, R.J. and Hogan, J.P. (1971) The digestion of pasture plants by sheep. V. Studies with subterranean and berseem clovers. *Australian Journal of Agricultural Research* 22, 139–157.
- Whitelaw, F.G., Hyldgaard-Jensen, J., Reid, R.S. and Kay, M.G. (1970) Volatile fatty acid production in the rumen of cattle given an all-concentrate diet. *British Journal of Nutrition* 24, 179–195.
- Williams, A.G. and Coleman, G.S. (1997) The rumen protozoa. In: Hobson, P.N. and Stewart, C.S. (eds) *The Rumen Microbial Ecosystem*, 2nd edn. Blackie Academic and Professional, London, pp. 73–138.
- Wiltout, D.W. and Satter, L.D. (1972) Contribution of propionate to glucose synthesis in the lactating and non-lactating cow. *Journal of Dairy Science* 55, 307–317.
- Ziemer, C.J., Sharp, R., Stern, M.D., Cotta, M.A., Whitehead, T.R. and Stahl, D.A. (2000) Comparison of microbial populations in model and natural rumens using 16S ribosomal RNA-targeted probes. *Environmental Microbiology* 2, 632–643.

*This page intentionally left blank*

---

# 7

## Nitrogen Transactions in Ruminants

J.V. Nolan<sup>1</sup> and R.C. Dobos<sup>2</sup>

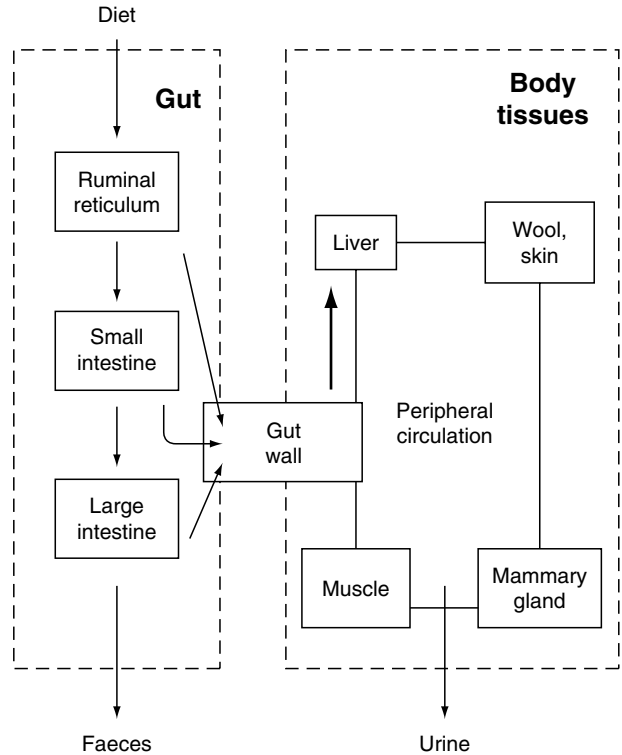
<sup>1</sup>*School of Rural Science and Agriculture, University of New England, Armidale, 2351 Australia;* <sup>2</sup>*Beef Industry Centre of Excellence, NSW Department of Primary Industries, Armidale, 2351 Australia*

---

### Introduction

The primary goal of ruminant nutritionists is to achieve maximum output of proteinaceous materials in products such as milk, meat and wool with a minimum of dietary crude protein (CP) inputs. In practice, this nitrogen (N) output to input ratio is relatively low. For example, it can vary from 13% for milk protein production in pasture-fed dairy cows (Wanjaiya *et al.*, 1993) to 31% in dairy cows grazing on *Lolium perenne*-based pasture (Delagarde *et al.*, 1997). However, since 40–45% efficiency coefficients are theoretically possible in dairy cows (Van Vuuren and Meijjs, 1987; Hvelplund and Madsen, 1995), there is scope for considerable improvement in nutritional management of our grazing livestock. Moreover, increasing the efficiency of use of protein N by livestock, leading to lower N excretion, is becoming an environmental imperative in many countries (Castillo *et al.*, 2001).

In theory, efficient use of N in the diet of ruminants can be facilitated by provision of N to the rumen in appropriate forms and amounts so that the animal's tissues are provided with amino acids (AA), especially each of the essential AA, in the appropriate proportions to meet the current requirements for tissue protein synthesis. These tissue requirements depend on the physiological state of the animal and the types of products being produced. AA requirements are dependent on the animal's genetic potential for protein deposition, but factors such as restricted metabolizable energy (ME) intake or mineral or vitamin deficiencies lead to sub-maximal protein deposition in the animal and N requirements are reduced accordingly (Oldham *et al.*, 1977). A sub-optimal supply of only one essential nutrient will restrict the animal's ability to grow at its genetic potential and will thus reduce its concomitant requirement for AA and ME. However, environmental interactions also make it difficult to specify the optimal level of nutrient supply: the requirement for protein relative to ME, for example, can be higher in parasitized and diseased



**Fig. 7.1.** A representation of the digestive tract and other important body tissues that are important sites of movement and metabolism of nitrogenous materials in ruminants.

animals relative to their healthy, pair-fed counterparts. It is therefore not desirable to simply view protein or AA requirements in isolation, so if our concentration on AA in this review appears rather single-minded, it is simply a matter of convenience. Nitrogen kinetics in major gut and body components will be reviewed in the context provided by Fig. 7.1. Urea synthesis in the body and N recycling to the gut are also discussed, but not tissue metabolism issues which are covered elsewhere in this book (see Chapters 12 and 14).

In ruminants, ingested feed constituents (carbohydrates and proteins) are modified by microorganisms in the forestomachs. The anaerobic bacteria, protozoa and fungi ferment feed constituents (e.g. polysaccharides, sugars, proteins) in order to conserve energy (as ATP or transmembrane potentials) and to generate intermediates that are the starting materials for synthesis of cell constituents such as polysaccharides, lipids, proteins and nucleic acids. End-products of the fermentation process, i.e. short-chain fatty acids (VFA) and  $\text{NH}_3$ , and the microbial cells are either re-used in the rumen (recycled) or are absorbed and metabolized by the animal's tissues.

The stoichiometry of the fermentation and cell growth process depends on the ratios of digestible energy- and nitrogen-rich substrates in the diet and, if N and other nutrients are non-limiting, microbial growth is usually directly dependent on digestible energy intake (see review by Russell, 2002). However, N-limiting diets, especially those lacking peptides and AA, with an excess of

rapidly fermentable carbohydrate may induce, at least in continuous cultures of rumen bacteria, rates of 'non-growth energy expenditure' that can be ten times the rate occurring in carbohydrate-limited cultures, the latter closely representing the true rate of 'maintenance' energy expenditure for the culture. The 'additional' energy expenditure of fast-growth cultures, referred to by Russell (2002) as 'energy spilling', serves to prevent the microbes from 'eating themselves to death', but greatly reduces microbial growth efficiency. (Bacteria do have mechanisms to limit sugar uptake (inducer exclusion), but these mechanisms apparently act mainly to inhibit uptake of non-preferred sugars.) An excess of degradable N in the diet relative to energy-rich substrates also leads to an inefficient assimilation of N by rumen microbes.

As our quantitative understanding of N kinetics in ruminants has developed, researchers have tried to summarize our current knowledge using either qualitative (e.g. Buttery and Lewis, 1982) or quantitative models (e.g. Mazanov and Nolan, 1976; Baldwin and Denham, 1979). The quantitative models developed over the last 30 years vary from being essentially mechanistic, where processes are described biochemically, to empirical where regression equations derived from large databases are commonly used. Some of these models have been used to underpin feeding standards, e.g. Cornell Net Carbohydrate and Protein System (CNCPS; Fox *et al.*, 1992) and GRAZFEED (Freer *et al.*, 1997). The earlier models gave more emphasis to gut N transactions than to metabolism in the animal tissues (e.g. Mazanov and Nolan, 1976), but more recent models present a more balanced view of gut, organ and tissue transactions, and even of nutrient partition between animal products and the environment (e.g. Kebreab *et al.*, 2002).

## Sources of AA in Ruminants

The modification of ingested feed proteins by rumen microorganisms has major implications for the supply of AA to the intestines and tissues. Rumen microorganisms degrade a substantial fraction of the total nitrogenous material in feed (referred to as rumen degraded CP or RDP) and a smaller fraction escapes ruminal breakdown and flows into the abomasum and small intestine (referred to as undegraded CP, or UDP or RUP). The latter fraction is also termed 'escape protein', 'bypass protein', 'protected protein' and 'undegradable (intake) protein'. The rumen microbes synthesize proteins and other nitrogenous materials (microbial CP, MCP) for their own needs by assimilating RDP. A mixture of MCP and UDP passes into the small intestine, thereby providing the major source of digestible AA for the host. The mixed fraction is described by SCA (1990) as 'apparently digested CP leaving the stomach' (ADPLS).

Microbial protein provides both essential and non-essential AA, which are present in proportions that fairly closely match the overall AA spectrum of proteins being deposited in the animal's tissues. The occurrence of marginal protein deficiency in ruminants that have a high potential for meat, milk and wool production can be due to inefficient microbial protein production in the

rumen brought about by deficiencies in RDP or S or other growth factors, which results in inadequate absorption of certain essential AA, relative to ME. However, in ruminants with high production capacity, even when microbial protein flow to the intestines is optimized, UDP sources may be needed to augment the intestinal protein supply (Egan, 1965). From a husbandry point of view, management priorities for supplying additional essential AA are therefore as follows (Leng and Preston, 1985). First, ensure that rumen conditions are such as to maximize MCP yield from the rumen (because microbial protein is normally the least expensive source of protein); and second, if the ratio of intestinally absorbed AA to dietary ME is still inadequate, then supplement the animal with a UDP concentrate. The nature and amount of UDP ingested will usually determine which essential AA is first limiting for milk production and tissue growth.

## **Feed Protein Degradation in the Rumen**

### ***Feed protein characteristics***

The chemical and physical properties of proteins in the diet affect the accessibility of the hydrolysable sites in the polypeptide chain to plant and microbial proteases. This accessibility depends on the types of enzyme involved and on conditions at the site of binding to the cell wall (i.e. pH, availability of metal cofactors, etc.). The surface area of protein accessible to proteases and peptidases may be reduced by the presence of lipids or other water-insoluble materials, and disruption of these associations may increase protein degradation rate. Studies with proteins such as zein and casein have led to the view that, in general, degradability is positively related to solubility (McDonald and Hall, 1957). However, 'soluble' is not always synonymous with 'highly degradable'. Soluble albumins, for example, are relatively slowly degraded (Annison and Lewis, 1959) indicating that degradability depends on other factors. The degree of secondary and tertiary structures and the density of disulphide cross linkages either within a single polypeptide chain or linking two different chains also appear to correlate closely with lower degradation rates (Nugent and Mangan, 1978; Mahadevan *et al.*, 1980).

### ***Effects of feed processing***

Various chemicals and physical treatments have been applied to potential protein supplements such as soybean meal in order to reduce their degradability and increase the UDP fraction (see Broderick *et al.*, 1991; Chapter 24 this volume). The aim is to create a pH-dependent chemical modification that reduces degradation rate at the pH of the rumen, but is reversible at the lower pH of the abomasum and upper small intestine so that absorption of essential AA from the small intestine can occur (Ashes *et al.*, 1984).



### ***Pasture protein characteristics***

The CP concentration in pasture dry matter (DM) may range from 3% in dry, mature roughage (e.g. some hays and straws) to over 30% in heavily fertilized, rapidly growing temperate grasses. Legumes such as white clover contain up to 24% CP in the DM. The true protein content of most pasture plants is about 70–90% of their CP content (Tamminga, 1986). In the leaves of temperate C<sub>3</sub> plants, the chloroplasts contain about 75% of the total protein and about 50% of this is in one soluble protein – the photosynthetic enzyme, ribulose biphosphate carboxylase (RuBisCo). In tropical C<sub>4</sub> plants such as sugarcane, maize and kikuyu, the distribution of chloroplasts and the associated proteins differs from that of C<sub>3</sub> plants (an arrangement known as the *Kranz anatomy*): phosphoenolpyruvate (PEP) carboxylase is the primary enzyme of CO<sub>2</sub> fixation and there are other enzymes not found in C<sub>3</sub> plants. The true protein content is usually lower than in C<sub>3</sub> plants. Proteins are also found in plant cell walls and membranes and in the mitochondria and nucleus. The non-protein N (NPN) fraction, which includes nucleic acids, amides, amines, AA and nitrate, may represent 10–30% of the total N present in immature grasses, and 50–90% in some legume forages (Tamminga, 1986). Most of the N in seeds is present in husk (structural proteins), pericarp (storage protein) and in the seed itself (enzyme proteins). At times, nitrate may be an important non-protein, non-AA N constituent, especially when its rate of reduction to NH<sub>3</sub> in plant cells is less than its rate of uptake by the roots (Mangan, 1982).

Mangan (1982) has categorized plant proteins according to commonly used separation procedures into a readily degradable *Fraction I* containing mainly RuBisCo in C<sub>3</sub> plants, regarded as RDP, and a slowly degradable *Fraction II* containing about 25% of the leaf protein of which about 40% is chloroplast membrane proteins. *Fraction II* is also mainly RDP but includes some UDP. A third fraction consists mainly of proteins that are resistant to ruminal fermentation and are therefore mainly UDP.

### ***Effect of diet type on ruminal protein degradation***

The nature of the diet influences the activity of ruminal proteases of both plant and microbial origin. Theodorou and co-workers (Theodorou *et al.*, 1996; Kingston-Smith and Theodorou, 2000) have pointed out that when ruminants ingest fresh forages, the majority of plant cells arrive in the rumen intact. Their studies suggest that degradation of proteins is initiated within intact plant cells by the plant's own proteases in response to rumen stresses (anoxia and high temperature). Eventually autolysis occurs with release of cellular proteins, peptides and AA into the rumen fluid. Rumination and chewing further promote the activity of plant proteases and create opportunities for microbial activity.

Fresh forage diets that are usually high in protein and soluble carbohydrate promote growth of populations of rumen bacteria with proteolytic specific

activity that can be more than nine times greater than that found in animals given low-protein, hay-based diets. Application of N fertilizer to pasture increases CP content, but also increases the amount of NPN in the forage and the CP degradability in the rumen. In sheep grazing on fresh pasture, for example, dietary CP is often almost totally degraded in the rumen, thus providing very little UDP (Corbett, 1987). The proteins of dried forages and cereal grains, on the other hand, are generally less degradable (70–90%), and the protein meals of vegetable origin – especially those that are subject to heat, pressure and/or solvent extraction – may be less degradable again (50–70%) and are considered to be good UDP supplements. Even the sun-drying of forages during hay-making reduces the rumen degradability of the hay proteins relative to the proteins in the freshly harvested starting materials.

### ***Microbial proteolytic activity***

In general, only relatively low levels of proteolytic activity have been found in particle-free (centrifuged) rumen fluid (Nugent and Mangan, 1981). However, Cotta and Hespell (1986) found that 90% of the proteolytic activity of *Butyrivibrio fibrisolvens* was present in the fluid rather than associated with the cells themselves. A highly proteolytic group of bacteria also lives in close association with, and digests the keratinized rumen wall epithelial tissue (Cheng and Costerton, 1980) but represents only a small part of the total biomass. Many species and strains of rumen bacteria, ciliate protozoa and fungi exhibit proteolytic activity from a variety of different types of enzymes (Wallace, 1996). Brock *et al.* (1982) tentatively concluded that the rumen bacteria possessed mainly serine-, cysteine- and metallo-proteases. Wallace and Cotta (1988) and Chen and Russell (1989) have argued that cooperative roles of bacterial species may enhance the overall proteolytic activities of mixed cultures in ways that are not obvious from their characteristics in pure culture.

Ushida *et al.* (1984) have described the proteolytic roles of protozoa. The isotrichid protozoa (holotrichs) utilize both soluble and particulate protein sources and degrade protein internally, whereas the entodiniomorphs appear to utilize insoluble proteins associated with particulate matter, including bacteria and chloroplasts. At times mixed protozoa produce both cysteine and aspartate proteases and they exhibit higher aminopeptidase activity than bacteria. They have low activity for soluble proteins but are probably mainly responsible for the digestion of protein-rich feed particles, bacteria and chloroplasts. Protozoa also engulf and degrade bacteria and digest their proteins, excreting ammonia as an end-product.

The anaerobic phycomycetous fungi constitute a small biomass (<8% of total microbial mass) with high proteolytic activity. Apparently, the fungal proteases are cell bound during early growth but later become extracellular as growth rate declines (Wallace, 1985). Their activities may increase fibre degradation but fungi are usually not represented in current models.

### ***Degradability of protein supplements***

To assist in feeding management of livestock, tabulations of degradability coefficients for proteins in specific feed ingredients are more useful if they are linked in some way to their mean residence time (MRT) in the rumen. Higher turnover rates for digesta, and thus shorter MRT of proteins in general reduce the realized protein degradability, but reductions are more marked with less soluble, more slowly degraded fractions (Jouany, 1996). Protein concentrates have been given rankings based on their solubility, or on their rate of disappearance from porous synthetic fibre bags placed in the rumen. When interpreting the curves for *in sacco* disappearance of proteins over time, it can be helpful to classify feed N into soluble NPN, rapidly degradable protein, slowly degradable protein and totally undegradable protein. Undegradable protein sources are generally found in the last two categories, and the UDP fraction in practice depends on the plant and microbial proteolytic activity present and the time the slowly degradable fraction spends in the rumen.

Ørskov and Mehrez (1977) suggested that a degradability coefficient could be obtained from the *in sacco* N disappearance in the period required for 90% of the digestible DM to disappear. As noted already, however, actual protein degradability is not a static coefficient for individual feeds because it is affected by MRT. Ørskov and McDonald (1979) suggested a set of non-linear equations to determine the effective degradability of a protein supplement. These equations allow for feed turnover rate, which depends on feed intake, type of feed and other factors and can vary quite widely, ranging from 2% to 8% per hour.

### ***Models of rumen protein degradation***

Models of rumen function have been based on two main approaches. The first is essentially an empirical approach based on degradation characteristics of the feed and its rumen passage rate (e.g. Waldo *et al.*, 1972). The second depends on a more mechanistic understanding and quite complex models of the stoichiometry of the rumen processes have been developed to enable prediction of fermentation outcomes (e.g. Baldwin *et al.*, 1970; Dijkstra *et al.*, 1996). A combination of the two approaches has also been used. The CNCPS (Fox *et al.*, 1992) is essentially empirical but utilizes both approaches. Another successful empirical model, which incorporates a plant–animal interface, is GRAZFEED (Freer *et al.*, 1997) based on concepts given in SCA (1990).

Dijkstra (1994) modified the mathematical model of the rumen proposed by Dijkstra *et al.* (1992) to simulate the N dynamics of rumen microorganisms, with specific regard to rumen protozoa. Several protozoal characteristics were represented: their preference for the utilization of starch and sugars rather than fibre and for insoluble rather than soluble protein; their engulfment of and storage of starch; their inability to use  $\text{NH}_3$  to synthesize AA; their engulfment and digestion of bacteria and other protozoa; their selective retention within the rumen; and their death and lysis in response to low nutrient availability.

Model predictions generally compared favourably with experimental observations although protozoal turnover time was poorly predicted. There was a need for more reliable estimates of bacterial engulfment rate, protozoal maintenance requirement and death rate.

Another model describing ruminal protein degradation is a first-order disappearance model without time-delay (NRC, 2001), similar to that applied by Mertens (1987) to describe ruminal fibre digestion. Total feed CP content is divided into fractions A, B and C, which sum to unity. Fraction A is the proportion of total CP present in the feed as NPN 'already degraded' at zero-time, B is the fraction that is potentially degradable and C is the fraction that is completely undegradable (NRC, 2001). The proportion of total CP degraded in the rumen is determined by the fractional rates of degradation ( $k_d$ ) and passage ( $k_p$ ). Total CP degradation is given by the equation:

$$\text{RDP} = A + B[k_d/(k_d + k_p)] \quad (7.1)$$

The fraction of total CP escaping undegraded is given by the equation:

$$\text{UDP} = B[k_p/(k_d + k_p)] + C \quad (7.2)$$

Volden *et al.* (2002) extracted soluble N fractions from forages, injected these fractions into the rumen and described their kinetics of disappearance. They developed a multi-pool model to predict the 'escape' of various N fractions that could also be useful for other purposes.

## Microbial Use of Energy- and Nitrogen-rich Substrates

### *Interaction between energy and nitrogen supply*

Fresh forages may supply the rumen microbial populations of animals with excess RDP relative to fermentable energy. It has been often shown that provision of soluble carbohydrate to the rumen can increase microbial protein outflow rate and reduce rumen  $\text{NH}_3$  concentration and absorption rate (see review by Obara *et al.*, 1991). To alleviate this imbalance, newer species of ryegrasses have been developed that have a high water-soluble carbohydrate (WSC) concentration (20–40% of DM). Feeding animals with these grasses has also been shown to increase the flow of AA to the small intestine in beef steers (Lee *et al.*, 2002), to elevate lamb growth rates (Lee *et al.*, 2003) and to improve milk yields (Miller *et al.*, 1999). In general, forages grazed in the afternoon have higher WSC concentrations than the same forages grazed in the morning and this helps explain why ruminants alter their preferences for clover and grass as the day progresses (Rutter *et al.*, 2004).

Various workers (e.g. Sinclair *et al.*, 1993) have argued that the rumen efficiency of use of dietary CP would be highest when fermentable carbohydrate energy is not only in an appropriate ratio with RDP in the diet but the energy substrate is also fermented in synchrony with release of RDP

sources. Asynchrony could therefore result in inefficient microbial growth and relatively high  $\text{NH}_3$  absorption. Earlier, Chamberlain *et al.* (1985) had argued that asynchrony is usually not an important issue in practice and there is still uncertainty about this issue.

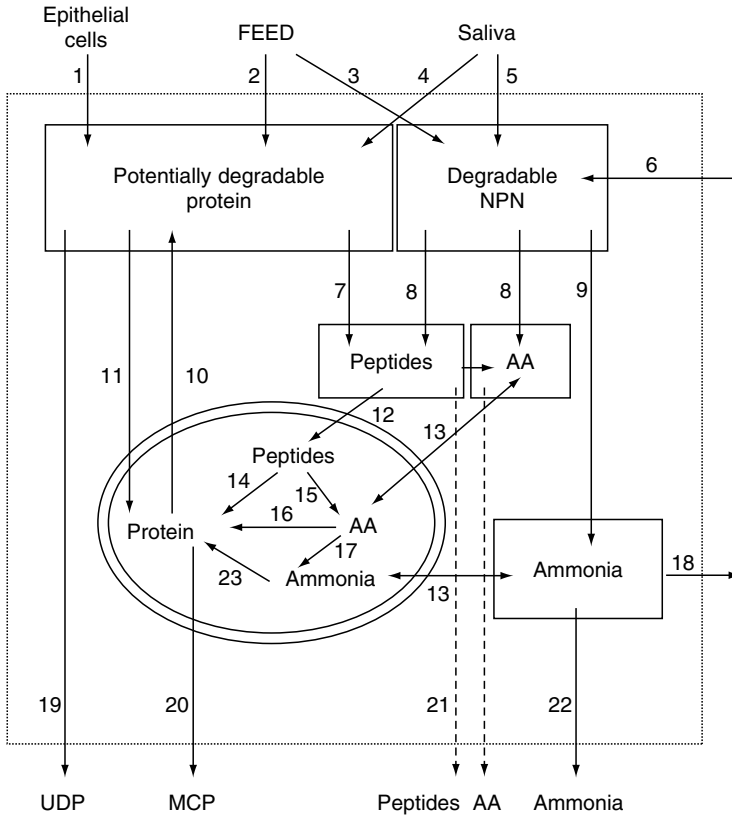
### **Assimilation of peptides and AA**

Although ruminants can survive and produce at moderate levels on diets that contain no true protein or AA-N, an important and as yet only partly answered question is whether, or when, peptides and AA must accompany  $\text{NH}_3$  in rumen fluid to enable efficient microbial protein synthesis (MPS) to occur. On one hand, the concentration of  $\text{NH}_3$  in rumen fluid has been used as a practical indicator of whether microbial efficiency is likely to be impaired by an inadequate N supply with Satter and Slyter (1974), for example, suggesting that 50 mg  $\text{NH}_3\text{-N/l}$  is adequate to ensure that microbial growth efficiency is not restricted. On the other hand, it has been argued that provision of peptides or AA may enable rumen bacteria to grow more efficiently than with  $\text{NH}_3$  alone.

The presence of higher concentrations of peptides and AA in rumen fluid has often been shown to stimulate growth of rumen bacteria (e.g. Cruz Soto *et al.*, 1994). Nevertheless, in some situations, when the diet is low in peptides and AA, microbial growth efficiency is not necessarily impaired (Neutze *et al.*, 1986). Unanswered questions include the following. Can intraruminal recycling of microbial materials provide enough of these materials? If not, will diets formulated to supply additional peptides or AA improve the rate of feed digestion and MPS, and thus stimulate animal production? Russell (1998) gives an excellent discussion of these issues.

Peptides are essential for some species such as *Bacteroides ruminicola*, which is incapable of assimilating free AA (Pittman and Bryant, 1964). However, during short-term incubations of less than 5 min, mixed bacteria from the rumen of a sheep given a diet of hay and concentrates assimilated both  $^{14}\text{C}$ -labelled peptides and free AA and their intracellular metabolism was also rapid (Armstead and Ling, 1993). Free AA are taken up from the medium by protozoa using an 'active' transport process when extracellular concentrations are low (Coleman, 1967). Smaller peptides (<5 AA) can be assimilated via membrane transporters in many microorganisms (Broderick *et al.*, 1991). Bacteria use the AA for protein synthesis and degrade excess AA intracellularly. They then use the resulting fatty acids and ammonia *in situ* or excrete them into the medium (Erfle *et al.*, 1977) (see Fig. 7.2). Most extracellular AA are therefore probably excreted from living cells or are digestion products of lysed cells, rather than being the extracellular products of dietary protein degradation.

Our understanding of peptides and AA assimilation by rumen microbes was considerably advanced by Russell and colleagues (e.g. Chen and Russell, 1989) when they identified species with an obligatory requirement for peptide and AA. These species oxidize peptides and AA as their sole energy source and



**Fig. 7.2.** A model of nitrogen transactions in the rumen. The ovals delineate the microbial cell wall, rectangles depict substrate pools in rumen contents and numbers adjacent to arrows refer to individual pathways as follows: 1 sloughed epithelial cell protein; 2 feed protein ingestion; 3 non-protein N ingested in forage and supplements; 4 salivary protein input; 5 salivary urea input, allantoin etc.; 6 endogenous urea transfer through rumen wall; 7 proteolysis by microbial proteases; 8 feed peptides and amino acids; 9 ammonia produced from amides, amines, nucleic acids etc.; 10 protein and NPN of lysed cells; 11 protozoal engulfment of proteinaceous particles; 12 carrier-mediated peptide uptake into microbial cells; 13 assimilation/excretion of AA and NH<sub>3</sub>; 14 peptide utilization for microbial protein synthesis; 15 peptidolysis; 16 amino acid utilization for microbial protein synthesis; 17 deamination/amination; 18 ammonia absorption through rumen wall; 19 protein leaving the rumen undegraded; 20 microbial protein efflux; 21 extracellular peptides and AA efflux; 22 extracellular NH<sub>3</sub> efflux; 23 ammonia utilization for protein synthesis.

they have a high specific activity for ammonia production. In animals given high-protein diets, they may be responsible for removing ruminal AA that would be potentially useful for other microbial species or absorbable from the small intestine. In addition, they may contribute to low efficiency of N use by the host, by elevating ammonia absorption and urinary urea excretion.

Even though it is clear that many rumen microorganisms need or use peptides and AA, NH<sub>3</sub> seems to have been given prominence among the potential N sources, either because NH<sub>3</sub> is also essential for some species

or because the majority of bacterial species can utilize it (Allison, 1969). In fact  $\text{NH}_3$  is the only N source required by the three species that probably contribute most of the cellulolytic activity in the rumen, i.e. *Ruminococcus albus*, *R. flavefaciens* and *Fibrobacter succinogenes*.

Studies using  $^{15}\text{N}$ -labelled  $\text{NH}_3$  have greatly helped to elucidate the relative importance of microbial N sources. Depending on the animal's diet, from 40% to 95% of the N in bacteria is derived from  $\text{NH}_3$  (Mathison and Milligan, 1971; Nolan and Leng, 1972; Neutze *et al.*, 1986), implying indirectly that 5–60% of bacterial N is derived from non- $\text{NH}_3$  sources, i.e. peptides and AA. More direct estimates of peptide and AA utilization by rumen populations have been made using  $^{15}\text{N}$ -labelled protein hydrolysates (Cottle, 1980) and  $^{15}\text{N}$ -labelled plant materials (Chapman and Norton, 1984; Damry and Nolan, 2002). These show that peptides and AA are used when they are available. *In vitro* studies of Atasoglu *et al.* (1999) led to a similar conclusion and provided additional information about fermentation rate and microbial AA synthesis when RDP contains AA-N.

Contradictory views about whether rumen microbial populations require peptides and AA in addition to ammonia may be reconcilable if the type of diet being used (e.g. roughage-based vs. concentrate-rich) is considered. Diet type affects the rates of fermentation of substrates (whether high or low) that occur in the rumen. Russell (1998) found that when AA-N was provided to ruminal bacteria suffering 'carbohydrate overload', as might be predicted in animals given rapidly fermentable energy substrates, their 'energy spillage' via futile anabolic–catabolic cycles was reduced, and growth efficiency was increased.

Such 'carbohydrate overload' is less likely to occur in animals on less digestible fibrous feeds, and so peptides and AA are less likely to improve microbial efficiency. For example, when Neutze *et al.* (1986) infused  $\text{NH}_3$  into the rumen of sheep given alkali-treated, low-N straw supplemented with 3.5, 5.9 or 11.6 g urea-N/(kg DM), on all diets, about 97% of the bacterial N was assimilated as  $\text{NH}_3$  and thus only 3% was derived from unlabelled dietary or endogenous non-ammonia N (NAN) sources. The efficiency of MPS averaged 24 g N/kg OM apparently digested in the rumen (OMADR), which is quite high relative to the maximum theoretical efficiency of 30 (discussed later). The results suggest that high growth efficiencies are possible with  $\text{NH}_3$  as the main N source, at least in sheep given a feed of relatively low digestibility. Unfortunately, studies of this type do not indicate the extent to which peptides and AA from lysed bacteria are provided by 'cross-feeding' between microbial species.

### **Assimilation of ammonia**

The rate of assimilation of ammonia by bacteria and fungi depends on their rate of growth. Ammonia usually enters microbial cells by passive diffusion, mainly of the unionized ( $\text{NH}_3$ ) form, although there is also evidence, at least for fungi, for uptake in the ionic form,  $\text{NH}_4^+$  (Hackett *et al.*, 1970). Boggs (1959) studied  $^{15}\text{N}$ -ammonia incorporation into microbial AA and concluded that

glutamate and aspartate were early intermediates in the process of  $\text{NH}_3$  assimilation. Salter and Smith (1977) confirmed and extended these findings, showing that ammonia-N incorporation into bacterial amide-N was 2–20 times greater than into other forms of bacterial N.

Two systems for assimilation of  $\text{NH}_3$  appear to be widespread, namely a low-affinity system, mediated by NADP-dependent glutamate dehydrogenase, and a high-affinity system mediated by glutamine synthetase and glutamate synthase, the former utilizing ATP in the reaction of ammonia and glutamate to form glutamine, and the latter reductively transaminating the amide group of glutamine to  $\alpha$ -ketoglutarate to form two moles of glutamate (Erflé *et al.*, 1977). The ATP-requiring high-affinity system (its  $K_m$  for most predominant species is less than  $5 \mu\text{M}$ ) enables efficient 'scavenging' of  $\text{NH}_3$  when the concentration in rumen fluid is low but the use of ATP for this essentially maintenance activity must reduce the energetic efficiency of growth (Schaefer *et al.*, 1980). In contrast, the lower affinity system that operates at higher ammonia concentrations does not utilize ATP. Ammonia assimilation by NADP-dependent alanine dehydrogenase or aspartate dehydrogenase also occurs in some rumen anaerobes (Wallace, 1979) and these systems may be enhanced by the highly reducing conditions of the rumen. Aminotransferases in microbial cells enable the amino groups of glutamate, glutamine or alanine to be passed to other AA in the intracellular pool.

### **Models describing peptide, free AA and ammonia assimilation in the rumen**

In the model described by Baldwin *et al.* (1970),  $\text{NH}_3$  is utilized as the sole N source for cellulolytic bacteria, whereas both  $\text{NH}_3$  and AA may be required for the amylolytic and saccharolytic groups. A specific role for peptides and AA is also included in the CNCPS model (Pitt *et al.*, 1996), which takes account of their effects on the fermentation of non-structural carbohydrates. As with most other such models, CNCPS allows bacteria that degrade non-structural carbohydrates to use only  $\text{NH}_3$ . When dietary protein degradation is rapid, the rumen microbes are unable to utilize all of the peptides, AA and  $\text{NH}_3$  produced and some soluble dietary N escapes intact into the intestines (Udén, 2000). Some simulation models of the growth of rumen microbes account for this possibility (e.g. Baldwin and Sainz, 1995).

Various models assume that efficient microbial growth can be achieved by providing diets that only contain urea or  $\text{NH}_3$ , often using  $\text{NH}_3$  to supply all RDN, e.g. GRAZFEED. This is perhaps because workers such as Virtanen (1966) have demonstrated that ruminants can be maintained and produce at satisfactory levels on urea-based diets, or because these models appear to give good predictions of animal performance under some conditions. Nevertheless, because substitution of NPN for true protein in supplements for animals given forage diets often impairs forage utilization and animal performance (Owens *et al.*, 1980), models that do not account for peptides and AA may have limitations.



## Nitrogen Pools in the Rumen

Peptide, AA and  $\text{NH}_3$  concentrations in rumen contents tend to increase in the 2–4 h period after each meal. Concentrations of peptides range from 2 to 50 mg N/l (Annisson *et al.*, 1954) or 10 to 150 mg N/l (Wallace, 1990) whereas the free AA pool may contain 0.1–16 mg N/l (Annisson and Lewis, 1959) equivalent to 6–600 and 60–6000 mg N in sheep and cattle, respectively. At times  $\text{NH}_3$  concentrations can exceed 400 mg N/l after animals have ingested fresh pasture materials (Johns, 1955). Microbial assimilation of peptides, AA and  $\text{NH}_3$  lowers the potential peak concentrations after feeding, so that the exact nature of the concentration vs. time curve is dependent on the feed protein degradability and microbial growth conditions.

### *The rumen ammonia pool: production and removal of ammonia*

Ammonia in rumen fluid is the final end-product of proteolysis by mixed rumen populations and is a major source of N for protein synthesis by many bacterial species. At any particular time, rumen  $\text{NH}_3$  concentration depends on the relative rates of entry and removal of  $\text{NH}_3$  (see Fig. 7.2 for overview of ammonia transactions). It has generally been believed that  $\text{NH}_3$  in rumen fluid is formed when AA in excess of requirements are metabolized intracellularly by a diverse range of microorganisms. When intracellular  $\text{NH}_3$  concentration increases,  $\text{NH}_3$  is excreted into the medium. This  $\text{NH}_3$  is then available for 'cross-feeding', being especially useful for some cellulolytic species. However, Russell *et al.* (1991) argued that very few strains themselves produce  $\text{NH}_3$  from true protein under genuine rumen conditions and identified *B. ruminicola* as the most important representative of only very few species with this ability.

In the 1980s, three Gram-positive, monensin-sensitive species capable of rapid fermentation of peptides and AA and high rates of  $\text{NH}_3$  production were isolated (i.e. *Clostridium sticklandii*, *Peptostreptococcus anaerobius* and *Clostridium aminophilum*) (Paster *et al.*, 1993). Dubbed the 'ammonia hyper-producing bacteria', these organisms do not ferment carbohydrates or intact proteins. They obtain most of their energy requirements by degrading peptides and AA. Attwood *et al.* (1998) isolated rumen bacteria with similar capabilities from pasture-grazed ruminants in New Zealand and suggested that these  $\text{NH}_3$  hyperproducing species can rapidly remove the peptides and AA produced by proteolytic species with which they are probably closely associated.

Studies using  $^{15}\text{N}$  have demonstrated that the rumen  $\text{NH}_3$  pool is relatively small and turns over rapidly. For example, in sheep given a daily ration of 800 g/day of chopped lucerne hay, providing 23 g N/day, approximately 14 g N/day passed through the  $\text{NH}_3$  pool, which contained only 0.6–1.2 g N (Nolan, 1975), i.e. the  $\text{NH}_3$ -N pool was completely removed and replaced in less than 2 h. Small changes in the relative rates of  $\text{NH}_3$  production and removal can therefore result in rapid changes in rumen  $\text{NH}_3$  pool size and concentration, even when animals have continuous access to food. Similar conclusions were reached by Koenig *et al.* (2000) in a study of sheep given

2-hourly meals. Much greater variation in rumen  $\text{NH}_3$  concentrations may occur when animals are given meals only once or twice a day.

### ***Intraruminal ammonia recycling***

Ammonia-N that is fixed into non- $\text{NH}_3$  compounds, either within the rumen or in the body, and is subsequently released into the rumen  $\text{NH}_3$  pool is said to have recycled. (The same is true of peptide and AA pools.) The difference between the total and net flux rates of N through the  $\text{NH}_3$  pool, estimated from the enrichment of rumen  $\text{NH}_3$  and its rate of decline after a single intraruminal injection of  $^{15}\text{N}$ -ammonium salts (Nolan and Leng, 1974), indicate that there is considerable intraruminal recycling of N via NAN pools (proteins, peptides and free AA) and there is therefore a considerable 'sharing' by microorganisms of the N of  $\text{NH}_3$ , peptide and AA in the rumen.

Recycling within the rumen involves the re-utilization of nitrogenous materials released from living microbes and also from bacteria and protozoa that have lysed. Protozoa graze on bacteria and then digest them and excrete nitrogenous materials into the medium. Protozoa are also a source of fermentable materials when they die in the rumen – and as they are selectively retained in the rumen, the majority of protozoan materials will eventually be subjected to further microbial processing. This has led some workers (e.g. Wallace and McPherson, 1987) to argue that recycling of microbial matter is mainly associated with protozoal activities. Earlier studies with defaunated sheep, however, led Nolan and Stachiw (1979) to conclude that up to 50% of the microbial protein present in the rumen was recycled intraruminally in the absence of protozoa. Demeyer and van Nevel (1979), Krebs *et al.* (1987) and Koenig *et al.* (2000) have reached the same conclusion. Bacterial numbers in the rumen increase when protozoa are eliminated, and the bacteria are still subject to lysis for reasons other than engulfment and digestion (Morrison and Mackie, 1996). Some bacteria lyse spontaneously when substrates are limiting (Wells and Russell, 1996) and temperate and lysogenic phages (viruses) may hasten lysis under these conditions. Lysogenic phages have been found in relatively high concentrations in the rumen of sheep on forage diets and lysogeny is triggered by certain factors that are as yet poorly understood (Swain *et al.*, 1996).

It has been argued that this intraruminal recycling of N affects the efficiency of both energy and protein utilization and leads to inefficient microbial growth in ruminants (Jouany, 1988). On the other hand, N recycling promotes a form of 'cross-feeding' that may enable certain species with specialized abilities to live in the rumen when otherwise they would not survive because of a lack of essential nutrients.

### ***Ammonia and AA absorption from the rumen***

Most of the  $\text{NH}_3$  in rumen fluid that is not assimilated by microbes diffuses through the rumen wall at a rate that is determined by its unionized

concentration and passes via the portal blood to the liver (McDonald, 1948). A smaller fraction passes out in digesta moving to the lower digestive tract (this amount is the product of fluid outflow and  $\text{NH}_3$  concentration). *In vivo* estimates of  $\text{NH}_3$  absorption have been made in fed sheep by estimating the  $^{15}\text{N}$  efflux from the rumen during intraruminal infusions of  $^{15}\text{N}$ -labelled ammonium salts (e.g. Siddons *et al.*, 1985; Obara *et al.*, 1991). The latter researchers found a linear relationship between net  $\text{NH}_3$  absorption and unionized  $\text{NH}_3$  concentration. In studies with sheep by Dellow and co-workers (see Nolan, 1993), there was substantial  $\text{NH}_3$  absorption at levels of feed intake ranging from one to three times the estimated ME requirements for maintenance. Estimates of absorption rate have also been made in ruminants by estimating arteriovenous differences in  $\text{NH}_3$  concentration in blood perfusing the gut (Huntington, 1982; Remond *et al.*, 2003).

Uptake of AA or peptides across the rumen wall can occur (e.g. Webb *et al.*, 1993) and transporters have been demonstrated in ruminal and omasal epithelia of sheep and dairy cows (Chen *et al.*, 1999). However, the amount of AA absorbed from the forestomachs is probably nutritionally insignificant. Peptides and AA in rumen fluid will also contribute to the AA flow into the small intestine to an extent determined by their concentration in rumen fluid and the fluid outflow rate.

## Microbial Protein Synthesis

MPS in the rumen requires energy-rich substrates, along with peptides, or AA or  $\text{NH}_3$ , and other essential nutrients, e.g. sulphur and trace minerals and branched-chain fatty acids and certain growth factors. Mechanistic models have been developed for predicting rumen fermentation and microbial growth outputs (see review by Dijkstra and Bannink, 2000). None currently takes account of all microbial growth requirements but the models have helped to identify major factors that may modulate microbial protein outflow from the rumen and which require further practical experimentation, e.g. types of substrates, microbial interactions and the AA concentrations in microbial protein (Dijkstra *et al.*, 1998). However, Dewhurst *et al.* (2000) have cautioned against overuse of models such as decision support systems (DSS) for predicting production from farm herds, arguing that animals are subjected to many additional environmental variables and feed analyses are not always reliable.

### *Efficiency of MPS*

Microbial growth efficiency in the rumen has proved especially difficult to estimate with confidence experimentally. Efficiency can be expressed as the yield of cell DM or OM per unit of feed OM *truly* fermented (OMTDR) in the rumen. The yield of microbial protein may be similarly expressed, but values will be more variable because the protein content of mixed microbial cells also varies. A commonly used alternative expression is microbial DM yield per unit

(OMADR). This is less meaningful stoichiometrically, but has persisted for the pragmatic reason that it represents what is often measured, i.e. the difference between feed OM intake and OM flowing from the rumen. The OM of digesta entering the abomasum contains true feed OM (undigested) and microbial OM, but also relatively smaller amounts of endogenous OM, VFA and other materials.

With accepted stoichiometry, the maximum yield of microbial OM from the rumen is unlikely to exceed 360 g/kg dietary OMTDR (SCA, 1990). Based on a concentration of true protein in bacteria of 320 or CP content of 500 g/kg DM, respectively, this is equivalent to 115 g microbial AA or 180 g CP/kg OMTDR (Czerkawski, 1986). Similar calculations of the maximum theoretical yield per OMADR give corresponding values of 180 g AA and 281 g CP/kg. The latter value is similar to the highest values found experimentally in cattle grazing high-quality grass which were 190–280 g microbial CP/kg OMADR (Beever *et al.*, 1986; Dove and Milne, 1994). In practice, mean values for MCP yield efficiency found in larger experimental data sets are below these theoretical values, e.g.  $184 \pm 60.1$  (SD) for lactating and non-lactating cattle mainly on mixed diets of roughage and concentrates ( $n = 107$ ) and  $224 \pm 69.1$  (SD) for sheep on pasture or hay diets, some with grain, urea or protected casein ( $n = 83$ ) (SCA, 1990). Czerkawski (1986) averaged results of 65 estimates from 25 separate studies and after expressing the results on a common basis, found that yield was remarkably constant, i.e.  $19.3 \pm 0.5$  (SE) g microbial N/kg OMTDR (or 121 g MCP/kg OMTDR).

The standard deviations listed above indicate there is wide variability in the efficiency of microbial cell supply from the rumen. A major reason is that a variable proportion of the ATP and membrane potential generated by the fermentation processes is used by different populations of rumen microbes for non-growth purposes, i.e. the maintenance requirement of cells (Pirt, 1965). Moreover, some microorganisms appear at times to dissociate catabolism of substrates and ATP generation from synthesis of cell constituents, and dissipate excess ATP as heat by so-called 'energy-spilling' reactions (see Chapter 9). Other factors affecting variability include diet quality (affected by composition of supplements), level of intake, retention time of solids and liquids, and the timing of release of energy substrates and nitrogenous materials into the medium (rumen 'synchrony').

### ***Effect of turnover rate of liquid and particulate matter***

Turnover rate (dilution rate) of the microbial populations is known to markedly affect microbial growth efficiency in continuous fermentations of mixed cultures (Isaacson *et al.*, 1975). The situation *in vivo* is, however, more complex than that in a continuous fermenter and efficiency of microbial yield is not always predictably increased by increases in dilution rate resulting, for example, from increased feed intake. Continuous fermentations are usually energy limited whereas, in practice, microbial growth rate in the rumen is frequently limited by availability of specific nutrients such as  $\text{NH}_3$  or sulphide

as discussed above. Moreover, groups of microbes in different niches have different rates of turnover, e.g. those closely associated with fibrous feeds may turnover less rapidly than those in the fluid phase. Thus, there are likely to be differences in the residence time of microorganisms fermenting particulate and soluble substrates.

Owens and Goetsch (1986) used an equation derived from unpublished data of C.J. Sniffen and P.H. Robinson to describe rumen microbial yield efficiency ( $Y$ , g microbial N/kg OMTDR) in terms of roughage intake (RI) and concentrate intake (CI), viz.:

$$Y = 8.42 + 3.69CI + 17.71RI - 4.66RI^2 \quad (7.3)$$

$(R^2 = 0.28; n = 144; p < 0.01)$

$Y$  (the predicted efficiency of yield) has theoretical extremes of 12.1 to 21.5 for all-concentrate and all-roughage diets, respectively. It indicates that efficiency generally increases with level of intake, with RI having a relatively greater effect than CI. The equation seems to encompass results of other researchers. For example, Mathers and Miller (1981) found that the efficiency of MPS was higher in sheep given chopped lucerne than in those given rolled barley or combinations of barley and lucerne, and the differences did not appear to be related to fractional outflow rate (dilution rate). On the other hand, other workers (e.g. Teller and Godeau, 1989) have found positive correlations between fractional outflow rate and efficiency of MPS in the rumen. Van Soest (1982) cites data of P.H. Robinson, which suggest that *in vitro* bacterial yield increased from 140 to 290 g/kg OMTDR as dilution rate increased from 3% to 8% per hour. However, increases in efficiency with increased dilution rates are not always evident in practice. The latter data set, for example, includes yield values that are higher than those theoretically possible. Nevertheless, the data support the concept that microbes in the fluid phase may be more affected by dilution rate than microbes associated with slower-moving particles. This idea has been captured by Dijkstra *et al.* (1992) in their model of rumen function.

### **Role of protozoa**

Under certain conditions, eliminating protozoa from the rumen can increase protein outflow or improve production (Bird and Leng, 1984; Ivan *et al.*, 1991). For example, defaunated lambs given a diet of chaffed oat straw, sucrose and fishmeal (48:48:4, w/w) gained weight 9% faster and grew 37% more wool than the lambs with protozoa (Bird and Leng, 1984). Efforts have been made to find methods of permanently eliminating protozoa from the rumen or reducing their numbers (Bird, 1995) but to date none has been adopted. However, many studies suggest that, in situations where AA availability is constraining production, the potential improvements in production would be considerable if control of protozoal populations could be achieved in a practical way.

### ***Experimental estimation of rumen microbial outflow using purine derivatives***

Because ingested nucleic acids in the diet are extensively degraded in the rumen (Smith and McAllan, 1970), most nucleic acids absorbed post-ruminally have been synthesized *de novo* by microbes in the rumen. Moreover, the rate of urinary purine derivatives (PD) excretion closely reflects the flows of (microbial) purines into the intestines (Topps and Elliott, 1967). Thus, if the urinary PD excretion rate is known, the rate of outflow of microbial biomass (or MCP) from the rumen can be estimated provided the concentration of microbial purines (or CP) in a pure sample of the mixed rumen microbial biomass is also known. During the last decade, this prediction method has been extended for use with different species of ruminants (see review by IAEA, 2004). It offers an effective means of predicting AA supply to the small intestine in animals. It is an alternative to methods dependent on the surgical fitting of gut cannulas and on marker-assisted estimation of digesta flow rate through the abomasum or duodenum.

## **Post-ruminal Utilization of Nitrogen**

### ***Digestion in the small intestine***

Microbial protein, UDP and endogenous proteins entering the small intestine are efficiently digested and absorbed (see review by Annison *et al.*, 2002). It has been suggested that the AA composition of UDP is virtually identical to that of its feed precursors, but more recent research shows that the feed AA profile may be altered by fermentative processes (e.g. Varvikko, 1986). Different combinations of dietary proteins do affect the profile of AA in duodenal digesta, at least in high-producing dairy cows (King *et al.*, 1990) and processing of feeds before they are ingested can also influence the intestinal digestibility of AA. These effects are probably only of importance when proteins are incorporated in high concentrations in the diet, or have a short residence time in the rumen. A method referred to as the 'mobile nylon bag' method has been used to compare the relative intestinal digestibilities of proteins in concentrate (e.g. cereal grains) and roughage materials (grass and silages). Coefficients obtained by this method vary from about 60% to 90% (Tamminga, 1990).

Bacteria contain proteins that are readily digested in the small intestine and have a well-balanced, though less than ideal, array of essential AA. The essential AA profiles of protozoa and fungi appear to be even closer to those of the protein in animal products. The protozoa and fungi also tend to have higher intestinal digestibility, but their low yields generally make them of little significance to the host animal. The amounts of endogenous AA relative to AA of MCP and UDP flowing from the rumen are poorly understood, but one study (Buttery *et al.*, 1983) indicates that the amounts of endogenous N secreted into the proximal small intestine may be considerably higher than amounts passing out of the rumen. Digestive enzymes and mucus and sloughed intestinal

cells also contain AA-N that is secreted into the gut lumen and is mostly re-absorbed before digesta pass out of the small intestine. Their net (or *apparent*) absorption coefficient is lower than 90%. The relative profiles of most AA are unchanged during the absorptive process, but disproportional losses can occur for threonine, valine and cysteine, probably due to poor re-absorption of mucin proteins (Lapierre and Lobley, 2001). Uncertainty about the sites and quantity of secretion of endogenous N and its fractional re-absorption is a major constraint to diet formulation (Ouellet *et al.*, 2002).

In addition to AA, MCP includes nucleic acids (purines and pyrimidines) and other N compounds. Smith *et al.* (1969) showed that 85% of RNA was apparently digested in the small intestine of calves and Chen *et al.* (1990) found that 91% of an infused source of microbial purines was digested in the small intestine of lambs. Knowledge of nucleic acid digestion and metabolism in ruminants has been extended in the last decade (see review by IAEA, 2004) in line with the development of the urinary PD microbial outflow prediction method (discussed above).

### ***Fermentation and digestion in the large intestine***

The large intestine (caecum, colon and rectum), like the rumen, supports microbial populations that ferment materials entering it. There is a net disappearance of OM between the ileum and anus providing energy for microbial fermentation and growth. The relative magnitude of the fermentative activity can be gauged from the production of VFA and methane, which is usually less than 10% of that produced in the rumen of the same animal.

Microbial protein produced by fermentation processes using urea from the blood and undigested endogenous N, microbial N and UDP is the major form of N excreted in faeces. Apparently AA are not absorbed from the large intestine of ruminants. When given an N-free but otherwise adequate diet, ruminants continue to excrete faecal N from endogenous sources at about 5 g N/kg DM intake. Dixon and Nolan (1982) and Dixon *et al.* (1982) have developed quantitative models of OM and N transactions in the large intestine of sheep. A net  $\text{NH}_3\text{-N}$  absorption equivalent to 0.5 g/day was found in sheep on a high-fibre, low N diet but in similar sheep supplemented with fishmeal, the net absorption increased to 5.3 g N/day (Dixon and Nolan, 1982).

### ***Ammonia and urea metabolism in the body***

Lapierre and Lobley (2001) give a detailed account of urea metabolism in ruminants. In ruminants, urea synthesis in the liver and kidney provides a means by which excess amino-N and the  $\text{NH}_3$  resulting from inefficient N utilization in the rumen are prevented from causing toxicity in the body. This detoxification incurs energy costs of 4 ATP per mole urea synthesized (McBride and Kelly, 1990), and there are probably extra associated energy costs of maintenance of the liver, which increases in size with N intake (Marini

*et al.*, 2004). On the other hand some ATP may be recovered in cells when keto acids, formed during AA deamination, are oxidized via the Krebs cycle (Newsholme and Leech, 1983). Nevertheless, any requirement for urea synthesis brought about by a low efficiency of N utilization not only represents a waste of N but also of potentially useful energy. If, for example, a 600 kg cow producing 30 l milk per day ingested 16.6 kg of ryegrass DM containing 4.0% N (80% digestible) so that her N intake was 382 g in excess of requirements, the energy cost of NH<sub>3</sub> detoxification could be 20 MJ/day, equivalent to about 4 l/day of fat-corrected milk (SCA, 1990).

Urea synthesized in the liver or kidney is released into the blood. As ruminants have no endogenous urease, this urea is removed only by excretion via the kidney or by transfer into the gut. The latter transfer can be by diffusion through the ruminal or intestinal epithelia or in secretions (saliva, gastric and pancreatic juices), or in sloughed intestinal cells (see review by Nolan, 1986). This urea is degraded to NH<sub>3</sub> by microbial urease associated with the gut wall or in digesta. Microbial AA formed from this NH<sub>3</sub> in the rumen are available for digestion by the ruminant host. This 'protein regeneration cycle' assists ruminants to survive on low-protein diets (Houpt, 1959) and it is tempting to speculate that urea conservation by the kidney and its transfer to the gut might be regulated.

Various mechanisms appear to reduce renal excretion of urea and redirect it to the rumen at times when RDP availability is a limitation for microbial growth (see review by Obara *et al.*, 1991). A change in urease activity in the rumen wall with changing N status of the animal is one means by which the rate of urea transfer to the rumen is altered (Marini *et al.*, 2004). Rumen NH<sub>3</sub> concentration has also been thought to regulate urea transfer but Remond *et al.* (2003) believe that NH<sub>3</sub> concentration is secondary to the rate of substrate fermentation. The discovery of urea transporters in the gut wall of ruminants (Ritzhaupt *et al.*, 1998) suggests another mechanism by which urea transfer might be regulated to an animal's advantage. However, Marini *et al.* (2004) found that changes in N intake of lambs did not affect the numbers of transporters in the rumen wall and kidney medulla.

When reviewing the role of regulatory mechanisms, it is prudent to remember that N recycling often does not completely correct a RDP deficiency, because often both intake and digestibility of low-protein diets are improved by the provision of RDP from a dietary urea supplement. It is therefore clear that so-called 'urea recycling' does not always completely correct a RDP shortfall even though it clearly reduces the maintenance N requirements of ruminant animals.

## Practical Protein Feeding Systems

Mathematical models have become the basis for the modern protein and energy feeding systems. They are being updated by new research, which is helping them accommodate a much wider range of practical management issues. Attempts to improve feeding system models tend to lead to an increase



in their complexity. However, the advent of software packages for incorporating this complexity into easy-to-use DSS has meant a wider range of livestock consultants and managers can access research information relevant to their own countries or districts.

The GRAZFEED DSS, for example, is a component of the GRAZPLAN decision support project for Australian grazing enterprises (Freer *et al.*, 1997). GRAZFEED is designed to help the user assess the nutritive value of a defined pasture, for specified animals grazing on it, and to show how a desired weight gain or milk yield might be achieved with or without supplementation. It does this by predicting the intake of energy and protein and their use for maintenance and production according to information in SCA (1990), with recent modifications in Freer *et al.* (2003). The CNCPS model is now available as a DSS for cattle (see CNCPS, 2004). The developers' objective is to improve nutrient utilization, environmental issues and profitability of the dairy and livestock industries in the USA. In the UK, the AFRC (1993) feeding standards have been incorporated into the RUMNUT DSS (see RUMNUT, 2004), which also incorporates US, French and Australian feeding standards.

## Conclusions

Computer models that quantitatively describe microbial fermentation and growth in the rumen are now useful adjuncts to research in ruminant protein nutrition. Efficient N metabolism in ruminants depends on a complex interaction between energy and various nutrients both in the gut and in tissues. Nitrogen is not utilized efficiently by rumen microbes unless there is an adequate and synchronous supply of energy-rich substrates in the diet. Improved pastures often provide an imbalanced and asynchronous supply of amino N relative to energy-rich substrates. Further work is still required to better elucidate the roles of protozoa and bacteriophages (viruses) as agents causing death and lysis of rumen bacteria (promoting intraruminal N recycling with consequent reductions in net microbial synthesis) and to define more fully the roles of UDP and RDP, and the importance of recycled urea as part of the RDP supply. A new and exciting area of research is the breeding of pastures that are higher in WSC relative to CP.

The major source of AA for ruminants is the microbial biomass flowing into the small intestine but accurate estimation of its magnitude has been an ongoing constraint for ruminant research workers. Development of the technique based on estimation of the rate of urinary excretion of PD now enables microbial AA outflow from the rumen to be predicted in most ruminant species without the need for surgical implantation of cannulas. Microbial AA, augmented by UDP and endogenous CP, are digested and used by the host animal, but at efficiencies that currently still show room for considerable improvement. Excretion of endogenous N and its re-absorption in the small intestine, and N transactions in the large intestine also affect the efficiency of utilization of N by the animal and are not yet adequately described in most DSS.

Quantitative results from experimental studies of gut and tissue processes and the models of N kinetics based on them have aided integration of research findings and are continuing to assist researchers to identify gaps in knowledge. Models describing N metabolism in tissues are covered elsewhere in this volume (see Chapter 27), but it is notable that few, as yet, take account of the limiting essential AA for tissue protein synthesis.

Some DSS models are already providing exciting and practical benefits for researchers, animal nutritionists and farmers. Whole-animal models, for example, are helping farm managers to reduce environmental problems resulting from the provision of rations with excess dietary protein and to make to more efficient use of expensive protein sources.

## References

- Agricultural and Food Research Council (AFRC) (1993) *Energy and Protein Requirements of Ruminants*. CAB International, Wallingford, UK.
- Allison, M.J. (1969) Biosynthesis of amino acids by ruminal microorganisms. *Journal of Animal Science* 29, 797–807.
- Annisson, E.F. and Lewis, D. (1959) *Metabolism in the Rumen*. Methuen & Co Ltd, London.
- Annisson, E.F., Chalmers, M.I., Marshall, S.B.M. and Synge, R.L.M. (1954) Rumen ammonia formation in relation to protein need of sheep. III. Ruminal ammonia formation with various diets. *Journal of Agricultural Science* 44, 270–273.
- Annisson, E.F., Lindsay D.B and Nolan, J.V. (2002) Digestion and metabolism of protein. In: Freer, M. and Dove, H. (eds) *Sheep Nutrition*. CAB International, Wallingford, UK, pp. 95–118.
- Armstead, I.P. and Ling, J.R. (1993) Variations in the uptake and metabolism of peptides and amino acids by mixed ruminal bacteria *in vitro*. *Applied and Environmental Microbiology* 59, 3360–3366.
- Ashes, J.R., Mangan, J.L. and Sidhu, G.S. (1984) Nutritional availability of amino acids from protein cross-linked to protect against degradation in the rumen. *British Journal of Nutrition* 52, 239–247.
- Atasoglu, C., Valdes, C., Newbold, C.J. and Wallace, R.J. (1999) Influence of peptides and amino acids on fermentation rate and *de novo* synthesis of amino acids by mixed micro-organisms from the sheep rumen. *British Journal of Nutrition* 81, 307–314.
- Attwood, G.T., Klieve, A.V., Ouwkerk, D. and Patel, B.K. (1998) Ammonia-hyper-producing bacteria from New Zealand ruminants. *Applied and Environmental Microbiology* 64, 1796–1804.
- Baldwin, R.L. and Denham, S.C. (1979) Quantitative and dynamic aspects of nitrogen metabolism in the rumen: a modeling analysis. *Journal of Animal Science* 49, 1631–1639.
- Baldwin, R.L. and Sainz, R.D. (1995) Energy partitioning and modeling in animal nutrition. *Annual Review of Nutrition* 15, 191–211.
- Baldwin, R.L., Lucas, H.L. and Cabrera, R. (1970) Energetic relationship in the formation and utilisation of fermentation end products. In: Phillipson, A.T. (ed.) *Physiology of Digestion and Metabolism in the Ruminant*. Oriel Press, Newcastle upon Tyne, UK, pp. 319–344.

- Beever, D.E., Dhanoa, M.S., Losada, H.R., Evans, R.T., Cammell, S.B. and France, J. (1986) The effect of forage species and stage of harvest on the processes of digestion occurring in the rumen of cattle. *British Journal of Nutrition* 56, 439–454.
- Bird, S.H. (1995) Manipulation of rumen protozoa. In: Leng, R.A. and Bennett, W.R. (eds) *Improvement of the Nutritive Value of Forages given to Ruminants through Manipulation of the Rumen: Methods and Potential*. FAO Publications, Vienna, Austria, pp. 43–78.
- Bird, S.H. and Leng, R.A. (1984) Further studies on the effects of the presence or absence of protozoa in the rumen on live-weight gain and wool growth of sheep. *British Journal of Nutrition* 52, 607–611.
- Boggs, D.E. (1959) *In vivo* <sup>15</sup>N tracer study of amino acid metabolism in the rumen of sheep on a purified diet. PhD thesis, Cornell University, Ithaca, New York.
- Brock, F.M., Forsberg, C.W. and Buchanan-Smith, J.G. (1982) Proteolytic activity of rumen microorganisms and effects of proteinase inhibitors. *Applied and Environmental Microbiology* 44, 561–569.
- Broderick, G.A., Wallace, R.J. and Ørskov, E.R. (1991) Control of rate and extent of protein degradation. In: Tsuda, T., Sasaki, T. and Kawashima, R. (eds) *Physiological Aspects of Digestion and Metabolism in Ruminants*. Academic Press, New York, pp. 515–539.
- Buttery, P.J. and Lewis, D. (1982) Nitrogen metabolism in the rumen. In: Thomson, D.J., Beever, D.E. and Gunn, R.G. (eds) *Forage Protein in Ruminant Animal Production*. British Society of Animal Production, Edinburgh, pp. 1–11.
- Buttery, P.J., Marsden, M. and Nolan, J.V. (1983) Preliminary studies on the nature of the endogenous protein leaving the abomasum of sheep. In: Arnal, M., Pion, R. and Bonin, D. (eds) *Proceedings of the Fourth International Symposium on Protein Metabolism and Nutrition*. INRA, Paris, pp. 275–278.
- Castillo, A.R., Kebreab, E., Beever, D.E., Barbi, J.H., Sutton, J.D., Kirby, H.C. and France, J. (2001) The effect of energy supplementation on nitrogen utilisation in lactating dairy cows fed grass silage diets. *Journal of Animal Science* 79, 240–246.
- Chamberlain, D.G., Thomas, P.C., Wilson, W., Newbold, C.J. and MacDonald, J.C. (1985) The effects of carbohydrate supplements on ruminal concentrations of ammonia in animals given diets of grass silage. *Journal of Agricultural Science, Cambridge* 104, 331–340.
- Chapman, P.G. and Norton, B.W. (1984) The estimation of feed protein degradability in the rumen using nylon bag, microbial labelling (<sup>35</sup>S) and plant labelling (<sup>15</sup>N) techniques. *Animal Production in Australia* 15, 286–289.
- Chen, G. and Russell, J.B. (1989) More monensin-sensitive, ammonia-producing bacteria from the rumen. *Applied and Environmental Microbiology* 55, 1052–1057.
- Chen, X.B., Hovell, F.D., Ørskov, E.R. and Brown, D.S. (1990) Excretion of purine derivatives by ruminants: effect of exogenous nucleic acid supply on purine derivative excretion by sheep. *British Journal of Nutrition* 63, 131–142.
- Chen, H., Wong, E.A. and Webb, K.E., Jr (1999) Tissue distribution of a peptide transporter mRNA in sheep, dairy cows, pigs, and chickens. *Journal of Animal Science* 77, 1277–1283.
- Cheng, K.-J. and Costerton, J.W. (1980) Adherent rumen bacteria – their role in the digestion of plant material, urea and epithelial cells. In: Ruckebusch, Y. and Thivend, P. (eds) *Digestive Physiology and Metabolism in Ruminants*. MTP Press, Lancaster, pp. 227–250.

- CNCPS (2004) Cornell Ruminant Decision Support System. Available at: [www.cncps.cornell.edu](http://www.cncps.cornell.edu)
- Coleman, G.S. (1967) The metabolism of free amino acids by washed suspensions of the rumen ciliate *Entodinium caudatum*. *Journal of General Microbiology* 47, 433–447.
- Corbett, J.L. (1987) Energy and protein utilization by grazing animals. In: Wheeler, J.L., Pearson, C.J. and Robards, G.E. (eds) *Temperate Pastures: Their Production, Use and Management*. CSIRO, Melbourne, Australia, pp. 341–355.
- Cotta, M.A. and Hespell, R.B. (1986) Protein and amino acid metabolism of rumen bacteria. In: Milligan, L.P., Grovum, W.L. and Dobson, A. (eds) *Control of Metabolism and Digestion in Ruminants*. Prentice-Hall, Englewood Cliffs, New Jersey, pp. 122–136.
- Cottle, D.J. (1980) The synthesis, turnover and outflow of ruminal microorganisms. PhD thesis, University of New England, Armidale, New South Wales, Australia.
- Cruz Soto, R., Muhammed, S.A., Newbold, C.J., Stewart, C.S. and Wallace, R.J. (1994) Influence of peptides, amino acids and urea on microbial activity in the rumen of sheep receiving grass hay and on the growth of rumen bacteria *in vitro*. *Animal Feed Science and Technology* 49, 151–161.
- Czerkawski, J.W. (1986) *An Introduction to Rumen Studies*. Pergamon Press, Oxford, UK.
- Damry and Nolan, J.V. (2002) Degradation of duckweed protein in the rumen of sheep. *Animal Production in Australia* 24, 45–48.
- Delagarde, R., Peyraud, J.L. and Delaby, L. (1997) The effect of nitrogen fertilisation level and protein supplementation on herbage intake, feeding behaviour and digestion in grazing dairy cows. *Animal Feed Science and Technology* 66, 165–180.
- Demeyer, D.I. and van Nevel, C.J. (1979) Effect of defaunation on the metabolism of rumen micro-organisms. *British Journal of Nutrition* 42, 515–524.
- Dewhurst, R.J., Davies, D.R. and Merry, R.J. (2000) Microbial protein supply from the rumen. *Animal Feed Science and Technology* 85, 1–21.
- Dijkstra, J. (1994) Simulation of the dynamics of protozoa in the rumen. *British Journal of Nutrition* 72, 679–699.
- Dijkstra, J. and Bannink, A. (2000) Analyses of modelling whole-rumen function. In: Theodorou, M.K. and France, J. (eds) *Feeding Systems and Feed Evaluation Models*. CAB International, Wallingford, UK, pp. 299–322.
- Dijkstra, J., Neal, H.D.St.C., Beaver, D.E. and France, J. (1992) Simulation of nutrient digestion, absorption and outflow in the rumen: model description. *Journal of Nutrition* 122, 2239–2256.
- Dijkstra, J., France, J., Assis, A.G., Neal, H., Campos, O.F. and Aroeira, L.J.M. (1996) Simulation of digestion in cattle fed sugarcane – prediction of nutrient supply for milk production with locally available supplements. *Journal of Agricultural Science, Cambridge* 127, 247–260.
- Dijkstra, J., France, J. and Davies, D.R. (1998) Different mathematical approaches to estimating microbial protein supply in ruminants. *Journal of Dairy Science* 81, 3370–3384.
- Dixon, R.M. and Nolan, J.V. (1982) Studies of the large intestine of sheep. 1. Fermentation and absorption in sections of the large intestine. *British Journal of Nutrition* 47, 289–300.
- Dixon, R.M., Nolan, J.V. and Milligan, L.P. (1982) Studies of the large intestine of sheep. 2. Kinetics of liquid and solid phase markers in the caecum and proximal colon. *British Journal of Nutrition* 47, 301–309.

- Dove, H. and Milne, J.A. (1994) Digesta flow and rumen microbial protein production in ewes grazing perennial ryegrass. *Australian Journal of Agricultural Research* 45, 1229–1245.
- Egan, A.R. (1965) Nutritional status and intake regulation in sheep. III. The relationship between improvement of nitrogen status and increase in voluntary intake of low-protein roughages by sheep. *Australian Journal of Agricultural Research* 16, 463–472.
- Erfle, J.D., Sauer, F.D. and Mahadevan, S. (1977) Effect of ammonia concentration on activity of enzymes of ammonia assimilation and on synthesis of amino acids by mixed rumen bacteria in continuous culture. *Journal of Dairy Science* 60, 1064–1072.
- Fox, D.G., Sniffen, C.J., O'Connor, J.D., Russell, J.B. and Van Soest, P.J. (1992) A net carbohydrate and protein system for evaluating cattle diets. III. Cattle requirements and diet adequacy. *Journal of Animal Science* 70, 3578–3596.
- Freer, M., Moore, A.D. and Donnelly, J.R. (1997) GrazPlan – Decision Support Systems For Australian Grazing Enterprises. II. The Animal Biology Model For Feed Intake, Production and Reproduction and the Grazfeed DSS. *Agricultural Systems* 54, 77–126.
- Freer, M., Moore, A.D. and Donnelly, J.R. (2003) The GRAZPLAN animal biology model for sheep and cattle and the GrazFeed decision support tool. CSIRO Plant Industry Technical paper. Available at: [http://www.csiro.au/proprietaryDocuments/TechPaper\\_Oct03.pdf](http://www.csiro.au/proprietaryDocuments/TechPaper_Oct03.pdf)
- Hackette, S.L., Skye, G.E., Burton, C. and Segel, I.H. (1970) Characterization of ammonium transport system in filamentous fungi with methyl-ammonium-<sup>14</sup>C as the substrate. *Journal of Biological Chemistry* 245, 4241–4245.
- Haupt, T.R. (1959) Utilization of blood urea in ruminants. *American Journal of Physiology* 197, 115–120.
- Huntington, G.B. (1982) Portal blood flow and net absorption of ammonia-nitrogen, urea-nitrogen and glucose in nonlactating Holstein cows. *Journal of Dairy Science* 65, 1155–1162.
- Hvelplund, T. and Madsen, J. (1995) Protein utilization in ruminants. In: Nunes, A.F., Portugal, A.V., Costa, J.P. and Ribeiro, J.R. (eds) *Proceedings of the Seventh International Symposium on Protein Metabolism and Nutrition*. Estacao Zootechnica National Santerem, Valde Santare, Portugal, pp. 83–89.
- IAEA (2004) In: Makkar, H.P.S. and Chen, X.B. (eds) *Estimation of Microbial Protein Supply in Ruminants using Urinary Purine Derivatives*. Kluwer Academic Publishers, London.
- Isaacson, H.R., Hinds, F.C., Bryant, M.P. and Owens, F.N. (1975) Efficiency of energy utilisation by mixed rumen bacteria in continuous culture. *Journal of Dairy Science* 58, 1645–1659.
- Ivan, M., Charmley, L.L., Neill, L. and Hidiroglou, M. (1991) Metabolic changes in the rumen following protozoal inoculation of fauna-free sheep fed a corn silage diet supplemented with casein or soybean meal. *Annals Recherche Veterinaire* 22, 227–238.
- Johns, A.T. (1955) Ammonia concentrations in the rumen of sheep. *New Zealand Journal of Science and Technology* A37, 323–331.
- Jouany, J.P. (1988) Effects of diet on populations of rumen protozoa in relation to fibre digestion. In: Nolan, J.V., Leng, R.A. and Demeyer, D.I. (eds) *The Role of Protozoa and Fungi in Ruminant Digestion*. Penambul Books, Armidale, Australia, pp. 133–153.

- Jouany, J.P. (1996) Effect of rumen protozoa on nitrogen utilization by ruminants. *Journal of Nutrition* 126, 1335S–1346S.
- Kebreab, E., France, J., Mills, J.A., Allison, R. and Dijkstra, J. (2002) A dynamic model of N metabolism in the lactating dairy cow and an assessment of impact of N excretion on the environment. *Journal of Animal Science* 80, 248–259.
- King, K.J., Huber, J.T., Sadik, M., Bergen, W.G., Grant, A.L. and King, V.L. (1990) Influence of dietary protein sources on the amino acid profiles available for digestion and metabolism in lactating cows. *Journal of Dairy Science* 73, 3208–3216.
- Kingston-Smith, A.H. and Theodorou, M.K. (2000) Post-ingestion metabolism of fresh forage. Tansley review. *New Phytologist* 148, 37–55.
- Koenig, K.M., Newbold, C.J., McIntosh, F.M. and Rode, L.M. (2000) Effects of protozoa on bacterial nitrogen recycling in the rumen. *Journal of Animal Science* 78, 2431–2445.
- Krebs, G.L., Nolan, J.V. and Leng, R.A. (1987) The effect of defaunation and urea supplementation on bacterial pool size and turnover in the rumen of sheep given oaten chaff. In: Farrell, D.J. (ed.) *Recent Advances in Animal Nutrition in Australia*. University of New England Publishing Unit, Armidale, New South Wales, Australia, p. 6A.
- Lapierre, H. and Lobley, G.E. (2001) Nitrogen recycling in the ruminant: a review. *Journal of Dairy Science* 84 (Suppl.), E223–E236.
- Lee, M.R.F., Harris, L.J., Moorby, J.M., Humphreys, M.O., Theodorou, M.K., MacRae, J.C. and Scollan, N.D. (2002) Rumen metabolism and nitrogen flow to the small intestine in steers offered *Lolium perenne* containing different levels of water-soluble carbohydrate. *Animal Science* 74, 587–596.
- Lee, M.R.F., Merry, R.J., Davies, D.R., Moorby, J.M., Humphreys, M.O., Theodorou, M.K., MacRae, J.C. and Scollan, N.D. (2003) Effect of increasing availability of water-soluble carbohydrates on *in vitro* rumen fermentation. *Animal Feed Science and Technology* 104, 59–70.
- Leng, R.A. and Preston, T.R. (1985) Matching livestock systems to available feed resources. *Asian Livestock* 10, 158–163.
- Mahadevan, S., Erfle, J.D. and Sauer, F.D. (1980) Degradation of soluble and insoluble proteins by *Bacteriodes amylophilus* protease and by rumen microorganisms. *Journal of Animal Science* 50, 723–728.
- Mangan, J.L. (1982) The nitrogenous constituents of fresh forages. In: Thomson, D.J., Beever, D.E. and Gunn, R.G. (eds) *Forage Protein in Ruminant Animal Production*. British Society of Animal Production, Edinburgh, pp. 25–40.
- Marini, J.C., Klein, J.D., Sands, J.M. and Van Amburgh, M.E. (2004) Effect of nitrogen intake on nitrogen recycling and urea transporter abundance in lambs. *Journal of Animal Science* 82, 1157–1164.
- Mathers, J.C. and Miller, E.L. (1981) Quantitative studies of food protein degradation and the energetic efficiency of microbial protein synthesis in the rumen of sheep given chopped lucerne and rolled barley. *British Journal of Nutrition* 45, 587–604.
- Mathison, G.W. and Milligan, L.P. (1971) Nitrogen metabolism in sheep. *British Journal of Nutrition* 25, 351–366.
- Mazanov, A. and Nolan, J.V. (1976) Simulation of the dynamics of nitrogen metabolism in sheep. *British Journal of Nutrition* 35, 149–174.
- McBride, B.W. and Kelly, J.M. (1990) Energy cost of absorption and metabolism in the ruminant gastrointestinal tract and liver: a review. *Journal of Animal Science* 68, 2997–3010.

- McDonald, I.W. (1948) The absorption of ammonia from the rumen of sheep. *Biochemistry Journal* 42, 584–587.
- McDonald, I.W. and Hall, R.J. (1957) The conversion of casein into microbial proteins in the rumen. *Biochemical Journal* 67, 400–403.
- Mertens, D.R. (1987) Predicting intake and digestibility using mathematical models of ruminal function. *Journal of Animal Science* 64, 1548–1558.
- Miller, L.A., Theodorou, M.K., MacRae, J.C., Evans, R.T., Adesogan, A.T., Humphreys, M.O., Scollan, N.D. and Moorby, J.M. (1999) Milk production and N partitioning responses in dairy cows offered perennial ryegrass selected for high water soluble carbohydrate concentrations. *South African Journal of Animal Science* 29, 281–282.
- Morrison, M. and Mackie, R.I. (1996) Nitrogen metabolism by ruminal microorganisms: current understanding and future perspectives. *Australian Journal of Agricultural Research* 47, 227–246.
- Neutze, S.A., Kellaway, R.C. and Faichney, G.J. (1986) Kinetics of nitrogen transfer across the rumen wall of sheep given a low-protein roughage. *British Journal of Nutrition* 56, 497–507.
- Newsholme, E.A. and Leech, A.R. (1983) *Biochemistry for the Medical Sciences*. Wiley, New York.
- Nolan, J.V. (1975) Quantitative models of nitrogen metabolism in sheep. In: McDonald, I.W. and Warner, A.C.I. (eds) *Digestion and Metabolism in the Ruminant*. University of New England Publishing Unit, Armidale, Australia, pp. 416–431.
- Nolan, J.V. (1986) Movement of nitrogenous materials into and out of the gut. In: Taylor, P.G. (ed.) *Proceedings of the 13th International Congress of Nutrition*. John Libbey, London, pp. 365–370.
- Nolan, J.V. (1993) Nitrogen kinetics. In: Forbes, J.M. and France, J. (eds) *Quantitative Aspects of Ruminant Digestion and Metabolism*. CAB International, Wallingford, UK, pp. 123–143.
- Nolan, J.V. and Leng, R.A. (1972) Dynamic aspects of ammonia and urea metabolism in sheep. *British Journal of Nutrition* 27, 177–194.
- Nolan, J.V. and Leng, R.A. (1974) Isotope techniques for studying the dynamics of nitrogen metabolism in ruminants. *Proceeding of the Nutrition Society* 33, 1–8.
- Nolan, J.V. and Stachiw, S. (1979) Fermentation and nitrogen dynamics in Merino sheep given a low-quality-roughage diet. *British Journal of Nutrition* 42, 63–80.
- NRC (2001) *Nutrient Requirements of Dairy Cattle*, 7th revised edn. National Academy Press, Washington DC.
- Nugent, J.H.A. and Mangan, J.L. (1978) Rumen proteolysis of fraction I leaf protein, casein and bovine serum albumin. *Proceedings of the Nutrition Society* 37, 48A.
- Nugent, J.H.A. and Mangan, J.L. (1981) Characteristics of the rumen proteolysis of fraction I (18S) leaf protein from lucerne (*Medicago sativa* L.). *British Journal of Nutrition* 46, 39–58.
- Obara, Y., Dellow, D.W. and Nolan, J.V. (1991) The influence of energy-rich supplements on nitrogen kinetics in ruminants. In: Tsuda, T., Sasaki, T. and Kawashima, R. (eds) *Physiological Aspects of Digestion and Metabolism in Ruminants*. Academic Press, New York, pp. 515–539.
- Oldham, J.D., Buttery, P.J., Swan, H. and Lewis, D. (1977) Interactions between dietary carbohydrate and nitrogen and digestion in sheep. *Journal of Agricultural Science, Cambridge* 89, 467–479.
- Ørskov, E.R. and McDonald, I. (1979) The estimation of protein degradability in the rumen from incubation measurements weighted according to rate of passage. *Journal of Agricultural Science, Cambridge* 92, 499–503.

- Ørskov, E.R. and Mehrez, A.Z. (1977) Estimation of extent of protein degradation from basal feeds in the rumen of sheep. *Proceedings of the Nutrition Society* 36, 78A.
- Ouellet, D.R., Demers, M., Zuur, G., Lobley, G.E., Seoane, J.R., Nolan, J.V. and Lapierre, H. (2002) Effect of dietary fiber on endogenous nitrogen flows in lactating dairy cows. *Journal of Dairy Science* 85, 3013–3025.
- Owens, F.N. and Goetsch, A.L. (1986) Digesta passage and microbial protein synthesis. In: Milligan, L.P., Grovum, W.L. and Dobson, A. (eds) *Control of Metabolism and Digestion in Ruminants*. Prentice-Hall, Englewood Cliffs, New Jersey, pp. 196–223.
- Owens, F.N., Lusby, K.S., Mizwicki, K. and Forero, O. (1980) Slow ammonia release from urea: rumen and metabolism studies. *Journal of Animal Science* 50, 527–531.
- Paster, B.J., Russell, J.B., Yang, C.M., Chow, J.M., Woese, C.R. and Tanner, R. (1993) Phylogeny of the ammonia-producing ruminal bacteria *Peptostreptococcus anaerobius*, *Clostridium sticklandii* and *Clostridium aminophilum* sp. nov. *International Journal of Systematic Bacteriology* 43, 107–110.
- Pirt, S.J. (1965) The maintenance energy of bacteria in growing cultures. *Proceedings of the Royal Society of London, Series B Biological Sciences* 163, 224–231.
- Pitt, R.E., Van Kessel, J.S., Fox, D.G., Pell, A.N., Barry, M.C. and Van Soest, P.J. (1996) Prediction of ruminal volatile fatty acids and pH within the net carbohydrate and protein system. *Journal of Animal Science* 74, 226–244.
- Pittman, K.A. and Bryant, M.P. (1964) Peptides and other nitrogen sources for growth of *Bacteroides ruminicola*. *Journal of Bacteriology* 88, 401–410.
- Remond, D., Bernard, L., Chauveau, B., Nozière, P. and Poncet, C. (2003) Digestion and nutrient net fluxes across the rumen, and the mesenteric- and portal-drained viscera in sheep fed with fresh forage twice daily: net balance and dynamic aspects. *British Journal of Nutrition* 89, 649–666.
- Ritzhaupt, A., Wood, I.S., Jackson, A.A., Moran, B.J. and Shirazi-Beechey, S.P. (1998) Isolation of an RT-PCR fragment from human colon and sheep rumen RNA with nucleotide similarity to human and rat urea transporter isoforms. *Biochemical Society Transactions* 26, S122.
- RUMNUT (2004) The RUMNUT nutrition program. Available at: [www.rumnut.com](http://www.rumnut.com)
- Russell, J.B. (1998) Strategies that ruminal bacteria use to handle excess carbohydrate. *Journal of Animal Science* 76, 1955–1963.
- Russell, J.B. (2002) *Rumen Microbiology and its Role in Ruminant Nutrition*. Cornell University, Ithaca, New York.
- Russell, J.B., Onodera, R. and Hino, T. (1991) Ruminal protein fermentation: new perspectives on previous contradictions. In: Tsuda, T., Sasaki, T. and Kawashima, R. (eds) *Physiological Aspects of Digestion and Metabolism in Ruminants*. Academic Press, New York, pp. 681–697.
- Rutter, S.M., Orr, R.J., Yarrow, N.H. and Champion, R.A. (2004) Dietary preference of dairy cows grazing ryegrass and white clover. *Journal of Dairy Science* 87, 1317–1324.
- Salter, D.N. and Smith, R.H. (1977) Incorporation of urea nitrogen into microbial-N in the stomach of the young steer: experiments with <sup>15</sup>N. *Proceedings of the Nutrition Society* 36, 54A.
- Satter, L.D. and Slyter, L.L. (1974) Effect of ammonia concentration of rumen microbial protein production *in vitro*. *British Journal of Nutrition* 32, 199–208.
- SCA (1990) *Feeding Standards for Australian Livestock: Ruminants*. CSIRO Publications, Melbourne, Australia.



- Schaefer, D.M., Davies, C.L. and Bryant, M.P. (1980) Ammonia saturation constants for predominant species of rumen bacteria. *Journal of Dairy Science* 63, 1248–1263.
- Siddons, R.C., Nolan, J.V., Beever, D.E. and MacRae, J.C. (1985) Nitrogen digestion and metabolism in sheep consuming diets containing contrasting forms and levels of N. *British Journal of Nutrition* 54, 175–187.
- Sinclair, L.A., Garnsworthy, P.C., Newbold, J.R. and Buttery, P.J. (1993) Effect of synchronizing the rate of dietary energy and nitrogen release on rumen fermentation and microbial protein synthesis in sheep. *Journal of Agricultural Science, Cambridge* 120, 251–263.
- Smith, R.H. and McAllan, A.B. (1970) Nucleic acid metabolism in the ruminant. 2. Formation of microbial nucleic acids in the rumen in relation to the digestion of food nitrogen and the fate of dietary nucleic acids. *British Journal of Nutrition* 24, 545–556.
- Smith, R.H., McAllan, A.B. and Hill, W.B. (1969) Nucleic acids in bovine nutrition. 3. Fate of nucleic acids presented to the small intestine. *Proceedings of the Nutrition Society* 28, 28A.
- Swain, R.A., Nolan, J.V. and Klieve, A.V. (1996) Natural variability and diurnal fluctuations within the bacteriophage population of the rumen. *Applied and Environmental Microbiology* 62, 994–997.
- Tamminga, S. (1986) Utilisation of naturally occurring NPN compounds by ruminants. *Archives of Animal Nutrition* 36, 169–176.
- Tamminga, S. (1990) Biotechnology and improvement of animal nutrition. *Mededelingen van de Fakulteit Landbouwwetenschappen, Rijksuniversiteit Gent* 55, 1373–1382.
- Teller, E. and Godeau, J.M. (1989) Protein and energy relationships in dairy cattle. 2. Lactating cows. *Archives of Animal Nutrition* 39, 543–551.
- Theodorou, M.K., Merry, R.J. and Thomas, H. (1996) Is proteolysis in the rumen of grazing animals mediated by plant enzymes? *British Journal of Nutrition* 75, 507–508.
- Topps, J.H. and Elliott, R.C. (1967) Partition of nitrogen in the urine of African sheep given a variety of low-protein diets. *Animal Production* 9, 219–227.
- Udén, P. (2000) Ruminal metabolism of buffer-soluble proteins, peptides and amino acids *in vitro*. In: McNamara, J.P., France, J. and Beever, D.E. (eds) *Modelling Nutrient Utilization in Farm Animals*. CAB International, Wallingford, UK, pp. 63–71.
- Ushida, K., Jouany, P., Lassalas, B. and Thivend, P. (1984) Protozoal contribution to nitrogen digestion in sheep. *Canadian Journal of Animal Science* 64 (Suppl.), 20–21.
- Van Soest, P. (1982) *Nutritional Ecology of the Ruminant*. O & B Books, Corvallis, Oregon.
- Van Vuuren, A.M. and Meijs, J.A. (1987) Fertilizer or waste? Effects of herbage excretion and supplement feeding on the excretion of nitrogen in dung and urine by grazing dairy cows. In: Van der Meer, H.G., Unwin, R.J., Van Dijk, T.A. and Ennik, G.C. (eds) *Animal Manure on Grassland and Fodder Crops*. Martinus Nijhoff Publishers, Dordrecht, The Netherlands, pp. 17–25.
- Varvikko, T. (1986) Microbially corrected amino acid composition of rumen-undegraded feed protein and amino acid degradability in the rumen of feeds enclosed in nylon bags. *British Journal of Nutrition* 56, 131–140.
- Virtanen, A.I. (1966) Milk production of cows on protein-free feed. *Science* 153, 1603–1614.

- Volden, H., Mydland, L.T. and Olaisen, V. (2002) Apparent ruminal degradation and rumen escape of soluble nitrogen fractions in grass and grass silage administered intraruminally to lactating dairy cows. *Journal of Animal Science* 80, 2704–2716.
- Waldo, D.R., Smith, L.W. and Cox, E.L. (1972) Model of cellulose disappearance from the rumen. *Journal of Dairy Science* 55, 125–129.
- Wallace, R.J. (1979) Effect of ammonia concentration on the composition, hydrolytic activity and nitrogen metabolism of the microbial flora of the rumen. *Journal of Applied Bacteriology* 47, 443–455.
- Wallace, R.J. (1985) Adsorption of soluble proteins to rumen bacteria and the role of adsorption in proteolysis. *British Journal of Nutrition* 53, 399–408.
- Wallace, R.J. (1990) Peptide metabolism in the rumen. In: Bercovici, D. (ed.) *Abstracts of Eurolysine Nutrition Workshop, Marseilles-Luminy*. Eurolysine, Paris.
- Wallace, R.J. (1996) Ruminal microbial metabolism of peptides and amino acids. *Journal of Nutrition* 126, 1326S–1334S.
- Wallace, R.J. and Cotta, M.A. (1988) Metabolism of nitrogen-containing compounds. In: Hobson, P.N. (ed.) *The Rumen Microbial Ecosystem*. Elsevier Applied Science, London, pp. 217–249.
- Wallace, R.J. and McPherson, C.A. (1987) Factors affecting the rate of breakdown of bacterial protein in rumen fluid. *British Journal of Nutrition* 58, 313–323.
- Wanjaiya, G.W., Wales, W.J. and Dellow, D.W. (1993) Utilisation of white clover pasture and maize silage by the lactating dairy cow. *Proceedings of the New Zealand Society of Animal Production* 53, 73–75.
- Webb, K.E., Jr, Dirienzo, D.B. and Matthews, J.C. (1993) Recent developments in gastrointestinal absorption and tissue utilization of peptides: a review. *Journal of Dairy Science* 76, 351–361.
- Wells, J.E. and Russell, J.B. (1996) Why do many ruminal bacteria die and lyse so quickly? *Journal of Dairy Science* 79, 1487–1495.

---

# 8

## Rumen Microorganisms and their Interactions

M.K. Theodorou<sup>1</sup> and J. France<sup>2</sup>

<sup>1</sup>BBSRC Institute for Grassland and Environmental Research, Aberystwyth, Dyfed SY23 3EB, UK; <sup>2</sup>Centre for Nutrition Modelling, Department of Animal & Poultry Science, University of Guelph, Guelph, Ontario N1G 2W1, Canada

---

### Introduction

Whilst herbivory is widespread in the animal kingdom, no vertebrates and few invertebrates are capable of synthesizing cellulose- or hemicellulose-digesting enzymes. Instead, herbivores have evolved symbiotic associations with microorganisms. Two main types of herbivory exist among mammals. The ruminants, cloven-hoofed mammals of the Artiodactyla, are best equipped for maximal digestion of plant biomass, which is achieved by prolonged retention within the gastrointestinal (GI) tract. The second type of herbivory is exemplified by members of the Equidae (horses) and Elephantidae (elephants), where plant material is passed through the GI tract more rapidly at the expense of maximal plant cell wall digestion. With this form of herbivory, a greater proportion of the nutrient supply to the animal is obtained from plant-cell contents than from cell-wall polymers.

Both types of herbivory are dependent upon microorganisms for the degradation and fermentation of plant-cell contents, cellulose, hemicellulose and pectin. Ruminants rely on a predominantly pre-gastric fermentation in the rumen, whereas in horses and elephants the fermentation occurs in the hind-gut, predominantly in the caecum. Although this chapter is concerned with quantitative aspects of rumen microbiology, it may have wider relevance since many similarities exist between microbial populations in the rumen and those found within the GI tract of post-gastric herbivores.

Due to microbial activity, conditions in the rumen are highly anaerobic with a redox potential of between  $-300$  and  $-350$  mV. Temperature remains relatively static at  $38-42^{\circ}\text{C}$ , due in part to the heat generated during fermentation, but mainly to the homoeothermic metabolism of the animal. Buffering capacity in the rumen is provided by the production of copious quantities of saliva containing bicarbonate and phosphate salts, which enable the rumen to be maintained at a pH of 6–7. Mixing of rumen contents and

some comminution of digesta particles occurs by repeated rhythmic contractions and relaxations of the rumen wall. However, most of the physical breakdown of plant biomass is brought about by initial chewing and subsequent rumination. Passage of digesta from the rumen is selective and is based on liquid flow and particle size. The flow of water, solute and small particles (including microbial cells) through the rumen may take 10–24 h, whereas larger particles (and attached microorganisms) can be retained for up to 2–3 days, thus providing time for microbial degradation of plant fibres.

In return for provision of a relatively constant environment and the continual supply of plant nutrients, the microbial population in the rumen supplies the host with easily utilizable forms of carbon and energy and with a protein source in the form of microbial biomass. The microorganisms, predominantly fermentative populations of bacteria, protozoa and fungi, are present in the liquid phase of digesta contents, in association with plant fragments, and as a lining on the rumen epithelium. Most are obligate anaerobes and will not grow in the presence of oxygen. Some facultative anaerobes are also present, and these scavenge available oxygen that enters the rumen with the feed or by diffusion across the rumen epithelium. Bacteria in rumen liquid are found at concentrations of  $10^9$ – $10^{10}$ /ml, whereas protozoal populations range from  $10^5$  to  $10^6$ /ml. The population density of rumen fungi (fungal zoospores) appears to be within the range  $10^3$ – $10^5$ /ml. Bacteria are generally believed to constitute most of the microbial biomass in the rumen, although estimates of up to 40% have been recorded for protozoal biomass in some animals. The amount of fungal biomass is thought to contribute less than 8% of the total.

Over 200 species of rumen bacteria have been described since the pioneering work of R.E. Hungate began in the 1940s. All of the principal morphological forms of small bacteria, including Gram-positive and Gram-negative rods, cocci, crescents, vibrios and helices, occurring singly, in chains, tetrads and clumps, are found in the rumen. Larger bacteria such as the distinctive 'Quin's and Eadie's ovals', notable from our inability to grow them in pure culture, are also represented. The rumen also contains numerous species of protozoa, most of which do not rely solely on plant nutrients for growth, but feed by phagocytosis (predation) on rumen bacteria, fungal zoospores and other protozoa. Of the 100 plus species of rumen protozoa described in the literature, none are maintainable in axenic culture and only about 20 have been grown *in vitro* in the presence of bacteria. Three groups of protozoa are recognized: the rumen flagellates, the entodiniomorphs and the holotrichs. The rumen flagellates have been the least studied and some are now considered to be zoospores of rumen fungi. The rumen fungi are a unique group of cellulolytic anaerobes whose existence in the rumen was not accepted until comparatively recently. At least 12 species belonging to six genera have now been described and this number is expected to increase with continued research.

## Species Diversity and Activity

Species diversity and the size and activity of the microbial population in the rumen are not constant, but vary according to changing dietary conditions. In the wild, this variation is largely a reflection of seasonal and climatic differences and their effect on the availability, composition and variety of vegetation for ingestion by ruminants. In domesticated ruminants, however, where conditions are less variable, changes in diet composition and its physical form are largely responsible for changes in the microbial population (Thorley *et al.*, 1968; Mackie *et al.*, 1978). Frothy bloat in cattle can be cited as an extreme case, where dietary change has a dramatic influence on the rumen microbial population. This disorder, occurring soon after the ingestion of certain rapidly degradable forage legumes, is related to persistence of an extremely high bacterial population in the rumen dominated by the murinolytic bacterium, *Lachnospira multiparus* (Theodorou *et al.*, 1984).

Much of the available energy in ruminant feeds is in the form of structural plant cell-wall polymers – cellulose, hemicellulose and pectin. Microorganisms capable of degrading these polymers to their monomeric constituents for fermentation by themselves or by others are of principal importance in the rumen. The major species involved in cellulose degradation are *Bacteroides succinogenes*, *Ruminococcus albus*, *R. flavefaciens* and *Eubacterium cellulosolvens*. These bacteria adhere closely to plant cell-wall surfaces forming erosion pits as they degrade cellulosic substrates (Chesson and Forsberg, 1997). Recent molecular techniques allow an improved insight into the kinetics of fibre attachment by rumen bacteria, demonstrating that degradation is not necessarily synchronized with changes in attached bacterial biomass (Koike *et al.*, 2003). Hemicellulose is also degraded by some of the cellulolytic microorganisms, together with other bacteria such as *Butyrivibrio fibrisolvens* and *Bacteroides ruminicola* (Hungate, 1966; Dehority and Scott, 1967). Fungi and bacteria contribute most towards degradation of plant cell walls, the protozoal contribution on the majority of diets being only some 5% to 20% of total rumen NDF degradation (Dijkstra and Tamminga, 1995). The pectolytic activities of the predominant pectin-degrading bacteria (e.g. *B. fibrisolvens*, *L. multiparus*) and protozoa have been identified (Wojciechowicz *et al.*, 1982; Williams, 1986), though little has been published on their properties. In contrast to rumen bacteria and protozoa, the anaerobic fungi exhibit little hydrolytic activity towards pectin (Williams and Orpin, 1987).

Although absent from plant cell walls, starch is an important component of many ruminant diets, especially those including grain. Some cellulolytic bacteria, such as certain strains of *B. succinogenes*, are also amylolytic. In general, however, the principal amylase-producing bacteria, *Bacteroides amylopilus*, *Selenomonas ruminantium* and *Streptococcus bovis*, have a limited ability to utilize other polysaccharides. These microorganisms, together with soluble-sugar utilizers such as *Megasphaera elsdenii*, occupy a distinct ecological niche in the rumen. Although they are in competition with many other rumen microorganisms

for these readily degradable substrates, they survive because of their faster growth rates or greater substrate affinities (Hobson, 1971; Lin *et al.*, 1985).

Proteins entering the rumen are rapidly degraded with the release of nitrogen as ammonia. Most rumen microorganisms, with the possible exception of the main cellulolytic bacteria, are proteolytic to some extent. *B. amylophilus*, *B. fibrisolvens*, *B. ruminicola* and the proteolytic *Butyrivibrios* are considered to be the major proteolytic species in the rumen (Hobson and Wallace, 1982). Almost all species of rumen bacteria and fungi, but few protozoa, can utilize ammonia as a precursor for cellular nitrogen compounds (Bryant and Robinson, 1962; Wolin, 1979). Competition for ammonia by rumen microorganisms will only occur in certain situations, notably when the quality of the feed and dietary levels of N are poor (mainly in the tropics and subtropics). Rumen bacteria are efficient scavengers of N sources and uptake of ammonia is represented satisfactorily using saturated kinetics, allowing predictions of optimal levels of N-supplementation when the basal diet is deficient in N (see review by Dijkstra *et al.*, 2002).

The majority of rumen microorganisms use the Embden–Meyerhof–Parnas and pentose–phosphate pathways to ferment the hexose and pentose products of polysaccharide degradation to pyruvate. Pyruvate can then be metabolized in a number of different ways to various end-products, including formate, acetate, propionate, butyrate, lactate, succinate, methanol, ethanol, CO<sub>2</sub> and H<sub>2</sub>. In the rumen ecosystem, however, some of these compounds are present in only trace amounts, since they are utilized as substrates for growth by secondary microorganisms. Some examples of bacteria that exist in the rumen by using the products of primary fermentation include the lactate and succinate utilizing species, *Veillonella parvula*, *M. elsdenii* and *S. ruminantium*. As a consequence of their activity, lactate and succinate are converted to acetate or propionate. Methanogenic archaeobacteria such as *Methanobrevibacter ruminantium* and *Methanosacina barkeri* utilize either H<sub>2</sub> and CO<sub>2</sub> or formate, acetate, methylamine and methanol for the production of methane. The involvement of these bacteria in inter-species hydrogen transfer is an important interaction that alters the fermentation balance and results in a shift of the overall fermentation from less- to more-reduced end-products (Wolin, 1974). Although fermentation pathways are well established, the prediction of the type of volatile fatty acids (VFA) that is produced in the functioning rumen remains a difficult task (Bannink *et al.*, 2000).

Some of the bacteria that participate in degradation of structural polysaccharides are unable to utilize all of the products liberated as a consequence of their activity. Whereas *R. flavefaciens* produces both xylanase and pectinase, it cannot utilize the end-products of xylan or pectin degradation (Pettipher and Latham, 1979a,b). Thus, these energy-rich compounds are made available as substrates for growth of other rumen microorganisms. In a similar case, some of the energy-rich products of hemicellulose degradation are not utilized by the anaerobic fungus *Neocallimastix hurleyensis* that produces them (Lowe *et al.*, 1987; Theodorou *et al.*, 1989). This apparently altruistic behaviour between rumen microorganisms has been demonstrated on numerous occasions and is thought to be related to cross-feeding interactions. In return for the provision of readily

utilizable substrates, the recipient microorganism provides the primary degrader with an essential growth factor, such as a vitamin or cofactor. In another example, the combination of a pectin-utilizing bacterium (*B. ruminicola*) increased the degradation and utilization of lucerne pectin (Gradel and Dehority, 1972). In this situation both organisms benefit from a mutualistic association.

Some microorganisms are able to coexist in the rumen without affecting the metabolism of others. This situation is comparatively rare and is usually attributed to highly specialized microorganisms, which have the ability to use substrates that are not degradable by others. As examples of this type of neutralistic interaction, the degradation of oxalate by *Oxalobacter formigenes* (Dawson *et al.*, 1980) and 3-hydroxy-4-1(H)-pyridone degradation by unidentified Gram-negative rods (Jones and Megarrity, 1986; Allison *et al.*, 1987) can be cited.

Protozoa are able to degrade all the major plant biomass for subsequent digestion within the body of the ciliate, and holotrich protozoa such as *Dasytricha* and *Isostricha* can obtain their energy requirements either by uptake of soluble sugars or via the production of cellulases for degradation of plant biomass polymers (Hobson and Wallace, 1982; Williams and Coleman, 1997). One of the least studied but perhaps the most significant interactions in the rumen is that of predation. Although protozoa are able to utilize plant nutrients, much of their nitrogen requirements are derived from the phagocytosis of other microorganisms. The role of protozoa in the rumen is not entirely clear and this is due in part to limited success in culturing these microorganisms *in vitro*. Alternatively, mathematical modelling has been applied to examine quantitatively protozoal biomass and activities in the rumen and interactions (through predation amongst others) with bacteria (Dijkstra, 1994). In addition, since defaunated animals remain perfectly healthy, it could be argued that protozoa are not an essential component of the rumen microflora. However, these organisms can form a significant proportion of the microbial biomass apparently selectively retained within the rumen (Michalowski *et al.*, 1986). As a consequence of sequestration and because of their involvement in predator-prey interactions, the rumen protozoa undoubtedly affect feed conversion efficiency via the recycling of microbial cells in the rumen (Dijkstra *et al.*, 1998).

Even minor microbial populations can have a significant effect on rumen function. The anaerobic fungi are relatively low in numbers in comparison with cellulolytic bacteria. When fully developed, the fungal thallus consists of one (monocentric) or more (polycentric) zoosporangia supported by a system of branched, tapering rhizoids (as in *Neocallimastix* spp., *Piromyces* spp. and *Orpinomyces* spp.) or bulbous holdfasts (as in *Caecomycetes* spp.). These penetrate plant substrates, both for anchorage and to obtain nutrients for growth. Thus, due to their invasive habit, the anaerobic fungi may escape competition with faster growing cellulolytic bacteria. Upon completion of the life cycle, the particle-associated zoosporangium ruptures, liberating zoospores back into the rumen liquid. These swimming cells have evolved a chemotrophic mechanism that assists in the search for, attachment to and colonization of freshly ingested plant fragments. The most likely role for rumen fungi is that they participate in primary colonization of plant cell walls thereby increasing the accessibility of plant fragments to invasion by other microorganisms (Bauchop, 1979a,b). Indeed, in

co-cultures the fungal mode of attack reduces mechanical resistance of particles, allowing increased bacterial attack on those damaged particles and possible coexistence of fungi and bacteria (Dijkstra and France, 1997; Fonty *et al.*, 1999). In addition to degrading plant cell walls, these microorganisms can also utilize certain soluble sugars, starch and proteins, but not pectin (Orpin and Joblin, 1988).

Although it is essential in rumen microbial ecology to obtain knowledge of which species are present and of their activities, traditional methods have limited applicability. Despite major improvements in isolation or cultivation strategies, only a minority of the rumen microorganisms have been described in pure culture. Total viable counts are usually much lower than total microscopic counts (Zoetendal *et al.*, 2003). The majority of microbial species cannot be obtained in culture and have only been detected using molecular detection methods (Amann *et al.*, 1995), with an estimated culturability of bacteria in the total GI tract of some 10–50%. To date, the majority of molecular studies of microbial ecosystems have been focused on the characterization of the community structure or identifying the bacteria in the rumen. More important, however, is the study of operation and interaction of different organisms. To achieve this, a promising way forward is to measure the expression of functional genes.

The above account is an overview and the reader is referred to Hobson and Stewart (1997) for a more detailed description of the rumen ecosystem and the various species of anaerobic and facultative bacteria, protozoa and fungi found therein.

## Growth Characteristics

The growth characteristics of a microorganism are generally defined in terms of various parameters: specific growth rate  $\mu$  (per hour) or biomass doubling time, growth lag  $L$  (h), growth yield, maximum biomass, metabolic quotient for substrate utilization  $q_i$  [mg substrate  $i$ /(mg biomass)/h] and for product formation and substrate affinity. Most of these parameters are usually determined from the growth of an axenic batch culture consisting of a well-mixed batch of inoculated medium. Parameters that cannot readily be determined in this way are generally obtained using a chemostat. The requisite conditions for biomass growth in culture are: (i) a viable inoculum; (ii) an energy source; (iii) nutrients to provide the essential materials for biomass synthesis; (iv) absence of growth-preventing inhibitors; and (v) suitable physicochemical conditions (Pirt, 1975). If these conditions are met and provided substrate concentrations are non-limiting, the following  $N + 1$  differential equations describe the dynamic behaviour of the batch culture:

$$\frac{dX}{dt} = 0 \quad 0 \leq t < L \quad (8.1a)$$

$$= \mu X \quad t \geq L \quad (8.1b)$$



$$dS_i/dt = 0 \quad 0 \leq t < L \quad (8.2a)$$

$$= -q_i X \quad t \geq L \quad (8.2b)$$

where  $t$  (h) denotes time since inoculation,  $X$  (mg) is the amount of biomass at time  $t$  and  $S_i$  (mg) is the instantaneous quantity of substrate  $i$ , where  $i = 1, 2, \dots, N$ . For constant  $\mu$ , integration of Eqs (8.1a) and (8.1b) gives:

$$X = X_0 \quad 0 \leq t < L \quad (8.3a)$$

$$= X_0 e^{\mu(t-L)} \quad t \geq L \quad (8.3b)$$

where  $X_0$  is initial biomass, therefore biomass obeys the law of constant exponential growth. Logarithmic transformation of Eq. (8.3b) yields:

$$\ln X = \ln X_0 + \mu(t - L) \quad t \geq L \quad (8.4)$$

Thus the plot of log biomass against time ( $\geq L$ ) is a straight line whose slope equals the specific growth rate  $\mu$ . The growth lag  $L$  can also be determined graphically by extrapolating this straight line back to the initial biomass level and reading off the intercept on the time axis. Values of  $\mu$  determined in this way by Russell and Baldwin (1978) for rumen bacteria grown on a single energy substrate in a defined medium are presented in Table 8.1. Corresponding values for  $L$  appear to be in the range 0–2 h, mostly nearer to 0 than 2 h.

The doubling time  $t_d$  (h) of the biomass is found by setting  $X = 2X_0$  and  $t = t_d$  in Eq. (8.4) and rearranging:

$$t_d = (\ln 2)/\mu + L \quad (8.5)$$

For example, the doubling times (from the commencement of growth) of the rumen bacteria grown on glucose shown in Table 8.2 range from 0.34 h for *S. bovis* to 1.78 h for *B. fibrisolvens*. The ratio  $X/X_0$  represents the degree of multiplication and is equal to  $e^{\mu(t-L)}$ ,  $t \geq L$  (see Eq. (8.3b)). Alternatively, this ratio can be expressed as  $2^n$ , where  $n$  is the number of doublings or generations that the biomass has undergone, giving:

**Table 8.1.** Specific growth rates for rumen bacteria on single substrates.

Species	Specific growth rate (per h) in					
	Glucose	Maltose	Sucrose	Cellobiose	Xylose	Lactate
<i>S. ruminantium</i>	0.72	0.35	0.67	0.06	0.64	0.15
<i>B. ruminicola</i>	0.56	0.52	0.62	0.20	0.04	
<i>B. fibrisolvens</i>	0.39	0.54	0.52	0.53	0.45	
<i>S. bovis</i>	2.04	1.85	2.10	1.83		
<i>M. elsdenii</i>	0.45	0.55	0.14			0.21

**Table 8.2.** Theoretical maximum growth yields on glucose for rumen bacteria (derived from double reciprocal plots of yield against dilution rate).

Species	Yield (mg biomass per g glucose)
<i>B. fibrisolvens</i>	0.4
<i>B. ruminicola</i>	0.5
<i>M. elsdenii</i>	0.46
<i>S. bovis</i>	0.4
<i>S. ruminantium</i>	0.58

$$n = [\ln(X/X_0)] / \ln 2 \quad (8.6)$$

The growth yield parameter provides a means of expressing the nutrient requirement of a microorganism. Growth yield with respect to substrate  $i$ ,  $Y_i$  [mg biomass/(mg substrate  $i$ )], is defined by:

$$Y_i = -dX/dS \quad (8.7)$$

For constant  $Y_i$ , integration of Eq. (8.7) yields:

$$X = X_0 + Y_i(S_{i,0} - S_i) \quad (8.8)$$

where  $S_{i,0}$  denotes the initial value of  $S_i$ . Hence, if the culture volume remains constant, a plot of biomass concentration against concentration of substrate  $i$  should be a straight line with slope  $Y_i$ . Some yields estimated for glucose by Russell and Baldwin (1979a) are shown in Table 8.2, though we note that these were estimated using chemostat rather than batch culture. For a growth-limiting substrate  $S_i$ , biomass reaches its maximum  $X_\infty$  when  $S_i$  reaches zero. Equation (8.8) gives:

$$X_\infty = X_0 + Y_i S_{i,0} \quad (8.9)$$

The growth yield and specific growth rate are related by the metabolic quotient:

$$q_i = \mu/Y_i \quad (8.10)$$

This can be shown by dividing Eqs (8.1b) by (8.2b) to give:

$$dX/dS_i = -\mu/q_i \quad (8.11)$$

and comparing Eqs (8.7) and (8.11). Equation (8.10) can be used to estimate the demands for substrates at different growth rates. For example, values of  $q_{\text{glucose}}$  for rumen bacteria obtained from Tables 8.1 and 8.2 range from 1 to 5.1 g/(g biomass)/h.

If the law of constant exponential growth is not satisfied, then the specific growth rate of the biomass will vary. Let  $\mu$  change with substrate concentration and assume that the  $i$ th substrate alone is limiting:

$$\mu = \mu_{\max}/[1 + K_i/(S_i/V)] \quad (8.12)$$

where  $\mu_{\max}$  denotes the maximum value of  $\mu$ ,  $K_i$  (mg substrate  $i$  per ml) the saturation constant and  $V$  (ml) the culture volume. This rectangular hyperbola is known as the Monod equation after Monod (1942) who first demonstrated that the expression accorded well with the relation of bacterial growth to substrate concentration. It is analogous to the Michaelis–Menten equation of enzyme kinetics. Specific growth rate is half maximal (i.e. equals  $\mu_{\max}/2$ ) when substrate concentration equals the saturation constant  $K_i$  and this constant is inversely related to the affinity of the microorganism for substrate  $i$ , a high  $K_i$  value indicating a low-affinity and vice versa. Inverting Eq. (8.12) gives:

$$1/\mu = \mu_{\max}^{-1} + K_i\mu_{\max}^{-1}/(S_i/V) \quad (8.13)$$

Hence a double reciprocal plot of specific biomass growth rate against substrate  $i$  concentration should give a straight line with intercept  $\mu_{\max}^{-1}$  and slope  $K_i\mu_{\max}^{-1}$ . If the biomass is cultivated in a chemostat, then Eq. (8.1b) is replaced by:

$$dX/dt = (\mu - D)X \quad t \geq T \quad (8.14)$$

where  $D$  (per hour) denotes the constant dilution rate. Biomass cultivation reaches steady state when  $\mu$  equals  $D$ , and then Eq. (8.13) becomes:

$$1/D = \mu_{\max}^{-1} + K_i\mu_{\max}^{-1}/(S_i/V) \quad (8.15)$$

Values of  $\mu_{\max}$  and  $K_i$  determined in this way by Russell and Baldwin (1979b) by altering  $D$  are given in Tables 8.3 and 8.4, respectively.

## Physical Analogues

In attempting to understand microbial growth and interaction in the rumen, physical analogues of the rumen ecosystem have often been employed, mostly

**Table 8.3.** Maximum specific growth rates for rumen bacteria grown on single substrates.

Species	Maximum specific growth rate (per h) in					
	Glucose	Maltose	Sucrose	Cellobiose	Xylose	Lactate
<i>S. ruminantium</i>	0.95	0.83	1.25		1.11	
<i>B. ruminicola</i>	0.59	2.1	5.0	4.0		
<i>B. fibrisolvens</i>	0.5	0.5	0.83	0.62	0.71	
<i>S. bovis</i>	20.0	2.94	3.5	5.88		
<i>M. elsdenii</i>	0.53	1.66				1.0

**Table 8.4.** Saturation constants for rumen bacteria grown on single substrates.

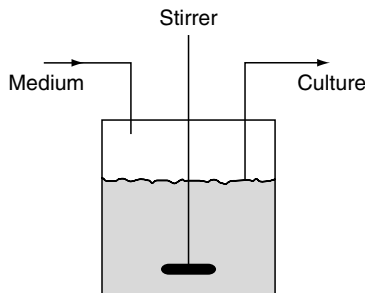
Species	Saturation constant (mM) in					
	Glucose	Maltose	Sucrose	Cellobiose	Xylose	Lactate
<i>S. ruminantium</i>	0.046	0.058	0.004		0.07	
<i>B. ruminicola</i>	0.168	0.975	2.94	11.76		
<i>B. fibrisolvans</i>	0.009	0.006	0.262	0.01	0.367	
<i>S. bovis</i>	5.56	0.155	0.058	1.27		
<i>M. elsdenii</i>	0.111	0.34				0.37

based on the chemostat. Whilst these fall short of fully simulating the rumen, they do offer a useful means of studying its microorganisms under closely controlled and defined conditions. In this section, simplified mathematical models of three analogues are developed, namely the chemostat, the consecutive batch culture and the repeated fed batch culture. For ease of exposition, the models deal with mixed cultures containing only two microbial species  $X_1$  and  $X_2$  (both mg biomass) though they can be generalized to accommodate a larger number of species.

### The chemostat

A chemostat culture (Fig. 8.1) consists of a thoroughly mixed suspension of biomass into which medium is added at a constant rate  $F$  (ml/h) and culture is removed at the same rate so that the culture volume  $V$  (ml) in the chemostat stays constant. For any microbial species to survive in a chemostat culture, its specific growth rate  $\mu$  (per hour) must exceed the dilution rate  $D$  (per hour) (i.e. the culture outflow per unit volume =  $F/V$ ). The conditions for the continued survival of two species are summarized in Table 8.5.

If there is free competition for the same growth-limiting substrate  $S$  (mg), chemostat dynamics (subsequent to any growth lag that might occur) are essentially described by three differential equations:



**Fig. 8.1.** The chemostat. The shaded area represents the constant volume and the arrowed lines continuous flows.

**Table 8.5.** Basic conditions for maintaining two microbial species in a chemostat culture given the dilution rate does not exceed the critical dilution rate for either species (after Pirt, 1975).

- 
- I. With same growth-limiting substrate
    - (i) when specific growth rates coincide
    - (ii) when the faster-growing species is inhibited by its own product
    - (iii) when a product of the faster-growing species activates growth of the other species
  - II. With different growth-limiting substrates
    - (i) when the different growth-limiting substrates are fed into the culture
    - (ii) when a product of one species is the growth-limiting substrate for the other
    - (iii) when there is a predator–prey relationship
- 

$$dX_1/dt = (\mu_1 - D)X_1 \tag{8.16}$$

$$dX_2/dt = (\mu_2 - D)X_2 \tag{8.17}$$

$$dS/dt = CF - \mu_1 X_1/Y_1 - \mu_2 X_2/Y_2 - DS \tag{8.18}$$

where:

$$\mu_1 = \mu_{1, \max}/[1 + K_1/(S/V)] \tag{8.19}$$

$$\mu_2 = \mu_{2, \max}/[1 + K_2/(S/V)] \tag{8.20}$$

In these equations,  $K$  (mg substrate per ml) and  $Y$  [mg biomass/(mg substrate)] denote saturation and yield constants, respectively, and  $C$  [mg substrate/(ml medium)] is the concentration of substrate in the added medium. As the two species compete freely for the same substrate, the one with the faster specific growth rate will eventually eliminate the other from the culture. If there is a crossover of specific growth rates (i.e.  $\mu_1$  exceeds  $\mu_2$  when the concentration of  $S$  is less than  $S_x/V$  but  $\mu_2$  exceeds  $\mu_1$  when the concentration is greater than  $S_x/V$ , or vice versa), the rate of addition of substrate via the medium determines the faster growing species. The two species would be maintained in the chemostat at the crossover point where  $\mu_1 = \mu_2 = \mu_x = D_x$  and  $S = S_x$  (case I(i), Table 8.5).  $S_x$  is found by equating Eqs (8.19) and (8.20):

$$S_x = V(K_1\mu_{2, \max} - K_2\mu_{1, \max})/(\mu_{1, \max} - \mu_{2, \max}) \tag{8.21}$$

Competition for the same growth-limiting substrate can be controlled by the faster growing of the two species inhibiting its own growth rate through a product (case I(ii)). If a product  $P$  (mg) of species 1 competitively inhibits its uptake of substrate  $S$ , then chemostat dynamics is as above but with Eq. (8.19) replaced by:

$$\mu_1 = \mu_{1, \max}/[1 + \alpha K_1/(S/V)] \tag{8.22}$$

where

$$\alpha = [1 + (P/V)/J] \tag{8.23}$$

The parameter  $J$  (mg product per ml) is an inhibition constant. If  $\mu_1$  is greater than  $\mu_2$  when  $P$  is zero, then by increasing  $P$  it is possible for  $\mu_1$  and  $\mu_2$  to become equal so that the two species are maintained in the chemostat and the system is self-regulating. If  $P$  is a non-competitive inhibitor of growth, then Eq. (8.19) is replaced by:

$$\mu_1 = \mu_{1,\max}/\{\alpha[1 + K_1/(S/V)]\} \quad (8.24)$$

where  $\alpha$  is again given by Eq. (8.23). Competition can also be controlled if the faster-growing species 1 produces a growth activator for species 2 (case I(iii)). Chemostat dynamics is now given by Eqs (8.16)–(8.19) above and Eq. (8.20) is replaced by:

$$\mu_2 = \beta\mu_{2,\max}/[1 + K_2/(S/V)] \quad (8.25)$$

where  $\beta$  increases with the concentration of the activatory product  $P$ . It is assumed that  $\beta$  is unity and  $\mu_2$  is less than  $\mu_1$  when  $P$  is zero.  $\beta$  increases with increasing  $P$  until eventually  $\mu_1$  and  $\mu_2$  are equal.

If the two microbial species utilize different growth-limiting substrates  $S_1$  and  $S_2$ , respectively (case II(i)), the basic differential equations for the chemostat culture become:

$$dX_1/dt = (\mu_1 - D)X_1 \quad (8.26)$$

$$dX_2/dt = (\mu_2 - D)X_2 \quad (8.27)$$

$$dS_1/dt = C_1F - \mu_1X_1/Y_1 - DS_1 \quad (8.28)$$

$$dS_2/dt = C_2F - \mu_2X_2/Y_2 - DS_2 \quad (8.29)$$

where

$$\mu_1 = \mu_{1,\max}/[1 + K_1/(S_1/V)] \quad (8.30)$$

$$\mu_2 = \mu_{2,\max}/[1 + K_2/(S_2/V)] \quad (8.31)$$

The symbols  $C_1$  and  $C_2$  denote the respective concentrations of the substrates  $S_1$  and  $S_2$  in the added medium. Both species are maintained in the chemostat provided, of course, that  $D$  does not exceed the critical dilution rate for either species. If the growth-limiting substrate for species 2 is a product of the growth of species 1 (case II(ii)), the same dynamic equations (i.e. Eqs (8.26)–(8.31)) apply but with Eq. (8.29) amended to:

$$dS_2/dt = Y'\mu_1X_1 - \mu_2X_2/Y_2 - DS_2 \quad (8.32)$$

where  $Y'$  [mg  $S_2$ /(mg  $X_1$ )] is the yield of product per unit growth of species 1.

Predator–prey interaction in the rumen is exemplified by protozoa ingesting bacteria. With regard to our chemostat (case II(iii)), let  $X_2$  be the predator

species and  $X_1$  the prey which utilizes a single growth-limiting substrate  $S$ . For this case, chemostat dynamics are described by:

$$dX_1/dt = (\mu_1 - D)X_1 - \mu_2 X_2 / Y_2 \quad (8.33)$$

$$dX_2/dt = (\mu_2 - D)X_2 \quad (8.34)$$

$$dS/dt = CF - \mu_1 X_1 / Y_1 - DS \quad (8.35)$$

where

$$\mu_1 = \mu_{1, \max} / [1 + K_1 / (S/V)] \quad (8.36)$$

$$\mu_2 = \mu_{2, \max} / [1 + K_2 / (X_1/V)] \quad (8.37)$$

Note that  $Y_2$  and  $K_2$  are now in slightly changed units, namely mg of  $X_2$  biomass synthesized per mg  $X_1$  biomass ingested and mg of  $X_1$  biomass per ml of culture. Also note that in this set of equations, protozoa do not utilize substrate, but obtain all of their nutritional requirements from ingested bacteria. This assumption is not valid in the rumen proper and further extensions of the equations described above to include substrate utilization by protozoa are necessary (Dijkstra, 1994). It can be seen from an inspection of Eqs (8.33) and (8.34) that in steady state the specific growth rate of the predator equals the dilution rate and the specific growth rate of the prey exceeds the dilution rate if both species are to be maintained. The reader is referred to Dijkstra and France (1997) and Grivet (2001) for further modelling and mathematical analysis of the chemostat.

### ***The consecutive batch culture***

A consecutive batch culture (Fig. 8.2) involves sequential transfer of inoculum from one batch culture to the next, with a representative sample of the current batch providing the inoculum for the next. Unlike a simple batch culture, the system is not a closed one, yet it does not require the level of technical skill needed to operate a truly continuous system such as a chemostat. The culture conditions represent an intermediate step between batch and continuous cultures.

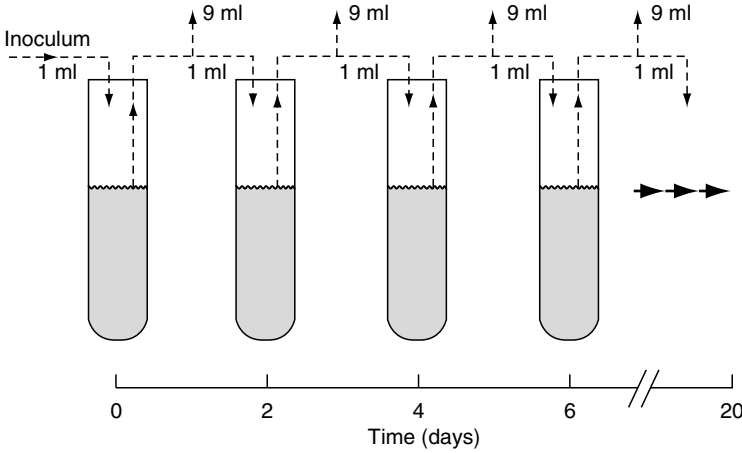
The dynamics of the growth (subsequent to any lag) of two microbial species competing freely for the same growth-limiting substrate in a simple batch culture are modelled using the following equations:

$$dX_1/dt = \mu_1 X_1 \quad (8.38)$$

$$dX_2/dt = \mu_2 X_2 \quad (8.39)$$

$$dS/dt = -\mu_1 X_1 / Y_1 - \mu_2 X_2 / Y_2 \quad (8.40)$$

where



**Fig. 8.2.** The consecutive batch culture. In the exemplary scheme depicted, 1 ml of inoculum is added to 9 ml of medium on Day 0, and on Day 2 a representative 1 ml sample of this culture is added to another 9 ml of the medium. The process is repeated every second day until Day 20. The shaded area represents culture volume and the broken lines periodic transfers. The culture is shaken or stirred from time to time.

$$\mu_1 = \mu_{1, \max} / [1 + K_1 / (S/V)] \quad (8.41)$$

$$\mu_2 = \mu_{2, \max} / [1 + K_2 / (S/V)] \quad (8.42)$$

The species 1 and 2 simultaneously cease to grow when the supply of  $S$  becomes exhausted. Equations (8.38)–(8.42) apply equally to a consecutive batch system. They are, however, perturbed every time a transfer is made. If  $X_{1,0}^{(1)}$ ,  $X_{2,0}^{(1)}$  and  $S_0^{(1)}$  are the original values of  $X_1$ ,  $X_2$  and  $S$  (i.e. the initial values for the first batch), then the initial values for the  $i$ th batch culture in the sequence ( $i = 2, 3, \dots, N$ ) are:

$$X_{1,0}^{(i)} = (V'/V)X_{1,f}^{(i-1)} \quad (8.43)$$

$$X_{2,0}^{(i)} = (V'/V)X_{2,f}^{(i-1)} \quad (8.44)$$

$$S_0^{(i)} = S_0^{(1)} + (V'/V)S_f^{(i-1)} \quad (8.45)$$

where  $X_{1,f}^{(i-1)}$ ,  $X_{2,f}^{(i-1)}$  and  $S_f^{(i-1)}$  denote the values of  $X_1$ ,  $X_2$  and  $S$  in the  $i-1$ th batch immediately prior to transfer of inoculum to the  $i$ th batch. These three equations assume constant culture and transfer volumes  $V$  and  $V'$  (both ml), respectively, and the same quantity of substrate  $S_0^{(1)}$  in each batch prior to inoculation.

The model is adapted for controlled competition in the way described for the chemostat. If competition for  $S$  is controlled by the faster-growing microbial species (1 say) competitively inhibiting its own growth rate through a product  $P$ , Eq. (8.41) above is replaced by Eqs (8.22) and (8.23). However, if competition is controlled by species 1 non-competitively inhibiting its growth rate, Eqs



(8.23) and (8.24) apply instead of (8.41). If competition is controlled by species 1 producing a growth activator for species 2, Eq. (8.42) above is replaced by Eq. (8.25).

If species 1 and 2 utilize different growth-limiting substrates  $S_1$  and  $S_2$  respectively, then (post-lag) dynamics in a simple batch culture are given by:

$$dX_1/dt = \mu_1 X_1 \quad (8.46)$$

$$dX_2/dt = \mu_2 X_2 \quad (8.47)$$

$$dS_1/dt = -\mu_1 X_1/Y_1 \quad (8.48)$$

$$dS_2/dt = -\mu_2 X_2/Y_2 \quad (8.49)$$

where

$$\mu_1 = \mu_{1,\max}/[1 + K_1/(S_1/V)] \quad (8.50)$$

$$\mu_2 = \mu_{2,\max}/[1 + K_2/(S_2/V)] \quad (8.51)$$

The two species cease to grow when their respective substrates are exhausted. These equations can be solved analytically for constant yields  $Y_1$  and  $Y_2$  to give:

$$(X_1/X_{1,0})^{A_1}/[(Y_1 S_{1,0} + X_{1,0} - X_1)/(Y_1 S_{1,0})]^{B_1} = \exp(\mu_{1,\max} t) \quad (8.52)$$

$$(X_2/X_{2,0})^{A_2}/[(Y_2 S_{2,0} + X_{2,0} - X_2)/(Y_2 S_{2,0})]^{B_2} = \exp(\mu_{2,\max} t) \quad (8.53)$$

where

$$A_1 = (K_1 Y_1 + S_{1,0} Y_1 + X_{1,0})/(S_{1,0} Y_1 + X_{1,0}) \quad (8.54)$$

$$B_1 = K_1 Y_1/(S_{1,0} Y_1 + X_{1,0}) \quad (8.55)$$

and the subscript 0 indicates an initial value. The parameters  $A_2$  and  $B_2$  are similarly defined with subscript 2 replacing 1. Equation (8.52) describes a growth curve in which  $X_1$  increases sigmoidally to asymptote at  $(Y_1 S_{1,0} + X_{1,0})$ ; likewise Eq. (8.53). If the growth-limiting substrate for species 2 is a product of the growth of species 1, Eqs (8.46)–(8.51) apply but with Eq. (8.49) amended to:

$$dS_2/dt = Y' \mu_1 X_1 - \mu_2 X_2/Y_2 \quad (8.56)$$

(cf. Eq. (8.32)). However, this revised set of equations no longer has an analytical solution. Equations (8.46)–(8.56) apply equally to a consecutive batch system and initial values for the  $i$ th batch in the sequence are given by Eqs (8.43)–(8.45).

Predator–prey interactions can be modelled as follows. If  $X_2$  represents the biomass of the predator and  $X_1$  that of the prey which utilizes a single-growth limiting substrate  $S$ , simple-batch-culture dynamics are described by:

$$dX_1/dt = \mu_1 X_1 - \mu_2 X_2 / Y_2 \quad (8.57)$$

$$dX_2/dt = \mu_2 X_2 \quad (8.58)$$

$$dS/dt = -\mu_1 X_1 / Y_1 \quad (8.59)$$

where  $\mu_1$  and  $\mu_2$  are given by Eqs (8.36) and (8.37), respectively. This set of equations also applies to a consecutive batch system, with initial values again given by Eqs (8.43)–(8.45).

### The repeated fed batch culture

A repeated fed batch (RFB) culture (Fig. 8.3) is a stirred batch culture that is fed continuously with nutrient medium and a portion of the culture is withdrawn at intervals. Like the chemostat and consecutive batch culture, it can be maintained indefinitely. The cyclical volume variation distinguishes it from a chemostat culture in which the culture volume must be kept constant.

If there is free competition for the same growth-limiting substrate, RFB culture dynamics (subsequent to any growth lag that might occur) are essentially described by four differential equations:

$$dX_1/dt = \mu_1 X_1 \quad (8.60)$$

$$dX_2/dt = \mu_2 X_2 \quad (8.61)$$

$$dS/dt = CF - \mu_1 X_1 / Y_1 - \mu_2 X_2 / Y_2 \quad (8.62)$$

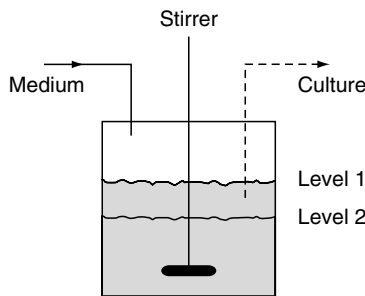
$$dV/dt = F \quad (8.63)$$

where

$$\mu_1 = \mu_{1, \max} / [1 + K_1 / (S/V)] \quad (8.64)$$

$$\mu_2 = \mu_{2, \max} / [1 + K_2 / (S/V)] \quad (8.65)$$

$F$  denotes the rate at which feed is added to the culture and  $C$  the concentration of substrate in the added nutrient medium. These differential equations are



**Fig. 8.3.** The repeated fed batch culture. The shaded area represents culture volume, which oscillates between levels 1 and 2. Medium is continuously added and culture periodically removed. Some of the culture is removed when level 1 is reached, reducing its volume to level 2.

perturbed each time the culture volume  $V$  reaches a value  $V_f$  when a portion is removed leaving a residual volume  $V_0$ . The initial values of  $X_1$ ,  $X_2$  and  $S$  for the current cycle are therefore their respective final values for the previous cycle multiplied by the ratio  $V_0/V_f$ . The model is adapted for controlled competition as described for the chemostat and consecutive batch culture.

If the two microbial species utilize different growth-limiting substrates, the basic differential equations for the RFB batch culture are:

$$dX_1/dt = \mu_1 X_1 \quad (8.66)$$

$$dX_2/dt = \mu_2 X_2 \quad (8.67)$$

$$dS_1/dt = C_1 F - \mu_1 X_1/Y_1 \quad (8.68)$$

$$dS_2/dt = C_2 F - \mu_2 X_2/Y_2 \quad (8.69)$$

$$dV/dt = F \quad (8.70)$$

where

$$\mu_1 = \mu_{1,\max}/[1 + K_1/(S_1/V)] \quad (8.71)$$

$$\mu_2 = \mu_{2,\max}/[1 + K_2/(S_2/V)] \quad (8.72)$$

$C_1$  and  $C_2$  denote the respective concentrations of the substrates  $S_1$  and  $S_2$  in the added nutrient medium. The initial values of  $X_1$ ,  $X_2$ ,  $S_1$  and  $S_2$  for the current cycle are their respective final values for the previous cycle multiplied by the factor  $V_0/V_f$ , as for a single growth-limiting substrate. If the growth-limiting substrate for species 2 is a product of the growth of species 1, the same dynamic equations apply but with Eq. (8.69) amended to:

$$dS_2/dt = Y' \mu_1 X_1 - \mu_2 X_2/Y_2 \quad (8.73)$$

(cf. Eqs (8.32) and (8.56)).

To introduce predator-prey interactions, let  $X_2$  relate to the predator species and  $X_1$  the prey, which uses a single growth-limiting substrate. RFB culture dynamics now become:

$$dX_1/dt = \mu_1 X_1 - \mu_2 X_2/Y_2 \quad (8.74)$$

$$dX_2/dt = \mu_2 X_2 \quad (8.75)$$

$$dS/dt = CF - \mu_1 X_1/Y_1 \quad (8.76)$$

$$dV/dt = F \quad (8.77)$$

where

$$\mu_1 = \mu_{1,\max}/[1 + K_1/(S/V)] \quad (8.78)$$

$$\mu_2 = \mu_{2,\max}/[1 + K_2/(X_1/V)] \quad (8.79)$$

and initial values are as described after Eq. (8.65).

## Conclusions

Substantial progress has been made in identifying the types of microorganisms present in the rumen and describing their activities in axenic culture. Systems based on axenic culture can demonstrate the activity of an individual microorganism and suggest how microbial interactions may occur in more complete systems. Often, however, many aspects of the interaction can only be determined by using mixed populations. Detailed analyses of cultures containing two or even three species of rumen microorganisms have been made, of which there are several reports in the literature (e.g. Iannotti *et al.*, 1973; Mountfort *et al.*, 1982; Fonty *et al.*, 1999). In each case, *in vitro* systems were constructed in which microorganisms that were likely to coexist were selected and grown together. Analogues based on this rationale have contributed much towards our understanding of some of the fundamental interactions, which occur in the rumen, such as inter-species hydrogen transfer, microbial competition for substrate, and predator-prey and cross-feeding interactions.

Although the rumen contains many microbial species, only a small proportion of them are required to contribute the majority of the metabolic pathways known to occur in the rumen. Acting together in a mixed population, these few species might be able to reproduce the attributes of the entire community. This principle formed the basis of the gnotobiotic rumen programme in which a defined consortium of microorganisms was used to inoculate germ-free ruminants (Hobson and Wallace, 1982). These studies represent an extension of the *in vitro* co-culture system in which a wider range of microorganisms are subjected to animal function. Using such an approach, rate and extent of starch digestion approximating to that observed *in vivo* have been demonstrated for short periods but attempts to produce a defined fibre-digesting population have had only limited success.

Instead of constructing analogues based on a limited number of species or defined consortia, an alternative approach is to use inocula prepared from rumen liquid in culture systems that are thought to be representative of the rumen environment. In the chemostat, however, significant changes in the composition of the microbial population, as compared with that of the original inoculum, have been demonstrated and important subpopulations, such as the protozoa or fungi, may disappear completely (Mansfield *et al.*, 1995). Some analogues, however, which are based on the RFB principle, such as the rumen stimulation technique (Rusitec) of Czerkawski and Breckenridge (1977) and the system of Merry *et al.* (1983), are able to maintain a higher degree of species diversity and have been shown to approximate rumen function with respect to digestibility of feed and production of VFA and microbial protein. However, the complexity of these analogues, which often employ pulse addition of heterogeneous, particulate substrate and differential and/or intermittent removal of spent nutrients and microbial biomass, makes precise quantitative analysis using dynamic mechanistic modelling an intractable task though limited empirical description should be possible.

As indicated by Hungate (1966), a complete analysis of any natural ecosystem requires an elaboration of the kinds of organisms present, their activities and the extent to which these activities are expressed (or modified) within the ecosystem. Although considerable progress has been made in identifying the microorganisms and describing their activities, much remains to be done to understand the complex interactions that regulate microbial activity and govern species diversity in the rumen.

## References

- Allison, M.J., Cook, H.M. and Stahl, D.A. (1987) Characterisation of rumen bacteria that degrade dihydroxypyridine compounds produced from mimosine. In: Rose, M. (ed.) *Proceedings of the Second International Symposium on Nutrition of Herbivores*. Australian Society of Animal Production, Brisbane, Australia, pp. 55–56.
- Amann, R.I., Ludwig, W. and Schleifer, K.H. (1995) Phylogenetic identification and *in situ* detection of individual cells without cultivation. *Microbiological Reviews* 59, 143–169.
- Bannink, A., Kogut, J., Dijkstra, J., France, J., Tamminga, S. and Van Vuuren, A.M. (2000) Modelling production and portal appearance of volatile fatty acids in dairy cows. In: McNamara, J.P., France, J. and Beever, D.E. (eds) *Modelling Nutrient Utilization in Farm Animals*. CAB International, Wallingford, UK, pp. 87–102.
- Bauchop, T. (1979a) Rumen anaerobic fungi of cattle and sheep. *Applied and Environmental Microbiology* 38, 148–158.
- Bauchop, T. (1979b) The rumen anaerobic fungi: colonizers of plant fibre. *Annals de Recherches Veterinaires* 10, 246–248.
- Bryant, M.P. and Robinson, I.M. (1962) Some nutritional characteristics of predominant culturable ruminal bacteria. *Journal of Bacteriology* 82, 605–614.
- Chesson, A. and Forsberg, C.W. (1997) Polysaccharide degradation by rumen microorganisms. In: Hobson, P.N. and Stewart, C.S. (eds) *The Rumen Microbial Ecosystem*, 2nd edn. Blackie Academic & Professional, London, pp. 329–381.
- Czerkawski, J.W. and Breckenridge, G. (1977) Design and development of a long-term rumen simulation technique (Rusitec). *British Journal of Nutrition* 38, 371–384.
- Dawson, K.A., Allison, M.J. and Hartman, P.A. (1980) Isolation and some characteristics of anaerobic oxalate degrading bacteria from the rumen. *Applied and Environmental Microbiology* 40, 833–839.
- Dehority, B.A. and Scott, H.W. (1967) Extent of cellulose and hemicellulose digestion in various forages by pure cultures of rumen bacteria. *Journal of Dairy Science* 50, 1136–1141.
- Dijkstra, J. (1994) Simulation of the dynamics of protozoa in the rumen. *British Journal of Nutrition* 72, 679–699.
- Dijkstra, J. and France, J. (1997) Modelling interactions among microorganisms in the reticulo-rumen. In: Martins, M.T., Sato, M.I.Z., Tiedje, J.M., Hagler, L.C.N., Dobereiner, J. and Sanchez, P.S. (eds) *Progress in Microbial Ecology, Seventh International Symposium on Microbial Ecology*, 27 August–1 September 1995, Sao Paulo, Brazil. Brazilian Society for Microbiology/International Committee on Microbial Ecology, Sao Paulo, pp. 297–309.
- Dijkstra, J. and Tamminga, S. (1995) Simulation of the effects of diet on the contribution of rumen protozoa to degradation of fibre in the rumen. *British Journal of Nutrition* 74, 617–634.

- Dijkstra, J., France, J. and Davies, D.R. (1998) Different mathematical approaches to estimating microbial protein supply in ruminants. *Journal of Dairy Science* 81, 3370–3384.
- Dijkstra, J., Mills, J.A.N. and France, J. (2002) The role of dynamic modelling in understanding the microbial contribution to rumen function. *Nutritional Research Reviews* 15, 67–90.
- Fonty, G., Chavarot, M., Lepetit, J., Canistro, J. and Favier, R. (1999) Mechanical resistance of wheat straw after incubation in cultures of rumen cellulolytic microorganisms. *Animal Feed Science and Technology* 80, 297–307.
- Gradel, C.M. and Dehority, B.A. (1972) Fermentation of isolated pectin and pectin from intact forages by pure cultures of rumen bacteria. *Applied Microbiology* 23, 332–340.
- Grivet, J.-P. (2001) Nonlinear population dynamics of the chemostat. *Computing in Science & Engineering* (January/February), 48–55.
- Hobson, P.N. (1971) Rumen microorganisms. *Progress in Industrial Microbiology* 9, 42–77.
- Hobson, P.N. and Stewart, C.S. (1997) *The Rumen Microbial Ecosystem*, 2nd edn. Blackie Academic & Professional, London.
- Hobson, P.N. and Wallace, R.J. (1982) Microbial ecology and activities in the rumen: Part 1. *Critical Reviews in Microbiology* 9, 165–225.
- Hungate, R.E. (1966) *The Rumen and its Microbes*. Academic Press, New York and London.
- Iannotti, E.L., Kafkewitz, D., Wolin, M.J. and Bryant, M.P. (1973) Glucose fermentation products of *Ruminococcus albus* grown in continuous culture with *Vibrio succinogenes*: changes caused by inter-species transfer of H<sub>2</sub>. *Journal of Bacteriology* 114, 1231–1240.
- Jones, R.J. and Megaritty, R.G. (1986) Successful transfer of DHP-degrading bacteria from Hawaiian goats to Australian ruminants to overcome the toxicity of *Leucaena*. *Australian Veterinary Journal* 63, 259–262.
- Koike, S., Pan, J., Kobayashi, Y. and Tanaka, K. (2003) Kinetics of *in sacco* fiber attachment of representative ruminal cellulolytic bacteria monitored by competitive PCR. *Journal of Dairy Science* 86, 1429–1435.
- Lin, K.W., Patterson, J.A. and Ladisch, M.R. (1985) Anaerobic fermentation: microbes from ruminants. *Enzyme and Microbial Technology* 7, 98–107.
- Lowe, S.E., Theodorou, M.K. and Trinci, A.P.J. (1987) Cellulases and xylanase of an anaerobic rumen fungus grown on wheat straw, wheat straw holocellulose, cellulose and xylan. *Applied and Environmental Microbiology* 53, 1216–1223.
- Mackie, R.I., Gilchrist, F.M., Roberts, A.M., Hannah, P.E. and Schwartz, H.M. (1978) Microbiological and chemical changes in the rumen during the stepwise adaptation of sheep to high concentrate diets. *Journal of Agricultural Science, Cambridge* 90, 241–254.
- Mansfield, H.R., Endres, M.I. and Stern, M.D. (1995) Comparison of microbial fermentation in the rumen of dairy cows and dual flow continuous culture. *Animal Feed Science and Technology* 55, 47–66.
- Merry, R.J., Smith, R.H. and McAllan, A.B. (1983) Studying rumen function in a model *in vitro* system. In: *Proceedings of the Fourth International Symposium on Protein Metabolism and Nutrition*, Vol. II, Clermont Ferrand, France. INRA, Paris, pp. 227–230.
- Michalowski, T., Harmeyer, J. and Breves, G. (1986) The passage of protozoa from the reticulo-rumen through the omasum of sheep. *British Journal of Nutrition* 56, 625–634.

- Monod, J. (1942) *Research on the Growth of Bacterial Cultures*, 2nd edn. Hermann, Paris.
- Mountfort, D.O., Asher, R.A. and Bauchop, T. (1982) Fermentation of cellulose to methane and carbon dioxide by a rumen anaerobic fungus in a triculture with *Methanobrevibacter* sp. strain RA1 and *Methanosarcina barkeri*. *Applied and Environmental Microbiology* 44, 128–134.
- Orpin, C.G. and Joblin, K.N. (1988) The rumen anaerobic fungi. In: Hobson, P.N. (ed.) *The Rumen Microbial Ecosystem*. Elsevier Applied Science, London, pp. 129–150.
- Pettipher, G.L. and Latham, M.J. (1979a) Characteristics of enzymes produced by *Ruminococcus flavefaciens* which degrade plant cell walls. *Journal of General Microbiology* 110, 21–27.
- Pettipher, G.L. and Latham, M.J. (1979b) Production of enzymes degrading plant walls and fermentation of cellulose by *Ruminococcus flavefaciens* in batch and continuous culture. *Journal of General Microbiology* 110, 29–38.
- Pirt, S.J. (1975) *Principles of Microbe and Cell Cultivation*. Blackwell Scientific Publications, Oxford, UK.
- Russell, J.B. and Baldwin, R.L. (1978) Substrate preferences in rumen bacteria: evidence of catabolite regulatory mechanisms. *Applied and Environmental Microbiology* 36, 319–329.
- Russell, J.B. and Baldwin, R.L. (1979a) Comparison of maintenance energy expenditures and growth yields among several rumen bacteria grown in continuous culture. *Applied and Environmental Microbiology* 37, 537–543.
- Russell, J.B. and Baldwin, R.L. (1979b) Comparison of substrate affinities among several rumen bacteria: a possible determinant of rumen bacterial competition. *Applied and Environmental Microbiology* 37, 531–536.
- Theodorou, M.K., Austin, A.R. and Hitching, S. (1984) A comparison of steers fed on grass and clover in relation to some microbiological aspects of bloat. In: Thomson, D.J. (ed.) *Forage Legumes, Occasional Symposium of the British Grassland Society No. 16*. British Grassland Society, Hurley, UK, pp. 104–108.
- Theodorou, M.K., Longland, A.C., Dhanoa, M.S., Low, E. and Trinci, A.P.J. (1989) Growth of *Neocallimastix* sp. strain R1 on Italian ryegrass hay: removal of neutral sugars from plant cell walls. *Applied and Environmental Microbiology* 55, 1363–1367.
- Thorley, C.M., Sharpe, M.E. and Bryant, M.P. (1968) Modifications of the rumen bacterial flora by feeding cattle ground and pelleted roughage as determined with culture media with and without rumen fluid. *Journal of Dairy Science* 51, 1811–1816.
- Williams, A.G. (1986) Rumen holotrich ciliate protozoa. *Microbiological Reviews* 51, 25–49.
- Williams, A.G. and Coleman, G.S. (1997) The rumen protozoa. In: Hobson, P.N. and Stewart, C.S. (eds) *The Rumen Microbial Ecosystem*, 2nd edn. Blackie Academic & Professional, London, pp. 73–139.
- Williams, A.G. and Orpin, C.G. (1987) Glycosidase hydrolase enzymes present in the zoospore and vegetative growth stages of rumen fungi *Neocallimastix patriarum*, *Pirromonas communis* and an unidentified isolate grown on a range of carbohydrates. *Canadian Journal of Microbiology* 33, 427–434.
- Wojciechowicz, M., Heinrichova, K. and Zioleck, A. (1982) An exopectate lyase of *Butyrivibrio fibrisolvens* from the bovine rumen. *Journal of General Microbiology* 128, 2661–2665.

- Wolin, M.J. (1974) Metabolic interactions among intestinal microorganisms. *American Journal of Clinical Nutrition* 27, 1320–1328.
- Wolin, M.J. (1979) The rumen fermentation: a model for microbial interactions in anaerobic ecosystems. In: Alexander, M. (ed.) *Advances in Microbial Ecology*, Vol. 3. Plenum Press, New York, pp. 49–77.
- Zoetendal, E.G., Koike, S. and Mackie, R.I. (2003) A critical view on molecular microbial ecology of the gastrointestinal tract. In: 't Mannetje, L., Ramírez-Avilés, L., Sandoval-Castro, C.A. and Ku-Vera, J.C. (eds) *Matching Herbivore Nutrition to Ecosystems Biodiversity. Proceedings of the Fifth International Symposium on the Nutrition of Herbivores*. Universidad Autónoma de Yucatán, Mérida, Mexico, pp. 101–127.



---

# 9

## Microbial Energetics\*

J.B. Russell<sup>1</sup> and H.J. Strobel<sup>2</sup>

<sup>1</sup>Agricultural Research Service, USDA and Department of Microbiology, Cornell University, Ithaca, NY 148531, USA; <sup>2</sup>Department of Animal Sciences, University of Kentucky, Lexington, KY 40546-0215, USA

---

### Introduction

Rumen fermentation is an exergonic process that converts feedstuffs to short-chain volatile fatty acids (VFA), methane, ammonia and occasionally lactic acid. Some of the free energy is used to drive microbial growth, but heat is also evolved. The efficiency of rumen microbial growth can have a profound effect on animal performance, and organic acids produced during microbial fermentations are an important source of energy for the host animal. Microbial protein is an important amino acid supply for the animal, and it is now apparent that the yield of microbial protein can vary significantly (Nocek and Russell, 1988).

A diverse and complex microbial population that includes bacteria, protozoa and fungi inhabits the rumen (Orpin and Joblin, 1989; Stewart and Bryant, 1989; Williams and Coleman, 1989). Given the observation that the density of protozoa in omasal contents was less than 10% of that in the rumen, it appears that protozoa contribute little microbial protein to the animal (Weller and Pilgrim, 1974; Leng, 1982). Protozoa are involved in the turnover of bacterial protein (Leng and Nolan, 1984) and regulation of starch fermentation (engulfment of starch grains), but defaunation studies have indicated that protozoa are not required for a normal rumen fermentation (Abou Akada and El-Shazly, 1964; Eadie and Gill, 1971). The role of the fungi is less clear (Bauchop, 1979). When animals were fed highly lignified fibre, fungi accounted for approximately 8% of the microbial mass (Citron *et al.*, 1987), but their numbers were much lower in animals fed diets rich in concentrates (Fonty *et al.*,

\*Mandatory disclaimer: Proprietary or brand names are necessary to report factually on available data; however, the USDA neither guarantees nor warrants the standard of the product, and the use of the name by the USDA implies no approval of the product, and exclusion of others that may be suitable.

1987). The bacteria are the dominant microbial group in the rumen, and they are clearly essential.

With the evolution of molecular techniques, it has become apparent that bacterial diversity in the rumen is much greater than previously thought, and it is likewise evident that the rumen has a large population of non-culturable bacteria (Whitford *et al.*, 1998; Tajima *et al.*, 1999). None the less, individual species performing all of the major metabolic transformations observed in the rumen have been isolated, and the activities of these organisms serve as a model of ruminal fermentation (Hungate, 1966; Prins, 1977). The fermentation pathways of these organisms are fairly well understood, but there has been less information regarding the energetics of growth (Hespell and Bryant, 1979).

## ATP Formation

The absence of oxygen and production of reducing agents (e.g. sulphide) in the rumen creates a highly reduced environment ( $E_h = -250$  to  $-450$  mV) that is suitable for the growth of strictly anaerobic bacteria (Clarke, 1977). In virtually all cases, strict anaerobes outnumber facultative anaerobes and aerobes by a factor of at least 10,000 to 1. Because oxygen is not available as an electron acceptor, other means of oxidation must be employed and these oxidations must be closely coupled to reduction reactions. Anaerobic oxidations are, by their very nature, incomplete, but ruminal bacteria have evolved very efficient mechanisms of energy conservation. They often produce as many cells from glucose as *Escherichia coli* grown aerobically, even though the free energy change is as much as sevenfold lower (Russell and Wallace, 1989).

Carbohydrates are the primary energy source for microbial growth in the rumen, and the majority of ruminal bacteria ferment carbohydrates (Hungate, 1966). Some carbohydrate-fermenting ruminal bacteria also ferment amino acids, but most of them are unable to utilize amino acids or peptides as a sole energy source (Bladen *et al.*, 1961). The rumen also contains specialized obligate amino acid-fermenting bacteria, and these bacteria appear to produce a large fraction of the ammonia in cattle-fed forages (Russell *et al.*, 1988; Chen and Russell, 1989; Attwood *et al.*, 1998). Although some ruminal bacteria are able to hydrogenate fats, lipid metabolism alone does not support microbial growth in the rumen (MacZulak *et al.*, 1981).

Most carbohydrate entering the rumen is composed of hexose sugars (Wolin, 1960), and  $^{14}\text{C}$  labelling studies indicated that the Embden–Meyerhof pathway was the major route of glucose fermentation by ruminal microorganisms (Baldwin *et al.*, 1963). This pathway splits a carbon–carbon bond (fructose 1,6 biphosphate), but little energy is derived from this cleavage. During homolactic fermentation, glucose, a molecule of neutral and uniform oxidation–reduction state, is converted to lactate, which has a highly reduced methyl group and a highly oxidized carboxyl group. Most of the free energy change is derived from this simultaneous oxidation and reduction.

The role of phosphate esters in fermentation was recognized by Harden and Young (1906), but it was not until the early 1940s that the significance of phosphate esters was more fully appreciated (Lipmann, 1941). For many years, biochemists focused on the anhydride structure of ATP to describe the 'high energy' nature of the compound. However, as Nicholls and Ferguson (1992) noted, the mass action ratio and the extent to which the reaction is displaced from equilibrium actually determine the free energy change of ATP hydrolysis. Since the mass action ratio in living cells is as much as ten orders of magnitude out of equilibrium, ATP serves as an effective means by which to transfer metabolic energy.

ATP can arise from enzymatic reactions, which give rise to phosphorylated intermediates (e.g. 1,3 biphosphoglycerate, phosphoenolpyruvate, acetyl phosphate and butyryl phosphate) and kinase reactions (e.g. phosphoglycerate kinase, pyruvate kinase, acetate kinase and butyrate kinase), which transfer a phosphate group to ADP. In anaerobic protozoa, acetyl CoA lyase is directly coupled to ATP formation (Coleman, 1980). These reactions are collectively known as substrate level phosphorylation.

Previously, it was assumed that substrate level phosphorylation was the only mechanism of energy conservation in anaerobic bacteria. However, White *et al.* (1962) showed that the ruminal bacterium, *Prevotella (Bacteroides) ruminicola*, had cytochromes. The observation that many *Bacteroides* strains required hemin, and the influence of hemin on growth yield and succinate production suggested that fumarate reduction might be linked to ATP formation (Macy *et al.*, 1975). In fact, coupling of fumarate reduction and ATP synthesis was demonstrated in the ruminal bacterium *Wolinella succinogenes* (Kroger and Winkler, 1981). The acrylyl CoA reductase of *Megasphaera elsdenii* also involves electron transfer, but there is as yet no evidence that this reaction is linked to ATP formation (Brockman and Wood, 1975).

Pure cultures of ruminal bacteria often produce reduced products (e.g. ethanol and lactate) and sacrifice ATP for reducing equivalent disposal. However, methanogens keep the partial pressure of hydrogen low *in vivo*, and under these conditions hydrogen production provides an alternative means of oxidation (Wolin and Miller, 1989). Such interspecies hydrogen transfer and methanogenesis allow saccharolytic bacteria to produce acetate and increase their ATP production.

Some ruminal bacteria vary their fermentation end-products as a function of growth rate and this influences ATP production. *Selenomonas ruminantium* (Russell, 1986) and *Streptococcus bovis* (Russell and Baldwin, 1979) switch from VFA production to homolactic fermentation at rapid growth rates, even though ATP production per hexose apparently decreases (3 or 4 to 2 ATP per hexose). Such a change might seem detrimental, but as Hungate (1966) pointed out, ATP per unit of time is a more critical factor than ATP per glucose. Since *S. bovis* and *S. ruminantium* can ferment glucose at a faster rate when lactate is the end-product, ATP per time increases even though ATP per glucose decreases.

## Ion Gradients

ATP formation is the primary energy transducing mechanism for fueling biosynthesis, but transmembrane ion gradients are also critical components of bacterial energy transduction. According to the chemiosmotic theory of Mitchell (1961), bacteria translocate protons across the cell membrane to establish a chemical gradient of protons ( $\Delta\text{pH}$ ) and a charge gradient ( $\Delta\Psi$ ). Electron transport systems (e.g. cytochrome-linked fumarate reductase) can establish proton gradients, but many anaerobes must rely almost exclusively on membrane-bound proton ATPases to expel protons from the cell interior. In certain streptococci, lactate efflux can be coupled to electrogenic proton efflux (Michels *et al.*, 1979), but such mechanisms have not been demonstrated in ruminal bacteria.

Although proton gradients are the major means of coupling energy to membrane function, sodium gradients play a significant role in the bioenergetics of many bacteria (Maloy, 1990). Most bacteria maintain low intracellular concentrations of sodium, and in *E. coli* these gradients are created by a sodium/proton antiporter, which interconverts the chemical gradient of protons into a chemical gradient of sodium (West and Mitchell, 1974). The rumen is a sodium-rich environment ( $\sim 100$  mM), and ruminal organisms take advantage by employing sodium-dependent transport systems (see below). Relatively little work has been done on sodium-expulsion systems in ruminal bacteria, but there is evidence that *S. bovis* has an ATPase which pumps sodium as well as one that pumps protons (Strobel and Russell, 1989).

Decarboxylation reactions are associated with a decrease in free energy, but decarboxylation is not typically coupled directly to synthesis of ATP (Buckel, 2001). However, energy in the form of an electrochemical ion gradient can be used to drive ATP synthesis. For instance, the ruminal organism *Oxalobacter formigenes* transports oxalic acid across the cell membrane with subsequent decarboxylation to formate and carbon dioxide (Kuhner *et al.*, 1996). This decarboxylation consumes an intracellular proton thus generating a proton gradient. In addition, substrate uptake involves an antiport exchange with one of the products, formate. This exchange is electrogenic (net accumulation of negative charge inside the cell) and an electrochemical is formed. In contrast to most other anaerobes, *O. formigenes* uses its membrane-bound ATPase for ATP synthesis rather than proton expulsion.

Decarboxylation reactions in other organisms can be biotin-dependent and linked to sodium expulsion (Dimroth, 1987). The ruminal bacterium *Acidaminococcus fermentans* has a membrane-bound glutaconyl-CoA decarboxylase, which expels sodium from the cell interior (Braune *et al.*, 1999). *S. ruminantium* (Melville *et al.*, 1988) and the amino acid-fermenting bacterium *Clostridium aminophilum* (Chen and Russell, 1990), appear to have sodium-dependent decarboxylases, that are associated with succinate and glutamate metabolism, respectively. It is likely that additional energy transduction systems involving decarboxylases will be discovered in gastrointestinal organisms.

## Transport of Carbohydrates

The survival and growth of bacteria in natural environments such as the rumen depends on their ability to scavenge and concentrate nutrients across the cell membrane. The work of bacterial transport can be driven by the hydrolysis of chemical bonds (e.g. ATP or phosphoenolpyruvate), ion gradients, or the concentration gradient of the substrate itself. ATP hydrolysis is associated with a large decrease in free energy, and ATP-driven transport systems can establish very high concentration gradients ( $>10^6$ ) that are virtually unidirectional (little efflux). The phosphotransferase system (PTS) is driven by the conversion of phosphoenolpyruvate to pyruvate, and it can also create high accumulation ratios.

Some transport systems are sensitive to chemicals that dissipate transmembrane ion gradients. Although the chemiosmotic model of Mitchell (1961) provided a scheme for ion-mediated transport, definitive proof for solute/proton symport was not available until membrane vesicle techniques were developed (Kaback, 1969). Since membrane-bound ATPases can expel approximately three protons per ATP (Harold, 1986), and proton symport systems only require one or two protons, ion-driven transport can be more efficient than ATP-driven transport. However, these mechanisms are freely reversible and in many cases are only able to establish accumulation ratios of  $10^3$ . The study of ion-mediated transport initially focused on proton symport systems, but it has since become apparent that a variety of bacteria, including ruminal organisms, can utilize sodium gradients (Maloy, 1990).

Hexoses entering the cell by active transport (ATP or ion-driven) must be phosphorylated by kinases before they can be glycolysed, but the PTS is able to phosphorylate the sugar as it passes across the cell membrane. Since a kinase reaction is not required, the PTS spares ATP. Many bacteria are able to transport disaccharides as well as monosaccharides, and disaccharide transport systems are obviously a more efficient mechanism of uptake. A disaccharide PTS is more favourable than active transport and an intracellular hydrolase, but it has little advantage if the bacterium has a disaccharide phosphorylase (Russell *et al.*, 1990). *P. ruminicola* (Lou *et al.*, 1996) and *Ruminococcus albus* (Lou *et al.*, 1997a) have active transport systems for disaccharides and intracellular phosphorylases. *S. bovis*, *S. ruminantium* and *M. elsdenii* have PTS systems, but PTS activity could not be detected in *P. ruminicola*, *Fibrobacter succinogenes* or *Butyrivibrio fibrisolvens* (Martin and Russell, 1986). An *S. bovis* mutant that was deficient in PTS activity (enzyme II glucose) was still able to take up glucose, but the relationship between glucose transport rate and glucose concentration was linear rather than a Michaelis–Menten-type kinetics (Russell, 1991a). These results indicated that *S. bovis* had a facilitated diffusion system for glucose as well as glucose PTS activity. Such diffusion-driven systems allow bacteria to conserve energy when substrate concentrations are high.

Ruminal bacteria also utilize ion-driven transport systems to transport carbohydrates. *Prevotella bryantii* (Strobel, 1993b) and *S. ruminantium* (Strobel, 1993a) use sodium- and proton-dependent systems, respectively, in

the uptake of xylose and arabinose. The glucose transport system of *F. succinogenes* was sodium-dependent, although it is not clear if a sodium-symport is involved (Franklund and Glass, 1987). In contrast, both pentose sugars appear to be taken up by ATP-driven mechanisms in *B. fibrisolvens* (Strobel, 1994) and *R. albus* (Thurston *et al.*, 1994). Interestingly, glucose uptake may share a common system with xylose transport in the latter bacterium. Although only relatively few organisms have been studied thus far, it is clear that a diversity of transport mechanisms and regulatory events control carbohydrate uptake in ruminal bacteria.

## Amino Acid-fermenting Bacteria

Bladen *et al.* (1961) examined the capacity of pure rumen bacterial cultures to ferment protein hydrolyzate and produce ammonia. *M. elsdenii* was the most active species, but it was concluded that *P. bryantii* was the most important amino acid-fermenting bacterium in the rumen of cattle. However, neither of these species could account for ammonia production *in vivo*. *P. bryantii* B<sub>14</sub>, one of the most active strains, had a specific activity of 13.5 nmol/mg protein per min (Russell, 1983), but mixed ruminal bacteria produced ammonia at a rate of 31 nmol/mg protein per min (Hino and Russell, 1985). How could the best strain have an activity that was less than the average of the mixed population?

Dinius *et al.* (1976) noted that monensin decreased ruminal ammonia concentrations. *In vitro* studies indicated that ionophores inhibited amino acid deamination (Van Nevel and Demeyer, 1977; Russell and Martin, 1984), but most active ammonia-producing bacteria were Gram-negative (Bladen *et al.*, 1961) and resistant to monensin (Chen and Wolin, 1979). In the 1980s, three obligate amino acid-fermenting, monensin-sensitive bacteria were isolated from the rumen (Russell *et al.*, 1988; Chen and Russell, 1989), and 16S rRNA sequencing indicated that these isolates were *Clostridium sticklandii*, *Peptostreptococcus anaerobius* and a new species, *C. aminophilum* (Paster *et al.*, 1993). More recently Attwood *et al.* (1998) isolated several more 'hyper-ammonia producing' strains. Only one of these latter isolates was closely related to *P. anaerobius*.

Obligate amino acid-fermenting bacteria have very high rates of amino acid deamination, but anaerobic amino acid degradation provides very little energy. Batch and continuous culture studies indicated that the obligate amino acid-fermenting bacteria degraded 10 to 25 times as many amino acids as were incorporated into microbial protein (Chen and Russell, 1988). Transport studies indicated that amino acid transport was often driven by a chemical gradient of sodium, but facilitated diffusion was also possible if the amino acid concentration was high (e.g. Van Kessel and Russell, 1992).

*C. aminophilum* F ferments glutamate via a pathway involving acetate kinase and butyrate kinase, and substrate level phosphorylation would only yield 1.5 ATP per glutamate (Chen and Russell, 1990). However, the glutamate fermentation pathway appears to have a glutaconyl-CoA decarboxylase

reaction, and this biotin-linked enzyme may create a sodium gradient, which could be used for various energy-requiring processes. *C. sticklandii* converted arginine to ornithine, and ornithine efflux created a chemical gradient of sodium (Van Kessel and Russell, 1992). *P. anaerobius* ferments leucine by a dual pathway which recycles reducing equivalents and produces 0.33 isovalerate and 0.67 isocaproate (Chen and Russell, 1988). Since this scheme has only one kinase reaction, the ATP yield from substrate level phosphorylation is very low (0.33 ATP/leucine). The question then becomes, how is the organism able to establish a sodium gradient for transport or to grow? Since the decarboxylation of keto-isocaproate is probably linked to thiamine, there should be another mechanism of creating a sodium gradient.

## ATP Synthesis, Heat Production and Growth

Catabolic pathways differ in their ability to conserve energy as ATP. Since free energy changes are independent of the route, the enthalpy change of a fermentation can be calculated from heats of combustion (substrates vs. products, Table 9.1). A homolactic fermentation requires 10.5 cal of enthalpy to synthesize 1 mmol ATP, but pathways yielding acetate, formate and ethanol or acetate and propionate are less efficient. Assuming approximately 1 ATP/methane (Blaut *et al.*, 1990), a typical mixed ruminal fermentation would have an enthalpy to ATP ratio of 10 cal/mmol. Biosynthetic reactions are inherently inefficient. A peptide bond has an enthalpy content of approximately 3 cal/mmol, and yet it takes 4 ATP to synthesize the bond. If one assumes 10 cal/mmol ATP, less than 8% of the total enthalpy change would be trapped in the peptide bond (92% would be dissipated as heat). Polysaccharide synthesis is more efficient because glycosidic bonds have 4.5 cal/mmol and formation only requires 2 ATP/bond. However, even in this case, the efficiency of energy trapping is less than 23%. Since protein synthesis accounts for nearly two-thirds of the total ATP requirement for growth, an overall efficiency of 12% for cell synthesis is probably reasonable.

The question then becomes, why is growth so inefficient? As reviewed by Harold (1986), growth and reproduction is not a series of random biosynthetic

**Table 9.1.** Enthalpy changes ( $\Delta H$ ) and ATP production for various fermentation schemes.

Pathway of glucose catabolism	$\Delta H$ (cal/mmol)	ATP (mmol/mmol)	$\Delta H/\text{ATP}$ (cal/mmol)
Glucose $\rightarrow$ 2 lactate	21	2	10.5
Glucose $\rightarrow$ acetate + formate + ethanol	73	3	24.5
Glucose $\rightarrow$ 1.33 propionate + 0.67 acetate	45	3	15
Glucose $\rightarrow$ 2 formate + butyrate	19	3	6.33
Glucose $\rightarrow$ 1.12 acetate + 0.32 propionate + 0.28 butyrate + 0.62CH <sub>4</sub> + 1.05CO <sub>2</sub>	45	4.5	10

reactions; it is an assemblage of information contained within the biomolecules and organization of the cell. James Maxwell pondered the relationship between information and thermodynamics in 1867 in a proposition that has since been called 'Maxwell's demon' (Harold, 1986). While this concept cannot be tested experimentally, 'it appears that you don't get something for nothing – not even information' (Morowitz, 1978).

The study of bacterial growth efficiency has typically been an exercise of feeding and weighing bacteria, but it is possible to directly measure heat production with a calorimeter. Walker and Forrest (1964) showed that mixed ruminal bacteria produced heat at a rate proportional to the rate of fermentation (gas production), but bacterial growth was not measured. More recently, Russell (1986) showed that bacterial heat production was inversely related to the rate of cell production so long as glucose was limiting. However, when pulse doses of glucose were added to the continuous culture vessel, there was an increase in heat production, which was not associated with an increase in bacterial protein or dry matter. These latter results indicated that ruminal bacteria have mechanisms of dissipating ('spilling') energy. Such an energetic strategy does not appear to be efficient but may be an unavoidable consequence of an organism's physiology (see below).

### **Yield Based on ATP ( $Y_{ATP}$ )**

Because the amount of ATP derived from an energy source can vary significantly, Bauchop and Elsdon (1960) attempted to correlate the energetics of bacterial cell production with the amount of ATP that was produced from catabolic pathways. Their ' $Y_{ATP}$ ' values ranged from 8.3 to 12.5 g cells/mol ATP and the average was 10.5 g cells/mol ATP. This latter number continues to be treated as something of a biological constant, but subsequent work indicated that the range was actually much greater (Stouthamer, 1973; Russell and Wallace, 1989).

Stouthamer (1979) presented calculations on the amount of ATP which would be needed to synthesize bacterial biomass and several points are clear: (i) some cell constituents are far less costly to synthesize than others (protein three times greater than polysaccharide); (ii) approximately two-thirds of the ATP is needed for polymerization reactions; and (iii) transport is a significant energy cost (15% to 27% of the total). Based on Stouthamer's assumptions, the yield should be 32 g cells/mol ATP, but these calculations did not consider non-growth related functions.

In many cases, bacterial growth yields have been based on energy source disappearance, rather than production or ATP production. If carbon from the energy source is used for cell production, ATP production can be significantly overestimated. This point is illustrated by continuous culture studies with *P. bryantii* B<sub>1</sub>4 (Russell, 1983). When the medium had ammonia as the only nitrogen source, the theoretical maximum yield was 48 g cells per 100 g glucose, and less than half of the glucose could be recovered as fermentation acids.

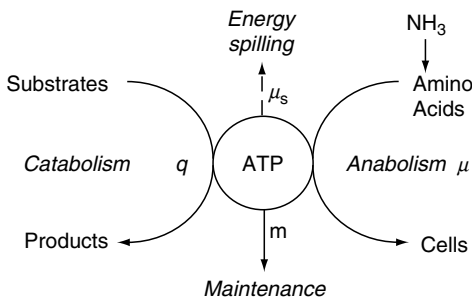


## Maintenance Energy

With the advent of continuous culture techniques in the 1950s, it became apparent that bacteria had lower yields at slower growth rates (Herbert *et al.*, 1956), and the idea of a bacterial maintenance energy requirement was introduced. In the 1960s, Marr *et al.* (1962) and Pirt (1965) presented maintenance derivations that were based on double reciprocal plots of yield and growth rate. Maintenance was defined as a time-dependent function that was proportional to cell mass. The theoretical maximum yield is defined as the yield that one would obtain if there was no maintenance energy requirement. These non-growth related functions (Fig. 9.1) have never been precisely defined, but they are essential for cell survival even though they do not directly result in cell mass increases. Ion balance across the cell membrane is probably most important.

When bacteria grow slowly, a large proportion of the energy is used to maintain the cells, and so maintenance energy is analogous to overhead in a business. One can only make a profit (growth) after the overhead (maintenance) is met, but if cash flow is large (rapid rates of energy utilization), the overhead will make up a small proportion of the total budget. Isaacson *et al.* (1975) grew mixed ruminal bacteria in continuous culture and determined a maintenance energy requirement of 0.26 mmol glucose per g bacteria per hour and a theoretical maximum growth yield of 0.089 g cells/mmol glucose. Within the rumen, bacterial growth rates often range from 0.20 to 0.05/h, and under these conditions maintenance energy would account for 10% to 31% of the total energy consumption, respectively.

The maintenance energy of ruminal bacteria can vary greatly. *S. ruminantium* and *B. fibrisolvens* had maintenance requirements of 0.12 and 0.27 mmol glucose/g bacteria per hour, respectively, but *S. bovis* and *M. elsdenii*, organisms that proliferate on cereal grain rations, had maintenance values that were greater than 0.83 mmol glucose/g bacteria per hour (Russell and Baldwin, 1979). *P. bryantii*, an organism that thrives on a variety of different rations, had a maintenance energy of 0.28 mmol glucose/g bacteria per hour (Russell, 1983), and this value was similar to the one determined by Isaacson *et al.* (1975). Pirt plots indicate that ‘apparent’ maintenance energy can also be energy source-dependent. This point was illustrated by the observation that *R. albus* had a fourfold higher maintenance energy coefficient



**Fig. 9.1.** The production of ATP from catabolic reactions ( $q$ ) and its utilization for growth ( $\mu$ ), maintenance ( $m$ ) and energy spilling ( $\mu_s$ ).

when it was grown on glucose as compared to cellobiose (Thurston *et al.*, 1993), and *B. fibrisolvens* cells that were grown on arabinose had a higher coefficient than cells grown on other mono- and disaccharides (Strobel and Dawson, 1993).

Pirt plots are designed to differentiate growth from maintenance, but the biochemical definitions are not always clear-cut. For example, protein synthesis is clearly a growth function, but the turnover of protein is maintenance. Similarly, the uptake of ions such as potassium is a growth function, but the leakage of potassium ions and their subsequent uptake is maintenance. Even Pirt (1965) noted 'Pirt plots' were not always linear, and he cited the ruminal bacterium *S. ruminantium* as an example. The responsible factor was originally 'obscure', but later work indicated that this deviation was caused by fermentation shifts and variations in ATP per hexose rather than maintenance (Russell and Baldwin, 1979). When the amino acid-fermenting ruminal bacterium *C. sticklandii* was grown in continuous culture, the Pirt plot for arginine utilization was linear, but a shift from active transport to facilitated diffusion at high dilution rates caused an increase in the apparent maintenance energy requirement (Van Kessel and Russell, 1992). Given these observations, Pirt plot interpretations must be performed with care.

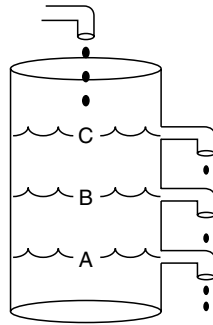
## Energy Spilling

### *Mechanisms of dissipating excess ATP*

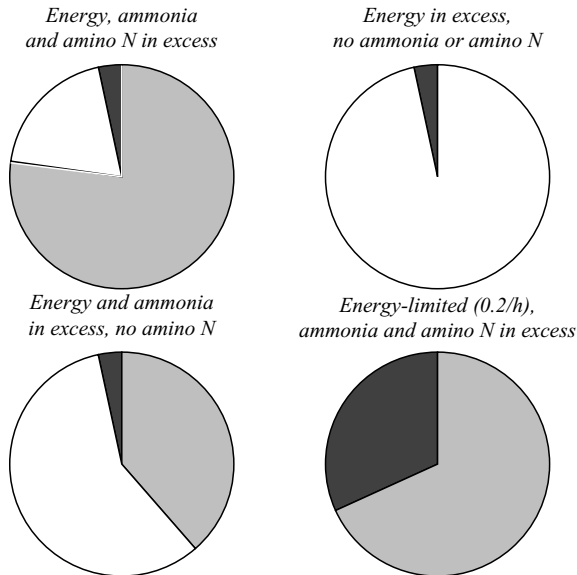
Maintenance energy costs account for changes in yield that are caused by variations in growth rate, but it should be realized that maintenance is usually determined under energy-limiting conditions. If energy is in excess, and growth is limited by some other factor (e.g. nitrogen), the rate of 'resting cell metabolism' can exceed the maintenance rate by as much as 18-fold (Russell and Cook, 1995). For example, when *S. bovis* was incubated in a nitrogen-free medium with an excess of glucose, the fermentation rate was 90 mmol glucose per g bacterial protein per hour, but the maintenance rate (as measured under carbon-limitation) was only 1.6 mmol glucose per g bacterial protein per hour (Russell and Strobel, 1990; Russell, 1991a). Based on these results, it appeared that *S. bovis* had a third avenue of energy expenditure that could be classified as energy spilling (Fig. 9.2).

Maintenance and energy spilling are physiologically distinct. When bacteria are grown at slow growth rates under energy limitation, intracellular ATP concentrations are low, but bacteria spilling energy can have ATP concentrations that are two- to threefold higher (Russell and Strobel, 1990). Energy spilling is most easily demonstrated when cells are limited for nutrients other than energy source, but it is clear that even rapidly growing cells can spill significant amounts of energy (Fig. 9.3). Only cells limited for energy do not seem to spill energy.

In *S. bovis*, energy spilling can be explained by increased membrane-bound ATPase activity, and a futile cycle of protons through the cell membrane. Until recently, the regulation of the futile cycle was not entirely clear, but recent work



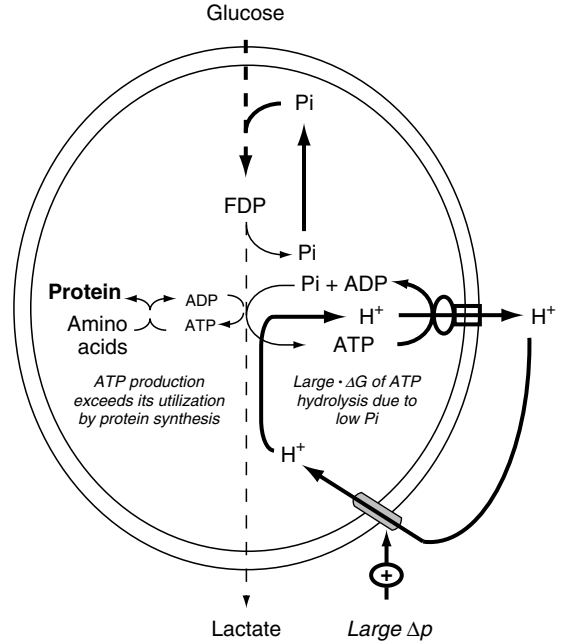
**Fig. 9.2.** A simple bucket model of energy utilization by bacteria. The first priority of the cells is maintenance (A). Once the maintenance requirement has been fulfilled, growth is possible (B). If more energy is available than growth or maintenance can use, the remaining energy is spilled (C).



**Fig. 9.3.** A schematic showing the effect of energy, ammonia and amino N on the relative distribution of energy utilization by *Streptococcus bovis*. Black, maintenance energy; grey, growth; and white, energy spilling.

indicates that it is caused by a cascade of effects (Fig. 9.4). When glucose is in excess, and the potential glycolytic rate is faster than the rate at which ATP can be used for growth, fructose 1,6 bisphosphate accumulates (Bond and Russell, 1996), and this accumulation is associated with a decrease in intracellular phosphate (Bond and Russell, 1998). When the intracellular phosphate concentration decreases, the  $\Delta G$  of ATP hydrolysis increases, and this latter increase allows the membrane-bound ATPase to pump more protons and create a large proton motive force (Bond and Russell, 2000). When proton motive force increases, the membrane becomes more permeable to protons, and as protons are cycled through the cell membrane, excess ATP is dissipated.

**Fig. 9.4.** A schematic showing the energy spilling reaction of *Streptococcus bovis*. When the glycolytic rate is higher than the ATP utilization rate for growth, fructose 1,6-diphosphate (FDP) accumulates in the cell. The accumulation of FDP causes a decrease in intracellular phosphate. When the intracellular phosphate declines, the  $\Delta G$  of ATP hydrolysis increases, and the ATPase is able to pump more protons. The increase in proton motive force causes a decrease in membrane resistance, protons are allowed to re-enter the cells and futile cycle of protons allows the ATPase to consume the excess ATP.



Fructose 1,6 biphosphate accumulation is characteristic of low  $G + C$  Gram-positive bacteria like *S. bovis*, but some bacteria spill energy in mechanisms that are not directly linked to fructose 1,6 biphosphate or a futile cycle of protons. In *E. coli*, energy spilling is facilitated by the low-affinity potassium proton symporter (Mulder *et al.*, 1986; Buurman *et al.*, 1991). When potassium or ammonium ion is limiting growth, the high-affinity ATP-driven potassium (ammonium) uptake system is induced.

Most bacteria have metabolic regulation that counteracts the potential action of futile enzyme cycles, but research with *F. succinogenes* suggests that glycogen synthesis and turnover may occur simultaneously (*e.g.* Matheron *et al.*, 1998). Because glycogen turnover involves an expenditure of ATP, it appears that *F. succinogenes* lacks regulatory mechanisms found in other bacteria. The physiological reasons and consequences of glycogen metabolism in *F. succinogenes* are clearly not completely understood and require more study.

### Effect of amino acids

Stouthamer (1979) indicated that amino acid availability should have little effect (less than 2%) on  $Y_{ATP}$ , but in his example: (i) amino acids rather than peptides were transported; (ii) the cost of amino acid transport was greater than the cost of amino acid biosynthesis; and (iii) ammonia was taken up by active transport. Mixed ruminal bacteria utilize peptides at a faster rate than amino acids (Chen *et al.*, 1987) and take up ammonia by passive diffusion (Russell and Strobel, 1987). However, even if corrections are made for peptide transport (di- or tripeptides) and ammonia assimilation, amino acids should provide little improvement in growth efficiency.

*In vitro* studies indicated that amino acids could have a much larger impact on the growth yields of ruminal bacteria (Maeng and Baldwin, 1976a; Maeng *et al.*, 1976; Russell and Sniffen, 1984) than Stouthamer (1979) predicted, and *in vivo* studies (Hume *et al.*, 1970; Maeng and Baldwin, 1976b) supported these results. At least four factors could have contributed to the apparent contradiction between Stouthamer (1979) and the ruminal studies: (i) Stouthamer's calculations refer solely to the amount of ATP that is necessary to synthesize cell material and the impact of amino acids on amount of substrate that is available to drive ATP synthesis (carbon sparing) is ignored; (ii) the calculations are based on a defined cell composition typical of bacteria growing *in vitro* with excess nitrogen and energy; (iii) potential impact of amino acids on growth rate and maintenance is ignored; and (iv) energy-spilling reactions are not considered.

The potential impact of amino acids on carbon sparing and cell composition on yield is illustrated by continuous culture studies with *P. bryantii* B<sub>14</sub> (Russell, 1983). Based on an ATP/glucose ratio of 3, the  $Y_{\text{ATP}}$  for cultures growing with ammonia as a nitrogen source was 27 g cells/mol ATP, but a significant fraction of the glucose was needed to synthesize cell material. When large amounts of protein hydrolysate were added to the medium, less glucose was used as a carbon source and the  $Y_{\text{ATP}}$  increased to 39 g cells/mol ATP, a value higher than the one proposed by Stouthamer (1979). However, cells that were provided with protein hydrolysate accumulated significant amounts of polysaccharide. When corrections were made for carbohydrate accumulation, the apparent  $Y_{\text{ATP}}$  declined to 31.

In continuous culture, it is possible to regulate the growth rate of bacteria, and the contribution of maintenance to yield can be defined, but in batch culture growth rates can vary. Most ruminal bacteria can utilize ammonia as a nitrogen source for growth (Allison, 1969), but they often grow faster if amino acids are provided. When mixed ruminal bacteria were provided with a mixture of soluble sugars and ammonia, the addition of amino acid nitrogen caused an increase in growth rate and yield, but Pirt plots indicated that the yield change was at least fivefold greater than what could be explained by maintenance *per se* (Van Kessel and Russell, 1996). Based on these results, it appeared that pre-formed amino acids were allowing the bacteria to better match their anabolic and catabolic rates and spill less energy.

The idea that amino acids can be a regulator of energy spilling was supported by experiments with *S. bovis*. When a culture of *S. bovis* (0.65/h) was given supplemental amino acids, fructose 1,6 bisphosphate declined, intracellular phosphate increased, the  $\Delta G$  of ATP hydrolysis and proton motive declined, and the cells spilled energy (Bond and Russell, 1998). Since the growth rate was fixed by the dilution rate, the change in yield could not be explained by changes in growth rate or maintenance.

## Low pH

It has long been recognized that low pH can have negative impacts on bacteria, particularly when fermentation acids are present (Russell and Diez-Gonzalez,

1998). Because organic acids like acetate can diffuse across the cell membranes of bacteria and dissociate in the more alkaline interior, fermentation acid toxicity was often described as 'uncoupling', but this idea did not explain why some bacteria were much more sensitive than others (Russell, 1992). Experiments with *S. bovis* and other acid-tolerant ruminal bacteria indicated that pH resistance could be explained by the ability to decrease intracellular pH as a function of extracellular pH (Russell, 1991b). When bacteria try to maintain a constant intracellular pH, the transmembrane pH gradient can increase, and this gradient causes an influx and logarithmic accumulation of fermentation anions. By keeping the transmembrane pH gradient low, fermentation acid anion accumulation can be circumvented. The strategy of allowing intracellular pH drop, however, necessitates an intracellular metabolism that is pH resistant. If the metabolism is not pH resistant, low pH causes complete de-energization (Thurston *et al.*, 1993; Russell and Diez-Gonzalez, 1998).

Continuous culture studies indicated that ruminal bacteria have different sensitivities to low pH (Russell and Dombrowski, 1980). Cellulolytic bacteria were the most sensitive group, and these species washed out if the extracellular pH was less than 6.0. The cellulolytic bacteria did not show a marked decline in yield prior to wash out, and this result indicated that anion accumulation was the most likely cause of the growth inhibition (Russell and Wilson, 1996). Several non-cellulolytic bacteria showed a significant decline in the hexose yield or  $Y_{ATP}$  at low pH, and these results indicated ATP was being diverted from growth to non-growth functions (Russell and Dombrowski, 1980). Because intracellular ATP of *S. bovis* increases when the extracellular pH is low, it appears that acidic pH can be a trigger of energy spilling, in at least some bacteria (Cook and Russell, 1994).

### **Why would bacteria spill energy?**

Bacterial energy metabolism can be envisioned as a balance of anabolic and catabolic rates, and three avenues of energy dissipation: (i) maintenance; (ii) growth; and (iii) energy spilling (Fig. 9.1). When the catabolic rate is very low, the rate of ATP production does not exceed the rate needed to maintain the cells, and growth is not possible. If the catabolic rate increases and other essential nutrients are available, growth is then possible. However, if other nutrients are not available, growth can be constrained by factors other than energy, and ATP can be spilled (Fig. 9.2).

Pure culture studies support the idea that energy spilling can be beneficial if energy is in excess and other nutrients are limiting growth. *S. bovis* has high rates of energy spilling and this organism is not adversely affected by nitrogen deprivation. However, *P. bryantii* and *F. succinogenes* have little capacity to spill energy, and these bacteria are killed if the rate of carbohydrate catabolism exceeds the anabolic rate (Maglione and Russell, 1997).

The death of *P. bryantii* could be explained by methylglyoxal production. *P. bryantii* catabolizes glucose by the Embden–Meyerhof–Parnas schemes, but

this pathway is dependent on ADP availability and the turnover of ATP by anabolic reactions. When ATP does not turnover, ADP becomes limiting, and the glucose carbon is diverted to methylglyoxal production (Russell, 1993). This compound is a highly toxic substance that causes potassium depletion and protein and DNA damage. *F. succinogenes* does not produce methylglyoxal, but it accumulates large amounts of polysaccharide when cellobiose is in excess (Maglione and Russell, 1997). The cells that had excess cellobiose could not maintain an intracellular ATP pool or a membrane potential, and their viability was very low ( $\leq 10^3$  cells/ml).

## Endogenous Metabolism

When exogenous energy sources are not available, bacteria depend on endogenous sources to sustain their viability. Endogenous metabolism and maintenance energy have certain similarities, but organisms with a high maintenance rate can have a low endogenous metabolism and vice versa. A variety of intracellular molecules can be used as an energy source for endogenous metabolism, but glycogen is utilized most efficiently. Many ruminal bacteria store glycogen-like materials (Cheng *et al.*, 1973), and as much as 70% and 60% of the cell dry weight in *F. succinogenes* (Stewart *et al.*, 1981), and *P. bryantii* (Lou *et al.*, 1997b), respectively, can be glycogen. Both organisms synthesize glycogen during exponential growth; for instance, *P. bryantii* converts nearly 40% of fermentable maltose to the polysaccharide while growing. In contrast, other bacteria synthesize glycogen only when there is an excess of carbon, depletion of a non-carbon nutrient or during periods of environmental stress (Preiss, 1984).

Glycogen reserves typically decrease during periods of carbon deprivation (Mink and Hespell, 1981; Mink *et al.*, 1982; Van Kessel and Russell, 1997), but other factors can also influence glycogen deposition and utilization. When *P. bryantii* was grown in maltose-limited continuous cultures, nearly 60% of cell dry weight was glycogen at growth rates less than 0.2/h even though there was virtually no disaccharide present in the growth medium (Lou *et al.*, 1997b), and work with non-ruminal bacteria indicates that metabolites such as pyrophosphate and guanosine tetraphosphate can stimulate glycogen synthesis even if the growth rate is slow (Preiss and Romeo, 1989). Thus, it can be misleading to assume that carbon deprivation always leads to glycogen depletion.

When cellobiose-limited *F. succinogenes* batch cultures reached stationary phase, glycogen depletion was a simple first-order function, and the initial rate of glycogen degradation was tenfold greater than the endogenous rate needed to maintain cell viability (Wells and Russell, 1994). Because the glycogen was prematurely degraded, *F. succinogenes* had a short half-life. After 100 h of starvation, the viable cell count was  $< 10^2$ /ml. The rapid death rate of *F. succinogenes* could be explained by its method of sugar transport. *F. succinogenes* does not have a phosphoenolpyruvate PTS to take up sugar, and it must use sodium symport mechanisms (Franklund and Glass, 1987).

When the endogenous metabolic rate of *F. succinogenes* was  $<0.02$  mg of glycogen/mg of protein per hour, the membrane potential declined, sodium accumulated, sugar transport was no longer possible and the viable cell count decreased (Wells and Russell, 1994).

*S. bovis* does not store glycogen (Russell and Robinson, 1984), but streptococci like *S. bovis* can use phosphoenolpyruvate reserves and the PTS to drive sugar transport and reinitiate growth (Thompson, 1987). *S. bovis* can survive for long periods of time even when intracellular ATP and membrane potential are too low to be measured. *S. ruminantium* also has a PTS for glucose (Martin and Russell, 1986) and stores large amounts of glycogen (Strobel and Russell, 1991). The rapid death rate of *S. ruminantium* (Mink and Hespell, 1981; Mink *et al.*, 1982) may be related to lysis rather than starvation *per se*.

Because some ruminal bacteria can only tolerate brief periods of starvation before there is a distinct decrease in viability, the question arises, could feeding schedules have an impact on the metabolic activity of ruminal bacteria? When mixed ruminal bacteria were starved *in vitro*, intracellular glycogen reserves decreased exponentially and there was a concomitant decrease in the endogenous metabolic rate (Van Kessel and Russell, 1997). When the endogenous metabolic rate was less than  $10 \mu\text{g}$  hexose/mg protein per hour, subsequent metabolic activity (methane production, cellulose digestion, deamination and sugar fermentation) was depressed, but this decrease did not occur until the bacteria had been starved for more than 12 h. Based on these results, feeding interval would not normally have a significant impact on potential fermentation rate.

## Crossfeeding

Early work indicated that pure cultures of ruminal bacteria often produced end-products not observed in ruminal fluid (lactate, succinate, ethanol, etc.), and later work showed that these products were either intermediates in the overall fermentation or end-products not produced if other bacteria are present (Wolin and Miller, 1989). Succinate is decarboxylated by propionate-producing bacteria, methanogens keep the partial pressure of hydrogen low enough so ethanol and hydrogen are not produced, and lactate-utilizing bacteria convert lactate to acetate and propionate. In the 1970s, Scheifinger and Wolin (1973) demonstrated that cellulolytic and non-cellulolytic ruminal bacteria could coexist on cellulose, and they explained this phenomenon by a 'crossfeeding' of cellodextrins. Because this process appeared to be a strictly extracellular event, it appeared that the non-cellulolytic species was simply robbing the cellulolytic. Later work, however, indicated that *F. succinogenes* cultures that were given large amounts of glucose secreted water-soluble cellodextrins in the growth medium (Wells *et al.*, 1995). Because even cells growing on cellulose produced cellodextrins, it appeared that phosphorylation reactions needed to catabolize cellobiose and cellodextrins were working reversibly to facilitate a leakage of carbohydrate (cellodextrins) from the cells. At first glance, the cellodextrin efflux appears to be an altruism, a feature not common in bacteriology, but this



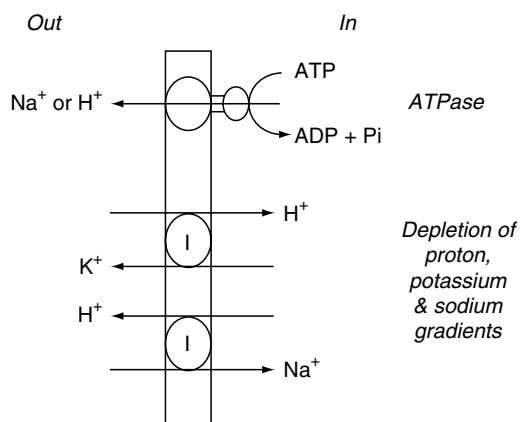
assumption is probably too simplistic. When *F. succinogenes* uses a phosphorylase to cleave cellobiose, the energetic advantage (as compared to a hydrolase) is 25%, and co-culture experiments indicated that only 25% of the cellulose was going to the non-cellulolytic organism (Wells *et al.*, 1995).

## Ionophores and Bacteriocins

Ionophores are routinely used as feed additives in beef cattle rations in the USA, and they were originally marketed as 'methane inhibitors'. Ionophores appear to have little direct effect on methanogens, but they do inhibit bacteria that produce hydrogen, the precursor of methane (Van Nevel and Demeyer, 1977). These compounds also inhibit Gram-positive bacteria, which produce lactate and ammonia. Ionophores increase feed efficiency by decreasing methane, increasing propionate to acetate ratio, increasing ruminal pH or sparing protein (Russell and Strobel, 1989).

Ionophores are highly lipophilic substances that move ions across membranes (Pressman, 1976). Monensin is a metal/proton antiporter with a high selectivity for sodium, but it also has the ability to translocate potassium. Bacteria usually maintain high intracellular concentrations of potassium and low concentrations of sodium, and monensin can dissipate these gradients (Russell, 1987). If the potassium gradient is larger than the sodium gradient, protons will accumulate intracellularly and decrease the internal pH (Fig. 9.5).

Although the pattern of ion flux amongst bacteria may be similar, the mechanism of growth inhibition is not necessarily the same. Even if transport and metabolism are not inhibited, sensitive bacteria may expend energy to counteract ion fluxes. *S. bovis* transports glucose by a PTS (Martin and Russell, 1987) and facilitated diffusion (Russell, 1990), and it ferments glucose even



**Fig. 9.5.** The effect of an ionophore (I) like monensin on the ion gradients and ATPase activity of sensitive ruminal bacteria. Redrawn from Russell and Strobel (1990).

after growth is inhibited by monensin (Russell, 1987). Some bacteria (e.g. *F. succinogenes*) transport carbohydrate by sodium-dependent mechanisms (Franklund and Glass, 1987), and these transport systems are inhibited by monensin. ATP-driven transport is sensitive to even small declines in intracellular pH (Strobel *et al.*, 1989), and proton symport mechanisms would also be inhibited by a decline in the chemical gradient of protons across the cell membrane.

When *S. bovis* was grown in a glucose-limited chemostat and the concentration of monensin or lasalocid in the medium reservoir was sequentially increased, yield declined and this effect was more pronounced at pH 5.7 than 6.7 (Chow and Russell, 1990). Since the specific rate of glucose consumption and ATP utilization increased dramatically, it appeared that the ionophores were increasing energy spilling. Since monensin caused an increase in heat production, which was sensitive to the ATPase inhibitor, DCCD (dicyclohexylcarbodiimide), it appeared that energy spilling was caused by a futile cycle of protons through the cell membrane (Russell and Strobel, 1990).

Gram-negative bacteria, which have an outer membrane to protect the cell membrane, are more resistant to ionophores than Gram-positive bacteria, but even Gram-negative bacteria may be affected by ionophores. Chen and Wolin (1979) noted that five strains of *S. ruminantium* were highly resistant to monensin and lasalocid, but *F. succinogenes* S85 and *P. ruminicola* GA33 were inhibited even by low concentrations. The sensitive strains eventually adapted, but they were never able to tolerate high concentrations. Bates *et al.* (1987) noted that monensin and lasalocid promoted proton influx into Gram-negative ruminal bacteria as well as Gram-positives, but the response was faster in Gram-positive bacteria. Pure culture experiments, however, may not reflect the impact of ionophores on energy spilling *in vivo*. If the organism is displaced from the rumen, it will not be able to spill energy!

The outer membrane model of monensin resistance is confounded by the observation that: (i) some ruminal bacteria have outer membranes (e.g. *S. ruminantium* and *M. elsdenii*) even though they are most closely related to Gram-positive species (Callaway *et al.*, 1999); (ii) some Gram-positive strains are as monensin-sensitive as Gram-negative species (Callaway and Russell, 2000); and (iii) the finding that some Gram-positive and Gram-negative bacteria can exclude monensin by accumulating extracellular polysaccharide (Callaway *et al.*, 1999; Rychlik and Russell, 2002). Work with *P. ruminicola* 23 showed that monensin-adapted strains produced more propionate and less acetate than the corresponding non-adapted cultures, but the role of this fermentation shift in monensin-resistance was not defined (Morehead and Dawson, 1992). More detailed work is needed to determine whether such adaptations play a significant role in animals fed ionophores.

The influence of ionophores on the efficiency of microbial growth *in vivo* is not entirely clear, and it should be noted that the ratio of ionophore to bacterial mass *in vitro* has typically been much higher than *in vivo* (Chow and Russell, 1990). When Dawson and Boling (1983) fed monensin to calves, ruminal bacteria from the treated animals were more resistant than the controls, but this difference was confounded by a change in the controls rather than treated

animals. Subsequent work, however, supported the idea that monensin concentration *in vivo* could be high enough to change the microbial population (Lana and Russell, 1996). When ruminal bacteria were obtained from animals not consuming monensin, the amount of monensin needed to cause half maximal potassium efflux was approximately 0.2  $\mu\text{M}$  (per optical density of cells), but the amount needed to cause a similar efflux was eightfold greater if the animals had been consuming monensin. *In vitro* studies indicated that monensin caused a significant decrease in microbial growth yields, but these mixed ruminal bacteria were obtained from unadapted animals (Van Nevel and Demeyer, 1977). When mixed ruminal microorganisms were taken from animals fed monensin and transferred in a semi-continuous fashion, there was little decrease in yield (Short *et al.*, 1978), and continuous culture studies indicated that monensin caused a small increase in  $Y_{\text{ATP}}$  (Wallace *et al.*, 1981). Poos *et al.* (1978) noted a dramatic decrease in microbial nitrogen flow to the abomasum, which was counteracted by an increase in plant nitrogen, but Yang and Russell (1993) saw a significant increase in unattached ruminal bacteria.

Ionophores have been added to ruminant diets for less than 30 years, but some ruminal bacteria produce small peptides (bacteriocins) that have similar antimicrobial activity. Bacteriocins are typically small peptides that aggregate in cell membranes to form pores (Jack *et al.*, 1995) and disrupt normal mechanisms of energy transduction (Venema *et al.*, 1995). *S. bovis* was the first bacteriocin-producing ruminal bacterium to be studied (Iverson and Mills, 1976; Whitford *et al.*, 2001), but more recent work indicates that strains of *B. fibrisolvens* (Kalmokoff *et al.*, 1996, 1999), *R. albus* (Odenyo *et al.*, 1994) and lactobacilli (Wells *et al.*, 1997) can also produce bacteriocins. Some ruminal bacteriocins only target specific species and strains, but some have a relatively broad spectrum (Kalmokoff and Teather, 1997). Based on the observation that the non-ruminal bacteriocin, nisin, had activities *in vitro* that were virtually identical to monensin (Callaway *et al.*, 1997), it is conceivable that bacteriocins could be useful tools for manipulating ruminal fermentation, perhaps in an even more specific fashion (Teather and Forster, 1998).

## Genetic Engineering, Ruminal Inoculation and Metabolic Analysis

Since the late 1970s, microbiologists have used recombinant DNA methodology to create organisms with new and sometimes amazing capabilities. In the 1980s, several groups of rumen microbiologists began to use these techniques, but their efforts were thwarted by: (i) the diversity of ruminal strains; (ii) their inability to clone critical enzymes (e.g. native cellulases); (iii) the production of truncated proteins in *E. coli*; (iv) novel promoters and transcriptional machinery; (v) a lack of shuttle vectors to move genes into ruminal bacteria; and (vi) fitness of genetically altered bacteria (Teather *et al.*, 1997; Russell and Rychlik, 2001). The fitness of genetically altered bacteria in natural environments has not been fully assessed. One might argue that the synthesis of a few additional proteins would not impose a significant energetic burden, but it

should be realized that not all proteins are produced at the same rate. In *E. coli*,  $\beta$ -galactosidase, an intracellular protein, which is involved in the utilization of a single energy source (lactose), can account for more than 4% of the total protein (Novick, 1960). The cost of extracellular protein synthesis is difficult to estimate. If the enzyme does not remain cell associated, it will be diluted into the extracellular space. Protein secretion across the cell membrane requires energy (protonmotive force and ATP), but the cost of secretion is not well defined (Neidhardt *et al.*, 1990).

There is the added question of whether artificially introduced organisms survive and persist in the rumen. Several studies have attempted to address this question and the answers, at this point, are inconclusive. Perhaps the most successful example of the establishment of a new organism in the rumen is that of *Synergistes jonesii* into animals consuming the tropical plant *Leucaena leucocephala* (Allison *et al.*, 1985). This plant contains high levels of an amino acid, mimosine, which is converted to 3-hydroxy-4(1H)-pyridone (DHP). This compound is normally a terminal end-product of ruminal fermentation and causes goiterogenic effects in the animal. However, introduction of ruminal fluid from animals adapted to *L. leucocephala* into non-adapted animals results in a prevention of the toxicity. This is due to the presence of *S. jonesii*, which converts DHP to VFA. It is clear that the organism is occupying a very specific ecological niche and is able to persist.

Although the *S. jonesii* example is dramatic, the situation is much less clear when attempts are made to introduce bacteria which utilize substrates that are used by many other organisms already resident in the rumen. In the late 1980s, Flint *et al.* (1989) reported that a strain of *S. ruminantium* persisted in the rumen for more than 30 days, but in most other cases ruminal inoculation has not been successful. For instance, Wallace and Walker (1993) noted that another *S. ruminantium* strain did not survive in the rumen for long periods, and Attwood *et al.* (1988) found that the apparent half-life of an introduced *P. bryantii* strain was less than 30 min. When ruminants were repeatedly dosed with fibrolytic ruminococci, bacterial numbers increased, but there was no increase in fibre digestibility (Krause *et al.*, 2001). These various studies highlight the fact that introduction of organisms, whether genetically altered or not, into an ecologically complex environment such as the rumen is not a straightforward endeavour.

While the prospects for altering ruminal function with engineered or even naturally occurring organisms remain unclear, advances in genomics, bioinformatics and protein biochemistry offer the promise for a much greater understanding of ruminal fermentations *in situ*. Through the use of nucleic acid arrays and proteomics, it is now possible to analyse gene expression and protein profiles in complex mixed cultures of organisms. These approaches have not yet been used quantitatively, but they offer the possibility of mapping the genetics and gene expression of mixed microbial populations. These techniques will almost certainly be powerful tools for understanding ruminal fermentations.

## Cornell Net Carbohydrate Protein System

In ruminants, the prediction of animal performance from dietary ingredients has been confounded by the impact of ruminal fermentation on host nutrition and difficulties in predicting the efficiency of microbial growth. In the last 15 years, nutritionists have striven to model rumen fermentation in a more mechanistic fashion so the impact of fermentation products and microbial protein availability can be more accurately predicted. The Cornell Net Carbohydrate Protein System (CNCPS) (Fox *et al.*, 1992; Russell *et al.*, 1992; Sniffen *et al.*, 1992) continues to be the most widely used of these models, although various aspects of the CNCPS have been criticized (Alderman *et al.*, 2001).

A basic feature of the CNCPS is the prediction of ruminal availability from the relative rates of fermentation ( $K_d$ ) and passage ( $K_p$ ) (i.e. availability is  $K_d/(K_d + K_p)$ ) (Waldo *et al.*, 1972). Once the ruminally degraded pool of each feed component has been calculated, bacterial growth in the rumen is computed from carbohydrate fractions. Fats do not drive microbial growth, and ruminally degraded proteins (and resulting peptide and amino acids) only stimulate the bacterial mass that is derived from carbohydrates. Although it is now recognized that the rumen also has a pool of obligate amino acid-fermenting bacteria, these bacteria are found at low numbers in the rumen and are not a significant source of microbial protein (see above).

The rumen sub-model assumes that bacteria are the only source of microbial protein leaving the rumen. This assumption is a major simplification, but *in vivo* studies have indicated that ruminal protozoa lyse easily and account for less than 10% of the microbial protein entering the abomasum (Weller and Pilgrim, 1974; Leng, 1982). The CNCPS accounts for the impact of ruminal protozoa on bacteria by decreasing the theoretical maximum growth yield of the bacteria by 20%. This adjustment seeks to account for the impact of bacterial predation by protozoa as well as protozoal competition with bacteria and their subsequent lysis.

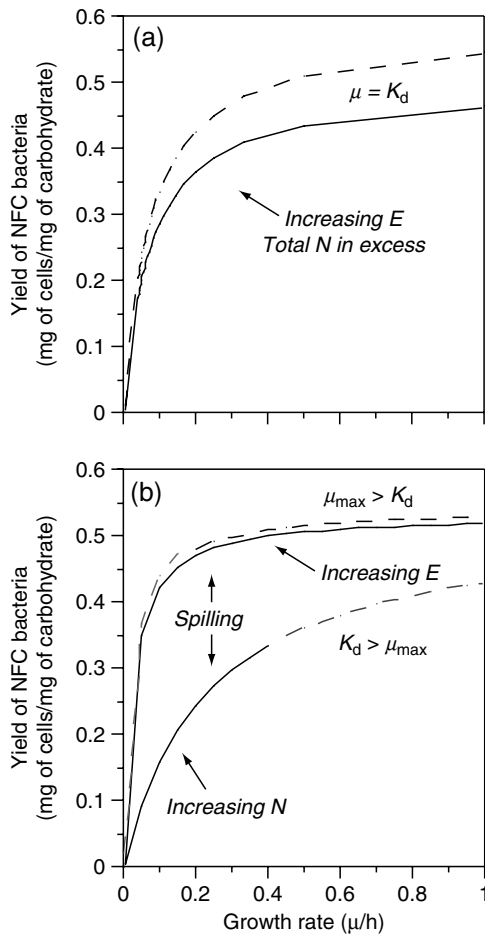
Because each carbohydrate fraction is described by a first-order rate constant, it is possible to: (i) predict growth rates of the bacteria; and (ii) estimate yields that are corrected for maintenance energy. The ruminal bacteria are divided into two pools: (i) the fibre carbohydrate (FC) bacteria; and (ii) the non-fibre carbohydrate (NFC) bacteria. These bacterial groups have different maintenance energy coefficients (Russell and Baldwin, 1979) and patterns of nitrogen utilization (Atasoglu *et al.*, 2001). The rumen sub-model was constructed before the isolation of obligate amino acid-fermenting bacteria, and these bacteria are currently part of the NFC pool.

NFC (but not FC) bacteria are stimulated by the availability of peptide and amino acids in the rumen, and amino nitrogen availability is a function of protein degradation rates, the peptide uptake rate and the relative utilization of ammonia and amino N by NFC bacteria. FC bacteria are assumed to use only ammonia nitrogen, but NFC bacteria can derive as much as two-thirds of the nitrogen from amino N, if amino nitrogen is still available. The impact of amino nitrogen on NFC bacterial yield is based on the ratio of peptide and amino acids to total organic matter (peptide and amino acid plus carbohydrates)

digested in the rumen, and yield can be increased by as much as 18.7% if the peptide and amino acids account for 14% of this organic matter.

The peptide stimulation function does not directly address the potential impact of amino nitrogen on the microbial growth rate or the impact of growth rate on maintenance. Because the peptide stimulation is invoked even if the fermentation rate ( $K_d$ ) of NFC is low, the relationship of amino nitrogen and energy spilling is simplistic. Amino acid-dependent declines in energy spilling are only great if the rate of energy source degradation is fast, and amino acids and not energy are restricting the bacteria (Fig. 9.6).

The original CNCPS (Russell *et al.*, 1992) noted that low pH could have a negative impact on the yield of NFC bacteria if ruminal pH was 5.7 (Strobel and



**Fig. 9.6.** The effect of increasing energy (E) or ammonia (solid lines) or ammonia plus amino N (dotted lines) on the yield of NFC bacteria in the original version of the CNCPS (Russell *et al.*, 1992) is shown in part (a). When carbohydrate is the factor limiting growth rate ( $\mu$ ), the maximum growth rate of the bacteria ( $\mu_{max}$ ) is greater than the degradation rate of NFC ( $K_d$ ). Part (b) shows the potential impact of energy spilling. If energy (NFC) is in excess,  $K_d$  is greater than  $\mu_{max}$ . These graphs were redrawn from the data of Van Kessel and Russell (1996).

Russell, 1986), but it did not attempt to predict ruminal pH *per se*. The yield of NFC bacteria was simply decreased 2.5% for every 1% decrease in the NDF content of the ration. The impact of pH on FC digestion was ignored, but it was assumed that FC would only make up a small part of the ration when pH was low enough to have a negative impact on FC digestion. Pitt *et al.* (1996) attempted to describe the relationship between effective NDF in a more mechanistic fashion, and three facets of this work were incorporated into later versions of the CNCPS (Fox *et al.*, 2000). First, pH was a function of effective NDF where eNDF was defined by cell wall content and particle size. Secondly, yield of NFC bacteria was decreased as a function of eNDF. Thirdly, as ruminal pH declined, the maintenance energy coefficient of FC bacteria was increased and the rate of fibre digestion was decreased. These adjustments did not account for the effect of NFC digestion rate on pH or the impact of ruminal fluid dilution rates on VFA concentrations in the rumen. De Veth and Kolver (2000) concluded that these adjustments had too high a pH threshold and led to an under-prediction of microbial growth and fibre digestion at low pH.

The original CNCPS (Russell *et al.*, 1992) recognized that a ruminal nitrogen deficiency would have a negative impact on bacterial yield, but it did not quantify this effect. Tedeschi *et al.* (2000) added a series of equations to the CNCPS that adjusted the yield and fibre digestion when nitrogen was limiting. These equations use ruminally available amino acid and ammonia nitrogen to determine the N-allowable microbial growth. The N-allowable microbial growth value is then subtracted from the energy-allowable microbial growth to obtain the reduction in microbial mass. This mass reduction is allocated between FC and NFC bacteria digesters according to their original proportions in the energy-allowable microbial growth. The reduction in fermented FC is computed as the FC bacterial mass reduction divided by its yield. This reduction is then added to the FC fraction escaping the rumen.

Ammonia accumulation in the rumen causes a loss of feed protein and environmental pollution. The CNCPS uses protein degradation and the greater peptide uptake rate to estimate the amount of amino nitrogen that the NFC bacteria take up, and the relative incorporation of amino N vs ammonia nitrogen into NFC bacteria is computed from the yield equations described above. The remaining amino nitrogen taken up by the NFC bacteria is then converted to ammonia. Because the obligate amino acid-fermenting bacteria are not partitioned into a separate bacteria pool, it is difficult to assess the effect of additives (e.g. monensin). Monensin is more effective against Gram-positive bacteria than Gram-negative species and the NFC has both types of these bacteria.

The CNCPS estimates the pool of peptide and amino acids in the rumen, but the amount of peptide and amino acids that pass out of the rumen undegraded is typically very small relative to other nitrogen fluxes. The peptide and amino acid pool, however, provides a diagnostic tool to monitor the amino status of the NFC bacteria. By monitoring the peptide and amino acid pool (balance), the user can predict whether the addition of ruminal degraded protein is likely to have a positive impact on the flow of NFC bacteria from the rumen or whether this protein will simply enter the ammonia pool.

## Conclusions

Bacterial growth is a summation of reactions, which allow organisms to reproduce and adapt to a changing environment. As pointed out by Hungate (1966), the selection for maximum biochemical work has been a key determinant of microbial evolution. Since growth in the rumen is usually energy-limited, the development of efficient catabolic and anabolic reaction mechanisms has been a critical element of growth and survival. Growing cells must be able to scavenge nutrients from the environment, accumulate these materials intracellularly, maintain an appropriate intracellular environment, derive energy and synthesize a variety of cellular constituents. There are innumerable combinations of reactions leading to the formation of cell material, and this complexity is compounded by the diversity of the rumen microbial population. Since feeds are highly heterogeneous, it appears that no single organism can be ideally fitted to all of the available niches. This complexity has thwarted the ability of nutritionists to estimate the availability of nutrients from dietary ingredients. However, rumen microbiologists and nutritionists are beginning to design models that are able to predict microbial growth in the rumen. New molecular tools and bioinformatics offer the promise for an even better understanding of this ecologically complex environment.

## References

- Abou Akada, A.R. and El-Shazly, K. (1964) Effect of absence of ciliate protozoa from the rumen on microbial activity and growth of lambs. *Applied Microbiology* 12, 384–390.
- Alderman, G., France, J. and Kebreab, E. (2001) A critique of the Cornell net carbohydrate and protein system with emphasis on dairy cattle. 1. The rumen model. *Journal of Animal and Feed Sciences* 10, 1–24.
- Allison, M.J. (1969) Biosynthesis of amino acids by ruminal microorganisms. *Journal of Animal Science* 29, 797–807.
- Allison, M.J., Dawson, K.A., Mayberry, W.R. and Foss, J.G. (1985) *Oxalobacter formigenes* gen-nov, sp-nov oxalate-degrading anaerobes that inhabit the gastrointestinal tract. *Archives of Microbiology* 141, 1–7.
- Atasoglu, C., Newbold, C.J. and Wallace, R.J. (2001) Incorporation of [<sup>15</sup>N] ammonia by the cellulolytic ruminal bacteria *Fibrobacter succinogenes* BL2, *Ruminococcus albus* SY3, and *Ruminococcus flavefaciens* 17. *Applied and Environmental Microbiology* 67, 2819–2822.
- Attwood, G.T., Lockington, R.A., Xue, G.P. and Brooker, G.P. (1988) Use of a unique gene sequence as a probe to enumerate a strain of *Bacteroides rumenicola* introduced into the rumen. *Applied and Environmental Microbiology* 54, 534–539.
- Attwood, G.T., Klieve, A.V., Ouwkerk, D. and Patel, B.K. (1998) Ammonia-hyperproducing bacteria from New Zealand ruminants. *Applied and Environmental Microbiology* 64, 1794–1804.
- Baldwin, R.L., Wood, W.A. and Emery, R.S. (1963) Conversion of glucose-C14 to propionate by the rumen microbiota. *Journal of Bacteriology* 85, 1346–1349.



- Bates, D.B., Schwingel, W.R. and Denham, S.C. (1987) Effects of mineral cations on ionophore catalyzed proton flux into ruminal bacteria. In: *19th Conference on Rumen Function*, 17–19 November 1987, Chicago, Illinois.
- Bauchop, T. (1979) Rumen anaerobic fungi of cattle and sheep. *Applied and Environmental Microbiology* 38, 148–158.
- Bauchop, T. and Elsdon, S.R. (1960) The growth of microorganisms in relation to their energy supply. *Journal of General Microbiology* 23, 457–469.
- Bladen, H.A., Bryant, M.P. and Doetsch, R.N. (1961) A study of bacterial species from the rumen which produce ammonia from protein hydrolyzate. *Applied Microbiology* 9, 175–180.
- Blaut, M., Muller, V. and Gottschalk, G. (1990) Energetics of methanogens. In: Krulwich, T. (ed.) *Bacterial Energetics*. Academic Press, New York, pp. 505–537.
- Bond, D.R. and Russell, J.B. (1996) A role for fructose 1,6 diphosphate in the ATPase-mediated energy-spilling reaction of *Streptococcus bovis*. *Applied and Environmental Microbiology* 62, 2095–2099.
- Bond, D.R. and Russell, J.B. (1998) Relationship between intracellular phosphate, proton motive force, and the rate of non-growth energy dissipation (energy spilling) in *Streptococcus bovis* JB1. *Applied and Environmental Microbiology* 64, 976–981.
- Bond, D.R. and Russell, J.B. (2000) Protonmotive force regulates the membrane conductance of *Streptococcus bovis* in a non-Ohmic fashion. *Microbiology* 146, 687–694.
- Braune, A., Bendrat, K., Rospert, S. and Buckel, W. (1999) The sodium ion translocating glutaconyl-CoA decarboxylase from *Acidaminococcus fermentans*: cloning and function of the genes forming a second operon. *Molecular Microbiology* 31, 473–487.
- Brockman, H.L. and Wood, W.A. (1975) Acrylyl-coenzyme A. *Journal of Bacteriology* 123, 1447–1453.
- Buckel, W. (2001) Sodium ion-translocating decarboxylases. *Biochimica et Biophysica Acta* 1505, 15–27.
- Buurman, E.T., Teixeira de Mattos, M.J. and Neijssel, O.M. (1991) Futile cycling of ammonium ions via the high affinity potassium uptake system ( $K_{dp}$ ) of *Escherichia coli*. *Archives of Microbiology* 155, 391–395.
- Callaway, T.R. and Russell, J.B. (2000) Variations in the ability of ruminal Gram-negative *Prevotella* species to resist monensin. *Current Microbiology* 40, 185–190.
- Callaway, T.R., Carneiro De Melo, A.M.S. and Russell, J.B. (1997) The effect of nisin and monensin on ruminal fermentations *in vitro*. *Current Microbiology* 35, 90–96.
- Callaway, T.R., Adams, K.A. and Russell, J.B. (1999) The ability of 'low G+C Gram-positive' ruminal bacteria to resist monensin and counteract potassium depletion. *Current Microbiology* 39, 225–230.
- Chen, G. and Russell, J.B. (1988) Fermentation of peptides and amino acids by a monensin-sensitive ruminal peptostreptococcus. *Applied and Environmental Microbiology* 54, 2742–2749.
- Chen, G. and Russell, J.B. (1989) More monensin-sensitive, ammonia producing bacteria from the rumen. *Applied and Environmental Microbiology* 55, 1052–1057.

- Chen, G. and Russell, J.B. (1990) Transport and deamination of amino acids by a Gram-positive, monensin sensitive ruminal bacterium. *Applied and Environmental Microbiology* 56, 2186–2192.
- Chen, M. and Wolin, M.J. (1979) Effect of monensin and lasalocid-sodium on the growth of methanogenic and rumen saccharolytic bacteria. *Applied and Environmental Microbiology* 38, 72–77.
- Chen, G., Strobel, H.J., Russell, J.B. and Sniffen, C.J. (1987) The effect of hydrophobicity on the uptake and deamination of peptides by ruminal bacteria *in vitro*. *Applied and Environmental Microbiology* 53, 2021–2025.
- Cheng, K.-J., Hironaka, R., Roberts, D.W.A. and Costerton, J.W. (1973) Cytoplasmic glycogen inclusions in cells of anaerobic Gram-negative rumen bacteria. *Canadian Journal of Microbiology* 19, 1501–1506.
- Chow, J.M. and Russell, J.B. (1990) Effect of ionophores and pH on growth of *Streptococcus bovis* in batch and continuous culture. *Applied and Environmental Microbiology* 56, 1588–1593.
- Citron, A., Breton, A. and Fonty, G. (1987) Rumen anaerobic fungi. *Bulletin Institute Pasteur* 85, 329–343.
- Clarke, R.T.J. (1977) Methods for studying gut microbes. In: Clarke, R.T.J. and Bauchop, T. (eds) *Microbial Ecology of the Gut*. Academic Press, New York, pp. 1–26.
- Coleman, G.S. (1980) Rumen ciliate protozoa. *Advances in Parasitology* 18, 121–173.
- Cook, G.M. and Russell, J.B. (1994) The effect of extracellular pH and lactic acid on pH homeostasis in *Lactococcus lactis* and *Streptococcus bovis*. *Current Microbiology* 28, 165–168.
- Dawson, K.A. and Boling, J.A. (1983) Monensin-resistant bacteria in the rumens of calves on monensin-containing and unmedicated diets. *Applied and Environmental Microbiology* 46, 160–164.
- De Veth, M.J. and Kolver, E.S. (2000) Digestion of ryegrass pasture in response to change in pH in continuous culture. *Journal of Dairy Science* 84, 1449–1457.
- Dimroth, P. (1987) Sodium ion transport decarboxylases and other aspects of sodium cycling in bacteria. *Microbiological Reviews* 51, 320–340.
- Dinius, D.A., Simpson, M.E. and Marsh, P.B. (1976) Effect of monensin fed with forage on digestion and the ruminal ecosystem of steers. *Journal of Animal Science* 42, 229–234.
- Eadie, J.M. and Gill, J.C. (1971) Effect of the absence of rumen ciliate protozoa on growing lambs fed on a roughage-concentrate diet. *British Journal of Nutrition* 26, 155–167.
- Flint, H.J., Bisset, J. and Webb, J. (1989) Use of antibiotic resistance mutations to track strains of obligately anaerobic bacteria introduced into the rumen of sheep. *Journal of Applied Bacteriology* 67, 177–183.
- Fonty, G., Breton, A., Fevre, M., Citron, A., Hebraud, M. and Gouet, P. (1987) Isolement et caractérisation des champignons anaérobies stricts du rumen de moutons. Premiers résultats. *Reproduction Nutrition Development* 27, 237–238.
- Fox, D.G., Sniffen, C.J., O'Connor, J.D., Russell, J.B. and Van Soest, P.J. (1992) A net-carbohydrate and protein system for evaluating cattle diets. III. Cattle requirements and diet adequacy. *Journal of Animal Science* 70, 3578–3596.
- Fox, D.G., Tylutki, T.P., Van Amburgh, M.E., Chase, L.E., Pell, A.N., Overton, T.R., Tedeschi, L.O., Rasmussen, C.N. and Durbal, V.M. (2000) *The Net Carbohydrate and Protein System for Evaluating Herd Nutrition and Nutrient Excretion*. Department of Animal Science, Cornell University, Ithaca, New York.

- Franklund, C.V. and Glass, T.L. (1987) Glucose uptake by the cellulolytic ruminal anaerobe *Bacteroides succinogenes*. *Journal of Bacteriology* 169, 500–506.
- Harden, A. and Young, W.J. (1906) The alcoholic fermentation of yeast juice. II. The coferment of yeast juice. *Proceedings of the Royal Society, Series B* 78, 369–375.
- Harold, F.M. (1986) *The Vital Force: a Study of Bioenergetics*. W.H. Freeman and Company, New York, 577 pp.
- Herbert, D.R., Elsworth, R. and Telling, R.C. (1956) The continuous culture of bacteria: a theoretical and experimental study. *Journal of General Microbiology* 14, 601–622.
- Hespehl, R.B. and Bryant, M.P. (1979) Efficiency of rumen microbial growth: influence of some theoretical and experimental factors on  $Y_{ATP}$ . *Journal of Animal Science* 49, 1640–1659.
- Hume, I.D., Moir, R.J. and Somers, M. (1970) Synthesis of microbial protein in the rumen. I. Influence of the level of nitrogen intake. *Australian Journal of Agricultural Research* 21, 283–296.
- Hungate, R.E. (1966) *The Rumen and its Microbes*. Academic Press, New York.
- Isaacson, H.R., Hinds, F.C., Bryant, M.P. and Owens, F.N. (1975) Efficiency of energy utilization by mixed rumen bacteria in continuous culture. *Journal of Dairy Science* 58, 1645–1659.
- Iverson, W.G. and Mills, N.F. (1976) Bacteriocins of *Streptococcus bovis*. *Canadian Journal of Microbiology* 22, 1040–1047.
- Jack, R.W., Tagg, J.R. and Ray, B. (1995) Bacteriocins of Gram-positive bacteria. *Microbiological Reviews* 59, 171–200.
- Kaback, H.R. (1969) Regulation of sugar transport in isolated bacterial membrane preparations from *Escherichia coli*. *Proceedings of the National Academy of Sciences USA* 63, 724–731.
- Kalmokoff, M.L. and Teather, R.M. (1997) Isolation and characterization of a bacteriocin (butyriovibriocin AR10) from the ruminal anaerobe *Butyriovibrio fibrisolvens* AR10: evidence in support of widespread occurrence of bacteriocin-like activity among ruminal isolates of *B. fibrisolvens*. *Applied Environmental Microbiology* 63, 394–402.
- Kalmokoff, M.L., Bartlett, F. and Teather, R.M. (1996) Are ruminal bacteria armed with bacteriocins? *Journal of Dairy Science* 79, 2297–2306.
- Kalmokoff, M.L., Lu, D., Whitford, M.F. and Teather, R.M. (1999) Evidence for production of a new antibiotic (butyriovibriocin OR79A) by the ruminal anaerobe *Butyriovibrio fibrisolvens* OR79: characterization of the structural gene encoding butyriovibriocin OR79A. *Applied and Environmental Microbiology* 65, 2128–2135.
- Krause, D.O., Bunch, R.J., Conlan, L.L., Kennedy, P.M., Smith, W.J., Mackie, R.I. and McSweeney, C.S. (2001) Repeated ruminal dosing of *Ruminococcus* spp. does not result in persistence, but changes in other microbial populations occur that can be measured with quantitative 16S-rRNA-based probes. *Microbiology* 147, 1719–1729.
- Kroger, A. and Winkler, E. (1981) Phosphorylative fumarate reduction in *Vibrio succinogenes*: stoichiometry of ATP synthesis. *Archives of Microbiology* 129, 100–104.
- Kuhner, C.H., Hartman, P.A. and Allison, M.J. (1996) Generation of a proton motive force by the anaerobic oxalate-degrading bacterium *Oxalobacter formigenes*. *Applied and Environmental Microbiology* 62, 2494–2500.

- Lana, R.P. and Russell, J.B. (1996) Use of potassium depletion to assess adaptation of ruminal bacteria to ionophores. *Applied and Environmental Microbiology* 62, 4499–4503.
- Leng, R.A. (1982) Dynamics of protozoa in the rumen of sheep. *British Journal of Nutrition* 48, 299.
- Leng, R.A. and Nolan, J.V. (1984) Nitrogen metabolism in the rumen. *Journal of Dairy Science* 67, 1072–1089.
- Lipmann, F. (1941) Metabolic generation and utilization of phosphate bond energy. *Advances in Enzymology* 1, 99–162.
- Lou, J., Dawson, K.A. and Strobel, H.J. (1996) Role of phosphorylytic cleavage in cellobiose and cellodextrin metabolism by the ruminal bacterium *Prevotella ruminicola*. *Applied and Environmental Microbiology* 62, 1770–1773.
- Lou, J., Dawson, K.A. and Strobel, H.J. (1997a) Cellobiose and cellodextrin metabolism by the cellulolytic ruminal bacterium *Ruminococcus albus*. *Current Microbiology* 35, 221–227.
- Lou, J., Dawson, K.A. and Strobel, H.J. (1997b) Glycogen metabolism by the ruminal bacterium *Prevotella ruminicola*. *Applied and Environmental Microbiology* 63, 1483–1488.
- Macy, J., Probst, I. and Gottschalk, G. (1975) Evidence for cytochrome involvement in fumarate reduction and adenosine 5'-triphosphate synthesis by *Bacteroides fragilis* grown in the presence of hemin. *Journal of Bacteriology* 123, 436–442.
- MacZulak, A.E., Dehority, B.A. and Palmquist, D.L. (1981) Effects of long-chain fatty acids on growth of rumen bacteria. *Applied Environmental Microbiology* 42, 856–862.
- Maeng, W.J. and Baldwin, R.L. (1976a) Dynamics of fermentation of a purified diet and microbial growth in the rumen. *Journal of Dairy Science* 59, 636–642.
- Maeng, W.J. and Baldwin, R.L. (1976b) Factors influencing rumen microbial growth rates and yields: effects of amino acid additions over time. *Journal of Dairy Science* 59, 643–647.
- Maeng, W.J., Van Nevel, C.J., Baldwin, R.L. and Morris, J.G. (1976) Rumen microbial growth rates and yields: effect of amino acids and protein. *Journal of Dairy Science* 59, 68–79.
- Maglione, G. and Russell, J.B. (1997) The adverse effect of nitrogen limitation and excess-cellobiose on *Fibrobacter succinogenes*. *Applied Microbiology in Biotechnology* 48, 720–725.
- Maloy, S.R. (1990) Sodium-coupled cotransport. In: Krulwich, T.A. (ed.) *Bacterial Energetics*. Academic Press, New York, pp. 203–224.
- Marr, A.G., Nilson, E.H. and Clark, D.J. (1962) The maintenance requirement of *Escherichia coli*. *Annals of the New York Academy of Science* 102, 536–548.
- Martin, S.A. and Russell, J.B. (1986) Phosphoenolpyruvate-dependent phosphorylation of hexoses by rumen bacteria: evidence for the phosphotransferase system of transport. *Applied and Environmental Microbiology* 52, 1348–1352.
- Martin, S.A. and Russell, J.B. (1987) Transport and phosphorylation of disaccharides by the ruminal bacterium, *Streptococcus bovis*. *Applied and Environmental Microbiology* 53, 2388–2393.
- Matheron, C., Delort, A.-M., Gaudet, G., Forano, E. and Tibor, L. (1998) <sup>13</sup>C and <sup>1</sup>H nuclear magnetic resonance study of glycogen futile cycling in strains of the genus *Fibrobacter*. *Applied and Environmental Microbiology* 64, 74–81.
- Melville, S.B., Michel, T.A. and Macy, J.M. (1988) Pathway and sites for energy conservation in the metabolism of glucose by *Selenomonas ruminantium*. *Journal of Bacteriology* 170, 5298–5304.

- Michels, P.A.M., Michels, J.P.J., Boonstra, J. and Konings, W.N. (1979) Generation of an electrochemical proton gradient in bacteria by the excretion of metabolic end products. *FEMS Letters* 5, 357–364.
- Mink, R.W. and Hespell, R.B. (1981) Long-term nutrient starvation of continuously cultured (glucose-limited) *Selenomonas ruminantium*. *Journal of Bacteriology* 148, 541–550.
- Mink, R.W., Patterson, J.A. and Hespell, R.B. (1982) Changes in viability, cell composition, and enzyme levels during starvation of continuously cultured (ammonia-limited) *Selenomonas ruminantium*. *Applied and Environmental Microbiology* 44, 913–918.
- Mitchell, P. (1961) Coupling of phosphorylation to electron and hydrogen transfer by a chemiosmotic type mechanism. *Nature (London)* 191, 144–148.
- Morehead, M.C. and Dawson, K.A. (1992) Some growth and metabolic characteristics of monensin-sensitive and monensin-resistant strains of *Prevotella (Bacteroides) ruminicola*. *Applied and Environmental Microbiology* 58, 1617–1623.
- Morowitz, H.J. (1978) *Foundations of Bioenergetics*. Academic Press, New York, 344 pp.
- Mulder, M.M., Teixeira, M.J., Postma, P.W. and van Dam, K. (1986) Energetic consequences of multiple  $K^+$  uptake systems in *Escherichia coli*. *Biochimica et Biophysica Acta* 851, 223–228.
- Neidhardt, F.C., Ingraham, J.L. and Schaechter, M. (1990) *Physiology of the Bacterial Cell*. Sinauer Associates, Incorporated, Sunderland, Massachusetts, 506 pp.
- Nicholls, D.G. and Ferguson, S.J. (1992) *Bioenergetics 2*. Academic Press, New York, 255 pp.
- Nocek, J. and Russell, J.B. (1988) Protein and carbohydrate as an integrated system. Relationship of ruminal availability to microbial contribution and milk production. *Journal of Dairy Science* 71, 2070–2107.
- Novick, A. (1960) Bacteria with high levels of specific enzymes. In: Zarrow, M.X. (ed.) *Growth in Living Systems. Proceedings of the International Symposium on Growth*. Basic Books Inc., New York, pp. 93–106.
- Odenyo, A.A., Mackie, R.I., Stahl, D.A. and White B.A. (1994) The use of 16S rRNA-targeted oligonucleotide probes to study competition between ruminal fibrolytic bacteria: development of probes for *Ruminococcus* species and evidence for bacteriocin production. *Applied and Environmental Microbiology* 60, 3688–3696.
- Orpin, C.G. and Joblin, K.N. (1989) The rumen fungi. In: Hobson, P.N. and Wallace, R.J. (eds) *The Rumen Microbial Ecosystem*. Elsevier Applied Science, London, pp. 129–150.
- Paster, B., Russell, J.B., Yang, C.M.J., Chow, J.M., Woese, C.R. and Tanner, R. (1993) Phylogeny of ammonia-producing ruminal bacteria, *Peptostreptococcus anaerobius*, *Clostridium sticklandii* and *Clostridium aminophilum* sp. nov. *International Journal of Systematic Bacteriology* 43, 107–110.
- Pirt, S.J. (1965) The maintenance energy of bacteria in growing cultures. *Proceedings of the Royal Society of London Series B* 163, 224–231.
- Pitt, R.E., Van Kessel, J.S., Fox, D.G., Pell, A.N., Barry, M.C. and Van Soest, P.J. (1996) Prediction of volatile fatty acids and pH within the net carbohydrate and protein system. *Journal of Animal Sciences* 74, 226–244.
- Poos, M.I., Hanson, T.L. and Klopfenstein, J. (1978) Effect of monensin on rumen bypass of protein and microbial protein synthesis. *American Society of Animal Science Annual Meeting*, July 9–13, 1978, East Lansing, Michigan.

- Pressman, B.C. (1976) Biological applications of ionophores. *Annual Reviews of Biochemistry* 45, 501–530.
- Preiss, J. (1984) Bacterial glycogen synthesis and its regulation. *Annual Review of Microbiology* 38, 419–458.
- Preiss, J. and Romeo, T. (1989) Physiology, biochemistry, and genetics of bacterial glycogen synthesis. *Advances in Microbial Physiology* 30, 183–238.
- Prins, R.A. (1977) Biochemical activities of gut micro-organisms. In: Clarke, R.T.J. and Bauchop, T. (eds) *Microbial Ecology of the Gut*. Academic Press, New York, pp. 73–184.
- Russell, J.B. (1983) Fermentation of peptides by *Bacteroides rumenicola* B<sub>14</sub>. *Applied and Environmental Microbiology* 45, 1566–1574.
- Russell, J.B. (1986) Heat production by ruminal bacteria in continuous culture and its relationship to maintenance energy. *Journal of Bacteriology* 168, 694–701.
- Russell, J.B. (1987) A proposed model of monensin action in inhibiting rumen bacterial growth: effects on ion flux and protonmotive force. *Journal of Animal Science* 64, 1519–1525.
- Russell, J.B. (1990) Low affinity, high capacity system of glucose transport in the ruminal bacterium *Streptococcus bovis*: evidence for a mechanism of facilitated diffusion. *Applied and Environmental Microbiology* 56, 3304–3307.
- Russell, J.B. (1991a) A re-assessment of bacterial growth efficiency: the heat production and membrane potential of *Streptococcus bovis* in batch and continuous culture. *Archives of Microbiology* 155, 559–565.
- Russell, J.B. (1991b) Intracellular pH of acid-tolerant ruminal bacteria. *Applied and Environmental Microbiology* 57, 3383–3384.
- Russell, J.B. (1992) Another explanation for the toxicity of fermentation acids at low pH: anion accumulation versus uncoupling. *Journal of Applied Bacteriology* 73, 363–370.
- Russell, J.B. (1993) The glucose toxicity of *Prevotella ruminicola*: methylglyoxal accumulation and its effect of membrane physiology. *Applied and Environmental Microbiology* 59, 2844–2850.
- Russell, J.B. and Baldwin, R.L. (1979) Comparison of maintenance energy expenditures and growth yields among several rumen bacteria grown on continuous culture. *Applied and Environmental Microbiology* 37, 537–543.
- Russell, J.B. and Cook, G.M. (1995) Energetics of bacterial growth: balance of anabolic and catabolic reactions. *Microbiological Reviews* 59, 48–62.
- Russell, J.B. and Diez-Gonzalez, F. (1998) The effects of fermentation acids on bacterial growth. *Advances in Microbial Physiology* 39, 205–234.
- Russell, J.B. and Dombrowski, D.B. (1980) Effect of pH on the efficiency of growth by pure cultures of rumen bacteria in continuous culture. *Applied and Environmental Microbiology* 39, 604–610.
- Russell, J.B. and Martin, S.A. (1984) Effects of various methane inhibitors on the fermentation of amino acids by mixed rumen microorganisms *in vitro*. *Journal of Animal Science* 59, 1329–1338.
- Russell, J.B. and Robinson, P.H. (1984) Compositions and characteristics of strains of *Streptococcus bovis*. *Journal of Dairy Science* 67, 1525–1531.
- Russell, J.B. and Rychlik, J.L. (2001) Factors that alter rumen microbial ecology. *Science* 292, 1119–1122.
- Russell, J.B. and Sniffen, C.J. (1984) Effect of carbon-4 and carbon-5 volatile fatty acids on growth of mixed rumen bacteria *in vitro*. *Journal of Dairy Science* 67, 987–994.

- Russell, J.B. and Strobel, H.J. (1987) Concentration of ammonia across the cell membranes of mixed rumen bacteria. *Journal of Dairy Science* 70, 970–976.
- Russell, J.B. and Strobel, H.J. (1989) The effect of ionophores on ruminal fermentation. *Applied and Environmental Microbiology* 55, 1–6.
- Russell, J.B. and Strobel, H.J. (1990) ATPase-dependent energy spilling by the ruminal bacterium, *Streptococcus bovis*. *Archives of Microbiology* 153, 378–383.
- Russell, J.B. and Wallace, R.J. (1989) Energy yielding and consuming reactions. In: Hobson, P.N. and Wallace, R.J. (eds) *The Rumen Microbial Ecosystem*. Elsevier Applied Science, London, pp. 185–216.
- Russell, J.B. and Wilson, D.B. (1996) Why are ruminal cellulolytic bacteria unable to digest cellulose at low pH? *Journal of Dairy Science* 79, 1503–1509.
- Russell, J.B., Strobel, H.J. and Chen, G. (1988) The enrichment and isolation of a ruminal bacterium with a very high specific activity of ammonia production. *Applied and Environmental Microbiology* 54, 872–877.
- Russell, J.B., Strobel, H.J. and Martin, S.A. (1990) Strategies of nutrient transport by ruminal bacteria. *Journal of Dairy Science* 73, 2996–3012.
- Russell, J.B., O'Connor, J.D., Fox, D.G., Van Soest, P.J. and Sniffen, C.J. (1992) A net-carbohydrate and protein system for evaluating cattle diets. I. Ruminal. *Journal of Animal Science* 70, 3551–3561.
- Rychlik, J.L. and Russell, J.B. (2002) The adaptation and resistance of *Clostridium aminophilum* F to the butyrylvibriocin-like substance of *Butyrivibrio fibrisolvens* JL5 and monensin. *FEMS Microbiology Letters* 209, 93.
- Scheifinger, C.C. and Wolin, M.J. (1973) Propionate formation from cellulose and soluble sugars by combined cultures of *Bacteroides succinogenes* and *Selenomonas ruminantium*. *Applied Microbiology* 26, 789–795.
- Short, D.E., Bryant, M.P., Hinds, F.C. and Fahey, G.C. (1978) Effect of monensin upon fermentation end products and cell yield of anaerobic microorganisms. *Abstracts – 11th Annual Meeting*, American Society of Animal Science Midwestern Section, p. 44.
- Sniffen, C.J., O'Connor, J.D., Van Soest, P.J., Fox, D.G. and Russell, J.B. (1992) A net-carbohydrate and protein system for evaluating cattle diets. II. Carbohydrate and protein availability. *Journal of Animal Science* 70, 3562–3577.
- Stewart, C.S. and Bryant, M.P. (1989) The rumen bacteria. In: Hobson, P.N. and Wallace, R.J. (eds) *The Rumen Microbial Ecosystem*. Elsevier Applied Science, London, pp. 21–76.
- Stewart, C.S., Paniagua, D., Dinsdale, D., Cheng, K.-J. and Garrow, S. (1981) Selective isolation and characteristics of *Bacteroides succinogenes* from the rumen of a cow. *Applied and Environmental Microbiology* 41, 504–510.
- Stouthamer, A.H. (1973) A theoretical study on the amount of ATP required for synthesis of microbial cell material. *Antonie van Leeuwenhoek* 39, 545–565.
- Stouthamer, A.H. (1979) The search for correlation between theoretical and experimental growth yields. In: Quayle, J.R. (ed.) *International Review of Biochemistry and Microbial Biochemistry*, vol. 21. University Park Press, Baltimore, Maryland, pp. 1–47.
- Strobel, H.J. (1993a) Evidence for catabolite inhibition in regulation of pentose utilization and transport in the ruminal bacterium *Selenomonas ruminantium*. *Applied and Environmental Microbiology* 59, 40–46.
- Strobel, H.J. (1993b) Pentose utilization and transport by the ruminal bacterium *Prevotella ruminicola* B<sub>14</sub>. *Archives of Microbiology* 165, 465–471.

- Strobel, H.J. (1994) Pentose transport by the ruminal bacterium *Butyrivibrio fibrisolvens*. *FEMS Microbiology Letters* 122, 217–222.
- Strobel, H.J. and Dawson, K.A. (1993) Xylose and arabinose utilization by the ruminal bacterium *Butyrivibrio fibrisolvens*. *FEMS Microbiology Letters* 113, 291–296.
- Strobel, H.J. and Russell, J.B. (1986) Effect of pH and energy spilling on bacterial protein synthesis by carbohydrate-limited cultures of mixed rumen bacteria. *Journal of Dairy Science* 69, 2941–2947.
- Strobel, H.J. and Russell, J.B. (1989) Non-proton-motive-force-dependent sodium efflux from the ruminal bacterium *Streptococcus bovis*: bound versus free pools. *Applied and Environmental Microbiology* 55, 2664–2668.
- Strobel, H.J. and Russell, J.B. (1991) Succinate transport by a ruminal selenomonad and its regulation by carbohydrate availability and osmotic strength. *Applied and Environmental Microbiology* 57, 248.
- Strobel, H.J., Russell, J.B., Driessen, A.J.M. and Konings, W.N. (1989) Transport of amino acids in *Lactobacillus casei* by proton-motive-force-dependent and non-proton-motive-force-dependent mechanisms. *Journal of Bacteriology* 171, 280–284.
- Tajima, K., Aminov, R.I., Nagamine, T., Ogata, K., Nakamura, M., Matsui, H. and Benno, Y. (1999) Rumen bacterial diversity as determined by sequence analysis of 16S rDNA libraries. *FEMS Microbiology Ecology* 29, 159–169.
- Teather, R.M. and Forster, R.J. (1998) Manipulating the rumen microflora with bacteriocins to improve ruminant production. *Canadian Journal of Animal Science* 78 (Suppl.), 57–69.
- Teather, R.M., Hefford, M.A. and Forster, R.J. (1997) Genetics of rumen bacteria. In: Hobson, P.N. and Stewart, C.S. (eds) *The Rumen Microbial Ecosystem*. Blackie Academic and Professional, London, pp. 427–466.
- Tedeschi, L.O., Fox, D.G. and Russell, J.B. (2000) Accounting for the effect of a ruminal nitrogen deficiency with the structure of the Cornell Net Carbohydrate and Protein System. *Journal of Animal Science* 78, 1648–1658.
- Thompson, J. (1987) Regulation of sugar transport and metabolism in lactic acid bacteria. *FEMS Microbiology Reviews* 46, 221–231.
- Thurston, B., Dawson, K.A. and Strobel, H.J. (1993) Cellobiose versus glucose utilization by the ruminal bacterium *Ruminococcus albus*. *Applied and Environmental Microbiology* 59, 2631–2637.
- Thurston, B., Dawson, K.A. and Strobel, H.J. (1994) Pentose utilization by the ruminal bacterium *Ruminococcus albus*. *Applied and Environmental Microbiology* 60, 1087–1092.
- Van Kessel, J.S. and Russell, J.B. (1992) The energetics of arginine and lysine transport by whole cells and membrane vesicles of strain SR, a monensin-sensitive ruminal bacterium. *Applied and Environmental Microbiology* 58, 969–975.
- Van Kessel, J.S. and Russell, J.B. (1996) The effect of amino nitrogen on the energetics of ruminal bacteria and its impact on energy spilling. *Journal of Dairy Science* 79, 1237–1243.
- Van Kessel, J.S. and Russell, J.B. (1997) The endogenous polysaccharide utilization rate of mixed ruminal bacteria and the effect of energy starvation on ruminal fermentation rates. *Journal of Dairy Science* 80, 2442–2448.
- Van Nevel, C.J. and Demeyer, D.I. (1977) Effect of monensin on rumen metabolism *in vitro*. *Applied and Environmental Microbiology* 34, 251–257.
- Venema, K., Venema, G. and Kok, J. (1995) Lactococcal bacteriocins – mode of action and immunity. *Trends in Microbiology* 3, 299–304.



- Waldo, D.R., Smith, L.W. and Cox, E.L. (1972) Model of cellulose disappearance from the rumen. *Journal of Dairy Science* 55, 125–129.
- Walker, D.J. and Forrest, W.W. (1964) The application of calorimetry to the study of ruminal fermentation *in vitro*. *Australian Journal of Agricultural Research* 15, 299–315.
- Wallace, R.J. and Walker, N.D. (1993) Isolation and attempted introduction of sugar alcohol-utilizing bacteria in the sheep rumen. *Journal of Applied Bacteriology* 74, 353–359.
- Wallace, R.J., Czerkawski, J.W. and Breckenridge, G. (1981) Effect of monensin on the fermentation of basal rations in the rumen simulation technique (Rusitec). *British Journal of Nutrition* 46, 131–147.
- Weller, R.A. and Pilgrim, A.F. (1974) Passage of protozoa and volatile fatty acids from the rumen of the sheep and from a continuous *in vitro* fermentation system. *British Journal of Nutrition* 32, 341–347.
- Wells, J.E. and Russell, J.B. (1994) The endogenous metabolism of *Fibrobacter succinogenes* and its relationship to cellobiose transport, viability and cellulose digestion. *Applied Microbiology and Biotechnology* 41, 471–476.
- Wells, J.E., Russell, J.B., Shi, Y. and Weimer, P.J. (1995) Cellodextrin efflux by the cellulolytic ruminal bacterium *Fibrobacter succinogenes* and its potential role in the growth of nonadherent bacteria. *Applied Environmental Microbiology* 61, 1757–1762.
- Wells, J.E., Krause, D.O., Callaway, T.R. and Russell, J.B. (1997) A bacteriocin-mediated antagonism by ruminal lactobacilli against *Streptococcus bovis*. *FEMS Microbiology Ecology* 22, 237–243.
- West, I.C. and Mitchell, P. (1974) Proton/sodium ion antiport in *Escherichia coli*. *Biochemical Journal* 144, 87–90.
- White, D.C., Bryant, M.P. and Caldwell, D.R. (1962) Cytochrome-linked fermentation in *Bacteroides ruminicola*. *Journal of Bacteriology* 84, 822–828.
- Whitford, M.F., Forster, R.J., Beard, C.E., Gong, J. and Teather, R.M. (1998) Phylogenetic analysis of rumen bacteria by comparative sequence analysis of cloned 16S rRNA genes. *Anaerobe* 4, 153–163.
- Whitford, M.F., McPherson, M.A., Forster, R.J. and Teather, R.M. (2001) Identification of bacteriocin-like inhibitors from rumen *Streptococcus* spp. and isolation and characterization of bovicin 255. *Applied and Environmental Microbiology* 67, 569–574.
- Williams, A.G. and Coleman, G.S. (1989) The rumen protozoa. In: Hobson, P.N. and Wallace, R.J. (eds) *The Rumen Microbial Ecosystem*. Elsevier Applied Science, London, pp. 77–128.
- Wolin, M.J. (1960) A theoretical rumen fermentation balance. *Journal of Dairy Science* 43, 1349–1452.
- Wolin, M.J. and Miller, T.L. (1989) Microbe–microbe interactions. In: Hobson, P.N. and Wallace, R.J. (eds) *The Rumen Microbial Ecosystem*. Elsevier Applied Science, London, pp. 343–359.
- Yang, C.M.J. and Russell, J.B. (1993) The effect of monensin supplementation on ruminal ammonia accumulation *in vivo* and the numbers of amino-acid fermenting bacteria. *Journal of Animal Science* 71, 3470–3476.

*This page intentionally left blank*

---

# 10 Rumen Function

A. Bannink<sup>1</sup> and S. Tamminga<sup>2</sup>

<sup>1</sup>*Division of Nutrition and Food, Animal Sciences Group, Wageningen University Research Centre, P.O. Box 65, 8200 AB Lelystad, The Netherlands;*

<sup>2</sup>*Animal Nutrition Group, Wageningen Institute of Animal Sciences, Marijkeweg 40, 6709 PG Wageningen, The Netherlands*

---

## Introduction

Under natural conditions the compartmentalization of the digestive tract of ruminants is a vital adaptation to the utilization of the biomass they select with grazing or browsing. The evolution of the reticulorumen made it possible to retain fibrous material in the rumen for long periods, and to sustain a microbial population that lives in symbiosis with the ruminant as the host. This has evolved in distinct morphological characteristics of the multiple-stomach system among ruminant species (Van Soest, 1994). Differentiation among species, and even breeds, supports the idea that next to dietary factors, rumen factors may also be important determinants of microbial activity and rumen function as a whole.

As a result of microbial fermentation, biomass that otherwise could not have been digested enzymatically by the host, becomes degraded and is converted to digestible microbial matter, volatile fatty acids (VFA), fermentation gases and heat. The major end-products of fermentation deliver most of the metabolizable energy and metabolizable protein to the host. This emphasizes the importance of rumen function, as an essential link in the chain of feed ingestion, microbial fermentation, intestinal digestion and metabolic utilization. In current practice, nutrient supply to the host is expressed in terms of energy and protein supply, without integrating the two and without taking into account that the host requires specific nutrients rather than energy for specific purposes. Feed evaluation systems were developed to fulfil the need for rating individual dietary components on their contribution to the nutritive value of the whole diet, and the need to optimize the dietary composition to what were considered requirements for energy and protein of the ruminant (Van der Honing and Alderman, 1988). It is now widely recognized that in feed evaluation the principles of rumen function should be taken into account and many different processes taking place in the rumen have been subject to intensive

investigations for several decades. Attempts have been made to incorporate all the information gathered in integrated models, in order to understand the effects of dietary treatments on rumen function as a whole and the consequences for nutrient supply to the host. From several reviews (Baldwin, 1995; Dijkstra *et al.*, 1996; Bannink and de Visser, 1997; Bannink *et al.*, 1997; Dijkstra and Bannink, 2000), it becomes apparent what mechanisms have to be included in such models to obtain an understanding of rumen function.

As a simplified approach, the rumen can be considered to behave as a continuous fermentor in steady state, and rumen function can be represented as a set of pools in which fluxes are described mathematically with a set of mass action and Michaelis–Menten type of equations. Inputs are feed intake as substrate supply to the microorganisms, and water intake and saliva flow as diluting and buffering agents, respectively. Outputs are by eructation and by absorption and outflow of the liquid and solid phase to the post-ruminal compartments of the digestive tract. Fractions of rumen contents to be considered are water, carbohydrates, proteins, lipids, microbial mass, VFA and possibly inorganic compounds such as electrolytes. Of special importance in this approach is the possibility of accounting for interactions occurring among the different fractions and with the level of feed intake.

This chapter deals with the effects of dietary changes on the fermentation processes in the rumen and their consequences for the amount and type of nutrients delivered to the ruminant host, as well as the mathematical description of these processes. In addition to the fermentation in the lumen, the tissues in the rumen wall are also of importance for rumen function (Bergman, 1990). Therefore, in this chapter some effort is also made to identify the interactions between the functioning of the rumen wall and events taking place in the lumen.

## Carbohydrate Degradation

When discussing carbohydrate fermentation, three distinctly different types of carbohydrates are distinguished: fibre, starch and a fraction defined by organic matter minus crude fat, crude protein, starch and fibre. The latter fraction is highly heterogeneous and in the remainder of this chapter the fraction will be referred to with the term soluble carbohydrate. In this section, an extensive collection of data (data set used by Bannink *et al.*, 2000) from rumen digestion trials with lactating Holstein Friesian dairy cows, covering a large variety of dietary treatments, is used to discuss degradation of different types of carbohydrates.

### *Fibre degradation*

In general, ruminant diets contain forages with a relatively high content of cell wall material and concentrates also contain limited amounts of cell walls. Cell walls, also known as structural carbohydrates, or simply fibre, are chemically

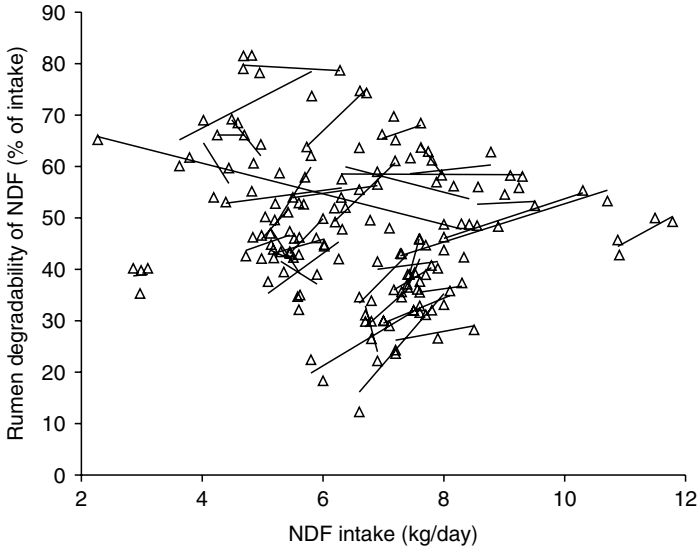
characterized as insoluble in neutral detergent and hence are called neutral detergent fibre (NDF). This NDF is considered to consist of cellulose, hemicellulose, lignin and a small amount of nitrogen-containing material. Part of the pectic substances also contributes to NDF. The main role of the rumen is the fermentation of dietary fibre. Several factors influence the fermentation characteristics of the NDF in forage, such as stage of maturity, growing season and rate of (primarily nitrogen) fertilization applied (Valk, 2002). These factors influence the chemical composition of forages, including extent of lignification of NDF and degradation characteristics. Microbial fermentation of fibre comprises several sequential actions: hydration, adherence of the appropriate microorganisms, release of a mixture of hydrolytic enzymes and finally hydrolysis itself. The resulting release of monomers is followed by their further intracellular degradation into VFA and fermentation gases.

Several techniques may be used to characterize the degradation of NDF by microbial activity in the rumen (see Chapter 4). Most widely applied are *in situ* methods in which forage samples are incubated in the rumen environment itself and which allow comparison of their quality in terms of (rate of) degradation, measured as the disappearance of NDF from nylon bags with time. Alternatively, *in vitro* methods have been developed in which feed samples are incubated with inocula of rumen fluid outside the rumen environment. In current feed evaluation the results of such incubations are applied and used as representations of the actual (degradative) behaviour in the rumen environment *in vivo*. However, they only reflect the inherent characteristics of the feed tested under a fixed set of incubation conditions. Standardizing the incubation protocols will reduce the effects of rumen factors and improve the comparability between the outcomes of different trials, but as a consequence of standardization results may increasingly deviate from the actual degradation characteristics *in vivo*.

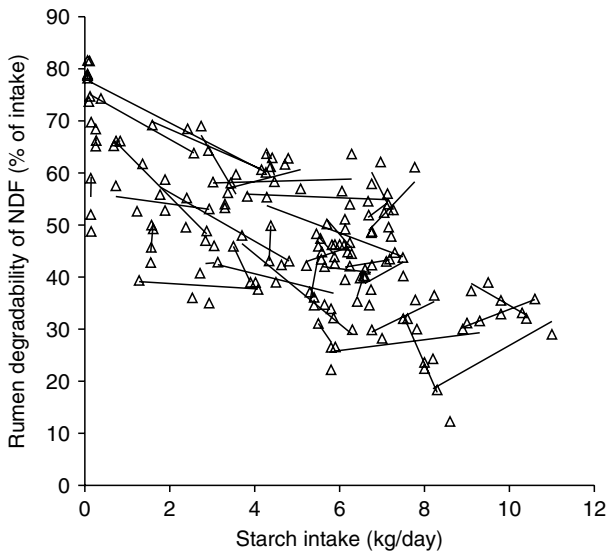
Examples of rumen factors influencing NDF degradation are variation in pH of rumen fluid, variation in the fractional outflow rate of rumen contents and the amount and activity of fibrolytic microorganisms present in the rumen. Rumen pH is largely determined by rumen VFA concentrations (Tamminga and van Vuuren, 1988), and long periods of low pH substantially reduce fibrolytic activity (Argyle and Baldwin, 1988). Passage behaviour of rumen fluid and particles is usually estimated by the application of markers, the suitability of which has recently been reviewed by Tamminga and Chen (2000). Variation of the fractional passage rate of particulate material influences the retention time and hence the amount of NDF available for microbial degradation. Several reviews (Owens and Goetsch, 1986; Clark *et al.*, 1992) indicate that fractional passage rate affects the concentration of microorganisms present, and also the efficiency of microbial growth. Thus, fractional passage rate may be positively related to fractional degradation rate. Fractional degradation rate itself determines the time required for a feed particle to reach the appropriate specific weight to flow out of the rumen. Using  $^{13}\text{C}$  as an internal marker for NDF, Pellikaan (2004) indeed demonstrated a relationship between rate of degradation and rate of passage. It then also becomes apparent why particle size and rate of particle comminution are important for

the degradation rate of NDF (Kennedy and Murphy, 1988). The size of rumen particles influences the surface area available for microbial attack, their retention time in the rumen and the concentration of fibrolytic microorganisms attached to them. Baldwin *et al.* (1987) attempted to represent the effects of particle dynamics on rumen function. Interactions also exist between amylolytic and fibrolytic activity in the rumen. Large amounts of starch and soluble carbohydrates not only reduce fibrolytic activity (via rumen pH as mentioned above), but also affect the availability of ammonia and protein as nitrogen sources for the growth of fibrolytic microorganisms (Dijkstra *et al.*, 1992). Yet, current feed evaluation systems largely ignore the effects of variation in rumen pH and passage rates, and the fractional rates of degradation and passage are as yet considered independent of each other. If considered at all, current feed evaluation treats the amylolytic and fibrolytic activity in the rumen as fully independent of each other.

From analysing the database with reported rates of NDF degradation, it appears that the extent of rumen NDF degradation varies from as low as 13% to as high as 82% (Fig. 10.1), and seems to depend more on degradation characteristics of NDF than on the level of NDF intake. When NDF consumption exceeds 9 kg/day, values seem to be limited to between 50% and 60%. An analysis of the relationship between NDF degradation and the intake of starch (Fig. 10.2) and soluble carbohydrate (Fig. 10.3) showed that both are related to rumen NDF degradation. Ignoring the large variation ( $\pm 20\%$ ), NDF degradation declines from on average 65% with no starch consumed, to as low as 30% with a consumption of 10 kg of starch per day. The effect of soluble carbohydrate on NDF degradation seems to be opposite to that of starch. The highest values of around 80% NDF degradation were all achieved on diets based on fresh ryegrass supplemented with only small quantities of concentrates. Consumption of this type of forage with less than 45% of NDF resulted in the highest intake of soluble carbohydrate of 4 kg/day or more. At first sight one would conclude that the apparent stimulatory effect of soluble carbohydrate intake on NDF degradation coincides with a lack of starch intake. However, no reason exists why a depression of NDF degradation should only be caused by starch. Soluble carbohydrates ferment even faster and more completely than the various starch sources and similar quantities digested will also result in reduced rumen pH and cellulolytic activity. Yet, results point rather in the direction of a stimulatory than of a depressing effect of increased intake of soluble carbohydrate (Fig. 10.3). The relationship between the total quantity of rapidly fermentable carbohydrate (starch plus soluble carbohydrates) and NDF degradation (Fig. 10.4) is very similar to that for starch only (Fig. 10.2). Either these effects are all caused by starch, or, in contrast to the depressing effect of starch, there is a stimulatory effect of soluble carbohydrates. A possible explanation of the latter could be a specific and stimulatory effect of sugars on the protozoa (Dijkstra and Tamminga, 1995; Williams and Coleman, 1997). In this way, NDF degradation may become stimulated by protozoal degradation in addition to that by fibrolytic bacteria. Alternatively, intrinsic high NDF degradation characteristics could coincide with high levels of soluble sugars.



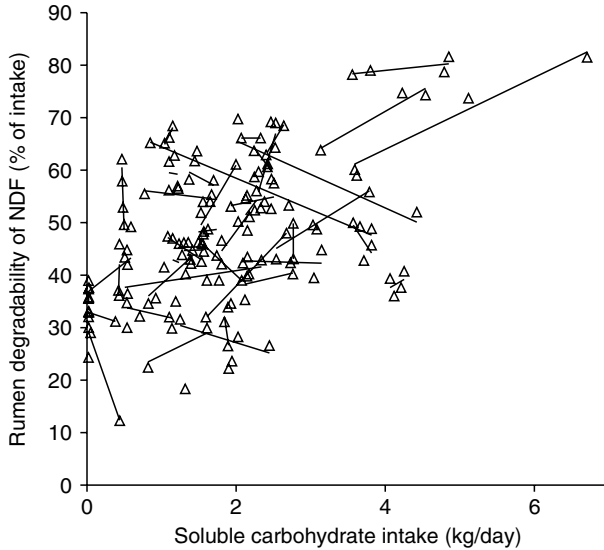
**Fig. 10.1.** Relationship between NDF intake (kg of NDF per day) and rumen degradability of NDF (% of NDF intake). Only reported values have been used. The drawn lines indicate the results of linear regression for individual experiments. Regression of the full data set resulted in the relationship:  $\text{NDF degradation} = -1.37 \times \text{NDF intake} + 56.90$  ( $R^2 = 0.03$ ).



**Fig. 10.2.** Relationship between starch intake (kg of starch per day) and rumen degradability of NDF (% of NDF intake). Only reported values have been used. Regression of the full data set resulted in the relationship:  $\text{NDF degradation} = -3.46 \times \text{starch intake} + 64.79$  ( $R^2 = 0.47$ ).

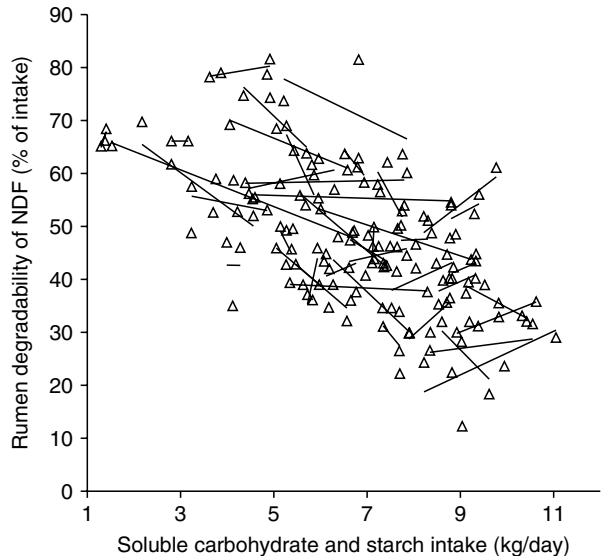
### **Starch degradation**

Although starch is not a major constituent of most forages, it may be a significant component of many ruminant diets through the use of grain-based supplements. Such supplements with a high energy density may have profound



**Fig. 10.3.** Relationship between soluble carbohydrate intake (defined as organic matter minus fat, crude protein, starch and NDF, kg of soluble carbohydrate per day) and rumen degradability of NDF (% of NDF intake). Only reported values have been used. Regression of the full data set resulted in the relationship:  $\text{NDF degradation} = 5.33 \times \text{soluble carbohydrate intake} + 37.74$  ( $R^2 = 0.23$ ).

**Fig. 10.4.** Relationship between intake of sugar or soluble carbohydrate (defined as organic matter minus fat, crude protein, starch and NDF, kg of soluble carbohydrate per day) plus starch (kg of starch per day) and rumen degradability of NDF (% of NDF intake). Only reported values have been used. Regression of the full data set resulted in the relationship:  $\text{NDF degradation} = -4.02 \times \text{soluble carbohydrate and starch intake} + 75.17$  ( $R^2 = 0.38$ ).



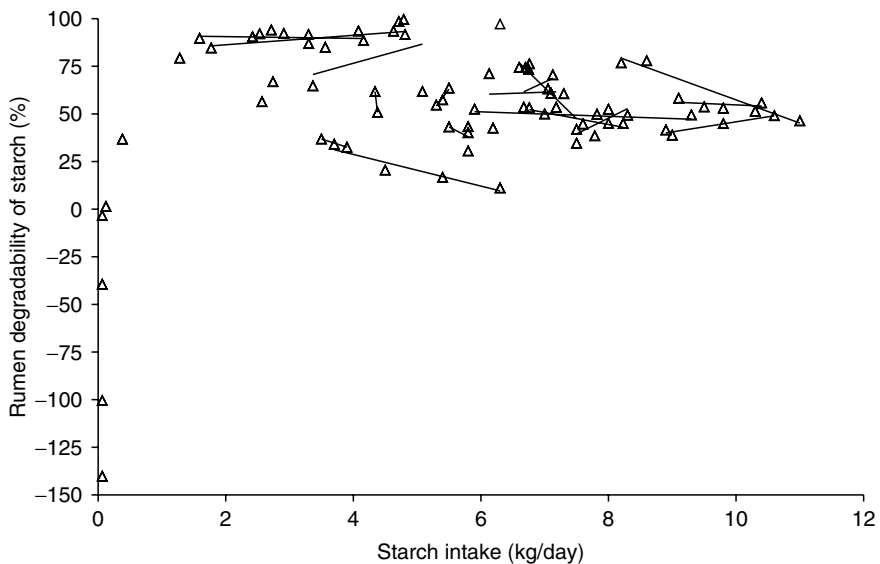
effects on production and product composition, partly related to their effects on rumen fermentation processes. In high-yielding dairy cows starch intake may be considerable, but the purpose of starch is not only to increase energy intake. Starch is only partly degraded in the rumen and substantial amounts of starch may escape rumen fermentation and become enzymatically digested and absorbed as glucose in the small intestine. Starch escaping rumen fermentation



serves as an important source of glucose for the viscera with a high glucose demand (Reynolds *et al.*, 1997; Mills *et al.*, 1999).

As with dietary fibre, *in situ* or *in vitro* methods are performed under standardized conditions in order to establish the intrinsic characteristics of starch-rich sources and their susceptibility to microbial degradation in the rumen. Most types of starch are readily degradable (e.g. cereals) and rumen degradation is high, up to 95% with the lowest figures established for maize starch (Nocek and Tamminga, 1991; Mills *et al.*, 1999). Characteristics measured as indicated above are applied in feed evaluation to give a figure of the *in vivo* degradation in the rumen. However, actual rumen conditions influence the starch degradation as well. The fractional passage rate of particles determines the availability of insoluble starch for microorganisms. Rumen pH may affect starch degradation as well because it affects protozoal activity and consequently microbial recycling within the rumen and the concentration of amylolytic microorganisms (Williams and Coleman, 1997). Further, starch may be incorporated into amylolytic microorganisms as storage polysaccharides. The amount of starch stored in this way, and flowing to the duodenum may be considerable.

An analysis of the available data on observed rumen degradation of starch indicated that with starch intakes below 2 kg/day apparent rumen starch degradability drops severely and even turns into apparently negative values when starch intake is lower than 1 kg/day (Fig. 10.5). For starch intakes above 2 kg/day, a highly variable fraction of consumed starch was degraded (from 10% up to almost 100%) and many trials showed a relatively low starch digestibility and high escape from rumen fermentation. With high levels of



**Fig. 10.5.** Relationship between starch intake (kg of starch per day) and apparent rumen starch degradability (% of starch intake). Only reported values have been used. Regression of the full data set resulted in the relationship: starch degradation =  $2.96 \times$  starch intake + 36.25 ( $R^2 = 0.05$ ).

starch consumption, above 8 kg of starch per day, this variation seems to be smaller and both the escape and the degradation of starch appear to be mostly between 40% and 60% (Fig. 10.5). With small differences in starch intake among treatments, no consistent effects were observed. In the two studies with the widest range in starch intake among treatments, starch degradation became reduced with increased starch intake. However, in both studies starch intake was confounded with starch source. In the study where starch intake ranged from 8.2 to 11.0 kg/day, increasing starch intake was confounded with the replacement of starch from steamrolled barley by less readily degradable starch from ground shelled maize. In the study with starch intake ranging from 3.7 to 6.3 kg/day, the lowest starch degradabilities were with the highest intake of the readily degradable starch from rolled barley compared to starch from ground maize.

In many studies starch degradabilities as low as 30% were established (Fig. 10.5). These values are far lower than *in situ* or *in vitro* degradation characteristics would suggest, and may be explained by the storage and subsequent outflow of microbial starch, lowering apparent starch degradation. An alternative explanation is that a considerable proportion of dietary starch is considered to be soluble and to become immediately and fully degraded in the rumen. In reality, this fraction is composed mainly of particles small enough to pass the pores (usually around 40  $\mu\text{m}$ ) of the nylon used in the *in situ* procedure. In the laboratory of the first author, *in vitro* incubation studies (Cone *et al.*, unpublished results) indicated that around 85% of the washable fraction of starch consisted of small particles with a similar fractional degradation rate as the degradable fraction. In the laboratory of the second author it was shown that 32% and 47% of dry matter in maize and barley was washable, but that only 20% of this washable fraction was really soluble (Yang *et al.*, unpublished results), with *in vitro* only a slightly higher fractional degradation rate than that of the non-washable fraction. These results show that the washable fraction of starch is likely much more susceptible to outflow to the duodenum than generally assumed. The data collected by Reynolds *et al.* (1997) and Mills *et al.* (1999) indicate that variation in rumen starch degradability was much larger than the ileal or total tract degradability, illustrating the importance of the impact of factors other than the inherent characteristics of the starch sources involved.

The degradability of starch may be altered by ways of processing that alter the physical or chemical structure of starch (see Chapter 24). Nevertheless, the results from *in situ* or *in vitro* incubations would likely already cover most of these changes and hence this will not be discussed further.

### **Soluble carbohydrates**

Compared with the dietary content of fibre and starch as carbohydrate sources, water-soluble carbohydrates (WSC), including lactate as a major component in silages, normally form a modest fraction of up to 15% of the dry matter. An assumption generally made is that WSC are fermented in the rumen almost

instantaneously after ingestion. This is supported by the observation that only very small concentrations of WSC are found in rumen fluid. Fractional degradation rates of 300% per hour have been suggested (Russell *et al.*, 1992). With a fractional passage rate of rumen fluid of 15% per hour, about 5% of the WSC ingested would escape from the rumen. In such a situation and assuming a daily intake of 20 kg DM containing 15% WSC, only 150 g/day of WSC would flow to the duodenum. But, as was argued for fibre and starch, in reality the fractional degradation rate of WSC must also be a function of rumen microbial activity rather than a constant value of 300% per hour. Despite this, the amounts escaping the rumen will remain small under normal feeding conditions. Large quantities of WSC may however induce fluctuations of rumen pH. This could notably be the case with sugars that are immediately available, such as in molasses. Such WSC may have consequences for the fibrolytic activity, as well as the protozoa in the rumen, with a subsequent influence on predation rate and apparent efficiency of microbial growth on the whole rumen level. The WSC present in roughages such as grasses or sugarcane have to be released first from the plant cells before they are available for microorganisms, and therefore are less likely to cause severe fluctuations in rumen pH.

Next to the dietary content of fibre, starch and soluble sugars, a significant fraction of organic matter (generally more than 10%) remains unaccounted for in standard feed analysis. The size of this fraction is often close to that of the WSC and hence, may not be neglected in attempts to understand the effect of nutrition on rumen function or on ruminant performance. The types of chemical compounds in this fraction are likely xylans and glucans, linked with beta linkages. In some feed ingredients significant amounts of organic acids may be present, like oxalic acid. Because knowledge on their behaviour in the rumen is lacking, for the time being, they are best compared to that of readily fermented carbohydrates such as starch.

## Nitrogen Degradation

Dietary nitrogen (N) is the main source of N for microbial use, but additional inflow of endogenous N via the rumen wall and saliva may be significant (Siddons *et al.*, 1985). Dietary N may be distinguished into a true protein fraction consisting of a soluble (washable), a degradable and an undegradable fraction, and a non-protein N fraction consisting of amongst others amino acids, peptides, nitrate and ammonia (see Chapter 7). The latter includes urea, which is rapidly hydrolysed to ammonia because of the high urease activity in the rumen (Wallace *et al.*, 1997). With respect to the effect of different N sources on rumen function, a distinction between N in ammonia and N in amino acids in the liquid phase, and degradable and undegradable N in the particulate phase is appropriate. Furthermore, the fractional degradation rate as an intrinsic characteristic of the degradable N fraction is relevant.

Fresh as well as ensiled forages grown with high levels of N fertilization contain a large N fraction that is highly soluble (up to 50% of N) and readily degradable in the rumen (Valk, 2002) with a minor truly undegradable fraction

(around 5% of N). As a result, during grazing or when ruminants are fed diets composed mainly of such forages, substantial losses of N from the rumen occur. Although part of this N may be recycled to the rumen as urea from blood and with saliva flow, the extent of capture is limited due to lack of energy. It is also assumed that high ammonia concentrations in rumen fluid depress transport of urea from blood to the rumen (Baldwin *et al.*, 1987; Dijkstra *et al.*, 1992; Wallace *et al.*, 1997) and recycled N is readily absorbed again as ammonia when not rapidly incorporated in microbial mass. Microbial protein synthesized in the rumen constitutes the major part of the duodenal entry of non-ammonia N. In addition, a variable portion of feed non-ammonia N escapes rumen degradation, the size of which depends on the intrinsic degradation characteristics of the protein source involved, and on additional aspects of rumen function as already discussed for carbohydrates fermented in the rumen. Finally, some endogenous protein flows to the duodenum, but quantities remain relatively small.

There are a number of reasons why intrinsic degradation characteristics obtained from *in situ* or *in vitro* incubations are inadequate to assess the real protein value. The type of N source influences the energy cost of microbial protein synthesis (Stouthamer, 1973) and therefore a distinction between amino acid N and ammonia N has to be made. Further, fermented protein is part of the fermentable organic matter. However, the efficiency of microbial growth on fermented protein as source of energy is lower than that on protein-free organic matter (Dijkstra *et al.*, 1996; Bannink and de Visser, 1997). Based on theoretical considerations the ATP yield per g of fermented protein was estimated as about half the amount derived from the fermentation of carbohydrates (Tamminga, 1979).

## Microbial Metabolism

### *Hexose utilization in relation to microbial growth*

The fermentation of hexoses to VFA, carbon dioxide and methane generates metabolic energy for microorganisms (ATP) (see Chapter 9). Hexoses and fermentation intermediates are also used as precursors for biosynthetic processes in microbial growth. In addition, the so-called spilling of energy may occur as well as the storage of polysaccharides during conditions of a surplus of available energy in the rumen environment. Furthermore, microbial protein synthesis on preformed monomers such as amino acids requires less energy than growth on ammonia as source of N (Baldwin *et al.*, 1987; Dijkstra *et al.*, 1992), affecting efficiency of microbial growth.

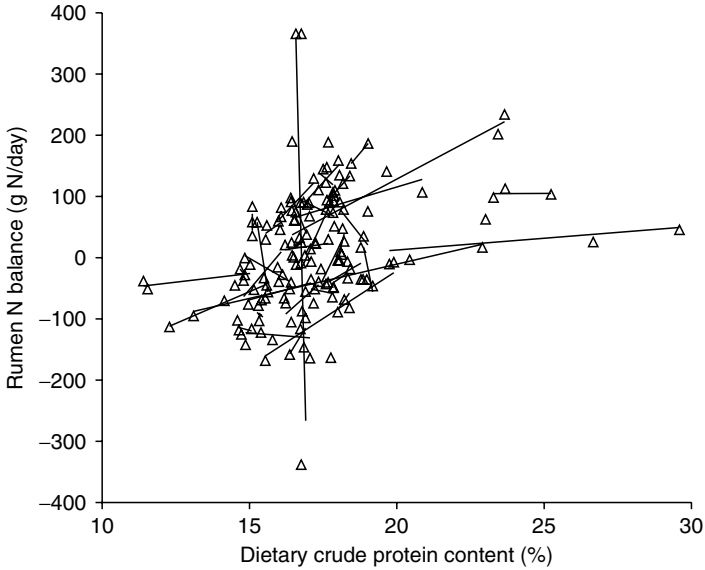
*In vivo* efficiencies of microbial growth, derived from observed outflows of organic matter and microbial matter to the duodenum, have been reviewed frequently (e.g. Sniffen and Robinson, 1987; Clark *et al.*, 1992). Efficiency of microbial growth in continuous fermentors appears to be influenced by factors such as substrate supply, the ratio of roughage and concentrate in the substrate and the sources and availability of carbohydrate and N. Specific rumen

conditions are also considered important. Examples are pH of rumen fluid, which may affect the energy requirement for maintenance of the bacteria (Baldwin, 1995), the rate of predation by rumen protozoa (Dijkstra and Tamminga, 1995), or the fractional rate of passage or dilution (Isaacson *et al.*, 1975). Though *in vitro* experiments have provided useful information on the mechanisms of microbial growth and efficiency, the quantitative results may be misleading. Batch cultures do not include the effect of outflow on the efficiency of microbial growth, whereas continuous cultures usually do not discriminate between fluid-associated and particle-associated bacteria, which may have a significant impact on the efficiency of microbial protein production *in vivo* (Demeyer and van Nevel, 1986; Dijkstra *et al.*, 2002). Specific studies have often considered the effect of only a single factor. Also a statistical treatment of the matter (e.g. Owens and Goetsch, 1986; Clark *et al.*, 1992; Firkins *et al.*, 1998) may lead to expectations that prove to be quite different from the values actually found under different production conditions. In order to circumvent this problem, several attempts have been made to integrate the effects of the most relevant influencing factors on microbial growth by mechanistic modelling.

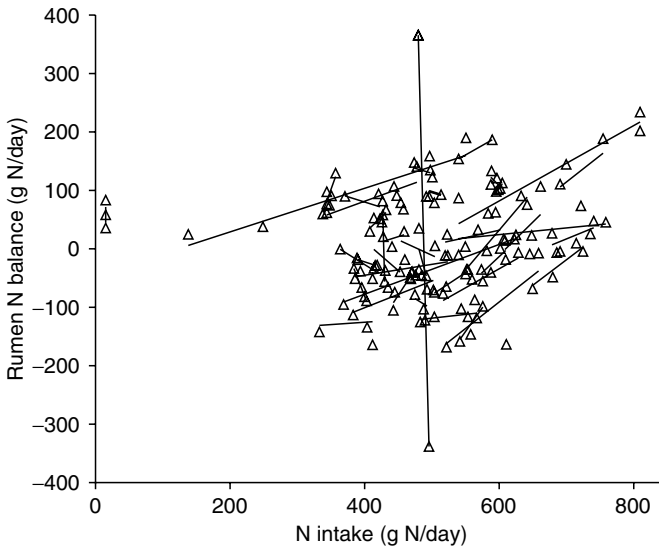
### ***N utilization in relation to microbial growth***

A helpful indicator of N utilization by rumen microorganisms is the rumen N-balance. The N-balance in the rumen is calculated as degraded dietary N minus potential microbial N synthesis from degraded organic matter, usually calculated by applying a presumed efficiency of microbial N synthesis (e.g. Tamminga *et al.*, 1994). For example, starch-rich products low in N have a negative N-balance, and microorganisms require additional N (supplied by urea with saliva and transferred through the rumen wall) to use the energy from the starch efficiently. Young leafy forages high in N have a positive N balance, and the surplus of N in the form of ammonia is absorbed through the rumen wall. Rates of degradation are calculated from the measured ingredient characteristics, table values, presumed passage rates and so on. However, such feed evaluation systems all have in common that important aspects of rumen function known to influence the rate of degradation and the efficiency of microbial N synthesis are not represented. This may lead to wrong conclusions on the N balance for the rumen as a whole. It is questionable whether in this way accurate estimates of actual losses of N as ammonia absorbed from the rumen are obtained.

An analysis on the rumen N balance was made of observations available in the database used in the present study. The data indicate that rumen N balance increases with an increased dietary crude protein content (Fig. 10.6), but more clearly with an increase in the quantity of N consumed (Fig. 10.7). Variation among different studies remained very large, however. Only for the extreme cases with a dietary content of crude protein less than 15% or more than 19%, positive and negative N balances, respectively, seem to be lacking. For intermediate protein contents the N balance varies from -150 to +150 g of N per day. From this it may be concluded that other factors are also important to



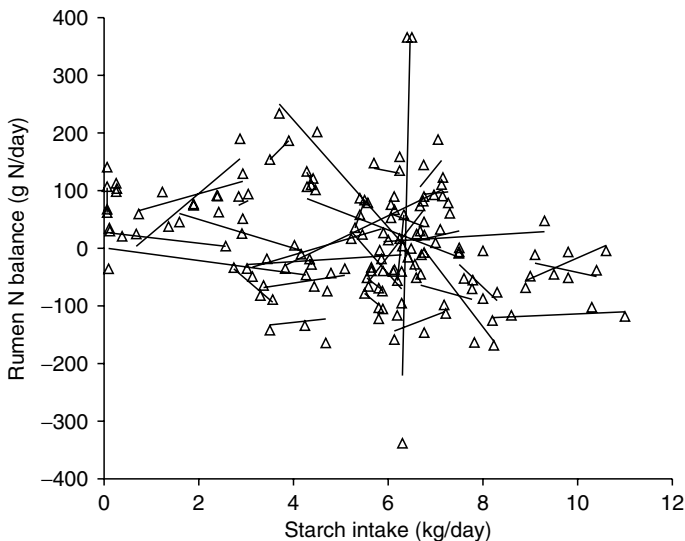
**Fig. 10.6.** Relationship between crude protein content of the diet (%) and observed rumen N balance (defined as N consumed minus duodenal flow of N, g N per day). Regression of the full data set resulted in the relationship: rumen N balance =  $13.83 \times$  crude protein content  $- 226.75$  ( $R^2 = 0.12$ ).



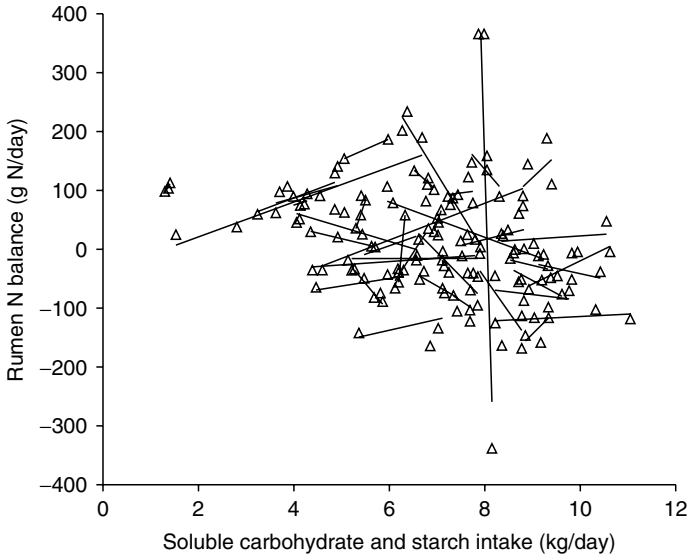
**Fig. 10.7.** Relationship between N intake (g of N per day) and observed rumen N balance (defined as N consumed minus duodenal flow of N, g N per day). Regression of the full data set resulted in the relationship: rumen N balance =  $0.146 \times$  N intake  $- 62.49$  ( $R^2 = 0.03$ ).

explain the efficiency of N capture in duodenal flows, or that estimation of duodenal flows is not very accurate. Furthermore, the results indicate that N recycling to the rumen may incidentally still be substantial even with fairly high protein contents such as 19%.

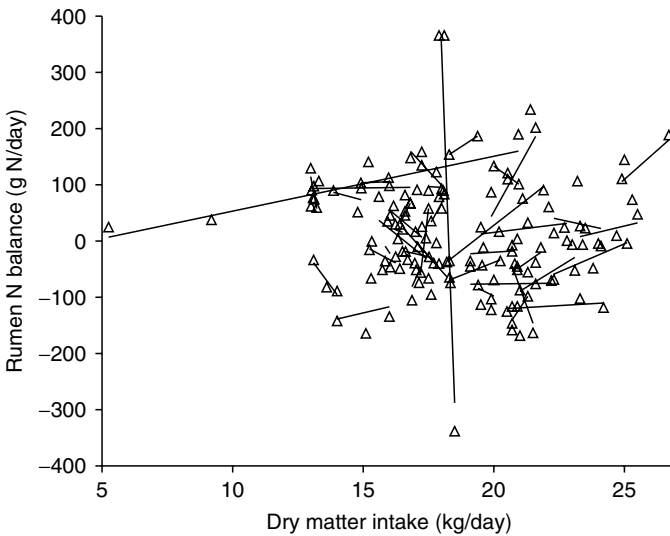
Inclusion of rapidly fermentable carbohydrates in the diet is often thought to reduce the rumen loss of ammonia-N (Sinclair and Wilkinson, 2000) originating from dietary ammonia, and soluble and rapidly degradable protein, and hence to affect the N balance of the rumen. However, such a relationship did not become immediately apparent from the data analysis in the present study (Fig. 10.8). In general there appears to be a tendency for a positive rumen N balance with low starch intake, whereas this balance becomes predominantly negative with high starch intake. Again, variation among studies is very large and also within studies the effect of starch intake remains variable or is not apparent. One reason for the absence of a clear relationship with starch intake may be that with different dietary treatments starch-rich sources are often exchanged with sources rich in soluble carbohydrates. However, summation of both types of carbohydrate revealed a less clear relationship (Fig. 10.9). Also the total quantity of degraded carbohydrates revealed no clear relationship (not shown). Finally, the total intake of dry matter might be a determinant for rumen N balance. Again, variation among studies was extremely large, with high positive as well as negative values established for rates of dry matter intake ranging from 13 to 25 kg/day (Fig. 10.10). Surprisingly, within studies rumen



**Fig. 10.8.** Relationship between starch intake (kg of starch per day) and observed rumen N balance (defined as N consumed minus duodenal flow of N, g N per day). Regression of the full data set resulted in the relationship: rumen N balance =  $-11.43 \times$  starch intake + 72.91 ( $R^2 = 0.08$ ).



**Fig. 10.9.** Relationship between soluble carbohydrate plus starch intake (kg/day) and observed rumen N balance (defined as N consumed minus duodenal flow of N, kg of N per day). Regression of the full data set resulted in the relationship: rumen N balance =  $-14.19 \times$  soluble carbohydrate and starch intake + 111.54 ( $R^2 = 0.08$ ).



**Fig. 10.10.** Relationship between dry matter intake (kg of dry matter per day) and observed rumen N balance (defined as N consumed minus duodenal flow of N, g N per day). Regression of the full data set resulted in the relationship: rumen N balance =  $-2.14 \times$  dry matter intake + 52.15 ( $R^2 = 0.01$ ).

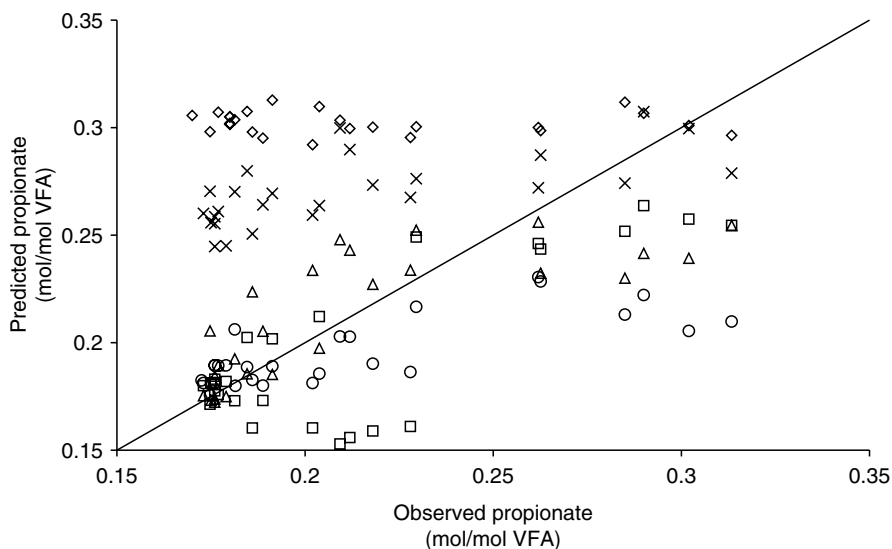


N balance seems to increase with an increased dry matter intake, indicating higher losses of N from or less reflux to the rumen.

### **Yield of VFA**

VFA produced in the rumen form the major source of energy to the ruminant (see Chapter 6). The type of VFA produced is also important. In particular, the ratio of glucogenic to non-glucogenic VFA will affect the energetic efficiency of the ruminant and the composition of the products (milk, meat) of the ruminant (review Dijkstra, 1994). A first attempt to derive the stoichiometry of yields of VFA from *in vivo* data of rumen fermentation was published by Murphy *et al.* (1982). Later, Argyle and Baldwin (1988) introduced the effect of pH on VFA yield based on *in vitro* results. Several other attempts have been made since (Pitt *et al.*, 1996; Friggens *et al.*, 1998; Bannink *et al.*, 2000; Kohn and Boston, 2000; Nagorcka *et al.*, 2000). Evaluating these results against each other is deceptive because of the different levels of aggregation chosen in these studies. Bannink *et al.* (2000) repeated the exercise of Murphy *et al.* (1982) with a simplified version of the regression model and derived new stoichiometric coefficients from data exclusively from lactating cows. Besides, they used rates of truly rather than apparently digested substrate, and used estimates of the rate of substrate actually converted into VFA (utilization for microbial biosynthesis excluded). Nagorcka *et al.* (2000) derived separate sets of stoichiometric coefficients for amylolytic bacteria, fibrolytic bacteria and protozoa by analysing the contribution to VFA yield by different microbial groups. A separate stoichiometry, indistinctive of the type of microorganism, was used for the fermentation of lactate, succinate and protein. A more mechanistic approach was adopted by Kohn and Boston (2000) who applied a thermodynamic model to explain the basis of the shift in VFA yield with changing conditions of rumen fermentation. However, influences of the type of substrate fermented and the type of microorganisms fermenting were not considered.

A major problem in evaluating the accuracy of such estimates of stoichiometry is that they are based on measurements of rumen VFA concentrations rather than on rates of production. The VFA data used in these studies are not only the result of VFA production in the rumen but also of the rates of outflow and absorption, which gives a serious complication. Outflow and absorption rates of VFA may vary widely depending on diet intake level and composition (Dijkstra, 1994). To circumvent this problem pragmatically, both Murphy *et al.* (1982) and Bannink *et al.* (2000) derived separate sets of stoichiometric coefficients of VFA yield for roughage-rich diets and concentrate-rich diets. Another problem preventing a proper evaluation is that the assumptions made during derivation of the stoichiometric estimates, as well as the rumen model used to calculate the estimates, differ substantially and hence bias the evaluation results. Not surprisingly, an attempt to compare these different representations of VFA stoichiometry against the same set of independent data, as used before for model evaluation by Bannink *et al.* (2000), showed large differences between the different approaches (for example propionic acid, Fig. 10.11).



**Fig. 10.11.** Measured against predicted molar proportion of propionate in rumen fluid based on the stoichiometry according to Baldwin *et al.* (1970) (×), Murphy *et al.* (1982) (□), Bannink *et al.* (2000) (△), Friggens *et al.* (1998) (○) and Pitt *et al.* (1996) (◇). For predictions according to Pitt *et al.* (1996) a standard pH of 6.0 was assumed which delivered minimum values of predicted molar proportion of propionate (lower pH up to 5.0 and higher pH up to 6.5 both inflated predicted molar proportions of propionate). Identical values were assumed for the partitioning of digested substrate over microbial growth and fermentation into VFA, and for the fractional absorption rate of individual types of VFA. Molar proportions of VFA other than acetate, propionate and butyrate were taken into account with all sources of representation stoichiometry and did not disturb the comparison of evaluation results.

In general, the observed variation in molar VFA proportions was poorly predicted. No comparisons were made with the stoichiometry according to Nagorcka *et al.* (2000) and Kohn and Boston (2000) because these cannot be performed independently from the mechanistic models used.

### **Yield of methane**

A variable part of the digested energy is lost as methane energy. Methanogenic bacteria in the rumen generate methane from hydrogen and carbon dioxide. In general, methane is regarded as the major route of disposal of fermentation hydrogen. Three separate factors can be identified which affect methane yield most: the rate of degradation of organic matter, the efficiency of microbial growth and the type of VFA produced from the fermentation of organic matter. In an empirical way, equations have been derived in early studies, which indicate the importance of these factors. Blaxter and Clapperton (1965) proposed an equation based on data from respiration trials, and indicated a

quadratic effect of apparent digestibility of organic matter and an interaction of the latter with level of feed intake. Another equation that is often used relates methane production to the intake of three carbohydrate fractions (cellulose, hemicellulose and non-fibre carbohydrates) (Moe and Tyrrell, 1979). Recently, Mills *et al.* (2003) compared various linear (including the Moe and Tyrrell equation) and non-linear regression equations to predict methane production in dairy cattle. The non-linear models were superior in predicting methane emissions. In recent years, more mechanistic approaches to represent rumen fermentation have been published. Benchaar *et al.* (1998) evaluated mechanistic models against empirical equations in predicting observed methane emissions. They concluded that mechanistic approaches delivered more accurate predictions over a range of diets than empirical equations. Contrary to the results of Benchaar *et al.* (1998), which were still based on the stoichiometry of Murphy *et al.* (1982), Mills *et al.* (2001) used the adapted stoichiometry of VFA production derived from lactating cow data only (Bannink *et al.*, 2000; Table 10.1) and developed a mechanistic model to predict methanogenesis in dairy cows. In evaluating this model with independent data from literature, the predicted methane production appeared to correspond well with measured values in the range of 5 to 25 MJ/day. Evaluation against another independent data set from their own laboratory, in the range of 19 to 30 MJ/day, showed an underprediction. Although the precise cause of this inaccuracy remains speculative, this type of modelling clearly is an improvement compared with that of Blaxter and Clapperton (1965) and Moe and Tyrrell (1979) in explaining the response in rates of methane production with changes in feeding strategy.

An accurate representation of the type of VFA formed is essential for a correct prediction of methane yields. The stoichiometric coefficients (Bannink *et al.*, 2000) used by Mills *et al.* (2001) do not include some important factors such as the shift in type of VFA and the quantity of methane produced with

**Table 10.1.** Estimates of the fraction of a specific substrate converted into a specific VFA for roughage (R) and concentrate (C) diets (according to Bannink *et al.*, 2000). Methane yield is calculated as kJ per g of substrate fermented into VFA.

Substrate type	Diet type	VFA type				CH <sub>4</sub>
		Ac	Pr	Bu	Bc	
Soluble carbohydrates	R	0.64	0.08	0.24	0.04	3.87
	C	0.53	0.16	0.26	0.06	3.08
Starch	R	0.49	0.22	0.21	0.08	2.53
	C	0.49	0.31	0.15	0.05	2.17
Hemicellulose	R	0.44	0.18	0.32	0.06	2.70
	C	0.51	0.12	0.32	0.05	3.26
Cellulose	R	0.56	0.20	0.17	0.07	2.88
	C	0.68	0.12	0.20	0.00	3.92
Protein	R	0.56	0.29	0.08	0.06	1.32
	C	0.44	0.18	0.17	0.21	1.15

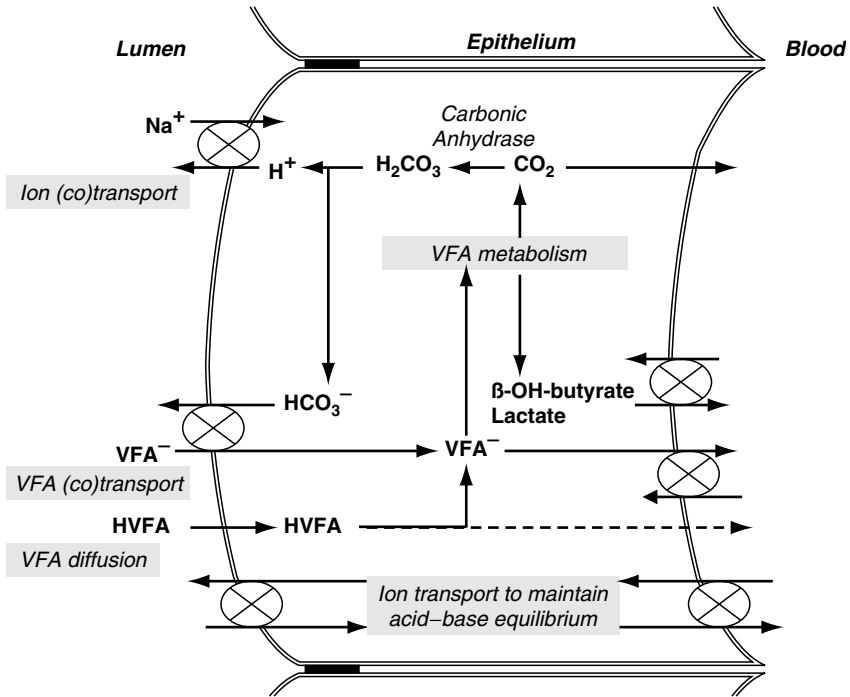
increased rates of fermentation and reduced rumen pH (Baldwin, 1995; Pitt *et al.*, 1996). Besides fermentation in the rumen, fermentation in the large intestine also contributes to methane production, and it may be expected that this contribution is not constant. Variation in level of feed intake, and in the amount of organic matter bypassing rumen fermentation, will affect hindgut fermentation. However, simulations by Mills *et al.* (2001) invariably indicated that this contribution remains low and rather constant at around 9% of the total rate of methane production.

## VFA Absorption through the Rumen Wall

Besides the degradative functions taking place in the lumen due to microbial activity, some non-degradative ones are also important for normal rumen functioning and hence of nutritive relevance. The rumen wall is the major site of VFA transport (Dijkstra *et al.*, 1993). The absorptive capacity depends on the conditions in the lumen (pH, outflow rate of rumen contents) as well as the conditions of the rumen mucosa (tissue mass, surface area, blood flow). There are indications that nutrition and the physiological state of the animal determine the capacity of the VFA absorption rate by the rumen wall (Dirksen *et al.*, 1997). Also the acidity of the rumen contents and the type of VFA involved appears to have a strong influence on the VFA absorption rate (Dijkstra *et al.*, 1993).

The transport of VFA is an important function of the rumen wall, the costs of which add to the high-energy requirement of the rumen mucosa, in particular to that of the epithelial cells. This requirement is large because of the intensive turnover of protein, transport of nutrients and ions and costs of mechanisms to maintain tissue integrity (proliferation, repair, immune response). An interaction between the transport and the metabolic activity of rumen wall tissues has been suggested, mainly based on *in vitro* studies (Bugaut, 1987; Bergman, 1990; Remond *et al.*, 1995), and seems not to have been tested *in vivo*. One may expect however that with a severe load of VFA supplied to the rumen wall, the energy costs of associated ion transport to maintain intracellular homeostasis (Gabel *et al.*, 2002) and of the proliferative response of the epithelial cell layer will increase as well (Fig. 10.12).

The transport of VFA and its associated ion transport mechanisms requires substantial amounts of energy. For instance, Reynolds and Huntington (1988) demonstrated that the oxygen utilization by the stomachs in beef steers accounted for up to 51% of that by the portal-drained viscera. At the same time, amino acid use by these tissues was large compared with the total quantity of amino acids net absorbed in portal blood, which indicates a high rate of protein turnover in stomach epithelia. Also in lactating cows it was established that 44% of the amino acids net absorbed in portal blood were utilized by stomach tissues (Berthiaume *et al.*, 2001). Further, McBride and Kelly (1990) observed that energy utilization by rumen epithelia increased with 20% to 30% after the ingestion of a meal. The fraction of energy associated with ion transport remained rather constant through time with approximately 25% of



**Fig. 10.12.** Schematic representation (adapted from Gabel *et al.*, 2002) of the interaction between VFA transport, ion transport and VFA metabolism in rumen epithelial cells.

total energy utilization. These figures indicate that substantial amounts of nutrients (mainly VFA) are used by stomach epithelia as a source of energy (see also Chapter 12).

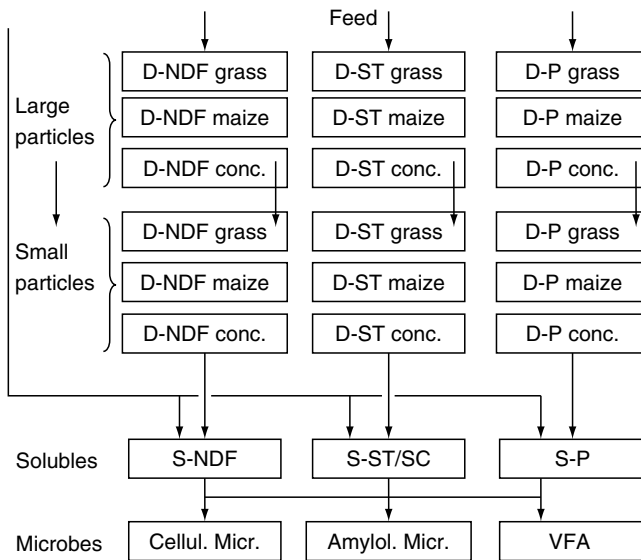
Considering the high demand of energy of the stomach epithelia and the need to adapt to changes in the diet consumed, it seems that quantifying these issues *in vivo* deserves more attention. In particular, the adaptive capacity of the rumen wall of high-yielding periparturient cows is of interest because of the need to adapt to an extreme and rapid increase in energy intake and to the supply of VFA immediately after calving (Dirksen *et al.*, 1997). In this period, cows are susceptible to the development of (sub-clinical) rumen acidosis, of which potential implications on health during later stages of lactation have also been suggested (Nocek, 1997; Gabel *et al.*, 2002).

## Carbohydrate and Nitrogen Interactions

When changing the protein characteristics or content of the whole diet, carbohydrate characteristics and content also change, and the reverse. This means that observed effects cannot be fully attributed to a single chemical constituent. Also other characteristics might change, such as the quantity of feed dry matter consumed or rumen pH. As a consequence, an evaluation of the feeding

value of a diet or a specific dietary ingredient can only be done at the level of the whole diet, taking into account all changes simultaneously. In mechanistic models, integration of all aspects involved allows such a complete view of the whole system. Current feed evaluation compares the relative feeding value of different dietary ingredients rather than representing the actual physiological mechanism involved (Van der Honing and Alderman, 1988), and only by adapting the requirements of the animals can the difference between relative and actual values be accounted for.

To illustrate the difference between concepts adopted in mechanistic models and those adopted in current feed evaluation, the relevance to synchronization of carbohydrate and N availability for microorganisms, an item that has received attention in recent years, was investigated with model simulations. The simulations were performed with an adapted version of the model of Dijkstra *et al.* (1992) on diets with grass silage, maize silage and concentrates. Adaptations to the model were the representation of separate meals of grass silage, maize silage and concentrates according to the schedule drawn in Fig. 10.13, and representation of a mechanism of comminution of large to small particles (Baldwin *et al.*, 1987) of which only the latter were assumed to be available for microbial degradation and outflow. Simulations were performed with several intake patterns and meal compositions, whereas on a daily basis



**Fig. 10.13.** Diagram of the adapted mechanism introduced in the rumen model of Dijkstra *et al.* (1992). Three different physical forms of substrate were distinguished (large particles which require comminution (D), small particles which are degraded (D) by microorganisms, or as a solute (S) in rumen fluid and available for microbial fermentation) for three types of substrate (neutral detergent fibre, NDF, fermented by fibrolytic microorganisms, starch and soluble carbohydrates, ST and SC, fermented by amylolytic microorganisms, and protein, P, fermented by both types of microorganism).

diets were of equal composition. In this way, the extent of synchronization of the rate at which N and energy become available for microbial utilization differed strongly according to the pattern of feed intake and the *in situ* degradation characteristics of carbohydrates and N. First, a diet was simulated with a daily dry matter intake of 10.0 kg of grass silage, 6.5 kg of maize silage and 5.8 kg of concentrates, offered either synchronous or asynchronous during the day. Secondly, a diet was simulated with a daily dry matter intake of 11 kg of grass silage and three alternative types of 9 kg of concentrate of varying carbohydrate composition (either fast, intermediate or slowly degradable). The simulation results showed hardly any change in rumen fermentation. Realistic changes in the dynamics of particle comminution and feed intake pattern resulted in shifts of only a few per cent in the apparent efficiency of microbial growth. Interestingly, also varying the carbohydrate composition of the concentrate resulted in shifts of 2% only. Such small shifts would usually not be significant in *in vivo* trials. Synchronization might affect other rumen factors that were kept unchanged in the simulations, such as pH, passage rates, volume and the proportion of protozoa in the microbial population. Changes in these factors would have a much larger impact on rumen function as demonstrated by sensitivity analysis of the original model (Neal *et al.*, 1992). The results also point at a high adaptive capacity of rumen function. It must be concluded that many, largely theoretical, claims in literature and current feeding practice (Sinclair and Wilkinson, 2000) about the beneficial effects of synchronizing energy and N availability for microorganisms may be valid, but probably remain rather small and rely more on changes in other factors of rumen function than a change in the dynamics of energy and N availability for microorganisms.

## Mathematical Modelling

### ***Empirical and mechanistic representations of whole rumen function***

Empirical models are models in which experimental data are used directly to quantify relationships. Empirical approaches are helpful in deriving simple but robust calculation rules to describe rumen function from a survey of rumen digestion trials reported in literature. As demonstrated in many reviews, such regression studies give a reasonable description of the set of data selected. In contrast, mechanistic models seek to understand causation. Mechanistic models describe the system in terms of its components and associated mechanisms. These models play a useful role in evaluation of hypotheses and in identification of areas where knowledge is lacking. Current feed evaluation systems are largely empirical in nature. However, mechanistic models offer more to scientific development, since they are based on mechanisms. For further details of empirical and mechanistic modelling, see Baldwin (1995) and Dijkstra *et al.* (2002).

Several mechanistic models of rumen function have been published (France *et al.*, 1982; Baldwin *et al.*, 1987; Argyle and Baldwin, 1988; Danfaer, 1990; Dijkstra *et al.*, 1992; Lescoat and Sauvant, 1995). Also

several reviews have been published in which these rumen models were evaluated against independent data or were directly compared with each other (Bannink and de Visser, 1997; Bannink *et al.*, 1997; Offner and Sauvant, 2004). Nevertheless, quantitative information on direct comparisons of these models remains scarce. More information is available on the theoretical concepts used (Baldwin, 1995; Dijkstra *et al.*, 1996, 2002). Important aspects that were covered by these models are representation of factors or processes which are responsible for variation in the degradation rate of feed substrates, efficiency of microbial growth, absorption kinetics, kinetics of fluid and particles, recycling of N with saliva and via the rumen wall and recycling of microbial matter within the lumen. For a more detailed discussion on individual rumen models, the reader is referred to the original papers describing the approaches adopted, or to the reviews comparing and evaluating these models.

Compared to current feed evaluation systems, the mechanistic models of rumen function are able to cover a wider range of rumen conditions and are more flexible in taking influencing factors into account. As a consequence, protein values of dietary ingredients do not have to be treated as constants, but can be made dependent on the diet and the rumen conditions. For example, the depression of NDF degradation in the rumen with low rumen pH is represented in almost every mechanistic model (Dijkstra *et al.*, 1992), whereas with current feed evaluation systems a weighted sum of the digestibility of all dietary ingredients is calculated without any consideration of interactions such as the depressive effect of high levels of starch intake (Fig. 10.2). Also, more precise representation of N recycling to the rumen with low protein diets is an important added value when attempts are made to evaluate whether crude protein content of the diet is reducing rumen digestion or not. These extra capabilities of mechanistic models are important steps put forward in explaining observations of rumen function.

### **Modelling non-digestive functions**

Modelling efforts of the non-digestive rumen functions seem to be limited to that of absorption from the rumen (Dijkstra *et al.*, 1993; Pitt *et al.*, 1996; Lopez *et al.*, 2003). However, there is extensive VFA metabolism by stomach epithelia and it has been suggested (Bergman, 1990; Bannink *et al.*, 2000; Gabel *et al.*, 2002) that metabolism also depends on the load of VFA transported by these tissues. Efforts to include this aspect in ruminant models seem to be lacking. Whole animal models assume constant fractions of VFA metabolism during absorption (Danfaer, 1990) or do not represent metabolism by the gastrointestinal tract separately from the remainder of the body (Baldwin, 1995). Only Gill *et al.* (1989) addressed the concept of energy costs of nutrients and ion transport, and of protein synthesis and degradation in tissues of the total gastrointestinal tract of growing lambs. No efforts are known, however, of integrating microbial activity and the fermentation process in the lumen with that of the absorptive, transport and metabolic functions of tissues in the stomachs.



## Conclusions

In current practice intrinsic characteristics of feed degradation are often used too easily without considering the conditions of the rumen environment or the interactions that exist between the different chemical fractions. The dynamic nature of fermentation processes, the variation and adaptation of microbial metabolism to changes in the diet and the importance of interactions between energy and N in the rumen are well established. Yet current feed evaluation systems have little regard for this. Given the wealth of data available on rumen fermentation, more detailed and integrated representations of nutrient dynamics in the rumen than current feed evaluation systems may be developed. Such integrated models will help in explaining rumen function over a wide range of production conditions and in evaluating the consequences of new feeding strategies on ruminant response as a function of feed but also as a function of animal characteristics.

## References

- Argyle, J.L. and Baldwin, R.L. (1988) Modeling of rumen water kinetics and effects of rumen pH changes. *Journal of Dairy Science* 71, 1178–1188.
- Baldwin, R.L. (1995) *Modeling Ruminant Digestion and Metabolism*. Chapman & Hall, London.
- Baldwin, R.L., Lucas, H.L. and Cabrera, R. (1970) Energetic relationships in the formation and utilization of fermentation end-products. In: Phillipson, A.T., Annisson, E.F., Armstrong, D.G., Balch, C.C., Comline, R.S., Nordy, R.S., Hobson, P.N. and Keynes, R.D. (eds) *Physiology of Digestion and Metabolism in the Ruminant*. Oriel Press, Newcastle-upon-Tyne, UK, pp.319–334.
- Baldwin, R.L., Thornley, J.H.M. and Beever, D.E. (1987) Metabolism of the lactating cow. II. Digestive elements of a mechanistic model. *Journal of Dairy Research* 54, 107–131.
- Bannink, A. and de Visser, H. (1997) Comparison of mechanistic rumen models on mathematical formulation of extramicrobial and microbial processes. *Journal of Dairy Science* 80, 1296–1314.
- Bannink, A., de Visser, H. and van Vuuren, A.M. (1997) Comparison and evaluation of mechanistic rumen models. *British Journal of Nutrition* 78, 563–581.
- Bannink, A., Kogut, J., Dijkstra, J., France, J., Tamminga, S. and van Vuuren, A.M. (2000) Modelling production and portal appearance of volatile fatty acids in cows. In: McNamara, J.P., France, J. and Beever, D.E. (eds) *Modelling Nutrient Utilization in Farm Animals*. CAB International, Wallingford, UK, pp. 87–102.
- Benchaar, C., Rivest, J., Pomar, C. and Chiquette, J. (1998) Prediction of methane production from dairy cows using existing mechanistic models and regression equations. *Journal of Animal Science* 76, 617–627.
- Bergman, E.N. (1990) Energy contributions of volatile fatty acids from the gastrointestinal tract in various species. *Physiological Reviews* 70, 567–590.
- Berthiaume, R., Dubreuil, P., Stevenson, M., McBride, B.W. and Lapierre, H. (2001) Intestinal disappearance and mesenteric and portal appearance of amino acid in dairy cows fed ruminally protected methionine. *Journal of Dairy Science* 84, 194–203.

- Blaxter, K.L. and Clapperton, J.L. (1965) Prediction of the amount of methane produced by ruminants. *British Journal of Nutrition* 19, 511–522.
- Bugaut, M. (1987) Occurrence, absorption and metabolism of short chain fatty acids in the digestive tract of mammals. *Comparative Biochemistry and Physiology, Comparative Biochemistry* 86B, 439–472.
- Clark, J.H., Klusmeyer, T.H. and Cameron, M. (1992) Microbial protein synthesis and flows of nitrogen fractions to the duodenum of dairy cows. *Journal of Dairy Science* 75, 2304–2323.
- Danfaer, A. (1990) *A Dynamic Model of Nutrition Digestion and Metabolism in Lactating Dairy Cows*. Beretning fra Statens Husdyrbrugforsog 671. National Institute of Animal Science, Foulum, Denmark.
- Demeyer, D. and van Nevel, C. (1986) Influence of substrate and microbial interactions on efficiency of rumen microbial growth. *Reproduction Nutrition Development* 26, 161–179.
- Dijkstra, J. (1994) Production and absorption of volatile fatty acids in the rumen. *Livestock Production Science* 39, 61–69.
- Dijkstra, J. and Bannink, A. (2000) Analyses of modelling whole-rumen function. In: Theodorou, M.K. and France, J. (eds) *Feeding Systems and Feed Evaluation Models*. CAB International, Wallingford, UK, pp. 299–302.
- Dijkstra, J. and Tamminga, S. (1995) Simulation of the effects of diet on the contribution of rumen protozoa to degradation of fibre in the rumen. *British Journal of Nutrition* 74, 617–634.
- Dijkstra, J., Neal, H.D.St.C., Beaver, D.E. and France, J. (1992) Simulation of nutrient digestion, absorption and outflow in the rumen: model description. *Journal of Nutrition* 122, 2239–2256.
- Dijkstra, J., Boer, H., van Bruchem, J., Bruining, M. and Tamminga, S. (1993) Absorption of volatile fatty acids from the rumen of lactating dairy cows as influenced by volatile fatty acid concentration, pH and rumen liquid volume. *British Journal of Nutrition* 69, 385–396.
- Dijkstra, J., France, J. and Sauvant, D. (1996) A comparative evaluation of models of whole rumen function. *Annales de Zootechnie* 45 (Suppl. 1), 175–192.
- Dijkstra, J., Mills, J.A.N. and France, J. (2002) The role of dynamic modelling in understanding the microbial contribution to rumen function. *Nutrition Research Reviews* 15, 67–90.
- Dirksen, G., Dori, S., Arbel, A., Schwarz, M. and Liebich, H.G. (1997) The rumen mucosa – its importance as a metabolic organ of the high producing dairy cow. *Israel Journal of Veterinary Medicine* 52, 73–79.
- Firkins, J.L., Allen, M.S., Oldick, B.S. and St-Pierre, N.R. (1998) Modeling ruminal digestibility of carbohydrates and microbial protein flow to the duodenum. *Journal of Dairy Science* 81, 3350–3369.
- France, J., Thornley, J.H.M. and Beaver, D.E. (1982) A mathematical model of the rumen. *Journal of Agricultural Science, Cambridge* 99, 343–353.
- Friggens, N.C., Oldham, J.D., Dewhurst, R.J. and Horgan, G. (1998) Proportions of volatile fatty acids in relation to the chemical composition of feeds based on grass silage. *Journal of Dairy Science* 81, 1331–1344.
- Gabel, G., Aschenbach, J.R. and Muller, F. (2002) Transfer of energy substrates across the ruminal epithelium: implications and limitations. *Animal Health Research Reviews* 3, 15–30.
- Gill, M., France, J., Summers, M., McBride, B.W. and Milligan, L.P. (1989) Simulation of the energy costs associated with protein turnover and Na<sup>+</sup>, K<sup>+</sup> transport in growing lambs. *Journal of Nutrition* 119, 1287–1299.

- Isaacson, H.R., Hinds, F.C., Bryant, M.P. and Owens, F.N. (1975) Efficiency of energy utilization by mixed rumen bacteria in continuous culture. *Journal of Dairy Science* 58, 1645–1659.
- Kennedy, P.M. and Murphy, M.R. (1988) The nutritional implications of differential passage of particles through the ruminant alimentary tract. *Nutrition Research Reviews* 1, 189–208.
- Kohn, R.A. and Boston, R.C. (2000) The role of thermodynamics in controlling rumen metabolism. In: McNamara, J.P., France, J. and Beever, D.E. (eds) *Modelling Nutrient Utilization in Farm Animals*. CAB International, Wallingford, UK, pp. 11–24.
- Lescoat, P. and Sauvant, D. (1995) Development of a mechanistic model for rumen digestion validated using duodenal flux of amino acids. *Reproduction Nutrition Development* 35, 45–70.
- Lopez, S., Hovell, F.D.D., Dijkstra, J. and France, J. (2003) Effects of volatile fatty acid supply on their absorption and on water kinetics in the rumen of sheep sustained by intragastric infusions. *Journal of Animal Science* 81, 2609–2616.
- McBride, B.W. and Kelly, J.M. (1990) Energy cost of absorption and metabolism in the ruminant gastrointestinal tract and liver: a review. *Journal of Animal Science* 68, 2997–3010.
- Mills, J.A.N., France, J. and Dijkstra, J. (1999) A review of starch digestion in the lactating dairy cow and proposals for a mechanistic model. 1. Dietary starch characterisation and ruminal starch digestion. *Journal of Animal and Feed Sciences* 8, 291–340.
- Mills, J.A.N., Dijkstra, J., Bannink, A., Cammell, S.B., Kebreab, E. and France, J. (2001) A mechanistic model of whole-tract digestion and methanogenesis in the lactating cow: model development, evaluation, and application. *Journal of Animal Science* 79, 1584–1597.
- Mills, J.A.N., Kebreab, E., Yates, C.M., Crompton, L.A., Cammell, S.B., Dhanoa, M.S., Agnew, R.E. and France, J. (2003) Alternative approaches to predicting methane emissions from dairy cows. *Journal of Animal Science* 81, 3141–3150.
- Moe, P.W. and Tyrrell, H.F. (1979) Methane production in dairy cows. *Journal of Dairy Science* 62, 1583–1586.
- Murphy, M.R., Baldwin, R.L. and Koong, L.J. (1982) Estimation of stoichiometric parameters for rumen fermentation of roughage and concentrate diets. *Journal of Animal Science* 55, 411–421.
- Nagorcka, B.N., Gordon, G.L.R. and Dynes, R.A. (2000) Towards a more accurate representation of fermentation in mathematical models of the rumen. In: McNamara, J.P., France, J. and Beever, D.E. (eds) *Modelling Nutrient Utilization in Farm Animals*. CAB International, Wallingford, UK, pp. 37–48.
- Neal, H.D.St.C., Dijkstra, J. and Gill, M. (1992) Simulation of nutrient digestion, absorption and outflow in the rumen: model evaluation. *Journal of Nutrition* 122, 2257–2272.
- Nocek, J.E. (1997) Bovine acidosis: implications on laminitis. *Journal of Dairy Science* 80, 1005–1028.
- Nocek, J.E. and Tamminga, S. (1991) Site of digestion of starch in the gastrointestinal tract of dairy cows and its effect on milk yield and composition. *Journal of Dairy Science* 74, 3598–3629.
- Offner, A. and Sauvant, D. (2004) Comparative evaluation of the Molly, CNCPS and LES rumen models. *Animal Feed Science and Technology* 112, 107–130.
- Owens, F.N. and Goetsch, A.L. (1986) Digesta passage and microbial protein synthesis. In: Milligan, L.P., Grovum, W.L. and Dobson, A. (eds) *Control of Digestion and Metabolism in Ruminants*. Prentice-Hall, Englewood Cliffs, New Jersey, pp. 196–223.

- Pellikaan, W.F. (2004) Passage of feed particles through the gastro-intestinal tract of dairy cows. PhD thesis, Wageningen University, Wageningen, The Netherlands.
- Pitt, R.E., van Kessel, J.S., Fox, D.G., Pell, A.N., Barry, M.C. and van Soest, P.J. (1996) Prediction of ruminal volatile fatty acids and pH within the net carbohydrate and protein system. *Journal of Animal Science* 74, 226–244.
- Remond, D., Ortigues, I. and Jouany, J.-P. (1995) Energy substrates for the rumen epithelium. *Proceedings of the Nutrition Society* 54, 95–105.
- Reynolds, C.K. and Huntington, G.B. (1988) Partition of portal-drained visceral net flux in beef steers. 1. Blood flow and net flux of oxygen, glucose and nitrogenous compounds across stomach and post-stomach tissues. *British Journal of Nutrition* 60, 539–551.
- Reynolds, C.K., Sutton, J.D. and Beever, D.E. (1997) Effects of feeding starch to dairy cows on nutrient availability and production. In: Garnsworthy, P.C. and Wiseman, J. (eds) *Recent Advances in Animal Nutrition*. Nottingham University Press, Nottingham, UK, pp. 105–134.
- Russell, J.B., O'Connor, J.D., Fox, D.G., van Soest, P.J. and Sniffen, C.J. (1992) A net carbohydrate and protein system for evaluating cattle diets. 1. Ruminal fermentation. *Journal of Animal Science* 70, 3551–3561.
- Siddons, R.C., Nolan, J.V., Beever, D.E. and MacRae, J.C. (1985) Nitrogen digestion and metabolism in sheep consuming diets containing contrasting forms and levels of N. *British Journal of Nutrition* 54, 175–187.
- Sinclair, L.A. and Wilkinson, R.G. (2000) Feeding systems for sheep. In: Theodorou, M.K. and France, J. (eds) *Feeding Systems and Feed Evaluation Models*. CAB International, Wallingford, UK, pp. 155–180.
- Sniffen, C.J. and Robinson, P.J. (1987) Microbial growth and flows as influenced by dietary manipulations. *Journal of Dairy Science* 70, 425–441.
- Stouthamer, A.H. (1973) A theoretical study on the amount of ATP required for synthesis of microbial cell material. *Antonie van Leeuwenhoek* 39, 545–565.
- Tamminga, S. (1979) Protein degradation in the forestomachs of ruminants. *Journal of Animal Science* 49, 1615–1640.
- Tamminga, S. and Chen, X.B. (2000) Animal-based techniques for the estimation of protein value of forages. In: Givens, D.I., Owen, E., Axford, R.F.E. and Omed, H.M. (eds) *Forage Evaluation in Ruminant Nutrition*. CAB International, Wallingford, UK, pp. 215–231.
- Tamminga, S. and van Vuuren, A.M. (1988) Formation and utilization of end products of lignocellulose degradation in ruminants. *Animal Feed Science and Technology* 21, 141–159.
- Tamminga, S., van Straalen, W.M., Subnel, A.P.J., Meijer, R.G.M., Steg, A., Wever, C.J.G. and Blok, M.C. (1994) The Dutch protein evaluation system: the DVB/OEB-system. *Livestock Production Science* 40, 139–155.
- Valk, H. (2002) Nitrogen and phosphorous supply of dairy cows. PhD thesis, Utrecht University, Utrecht, The Netherlands.
- Van der Honing, Y. and Alderman, G. (1988) Systems for energy evaluation of feeds and energy requirements for ruminants. *Livestock Production Science* 19, 217–278.
- Van Soest, P.J. (1994) *Nutritional Ecology of the Ruminant*, 2nd edn. Cornell University Press, Ithaca, New York.
- Wallace, R.J., Onodera, R. and Cotta, M.A. (1997) Metabolism of nitrogen-containing compounds. In: Hobson, P.N. and Stewart, C.S. (eds) *The Rumen Microbial Ecosystem*. Chapman and Hall, London, pp. 283–328.
- Williams, A.G. and Coleman, G.S. (1997) The rumen protozoa. In: Hobson, P.N. and Stewart, C.S. (eds) *The Rumen Microbial Ecosystem*. Chapman and Hall, London, pp. 73–139.

---

# Metabolism

---

*This page intentionally left blank*

---

# 11 Glucose and Short-chain Fatty Acid Metabolism

R.P. Brockman

*St. Peter's College, Muenster, Saskatchewan, Canada*

---

## Introduction

The characteristic feature of ruminants is the fermentative nature of their digestion. This feature of their digestive system allows them to survive on high-fibre diets (Leng, 1970). The principal products of fermentation of dietary fibre are short-chain fatty acids, the most important of which are acetate, propionate and butyrate (Kristensen *et al.*, 1998; Majdoub *et al.*, 2003). They account for more than 70% of the animals' caloric intake (Bergman, 1990). Since the dietary carbohydrate is fermented, ruminant animals normally absorb little or no dietary carbohydrate as hexose sugar (see Chapter 10), and their glucose needs must be met by gluconeogenesis even in the fed state (Bergman *et al.*, 1970; Lomax and Baird, 1983). In animals consuming high concentrate diets not all of the carbohydrate may be fermented, but even then the absorption of hexose sugar from the gut accounts for less than one-third of the whole-body glucose turnover (van der Walt *et al.*, 1983). Unlike in simple-stomached animals, in ruminants the liver is incapable of having a net uptake of glucose (Brockman, 1983).

## Metabolism of Glucose

### *Methodology*

Any discussion of the quantitative aspects of metabolism requires a discussion of the techniques used to obtain the information. Estimates of the rates of production and utilization of metabolites *in vivo* have been made principally using two techniques: isotope dilution and arteriovenous catheterization. Several isotopes may be used simultaneously. In addition, isotope dilution has been combined with the arteriovenous difference technique.

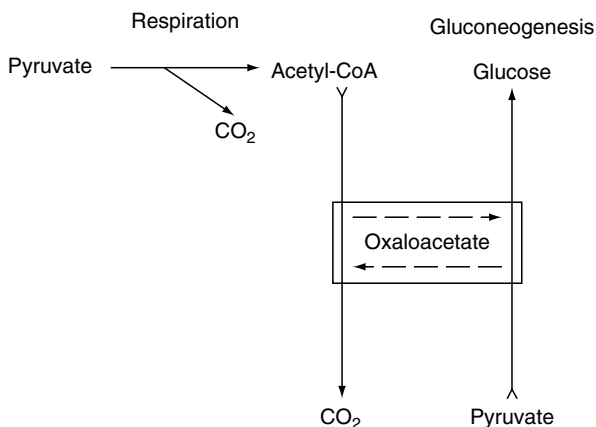
The use of isotope dilution techniques allows the measurement of the rate of turnover or irreversible loss of metabolites with minimal invasion of the body (Leng, 1970). The least invasive approach is to place indwelling catheters into the jugular veins. The labelled metabolite may be administered as a single injection or continuous infusion. Blood samples are taken and the amount of isotope is determined for the selected metabolites in the blood or plasma pool. This gives estimates of the exit/entry of the metabolites into blood or plasma. The simplest approach is to make the determinations when the system is in steady-state, but the measurements can also be made under non-steady-state conditions (Brockman and Laarveld, 1986). Under steady-state conditions, when the pool for a certain metabolite does not vary substantially over a given period of time, the rate of entry of the metabolite into the pool equals the rate of exit and represents its rate of turnover. The turnover rate may also be determined by measuring the rate of exit of the isotope from the blood or plasma pool after a single injection from the rate of decrease of the label in blood or plasma. With the continuous infusion of label the ratio of the infusion rate to the specific radioactivity of the metabolite gives the turnover rate (turnover rate = infusion rate/specific radioactivity).

The label also influences the estimates obtained. For example, glucose turnover may be estimated using (U- $^{14}\text{C}$ )glucose or tritiated or deuterated glucose (Bergman *et al.*, 1974). The carbon label may go from glucose to pyruvate or lactate and back to glucose. When this occurs, the exit and re-entry of the label from and to the glucose pool is not detected. This recycling error can be avoided by using other labels, such as tritium, or deuterium. However, the label in the 2-position is lost in the hexose phosphate isomerase reaction, whereas it is lost from the 6-position during the metabolism of pyruvate (see Fig. 11.2). When glucose goes to fructose-6-phosphate and back to glucose, the 2-label will show a loss of glucose, but the 6-label will not. Thus, the  $^{14}\text{C}$ -labelled isotope gives the lowest estimates of turnover rates and because of recycling of the label underestimates the true rate of glucose production. Glucose labelled in the 6-position with tritium gives estimates about 10% higher and in 2 or 3 position about 15% higher than  $^{14}\text{C}$ -labelled glucose (Bergman *et al.*, 1974). Because of the loss of label in the hexose phosphate isomerase reaction, the latter probably overestimates the rate of turnover of glucose. The best estimate is probably obtained with tritium label on the 6-carbon.

Double isotope techniques are useful to measure glucose turnover, substrate turnover and incorporation of substrate into glucose simultaneously (Brockman and Laarveld, 1986). Tritiated glucose may be used to measure glucose turnover while the carbon label may be used to monitor the glucose precursor. This approach eliminates the need to conduct separate experiments to obtain data for two metabolites, thereby reducing inter-experimental error.

Measuring the appearance of the carbon label into glucose may assess the fate of the metabolite. The specific radioactivities of the precursor and product (glucose) are determined and the fraction of product produced is the ratio of the specific radioactivities of product:precursor. A limitation of this method is that the estimate of glucogenic potential is underestimated because the calculation is based on blood or plasma specific radioactivity of the precursor.

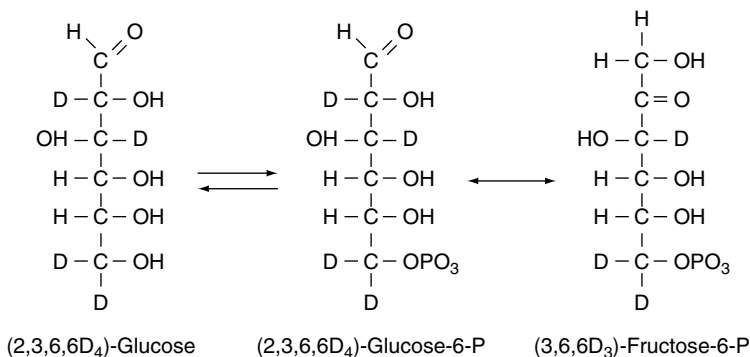




**Fig. 11.1.** Schematic representation of respiration and gluconeogenesis showing how crossing-over may occur when two pathways have a common intermediate, in this case oxaloacetate. Exchange between the two pathways intracellularly would reduce the specific radioactivity of the oxaloacetate in the gluconeogenic pool when a glucose precursor is the source of the label.

The intracellular activity and intracellular dilution of the isotope are ignored. For example, crossing-over of isotopic carbons between metabolic pathways with common intermediates, as between respiratory and gluconeogenic pathways both of which involve oxaloacetate (see Fig. 11.1) may occur. This reduces intracellular specific radioactivity (the exchange of oxaloacetate between the two oxaloacetate pools will reduce the labelled oxaloacetate in the gluconeogenic pool). Thus, the use of the specific radioactivity of the precursor in the blood or plasma, which is greater than the specific radioactivity of the precursor at the site of metabolic use, causes an underestimation of the rate of conversion of precursor to product. Consequently, estimates of the rate of conversion of precursor to product obtained by isotopic dilution are minimal estimates.

The arteriovenous catheterization approach allows the isolation of individual organs *in vivo* (Bergman *et al.*, 1970; Kaufman and Bergman, 1974). The blood supplying and draining the organ is sampled, which, with measurement



**Fig. 11.2.** A schematic representation of the loss of label from the 2-position, but not the 3 and 6 positions, of glucose during the isomerase reaction. In this reaction glucose-6-phosphate is converted to fructose-6-phosphate.

of the rate of blood flow, gives estimates of the net organ uptake or output. While the error of individual determinations in the blood samples may be low, the error of the net metabolism may be high, particularly when the concentration differences across the organ are low compared to the concentration of the respective metabolite in the vessels. This is the case for glucose across the portal-drained viscera and liver where the arteriovenous differences are less than 5% of the concentration in each vessel (Bergman *et al.*, 1970). The analytical error for the arteriovenous differences may be more than 20 times greater than the error in determining the concentrations in each vessel.

This technique cannot distinguish between different uses within the organ. Thus, it represents a maximum estimate of utilization for a specific purpose and overestimates the rate of utilization. For example, the net hepatic uptake of lactate may be three times the incorporation of lactate into glucose (Brockman and Laarveld, 1986). In those organs that are net producers of a metabolite, this approach does not show what has been produced and used intracellularly and underestimates the rate of production by the organ. Thus, the true rates of production and utilization lie somewhere between the values obtained by isotopic and arteriovenous difference techniques.

When the two techniques are combined, utilization and production within specific organs can be determined simultaneously. In addition to giving better estimates of organ production the dual approach allows the determination of metabolic interconversions within individual organs (van der Walt *et al.*, 1983).

### ***Glucose-producing organs and glucose production***

Many studies have estimated the rates of glucose production by ruminants under varying dietary and physiological conditions. An adult sheep (50–55 kg) on a maintenance diet produces approximately 25 mmol/h of glucose (Bergman *et al.*, 1974). Pregnant animals with the same food intake produce more glucose, with the amount increasing up to 50% during late pregnancy (Steel and Leng, 1973a; Wilson *et al.*, 1983). This indicates that endogenous sources of glucose precursors are used to a greater extent during pregnancy. As feed intake increases so does the rate of glucose production. Animals on an *ad libitum* diet produce about 50% more glucose than animals on a maintenance diet (Steel and Leng, 1973a; Wilson *et al.*, 1983). The highest rates of glucose production occur in lactating animals, where the production rates correlate with the increased food intake (Wilson *et al.*, 1983). For example, lactating ewes which received twice as much food (2500 vs. 1200 g/day of dried grass) produced proportionately more glucose (46–52 mmol/h) than non-pregnant, non-lactating animals (22 mmol/h).

The most important substrate for glucose synthesis in fed animals is propionate (Table 11.1). Ruminal propionate may account for more than half of the substrate used in glucose synthesis in fed animals (Leng *et al.*, 1967; Judson and Leng 1973b; Amaral *et al.*, 1990). Isotopic studies have shown that in sheep, propionate in the blood accounts for only about one-third of the glucose synthesis (Bergman *et al.*, 1966). This implies that not all of the

**Table 11.1.** Summary of the fraction of glucose derived from various substrates in sheep (data from Bergman *et al.*, 1966, 1968; Lindsay, 1978).

Metabolite	% of Glucose turnover			% of Hepatic extraction		
	Fed	Fasted	Pregnant	Fed	Fasted	Pregnant
Propionate <sup>a</sup>						
Blood	27–40	–	–	85–90	85–90	–
Rumen	40–50	–	34–43	n.a.	n.a.	n.a.
Lactate/pyruvate	15–20	13	10–15	8–15	20–30	29
Glycerol	5	15–30	18–40 <sup>b</sup>	40–50	60–70	–
Alanine	5–6	5–7	–	7–11	15	24

<sup>a</sup>Values were calculated from infusion of labelled propionate intraruminally and intravenously. The contribution of propionate depends on the duration of fasting.

<sup>b</sup>Values were taken from ketotic sheep.

propionate produced in the rumen is absorbed as propionate (see below). Lactate/pyruvate accounts for 15% of the glucose, with amino acids and other precursors making up the difference. The percentage of glucose derived from lactate/pyruvate appears to be relatively constant over a variety of physiological conditions. It appears that in cattle propionate may account for 50–60% of the glucose and 11–35% of the lactate (Danfaer *et al.*, 1995; Lozano *et al.*, 2000). Amino acids, based on net hepatic uptake, may contribute 30% or more to glucose production.

In fasted animals obviously less propionate is available. Then the glucose-producing organs must look to endogenous sources of substrate for gluconeogenesis, and glycerol from lipolysis becomes a more important glucose precursor; its contribution may reach 40% during fasting (Bergman *et al.*, 1968). While many studies have shown that amino acids are glucogenic, the best estimates of glucogenic potential are the differences after everything else is accounted for. Not surprisingly, the rate of glucose production is linearly related to the availability of its precursors in plasma (cf. Lindsay, 1978). That does not mean that glucose synthesis is not subject to hormonal regulation. The output of glucose by the sheep liver and uptake of some glucose precursors have been shown to increase markedly during exercise (Brockman, 1987) and glucagon administration (Brockman, 1985; Brockman *et al.*, 1975) and decrease during insulin administration (Brockman and Laarveld, 1986).

The organs that may release glucose into the blood are liver, gut and kidney. The liver is the most important glucose-producing organ in the ruminant. It accounts for 85–90% of whole-body glucose turnover in animals on a roughage diet (Bergman *et al.*, 1970). Since the rate of absorption of hexose sugar from the gut is low, the ruminant animal has little need to remove glucose from the portal blood. Not surprisingly, the ruminant liver has little or no glucokinase and little hexokinase (Ballard *et al.*, 1969). Experimentally, hyperglycaemia with high plasma insulin concentrations did not induce a net uptake of glucose by the liver (Brockman, 1983). This indicates that physiologically the

ruminant liver always has a net output of glucose (Bergman *et al.*, 1970; Brockman, 1983), even in the fed state and in animals on high concentrate diets (van der Walt *et al.*, 1983).

As discussed above, the absorption of glucose from the gut of ruminants on a roughage diet is minimal (Bergman *et al.*, 1970; Baird *et al.*, 1980; Lomax and Baird, 1983). Normally the portal-drained viscera is a net user of glucose, whose use amounts to 5–15% (about 2 mmol/h) of hepatic glucose production (Bergman *et al.*, 1970). However, when the ruminant animal eats a concentrate diet, glucose absorption from the gut may account for up to 30% of the whole-body glucose turnover (van der Walt *et al.*, 1983). This is obviously a function of the extent of fermentation in the rumen.

The role of the kidney in producing glucose is similarly small. Net renal production of glucose accounts for about 10% of whole-body glucose turnover, or about 2 mmol/h (Bergman *et al.*, 1974; Kaufman and Bergman, 1974). Isotopic studies suggest that the kidney may produce as much as 15% of the glucose (van der Walt *et al.*, 1983), assuming that the kidney is the only organ other than the liver and gut capable of glucose production.

The renal uptake of lactate, pyruvate, glycerol and alanine accounts for nearly 90% of its glucose output by the kidney (Table 11.2), with lactate providing for half of this. *In vivo* studies have shown that propionate may be used by the kidney for glucose synthesis as effectively as lactate or glycerol (Krebs and Yoshida, 1963; Faulkner, 1980). However, the amount of propionate reaching the kidney is small compared to that reaching the liver (Bergman and Wolff, 1971). The concentration of propionate in arterial plasma is 12–30  $\mu\text{M}$  (Bergman and Wolff, 1971; Baird *et al.*, 1980). If the kidney extracts propionate as efficiently as the liver, the arteriovenous difference across the kidney would be 10–25  $\mu\text{M}$ , which is 20–55% of the arteriovenous difference for glucose (Table 11.2). Thus, propionate could account for 10–25% of net renal glucose production. That is equivalent to the glucogenic potential of pyruvate, glycerol or alanine (Table 11.2). It seems that as a fraction of organ production it may be equal to the contribution of propionate to glucose synthesis in the liver (see above).

**Table 11.2.** Arterial concentrations, arteriovenous concentration differences (A–V) and net renal uptake (negative values are production) of glucose, lactate, glycerol and alanine in sheep (data from Kaufman and Bergman, 1974; Heitmann and Bergman, 1980).

Metabolite	Artery ( $\mu\text{M}$ )			A–V ( $\mu\text{M}$ )			Uptake (mmol/h)		
	Fed	Fasted	Pregnant	Fed	Fasted	Pregnant	Fed	Fasted	Pregnant
Glucose	2700	2600	2900	–45	–55	–53	–2.5	–3.0	–4.3
Lactate	761	892	848	52	54	56	2.9	2.8	4.6
Pyruvate	53	76	56	7	13	3	0.4	0.7	0.3
Glycerol	67	149	41	11	13	14	0.5	0.8	1.0
Alanine	87	96	–	13	10	–	0.5	0.4	–

## Glucose Utilization

Not all organs and tissues use glucose at the same rate (Table 11.3). The muscle, as reflected by the hind limb, extracts 3% of the glucose, which passes through in blood. However, because of the muscle mass, muscle utilization may account for 20–40% of the glucose turnover (Oddy *et al.*, 1985). Moreover, glucose uptake by muscle is subject to hormonal regulation (Jarrett *et al.*, 1976). Insulin appears to be able to increase the uptake as much as fivefold at high concentrations (Table 11.3; Jarrett *et al.*, 1974; Hay *et al.*, 1984; Prior *et al.*, 1984). As would be expected the fractional extraction of glucose by the hind limb in diabetic sheep is lower than in normal sheep (Jarrett *et al.*, 1974). Fat, as shown by tail fat pad studies (Khachadurian *et al.*, 1966), extracts about 10% of the glucose presented to it, suggesting that fat may be more efficient at removing glucose than muscle. However, the differences may be a reflection of differences in blood flow through the tissues, that is, a lower blood flow through fat may allow a higher extraction ratio. Glucose extraction by the fat pad was also increased by insulin (Khachadurian *et al.*, 1966). In both fat and muscle tissue insulin, concentrations of which are high in blood during feasting and low during fasting, appears to play a role in the regulation of glucose uptake by altering the efficiency of extraction.

The portal-drained viscera accounts for 20–30% of the whole-body glucose turnover (5–7 mmol/h). Estimates of utilization by the liver range from 0% to 15% (0–3 mmol/h) (Bergman *et al.*, 1970). The fractional extraction by the brain is about 18% and this does not change with fasting (Pell and Bergman, 1983). The brain accounts for over 10% of the whole-body glucose utilization ( $2.4 \pm 0.2$  mmol/h), which is used for 97% of oxygen uptake by the brain (Oyler *et al.*, 1970; Pell and Bergman, 1983). The estimates of fractional extraction of glucose by the uterus range from 8% to 30% (Morris *et al.*, 1980; Hay *et al.*, 1984) and by the mammary gland 25–50% (Bickerstaffe *et al.*, 1974; Laarveld *et al.*, 1981), depending on the stage of pregnancy or milk

**Table 11.3.** Arterial concentrations, arteriovenous concentration differences (A–V) and fractional extraction of glucose by various organs during periods of high and low plasma insulin concentrations in sheep (data from Khachadurian *et al.*, 1966; Hay *et al.*, 1984; Oddy *et al.*, 1985).

Insulin status	Artery (mM)		A–V (mM)		Extraction (ratio)	
	Low	High	Low	High	Low	High
Organ/tissue						
Hind limb	3.3	3.3	0.08	0.72	0.02	0.15
Tail fat pad	9.5 <sup>a</sup>	6.6	1.60	2.28	0.25	0.35
Tail fat pad	3.7 <sup>b</sup>	2.2	0.39	0.83	0.11	0.38
Uterus	3.3	3.3	1.15	1.19	0.35	0.36
Mammary gland	3.1	3.3	0.72	0.70	0.23	0.22

<sup>a</sup>These values are from the perfused fat pad.

<sup>b</sup>These values are from the intact animal.

yield, in other words according to the organs' needs. Studies in sheep, which were about 20 weeks pregnant, showed a strong correlation between blood glucose concentration and uterine uptake of glucose (Leury *et al.*, 1990). As the blood glucose concentrations decreased during underfeeding (from  $2.65 \pm 0.10$  to  $1.42 \pm 0.12$  mM), uterine uptake of glucose went from  $15.0 \pm 1.6$  to  $7.8 \pm 0.6$  mmol/h.

The sheep fetus relies on placental transport to meet about half of its glucose needs (Hodgson *et al.*, 1981). The glucose uptake by the pregnant uterus is greater than the glucose utilization by the fetus. The glucose used by the fetus accounts for 28% of the glucose taken up by the uterus (Meschia *et al.*, 1980). Another 20% of glucose removed by the uterus is taken up by the fetus as lactate. Thus, the fetus uses about half the glucose, which is removed by the uterus from the blood. This is discussed in greater detail in Chapter 20.

The major use of glucose in the mammary gland is for the production of lactose. This accounts for 50–60% of the glucose uptake by the bovine mammary gland (Bickerstaffe *et al.*, 1974; Baird *et al.*, 1983). In sheep, glucose uptake by the mammary gland is equivalent to 70% of lactose in the milk (Oddy *et al.*, 1985). The fractional extraction of glucose by the mammary gland (Laarveld *et al.*, 1981) and uterus (Morriss *et al.*, 1980; Hay *et al.*, 1984) does not change during starvation or insulin administration (Table 11.3). These organs appear to use glucose in direct proportion to the amount presented to them at all times. The hormonal regulation of glucose utilization seems to be directed at those organs which may store glucose, specifically muscle and fat, or which do not have constant needs for glucose. Regulation of glucose uptake by essential organs, i.e. the brain, mammary gland and uterus, appears to be based on availability, not by changing the extraction percentage or efficiency.

## Glucose–Lactate Interrelations

Lactate is a major precursor of glucose. It is second only to propionate in its glucogenic potential in fed ruminants (see Table 11.1 above). Lactate is a product of digestion and is produced endogenously in nearly every organ.

Lactate turnover in fasted non-pregnant, non-lactating sheep is about 20–30 mmol/h (Annison *et al.*, 1963a; Reilly and Chandrasena, 1978; Brockman and Laarveld, 1986) of which 20% is produced by the portal-drained viscera and 6% by the liver. In fed sheep lactate turnover is about 40% higher than in fasted sheep, or 30–50 mmol/h (Annison *et al.*, 1963a), reflecting a greater dietary contribution. Net production by the portal-drained viscera is 8–10 mmol/h in fed sheep and production by these tissues may account for up to 60% of the whole-body turnover (van der Walt *et al.*, 1983; Brockman, 1987). Endogenous lactate is produced by muscle, which always has a net output of lactate, except perhaps during exercise (Jarrett *et al.*, 1976), and adipose tissue, which also has a net production of lactate. In the latter, lactate production is equal to about half its glucose uptake (Khachadurian *et al.*, 1966).

The brain also produces lactate. Fasted sheep have a net output of lactate, but in fed sheep the brain has a net output of pyruvate, which equals the

lactate uptake. Lactate output by the brain is only a small fraction (6–15%) of glucose uptake (Pell and Bergman, 1983).

The ratios of organ production and utilization of lactate change during pregnancy and lactation. The uteroplacental unit is a net producer of lactate, whereas the mammary gland is a net user of lactate. In pregnant sheep extrahepatic production of lactate may be 75% of the whole-body turnover compared to about 55% of production by the portal-drained viscera in non-pregnant animals (van der Walt *et al.*, 1983). Lactate released into the maternal blood may account for 15–20% of the glucose utilization by the uteroplacental unit (Meschia *et al.*, 1980); an equivalent amount of lactate goes to the fetus. Thus, lactate production may account for one-third of the glucose taken up by the uterus, another third is taken up by the fetus as glucose.

The net uptake of lactate by the mammary gland of lactating animals is equal to about 20% of its glucose uptake on a molar basis (Oddy *et al.*, 1985). The liver uses more of the lactate, and is normally a net user of lactate (Table 11.4). About one-third of the lactate is removed by the liver and appears as glucose in fasted sheep (Brockman and Laarveld, 1986). The extraction of lactate by the liver varies with the dietary intake or physiological status (Brockman and Laarveld, 1986; Brockman, 1987) and is subject to hormonal regulation, the most important of which is insulin. While in the pregnant animal 75% of the lactate is used by the liver, presumably for gluconeogenesis, in the lactating animal about 40% of lactate turnover is used by the liver. The effects observed by changes in dietary status may also be influenced by metabolites. Propionate, for example, appears to reduce the hepatic removal of lactate independent of any effect of hormones (Baird *et al.*, 1980). It seems that when propionate is available, which means during feasting, the liver uses propionate preferentially as a substrate for glucose production, thereby sparing lactate and other glucose precursors for other uses.

**Table 11.4.** Insulin concentrations, lactate extraction by the liver and net hepatic uptake (NHU) and turnover rate (TR) of lactate in sheep under various physiological states and during glucagon and insulin infusion (data from van der Walt *et al.*, 1983; Brockman and Laarveld, 1986; R.P. Brockman, unpublished results).

Status	Insulin ( $\mu$ U/ml)	Hepatic extraction (%)	NHU (mmol/h)	Lactate TR (mmol/h)
Fed <i>ad lib</i> Maintenance	$60 \pm 8$	$7.6 \pm 1.9$	–	$17 \pm 1$
Control	$22 \pm 3$	$9.0 \pm 1.7$	$11 \pm 2$	–
Glucagon	$52 \pm 8$	$13 \pm 3$	$18 \pm 5$	–
Pregnant	–	$29 \pm 3$	$31 \pm 4$	$40 \pm 5$
Lactating	–	$14 \pm 2$	$18 \pm 2$	$51 \pm 1$
36-h fast	$6 \pm 1$	$29 \pm 3$	$18 \pm 3$	$21 \pm 2$
Insulin infusion	$47 \pm 7$	$18 \pm 7$	$10 \pm 2$	$21 \pm 3$
Insulin infusion	$95 \pm 9$	$9.2 \pm 2.5$	$7.2 \pm 2$	$26 \pm 2$

**Table 11.5.** Summary of the interconversions of lactate and glucose in sheep (data from Reilly and Chandrasena, 1978; van der Walt *et al.*, 1983; Brockman and Laarveld, 1986).

	% Glucose from lactate	% Lactate to glucose	% Lactate from glucose	% Glucose to lactate	Recycling (%)
Fed ( $n=4$ )	16 ± 1				
Fasted					
16 h ( $n=7$ )	15 ± 3	17 ± 2	31 ± 5	24 ± 3	4.7
36 h ( $n=5$ )	13 ± 1	26 ± 4	69 ± 5	33 ± 3	9.0
Pregnant	12	30	79	31	9.4
Lactating	6	16	57	19	3.4

In fasted, pregnant and lactating sheep about 26%, 30% and 16%, respectively, of the lactate turnover is used for gluconeogenesis (Table 11.5). The lower value in lactating sheep reflects lactate used by the mammary gland. The fraction of lactate used in glucose synthesis is probably lower in the fed animals compared to the fasted animals. In sheep that had feed withheld for 12–16 h (partially fasted), 18% of the lactate was used for gluconeogenesis whereas in sheep that were fasted for longer periods, it was 26% (Reilly and Chandrasena, 1978). Obviously this is related to the decreased availability of propionate during starvation.

Lactate, however, accounts for less than 20% of the substrate for glucose. The fraction of glucose that is derived from lactate seems relatively constant (10–20%) (Tables 11.1 and 11.5), except during lactation when substantial amounts of lactate are used by the mammary gland (Oddy *et al.*, 1985) and lactate accounts for only about 6% of glucose synthesis.

## Metabolism of Short-chain Fatty Acids

### Propionate

A sheep on a maintenance diet of 800 g of lucerne pellets per day produces 30–45 mmol propionate per hour in its rumen (Judson and Leng, 1973a; Steel and Leng, 1973b). Of this, 18–24 mmol/h is absorbed (Bergman *et al.*, 1966; Bergman and Wolff, 1971; Noziere *et al.*, 2000). Since absorption accounts for only 40–60% of ruminal production, a substantial amount of ruminal propionate is metabolized or converted to other metabolites before and/or during absorption. In studies with washed reticulorumens almost all the propionate, which was infused into the rumen, was recovered in the portal blood (Kristensen *et al.*, 2000; Kristensen and Harmon, 2004), indicating that propionate is not metabolized to a significant degree by the ruminal epithelium during absorption. This is consistent with the results of earlier studies in cattle that indicated that little propionate is metabolized during absorption (Weigland *et al.*, 1972). Thus, half of the ruminal propionate is metabolized within the gut.



Half (Judson and Leng, 1973b; Steel and Leng, 1973b; Amaral *et al.*, 1990) or more (Bergman *et al.*, 1966; Bergman and Wolff, 1971) of the propionate that is absorbed is used to synthesize glucose. Perhaps as much as 80% of the absorbed propionate may be converted to glucose, accounting for 27–30% of glucose production (Bergman *et al.*, 1966; Brockman, 1990). It may be slightly higher in pregnant animals (Judson and Leng, 1973b). Data from the study of Brockman (1990), in which propionate was infused intraportally in fasted sheep at rates equivalent to normal absorption rates, indicated that the liver of fasted sheep may be even more efficient in using propionate for glucose synthesis. About 90% of the propionate, which was removed by the liver, was converted to glucose. The liver is very efficient at removing propionate from the blood. It extracts about 90% of the propionate reaching it and propionate uptake by the liver accounts for more than 90% of the portal production in both cattle (Baird *et al.*, 1980; Lozano *et al.*, 2000) and sheep (Bergman and Wolff, 1971).

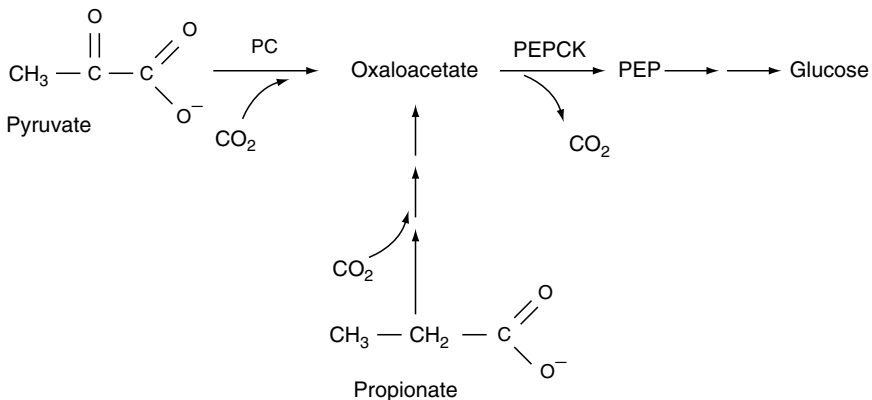
The rate of utilization of propionate for glucose synthesis appears to be determined by availability. This conclusion is supported by many observations. First, propionate utilization is linearly related to its concentrations in plasma (Bergman *et al.*, 1966; Judson and Leng, 1973a). Secondly, infusion of exogenous propionate into the rumen increases the absolute amount of propionate incorporated into glucose, but it does not change the fraction of propionate used for glucose synthesis (Judson and Leng, 1973b; Amaral *et al.*, 1990). Similarly the intravenous infusion of propionate increases glucose production and the proportion of glucose derived from propionate without changing the proportion of propionate appearing in glucose (Bergman *et al.*, 1966). In studies in cows the intravenous infusion of propionate at rates which doubled the entry rate of propionate only marginally reduced the hepatic extraction of propionate, from 80–85% to 70–75%, while the hepatic uptake of propionate doubled (Baird *et al.*, 1980). Similar results were obtained in sheep during intraruminal infusion of propionate at 58 mmol/h (Berthelot *et al.*, 2002). Thirdly, the hepatic extraction efficiency and incorporation of propionate into glucose do not appear to be influenced by glucoregulatory hormones, e.g. insulin (Baird *et al.*, 1980; Brockman, 1990). Finally, glucose infusion sufficient to cause hyperglycaemia and hyperinsulinaemia in cows did not appear to affect the net hepatic uptake of propionate while the hepatic output of glucose decreased (Baird *et al.*, 1980). Another study showed that this occurred without a change in the amount of propionate converted to glucose (Amaral *et al.*, 1990).

Propionate may influence the utilization of other substrates for glucose synthesis. First, propionate is a known substrate for lactate production (Leng and Anison, 1963), with perhaps half of the blood lactate being derived from ruminal propionate (Leng *et al.*, 1967). Secondly, the infusion of exogenous propionate in cows was associated with a decrease in the hepatic extraction of lactate in the absence of changes in plasma insulin concentrations (Baird *et al.*, 1980). In studies where propionate was infused at 40 mmol/h into a mesenteric vein in fasted sheep, whole-body lactate production went from  $16 \pm 1$  to  $29 \pm 3$  mmol/h while hepatic production of lactate increased less than

5 mmol/h ( $1.3 \pm 0.7$  vs.  $5.9 \pm 1.6$  mmol/h) (R.P. Brockman, unpublished data). Thus, the change in hepatic production of lactate accounted for less than half of the increase in whole-body production of lactate during propionate infusion.

The relationship between lactate and propionate and the differential hormonal response between lactate/pyruvate and propionate in the liver, are undoubtedly related to the differences in their entry into the gluconeogenic pathway. The conversion of lactate/pyruvate to triose phosphate involves both the pyruvate carboxylase (PC) and the phosphoenolpyruvate carboxykinase (PEPCK) catalysed reactions (the first reaction is the conversion to oxaloacetate, the second oxaloacetate to triose phosphate), whereas the conversion of propionate to triose phosphate does not involve PC (propionate is converted to oxaloacetate by another process, see Fig. 11.3). The activity of PC, but not PEPCK, is responsive to changes in physiological status and hormones (Ballard *et al.*, 1969; Filsell *et al.*, 1969; Brockman and Manns, 1974) and it follows that changes in PC activity can alter the rate of conversion of lactate/pyruvate, but not propionate, to triose phosphate. An increase in the availability of propionate, it seems, would increase the intracellular concentration of oxaloacetate, thereby reducing the proportion of oxaloacetate derived from lactate/pyruvate that is used to form triose phosphate if there is no change in the PEPCK reaction rate. This may explain how propionate decreases the net hepatic uptake of lactate and pyruvate (Baird *et al.*, 1980).

Some extrahepatic organs can metabolize propionate. The hind limb has been shown to remove about 40% of the propionate reaching it in a single pass (Prior *et al.*, 1984) and the brain about 25% (Oyler *et al.*, 1970). Since 85–90% of the absorbed propionate is removed in a single pass through the liver (Bergman and Wolff, 1971), only small amounts of propionate reach other organs. Quantitatively, extrahepatic metabolism of propionate is minimal. For comparison, the arteriovenous difference of propionate across the brain is only 3–4% of that of glucose (Oyler *et al.*, 1970).



**Fig. 11.3.** A summary of the entry of propionate and pyruvate to the pyruvate carboxylase (PC) and phosphoenolpyruvate carboxykinase (PEPCK) reactions in gluconeogenesis.

## Acetate

### Production

Quantitatively, acetate is the most important short-chain fatty acid in the ruminant. About 70% of the intraruminal turnover or production of acetate can be accounted for by portal absorption of acetate (Bergman and Wolff, 1971; Kristensen, 2001). In sheep on a maintenance diet this would be about 100 mmol/h. Net portal production of acetate in 340 kg steers fed *ad libitum* was about 550 mmol/h (Lozano *et al.*, 2000). Since virtually all the acetate that was infused into washed reticulorumen preparations was recovered in the portal blood in both sheep (Kristensen *et al.*, 2000) and cattle (Kristensen and Harmon, 2004), it appears that intraruminal use, not rumen epithelial metabolism, accounts for the 30% of ruminal acetate that does not appear in the portal blood. Studies in cattle indicate that less than 10% of ruminal acetate passes into the lower gut and about 20% is absorbed as non-acetate volatile fatty acids (Kristensen, 2001).

The whole-body production of acetate in sheep on a maintenance diet is 120–150 mmol/h (Annison *et al.*, 1967; Bergman and Wolff, 1971). Arteriovenous difference studies have shown that the portal-drained viscera, presumably representing absorption, produce about three-quarters of this. About 20% of endogenous acetate production comes from the liver, but the liver utilizes about the same amount and its net production of acetate is less than 5% of the whole-body turnover (Bergman and Wolff, 1971; Lozano *et al.*, 2000). During fasting the endogenous production of acetate is about the same as during feasting (Bergman and Wolff, 1971; Pethick *et al.*, 1981), but since absorption from the gut is low during fasting, liver production may account for 25% of acetate turnover, with the muscle producing the rest.

The situation changes during lactation. In lactating ewes (Costa *et al.*, 1976) the net hepatic production of acetate accounts for about 40% of its whole-body turnover. In lactating dairy cows its net hepatic production is about one-third of that of the gut (Lomax and Baird, 1983). The increased acetate production by the liver is probably due to increased uptake of free fatty acids by the liver (Costa *et al.*, 1976). While the lactating mammary gland is a net user of acetate, it produces a small amount of acetate (about 4% of whole-body production) (King *et al.*, 1985). This amounts to about one-quarter of its utilization rate by the organ.

### Utilization

Acetate is metabolized rapidly by the body. Estimates of acetate's half-life range from 3 to 4 min (Annison and Lindsay, 1961) to 13 min (Jarrett *et al.*, 1974). Acetate extraction by the hind limb is 50–60%, where the net uptake accounts for 20% of the oxygen uptake (Jarrett *et al.*, 1976). Acetate extraction is lower during fasting and exercise when ketone bodies and long-chain free fatty acids make up the major energy sources (Jarrett *et al.*, 1976). At these times acetate extraction efficiency may be as low as 15%.

**Table 11.6.** Arterial concentrations [Art], arteriovenous concentration differences [A–V], extraction of acetate by the hind limb (Extr.) and arterial insulin concentrations [Insulin] in sheep under various conditions (adapted from Knowles *et al.*, 1974).

	[Art] ( $\mu\text{M}$ )	[A–V] ( $\mu\text{M}$ )	Extr. (%)	[Insulin] ( $\mu\text{U/ml}$ )
Fed	630 $\pm$ 8	321 $\pm$ 60	51	55 $\pm$ 9
Fasted				
48 h	101 $\pm$ 22	35 $\pm$ 8	35	8 $\pm$ 1
120 h	90 $\pm$ 11	25 $\pm$ 9	28	4 $\pm$ 1
Refed	352 $\pm$ 78	148 $\pm$ 48	42	40 $\pm$ 8
Diabetic	2471 $\pm$ 151	123 $\pm$ 94	5	1 $\pm$ 1
ITA <sup>a</sup>	470 $\pm$ 81	310 $\pm$ 57	66	25 $\pm$ 6

<sup>a</sup>Insulin-treated alloxan diabetic animals.

The brain also removes acetate from the blood. The net uptake may account for about 3% of acetate turnover, about 3 mmol/h (Pell and Bergman, 1983). On a molar basis this is equivalent to about 10% of the glucose uptake by the brain, so that the brain is not a major user of acetate. In lactating animals up to 20% of the acetate turnover is accounted for by mammary gland utilization (Pethick and Lindsay, 1982; King *et al.*, 1985). It removes about half the acetate presented to it (Bickerstaffe *et al.*, 1974; Laarveld *et al.*, 1985), and 17–29% of the organ's fatty acid synthesis is attributable to acetate (King *et al.*, 1985). Obviously, the absolute amount removed is a function of milk yield.

Acetate turnover is reduced during insulin deficiency (Jarrett *et al.*, 1974) and the uptake by the hind limb is increased by insulin (Table 11.6). In untreated diabetic sheep the extraction of acetate by the hind limb may be as low as 5% (Knowles *et al.*, 1974), compared to 50–60% when insulin is available as in normal animals and treated diabetics (Knowles *et al.*, 1974; Pethick *et al.*, 1981). In contrast, the uptake of acetate by the mammary gland is not influenced by insulin (Laarveld *et al.*, 1985). Typically insulin concentrations are lower in lactating animals than in non-lactating animals and the difference in the responses to insulin allows the body to direct acetate to the mammary gland by reducing uptake by insulin-responsive organs.

Acetate is a major source of energy for the ruminant. About 25% of respiratory carbon dioxide is derived from acetate (Pethick *et al.*, 1981). If all the acetate was oxidized it would account for about 40% of the respiratory carbon dioxide (see also Majdoub *et al.*, 2003, in which the net uptake of acetate by the hind limb in sheep could account for about one-third of the oxygen uptake). About two-thirds of all acetate is oxidized, leaving one-third for other uses, such as lipogenesis (Ballard *et al.*, 1969).

### Butyrate

Butyrate is the third most important product of carbohydrate fermentation in the rumen. Butyrate metabolism has been studied less than acetate and

propionate. The amount of butyrate which is absorbed is low in relation to the amount produced in the rumen. A sheep on a maintenance diet absorbs about 2 mmol/h as butyrate (Bergman and Wolff, 1971), compared with a ruminal production between 20 and 40 mmol/h (Annison *et al.*, 1967). About 20% of butyrate is converted to acetate in the rumen. Much of the butyrate is metabolized in the ruminal epithelium during absorption (Kristensen *et al.*, 2000; Kristensen and Harmon, 2004). Only about one quarter of the butyrate which was infused into a washed reticulorumen preparation was recovered in the portal blood (Kristensen *et al.*, 2000).

During absorption butyrate is largely converted to ketone bodies in the ruminal epithelium (Emmanuel, 1980). In sheep on a maintenance diet the net production of ketone bodies by the portal-drained viscera has been reported to be 15–20 mmol/h (Katz and Bergman, 1969), although estimates of net portal production of ketone bodies as low as 3 mmol/h have been reported (Noziere *et al.*, 2000; Majdoub *et al.*, 2003). Studies with cattle suggest that the net production of ketone bodies by the portal-drained viscera may be two to three times more than the net portal production of butyrate (Lomax and Baird, 1983; Lozano *et al.*, 2000). Kristensen *et al.* (2000) cited unpublished studies in which 40% of the intraruminally infused butyrate was accounted for by the release of 3-hydroxybutyrate into the portal-drained viscera. Ketone body production by the portal-drained viscera decreases during fasting, when butyrate production is decreased (Noziere *et al.*, 2000).

Studies in sheep indicate that more than 80% of the butyrate that is absorbed from the gut is removed in a single pass through the liver (Bergman and Wolff, 1971). It may be lower in cattle where hepatic extraction of butyrate was about two-thirds (Lozano *et al.*, 2000). Only 20–33% is used by the peripheral tissues. Thus, while the sheep hind limb appears to be able to remove about one-third of the butyrate presented to it (Majdoub *et al.*, 2003), quantitatively utilization by muscle is small. In contrast, the liver is a net producer of ketone bodies (Katz and Bergman, 1969; Majdoub *et al.*, 2003) and appears to be able to use butyrate as a substrate (Annison *et al.*, 1963b). It appears that at least in cattle the production of ketone bodies by the liver may exceed hepatic uptake of butyrate in fed animals (Lozano *et al.*, 2000). Ketone body production by the liver is greatest when free fatty acids rather than butyrate are available as substrates (Katz and Bergman, 1969). Hepatic ketone body production is reduced by insulin (Brockman and Laarveld, 1985). Normally when dietary butyrate is readily available, insulin concentrations are high. Thus, the conversion of butyrate to ketone bodies by the ruminal epithelium during absorption allows hepatic ketogenesis to occur at a low rate without impairing the conversion of butyrate to ketone bodies.

Since both the liver and portal-drained viscera are net producers of ketone bodies they must be used by the peripheral tissues. The hind limb appears to extract less than one-fifth of ketone bodies presented to it in the blood (Majdoub *et al.*, 2003).

The most important function of butyrate is as a substrate for ketone body production. Since butyrate infusions appear to cause hyperglycaemia, there is some suggestion that butyrate may be glucogenic. However, butyrate has no

glucogenic capacity (Annison *et al.*, 1963b). The distribution of radioactivity in glucose indicates that any label from butyrate that appears in glucose is incorporated through the entry of acetyl-CoA into the tricarboxylic acid cycle (Annison *et al.*, 1963b; Leng and Annison, 1963). Thus, there is no net synthesis of glucose from the incorporation of butyrate carbon into glucose.

Isobutyrate is also produced in the rumen, but in smaller quantities than butyrate. In underfed (about one-half maintenance diet) sheep the net portal production of isobutyrate was 0.39 mmol/h compared to 0.58 mmol/h for butyrate (Noziere *et al.*, 2000). Comparable values were reported for steers (Lozano *et al.*, 2000). In studies with the washed reticulorumen all of the isobutyrate which was infused into the washed reticulorumen was accounted for in portal absorption (Kristensen *et al.*, 2000), indicating that it is not metabolized during absorption.

Valerate and isovalerate are other minor short-chain fatty acids that are produced by ruminal fermentation. The net portal production (absorption) of valerate was about 0.08 mmol/h in sheep fed a diet that met 53% of their energy needs (Noziere *et al.*, 2000). Net portal production of isovalerate was about 0.25 mmol/h in the same animals. Studies with the washed reticulorumen preparation indicated that net portal production may account for about one-third of the ruminal production of valerate and half that of isovalerate (Kristensen *et al.*, 2000; Kristensen and Harmon, 2004), which suggests that there is substantial metabolism of these metabolites during absorption. All of the valerate and about 85% of the isovalerate that is absorbed into the portal blood is removed by the liver so that essentially little or no valerate and isovalerate pass through the liver into the general circulation (Kristensen and Harmon, 2004).

## Conclusions

Due to the fermentative nature of their digestion, ruminant animals normally absorb little dietary carbohydrate as hexose sugar, and short-chain fatty acids account for up to 70% of their energy needs. Acetate is the major substrate for lipogenesis and oxidation. Propionate is a major substrate for gluconeogenesis. The fed animal appears to use propionate as the major glucose precursor, thereby sparing other glucose precursors, such as amino acids, for synthetic functions in other parts of the body. When propionate is less abundant, lactate, glycerol from fat and amino acids from extrahepatic tissues are used to a greater extent to produce glucose. Similarly, during fasting fatty acids from lipolysis may replace butyrate and acetate as energy sources.

## References

- Amaral, D.M., Veenhuizen, J.J., Drackley, J.K., Cooley, M.H., McGilliard, A.D. and Young, J.W. (1990) Metabolism of propionate, glucose, and carbon dioxide as affected by exogenous glucose in dairy cows at energy equilibrium. *Journal of Dairy Science* 73, 1244–1254.

- Annison, E.F. and Lindsay, D.B. (1961) Acetate utilization in sheep. *Biochemical Journal* 78, 777–785.
- Annison, E.F., Lindsay, D.B. and White, R.R. (1963a) Metabolic interactions of glucose and lactate in sheep. *Biochemical Journal* 88, 243–248.
- Annison, E.F., Leng, R.A., Lindsay, D.B. and White, R.R. (1963b) The metabolism of acetic acid, propionic acid and butyric acid in sheep. *Biochemical Journal* 88, 248–252.
- Annison, E.F., Brown, R.E., Leng, R.A., Lindsay, D.B. and West, C.F. (1967) Rates of entry and oxidation of acetate, glucose, D(-)β-hydroxybutyrate, palmitate, oleate and stearate and rates of production and oxidation of propionate and butyrate in fed and starved sheep. *Biochemical Journal* 104, 135–147.
- Baird, G.D., Lomax, M.A., Symonds, H.W. and Shaw, S.R. (1980) Net hepatic and splanchnic metabolism of lactate, pyruvate and propionate in dairy cows *in vivo* in relation to lactation and nutrient supply. *Biochemical Journal* 86, 47–57.
- Baird, G.D., van der Walt, R.G. and Bergman, E.N. (1986) Whole body metabolism of glucose and lactate in productive sheep and cows. *British Journal of Nutrition* 50, 249–265.
- Ballard, F.J., Hanson, R.W. and Kronfeld, D.S. (1969) Gluconeogenesis and lipogenesis in tissue from ruminant and nonruminant animals. *Federation Proceedings* 28, 218–231.
- Bergman, E.N. (1990) Energy contributions of volatile fatty acids from the gastrointestinal tract in various species. *Physiological Reviews* 70, 567–590.
- Bergman, E.N. and Wolff, J.E. (1971) Metabolism of volatile fatty acids by liver and portal-drained viscera in sheep. *American Journal of Physiology* 221, 586–592.
- Bergman, E.N., Roe, W.E. and Kon, K. (1966) Quantitative aspects of propionate metabolism and gluconeogenesis in sheep. *American Journal of Physiology* 211, 793–799.
- Bergman, E.N., Starr, D.J. and Ruelein, S.S. (1968) Glycerol metabolism and gluconeogenesis in normal and hypoglycemic sheep. *American Journal of Physiology* 215, 874–880.
- Bergman, E.N., Katz, M.L. and Kaufman, C.F. (1970) Quantitative aspects of hepatic and portal glucose metabolism and turnover in sheep. *American Journal of Physiology* 219, 785–793.
- Bergman, E.N., Brockman, R.P. and Kaufman, C.F. (1974) Glucose metabolism: comparison of whole-body turnover with production by gut, liver and kidneys. *Federation Proceedings* 33, 1849–1854.
- Berthelot, V., Pierzynowski, S.G., Sauvant, D. and Kristensen, N.B. (2002) Hepatic metabolism of propionate and methylmalonate in growing lambs. *Livestock Production Science* 74, 33–43.
- Bickerstaffe, R., Annison, E.F. and Linzell, J.L. (1974) The metabolism of glucose, acetate, lipids and amino acids in lactating dairy cows. *Journal of Agricultural Science, Cambridge* 83, 71–85.
- Brockman, R.P. (1983) Effects of insulin and glucose on the production and utilisation of glucose in sheep (*Ovis aries*). *Comparative Biochemistry and Physiology* 74A, 681–685.
- Brockman, R.P. (1985) Role of insulin in regulating hepatic gluconeogenesis in sheep. *Canadian Journal of Physiology and Pharmacology* 63, 1460–1464.
- Brockman, R.P. (1987) Effect of exercise on net hepatic uptake of lactate, pyruvate, alanine and glycerol in sheep. *Canadian Journal of Physiology and Pharmacology* 65, 2065–2070.

- Brockman, R.P. (1990) Effect of insulin on the utilisation of propionate in sheep. *British Journal of Nutrition* 64, 95–101.
- Brockman, R.P. and Laarveld, B. (1985) Effects of insulin on the net hepatic metabolism of acetate  $\beta$ -hydroxybutyrate in sheep (*Ovis aries*). *Comparative Biochemistry and Physiology* 81A, 255–257.
- Brockman, R.P. and Laarveld, B. (1986) Effect of insulin on gluconeogenesis and the metabolism of lactate in sheep. *Canadian Journal of Physiology and Pharmacology* 66, 1055–1059.
- Brockman, R.P. and Manns, J.G. (1974) Effects of glucagon on activities of hepatic enzymes in sheep. *Cornell Veterinarian* 64, 217–224.
- Brockman, R.P., Bergman, E.N., Joo, P.K. and Manns, J.G. (1974) Effects of glucagon and insulin on net hepatic metabolism of glucose precursors in sheep. *American Journal of Physiology* 229, 1344–1350.
- Costa, N.D., McIntosh, G.H. and Snoswell, A.M. (1976) Production of endogenous acetate by the liver in lactating ewes. *Australian Journal of Biological Sciences* 29, 33–42.
- Danfaer, A., Tetens, U. and Agergaard, N. (1995) Review and an experimental study on the physiological and quantitative aspects of gluconeogenesis in lactating ruminants. *Comparative Biochemistry and Physiology* III B, 201–210.
- Emmanuel, B. (1980) Oxidation of butyrate to ketone bodies and CO<sub>2</sub> in the rumen epithelium, liver, kidney, heart and lung of camel (*Camelus dromedarius*), sheep (*Ovis aries*) and goat (*Capra hircus*). *Comparative Biochemistry and Physiology* 65B, 699–704.
- Faulkner, A. (1980) Renal gluconeogenesis in pregnant and nonpregnant sheep. *International Journal of Biochemistry* 11, 191–293.
- Filsell, O.H., Jarrett, I.G., Taylor, P.H. and Keech, D.B. (1969) Effects of fasting, diabetes and glucocorticoids on gluconeogenic enzymes in sheep. *Biochimica et Biophysica Acta* 184, 54–63.
- Hay, W.W., Sparks, J.W., Gilbert, M., Battaglia, F.C. and Meschia, G. (1984) Effect of insulin on glucose uptake by the maternal hindlimb and uterus, and by the foetus in conscious pregnant sheep. *Journal of Endocrinology* 100, 119–124.
- Heitmann, R.N. and Bergman, E.N. (1980) Integration of amino acid metabolism in sheep: effects of fasting and acidosis. *American Journal of Physiology* 239, E248–E254.
- Hodgson, J.C., Mellor, D.J. and Field, A.C. (1981) Foetal and maternal rates of glucose production in chronically catheterized dicotous ewes. *Biochemical Journal* 196, 179–186.
- Jarrett, I.G., Filsell, O.H. and Ballard, F.J. (1974) Metabolic and endocrine interrelationships in normal and diabetic sheep. *Hormone and Metabolic Research* 4 (Suppl.), 111–116.
- Jarrett, I.G., Filsell, O.H. and Ballard, F.J. (1976) Utilisation of oxidizable substrates by the sheep hind limb: effects of starvation and exercise. *Metabolism Clinical and Experimental* 5, 523–531.
- Judson, J.G. and Leng, R.A. (1973a) Studies on the control of gluconeogenesis in sheep: effect of glucose infusions. *British Journal of Nutrition* 29, 159–174.
- Judson, J.G. and Leng, R.A. (1973b) Studies on the control of gluconeogenesis in sheep: effect of propionate, casein and butyrate infusions. *British Journal of Nutrition* 29, 175–195.
- Katz, M.L. and Bergman, E.N. (1969) Hepatic and portal metabolism of glucose, free fatty acids and ketone bodies in sheep. *American Journal of Physiology* 216, 953–960.



- Kaufman, C.F. and Bergman, E.N. (1974) Renal ketone body metabolism and gluconeogenesis in normal and hypoglycemic sheep. *American Journal of Physiology* 221, 967–972.
- Khachadurian, A.K., Adrouni, B. and Yacoubian, H. (1966) Metabolism of adipose tissue in the tail fat of the sheep *in vivo*. *Journal of Lipid Research* 7, 427–436.
- King, K.R., Gooden, J.M. and Annison, E.F. (1985) Acetate metabolism in the mammary gland of the lactating ewe. *Australian Journal of Biological Sciences* 38, 23–31.
- Knowles, S.E., Jarrett, I.G., Filsell, O.H. and Ballard, F.J. (1974) Production and utilisation of acetate in mammals. *Biochemical Journal* 142, 401–411.
- Krebs, H.A. and Yoshida, Y. (1963) Renal gluconeogenesis. 2. The gluconeogenic capacity of the kidney cortex of various animals. *Biochemical Journal* 89, 398–400.
- Kristensen, N.B. (2001) Rumen microbial sequestration of [2-<sup>13</sup>C]acetate in cattle. *Journal of Animal Science* 79, 2491–2498.
- Kristensen, N.B. and Harmon, D.L. (2004) Splanchnic metabolism of volatile fatty acids absorbed from the washed reticulorumen. *Journal of Animal Science* 82, 2033–2042.
- Kristensen, N.B., Danfaer, A. and Agergaard, N. (1998) Absorption and metabolism of short-chain fatty acids in ruminants. *Archives of Animal Nutrition* 51, 165–175.
- Kristensen, N.B., Gabel, G., Pierzynowski, S.G. and Danfaer, A. (2000) Portal recovery of short-chain fatty acids infused into the temporarily-isolated and washed reticulorumen of sheep. *British Journal of Nutrition* 84, 477–482.
- Laarveld, B., Christensen, D.A. and Brockman, R.P. (1981) The effect of insulin on net metabolism of glucose and amino acids in the bovine mammary gland. *Endocrinology* 108, 2217–2221.
- Laarveld, B., Chaplin, R.K. and Brockman, R.P. (1985) Effects of insulin on the metabolism of acetate,  $\beta$ -hydroxybutyrate and triglyceride by the bovine mammary gland. *Comparative Biochemistry and Physiology* 83B, 265–267.
- Leng, R.A. (1970) Glucose synthesis in ruminants. *Advances in Veterinary Sciences* 14, 209–260.
- Leng, R.A. and Annison, E.F. (1963) Metabolism of acetate, propionate and butyrate by sheep-liver slices. *Biochemical Journal* 86, 319–327.
- Leng, R.A., Steel, J.W. and Luick, J.R. (1967) Contribution of propionate to glucose synthesis in sheep. *Biochemical Journal* 103, 785–790.
- Leury, B.J., Bird, A.R., Chandler, E.D. and Bell, A.W. (1990) Glucose partitioning in the pregnant ewe: effects of undernutrition and exercise. *British Journal of Nutrition* 64, 449–462.
- Lindsay, D.B. (1978) Gluconeogenesis in ruminants. *Biochemical Society Transactions* 6, 1152–1156.
- Lomax, M.A. and Baird, G.D. (1983) Blood flow and nutrient exchange across the liver and gut of the dairy cow. *British Journal of Nutrition* 49, 481–496.
- Lozano, O., Theurer, C.B., Alio, A., Huber, J.T., Delgado-Elorduy, A., Cuneo, P., DeYoung, D., Sadik, M. and Swingle, R.S. (2000) Net absorption and hepatic metabolism of glucose, L-lactate, and volatile fatty acids by steers fed diets containing sorgum grain processed as dry-rolled or steam-flaked at different densities. *Journal of Animal Science* 78, 1364–1371.
- Majdoub, L., Vermorel, M. and Ortigues-Marty, I. (2003) Intraruminal propionate supplementation modifies hindlimb energy metabolism without changing the

- splanchnic release of glucose in growing lambs. *British Journal of Nutrition* 89, 39–50.
- Meschia, G., Battaglia, F.C., Hay, W.W. and Sparks, J.W. (1980) Utilisation of substrate by the ovine placenta *in vivo*. *Federation Proceedings* 39, 481–496.
- Morriss, F.H., Rosenfeld, C.R., Crandell, S.S. and Adcock, E.W. III (1980) Effects of fasting on uterine blood flow and substrate uptake in sheep. *Journal of Nutrition* 110, 2433–2443.
- Noziere, P., Martin, C., Remond, D., Kristensen, N.B., Bernard, R. and Doreau, M. (2000) Effect of composition of ruminally infused short-chain fatty acids on net fluxes of nutrients across portal-drained viscera in underfed ewes. *British Journal of Nutrition* 83, 521–531.
- Oddy, V.H., Gooden, J.M., Hough, G.M., Leleni, E. and Annison, E.F. (1985) Partition of nutrients in merino sheep. II. Glucose utilisation by skeletal muscle, the pregnant uterus and mammary gland in relation to whole body glucose utilisation. *Australian Journal of Biological Sciences* 38, 95–108.
- Oyler, J.M., Jones, K.L. and Goetsch, D.D. (1970) Utilisation of glucose and volatile fatty acids by canine and caprine brain. *American Journal of Veterinary Research* 31, 1801–1805.
- Pell, J.M. and Bergman, E.N. (1983) Cerebral metabolism of amino acids and glucose in fed and fasted sheep. *American Journal of Physiology* 244, E282–E289.
- Pethick, D.W. and Lindsay, D.B. (1982) Acetate metabolism in lactating sheep. *British Journal of Nutrition* 48, 319–328.
- Pethick, D.W., Lindsay, D.B., Barker, P.J. and Northop, A.J. (1981) Acetate supply and utilisation by the tissues of sheep *in vivo*. *British Journal of Nutrition* 46, 97–110.
- Prior, R.L., Huntingdon, G.R. and Reynolds, P.J. (1984) Role of insulin and glucose on metabolite uptake by the hind limbs of beef steers. *Journal of Animal Science* 58, 1146–1453.
- Reilly, P.E.B. and Chandrasena, L.G. (1978) Glucose–lactate interrelations in sheep. *American Journal of Physiology* 235, E487–E492.
- Steel, J.W. and Leng, R.A. (1973a) Effects of plane of nutrition and pregnancy on gluconeogenesis in sheep. 1. The kinetics of glucose metabolism. *British Journal of Nutrition* 30, 475–489.
- Steel, J.W. and Leng, R.A. (1973b) Effects of plane of nutrition and pregnancy on gluconeogenesis in sheep. 2. Synthesis of glucose from ruminal propionate. *British Journal of Nutrition* 30, 475–489.
- van der Walt, J.G., Baird, D.G. and Bergman, E.N. (1983) Tissue glucose and lactate metabolism and interconversions in pregnant and lactating sheep. *British Journal of Nutrition* 50, 267–280.
- Weigand, E., Young, J.W. and McGilliard, D. (1972) Extent of propionate metabolism during absorption from the bovine rumenoreticulum. *Biochemical Journal* 126, 201–209.
- Wilson, S., MacRae, J.C. and Buttery, P.J. (1983) Glucose production and utilization in non-pregnant, pregnant and lactating ewes. *British Journal of Nutrition* 50, 303–316.

---

# 12 Metabolism of the Portal-drained Viscera and Liver

D.B. Lindsay<sup>1</sup> and C.K. Reynolds<sup>2</sup>

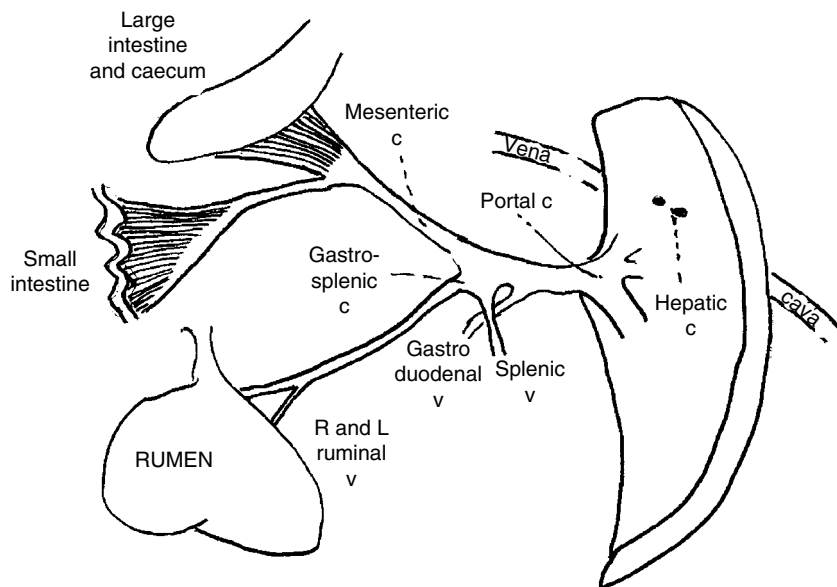
<sup>1</sup>*Division of Nutritional Sciences, School of Biosciences, University of Nottingham, Sutton Bonington Campus, Loughborough, Leicestershire LE12 5RD, UK;* <sup>2</sup>*Department of Animal Sciences, The Ohio State University, OARDC, 1680 Madison Avenue, Wooster, OH 44691-4096, USA*

---

## Introduction

Viscera whose blood supply drains into the portal vein include most of the alimentary tract, the spleen and the pancreas. In addition, mesenteric and omental fat depots, which can be substantial, contribute portal venous blood. Since it is the large expansion of the stomach that characterizes ruminants, it is understandable that special attention is devoted to metabolism in this region. Many metabolic peculiarities of ruminants stem from this. Most blood flowing into the liver is portal and since the metabolism of the liver is linked with that of the gastrointestinal (GI) tract, some features of its metabolism are also included.

This chapter emphasizes the quantification of nutrient and hormonal flows in the splanchnic region. Several techniques have been used to study ruminant metabolism. Among the most recent techniques available for use in intact animals is that of nuclear magnetic resonance (NMR), e.g. glycogen metabolism in human liver (Morris *et al.*, 1994). However, the high cost of equipment for this has rendered it unavailable for large animals such as sheep, goats and cattle. Thus only the arteriovenous (A–V) difference technique is considered here. This involves implantation (under general anaesthesia) of plastic catheters in an artery and in the mesenteric, portal and hepatic veins (see Fig. 12.1). Any artery may be used since the concentration of metabolites is virtually the same in all arteries. After adequate recovery from the operation, sampling of blood through these catheters together with some means of estimating blood flow is used to estimate net inflow/outflow (typically referred to as ‘net flux’) of metabolites across the whole of the portal-drained viscera (PDV) and liver. It has also proved possible to estimate the net movement of metabolites across sections of the PDV, such as the mesenteric-drained viscera (MDV) or the rumen. Moreover, the combination of A–V differences, blood flow and other measurements, such as nutrient disappearance from the lumen of the gut, or isotopic extraction and interconversion provides invaluable insight into the



**Fig. 12.1.** The siting of catheters (c) in splanchnic studies. c indicates catheter, v indicates vein. More detailed descriptions of the vascular anatomy of the bovine intestines (Habel, 1992) and liver (Seal and Reynolds, 1993) are provided in other texts.

quantitative metabolism of absorbed nutrients by the splanchnic tissues. The rates of protein synthesis by splanchnic tissues are not dealt with in this chapter, since these rates are described in Chapter 14.

## Methods of Calculating Metabolism

The general principles have been well described by Bergman (1975), van der Walt *et al.* (1983), Pethick *et al.* (1981) and Pell *et al.* (1986).

### Portal-drained viscera

*Net exchange (flux)*

$$\text{Net flux of compound } x_m = (P_m - A_m) \text{ PBF} \quad (12.1)$$

where PBF represents the portal blood flow;  $P_m$  and  $A_m$  are the portal and arterial blood concentrations of metabolite  $m$ . If  $P_m > A_m$  net flux of  $m$  is positive (there is net release or absorption into venous blood). If  $P_m < A_m$  net flux of  $m$  is negative (there is net uptake or removal from arterial blood).

*True (gross) release and removal*

By infusing isotopically labelled  $m$  one may distinguish release and utilization when both occur simultaneously. Since the earlier edition of this book, most isotopic studies have been made with stable (non-radioactive) isotopes. Enriched  $m$  is infused at a constant rate into any peripheral vessel, which is usually the jugular vein. After some time a steady state may be assumed (enrichments do not change with time). The period of infusion used may also be based on reaching a plateau enrichment of a metabolite of  $m$ , such as  $\text{CO}_2$ .

$$\text{The isotopic input of } m = A_m E_{am} \text{PBF} \quad (12.2)$$

$$\text{The uptake of isotopic } m = \text{PBF}(P_m E_{pm} - A_m E_{am}) \quad (12.3)$$

$$\begin{aligned} \text{Fractional uptake of isotopic } m &= \text{Eq.(12.2)/Eq.(12.3)} \\ &= [(P_m E_{pm})/(A_m E_{am})] - 1 \end{aligned} \quad (12.4)$$

where  $E_{pm}$  = enrichment (APE = atom per cent excess) of  $m$  in portal vein; and  $E_{am}$  = enrichment of  $m$  in artery.

$$\begin{aligned} \text{The true (gross) uptake} &= \text{input of } m \cdot \text{Eq. (12.4)} \\ &= \text{PBF} A_m [(P_m E_{pm}/A_m E_{am}) - 1] \end{aligned} \quad (12.5)$$

This assumes that over a short period no labelled  $m$  is released to the circulation by the tissue examined. This may not be true for all metabolites, resulting in underestimation of unidirectional uptake. Thus the following should be regarded as best estimates.

True (gross) release is the sum of the true uptake plus the net flux, thus:

$$\begin{aligned} \text{True release} &= \text{PBF}\{P_m - A_m + A_m[(P_m E_{pm})/(A_m E_{am})] - 1\} \\ &= \text{PBF}\{P_m - A_m(P_m E_{pm})/(A_m E_{am})\} \end{aligned} \quad (12.6)$$

*Oxidation*

Measurement of oxidation of  $m$  by measuring production of  $^3\text{H}$  or  $^2\text{H}$  across the GI tract is impracticable because of the large flux of water across it. If  $^{13}\text{C}$ - $m$  is used, letting  $P_{\text{CO}_2}$  and  $E_{P_{\text{CO}_2}}$  be the concentration and enrichment of  $\text{CO}_2$  in portal and  $A_{\text{CO}_2}$ ,  $E_{A_{\text{CO}_2}}$  the values in arterial blood, then:

$$\text{Net } \text{CO}_2 \text{ release} = (P_{\text{CO}_2} - A_{\text{CO}_2})\text{PBF} \quad (12.7)$$

$$^{13}\text{CO}_2 \text{ derived from } m = (P_{\text{CO}_2} E_{P_{\text{CO}_2}} - A_{\text{CO}_2} E_{A_{\text{CO}_2}})\text{PBF} \quad (12.8)$$

To express the fraction of  $\text{CO}_2$  derived from  $m$  this is divided by the enrichment of precursor  $m$ . This requires an assumption as to the enrichment of  $m$  in the tissues being studied. It is usually taken as the venous-specific activity although the value is perhaps more likely to lie between arterial and venous. For further discussion of this point, see also France *et al.* (1999).

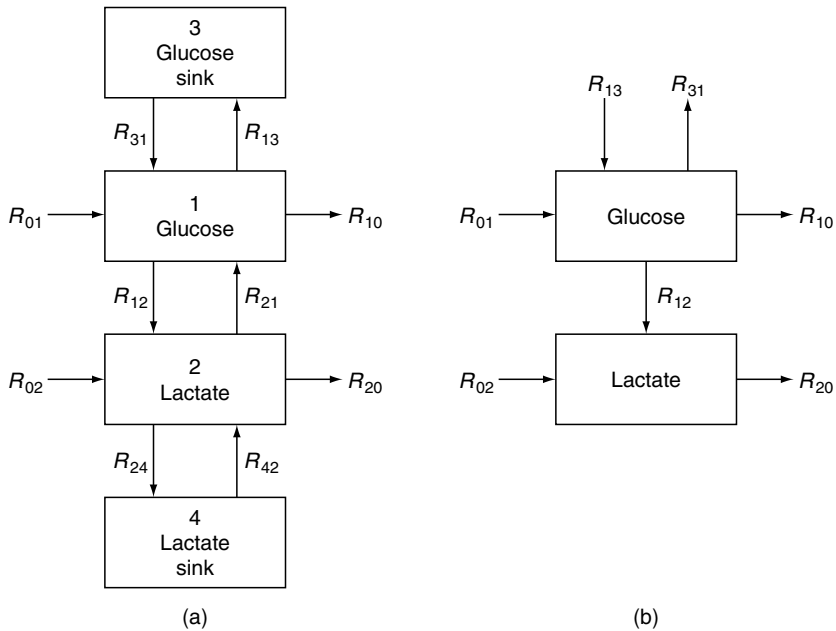
$$\text{Fraction of CO}_2 \text{ derived from } m = [(P_{\text{CO}_2} E_{P_{\text{CO}_2}} - A_{\text{CO}_2} E_{A_{\text{CO}_2}}) \text{PBF}] / E_{\text{pm}} \quad (12.9)$$

The fraction of  $m$  uptake oxidized by the site studied is given as Eq. (12.8)/Eq. (12.5).

One concern with the use of  $^{13}\text{C}$  to determine oxidation of  $m$  is the amount of labelled  $m$  required to measurably enrich  $\text{CO}_2$ . For many metabolites with low rates of oxidation, the infusion rate of  $^{13}\text{C}$ - $m$  required for measurable enrichment of  $\text{CO}_2$  may be such a large proportion of daily  $m$  turnover that metabolic responses to the  $^{13}\text{C}$ - $m$  occur, and thus the principles of tracer methodology are violated.

#### Interconversion of metabolites

To determine the interconversion of glucose and lactate (or leucine/ketoleucine; 3-hydroxybutyrate/acetoacetate) compartmental analysis is required. Estimates of rates will then depend on the model assumed. Figure 12.2a shows a model in which glucose and lactate represent homogeneous compartments each communicating with a 'sink' (this is conceptual – it may represent part of the cell, such as glycogen; or it could be the gut lumen). There are ten rate constants, of which  $R_{01}$ ,  $R_{02}$ ,  $R_{10}$  and  $R_{20}$  can be determined experimentally from glucose and lactate concentrations and enrichments and



**Fig. 12.2.** Compartmental models for analysis of glucose/lactate interconversions. (a) Full solution requires infusions of both labelled glucose and lactate. (b) Simplified model (see text) requiring infusion only of labelled glucose.

blood flow. This leaves six unknown. Equations for carbon balance for the glucose and the lactate pools supply two equations (e.g. for the glucose pool  $R_{01} + R_{21} + R_{31} = R_{10} + R_{12} + R_{13}$ ) and with  $^{13}\text{C}$ -glucose infused, isotope balance for the glucose and lactate pools supplies a further two equations. Thus where A and V represent the arterial and venous input (and assuming the latter reflects the tissue pools) we have:

$$AE_{\text{gluc}}R_{01} + VE_{\text{lact}}R_{21} = (R_{13} + R_{12} + R_{10})VE_{\text{gluc}} \quad (12.10)$$

$$AE_{\text{lact}}R_{02} + VE_{\text{gluc}}R_{12} = (R_{21} + R_{24} + R_{20})VE_{\text{lact}} \quad (12.11)$$

In the same way, results following infusion of labelled lactate yield two further equations for isotope balance for the glucose and lactate pools. Then six simultaneous equations will lead to a unique solution for the six unknown rates.

It may be reasonable to take a simpler model (shown in Fig. 12.2b). Here it is assumed that lactate metabolism occurs only through glucose (this is biochemically improbable, since it is likely that lactate carbon would be metabolized to compounds such as glucogenic amino acids without passing through the glucose pool). However, the amount so utilized might well be small and its neglect may lead to little error.  $R_{21}$  is also omitted from the model; this implies that gluconeogenesis from lactate does not occur in the GI which is almost certainly true. With this simplified model it is not necessary to use two labelled compounds since there are only three unknown rates; the two carbon balance equations, plus the two for isotope balance obtained from use with  $^{13}\text{C}$ -glucose are more than sufficient to solve for the unknowns. Indeed it is possible to solve without matrix analysis since first  $R_{12}$  may be obtained from isotope balance ( $R_{12} + R_{02} = R_{20}$ ); then  $R_{13} = R_{01} - (R_{10} + R_{12})$ , since  $R_{31}$  does not contribute label. Finally  $R_{31}$  is obtained from carbon balance.

*Determination of the amount of amino acid 'sequestration' during absorption*

The amount of an amino acid 'sequestered' is the amount metabolized in the absorptive cells of the small intestine, either as export or constitutive protein synthesis or by catabolism. Similar approaches could be used for other metabolites if the rate of disappearance from the gut lumen can be determined or estimated. The approach requires the differential labelling of both the blood and small intestinal lumen pools, as the recovery of isotope infused into the gut lumen must be corrected for absorbed isotope subsequently extracted (sequestered) by the PDV from arterial blood. Utilization of blood-derived (arterial) amino acids by the PDV is determined isotopically much as described above. After intravenous infusion of labelled  $m$  ( $I_1$ ), when steady state is reached,  $E_{pm}$  and  $E_{am}$  represent respective enrichments of portal and arterial  $m$ .

$$\begin{aligned} &\text{The fractional extraction of } I_1 \text{ from arterial blood } (S_1) \\ &= (A_m E_{am} - P_{pm} E_{pm}) / A_m E_{am} \end{aligned} \quad (12.12)$$

A different isotope ( $I_2$ ) of the amino acid is also infused into the duodenum (or the same isotope could be infused on a separate occasion), and its fractional

disappearance from the small intestinal lumen is calculated as: (infused  $I_2$  - ileal  $I_2$ )/infused  $I_2$ .

The true fractional recovery of  $I_2$  in the portal system is calculated as:

$$(S_2) = (P_{m_2}E_{pm_2} - A_{m_2}E_{pm_2}) + S_1(A_{m_2}E_{pm_2})PBF/(\text{infused } I - \text{ileal } I) \quad (12.13)$$

$$\text{The fraction sequestered} = 1 - S_2 \quad (12.14)$$

The amount sequestered is then given as:

$$(1 - S_2) (\text{apparent absorbed amino acid} + \text{ileal endogenous amino acid}) \quad (12.15)$$

Apparent absorbed amino acid and ileal endogenous amino acid are obtained from separate (non-isotopic) experiments using measurements of duodenal and ileal flow and an estimate of endogenous flow in the ileum (e.g. MacRae *et al.*, 1997a).

### **Mesenteric-drained viscera**

The calculations are identical with the ones above, substituting mesenteric for portal vein.

### **Liver**

In this case, the calculations are somewhat more complicated since the hepatic input is the sum of the portal output plus the arterial input (taking the flow as that of the hepatic artery). The output is that from the hepatic veins. Otherwise the calculations are as above, except that in calculating metabolic interactions gluconeogenesis and ureagenesis are of considerable importance.

### **Irreversible loss (ILR)**

Finally, when labelled  $m$  is infused intravenously under steady-state conditions the total ILR of  $m$  from the blood pool can be determined:

$$ILR = I/A_m \quad (12.16)$$

Again, the choice of sampling site for measuring enrichment of  $m$  is critical, but in most cases whole-body ILR is calculated using the arterial pool, in some cases with correction for liver (and gut) sequestration during absorption of  $m$  (Bergman, 1975). For essential amino acids (EAA), this ILR is equal to their use for protein synthesis and oxidation, which will be equal to their release from protein degradation and absorption from the gut lumen.



### **Requirements of the A–V difference method**

The A–V difference technique is now widely used since many workers can prepare and maintain catheterized animals that can be usable for months or years. Crucial features are the ability to measure accurately both blood flow and small A–V differences. For blood flow measurement, infusion of a marker such as  $\rho$ -amino-hippurate (PAH) has been widely used. The method involves infusion into the blood at one point and measurement of concentration downstream. Substantial extraction by kidney (PAH) or liver is required for each circulation time to maintain a constant background (arterial) concentration of marker. It is also possible to inject 'cold' saline and measure the temperature change. This method has been used successfully, but requires meticulous attention to technique. When PAH is used portal vein and liver blood flow can be measured simultaneously, and the hepatic artery flow calculated by difference.

Other techniques have been described for measurement of blood flow, including electronic methods using a 'cuff' or 'probe' around a vessel such as the portal vein or hepatic artery. Electromagnetic or ultrasound/Doppler shift techniques were used earlier. The disadvantage was that estimation varied with the diameter of the vessel and this changed with time. Another technique involves a probe with a yoke around the vessel that measures fluid flow through a beam of ultrasound. The probe measures transit time of blood through the probe, which is a function of the volume flow through the beam (Drost, 1978). Estimation is independent of vessel diameter if probe size and alignment within the vessel are correct. Both instant and time-averaged flow are possible. This method has not generally been feasible in cattle, because of difficulties in probe placement about the portal vein. As opposed to sheep, who have a common portal vein, the convergence of the gastrosplenic and anterior mesenteric veins typically occur at the porta hepatis in cattle. Huntington *et al.* (1990) have described such a technique in young steers, but encountered problems in correctly placing the probe on the portal vein. Few comparisons have been made of the ultrasound and dye dilution techniques. However, Rémond *et al.* (1998) have shown that in sheep, results with a new cuff-type transit-time ultrasound probe (A type) agreed fairly well with dye dilution ( $\pm 10\%$ ). This new type of probe would be much easier to place in the portal vein of cattle than the type of probes used by Huntington *et al.* (1990). Rémond *et al.* (1998) concluded absolute accuracy of such flow estimations was within 5% for portal flow. It is still necessary to determine hepatic flow independently. This may be obtained by a clearance technique, using compounds such as indocyanine or bromsulphthalein, which do not depend on adequate mixing in the portal vein. Alternatively, a smaller electronic probe can be used to measure hepatic artery flow directly (Ortigue *et al.*, 1996).

The importance of precision in A–V difference measurement is indicated by comparing the measurement of oxygen consumption and carbon dioxide production in one experiment: oxygen concentrations in arterial, portal and hepatic vessels were 4.3, 3.0 and 1.0 mM; CO<sub>2</sub> concentrations were 27.2, 28.4 and 29.6 mM. While the fractional difference across the tissues for oxygen is 0.2–0.3, the corresponding difference for CO<sub>2</sub> is only about 0.04,

a change much more difficult to quantify. Measurement of CO<sub>2</sub> production by the PDV is also complicated because CO<sub>2</sub> derives from fermentation and saliva in the gut lumen, as well as the PDV tissues, and can be transferred from blood to the gut lumen.

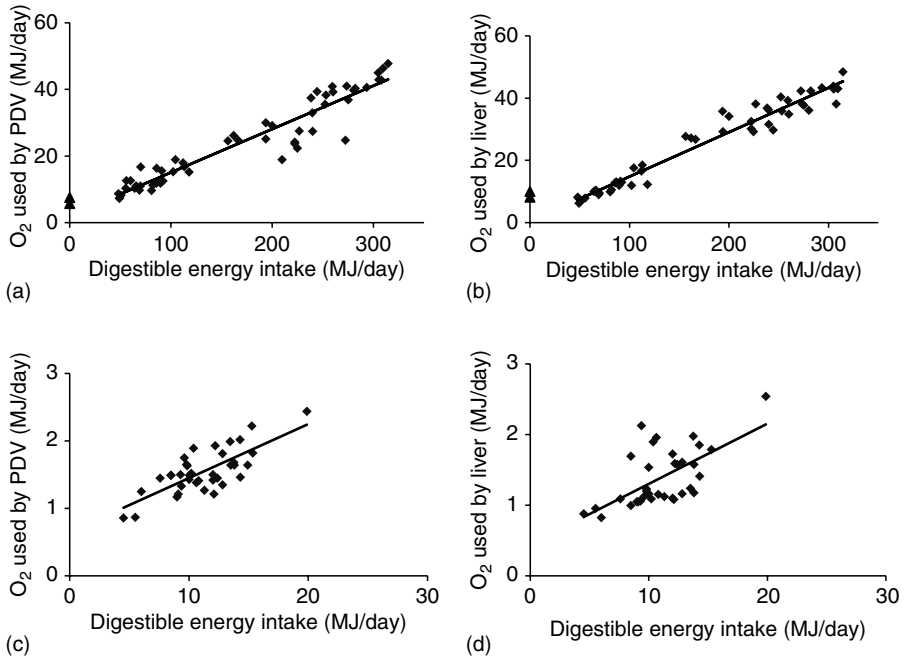
#### *Limitations of the method*

Limitations of the A–V difference method include:

1. Loss of patency of even one catheter may prevent use of an animal. The arterial sample is essential, thus the carotid artery is often elevated to a subcutaneous position to allow insertion of a temporary catheter (Huntington *et al.*, 1989). In addition, the use of PAH for measuring blood flow is dependent on a patent and appropriately placed mesenteric vein catheter for PAH infusion, thus two catheters are often established to provide a backup if one loses patency or gives invalid results.
2. Incomplete mixing in blood vessels may result in over- or underestimation of an A–V difference and an error in blood flow estimation if a dilution method is used. Therefore, mesenteric infusion catheters should be established with their tips as far as possible from portal and mesenteric vein sampling sites, and portal vein sampling catheters should be inserted downstream from the porta hepatis, where turbulence helps to mix portal blood as it is delivered to the liver.
3. The PDV are a heterogeneous group of tissues. More recent methods in which catheters are implanted both before and after the conjunction of anterior mesenteric and gastrosplenic veins, permit partitioning into ‘pre-’ and ‘post-stomach’ metabolism. This is an improvement but both components remain heterogeneous.
4. There is no common hepatic vein; nearly all studies have relied on the same major hepatic vein and sample a similar region of the liver. There is little information on possible site variation in hepatic metabolism, but strong evidence for regional distribution of anterior mesenteric and gastrosplenic blood, especially in younger animals (Heath and Perkins, 1985).
5. Ideally, one should estimate 24-h integrated values for blood flow and metabolite concentration but this is rarely done. Hourly feeding reduces but does not eliminate variation over 24 h, depending in part on the level of intake prescribed, and may well distort ‘normal’ metabolism. In addition, in the authors’ experience, it is difficult to arrange hourly feeding of sheep in late pregnancy or with suckling lambs. The best that can be done is to feed three to four meals per day of concentrates with free feeding of forage. This may also be true for lactating dairy cows if the capacity of automated feeders is limited.

## **Oxygen Consumption**

In the first edition evidence was presented that oxygen uptake by the splanchnic tissues of sheep and cattle was about 40–50% of total body oxygen consumption, with roughly equal contributions by the viscera and the liver. There is now much more evidence supporting this conclusion (see e.g.



**Fig. 12.3.** Energy use by portal-drained viscera and liver as a function of digestible energy intake in sheep and cattle. (a) Portal oxygen consumption in cattle:  $y = 0.13x + 2.05$  ( $R^2 = 0.908$ ). (b) Hepatic oxygen consumption in cattle:  $y = 0.14x + 0.54$  ( $R^2 = 0.956$ ). (c) Portal oxygen consumption in sheep:  $y = 0.08x + 0.65$  ( $R^2 = 0.569$ ). (d) Hepatic oxygen consumption in sheep:  $y = 0.09x + 0.45$  ( $R^2 = 0.393$ ). Data for cattle taken from Huntington and Tyrrell (1985); Reynolds *et al.* (1986, 1988a, 1991b, 1992a–c, 1994a, 1995, 1998a,b, 1999, 2000, 2001, 2003a,b); Huntington *et al.* (1988); Eisemann and Nienaber (1990); Maltby *et al.* (1993); Casse *et al.* (1994); Taniguchi *et al.* (1995); Bruckental *et al.* (1997); Caton *et al.* (2001) and Benson *et al.* (2002). Data for sheep taken from Goetsch and Ferrell (1995); Patil *et al.* (1995, 1996); Goetsch *et al.* (1997a–d); Park *et al.* (1997); Lindsay (unpublished).

Reynolds, 2002). In addition much new evidence shows that the amount of food consumed and digested is a significant factor determining oxygen uptake by these tissues. Figure 12.3 shows that for both sheep and cattle, oxygen consumption of both PDV and liver is related to digestible energy (DE) intake. The slope of these equations suggests that these tissues in the course of digestion use the equivalent of 8% in sheep and 13–14% in cattle of the DE input. It is tempting to suppose that during absorption of nutrients, this proportion is therefore directly utilized – what Reynolds (2002) has described as a ‘toll-keeping’ charge. However, more critical examination suggests this is an oversimplification. In fasted sheep, oxygen uptake is equivalent to about 1.14 MJ/day for PDV and 1.97 MJ/day for liver and in cattle 6.34 and 8.71 MJ/day correspondingly. These values are significantly larger than the intercept values for the above equations. Thus at least part of the energy consumption is related to maintenance requirements, rather than being directly related to nutrient assimilation. This would be consistent with the thesis

developed by Reynolds (2002) that the greater part of the energy and nutrient costs associated with absorption of food is derived from arterial blood. At present it is still unknown what additional factors, dietary or endogenous, determine energy consumption by the viscera. Noziere *et al.* (2000) have shown, infusing varying mixtures of short-chain fatty acids (SCFA), that differences in the molar proportions of these acids in the rumen have no significant effect on the total energy absorbed into the portal vein, although they did not measure possible effects on visceral oxygen consumption.

## Efficiency of Nutrient Absorption into the Portal Vein

A major issue discussed in the earlier edition of this chapter was the discrepancy between disappearance of nutrients from the gastrointestinal tract and their appearance in the portal vein. This is frequently illustrated by the comparisons made by Bergman and Wolff (1971) of the net and true PDV release of SCFA in sheep with previous measurements at another location of net SCFA production in the rumen of sheep fed a similar diet. In this case, comparison of PDV release with rumen production suggested a considerable amount of sequestration during absorption. These observations were supported by the extensive metabolism of SCFA by rumen epithelial tissue *in vitro*, as well as subsequent studies in which the SCFA were ruminally infused in multicatheterized sheep and cattle (Reynolds, 2002).

### Short-chain fatty acids

The metabolism of SCFA by the PDV has been re-examined recently by Kristensen *et al.* (2000a). The authors used catheterized sheep with the rumen temporarily isolated, washed free of rumen contents and filled with buffered salts (pH 7.1). In these conditions, the net release (flux) in the portal vein of the SCFA absorbed by the sheep was (%)  $89 \pm 5$  (acetate),  $95 \pm 7$  (propionate),  $102 \pm 9$  (isobutyrate),  $23 \pm 3$  (*n*-butyrate),  $48 \pm 5$  (isovalerate) and  $32 \pm 4$  (*n*-valerate). Because  $2\text{-}^{13}\text{C}$ -acetate was infused intravenously, it was possible to correct net acetate release for arterial blood acetate removal by the PDV as described earlier. Corrected in this way, acetate release was  $109\% \pm 7\%$ , and the increase in ILR was  $101\% \pm 7\%$ , of the acetate absorbed from the rumen. The additional 'recovery' of acetate in this case may reflect endogenous release by PDV tissues. Pethick *et al.* (1981) had shown (by using  $^{14}\text{C}$ -labelled blood acetate) that in sheep on a maintenance ration, nearly 80% of the acetate utilized by the PDV was oxidized, accounting for possibly 50% of the energy used by the PDV. There is thus a clear distinction between acetate absorption (which is quantitatively recovered) and blood acetate, which meets (in part) the energy needs of the PDV as Reynolds (2002) had indicated. The almost complete recovery of absorbed propionate in the portal vein suggests that during absorption by the epithelia it is not appreciably oxidized, or metabolized to other metabolites. The arterial concentration of blood propionate is too low for it to

act as an energy source for the remainder of the PDV. It has been suggested that propionate is in part converted to lactate, but evidence suggests this is at best a minor pathway (2–5%) (Weekes and Webster, 1975). The low recovery of *n*-butyrate is attributed to partial conversion to 3-hydroxybutyrate, a reaction that has been known for about 50 years to occur in rumen epithelium. However, measurement of the extent of this conversion has only recently been quantified by Kristensen *et al.* (2000b). Sheep were infused via the rumen with either water or *n*-butyrate. Recovery (increment in net PDV release over the water control) of added *n*-butyrate was only 19%. However, assuming 3-hydroxybutyrate appearing in the portal vein was also derived from rumen *n*-butyrate, recovery increased to 43%. <sup>13</sup>C-labelled 3-hydroxybutyrate was also infused into a mesenteric vein, so that it was possible to determine uptake of 3-hydroxybutyrate by PDV tissues from arterial blood. This correction increased the total recovery of ruminal *n*-butyrate to 65%. The authors did not measure acetoacetate, but Lindsay and Oddy (1985) reported in sheep net PDV acetoacetate production of 1.0–3.6 mmol/h, accompanying a net PDV 3-hydroxybutyrate production in the range reported by Kristensen *et al.* (2000b). It is plausible therefore that if account were taken of probable acetoacetate production, portal recovery of *n*-butyrate as 4-carbon compounds would be 80% or more.

The C<sub>5</sub> acids and isobutyrate are derived from the catabolism in the rumen of branched-chain amino acids. The total amounts available are always small relative to the other SCFA. Isobutyrate, which is glycogenic, might in part be released as methyl malonic or succinic acid, although in the study above (Kristensen *et al.*, 2000a) recovery was essentially complete. Isovaleric is ketogenic while valeric is both glycogenic and ketogenic. They may also be partly metabolized in the rumen epithelium. Overall, the total (2–5)-C compounds appearing in the portal vein can account for at least 80–90% of the amount of SCFA produced in the rumen and caecum. It is at present assumed that the remaining difference may be due to oxidative metabolism during absorption or microbial utilization of SCFA in the digestive organs.

### **Long-chain fatty acids (LCFA)**

So far as we are aware no new studies have appeared in the last few years aimed at quantifying the absorption and metabolism of LCFA. It may be in part because of technical difficulties. Durand *et al.* (1990) presented evidence in pre-ruminant calves that as much chylomicra and very low-density lipoproteins (VLDL) may be absorbed via the portal vein as are absorbed via lymphatics. Moreover it is difficult to distinguish LCFA released from the GI tract from that released from adipose tissue. As stated in the earlier edition, approximately 20 g/day of LCFA is absorbed via the lymph duct in sheep on a hay diet. In dry cattle the estimates were 200 g/day and in lactating cows 400 g/day. Bergman *et al.* (1971) showed that about 15% of circulating triacylglyceride LCFA utilized was taken up by the PDV of sheep. If oxidized this would substantially contribute to energy needs of the PDV; but this utilization may also represent uptake and storage of triglyceride LCFA by portal-drained adipose tissue.

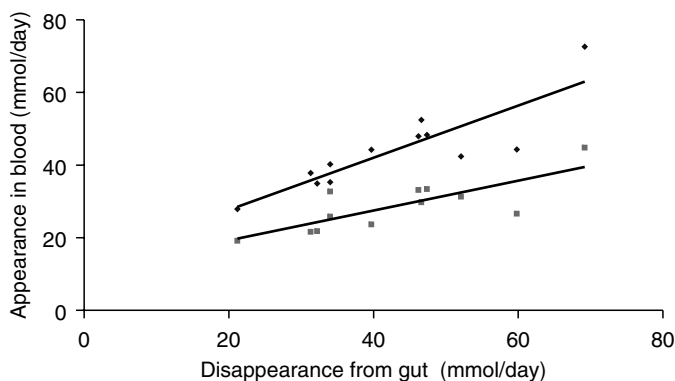
## Glucose

The low net portal vein absorption of glucose, even when diets high in starch are fed, has been recognized for some years. It is now clear that when starch or glucose is infused into the abomasum, glucose may be incompletely recovered in the portal vein on a net basis. Kreikemeier and Harmon (1995) made infusions into cattle abomasum of glucose, maize starch or maize dextrin (66 g/h for each). Only 73% of glucose that disappeared from the small intestine appeared as increased net PDV release of glucose. For dextrans the value was 60% and for starch 57%. In other studies, net recovery in the portal vein of glucose derived from starch infused into the abomasum has ranged from 25% to 51% (Reynolds, 2002). This low net recovery is in part due to increased metabolism of arterial glucose within the PDV. Reynolds and Huntington (1988) were able to measure in cattle release of glucose into the mesenteric vein (MDV) as well as the portal vein (MDV + stomach tissues). On a lucerne diet, glucose was removed by MDV (22–26 mmol/h), which was greater than that by the stomach (5–16 mmol/h). When a concentrate diet rich in maize meal was fed, there was net release of glucose across the MDV (29 mmol/h) while glucose removal by the stomach substantially increased (31 mmol/h), perhaps reflecting omental adipose use. One might reasonably suppose that on the maize diet, MDV glucose removal resulted in significant underestimation of the amount of glucose absorbed. In studies with sheep on a maize diet (Janes *et al.*, 1985), intravenous infusion of  $^{14}\text{C}$ -glucose permitted measurement of arterial glucose utilization at the same time as net absorption of glucose in the MDV. The rate of removal (which was not affected by change from dried grass to a maize diet) was about 20% of the rate of net appearance of glucose. In a recent study in cattle (Harmon *et al.*, 2001), when account was taken of increased arterial glucose utilization by the PDV (measured as above by infusion of  $^{14}\text{C}$ -glucose) following infusion of starch into the abomasum, apparent recovery (as glucose) in the portal vein increased from 51% to 71%.

Even taking arterial glucose utilization by PDV into account, it is possible that we can still not fully account for recovery of starch escaping rumen fermentation. This may be due to incomplete digestion or fermentation, or there also may be some metabolism of glucose within the small intestine, perhaps to supply glyceride for the absorption of LCFA. Release as lactate however, does not seem to be important (Reynolds and Huntington, 1988).

## Amino acids

It has been recognized for some years that there is incomplete net recovery in the portal vein of amino acids disappearing from the small intestine of ruminants, as was first shown by Tagari and Bergman (1978). Likely reasons were discussed in the earlier edition, major factors being utilization of amino acids for protein turnover and gut protein secretions. Supportive evidence came from estimation of endogenous protein secretion and absorption using  $^{15}\text{N}$ -labelled diets (Van Bruchem *et al.*, 1997). In sheep about 3 g/day endogenous



**Fig. 12.4.** Relation in sheep between amino acids absorbed from the small intestine and appearing in (a) portal vein. ◆  $y = 0.72x + 13.23$  ( $R^2 = 0.7397$ ). (b) mesenteric vein. ■  $y = 0.41x + 11.0$  ( $R^2 = 0.6123$ ). Amino acids plotted were the sum of leucine, lysine, threonine, isoleucine, valine and phenylalanine each at two doses. Data from MacRae *et al.* (1997b).

nitrogen appeared in the proximal duodenum, increasing to 10 g/day at the distal duodenum and falling to 5 g/day at the ileum. There is now much direct evidence supporting the concept of substantial amino acid utilization to support endogenous protein synthesis. MacRae *et al.* (1997b) measured disappearance of several EAA from the small intestine and their net release into the mesenteric and portal vein of sheep. As Fig. 12.4 shows, there was a substantially greater recovery in the mesenteric than in the portal vein. There is thus significant utilization of these EAA in the stomach and other tissues not drained by the anterior mesenteric vein, presumably for synthesis of secreted and constitutive epithelial proteins. In dairy cows 99% of absorbed EAA was recovered (measured in separate animals equipped with duodenal and ileal cannulas) in the mesenteric vein, but only 61% in the portal vein (Berthiaume *et al.*, 2001). For the non-essential amino acids (NEAA), recovery was about 76% in the mesenteric vein but only 38% in the portal vein. It thus appears that the NEAA were more extensively metabolized than the EAA. It is likely that this reflects greater oxidation of the NEAA.

A more direct approach was taken by MacRae *et al.* (1997a). They measured in sheep the sequestration of labelled amino acids (using either mixed U- $^{13}\text{C}$ -amino acids or 1- $^{13}\text{C}$  leucine) from arterial blood or during absorption, as described previously. Extraction of label was measured either during absorption of amino acids between the jejunum and ileum, or from arterial blood by the total PDV. For the PDV, the fractional extraction of labelled EAA from arterial blood ranged from 0.126 (leucine) to 0.06 (histidine). Portal vein recovery of most labelled EAA infused into the jejunum was 76–82%, but lower recovery was measured for phenylalanine (65%) and histidine (61%). In total, PDV utilization (arterial and intestinal sequestration) accounted for 32% (histidine) to 65% (valine) of whole-body flux of the EAA studied. These results clearly showed that most of the EAA metabolized (presumably for endogenous protein

secretions) by the PDV were derived from the arterial supply (about 80%, except for phenylalanine, where it was around 50%).

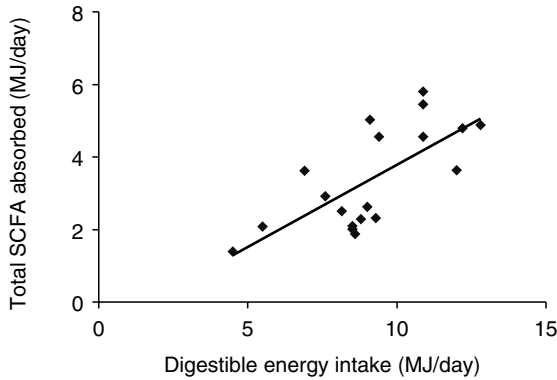
Reynolds *et al.* (2001) applied this technique in dairy cattle at two feed intakes in late lactation (mean 15.4 kg/day milk yield) and in the dry period. Their results confirmed the findings by MacRae *et al.* (1997a) in sheep that the arterial supply is a major source for metabolism of EAA by the PDV, and this is more striking for leucine than for phenylalanine, especially in dry cows. They also found that increasing food intake increases this metabolism. Most of the metabolized EAA are probably anabolized for the synthesis of secreted proteins, rather than catabolized. Yu *et al.* (2000) found that about 15% of the arterial leucine sequestered by the PDV was oxidized; and of that sequestered during absorption, only 0.1% was oxidized. There is some production of keto-isocaproate and other branched-chain keto acids in the portal vein of sheep (Pell *et al.*, 1986) and cattle (Early *et al.*, 1987). However, at least for leucine, such production is likely to be at most 5% of the total metabolized.

Further studies using lactating cows have shown that the pattern of amino acids absorbed by the small intestine, or site of absorption, may itself affect metabolism. Caton *et al.* (2001) have shown that when amino acids are supplied as casein infused into the abomasum, there is increased absorption of amino acids into the portal vein, but little increase in PDV sequestration of leucine or phenylalanine during absorption or from arterial blood. In contrast, when an equivalent amount of EAA is supplied as free amino acids, there is both increased absorption and sequestration, both during absorption and via extraction of the arterially supplied amino acids. The mechanism behind this is not yet understood. It may reflect absorption of an 'unbalanced' mixture of amino acids, or may be related to the site of absorption. Presumably, free amino acids infused into the abomasum will be absorbed in the upper small intestine, whilst casein amino acids will be absorbed from the lower half of the small intestine.

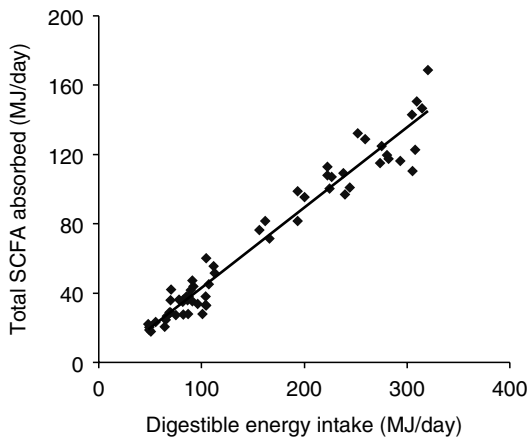
## SCFA Absorption

In studies published in the last 10 years, the correlation between SCFA absorption (net PDV release) and DE intake of sheep is not high ( $R^2$  about 0.5). However, the relation is substantially better for cattle ( $R^2 = 0.95$ ), where measurements across a much wider range of DE intakes have been published (Fig. 12.5). For sheep the total net PDV absorption of SCFA (and lactate) was about  $46\% \pm 3.1\%$  of DE intake and for cattle  $53\% \pm 2.5\%$ , but this underestimates true absorption to the extent these acids are utilized by the PDV. Perhaps surprisingly, there was a positive correlation between 'ketogenic' (acetate, *n*-butyrate, 3-hydroxybutyrate) and 'glycogenic' (propionate, lactate and isobutyrate) SCFA release by the PDV (Fig. 12.6). In relation to production in the rumen, it has generally been considered that the two components are negatively related (e.g. Rook, 1976). However, this is largely indicative of changes in diet composition, as opposed to changes in SCFA appearance across a range of DE intakes. Where total amounts of SCFA absorbed are driven primarily by the amount of organic matter fermented in the gut, they are positively related across





(a)



(b)

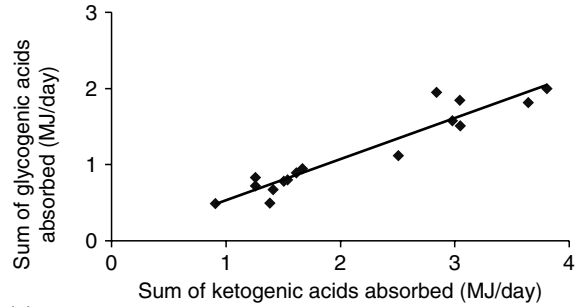
**Fig. 12.5.** Absorption of short-chain fatty acids (SCFA) in the portal vein as a function of digestible energy intake. (a) Sheep:  $y = 0.46x - 0.76$  ( $R^2 = 0.496$ ). (b) Cattle:  $y = 0.46x - 3.09$  ( $R^2 = 0.954$ ). Data are taken from (a) sheep: Gross *et al.* (1990); Rémond *et al.* (1993); Goetsch and Ferrell (1995); Goetsch *et al.* (1994); Patil *et al.* (1995); Freetly and Ferrell (1998); Han *et al.* (2002). (b) Cattle: Gross *et al.* (1988); Huntington *et al.* (1988, 1996); Reynolds *et al.* (1988a, 1992b,c, 1993a,b, 1994b, 1995, 1998a,b, 1999, 2000, 2001, 2003a,b); Maltby *et al.* (1993); Casse *et al.* (1994); Taniguchi *et al.* (1995); Lozano *et al.* (2000); Caton *et al.* (2001); Benson *et al.* (2002); Reynolds (unpublished).

a range of intakes. We have seen that the lower rates of appearance of SCFA in the portal vein compared with rates of production in the rumen may be attributed to metabolism in the PDV. The pattern of metabolites used by the PDV may be affected by the pattern produced in the rumen, so that increased production of acetate units leads to its greater oxidation by the PDV. Since metabolism is primarily from blood-derived nutrients, this could readily be tested.

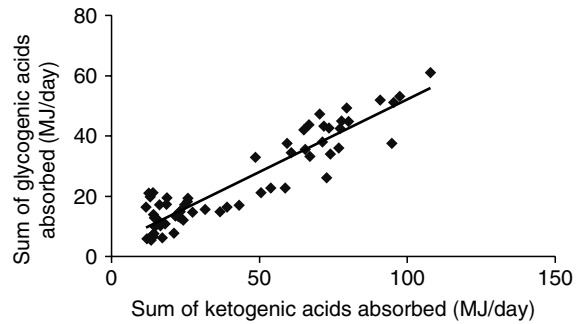
## Hepatic Metabolism

### Glucose production

The strong relation in sheep and cattle between DE and glucose ILR as determined by isotope dilution has been known for more than 30 years. Since about 90% of glucose production is derived from the liver, it is to be expected that there will be a correspondingly close relation between DE and hepatic glucose release, and as Fig. 12.7a shows this is seen in cattle. In the



(a)

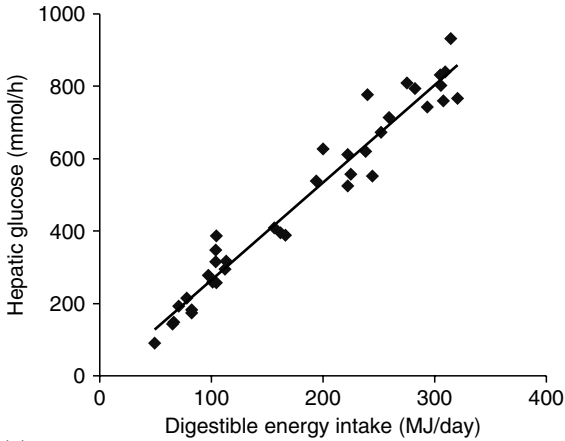


(b)

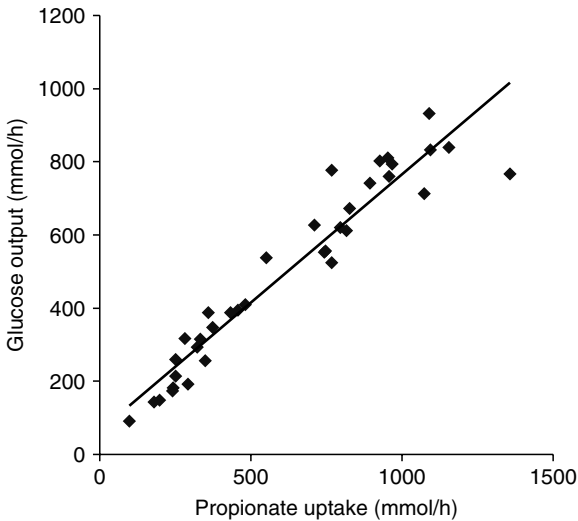
**Fig. 12.6.** Relation between the sum of glycogetic (propionate, isobutyrate, lactate) and ketogenic (acetate, butyrate, 3-hydroxybutyrate) short-chain fatty acids released from the portal vein. (a) Sheep:  $y = 0.54x - 0.01$  ( $R^2 = 0.904$ ) and (b) cattle:  $y = 0.48x + 3.97$  ( $R^2 = 0.863$ ). Data taken from the same sources as Fig. 12.5.

studies in sheep the relation is marginally significant ( $R^2 = 0.2$ ), but as mentioned previously the range of intakes is less. In cattle, there is a strong positive relation between hepatic glucose release and propionate removal ( $R^2 = 0.91$ ) (Fig. 12.7b) although not for glucose release and lactate removal. This likely reflects the fact that both hepatic glucose production and propionate absorption (and hepatic removal) are highly correlated with DE intake, whilst lactate uptake by the liver varies with the supply of other glucose precursors and the extent of Cori cycling (Reynolds, 1995). In contrast to cattle, in sheep there is no significant relationship between propionate removal and glucose release, although a significant one exists for lactate removal and glucose release ( $R^2 = 0.6$ ), which again may reflect greater variation in glucose requirement within a smaller range of feed intake. In cattle, on average, propionate, lactate and isobutyrate removal are sufficient to account for  $73\% \pm 4\%$  of hepatic glucose release and the mean value in sheep is probably very similar (see references for Figs 12.5 and 12.6). Few measurements were reported for isobutyrate removal but removal of propionate and lactate alone could account for  $71.5\% \pm 7.9\%$ . Even fewer measurements are reported for liver glycerol removal although it can account for 5–20% of glucose output. In fed animals however, the lower figure is more realistic. Propionate extraction by the liver was slightly less complete in sheep (86%) than in cattle (92%).

Eisemann and Huntington (1994) and Eisemann *et al.* (1997) have clarified the effect of insulin on glucose release. First the response is lower with



(a)



(b)

**Fig. 12.7.** (a) Glucose released by cattle liver, as a function of the digestible energy intake:  $y = 2.69x - 3.06$  ( $R^2 = 0.952$ ). (b) Glucose released in relation to propionate taken up by cattle liver:  $y = 0.70x + 65.3$  ( $R^2 = 0.914$ ). Data are taken from the same sources as Figs 12.5 and 12.6.

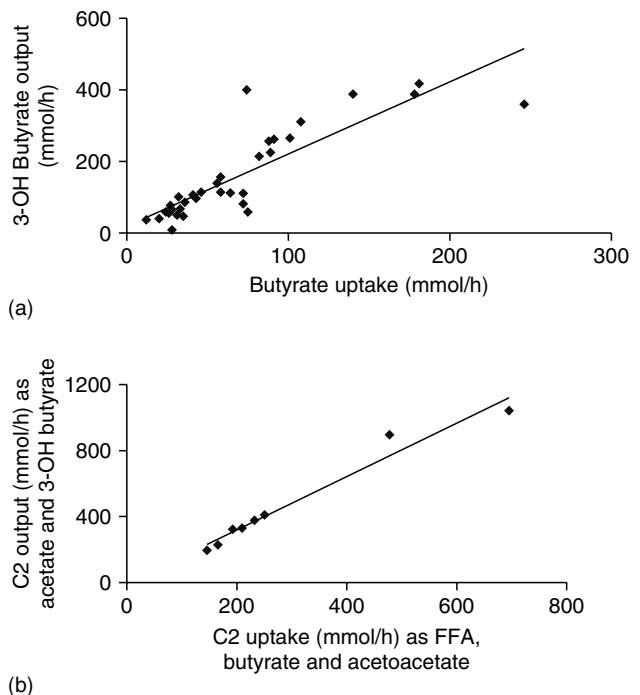
increasing age as occurs with non-ruminants. Secondly the liver is more sensitive to insulin than peripheral tissues (as exemplified by hindquarters). Thus  $ED_{50}$  for liver (the arterial concentration required to have 50% of the maximum effect) is  $44 \pm 11 \mu\text{U/ml}$  in young cattle and  $89 \pm 22 \mu\text{U/ml}$  in older animals. For the hindquarters, respective values are  $243 \pm 78$  and  $488 \pm 151 \mu\text{U/ml}$ , but this may relate, in part, to the proportion of cardiac output received by these tissue beds, and relative extraction rates.

### Fatty acid metabolism

This topic has been much less studied in the last few years. Normally in fed sheep and cattle liver *n*-butyrate and acetoacetate are almost completely

removed whereas there is usually a release of acetate and 3-hydroxybutyrate. Recent studies show liver release of the two are significantly correlated to liver *n*-butyrate removal (although  $R^2$  is only about 0.3). *n*-Butyrate is an obvious source of 3-hydroxybutyrate and studies in cattle of liver 3-hydroxybutyrate release in response to *n*-butyrate infusions have indeed shown a significant correlation between the two (Fig. 12.8a). However, the slope of the linear relation (about 2 in cattle and  $>3$  in sheep) indicates that 3-hydroxybutyrate release is substantially greater than *n*-butyrate removal. Non-esterified fatty acids (NEFA) are an obvious source of the additional carbon. Unfortunately there are few publications with additional information on NEFA uptake by the liver. However, data by Krehbiel *et al.* (1992) and Reynolds *et al.* (1992b) in cattle shows (Fig. 12.8b) that there is a strong ( $R^2 = 0.96$ ) relation between removal of NEFA, *n*-butyrate and acetoacetate, and release of 3-hydroxybutyrate and acetate. However, the slope of the line is still  $>1$  (1.61), leaving the origin of all the ketogenic carbon uncertain. Moreover, some NEFA must be oxidized, and some would be released as esterified lipid, especially triacylglycerides. The most likely origin of the additional carbon is from the oxidation of amino acids. There does not seem to be comparable information relating to sheep. In pregnant sheep Freetly and Ferrell (1998, 2000) reported release of acetate and triacylglycerides and removal of NEFA and *n*-butyrate, but unfortunately no measurement of 3-hydroxybutyrate and acetoacetate. Triacylglyceride and acetate release would account for 34%, 22% and 43% of the carbon taken up as NEFA and *n*-butyrate in dry, single- or twin-pregnant ewes; the

**Fig. 12.8.** (a) 3-Hydroxybutyrate release from cattle liver as a function of butyrate removal:  $y = 2.01x + 19.3$  ( $R^2 = 0.725$ ). (b) Release of C2 units (as acetate and 3-hydroxybutyrate, related to removal of free fatty acids, butyrate and acetoacetate:  $y = 1.65x - 3.43$  ( $R^2 = 0.964$ ). Data taken from: Reynolds *et al.* (1988a, 1992b, 1994b, 2003a); Reynolds and Tyrrell (1991); Krehbiel *et al.* (1992); Casse *et al.* (1994); Taniguchi *et al.* (1995). Huntington *et al.* (1996); Lozano *et al.* (2000); Caton *et al.* (2001).

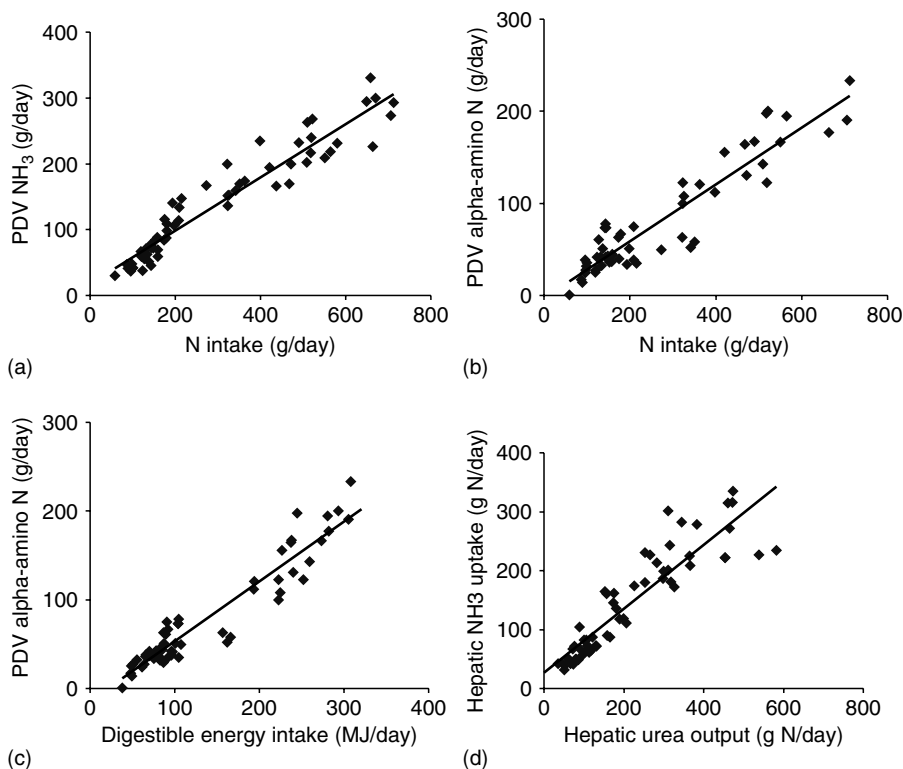


remaining carbon could allow a maximum release of 7.5, 22.9 and 22.3 mmol/h of ketones, respectively. In practice, as reported in the first edition, ketone output even in healthy twin-pregnant sheep can be about 30 mmol/h. Since some oxidation of NEFA is also to be expected, again this implies another carbon source for this purpose. However it should be appreciated that triacylglycerides, like acetate and acetoacetate, can be taken up as well as released (Reynolds *et al.*, 2003a). For complete estimates of carbon balance all metabolites should be measured in the same animals under similar conditions. These points are more fully discussed by Hanigan *et al.* (2004).

### **Nitrogen metabolism**

One of the most striking characteristics of ruminants is the extensive degradation of nitrogenous compounds in the rumen. Much of the nitrogen is reduced to ammonia, which is absorbed into the portal vein if not utilized by rumen microbes. The amount so absorbed depends to some extent on the nitrogen intake. For sheep the relationship is weak ( $R^2 = 0.17$ ) but much stronger for cattle ( $R^2 = 0.92$ ) as Fig. 12.9a shows. Overall for cattle the mean value for the net appearance of ammonia in the portal vein as a percentage of nitrogen intake is  $48\% \pm 2\%$  and for sheep  $32\% \pm 2\%$ . Ammonia in significant concentration in peripheral blood is toxic, through effects on the central nervous system. It is essential for the liver to remove it effectively, by conversion to urea or amination reactions such as the synthesis of glutamine from glutamate. In practice, hepatic removal of  $\text{NH}_3$  is often a little less than the PDV release in cattle ( $95\% \pm 8\%$ ), but greater in sheep ( $111\% \pm 1\%$ ). Ammonia removal by the liver could account in cattle for  $71\% \pm 2\%$  of the urea-nitrogen produced, but rather less in sheep ( $48\% \pm 4\%$ ). It is thus not surprising that in cattle there is a good correlation between ammonia removal and urea release ( $R^2 = 0.82$ ) (Fig. 12.9d), which is not improved when removal of  $\alpha$ -amino-N is also taken into account. In sheep however, there is a very weak correlation within the studies reported ( $R^2 = 0.15$ ). However, when  $\text{NH}_3$  is infused into the mesenteric vein of sheep there is a strong correlation between ammonia removal by the liver and release of urea (Milano *et al.*, 2000) with  $R^2 = 0.89$  and a slope not significantly different from 1  $\mu\text{mol}$  urea N released per  $\mu\text{mol}$   $\text{NH}_3$ -N.

In the portal vein the urea concentration is almost always lower than arterial, so that urea is taken up by PDV and, after hydrolysis by ureases, the N may be used for bacterial protein synthesis. This return of urea occurs to some extent throughout the GI tract. However, bacterial protein formed in the large intestine is probably simply lost in the faeces. In contrast, ammonia-N returned to the rumen can be incorporated into protein that may subsequently be hydrolysed and the amino acids or peptides formed absorbed in the small intestine. Quantitatively, the rumen must be the main site of potential bacterial protein synthesis. There have been several studies in cattle in which both mesenteric and portal absorption have been measured (Reynolds and Huntington, 1988; Huntington, 1989; Seal *et al.*, 1992; Seal and Parker, 1994; Huntington *et al.*, 1996; Theurer *et al.*, 2002). These allow estimates of the fraction of



**Fig. 12.9.** Nitrogen metabolism in cattle. (a) Ammonia absorbed in the portal vein as a function of dietary nitrogen intake:  $y = 0.41x + 17.1$  ( $R^2 = 0.917$ ). (b) Alpha amino nitrogen absorbed in the portal vein as a function of dietary nitrogen intake:  $y = 0.31x - 2.53$  ( $R^2 = 0.871$ ). (c) Alpha amino nitrogen absorbed in the portal vein as a function of digestible energy intake:  $y = 0.68x - 14.4$  ( $R^2 = 0.904$ ). (d) Ammonia removal by liver in relation to urea release:  $y = 0.54x + 26.4$  ( $R^2 = 0.815$ ). Data derived from: Gross *et al.* (1988); Huntington *et al.* (1988, 1996); Reynolds *et al.* (1988b, 1991c, 1992a–c, 1995, 1998a,b, 1999, 2000, 2001, 2003a,b); Reynolds and Tyrrell (1991); Maltby *et al.* (1993); Casse *et al.* (1994); Taniguchi *et al.* (1995); Bruckental *et al.* (1997); Alio *et al.* (2000); Lapiere *et al.* (2000); Caton *et al.* (2001); Blouin *et al.* (2002); Reynolds (unpublished).

urea taken up by the PDV, which passes to the rumen. In these studies about  $82\% \pm 6\%$  was taken up by the rumen. The other significant source of urea transport to the rumen is via saliva. This has been estimated from the rate of urea production by the liver less that lost from blood to the PDV or by urinary excretion. The amount transferred in this way seems to vary greatly in different studies, perhaps mainly due to different effects of diet. In the studies above, when account was taken of salivary urea, the rumen appeared to account for  $73\% \pm 7\%$  of urea transferred to the GI tract. The recycling of nitrogen in this way is of great significance in ruminants. Lapiere and Lobley (2001) have estimated that 45–60% of urea-N is anabolized. Moreover, they show that nitrogen may recycle repeatedly, increasing the chance of

anabolic conversion to protein by 20–50%. It is this feature that explains how hepatic urea-N production can in some circumstances be greater than dietary N.

It is not clearly established what factors might result in increased transfer of urea from blood to PDV. It had earlier been suggested that arterial urea concentration might be a driving force. However, there is no correlation between arterial urea and PDV urea transfer. It is feasible that with increased energy available for bacterial protein synthesis, availability of nitrogen could be limiting and met by drawing in urea (see Chapter 10). In beef cattle, a greater proportion of urea transfer to the PDV occurred across stomach tissues when a high concentrate diet was fed, perhaps due to increased energy supply for microbial fermentation (Reynolds and Huntington, 1988). In contrast, feeding lucerne shifted urea transfer to the MDV, perhaps reflecting an increased fermentation of fibre in the hindgut. In cattle, there is a moderate correlation between DE intake and PDV urea transfer ( $R^2 = 0.43$ ). However, in sheep there is no significant relationship.

The mean values for nitrogen absorbed as  $\alpha$ -amino nitrogen are actually less than those absorbed as  $\text{NH}_3$ . In sheep the proportion is  $42.5\% \pm 2.1\%$  and in cattle  $29.0\% \pm 1.6\%$ . For sheep the correlation between portal  $\alpha$ -amino-N and dietary N intake is moderate with  $R^2$  about 0.5 but for cattle it is high ( $R^2 = 0.87$ ). In cattle there is also a strong relation with DE intake ( $R^2 = 0.90$ ; see Fig. 12.9b and c); but for sheep the relation with DE intake is poorer ( $R^2 = 0.38$ ) than that seen with N intake.

One question that has been much discussed since the previous edition is whether the requirement for urea formation from ammonia affects the utilization of amino acids by the liver. Two features bear on this point. First, in the formation of urea, while the nitrogen for carbamyl phosphate formation is derived from ammonia, the second nitrogen is derived from aspartate. This second nitrogen could be derived from ammonia via glutamate formation; but its requirement could also increase utilization of amino acids to supply more aspartate by transamination. In fact (see Lobley *et al.*, 2000) studies with  $^{15}\text{N}$ -labelled ammonia have shown that in fasted sheep subjected to an overload of ammonia about one-third of aspartate-N was derived from ammonia. Secondly, in contrast, there is a limited capacity for the liver to form urea (approximately 29 g urea-N per day for a 40 kg sheep and 435 g/day for a 600 kg cow or steer; Lobley *et al.*, 2000). The question then arises whether, when capacity approaches the limit, the liver gives priority to limiting peripheral ammonia or amino acid concentrations. At peak release of ammonia after a meal it is suggested the maximal capacity may be exceeded. Lobley *et al.* (2000) found that a 30 min infusion of 2 mmol/min of ammonium bicarbonate into the mesenteric vein of sheep was sufficient to result in incomplete removal of the  $\text{NH}_3$  and the non-ammonia-N contribution to ureagenesis declined from 0.36 to 0.14 mmol/min. When an amino acid mixture (1.84 mmol/min) was infused in sheep fed a diet above maintenance, there was no change in hepatic ammonia removal although a marked arterial hyperaminoacidaemia resulted. Minimizing peripheral ammonia increase appears to have the greater priority, at least in the short term. When faced with an excess supply of amino acids, the

capacity for ureagenesis from amino acids takes much longer to adapt than is required for increased ammonia supply (Reynolds, 1995).

Apparent nitrogen balance across the liver as measured by the difference between N-output (as urea) and N-input (as  $\text{NH}_3$  + amino acids) may be either positive or negative. Thus Reynolds *et al.* (2001) found a positive value (83 mmol N per hour) in dry cows given a restricted feed intake (urea release 520 mmol N per hour;  $\text{NH}_3$  + amino acids removed 603 mmol N per hour). When the same cows received a higher feed intake, the balance became negative (283 mmol N per hour; urea release 1090 mmol N per hour;  $\text{NH}_3$  + amino acids removed 797 mmol N per hour). Finally with the same cows lactating, with the higher feed intake, the balance was even more negative (538 mmol N per hour; urea release 1352 mmol N per hour;  $\text{NH}_3$  + amino acid removal 814 mmol N per hour). Positive values might be expected since some amino acids must be used for synthesis of proteins known to be secreted by the liver. There are several possible reasons for apparent negative N balance. Account should be taken of the non- $\alpha$ -amino-N in amino acids. In the study above, where individual amino acids were measured, this could increase the positive balance by 122 mmol N per hour and decrease the negative balances by 187 and 152 mmol N per hour. However, this would still leave a net negative balance. It is possible that removal of peptides, and possibly even of protein may account for the further discrepancy.

Removal of amino acids by the liver is extremely variable. This is to be expected since, with the exception of the branched-chain acids, the liver is the predominant site for the catabolism of amino acids surplus to anabolic needs. Moreover the liver itself is heavily involved in anabolism: in 1-C reactions, in detoxification and in acting as a protein reserve by increasing readily in size in response to increase in protein availability, decreasing as it becomes inadequate. Loble *et al.* (2000) found in a survey of eight studies of sheep and cattle that the fractional extraction of amino acids absorbed varied considerably, values ranged from  $-0.25$  to  $+0.07$  for arginine, or  $-0.36$  to  $+1.12$  for methionine. A major factor is undoubtedly physiological state, the absorption of amino acids relative to requirements and associated changes in arterial concentration (Reynolds, 2002). Thus in the study by Reynolds *et al.* (2001), for the ratio net hepatic removal/portal absorption, there is a striking difference between lactation and the dry period (Table 12.1). In contrast, simply varying the amino acid input results in little appreciable change in this ratio (Caton *et al.*, 2001).

## Minerals

There have been few reports of the net exchange of minerals across the PDV or liver. The probable reasons for this are illustrated in work by Reynolds *et al.* (1991a). The authors studied exchange of Na, K, Ca, P and Mg in dairy cattle, first in lactating animals and then in a dietary study comparing hay and concentrate diets. Portal vein and arterial concentration differences were at best of the order of 1–3% of the arterial concentration, and frequently less than



**Table 12.1.** Ratio of the net removal of amino acids by the liver to their net release into the portal vein. Results from studies in lactating and dry cows by Reynolds *et al.* (2001) and abomasal infusion studies in lactating cows of Caton *et al.* (2001). The ratios have been calculated from the sum of the essential (valine, isoleucine, leucine, methionine, lysine, threonine, phenylalanine, tryptophan and histidine) amino acids (EAA) and the non-essential (arginine, ornithine, citrulline, alanine, glycine, serine, aspartate, asparagine, glutamate, glutamine, proline and tyrosine) amino acids (NEAA).

	Dry		Lactating	
	Low intake	High intake	Low intake	High intake
Reynolds <i>et al.</i> (2001)				
EAA	0.73	0.55	0.13	0.08
NEAA	1.43	1.26	0.67	0.66
Caton <i>et al.</i> (2001)	Control	+EAA	Control	+Casein
EAA	0.32	0.38	0.41	0.39
NEAA	0.88	0.91	1.07	1.04

1%. It is difficult to get adequate precision with such small differences. For portal-hepatic vein differences, relative to portal concentrations, the differences were generally even smaller, suggesting little net metabolism of plasma minerals by the liver. There is a slight improvement with measurement of absorption into the mesenteric vein when differences can be up to 6–7%. There is a further complication with Na and P, since large amounts of these ions are secreted into the rumen in saliva. Thus Na was apparently absorbed in amounts many times greater than the dietary intake.

Nevertheless some consistent findings were demonstrable. For Mg, in the dietary study, net PDV release was about 20% of intake, and as earlier evidence has suggested, was almost entirely from the ‘stomach’ tissues. In lactation, net PDV release was 17% of intake, from a much higher amount. For Ca in the dietary study, net PDV release was 16% of intake, and in lactation 17%. For K, net PDV release in the dietary study was 50–60% of intake, and in lactation, 66%. For both Ca and K, post-stomach tissues (probably small intestine) accounted for most of the absorption (80–90%).

## Hormones

A selection of papers relating to hormones produced and metabolized in the PDV of cattle is shown in Table 12.2.

Although insulin is still perhaps the hormone most studied, there is increasing information on glucagon, and there is increasing discrimination between pancreatic and gut-derived glucagons. Discrimination between various glucagon-like hormones emphasizes the importance of specific assays. The apparent net release of gut glucagon by the liver may reflect release of glucagon fragments and may indicate that assay for fragments will be desirable. Apart from data in the first paper in the table, there is a strong correlation between arterial pancreatic glucagon and the rate of net secretion by the PDV, as was

**Table 12.2.** Some values in cattle for arterial concentrations, rates of net secretion into the portal vein and removal by the liver of insulin, IGF-1 (insulin-like growth factor-1), glucagon, GLP (glucagon-like peptide 1) and CCK-8 (cholecystokinin) in various physiological conditions.

Authors	Condition	Hormone	Arterial concentration (pM)	PDV release (nmol/h)	Liver removal (nmol/h)	% Supply extracted by liver
Reynolds <i>et al.</i> (1992b)	Beef steers (basal)+ butyrate (25 mmol/h)	Insulin	193.5 208.1	28.4 29.4	8.2 9.1	7.6 7.5
Lapierre <i>et al.</i> (1992)	Beef steers (high intake)	Insulin	177.9	28.8	4.0	2.8
		Glucagon	114.7	11.7	6.1	8.6
		IGF-1	22.3 (nM)	-225	61.4	
Krehbiel <i>et al.</i> (1992)	Beef steers (basal)+ butyrate (50–250 mmol/h)	Insulin	253.7 266.4	22.2 27.1	26.2 5.1	19.2 3.3
Casse <i>et al.</i> (1994)	Lactating cows (basal)+ propionate (150 mmol/h)	Insulin	191.1 199.3	30.5 45.5	21.3 15.9	5.4 3.8
	Lactating cows (basal)+ propionate (150 mmol/h)	Glucagon	117.9 123.4	29.8 40.5	20.4 38.5	8.6 14.2
Lapierre <i>et al.</i> (2000)	Beef steers					
	Low intake (0.6 M)	Insulin	54.1	12.9	4.4	14.6
	Medium intake (M)		61.0	18.0	9.1	23.3
	High intake (1.6 M)		104.6	27.9	13.1	18.9
	Low	Glucagon	23.0	1.7	0.0	
	Medium		28.7	3.7	0.3	2.1
	High		34.4	5.5	1.4	7.5
	Low	IGF-1	23.9	-29.4	51.0	
	Medium		32.8	84.3	-129.8	
	High		31.8	326.8	425.4	

Benson and Reynolds (2001)		Dairy cows 55 days (early lactation); 110 days (medium lactation)			
Early, basal	Insulin	59.4	38.5	20.8	12.4
Early, unsaturated fatty acids (UFA)		53.4	36.4	18.8	10.4
Medium, basal		87.7	43.3	21.1	9.8
Medium, UFA		65.9	39.2	18.1	9.9
Early, basal	Gut glucagon	337	2	-23.8	
Early, UFA		385	-4.6	-37.8	
Medium, basal		264	-4.8	-30.3	
Medium, UFA		342	2.9	-51	
Early, basal	Pancreatic glucagon	87.2	25.9	6.7	2.3
Early, UFA		92.5	30.6	15.6	4.9
Medium, basal		104.5	35	3.9	0.5
Medium, UFA		121	42.6	7.6	2.2
Early, basal	GLP	54.3	-3.9	1.5	
Early, UFA		59.1	-5.7	2.2	
Medium, basal		48.1	-1.8	1.1	
Medium, UFA		55.4	-5.5	1.1	
Early, basal	CCK-8	25.7	8	1.6	2.8
Early, UFA		24.3	5.2	0.9	2.9
Medium, basal		19.9	10.1	5.7	8.5
Medium, UFA		18.2	8.8	4.9	10.4

suggested for insulin in the first edition of this chapter. The data also emphasize the importance of the liver in extracting hormones, thereby affecting peripheral concentrations.

## Conclusions

The continuing extensive use of animals surgically prepared with gastrointestinal and hepatic venous catheters has demonstrated that the technique is now fairly reliable and there is increasing understanding of limitations and how they may be overcome. In the earlier edition, doubt was expressed whether the technique would be sufficiently sensitive to look at variations of diet. For many purposes at least, such doubts were not justified. We may expect to see increasing use of the technique as a tool for future investigations of ruminant metabolism. However, for many metabolites the limitations of net flux measurements encourage the combined use of multicatheterization and isotopic labelling techniques, which can provide much greater insight into the nuances of PDV metabolism.

## References

- Alio, A., Theurer, C.B., Lozano, O., Huber, J.T., Swingle, R.S., Delgado-Elorduy, A., Cuneo, P., DeYoung, D. and Webb, K.E. Jr (2000) Splanchnic nitrogen metabolism by growing beef steers fed diets containing sorghum grain flaked at different densities. *Journal of Animal Science* 78, 1355–1363.
- Benson, J.A. and Reynolds, C.K. (2001) Effects of abomasal infusion of long-chain fatty acids on splanchnic metabolism of pancreatic and gut hormones in lactating dairy cows. *Journal of Dairy Science* 84, 1488–1500.
- Benson, J.A., Reynolds, C.K., Aikman, P.C., Lupoli, B. and Beaver, D.E. (2002) Effects of abomasal long chain fatty acid infusion on splanchnic nutrient metabolism in lactating dairy cows. *Journal of Dairy Science* 85, 1804–1814.
- Bergman, E.N. (1975) Production and utilisation of metabolites by the alimentary tract as measured in portal and hepatic blood. In: McDonald, I.W. and Warner, A.C.I. (eds) *Digestion and Metabolism in the Ruminant*. University of New England, Armidale, New South Wales, pp. 292–305.
- Bergman, E.N. and Wolff, J.E. (1971) Metabolism of volatile fatty acids by liver and portal-drained viscera in sheep. *American Journal of Physiology* 221, 586–592.
- Bergman, E.N., Havel, R.J., Wolff, B.M. and Bohmer, T. (1971) Quantitative studies of the metabolism of chylomicron triglycerides and cholesterol by liver and extra-hepatic tissues of sheep and dogs. *Journal of Clinical Investigation* 50, 1831–1839.
- Berthiaume, R., Debreuil, P., Stevenson, M., McBride, B.W. and Lapierre, H. (2001) Intestinal disappearance and mesenteric and portal appearance of amino acids in dairy cows fed ruminally protected methionine. *Journal of Dairy Science* 84, 194–203.
- Blouin, J.P., Bernier, J.F., Reynolds, C.K., Lobley, G.E., Dubreuil, P. and Lapierre, H. (2002) Effect of diet quality on splanchnic fluxes of nutrients and hormones in lactating cows. *Journal of Dairy Science* 85, 2618–2630.

- Bruckental, I., Huntington, G.B., Baer, C., Kirk, J. and Erdman, R.A. (1997) The effect of abomasal infusion of casein and recombinant somatotropin hormone injection on nitrogen balance and amino acid fluxes in portal-drained viscera and net hepatic and total splanchnic tissues in Holstein steers. *Journal of Animal Science* 75, 1119–1129.
- Casse, E.A., Rulquin, H. and Huntington, G.B. (1994) Effect of mesenteric vein infusion of propionate on splanchnic metabolism in primiparous Holstein cows. *Journal of Dairy Science* 77, 3296–3303.
- Caton, J.S., Reynolds, C.K., Bequette, B.J., Lupoli, B., Aikman, P.C. and Humphries, D.J. (2001) Effects of abomasal casein or essential amino acid infusions on splanchnic leucine and phenylalanine metabolism in lactating cows. *Journal of Dairy Science* (Suppl. 1) 79, 362.
- Drost, C.J. (1978) Vessel diameter-independent volume flow measurement using ultrasound. *Proceedings of the San Diego Biomedical Symposium* 17, 299–302.
- Durand, D., Bauchart, D., Laplaud, P.M., Lefaivre, J. and Chapman, M.J. (1990) Importance of the portal venous pathway to the transport of intestinal triglyceride-rich lipoproteins in the pre-ruminant calf. *Reproduction, Nutrition et Développement* (Suppl. 2), 228S.
- Early, R.J., Thompson, J.R., Christopherson, R.J. and Sedgwick, G.W. (1987) Blood branched-chain amino acid and  $\alpha$ -keto acid concentrations and net exchange across the portal-drained viscera and hindlimb of fed and fasted ruminants. *Canadian Journal of Animal Science* 67, 1011–1020.
- Eisemann, J.H. and Huntington, G.B. (1994) Metabolite flux across portal-drained viscera, liver, and hindquarters of hyperinsulinemic, euglycemic beef steers. *Journal of Animal Science* 72, 2919–2929.
- Eisemann, J.H. and Nienaber, J.A. (1990) Tissue and whole body oxygen uptake in fed and fasted steers. *British Journal of Nutrition* 64, 399–411.
- Eisemann, J.H., Huntington, G.B. and Catherman, D.R. (1997) Insulin sensitivity and responsiveness of portal-drained viscera, liver, hindquarters, and whole body of beef steers weighing 275 or 490 kilograms. *Journal of Animal Science* 75, 2084–2091.
- France, J., Hanigan, M.D., Reynolds, C.K., Dijkstra, J., Crompton, L., Maas, J.A., Bequette, B.J., Metcalf, J.A., Lobley, J.E., Macrae, J.C. and Beever, D.E. (1999) An isotope dilution model for partitioning leucine uptake by the liver of the lactating dairy cow. *The Journal of Theoretical Biology* 198, 121–133.
- Freetly, H.C. and Ferrell, C.L. (1998) Net flux of glucose, glucose, lactate, volatile fatty acids, and nitrogen metabolites across the portal-drained viscera and liver of pregnant ewes. *Journal of Animal Science* 76, 3133–3145.
- Freetly, H.C. and Ferrell, C.L. (2000) Net flux of nonesterified fatty acids, cholesterol, triacylglycerol, and glycerol across the portal-drained viscera and liver of pregnant ewes. *Journal of Animal Science* 78, 1380–1388.
- Goetsch, A.L. and Ferrell, C.L. (1995) Effects of dietary maize level on net flux across splanchnic tissues of oxygen and nutrients in wethers consuming *ad libitum* different forages. *Animal Science* 61, 43–55.
- Goetsch, A.L., Ferrell, C.L. and Freetly, H.C. (1994) Effects of different supplements on splanchnic oxygen consumption and net fluxes of nutrients in sheep consuming bromegrass (*Bromus inermis*) hay *ad libitum*. *British Journal of Nutrition* 72, 701–712.
- Goetsch, A.L., Patil, A.R., Galloway, D.L., Kouakou, B., Wang, Z.S., Park, K.R. and Rossi, J.E. (1997a) Net flux of nutrients across splanchnic tissues in wethers

- consuming grasses of different sources and physical forms *ad libitum*. *British Journal of Nutrition* 77, 769–781.
- Goetsch, A.L., Patil, A.R., Galloway, D.L., Sr, Wang, Z.S., Kouakou, B., Park, K.K. and Rossi, J.E. (1997b) Oxygen consumption by splanchnic tissues in wethers consuming *ad libitum* different proportions of bermudagrass and ryegrass-wheat. *Archives of Animal Nutrition* 50, 1–11.
- Goetsch, A.L., Patil, A.R., Wang, Z.S., Park, K.K., Galloway, D.L., Sr, Rossi, J.E. and Kouakou, B. (1997c) Net flux of nutrients across splanchnic tissues in wethers consuming grass hay with or without corn and alfalfa. *Animal Feed Science Technology* 66, 271–282.
- Goetsch, A.L., Patil, A.R., Wang, Z.S., Park, K.K., Galloway, D.L., Sr, Rossi, J.R. and Kouakou, B. (1997d) Net flux of nutrients across splanchnic tissues in wethers consuming bermudagrass or ryegrass-wheat supplemented with rumen undegradable protein. *Small Ruminant Research* 25, 119–128.
- Gross, K.L., Harmon, D.L. and Avery, T.B. (1988) Net portal flux in steers fed diets containing wheat and sorghum grain alone or in combination. *Journal of Animal Science* 66, 543–551.
- Gross, K.L., Harmon, D.L. and Avery, T.B. (1990) Portal-drained visceral flux of nutrients in lambs fed alfalfa or maintained by total intragastric infusion. *Journal of Animal Science* 68, 214–221.
- Habel, R.E. (1992) *Guide to the Dissection of Domestic Ruminants*. R.E. Habel, Ithaca, New York.
- Han, X.T., Noziere, P., Remond, D., Chabrot, J. and Moreau, M. (2002) Effects of nutrient supply and dietary bulk on O<sub>2</sub> uptake and nutrient net fluxes across rumen, mesenteric- and portal-drained viscera in ewes. *Journal of Animal Science* 80, 1362–1375.
- Hanigan, M.D., Crompton, L.A., Reynolds, C.K., Wray-Cohen, D., Lomax, M.A. and France, J. (2004) An integrative model of amino acid metabolism in the liver of the lactating dairy cow. *The Journal of Theoretical Biology* 228, 271–289.
- Harmon, D.L., Richards, K.C., Swanson, J.A., Howell, J.C., Matthews, J.C., True, A.D., Huntington, G.B., Gahr, S.A. and Russell, R.W. (2001) Influence of ruminal or post-ruminal starch on visceral glucose metabolism in steers. In: Chwalibog, A. and Jakobsen, K. (eds) *Energy Metabolism in Farm Animals*, EAAP publication No 103. Wageningen Press, Wageningen, The Netherlands, p. 273.
- Heath, T.J. and Perkins, N.R. (1985) Effect of development of the ovine forestomachs of the anatomy of portal vessels and on the intrahepatic distribution of portal blood. *Research in Veterinary Science* 39, 216–221.
- Huntington, G.B. (1989) Hepatic urea synthesis and site and rate of urea removal from blood of beef steers fed alfalfa hay or a high concentrate diet. *Canadian Journal of Animal Science* 69, 215–223.
- Huntington, G.B. and Tyrrell, H.F. (1985) Oxygen consumption by portal-drained viscera of cattle: comparison of analytical methods and relationships to whole body oxygen consumption. *Journal of Dairy Science* 68, 2727–2731.
- Huntington, G.B., Varga, G.A., Glenn, B.P. and Waldo, D.R. (1988) Net absorption and oxygen consumption by Holstein steers fed alfalfa or orchardgrass silage at two equalised intakes *Journal of Animal Science* 66, 1292–1302.
- Huntington, G.B., Reynolds, C.K. and Stroud, B. (1989) Techniques for measuring blood flow in the splanchnic tissues of cattle. *Journal of Dairy Science* 72, 1583–1595.

- Huntington, G.B., Eisemann, J.H. and Whitt, J.M. (1990) Portal blood flow in beef steers. Comparison of techniques and relation to hepatic flow, cardiac output and oxygen uptake. *Journal of Animal Science* 68, 1666–1673.
- Huntington, G.B., Zetina, E.J., Whitt, J.M. and Potts, W. (1996) Effects of dietary concentrate level on nutrient absorption, liver metabolism, and urea kinetics of beef steers fed isonitrogenous and isoenergetic diets. *Journal of Animal Science* 74, 908–916.
- Janes, A.N., Weekes, T.E.C. and Armstrong, D.G. (1985) Absorption and metabolism of glucose by the mesenteric-drained viscera of sheep fed on dried-grass or ground maize-based diets. *British Journal of Nutrition* 54, 449–458.
- Krehbiel, C.R., Harmon, D.L. and Schneider, J.E. (1992) Effect of increasing ruminal butyrate on portal and hepatic nutrient flux in steers. *Journal of Animal Science* 70, 904–914.
- Kreikemeier, K.K. and Harmon, D.L. (1995) Abomasal glucose, maize starch and maize dextrin infusions in cattle: small intestinal disappearance, net portal flux and ileal oligosaccharide flow. *British Journal of Nutrition* 73, 763–772.
- Kristensen, N.B., Gabel, G., Pierzynowski, S.G. and Danfaer, A. (2000a) Portal recovery of short-chain fatty acids infused into the temporarily-isolated and washed reticulo-rumen of sheep. *British Journal of Nutrition* 84, 477–482.
- Kristensen, N.B., Pierzynowski, S.G. and Danfaer, A. (2000b) Portal-drained visceral metabolism of 3-hydroxy butyrate in sheep. *Journal of Animal Science* 78, 2223–2228.
- Lapierre, H. and Lobley, G.E. (2001) Nitrogen recycling in the ruminant: a review. *Journal of Dairy Science* (Suppl. 84), E223–E236.
- Lapierre, H., Reynolds, C.K., Elsasser, T.H., Gaudreau, P., Brazeau, P. and Tyrrell, H.F. (1992) Effects of growth hormone-releasing factor and feed intake on energy metabolism in growing beef steers: net hormone metabolism by portal-drained viscera and liver. *Journal of Animal Science* 70, 742–751.
- Lapierre, H., Bernier, J.F., Dubreuil, P., Reynolds, C.K., Farmer, C., Ouellet, D.R. and Lobley, G.E. (2000) The effect of feed intake level on splanchnic metabolism in growing beef steers. *Journal of Animal Science* 78, 1084–1099.
- Lindsay, D.B. and Oddy, V.H. (1985) Pregnancy toxemia in sheep – a review. In: Cumming, R.B. (ed.) *Recent Advances in Animal Nutrition in Australia in 1985*. University of New England Publishing Unit, Armidale, Australia, Section 32.
- Lobley, G.E., Milano, G.D. and van der Walt, J.G. (2000) The liver: integrator of nitrogen metabolism. In: Cronje, P.B. (ed.) *Ruminant Physiology. Digestion, Metabolism, Growth and Reproduction*. CAB International, Wallingford, UK, pp. 149–168.
- Lozano, O., Theurer, C.B., Alio, A., Huber, J.T., Delgado-Elorduy, A., Cuneo, P., De Young, D., Sadik, M. and Swingle, R.S. (2000) Net absorption and hepatic metabolism of glucose, L-lactate, and volatile fatty acids by steers fed diets containing sorghum grain processed as dry-rolled or steam-flaked at different densities. *Journal of Animal Science* 78, 1364–1371.
- MacRae, J.C., Bruce, L.A., Brown, D.S. and Calder, G. (1997a) Amino acid use by the gastrointestinal tract of sheep given lucerne forage. *American Journal of Physiology* 273, G1200–G1207.
- MacRae, J.C., Bruce, L.A., Brown, D.S., Farningham, D.A.H. and Franklin, M. (1997b) Absorption of amino acids from the intestine and their net flux across

- the mesenteric- and portal-drained viscera of lambs. *Journal of Animal Science* 75, 3307–3314.
- Maltby, S.A., Reynolds, C.K., Lomax, M.A. and Beever, D.E. (1993) The effect of increased absorption of ammonia and arginine on splanchnic metabolism of beef steers. *Animal Production* 56, 462.
- Milano, G.D., Hotston-Moore, A. and Lobley, G.E. (2000) Influence of hepatic ammonia removal on ureagenesis, amino acid utilisation and energy metabolism in the ovine liver. *British Journal of Nutrition* 83, 307–315.
- Morris, P.G., Dominick, J.O., Coxon, R., Bachelard, H.S., Moriarty, K.T., Greenhaff, P.L. and McDonald, I.A. (1994) Nuclear magnetic resonance spectroscopy as a tool to study carbohydrate metabolism. *Proceedings of the Nutrition Society* 53, 335–343.
- Nozire, P., Martin, C., Rémond, D., Kristensen, N.B., Bernard, R. and Doreau, M. (2000) Effect of composition of ruminally-infused short-chain fatty acids on net flux of nutrients across portal-drained viscera in underfed ewes. *British Journal of Nutrition* 83, 521–531.
- Ortigue, I., Martin, C. and Durand, D. (1996) Circadian changes in net nutrient flows across the portal-drained viscera, the liver and hindquarters in preruminant calves. *Journal of Animal Science* 74, 895–907.
- Park, K.K., Goetsch, A.L., Johnson, Z.B. and Rossi, J.E. (1997) Temporal pattern of nutrients across splanchnic tissues in wethers consuming different forages. *Small Ruminant Research* 25, 107–118.
- Patil, A.R., Goetsch, A.L., Park, K.K., Kouakou, B., Galloway, D.L., Sr and Johnson, Z.B. (1995) Influence of grass source on net flux of nutrients across splanchnic tissues in sheep with restricted intake. *Archives of Animal Nutrition* 48, 257–269.
- Patil, A.R., Goetsch, A.L., Park, K.K., Kouakou, B., Galloway, D.L. Sr and Johnson, Z.B. (1996) Influence of grass source and legume level on net flux of nutrients across splanchnic tissues in sheep. *Small Ruminant Research* 22, 111–122.
- Pell, J.M., Calderone, E.M. and Bergman, E.N. (1986) Leucine and  $\alpha$ -ketoisocaproate metabolism and interconversions in fed and fasted sheep. *Metabolism* 35, 1005–1016.
- Pethick, D.W., Lindsay, D.B., Barker, P.J. and Northrop, A.N. (1981) Acetate supply and utilisation by the tissues of sheep *in vivo*. *British Journal of Nutrition* 46, 97–110.
- Rémond, D., Chaise, J.P., Delval, E. and Poncet, C. (1993) Net flux of metabolites across the ruminal wall of sheep fed twice a day with orchardgrass hay. *Journal of Animal Science* 71, 2529–2538.
- Rémond, D., Ortigue-Marty, L., Isserty, A. and Lefaire, J. (1998) Technical note: measuring portal blood in sheep using an ultrasonic transit time flow probe. *Journal of Animal Science* 76, 2712–2716.
- Reynolds, C.K. (1995) Quantitative aspects of liver metabolism in ruminants. In: Cronje, P.B. (ed.) *Ruminant Physiology. Digestion, Metabolism, Growth and Reproduction*. CAB International, Wallingford, UK, 351–371.
- Reynolds, C.K. (2002) Economics of visceral energy metabolism in ruminants – toll keeping or internal revenue service? *Journal of Animal Science* 80 (Suppl. 2), E74–E84.
- Reynolds, C.K. and Huntington, G.B. (1988) Partition of portal-drained visceral net flux in beef steers. 1. Blood flow and net flux of oxygen, glucose and nitrogenous compounds across stomach and post-stomach tissues. *British Journal of Nutrition* 60, 539–551.



- Reynolds, C.K. and Tyrrell, H.F. (1991) Effects of mesenteric vein L-alanine infusion on liver metabolism in beef heifers fed on diets differing in forage:concentrate ratio. *British Journal of Nutrition* 66, 437–450.
- Reynolds, C.K., Huntington, G.B., Tyrrell, H.F. and Reynolds, P.J. (1986) Splanchnic tissue and whole animal oxygen consumption by lactating Holstein cows. *Journal of Dairy Science* 69 (Suppl. 1), 193.
- Reynolds, C.K., Huntington, G.B., Tyrrell, H.F. and Reynolds, P. (1988a) Net metabolism of volatile fatty acids, D- $\beta$ -hydroxybutyrate, non-esterified fatty acids, and blood gases by portal-drained viscera and liver of lactating Holstein cows. *Journal of Dairy Science* 71, 2395–2405.
- Reynolds, C.K., Huntington, G.B., Tyrrell, H.F. and Reynolds, P. (1988b) Net portal-drained visceral and hepatic metabolism of glucose, L-lactate, and nitrogenous compounds in lactating Holstein cows. *Journal of Dairy Science* 71, 1803–1812.
- Reynolds, C.K., Huntington, G.B., Tyrrell, H.F. and Reynolds, P.J. (1991a) Net absorption of macrominerals by portal-drained viscera from lactating Holstein cows and beef steers. *Journal of Dairy Science* 74, 450–459.
- Reynolds, C.K., Tyrrell, H.F. and Reynolds, P.J. (1991b) Effects of diet forage-to-concentrate ration and intake on energy metabolism in growing beef heifers: whole body energy and nitrogen balance and visceral heat production. *Journal of Nutrition* 121, 994–1003.
- Reynolds, C.K., Tyrrell, H.F. and Reynolds, P.J. (1991c) Effects of diet forage-to-concentrate ration and intake on energy metabolism in growing beef heifers: net nutrient absorption by visceral tissues. *Journal of Nutrition* 121, 1004–1015.
- Reynolds, C.K., Lapierre, H., Tyrrell, H.F., Elsasser, T.H., Staples, R.C., Gaudreau, P. and Brazeau, P. (1992a) Effects of growth hormone-releasing factor and intake on energy metabolism in growing beef steers: net nutrient metabolism by portal-drained viscera and liver. *Journal of Animal Science* 70, 752–763.
- Reynolds, C.K., Tyrrell, H.F. and Armentano, L.E. (1992b) Effects of mesenteric vein n-butyrate infusion on liver metabolism by beef steers. *Journal of Animal Science* 70, 2250–2261.
- Reynolds, C.K., Casper, D.P., Harmon, D.L. and Milton, C.T. (1992c) Effect of CP and ME intake on visceral nutrient metabolism in beef steers. *Journal of Animal Science* 70 (Suppl. 1), 315.
- Reynolds, C.K., Lapierre, H., Tyrrell, H.F., Elsasser, T.H., Casper, D.P., Gaudreau, P. and Brazeau, P. (1993a) Intake and growth hormone-releasing factor (GRF) affect visceral metabolism of VFA in growing beef steers. *Journal of Animal Science* 71 (Suppl. 1), 270.
- Reynolds, C.K., Tyrrell, H.F. and Reynolds, P.J. (1993b) Effects of forage-to-concentrate ratio and intake on net visceral metabolism of VFA in growing beef heifers. *Journal of Dairy Science* 76 (Suppl. 1), 283.
- Reynolds, C.K., Huntington, G.B. and Tyrrell, H.F. (1994a) Effects of feeding maize grain harvested at 2 stages of maturity on net nutrient metabolism by splanchnic tissues of lactating dairy cows. *Animal Production* 58, 433.
- Reynolds, C.K., Harmon, D.L., Prior, R.L. and Tyrrell, H.F. (1994b) Effects of mesenteric vein L-alanine infusion on liver metabolism of organic acids by beef heifers fed diets differing in forage: concentrate ratio. *Journal of Animal Science* 72, 3196–3206.
- Reynolds, C.K., Crompton, L.A., Firth, K., Beever, D., Sutton, J., Lomax, M., Wray-Cahen, D., Metcalfe, J., Chettle, E., Bequette, B., Backwell, C., Lobley, G. and MacRae, J. (1995) Splanchnic and milk protein responses to mesenteric vein

- infusion of 3 mixtures of amino acids in lactating dairy cows. *Journal of Animal Science* 73 (Suppl. 1), 274.
- Reynolds, C.K., Humphries, D.J., Cammell, S.B., Benson, J., Sutton, J.D. and Beever, D.E. (1998a) Effects of abomasal wheat starch infusion on splanchnic metabolism and energy balance of lactating dairy cows. In: McCracken, K.J., Unsworth, E.F. and Wylie, A.R.G. (eds) *Energy Metabolism of Farm Animals*, Proceedings of the 14th Symposium on Energy metabolism. CAB International, Wallingford, UK, pp. 39–42.
- Reynolds, C.K., Humphries, D.J., Benson, J.A. and Beever, D.E. (1998b) Effects of abomasal starch infusion on splanchnic metabolism and milk production in dairy cows. *Journal of Animal Science* 76 (Suppl. 1), 310.
- Reynolds, C.K., Lupoli, B., Aikman, P.C., Humphries, D.J., Crompton, L.A., Sutton, J.D., France, J., Beever, D.E. and MacRae, J.C. (1999) Effects of abomasal casein or essential amino acid infusions on splanchnic metabolism in dairy cows. *Journal of Animal Science* 77 (Suppl. 1), 266.
- Reynolds, C.K., Lupoli, B., Aikman, P.C., Benson, J.A., Humphries, D.J., Crompton, L.A., Sutton, J.D., France, J., Beever, D.E. and MacRae, J.C. (2000) The effects of diet protein level and abomasal amino acid infusions on splanchnic metabolism in lactating dairy cows. *Journal of Animal Science* 83 (Suppl. 1), 299.
- Reynolds, C.K., Bequette, B.J., Caton, J.S., Humphries, D.J., Aikman, P.C., Lupoli, B. and Sutton, J.D. (2001) Effects of intake and lactation on absorption and metabolism of leucine and phenyl alanine by splanchnic tissues of dairy cows. *Journal of Dairy Science* 84 (Suppl. 1), 362.
- Reynolds, C.K., Aikman, P.C., Lupoli, B., Humphries, D.J. and Beever, D.E. (2003a) Splanchnic metabolism of dairy cows during the transition from late gestation through early lactation. *Journal of Dairy Science* 86, 1201–1217.
- Reynolds, C.K., Benson, J.A., Aikman, P.C., Lupoli, B., Hanigan, M.D., Beever, D.E. and MacRae, J.C. (2003b) Effects of diet forage:concentrate ratio on splanchnic nutrient metabolism in lactating dairy cows. *Journal of Dairy Science* 86 (Suppl. 1), 219.
- Rook, J.A.F. (1976) Nutritional influences on milk quality. In: Swan, H. and Broster, W.H. (eds) *Principles of Cattle Production*, Chapter 10. Butterworths, London, pp. 221–237 (reference on pp. 224–225).
- Seal, C.J. and Parker, D.S. (1994) Effect of intraruminal propionic acid infusion on metabolism of mesenteric and portal-drained viscera in growing steers fed a forage diet. I. Volatile fatty acids, glucose and lactate. *Journal of Animal Science* 72, 1325–1334.
- Seal, C.J. and Reynolds, C.K. (1993) Nutritional implications of gastrointestinal and liver metabolism in ruminants. *Nutrition Research Reviews* 6, 185–208.
- Seal, C.J., Parker, D.S. and Avery, P.J. (1992) The effect of forage and forage-concentrate diets on rumen fermentation and metabolism of nutrients by the mesenteric and portal-drained viscera of growing steers. *British Journal of Nutrition* 67, 355–370.
- Tagari, H. and Bergman, E.N. (1978) Intestinal disappearance and portal blood appearance of amino acids in sheep. *Journal of Nutrition* 108, 790–803.
- Taniguchi, K., Huntington, G.B. and Glenn, B.P. (1995) Net nutrient flux by visceral tissues of beef steers given abomasal and ruminal infusions of casein and starch. *Journal of Animal Science* 73, 236–249.
- Theurer, C.B., Huntington, G.B., Huber, J.T., Swingle, R.S. and Moore, J.A. (2002) Net absorption and utilisation of nitrogen compounds across ruminal, intestinal and

- hepatic tissues of growing beef steers fed dry-rolled or steam-flaked sorghum grain. *Journal of Animal Science* 80, 525–532.
- Van Bruchem, J., Voigt, J., Lammers-Wienhoven, S.C.W., Schonhusen, U., Ketelaars, H. and Tamminga, S. (1997) Secretion and reabsorption of endogenous protein along the small intestine of sheep: estimates derived from  $^{15}\text{N}$  dilution of plasma non-protein-N. *British Journal of Nutrition* 77, 273–286.
- van der Walt, J.G., Baird, G.D. and Bergman, E.N. (1983) Tissue glucose and lactate metabolism and interconversions in pregnant and lactating sheep. *British Journal of Nutrition* 50, 267–280.
- Weekes, T.E.C. and Webster, A.J.F. (1975) Metabolism of propionate in the tissues of the sheep gut. *British Journal of Nutrition* 33, 425–438.
- Yu, F., Bruce, L.A., Calder, A.G., Milne, E., Coop, R.L., Jackson, F., Horgan, G.W. and MacRae, J.C. (2000) Subclinical infection with the nematode *Trichostrongylus colubriformis* increases gastrointestinal tract leucine metabolism and reduces availability of leucine for other tissues. *Journal of Animal Science* 78, 380–390.

*This page intentionally left blank*

---

# 13 Fat Metabolism and Turnover

D.W. Pethick,<sup>1</sup> G.S. Harper<sup>2</sup> and F.R. Dunshea<sup>1,3</sup>

<sup>1</sup>*School of Veterinary and Biomedical Sciences, Murdoch University, Murdoch, WA 6150, Australia;* <sup>2</sup>*CSIRO, Division of Livestock Industries, St. Lucia, QLD 4067, Australia;* <sup>3</sup>*Department of Primary Industries, Werribee, VIC 3030, Australia*

---

## Introduction

This chapter will emphasize the metabolism of non-esterified fatty acids (NEFA) although some discussion will relate to triglyceride (TAG) and ketone bodies. Plasma NEFA are a highly labile form of lipid that are transported between tissues in the circulation bound to albumin. Although plasma NEFA are only a small proportion (5%) of total plasma lipid they represent an important source of oxidizable energy, particularly during periods of negative energy balance or when there is an acute need for energy such as during exercise. This chapter will deal with the composition and sources of plasma NEFA, the fate of NEFA during different physiological states as well as the acute and chronic regulation of NEFA metabolism. In addition, this chapter will cover methodology and principles of NEFA metabolism and also describe adaptations to different physiological states. Although these areas have been covered in several reviews (Lindsay, 1975; Emery, 1979; Annison, 1984; Wiseman, 1984; Chilliard *et al.*, 2000), this chapter will emphasize the quantitative aspects of NEFA metabolism.

## Composition and Sources of Plasma NEFA and TAG

The metabolically most active pool of long-chain fatty acids is transported and metabolized as either NEFA (bound to albumin) or TAG. In the fed animal NEFA represent less than 5% by weight of total plasma lipid (2 g/l) with the remainder incorporated into various lipoprotein fractions (Kris-Etherton and Etherton, 1982). TAG (<10% of plasma lipid) is present mainly as very low-density lipoproteins (VLDL), with few chylomicrons on most diets. Sources of plasma lipid include the gut, liver and adipose tissue.

The gut is limited in its quantitative contribution since the lipid content of typical forage is less than 3%. A 45 kg sheep being fed to maintenance would

consume about 700 g dry matter (DM) of good quality forage, including some 21 g of lipid (19 g of fatty acids) per day. Dietary lipid is absorbed as NEFA, rapidly esterified to TAG and then packaged into chylomicrons and VLDL within the intestinal mucosal cell (Noble, 1981). From here lipid enters the lymph and finally the venous blood. Passage through the rumen results in significant biohydrogenation, which is reflected in a relatively high proportion of saturated fatty acids in the circulating TAG and NEFA of fed animals (Table 13.1). Mobilization of adipose tissue lipid (rich in oleic acid) during either undernutrition or exercise results in a significant decrease in the saturation of plasma NEFA and indeed the ratio of stearic to oleic (S:O) acids and the sum of stearic and linoleic to oleic (SL:O) acids have been shown to be negatively related to energy balance (Dunshea, 1987).

The dynamic nature of the profile of plasma NEFA is illustrated in Fig. 13.1 where the chronic and the acute-upon-chronic effects of undernutrition on plasma NEFA and SL:O are shown. In this study, Dunshea (1987) fed goats at either maintenance or 0.25 × maintenance in 12 equally spaced meals per day in an attempt to create a quasi-steady state. This was certainly achieved for goats fed at maintenance where total NEFA concentrations and the ratio SL:O were relatively constant across the 2-h interval between feeding. Sub-maintenance feeding resulted in a chronic increase in plasma NEFA and a decrease in SL:O. However, there were also post-prandial effects on both total NEFA and SL:O consistent with dynamic changes in NEFA mobilization in response to the 2-hourly feeding bouts.

## Lipolysis and Fat Mobilization

The major pathways within and adjacent to the adipocyte are shown in Fig. 13.2 (see Vernon, 1981). Fat is stored as TAG. Glucose is the source of glycerol while fatty acids can be either synthesized *de novo*, principally from acetate, or be preformed. There is some evidence that intramuscular

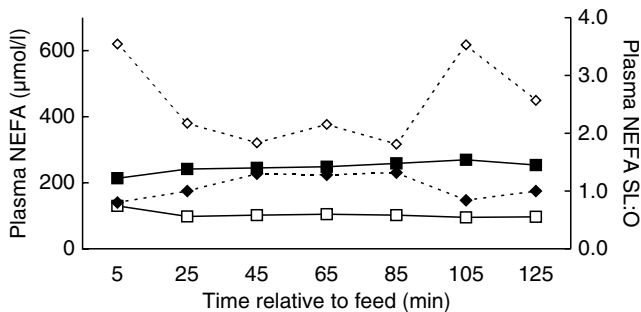
**Table 13.1.** Composition of long-chain fatty acids (molar %) in blood of sheep. (Data from Pethick *et al.*, 1987; Pethick and Parry, unpublished.)

Fatty acid	NEFA: fed at rest <sup>a</sup>	NEFA: fasted	NEFA: exercise <sup>a</sup>
Myristic (C14:0)	1.5	0.8	0.8
Palmitic (C16:0)	26.7	20.8 <sup>b</sup>	20.8 <sup>b</sup>
Palmitoleic (C16:1)	4.0	4.2	3.8
Stearic (C18:0)	35.5	32.3	32.1
Oleic (C18:1)	23.9	37.5 <sup>b</sup>	37.6 <sup>b</sup>
Linoleic (C18:2)	5.2	2.2 <sup>b</sup>	3.4 <sup>b</sup>
Linolenic (C18:3)	2.9	ND	ND

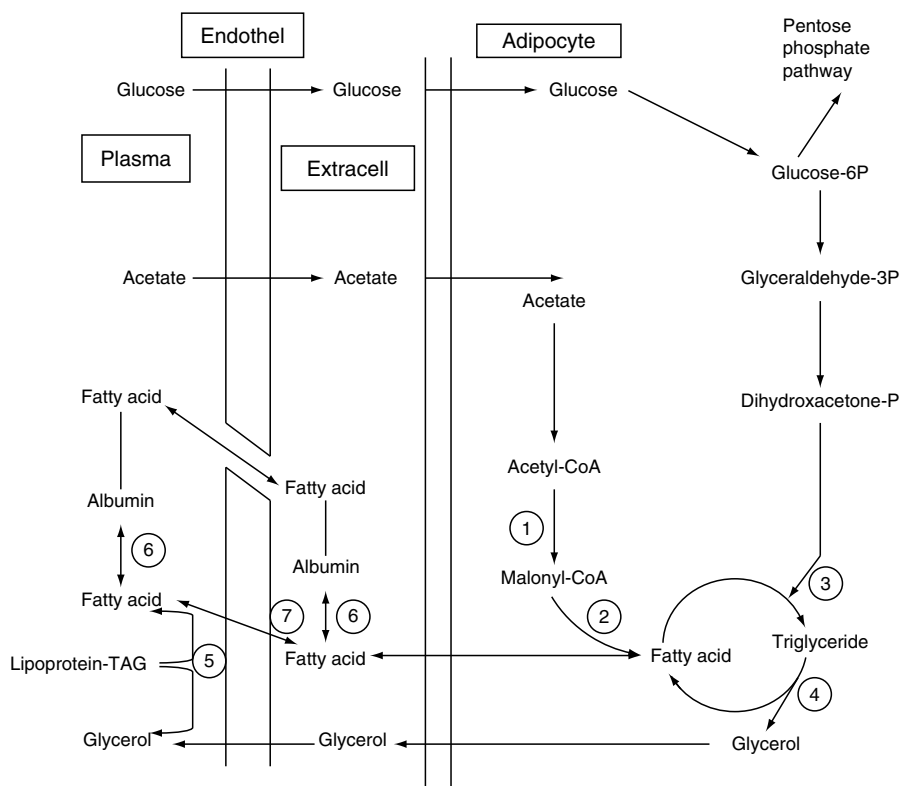
ND, not determined.

<sup>a</sup>Fed a ration of ground and pelleted *Medicago sativa*.

<sup>b</sup>Significantly different to fed sheep at rest.



**Fig. 13.1.** Relationships between plasma NEFA concentrations (open symbols), the ratio of the molar proportions of stearic plus linoleic to oleic acids (SL:O) in NEFA (closed symbols) and time relative to feeding in a dry goat that was chronically offered either 140 ( $\square$ ,  $\blacksquare$ ) or 35 ( $\diamond$ ,  $\blacklozenge$ ) kJ ME/kg/day divided into 12 equal portions given at 120 min intervals (Dunshea, 1987).



**Fig. 13.2.** Triacylglycerol synthesis/degradation cycle in adipose tissue. TAG = triacylglycerol. 1, Acetyl CoA carboxylase; 2, Fatty acid synthase; 3, Esterification; 4, Hormone sensitive lipase; 5, Lipoprotein lipase; 6, Fatty acid equilibration; 7, Membrane transport of fatty acids.

adipocytes have a preference for glucose and lactate over acetate but the significance of this is still not fully resolved (Pethick *et al.*, 2004). Preformed fatty acids can arise from uptake of plasma NEFA or after hydrolysis of circulating VLDL TAG by lipoprotein lipase (LPL). In addition, an intracellular source of fatty acids can arise during lipolysis, a process regulated by hormone-sensitive lipase (HSL). Fatty acids resulting from lipolysis can be released into the circulation or else re-esterified into TAG. In contrast, the lack of glycerol kinase within the adipocyte ensures that glycerol is quantitatively released into the circulation. Therefore, glycerol and NEFA entry into the plasma pool should reflect lipolysis and fat mobilization, respectively. This is provided that the contribution from the adipocyte is much greater than that released into the circulation as a result of LPL-catalysed hydrolysis of VLDL TAG which, as discussed later, may not always be the case.

## NEFA Entry Rate

### *Definition and methodology*

Under conditions of constant circulating concentrations and physiological state (steady state) the amount of NEFA entering and leaving the plasma will be equal. This is defined as the NEFA entry rate, which is best determined by isotope dilution. A potassium soap of radiolabelled fatty acids is dissolved in plasma and infused intravenously at a constant rate. After about 1 h the specific radioactivity of plasma NEFA in arterial blood will reach a plateau value and entry rate can be calculated as:

$$\text{Entry rate of total NEFA (mmol/h)} = \frac{\text{Infusion rate radiolabelled NEFA (dpm/h)}}{\text{Specific activity total NEFA (dpm/mmol)}}$$

The site of both infusion and sampling to determine NEFA kinetics has been the source of some debate, but the above schedule has been validated (Jensen *et al.*, 1988).

Plasma NEFA consists of a number of fatty acids of which palmitic, stearic and oleic acids represent some 85% (Table 13.1). Herein lies a difficulty in quantifying NEFA metabolism because not all NEFA behave as a homogeneous unit. Generally, one radioactive fatty acid is used as a tracer for total NEFA, with the assumption that all NEFA behave similarly. Other workers have improved the method by infusing mixtures of the three major radiolabelled fatty acids (Bell and Thompson, 1979; Dunshea *et al.*, 1988). Typically, palmitic acid has a higher entry rate than the other fatty acids when compared in a similar concentration (Lindsay, 1975). Stearic acid and oleic acid more commonly show a similar relationship between entry rate and concentration (Pethick *et al.*, 1987). In this chapter (unless otherwise directed) the tracer fatty acid has been assumed to be representative of all NEFA. Finally, determination of NEFA concentration requires care. It is best performed using either HPLC, GLC or enzymatic methods. Non-specific

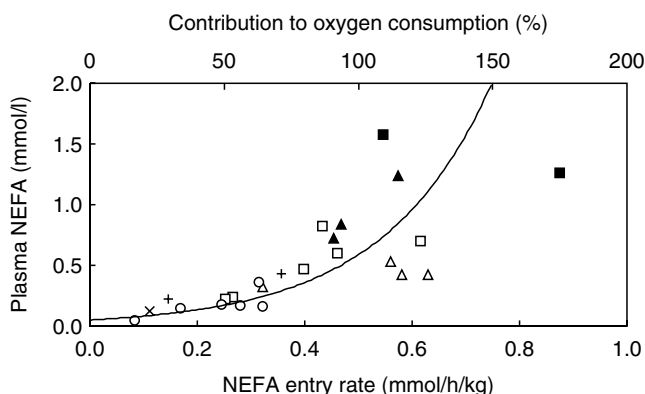


methods employing titration of copper soaps are prone to overestimation due to lack of specificity. Rapid, enzymatically based micro-assays now exist for the determination of NEFA (Johnson and Peters, 1993) and unless knowledge about specific fatty acids is required readers are recommended to use these assays.

### Plasma NEFA concentrations vs. NEFA entry rate

The published data for non-lactating small ruminants, in the fed and fasted state, are summarized in Fig. 13.3. These studies have been grouped together because in all cases the spectrum of tissues utilizing NEFA is similar. This extends to pregnancy since the pregnant uterus uses very little NEFA (Pethick *et al.*, 1983). Secondly, the metabolic rate of tissues is not greatly altered. Large changes in the metabolic rate alter the relationship between concentration and utilization or entry rate (Table 13.2; see also 'Exercise' below).

When all studies are viewed together (Fig. 13.3) a curvilinear relationship is found, implying a plateau in the entry rate of NEFA. This plateau is not due to peak stimulation of HSL since studies both *in vitro* (Vernon, 1981) and *in vivo* (Table 13.6) suggest a much greater capacity. However, two factors limit the extent of fat mobilization as the NEFA concentration increases in plasma. First, in animals at rest, fat mobilization is associated



**Fig. 13.3.** Relationship between the entry rate of NEFA, contribution of NEFA to oxidation and circulating concentration in non-lactating animals. Key: O, sheep fed; □, sheep pregnant fed; ×, goats fed; +, goats underfed; △ sheep starved 1 day; ▲, sheep starved 3–4 days; ■, sheep pregnant starved 3–4 days. If  $x$  is the NEFA entry rate (mmol/h/kg) and  $y$  the NEFA in plasma (mmol/l) then  $y = 0.05 \times 10^{2.14x}$ ,  $r^2 = 0.77$  ( $P < 0.001$ ). In calculating the regression each study was weighted for the number of animals. Contribution to oxygen consumption is calculated assuming complete oxidation of NEFA and an oxygen consumption of 12.5 mmol/h/kg for all metabolic states. No discrimination on the basis of tracer NEFA was made. Sources: Bergman *et al.* (1971); Pethick *et al.* (1983, 1987); Dunshea *et al.* (1988); Pethick and Harman (unpublished); Hall and Dunshea (unpublished); plus those cited by Vernon (1981).

**Table 13.2.** Metabolism of NEFA by the hind limb muscle of sheep. (Data from Pethick *et al.*, 1983 (flux rates across muscle halved due to overestimate of blood flow), 1987; Harman, 1991.)

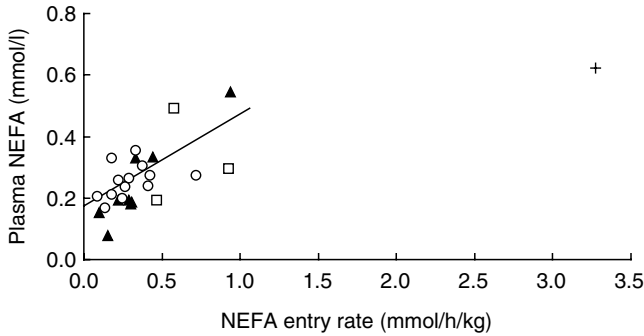
Metabolic state	Plasma NEFA (mM)	Gross utilization by muscle (mmol/h/kg)	Gross extraction across muscle (%)	O <sub>2</sub> uptake by muscle (mmol/h/kg)
Dry fed	0.1 ± 0.01	0.1 ± 0.02	19 ± 4	11 ± 1
Dry 3-day fasted	1.1 ± 0.1	0.2 ± 0.04	7 ± 1	10 ± 1
Pregnant 3-day fasted <sup>a</sup>	1.6 ± 0.2	0.5 ± 0.1	8 ± 1	15 ± 3
Exercise 30% VO <sub>2</sub> max <sup>b</sup>	1.1 ± 0.1	1.0 ± 0.2	9 ± 2	47 ± 3
Exercise 60% VO <sub>2</sub> max <sup>b</sup>	1.6 ± 0.2	2.3 ± 0.2	7 ± 2	80 ± 12

<sup>a</sup>Last month of pregnancy.

<sup>b</sup>Exercise at 30% and 60% VO<sub>2</sub> max was at 4.5 km/h on 0° or 9° incline respectively, see Harman (1991).

with increased rates of ketogenesis (Table 13.5) and subsequent elevation of D-3-hydroxybutyrate. This ketone body tends to reduce NEFA concentration probably by increasing the rate of insulin secretion (Heitmann *et al.*, 1987). Secondly, as NEFA concentration increases the plasma albumin approaches saturation and the resultant stimulation of intracellular re-esterification reduces fat mobilization despite no change in lipolysis (Madsen *et al.*, 1986). These mechanisms regulate fat mobilization and are essential to prevent toxic levels of NEFA in plasma (about 2 mM; Newsholme and Leech, 1983). Saturation of tissue uptake could also inhibit further elevation of entry rate. In the liver, NEFA uptake is non-saturable within the physiological range (Bell, 1981), but for skeletal muscle there is evidence for limited uptake as the concentration of NEFA increases with fasting. The fractional extraction of NEFA in fed sheep was over twice that found for fasted counterparts (Table 13.2) despite similar blood flow in the hind limb muscle. Muscle can form acetate or esterify NEFA, but it would appear that these pathways can be saturated within the physiological range of substrate supply. The oxidative pathway for NEFA can only increase to the limit set by oxygen consumption and this is probably the major limiting aspect of NEFA utilization at rest (Table 13.2).

The relationship between entry rate of NEFA and concentration in plasma for lactating animals is shown in Fig. 13.4. The relationship is different for non-lactating animals. First, the concentration of NEFA is generally lower than observed in non-lactating animals, even though the range of NEFA entry rate is similar or in the case of the fasted goat considerably higher. Secondly, there is no tendency for the entry rate of NEFA to reach a maximum with a linear relationship being adequate to explain the data. This is likely due to the mammary gland acting as a non-saturable sink for long-chain fatty acids (see also 'lactation' below).



**Fig. 13.4.** Relationship between the entry rate of NEFA and circulating concentration in lactating animals. Key: O, cow fed; ▲, goat fed, □, sheep fed, +, goat fasted. If  $x$  is the NEFA entry rate (mmol/h/kg) and  $y$  the NEFA in plasma (mM) of fed animals, then  $y = 0.27x + 0.17$ ,  $r^2 = 0.36$  ( $P < 0.001$ ). If the value for the fasted goat is included, the slope is significantly reduced to 0.15,  $r^2 = 0.45$  ( $P < 0.001$ ). In calculating the regression each study was weighted for the number of animals. Sources: Annison *et al.* (1967a, 1968); Yamadagni and Schultz (1969); Bickerstaffe *et al.* (1972, 1974); König *et al.* (1979, 1984); King (1983); Emmanuel and Kennelly (1984); McDowell *et al.* (1987, 1988); Bauman *et al.* (1988); Sandles *et al.* (1988); Dunshea *et al.* (1989, 1990); Pullen *et al.* (1989); Sechen *et al.* (1989).

## Utilization of NEFA

### Tissue uptake

All tissues that utilize long-chain fatty acids also show simultaneous release. Consequently the terms *net* and *gross* utilization have been used to describe NEFA uptake by tissues. Net utilization is derived from the extraction of NEFA measured as an amount while gross utilization is calculated from the extraction of infused radiolabelled NEFA. For liver the difference between the two values is not large; however, for the gut and muscle it is not uncommon to find a net release of NEFA, while the mammary gland shows no net exchange in fed animals. Reasons for tissue release of NEFA include lipolysis due to LPL (mammary gland and muscle) and lipolysis from adipose tissue within the tissue bed of interest (muscle and the gut). To discriminate between the sources the method of Zierler and Rabinowitz (1964) could be utilized, where a local infusion of insulin is given to inhibit HSL (Capaldo *et al.*, 1994).

There is no evidence that individual NEFA are utilized at different rates by muscle, but there is conflicting evidence as to the rate of the stearic acid utilization by liver. Bell (1981) reviewed the data and suggested minimal hepatic utilization of stearic acid; in contrast there is substantial incorporation of radiolabelled stearic acid into ketones, suggesting no impairment to uptake (Pethick *et al.*, 1983). In resting fed (and probably fasted) sheep about half of the NEFA entry rate is accounted for by the gut, liver and muscle (Table 13.3). Alternative sites might include the heart, kidneys and spleen. Assuming the

**Table 13.3.** Gross utilization of NEFA by different tissues in sheep. (Data from Bergman *et al.*, 1971; Pethick *et al.*, 1983, 1987; Harman, 1991.)

Tissue	Utilization as % of entry rate		
	Dry, fed <sup>a</sup> at rest	Exercise <sup>b</sup> 30–60% VO <sub>2</sub> max	Fasted pregnant <sup>c</sup>
Gut	8	5	ND
Liver	26	11–16	ND
Muscle <sup>d</sup>	20	19–26	20
Total	54	35–47	

ND, not determined.

<sup>a</sup>Entry rate 0.1 mmol/h/kg.

<sup>b</sup>Entry rate 1.6–3 mmol/h/kg.

<sup>c</sup>Entry rate 0.6 mmol/h/kg, last month of pregnancy.

<sup>d</sup>Muscle value extrapolated from measurements of hind limb muscle assuming that muscle weight is 24% of fleece body weight (Butterfield *et al.*, 1983).

gross extraction of NEFA by the heart is 55% as in man (Wisneski *et al.*, 1987), the heart could utilize 19% of the NEFA entry rate. Finally, adipose tissue, which receives 16% of the cardiac output at rest (Bell and Hales, 1985), could also utilize significant NEFA. During exercise the muscle becomes a relatively more important sink for NEFA.

## Oxidation of NEFA

### Whole body

Two methods are commonly employed to measure the oxidation rate of NEFA. Either the entry rate of NEFA and CO<sub>2</sub> are determined along with the contribution of NEFA to the blood bicarbonate pool at equilibrium, or alternatively an open circuit calorimeter is utilized and the amount of radioactivity infused is compared to that excreted as respiratory <sup>14</sup>CO<sub>2</sub> either at equilibrium or during a 12 to 24-h period. For accurate results, long infusion times are preferred since there is a delay (5 h) in the accumulation of <sup>14</sup>C in CO<sub>2</sub> (Annison *et al.*, 1967a). During ketosis this time extends to 15 h due to catabolism of NEFA via ketones (Pethick *et al.*, 1983). Another factor of concern is CO<sub>2</sub> fixation, which amounts to 17% and 7% of CO<sub>2</sub> entry rate in fed and fasted sheep, respectively (Annison *et al.*, 1967a). The common NEFA in plasma are oxidized at similar rates. However, due to ruminal biohydrogenation of fatty acids the absorption of linoleate is low and hence there is limited oxidation of this essential fatty acid (Lindsay and Leat, 1977). Estimates of prompt NEFA oxidation are shown in Table 13.4. Inter-laboratory comparisons are difficult but, whether fed or fasted, NEFA oxidation is relatively low and generally only about half that of other fatty acids, such as acetate or ketones. Oxidation increases during late gestation but there still remain substantial amounts of NEFA, which enter non-oxidative pathways.

**Table 13.4.** Oxidation of NEFA in ruminants.<sup>a</sup>

Experimental method	Metabolic state/species	% NEFA promptly oxidized	References
Whole-body oxidation	<i>Fed animals</i>		
	Dry sheep	47 <sup>a</sup>	Leat and Ford (1966)
	Pregnant sheep	55, 70 <sup>a</sup>	Pethick <i>et al.</i> (1983); Wilson (1984)
	Growing heifers	32 <sup>a</sup>	Eisemann <i>et al.</i> (1986)
	Lactating cows	15, 21	Bauman <i>et al.</i> (1988); Pullen <i>et al.</i> (1989)
	<i>Fasted animals</i>		
	Dry sheep (1 day)	37	Annisson <i>et al.</i> (1967a)
	Dry sheep (3 days)	45, 35 <sup>a</sup>	Lindsay and Leat (1977); Leat and Ford (1966)
	Pregnant sheep (3 days)	63, 46 <sup>a</sup>	Pethick <i>et al.</i> (1983); Wilson (1984)
	Oxidation by hind-limb muscle	<i>Sheep</i>	
Fed		40	Pethick <i>et al.</i> (1987)
Exercise, 30% VO <sub>2</sub> max		87	Pethick <i>et al.</i> (1987)
Fasted pregnant (3 days)		52	Pethick (1980)
<i>Steer</i>			
Fed		3	Bell and Thompson (1979)
Fasted (1 day)	14	Bell and Thompson (1979)	

<sup>a</sup>Values corrected for CO<sub>2</sub> fixation using data from Annisson *et al.* (1967a) of 1.2 and 1.07 for fed and fasted animals, respectively. Experiments where <sup>14</sup>C-linoleic acid was used as a tracer have not been included. Pregnant animals in last month of pregnancy.

### *Tissue oxidation*

Measurement of tissue oxidation compares the rate of <sup>14</sup>C-NEFA uptake with <sup>14</sup>CO<sub>2</sub> release. Both long infusion and/or collection times are required for reliable results. This is due to very slow equilibration of CO<sub>2</sub>, especially in resting muscle (Pethick *et al.*, 1983).

Direct oxidation of NEFA by resting muscle is low (Table 13.4) with values reflecting that found in the whole animal. However, if fixation of CO<sub>2</sub> is allowed for (possibly as high as 20%; Pell *et al.*, 1986) then 50–60% of the NEFA is probably oxidized in sheep. Even lower rates of oxidation were found for the steer hind limb. These lower rates are perhaps surprising but they are not related to poor methodology since short-chain fatty acids are extensively oxidized in similar experiments (Pethick *et al.*, 1981). Intramuscular fat might act as a significant site of esterification; alternatively NEFA could pass through an intramuscular pool of TAG before being directly oxidized (Dagenais *et al.*, 1976). A similar mechanism is implicated for adipose tissue (Ookhtens *et al.*, 1987). This may represent an adaptation to maintain intracellular NEFA concentration below toxic levels. During exercise NEFA are directed more

readily to oxidation (Table 13.4) either directly or due to a higher rate of esterification and lipolysis in muscle.

## NEFA Metabolism in Different Physiological States

### *Fed animals at rest*

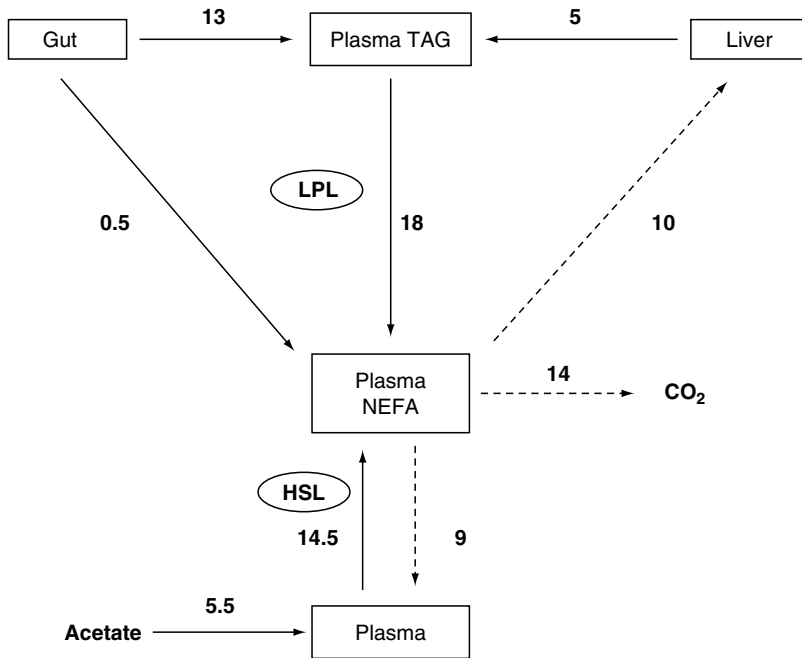
#### *Magnitude*

Estimates of NEFA entry rate in maintenance-fed small ruminants range from 0.08 to 0.32 mmol/h/kg (21–121 g/day, see Fig. 13.3). Much of the variation in these measurements relates to the pattern of feeding, with the lower values being observed in animals fed semi-continuously. Plasma NEFA levels and entry rates are highest before and lowest after feeding (Dunshea *et al.*, 1988). A further source of variation occurs because plasma NEFA are highly labile ( $t_{1/2} < 2$  min) and also very stress-sensitive (Holmes and Lambourne, 1970; Boisclair *et al.*, 1997). In this context, Boisclair *et al.* (1997) found that excitement around feeding or other minor animal handling procedures were sufficient to elevate plasma NEFA, particularly in young cattle treated with bovine somatotropin (bST). Therefore, it is imperative for animals to be accustomed to handling before commencing studies. This has not always been the case. The value of about 35 g/day appears to be a good estimate of the NEFA entry rate in a 45 kg ruminant fed to maintenance, although lower values have been measured (Pethick *et al.*, 1987).

#### *Sources of plasma NEFA and TAG*

Estimates of lipid absorption in sheep fed roughage-based diets are in the order of 12 to 16 g/day of TAG (Harrison and Leat, 1972; Pullen *et al.*, 1988). NEFA content of intestinal lymph is low such that only some 0.5 g/day enter the circulating pool directly. However, the absorbed TAG also makes a contribution towards the NEFA entry rate through the action of LPL and to a small extent hepatic lipase. The work of Bergman *et al.* (1971) demonstrated release of NEFA into the circulation as chylomicron TAG was hydrolysed by liver, gut and hindquarters. The extent to which fatty acids liberated by LPL pass through the circulating NEFA pool before intracellular metabolism is questionable (Fig. 13.2); however, in Fig. 13.5 it is assumed that complete equilibration occurs. A further source of TAG and NEFA is VLDL TAG formed in the liver. While little *de novo* lipogenesis occurs in the liver of ruminants (Bell, 1981), there is extraction of NEFA from the circulation with subsequent release of about 4–5 g/day (double this in pregnant animals) of VLDL TAG (Pullen *et al.*, 1988; Freetly and Ferrell, 2000). Overall TAG derived from the diet and liver might account for 50% of the NEFA entry rate (Fig. 13.5).

The remaining component of NEFA entry rate probably arises from lipolysis within adipose tissue. Again, some released fatty acids would emanate from the action of LPL on circulating TAG but this contribution remains unknown. The alternative source is due to the action of HSL. Further experi-



**Fig. 13.5.** Source and fate of NEFA (g/day) in a dry sheep fed to maintenance. This figure represents a working hypothesis to account for NEFA in a roughage-fed, 45 kg, dry sheep. Rates and assumptions are discussed in the text. All values represent flux of NEFA whether in the form of TAG-fatty acids or NEFA. The flux of NEFA into adipose tissue represents the sum of TAG synthesis in all tissues. The estimated rate of lipogenesis from acetate is calculated from van der Walt (1984). LPL = lipoprotein lipase; HSL = hormone-sensitive lipase; TAG = triacylglycerol.

ments are required perhaps utilizing the fat-tailed sheep or an inguinal fat pad as a model.

The relative contribution of adipose and non-adipose sources towards plasma NEFA in the sheep can be derived from the work of Petterson *et al.* (1994). In that study, insulin (a potent inhibitor of adipose tissue lipolysis) was infused while maintaining euglycaemia. Maximally inhibited NEFA concentrations are assumed to be the result of insulin-independent, LPL-catalysed hydrolysis of circulating TAGs. In the study of Petterson *et al.* (1994) insulin infusion decreased plasma NEFA concentration from 0.15 to 0.07 mM in sheep fed to maintenance. Given that at low concentrations of NEFA the relationship between plasma NEFA concentration and entry rate is essentially linear (Fig. 13.3), then lipolysis (via HSL) would account for about 50% of the NEFA entry rate. Hyperinsulinaemia caused similar plasma NEFA concentrations to the basal values observed by Pethick *et al.* (1987) where entry rate of NEFA was 21 g/day. This value can be largely accounted for by the estimates of NEFA derived via TAG metabolism from the diet (13 g/day) and hepatic production (5 g/day). Therefore, it appears that in resting undisturbed sheep, minimal NEFA are released into the circulation as a result of adipose tissue

lipolysis. Given these assumptions it seems that all TAG-bound fatty acids initially pass through the NEFA pool during metabolism. Although there is some evidence for this in the mammary gland (Annison, 1984), there is also evidence for preferential uptake of NEFA arising from TAG hydrolysis (pathway 7, Fig. 13.2; Hamosh and Hamosh, 1983; Raclot and Oudart, 2000).

The most striking feature of the model shown in Fig. 13.5 is the rough equivalence between the amount of NEFA being absorbed (as TAG) and that oxidized. Most of the NEFA turnover seems to involve recycling of fatty acids between plasma TAG and adipose tissue.

## Undernutrition

### Fasting

Fuel homeostasis during fasting requires both a new source of energy and the maintenance of euglycaemia so that tissues with an absolute glucose requirement retain normal function. Mobilization of NEFA from adipose tissue helps satisfy both needs. Estimates of NEFA entry rate during fasting range from 0.32 to 0.64 mmol/h/kg (120–240 g/day, Fig. 13.3) which is sufficient to account for over 100% of the oxygen consumption assuming complete oxidation.

To maximize NEFA oxidation the liver partially oxidizes NEFA into ketones (Table 13.5) and to a lesser extent acetate. Ketogenesis is stimulated due to a combination of several events. Increased hepatic delivery of NEFA is crucial but changes to intrahepatic metabolism are also triggered by the declining ratio of insulin to glucagon and reduced food intake (Brindle *et al.*, 1985), ensuring that much of the NEFA enter into the mitochondrion for subsequent beta oxidation and formation of ketones. Overall about 50% of the NEFA carbon is processed via ketogenesis, an adaptation that increases the use of NEFA since ketones, being water-soluble and more diffusible, are readily oxidized. Thus ketone body accumulation in plasma should be thought of as a normal physiological adaptation. However, pathological cases can occur, particularly during pregnancy

**Table 13.5.** Concentration of circulating fatty acids and rates of ketogenesis in the blood of sheep. AcAc = acetoacetate; 3-HB = D-3-hydroxybutyrate. Pregnant animals in last month of pregnancy.<sup>a</sup>

Metabolic state	Metabolite concentration (mM)			Ketone body synthesis (mmol/h/kg)
	Blood [AcAc]	Blood [3-HB]	Plasma <sup>a</sup> [NEFA]	
Dry fed <sup>b</sup>	0.04	0.36	0.2	0.1
Dry 3–4 days fasted <sup>b</sup>	0.12	0.74	1.0	1.0
Pregnant fed <sup>b</sup>	0.05	0.57	0.6	0.3
Pregnant 3–4 days fasted <sup>c</sup>	0.51	2.72	1.6	1.0

<sup>a</sup>Mean values from Fig. 13.3.

<sup>b</sup>Data from Heitmann *et al.* (1987).

<sup>c</sup>Data from Pethick and Lindsay (1982).



(see pregnancy below). Utilization of NEFA and ketones by the extra hepatic tissues results in the sparing of glucose. Both the uptake and oxidation of glucose decline. Reduced oxidation is augmented by regulation at pyruvate dehydrogenase with much of the glucose recycled via lactate or glycogenic amino acids. Increased NEFA and ketone body utilization is an important component of decreasing the proportion of pyruvate dehydrogenase in the active state (Randle, 1986). The overall effect of a prolonged fast is for near cessation of glucose oxidation by skeletal muscle with NEFA and ketones (roughly 50:50) becoming the predominant fuel (Pethick *et al.*, 1983).

#### *Chronic undernutrition*

The situation most often facing a grazing ruminant during food shortage is one of chronic undernutrition rather than acute fasting. With this in mind Dunshea *et al.* (1988) investigated the effect of chronic food restriction on fat mobilization in goats. Both plasma NEFA concentration and entry rate were increased during chronic undernutrition and these increases were related to the severity of feed restriction. Indeed, plasma NEFA concentration and entry rate were closely and negatively related to energy balance. Importantly, the increases in NEFA entry rate were highly correlated with body fat mobilization. Thus, NEFA entry rate increased from 0.12 at maintenance to 0.14 and 0.36 mmol/h/kg at 0.5 and 0.25 times maintenance energy intake, respectively (Dunshea *et al.*, 1988).

One of the reasons for an increase in plasma NEFA and entry rate during chronic undernutrition is the reduction in plasma insulin, a potent antilipolytic hormone. In this context, Petterson *et al.* (1994) found that plasma NEFA doubled whereas plasma insulin decreased by 25% in sheep that were fed at 0.5 times maintenance compared to maintenance-fed controls. However, infusion of insulin during an euglycaemic clamp decreased plasma NEFA to similar concentrations in both groups of animals. Importantly, the nadir in plasma NEFA was achieved within the physiological range of plasma insulin (see section on 'Acute homeostatic regulation' for further discussion).

#### **Thermal stress**

Cold exposure sufficient to induce shivering has been shown to reduce the respiratory quotient and dramatically increase the whole-body turnover (0.05 to 0.17 mmol/h/kg) and hind leg uptake of NEFA in cattle (Bell and Thompson, 1979), suggesting that shivering relies heavily on NEFA as a fuel. Production systems, which are designed to maximize fatness, such as when cattle are fed to increase intramuscular fat reserves, should obviously attempt to minimize cold exposure and so oxidative loss of adipose tissue.

Heat stress and its effects on NEFA metabolism are less well investigated in ruminants. Recent studies in our laboratories have investigated the effects of heat stress on NEFA metabolism (Beatty *et al.*, 2004). *Bos taurus* (Angus) heifers (six treated vs. six controls of 350 kg liveweight) housed in climate rooms were offered feed at 2.25% of body weight and had *ad libitum* access to water. The wet bulb temperature was increased (over 6 days) to 32°C,

maintained at this temperature for 6 days and then lowered over the next 6 days. The main effect was virtual cessation of feed intake (2.0% vs. 0.15% BW,  $P < 0.001$ ) and a fivefold increase in plasma NEFA as the temperature increased above 28–30°C. Pair feeding the same *Bos taurus* cattle at a level observed during heat stress but with the cattle kept at thermoneutral temperatures caused a similar increase in plasma NEFA. This suggests that a reduced feed intake and not an extra effect of heat stress drove the increased mobilization of adipose tissue (measured as elevated plasma NEFA) *per se*. To further support this finding, *Bos indicus* cattle subjected to similar wet bulb extremes maintained feed intake and showed no rise in plasma NEFA.

### Pregnancy

Most studies have shown that NEFA concentration and entry rate are elevated in late pregnancy, even in ewes that are apparently well fed (Table 13.5). The observed entry rates vary between 0.35 and 0.62 mmol/h/kg, a range similar to that seen in fasted dry sheep. There are two reasons to explain these high values. First, twin pregnant ewes have difficulty in consuming enough feed to meet energy requirements; this is particularly so on poor quality roughage diets (Foot and Russell, 1979). Secondly, there is a tendency for fat mobilization due to insulin resistance (Petterson *et al.*, 1994). The function of increased fat mobilization is presumably to maintain euglycaemia in the face of an enormous glucose drain by the pregnant uterus.

A special adaptation of pregnancy is utilization of D-3-hydroxybutyrate by the pregnant uterus sufficient to account for up to 25% of the oxygen consumption (Pethick *et al.*, 1983). A resultant net 18% reduction in glucose requirement would be a great benefit to a twin-pregnant ewe where some 70% of the glucose synthesized is consumed by the pregnant uterus (see Chapter 20). Neither acetoacetate nor NEFA are utilized as a fuel by the pregnant uterus (Pethick *et al.*, 1983).

During fasting, NEFA entry rates increase up to 0.9 mmol/h/kg (Fig. 13.3). A puzzling problem is the hyperketonaemia seen in fasted pregnant animals compared to the fasted dry animals, despite similar rates of ketogenesis (Table 13.5). These data point to limitations in ketone uptake in the pregnant animals. This has been shown for skeletal muscle, where D-3-hydroxybutyrate is used less rapidly as the concentration increases, while acetoacetate uptake remains more proportional to concentration (Pethick and Lindsay, 1982). It is likely that increased NEFA uptake and oxidation inhibit the D-3-hydroxybutyrate dehydrogenase reaction due to a more reduced state of the pyridine nucleotides. Thus we have a mechanism for pathological ketoacidosis seen in pregnancy toxemia.

Another finding in ketotic animals (pregnant or lactating) is the development of fatty liver. The aetiology of this accumulation seems to be associated with liver uptake of NEFA in proportion to concentration, attainment of maximal rates of ketogenesis and therefore a substrate-regulated increase in the rate of esterification. Normally, the esterified lipid is released as VLDL TAG, but when the NEFA entry rate is chronically elevated VLDL synthesis is not increased sufficiently to

prevent lipid accumulation (Gruffat *et al.*, 1997), which can reach 20% of liver weight (Gerloff *et al.*, 1986). Some view this as a pathological accumulation leading to dysfunction; alternatively it represents another adaptation to remove NEFA from circulation and so alleviate toxic effects.

## Lactation

Fat metabolism during lactation has been extensively studied, primarily because the lactating mammary gland has an enormous demand for preformed fatty acids. In addition, the arteriovenous difference technique is readily applicable to the mammary gland so as to provide quantitative information on metabolism. There are a number of reviews (Moore and Christie, 1981; Annison, 1984; Vernon and Flint, 1984) to which the reader is referred.

The entry rate of NEFA in fed, lactating ruminants ranges from 0.14 to 0.94 mmol/h/kg (Fig. 13.4). The quantitative importance of fat mobilization during lactation becomes apparent when it is realized that in high-yielding cows, the estimated mobilization of fat to meet the energy deficit is equivalent to 50% of the milk fat output (Vernon and Flint, 1984). The extent of fat mobilization is related to energy balance, which is inversely correlated to NEFA entry rate (Bauman *et al.*, 1988; Dunshea *et al.*, 1989, 1990, 2000).

Although early work showed little net uptake of NEFA across the mammary gland in fed goats (Annison *et al.*, 1967b), there was a marked gross uptake indicating a large simultaneous release and uptake of NEFA due to the action of LPL on plasma TAG (Annison, 1984). Indeed, the lactating mammary gland in fed animals contributes around half of the circulating NEFA. Upon fasting, the role of circulating TAG as a source of milk fat declines such that a large net extraction of NEFA (34–51%) across the mammary gland is detected (Annison *et al.*, 1968). Therefore, in the fed goat the mammary gland is a significant source of plasma NEFA while upon fasting the contribution declines to less than 1%. This might explain why NEFA do not accumulate to high levels in the plasma of fasted lactating ruminants (Fig. 13.4).

In the fed goat the extraction of plasma TAG and NEFA by the mammary gland is equivalent to 63–82% of the milk fat (Annison *et al.*, 1967b). Oxidation is negligible in the fed animal and so most of the fatty acids end up as milk fat. The high rate of NEFA uptake into milk fat is consistent with a relatively low rate of hepatic incorporation of NEFA into VLDL TAG. Pullen *et al.* (1989) estimated that only 15% of the NEFA entry rate was incorporated into VLDL TAG in the lactating cow. This rate was negatively correlated with plasma NEFA concentration. Thus, mobilized fat is primarily utilized as NEFA in lactating animals.

## Exercise

Exercise is the classic catecholamine stimulus for fat mobilization. The NEFA entry rate of up to 3.1 mmol/h/kg (Table 13.6) is much higher than during

**Table 13.6.** Parameters of fat metabolism during exercise in sheep. (Data from Pethick *et al.*, 1987; Harman, 1991).<sup>a</sup>

Level of exercise <sup>a</sup>	Plasma NEFA (mM)	Entry rate NEFA (mmol/h/kg)	Contribution to energy expenditure (%) <sup>b</sup>	Conc. in blood of	
				Ketones (mM)	Acetate (mM)
Rest	0.1 ± 0.01	0.1 ± 0.02	14	0.46 ± 0.01	1.2 ± 0.2
30% VO <sub>2</sub> max	1.1 ± 0.1	1.7 ± 0.2	117	0.54 ± 0.03	1.5 ± 0.2
60% VO <sub>2</sub> max	1.6 ± 0.2	3.1 ± 0.4	122	0.54 ± 0.03	2.3 ± 0.3

<sup>a</sup>Speed of exercise is described in Table 13.2. Exercise at 30% and 60% VO<sub>2</sub> max was of 4 and 2 h duration, respectively; results are presented as a mean of the exercise period.

<sup>b</sup>Contribution to whole-body CO<sub>2</sub> entry assuming complete oxidation.

fasting despite a similar plasma NEFA concentration. This occurs because plasma clearance of NEFA is increased during exercise (Table 13.2). A similar response is seen when the metabolic rate is increased as a result of cold stress (Bell and Thompson, 1979; Symonds *et al.*, 1989). Although the extent of mobilization is sufficient to account for all the energy expenditure, the actual contribution to oxidation remains unclear. A maximum rate of fat mobilization in exercise in sheep is not known but in man mobilization and oxidation does not increase beyond 50% VO<sub>2</sub> max (Sahlin, 1986). Exercise above this level has to be fuelled from aerobic or anaerobic use of carbohydrate because only these pathways can supply sufficient ATP per minute to the contractile proteins. Limitations of fat as a fuel for exercise reside in poor solubility and perhaps attainment of maximal rates of lipolysis (Newsholme and Leech, 1983). A contributing cause is inhibition of fat mobilization due to elevated lactate that increases rapidly at exercise above the aerobic threshold (Issekutz *et al.*, 1965).

Partial oxidation of NEFA to ketones is small during exercise, suggesting that ketogenesis is inhibited. In contrast, sustained exercise above the aerobic threshold prompts an elevated concentration of acetate in the blood (Table 13.6). The net result is extra fuel available to skeletal muscle such that acetate could account for around 10% of the energy expenditure of skeletal muscle (compared to ketones at 5%; Harman, 1991). The differential control of NEFA conversion to either ketone bodies or acetate is yet to be understood but it may reside in a change of NEFA oxidation from mitochondrial  $\beta$ -oxidation in fasting to peroxisomal oxidation during exercise.

## Growth

The entry rate of NEFA in the growing animal is very low, ranging from 0.05 to 0.17 mmol/h/kg (Bell and Thompson, 1979; van der Walt *et al.*, 1984; Eisemann *et al.*, 1986). The rate of oxidation is also low (Table 13.4) with much of the remaining NEFA entering pathways of esterification (Payne and Masters, 1971). There is evidence that virtually all plasma NEFA are of

non-adipose tissue origin due to minimal rates of lipolysis. Thus infusion of insulin, while maintaining euglycaemia, caused only a small decrease in the already low plasma NEFA concentration in the growing steer (from 0.11 to 0.07  $\mu\text{M}$ ; Dunshea *et al.*, 1995). Similarly, in the rapidly growing pig that is in a net lipogenic state, with very low-plasma NEFA and high insulin clearance rates, exogenous insulin has relatively little effect on plasma NEFA (Dunshea *et al.*, 1992; Dunshea and King, 1995; Ostrowska *et al.*, 2002).

An area of commercial interest is the differential development of specific adipose tissue reserves – in particular the positive expression of intramuscular fat at the expense of other sites. The known factors, which regulate the expression of intramuscular fat, include genetic and environmental effects and these are discussed by Pethick *et al.* (2004). Further research is needed into the quantitative aspects of NEFA/TAG synthesis and mobilization in the different fat depots to allow for the development of improved control strategies.

## Endocrine Control of NEFA Entry

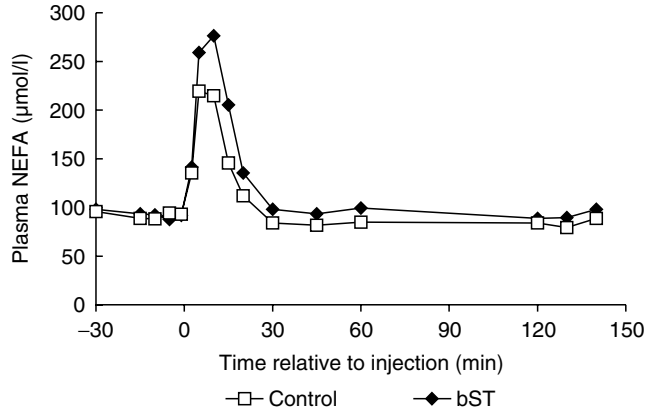
### *Acute homeostatic regulation of NEFA metabolism*

Lipolysis within the adipocyte is under the control of HSL, which catalyses the initial hydrolysis of TAG (Fig. 13.2). HSL is activated by cAMP via a cascade system after initial stimulation by the membrane-bound adenylate cyclase complex. Adenylate cyclase is comprised of at least three proteins: a catalytic protein, one or more hormone receptors and a nucleotide-binding protein with both stimulatory (Ns) and inhibitory (Ni) GDP-binding components (Ross and Gilman, 1980; Fain and Garcia-Sainz, 1983).

Activation of the Ns component of adenylate cyclase by catecholamines or glucagon is very rapid and generally of short duration, with elevated lipolysis occurring only as long as cAMP levels are high. Examples of rapid lipolytic responses include exercise and cold stress. These effects are rapid in onset and duration and highlight the central role played by catecholamines in the acute control of lipolysis and fat mobilization. An example of the rapidity with which catecholamines can increase fat mobilization is provided in Fig. 13.6 where the plasma NEFA response to an intravenous injection of epinephrine in control and bST-treated steers is shown (Boisclair *et al.*, 1997). The NEFA response is rapid in onset, short in duration and, as will be discussed later, augmented in bST-treated animals. However, at a more chronic level of regulation, fat metabolism does not appear to be mediated completely via the sympathetic nervous system although there can be quite clear changes in responsiveness and sensitivity to catecholamines as the ruminant animal moves from one physiological state to another (see below).

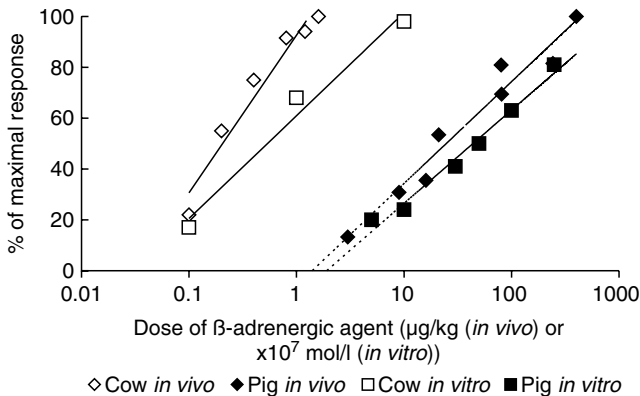
Fat mobilization in the ruminant animal appears to be particularly sensitive to adrenergic stimulation, a concept initially introduced by Pethick and Dunshea (1996). *In vivo* NEFA responses to epinephrine in lactating dairy cows have suggested an effective dose that gives 50% of the maximal NEFA response ( $\text{ED}_{50}$ ) of approximately 0.5–0.7  $\mu\text{g}/\text{kg}$  (Sechen *et al.*, 1990;

**Fig. 13.6.** Plasma NEFA response to an epinephrine challenge in steers. Treatments were daily injection of excipient (control) or bovine somatotropin (bST, 120  $\mu\text{g}/\text{kg}$ ). The epinephrine challenge was administered intravenously on day 16 of treatment, 26.25 h after the last injection (Boisclair *et al.*, 1997).



Burmeister *et al.*, 1992) which is much less than any estimate of  $\text{ED}_{50}$  for synthetic  $\beta$ -agonists in pigs (12 to 25  $\mu\text{g}/\text{kg}$ ; Dunshea *et al.*, 1998) (Fig. 13.7). Although there may be differences between physiological states and test  $\beta$ -adrenergic agents it does raise the possibility that dietary  $\beta$ -agonists are more efficacious in reducing fat deposition in ruminants than in pigs because of their greater adipose tissue adrenergic sensitivity.

There are also differences in adrenergic sensitivity in fat depots between depot location, animal breeds and stages of development (Dunshea and D'Souza, 2003). For example, although there was no difference in fasting plasma NEFA concentrations in Merino vs. Merino  $\times$  British breed (crossbreds)



**Fig. 13.7.** Effect of dose of *in vivo*  $\beta$ -adrenergic challenge ( $\mu\text{g}/\text{kg}$ ) on plasma NEFA responses (diamonds) and of *in vitro*  $\beta$ -adrenergic incubation ( $\times 10^7$  M) on glycerol release from adipose tissue explants (squares). Data are for lactating dairy cow (open symbol) and growing pig (closed symbol). All data were generated using epinephrine with the exception of *in vivo* pig study where fenoterol, which has a similar potency to epinephrine (Mersmann, 1987) was used. (Mersmann *et al.*, 1974; McNamara, 1988; Sechen *et al.*, 1990; Dunshea *et al.*, 1998).

sheep chronically fed at 1.5 times maintenance (0.43 vs. 0.47 mM), fasting plasma NEFA concentrations were increased to a lesser extent in Merino than in the crossbred sheep when chronically fed at 0.5 times maintenance (0.61 vs. 0.93 mM) (Leury and Dunshea, 2003). The maximal adrenergic stimulated NEFA concentrations were also not different between the breeds when lambs were fed at 1.5 times maintenance, whereas they were higher in the crossbred lambs when fed at 0.5 times maintenance. The final response in terms of NEFA turnover is an interplay between energy intake, total body fatness and differential changes in catecholamine sensitivity of regional fat depots induced by feed restriction such that animals with a reputation for greater adaptation to harsher environments (e.g. Merino and fat-tailed sheep) have a more moderate NEFA turnover in response to feed restriction (Chilliard *et al.*, 2000). This lower rate of fat mobilization is presumably related to a greater capacity to survive chronic feed restriction.

An additional and unresolved factor will be the basal energy requirement of the animal such that part of the adaptation may be a lower metabolic rate in animals evolved to adapt to harsh environments meaning a reduced energetic need for fat mobilization. The interplay between these factors is well discussed by Chilliard *et al.* (2000) but requires more work to allow a full understanding of the mechanisms involved.

Conversely, infusion of insulin decreases glycerol and NEFA concentrations and entry rate (Bergman, 1968; Dunshea *et al.*, 1995). The antilipolytic action of insulin is concentration dependent and evident within the physiological range (Pettersson *et al.*, 1994). Indeed, the plasma NEFA response to insulin appears to be more sensitive (i.e. occur at lower insulin concentrations) than the stimulatory effect of insulin on whole-body glucose utilization and the inhibitory effect of insulin on glucose production (Pettersson *et al.*, 1993). These different responses may reflect different sensitivities of the major tissue sites involved in the NEFA response (e.g. adipose tissue) and glucose metabolism (muscle and liver).

Recent data have suggested that NEFA and TAG metabolism in sheep muscle may also be acutely regulated by nitric oxide (NO). Cottrell *et al.* (2004) inhibited nitric oxide synthase (NOS) through infusion of L-N<sup>G</sup>-nitroarginine methyl ester (hydrochloride) (L-NAME) in lambs surgically prepared with hind limb arterial and venous catheters. Hind limb venous plasma NEFA concentrations were increased, suggesting an increase in lipolysis and/or a decrease in hind limb NEFA utilization. These authors suggested that the mechanism initiating increases in venous NEFA concentrations were unlikely to involve plasma TAG hydrolysis since plasma TAG concentrations were not decreased by NOS inhibition. Therefore, it is likely that increased venous NEFA concentrations were due to increased adipose tissue or skeletal muscle TAG hydrolysis or decreased NEFA utilization (Cottrell *et al.*, 2004). Also, the increase in venous plasma NEFA concentrations was not mediated via altered plasma insulin concentrations. It is likely that elucidating the role of NO in NEFA metabolism will be an active area of research over the next few years.

### **Chronic homoeorrhetic regulation of NEFA metabolism**

While insulin, glucagon and catecholamines are obviously involved in the acute regulation of fat metabolism it was apparent to Bauman and Currie (1980) that there must be some more chronic homoeorrhetic regulation of all aspects of metabolism during different physiological states. They suggested somatotropin (ST) as the agent for this form of regulation during growth and lactation and that this action may be mediated by altering the tissue response (via change in receptor number or modification of intracellular signals) to homoeostatic signals such as catecholamines and insulin.

One physiological state where an altered response to homoeostatic hormones occurs is the onset of lactation. For example, there is a progressive increase in adipose tissue adrenergic lipolytic sensitivity to adrenergic agents as animals progress from the dry state through pregnancy and into lactation (Guesnet *et al.*, 1987, 1991). As milk production decreases and feed intake increases and the lactating animal moves into positive energy balance, adrenergic sensitivity decreases once more. Catecholamine-stimulated lipolysis increases whereas insulin-stimulated glucose utilization by adipocytes decreases during early lactation, at a time when circulating levels of ST are elevated (Bauman *et al.*, 1989). Treatment of lactating dairy cows with exogenous ST, while increasing milk production, also increases the lipolytic response to adrenaline (Sechen *et al.*, 1990). Whether chronic increases in NEFA metabolism occur during ST treatment is dependent upon whether the milk production response is sufficient to move the animal into a lower energy balance. In this regard the study of Bauman *et al.* (1988) provides a classic example of the qualitative utility of NEFA kinetics. Exogenous ST resulted in an increase in milk fat secretion, which was matched by a similar increase in the entry rate of NEFA when corrected for oxidation. By contrast, in the study of Sechen *et al.* (1989), where the milk fat response to ST was more modest, there was predictably no discernible effect on the entry rate of NEFA.

Chronic treatment of well-fed growing ruminants with ST does not generally have any effect on plasma NEFA (Peters, 1986; Crooker *et al.*, 1990; Boisclair *et al.*, 1994, 1997). However, if feed is restricted or the animals are undergoing mild disturbances, ST treatment can increase plasma NEFA and/or NEFA entry rate in growing cattle (Eisemann *et al.*, 1986; Boisclair *et al.*, 1997). In part, this is because ST treatment causes an increase in the lipolytic response to catecholamines in growing animals (Boisclair *et al.*, 1997) as is the case for lactating animals. ST is high during early stages of growth and lactation and may exert at least some of its effects on nutrient partitioning in favour of lean tissue deposition via changes in sensitivity or responsiveness to homoeostatic signals involved in NEFA metabolism. Although similar changes in response to homoeostatic signals occur during pregnancy (see above), ST is not implicated in the chronic regulation during this physiological state.



## Conclusion

Fat metabolism plays a crucial role in the homeostasis of energy and carbohydrate balance of ruminants. The metabolism would seem to be adequately described by utilizing kinetic measurements of the plasma NEFA obtained using labelled tracer (either radioactive or stable) to determine the entry rate of NEFA. Indeed, such measurements seem to account for the metabolism of both plasma NEFA and TAG, although further verification would be desirable. Furthermore, these kinetic measurements are closely correlated with energy balance lending further support to the usefulness of NEFA biokinetics. Areas requiring further work include the fate of NEFA, particularly the role of oxidation vs. esterification, and the quantitative contribution of tissues to NEFA use. Further studies are also needed to quantify and understand the metabolism of different adipose tissue sites and how this is affected by genotypic and environmental variables.

## References

- Annison, E.F. (1984) The metabolism of neutral and acidic lipids by tissues of the ruminant. In: Gilchrist, F.M.C. and Mackie, R.I. (eds) *Herbivore Nutrition in the Subtropics and Tropics*. The Science Press, Pretoria, pp. 549–570.
- Annison, E.F., Brown, R.E., Leng, R.A., Lindsay, D.B. and West, C.E. (1967a) Rates of entry and oxidation of acetate, glucose, D(-)- $\beta$ -hydroxy-butyrate, palmitate, oleate and stearate, and rates of production and oxidation of propionate and butyrate in fed and starved sheep. *Biochemical Journal* 104, 135–147.
- Annison, E.F., Linzell, J.L., Fazakerly, S. and Nichols, B.W. (1967b) The oxidation and utilisation of palmitate, stearate, oleate and acetate by the mammary gland of the fed goat in relation to their overall metabolism, and the role of plasma phospholipids and neutral lipids in milk fat synthesis. *Biochemical Journal* 102, 637–647.
- Annison, E.F., Linzell, J.L. and West, C.E. (1968) Mammary and whole animal metabolism of glucose and fatty acids in fasting lactating goats. *Journal of Physiology, London* 197, 445–459.
- Bauman, D.E. and Currie, W.B. (1980) Partitioning of nutrients during pregnancy and lactation: a review of mechanisms involving homeostasis and homeorhesis. *Journal of Dairy Science* 63, 1514–1529.
- Bauman, D.E., Peel, C.J., Steinhour, W.D., Reynolds, P.J., Tyrrell, H.F., Brown, A.G.G. and Haaland, G.L. (1988) Effect of bovine somatotropin on metabolism of lactating cows: influence on rates of irreversible loss and oxidation of glucose and nonesterified fatty acids. *Journal of Nutrition* 118, 1031–1040.
- Bauman, D.E., Dunshea, F.R., Boisclair, Y.R., McGuire, M.A., Harris, D.M. and Houseknecht, K.L. (1989) Regulation of nutrient partitioning; homeostasis, homeorhesis and exogenous somatotropin. In: *Proceedings of the Seventh International Conference on Production Disease in Farm Animals, Ithaca, 1989*. Cornell University, Ithaca, New York, pp. 306–323.
- Beatty, D., Barnes, A., Pethick, D.W., Taylor, E. and Dunshea, F.R. (2004) *Bos indicus* cattle can maintain feed intake and fat reserves in response to heat stress better than *Bos taurus* cattle. *Journal of Animal and Feed Sciences*, 13 (Suppl. 1), 619–622.

- Bell, A.W. (1981) Lipid metabolism in liver and selected tissues and in the whole body of ruminant animals. In: Christie, W.W. (ed.) *Lipid Metabolism and Ruminant Animals*. Pergamon Press, Oxford, UK, pp. 363–410.
- Bell, A.W. and Hales, J.R.S. (1985) Circulatory implications of exercise and heat stress. *Pharmacology & Therapy* 31, 103–120.
- Bell, A.W. and Thompson, G.E. (1979) Free fatty acid oxidation in bovine muscle *in vivo*: effects of cold exposure and feeding. *American Journal of Physiology* 237, 309–315.
- Bergman, E.N. (1968) Glycerol turnover in the nonpregnant and ketotic pregnant sheep. *American Journal of Physiology* 215, 865–873.
- Bergman, E.N., Havel, R.J., Wolfe, B.M. and Bohmer, T. (1971) Quantitative studies of the metabolism of chylomicron triglycerides and cholesterol by liver and extra hepatic tissues of sheep and dogs. *Journal of Clinical Investigations* 50, 1831–1839.
- Bickerstaffe, R., Noakes, D.E. and Annison, E.F. (1972) Quantitative aspects of fatty acid biohydrogenation, absorption and transfer into milk fat in the lactating goat, with special reference to the *cis*- and *trans*-isomers of octadecenoate and linoleate. *Biochemical Journal* 130, 607–617.
- Bickerstaffe, R., Annison, E.F. and Linzell, J.L. (1974) The metabolism of glucose, acetate, lipids and amino acids in lactating dairy cows. *Journal of Agricultural Science, Cambridge* 82, 71–85.
- Boisclair, Y.R., Bauman, D.E., Bell, A.W., Dunshea, F.R. and Harkins, M. (1994) Nutrient utilisation and protein turnover in the hindlimb of cattle treated with bovine somatotropin. *Journal of Nutrition* 124, 664–673.
- Boisclair, Y.R., Johnston, K.B., Bauman, D.E., Crooker, B.A., Dunshea, F.R. and Bell, A.W. (1997) Paradoxical increases of circulating nonesterified fatty acids in somatotropin treated cattle undergoing mild disturbances. *Domestic Animal Endocrinology* 14, 251–262.
- Brindle, N.P.J., Zammit, V.A. and Pogson, C.I. (1985) Regulation of carnitine palmitoyltransferase activity by malonyl-CoA in mitochondria from sheep liver, a tissue with a low capacity for fatty acid synthesis. *Biochemical Journal* 232, 177–182.
- Burmeister, J.E., Crooker, B.A., Hansen, L.B. and Young, C.W. (1992) Effect of genetic selection for milk yield on plasma nonesterified fatty acid response of lactating heifers to epinephrine. *Journal of Dairy Science* 75 (Suppl. 1), 183.
- Butterfield, R.M., Griffiths, D.A., Thompson, J.M., Zamora, J. and James, A.M. (1983) Changes in body composition relative to weight and maturity in large and small strains of Australian Merino rams. 1. Muscle, bone and fat. *Animal Production* 36, 29–37.
- Capaldo, B., Napoli, R., Marino, L., Di Guida, R., Pardo, F. and Sacca, L. (1994) Role of insulin and free fatty acid (FFA) availability on regional FFA kinetics in the human forearm. *Journal of Clinical Endocrinology and Metabolism* 79, 879–882.
- Chilliard, Y., Ferlay, A., Faulconnier, Y., Bonnet, M., Rouel, J. and Bocquier, F. (2000) Adipose tissue metabolism and its role in adaptations to undernutrition in ruminants. *Proceedings of the Nutrition Society* 59, 127–134.
- Cottrell, J.J., Warner, R.D., McDonagh, M.B. and Dunshea, F.R. (2004) Inhibition of endogenous nitric oxide production influences ovine hindlimb metabolism independently of insulin concentrations. *Journal of Animal Science* 82, 2558–2567.
- Crooker, B.A., McGuire, M.A., Cohick, W.S., Harkins, M., Bauman, D.E. and Sejrsen, K. (1990) Effect of dose of bovine somatotropin on nutrient utilisation in growing dairy heifers. *Journal of Nutrition* 120, 1256–1263.

- Dagenais, G.R., Tancredi, R.G. and Zierler, K.L. (1976) Free fatty acid oxidation by forearm muscle at rest, and evidence for an intramuscular lipid pool in the human forearm. *Journal of Clinical Investigations* 58, 421–431.
- Dunshea, F.R. (1987) Use of labile tissue reserves during early lactation and chronic undernutrition in goats. PhD thesis, La Trobe University, Melbourne, Australia.
- Dunshea, F.R. and King, R.H. (1995) Responses to homeostatic signals in ractopamine-treated pigs. *British Journal of Nutrition* 73, 809–818.
- Dunshea, F.R. and D'Souza, D.N. (2003) Factors influencing fat deposition and metabolism in the pig. In: Paterson, J. (ed.) *Manipulating Pig Production IX*. Australasian Pig Science Association, Werribee, Australia, pp. 127–150.
- Dunshea, F.R., Bell, A.W. and Trigg, T.E. (1988) Relations between plasma non-esterified fatty acid metabolism and body tissue mobilisation during chronic undernutrition in goats. *British Journal of Nutrition* 60, 633–644.
- Dunshea, F.R., Bell, A.W. and Trigg, T.E. (1989) Relationships between plasma non-esterified fatty acid metabolism and body fat mobilisation in primiparous lactating goats. *British Journal of Nutrition* 62, 51–61.
- Dunshea, F.R., Bell, A.W. and Trigg, T.E. (1990) Non-esterified fatty acid and glycerol kinetics and re-esterification in early lactating goats. *British Journal of Nutrition* 64, 133–145.
- Dunshea, F.R., Harris, D.M., Bauman, D.E., Boyd, R.D. and Bell, A.W. (1992) Effect of somatotropin on non-esterified fatty acid and glycerol metabolism in growing pigs. *Journal of Animal Science* 70, 132–140.
- Dunshea, F.R., Boisclair, Y.R., Bauman, D.E. and Bell, A.W. (1995) Effects of bovine somatotropin and insulin on whole-body and hindlimb glucose metabolism in the growing steer. *Journal of Animal Science* 73, 2263–2271.
- Dunshea, F.R., Leury, B.J. and King, R.H. (1998) Lipolytic responses to catecholamines in ractopamine treated pigs. *Australian Journal of Agricultural Research* 49, 875–881.
- Dunshea, F.R., Trigg, T.E., Chandler, K.D. and Bell, A.W. (2000) Relationships between *in vivo* and *in vitro* lipid metabolism in lactating goats. *Australian Journal of Agricultural Research* 51, 139–145.
- Eisemann, J.H., Hammond, A.C., Bauman, D.E., Reynolds, P.J., McCutcheon, S.N., Tyrrell, H.F. and Haaland, G.L. (1986) Effect of bovine growth hormone administration on metabolism of growing Hereford heifers: protein and lipid metabolism and plasma concentrations of metabolites and hormones. *Journal of Nutrition* 116, 2504–2515.
- Emery, R.S. (1979) Deposition, secretion, transport and oxidation of fat in ruminants. *Journal of Animal Science* 48, 1530–1537.
- Emmanuel, B. and Kennelly, J.J. (1984) Effect of propionic acid on kinetics of acetate and oleate and on plasma and milk fatty acid composition of goats. *Journal of Dairy Science* 67, 1199–1208.
- Fain, J.N. and Garcia-Sainz, J.A. (1983) Adrenergic regulation of adipocyte metabolism. *Journal of Lipid Research* 24, 945–966.
- Foot, J.Z. and Russell, A.J.F. (1979) The relationship in ewes between voluntary food intake during pregnancy and forage intake during lactation and after weaning. *Animal Production* 28, 25–39.
- Freetly, H.C. and Ferrell, C.L. (2000) Net flux of nonesterified fatty acids, cholesterol, triacylglycerol, and glycerol across the portal-drained viscera and liver of pregnant ewes. *Journal of Animal Science* 78, 1380–1388.

- Gerloff, B.J., Herdt, T.H. and Emery, R.S. (1986) Relationship of hepatic lipodosis to health and performance in dairy cattle. *Journal of the American Veterinary Medical Association* 188, 845–850.
- Gruffat, D., Durand, D., Chilliard, Y., Williams, P. and Bauchart, D. (1997) Hepatic gene expression of apolipoprotein B100 during early lactation in underfed, high producing dairy cows. *Journal of Dairy Science* 80, 657–666.
- Guesnet, P., Massoud, M. and Demarne, Y. (1987) Effects of pregnancy and lactation on lipolysis of ewe adipocytes induced by beta-adrenergic stimulation. *Molecular and Cellular Endocrinology* 50, 177–181.
- Guesnet, P., Massoud, M. and Demarne, Y. (1991) Regulation of adipose tissue metabolism during pregnancy and lactation in the ewe: the role of insulin. *Journal of Animal Science* 69, 2057–2065.
- Hamosh, M. and Hamosh, P. (1983) Lipoprotein lipase: its physiological and clinical significance. *Molecular Aspects of Medicine* 6, 199–289.
- Harman, H.G. (1991) Energy metabolism in rested, exercised and overfed sheep. PhD thesis, Murdoch University, Western Australia.
- Harrison, F.A. and Leat, W.M.F. (1972) Absorption of palmitic, stearic and oleic acids in the sheep in the presence or absence of bile and/or pancreatic juice. *Journal of Physiology* 225, 565–575.
- Heitmann, R.N., Dawes, D.J. and Sensenig, S.C. (1987) Hepatic ketogenesis and peripheral ketone body utilisation in the ruminant. *Journal of Nutrition* 117, 1174–1180.
- Holmes, J.H.G. and Lambourne, L.J. (1970) The relations between plasma free fatty acid concentrations and the digestible energy intake of cattle. *Research in Veterinary Science* 11, 27–36.
- Issekutz, B., Miller, H.I., Paul, P. and Rodahl, K. (1965) Aerobic work capacity and plasma FFA turnover. *Journal of Applied Physiology* 20, 293–296.
- Jensen, M.D., Rogers, P.J., Ellman, M.G. and Miles, J.M. (1988) Choice of infusion-sampling mode for tracer studies of free fatty acids metabolism. *American Journal of Physiology* 254, E562–E565.
- Johnson, M.M. and Peters, J.P. (1993) Technical note: an improved method to quantify non-esterified fatty acids in bovine plasma. *Journal of Animal Science* 71, 753–756.
- King, K.R. (1983) Lipid metabolism in the lactating ewe. MAgSci thesis, University of Sydney, Sydney, Australia.
- Konig, B.A., Parker, D.S. and Oldham, J.D. (1979) Acetate and palmitate kinetics in lactating dairy cows. *Annales de Recherches Veterinaire* 10, 368–370.
- Konig, B.A., Oldham, J.D. and Parker, D.S. (1984) The effect of abomasal infusion of casein on acetate, palmitate and glucose kinetics in cows during early lactation. *British Journal of Nutrition* 52, 319–328.
- Kris-Etherton, P.M. and Etherton, T.D. (1982) The role of lipoproteins in lipid metabolism of meat animals. *Journal of Animal Science* 55, 804–817.
- Leat, W.M.F. and Ford, E.J.H. (1966) Utilisation of free fatty acids by starved and pregnant sheep. *Biochemical Journal* 101, 317–322.
- Leury, B.J. and Dunshea, F.R. (2003) Level of nutrition and breed can influence basal and  $\beta$ -adrenergic stimulated fat mobilisation in lambs. *Journal of Animal Science* 81 (Suppl. 1); *Journal of Dairy Science* 86 (Suppl. 1), 95.
- Lindsay, D.B. (1975) Fatty acids as energy sources. *Proceedings of the Nutrition Society* 34, 241–248.
- Lindsay, D.B. and Leat, W.M.F. (1977) Oxidation and metabolism of linoleic acid in fed and fasted sheep. *Journal of Agricultural Science, Cambridge* 89, 215–221.

- Madsen, J., Bulow, J. and Nielsen, N.E. (1986) Inhibition of fatty acid mobilisation by arterial free fatty acid concentration. *Acta Physiologica Scandinavica* 127, 161–166.
- McDowell, G.H., Hart, I.C., Bines, J.A., Lindsay, D.B. and Kirby, A.C. (1987) Effects of pituitary-derived bovine growth hormone on production parameters and biokinetics of key metabolites in lactating dairy cows at peak and midlactation. *Australian Journal of Biological Sciences* 40, 191–202.
- McDowell, G.H., Leenanuruksa, D., Niumsup, P., Gooden, J.M., van der Walt, J.G. and Smithard, R. (1988) Short-term effects of exogenous growth hormone: effects on milk production and utilisation of nutrients in muscle and mammary tissues of lactating ewes. *Australian Journal of Biological Sciences* 41, 279–288.
- McNamara, J.P. (1988) Regulation of bovine adipose tissue metabolism during lactation. Dose-responsiveness to epinephrine as altered by stage of lactation. *Journal of Dairy Science* 71, 643–649.
- Mersmann, H.J. (1987) Acute metabolic effects of adrenergic agents in swine. *American Journal of Physiology* 252, E85–E95.
- Mersmann, H.J., Brown, L.J., Underwood, M.C. and Stanton, H.C. (1974) Catecholamine-induced lipolysis in swine. *Comparative Biochemistry and Physiology* 47B, 263–270.
- Moore, J.H. and Christie, W.W. (1981) Lipid metabolism in the mammary gland of ruminant animals. In: Christie, W.W. (ed.) *Lipid Metabolism in Ruminant Animals*. Pergamon Press, Oxford, UK, pp. 227–277.
- Newsholme, E.A. and Leech, A.R. (1983) *Biochemistry for the Medical Sciences*. John Wiley, Chichester, UK.
- Noble, R.C. (1981) Digestion, absorption and transport of lipids in ruminant animals. In: Christie, W.W. (ed.) *Lipid Metabolism in Ruminant Animals*. Pergamon Press, Oxford, UK, pp. 57–93.
- Ookhtens, M., Montisano, D., Lyon, I. and Baker, N. (1987) Transport and metabolism of extracellular free fatty acids in adipose tissue of fed and fasted mice. *Journal of Lipid Research* 28, 528–539.
- Ostrowska, E., Cross, R.F., Muralitharan, M., Bauman, D.E. and Dunshea, F.R. (2002) Effects of dietary fat and conjugated linoleic acid on plasma metabolite concentrations and metabolic responses to homeostatic signals in pigs. *British Journal of Nutrition* 88, 625–634.
- Payne, E. and Masters, C.J. (1971) The *in vivo* incorporation of fatty acids into ovine tissue during rumen development. *International Journal of Biochemistry* 2, 349–367.
- Pell, J.M., Caldarone, E.M. and Bergman, E.N. (1986) Leucine and  $\alpha$ -ketoisocaproate metabolism and interconversions in fed and fasted sheep. *Metabolism* 35, 1005–1016.
- Peters, J.P. (1986) Consequences of accelerated gain and growth hormone administration on lipid metabolism in growing beef steers. *Journal of Nutrition* 116, 2490–2503.
- Pethick, D.W. (1980) Metabolism of fatty acids in normal and ketotic sheep. PhD thesis, Cambridge University, Cambridge, UK.
- Pethick, D.W. and Dunshea, F.R. (1996) The partitioning of fat in farm animals. *Proceedings of the Nutrition Society of Australia* 20, 3–13.
- Pethick, D.W. and Lindsay, D.B. (1982) Metabolism of ketone bodies in pregnant sheep. *British Journal of Nutrition* 48, 549–563.
- Pethick, D.W., Lindsay, D.B., Barker, P.J. and Northrop, A.J. (1981) Acetate supply and utilisation by the tissues of sheep *in vivo*. *British Journal of Nutrition* 46, 97–110.

- Pethick, D.W., Lindsay, D.B., Barker, P.J. and Northrop, A.J. (1983) The metabolism of circulating nonesterified fatty acids by the whole animal, hindlimb and uterus of pregnant ewes. *British Journal of Nutrition* 49, 129–143.
- Pethick, D.W., Harman, N.G. and Chong, J.K. (1987) Nonesterified long-chain fatty acid metabolism in fed sheep at rest and during exercise. *Australian Journal of Biological Research* 40, 221–234.
- Pethick, D.W., Harper, G.S. and Oddy, V.H. (2004) Growth, development and nutritional manipulation of marbling in cattle: a review. *Australian Journal of Experimental Agriculture* 44, 705–715.
- Petterson, J.A., Dunshea, F.R., Ehrhardt, R.A. and Bell, A.W. (1993) Pregnancy and undernutrition alter glucose metabolic responses to insulin in sheep. *Journal of Nutrition* 123, 1286–1295.
- Petterson, J.A., Slepatis, R., Ehrhardt, R.A., Dunshea, F.R. and Bell, A.W. (1994) Pregnancy but not moderate undernutrition attenuates insulin suppression of fat mobilisation in sheep. *Journal of Nutrition* 124, 2431–2436.
- Pullen, D.L., Emery, R.S. and Ames, N.K. (1988) Turnover of hepatic and plasma triacylglycerol in sheep. *Journal of Animal Science* 66, 1538–1547.
- Pullen, D.L., Palmquist, D.L. and Emery, R.S. (1989) Effect on days of lactation and methionine hydroxy analog on incorporation of plasma fatty acids into plasma triglycerides. *Journal of Dairy Science* 72, 49–58.
- Raclot, T. and Oudart, H. (2000) Net release of individual fatty acids from white adipose tissue during lipolysis *in vitro*: evidence for selective fatty acid re-uptake. *Biochemical Journal* 348, 129–136.
- Randle, P.J. (1986) Fuel selection in animals. *Biochemical Society Transactions* 14, 799–806.
- Ross, E.M. and Gilman, A.G. (1980) Biochemical properties of hormone-sensitive adenylate cyclase. *Annual Review of Biochemistry* 49, 533–564.
- Sahlin, K. (1986) Metabolic changes limiting muscle performance. In: Saltin, B. (ed.) *Biochemistry of Exercise*. International Series on Sport Sciences, Vol. 16. Human Kinetics, Illinois, pp. 323–343.
- Sandles, L.D., Sun, Y.X., D'Cruz, A.G.C., McDowell, G.H. and Gooden, J.M. (1988) Responses of lactating ewes to exogenous growth hormone: short- and long-term effects on productivity and tissue utilisation of key metabolites. *Australian Journal of Biological Science* 41, 357–370.
- Sechen, S.J., Bauman, D.E., Tyrell, H.E. and Reynolds, P.J. (1989) Effect of somatotropin on kinetics of nonesterified fatty acids and partition of energy, carbon and nitrogen in lactating cows. *Journal of Dairy Science* 72, 59–67.
- Sechen, S.J., Dunshea, F.R. and Bauman, D.E. (1990) Somatotropin in lactating cows: effect on response to epinephrine and insulin. *American Journal of Physiology* 258, E582–E588.
- Symonds, M.E., Bryant, M.J. and Lomax, M.A. (1989) Lipid metabolism in shorn and unshorn pregnant sheep. *British Journal of Nutrition* 62, 35–49.
- van der Walt, J.G. (1984) Metabolic interactions of lipogenic precursors in the ruminant. In: Gilchrist, F.M.C. and Mackie, R.I. (eds) *Herbivore Nutrition in the Subtropics and Tropics*. The Science Press, Pretoria, pp. 571–593.
- van der Walt, J.G., Marais, A., Campbell, S. and Gooden, J.M. (1984) Acetate and free fatty acid metabolism in the fat-tailed sheep. *Canadian Journal of Animal Science* 64 (Suppl.), 244–245.
- Vernon, R.G. (1981) Lipid metabolism in the adipose tissue of ruminant animals. In: Christie, W.W. (ed.) *Lipid Metabolism in Ruminant Animals*. Pergamon Press, Oxford, UK, pp. 279–362.

- Vernon, R.G. and Flint, D.J. (1984) Adipose tissue: metabolic adaptation during lactation. *Symposium Zoological Society, London* 51, 119–145.
- Wilson, S. (1984) The metabolism of fatty acids in undernourished pregnant ewes. *Canadian Journal of Animal Science* 64 (Suppl.), 246–247.
- Wiseman, J. (ed.) (1984) *Fats in Animal Nutrition: Proceedings of the 37th Nottingham Easter School*. Butterworths, London.
- Wisneski, J.A., Gertz, E.W., Neese, R.A. and Mayr, M. (1987) Myocardial metabolism of free fatty acids. *Journal of Clinical Investigation* 79, 359–366.
- Yamadagni, S. and Schultz, C.H. (1969) Metabolism of 1-<sup>14</sup>C palmitic acid in goats in various metabolic states. *Journal of Dairy Science* 52, 1278–1288.
- Zierler, K.L. and Rabinowitz, D.L. (1964) Effect of very small concentrations of insulin on forearm metabolism: persistence of its action on potassium and free fatty acids without its effect on glucose. *Journal of Clinical Investigation* 43, 950–962.

*This page intentionally left blank*



---

# 14 Protein Metabolism and Turnover

D. Attaix,<sup>1</sup> D. Rémond<sup>1</sup> and I.C. Savary-Auzeloux<sup>2</sup>

<sup>1</sup>*Institut National de la Recherche Agronomique, Unité de Nutrition et Métabolisme Protéique, Theix, 63122 Ceyrat, France;* <sup>2</sup>*Institut National de la Recherche Agronomique, Unité de Recherches sur les Herbivores, Theix, 63122 Ceyrat, France*

---

## Introduction

All cellular proteins are in a continuous state of turnover in which they are synthesized and degraded (Waterlow *et al.*, 1978). Thus, the intracellular concentration of any protein, and the tissue, organ or whole-body protein mass, are determined by the relative synthetic and degradation rates. It should be pointed out that a change in the size of a given protein pool only depends on the imbalance between both processes of protein turnover. In other words, an increase or a decrease in such a protein pool does not necessarily correlate with only an enhanced rate of either protein synthesis or protein breakdown, respectively. For example, the anabolic agent trenbolone acetate decreased rates of both protein synthesis and breakdown and resulted in net muscle protein gain (Vernon and Buttery, 1976).

The cyclical nature of protein turnover also implies that rates of protein synthesis and degradation are considerably greater than the net flux (protein deposition or loss) through the protein turnover cycle. For example, a large proportion of free amino acids arising from protein breakdown is reutilized for protein synthesis, so that the rate of whole-body protein synthesis is much greater than the rate of dietary influx of amino acids.

Both protein synthesis and breakdown require energy (see below). However, the process of protein turnover provides the organism with several adaptive mechanisms that clearly outweigh the metabolic costs:

1. Growth and mobilization of tissue/organ and whole-body protein mass is easily achieved, depending on the physiological status.
2. Large amounts of free amino acids can be mobilized from skeletal muscle and used to provide energy and precursors for protein synthesis in vital organs (brain, heart, etc.) and synthesis of specific sets of proteins (e.g. acute phase

proteins by the liver) in stress situations, even when dietary amino acid supply is deficient.

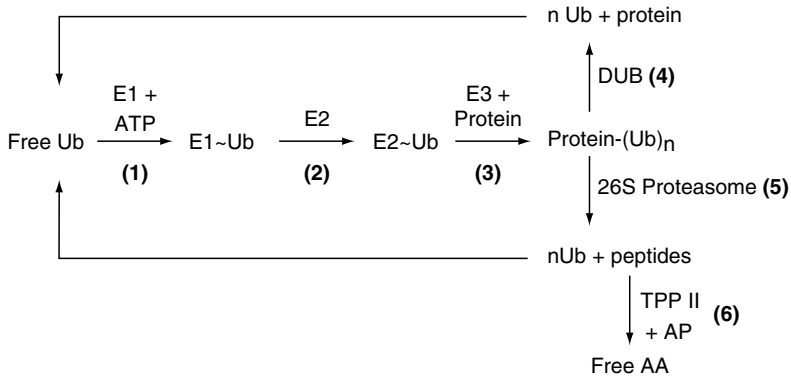
3. Abnormal (e.g. miscoded or misfolded) proteins can be broken-down and do not accumulate in cells.
4. Both endogenous and exogenous proteins, including bacterial and viral proteins, are hydrolysed into peptides and presented on major histocompatibility complexes to eventually activate the immune system.
5. The intracellular abundance of key proteins (e.g. enzymes, cyclins or transcription factors) is tightly regulated so that major biological processes are precisely controlled.

A major challenge is to understand both general and tissue/organ-specific mechanisms, which are responsible for these adaptations. *In vitro* studies have provided detailed information on the regulatory mechanisms of protein turnover. *In vivo* studies are inevitably more descriptive, and experiments in animal production are mostly designed to optimize protein deposition efficiency in skeletal muscle (meat) or milk production. Furthermore, the cost of research in large animal species has clearly impeded our understanding of protein metabolism in ruminants, so that most available information remains fragmentary.

## Mechanisms of Protein Turnover

The precise mechanisms of protein synthesis, which include transcription, translation and post-translational modifications, have been extensively studied and are detailed in many textbooks of biochemistry. The mechanisms that regulate protein breakdown are much more obscure. First, there are several proteolytic pathways within cells (e.g. lysosomal, Ca<sup>2+</sup>-dependent, ubiquitin–proteasome-dependent (see Fig. 14.1), etc.), and many proteases remain to be discovered or characterized. In addition, the relative contribution of proteolytic pathways to the rate of overall proteolysis is tissue specific. The lysosomal pathway plays a prominent role in liver (Attaix *et al.*, 1999), while the ubiquitin–proteasome system has a major importance in skeletal muscle (Attaix and Taillandier, 1998; Jagoe and Goldberg, 2001). Second, there are many alternative routes within a given proteolytic process (Attaix *et al.*, 1999). Third, *in vivo*, different proteolytic systems may either independently degrade a given protein substrate (Attaix *et al.*, 1999), or sequentially participate to its complete hydrolysis into free amino acids (Attaix *et al.*, 2002).

Protein synthesis requires the hydrolysis of both ATP and GTP. However, the actual cost of protein synthesis is much higher than the theoretical cost of peptide bond formation, presumably because many proteins involved in translational control are G-proteins, which are activated in the presence of GTP. Direct measurements of oxygen consumption in the presence of cycloheximide have yielded values of 5.4 and 7.5 kJ/g protein synthesis when measured *in vivo* in chickens, and *in vitro* in sheep muscle, respectively (see Lobley, 1994). Protein breakdown also requires energy. For example, ATP hydrolysis is required in many steps of ubiquitin–proteasome-dependent proteolysis



**Fig. 14.1.** Schematic representation of the ubiquitin (Ub)–proteasome-dependent proteolytic pathway. Polyubiquitination of the substrate is achieved in sequential steps (1) to (3). (1) The Ub-activating enzyme, E1, forms a thiol–ester bond with Ub. (2) The activated Ub is then transferred to an Ub-conjugating enzyme, E2, which also forms a thiol–ester linkage with Ub. (3) In the presence of an Ub–protein ligase, E3, that specifically recognizes the substrate, the E2 and / or E3 covalently binds a polyUb chain (Ub)<sub>n</sub> to the target protein. (4) A huge family of deubiquitinating enzymes (DUB) can remove the polyUb degradation signal, so that the substrate is not degraded and free ubiquitin is recycled. (5) More generally, the polyUb degradation signal is recognized by the 26S proteasome, and the substrate is cut into peptides with recycling of free Ub. (6) The peptides generated by the proteasome are finally hydrolysed into free amino acids (AA) by the tri-peptidyl peptidase II (TPP II) and several associated aminopeptidases (AP) (see Attaix *et al.*, 2002 for more detailed information).

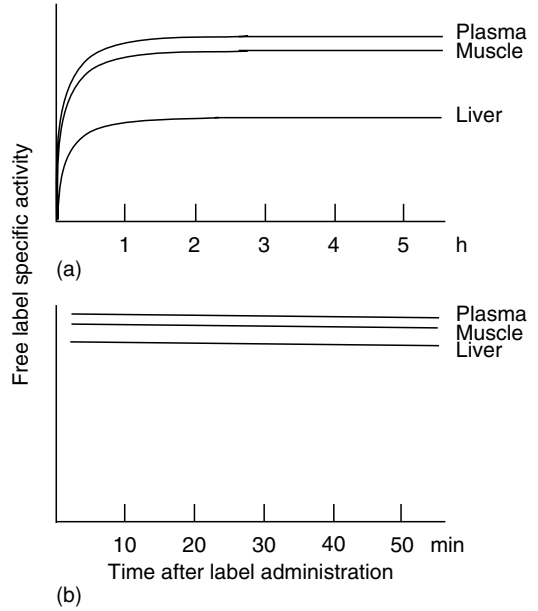
(Attaix *et al.*, 2002). It has been suggested that 10% of the cellular energy requirements are linked to proteolysis (Lobley, 1994). This estimation must be taken with caution. The amount of energy required to degrade 1 g of protein is unknown, cannot be assessed experimentally, and presumably largely depends on numerous factors, which include the nature of the substrate, the proteolytic system(s) involved in its breakdown, the site of proteolysis, etc.

## Measurement of Protein Synthesis and Degradation

### Whole-body protein turnover

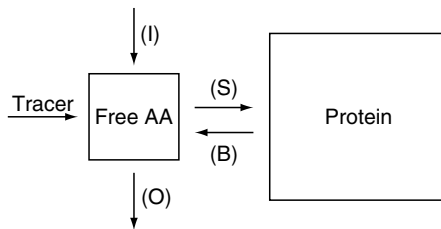
The constant infusion technique has been widely used to estimate both components of whole-body protein turnover. A labelled amino acid is infused intravenously until the plasma specific radioactivity or enrichment (for a radio- or a stable isotope, respectively) of the free amino acid used as a marker reaches a plateau. This is achieved within a few hours (Fig. 14.2a). The ratio, rate of isotope infusion/isotopic activity at the plateau, gives the flux or irreversible loss rate (ILR) of the amino acid from the plasma. If the labelled amino acid infused into the blood/plasma free amino acid pool is an essential amino acid, and if this pool has a constant size (steady state) the total input through this pool is equal to the total output, so that:

**Fig. 14.2.** Schematic representation of the specific activity of the tracer following the administration of a constant infusion (a) or of a flooding-dose (b) of a labelled amino acid. In (a) the ratio of the isotopic activity of the label at the end of the infusion crucially depends on the rate of protein turnover in the tissue (e.g. the tissue homogenate/plasma isotopic activity is high (0.9 to 0.7) in skeletal muscle, where the intensity of protein turnover is low, and is low (0.6 to 0.3) in tissues where protein turnover is rapid (liver, gut)). In (b), this problem is minimized over a short period of time, and this ratio is usually over 0.7, including when protein turnover is a rapid process (see Attaix and Arnal, 1987).



$$ILR = \text{Synthesis}(S) + \text{Oxidation}(O) = \text{Breakdown}(B) + \text{Intake}(I)$$

Amino acid oxidation (O) can be determined by using a 1-<sup>14</sup>C or 1-<sup>13</sup>C tracer amino acid, and collecting expired <sup>14</sup>CO<sub>2</sub> or <sup>13</sup>CO<sub>2</sub> that should be corrected for an apparent CO<sub>2</sub> fixation in the body. The whole-body protein synthesis rate (S) is then deduced from  $S = ILR - O$ . Alternatively, the whole-body rate of protein breakdown (B) is equal to  $B = ILR - I$  in the fed state, or to  $B = ILR$



**Fig. 14.3.** Two-pool model used for the estimation of the whole-body irreversible loss rate (ILR) and tissue protein fractional synthesis rate (FSR) *in vivo*, see text. Amino acid (AA) fluxes, which are inputs into the free amino acid pool (e.g. intake (I) and protein breakdown (B)), and outputs from this pool (e.g. protein synthesis (S) and amino acid oxidation (O)) are shown. The tracer, usually an essential amino acid, is infused or injected into the blood/plasma free amino acid pool, which is assumed to be the precursor pool for protein synthesis. A third pool (e.g. the intracellular free amino acid pool in equilibrium with the blood/plasma free amino acid pool and the protein pool) is often used to calculate the fractional rate of protein synthesis in a given tissue or organ (see Waterlow *et al.*, 1978 for detailed explanations).

in the fasted state. In ruminants I (absorption) is particularly difficult to estimate, and fasting is not easily achieved.

The technique is simple, non-destructive, allows different measurements in the same animal, but has some major flaws, which have been extensively discussed elsewhere (Waterlow *et al.*, 1978; Lobley, 1994). First, whole-body data are difficult to interpret and the ILR technique totally obscures changes in both rates of protein synthesis and breakdown in various tissues. Second, the technique provides only a minimum estimate of the rates of protein turnover and of amino acid oxidation since the isotopic activity is much higher in the plasma than in tissues, where the tracer is diluted by unlabelled free amino acid from protein degradation (Fig. 14.2a). Third, there is some recycling of the tracer from tissues where protein turnover is rapid (e.g. liver, gastrointestinal tract (GIT), see below), and this also causes underestimation of the ILR.

### ***Regional estimations of protein turnover***

Another closely related technique involves selective catheterization of an artery and a vein draining a hind limb bed. An index of both the rates of protein breakdown and synthesis is calculated by measuring the concentration of the label and its isotopic activity in arterial and venous blood, and the blood flow. Labelled phenylalanine (Barrett and Gelfand, 1989) and other amino acids can be used (Hoskin *et al.*, 2001). Amino acid oxidation can also be determined by following the fate of the C-1 moiety of essential amino acids. The arteriovenous approach has the same limitations as the ILR technique, and there is some contamination from the other tissues within the hind limb, e.g. skin and bone. Amino acid mass transfers have been also quantified by arteriovenous procedures across the portal-drained viscera (PDV) and liver in sheep (Lobley *et al.*, 1996). Such procedures require extensive surgery, but they allow repeated measurements within the same animal.

### ***Tissue and organ protein turnover***

#### ***Protein synthesis***

To measure fractional rates of protein synthesis (FSR, usually expressed in % per day) *in vivo* the specific radioactivity (or enrichment) of the labelled amino acid must be measured in both the precursor and the protein pools (Waterlow *et al.*, 1978). Except for skeletal muscle and skin, in which biopsies can be easily performed, slaughter is usually required to collect internal samples. Two techniques have provided most of the data available in ruminants.

The most commonly used is the constant tracer infusion analysis, as in the ILR technique (see above and Fig. 14.2a). The difficulty is to estimate the activity of the precursor pool for protein synthesis. The activity of the actual pool, the charged aminoacyl-tRNAs, is technically very difficult to determine. Based on experiments performed *in vitro* and *in vivo*, it is generally assumed that aminoacyl-tRNAs are charged from both extracellular (plasma) and intracellular

(tissue homogenate) free amino acid pools (Waterlow *et al.*, 1978). However, as the label is diluted by the unlabelled amino acid used as a marker, which arises from protein breakdown, there are large differences between the isotopic activities in these pools (Fig. 14.2a). This is especially true when protein turnover is high (liver, GIT). Consequently there are also large differences between FSR calculated by using the isotopic activity of the free label in the plasma and the tissue homogenates. In addition, since the label is infused during several hours, secreted or export proteins, which are for example synthesized in the liver and the intestines, are not taken into account in the measurements.

To overcome all these problems, the label can be injected with a large or flooding dose of the same unlabelled amino acid. This results in nearly constant and close isotopic activity of the tracer, both in the plasma and in tissue homogenates within a short period of time (Fig. 14.2b). To meet these goals the large dose of unlabelled amino acid should ideally represent several times the whole-body free amino acid content. For example, when [<sup>3</sup>H]valine was used as a tracer in 1-week-old lambs the flooding dose was very efficient with an unlabelled amount of valine that represented about ten times the whole-body free valine content (Attaix, 1988). In such conditions, FSR calculated from the isotopic activity of the free label either in the plasma or the tissue homogenates are quite similar. Although the technique is potentially interesting for measuring protein synthesis in tissues where FSR are high, there are some potential problems. First, the injection of a large amount of amino acid may affect amino acid transport and/or hormonal secretions (e.g. insulin). Second, the procedure is rather expensive. Consequently, there are very few measurements in adult ruminants, and all published data have been obtained for only the ovine species. Finally, the procedure may favour the measurement of FSR in short-lived proteins.

### *Protein breakdown*

Methodological problems associated with reliable measurements of *in vivo* proteolysis impede the understanding of its regulation. In addition, all techniques that can be used *in vivo* do not provide any information on proteolytic systems that are responsible for changes in proteolysis.

In tissues and organs from growing animals, the fractional rate of protein breakdown (FBR) can be calculated as the difference between FSR and the fractional rate of protein deposition (FGR) (Waterlow *et al.*, 1978). Such estimations are very imprecise because FGR must be estimated over several days, FSR being measured over a few minutes or hours. However, FSR and FGR are not necessarily constant over the period of measurements. For example, they may fluctuate largely with the feeding pattern. In addition the technique requires slaughter and cannot be used in tissues that secrete or export proteins.

3-Methylhistidine is formed by a post-translational methylation of histidine residues in actin and in myosin heavy chains of fast-twitch glycolytic skeletal muscles. In the rat and cattle, but not all species (see below), the urinary excretion of 3-methylhistidine provides an index of myofibrillar protein breakdown. Unfortunately, the visceral smooth muscles of the GIT and other tissues such as skin contain significant amounts of actin. These tissues contribute disproportionately for their size to 3-methylhistidine urinary excretion, because of

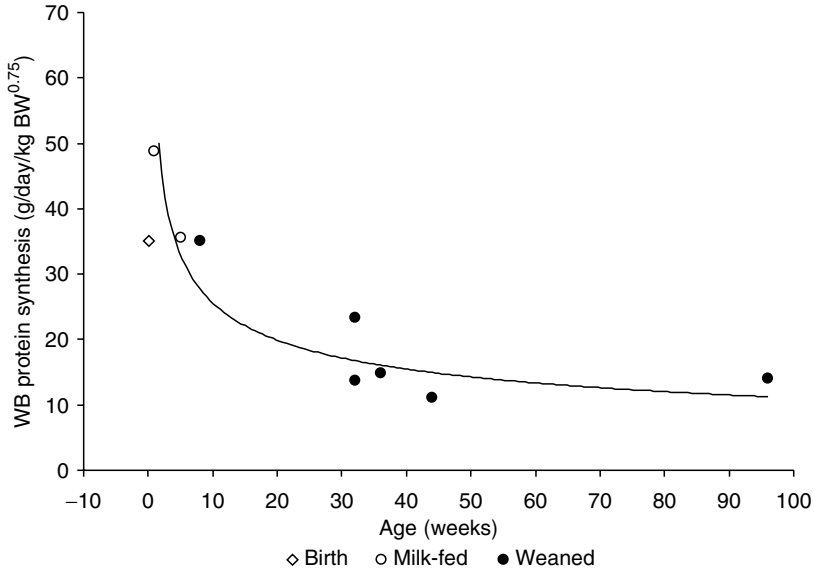
their high rates of protein turnover. In addition, changes in renal clearance of 3-methylhistidine may affect the interpretation of the data (see Attaix and Taillandier, 1998). Finally, in some species (e.g. in pigs and to a lesser extent in sheep), a high proportion of 3-methylhistidine is retained in muscle as a dipeptide, balenine (Harris and Milne, 1987). A compartmental model of 3-methylhistidine metabolism has been developed, which involves the assessment of muscle proteolysis and 3-methylhistidine kinetics without the collection of urine (Rathmacher and Nissen, 1998). However, due to the numerous limitations of the 3-methylhistidine approach, caution must be exercised.

### ***Non-quantitative approaches***

Non-quantitative approaches may be of special interest in ruminant tissues, due to the costs of experiments with isotopic amino acids. As a very crude rule, the control of protein synthesis occurs mainly at the transcriptional level. Therefore the quantification of the mRNA(s) of a given protein by molecular biology techniques is often used as an index of protein synthesis. However, many mRNAs are also subject to translational control, and the relative amount of any mRNA depends on both rates of transcription and of mRNA breakdown. Finally, there are frequent discrepancies between mRNA levels and the corresponding protein levels and/or activities. Similarly, changes in mRNA levels for many proteolytic genes, in particular within the muscle ubiquitin–proteasome-dependent pathway, closely mimic variations of proteolytic rates measured with incubated rodent muscles (see Attaix and Taillandier, 1998). These observations, together with the use of specific inhibitors of lysosomal and  $\text{Ca}^{2+}$ -dependent proteases and of the proteasome, lead to the concept that most muscle proteins, and in particular myofibrillar proteins, are degraded in an ubiquitin–proteasome-dependent fashion (Attaix and Taillandier, 1998; Jagoe and Goldberg, 2001). However and again, elevated mRNA levels for proteolytic genes only reflect increased transcription in a few instances (see Attaix and Taillandier, 1998), and do not always strictly correlate with rates of proteolysis (see Combaret *et al.*, 2002). Measuring proteolytic gene expression may be of interest in small muscle biopsies from ruminants, with complementary approaches (e.g. measurements of protein levels for some enzymes of the ubiquitination machinery and proteasomal subunits, of the rate of ubiquitination of protein substrates, and of proteasome activities).

## **Whole-body Protein Metabolism**

The age of animals and the level of nutrition are the best described factors that regulate whole-body protein metabolism in ruminants. When expressed on a metabolic liveweight basis, whole-body protein synthesis in lambs increases during the first days following birth, declines very rapidly within 6 months (without any major effect of weaning), and thereafter remains stable with increasing age (Fig. 14.4).



**Fig. 14.4.** Effect of age on whole-body (WB) protein synthesis in sheep. (Data from Patureau Mirand *et al.*, 1985; Attaix, 1988; Harris *et al.*, 1992; Neutze *et al.*, 1997; Adams *et al.*, 2000; Yu *et al.*, 2000; Savary *et al.*, 2001.)

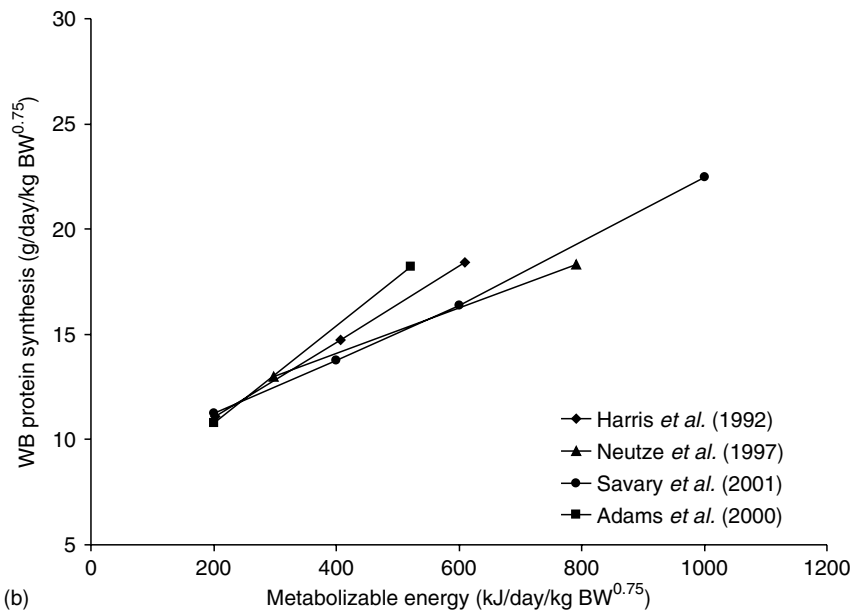
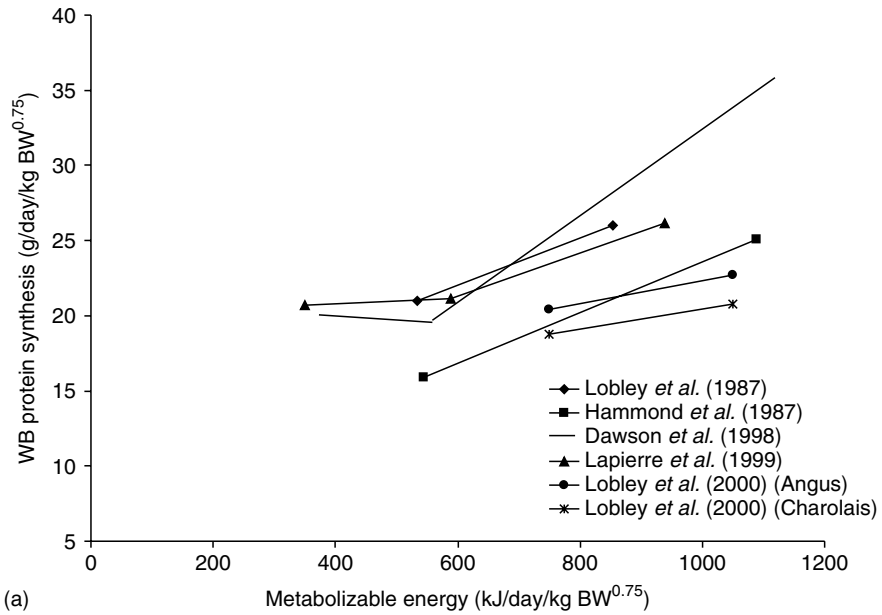
Whole-body protein synthesis ( $\text{g/day/kg BW}^{0.75}$ ) increases with metabolizable energy (ME) intake ( $\text{kJ/day/kg BW}^{0.75}$ ) (Fig. 14.5). This increase is linear in sheep (Harris *et al.*, 1992; Yu *et al.*, 2000; Savary *et al.*, 2001), but not in steers (Dawson *et al.*, 1998; Lapierre *et al.*, 1999). In both species fed above maintenance (based on an energy maintenance requirement of 400 and 500  $\text{kJ/day/kg BW}^{0.75}$  for sheep and steers, respectively) the slope of the relationship is very similar (e.g. 13–14 g of protein synthesized per MJ ME). However, below maintenance, protein synthesis decreases in sheep but is not altered in steers (Lapierre *et al.*, 1999). Above maintenance requirements, the calculated whole-body protein degradation rate (protein synthesis minus deposition) increases in both sheep and steers (Harris *et al.*, 1992; Lapierre *et al.*, 1999). Below maintenance protein breakdown decreases in sheep (Harris *et al.*, 1992), but increases in steers (Lapierre *et al.*, 1999). Besides species differences, the duration of the underfeeding period, the composition of the diet and the age of animals may account for these discrepancies. Nevertheless, whole-body protein loss was similar (about 1  $\text{g/day/kg BW}^{0.75}$ ) in both underfed ( $0.6 \times$  maintenance) steers and sheep.

## Tissue Protein Metabolism

### Portal-drained viscera

On average, the portal net release of essential amino acids accounts for only two-thirds of their apparent disappearance from the small intestine (MacRae





**Fig. 14.5.** Effect of metabolizable energy intake on whole-body (WB) protein synthesis in cattle (a) and sheep (b).

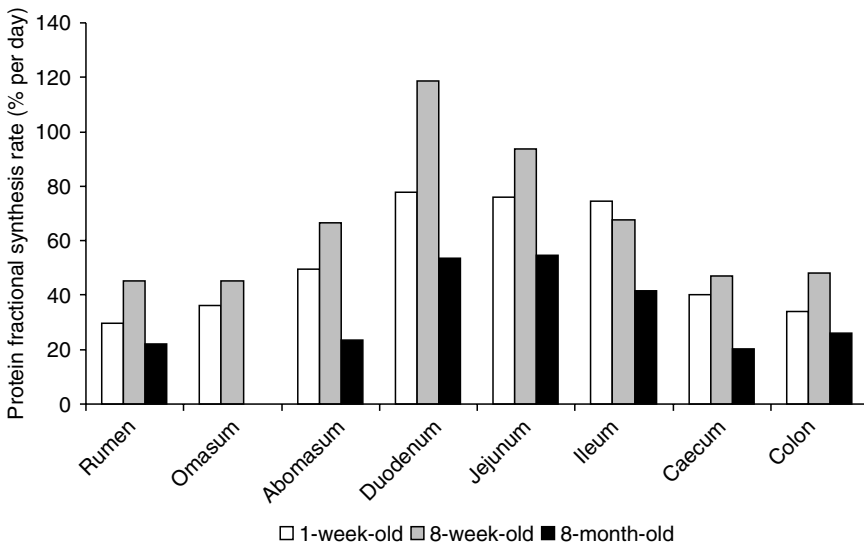
*et al.*, 1997b, Berthiaume *et al.*, 2001). Moreover, the sequestration of individual essential amino acids in the PDV may account from one- to two-thirds of their whole-body flux, and the majority (~80%) of the amino acids sequestered arose from the arterial supply (MacRae *et al.*, 1997a). Thus, first-pass PDV

metabolism of dietary amino acids as well as PDV use of systemic amino acids significantly impact the quantitative and qualitative supply of amino acids to other tissues or organs. The portal vein drains heterogeneous tissues (GIT, pancreas, spleen, omentum), but the GIT is by far the major contributor to PDV protein synthesis. For this reason, only GIT protein metabolism is reviewed below.

### *Gastrointestinal tract*

The mass of the GIT increases with intake, and the importance of its different compartments varies according to the composition of the diet. Protein mass of the ruminant GIT accounts for 4–6% of whole-body proteins (Lobley *et al.*, 1980; Attaix, 1988; MacRae *et al.*, 1993). However, because of the high FSR in these tissues, the GIT contributes ~25–35% of whole-body protein synthesis (Lobley *et al.*, 1980, 1994; Attaix, 1988) compared to ~12% in pre-ruminant animals (Attaix and Arnal, 1987). The large dose procedure is best suited for measuring protein synthesis in the GIT (see above), and data reported in this section are derived from studies using this technique (export proteins being included in synthesis). Whatever the age, the pattern of FSR along the GIT is very similar to the highest values in the small intestine (Fig. 14.6).

FORESTOMACHS. Rumen growth is rapid and stimulated by the initiation of solid food intake and the concomitant establishment of microbial fermentation. Thus, the reticulorumen represents ~7% and 30% of the GIT protein mass in 1-week-old milk-fed and 8-week-old weaned lambs, respectively (Attaix,



**Fig. 14.6.** Protein fractional synthesis rates in the gastrointestinal tract from milk-fed (1-week-old) and weaned lambs. (Data from Attaix, 1988; Lobley *et al.*, 1994.)

1988). After weaning, the rumen development results from a stimulated FSR, which reflects an increase in both ribosomal capacity (e.g. total RNA-to-protein ratio) and protein synthetic efficiency (e.g. the amount of protein synthesized per unit RNA) (Attaix, 1988). In adult ruminants the mass of the rumen mucosa increases with the amount of food ingested (Nozière *et al.*, 1999) and is associated with an increased FSR (Lobley *et al.*, 1994; Adams *et al.*, 2000). Whether the nature of the diet may affect ruminal protein turnover is not documented.

**ABOMASUM.** Protein metabolism in the abomasum is dominated by the secretion of digestive enzymes (pepsin, lysosyme, etc.) and mucins, and in young ruminants the FSR is eightfold greater in the mucosa than in the serosa (Attaix, 1988). Both the abomasum protein mass (Nozière *et al.*, 1999) and FSR (Lobley *et al.*, 1994) are poorly influenced by dietary treatments. However, weaning stimulates FSR in the abomasum, and this effect is more marked in the musculosa than in the mucosa (Attaix, 1988; Attaix *et al.*, 1988).

**SMALL INTESTINE.** FSR in the small intestine are higher than in any other part of the GIT (Fig. 14.6). This high protein synthesis activity reflects epithelial cell turnover, synthesis of brush border enzymes and mucins and the presence of immune cells. Accordingly, FSR in the mucosa is considerably higher than in the serosa all along the small intestine (Lobley *et al.*, 1994). FSR decrease from the duodenum to the ileum (Attaix *et al.*, 1992; Southorn *et al.*, 1992; Lobley *et al.*, 1994). This gradient, which correlates with reduced efficiency of protein synthesis, is seen in 8-week-old lambs, either milk-fed or weaned, but does not prevail in younger animals (Attaix *et al.*, 1992). Thus, intrinsic developmental factors are presumably mainly responsible for the regional differences in small intestinal FSR, which poorly reflect rates of cell renewal in lambs raised in similar conditions (Attaix and Meslin, 1991).

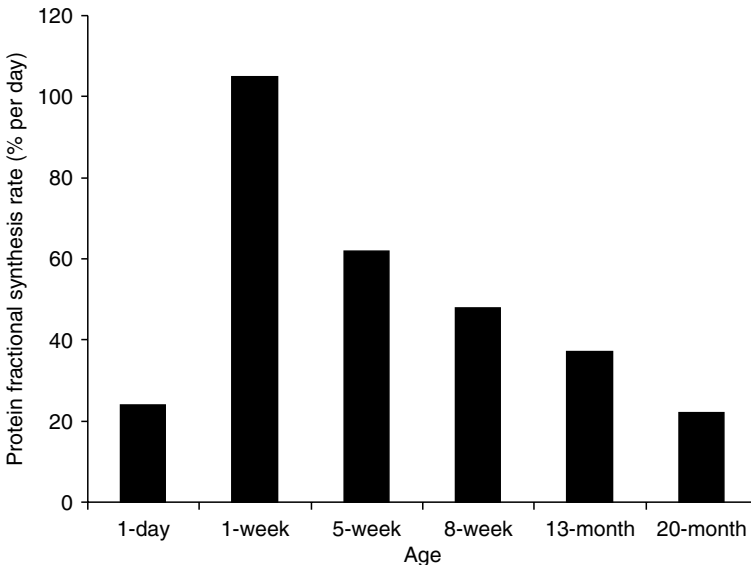
The small intestine receives amino acids for protein synthesis from both luminal and systemic routes. It is difficult to demonstrate *in vivo* whether the precursor pool for protein synthesis is preferentially charged from either source. However, it is noteworthy that intestinal FSR are poorly reduced in fasted rats (Samuels *et al.*, 1996), and only slightly increased with the level of intake in lambs fed above maintenance (Lobley *et al.*, 1994; Adams *et al.*, 2000). This suggests that luminal factors have no major influence on small intestinal protein synthesis, except solid food ingestion at the time of weaning (Attaix *et al.*, 1992). Observations in piglets showed that amino acids may actually decrease mucosal FSR in jejunal segments isolated from systemic influence (Adegoké *et al.*, 1999). In contrast, intestinal protein mass is highly sensitive to food intake and dramatically reduced in fasting, suggesting that proteolysis plays a major role in this tissue. Accordingly, mRNAs for several proteolytic genes increased in the small intestine from fasted rats (Samuels *et al.*, 1996). Conversely, amino acids decreased the expression of proteolytic genes in the intestinal mucosa from piglets (Adegoké *et al.*, 1999). However, there was no change in the expression of proteolytic genes in the intestines

from chronically underfed ewes (Nozière *et al.*, 1999), suggesting that such changes are only seen following acute manipulation of dietary intake.

**LARGE INTESTINE.** In 8-week-old weaned lambs the large intestine accounts for 13% of the protein mass of the GIT, and for 9% of its absolute rate of protein synthesis (Attaix, 1988). In mature sheep, corresponding values are 22% (Nozière *et al.*, 1999) and 18% (Lobley *et al.*, 1994). The mass of the large intestine increases with the level of intake (Nozière *et al.*, 1999), owing to a tendency for enhanced FSR (Lobley *et al.*, 1994). However, several lines of evidence suggest a role of proteolysis in the control of large-intestinal protein mass (Attaix *et al.*, 1992; Samuels *et al.*, 1996).

### Liver

FSR in the liver follows the general pattern observed for whole-body protein synthesis (Fig. 14.7). FSR increases during the first days following birth, and thereafter declines exponentially with increasing age. This decline is linked to a decrease in both ribosomal capacity and protein synthesis efficiency. In ruminants, FSR in the liver is not affected by the level of intake (Lobley *et al.*, 1994; Adams *et al.*, 2000). Absolute protein synthesis in the liver accounts for about 35–40% of the PDV protein synthesis (Attaix, 1988; Lobley *et al.*, 1994). Assuming that all plasma proteins are of hepatic origin, it has been estimated that export proteins accounted for 38–51% of total hepatic protein synthesis,



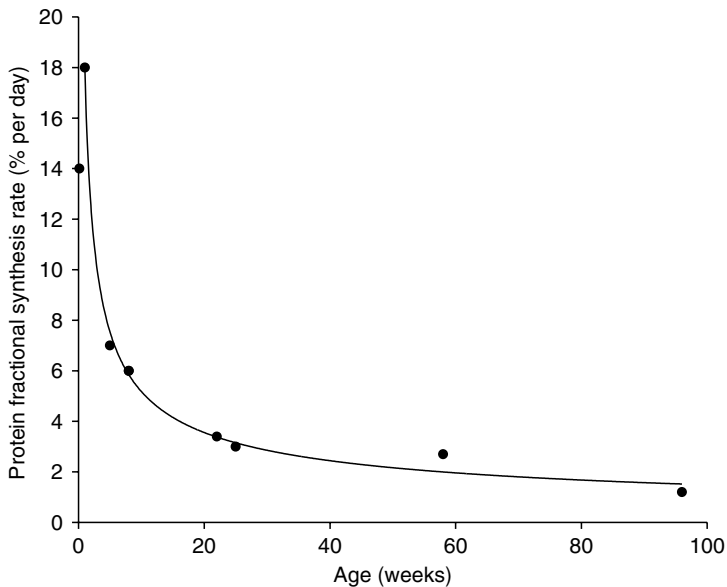
**Fig. 14.7.** Effect of age on protein fractional synthesis rate in sheep liver. (Data from Patureau Mirand *et al.*, 1985; Attaix, 1988; Lobley *et al.*, 1992; Adams *et al.*, 2000.)

and that albumin represented 15–22% of export protein production (Connell *et al.*, 1997). These proteins act as a mobile protein reservoir, and synthesis in this fraction (but not in the constitutive protein fraction) is particularly sensitive to acute change in nutritional status such as fasting (Connell *et al.*, 1997; Lobley *et al.*, 1998). In contrast, changes in liver protein mass in response to intake (Burrin *et al.*, 1992; Nozière *et al.*, 1999) seem mainly related to alterations in protein degradation (Lobley and Milano, 1997).

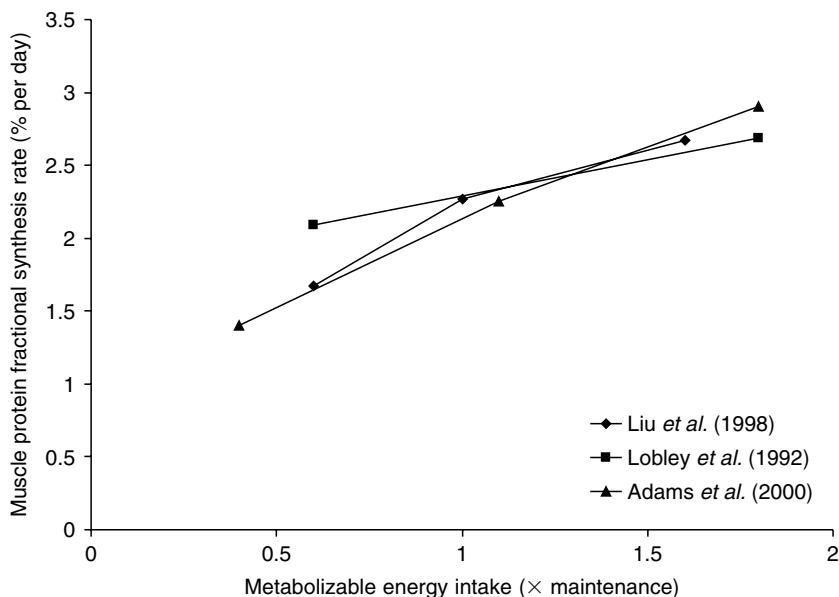
## Peripheral tissues

### Skeletal muscle

Proteins in skeletal muscle account for about 30–45% of whole-body protein mass (Attaix, 1988; Lobley *et al.*, 1994). Although this is the largest protein reservoir in the body, muscle contributes only 15% to 22% to whole-body protein synthesis because of its low FSR (Attaix, 1988; Adams *et al.*, 2000; Lobley *et al.*, 2000). In lambs, FSR declines exponentially between birth and 4 months of age (Fig. 14.8). This decline is fully related to a decrease in the capacity for protein synthesis and is not confounded by nutritional effects (Attaix *et al.*, 1988). In sheep, muscle FSR increases linearly with the level of intake from 0.6 to 1.8  $\times$  maintenance (Fig. 14.9). Similar data were obtained in the perfused hind limb between 0.5 and 2.5  $\times$  maintenance (Boisclair *et al.*, 1993; Thomson *et al.*, 1997; Hoskin *et al.*, 2001; Savary *et al.*, 2001). Data on protein degradation in the perfused hind limb are more confusing. An



**Fig. 14.8.** Effect of age on protein fractional synthesis rate in sheep skeletal muscle. (Data from Patureau Mirand *et al.*, 1985; Attaix, 1988; Lobley *et al.*, 1992; Adams *et al.*, 2000.)



**Fig. 14.9.** Effect of metabolizable energy intake on protein fractional synthesis rate in sheep skeletal muscle.

increased intake above maintenance resulted in a concomitant increase in both protein synthesis and breakdown in two studies (Harris *et al.*, 1992; Lobley *et al.*, 2000). In contrast, protein breakdown was unchanged in two different experiments where the level of intake increased up to  $2.5 \times$  maintenance (Thomson *et al.*, 1997; Savary *et al.*, 2001).

Below maintenance, protein loss in the hind limb depends on the duration and of the severity of underfeeding. In restricted animals ( $0.5$ – $0.6 \times$  maintenance for 1 week), proteolysis tended to increase (McDonagh *et al.*, 1999; Hoskin *et al.*, 2001). Conversely, after 2 weeks of underfeeding, muscle proteolysis was unchanged (Harris *et al.*, 1992; Boisclair *et al.*, 1993) or eventually decreased (Thomson *et al.*, 1997), and muscle protein loss totally resulted from an impairment in protein synthesis.

### Skin

FSR in skin from cattle (4–6% per day; Lobley *et al.*, 1980) and goats (2.5% per day; Champredon *et al.*, 1990) are much lower than in sheep (6–25% per day; Attaix, 1988; Lobley *et al.*, 1992; Liu *et al.*, 1998; Adams *et al.*, 2000), evidencing the production of wool in the latter species, which accounts for 10–20% of skin protein synthesis (Liu *et al.*, 1998; Adams *et al.*, 2000). During the first week of life, FSR are roughly equivalent in skin and muscles of lambs (Patureau Mirand *et al.*, 1985; Attaix *et al.*, 1988). After weaning, FSR in skin are three- to ninefold higher than in muscle (Attaix, 1988; Lobley *et al.*, 1992; Liu *et al.*, 1998; Adams *et al.*, 2000). Consequently, the contribution of skin to whole-body protein synthesis in ruminants is about

1.5-fold greater than that of skeletal muscle (Attaix, 1988; Adams *et al.*, 2000). FSR in skin increases with the level of intake (Liu *et al.*, 1998; Adams *et al.*, 2000), and is greater in sheep fed rapeseed meal than in sheep receiving lupin seed, which contains less methionine, the primary limiting amino acid for wool growth (Liu *et al.*, 1998).

#### *Mammary gland*

Protein synthesis in the mammary gland is a negligible part of whole-body protein synthesis in dry animals, but becomes a major contributor in lactating animals (Champredon *et al.*, 1990; Baracos *et al.*, 1991; Bequette *et al.*, 1996). The mammary gland synthesizes not only milk proteins but also structural proteins and enzymes. These constitutive proteins may account for 40–45% of total mammary gland protein synthesis (Oddy *et al.*, 1988; Champredon *et al.*, 1990; Baracos *et al.*, 1991). Degradation of newly synthesized milk proteins could account for about one-third of milk protein synthesis (Oddy *et al.*, 1988).

## Control and Manipulation of Protein Metabolism

### *Insulin*

This polypeptide hormone secreted by the pancreatic  $\beta$ -islets plays a key role in the regulation of growth and nutrient utilization in ruminants (see Lobley, 1994, 1998; Grizard *et al.*, 1999; Nieto and Lobley, 1999).

Insulin inhibits whole-body protein breakdown in lambs (Oddy *et al.*, 1987) or adult goats (Tesseraud *et al.*, 1993) and decreases plasma amino acid concentrations, but does not stimulate whole-body protein synthesis (Tesseraud *et al.*, 1993; Tauveron *et al.*, 1994).

Insulin increases protein synthesis and decreases proteolysis in cell cultures or muscle explants, leading to a strong anabolic effect (see Lobley, 1998; Grizard *et al.*, 1999). Insulin infusion stimulates protein synthesis in various muscles from young piglets and rats, but has no effect in young and adult fasted ruminants (Douglas *et al.*, 1991). Actually, protein breakdown and even protein synthesis were inhibited in skeletal muscle from insulin-infused fasted lambs (Oddy *et al.*, 1987). In fed ruminants, insulin had no effect on muscle protein synthesis (Oddy *et al.*, 1987; Tauveron *et al.*, 1994).

The lack of the effect of insulin on *in vivo* protein synthesis in the majority of studies was attributed to hypoaminoacidaemia and hypoglycaemia. However, the utilization of eu- or hyperaminoacidaemic and euglycaemic clamps after insulin infusion in fed or fasted ruminants (Tesseraud *et al.*, 1993; Tauveron *et al.*, 1994) failed to demonstrate any stimulatory effect of insulin on both whole-body and muscle protein synthesis.

These data suggest that the effect of insulin is only seen: (i) in fasted or restricted animals where the endogenous insulin concentration is low, because basal insulinaemia is already stimulating protein synthesis at its maximum rate in the fed state; and (ii) in young growing animals exhibiting a high insulin

sensitivity. The former hypothesis has been recently confirmed *in vivo* using fed rats submitted to an acute hypoinsulinaemia induced by diazoxide, which decreased muscle protein synthesis by 40% (Sinaud *et al.*, 1999). Recent data from Wray-Cahen *et al.* (1998) also confirmed the latter hypothesis, since the stimulation of muscle protein synthesis by insulin was greater in 7- than in 26-day-old pigs. Therefore, the sensitivity of muscle to insulin decreases with age in monogastrics and presumably in ruminants (Eisemann *et al.*, 1997). The lack of effect of insulin on muscle protein synthesis in ruminants, even at an early stage of development, is presumably due to their digestion pattern, which results in relatively high insulin circulating levels that prevent any further anabolic effect (Tesseraud *et al.*, 1993; Tauveron *et al.*, 1994).

Insulin regulates protein synthesis by several mechanisms. A long-term insulin deficiency decreases ribosomal capacity, but acute insulin deficiency impairs the translation efficiency through changes in phosphorylation/dephosphorylation of initiation factors (Kimball *et al.*, 1997). In ruminant species, and possibly in pre-ruminants, one or several components of the translational apparatus are presumably insulin-resistant.

*In vitro*, insulin inhibits the muscle lysosomal and ubiquitin-proteasome-dependent proteolytic pathways. For example, insulin decreased both the mRNA levels for the 14-kDa ubiquitin-conjugating enzyme E2 and proteasome activity in cultured cells (see Larbaud *et al.*, 2001). A role of insulin on *in vivo* muscle proteolysis has also been suggested in euglycaemic hyperinsulinaemic ruminants (Larbaud *et al.*, 1996) and rats (Larbaud *et al.*, 2001). In contrast with *in vitro* data, insulin had no effect on the mRNA levels for the 14-kDa E2, but decreased ubiquitin expression in fast-twitch or mixed muscles, without any effect on the amount of ubiquitin conjugates. However, alterations in the expression of regulatory subunits of the 26S proteasome may contribute to explain the antiproteolytic effect of insulin *in vivo* (Larbaud and Attaix, unpublished data).

In lactation, insulin increases (15% to 30%) the partition of the amino acids towards the mammary gland (Bequette *et al.*, 2001). Although insulin infusion results in hypoaminoacidaemia, the utilization of amino acids for milk protein synthesis, and mammary amino acid net extraction is not altered or even increased (Mackle *et al.*, 2000). This can be explained by an increase in both the mammary blood flow and the udder sensitivity to insulin (Bequette *et al.*, 2001).

### **Growth hormone/IGF-1 axis**

Growth hormone or somatotropin (ST) is a polypeptide hormone secreted by the anterior pituitary gland that stimulates, directly or indirectly, anabolic processes such as cell division, skeletal muscle growth and protein synthesis.

ST increases nutrient partitioning between skeletal muscle and adipose tissue, and alters the growth of lean tissues and bones (see Etherton and Bauman, 1998). In ruminants, bovine ST induces a 40% increase in protein accretion in lean tissues, including muscle (Boisclair *et al.*, 1994). An even



more impressive effect has been reported in pigs where porcine ST infusion resulted in a 90% increase in protein accretion (Etherton and Bauman, 1998). An ST treatment for several weeks tends to induce a less important effect on growth and nitrogen retention than a short treatment (e.g. several hours to several days) (Boisclair *et al.*, 1994), possibly due to the development of a relative ST resistance state. However, there is a positive effect of a long-term ST treatment on whole-body nitrogen retention in well-fed animals and when nitrogen supply is adequate for maximal growth (Spencer *et al.*, 1994). Rausch *et al.* (2002) reported that cattle fed at two levels of energy and protein intake ( $0.75 \times ad\ libitum$  and *ad libitum*) and submitted to a bST treatment for 14 days, grew more rapidly and efficiently with the highest level of intake. An increased amino acid requirement during ST treatment is consistent with the increased protein accretion, since more amino acids are required to sustain the rapid growth of the animals.

Except in early lactation, ST has pronounced effects on milk output and milk protein yield, which increased by about 10–20% (Faulkner, 1999). An increased blood flow and an increased amino acid utilization explain this improvement by the mammary gland. The possible mechanisms by which ST increases milk production have been extensively reviewed elsewhere and may involve an increased local production of IGF-1 (see Etherton and Bauman, 1998).

In ruminants, ST infusion increases whole-body (Eisemann *et al.*, 1989) and muscle (Eisemann *et al.*, 1989; Boisclair *et al.*, 1994) protein synthesis. In contrast, no strong effect of ST on protein degradation was reported (Boisclair *et al.*, 1994).

ST administration results in elevated hepatic insulin-like growth factor-1 (IGF-1) mRNA levels, an increased release of IGF-1 by the liver and a global increase in IGF-1 circulating levels (Rausch *et al.*, 2002). A direct effect of ST cannot be excluded since acute ST infusion stimulated protein synthesis without any alteration in IGF-1 levels, which commonly occurs within 10–12 h. However, a comparison of *in vivo* studies using close arterial infusions of IGF-1 to systemic/close arterial infusions of ST in humans or ruminants led to the conclusion that ST has a direct effect on protein accretion in lean tissues and milk synthesis, and an indirect effect via IGF-1. Indeed, IGF-1 is not only synthesized in the liver but also in other target tissues such as skeletal muscle. Thus the hormone exhibits both endocrine and paracrine effects. In addition, IGF-1 binds non-covalently to carrier proteins (IGFBPs), which extend its half-life and can regulate its action (see Lobley, 1998 for review).

*In vivo*, IGF-1 increased muscle protein synthesis in lambs (Douglas *et al.*, 1991; Koea *et al.*, 1992). In mice, this stimulatory effect is localized to muscle, and does not prevail in other tissues or organs. However, IGF-1 infusion in the sheep hind limb artery for 24 h increased transiently skin and wool protein synthesis (Lobley *et al.*, 1997).

In the IGF-1-infused hind limb of lambs, Oddy and Owens (1996) have reported a pronounced reduction in protein breakdown, regardless of feed intake. A strong inhibition of whole-body protein breakdown was also observed in fasted IGF-1 infused lambs, but this antiproteolytic effect was potentialized by total parental nutrition (Koea *et al.*, 1992). The proteolytic systems

downregulated by IGF-1 are not fully identified but a decrease in  $\mu$ -calpain activity in muscle (McDonagh *et al.*, 1999) and in the expression of some components of the ubiquitin-dependent proteolytic system have been observed after IGF-1 treatment (see Attaix and Taillandier, 1998).

### **$\beta$ -Agonists**

$\beta$ -Agonists currently used as growth promoters are clenbuterol, cimaterol, ractopamine and L644,969. These molecules present chemical similarities with natural catecholamines and can bind to  $\beta$ -adrenergic receptors. Like ST,  $\beta$ -agonists alter nutrient partitioning and promote the growth of lean tissues at the expense of the fat stores, but they act independently. An increased heart rate and blood flow increases nutrient supply to the target tissues in  $\beta$ -agonist-treated ruminants (Eisemann *et al.*, 1988). In contrast with ST,  $\beta$ -agonists are more effective in ruminants than in monogastrics, and may induce an up to 65% increase in muscle mass (Byrem *et al.*, 1998).

The direct or indirect role of  $\beta$ -agonists in protein deposition has been extensively studied, because they induce changes in circulating levels of anabolic hormones. A consistent anabolic effect of  $\beta$ -agonists prevails in many catabolic situations (e.g. diabetes, denervation) or in castrated and adrenalectomized animals and suggests a direct effect of  $\beta$ -agonists on protein metabolism. Indeed, close arterial infusion of cimaterol in the hind limb of young steers, both in acute (6 h) or chronic (1–20 days) conditions, increased muscle protein content by 9–11% (Byrem *et al.*, 1998). However, these results do not exclude an indirect effect of  $\beta$ -agonists. For example, clenbuterol administration increased muscle mass by 10–13% in rodents and this effect was associated with increased IGF-1 mRNA and protein levels, and IGF-binding protein mRNA levels (Awede *et al.*, 2002). Furthermore, clenbuterol increased in rat muscle the phosphorylation of eIFBP-1 and P70S6k, involved in the signal transduction pathways of insulin and IGFs (Sneddon *et al.*, 2001).

The precise mechanisms responsible for the positive effect of  $\beta$ -agonists on muscle protein deposition are not fully understood. The elevated protein synthesis is consistent with an increased capacity for protein synthesis in some experiments, but ractopamine seems to increase myosin mRNA in steers and  $\alpha$ -actin mRNA in pigs (reviewed by MacRae and Loble, 1991). In addition, in muscle showing clenbuterol-induced anabolism, Sneddon *et al.* (2001) have also recently reported an increased phosphorylation of eukaryotic initiation factor 4E-BP1, suggesting a stimulation of translation.  $\beta$ -Agonists also suppressed muscle proteolysis (e.g. Bohorov *et al.*, 1987), possibly by inhibiting  $\text{Ca}^{2+}$ -dependent proteases (Navegantes *et al.*, 2001).

The interaction of  $\beta$ -agonist treatment with amino acid utilization is not very clear. However, clenbuterol is more effective in well-fed than in underfed cattle (Sillence *et al.*, 1993). Consequently, animals treated with  $\beta$ -agonists present greater protein requirements.

### **Anabolic steroids**

These molecules include the natural androgens, oestrogens and some biosynthetic compounds with similar activities (e.g. zeranol or trenbolone acetate, which exhibit an oestrogenic or an androgenic activity, respectively). A combination of an oestrogenic and an androgenic molecule is usually used in ruminants. This makes it difficult to understand the actual effect of each steroid on protein metabolism. Furthermore, steroid administration induces an alteration in the concentration of ST, IGF-1, insulin and thyroid hormones. Therefore, the direct and indirect effect of steroids on protein metabolism are still not well understood.

Entire males have higher whole-body and muscle growth rates and less body fat than castrated animals. Consequently, the involvement of sex steroids in the control of muscle growth has been extensively studied in farm animal species. The role of steroids with androgenic activity such as trenbolone acetate has also been studied in female ruminants where they also improve protein deposition (Sinnott-Smith *et al.*, 1983). Trenbolone acetate and estradiol are commonly used as growth promoters in the USA. They act synergetically and increase the growth rate and feed efficiency by about 15–20%, even after 115 days of treatment in steers (Johnson *et al.*, 1996).

Most studies indicate a decrease in protein breakdown after trenbolone acetate or testosterone treatment in ruminants (MacRae and Lobley, 1991), with no effect or a small decrease in both whole-body (Sinnott-Smith *et al.*, 1983; Lobley *et al.*, 1985) and muscle protein synthesis (Lobley *et al.*, 1990).

## **Conclusions**

As pointed out at the beginning of this chapter, our knowledge of protein turnover in ruminants remains fragmentary. Although species differences may explain some discrepancies between monogastrics and pre-ruminants/ruminants, more information is obviously needed on farm species. In this respect, the recent development of new approaches such as cDNA macro- and microarrays will certainly contribute to solving many questions and to providing more information about the precise mechanisms that regulate protein turnover in ruminants (e.g. to identify signalling pathways or crucial genes that have a major influence on protein synthesis and breakdown). However, protein turnover in the GIT from adult ruminants has probably some important effects on whole-body and peripheral tissue protein turnover. An important unresolved question is to determine whether protein turnover in the GIT should be stimulated or inhibited to optimize protein deposition efficiency in skeletal muscle. This clearly requires new experiments that aim to understand the relationships between protein turnover in different tissues (e.g. muscle, liver and GIT).

## References

- Adams, N.R., Liu, S.M., Briegel, J.R. and Greef, J.C. (2000) Protein metabolism in skin and muscle of sheep selected for or against staple strength. *Australian Journal of Agricultural Research* 51, 541–546.
- Adegoke, O.A., McBurney, M.I., Samuels, S.E. and Baracos, V.E. (1999) Luminal amino acids acutely decrease intestinal mucosal protein synthesis and protease mRNA in piglets. *Journal of Nutrition* 129, 1871–1878.
- Attaix, D. (1988) Influence de l'âge et du sevrage sur la synthèse protéique chez l'agneau. Thèse de Doctorat d'Etat, Université Blaise Pascal, Clermont II, France.
- Attaix, D. and Arnal, M. (1987) Protein synthesis and growth in the gastrointestinal tract of the young preruminant lamb. *British Journal of Nutrition* 58, 159–169.
- Attaix, D. and Meslin, J.C. (1991) Changes in small intestinal mucosa morphology and cell renewal in suckling, prolonged-suckling and weaned lambs. *American Journal of Physiology* 261, R811–R818.
- Attaix, D. and Taillandier, D. (1998) The critical role of the ubiquitin–proteasome pathway in muscle wasting in comparison to lysosomal and  $\text{Ca}^{2+}$ -dependent systems. In: Bittar, E.E. and Rivett, A.J. (eds) *Intracellular Protein Degradation*. JAI Press Inc., Greenwich, Connecticut, pp. 235–266.
- Attaix, D., Arousseau, E., Bayle, G., Rosolowska-Huszcz, D. and Arnal, M. (1988) Respective influences of age and weaning on skeletal and visceral muscle protein synthesis in the lamb. *Biochemical Journal* 256, 791–795.
- Attaix, D., Arousseau, E., Rosolowska-Huszcz, D., Bayle, G. and Arnal, M. (1992) *In vivo* longitudinal variations in protein synthesis in developing ovine intestines. *American Journal of Physiology* 263, R1318–R1323.
- Attaix, D., Combaret, L. and Taillandier, D. (1999) Mechanisms and regulation in protein degradation. In: Lobley, G.E., White, A. and MacRae, J.C. (eds) *Protein Metabolism and Nutrition*, EAAP No. 96. Wageningen Pers, The Netherlands, pp. 51–67.
- Attaix, D., Combaret, L., Pouch, M.N. and Taillandier, D. (2002) Cellular control of ubiquitin–proteasome-dependent proteolysis. *Journal of Animal Science* 80 (E. Suppl. 2), E56–E63.
- Awede, B.L., Thissen, J.P. and Lebacqz, J. (2002) Role of IGF-1 and IGF-BPs in the changes of mass and phenotype induced in rats soleus muscle by clenbuterol. *American Journal of Physiology, Endocrinology and Metabolism* 282, E31–E37.
- Baracos, V.E., Brun-Bellut, J. and Marie, M. (1991) Tissue protein synthesis in lactating and dry goats. *British Journal of Nutrition* 66, 451–465.
- Barrett, E.J. and Gelfand, R.A. (1989) The *in vivo* study of cardiac and skeletal muscle protein turnover. *Diabetes Metabolism Reviews* 5, 133–148.
- Bequette, B.J., Metcalf, J.A., Wray-Cahen, D., Backwell, F.R.C., Sutton, J.D. and Lomax, M.A. (1996) Leucine and protein metabolism in the lactating dairy cow mammary gland: responses to supplemental dietary crude protein intake. *Journal of Dairy Research* 63, 209–222.
- Bequette, B.J., Kyle, C.E., Crompton, L.A., Buchan, V. and Hanigan, M.D. (2001) Insulin regulates milk production and mammary gland and hind-leg amino acid fluxes and blood flow in lactating goats. *Journal of Dairy Science* 84, 241–255.
- Berthiaume, R., Bubreuil, P., Stevenson, M., McBride, B.W. and Lapierre, H. (2001) Intestinal disappearance and mesenteric and portal appearance of amino acids in dairy cows fed ruminally protected methionine. *Journal of Dairy Science* 84, 194–203.

- Bohorov, O., Buttery, P.J., Correia, J.H.R.D. and Soar, J.B. (1987) The effect of the  $\beta$ 2-adrenergic agonist clenbuterol or implantation with oestradiol plus trenbolone acetate on protein metabolism in wether lambs. *British Journal of Nutrition* 57, 99–107.
- Boisclair, Y.R., Bell, A.W., Dunshea, F.R., Harkins, M. and Bauman, D.E. (1993) Evaluation of the arteriovenous difference technique to simultaneously estimate protein synthesis and degradation in the hindlimb of fed and chronically underfed steers. *Journal of Nutrition* 123, 1076–1088.
- Boisclair, Y.R., Bauman, D.E., Bell, A.W., Dunshea, F.R. and Harkins, M. (1994) Nutrient utilization and protein turnover in the hindlimb of cattle treated with bovine somatotropin. *Journal of Nutrition* 124, 664–673.
- Burrin, D.G., Britton, R.A., Ferrel, C.L. and Bauer, M.L. (1992) Level of nutrition and visceral organ protein synthetic capacity and nucleic acid content in sheep. *Journal of Animal Science* 70, 1137–1145.
- Byrem, T.M., Beermann, D.H. and Robinson, T.F. (1998) The  $\beta$ -agonist cimaterol directly enhances chronic protein accretion in skeletal muscle. *Journal of Animal Science* 76, 988–998.
- Champredon, C., Debras, E., Patureau Mirand, P. and Arnal, M. (1990) Methionine flux and tissue protein synthesis in lactating and dry goats. *Journal of Nutrition* 120, 1006–1015.
- Combaret, L., Tilignac, T., Claustre, A., Voisin, L., Taillandier, D., Obled, C., Tanaka, K. and Attaix, D. (2002) Torbafylline (HWA 448) inhibits enhanced skeletal muscle ubiquitin–proteasome-dependent proteolysis in cancer and septic rats. *Biochemical Journal* 361, 185–192.
- Connell, A., Calder, A.G., Anderson, S.E. and Lobley, G.E. (1997) Hepatic protein synthesis in the sheep: effect of intake as monitored by use of stable-isotope-labelled glycine, leucine and phenylalanine. *British Journal of Nutrition* 77, 255–271.
- Dawson, J.M., Greathead, H.M.R., Craigon, J., Hachey, D.L., Reeds, P.J., Pell, J.M. and Buttery, P.J. (1998) The interaction between nutritional status and growth hormone in young cattle: differential responsiveness of fat and protein metabolism. *British Journal of Nutrition* 79, 275–286.
- Douglas, R.G., Gluckman, P.D., Ball, K., Breier, B. and Shaw, J.F.H. (1991) The effect of infusion of insulin like growth factor (IGF)-I, IGF-II, and insulin on glucose and protein metabolism in fasted lambs. *Journal of Clinical Investigation* 88, 614–622.
- Eisemann, J.H., Huntington, G.B. and Ferrell, C.L. (1988) Effects of dietary clenbuterol on metabolism of the hindquarters in steers. *Journal of Animal Science* 66, 342–353.
- Eisemann, J.H., Hammond, A.C. and Rumsey, T.S. (1989) Tissue protein synthesis and nucleic acid concentrations in steers treated with somatotropin. *British Journal of Nutrition* 62, 657–671.
- Eisemann, J.H., Huntington, G.B. and Catherman, D.R. (1997) Insulin sensitivity and responsiveness of portal-drained viscera, liver, hindquarter, and whole body of beef steers weighing 275 or 490 kilograms. *Journal of Animal Science* 75, 2084–2091.
- Etherton, T.D. and Bauman, D.E. (1998) Biology of somatotropin in growth and lactation of domestic animals. *Physiological Reviews* 78, 745–761.
- Faulkner, A. (1999) Changes in plasma and milk concentrations of glucose and IGF-1 in response to exogenous growth hormone in lactating goats. *Journal of Dairy Research* 66, 207–214.

- Grizard, J., Picard, B., Dardevet, D., Balage, M. and Rochon, C. (1999) Regulation of muscle growth and development. In: Lobley, G.E., White, A. and MacRae, J.C. (eds) *Protein Metabolism and Nutrition*, EAAP No. 96. Wageningen Pers., The Netherlands, pp. 177–201.
- Hammond, A.C., Huntigton, G.B., Reynolds, P.J., Tyrrel, H.F. and Eisemann, J.H. (1987) Absorption, plasma flux and oxidation of L-leucine in heifers at two levels of intake. *Journal of Animal Science* 64, 420–425.
- Harris, C.I. and Milne, G. (1987) The identification of the N-tau-methylhistidine-containing dipeptide, balenine, in muscle extracts from various mammals and the chicken. *Comparative Biochemistry and Physiology B* 86, 273–279.
- Harris, P.M., Skene, P.A., Buchan, V., Milne, E., Calder, A.G., Anderson, S.E., Connell, A. and Lobley, G.E. (1992) Effect of food intake on hind-limb and whole-body protein metabolism in young growing sheep: chronic studies based on arterio-venous techniques. *British Journal of Nutrition* 68, 389–407.
- Hoskin, S.O., Savary, I.C., Zuur, G. and Lobley, G.E. (2001) Effect of feed intake on ovine hindlimb protein metabolism based on thirteen amino acids and arterio-venous techniques. *British Journal of Nutrition* 86, 577–585.
- Jagoe, R.T. and Goldberg, A.L. (2001) What do we really know about the ubiquitin-proteasome pathway in muscle atrophy? *Current Opinion in Clinical Nutrition and Metabolic Care* 4, 183–190.
- Johnson, B.J., Hathaway, M.R., Anderson, P.T., Meiske, J.C. and Dayton, W.R. (1996) Stimulation of circulating insulin-like growth factor I (IGF-I) and insulin-like growth factor binding proteins (IGFBP) due to administration of a combined trenbolone acetate and estradiol implant in feed lot cattle. *Journal of Animal Science* 74, 372–379.
- Kimball, S.R., Jurasinski, C.V., Lawrence, J.C. and Jefferson, L.S. (1997) Insulin stimulates protein synthesis in skeletal muscle by enhancing the association of eIF-4E and eIF-4G. *American Journal of Physiology* 272, C754–C759.
- Koea, J.B., Douglas, R.G., Breier, B.H., Shaw, J.F.H. and Gluckman, P.D. (1992) Synergistic effect of insulin-like growth factor-I administration on the protein-sparing effects of total parenteral nutrition in fasted lambs. *Endocrinology* 131, 643–648.
- Lapierre, H., Bernier, J.F., Dubreuil, P., Reynolds, C.K., Farmer, C., Ouellet, D.R. and Lobley, G.E. (1999) The effect of intake on protein metabolism across splanchnic tissues in growing beef steers. *British Journal of Nutrition* 81, 457–466.
- Larbaud, D., Debras, E., Taillandier, D., Samuels, S.E., Temparis, S., Champredon, C., Grizard, J. and Attaix, D. (1996) Euglycemic hyperinsulinemia and hyperaminoacidemia decrease skeletal muscle ubiquitin mRNA in goats. *American Journal of Physiology* 271, E505–E512.
- Larbaud, D., Balage, M., Taillandier, D., Combaret, L., Grizard, J. and Attaix, D. (2001) Differential regulation of the lysosomal, Ca<sup>2+</sup>-dependent and ubiquitin/proteasome-dependent proteolytic pathways in fast-twitch and slow-twitch rat muscle following hyperinsulinaemia. *Clinical Science* 101, 551–558.
- Liu, S.M., Mata, G., O'Donoghue, H. and Masters, D.G. (1998) The influence of live weight, live-weight change and diet on protein synthesis in the skin and skeletal muscle in young Merino sheep. *British Journal of Nutrition* 79, 267–274.
- Lobley, G.E. (1994) Amino acid and protein metabolism in the whole body and individual tissues of ruminant. In: Asplund, J.M. (ed.) *Principles of Protein Nutrition of Ruminants*. CRC Press, Orlando, Florida, pp. 147–178.
- Lobley, G.E. (1998) Nutritional and hormonal control of muscle and peripheral tissue metabolism in farm species. *Livestock Production Science* 56, 91–114.

- Lobley, G.E. and Milano, G.D. (1997) Regulation of hepatic nitrogen metabolism in ruminants. *Proceedings of the Nutrition Society* 56, 547–563.
- Lobley, G.E., Milne, M., Lovie, J.M., Reeds, P.J. and Pennie, K. (1980) Whole body and tissue protein synthesis in cattle. *British Journal of Nutrition* 43, 491–502.
- Lobley, G.E., Connell, A., Mollison, G.S., Brewer, A., Harris, C.I. and Buchan, V. (1985) The effects of a combined implant of trenbolone acetate and oestradiol-17 $\beta$  on protein and energy metabolism in growing beef steers. *British Journal of Nutrition* 54, 681–694.
- Lobley, G.E., Connell, A. and Buchan, V. (1987) Effect of food intake on protein and energy metabolism in finishing beef steers. *British Journal of Nutrition* 57, 457–465.
- Lobley, G.E., Connell, A., Milne, E., Buchan, V., Calder, A.G., Anderson, S.E. and Vint, H. (1990) Muscle protein synthesis in response to testosterone administration in wether lambs. *British Journal of Nutrition* 64, 691–704.
- Lobley, G.E., Harris, P.M., Skene, P.A., Brown, D., Milne, E., Calder, A.G., Anderson, S.E., Garlick, P.J., Nevison, I. and Connell, A. (1992) Responses in tissue protein synthesis to sub- and supra-maintenance intake in young growing sheep: comparison of large-dose and continuous-infusion techniques. *British Journal of Nutrition* 68, 373–388.
- Lobley, G.E., Connell, A., Milne, E., Newman, A.M. and Ewing, T.A. (1994) Protein synthesis in splanchnic tissues of sheep offered two levels of intake. *British Journal of Nutrition* 71, 3–12.
- Lobley, G.E., Connell, A., Revell, D.K., Bequette, B.J., Brown, D.S. and Calder, A.G. (1996) Splanchnic-bed transfers of amino acids in sheep blood and plasma, as monitored through use of a multiple U-<sup>13</sup>C-labelled amino acid mixture. *British Journal of Nutrition* 75, 217–235.
- Lobley, G.E., Lee, J., Edwards, J.H. and Harris, P.M. (1997) A comparison of changes in whole body and skin amino acid metabolism of sheep in response to 24 h continuous infusions of variants of insulin-like growth factor 1. *Canadian Journal of Animal Science* 77, 695–706.
- Lobley, G.E., Bremner, D.M., Nieto, R., Obitsu, T., Moore, A.H. and Brown, D.S. (1998) Transfers of N metabolites across the ovine liver in response to short-term infusions of an amino acid mixture into the mesenteric vein. *British Journal of Nutrition* 80, 371–379.
- Lobley, G.E., Sinclair, K.D., Grant, C.M., Miller, L., Mantle, D., Calder, A.G., Warkup, C.C. and Maltin, C.A. (2000) The effects of breed and level of nutrition on whole-body and muscle protein metabolism in pure-bred Aberdeen angus and Charolais beef steers. *British Journal of Nutrition* 84, 275–284.
- Mackle, T.R., Dwyer, D.A., Ingvarsen, K.L., Chouinard, P.Y., Ross, D.A. and Bauman, D.E. (2000) Effects of insulin on postprandial supply of protein on use of amino acids by the mammary gland for milk protein synthesis. *Journal of Dairy Science* 83, 93–105.
- MacRae, J.C. and Lobley, G.E. (1991) Physiological and metabolic implications of conventional and novel methods for the manipulation of growth and production. *Livestock Production Science* 27, 43–59.
- MacRae, J.C., Walker, A., Brown, D. and Lobley, G.E. (1993) Accretion of total protein and individual amino acids by organs and tissues of growing lambs and the ability of nitrogen balance techniques to quantitate protein retention. *Animal Production* 57, 237–245.

- MacRae, J.C., Bruce, L.A., Brown, D.S. and Calder, G. (1997a) Amino acid use by the gastrointestinal tract of sheep given lucerne forage. *American Journal of Physiology (Gastrointestinal Liver Physiology)* 36, G1200–G1207.
- MacRae, J.C., Bruce, L.A., Brown, D.S., Farningham, D.A.H. and Franklin, M. (1997b) Absorption of amino acids from the intestine and their net flux across the mesenteric- and portal-drained viscera of lambs. *Journal of Animal Science* 75, 3307–3314.
- McDonagh, M.B., Fernandez, C. and Oddy, V.H. (1999) Hind-limb protein metabolism and calpain system activity influence post-mortem change in meat quality in lamb. *Meat Science* 52, 9–18.
- Navegantes, L.C.C., Resano, N.M.Z., Migliorini, R.H. and Kettelhut, I.C. (2001) Catecholamines inhibit  $\text{Ca}^{2+}$ -dependent proteolysis in rat skeletal muscle through  $\beta$ 2-adrenoreceptors and cAMP. *American Journal of Physiology, Endocrinology and Metabolism* 281, E449–E454.
- Neutze, S.A., Gooden, J.M. and Oddy, V.H. (1997) Measurement of protein turnover in the small intestine of lambs. 2. Effects of feed intake. *Journal of Agricultural Science (Cambridge)* 128, 233–246.
- Nieto, R. and Lobley, G.E. (1999) Integration of protein metabolism within the whole body and between organs. In: Lobley, G.E., White, A. and MacRae, J.C. (eds) *Protein Metabolism and Nutrition*, EAAP No. 96. Wageningen Pers, The Netherlands, pp. 177–201.
- Nozière, P., Attaix, D., Bocquier, F. and Doreau, M. (1999) Effects of underfeeding and refeeding on weight and cellularity of splanchnic organs in ewes. *Journal of Animal Science* 77, 2279–2290.
- Oddy, V.H. and Owens, P.C. (1996) Insulin-like growth factor I inhibits degradation and improves retention of protein in hindlimb muscle of lambs. *American Journal of Physiology* 271, E973–E982.
- Oddy, V.H., Lindsay, D.B., Parker, P.J. and Northrop, A.J. (1987) Effect of insulin on hind-limb and whole-body leucine and protein metabolism in fed and fasted lambs. *British Journal of Nutrition* 58, 437–452.
- Oddy, V.H., Lindsay, D.B. and Fleet, I.R. (1988) Protein synthesis and degradation in the mammary gland of lactating goats. *Journal of Dairy Research* 55, 143–154.
- Patureau Mirand, P., Bernard, O., Prugnaud, J. and Arnal, M. (1985) Métabolisme protéique de l'agneau nouveau-né. II. Influence de l'alimentation sur les flux et le taux de renouvellement des protéines. *Reproduction Nutrition Développement* 25, 1061–1073.
- Rathmacher, J.A. and Nissen, S.L. (1998) Development and application of a compartmental model of 3-methylhistidine metabolism in humans and domestic animals. *Advances in Experimental Medicine and Biology* 445, 303–324.
- Rausch, M.I., Tripp, M.W., Govoni, K.E., Zang, W., Weber, W.J., Crooker, B.A., Hoagland, T.A. and Zinn, S.A. (2002) The influence of level of feeding on growth and serum insulin-like growth factor-I and insulin-like growth factor-binding proteins in growing beef cattle supplemented with somatotropin. *Journal of Animal Science* 80, 94–100.
- Samuels, S.E., Taillandier, D., Aurousseau, E., Chereil, Y., Le Maho, Y., Arnal, M. and Attaix, D. (1996) Gastrointestinal tract protein synthesis and mRNA levels for proteolytic systems in adult fasted rats. *American Journal of Physiology* 271, E232–E238.
- Savary, I.C., Hoskin, S.O., Dennison, N. and Lobley, G.E. (2001) Lysine metabolism across the hindquarters of sheep; effect of intake on transfers from plasma and red blood cells. *British Journal of Nutrition* 85, 565–573.



- Sillence, M.N., Hunter, R.A., Pegg, G.G., Brown, L., Matthews, M.L., Magner, T., Sleeman, M. and Lindsay, D.B. (1993) Growth, nitrogen metabolism, and cardiac responses to clenbuterol and ketoclenbuterol in rats and underfed cattle. *Journal of Animal Science* 71, 2942–2951.
- Sinaud, S., Balage, M., Bayle, G., Dardevet, D., Vary, T.C., Kimball, S.R., Jefferson, L.S. and Grizard, J. (1999) Diazoxide-induced insulin deficiency greatly reduced muscle protein synthesis in rats: involvement of eIF4E. *American Journal of Physiology* 276, E50–E61.
- Sinnett-Smith, P.A., Dumelow, N.W. and Buttery, P.J. (1983) Effects of trenbolone acetate and zeranol on protein metabolism in male castrate and female lambs. *British Journal of Nutrition* 50, 225–234.
- Sneddon, A.A., Delday, M.I., Steven, J. and Maltin, C.A. (2001) Elevated IGF-II mRNA and phosphorylation of 4<sup>E</sup>-BP1 and P70<sup>S6k</sup> in muscle showing clenbuterol-induced anabolism. *American Journal of Physiology, Endocrinology, and Metabolism* 282, E676–E682.
- Southorn, B.G., Kelly, J.M. and McBride, B.W. (1992) Phenylalanine flooding dose procedure is effective in measuring intestinal and liver protein synthesis in sheep. *Journal of Nutrition* 122, 2398–2407.
- Spencer, G.S.G., Schurmann, A., Berry, C., Wolff, J.E., Napier, J.R., Hodgkinson, S.C. and Bass, J.J. (1994) Comparison of the effects of recombinant ovine, bovine and porcine growth hormones on growth, efficiency and carcass characteristics in lamb. *Livestock Production Science* 37, 311–321.
- Tauveron, I., Larbaud, D., Champredon, C., Debras, E., Tesseraud, S., Bayle, G., Bonnet, Y., Thiéblot, P. and Grizard, J. (1994) Effect of hyperinsulinemia and hyperaminoacidemia on muscle and liver protein synthesis in lactating goats. *American Journal of Physiology* 267, E877–E885.
- Tesseraud, S., Grizard, J., Debras, E., Papet, I., Bonnet, Y., Bayle, G. and Champredon, C. (1993) Leucine metabolism in lactating and dry goats: effect of insulin and substrate availability. *American Journal of Physiology* 265, E402–E413.
- Thomson, B.C., Hosking, B.J., Sainz, R.D. and Oddy, V.H. (1997) The effect of nutritional status on protein degradation and components of the calpain system in skeletal muscle of weaned wether lambs. *Journal of Agricultural Science (Cambridge)* 129, 471–477.
- Vernon, B.G. and Buttery, P.J. (1976) Protein turnover in rats treated with trienbolone acetate. *British Journal of Nutrition* 36, 575–579.
- Waterlow, J.C., Garlick, P.J. and Millward, D.J. (1978) *Protein Turnover in Mammalian Tissues and in the Whole Body*. Elsevier-North Holland, Amsterdam.
- Wray-Cahen, D., Nguyen, H.V., Burrin, D.G., Beckett, P.R., Fiorotto, M.L., Reeds, P.J., Wester, T.J. and Davis, T.A. (1998) Response of skeletal muscle protein synthesis to insulin in suckling pigs decreases with development. *American Journal of Physiology* 275, E602–E609.
- Yu, F., Bruce, L.A., Galder, A.G., Milne, E., Coop, R.L., Jackson, F., Horgan, G.W. and MacRae, J.C. (2000) Subclinical infection with the nematode *Trichostrongylus colubriformis* increases gastrointestinal tract leucine metabolism and reduces availability of leucine for other tissues. *Journal of Animal Science* 78, 380–390.

*This page intentionally left blank*

---

# 15 Interactions between Protein and Energy Metabolism

T.C. Wright<sup>1</sup>, J.A. Maas<sup>2</sup> and L.P. Milligan<sup>1</sup>

<sup>1</sup>*Department of Animal and Poultry Science, University of Guelph, Guelph, Ontario N1G 2W1, Canada;* <sup>2</sup>*Centre for Integrative Biology, University of Nottingham, Sutton Bonnington, Leicestershire LE12 5RD, UK*

---

## Introduction

The corresponding chapter in the previous edition of this book concluded by describing protein and energy metabolism as a unity instead of an interaction of separate components of metabolism. This edition will examine some of the recent knowledge generated about this subject with an emphasis on those metabolites and tissues that serve important roles for biochemical reactions in which carbon and nitrogen are, in effect, equal partners.

Animals encounter numerous challenges during their lives, and respond to achieve maximum advantage for their welfare and survival in meeting those challenges. This does not imply, however, that the response will necessarily be measured as the most efficient possible in terms of agricultural animal performance. It is possible to make estimates of the stoichiometry of numerous reactions for many metabolic pathways involving protein and energy intermediates. The opportunity for nutritionists is to develop a better understanding of the fate of nutrients under differing circumstances and of the regulatory system that determines an end point. The energetic costs associated with disposing of an amino acid (AA) can differ from tissue to tissue. Current models have advanced nutritional efficiency, in terms of product per unit animal, but it is appropriate now to explore those pivot points and signals that may determine nutrient fate and associated energetic costs of protein and energy metabolism. It will become clear that a better comprehension of the unity of protein and energy metabolism follows from the further development of quantitative models that reflect metabolic mechanisms.

## Rumen Aspects

The initiation of ruminant protein and energy metabolism begins in the rumen where the energetic efficiency of the rumen microbes within their anaerobic

environment compares unfavourably with the aerobic environment of the host. The anaerobic state of the rumen dictates that the microbes must metabolize greater amounts of carbon substrates than the host to derive equal energy (see Chapter 9). Recent advances in protein and carbohydrate nutrition for ruminant animals have produced some estimates for AA requirements in ruminants (e.g. NRC, 2001) as well as a better understanding of the fermentation of nitrogen and carbohydrate sources in relation to each other (see Chapter 10).

The proportions of fermentation end-products, principally AA, protein, volatile fatty acids (VFA), carbon dioxide and methane can dictate in large part the subsequent metabolic efficiencies for the host. Nutritional manipulations that affect the end-products of rumen fermentation in a sustained manner are often difficult to achieve. Asanuma *et al.* (1999) investigated the contributions to ruminal H<sub>2</sub> production from the major cellulolytic bacteria *Ruminococcus albus* and *R. flavefaciens* and the potential benefits of enhanced electron accepting reactions *in vitro*. Asanuma *et al.* (1999) concluded that there was potential to reduce ruminal methane production and enhance energy efficiency of the animal through the use of fumarate and malate as feed additives that would serve as electron acceptors. The importance of AA, peptides and ammonia as substrates for microbial protein synthesis should be quantitatively described in terms of both the ruminal environment they contribute to, and as the major source of protein for the host, as microbes pass from the rumen to the small intestine. Oldick *et al.* (1999) and Clark *et al.* (1992) both reported that the profile of microbes passing to the small intestine from the rumen changes depending on the diet, and therefore the AA profile of microbial protein is not constant, as is commonly assumed in several models. The availability of AA in the animal can be increased by increasing dry matter intake, which increases the synthesis of microbial protein, and by providing dietary proteins that are resistant to ruminal digestion but are digested by the animal. One of the most important variables associated with abomasal protein flow is the level of feed intake.

VFA represent the principal form of energy substrate for ruminant animals (Sutton, 1985). Considerable proportions (30%, 50% and 92% of acetate, propionate and butyrate, respectively) are subjected to first-pass absorptive metabolism and never reach the venous blood (Reynolds, 2002). Fermentation imbalances in the rumen (e.g. resulting from excess supply of degradable nitrogen) can be minimized by using current feeding recommendations, that will benefit animal performance as well as reduce the negative impact on the environment, whether measured locally (e.g. on-farm balance of nitrogen and phosphorus) or in a more global sense (e.g. greenhouse gases). Further improvements to mechanistic models of metabolism will result in more effective strategies to minimize the potential for negative environmental impact.

## Energetics and Protein Metabolism

The synthesis and degradation of protein in the body continues to be the subject of most research. Energetically costly, the estimate for ATP-equivalent

cost per peptide bond formed remains at 5 ATP. However, the true cost of peptide bond formation *in vivo* remains unknown. Various experimental estimates for peptide bond formation cost are presented in Table 15.1. Of interest from the study of Storch and Portner (2003; see Table 15.1) was their determination of peptide bond formation cost in cold-adapted or eurythermal fish species; the authors reported no difference in bond formation cost between these two types of fish, and noted that cold adaptation may be achieved at the level of protein stability. A problem with all peptide bond cost estimates is the absence of accounting for protein specific pre- and post-translational energy costs. The general acceptance of 5 ATP/bond is based on 2 ATP for AA activation, 1 ATP for bond formation, 1 ATP for translocation and 1 ATP for AA transportation, RNA production and associated errors (Fuery *et al.*, 1998). Protein degradation costs have been estimated to be less than 25% of the cost of protein synthesis (Lobley, 2003), which in tissues with rapid protein turnover rates, such as the small intestine, still represents a significant energy expenditure for the animal. Protein turnover estimates should also include the indirect costs such as RNA turnover and the cost of metabolic regulation (Storch and Portner, 2003), to provide a more accurate picture of total energy cost.

Experiments designed to examine the regulation of protein turnover in the body have the potential to increase our understanding of metabolism, beyond an appreciation of protein turnover costs. The concept of nutrients, including AA, functioning in the dual role of nutrient signal and biochemical substrate is well established (Grizard *et al.*, 1995). Amino acids have been shown to affect protein synthesis and degradation through their role as metabolic signals. A complex regulatory framework interacts to govern independent protein synthesis and degradation rates in different tissues, including hormones, neural signals, physical activity, nutritional status and environmental conditions.

There have been studies of protein and energy metabolism in humans that have explored a variety of conditions (e.g. such as normal man, burn trauma and ageing), which have increased knowledge of protein metabolism and energy expenditures. Wolfe (2002) noted that in burn patients in whom protein

**Table 15.1.** Energy cost estimates of protein synthesis (revised from Kelly *et al.*, 1993).

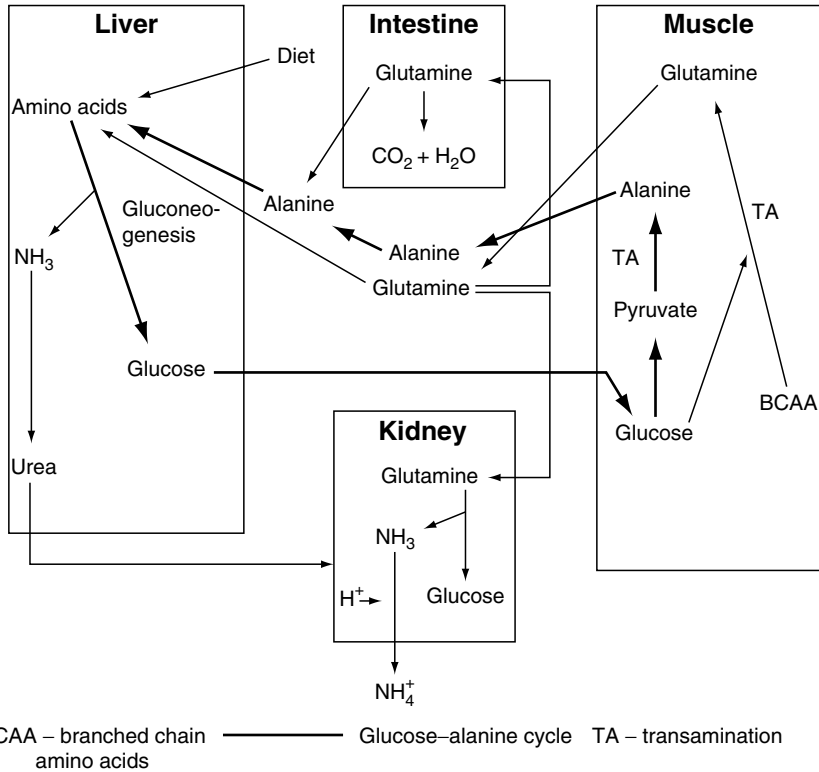
Method	Energy cost (mole ATP per molar peptide bond synthesized)	References
Inhibition (reticulocytes)	3.0	Siems <i>et al.</i> (1984)
Inhibition (chicks)	7.5	Aoyagi <i>et al.</i> (1988)
Inhibition (fish)	4.3–5.6	Storch and Portner (2003)
Stoichiometry	4.0	Buttery and Boorman (1976)
Stoichiometry	5.0	Millward <i>et al.</i> (1976)
Stoichiometry	6.3–7.0	Webster (1981)
Regression (swine)	30.2	Reeds <i>et al.</i> (1980)
Regression (chicks)	18.8	Muramatsu and Okumura (1985)

degradation rates were elevated above protein synthesis rates, supplementation of AA had the effect of reducing protein degradation without an offsetting effect on protein synthesis rate. The results of this study led the author to ask the question as to whether or not there is independent regulation of protein degradation and protein synthesis (Wolfe, 2002). The answer to this question has important implications for nutritionists who must consider that a variety of results can be achieved from intake of the same AA. The outcome of a set AA intake will depend on the dynamics of the governing factors in play in the metabolic situation being studied. We concur with the conclusion of Wolfe (2002) that it may be more beneficial in the long run to determine the mechanisms by which AA and energy affect muscle protein synthesis and degradation rather than seeking a particular value for a 'requirement'. There is potential for direct regulation of proteolysis by AA (Kadowaki and Kanazawa, 2003). The regulation of protein synthesis by AA in human skeletal muscle (Liu *et al.*, 2002) has recently been reviewed (Wolfe and Miller, 1999; Yoshizawa, 2004). While there are likely to be similarities between humans and ruminants in the underlying mechanisms for AA signalling to quantitatively alter protein synthesis and degradation rates, this remains to be confirmed.

Sarcopenia, the condition of muscle protein wasting in ageing humans, presents an interesting model to examine the factors that control muscle protein turnover. Volpi *et al.* (2001) conducted a large study of young and elderly men to examine the basis for muscle protein loss observed in the elderly. Earlier studies had suggested that sarcopenia results from a decreased muscle protein synthesis rate (Volpi *et al.*, 2001). However, Volpi *et al.* (2001) concluded that older men had slightly higher protein synthesis and degradation rates in leg muscle than younger men, but that the basal protein turnover rate in muscle was unlikely to account for the muscle loss associated with ageing. This suggests that additional factors that determine muscle protein loss with ageing (e.g. hormonal or nutritional) play an important role in controlling muscle protein mass, and that individually, neither synthesis nor degradation rates can explain the net balance of protein turnover. Integration of the myriad factors that control the balance between protein synthesis and degradation into a mathematically based description is likely the most effective approach to arrive at accurate predictions of the synthesis and degradation balance that will result from changes in nutritional or hormonal status.

## Non-essential Amino Acids

Non-essential AA such as alanine, glutamine and glutamate are direct metabolic links between energy and protein metabolism. Some of the inter-organ relationships for alanine and glutamine are illustrated in Fig. 15.1. Olde Damink *et al.* (1999) summarized the important metabolic functions provided by glutamine as: the inter-organ transfer of nitrogen and carbon; to provide energy for rapidly dividing cells; as a precursor for nucleic acid biosynthesis; and the regulation of acid/base homeostasis. Peripheral tissues synthesize glutamine and alanine as a way of partially oxidizing AA and yet supplying nitrogen and



**Fig. 15.1.** Inter-organ relationships in the metabolism of alanine and glutamine (from Kelly *et al.*, 1993).

carbon to the tissues of the gut and the liver. The compromise of incomplete oxidation leaves the nitrogen in a non-toxic form that can be transported back to the liver. Because the tissues of the gut almost completely metabolize the supply of glutamate, aspartate and glutamine during first-pass absorption, the supply of these AA for protein synthesis in other tissues must be met almost completely from *de novo* synthesis (Reeds *et al.*, 1996). These are likely to be synthesized by transamination from glutamate at a cost of 4 ATP per molecule of non-essential AA. Thus diets balanced for non-essential as well as essential AA could have an energy sparing effect for the animal.

Lobley *et al.* (2001) provided an interesting perspective whereby the metabolism of glutamine was described with respect to its contribution to whole-body protein and energy metabolism. Glutamine has many metabolic roles, but responses to glutamine supplementation have been inconsistent and it is not considered to be limiting for growth or lactation. For example, glutamine is the most abundant free AA in tissues of most animals, which Van Milgen (2002) noted is energetically favourable compared with protein storage. Previously, researchers have focused on the extensive use of glutamine and glutamate as energy substrates by the tissues of the gut.

Glutamine and glutamate, respectively, constitute 6.5–12.5% and 7.2–10.0% of AA residues in bovine caseins, therefore uptake and synthesis of glutamine by the mammary glands must be considerable in a high-producing dairy cow. In addition, the uptake of many non-essential AA by the mammary glands is below that required for milk synthesis, and glutamine is likely the source of both carbon and nitrogen for mammary synthesis of other non-essential AA. Glutamine also appears to have a role in mediating intracellular activity through transport-mediated changes in cell volume.

Reeds *et al.* (2000), using the neonatal pig as a model, suggested mechanisms exist that allow pigs to sense an imbalance in the AA supply from milk so they can make acute metabolic changes to ensure AA are still used with high efficiency. These mechanisms may also be present in more mature animals. Data from both the rat and the neonatal pig suggest that the number of ribosomes decreases but the translational activity of each ribosome increases as the animal approaches weaning. The reduction in efficiency of protein utilization in neonatal pigs from birth to 26 days of age is mirrored by changes in sensitivity and responsiveness of protein deposition to insulin concentration.

Lobley (1992) suggested that in lambs the conversion of dietary nitrogen to body nitrogen was only 13%. Data from isotopic studies suggest that 50% to 100% of oxidized glucose was synthesized from glutamate, glutamine and alanine. The incremental efficiency for protein gain of absorbed AA ranges from 40% to 80% (Lobley, 1992). Tracer approaches suggest that in fasted sheep, daily protein synthesis amounted to approximately 8% of the whole-body protein pool. There is some suggestion that gluconeogenesis from AA occurs even under supramaintenance conditions, which may explain the low efficiency of incremental AA use as supply increases (Lobley, 1992).

The use of non-essential AA as a fuel source in visceral tissues is, intuitively, energetically more expensive than the direct use of glucose. Van Milgen (2002) presented a useful framework to examine the energetics of intermediary metabolism, wherein this efficiency was re-examined in some detail. The additional net cost of converting glucose to glutamate and then oxidizing the glutamate and regenerate ATP (in muscle and viscera, respectively), relative to using glucose as an ATP precursor, is the equivalent of 1.25 ATP, which Van Milgen (2002) indicated is less than the energy cost involved in glycogen turnover. The benefits of deriving energy from non-essential AA presumably outweigh the better theoretical energetic efficiency of direct use of glucose as a fuel source.

Glutamine may also have benefits to visceral tissues in terms of modulating protein turnover, with a resulting economy for energy expenditure. Coëffier *et al.* (2003) used enteral infusion of glutamine into human subjects to examine effects on protein metabolism. Two noteworthy findings resulted from their experiment. The first was that glutamine stimulated non-specific protein synthesis as has been demonstrated in other mammals. The second, based on the analysis of duodenal biopsies, indicated a decrease in ubiquitin mRNA level compared with either a saline control or an isonitrogenous AA mixture infusion. Coëffier *et al.* (2003) concluded that mucosal protein degradation through the ATP-ubiquitin dependent proteolytic pathway might be limited



via a glutamine-specific mechanism. These authors also raised the possibility that glutamine could regulate the inflammatory response in the intestinal mucosa of humans. These possibilities are worthy of investigation in ruminant animals in which glutamine supplementation may be useful to support animal well-being during periods of physiological and metabolic stress, for example the periparturient dairy cow, which can experience metabolic disorders and which mobilizes significant body reserves to support milk production.

## Portal-drained Viscera (PDV)

The PDV in mature ruminant animals comprises those tissues whose venous drainage is combined and flows into the hepatic portal vein, including the rumen, reticulum, omasum, abomasum, small intestine, large intestine, spleen, pancreas, caecum and mesenteric and omental fat tissue. Some small anatomical differences exist between ruminant species but they are generally quite similar (Seal and Reynolds, 1993). The PDV tissues differ from other tissues of the body because of their exposure to dual sources of nutrient supply, namely digesta and arterial blood supply. Ruminant PDV tissues utilize glucose, volatile or short-chain fatty acids, ketones and AA as oxidative substrates (Reynolds *et al.*, 1990). The absorption of free AA and peptides across the small intestine is achieved by specific transporters, some of which require energy. This, and the high turnover rate of gut tissue, are two significant contributions of the small intestine to whole-body energy expenditure. Maintenance of  $\text{Na}^+$ ,  $\text{K}^+$ , ATPase activity, substrate cycling, urea synthesis, protein synthesis and degradation in the gastrointestinal tract and liver were estimated together to account for 22.8% of whole-body oxygen consumption in growing steers (Huntington and McBride, 1988) and, more recently, Reynolds (2002) estimated that the total splanchnic tissues usually account for 40–50% of total body oxygen consumption. The energetic cost to the animal for maintenance and turnover of gut tissues and for nutrient absorption is, therefore, considerable and a large proportion of this energy expenditure is directly linked to protein and AA metabolism.

Coordination of nutrient use by the whole animal is an important part of protein/energy metabolism, particularly in the PDV. Ebner *et al.* (1994) conducted an experiment with 2-week-old pigs to examine the effects of a low-protein diet (15% crude protein (CP)) compared with a control, isocaloric protein diet (30% CP) on PDV tissue growth and metabolism. In their experiment, feed intake was not different ( $P = 0.76$ ) between the experimental groups, but after 2 weeks there was evidence of protein malnutrition including reduced carcass weight and higher circulating concentrations of 3-methylhistidine in the pigs fed low protein diet. These piglets had PDV blood flow and  $\text{O}_2$  consumption rates approximately 50% and 22% higher, respectively, than control pigs on a lean body mass basis, under fasting conditions. Ebner *et al.* (1994) suggested that under conditions of protein malnutrition, gastrointestinal tissues and their metabolic rate were preserved at the expense of peripheral tissues. Reduced concentrations of insulin were measured in the low protein

group, which may have helped to coordinate a response to reduce the use of AA for protein synthesis in skeletal muscle. Understanding the mechanisms in ruminant animals that serve to prioritize tissue nutrients to cope with situations of protein malnutrition (e.g. disease, parasitic infection, low feed quality, etc.) would improve our understanding of whole animal nutrient use.

The energetic cost of protein synthesis in the small intestine of lambs in response to level of feed intake was quantified by Neutze *et al.* (1997a,b). As in other studies of this type, the choice of pool to represent the actual AA-specific radioactive pool had a dramatic impact on fractional synthesis rate calculations. Use of the tissue-free phenylalanine-specific radioactivity gave a fractional synthesis rate of approximately 130% per day, while the use of the arterial blood phenylalanine-specific radioactivity gave estimates of approximately 30% per day. The small intestine accounted for approximately 13% of whole-body protein synthesis, which accounted for 18–27% of total energy use by that tissue, depending on the true precursor pool. Neutze *et al.* (1997a,b) accounted for the production of exported proteins and their results suggested that, in growing lambs, exported proteins such as sloughed cells and secretory proteins might account for the largest component of total protein synthesis in the small intestine. The energy expended for the synthesis of exported proteins is noteworthy because the opportunity for energetically efficient reuse of their carbon and nitrogen metabolites is reduced.

The important role of the PDV and the liver to modulate the quantity and concentration of nutrients supplied to peripheral tissues was reported by Lapierre *et al.* (2000) using multi-catheterized animals. These authors used growing steers and achieved three different levels of intake of a single diet, calculated to provide 0.6, 1.0 and 1.6 times the estimated requirements for ME and CP. Their experiment examined in detail the uptake and release of AA, hormones and key metabolites across tissues and provided a better understanding of nutrient fluxes in total splanchnic metabolism. The information gained from this intricate type of research provides important data on nutrient use and systemic regulation that will ultimately permit the development of diets that improve efficiency of the conversion of dietary nitrogen to animal protein. Further improvements in our understanding of PDV metabolism might be achieved if the luminal nutrients that can directly signal protein synthesis or degradation were determined. Identification of these nutrients through the use of normal feeding trials is difficult because as the luminal nutrient supply changes, both basolateral nutrient concentrations and hormonal changes will result.

The kinetics of AA use by the PDV are complex, in part because the use of AA of arterial origin appears to increase concomitantly with increases in luminal AA supply (Reynolds, 2002). The sensitivity of intestinal protein synthesis to the avenue of nutrient supply is unique. Discerning systemic effects from the direct effects of increased luminal nutrient concentration is difficult because techniques to distinguish these two events are a challenge to develop, and, invariably, increased luminal nutrient concentrations lead to systemic responses for growth factors and hormones that can stimulate protein synthesis.

Recently, a technique has been validated in piglets to determine the acute effects of luminal nutrient supply on intestinal protein synthesis (Adegoke *et al.*, 1999a) using multiple cannulation of the small intestine to permit luminal nutrient perfusion of short, discrete intestinal segments. Multiple segments of small intestine within the same animal can be perfused, which together account for less than 4% of total small intestinal absorptive surface area. This multiple perfusion approach, combined with the luminal flooding dose technique, resulted in a method that measured the acute effects of luminal nutrient concentration on intestinal protein synthesis in the absence of systemic responses such as increased plasma insulin, AA or glucose concentrations (Adegoke *et al.*, 1999a). Several interesting findings were reported with the application of this technique in an experiment designed to examine the acute effects of luminal nutrients on intestinal protein synthesis and mRNA abundance of m-calpain and components of the ATP-ubiquitin protein degradation system (Adegoke *et al.*, 1999b). A 20–25% suppression of mucosal protein fractional synthesis rate ( $K_s$ ) occurred with luminal perfusion of a 30 mmol/l mixture of AA or a 30 mmol/l perfusion of glutamine compared with a saline perfusion. A second experiment examined the perfusion of mucosal energy substrates (50 mmol/l glucose, 50 mmol/l short-chain fatty acids or 20 mmol/l  $\beta$ -hydroxybutyrate) without added AA and there was no effect on the fractional rate of protein synthesis in the mucosa (Adegoke *et al.*, 1999b). Analysis of the abundance of mRNA for the protein for degradation systems revealed that while there was no effect of AA perfusion on m-calpain expression, there was a 28% reduction in ubiquitin mRNA abundance and a 20% reduction in the ubiquitin-conjugating enzyme, which agrees with the data of Coëffier *et al.* (2003) in which enteral glutamine in humans reduced gut mRNA abundance of ubiquitin. The effectiveness of AA compared with ammonia to suppress protein synthesis was also tested by perfusing intestinal segments with buffer, 30 mmol/l mixture of AA or two concentrations of ammonium chloride. Their results (Table 15.2) indicated that there was a 26% reduction in  $K_s$  when the AA mixture was perfused, while ammonium chloride perfusion had the effect of raising tissue ammonia levels to those that resulted with AA perfusion, but without an equivalent effect on  $K_s$ . Thus, the signal for protein synthesis is mediated by AA. Adegoke *et al.* (1999b) noted the rapid (90 min) time frame for the changes detected in

**Table 15.2.** Effect of buffer, an AA mixture or ammonium chloride on mucosal protein fractional synthesis ( $K_s$ ) in piglets (from Adegoke *et al.*, 1999b).

Treatment	Buffer (PBS)	Amino acids 30 mmol/l	Ammonium chloride	
			0.5 mmol/l	1.0 mmol/l
Tissue ammonia, $\mu\text{g/g}$ wet weight	6.30 $\pm$ 0.17 <sup>a</sup>	8.42 $\pm$ 0.29 <sup>b</sup>	7.46 $\pm$ 0.28 <sup>ab</sup>	8.39 $\pm$ 0.28 <sup>b</sup>
$K_s$ , % PBS	100 $\pm$ 3.8 <sup>a</sup>	74 $\pm$ 3.7 <sup>b</sup>	98 $\pm$ 4.6 <sup>a</sup>	102 $\pm$ 3.4 <sup>a</sup>

Values are mean  $\pm$  SEM for  $n = 6$ . Different superscripts within a row are different from one another ( $P < 0.05$ ).

proteolytic gene expression, which is indicative of the sensitivity to nutrient supply in the small intestine. Adegoke *et al.* (1999b) concluded that while the suppression of protein synthesis and degradation in the gut associated with increased luminal AA concentrations may be counter-intuitive, it might also be a useful mechanism to reduce substrate utilization (and energetic costs) in the intestine, and to promote delivery of nutrients to peripheral tissues. Baracos *et al.* (2000) indicated, in their review of this approach, that regulation of protein synthesis and degradation in the intestine is poorly understood in humans relative to skeletal muscle. Increasing our knowledge about the role that specific AA can have to change protein degradation or synthetic rates in the small intestine of ruminants is necessary to develop a quantitative understanding as to how nutrient supply can alter tissue energy expenditure.

The energetic costs of protein synthesis and degradation in the PDV tissues are significant to ruminant animals. While our knowledge of dietary requirements has increased for ruminant livestock, further improvements to achieve more efficient nutrient use will depend on increasing our understanding of AA as nutrient signals that may together or independently regulate protein synthesis and degradation in the PDV. The relative importance of intracellular protein degradation routes (e.g. ATP-ubiquitin system, calcium-dependent or lysosomal pathways) in the gut and their energetic costs are unknown in ruminant animals, which also needs to be resolved.

## Hepatic Metabolism

Seal and Reynolds (1993) suggested that, excluding acetate, 85–100% of VFA arriving at the liver via the portal vein is removed from the blood. Acetate is the only VFA that is not almost completely removed and thus is found in peripheral blood in substantial concentrations. Propionate is a principal carbon source for hepatic glucose synthesis. Most AA are removed to some degree by the liver, the exceptions being branched chain AA and glutamate which appear to be produced by hepatic metabolism. Alanine, glycine and glutamine from peripheral tissues are carried to the liver where they serve as amino donors, are used in gluconeogenesis or protein synthesis or are degraded to yield urea (Fig. 15.1). Alanine and glycine also serve as amino group transporters for tissues of the PDV and thereby avoid potentially toxic ammonia concentrations. The kinetics of AA use by hepatic tissue is far from clear. Blouin *et al.* (2002) fed lactating dairy cows isonitrogenous diets that differed in rumen protein degradability and, hence, metabolizable protein (MP), and measured the effects on splanchnic (PDV and liver) fluxes of nutrients. Portal absorption of AA was increased on the high (1930 g/day) MP diet compared with the low (1654 g/day) MP diet; however, there was no difference in liver removal of AA between the diets. The similar AA removal from blood by the liver permitted more AA to be delivered to peripheral tissues, including the mammary glands with the higher MP diet. Milk and milk protein yield increased 1.8 kg/day and 64 g/day, respectively, as a result. In their experiment, the ratio of ammonia:AA-nitrogen in portal venous blood was affected by diet (0.91 and 1.3 for

the higher and lower MP diets, respectively), which reflects the importance of ruminal energy and nitrogen availability (Blouin *et al.*, 2002).

In the study by Lapierre *et al.* (2000), removal of AA by the liver increased linearly as feed intake increased for several individual AA including alanine, asparagine, phenylalanine, tyrosine, methionine and proline. There was a net removal of total AA by the liver at all feed intake levels, and, at the lowest intake level (60% of ME and CP requirements) the use of AA by the digestive tract probably caused the total AA release from the PDV to be close to zero, as would be expected when sub-maintenance diets are fed (Lapierre *et al.*, 2000). At the medium (100% of ME and CP requirements) and high (160% of ME and CP requirements) intake levels, the liver removed approximately 34% of the AA absorbed by the PDV. Removal of essential AA comprised 15% of total AA removal by liver. Therefore, in their experiment, the combination of the ratio of essential AA:total AA absorbed by the PDV and then the subsequent preferential use of non-essential AA by the liver, resulted in essential AA:total AA ratio in hepatic vein blood of 0.75:1 and 0.53:1, respectively, for the medium and high feed intake levels (Lapierre *et al.*, 2000). The total splanchnic flux of essential AA increased with increasing intake, except for tryptophan. Quantified from all gluconeogenic precursors, AA can contribute 15–30% of total glucose synthesis in lactating dairy cows. The importance of the liver in regulating the supply of AA and other substrates for peripheral tissue use subsequent to its own use is an important determinant in the overall energetic efficiency of ruminant animals.

## Skeletal Muscle

Cellular and molecular events that regulate protein synthesis and degradation are areas requiring more research. Amino acids have been identified as potent regulators of muscle protein synthesis (Wolfe, 2002) and many attempts to increase muscle or milk protein synthesis in ruminant animals have been made. Tesseraud *et al.* (2003) showed the importance of AA in regulating cytoplasmic serine/threonine kinase S6K1 and protein synthesis in an avian muscle cell line, independently of an insulin effect. The cell line used was demonstrated to be devoid of insulin receptors, and treatments in which AA were deprived, supplied or deprived and replenished demonstrated the ability of AA to affect phosphorylation of S6K1 and increase its activity (Tesseraud *et al.*, 2003). S6K1 phosphorylates 40S ribosomal protein S6 that can increase the translation of elongation factors and ribosomal proteins in a selective manner. Tesseraud *et al.* (2003) concluded that S6K1 phosphorylation was mediated through mammalian target of rapamycin (mTOR) PI3-kinase activity. This level of detail about the effects of AA on protein synthesis is necessary to increase our understanding of protein and energetic interactions in ruminant muscle.

Another thoughtfully designed experiment by Tesseraud *et al.* (2000) utilized chicks obtained from either a fast (FGL) or slow growing line (SGL), to examine the basis of genetic regulation of muscle protein deposition. The FGL line had greater total body weight and pectoralis muscle weight than the SGL at 1 and 2 weeks of age. As observed with mammals (Lobley, 1993),

$K_s$  declined with age in their experiment (Table 15.3), but was similar for the pectoralis major muscle between genotypes. In their experiment, fractional degradation rate ( $K_d$ ) in the FGL was less than the SGL between 1 and 2 weeks of age, which would favour muscle protein accretion. This implies that selection for enhanced growth may affect the  $K_d$  rate at a young age, which could result in a more metabolically efficient use of energy and protein. An important route for protein degradation, the ubiquitin-mediated proteolytic pathway, continues to be the subject of intensive research efforts. Tesseraud *et al.* (2000) noted that mechanisms associated with genetic differences in muscle protein degradation are poorly understood, and in the two lines of chickens selected for growth such a possibility could account for the differences detected in fractional protein degradation rates (Table 15.3). Lobley (2003) noted that the result of selecting animals for growth and efficiency could have important post-mortem implications on meat tenderness that is, in part, mediated by protein degradation.

There are numerous factors that affect muscle protein synthesis and degradation, and the regulatory mechanisms that control these factors can function discretely on different cell types, rather than only affect changes in whole-body muscle metabolism (Volpi *et al.*, 2001). It is likely then, that a better understanding of protein synthesis and degradation will require an examination of individual muscles or cell types in order to determine the extent of differential regulation. Tesseraud *et al.* (2001) investigated the potential for a nutrition-genotype interaction in two lines of chickens, a quality line selected for growth and carcass composition, and a control line for comparison purposes. Control or lysine-deficient diets were fed to both groups of chickens. Their results indicated that there was no difference in sartorius muscle protein metabolism, regardless of dietary treatment, for either line, nor was there a difference between lines fed the control diet in pectoralis muscle protein turnover. Differences in pectoralis major muscle metabolism between the lines of chickens were detected when the lysine-deficient diet was offered. The selected line of chickens had a fractional protein synthesis rate of 23.0% per day compared with 17.7% per day for the control chickens when the lysine-deficient diet was fed. This was an increase in the fractional synthesis rate for both lines compared with the control diet (12.7% and 13.0% per day for the selected and control chickens, respectively), although the increase was greater for the selected line. The line-related differences in protein turnover suggested a nutrition-genotype interaction. The differential response between muscle groups was intriguing, and Tesseraud *et al.* (2001) suggested that muscle fibre type might play a role in the differences between muscle tissues. Genetic selection affected pectoralis muscle protein metabolism in their experiment, though not sartorius muscle. The difference in muscle protein turnover rates reported by Tesseraud *et al.* (2001) suggests that there may be a hierarchy for the alteration of muscle protein metabolism and that mechanisms may exist to facilitate differential protein turnover rates in specific muscle tissues.

Energy supplied in the diet can also have a significant effect on protein metabolism in the whole animal. When the energy intake of sheep was increased from a medium to high level, both protein synthesis and degradation of the hind limb increased, but the magnitude of increase was greater for protein

**Table 15.3.** Pectoralis major muscle protein metabolism (mean from  $n = 6$  and SE) in chickens at 1 and 2 weeks of age from genetic lines selected for fast (FGL) or slow (SGL) growth over 33 generations (from Tesseraud *et al.*, 2000).

Item	1-week old				2-week old				Main effect			
	SGL		FGL		SGL		FGL		Line	Age	L*A	
	Mean	SE	Mean	SE	Mean	SE	Mean	SE				
<i>Pectoralis major muscle</i>												
Weight (g)	0.61	0.03	2.17	0.17	2.17	0.07	5.67	0.18	<0.001	<0.001	<0.001	
Relative weight (g/kg BW)	12.6	0.5	23.2	1.6	26.2	0.7	32.8	0.5	<0.001	<0.001	0.06	
<i>Absolute rates</i>												
Protein deposition (mg/day)	17	1	60	1	31	1	85	2	<0.001	<0.001	<0.01	
Protein synthesis (mg/day)	32	3	90	4	78	6	162	13	<0.001	<0.001	<0.05	
Protein breakdown (mg/day)	15	3	29	5	46	5	76	12	<0.001	<0.001	0.18	
<i>Fractional rates</i>												
Protein gain (% per day)	22.2	2.3	24.2	2.6	11.3	0.6	11.7	0.2	0.64	<0.001	0.75	
Protein synthesis (% per day)	40.2	3.6	35.0	2.2	28.0	2.4	22.0	1.3	0.14	<0.001	0.92	
Protein breakdown (% per day)	17.9	3.1	10.8	1.5	16.6	2.0	10.3	1.4	<0.05	<0.5	0.90	

synthesis than for degradation (Harris *et al.*, 1992). The apparent retention of newly synthesized protein was approximately 0.3. The authors stated that, on a whole animal basis, the contribution of protein synthesis to total energy expenditure was in the range of 12–33%. In terms of the whole body, when the sheep went from a medium- to high-energy diet, total tissue anabolism increased, and 83–85% of the net anabolism could be accounted for by changes in protein synthesis. Crompton and Lomax (1993) used radiolabelled tyrosine to show that there was simultaneous uptake and release of tyrosine by the hind limb of lambs, regardless of their nutritional state. As feed intake increased, protein synthesis rate and protein gain increased, but not protein degradation rate. Crompton and Lomax (1993) also suggested that the specific radioactivity of aminoacyl-tRNA in muscle cells was approximately halfway between extracellular and intracellular free specific radioactivity. Wolfe (2002) noted that AA concentrations are able to maintain the charge of tRNA in a variety of situations, and it is unlikely that tRNA charging is a direct regulator of protein synthesis. Changes in protein gain associated with increased dry matter intake were due to changes in the fractional synthesis rate. In underfed steers, protein synthesis accounted for approximately 13% of hind limb energy expenditure. Tauveron *et al.* (1994) found that increasing arterial concentration of AA, but not insulin, stimulated protein synthesis in skeletal muscle and hepatic tissue of lactating goats. Bohé *et al.* (2003) examined the relationship of human muscle protein synthesis to intramuscular and extracellular AA concentrations. Their data showed that there was not a strong relationship between muscle protein synthesis and intramuscular essential AA concentrations, but that there was a hyperbolic relationship to blood essential AA concentrations. Bohé *et al.* (2003) speculated that sensing of increased extracellular essential AA concentration was stimulatory to muscle protein synthesis.

Mutsvangwa *et al.* (2004) investigated the effects of a nutritionally induced chronic metabolic acidosis in dairy cattle on the ATP-ubiquitin-mediated proteolytic pathway. Under conditions of metabolic acidosis, ureagenesis decreases and glutamine synthesis increases. In this situation, liver metabolism adjusts to effect retention of bicarbonate. Chronic metabolic acidosis has been tied to increase in the levels of skeletal muscle degradation, via the ubiquitin-mediated proteolytic pathway, which is the primary route for the degradation of myofibrillar proteins of skeletal muscle in non-ruminants. Mutsvangwa *et al.* (2004) noted that these events are less clearly understood in ruminant animals. Loble *et al.* (1995) achieved a chronic metabolic acidosis in sheep using  $\text{NH}_4\text{Cl}$  but did not note changes in muscle protein degradation or synthesis. Mutsvangwa *et al.* (2004) reported increased ( $P < 0.05$ ) skeletal muscle mRNA abundance for ubiquitin-mediated protein degradation components, including ubiquitin, the 14-kDa E2 and the C8 subunit, although there was no effect of acidosis on the C9 subunit. The relative importance of these components to the regulation of this protein degradation pathway is not well understood at either the tissue or the species level (Mutsvangwa *et al.*, 2004). The muscle of interest in their study was the longissimus dorsi, and it would be interesting if other muscles were similarly affected by chronic acidosis, in light of the data from Tesseraud *et al.* (2001) who reported different protein

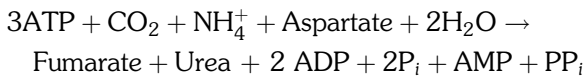


turnover rates in different chicken muscles. Our understanding of skeletal muscle protein turnover and associated energetics would improve with detailed knowledge of its determinants and by examining the possibility for differential regulation between muscles. Models similar to the one used by Mutsvangwa *et al.* (2004) may be useful for further ruminant-based research in this regard.

The ability of an animal to approach a steady-state condition in the face of genetic and environmental differences highlights the importance of understanding factors that regulate metabolism. The different metabolic responses possible in skeletal muscle tissue depending on AA and dietary energy supply under varying conditions are numerous. These various conditions are all addressed by the animal with survival as a goal. This objective dictates that a degree of biological flexibility or plasticity (Lobley, 2003) be maintained, at an energetic cost to the animal. The concept of maintenance energy requirement used to account for the vital service functions of the animal (Van Milgen, 2002) should be considered to be more dynamic than static. The data of Mutsvangwa *et al.* (2004) provided evidence that variations in physiological state (i.e. acidosis) could alter protein degradation components, with consequences for higher maintenance energy requirements, which may not be widely appreciated in practical nutrition.

## Urea Synthesis

A key aspect of protein/energy metabolism, in ruminant animals especially, is seen in the synthesis of urea. Conversion of ammonia to urea in the liver is necessary to safely eliminate it, and ureagenesis also functions in the physiological management of acid–base status (Lobley *et al.*, 1995). The synthesis of urea is described in the following summary:



However, the true net cost for ureagenesis remains unclear because of the potential for fumarate to be converted to aspartate in the urea cycle. This conversion produces 1 NADH, which generates 3 ATP in the process of oxidative phosphorylation, for a potential net ureagenesis cost of 1 ATP, after accounting for the use of four high-energy phosphate bonds in urea synthesis (Newsholme and Leech, 1983). Biologically, the cost associated with ureagenesis extends beyond the ATP cost of  $\text{NH}_3$  detoxification, because of the practical requirement for deamination of AA-N to provide a second N atom for urea synthesis. Lobley *et al.* (1995) aptly described the absorption of  $\text{NH}_3$  from the gastrointestinal tract as a ‘double penalty’, because feed nitrogen would be unavailable in an anabolic form, and the detoxification may require a net utilization of AA that could otherwise be used for protein synthesis.

The experimental results that provided evidence of urea synthesis in enterocytes in the weaned pig are noteworthy. Wu (1995) first reported urea

**Table 15.4.** Urea synthesis from glutamine (Gln) and ammonia in pig enterocytes (from Wu, 1995).

Age of pigs (days)	No substrates added	Urea synthesis (nmol per 30 min per mg of protein)			
		1 mM Gln	5 mM Gln	0.5 mM NH <sub>4</sub> Cl +2 mM Orn* +2 mM Asp*	2 mM NH <sub>4</sub> Cl +2 mM Orn* +2 mM Asp*
0–21	ND	ND	ND	ND	ND
29	ND	6.3 ± 0.74 <sup>c</sup>	15.2 ± 1.28 <sup>b</sup>	13.4 ± 1.56 <sup>b</sup>	21.6 ± 2.07 <sup>a</sup>
58	ND	7.9 ± 0.82 <sup>c</sup>	16.5 ± 1.43 <sup>b</sup>	14.6 ± 1.28 <sup>b</sup>	23.4 ± 3.25 <sup>a</sup>

Values are mean ± SE,  $n = 8$ . Means within a row having different letters (a–c) are different ( $P < 0.05$ ).

\*Ornithine and aspartate are required for the conversion of ammonia into urea. ND, not detected.

synthesis from arginine, glutamine and NH<sub>3</sub> in these cells from weaned, but not from suckling pigs. Data from Wu (1995) are shown in Table 15.4, illustrating enhanced capability for urea synthesis with age and substrate concentration. All enzymes of the urea cycle were present and the author speculated that the small intestine might function as a first line of defence against physiologically harmful concentrations of ammonia.

The importance of this anatomical location for urea synthesis to ruminant animals has not yet been described. However, Oba *et al.* (2004) recently reported that mixed primary cell cultures from the ruminant duodenum have the capacity to synthesize urea. There is important potential for ureagenesis in the small intestine to add to the understanding of nitrogen transactions and balance, and continued research in this area is necessary. The levels of complexity for nitrogen transactions are multiple. Marini *et al.* (2004) recently reported results for urea transporter abundance in the rumen, gut, kidney and liver of lambs, in relation to nitrogen recycling, when lambs consumed diets differing in protein content. No relationship was demonstrated in their study for some of the urea transactions by examining urea transporters in kidney or gut, although there were gains in both liver and kidney weights with the higher nitrogen diets. Their study provides useful early insight into the processes that may contribute to the regulation of nitrogen transactions and energy metabolism in ruminant animals. The absence of urea transporter change in this study highlights the coordination of the processes that are designed to regulate nitrogen metabolism, including changes to organ size, alterations to blood flow rates and transporter activity, which can all affect the nitrogen flux rate.

## Hormonal Regulation of Protein–Energy Interaction

The regulation of protein and energy metabolism, particularly for protein synthesis and degradation, is coordinated to a large extent by hormones.

Lobley (1998) provided an excellent review of the hormonal and nutritional control of metabolism in peripheral tissues; our objective here is to briefly highlight the role of hormones that are integral to the unity of protein and energy metabolism.

A number of specific hormones have a considerable diversity in their regulatory action. Insulin, for example, has effects in various tissues including the gut, liver and skeletal muscle to regulate the metabolism of carbohydrate, fat and protein. Nutritional stimuli including glucose, AA and VFA modulate plasma insulin concentrations. A main focus in domestic animal endocrinology has been on the growth hormone (GH) axis as a major regulator of protein and energy metabolism (see the review by Etherton and Bauman, 1998). Baumrucker and Erondy (2000) recently reviewed the role of the insulin-like growth factor (IGF) system, including its binding proteins, in bovine mammary glands. Interconnections between the GH axis and other hormonal control mechanisms are beginning to become clearer.

Breier (1999) reviewed the GH axis, particularly from the standpoint of reduced nutritional status. Undernutrition, observed in early lactation of dairy cattle, is a classic example of negative energy balance that requires mobilization of body reserves, including adipose tissue and AA from skeletal muscle to meet protein and energy requirements. The mediation of hormonal effects through the actions/alterations in receptors and binding proteins was underscored as a mechanism for regulation. This problem was investigated by Kim *et al.* (2004) who used biopsy techniques on pre- and post-calving dairy cows to examine GH receptors in liver and skeletal muscle. While there was no effect in muscle, the data demonstrated a significant reduction in GH receptor in the liver. The authors suggested that their results indicated a specific role for the GH receptor to affect responses to GH on a tissue-specific basis near the time of parturition (Kim *et al.*, 2004).

Block *et al.* (2001) examined plasma leptin concentrations in periparturient dairy cattle and noted that the functional consequences of reduced plasma leptin concentrations post-calving were unclear. However, the regulation of energy balance during this period required tight metabolic control, without which there would be detrimental consequences for reproduction, immune function and animal health. Understanding the contribution of leptin to this regulation will improve our understanding of nutrition and metabolism. The temporal changes of leptin, insulin, GH and IGF-1 for transition dairy cows are shown in Table 15.5. The characteristic surge in GH post-calving and the drop in IGF-1 concentrations are evident. The differential response in GH receptor noted by Kim *et al.* (2004) for liver and muscle tissues coincides with the GH surge post-calving.

An excellent review by Burrin *et al.* (2003) raised intriguing questions about the physiological effects of glucagon-like peptide 2 (GLP-2) in domestic animals. GLP-2 has been associated with intestinal mucosal growth and cell proliferation in several species, though not in ruminant animals. This hormone is influenced primarily by nutritional factors, although hormonal and neural stimulation have been reported. Understanding the role of this hormone in affecting the development of the small intestine would be particularly important

**Table 15.5.** Changes in plasma hormones (ng/ml) during the periparturient period in multiparous dairy cattle (from Block *et al.*, 2001).

Hormone	Weeks relative to parturition						Contrast <i>P</i> -value <sup>a</sup>			
	-4	-1	+1	+3	+8	SE	State	Preg.	Lact.	E-lact.
Leptin	5.8	5.5	3.0	3.2	2.9	0.9	0.01	NS	NS	NS
Insulin	0.8	0.7	0.3	0.5	0.8	0.1	0.01	NS	0.001	NS
GH	6.7	6.0	8.3	8.5	8.8	0.5	0.001	NS	NS	NS
IGF-1	124	77	40	36	40	9	0.001	0.001	NS	NS

*n* = 8.

<sup>a</sup>Linear contrasts were defined as state (dry or lactating, week -4 and -1 vs. week 1, 3 and 8); Preg. (week of pregnancy, week -4 vs. -1); Lact. (stage of lactation, week 1 and 3 vs. 8) and E-lact. (early-lactation, week 1 vs. 3). NS = *P* > 0.05.

for young animals, in which GLP-2 expression is more pronounced. There may also be potential therapeutic uses of GLP-2 in cases of gastrointestinal injury or disease for pre-weaning animals, but information on its physiological functions in regulating intestinal growth, and consequently protein turnover, in ruminant animals is lacking (Burrin *et al.*, 2003).

## Conclusions

The unity of protein and energy metabolism continues to be elucidated in mammals. A better understanding of the regulation of protein synthesis and degradation by AA in concert with hormones at both extracellular and intracellular levels in ruminant animals is needed. While the knowledge of the mechanics of protein turnover provides useful information, the factors that determine the rate of protein turnover are of greater interest. Characterization of the energetic cost of protein synthesis and degradation, and determining the relative importance of the various protein degradation systems in ruminant tissues, are other areas for further research. It is clear that appropriate decisions for animal diets can improve the efficiency of AA utilization, when measured at the whole animal level. However, less clear is our ability to design diets that support optimal animal health under varying environmental and physiological conditions, or to design diets that do not exacerbate maintenance energy costs, through higher protein turnover costs. An understanding of the factors that may independently regulate protein synthesis and degradation rates in the whole animal would open exciting opportunities to provide nutritional support conducive to efficient nutrient use and animal health. Clearly then, considering the complexity of AA as nutrients, and as signals that can affect protein and energy metabolism, and in light of the different aspects of metabolic regulation, further development of mechanistic models is the preferred approach to provide us with an accurate, quantitative understanding of this unity within whole-animal metabolism.

## References

- Adegoke, O.A.J., McBurney, M.I. and Baracos, V.E. (1999a) Jejunal mucosal protein synthesis: validation of luminal flooding dose method and effect of luminal osmolarity. *American Journal of Physiology* 276, G14–G20.
- Adegoke, O.A.J., McBurney, M.I., Samuels, S.E. and Baracos, V.E. (1999b) Luminal amino acids acutely decrease intestinal mucosal protein synthesis and protease mRNA in piglets. *Journal of Nutrition* 129, 1871–1878.
- Aoyagi, Y., Tasake, I., Okumura, J. and Muramatsu, T. (1988) Energy costs of whole-body protein synthesis measured *in vivo* in chicks. *Comparative Biochemistry and Physiology* 91A, 765–768.
- Asanuma, N., Iwamoto, M. and Hino, T. (1999) Effect of the addition of fumarate on methane production by ruminal microorganisms *in vitro*. *Journal of Dairy Science* 82, 780–787.
- Baracos, V.E., Samuels, S.E. and Adegoke, O.A.J. (2000) Anabolic and catabolic mediators of intestinal protein turnover: a new experimental approach. *Current Opinion in Clinical Nutrition and Metabolic Care* 3, 183–189.
- Baumrucker, C.R. and Erondy, N.E. (2000) Insulin-like growth factor (IGF) in the bovine mammary gland and milk. *Journal of Mammary Gland Biology and Neoplasia* 5, 53–64.
- Block, S.S., Butler, W.R., Ehrhardt, R.A., Bell, A.W., Van Amburgh, M.E. and Boisclair, Y.R. (2001) Decreased concentration of plasma leptin in periparturient dairy cows is caused by negative energy balance. *Journal of Endocrinology* 171, 339–348.
- Blouin, J.P., Bernier, J.F., Reynolds, C.K., Lobley, G.E., Dubreuil, P. and Lapierre, H. (2002) Effect of supply of metabolizable protein on splanchnic fluxes of nutrients and hormones in lactating dairy cows. *Journal of Dairy Science* 85, 2618–2630.
- Bohé, J., Low, A., Wolfe, R.R. and Rennie, M.J. (2003) Human muscle protein synthesis is modulated by extracellular, not intramuscular amino acid availability: a dose–response study. *Journal of Physiology* 552, 315–324.
- Breier, B.H. (1999) Regulation of protein and energy metabolism by the somatotrophic axis. *Domestic Animal Endocrinology* 17, 209–218.
- Burrin, D.G., Stoll, B. and Guan, X. (2003) Glucagon-like peptide 2 function in domestic animals. *Domestic Animal Endocrinology* 24, 103–122.
- Buttery, P.J. and Boorman, K.N. (1976) The energetic efficiency of amino acid metabolism. In: Cole, D.J.A., Boorman, K.N., Buttery, P.J., Lewis, D., Neal, R.J. and Swan, H. (eds) *Protein Metabolism and Nutrition*. Butterworths, London, pp. 197–206.
- Clark, J.H., Klusmeyer, T.H. and Cameron, M.R. (1992) Microbial protein-synthesis and flows of nitrogen fractions to the duodenum of dairy-cows. *Journal of Dairy Science* 75, 2304–2323.
- Coëffier, M., Claeysens, S., Hecketsweiler, B., Lavoine, A., Ducrotte, P. and Dechelotte, P. (2003) Enteral glutamine stimulates protein synthesis and decreases ubiquitin mRNA level in human gut mucosa. *American Journal of Physiology* 285, G266–G273.
- Crompton, L.A. and Lomax, M.A. (1993) Hindlimb protein-turnover and muscle protein-synthesis in lambs – a comparison of techniques. *British Journal of Nutrition* 69, 345–358.
- Ebner, K.E., Schoknecht, P., Reeds, P.J. and Burrin, D.G. (1994) Growth and metabolism of gastrointestinal and skeletal-muscle in protein-malnourished neonatal pigs. *American Journal of Physiology* 266, R1736–R1743.

- Etherton, T.D. and Bauman, D.E. (1998) Biology of somatotropin in growth and lactation of domestic animals. *Physiological Reviews* 78, 745–761.
- Fuery, C.J., Withers, P.C. and Guppy, M. (1998) Protein synthesis in the liver of *Bufo marinus*: cost and contribution to oxygen consumption. *Comparisons in Biochemistry and Physiology* 119A, 459–467.
- Grizard, J., Dardevet, D., Papet, I., Mosoni, L., Patureau-Mirand, P., Attaix, D., Tauveron, I., Bonin, D. and Arnal, M. (1995) Nutrient regulation of skeletal muscle protein metabolism in animals: the involvement of hormones and substrates. *Nutrition Research Reviews* 8, 67–91.
- Harris, P.M., Skene, P.A., Buchan, V., Milne, E., Calder, A.G., Anderson, S.E., Connell, A. and Lobley, G.E. (1992) Effect of food-intake on hindlimb and whole-body protein-metabolism in young growing sheep – chronic studies based on arteriovenous techniques. *British Journal of Nutrition* 68, 389–407.
- Huntington, G.B. and McBride, B.W. (1988) Ruminant splanchnic tissues – energy costs of absorption and metabolism. In: Steffens, G.L. and Rumsey, T.S. (eds) *Biomechanisms Regulating Growth and Development*. Kluwer Academic Publishers, Dordrecht, The Netherlands, pp. 313–328.
- Kadowaki, M. and Kanazawa, T. (2003) Amino acids as regulators of proteolysis. *Journal of Nutrition* 133, 2052S–2056S.
- Kelly, J.M., Park, H., Summers, M. and Milligan, L.P. (1993) Interactions between protein and energy metabolism. In: Forbes, J.M. and France, J. (eds) *Quantitative Aspects of Ruminant Digestion and Metabolism*. CAB International, Wallingford, UK, pp. 341–362.
- Kim, J.W., Rhoads, R.P., Block, S.S., Overton, T.R., Frank, S.J. and Boisclair, Y.R. (2004) Dairy cows experience selective reduction of the hepatic growth hormone receptor during the periparturient period. *Journal of Endocrinology* 181, 281–290.
- Lapierre, H., Bernier, J.F., Dubreuil, P., Reynolds, C.K., Farmer, C., Ouellet, D.R. and Lobley, G.E. (2000) The effect of feed intake level on splanchnic metabolism in growing beef steers. *Journal of Animal Science* 78, 1084–1099.
- Liu, Z., Jahn, L.A., Wei, L., Long, W. and Barrett, E.J. (2002) Amino acids stimulate translation initiation and protein synthesis through an Akt-independent pathway in human skeletal muscle. *The Journal of Clinical Endocrinology* 87, 5553–5558.
- Lobley, G.E. (1992) Control of the metabolic fate of amino acids in ruminants: a review. *Journal of Animal Science* 70, 3264–3275.
- Lobley, G.E. (1993) Species comparisons of tissue protein metabolism: effects of age and hormonal action. *Journal of Nutrition* 123, 337–343.
- Lobley, G.E. (1998) Nutritional and hormonal control of muscle and peripheral tissue metabolism in farm species. *Livestock Production Science* 56, 91–114.
- Lobley, G.E. (2003) Protein turnover – what does it mean for animal production? *Canadian Journal of Animal Science* 83, 327–340.
- Lobley, G.E., Connell, A., Lomax, M.A., Brown, D.S., Milne, E., Calder, A.G. and Farningham, D.A.H. (1995) Hepatic detoxification of ammonia in the ovine liver: possible consequences for amino acid catabolism. *British Journal of Nutrition* 73, 667–685.
- Lobley, G.E., Hoskin, S.O. and McNeil, C.J. (2001) Glutamine in animal science and production. *Journal of Nutrition* 131, 2525S–2531S.
- Marini, J.C., Klein, J.D., Sands, J.M. and Van Amburgh, M.E. (2004) Effect of nitrogen intake on nitrogen recycling and urea transporter abundance in lambs. *Journal of Animal Science* 82, 1157–1164.

- Millward, D.J., Garlick, P.J., James, W.P.T., Sender, P.M. and Waterlow, J.C. (1976) Protein turnover. In: Cole, D.J.A., Boorman, K.N., Buttery, P.J., Lewis, D., Neale, R.J. and Swan, H. (eds) *Protein Metabolism and Nutrition*. Butterworths, London, pp. 49–69.
- Muramatsu, T. and Okumura, J. (1985) Whole-body protein turnover in chick at early stages of growth. *Journal of Nutrition* 115, 483–490.
- Mutsvangwa, T., Gilmore, J., Squires, J.E., Lindinger, M.I. and McBride, B.W. (2004) Chronic metabolic acidosis increases mRNA levels for components of the ubiquitin-mediated proteolytic pathway in skeletal muscle of dairy cows. *Journal of Nutrition* 134, 558–561.
- Neutze, S.A., Gooden, J.M. and Oddy, V.H. (1997a) Measurement of protein turnover in the small intestine of lambs 1. Development of an experimental model. *Journal of Agricultural Science* 128, 217–231.
- Neutze, S.A., Gooden, J.M. and Oddy, V.H. (1997b) Measurement of protein turnover in the small intestine of lambs 2. Effects of feed intake. *Journal of Agricultural Science* 128, 233–246.
- Newsholme, E.A. and Leech, A.R. (1983) *Biochemistry for the Medical Sciences*. John Wiley & Sons, Chichester, UK.
- NRC (2001) *Nutrient Requirements of Dairy Cattle*, 7th revised edn. National Academy Press, Washington, DC.
- Oba, M., Baldwin VI, R.L., Owens, S.L. and Bequette, B.J. (2004) Urea synthesis by ruminal epithelial and duodenal mucosal cells from growing sheep. *Journal of Dairy Science* 87, 1803–1805.
- Olde Damink, S.W.M., De Blaauw, I., Deutz, N.E.P. and Soeters, P.B. (1999) Effects *in vivo* of decreased plasma and intracellular muscle glutamine concentration on whole-body and hindquarter protein kinetics in rats. *Clinical Science* 96, 639–646.
- Oldick, B.S., Firkins, J.L. and St Pierre, N.R. (1999) Estimation of microbial nitrogen flow to the duodenum of cattle based on dry matter intake and diet composition. *Journal of Dairy Science* 82, 1497–1511.
- Reeds, P.J., Cadenhead, A., Fuller, M.F., Lobley, G.E. and McDonald, J.D. (1980) Protein turnover in growing pigs. Effects of age and food intake. *British Journal of Nutrition* 43, 445–455.
- Reeds, P.J., Burrin, D.G., Jahoor, F., Wykes, L., Henry, J. and Frazer, E.M. (1996) Enteral glutamate is almost completely metabolized in first pass by the gastrointestinal tract of infant pigs. *American Journal of Physiology* 270, E413–E418.
- Reeds, P.J., Burrin, D.G., Davis, T.A., Fiorotto, M.L., Stoll, B. and van Goudoever, J.B. (2000) Protein nutrition of the neonate. *Proceedings of the Nutrition Society* 59, 87–97.
- Reynolds, C.K. (2002) Economics of visceral energy metabolism in ruminants: toll keeping or internal revenue service? *Journal of Animal Science* 80, 1–11.
- Reynolds, C.K., Tyrrell, H.F. and Lapierre, H. (1990) Effects of visceral metabolism on nutrient availability for production in ruminants. *California Animal Nutrition Conference*, pp. 45–58.
- Seal, C.J. and Reynolds, C.K. (1993) Nutritional implications of gastrointestinal and liver metabolism in ruminants. *Nutrition Research Reviews* 6, 185–208.
- Siems, W., Dubiel, W., Dumdey, R., Muller, M. and Rapoport, S.M. (1984) Accounting for the ATP-consuming processes in rabbit reticulocytes. *European Journal of Biochemistry* 139, 101–107.
- Storch, D. and Portner, H.O. (2003) The protein synthesis machinery operates at the same expense in eurythermal and cold stenothermal pectinids. *Physiological and Biochemical Zoology* 76, 28–40.

- Sutton, J.D. (1985) Digestion and absorption of energy substrates in the lactating dairy cow. *Journal of Dairy Science* 68, 3376–3393.
- Tauveron, I., Larbaud, D., Champredon, C., Debras, E., Tesseraud, S., Bayle, G., Bonnet, Y., Thieblot, P. and Grizard, J. (1994) Effect of hyperinsulinemia and hyperaminoacidemia on muscle and liver protein synthesis in lactating goats. *American Journal of Physiology* 30, E877–E885.
- Tesseraud, S., Chagneau, A.M. and Grizard, J. (2000) Muscle protein turnover during early development in chickens divergently selected for growth rate. *Poultry Science* 79, 1465–1471.
- Tesseraud, S., Temin, S., Le Bihan-Duval, E. and Chagneau, A.M. (2001) Increased responsiveness to dietary lysine deficiency of pectoralis major muscle protein turnover in broilers selected on breast development. *Journal of Animal Science* 79, 927–933.
- Tesseraud, S., Bigot, K. and Taouis, M. (2003) Amino acid availability regulates S6K1 and protein synthesis in avian insulin-insensitive QM7 myoblasts. *FEBS Letters* 540, 176–180.
- Van Milgen, J. (2002) Modeling biochemical aspects of energy metabolism in mammals. *Journal of Nutrition* 132, 3195–3202.
- Volpi, E., Sheffield-Moore, M., Rasmussen, B.B. and Wolfe, R.R. (2001) Basal muscle amino acid kinetics and protein synthesis in healthy young and older men. *Journal of the American Medical Association* 286, 1206–1212.
- Webster, A.J.F. (1981) The energetic efficiency of metabolism. *Proceedings of the Nutrition Society* 40, 121–128.
- Wolfe, R.R. (2002) Regulation of muscle protein by amino acids. *Journal of Nutrition* 132, 3219S–3224S.
- Wolfe, R.R. and Miller, S.L. (1999) Amino acid availability controls muscle protein metabolism. *Diabetes Nutrition and Metabolism* 12, 322–328.
- Wu, G. (1995) Urea synthesis in enterocytes of developing pigs. *Biochemical Journal* 312, 717–723.
- Yoshizawa, F. (2004) Regulation of protein synthesis by branched-chain amino acids *in vivo*. *Biochemical and Biophysical Research Communications* 313, 417–422.



---

# 16 Calorimetry

R.E. Agnew and T. Yan

*Agricultural Research Institute of Northern Ireland, Large Park, Hillsborough  
BT26 6DR, UK*

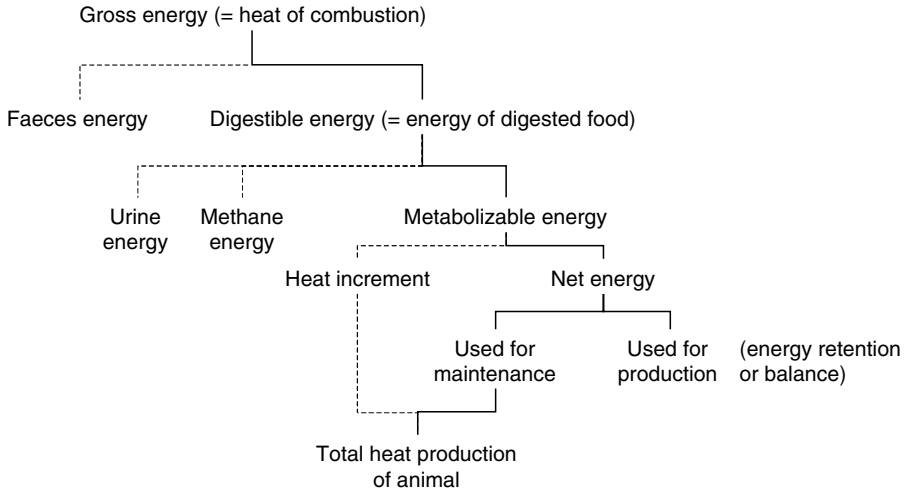
---

## Introduction

Calorimetry is the measurement of heat production. By means of calorimetry the energy costs of living can be estimated. All life processes including growth, work and animal production (milk, eggs, wool, etc.) use energy, the source of energy being food. Energy is contained in the feed as chemical energy and the maximum quantity it offers by oxidation in the body is measured by its heat of combustion. From this potential energy supply there are two major sources of loss, that associated with excreta and combustible gases and that with heat production. Figure 16.1 shows the fate of energy consumed by an animal.

Gross energy (GE) is a measure of the total quantity of chemical energy a food contains (as fed), and is determined by measuring the heat produced when the food is completely oxidized in a bomb calorimeter. However, the GE content of a feed does not give an accurate estimate of the energy actually available to an animal to support vital processes or for accretion of body tissue, as there are considerable losses associated with the digestion and metabolism of the nutrients in that feed. A major loss of energy is associated with the indigestible fraction of the feed, which is lost as faeces, and the determination of the digestible energy (DE) component of feeds therefore takes this proportion into account. Further losses of energy in urine, and methane produced during the digestive process, are accounted for in the measurement of metabolizable energy (ME). This latter description of the energy content of feeds is well recognized and represents the energy of the nutrients actually absorbed and available for metabolism in the animal.

However, ME is used at a tissue level with an efficiency of less than 1, such that the conversion of ME to the net energy (NE) used for maintenance of the animal, and that contained within animal products (milk, tissue, fetus) is associated with the production of heat. This quantity of heat, produced as a result of



**Fig. 16.1.** The partitioning of food energy in the ruminant (McDonald *et al.*, 2002) (solid lines indicate energy usage; dashed lines indicate energy wastage).

the chemical and physical processes associated with digestion and metabolism, is known as the heat increment (HI). Bondi (1987) summarized the main components of the HI as: (i) the work of nutrient metabolism (inefficiencies in the conversion of nutrients to ATP); (ii) the work associated with the digestion and mastication of food; (iii) the heat of fermentation; (iv) the work of excretion by the kidney; and (v) the increased muscular activity of various organs due to the metabolism of nutrients. Other processes contributing to the HI are the movement of substances (e.g.  $\text{Na}^+$  and  $\text{K}^+$  ions) against concentration gradients and the synthesis of body constituents (McDonald *et al.*, 2002). The NE of a feedstuff therefore represents that portion of its energy content that is completely useful for the body, as it is available to the animal for maintenance and productive purposes (Bondi, 1987).

In energy metabolism studies, heat produced by animals is measured as total heat production, which includes the heat used for maintenance and wasted as HI. The energy retained in body tissue (and in milk with lactating animals and/or for fetal growth with pregnant animals) is calculated as the difference between total GE intake and energy outputs from faeces, urine and methane and heat production. The dietary GE intake and energy outputs from faeces and urine can be measured in digestibility trials, while the measurement of heat production and methane output requires more specialized equipment. The equipment commonly used for this purpose is a calorimeter.

## Types of Calorimeters

Heat production may be measured directly by physical methods (direct calorimetry) or it may be inferred from quantitative measurements of some of the

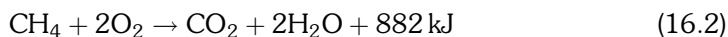
chemical by-products of metabolism (indirect calorimetry). These alternative methods of estimation are possible because of the natural constraints imposed on energy transformation by the laws of thermodynamics. According to the law of conservation of energy, 'energy cannot be created or destroyed, only changed in form' and Hess' law of constant heat summation states that 'the heat released by a chain reaction is independent of the chemical pathways, and dependent only on the end-products'. In effect these laws ensure that the heat evolved in the enormously complex cycle of biochemical reactions that occur in the body is exactly the same as that which is measured when the same food is converted to the same end-products by simple combustion at a laboratory bench or in a calorimeter.

Direct calorimetry is simple in theory, but difficult in practice. Calorimeters designed to measure the heat production of an animal are based on the same general principle as the bomb calorimeter, in that the heat evolved is used to increase the temperature of a surrounding medium. The animal calorimeter is an airtight insulated chamber, in which oxygen is supplied by flow of air. Heat loss from the animal can therefore be measured directly. Indirect calorimetry is based on the relationship between the amount of heat produced for oxidation of food or body components and the amount of oxygen consumed, carbon dioxide produced and nitrogen excreted in the urine. The general equation (Brouwer, 1965) is:

$$HP = 16.18O_2 + 5.02CO_2 - 2.17CH_4 - 5.99N \quad (16.1)$$

where HP is heat production (MJ/day),  $O_2$  is the rate of oxygen consumption (l/day),  $CO_2$  is the rate of carbon dioxide production (l/day),  $CH_4$  is the rate of methane production (l/day) and N is the nitrogen excreted in the urine (g/day). The equation is based on the combustion of starch, protein and fat with carbon dioxide, methane and urea being produced as end-products.

Methane gas, as produced by bacterial fermentation of organic matter, mainly in the rumen, and expelled through the mouth in ruminant animals, can also be determined in the indirect calorimeter. The combustion of methane may be represented as:



The energy which, but for the production of methane, would have been dissipated as heat is  $882/22.41$ , i.e.  $39.4 \text{ kJ/l}$  of methane (McLean and Tobin, 1987).

McLean and Tobin (1987) gave a comprehensive account of different systems of calorimetry. Blaxter (1967) indicated that earlier workers (e.g. Armsby, 1913) had reported that there was little difference in accuracy between the two techniques. Most of the developments in energy metabolism over the last 70 years have been recorded in the proceedings of the symposia entitled *Energy Metabolism of Farm Animals* and published as a series of European Association of Animal Production (EAAP) publications. Numerous methods of direct and indirect calorimetry have been used to study the effects

of various dietary, environmental and physiological variables on the energy metabolism of many species of animals. These data have been used to develop feeding standards for domestic livestock.

## Development of Energy Feeding Systems

The UK ME feeding system, developed by Blaxter (1962), was first proposed for use in the UK in 1965 by the Agricultural Research Council (ARC, 1965). This system was designed to overcome the deficiencies of the starch equivalent (SE) system (a NE system), which was then used in the UK. The SE system assumed a simple ratio of NE values of feeds for maintenance, fattening and lactation and also took no account of the effect of feeding level on NE concentration of a feed. Using the proposals put forward by ARC (1965), a simplified ME system was recommended for adoption in the UK by the Ministry of Agriculture, Fisheries and Food (MAFF, 1975). The original ME system (ARC, 1965) was later substantially revised by ARC (1980) and further modified by Agricultural and Food Research Council (AFRC, 1990) and a new working version was published in 1993 (AFRC, 1993). At the same time a number of NE systems were developed in Europe (Institut National de la Recherche Agronomique (INRA), 1978; Van Es, 1978) and northern America (National Research Council (NRC), 1978).

There is no difference in principle between the ME and NE systems, with both systems recognizing that the energy requirement of ruminant animals is the sum of their energy requirements for maintenance, production (milk, live-weight gain and wool growth) and fetal growth. For dairy cows this is demonstrated in Eqs (16.3a) to (16.4). The ME concentration in the diet is the basal unit for both systems. The only difference between the ME and NE systems is where the energetic efficiencies are embodied within the calculation. In the ME system the energetic efficiencies are used for ration formulation and the prediction of animal performance, while in the NE system the efficiencies are included as part of the energy evaluation of feeds.

ME system:

$$ME_{\text{req}} = ME_{\text{m}} + ME_{\text{l}} + ME_{\text{g}} + ME_{\text{preg}} \quad (16.3a)$$

or

$$ME_{\text{req}} = NE_{\text{m}}/k_{\text{m}} + NE_{\text{l}}/k_{\text{l}} + NE_{\text{g}}/k_{\text{g}} + NE_{\text{preg}}/k_{\text{p}} \quad (16.3b)$$

NE system:

$$NE_{\text{req}} = NE_{\text{m}} + NE_{\text{l}} + NE_{\text{g}} + NE_{\text{preg}} \quad (16.4)$$

where  $ME_{\text{req}}$ ,  $ME_{\text{m}}$ ,  $ME_{\text{l}}$ ,  $ME_{\text{g}}$  and  $ME_{\text{preg}}$  are total ME requirement, ME requirement for maintenance, lactation, liveweight gain and pregnancy, respectively;  $NE_{\text{req}}$ ,  $NE_{\text{m}}$ ,  $NE_{\text{l}}$ ,  $NE_{\text{g}}$  and  $NE_{\text{preg}}$  are total NE requirement, NE

requirement for maintenance, lactation, liveweight gain and pregnancy, respectively and  $k_m$ ,  $k_l$ ,  $k_g$  and  $k_p$  are the efficiencies of utilization of ME for maintenance, lactation, liveweight gain and pregnancy.

The energy unit used in NRC and French systems is the calorie for feeds (Mcal/kg DM) and the animal requirements (Mcal/kg or Mcal/kg<sup>0.75</sup>), while in other systems the corresponding unit is the joule (MJ/kg DM, MJ/kg or MJ/kg<sup>0.75</sup>). All equations discussed later are based on Eqs (16.3a), (16.3b) or (16.4), except for those specified, although in some equations the order of components may be changed or the components may be combined, e.g. milk energy output adjusted to zero energy balance (zero energy for liveweight change) ( $E_{l(0)}$ ).

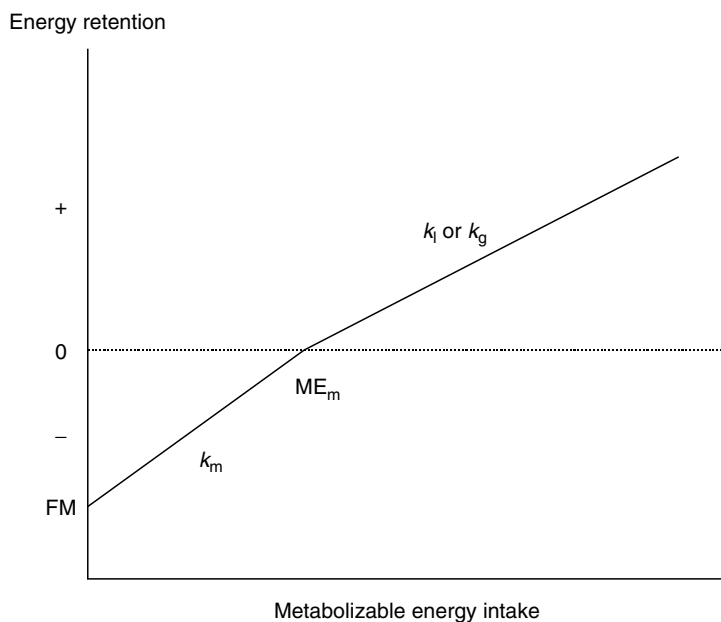
The above feeding systems follow the principle that the heat expenditure (fasting metabolism) obtained during fasting is the amount the animal uses for maintenance (i.e.  $NE_m$ ) and the heat expenditure (heat production) during the restricted feeding with zero energy for production is taken as  $ME_m$ . These measurements are usually made using calorimeters. Fasting metabolism is a sum of fasting heat production (FHP) and fasting urinary output. Prior to measurement of fasting metabolism, animals are offered diets at maintenance feeding level for a period normally more than 4 weeks and then are fasted for 4–5 days with the fasting metabolism being determined during the final 2 days.  $ME_m$  is the sum of the energy expenditures including fasting metabolism and energy costs associated with eating, ruminating, digestion and absorption, etc. However, it is not realistic to determine  $ME_m$  directly in calorimeters, because it is almost impossible to offer a diet to animals at a feeding level with zero energy balance (no energy for production) for a period of normally more than 4 weeks prior to and during the measurement of heat expenditure in calorimeters. Therefore  $ME_m$  is usually estimated either from fasting metabolism divided by  $k_m$ , or from regression of energy intake against energy outputs (discussed later).

It is also widely accepted that dietary ME is utilized more efficiently when feeding below maintenance than above maintenance for production (milk and liveweight gain), i.e.  $k_m$  is larger than  $k_l$  and  $k_g$ . This is illustrated in Fig. 16.2. In practice, for dairy cows Van Es (1978), INRA (1989) and NRC (2001) simplify these two functions by assuming that  $k_m$  is equal to  $k_l$  to calculate NE intake for lactation (NEL):

$$NEL = \text{ME intake} \times k_l \quad (16.5)$$

This simplification for these NE systems requires only one NE value for a given feed, rather than two data (NE for maintenance and NE for production) and would therefore avoid the difficulty of calculation during the ration formulation and the prediction of animal performance.

The amount of energy required for pregnancy is relatively small for animals until late pregnancy, in comparison with the requirements for maintenance and production. Therefore, for dairy cows the key components necessary in ration formulation and prediction of animal performance are the maintenance energy requirement,  $k_l$  and  $k_g$ .



**Fig. 16.2.** Generalized relationship between metabolizable energy (ME) intake and energy retention (FM, fasting metabolism;  $ME_m$ , ME requirement for maintenance;  $k_m$ , efficiency of utilization of ME for maintenance;  $k_l$  or  $k_g$ , efficiency of utilization of ME for lactation or live weight gain).

All energy feeding systems for dairy cattle were developed from calorimetric data of cattle. In the UK ME system the  $NE_m$  was based on the fasting metabolism data of beef steers and dry non-pregnant dairy cows after a prolonged period of restricted feeding. ARC (1980) reported a curvilinear relationship between fasting metabolism (FM) and fasting liveweight (FLW) ( $FM = 0.53 \times FLW^{0.67}$ ) from a review of eight sets of data. This relationship, plus an activity allowance ( $0.0091 \times LW$ , LW is liveweight), is taken as  $NE_m$  for use at present in the UK (AFRC, 1990). This approach would suggest a fasting metabolism of around 0.30 (or  $NE_m$  of 0.35 if the activity allowance is included) MJ/kg<sup>0.75</sup> for an adult dairy cow. The  $ME_m$  (MJ/day) is calculated as  $NE_m$  (MJ/day) divided by  $k_m$ :

$$ME_m = NE_m/k_m = (0.53 (LW/1.08)^{0.67} + 0.0091LW)/k_m \quad (16.6)$$

where LW is liveweight (kg) that is equal to 1.08 of FLW (kg).  $k_m$  is related to energy metabolizability (AFRC, 1990):

$$k_m = 0.35 ME/GE + 0.503 \quad (16.7)$$

A similar approach was also used to derive the  $NE_m$  in the Australian ME system for dairy cows (SCA, 1990) by relating fasting metabolism data to liveweight of cattle. However, the Australian systems relate  $ME_m$  (MJ/day) not just to live-

weight of animals, but also to the productivity (or total ME intake) and age of the animals (Eq. (16.8)):

$$ME_m = (0.392LW^{0.75} \times e^{(-0.03A)})/k_m + 0.1ME_p \quad (16.8)$$

where  $A$  is age in years and  $ME_p$  (MJ/day) is ME available for production.  $k_m$  is calculated as that in the UK ME system (Eq. (16.7)).

The maintenance energy requirement per unit of liveweight therefore varies in AFRC (1990) and SCA (1990). It is increased with increasing productivity in SCA (1990), while in AFRC (1990) it is marginally reduced with increasing liveweight (age of animals). However, it is a constant value in Van Es (1978), INRA (1989) and NRC (2001), irrespective of productivity and age of animals (discussed below).

Alternatively, the  $NE_m$  can be estimated using regression techniques relating ME intake (MEI) to milk energy output ( $E_l$ ), adjusted to zero energy balance ( $E_g$ ) ( $E_{l(0)}$ ), with dairy cows offered diets at production levels. Using this approach, Van Es (1975) reported  $NE_m$  values of 0.293 MJ/kg<sup>0.75</sup> (Eq. (16.9)) from calorimetric data obtained over the world ( $n = 1148$ ). Moe *et al.* (1972) summarized the calorimetric data of lactating cows ( $n = 543$ ) undertaken in Beltsville and reported  $NE_m$  values of 0.283 and 0.330 MJ/kg<sup>0.75</sup>, respectively using two regression models (Eqs (16.10a) and (16.10b)), with an average value of 0.305 MJ/kg<sup>0.75</sup>:

$$E_{l(0)} = 0.60MEI - 0.293 \quad (16.9)$$

$$E_{l(0)} = 0.608MEI - 0.283 \quad (16.10a)$$

$$MEI = 1.547E_{l(0)} + 0.511 \quad (16.10b)$$

The unit for these three equations is MJ/kg<sup>0.75</sup>. The  $NE_m$  of 0.305 MJ/kg<sup>0.75</sup> (Moe *et al.*, 1972) is used as the basis of the American NE system, with an activity allowance of proportionately 0.10 being added (NRC, 2001). The figure 0.293 MJ/kg<sup>0.75</sup> (Van Es, 1975) is adopted in the European NE systems used in The Netherlands, France, Germany and Switzerland. No activity allowance is adopted in The Netherlands (Van Es, 1978), while an activity allowance of proportionately 0.10 is added for loose-housed cows in France (INRA, 1989).

The  $k_l$  is designed to relate to energy metabolizability in all systems mentioned above, except that in NRC (2001). The calculation of  $k_l$  for AFRC (1990) and SCA (1990) is presented in Eq. (16.11), for Van Es (1978) and INRA (1989) in Eq. (16.12). For NRC (2001), dietary NEL concentration ( $NEL_{conc}$ ) is calculated from its ME concentration ( $ME_{conc}$ ) (Eq. (16.13)):

$$k_l = 0.35ME/GE + 0.42 \quad (16.11)$$

$$k_l = 0.24ME/GE + 0.463 \quad (16.12)$$

$$NEL_{conc} = 0.703ME_{conc} - 0.795 \quad (16.13)$$

The biology underlying the relationship between  $k_m$  or  $k_l$  and energy metabolizability may be that animals require a lower DM intake with high-quality diets than low-quality diets when consuming the same amount of ME. This obviously requires animals offered low-quality diets to spend more time (and hence more energy) on eating and ruminating and the higher intake would therefore enlarge the gastrointestinal tract of the animals. The internal organs can produce much more heat than muscle (Baldwin *et al.*, 1985; Johnson *et al.*, 1990).

The  $NE_m$  in the UK and Australian ME system is a curvilinear function of liveweight and is reduced per  $kg^{0.75}$ , with increasing liveweight (age) of cattle. This is because metabolic rate is higher for growing than adult cattle (ARC, 1965) and light adult animals generally have a greater proportion of internal organs over total liveweight than heavy adult ones (NRC, 1988). The internal organs produce much greater heat than muscle per unit weight. In contrast, the  $NE_m$  for cattle is constant per  $kg^{0.75}$  in the NE systems used in Europe and North America. In these systems the  $NE_m$  values were derived from data on mature dairy cows. It is therefore likely that these latter systems may theoretically underestimate the energy requirements of young cattle.

The use of fasting metabolism data to determine  $NE_m$  may have limitations. It has been suggested that fasting after a long period of restricted nutrition can result in deamination of amino acids from tissue protein for the supply of essential glucose (Chowdhury and Ørskov, 1994). This can induce a range of metabolic disorders in the animal, such as hypoglycaemia, hyperlipidaemia, hyperketonaemia and hypoinsulinaemia. The deamination caused by fasting can however be reduced, as evidenced by a lower N output in urine, after infusing a small amount of volatile fatty acids (VFA) or glucose with or without casein (Ku Vera *et al.*, 1987, 1989; Ørskov *et al.*, 1999). This type of infusion can also result in a lower heat production than FHP (Chowdhury, 1992). However, the maintenance metabolic rate obtained by fasting metabolism ( $0.30 \text{ MJ/kg}^{0.75}$ ) (ARC, 1980) is similar to that derived from regression techniques ( $0.305$  or  $0.293 \text{ MJ/kg}^{0.75}$ ) (Moe *et al.*, 1972; Van Es, 1975). It thus seems unlikely that the detriment of fasting to animal health greatly influences heat production.

## Recent Research on Maintenance Energy Requirement

As stated previously, the estimates of  $NE_m$  used in today's energy rationing systems for dairy cows (Van Es, 1978; INRA, 1989; AFRC, 1990; NRC, 2001) were based on classical energy metabolism studies undertaken 30–50 years ago, using very different animals and diets to those in use today. However, there is an increasing body of evidence to suggest that total energy requirements derived using these estimates are not relevant to many of the situations that presently exist. For example, recent data presented in a number of calorimetric studies on lactating cows undertaken in the UK have highlighted the major differences between actual and predicted (AFRC, 1990) performances. The data given in Table 16.1 are taken from four recently



**Table 16.1.** A comparison of observed and predicted (AFRC, 1990) performance from dairy cattle in recent calorimetric studies.

References	Forages (forage/diet)	ME intake (MJ/day)		Difference MJ/day
		Observed	Predicted	
Beever <i>et al.</i> (1998)	Maize silage (0.60)	239	220	19
Ferris <i>et al.</i> (1999)	Grass silage (0.46)	238	203	35
Sutton <i>et al.</i> (1998)	Crop wheat (0.61)	207	190	17
Yan <i>et al.</i> (1996)	Grass silage (0.61)	176	150	26
Mean		215	191	24

published studies from two centres. From these data it can be seen that adopting the present estimates of ME requirements and utilization (AFRC, 1990) considerably underestimates the total ME requirement of dairy cows in today's environment. The mean underestimation was 24 MJ/day (range 17–35).

The under-prediction of total ME requirement from AFRC (1990) may partially arise from an underestimation of maintenance energy requirement. As discussed previously,  $NE_m$  is 0.293, 0.322 or 0.336 MJ/kg<sup>0.75</sup> in Van Es (1978), INRA (1989) or NRC (2001);  $NE_m$  and  $ME_m$  in AFRC (1990) are around 0.35 and 0.48 MJ/kg<sup>0.75</sup>, respectively. However, Patle and Mudgal (1977) used regression techniques on data obtained from a total of 24 energy balance trials with lactating crossbred cows offered forage-based diets. These workers reported a value of  $ME_m$  of 0.57 MJ/kg<sup>0.75</sup>, a value which is some 33% higher than the value obtained for steers in earlier studies by these workers (Patle and Mudgal, 1975). Later work by Unsworth *et al.* (1994) with Friesian cows offered a range of grass or grass silage-based diets, and by Hayasaka *et al.* (1995) with Holstein cows offered total mixed rations containing 40% to 70% forage (DM basis), reported values of  $ME_m$  of 0.64 and 0.59 MJ/kg<sup>0.75</sup> (derived from regression techniques), respectively.

More recent work, reported by Yan *et al.* (1997a), used a range of regression techniques to analyse calorimetric data from 221 lactating dairy cows offered grass silage-based diets. The equations (Eqs (16.14a)–(16.14e)), developed using these techniques, and the derived estimates of  $ME_m$  and

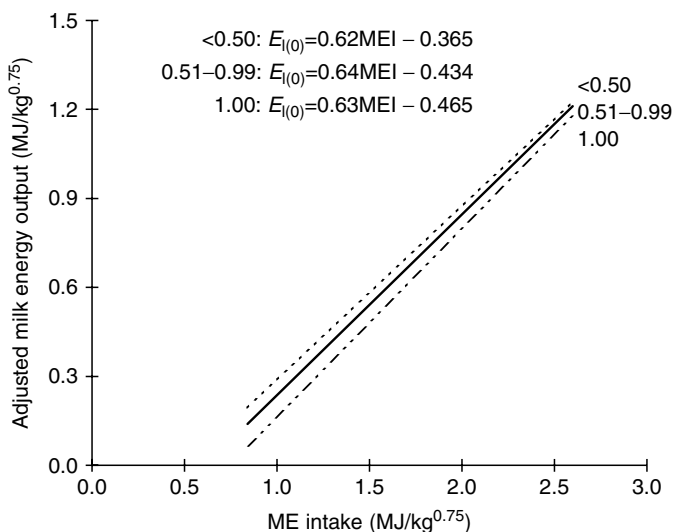
**Table 16.2.** The linear and multiple regression equations, and the derived ME requirement for maintenance ( $ME_m$ ) and the efficiency of ME utilization for lactation ( $k_l$ ) reported by Yan *et al.* (1997a).

Equations	$R^2$	$ME_m$ (MJ/kg <sup>0.75</sup> )	$k_l$	Equation
$E_{l(0)} = 0.65MEI - 0.435$	0.90	0.67	0.65	(16.14a)
$E_{l(0)} = 0.61MEI + 0.93(ME/GE - 0.65) - 0.372$	0.90	0.61	0.61	(16.14b)
$E_{l(0)} = -6.94[1 - \exp(-(-0.088)(MEI - 0.66))]$	0.89	0.66		(16.14c)
$MEI = 0.75MW + 1.48E_l + 1.11(+E_g) + 1.08(-E_g)$	0.92	0.75	0.68	(16.14d)
$E_{l(0)} = 0.65ME_p$	0.88		0.65	(16.14e)

$E_{l(0)}$ , adjusted milk energy output to zero energy balance (MJ/kg<sup>0.75</sup> in Eqs. (16.14a)–(16.14d) and MJ/day in Eq. (16.14e)); MEI, ME intake (MJ/kg<sup>0.75</sup> in Eqs. (16.14a)–(16.14d) and MJ/day in Eq. (16.14e)); MW, metabolic liveweight (kg<sup>0.75</sup>);  $E_l$  milk energy output (MJ/day);  $+E_g$ , positive energy balance (MJ/day);  $-E_g$ , negative energy balance (MJ/day);  $ME_p$ , ME available for production (MJ/day).

$k_1$  presented by Yan *et al.* (1997a), are summarized in Table 16.2. For all equations the proportion of variation accounted for by the variables was very high, ranging from 0.88 to 0.92, and all relationships were highly significant ( $P < 0.001$ ). Using the linear regression equation (Eq. (16.14a)) developed from these data as an example of the methodology, indicates estimates of  $ME_m$  of  $0.67 \text{ MJ/kg}^{0.75}$  and  $k_1$  of 0.65. The former value is 40% higher than that predicted using the approach of AFRC (1990). In order to examine if these high estimates of  $ME_m$  were a result of the diet offered, Yan *et al.* (1997a) divided their data set into three subsets depending upon GE intake derived from silage as a proportion of total GE intake (<0.50, 0.51–0.99 and 1.00). The linear regressions of  $E_{l(0)}$  against MEI within each of these three categories are given in Fig. 16.3. These data suggest that although the  $ME_m$  values significantly increase (0.59, 0.68 and  $0.74 \text{ MJ/kg}^{0.75}$ ) with increasing proportion of silage in the diet, the maintenance energy requirement derived from high concentrate diets was still over 0.20 higher than those recommended in Van Es (1978), INRA (1989), AFRC (1990) and NRC (2001).

A study by Kirkland and Gordon (1999) investigated  $ME_m$  and  $k_1$  on a non-grass silage-based diet to establish if the high  $ME_m$  and  $k_1$  values reported by Yan *et al.* (1997a) were also relevant to non-grass silage-based diets. Data from a series of 36 complete energy balance trials involving eight high genetic merit lactating Holstein–Friesian cows offered a straw/concentrate diet (0.18:0.82 on DM basis) were analysed by a range of regression techniques. In the data set, milk yield ranged from 1.0 to 37.2 kg/day. Mean  $ME_m$  was determined as  $0.61 \text{ MJ/kg}^{0.75}$  and the mean  $k_1$  was 0.59. These latter two figures are in agreement with the figures of Yan *et al.* (1997a).



**Fig. 16.3.** Effect of silage GE intake as a proportion of total GE intake (<0.50, 0.51–0.99, 1.00) on the relationships between ME intake (MEI) and milk energy output adjusted to zero energy balance ( $E_{l(0)}$ ) (from Yan *et al.*, 1997a).

Other recent work reported by Yan *et al.* (1997b) determined the FHP of Holstein–Friesian dairy cows and found that the mean FHP of 0.45 MJ/kg<sup>0.75</sup> (equivalent to ME<sub>m</sub> of 0.65 MJ/kg<sup>0.75</sup>) was in line with the value of ME<sub>m</sub> predicted using regression techniques (Yan *et al.*, 1997a). Birnie (1999) carried out a comprehensive series of studies examining aspects of FHP in non-lactating dairy cows and similarly reported estimates of FHP (and therefore ME<sub>m</sub>) which were much higher than those predicted from AFRC (1990), and which were close to those derived by Yan *et al.* (1997a,b).

The data presented above would therefore suggest higher ME<sub>m</sub> values than those adopted by AFRC (1990). This hypothesis is further supported by the finding derived from an analysis of the mean data of 42 calorimetric studies of lactating dairy cows reported since 1969 and outlined by Agnew and Yan (2000). Subjecting these mean data to linear and multiple regression analysis produced the following equations:

$$E_{l(0)} = 0.637MEI - 0.371 \quad (R^2 = 0.89) \quad (16.15a)$$

$$MEI = 0.664MW + 1.452E_l + 1.079E_g \quad (R^2 = 0.92) \quad (16.15b)$$

where MEI is ME intake and MW is metabolic liveweight (kg<sup>0.75</sup>) of cows. The unit for  $E_{l(0)}$  and MEI in Eq. (16.15a) is MJ/kg<sup>0.75</sup> and for MEI,  $E_l$  and  $E_g$  in Eq. (16.15b) is MJ/day. Using these relationships resulted in estimates of ME<sub>m</sub> of 0.58 and 0.66 MJ/kg<sup>0.75</sup> for the linear and multiple regression methods, respectively, and  $k_l$  of 0.64 and 0.69, respectively. The weight of evidence from recent calorimetric studies therefore suggests that maintenance energy requirements, as obtained by Moe *et al.* (1972), Van Es (1975) and ARC (1980) and currently used in Europe and North America, are considerably lower (proportionately 0.30–0.40) than that required by today's dairy cows.

The higher maintenance energy requirement may reflect differences in both the diet and the cow now used, particularly the considerable improvement in cow genetic merit during the last two decades (Coffey, 1992). The latter has led to an increase in milk yield of approximately 62 kg per lactation per year (Agnew *et al.*, 1998). Indeed, high-producing dairy cows were found 30 years ago by Flatt *et al.* (1969) to require proportionately 0.20 more ME for maintenance than cows producing moderate yield, as reported at the same time by Moe *et al.* (1970) and Van Es *et al.* (1970). The higher ME<sub>m</sub> (FHP) obtained in the recent studies may be attributable to a higher proportion of liveweight as body protein mass. This is evidenced by the fact that high genetic merit cows have a lower back fat thickness at a similar liveweight to medium and low genetic merit animals (Ferris *et al.*, 1999), and a higher estimated lipid-free empty body weight as a proportion of empty liveweight (Veerkamp *et al.*, 1994). Fasting metabolism has been reported to be a function of body protein mass (Oldham and Emmans, 1990). On the other hand, high genetic merit cows obviously require greater nutrient intakes and this could stimulate the activity of internal organs with greater digestive load, cardiac output and blood flow required to digest, absorb and deliver nutrients to the mammary gland and a greater oxygen consumption (Reynolds, 1996). These activities in return can enlarge the

internal organ size. Liver and other internal organs can produce much more heat (MJ/kg) than muscle (Baldwin *et al.*, 1985; Johnson *et al.*, 1990).

## Recent Research on Efficiencies of ME Utilization

### *Efficiency of utilization of ME for lactation ( $k_l$ )*

The term  $k_l$  represents the net efficiency of use of dietary ME for milk production (i.e. MJ of NE retained in milk per MJ of ME utilized for milk production). In Van Es (1978) and INRA (1989) (Eq. (16.12)) and AFRC (1990) (Eq. (16.11))  $k_l$  is designed to marginally and positively relate to dietary energy metabolizability (ME/GE), according to the research evidence. The  $k_l$  values are calculated to be 0.58–0.63 for Van Es (1978) and INRA (1989) and 0.60–0.67 for AFRC (1990) when ME/GE is between 0.50 and 0.70.

The development of the relationship between  $k_l$  and ME/GE was mainly based on the work undertaken in The Netherlands. In a summary of a large number of energy balance measurements ( $n = 1148$ ), Van Es (1975) showed a small positive effect of diet quality on  $k_l$ , concluding that  $k_l$  decreased by approximately 0.40 per unit decrease in ME/GE. Van Es (1976) stressed however that the accuracy of this latter figure was not very high due to the limited variation in the value of ME/GE in the rations of the dairy cows in their studies. He suggests that this (small) influence of ME/GE on  $k_l$  might be a consequence of increased intake and digestion costs and of lower absorbed propionate, fat and monosaccharides to absorbed acetate ratios at lower ME/GE value. It is possible that these ratios affect the efficiency of milk fat synthesis more than synthesis of milk protein and lactose (Van Es, 1976), the latter processes being more efficient biochemically than that of fat synthesis. Theoretical efficiencies are 0.70, 0.77 and 0.73, respectively, for synthesis of fat, protein and lactose from 'normal' products of digestion (Van Es, 1976). Similarly, Lobley (1986) highlights that the fibrous nature of roughage diets increases the energy costs of digestion by enhanced secretion of salts in digestive fluids, such as saliva, and enzymes, bile, mucin etc., accompanied by a greater desquamation through physical action. These secretions and losses involve considerable synthetic activity and replacement costs and must therefore have a negative influence on determined efficiency of such diets for metabolic processes.

Within an experimental context,  $k_l$  may be determined either by the use of regression techniques relating energy input and energy output parameters, or as the ratio between  $E_{l(0)}$  (MJ/day) and ME available for production ( $ME_p$ ) (MJ/day), where the latter is calculated as  $MEI - ME_m$  ( $ME_m$  is usually calculated from energy feeding systems) (Eq. (16.16)):

$$k_l = E_{l(0)}/ME_p = (E_l + aE_g)/(MEI - ME_m) \quad (16.16)$$

where  $a = 1/0.95$  (AFRC, 1990), 1 (Van Es, 1978; INRA, 1989),  $k_l/0.60$  (SCA, 1990) or  $0.64/0.75$  (NRC, 2001) for liveweight gain; or  $a = 0.84$

(AFRC, 1990; SCA, 1990), 0.80 (Van Es, 1978; INRA, 1989) or 0.82 (NRC, 1988) for liveweight loss.

When developing the previous discussion on  $ME_m$  the regression techniques used to provide estimates of this component have also provided information on  $k_1$ . The regression techniques used on the total calorimetric data set by Yan *et al.* (1997a) (Table 16.2) have indicated a range in  $k_1$  values from 0.61 to 0.68 with a mean of 0.65 (from Yan *et al.*, 1997a). This is the same figure as that obtained from Eq. (16.14e) (Table 16.2) by using the mean  $ME_m$  estimated from the present data set ( $0.67 \text{ MJ/kg}^{0.75}$ ) to calculate  $ME_p$  and then relating this to  $E_{I(0)}$ . This overall mean of 0.65 is very similar to the mean of 0.66 obtained by linear and multiple regression of the 42 sets of calorimetric data published since 1969 (Eqs (16.15a) and (16.15b)) (Agnew and Yan, 2000). Equally the sets of calorimetric data examined by a number of other authors (Moe *et al.*, 1970; Van Es *et al.*, 1970; Van Es, 1975; Unsworth *et al.*, 1994; Hayasaka *et al.*, 1995) have indicated  $k_1$  values between 0.60 and 0.67 with a mean of 0.63. All these  $k_1$  values are very similar to those predicted by AFRC (1990) from Eq. (16.11). Indeed, using Eq. (16.11), the mean  $k_1$  value predicted for the Hillsborough data set is 0.65, which is identical to the mean of those determined across the range of regression analysis. It is also interesting to note that, as indicated in Fig. 16.3, the proportion of GE intake derived from silage had no effect on  $k_1$  (range from 0.62 to 0.64) (Yan *et al.*, 1997a).

All the  $k_1$  values reported above and developed by regression techniques are much higher than those from studies where  $ME_m$  has been calculated from AFRC (1990) and then used to calculate ME available for production (Eq. (16.16)). For example, using this approach Gordon *et al.* (1995) reported average  $k_1$  values of 0.58, Unsworth *et al.* (1994) of 0.56 and Beever *et al.* (1998) of 0.54, which are considerably lower than the predicted AFRC (1990) values. These low  $k_1$  values are however a direct reflection of the value chosen for  $ME_m$ . For example, if AFRC (1990)  $ME_m$  is adopted for the data set ( $n = 221$ ) of Yan *et al.* (1997a) then the calculated  $k_1$  is 0.53, but this increases to 0.65 if the  $ME_m$  of 0.67, as determined by Yan *et al.* (1997a), is used. This would therefore support the view that the low  $k_1$  values reported by many authors may have arisen as a direct effect of the  $ME_m$  of AFRC (1990) used in the calculations and that this value may have been in error.

### **Relationship between $k_1$ (in the lactating cow) and $k_g$ (in the non-lactating cow)**

It has been suggested that the utilization of ME for milk production (adjusted to zero energy balance) ( $k_1$ ) in lactating cows is more efficient than that for tissue retention ( $k_g$ ) in dry cows (ARC, 1980). In a recent study reported by Yan *et al.* (1997b), a forced drying off procedure was adopted to study how the efficiency of ME changed with physiological state of the animal. All animals were managed to have similar ME intakes between the different physiological states. A reduction in milk energy of 1 MJ/day with lactating cows was found to be associated with an increase in tissue energy retention of 0.82 MJ/day with dry cows. When relating to  $ME_p$  (Eqs (16.16) and (16.17)), the efficiency ( $k_1$ ) for

lactating cows can be proportionately 0.09 higher than that ( $k_g$ ) for dry cows. A similar reduction (0.08) with dry dairy cows was also reported by Moe *et al.* (1970) using multiple regression techniques on calorimetric data of lactating ( $n = 350$ ) and non-lactating ( $n = 193$ ) dairy cattle (Eqs (16.18a) and (16.18b)):

$$k_g = E_g/ME_p = E_g/(MEI - ME_m) \quad (16.17)$$

$$\text{Lactating cows: } MEI = 0.51MW + 1.55E_1 + 1.34(+E_g) + 1.28(-E_g) \quad (16.18a)$$

$$\text{Non-lactating cows: } MEI = 0.42MW + 1.93(+E_g) - 1.13(-E_g) \quad (16.18b)$$

where  $+E_g$  and  $-E_g$  are positive and negative energy balance, respectively. The unit for all energy terms in these three equations is MJ/day and for MW is  $\text{kg}^{0.75}$ .

### **Relationship between $k_l$ and $k_g$ in lactating cows**

Yan *et al.* (1997b) observed an increase in tissue energy retention of 0.96 MJ/day associated with a decrease in energy of 1 MJ/day for milk synthesis in lactating dairy cows. This supports the proposal of ARC (1980) that the efficiency of ME utilization for concomitant tissue retention is 0.95 times that for milk production. Armstrong and Blaxter (1965), Aguilera *et al.* (1990) and Rapetti *et al.* (1998) also obtained similar results of 0.96, 0.91 and 0.99 with lactating goats, respectively. When using regression techniques on calorimetric data of lactating dairy cows, Flatt *et al.* (1969) and Van Es *et al.* (1970) found that ME was utilized no less efficiently for concomitant tissue retention than for milk secretion. The above findings indicate that during lactation the efficiency of ME utilization for concomitant tissue retention would appear to be similar to that for lactation. However, Moe *et al.* (1970) reported that ME was more efficiently utilized for concomitant tissue retention than for lactation in dairy cows (Eq. (16.18a)).

### **The efficiency of use of body tissue for lactation ( $k_t$ )**

It is commonly accepted that high yielding cows in early lactation are often unable to consume sufficient energy to meet their demands for milk production and they therefore mobilize body reserves to balance the deficit between food energy intake and milk energy production. Given the possible contribution of mobilized tissue as a supply of nutrients for lactation, it is recognized that the efficiency of use of energy from this source must be accurately known for incorporation into rationing systems. Estimates of  $k_t$  reported in the literature have been determined primarily by regression techniques and, while there is a degree of variation around the mean, these studies have generally shown that tissue energy is converted into milk energy with an efficiency of approximately 0.80 (Van Es and Van der Honing, 1979). Several of the studies discussed in previous sections have also provided estimates of  $k_t$ . For example, Yan *et al.*

(1997a) and Hayasaka *et al.* (1995) predicted  $k_t$  values of 0.73 and 0.74, respectively, while Vermorel *et al.* (1982) found a value of 0.80 from their data. Moe *et al.* (1970) reported values of 0.82 and 0.84 using regression techniques on data obtained from all lactating cows ( $n = 350$ ), or from those animals in negative energy balance only ( $n = 126$ ). Van Es *et al.* (1970) however, obtained an estimate of 0.90, much greater than other published estimates. Recent work reported by Agnew and Yan (2000) has derived a mean value of  $k_t$  of 0.74 (Eqs (16.19a) and (16.19b)) from high genetic merit dairy cows with negative energy balance ( $n = 127$ ), while Schiemann *et al.* (1974) (cited in ARC, 1980) using a slightly different approach, found a value of  $k_t$  of 0.81. Baldwin and Smith (1974) and Kronfeld (1976) estimated the theoretical maximum value of  $k_t$  to be 0.85 to 0.87, based upon biochemical reactions and optimal utilization of available nutrients.

$$\text{MEI} = 1.474E_1 + 1.067E_g + 0.745 \quad (16.19a)$$

$$E_1 = 0.578\text{MEI} - 0.749E_g - 0.359 \quad (16.19b)$$

The unit for all energy terms in these two equations is MJ/kg<sup>0.75</sup>.

The range of predicted values within the literature for  $k_t$  suggests differences in the regression approaches used to derive this factor, or differences in source data sets arising from different animal types or experimental treatments. These sources of error can be minimized in large data sets with a large range of variation in negative energy balance within the data set. However, in practice most data used in regression analysis have a small range in tissue balance relative to that of milk energy output, as the majority of cows in these trials were fed at or near their requirements for maintenance and milk production (Van Es and Van der Honing, 1979), and hence this could explain a large degree of the disparity between published estimates of  $k_t$ .

The trials referred to previously have predicted  $k_t$  from multiple regression relationships using energy utilization data obtained from non-specific metabolism studies designed to determine other metabolic efficiencies and parameters. Such studies have often incorporated data from many different trials and involved relatively large data sets. It is proposed that other, more precise, methodology could be used to determine the value of  $k_t$ . Such methods should facilitate the determination of  $k_t$  with cows representing particular levels of body condition, stage of lactation, parity etc. and therefore enable the prediction of this efficiency with particular animal types, or animals in different physiological conditions for example. Kirkland *et al.* (2002) reported a novel approach to determine  $k_t$  on a within cow basis. Data were obtained from a limited number of animals in a controlled calorimetric trial designed to specifically measure this efficiency. The novel approach involved abruptly restricting the level of feed intake of cows to facilitate a period of extensive negative energy balance (with minimal reduction in the level of milk yield). Using these data relationships that were developed between energy output parameters to determine  $k_t$  predicted values of  $k_t$  approximating to 0.80. The models used are described as follows:

$$k_t = E_{l(T)} / (-E_g) \quad (16.20)$$

where  $(-E_g)$  (MJ/day) is the absolute value of negative energy balance and  $E_{l(T)}$  (MJ/day) is the milk energy converted from the mobilized tissue energy. The estimate of  $E_{l(T)}$  was based on the  $ME_m$  and  $k_l$  (derived from a multiple regression, Eq. (16.21)) or heat production (HP) (derived from logistic regression, Eq. (16.22)) using data obtained in the study (Kirkland *et al.*, 2002):

$$E_l = a + bMEI + cE_g \quad (16.21)$$

$$HP = a + c / \{1 + \exp[-b (MEI - m)]\} \quad (16.22)$$

The unit for all energy terms in these two equations is MJ/day. Equation (16.21) follows the principle, as discussed previously, that ME intake is used for maintenance ( $a/b$ ), lactation ( $1/bE_l$ ) and liveweight change ( $c/bE_g$ ). The biology of Eq. (16.22) is that heat production is curvilinearly related to total ME intake, because the ratio of HP/MEI is reduced at increasing feeding levels.

## Curvilinear Modelling to Derive $ME_m$ and $k_l$

The two centres undertaking calorimetry within the UK independently published new estimates for  $ME_m$  and  $k_l$  using data obtained in the mid-1990s from lactating dairy cows (Yan *et al.*, 1997a; Cammell *et al.*, 1998). There were, however, substantial differences between the centres in their estimates of these factors and considerable debate arose as to their source.

Recently the UK Feed into Milk Project (Offer *et al.*, 2002) funded the collation of these two major data sets and new modelling approaches from which to derive new estimates of  $ME_m$  and  $k_l$ . A total of 642 individual cow records were collated and verified from the two centres. A new empirical modelling approach was developed to interpret the calorimetric data. This differs from the factorial approach previously used by ARC (1980) and AFRC (1993). Instead of deriving maintenance requirements from measurements of fasting metabolism, the new method allowed simultaneous calculation of  $ME_m$  and  $k_l$ . It is based on modelling the relationship between  $E_l$  and measured ME input. The following definition of  $k_l$  was adopted:

$$k_l = (E_l \text{ derived from diet MEI}) / (\text{diet MEI directed towards lactation}) \quad (16.23)$$

Thus, for cows in positive energy balance, when some ME intake is used for growth, MEI is adjusted. When cows are in negative energy balance, some body energy is used to support lactation so  $E_l$  is adjusted. To make these adjustments it was necessary to determine  $k_t$  and  $k_g$ . Values for  $k_t$  and  $k_g$  were derived from the data, independently of  $k_l$ , by an iterative procedure. First, values of MEI were plotted against  $E_l$  for all cows in zero energy balance ( $\pm 3$  MJ/day). Values

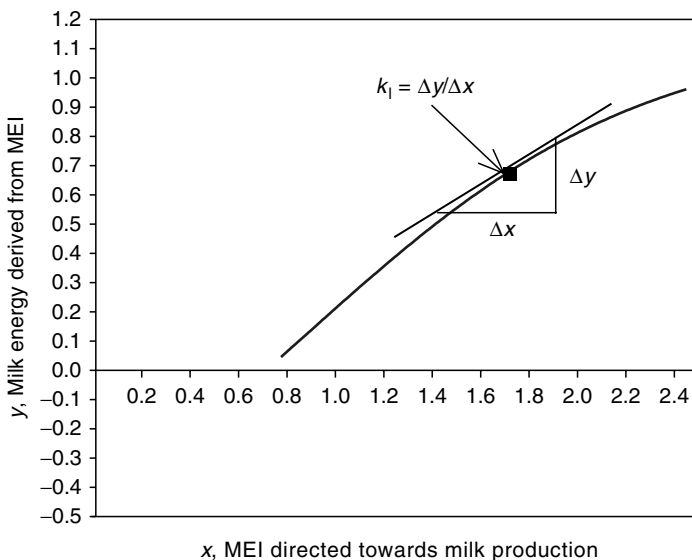


for cows in negative energy balance were then added to the plot with  $E_1$  values corrected using a range of values for  $k_t$ . The value for  $k_t$  which resulted in the regression line ( $MEI/E_1$ ) for cows in negative energy balance being closest in slope and intercept to that for cows at zero energy balance was adopted as the correct estimate of  $k_t$ . The same procedure, but adding data for cows in positive energy balance, was used to estimate  $k_g$ .

Once values for  $k_t$  and  $k_g$  had been obtained, the mathematics of the relationship between  $MEI$  and  $E_1$  (corrected for energy balance) was investigated. Five functions were evaluated including one linear and four non-linear methods. The residual sum of squares and variation in the data explained by fitting the functions ( $R^2$ ) were similar across all five models. It was concluded that traditional analysis using linear models was not adequate to describe the identified effects of level of feeding on  $k_1$ . The non-linear functions allowed for the observed effect of level of feeding on  $k_1$ . The non-linear functions used were parameterized so that they have biological interpretation. A Mitscherlich relationship of the form shown below and in Fig. 16.4 gave the best fit to the data ( $R^2 = 0.85$ ) and was recommended (Kebreab *et al.*, 2003; Agnew *et al.*, 2004):

$$E_1 = 5.06 - (5.06 + 0.453) \exp(-0.1326MEI) \quad (16.24)$$

The unit for  $E_1$  and  $MEI$  is MJ/day. Values for  $k_1$  are the gradient of the curve at each point. Thus, the recommended model uses a variable  $k_1$  (reduces as  $ME$  intake increases) but a fixed value for  $ME_m$ .



**Fig. 16.4.** Relationship between milk energy derived from  $MEI$  and  $MEI$  directed towards milk production (both in  $MJ/kg^{0.75}/day$ ).

## Future Perspectives

The last 70 years have seen considerable progress in developing and improving feeding standards using calorimetric data. Further improvements will continue to be made, which should result in considerable economic benefits in the production of food and fibre. Attention, however, must be given to the hormonal regulation of energy metabolism and the interactions of several neural and hormonal systems. Research is required to elucidate how leptin, uncoupling proteins and other factors affect food intake and energy metabolism. New and improved techniques for collecting, analysing and interpreting the immense amounts of data generated in calorimetric studies are already emerging. However, future rationing systems will benefit from a greater insight into the effects of nutrition on the utilization of specific nutrients within the body. Perhaps more importantly the ability to predict responses to and the partition of absorbed nutrients will only be achieved through appropriate characterization of the animal as well as its feed. This will require improved interactions between research workers involved in calorimetry studies, animal production and animal breeding.

## Acknowledgements

The authors acknowledge partial funding from 'Feed into Milk' – the DEFRA LINK programme on Sustainable Livestock Production with support from The Milk Development Council, AgriSearch and 27 companies from the animal feed and agricultural supply industry and also J. France and D.E. Beever, University of Reading, UK.

## References

- Agnew, R.E. and Yan, T. (2000) The impact of recent research on energy feeding systems for dairy cattle. *Livestock Production Science* 66, 197–215.
- Agnew, R.E., Yan, T. and Gordon, F.J. (1998) Nutrition of the high genetic merit dairy cow – energy metabolism studies. In: Garnsworthy, P.C. and Wiseman, J. (eds) *Recent Advances in Animal Nutrition*. Nottingham University Press, Nottingham, UK, pp. 181–208.
- Agnew, R.E., Yan, T., France, J., Kebreab, E., Beever, D.E., Gordon, F.J., Alderman, G., Porter, M.G. and Cammell, S.B. (2004) Development of a new approach to determine the energy requirements of dairy cows. *Proceedings of British Society of Animal Science Annual Meeting*, York, p. 2.
- Agricultural and Food Research Council (AFRC) (1990) Technical Committee on Responses to Nutrients, Report No. 5, Nutritive Requirements of Farm Animals: Energy. *Nutrition Abstracts and Reviews (Series B)* 60, 729–804.
- Agricultural and Food Research Council (AFRC) (1993) *Energy and Protein Requirements of Ruminants*. CAB International, Wallingford, UK.
- Agricultural Research Council (ARC) (1965) *The Nutrient Requirements of Farm Livestock*. No. 2, *Ruminants*. HMSO, London.

- Agricultural Research Council (ARC) (1980) *The Nutrient Requirements of Ruminant Livestock, Technical Review*. CAB International, Wallingford, UK.
- Aguilera, J.F., Prieto, C. and Fonolla, J. (1990) Protein and energy metabolism of lactating Granadina goats. *British Journal of Nutrition* 63, 165–175.
- Armsby, H.P. (1913) *The Nutrition of Farm Animals*. Macmillan, New York.
- Armstrong, D.G. and Blaxter, K.L. (1965) Effects of acetic and propionic acids on energy retention and milk secretion in goats. In: Blaxter, K.L. (ed.) *The Energy Metabolism of Ruminants. Proceedings of the Third Symposium on Energy Metabolism in Farm Animals*. EAAP, London Academic Press, London, pp. 59–72.
- Baldwin, R.L. and Smith, N.E. (1974) Molecular control of energy metabolism. In: Sink, J.D. (ed.) *The Control of Metabolism*. The Pennsylvania State University Press, University Park and London, pp. 17–34.
- Baldwin, L.R., Forsberg, N.E. and Hu, C.Y. (1985) Potential for altering partition in the lactating cow. *Journal of Dairy Science* 68, 3394–3402.
- Beever, D.E., Cammell, S.B., Sutton, J.D. and Humphries, D.J. (1998) The effect of stage of harvest of maize silage on the concentration and efficiency of utilisation of metabolisable energy by lactating dairy cows. In: McCracken, K., Unsworth, E.F. and Wylie, A.R.G. (eds) *Energy Metabolism of Farm Animals*. CAB International, Wallingford, UK, pp. 359–361.
- Birnie, J.W. (1999) Factors affecting the fasting heat production of non-lactating dairy cattle. PhD thesis, The Queen's University of Belfast, Belfast, UK.
- Blaxter, K.L. (1962) *The Energy Metabolism of Ruminants*. Hutchinson Scientific and Technical, London.
- Blaxter, K.L. (1967) Techniques in energy metabolism studies and their limitations. *Proceedings of Nutrition Society* 26, 86–96.
- Bondi, A.A. (1987) *Animal Nutrition*. Magnes Press, The Hebrew University of Jerusalem (English Edition by John Wiley & Sons).
- Brouwer, E. (1965) Report of the sub-committee on constants and factors. In: Blaxter, K.L. (ed.) *Energy Metabolism of Farm Animals*. European Association of Animal Production Publication No. 11, pp. 441–443.
- Cammell, S.B., Dhanoa, M.S., Beever, D.E., Sutton, J.D. and France, J. (1998) An examination of the metabolisable energy requirements of lactating cows. In: *Proceedings British Society of Animal Science Annual Meeting*, BSAS, Scarborough, p. 197.
- Chowdhury, S.A. (1992) Protein utilisation during energy undernutrition in sheep. PhD thesis, University of Aberdeen, Aberdeen, UK.
- Chowdhury, S.A. and Ørskov, E.R. (1994) Implications of fasting on the energy metabolism and feed evaluation in ruminants. *Journal of Animal and Feed Sciences* 3, 161–169.
- Coffey, M. (1992) Genetic trends – has progress been made in the last six years? *Holstein Friesian Journal* 74, 62–63.
- Ferris, C.P., Gordon, F.J., Patterson, D.C. and Porter, M.G. (1999) The effect of genetic index and concentrate proportion in the diet on nutrient utilisation by lactating dairy cows. *Journal of Agricultural Science, Cambridge* 132, 483–490.
- Flatt, W.P., Moe, P.W., Munson, A.W. and Cooper, T. (1969) Energy utilisation by high producing dairy cows. II. Summary of energy balance experiments with lactating Holstein cows. In: *Proceedings of the Fourth Symposium Energy Metabolism of Farm Animals*. EAAP Publication No. 12, Oriel Press, Newcastle-upon-Tyne, UK, pp. 235–249.

- Gordon, F.J., Porter, M.G., Mayne, C.S., Unsworth, E.F. and Kilpatrick, D.J. (1995) The effect of forage digestibility and type of concentrate on nutrient utilisation for lactating dairy cattle. *Journal of Dairy Research* 62, 15–27.
- Hayasaka, K., Takasuri, N. and Yamagishi, N. (1995) Energy metabolism in lactating Holstein cows (in Japanese, with English abstract). *Animal Science and Technology* 66, 374–382.
- Institut National de la Recherche Agronomique (INRA) (1978) *Alimentation des Ruminants*. INRA publications, Versailles, France, p. 597.
- Institut National de la Recherche Agronomique (INRA) (1989) *Ruminant Nutrition – Recommended Allowances and Feed Tables*. John Libbey Eurotext, Paris-London-Rome.
- Johnson, D.E., Johnson, K.A. and Baldwin, R.L. (1990) Changes in liver and gastrointestinal tract energy demands in response to physiological work load in ruminants. *Journal of Nutrition* 120, 649–655.
- Kebreab, E., France, J., Agnew, R.E., Yan, T., Dhanoa, M.S., Dijkstra, J., Beever, D.E. and Reynolds, C.K. (2003) Alternatives to linear analysis of energy balance data from lactating dairy cows. *Journal of Dairy Science* 86, 2904–2913.
- Kirkland, R.M. and Gordon, F.J. (1999) The metabolisable energy requirements for maintenance and the efficiency of use of metabolisable energy for lactation and tissue gain in dairy cows offered a straw/concentrate ration. *Livestock Production Science* 61, 23–31.
- Kirkland, R.M., Yan, T., Agnew, R.E. and Gordon, F.J. (2002) Efficiency of use of body tissue energy for milk production in lactating dairy cows. *Livestock Production Science* 73, 131–138.
- Kronfeld, D.S. (1976) The potential importance of the proportions of glucogenic, lipogenic and aminogenic nutrients in regard to the health and productivity of dairy cows. In: *Advances in Animal Physiology and Animal Nutrition*. Verlag Paul Parey, Hamburg, Germany, Vol. 7, pp. 5–26.
- Ku Vera, J.C., Ørskov, E.R., Hovell, F.D.D. and MacLeod, N.A. (1987) Effect of small amounts of glucose and different volatile fatty acid mixture on fasting N excretion in lambs. In: Poppe, S. (ed.) *The Fifth International Symposium on Protein Metabolism and Nutrition*. European Association for Animal Production, Rostock, Germany, p. 94.
- Ku Vera, J.C., MacLeod, N.A. and Ørskov, E.R. (1989) Energy exchanges of cattle nourished by intragastric infusion of nutrients. In: Van der Honing, Y. and Close, W.H. (eds) *Energy Metabolism of Farm Animals*. European Association for Animal Production, Publication No. 43, Pudoc, Wageningen, The Netherlands, pp. 217–274.
- Lobley, G.E. (1986) The physiological bases of nutrient responses: growth and fattening. *Proceedings of Nutrition Society* 45, 203–214.
- McDonald, P., Edwards, R.A., Greenhalgh, J.F.D. and Morgan, C.A. (2002) *Animal Nutrition*, 6th edn. Pearson Education Ltd, Harlow, UK.
- McLean, J.A. and Tobin, G. (1987) *Animal and Human Calorimetry*. Cambridge University Press, Cambridge, UK.
- Ministry of Agriculture, Fishery and Food (MAFF) (1975) *Energy Allowances and Feeding Systems for Ruminants*. MAFF Technical Bulletin No. 33. HMSO, London.
- Moe, P.W., Tyrrell, H.F. and Flatt, W.P. (1970) Partial efficiency of energy use for maintenance, lactation, body gain and gestation in the dairy cows. In: Schürch, A. and Wenk, C. (eds) *Energy Metabolism of Farm Animals*. European Association for Animal Production Publication No. 13. Vitznau, Switzerland, pp. 65–68.

- Moe, P.W., Flatt, W.P. and Tyrrell, H.F. (1972) The net energy values of feeds for lactation. *Journal of Dairy Science* 55, 945–958.
- National Research Council (NRC) (1978) *Nutrient Requirements of Dairy Cattle*, 5th revised edn. National Academy Press, Washington, DC.
- National Research Council (NRC) (1988) *Nutrient Requirements of Dairy Cattle*, 6th revised edn. National Academy Press, Washington, DC.
- National Research Council (NRC) (2001) *Nutrient Requirements of Dairy Cattle*, 7th revised edn. National Academy Press, Washington, DC.
- Offer, N.W., Agnew, R.E., Cottrill, B.R., Givens, D.I., Keady, T.W.J., Mayne, C.S., Rymer, C., Yan, T., Thomas, C., France, J. and Beever, D.E. (2002) Feed into Milk – an applied feeding model coupled with a new system of feed characterisation. 32nd Feed Manufacturers Conference, Nottingham, UK.
- Oldham, J.D. and Emmans, G.C. (1990) Animal performance as the criterion for feed evaluation. In: Wiseman, J. and Cole, D.J.A. (eds) *Feedstuff Evaluation*. Butterworths, London, pp. 73–90.
- Ørskov, E.R., Meehan, D.E., MacLeod, N.A. and Kyle, D.J. (1999) Effect of glucose supply on fasting nitrogen excretion and effect of level and type of volatile fatty acid infusion on response to protein infusion in cattle. *British Journal of Nutrition* 81, 389–393.
- Patle, B.R. and Mudgal, V.D. (1975) Maintenance requirements for energy in cross-bred cattle. *British Journal of Nutrition* 33, 127–139.
- Patle, B.R. and Mudgal, V.D. (1977) Utilisation of dietary energy for maintenance, milk production and lipogenesis by lactating crossbred cows during their mid-stage of lactation. *British Journal of Nutrition* 37, 23–33.
- Rapetti, L., Crovetto, G.M., Tamburini, A., Galassi, G., Sandrucci, A. and Succi, G. (1998) Some aspects of the energy metabolism in lactating goats. In: McCracken, K., Unsworth, E.F. and Wylie, A.R.G. (eds) *Energy Metabolism of Farm Animals*. CAB International, Wallingford, UK, pp. 93–96.
- Reynolds, C.K. (1996) Nutritional requirements of the high genetic merit dairy cow: constraints of feeding grasses and legumes. In: *Grass and Forage for Cattle of High Genetic Merit*. British Grassland Society, Great Malvern, UK.
- Standing Committee on Agriculture (SCA) (1990) *Feeding Standards for Australian Livestock – Ruminants*. CSIRO, Australia.
- Sutton, J.D., Cammell, S.B., Beever, D.E., Humphries, D.J. and Phipps, R. (1998) Treatment of urea-treated wholecrop wheat to improve its energy feeding value for lactating dairy cattle. In: McCracken, K., Unsworth, E.F. and Wylie, A.R.G. (eds) *Energy Metabolism of Farm Animals*. CAB International, Wallingford, UK, pp. 387–390.
- Unsworth, E.F., Mayne, C.S., Cushnahan, A. and Gordon, F.J. (1994) The energy utilisation of grass silage diets by lactating dairy cows. In: Aguilera, J.F. (ed.) *Energy Metabolism of Farm Animals*. European Association for Animal Production Publication No. 76, Mojacar, Spain, pp. 179–181.
- Van Es, A.J.H. (1975) Feed evaluation for dairy cows. *Livestock Production Science* 2, 95–107.
- Van Es, A.J.H. (1976) Factors influencing the efficiency of energy utilisation by beef and dairy cattle. In: Swan, H. and Broster, W.H. (eds) *Principles of Cattle Production*. Butterworths, London, pp. 237–253.
- Van Es, A.J.H. (1978) Feed evaluation for ruminants. 1. The systems in use from May 1977 onwards in the Netherlands. *Livestock Production Science* 5, 331–345.

- Van Es, A.J.H. and Van der Honing, Y. (1979) Energy utilisation. In: Broster, W.H. and Swan, H. (eds) *Feeding Strategy for the High Yielding Dairy Cow*. Granada Publishing, London, pp. 68–89.
- Van Es, A.J.H., Nijkamp, H.J. and Vogt, J.E. (1970) Feed evaluation for dairy cows. In: Wenk, C. (ed.) *Energy Metabolism of Farm Animals*. European Association for Animal Production Publication No 13. Vitznau, Switzerland, pp. 61–64.
- Veerkamp, R.F., Simm, G. and Oldham, J.D. (1994) Effects of interaction between genotype and feeding system on milk production, feed intake, efficiency and body tissue mobilisation in dairy cows. *Livestock Production Science* 39, 229–241.
- Vermorel, M., Remond, B., Vernet, J. and Liamadis, D. (1982) Utilisation of body reserves by high producing cows in early lactation: effects of crude protein and amino acid supply. In: Ekern, A. and Sundsol, F. (eds) *Energy Metabolism of Farm Animals*. European Association for Animal Production Publication No. 29, Norway, pp. 18–21.
- Yan, T., Patterson, D.C., Gordon, F.J. and Porter, M.G. (1996) The effects of wilting of grass prior to ensiling on the response to bacterial inoculation. 1. Silage fermentation and nutrient utilisation over three harvests. *Animal Science* 62, 405–418.
- Yan, T., Gordon, F.J., Agnew, R.E., Porter, M.G. and Patterson, D.C. (1997a) The metabolisable energy requirement for maintenance and the efficiency of utilisation of metabolisable energy for lactation by dairy cows offered grass silage-based diets. *Livestock Production Science* 51, 143–153.
- Yan, T., Gordon, F.J., Ferris, C.P., Agnew, R.E., Porter, M.G. and Patterson, D.C. (1997b) The fasting heat production and effect of lactation on energy utilisation by dairy cows offered forage-based diets. *Livestock Production Science* 52, 177–186.

---

# 17 Metabolic Regulation

R.G. Vernon

*Hannah Research Institute, Ayr KA6 5HL, UK*

---

## Introduction

Ruminants, like other animals, have to meet the nutritional demands of the many organs and cell types of the body. This has to be done against a background of a varying, and not always adequate, supply of nutrients. Thus, once absorbed there are a number of potential fates for a given nutrient and a plethora of mechanisms and factors, which influence the probability of a given fate. Such mechanisms operate within cells, between different cells and types within a tissue, and between organs. Mechanisms may be brought into play to deal with acute or chronic challenges: the former are important for homeostasis while the latter are critical for the homeorrhetic adaptations needed for different developmental, physiological, nutritional or pathological states. The nature of these mechanisms and the various types of factors involved are considered in subsequent sections. It will be obvious to those familiar with the previous edition of this book that the flavour of the current chapter is very different from that written by the late Bernard Crabtree. He focused on the important but still rather specialized field of mathematical modelling of metabolic pathways and their regulation; for those interested in this aspect I strongly recommend Bernard's chapter (Crabtree, 1993) and also articles by Brown (1994), Kacser *et al.* (1995) and Hofmeyr and Cornish-Bowden (2000).

## Levels of Metabolic Control

### *Within cells*

#### *Metabolic pathways*

Within cells the fate of a nutrient is determined not only by the activity of relevant enzymes but, in some cases at least, by: (i) translocases, reflecting the fact that the

cell is highly structured and a metabolic pathway may be split between more than one compartment, necessitating translocation of metabolites between compartments; and (ii) binding proteins because some metabolites may have deleterious effects at high concentration (e.g. long-chain fatty acids and their acyl-CoA esters), hence binding proteins are used to protect against this.

In general terms a nutrient such as glucose, a fatty acid or an amino acid, on entry into a cell, is first activated by a reaction involving ATP or another nucleoside triphosphate. Subsequently the 'activated' nutrient will be further metabolized, often by a branching metabolic pathway. Many studies have focused on identifying and characterizing key rate-limiting enzymes of these pathways. However, proponents of 'metabolic control theory' have made the point that within a linear pathway the flux through each individual step will be the same, and any step can be involved in determining the rate (Kacser *et al.*, 1995). Thinking has been coloured in part by studies of pathways of tryptophan synthesis and glycolysis in yeast and other microorganisms, which showed that increasing the amount in individual compartments had little effect on overall flux (Oliver, 2002). By contrast, studies with transgenic mice have shown, for example, that increasing the amount of the glucose transporter, Glut 4, in muscle and fat increased glucose uptake and subsequent rate of metabolism (Wallberg-Henriksson and Zierath, 2001). While it is true that if the activity of any component enzyme is reduced sufficiently it can constrain the overall flux through a pathway, some enzymes are clearly more important in this respect than others. Such enzymes catalyse essentially irreversible reactions and are usually subject to complex control by covalent modification (e.g. phosphorylation–dephosphorylation) and non-covalent control by metabolites and other small molecules.

Enzyme phosphorylation most commonly involves key serine residues, and can lead to activation (e.g. activation of hormone-sensitive lipase by protein kinase A) (Yeaman *et al.*, 1994) or inhibition (e.g. phosphorylation of acetyl-CoA carboxylase (ACC) by AMP-stimulated kinase) (Barber *et al.*, 1997). Control can be complex: protein kinase A and AMP-stimulated kinase phosphorylate different serine residues of hormone-lipase which are separated by a single amino acid; phosphorylation of one serine prevents phosphorylation of the other (Yeaman *et al.*, 1994). There are many examples of activity being modulated by small molecules: in some cases a molecule interacts directly with the catalytic site on the enzyme, in other cases the effector molecule interacts with a distant site causing a conformational change which results in altered activity (allosteric regulation). There can be simple product inhibition (e.g. inhibition of hexokinases I and II by glucose-6-phosphate); inhibition by the final product of a pathway (e.g. inhibition of ACC by fatty acids); inhibition by a component of another pathway (e.g. inhibition of carnitine palmitoyl-CoA transferase-1 by malonyl-CoA and methylmalonyl-CoA, intermediates of fatty acid synthesis and propionate metabolism, respectively). It is not always inhibition as glycogen synthase, for example, is activated by glucose-6-phosphate. The complexity of control is illustrated by the fact that phosphofructokinase is inhibited by both citrate and ATP (substrate) and activated by fructose-6-phosphate (substrate), ADP (product) and AMP. In general, changes in



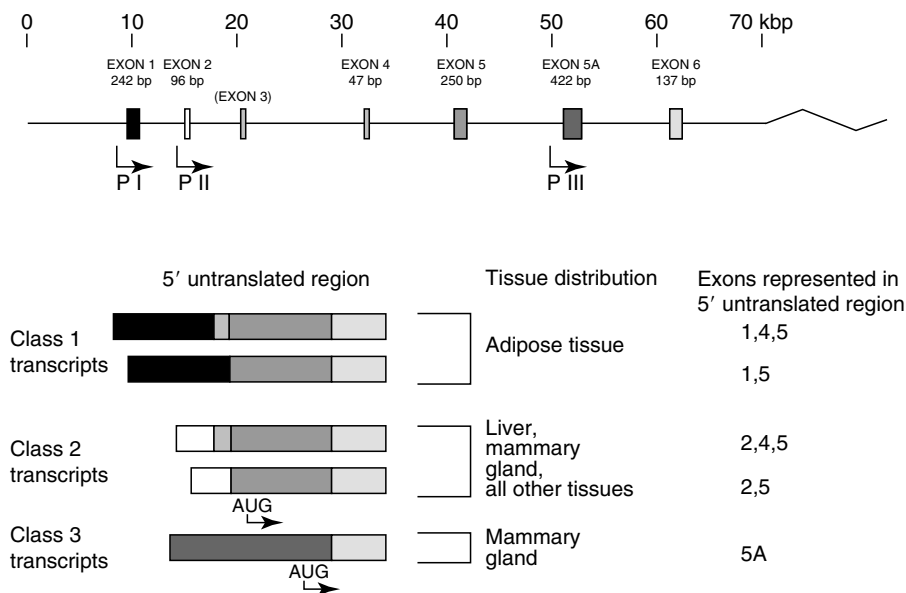
phosphorylation are due to extracellular stimuli, whereas modulation by small molecules is a response to intracellular stimuli.

Effective activity can also be modulated by translocation from one part of a cell to another. For example, activation of hormone-sensitive lipase by catecholamines in adipocytes results not only in increased enzyme activity, but also a movement of the enzyme from the cytosol to the surface of the fat droplet (Londos *et al.*, 1999). Stimulation of glucose transport by insulin into adipocytes and muscle cells involve a translocation of Glut 4-containing vesicles from the interior of the cell to the plasma membrane (Mueckler, 1994).

The effective activity of an enzyme is also determined by the concentration of the substrates. The importance of this depends on the concentration of substrate relative to the affinity of the enzyme for the substrate. Thus for both long-chain and short-chain (volatile) fatty acids, the  $K_m$  of the activating enzymes is relatively high so flux varies with fatty acid concentration over the normal physiological range (Bell, 1980). Similarly the  $K_m$  of hepatic hexokinase IV (glucokinase) is very high, so flux varies directly with glucose concentration (Bollen *et al.*, 1998). By contrast, the  $K_m$  of muscle hexokinase for glucose is very low; hence flux is less sensitive to glucose concentration.

The above mechanisms all provide for rapid changes in effective activity of an enzyme and hence are of considerable importance for homeostatic control (see below). In addition there are changes in the amount of enzymes, translocases and binding proteins, providing further, longer-term control. Amounts of such proteins are determined both by synthesis and degradation, but in most cases it is the former that is the key determinant.

Protein synthesis is regulated at the level of gene transcription and, in some cases, translation of the corresponding mRNA. Gene expression is regulated by promoters usually located upstream of the 5' end of the coding region. The key lipogenic enzyme ACC illustrates the complexity of control. This enzyme occurs as two distinct isoforms, coded by different genes (Travers and Barber, 2001). ACC- $\alpha$  is the major isoform of the liver (in non-ruminants), adipocyte and lactating mammary gland – all tissues with very high rates of lipogenesis. ACC- $\beta$  is found in a wider variety of tissues including heart and skeletal muscle; ACC- $\beta$  activity is lower than that of ACC- $\alpha$ , and is thought to have an important regulatory, rather than synthetic, role as its product, malonyl-CoA, is a key modulator of fatty acid oxidation (Zammit, 1999). ACC- $\alpha$  gene expression is regulated by at least three promoters (Fig. 17.1), with expression by these different promoters showing tissue specificity; P1 is the major promoter of adipocytes whereas PIII is important in lactating mammary tissue (Travers and Barber, 2001). Most studies of this type have focused on non-ruminant species, but in the case of ACC- $\alpha$  much of the data comes from work on sheep tissue. Expression via the different promoters is under distinct physiological and hormonal control. The decrease in ACC- $\alpha$  expression in sheep adipose tissue during lactation, for example, is due mostly to a fall in expression via the P1 promoter with only a small decrease in expression via the PII promoter (Travers and Barber, 2001). Regulation of gene expression via hormones and nutrients is mediated by transcription factors, which bind to response elements in the promoter regions of the gene.



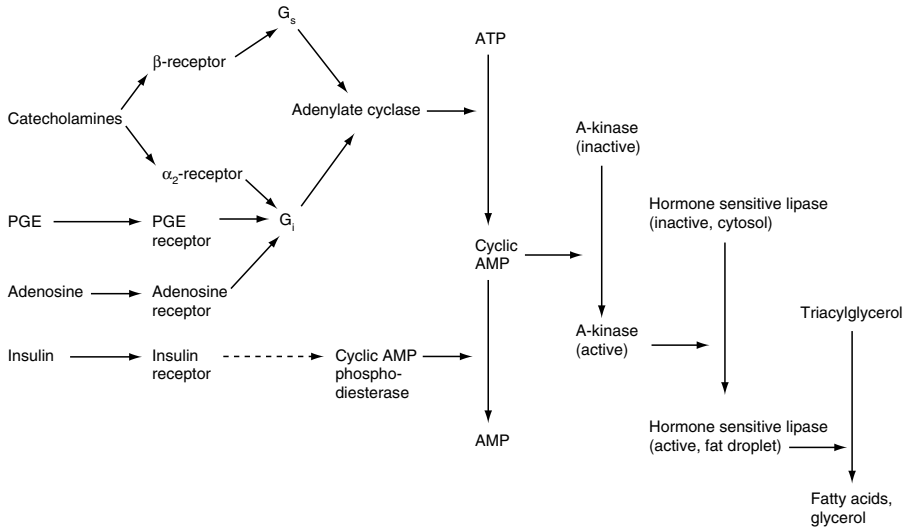
**Fig. 17.1.** Structure of the regulatory region of the ovine acetyl-CoA carboxylase- $\alpha$  gene (adapted from Travers and Barber, 2001).

Molecular biological approaches have not only revealed the complexity of promoter systems, they have also shown that many proteins exist in more isoforms than previously thought. For example, a novel form of ACC- $\alpha$  was found in sheep mammary gland, which has a missing sequence of eight amino acids prior to a key serine that is thought to be important for control of ACC- $\alpha$  activity by phosphorylation–dephosphorylation (Travers and Barber, 2001). Whether the altered amino acid sequence influences the phosphorylation of this serine is not known, but interestingly expression of this isoform of the enzyme in the mammary gland is increased markedly by lactation (Travers and Barber, 2001).

### Signal transduction pathways

As many hormones and growth factors have receptors in the plasma membrane, signals have to be transmitted to sites within the cell via signalling pathways. For some, e.g. catecholamine activation of lipolysis in adipocytes and its antagonism by adenosine and prostaglandin E, the signalling pathway appears to be well defined (Fig. 17.2).

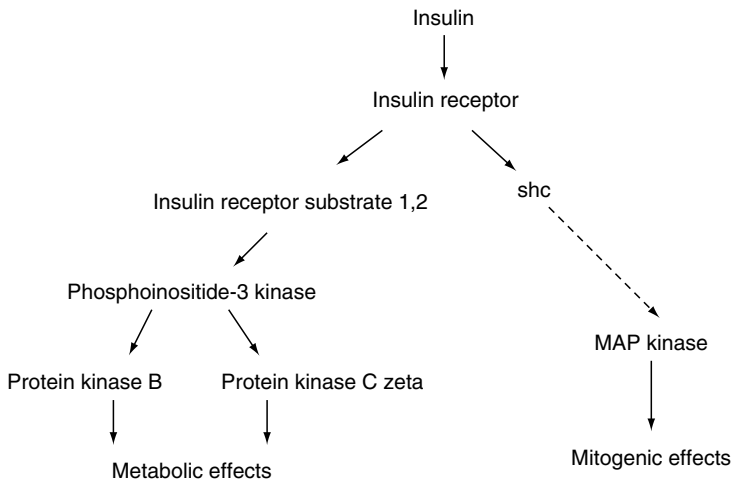
However, for many hormones the pathways are only partly resolved. Thus we know that insulin activates a series of branching pathways which mediate effects on metabolism, protein synthesis, mitogenesis, etc. (Fig. 17.3), but while early steps transmitting metabolic signals appear to be known, downstream effectors are still unresolved (Pessin and Saltiel, 2000; Litherland *et al.*, 2001). Furthermore, novel pathways continue to be identified. For example, insulin stimulation of glucose transport in adipocyte and muscle cells is thought to be mediated, in part at least, via the phosphoinositide-3 kinase/protein



**Fig. 17.2.** Lipolytic signalling cascade of adipocytes. PGE, prostaglandin E; G<sub>s</sub>, stimulatory GTP-binding protein; G<sub>i</sub>, inhibitory GTP-binding protein.

kinase B pathway (Fig. 17.3), but recently a new pathway involving the proteins TC10 and flotillin, which binds to lipid rafts in the plasma membrane, has been implicated as well (Litherland *et al.*, 2001).

For some important metabolic hormones, e.g. growth hormone, even less is known. Frustratingly for this key hormone with its important chronic homeorrhetic metabolic effects (Bauman and Vernon, 1993; Etherton and



**Fig. 17.3.** Some of the insulin signal transduction system. MAP kinase, mitogen-activated protein kinase; shc, src homology collagen-related protein.

Bauman, 1998) most research has focused on systems of questionable physiological significance (a transient insulin-like effect seen in rodent tissue after a period of abstinence from growth hormone, and a 'commitment to differentiation' effect observed in a preadipocyte cell line) (Herrington and Carter-Su, 2001). This reflects a tendency to study what is easy rather than what is important!

To add to the complexity, we now know that many signal transduction components exist in several isoforms; for example there are at least three isoforms of the  $\beta$ -adrenergic receptor (Carpene *et al.*, 1998), two of the GTP-binding protein  $G_s$ , at least three isoforms of  $G_i$  (Manning and Woolkalis, 1994) and nine of adenylate cyclase (Simonds, 1999). The proportion of the different isoforms varies with cell type and implies that the functions of the signal systems will show subtle variations depending on the isoforms involved.

A confusing feature of signalling is that many hormones and related factors appear to use the same intracellular signalling components, raising questions as to how specificity of effect is achieved (Dumont *et al.*, 2002). This could arise from use of different isoforms or activation of components in different parts of the cell. It may be that while a number of hormones may activate a similar network of signalling pathways, the individual receptors may interact slightly differently with the various components, thus achieving distinct, specific outcomes (Dumont *et al.*, 2002). As the various signalling pathways are resolved, this problem of specificity should provide an interesting challenge for modellers!

### **Within tissues**

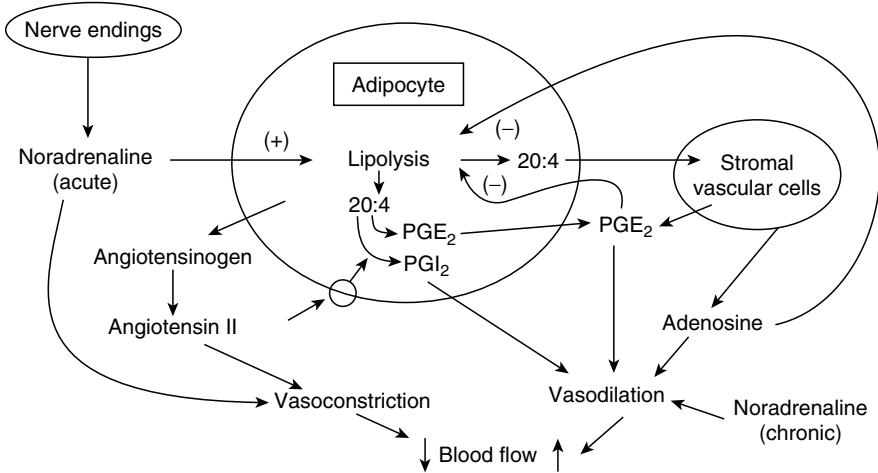
Tissues are composed of multiple cell types, which communicate with each other via autocrine and paracrine signals that can influence the fate of nutrients within a tissue. In addition, different cell types have different types and amounts of transporters needed to move nutrients across the plasma membrane. Adipose tissue, for example, comprises about 85% triacylglycerol by weight, but adipocytes, while being very large cells, comprise only about 10% of the total cell number of the tissue in the adipose tissue of adult sheep (Travers *et al.*, 1997). Other cell types include preadipocytes, endothelial cells and macrophages. The growing problem of obesity has focused much attention on adipose tissue in recent years and we now know that it secretes a whole battery of factors of various types (Table 17.1). Some substances are secreted by adipocytes (e.g. leptin, adiponectin), some by other cell types of the tissue (e.g. interleukin-6, oestrogen) and some by both (e.g. adenosine, prostaglandin E) (Vernon and Houseknecht, 2000). Some (e.g. leptin, adiponectin, sex steroids) are hormones and are released into the general circulation, influencing events elsewhere in the body (Vernon, 2003). Many, however, are locally active and may influence the fate of nutrients within the tissue. For example, there is an apparent relationship between lipolysis in adipocytes and blood flow through the tissue (Vernon and Clegg, 1985), and several locally produced factors modulate both (Vernon and Houseknecht, 2000; Vernon, 2003).

**Table 17.1.** Some substances secreted by adipose tissue.

<u>Metabolic modulators</u>	<u>Hormones</u>	<u>Complement system</u>
Lipoprotein lipase	Oestrone	Factor B
Acylation-stimulating protein	Oestradiol	Factor C
Apoprotein E	Testosterone	Factor D (adipsin)
Fatty acids	IGF-1	
Prostaglandin E <sub>2</sub>		<u>Binding proteins</u>
	<u>Adipocytokines</u>	IGF-binding proteins
<u>Vasoactive factors</u>	Leptin	Retinol-binding protein
Prostacyclin (prostaglandin I <sub>2</sub> )	Tumour necrosis factor $\alpha$	Cholesterol ester transfer protein
Monobutryin	Interleukin-6	
Angiotensinogen/angiotensin II	Resistin	<u>Other</u>
Atrial natriuretic peptide	Adiponectin	Plasminogen activator inhibitor-I

Fatty acids released from adipose tissue are transported in the blood bound to serum albumin. Albumin has two high-affinity binding sites for fatty acids and a further five low-affinity binding sites. The concentration of albumin in the blood is about 0.5 mM, so 1 mM fatty acid will potentially saturate both high-affinity binding sites; indeed a decreased release of fatty acids has been observed when the concentration exceeded about 1 mM (Vernon and Clegg, 1985). The blood flow through sheep adipose tissue is about 50  $\mu\text{l}/\text{min}/\text{g}$  tissue before a meal (Barnes *et al.*, 1983) and this will support a rate of fatty acid release of about 50 nmol/min/g tissue. The limited amount of data available suggests a rate of lipolysis of about 5 nmol fatty acid released per min per g tissue in the fed state, rising to about 15 nmol/min/g tissue on fasting in sheep (Vernon and Clegg, 1985). A substantial proportion of the binding sites of albumin entering the tissue will already be occupied by fatty acids in the fasted state, hence only a limited number will be free to accommodate newly released fatty acids. The various estimates come from a number of different studies, but the general point is that blood flow, or to be precise free-binding sites, has the potential to limit lipolysis.

Catecholamines both stimulate lipolysis and are vasoactive (Vernon and Clegg, 1985). In addition, stimulation of lipolysis in sheep adipose tissue *in vivo* by catecholamines resulted in a concomitant rise in prostaglandin E<sub>2</sub> (Doris *et al.*, 1996) which is vasodilatory and which also acts to attenuate lipolysis (Crandall *et al.*, 1997) (Fig. 17.4). The rise in prostaglandin E<sub>2</sub> production was associated with a fall in glycerol output, due either to decreased lipolysis, increased blood flow or both. Adenosine could have a similar role (Vernon, 1996a). It is also noteworthy that prostaglandin E<sub>2</sub> and adenosine are produced by the stromal-vascular cells of adipose tissue as well as adipocytes (Vernon and Houseknecht, 2000). Indeed it has been suggested that prostaglandin production requires both adipocytes and stromal-vascular cells, arachidonic acid released from adipocytes being metabolized to prostaglandin by the stromal-vascular cells (Richelsen, 1992).



**Fig. 17.4.** Modulation of lipolysis and blood flow by local factors in adipose tissue. PGE<sub>2</sub>, prostaglandin E<sub>2</sub>; PGI<sub>2</sub>, prostaglandin I<sub>2</sub> (prostaglyclin); 20:4, arachidonic acid.

### ***Between organs and tissues***

Nutrients need to be apportioned appropriately between the various organs and tissues of the body. Key factors are blood flow, metabolic capacity of cells and hormonal and nervous signals.

Blood flow varies considerably from tissue to tissue (Table 17.2) and there is even marked variation within some tissues such as skin (Bell *et al.*, 1983; Gregory and Christopherson, 1986). Differences in blood flow between organs in general reflect the differences in metabolic activity (Table 17.3) (Rolfe and Brown, 1997). A relationship between blood flow and metabolic activity within an organ has been demonstrated for the mammary gland in lactating goats (Linzell, 1974) and portal-drained viscera in sheep and cattle (see Chapter 12). Blood flow, and hence nutrient supply, to a tissue varies with physiological and nutritional state. For example, on feeding in sheep, blood flow increased to the rumen epithelium and salivary glands, decreased to abdominal adipose tissue, but did not change to heart, kidney and subcutaneous adipose tissue (Barnes *et al.*, 1983). The onset of lactation in goats results in a fivefold increase compared to pregnancy in blood flow to the mammary gland (Linzell, 1974). Exercise or stress induces marked changes in blood flow with a much greater proportion of cardiac output going to skeletal muscle (Bell *et al.*, 1983).

Blood flow is under complex control, involving paracrine and autocrine factors (e.g. Fig. 17.4), hormones and the nervous system. Catecholamines are vasoactive and can both accentuate and attenuate blood flow, depending on which receptors are activated. Increased sympathetic activity during exercise, for example, causes increased release of adrenalin from the adrenal medulla, which increases blood flow through skeletal muscle. In adipose tissue increased sympathetic activity can lead to initial vasoconstriction due to activation of

**Table 17.2.** Blood flow of various tissues in sheep (data from Barnes *et al.*, 1983; Bell *et al.*, 1983; Gregory and Christopherson, 1986; Weaver *et al.*, 1990).

Tissue	Blood flow (ml/min/100 g)
Brain	69, 70
Heart	62, 95, 110, 154
Kidney	460, 550, 650
Lactating mammary gland	50
<i>Gastrointestinal tract</i>	
Rumen	24, 112
Abomasum	67, 105, 204
Small intestine	60, 62, 130
Large intestine	48, 64, 80, 105
Liver – hepatic artery	4, 8, 13
Liver – hepatic portal vein	285
Skeletal muscle	2, 9, 10–65
Adipose tissue	0.3, 4, 8–23
Skin	1–13, 3, 2–20

$\alpha$ -adrenergic receptors, followed by vasodilatation due to activation of  $\beta$ -adrenergic receptors (Vernon and Clegg, 1985).

Access by nutrients to most cells requires their passage from the blood to the extracellular space. Endothelial cell permeability thus provides another means of manipulating nutrient fate (Vernon and Peaker, 1983). The liver in particular has a very 'leaky' endothelium, reflecting the important role of the liver in the uptake and degradation of proteins and even larger structures such

**Table 17.3.** Tissue oxygen use as percentage of whole body oxygen use and blood flow as percentage of cardiac output in sheep (data also from A.W. Bell, unpublished observations).

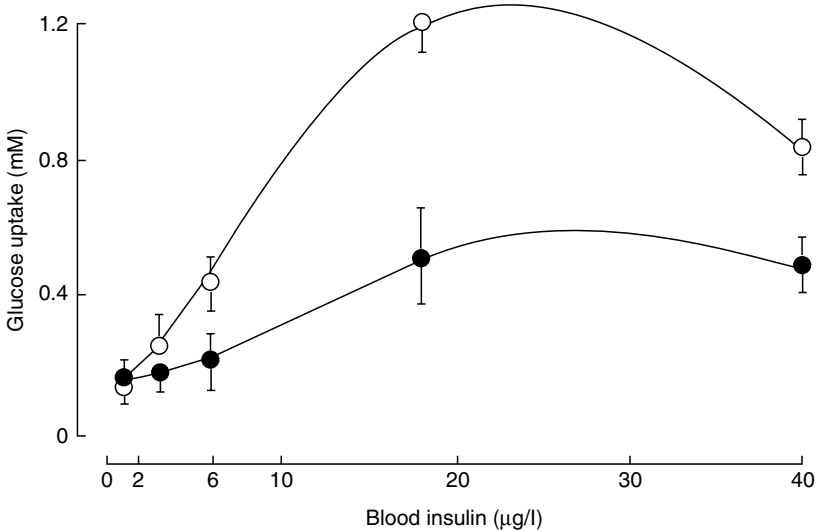
Tissue	Oxygen use (per cent use by whole body)	Blood flow (per cent cardiac output)	
		Hales (1973)	Weaver <i>et al.</i> (1990)
Gastrointestinal tract	20	33	28
Liver	20	–	5.8 <sup>a</sup>
Brain	10	2.3	2.6
Heart	10	6.9	4.8
Kidney	8	16.5	19
Skeletal muscle	20	12	15.6
Bone	5	–	3.9
Skin	7 (skin and adipose tissue combined)	13	7.5
Adipose tissue		–	1.5

<sup>a</sup>Via hepatic vein; liver also receives blood from gastrointestinal tract via hepatic portal vein.

as lipoprotein remnants. By contrast, the brain has a very tight endothelium, creating the so-called 'blood-brain barrier'.

The cellular distribution of translocases and the nature of the isoforms have important roles in determining the partitioning of nutrient between organs/tissues. For example, there are at least six well-characterized glucose transporters involved in transport across the plasma membrane (Mueckler, 1994; Hocquette *et al.*, 1996) and new ones continue to be discovered. The Glut-4 transporter is insulin-sensitive and is found in adipocytes and myocytes – cells with a high capacity for glucose metabolism (Mueckler, 1994; Hocquette *et al.*, 1996). Thus, if plasma glucose is increased, for example after a meal, the concomitant rise in serum insulin will cause a preferential uptake of glucose by cell types expressing Glut-4. Even in ruminants, which are thought to be less responsive to insulin than most non-ruminants, insulin-infusion induced a six-fold increase in glucose uptake across the hind limb of mature sheep (Fig. 17.5). The corollary, of course, is that when serum insulin and glucose concentrations are low as during fasting, utilization of glucose by other tissues (e.g. brain) will be favoured.

Fatty acids are mostly supplied to tissues either as non-esterified fatty acids (NEFA) bound to albumin or as a part of triacylglycerols, which are transported as part of very low-density lipoproteins (VLDL) secreted by the liver, and chylomicrons secreted by the gastrointestinal cells. VLDL and chylomicrons are too large to cross the endothelial cell barrier, so triacylglycerols are hydrolysed by the action of lipoprotein lipase, an enzyme secreted by a variety of cells including adipocytes, myocytes and mammary epithelial cells (Barber *et al.*, 1997). Following secretion it is transported to the luminal surface of the

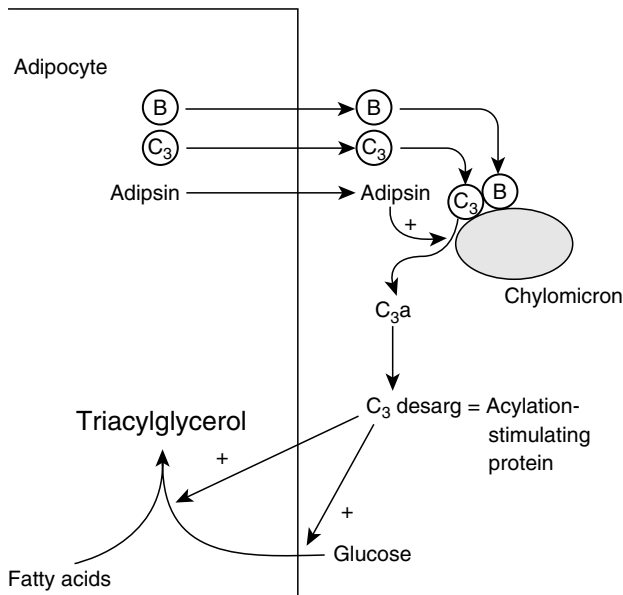


**Fig. 17.5.** Effect of insulin on glucose arteriovenous difference across the hind limb of lactating (●) and non-lactating (○) sheep (data from Vernon *et al.*, 1990).



endothelium within the tissue where it can then hydrolyse lipoprotein triacylglycerols. Fatty acids thus released are mostly taken up by cells of the tissue, although some escape into the general circulation. The proportion escaping immediate uptake probably varies from tissue to tissue and may be influenced by blood flow. Studies with lactating mammary gland, for example, which has a high rate of blood flow, suggest about 30% of fatty acids released escape from the tissue (Mendelson and Scow, 1972). Uptake may be more efficient in adipose tissue and skeletal muscle, which have much lower rate of blood flow than the lactating mammary gland (Table 17.2). The amount of effective (i.e. located on the endothelium) lipoprotein lipase of a tissue will thus be a major determinant of fatty acid availability for uptake by the tissue. Lipoprotein lipase is under tissue-specific control; fasting, for example, decreases activity in adipose tissue but increases activity in muscle, while lactation increases activity in mammary tissue while decreasing it in adipose tissue (Vernon and Clegg, 1985; Barber *et al.*, 1997). By contrast, NEFA are available to all tissues and their use is not under such tissue-specific regulation.

Adipocytes have a curious mechanism, which facilitates uptake of fatty acids specifically from chylomicron triacylglycerols (Fig. 17.6). Adipocytes secrete some proteins of the alternative pathway for complement production which bind to the surface of chylomicrons where factor D (adipsin) catalyses a proteolytic cleavage of factor  $C_3$  to  $C_{3a}$ . Factor  $C_{3a}$  then loses its N-terminal arginine to produce acylation-stimulating protein, which enhances fatty acid uptake and esterification by adipocytes and stimulates glucose uptake (Cianflone, 1997). Production of acylation-stimulating protein varies amongst adipose tissue

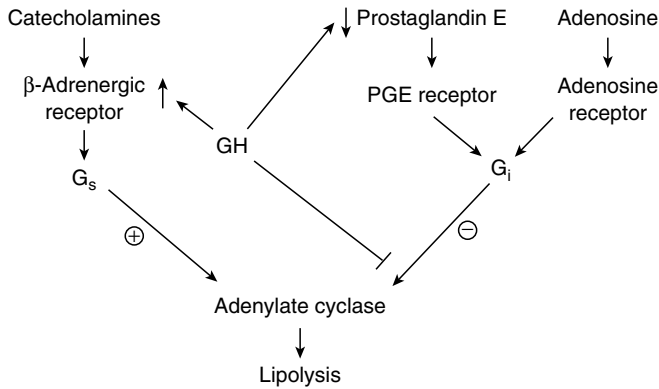


**Fig. 17.6.** Production and role of acylation-stimulating protein in adipose tissue. B, C<sub>3</sub>, C<sub>3a</sub>, complement factors B, C<sub>3</sub>, C<sub>3a</sub>, respectively.

depots, and so may act to influence fatty acid partitioning amongst them (Cianflone, 1997). Little is known about the role of acylation-stimulating protein in ruminants (normally ruminant diets have a relatively low fat content), but a recent paper shows that acylation-stimulating protein caused a small increase in fatty acid esterification in bovine adipose tissue *in vitro* (Jacobi and Miner, 2002).

Co-ordinating these various mechanisms are hormones and the nervous system. Hormones and neurohormonal transmitters such as catecholamines can alter the amount and activation status of enzymes and translocases in a tissue-specific manner, reflecting tissue-specific differences in the numbers and sometimes isoforms of their receptors. Some, such as the insulin receptor, are almost ubiquitous but others are much more restricted. Glucagon, for example, targets the liver but in ruminants it has no effect on other major metabolic tissues such as myocytes, adipocytes or mammary epithelial cells (She *et al.*, 1999). With respect to isoforms, the  $\beta_1$  and  $\beta_2$  adrenergic receptors, for example, are widespread, whereas the  $\beta_3$  adrenergic receptor is confined to adipocytes (Carpene *et al.*, 1998). Leptin has at least six receptors; the so-called long-form of the receptor, Ob-Rb, which has full signalling capacity, is localized primarily in the hypothalamus where it has an important role in appetite regulation and energy balance (Ahima and Flier, 2000; Vernon *et al.*, 2001). Other isoforms of the leptin receptor are more widespread in their distribution (Ahima and Flier, 2000).

Acutely acting hormones such as insulin and glucagon and also catecholamines achieve their effects primarily by changing the activities of key enzymes and translocases (e.g. by changes in phosphorylation status). Such hormones often have mutually antagonistic effects: e.g. insulin and glucagon stimulate synthesis and degradation of glycogen in the liver, while insulin and catecholamines stimulate synthesis and degradation of triacylglycerol in adipocytes. Chronically acting hormones can modulate function by changing the amount of key metabolic enzymes and translocases, but in addition such hormones may alter the ability of specific cell types to respond to acutely activating hormones. Growth hormone, for example, antagonizes the ability of adipocytes to respond to insulin and accentuates response to catecholamines (Bauman and Vernon, 1993; Etherton and Bauman, 1998). The mechanism whereby growth hormones antagonize the response to insulin is still unresolved, but effects of growth hormone on the lipolytic-signalling pathway have been studied in some detail in ruminants and are complex. In sheep, but not cattle, growth hormone causes a small increase in response and sensitivity to  $\beta$ -adrenergic agonists, at least partly due to an increase in the number of  $\beta$ -adrenergic receptors of adipocytes (Vernon, 1996a; Etherton and Bauman, 1998). By contrast, in sheep and cattle growth hormone attenuates response to the antilipolytic effect of adenosine and also prostaglandin  $E_2$  in sheep (Doris *et al.*, 1996; Etherton and Bauman, 1998). Furthermore, growth hormone decreases the catecholamine-induced increase in prostaglandin  $E_2$  production in sheep adipose tissue *in vivo* (Doris *et al.*, 1996). Thus in sheep, growth hormone facilitates lipolysis by at least three mechanisms (Fig. 17.7). All these effects of growth hormone are chronic, taking a number of hours to become manifest.



**Fig. 17.7.** Modulation of lipolytic regulatory systems by growth hormone. GH, growth hormone; PGE, prostaglandin E;  $G_s$ , stimulatory GTP-binding protein;  $G_i$ , inhibitory GTP-binding protein.

## Homoeostasis and Homoeorrhesis

### Homoeostasis

The top priority of the various mechanisms described in the preceding sections is to allow the animal to achieve homoeostasis throughout the body. At its simplest, all cells need to maintain the ratio of ATP to ADP and AMP at an appropriate level. Relative concentrations of these adenosine nucleotides are linked by the adenylate kinase reaction ( $ATP + AMP = 2 ADP$ ). Several formulae have been proposed to describe the 'energy state' of a cell (Vernon and Peaker, 1983); these include the 'energy charge':

$$0.5 \times ([ADP] + 2[ATP]) / ([AMP] + [ADP] + [ATP])$$

If all were ATP, then the 'energy charge' would be 1.0. In actual fact the ratio is normally about 0.85 and is remarkably constant. Another concept is based on the reaction  $ATP + H_2O = ADP + P_i$ , and is termed 'phosphorylation potential':

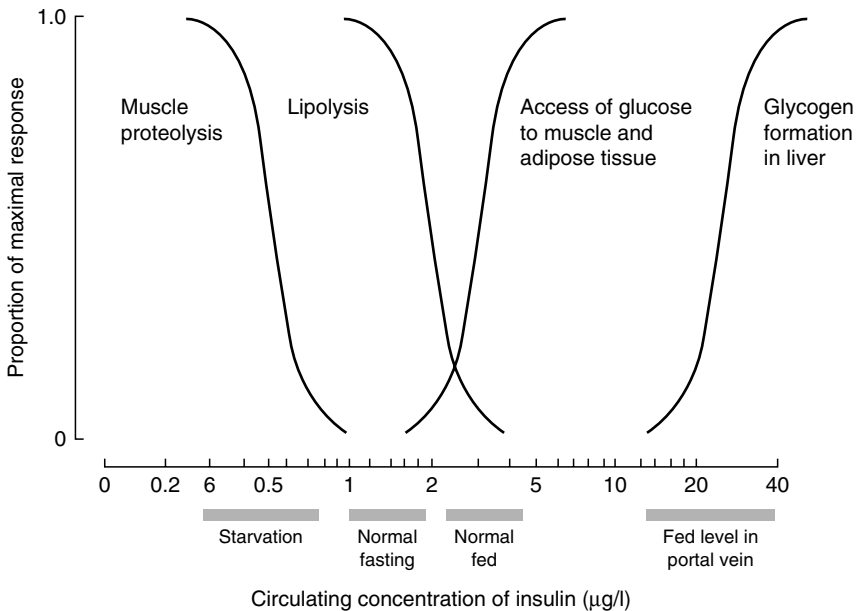
$$[ATP] / ([ADP] \times [P_i])$$

That is in essence an index of how far the reaction is from equilibrium; the greater the phosphorylation potential, the more energized the cell. Values vary more than the 'energy charge' normally ranging from about 200 to 800 when expressed in molar terms. Both equations have their limitations, but the key point is that cells need to maintain most of their small, but rapidly turning over, pools of adenosine nucleotides as ATP.

When nutrient supply is adequate or in excess of basic needs, maintaining homoeostasis involves the appropriate distribution of nutrients to all the cells of

the body. Excess nutrients can be used for productive processes or stored in reserves (see below); some may be dissipated as heat. When nutrient supply is inadequate, a coordinated series of changes then takes place to minimize energy expenditure and to release nutrients from reserves (Shetty, 1990). Key factors include a fall in serum insulin, leptin, IGF-1, thyroid hormones and a decrease in sympathetic nervous activity; the latter two result in a reduction in basal metabolic rate (Shetty, 1990; Ahima, 2000). The fall in serum insulin results in: (i) a reduction in anabolic processes (e.g. protein, glycogen, triacylglycerol synthesis); (ii) increased release of reserves of glucose (from glycogen) and fatty acids (from triacylglycerol) and during starvation; and (iii) increased proteolysis in muscle (Shetty, 1990). Furthermore, the fall in insulin results in partitioning of glucose, for example, away from use by muscle and adipose tissue while allowing continuing use by tissues such as brain. Interestingly, the sensitivity of these various processes to insulin varies (Fig. 17.8); the fall in serum insulin found on going from the fed to the fasted state (less than 24-h food deprivation) will decrease glucose utilization by adipose tissue and muscle and increase lipolysis in adipose tissue, but lower concentrations such as found during starvation are required to induce muscle proteolysis (Parsons, 1976).

Leptin is a recently discovered peptide hormone secreted primarily by adipocytes (Zhang *et al.*, 1994). It acts on the hypothalamus to both inhibit food intake and increase energy expenditure, thus acting as a potential adipostat (Ahima and Flier, 2000; Vernon *et al.*, 2001). It is also thought to have a key role in the adaptations to fasting (Ahima, 2000). Fasting alters the



**Fig. 17.8.** Sensitivity of different metabolic processes to insulin (adapted from Parsons, 1976).

secretion of pituitary hormones, including thyrotropin, gonadotropins, adrenocorticotropins, and leptin treatment at least partly prevents these changes (Ahima, 2000). Leptin secretion is stimulated by insulin (Ahima and Flier, 2000; Vernon *et al.*, 2001). Thus the fall in serum insulin during periods of negative energy balance, via resultant falls in leptin and thyrotropin, will lead to a decrease in basal metabolic rate, further emphasizing the critical, central role of insulin in the regulation of energy metabolism.

### **Homoeorrhesis**

Homoeostasis is concerned with maintaining stability, but this operates against a background of change as animals develop and move from one physiological or nutritional state, or indeed pathological state, to another. Such changes in state alter the nutrient needs of different tissues and hence require changes in the way nutrients are partitioned throughout the body. This led to the concept of homoeorrhesis, a term first used by Waddington in 1957, and then re-coined by Bauman and Currie in 1980; the latter defined homoeorrhesis as 'the orchestrated or coordinated change in metabolism of the body tissue necessary to support a physiological state' (Bauman, 2000).

The coordinated adaptations to inadequate nutrition and stress noted above are of course examples of homoeorrhesis. The more general need is to ensure that nutrients in excess of those needed for survival are directed to appropriate tissues in appropriate amounts for that particular state. This is also important from a production point of view. Thus in the growing animal, for example, nutrients should be used preferentially for muscle growth rather than accrued as adipose tissue; during pregnancy and lactation, nutrients are directed to the uterus and its contents and to the mammary gland, respectively, rather than adipose tissue. It is of course much more complex than this; in the growing animal, all organs and tissues will increase in size, but at different rates depending on the stage of development. During lactation, the exceptional demand of the mammary gland requires not only a partitioning of energy away from adipose tissue, but also a host of other changes (e.g. Table 17.4) to ensure sufficient supplies of amino acids, glucose, calcium, etc. for use by the gland.

Lactation also supplies some excellent quantitative examples of homoeorrhesis in ruminants. For example, the study by Bergman and Hogue (1967) showed that in sheep, lactation increased glucose turnover 2.4-fold (and hence production, by liver and kidney as virtually none comes from the diet). At 2.5 weeks of lactation 64% of glucose utilized was secreted in milk as lactose and 23% was oxidized to CO<sub>2</sub>. The amount of glucose unaccounted for by CO<sub>2</sub> and lactose secretion, which is used for other purposes, including for example synthesis of the glycerol moiety of milk fat triacylglycerols, was only 0.07 g/h/kg body weight<sup>0.75</sup>, compared to 0.15 g/h/kg body weight<sup>0.75</sup> in non-lactating sheep. That is, the additional glucose required by the mammary gland was produced by increased gluconeogenesis in liver and

**Table 17.4.** Some adaptations to lactation in various tissues.

Tissue	Weight	Blood flow	Activity
Mammary gland	Increased	Increased	Uptake of glucose, acetate, ketones, amino acids, VLDL-TG fatty acids, Ca <sup>2+</sup> and Pi, increased. Synthesis and secretion of protein, lipid and lactose increased. Secretion of Ca <sup>2+</sup> and Pi increased
Gastrointestinal tract	Increased	Increased	Absorptive capacity increased
Liver	Increased	Increased	Uptake of propionate, lactate, fatty acids, glycerol, amino acids increased. Synthesis and output of glucose and ketones increased; output of VLDL-TG unchanged
Heart	Increased (?)	Increased	Cardiac output increased
Adipose tissue	Decreased	?	Uptake of acetate, glucose and VLDL-TG fatty acid decreased. Synthesis of lipid decreased. Output of fatty acids and glycerol increased
Skeletal muscle	Decreased	Unchanged	Uptake of glucose and acetate may decrease; uptake of fatty acids increased. Output of lactate, amino acids increased. Protein synthesis decreased; proteolysis increased
Bone	Decreased	?	Uptake and accretion of Ca <sup>2+</sup> and Pi decreased; resorption and output of Ca <sup>2+</sup> and Pi increased

VLDL-TG, very low-density lipoproteins triacylglycerol; Pi, phosphate.

kidney and by a reduction in glucose utilization by processes other than oxidation to CO<sub>2</sub> by various non-mammary tissues of the body.

Fatty acid synthesis provides another well-studied example. The estimated rate of fatty acid synthesis of adipose tissue per sheep in non-lactating animals is about half that of the mammary gland in lactating sheep (Table 17.5). However, during lactation the rate falls by over 90% in adipose tissue, hence lipogenic precursors will be preferentially used by the mammary gland. There are similar homoeorrhetic adaptations in cattle (Vernon, 1996b). Changes in fatty acid synthesis in the two tissues are paralleled, qualitatively, by reciprocal changes in the amount of mRNA, total enzyme activity (Table 17.5) and activation status of ACC- $\alpha$  in adipose tissue and mammary gland (Travers *et al.*, 1997). The proportionately greater changes in lipogenic flux than in ACC activity are due to changes in the activation state of the latter (Travers *et al.*, 1997). Interestingly there are differential changes in ACC- $\alpha$  expression via the three promoters in the two tissues with lactation. In adipose tissue, expression via PI and PII is reduced to 11% and 43%, respectively, of that seen in non-lactating sheep. By contrast, in the mammary gland there is a 15-fold increase in expression via the PIII promoter (yielding a different isoform of the enzyme) and only a threefold increase in expression via the ubiquitous PII promoter (Travers and Barber, 2001). A different strategy is employed for

**Table 17.5.** Homoeorrhetic changes in fatty acid synthesis and acetyl-CoA carboxylase in sheep adipose tissue and mammary gland during lactation (data from Bauman *et al.*, 1974; Vernon *et al.*, 1987; Barber *et al.*, 1997).

	Non-lactating		Lactating	
	Adipose tissue	Mammary gland	Adipose tissue	Mammary gland
Tissue weight (kg)	14.0	0.05	8.4	1.5
Fatty acid synthesis (mmol acetate incorporated per h)	33.0	0.01	0.25	65.0
Acetyl-CoA carboxylase (mmol/h)	40.0	0.03	2.0	50.0

glycerol-3-phosphate acyltransferase, a key enzyme of fatty acid esterification. For this enzyme total adipose tissue activity falls from 60 to 23  $\mu\text{mol}/\text{min}$  per sheep with lactation, whereas mammary activity is increased to 990  $\mu\text{mol}/\text{min}$  per sheep (Vernon *et al.*, 1987). In this case the homoeorrhetic change in adipose tissue is not so important. Thus various homoeorrhetic strategies are used to ensure the preferential use of nutrients by the mammary gland.

Homoeorrhetic changes are not achieved just by tissue-specific changes in activities of important metabolic enzymes. In addition, there are also tissue-specific changes in response and sensitivity to hormones and other regulatory factors such as insulin, catecholamines and adenosine. For example, the ability of insulin to increase glucose uptake by the hind limb was decreased by lactation in sheep (Fig. 17.5); this is likely to contribute to the decreased use of glucose for processes other than oxidation to  $\text{CO}_2$  and lactose found by Bergman and Hogue (1967). While the mechanism of this diminished response of muscle to insulin is not resolved, it is known from studies in non-ruminants that lipid accumulation in muscle cells leads to insulin resistance (Shulman, 2000) and increased lipid has been found in sheep muscle during lactation, possibly as a result of the hypoleptinaemia (Vernon, 2003). Adipocytes also become less responsive to insulin during lactation (Vernon, 1996b). The molecular mechanism is not known; there does not appear to be a change in amount or activity of early steps in the insulin-signalling pathway, including activation of protein kinase B, but there does appear to be a decrease in amount of protein kinase C zeta (Fig. 17.3) (Vernon and Finley, 1999). Not only do some tissues become less responsive to insulin during lactation but, in cattle at least, the pancreatic islets become less responsive to insulinotropic agents, contributing to the hypoinsulinaemia of early lactation (Lomax *et al.*, 1979).

In contrast to the response to insulin, the response of adipocytes to catecholamines is enhanced by lactation in cattle and sheep, in part due to an increased number of  $\beta$ -adrenergic receptors of adipocytes (Vernon, 1996a). Paradoxically, however, there is also an increased response of adipocytes to the antilipolytic effect of adenosine (Vernon, 1996a). The latter is unexpected as sheep and cattle are usually in negative energy balance during early lactation and so are actively mobilizing adipose tissue lipid.

The factors responsible for these chronic, homoeorrhetic adaptations to lactation have not been identified but growth hormone and glucocorticoids are probably involved, especially with respect to the increased response of adipocytes to catecholamines (Vernon, 1996a). Glucocorticoids, but not growth hormone, could also be responsible for the increased response of adipocytes to adenosine (Vernon, 1996a). Growth hormone is probably at least partly responsible for the decreased fatty acid synthesis of adipocytes during lactation but it is not clear whether growth hormone is responsible for the diminished response of adipocytes to insulin (Bauman and Vernon, 1993; Etherton and Bauman, 1998). Growth hormone prevents a sustained activation of protein kinase B by insulin, whereas activation of this kinase by insulin does not appear to be impaired by lactation (Vernon and Finley, 1999).

The onset of lactation is associated with a three- to fourfold increase in blood flow per g tissue in the mammary gland in goats (Linzell, 1974) and mammary gland weight increases by 30-fold or more in ruminants (comparing peak lactation with non-lactating, non-pregnant size) (Table 17.5). The overall effect is that the proportion of cardiac output going to the gland increases from a negligible amount to 10–20% of total. In addition, a highly significant correlation between mammary blood flow and milk yield has been demonstrated (Linzell, 1974). Such changes suggest that altering blood flow, and hence nutrient supply, could be an important homoeorrhetic mechanism. This raises the question of whether blood flow determines or responds to metabolic activity. One situation where blood flow has a critical partitioning effect is during exercise/response to stress when changes in blood flow, due primarily to release of adrenalin from the adrenal gland, results in a preferential use of nutrients by skeletal muscle (Bell *et al.*, 1983).

### ***Competition or coordination***

More than 50 years ago Hammond (1944) proposed that tissues compete for nutrients and suggested that during lactation the high metabolic activity of the mammary gland allows it to compete very successfully. The concept of homoeorrhesis, on the other hand, emphasizes coordination, with a change in physiological state resulting in a series of changes, sometimes reciprocal, in functions in a number of organs to meet the needs of the new state (Bauman, 2000). It is arguable that both are right. For example, all cells of the body have access to the blood glucose pool and during the course of the day all cells will remove some molecules of glucose from the pool. The cellular fate of a particular molecule of glucose is not predetermined – it could be used by any cell, and in this respect, cells are all in competition with each other, both within a tissue and between tissues. What homoeorrhetic mechanisms do is alter the probability of a specific molecule being used by a particular cell. Thus, for example, from the data of Table 17.5 it can be calculated that in the non-lactating sheep the chance of a molecule of acetate being used for fatty acid synthesis by adipose tissue rather than the mammary gland is about 3000:1. However, at peak lactation this has reversed to about 250:1 in favour of the



mammary gland, due to reciprocal changes in the rate of fatty acid synthesis in the two tissues and an increase in size of the mammary gland. The greater blood flow to the mammary gland (Table 17.2) should increase even further the chance of a molecule of acetate being used by the mammary gland rather than adipose tissue. Thus, it is not really a case of 'competition' or 'coordination', but that animals, by their homeosthetic adaptations, manipulate the probability of a nutrient molecule being used by a particular cell to meet the needs of the current physiological state.

## Supply and Demand

Studies with microorganisms have shown that demand for product is a key determinant of metabolic flux (Hofmeyr and Cornish-Bowden, 2000; Oliver, 2002). For example, increasing the expression of specific glycolytic enzyme genes had little impact on the rate of glycolysis in microorganisms, but when a constitutively active ATPase was overexpressed, the glycolytic rate was markedly increased, suggesting that it is demand for ATP which determines glycolytic flux, rather than the ability to synthesize ATP (Oliver, 2002).

Mammals have more complex requirements than microorganisms, but again demand for the product is a critical determinant of flux through a metabolic pathway. This of course is the reason for feedback inhibition, often ignored when considering how a pathway is regulated. The importance of demand is diminished if there is a sink for the product. Cells can secrete a product, but this merely moves the problem elsewhere – a substance secreted into the blood is a stage in a pathway and not an end-product, unless it is then excreted. Milk production provides a considerable sink; however, this is normally constrained by the demands of the young. This is easily shown for species with multiple young, when varying the number of young alters the rate of milk production (Vernon *et al.*, 2002). Again there is an apparent feedback mechanism via the production of an inhibitor of milk secretion and hence production on milk accumulation in the gland (Peaker and Wilde, 1996). Machine milking creates, potentially, an insatiable demand. Increasing milking frequency increases milk production but eventually nutrient supply or mammary capacity becomes limiting. Thus a study with high-yielding cows, in which milk production was increased to very high levels by four times daily milking plus treatment with bST, showed that when milking was reduced to once daily for one-half of the udder, milk production was increased in the other half of the udder, which continued to be milked four times daily (Sorensen and Knight, 1999). In this case nutrient supply rather than mammary capacity was the constraint on yield.

A sink can also be created by storage of product. Some glucose can be stored as glycogen, especially in liver and skeletal muscle, but the capacity for glycogen storage is quite limited (about 5% of liver weight and less in muscle). The constraint on amount may well be physical as stored glycogen is hydrated and comprises about 75% water; hence 5% glycogen would in fact represent about 20% of the weight of an hepatocyte.

By contrast to glycogen, animals appear to have an almost unlimited capacity to store triacylglycerol in adipose tissue – at least this appears to be the case in humans, where in some individuals it can exceed 80% of body weight. Triacylglycerol is hydrophobic, hence contains virtually no water when stored. All vertebrates have to meet their needs (maintaining homeostasis, etc.) against a background of varying food availability, hence the requirement to store some nutrients during periods of surplus for use when supply is inadequate (Pond, 1992). The energy requirements of poikilotherms are relatively low compared to homeotherms, especially when ambient temperatures are low (Sheridan, 1994). Fish store lipid in liver and muscle, which is sufficient to meet their needs (Sheridan, 1994). However, reptiles have mesenteric adipose tissue (Pond, 1992), which is arguably an extension of the liver for fatty acids released pass into the portal blood and hence go through the liver before entering the general circulation. Homeotherms require mechanisms for the active generation of heat, thus markedly increasing the energy requirements of mammals and birds compared to poikilotherms; a consequence of this is a need for greater stores of energy (Pond, 1992). Thus mammals have multiple adipose tissue depots distributed throughout the body, some in the abdominal cavity, some under the skin and within the musculature (both inter- and intramuscular) (Pond, 1986). This distribution is present in marsupials and has been retained, with occasional modification, in eutherian mammals (Pond, 1986). While adipocytes are large cells, and vary markedly in size as fat is accreted or mobilized, they do have a maximum size (about 3 nl in cattle) (Vernon and Houseknecht, 2000). As adipocytes get large, this appears to induce the production of new adipocytes from precursor cells within the tissue (Faust *et al.*, 1978). Thus the capacity for storing fat is considerable, but in reality there are important constraints. While a large amount of adipose tissue provides a buffer against starvation, it can render an animal much more susceptible to predation. Thus, animals normally adjust the size of their adipose tissue reserves depending on whether starvation or predation is the greater threat to survival (Vernon and Houseknecht, 2000). So, while adipose tissue is potentially a vast sink for excess nutrients, the size of this reserve has to be carefully controlled, at least in the wild. Hence antelope on the plains of Africa, where predation is a greater threat than starvation, have very limited reserves of adipose tissue, but, by contrast, prior to an Arctic winter, reindeer accumulate substantial amounts of adipose tissue (Vernon and Houseknecht, 2000) as for them starvation is the greater threat to survival. Sheep also show seasonal cycles of adipose tissue accretion and loss if fed *ad libitum* (Vernon *et al.*, 1986). Thus, while adipose tissue can respond to ‘supply’ by depositing excess nutrient as fat, there are clearly signals which put constraints on this. In essence adipose tissue is under a form of autonomic control, secreting peptide hormones (adipocytokines), at a rate varying with the degree of adiposity, which modulate both nutrient supply and adipose tissue metabolism (Vernon, 2003). As mentioned above, leptin acts on hypothalamic neurones to limit appetite and increase energy expenditure, and so is, in theory at least, a feedback inhibitor of adipocyte size (Ahima and Flier, 2000; Vernon, 2003). Other factors such as tumour necrosis factor  $\alpha$  and resistin act locally as insulin

antagonists and also promote lipolysis (Vernon, 2003). Such factors should limit the rate of lipid accretion in adipocytes, but while these, and probably other mechanisms, are effective in the wild, it is painfully apparent in humans at least that such mechanisms do not necessarily protect from the accumulation of excess adipose tissue lipid.

The liver is also an important tissue from the point of view of supply and demand due to its role as a modulator of blood composition. Thus the liver responds to nutrient supply and may take up nutrients in excess of the actual needs, processing and eventually secreting the surplus nutrients. For example, in species in which blood glucose increases substantially following a meal, glucose is accumulated in the liver as glycogen for release as glucose in the subsequent postprandial period. To facilitate this, the liver has a bidirectional glucose transporter (Glut-2) and a hexokinase (glucokinase) with a  $K_m$  for glucose of about 20 mM, so flux through this reaction varies with plasma concentration as it changes following a meal (Bollen *et al.*, 1998). Interestingly, hepatic glucose metabolism is modulated by adipose tissue as it secretes adiponectin, a peptide hormone, which modulates hepatic sensitivity to insulin (Vernon, 2003). The liver also takes up fatty acids and again uptake and metabolism vary with plasma concentration (Zammit, 1990; Drackley *et al.*, 2001). The liver either oxidizes these fatty acids or uses them for the synthesis of lipid. Some fatty acids will be oxidized to provide ATP for use in the liver, but some oxidation products are released into the circulation as ketones (acetoacetate and  $\beta$ -hydroxybutyrate) to be used by other tissues (Zammit, 1990; Drackley *et al.*, 2001). The liver (e.g. for membrane turnover) uses some lipids produced by esterification but most are secreted as lipoproteins, transporting lipids, including triacylglycerols, to other tissues. Problems with the functioning of this system can occur during periods of sustained high rates of lipolysis (for example during early lactation) when the supply of fatty acids to the liver exceeds the capacity of the tissue to process and release them (Zammit, 1990; Drackley *et al.*, 2001). Curiously, in ruminants the capacity of the liver to secrete triacylglycerols as very low-density lipoproteins is quite limited; a consequence of this is that when supply of fatty acids is substantial, some triacylglycerols are retained within the hepatocyte (Zammit, 1990; Drackley *et al.*, 2001). If the high rate of fatty acid supply is not sustained these stored triacylglycerols will be eventually secreted, but when high rates of fatty acid supply are sustained, as can happen during early lactation, excess triacylglycerols can accumulate in the liver leading to 'fatty liver disease' and subsequently ketosis.

## Conclusions

Ruminants are no different from other mammals in having to rise to the challenge of meeting the nutrient demands of tissues against a background of variable supply. For much of the time this problem is tempered in ruminants by their eating behaviour, the nature of the diet and the digestive processes, which ensure a more continuous absorption of nutrients than in meal-eating species.

Nevertheless, supply does not always equal demand, even in domestic species (e.g. during early lactation). Under such circumstances demand is diminished where possible by decreasing basal metabolic rate and anabolic processes and, in addition, animals draw on reserves of nutrients.

When nutrient supply exceeds needs some of the excess is stored in reserves but some is also dissipated as heat. For some nutrients (e.g. calcium, protein) there are no specialized reserves but animals can avail themselves to some extent of such nutrients contained in structural tissues (bone, muscle). For energy there is a specialized reserve, adipose tissue, the size of which has to be carefully regulated depending on the needs of the animal, including whether starvation or predation is a greater threat.

Adjusting supply and demand does not just concern quantities of nutrient, it is also concerned with quality, the liver having a key role in this respect. Whereas most tissues are concerned with meeting their own demands, the liver is equally concerned with supply; this can in certain circumstances lead to a failure of control when supply exceeds the ability of the tissue to handle the nutrient influx.

The objectives of metabolic control are thus meeting these multiple challenges. A plethora of mechanisms and signals operate within the cell, within the tissue and within the body which coordinate the fate of nutrients, both in the short-term, meeting homeostatic demands, and in the longer term via homeorrhetic mechanisms. While the basic metabolic pathways and their key regulatory steps are known, more is still to be learnt about the intracellular organization of such pathways. By contrast to the metabolic pathways, new regulatory factors continue to be discovered and the signal transduction pathways, and their intracellular organization, which transmit signals to the metabolic pathways, are still largely unresolved even for very important hormones like insulin and growth hormone. Furthermore, it appears that hormones do not activate simple linear signalling pathways, rather many hormones and regulatory factors activate signalling networks, often with common components, raising questions of how specificity of signalling is achieved. As these various networks and control processes are unravelled, describing them in quantitative terms will present a major challenge for future modellers!

## References

- Ahima, R.S. (2000) Leptin and the neuroendocrinology of fasting. *Frontiers in Hormone Research* 26, 42–56.
- Ahima, R.S. and Flier, J.S. (2000) Leptin. *Annual Review of Physiology* 62, 413–417.
- Barber, M.C., Clegg, R.A., Travers, M.T. and Vernon, R.G. (1997) Lipid metabolism in the lactating mammary gland. *Biochimica et Biophysica Acta* 1347, 101–126.
- Barnes, R.J., Comline, R.S. and Dobson, A. (1983) Changes in the blood flow to the digestive organs of sheep induced by feeding. *Quarterly Journal of Experimental Physiology* 68, 77–88.
- Bauman, D.E. (2000) Regulation of nutrient partitioning during lactation: homeostasis and homeorhesis revisited. In: Cronje, P. (ed.) *Ruminant Physiology: Digestion,*

- Metabolism, Growth and Reproduction*. CAB International, Wallingford, UK, pp. 311–328.
- Bauman, D.E. and Vernon, R.G. (1993) Effects of exogenous bovine somatotropin on lactation. *Annual Review of Nutrition* 13, 437–461.
- Bauman, D.E., Mellenberger, R.W. and Ingle, D.L. (1974) Metabolic adaptations in fatty acid and lactose biosynthesis by sheep mammary tissue during cessation of lactation. *Journal of Dairy Science* 57, 719–723.
- Bell, A.W. (1980) Lipid metabolism in liver and selected tissues and in whole body of ruminant animals. *Progress in Lipid Research* 18, 117–164.
- Bell, A.W., Hales, J.R.S., King, R.B. and Fawcett, A.A. (1983) Influence of heat stress on exercise-induced changes in regional blood flow in sheep. *Journal of Applied Physiology* 55, 1916–1923.
- Bergman, E.N. and Hogue, D.E. (1967) Glucose turnover and oxidation rates in lactating sheep. *American Journal of Physiology* 213, 1378–1384.
- Bollen, M., Keppens, S. and Stalmans, W. (1998) Specific features of glycogen metabolism in the liver. *Biochemical Journal* 336, 19–31.
- Brown, G.C. (1994) Control analysis applied to the whole body: control by body organs over plasma concentrations and organ fluxes of substances in the blood. *Biochemical Journal* 297, 115–122.
- Carpene, C., Bousquet-Melou, A., Galitzky, J., Berlan, M. and Lafontan, M. (1998) Lipolytic effects of  $\beta$  1-,  $\beta$  2-, and  $\beta$  3-adrenergic agonists in white adipose tissue of mammals. *Annals of the New York Academy of Science* 839, 186–189.
- Cianflone, K. (1997) Acylation stimulating protein and the adipocyte. *Journal of Endocrinology* 155, 203–206.
- Crabtree, B. (1993) Metabolic regulation. In: Forbes, J.M. and France, J. (eds) *Quantitative Aspects of Ruminant Digestion and Metabolism*. CAB International, Wallingford, UK, pp. 222–248.
- Crandall, D.L., Hausman, G.J. and Kral, J.G. (1997) A review of the microcirculation of adipose tissue: anatomic, metabolic and angiogenic perspectives. *Microcirculation* 4, 211–232.
- Doris, R., Thompson, G.E., Finley, E., Kilgour, E., Houslay, M.D. and Vernon, R.G. (1996) Chronic effects of somatotropin treatment on response of subcutaneous adipose tissue lipolysis to acutely acting factors *in vivo* and *in vitro*. *Journal of Animal Science* 74, 562–568.
- Drackley, J.K., Overton, T.R. and Douglas, G.N. (2001) Adaptations of glucose and long-chain fatty acid metabolism in liver of dairy cows during the periparturient period. *Journal of Dairy Science* 84, E100–E112.
- Dumont, J.E., Dremier, S., Pirson, I. and Maenhaut, C. (2002) Cross signaling, cell specificity, and physiology. *American Journal of Physiology* 283, C2–C28.
- Etherton, T.E. and Bauman, D.E. (1998) Biology of somatotropin in growth and lactation of domestic animals. *Physiological Reviews* 78, 745–761.
- Faust, I.M., Johnson, P.R., Stern, J.S. and Hirsh, J. (1978) Diet-induced adipocyte number increase in adult rats: a new model of obesity. *American Journal of Physiology* 235, E279–E286.
- Gregory, N.G. and Christopherson, R.J. (1986) Effect of fasting on capillary blood flow in sheep. *Research in Veterinary Science* 40, 357–360.
- Hales, J.R.S. (1973) Radioactive microsphere measurement of cardiac output and regional tissue blood flow in the sheep. *Pflügers Archive* 344, 119–132.
- Hammond, J. (1944) Physiological factors affecting birth weight. *Proceedings of the Nutrition Society* 2, 8–12.

- Herrington, J. and Carter-Su, C. (2001) Signalling pathways activated by growth hormone. *Trends in Endocrinology and Metabolism* 12, 252–257.
- Hocquette, J.F., Balage, M. and Ferre, P. (1996) Facilitative glucose transporters in ruminants. *Proceedings of the Nutrition Society* 55, 221–236.
- Hofmeyer, J.-H.S. and Cornish-Bowden, A. (2000) Regulating the cellular economy of supply and demand. *FEBS Letters* 476, 47–51.
- Jacobi, S.K. and Miner, J.L. (2002) Human acylation-stimulating protein and lipid biosynthesis in bovine adipose tissue explants. *Journal of Animal Science* 80, 751–756.
- Kacser, H., Burns, J.A. and Fell, D.A. (1995) The control of flux: 21 years on. *Biochemical Society Transactions* 23, 341–366.
- Linzell, J.L. (1974) Mammary blood flow and methods of identifying and measuring precursors of milk. In: Larson, B.L. and Smith, V.R. (eds) *Lactation: a Comprehensive Treatise*, Vol. 1. Academic Press, New York, pp. 143–225.
- Litherland, G.J., Hajdich, E. and Hundal, H.S. (2001) Intracellular signalling mechanisms regulating glucose transport in insulin-sensitive tissues. *Molecular Membrane Biology* 18, 195–204.
- Lomax, M.A., Baird, G.D., Mallinson, C.B. and Symonds, H.W. (1979) Differences between lactating and non-lactating dairy cows in concentration and secretion rate of insulin. *Biochemical Journal* 180, 281–289.
- Londos, C., Brassaele, D.L., Schultz, C.J., Adler-Wailes, D.C., Levin, D.M., Kimmel, A.R. and Rondinone, C.M. (1999) On the control of lipolysis in adipocytes. *Annals of the New York Academy of Science* 892, 155–168.
- Manning, D.R. and Woolkalis, M.J. (1994) G Protein function and diversity: regulation of cAMP as a model system. In: Anas, I.M., Boyer, J.L., Fausto, N., Jakoby, W.B., Schachter, D.A. and Shafritz, D.A. (eds) *The Liver: Biology and Pathobiology*. Raven Press, New York, pp. 919–931.
- Mendelson, C.R. and Scow, R.O. (1972) Uptake of chylomicron-triglyceride by perfused mammary tissue of lactating rats. *American Journal of Physiology* 223, 1418–1423.
- Mueckler, M. (1994) Facilitative glucose transporters. *European Journal of Biochemistry* 219, 713–725.
- Oliver, S. (2002) Demand management in cells. *Nature* 418, 33–34.
- Parsons, J.A. (1976) Endocrine pharmacology. In: Parsons, J.A. (ed.) *Peptide Hormones*. Macmillan Press, London, pp. 67–82.
- Peaker, M. and Wilde, C.J. (1996) Feedback control of milk secretion from milk. *Journal of Mammary Gland Biology and Neoplasia* 1, 307–315.
- Pessin, J.E. and Saltiel, A.R. (2000) Signaling pathways in insulin action: molecular targets of insulin resistance. *Journal of Clinical Investigation* 106, 165–169.
- Pond, C.M. (1986) The natural history of adipocytes. *Science Progress (Oxford)* 70, 45–71.
- Pond, C.M. (1992) An evolutionary and functional view of mammalian adipose tissue. *Proceedings of the Nutrition Society* 51, 367–377.
- Richelsen, B. (1992) Release and effects of prostaglandins in adipose tissue. *Prostaglandins, Leukotrienes and Essential Fatty Acids* 47, 171–182.
- Rolfe, D.F.S. and Brown, G.C. (1997) Cellular energy utilization and molecular origin of standard metabolic rate in mammals. *Physiological Reviews* 77, 731–758.
- She, P., Hippen, A.R., Young, J.W., Lindburgh, G.L., Beitz, D.C., Richardson, L.F. and Tucker, R.W. (1999) Metabolic responses of lactating dairy cows to 14-day intravenous infusion of glucagon. *Journal of Dairy Science* 82, 1118–1127.

- Sheridan, M.A. (1994) Regulation of lipid metabolism in poikilothermic vertebrates. *Comparative Biochemistry and Physiology* 107B, 495–508.
- Shetty, P.S. (1990) Physiological mechanisms in the adaptive response of metabolic rates to energy restriction. *Nutrition Research Reviews* 3, 49–74.
- Shulman, G.I. (2000) Cellular mechanisms of insulin resistance. *Journal of Clinical Investigations* 106, 171–176.
- Simonds, W.F. (1999) G Protein regulation of adenylate cyclase. *Trends in Physiological Sciences* 20, 66–73.
- Sorensen, A. and Knight, C.H. (1999) Localisation of metabolic restriction point in cows of differing genetic merit. *British Society of Animal Production Occasional Publication* 24, 183–187.
- Travers, M.T. and Barber, M.C. (2001) Acetyl-CoA carboxylase- $\alpha$ : gene structure-function relationships. *Journal of Animal Science* 79, E136–E143.
- Travers, M.T., Vernon, R.G. and Barber, M.C. (1997) Repression of the acetyl-CoA carboxylase gene in ovine adipose tissue during lactation: the role of insulin responsiveness. *Journal of Molecular Endocrinology* 19, 99–107.
- Vernon, R.G. (1996a) Control of lipid mobilisation in ruminant adipose tissue. *Journal of Reproduction and Development* 42, 118–122.
- Vernon, R.G. (1996b) Signal transduction and lipid metabolism during lactation. In: Muramatsu, T. (ed.) *Gene Expression and Nutrition in Animals: From Cell to Whole Body*. Research Signpost, Trivandrum, India, pp. 137–150.
- Vernon, R.G. (2003) Adipose tissue: an expanding role in the regulation of energy metabolism. In: Souffrant, W.B. and Metges, C.C. (eds) *Progress in Research on Energy and Protein Metabolism*. Wageningen Academic Publishers, Wageningen, The Netherlands, pp. 451–464.
- Vernon, R.G. and Clegg, R.A. (1985) The metabolism of white adipose tissue *in vivo* and *in vitro*. In: Cryer, A. and Van, R.L.R. (eds) *New Perspectives in Adipose Tissue*. Butterworths, London, pp. 65–86.
- Vernon, R.G. and Finley, E. (1999) Insulin signalling in adipocytes of lactating sheep. *South African Journal of Animal Science* 29, 227–228.
- Vernon, R.G. and Houseknecht, K.L. (2000) Adipose tissue: beyond an energy reserve. In: Cronje, P. (ed.) *Ruminant Physiology: Digestion, Metabolism, Growth and Reproduction*. CAB International, Wallingford, UK, pp. 171–186.
- Vernon, R.G. and Peaker, M. (1983) The regulation of nutrient utilisation: basic principles and mechanisms. In: Rook, J.A.F. and Thomas, P.C. (eds) *The Nutritional Physiology of Farm Animals*. Longmans, London, pp. 41–113.
- Vernon, R.G., Clegg, R.A. and Flint, D.J. (1986) Adipose tissue in sheep: response to season and its modulation by reproductive state. *Hormone and Metabolic Research* 18, 308–312.
- Vernon, R.G., Faulkner, A., Finley, E., Pollock, H. and Taylor, E. (1987) Enzymes of glucose and fatty acid metabolism of liver, kidney, skeletal muscle, adipose tissue and mammary gland of lactating and non-lactating sheep. *Journal of Animal Science* 64, 1395–1411.
- Vernon, R.G., Faulkner, A., Hay, W.W. Jr, Calvert, D.T. and Flint, D.J. (1990) Insulin resistance of hind-limb tissues *in vivo* in lactating sheep. *Biochemical Journal* 270, 783–786.
- Vernon, R.G., Denis, R.G.P. and Sorensen, A. (2001) Signals of adiposity. *Domestic Animal Endocrinology* 21, 197–214.
- Vernon, R.G., Denis, R.G.P., Sorensen, A. and Williams, G. (2002) Leptin and the adaptations of lactation in rodents and ruminants. *Hormone and Metabolic Research* 34, 678–685.

- Wallberg-Henriksson, H. and Zierath, J.R. (2001) GLUT4: a key player regulating glucose homeostasis? Insight from transgenic and knockout mice. *Molecular Membrane Biology* 18, 205–211.
- Weaver, B.N.Q., Staddon, G.E. and Pearson, M.R.B. (1990) Tissue perfusion in anaesthetised sheep. *Comparative Biochemistry and Physiology* 95A, 359–361.
- Yeaman, S.J., Smith, G.M., Jepson, C.A., Wood, S.L. and Emmisoin, N. (1994) The multifunctional role of hormone sensitive lipase in lipid metabolism. *Advances in Enzyme Regulation* 34, 355–370.
- Zammit, V.A. (1990) Ketogenesis in the liver of ruminants – adaptations to a challenge. *Journal of Agricultural Science, Cambridge* 115, 155–162.
- Zammit, V.A. (1999) The malonyl CoA-long-chain acyl CoA axis in the maintenance of mammalian cell function. *Biochemical Journal* 343, 505–515.
- Zhang, Y., Proenca, R., Maffei, M., Barone, M., Leopold, L. and Friedman, J.M. (1994) Positional cloning of the mouse obese gene and its human homologue. *Nature* 372, 425–432.



---

# 18 Mineral Metabolism

E. Kebreab<sup>1</sup> and D.M.S.S. Vitti<sup>2</sup>

<sup>1</sup>Centre for Nutrition Modelling, Department of Animal & Poultry Science, University of Guelph, Guelph, Ontario, N1G 2W1, Canada; <sup>2</sup>Animal Nutrition Laboratory, Centro de Energia Nuclear na Agricultura, Caixa Postal 96, CEP 13400-970, Piracicaba, SP, Brazil

---

## Introduction

The number of mineral elements that have been shown to have essential functions in the body has been increasing steadily since the 1950s. Major or macrominerals are required in relatively larger quantities (> 50 mg/(kg DM)) and include calcium, phosphorus, potassium, sodium, sulphur, chlorine and magnesium. Trace or microminerals include iron, zinc, copper, molybdenum, selenium, iodine, manganese, cobalt, chromium, fluorine, arsenic, boron, lead, lithium, nickel, silicon, tin and vanadium. Due to lack of space, all the minerals and their quantitative aspects of metabolism cannot be discussed in detail here. As in the previous edition of the book, we chose to focus on quantitative aspects of two minerals. From the macro elements, phosphorus is taken as an example mainly because it is the element which has been a subject of much research in recent years due to concerns of overfeeding phosphorus to ruminants and the contribution to environmental pollution. The principles outlined are also applicable to other macrominerals such as calcium. A model of magnesium metabolism in sheep was developed by Robson *et al.* (1997) and modified by Bell *et al.* (2005) which followed similar principles. Symonds and Forbes (1993) took copper as an example of trace elements and discussed its metabolism. Although research in trace elements has not had the progress of the 1970s and 1980s, especially in terms of development of steady state (kinetic models) and dynamic modelling, we have updated the information on copper metabolism.

## Phosphorus

Phosphorus (P) is an essential nutrient involved not only with bone development, growth and productivity, but also with most metabolic processes of the body. Phosphorus and calcium (Ca) are the two most plentiful minerals in the

mammalian body. These elements are closely related so that deficiency or overabundance of one may interfere with the proper utilization of the other. Phosphorus constitutes 1% of the total body weight, 80% of which is found in the bones. The remaining 20% is distributed in body cells where it is involved in maintaining the structural integrity of cells and in intracellular energy and protein metabolism (McDowell, 1992). Most of the Ca in ruminants (99%) is found in the bones and teeth and the remaining 1% is distributed in various soft tissues of the body. In a 40 kg sheep there are approximately 400 g Ca and 220 g P, distributed between bones and teeth (CSIRO, 1990). Phosphorus is present in bone in the hydroxy-apatite molecule, where it occurs as tricalcium phosphate and magnesium phosphate. The Ca:P ratio in bone is almost constant at 2:1.

Adequate P nutrition is dependent upon different interrelated factors: (i) sufficient supply of the element is essential; (ii) suitable ratio of Ca:P, ideally between 2:1 and 1:1; however adequate nutrition is possible outside these limits (Thompson, 1978); and (iii) the presence of vitamin D. With sufficient vitamin D in the diet, the Ca:P ratio becomes less important (Maynard and Loosli, 1969). If P intake is marginal or inadequate a close ratio of Ca:P becomes most critical (McDowell, 1992).

### ***Types of models***

Quantitative aspects of P metabolism in ruminants have been considered using balance studies (e.g. Braithwaite, 1983), kinetic models based on experiments in which radioactive tracers were used (e.g. Vitti *et al.*, 2000), compartmental (e.g. Schneider *et al.*, 1987) and mechanistic models (Symonds and Forbes, 1993; Kebreab *et al.*, 2001, 2004). These mathematical approaches used in investigating P metabolism in ruminants can be broadly classified into empirical and mechanistic types of modelling. For example, approaches based on regression analysis (e.g. efficiencies of utilization of P as determined by Braithwaite, 1983) are empirical while mechanistic approaches are process-based such as the dynamic model presented in this chapter. Mechanistic models can be of three types depending on the solutions of the equation statements (see Dijkstra *et al.*, 2002). In steady state, Type I models obtain solutions by setting differentials to zero and manipulating to give algebraic expressions for each process (e.g. model reported by Vitti *et al.*, 2000). In non-steady state, Type II models solve rate:state equations analytically. Type III models solve complex cases of rate:state equations numerically in non-steady state (e.g. model developed in this chapter). Most models used for P analysis in ruminants are Type I and III. In the following paragraphs, examples of empirical models are discussed first, followed by kinetic models and finally the mechanistic P model of Kebreab *et al.* (2004) will be slightly modified and evaluated.

#### ***Empirical models***

Most of the models for calculating P requirements are based on a factorial approach by adding requirements for various physiological processes such as main-

tenance, growth, pregnancy and lactation. Such models compute the requirement of an animal for minerals for a predetermined level of production. Most European and American national standards for requirements of P are based on this approach. For example, in NRC (2001), absorbed P requirement for maintenance for growing animals was calculated to be 0.8 g/kg DMI (with 0.002 g/kg W allowance for urinary P) based on P balance studies. AFRC (1991) empirically calculated P requirements for growth ( $P_{\text{reqg}}$ ; g/day) in cattle as follows:

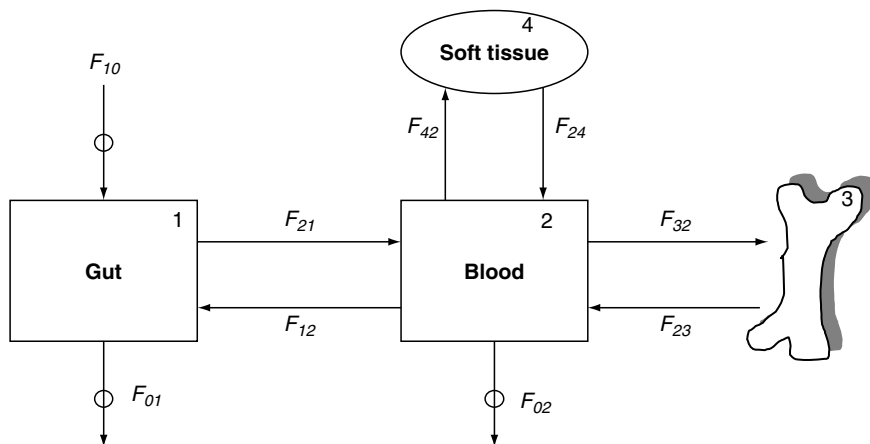
$$P_{\text{reqg}} = [1.6(-0.06 + 0.693\text{DMI}) + \text{WG}(1.2 + 4.635A^{0.22}W^{-0.22})]/0.58 \quad (18.1)$$

where DMI is dry matter intake (kg/day), WG is liveweight gain (kg/day), A is mature body weight (kg) and W is the current liveweight (kg). For a 600 kg cow producing 25 kg of milk, the recommended dietary P intake according to the German feeding standards is 61 g/day (GfE, 2001) which is slightly lower than that recommended by Kebreab *et al.* (2005a) (67 g/day) based on their experimental results.

#### *Mechanistic models*

STEADY-STATE (TYPE I) MODELS. Several approaches have been made to develop steady-state models mainly using results of experiments carried out with radioactive tracers (Schneider *et al.*, 1985, 1987; Vitti *et al.*, 2000). The models are based on the kinetics of  $^{32}\text{P}$  which is intravenously injected into the ruminant and its distribution within the body traced. Schneider *et al.* (1987) used eight compartments in the body to represent P pools in blood, soft tissues, bone, rumen, abomasum and upper small intestine, lower small intestine, caecum and colon and kidney. Analysis of  $^{32}\text{P}$  tracer data was conducted using a compartmental analysis computer program (Boston *et al.*, 1981). Schneider *et al.* (1987) reported that the main control site for P excretion was the gastrointestinal tract and model predictions were sensitive to the parameters describing absorption or salivation. In ruminants, a substantial amount of P is recycled through saliva. Salivation rate was also found to be a major controlling factor in urinary P excretion: decreasing salivation rate increased P concentrations in plasma and resulted in more P being excreted via urine.

Using data from balance and kinetic studies, a model of P metabolism in growing goats fed increasing levels of P was proposed by Vitti *et al.* (2000) (Fig. 18.1). The model has four pools (gut (1), blood (2), bone (3) and soft tissues (4)) and P enters the system via intake ( $F_{10}$ ) and exits via faeces ( $F_{01}$ ) and urine ( $F_{02}$ ). The daily intake and loss of P in faeces and urine were measured by chemical analysis. Endogenous P and P absorption were calculated from the specific activities (Vitti, 1989). The gut lumen, bone and soft tissue pools interchange bidirectionally with the blood pool, with fluxes  $F_{21}$  and  $F_{12}$ ,  $F_{23}$  and  $F_{32}$  and  $F_{24}$  and  $F_{42}$ , respectively. Labelled  $^{32}\text{P}$  was administered as a single dose,  $D$  cpm, at time zero, and the size and specific activity of the blood, bone and soft tissues pools were measured after 8 days. The scheme assumes there is no re-entry of label from external sources.



**Fig. 18.1.** Schematic representation of the model of P metabolism in goats.  $F_{ij}$  is the total flux of pool  $i$  from  $j$ ,  $F_{i0}$  is an external flux into pool  $i$  and  $F_{0j}$  a flux from pool  $j$  out of the system. Circles denote fluxes measured experimentally (Vitti *et al.*, 2000).

Vitti *et al.* (2000) postulated that with P intakes insufficient to meet maintenance requirements, the input of P to the blood pool is maintained by an increased bone P resorption and by P mobilization from soft tissues. Compared to goats fed high P diets, those on a low P diet had 74% more P mobilized from bone to blood. Despite the low P intake leading to a negative P balance, an inevitable endogenous faecal loss of P occurs. The minimum endogenous loss of P from the goats was 67 mg/day which must be absorbed to avoid being in negative balance. When P intake is increased to meet the maintenance requirements (zero P balance), the rate of absorption is increased in direct relation to P supply, so endogenous secretion in the tract is increased. The maintenance requirement of Saanen goats for P was calculated to be 610 mg/day or 55 mg/kg  $W^{0.75}$ /day. The model showed that bone resorption, faecal and endogenous P excretion and P absorption all play a part in P homeostasis in growing goats. Urinary P excretion did not significantly influence the control of P metabolism even in goats fed relatively high P level diets. At low P intakes, bone and tissue mobilization represented a vital process to maintain P levels in blood. Vitti *et al.* (2002) also adapted the model to illustrate the different processes that occur in goats fed various Ca levels and showed that Ca intake influenced absorption, retention and excretion of Ca (Vitti *et al.*, 2002). The model could be used to investigate P metabolism not only in goats but also in other ruminants as well.

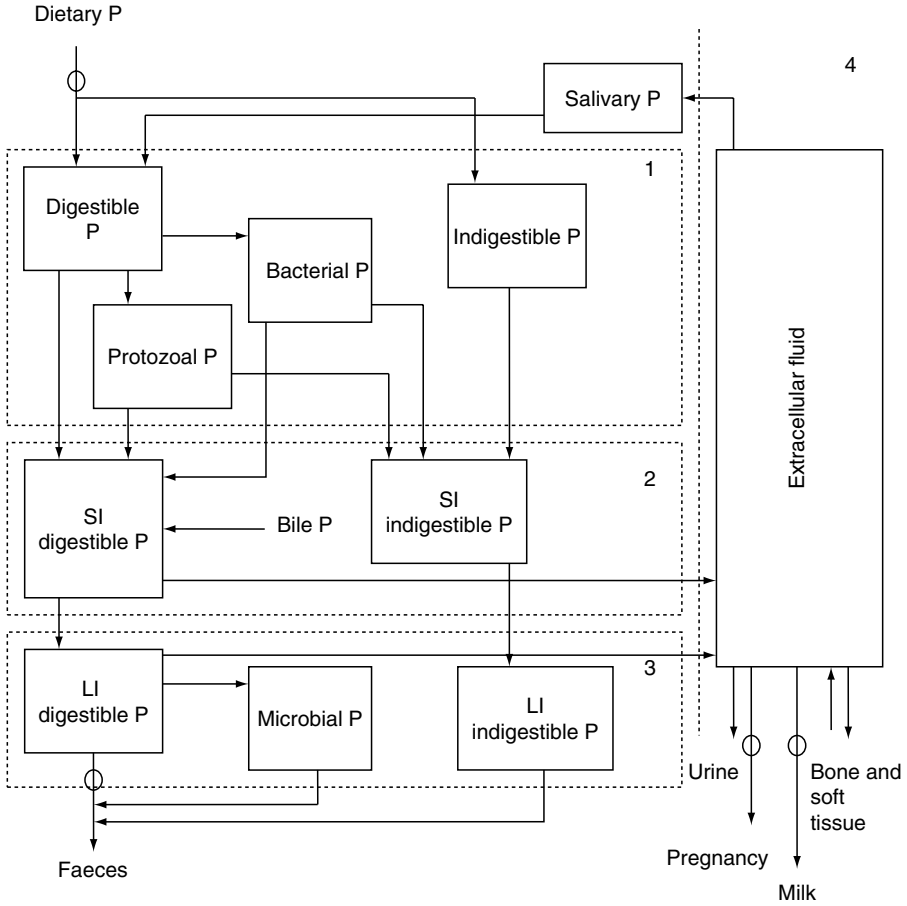
Grace (1981) used a compartmental P model to represent P flow in sheep. The model was comprised of four compartments which together represent the total exchangeable P pool ( $M_T$ ), the gut and non-exchangeable bone and soft tissues. Phosphorus flow to  $M_T$  is from the gut and in a steady state is equal to the outflow. The outflow of P from the total pool consists of the urinary P, faecal endogenous loss of P, P deposition into non-exchangeable bone and the

uptake by soft tissues. The total P inflow to the total exchangeable P pool is the sum of the P absorbed from the digestive tract and the P removed from the bone and soft tissues. P absorption from the gut is calculated as the difference between P intake and faecal P output, after correcting for the faecal endogenous P losses. Grace (1981) found that most of the P was excreted via faeces with only small amounts excreted in urine. However, as P intake increased, Grace (1981) found that proportionally more of the P lost from the body was excreted in the urine rather than returned to the digestive tract via the saliva.

**NON-STEADY-STATE (TYPE III) MODELS.** A dynamic P model of Kebreab *et al.* (2004) integrating information from various sources including the flow diagram described by Symonds and Forbes (1993) and the state variables of Vitti *et al.* (2000) is modified. The fluxes between pools and excretion parameters are estimated based on a wide range of sources. Sensitivity of selected parameter estimates were carried out and the model was then tested on independent data that were not used in the construction of the model. For clarity, the model can be seen as having four P compartments: rumen, small intestine (including duodenum), large intestine and extracellular fluid. In total, the model contains 11 state variables or pools, and arrows (Fig. 18.2) represent inputs and outputs to and from the pools. The standard cow was assumed to weigh 600 kg with a rumen volume of 90 l and non-pregnant. The input of P to the cow is via the diet and the outputs are in faeces, urine and milk.

The simulation model uses the dynamic rumen model of Dijkstra *et al.* (1992) and its subsequent modification (Dijkstra, 1994) to estimate rumen microbial synthesis and microbial outflow to the duodenum. In the rumen, two forms of P are represented based on digestibility. The digestible rumen P pool has two inputs, from the diet and saliva. P is consumed by the animal as organic (phytates, phospholipids and phosphoproteins) and inorganic P (mono-, di- and triphosphates). Soluble forms, some insoluble forms and phosphoric acid are dissolved by digestive juices in the rumen. Phytate is dissolved in the rumen by action of phytases produced by the microbes. The availability of P in the diet has been the subject of many investigations (e.g. Koddebusch and Pfeffer, 1988). 'True absorption' coefficients have been used to describe the amount of dietary P absorbed but this does not show the potentially available dietary P because true absorption coefficients decline with P intake. Wu *et al.* (2000) use 85% as the maximum amount of digestible P, which is also used here as the potentially available dietary P for microbial growth and passage to the lower tract.

Kebreab *et al.* (2005b) reported that, on average, 45% of P entering the rumen comes from saliva, as endogenous P, and plays a significant role as a buffer and is also important as a nutrient source for rumen microbes (Care, 1994). The salivation rate is based on the equation of Dijkstra *et al.* (1992) which was related to DMI and NDF content of the diet. Estimates of saliva production based on experiments of Valk (2002) were within 10% of those predicted by the equation. The concentration of P in the saliva depends on the P status of the animal and at steady state, the model calculations were influenced by P concentrations in the diet and extracellular fluid.



**Fig. 18.2.** Schematic representation of the model of P metabolism in the ruminant. The compartments were rumen (1), small intestine (2), large intestine (3) and extracellular fluid (4).

Phosphorus is an important component of the cell membrane and is essential for microbial growth. The bacterial and protozoal P pools in the rumen have an input from the digestible rumen P pool. Czerkawski (1976) estimated P contents of protozoa, large and small bacteria in the rumen to be 13.8, 13.3 and 18.8 mg/g of polysaccharide-free microbial DM, respectively. These are at the lower end of concentrations estimated by Hungate (1966) who reported that rumen microbe cells contain 20–60 mg P/g DM, and are present as nucleic acids (80%), phospholipids (10%) and other compounds. The values are closer to Durand and Kawashima’s (1980) estimate of 1.44% for an average P content of rumen bacteria. The rumen model of Dijkstra (1994) estimates protozoal and bacterial polysaccharide-free DM, therefore, P contents of 13.8 and 17.9 mg/g polysaccharide-free DM (assuming a ratio of 5:1 of small:large bacteria in the rumen liquor (Czerkawski, 1976)) for protozoa and bacteria, respectively,

were used in the model. High P concentrations occur in the rumen, ranging from 200 to 600 mg/l (Witt and Owens, 1983).

Bacteria are assumed to pass to the small intestine at a rate of 5.1% per hour but protozoa, due to their larger size and ability to adhere to particles in the rumen, pass at 45% of the rate of bacteria (Dijkstra, 1994). The ruminal P that was not incorporated into microbial cells is assumed to pass to the duodenum at a fractional outflow rate of fluid of 8.3% per hour. Phosphorus from the indigestible P pool in the rumen is assumed to pass to the small intestine at a particulate fractional passage rate of 4.0% per hour.

Microbial P constitutes a major proportion of P entering the small intestine. Pancreatic ribonuclease breaks down microbial RNA and P is released (Barnard, 1969). It is generally accepted that the upper small intestine, where the pH of the digesta is acid, is the major site for P absorption (Breves and Schröder, 1991). Studies have been carried out to define how P is absorbed in ruminants and it is suggested that two processes may be involved: one, a passive process, related to intake, and the other, an active process, related to demand (Braithwaite, 1984). It is suggested that a substantial portion of the active transport consists of a sodium-dependent P transport mechanism (Schröder *et al.*, 1995). The small intestinal digestible P pool has inputs from the rumen (microbial matter and free P) and endogenous P (mostly in bile). The outputs of P from the digestible P pool in the small intestine are P absorbed into the extracellular fluid pool and 'regulated' P excretion to the large intestine. A Michaelis–Menten type saturation equation was used to describe the absorption of P from small intestine to the extracellular fluid ( $P_{ab}$ ) as follows:

$$P_{ab} = 90.1/[1 + (0.91/C_{IP})] \quad (18.2)$$

where  $C_{IP}$  is concentration of absorbable P in intestine (g/l). Maximum theoretical absorption through this process was 90 g/day and the parameters were optimized by the model. Unabsorbed digestible P, which includes endogenous P, is assumed to pass to the large intestinal digestible P pool at the same fractional passage rate as for fluid. Endogenous faecal P is one of the most important pathways responsible for almost 80% of P leaving the animal (McCaskill, 1990). Undigested microbial P and indigestible dietary P in the rumen are inputs to the indigestible P in small intestine and P from this pool passes to the large intestine at a particulate matter passage rate of 4.0% per hour.

The large intestine of sheep has the capacity to absorb significant quantities of P (Milton and Ternouth, 1985), but this capacity does not appear to be used due to the low concentration of ultrafiltrable P. Most of the P is present as insoluble or nucleic acid (Poppi and Ternouth, 1979) in the large intestine. Yano *et al.* (1991) concluded that in sheep, little absorption or secretion of P appears to occur either in the rumen or large intestine. The potentially digestible and indigestible P in large intestine are excreted in faeces at a fractional passage rate of the large intestine (10.6%/h, Mills *et al.*, 2001). Due to selective retention of microbial matter within the caecum, microbial passage rates were 85% of large intestinal digesta passage rate.

Inputs to the extracellular fluid pool are from P absorbed post-ruminally and from bone resorption. The outputs are to the lower tract (via bile), bone absorption, secretion in milk and excretion in urine. If a pregnant cow is assumed, utilization by the pregnant uterus needs to be an output from this pool. The volume of the pool was set at 20% of liveweight (Ternouth, 1968). Digestible P in small intestine (microbial, dietary and salivary P) passed to the small intestine, which is not excreted as 'regulated P' is assumed to have been absorbed. Besides its structural function, bone represents a reserve of P. According to Sevilla (1985), when P deficiency occurs more than 40% of the animal requirement can be supplied by bone resorption depending on the severity of P deficiency. As shown in the small intestine compartment, there is secretion of P to the small intestine through bile, which was estimated by the model. Milk P output is directly related to milk yield as milk P concentration is constant (NRC, 2001). P secreted in milk was calculated as 0.9 g/kg of milk (Fox and McSweeney, 1998). In the current study the cow is assumed to be non-pregnant so there is no P deposition in the uterus. Ruminants usually excrete very little P in their urine when they are fed roughage diets and it is generally accepted that major variations in P balance are, in these circumstances, more dependent on the gut than on the kidney (Scott, 1988). Many studies have shown that urinary P excretion is related to P concentration in extracellular fluid (e.g. Challa and Braithwaite, 1988). Based on experiments of Challa and Braithwaite (1988), urinary P excretion was described by an exponential equation, where at lower levels of P concentration ( $< 1.8$  mmol/l) urinary P is relatively unimportant but increases significantly as P concentration in extracellular fluid rises.

Phosphorus in tissue can be present as lecithin, cephalin and sphingomyelin and in blood as phospholipids (Cohen, 1975). Blood is the central pool of minerals that can be promptly available. Total blood contains 350–450 mg P/l, mostly present in the cells. Plasma P is present mainly as organic compounds and the remainder is in inorganic form, as  $\text{PO}_4$ ,  $\text{HPO}_4$  and  $\text{H}_2\text{PO}_4$  (Georgievskii, 1982). Normal levels for sheep are between 40 and 90 mg P/l and values lower than 40 mg are indicative of deficiency (Underwood and Suttle, 1999). There is a correlation between inorganic P in plasma and P intake for animals fed deficient to moderate P levels (Ternouth and Sevilla, 1990; Scott *et al.*, 1995). However, at high P intakes, inorganic P plasma levels begin to stabilize. For sheep, levels of 27, 64 and 101 mg P/kg LW are considered deficient, moderate and adequate, respectively (Braithwaite, 1985). In cattle, P intake varying from 27.1 to 62.5 mg P/kg LW resulted in P plasma levels of 47 and 77 mg/l, respectively. In contrast, some authors did not observe a clear correlation between P intake and plasma levels (Louvandini and Vitti, 1994; Louvandini, 1995).

Homeostatic mechanisms in ruminants depend mainly on the reabsorption of P in the kidney and P secreted in saliva. A substantial amount of P recycling takes place through saliva. The rate is influenced by the quantity and physical form of the diet and by P intake (Scott *et al.*, 1995).

Saliva normally contains 200–600 mg P/l but a variation of 50 to 1000 mg/l can occur (Thompson, 1978). The amount of P secreted in saliva



has been reported to be directly related to blood inorganic P concentration. Salivary P secretion was found to increase in direct relation to P intake and P absorption (Challa and Braithwaite, 1988). Salivary P, because it is in inorganic form, is easily available to rumen microbes. On average, salivary P inputs represented 45–50% of the total P flow at the duodenum assuming no net absorption of P from the rumen (Ternouth, 1997; Shah, 1999). It has been reported that the salivary P secretion accounts for about 70% of total endogenous P entering the alimentary tract of sheep (Annenkov, 1982) and represents a major route of P excretion (Young *et al.*, 1966).

P homeostasis is normally maintained by control of absorption, excretion, secretion into the gut and accretion in or resorption from bone. Homeostasis is simulated in the model by estimating key parameters that control movement of P in the different pools of the body of the animal. Sensitivity analysis was conducted to investigate how variations in these parameters affect model predictions.

When the extracellular fluid volume was set at  $\pm 50\%$  of the model value (i.e.  $0.2 \times$  live weight), initially there were changes in P concentrations in extracellular fluid and saliva but, as the model reached steady state, there were no changes in the predictions of the model. The saliva production per kg DMI was also varied by  $\pm 50\%$  of the model value. Reduction of saliva production resulted in lower amounts of P getting into the rumen and P concentrations in saliva increased by about 40% to facilitate the removal of P from extracellular fluid and compensate for the volume of saliva produced. On the other hand, when saliva production per kg DMI was increased, P concentration in saliva decreased by about 36% and saliva P entering the rumen increased slightly. Reducing saliva production slightly decreased faecal P (because of less P of endogenous origin entering the duodenum) and P concentration in extracellular fluid. Urinary P excretion was unaffected because the increase in extracellular fluid P concentration did not reach the threshold. Increasing saliva production also did not affect urinary P excretion because P concentration in extracellular fluid was slightly reduced.

Information from published reports was used to simulate P mobilization in the cow and comparison of predicted and observed values are shown in Table 18.1. The report by Wu *et al.* (2000) was chosen because it illustrated P partition in the animal based on experimental results. Spiekers *et al.* (1993) suggested that faecal P may be partitioned into three fractions: (i) the unavailable part of dietary P which is not absorbed; (ii) the inevitable loss or endogenous P fraction which is excreted as a consequence of normal physiological and metabolic events in the animal; and (iii) the regulatory part, that depends on the extent to which actual supply of potentially available dietary P exceeds requirement. The simulation results are reported in such a way that it is possible to identify the various factors that contribute to faecal P excretion (Table 18.1).

Estimated P secretion in milk and unavailable P excretion in faeces are the same in both models because the parameters were set as constants based on milk yield and P intake, respectively. Although Wu *et al.* (2000) estimated higher faecal P at higher P intakes, there was a general agreement in the

**Table 18.1.** Comparison of model predictions for P in different pools with values reported by Wu *et al.* (2000).

Intake	Saliva <sup>a</sup>	Urine	Mbl <sup>b</sup>	Milk	Faeces (g P per day)			
					MbIMt <sup>c</sup>	UnAv <sup>d</sup>	Reg <sup>e</sup>	Total
<i>Model simulation</i>								
60	38.8	0.96	39.3	40.0	20.8	9.00	0.33	30.1
72	57.9	2.18	39.3	40.0	20.9	10.8	3.07	34.8
84	69.1	3.50	39.3	40.0	21.4	12.6	8.79	42.8
96	75.8	4.68	39.3	40.0	21.8	14.4	15.8	51.9
108	81.1	5.91	39.3	40.0	22.7	16.2	23.8	62.6
120	86.7	7.51	39.3	40.0	23.9	18.0	29.8	71.7
132	93.0	9.83	39.3	40.0	25.0	19.8	35.5	80.3
<i>Wu et al. (2000)</i>								
60	ND <sup>f</sup>	1.00		40.0	21.5	9.00	0.00	30.5
72	ND	1.00		40.0	21.5	10.8	3.50	35.8
84	ND	1.00		40.0	21.5	12.6	8.90	43.0
96	ND	2.00		40.0	21.5	14.4	18.6	54.0
108	ND	2.00		40.0	21.5	16.2	28.3	66.0
120	ND	3.00		40.0	21.5	18.0	37.4	77.0
132	ND	5.00		40.0	21.5	19.8	45.6	87.0

<sup>a</sup>Saliva, salivary P incorporated in the rumen (g/day).

<sup>b</sup>Mbl, total microbial P outflow to the duodenum (g/day).

<sup>c</sup>MbIMt, microbial and metabolic P output to faeces (g/day).

<sup>d</sup>UnAv, unavailable dietary P (g/day).

<sup>e</sup>Reg, regulated P (g/day).

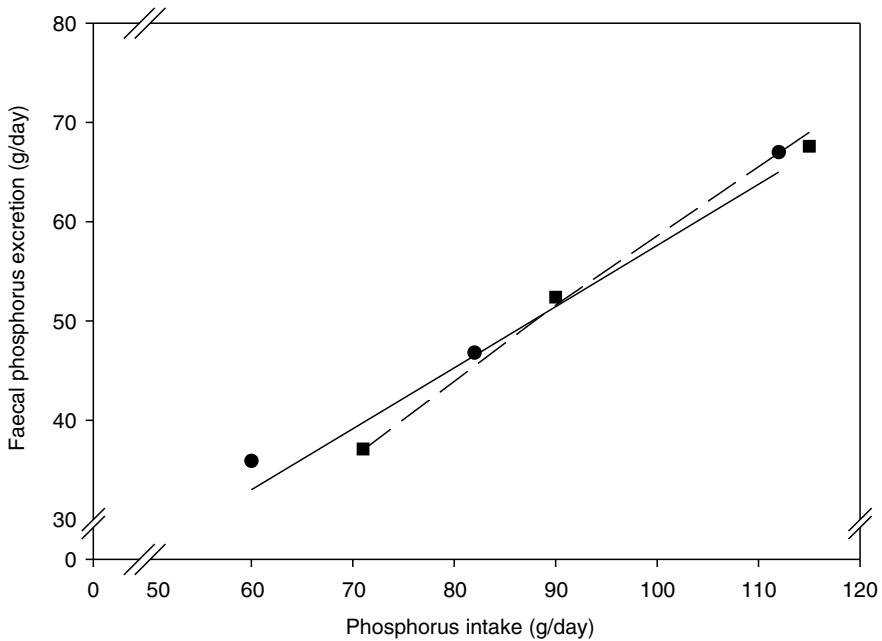
<sup>f</sup>ND, not determined.

total faecal P excreted. The differences at higher intakes were possibly because urinary P was underestimated by the predictions of Wu *et al.* (2000).

Experiments of Wu *et al.* (2000) and Morse *et al.* (1992) were used to provide inputs for model simulation. Figure 18.3 shows that there was a close agreement between model predictions and experimental results. Separate lines for model predictions were required because the experiments had different DMI and milk production, which modified the way the model predictions work.

The model can be extended to other ruminants by adjusting key parameters such as rumen and blood volume. There could be considerable intraspecies differences in P metabolism, which could be influenced by a number of factors. P interacts with other minerals, especially calcium, and responds to levels of vitamin D and endocrine factors. These issues need to be addressed to improve our understanding of P metabolism and better predict differences in P responses within species.

We anticipate that the dynamic model will help to a better understanding of P metabolism and lead to formulation of diets which will reduce environmental pollution of P without compromising animal performance or health. This can be done by matching the ruminant's requirement for various physiological



**Fig. 18.3.** Comparison of faecal P excretion in relation to P intake between experimentally observed values (symbols) and model predictions (lines). Solid and broken lines are model predictions based on experiments conducted by Wu *et al.* (2000) (●) and Morse *et al.* (1992) (■), respectively.

processes with dietary P intake, which can be simulated using the dynamic model.

## Copper

Copper (Cu) is an essential trace element required for enzyme systems, iron metabolism, connective tissue metabolism and mobilization, plus integrity of the central nervous and immune systems. The essentiality of Cu in ruminants had long been established when evidence was found that Cu is required for growth and prevention of disease (McDowell, 1992). Copper has also been reported to affect lipid metabolism in high-producing dairy cows and beef cattle (Engle *et al.*, 2000, 2001). In many parts of the world, Cu deficiency has been identified as a serious problem for grazing ruminants under a wide range of soil and climatic conditions (Ammerman *et al.*, 1995).

### *Copper requirements and absorption*

Dietary Cu requirements vary greatly among species. Dairy cattle can tolerate higher dietary levels of Cu than can safely be fed to sheep. Copper

requirements for an adult lactating cow (producing 30 kg milk per day) according to ARC (1980) were estimated to be 163 mg/day or 8 to 11 mg Cu/kg DM. In NRC (2001), the requirement for the same animal was 200 mg/day of dietary Cu. The higher requirement in NRC (2001) was an extra 50% allowance in milk Cu content. The requirement for adult sheep (50 kg) was 3.7 mg/day or 4.6 to 7.4 mg Cu/kg DM. Copper requirement for goats was suggested to be 10 to 20 mg/kg diet DM (TCORN, 1998). Copper toxicity has been reported to be a problem if animals ingest quantities that cannot be cleared by the liver. The levels at which toxicity occur depend on species. Non-ruminants are more tolerant while cattle and goats are less tolerant than sheep (Underwood and Suttle, 1999). There appears to be a delicate balance and narrow differential between Cu requirement and toxicity in sheep (Kellems and Church, 2002).

Copper requirements of ruminants depend on the absorbability rather than the concentration of Cu in the diet (Underwood and Suttle, 1999). The pre-ruminant animal absorbs Cu with an efficiency of 50–70% (ARC, 1980). However, with the development of the rumen, Cu absorption drops to less than 10%. This is mainly due to digestive processes in the rumen and the presence of sulphide that binds Cu and precipitates it as Cu sulphide, which is not absorbable (Suttle, 1991). The extent of Cu absorption is largely influenced by interactions with molybdenum (Mo), sulphur (S) and iron, which form complex chemicals and limit absorption in the gastrointestinal tract. The absorbability of Cu also depends on the sources of Cu for ruminants. In silages, Mo has a small and little studied effect on absorbability. Absorbable Cu ( $A$ , %) in ruminants fed fresh grass was described by the equation:

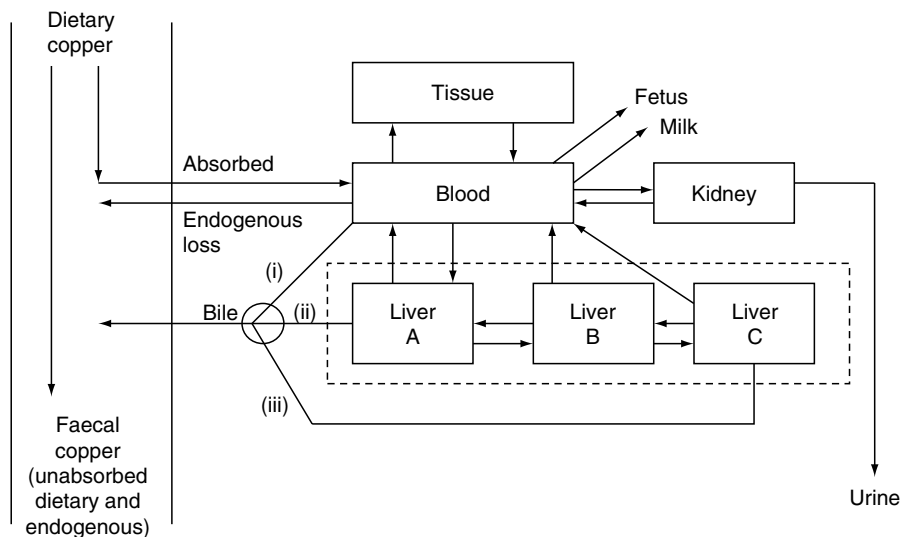
$$A = 5.7 - 1.3S - 2.785\ln(\text{Mo}) + 0.227(\text{Mo} \times S) \quad (18.3)$$

where Mo is given in mg/kg DM and S in g/kg DM (Underwood and Suttle, 1999).

#### *Modelling copper metabolism*

Quantitative descriptions of Cu metabolism available in the literature are largely dependent on empirical modelling and limited mechanistic modelling based on kinetic studies. The main kinetic models were those of Weber *et al.* (1980, 1983) using  $^{64}\text{Cu}$  in sheep, Gooneratne *et al.* (1989) using  $^{67}\text{Cu}$  in sheep, and Buckley (1991) using the stable isotope  $^{65}\text{Cu}$  in lactating dairy cows. Symonds and Forbes (1993) developed a framework of a mechanistic model of the possible routes of movements of Cu in the ruminant body based on kinetic models of Cu metabolism in sheep (Weber *et al.*, 1980; Gooneratne *et al.*, 1989) (Fig. 18.4). The boxes in Fig. 18.4 represent pool sizes and input, output and between-pool fluxes can be estimated from balance trials or injection of radioactive markers and sampling of tissues over time.

Homeostasis of Cu in ruminants is achieved predominantly by hepatic storage and biliary secretion (Underwood and Suttle, 1999). Copper metabolism in the liver has been represented by more than one compartment based on the information available to resolve Cu mobility and the species under study.



**Fig. 18.4.** Diagram of the possible routes of movement of copper in the ruminant body. A represents a temporary storage compartment for copper in the liver destined for exchange with blood and excretion into bile (ii), B represents a temporary storage for incorporation into caeruloplasmin and C represents a long-term storage compartment from which excretion into bile (iii) and secretion into blood are thought to be operative following tetrathiomolybdate administration. Excretion into bile was from the blood (i), temporary (ii) and long-term (iii) Cu storage compartments in the liver (Symonds and Forbes, 1993).

Weber *et al.* (1980) used two compartments for liver Cu metabolism in sheep but Buckley (1991) restricted the liver compartment to just one because of insufficient data and lesser significance of clearing tracer Cu from blood over the longer term. In the model of Buckley (1991) the liver took up most of the direct reacting Cu (92%) and the rest was distributed to the body (2.9%), milk (3.5%) and urine (1.5%). The efficiency with which Cu accumulates in the liver (0.7% of dietary Cu) seem to be constant in cows supplemented with 10 or 40 mg Cu/kg DM (Engle *et al.*, 2001). Genetic differences in Cu metabolism and especially liver storage were shown in Holstein and Jersey cows. In cows supplemented with 80 mg Cu/kg DM, Cu was accumulated in the liver at a rate of about 6.4  $\mu\text{g/g DM/day}$  in Holsteins compared to 7.5  $\mu\text{g/g DM/day}$  in Jerseys which indicates Jersey cows' susceptibility to Cu toxicity relative to Holsteins. Plasma Cu concentrations in both breeds remained constant (Du *et al.*, 1996).

In non-ruminants, Cu excretion in bile is a major route of Cu homeostasis. Ruminants, however, have a poor ability to excrete Cu in bile but Cu excretion increases as liver Cu concentrations increase. Buckley (1991) reported that  $0.87\% \pm 0.41\%$  of liver Cu was excreted per day in bile. Urinary Cu excretion is about 1% of absorbed Cu and unaffected by dietary Cu intake.

Symonds and Forbes (1993) reviewed quantitative aspects of Cu metabolism. Since then, most of the studies on Cu have been focused more on

requirements, absorption, sources of Cu and effect of Cu on lipid metabolism. Therefore, in this chapter, only a limited update of quantitative aspects of Cu metabolism has been possible.

## Conclusions

In this chapter, a similar approach was adopted to that taken by Symonds and Forbes (1993). Representative mineral elements P and Cu were used to describe quantitative aspects of mineral metabolism. However, in this case, P was handled in more detail as it is fast becoming a major environmental concern due to excessive use of P in feed. A new dynamic model based on various experiments is proposed which can be integrated with other extant models to provide a decision support tool that can lead to assessment of diets for their pollution impact and suggest mitigation options.

## References

- AFRC (1991) A reappraisal of the calcium and phosphorus requirements of sheep and cattle. *Nutrition Abstracts and Reviews (Series B)* 61, 573–612.
- Ammerman, C.B., Baker, D.H. and Lewis, A.J. (1995) *Bioavailability of Nutrients for Animals: Amino Acids, Minerals, Vitamins*. Academic Press, San Diego, California, 436 pp.
- Annenkov, B.N. (1982) Kinetics of mineral metabolism in blood. In: Georgievskii, V.I., Annenkov, B.N. and Samokhin, V.I. (eds) *Mineral Nutrition of Animals*. Butterworths, London, pp. 243–256.
- ARC (1980) *The Nutrient Requirements of Ruminant Livestock*. CAB International, Wallingford, UK, 351 pp.
- Barnard, E.A. (1969) Biological functions of pancreatic ribo-nuclease. *Nature* 221, 340–344.
- Bell, S.T., McKinnon, A.E. and Sykes, A.R. (2005) Estimating the risk of hypomagnesaemic tetany in dairy herds. In: Kebreab, E., Dijkstra, J., Bannink, A., Gerrits, W.J.J. and France, J. (eds) *Nutrient Utilization in Farm Animals: Modelling Approaches*. CAB International, Wallingford, UK, (in press).
- Boston, R.C., Greif, P.C. and Berman, M. (1981) Conversational SAAM – an interactive program for kinetic analysis of biological systems. *Computer Programs in Biomedicine* 13, 111–119.
- Braithwaite, G.D. (1983) Calcium and phosphorus requirements of the ewe during pregnancy and lactation. 2. Phosphorus. *British Journal of Nutrition* 50, 723–736.
- Braithwaite, G.D. (1984) Some observations on phosphorus homeostasis and requirements of sheep. *Journal of Agricultural Science, Cambridge* 102, 295–306.
- Braithwaite, G.D. (1985) Endogenous faecal loss of phosphorus in growing lambs and the calculation of phosphorus requirements. *Journal of Agricultural Science, Cambridge* 105, 67–72.
- Breves, G. and Schröder, B. (1991) Comparative aspects of gastrointestinal phosphorus metabolism. *Nutrition Research Reviews* 4, 125–140.

- Buckley, W.T. (1991) A kinetic model of copper metabolism in lactating dairy cows. *Canadian Journal of Animal Science* 71, 155–166.
- Care, A.D. (1994) The absorption of phosphate from the digestive tract of ruminant animals. *British Veterinary Journal* 150, 197–205.
- Challa, J. and Braithwaite, G.D. (1988) Phosphorus and calcium metabolism in growing calves with special emphasis on phosphorus homeostasis. 3. Studies of the effect of continuous intravenous infusion of different levels of phosphorus in ruminating calves receiving adequate dietary phosphorus. *Journal of Agricultural Science, Cambridge* 110, 591–595.
- Cohen, R.D.H. (1975) Phosphorus and the grazing ruminant. An examination of the role of phosphorus in ruminant nutrition with particular reference to the beef cattle industry in Australia. *Animal Production* 11, 27–43.
- CSIRO (1990) *Feeding Standards for Australian Livestock: Ruminants*. CSIRO Publishing, Victoria, Australia, 288 pp.
- Czerkawski, J.W. (1976) Chemical composition of microbial matter in the rumen. *Journal of the Science of Food and Agriculture* 27, 621–632.
- Dijkstra, J. (1994) Simulation of the dynamics of protozoa in the rumen. *British Journal of Nutrition* 72, 679–699.
- Dijkstra, J., Neal, H.D.St.C., Beever, D.E. and France, J. (1992) Simulation of nutrient digestion, absorption and outflow in the rumen: model description. *Journal of Nutrition* 122, 2239–2256.
- Dijkstra, J., Mills, J.A.N. and France, J. (2002) The role of dynamic modelling in understanding the microbial contribution to rumen function. *Nutrition Research Reviews* 15, 67–90.
- Du, Z., Hemken, R.W. and Harmon, R.J. (1996) Copper metabolism of Holstein and Jersey cows and heifers fed diets high in cupric sulphate or copper proteinate. *Journal of Dairy Science* 79, 1873–1880.
- Durand, M. and Kawashima, R. (1980) Influence of minerals in rumen microbial digestion. In: Ruckebusch, Y. and Thivend, P. (eds) *Digestive Physiology and Metabolism in Ruminants*. MTP Press, London, pp. 375–408.
- Engle, T.E., Spears, J.W., Armstrong, T.A., Wright, C.L. and Odle, J. (2000) Effects of dietary copper source and concentration on carcass characteristics and lipid and cholesterol metabolism in growing and finishing steers. *Journal of Animal Science* 78, 1053–1059.
- Engle, T.E., Fellner, V. and Spears, J.W. (2001) Copper status, serum cholesterol, and milk fatty acid profile in Holstein cows fed varying concentrations of copper. *Journal of Dairy Science* 84, 2308–2313.
- Fox, P.F. and McSweeney, L.R. (1998) *Dairy Chemistry and Biochemistry*. Blackie Academic and Professional, London.
- Georgievskii, V.I. (1982) The physiological role of macro elements. In: Georgievskii, V.I., Annenkov, B.N. and Samokhin, V.I. (eds) *Mineral Nutrition of Animals*. Butterworths, London, pp. 91–170.
- GFE (Ausschuss für Bedarfsnormen der Gesellschaft für Ernährungsphysiologie) (2001) *Empfehlungen zur Energie-und Nährstoffversorgung der Milchkühe and Aufzuchttrider*. DLG-Verlag, Frankfurt/Main, Germany.
- Gooneratne, S.R., Laarveld, B., Chaplin, R.K. and Christensen, D.A. (1989) Profiles of <sup>67</sup>Cu in blood, bile, urine and faeces from <sup>67</sup>Cu primed lambs: effect of 99Mo-labelled tetrathiomolybdate on the metabolism of <sup>67</sup>Cu long term storage. *British Journal of Nutrition* 61, 373–385.
- Grace, N.D. (1981) Phosphorus kinetics in the sheep. *British Journal of Nutrition* 45, 367–374.

- Hungate, R.E. (1966) *The Rumen and its Microbes*. Academic Press, New York, pp. 346–347.
- Kebreab, E., Crompton, L.A., Mills, J.A.N. and France, J. (2001) Phosphorus pollution by dairy cows and its mitigation by dietary manipulation. *Proceedings of the British Society of Animal Science*. BSAS, Penicuik, UK, p. 138.
- Kebreab, E., Mills, J.A.N., Crompton, L.A., Bannink, A., Dijkstra, J., Gerrits, W.J.J. and France, J. (2004) An integrated mathematical model to evaluate nutrient partition in dairy cattle between the animal and its environment. *Animal Feed Science and Technology* 112, 131–154.
- Kebreab, E., France, J., Sutton, J.D., Crompton, L.A. and Beaver, D.E. (2005a) Effect of energy and protein supplementation on phosphorus utilization in lactating dairy cows. *Journal of Animal and Feed Sciences* 14, 63–77.
- Kebreab, E., Shah, M.A., Beaver, D.E., Humphries, D.J., Sutton, J.D., France, J. and Mueller-Harvey, I. (2005b) Effects of contrasting forage diets on phosphorus utilisation in lactating dairy cows. *Livestock Production Science* 93, 125–135.
- Kellems, R.O. and Church, D.C. (2002) *Livestock Feeds and Feeding*, 5th edn. Prentice-Hall, New Jersey, 654pp.
- Koddebusch, L. and Pfeffer, E. (1988) Untersuchungen zur verwertbarkeit von phosphor verschiedener herkunft an laktierenden ziegen. *Journal of Animal Physiology and Animal Nutrition* 60, 269–275.
- Louvandini, H. (1995) Perda endógena de fósforo em ovinos suplementados com diferentes níveis do elemento na dieta. PhD thesis, Instituto de Pesquisas Energéticas e Nucleares, São Paulo, Brazil.
- Louvandini, H. and Vitti, D.M.S.S. (1994) Perda endógena de fósforo em ovinos com diferentes níveis do elemento na dieta. *Pesquisa Agropecuária Brasileira* 29, 145–149.
- Maynard, L.A. and Loosli, J.K. (1969) The inorganic element and their metabolism. In: *Animal Nutrition*, 5th edn. McGraw-Hill, New Delhi, India, pp. 154–228.
- McCaskill, M.R. (1990) Phosphorus and beef production in northern Australia: modeling phosphorus requirements of beef cattle. *Tropical Grassland* 24, 231–238.
- McDowell, L.R. (1992) *Minerals in Animal and Human Nutrition*. Academic Press, New York, 524 pp.
- Mills, J.A.N., Dijkstra, J., Bannink, A., Cammell, S.B., Kebreab, E. and France, J. (2001) A mechanistic model of whole-tract digestion and methanogenesis in the lactating dairy cow: model development, evaluation, and application. *Journal of Animal Science* 79, 1584–1597.
- Milton, J.T.B. and Ternouth, J.H. (1985) Phosphorus metabolism in ruminants. II. Effects of inorganic phosphorus concentration upon food intake and digestibility. *Australian Journal of Agricultural Research* 36, 647–654.
- Morse, D., Head, H.H. and Wilcox, C.J. (1992) Disappearance of phosphorus in phytate from concentrates *in vitro* and from rations fed to lactating dairy cows. *Journal of Dairy Science* 75, 1979–1986.
- NRC (2001) *Nutrient Requirement of Dairy Cattle*, 7th edn. National Academy Press, Washington, DC 381 pp.
- Poppi, D.P. and Ternouth, J.H. (1979) Secretion and absorption of phosphorus in the gastrointestinal tract of sheep fed on four diets. *Australian Journal of Agricultural Research* 30, 503–512.
- Robson, A.B., Field, A.C., Sykes, A.R. and McKinnon, A.E. (1997) A model of magnesium metabolism in young sheep. Magnesium absorption and excretion. *British Journal of Nutrition* 78, 975–992.



- Schneider, K.N., Ternouth, J.H., Sevilla, C.C. and Boston, R.C. (1985) A short-term study of calcium and phosphorus absorption in sheep fed on diets high and low in calcium and phosphorus. *Australian Journal of Agricultural Research* 36, 91–105.
- Schneider, K.M., Boston, R.C. and Leaver, D.D. (1987) Quantitation of phosphorus excretion in sheep by compartmental analysis. *American Journal of Physiology* 252, R720–R731.
- Schröder, B., Happner, H., Failing, K., Pfeffer, E. and Breves, G. (1995) Mechanisms of intestinal phosphate transport in small ruminants. *British Journal of Nutrition* 74, 635–648.
- Scott, D. (1988) Control of phosphorus balance in ruminants. In: *Proceedings of the Satellite Symposium of the International Congress of the International Union of Physiological Sciences, 30, Aspects of Digestive Physiology in Ruminants*. Comstock Publishing Associates, Ithaca, New York, pp. 156–174.
- Scott, D., Rajaratne, A.A.J. and Buchan, W. (1995) Factors affecting faecal endogenous phosphorus loss in the sheep. *Journal of Agricultural Science, Cambridge* 124, 145–151.
- Sevilla, C.C. (1985) Phosphorus deficiency in lambs. PhD thesis, University of Queensland, Brisbane, Australia.
- Shah, M.A. (1999) The effect of forage and concentrate type on phosphorus utilisation in lactating dairy cows. PhD thesis, University of Reading, UK.
- Spiekens, H., Brintrup, R., Balmelli, M. and Pfeffer, E. (1993) Influence of dry matter intake on faecal phosphorus losses in dairy cows fed rations low in phosphorus. *Journal of Animal Physiology and Animal Nutrition* 69, 37–43.
- Suttle, N.F. (1991) The interactions between copper, molybdenum and sulphur in ruminant nutrition. *Annual Review of Nutrition* 11, 121–140.
- Symonds, H.W. and Forbes, J.M. (1993) Mineral metabolism. In: Forbes, J.M. and France, J. (eds) *Quantitative Aspects of Ruminant Digestion and Metabolism*. CAB International, Wallingford, UK, pp. 363–379.
- Technical Committee on Responses to Nutrients (TCORN) (1998) *The Nutrition of Goats*. CAB International, Wallingford, UK.
- Ternouth, J.H. (1968) Changes in the thiosulphate space and some constituents of the blood after feeding. *Research in Veterinary Science* 9, 345–349.
- Ternouth, J.H. (1997) Phosphorus metabolism in ruminant animals. In: Onodera, R., Itabashi, H., Ushida, K., Yano, H. and Sasaki, Y. (eds) *Rumen Microbes and Digestive Physiology in Ruminants*. Japan Scientific Society Press, Tokyo, pp. 167–177.
- Ternouth, J.H. and Sevilla, C.C. (1990) The effects of low levels of dietary phosphorus upon the dry matter intake and metabolism of lambs. *Australian Journal of Agricultural Research* 41, 175–184.
- Thompson, W.R. (1978) Phosphorus in animal nutrition. In: *Phosphorus for Agriculture – a Situation Analysis*. Potash/Phosphate Institute, Atlanta, Georgia pp. 126–158.
- Underwood, B.J. and Suttle, N.F. (1999) *The Mineral Nutrition of Livestock*, 3rd edn. CAB International, Wallingford, UK, 614 pp.
- Valk, H. (2002) Nitrogen and phosphorus supply of dairy cows. PhD thesis, University of Utrecht, The Netherlands, 204 pp.
- Vitti, D.M.S.S. (1989) Avaliação da disponibilidade biológica do fósforo dos fosfatos bicálcico, Patos de Minas, Tapira e finos de Tapira para ovinos pela técnica da diluição isotópica. PhD Thesis, Instituto de Pesquisas Energéticas e Nucleares, São Paulo, Brazil, 87 pp.

- Vitti, D.M.S.S., Kebreab, E., Abdalla, A.L., De Carvalho, F.F.R., De Resende, K., Crompton, L.A. and France, J. (2000) A kinetic model of phosphorus metabolism in growing goats. *Journal of Animal Science* 78, 2706–2712.
- Vitti, D.M.S.S., Kebreab, E., Lopes, J.B., Dorigan, C.J., De Resende, K.T., Abdalla, A.L., Crompton, L.A. and France, J. (2002) Calcium metabolism in Saanen goats – a kinetic model. *Proceedings of the British Society of Animal Science*. BSAS, Penicuik, UK, p. 105.
- Weber, K.M., Boston, R.C. and Leaver, D.D. (1980) A kinetic model of copper metabolism in sheep. *Australian Journal of Agricultural Research* 31, 773–790.
- Weber, K.M., Boston, R.C. and Leaver, D.D. (1983) The effect of molybdenum and sulphur on the kinetics of copper metabolism in sheep. *Australian Journal of Agricultural Research* 34, 295–306.
- Witt, K.E. and Owens, F.M. (1983) Phosphorus ruminal availability and effects on digestion. *Journal of Animal Science* 56, 930–937.
- Wu, Z., Satter, L.D. and Sojo, R. (2000) Milk production, reproductive performance, and fecal excretion of phosphorus by dairy cows fed three amounts of phosphorus. *Journal of Dairy Science* 83, 1028–1041.
- Yano, F., Yano, H. and Breves, G. (1991) Calcium and phosphorus metabolism in ruminants. In: Tsuda, T., Sasaki, Y. and Kawashima, R. (eds) *Physiological Aspects of Digestion and Metabolism in Ruminants*. *Proceedings of the Seventh International Symposium on Ruminant Physiology*. Academic Press, San Diego, California, pp. 277–295.
- Young, V.R., Lofgreen, G.P. and Luick, J.R. (1966) The effects of phosphorus depletion and of calcium and phosphorus intake on the endogenous excretion of these elements by sheep. *British Journal of Nutrition* 20, 795–805.

---

# **The Whole Animal**

---

*This page intentionally left blank*

---

# 19 Growth

G.K. Murdoch,<sup>1</sup> E.K. Okine,<sup>1</sup> W.T. Dixon,<sup>1</sup>  
J.D. Nkrumah,<sup>1</sup> J.A. Basarab<sup>2</sup> and R.J. Christopherson<sup>1</sup>

<sup>1</sup>*Department of Agricultural, Food and Nutritional Science, University of Alberta, Edmonton, Alberta T6G 2P5, Canada;* <sup>2</sup>*Western Forage/Beef Group, Lacombe Research Centre, 6000 C&E Trail, Lacombe, Alberta T4L 1W1, Canada*

---

## Introduction

Growth of the whole animal involves an increase in mass as a result of changes in the size, development and structure of its various organs and tissues. Growth involves increases in both cell numbers (hyperplasia) and cell size (hypertrophy), and includes the deposition of substantial amounts of extracellular matrix material (e.g. collagen and mineral) in cartilage and bone, extracellular fluids and electrolytes and accumulation of structural or energy storage molecules (e.g. proteins and lipids) in intracellular locations. Although growth is thought of primarily as an increase in size of components, there is much remodelling of organ systems throughout life. For example, the size of visceral tissues fluctuates with diet and feeding level, as does lipid storage in adipose tissue, which fluctuates with nutrient availability and energy demand. All body components are subject to turnover with growth occurring when synthesis rates exceed degradation rates.

A detailed consideration of animal growth functions may be found in France and Thornley (1984) and, in a previous edition of this book, the chapter by Gill and Oldham (1993) provided a brief coverage of some of the models used to describe growth, how the environment and management systems impact growth and also of the impact of variations in an animal's ability to extract dietary nutrients on the growth process. Oldham (1999) suggested the need to incorporate knowledge of genotype and gene expression into the development of nutritional programmes for herbivores. We have chosen to focus on a review of certain regulatory systems, including components of the endocrine system and gene expression profiles as these relate to growth and energy balance and on linkages between energy utilization and growth of ruminant livestock. For our consideration of regulatory mechanisms, we have drawn upon published contributions based on a wide range of species, including non-ruminant animals, but have attempted to present the discussion in the context of ruminant livestock.

## Regulators

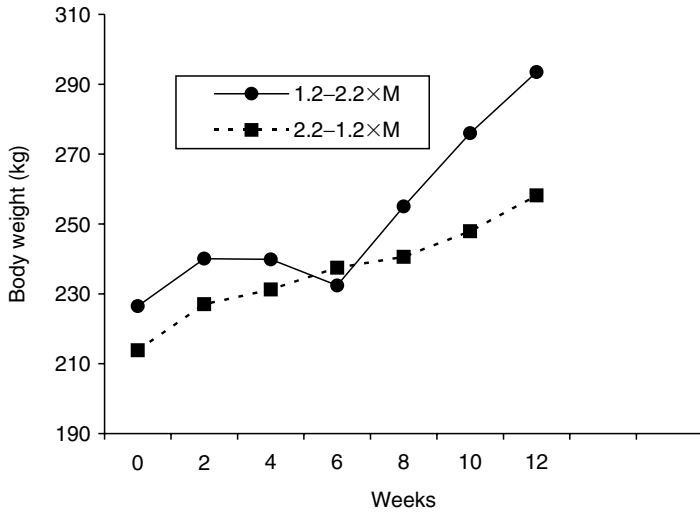
### *Growth hormone*

Growth hormone (GH) is a single-chain polypeptide of about 200 residues with two or three disulphide bridges (Conde *et al.*, 1973). GH is secreted from the anterior pituitary into the blood stream in a pulsatile manner. Plasma GH is positively regulated by hypothalamic growth hormone releasing hormone (GHRH) and negatively regulated by inhibitory feedback of GH itself and insulin-like growth factor I (IGF-I) on GHRH-producing cells in the hypothalamus, as well as somatostatin (SS), which inhibits the release of GH (Veldhuis *et al.*, 1991). GH acts as a systemic anabolic hormone on tissues expressing its specific receptor such as epiphyseal growth plates, skeletal and cardiac muscle, placenta, liver, kidney, brain and cartilage but is catabolic in function on adipose tissue. Somatic growth in vertebrates is dependent on growth hormone, and insufficiency or insensitivity results in dwarfism (Jorgensen, 1991) while hypersecretion induces gigantism, acromegaly and insulin insensitivity accompanied by hyperglycaemia. Of extreme importance to livestock production is the fact that normal, and slightly elevated, serum GH promotes deposition of lean body mass with associated reduction of adiposity.

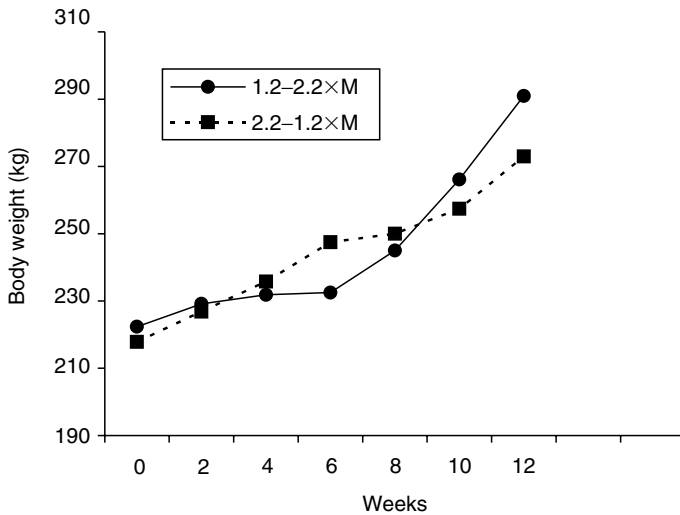
GH binds to GH receptor as a homodimer and initiates signal transduction mechanisms affecting metabolism and growth (Breier, 1995). Activation of GH receptor in the liver induces an increase in production of IGF-I, which mediates many of the anabolic effects (Thiessen *et al.*, 1994). Growth hormone is also involved in modulating other processes such as lipid, nitrogen, mineral and carbohydrate metabolism (*e.g.* Luft *et al.*, 1958).

In adipose tissue, GH decreases lipogenesis, increases lipolysis and fatty acid mobilization and oxidation, and inhibits insulin-mediated lipogenesis, probably by direct action on GH receptors (O'Connor *et al.*, 1999). Other roles of GH include elevation of plasma glucose levels and decreased glucose oxidation, mainly through insulin antagonism (Campbell *et al.*, 1985; Wurzbarger *et al.*, 1993). Treatment of ruminant livestock with growth hormone results in increased average daily gain (ADG) and feed efficiency, decreased fat accretion and increased protein accretion (*e.g.* Hayden *et al.*, 1993). Gladysz *et al.* (2001) reported that mean concentrations and amplitudes of GH in blood plasma of sheep were higher in feed-restricted compared to control animals, possibly due to reduced somatostatin release. The increase in circulating GH with feed restriction serves to mobilize lipid and glycogen stores for immediate use by tissues for maintenance rather than growth. In fact there is evidence for uncoupling of GH and IGF-I during feed restriction, whereby plasma IGF-I is reduced while GH is increased (Yambayamba *et al.*, 1996). This may contribute to the process of compensatory growth. Figure 19.1 describes the response of cattle to being switched from a low- to a high-energy intake or vice versa, when roughage or concentrate diets were on offer. Note that switching from a low- to a high-energy intake appeared to result in an accelerated weight change. The reduced energy expenditure associated with feed restriction could

## (a) Roughage



## (b) Concentrate



**Fig. 19.1.** Examples of compensatory growth in beef steers as they are switched, at 6 weeks, either from a restricted level ( $1.2 \times$  maintenance) to a higher ( $2.2 \times$  maintenance) level of feeding or vice versa. Data are presented for animals fed either high roughage (a) or high concentrate diets (b). (G.K. Murdoch *et al.*, unpublished observations.)

have been linked to reduced proteolysis and both might carry-over into the period immediately following the restriction (Murdoch *et al.*, 2003). However, Amstalden *et al.* (2000) found no significant effects of short-term fasting on plasma concentration, pulse amplitude and frequency of GH in heifers, which

suggests that there may be a threshold effect in terms of degree of nutrient restriction, and/or involvement of other endocrine processes.

### ***Insulin-like growth factors and IGF-binding proteins***

Insulin-like growth factors (IGF) and IGF-binding proteins (IGFBP) are part of a family of polypeptides structurally related to proinsulin and which are synthesized by the liver in response to GH stimulus (Thiessen *et al.*, 1994). IGF-I acts in an autocrine and/or paracrine manner (Louveau *et al.*, 2000) to influence growth. After release, IGFs bind mainly to IGFBPs, but also other plasma proteins, which serve to stabilize and increase the half-life of circulating IGF, and also modulate delivery of IGF to target tissues. For example, in sheep, the half-life of IGF-I in plasma increased from 10 min in the free form to 545 min when it was bound to IGFBP-3 (Gatford *et al.*, 1997). Thus IGFBP-3 has been suggested as the major carrier of IGF-I in adult sheep plasma whilst in the fetal sheep IGFBP-3, IGFBP-2 and a soluble form of the IGF-II receptor each appear to carry about a third of the circulating IGF. The extended half-life of IGF bound to its carriers allows for the maintenance of GH-induced, IGF-mediated anabolic effects beyond GH stimulation.

The plasma concentrations of IGFs increase with age until puberty. IGFs increase mitosis in immature chondrocytes within cartilage, which develop into bone and also increases cellular protein synthesis and amino acid uptake in muscle tissues (Thiessen *et al.*, 1994). IGFs have their own specific receptors, but they are also insulin receptor agonists and activate these receptors in both adipose and muscle tissues (Breier, 1995). Plasma IGF-I concentration decreased in response to fasting and undernutrition in heifers (Amstalden *et al.*, 2000) and both IGF-I and IGFBPs were altered by nutritional status in sheep (e.g. Gatford *et al.*, 1997). In addition, a study by Luna-Pinto and Cronje (2000) indicated that plasma IGF-I and IGFBP-3 concentrations were higher during a compensatory growth phase in dairy heifers, which followed a period of previous feed restriction, than in control animals. This indicated that IGF-I and IGFBP-3 had a role in adaptation of growth rates in response to both nutrient restriction and subsequent repletion and compensatory growth in cattle.

Concentrations of IGF receptors decrease as the animal matures (Thiessen *et al.*, 1994), but plasma IGF-I increases with growth until puberty. Studies also indicate an association between serum leptin concentration and IGF-I, IGF-II and IGFBP-3 concentrations in lean but not in fat subjects (Baile *et al.*, 2000). In sheep it was found that sustained high concentrations of GH and IGF-I might reduce adipose tissue mass and thereby, albeit indirectly, inhibit leptin expression (Kadokawa *et al.*, 2003). The presence of leptin receptors in several hypothalamic nuclei containing GHRH has led to the suggestion that leptin acts on GHRH or somatostatin to regulate GH secretion and action (Baile *et al.*, 2000). Administration of neuropeptide Y (NPY) appears to cause a dose-dependent inhibition of GH release from pituitary cells and decreases plasma GH concentrations in sheep (Gladysz *et al.*, 2001). These observations suggest



a complex interaction between the growth hormone system and other pathways in the regulation of growth and energy homeostasis in animals.

### **Insulin**

The main function of insulin is the promotion of nutrient storage. It plays a major role in lipogenesis, liver and muscle glycogenesis and protein synthesis (Davis *et al.*, 1998). In the liver, insulin regulates Glut-4 mediated hepatic glucose uptake and is also essential for the production of IGFs. Peripheral administration of insulin inhibits lipolysis, and it opposes the action of GH in fat cells (Woods *et al.*, 1998). Fasting in heifers causes parallel reductions in circulating insulin and leptin levels (Amstalden *et al.*, 2000), the flip side of the fact that both are upregulated by elevated plasma nutrient levels, especially glucose for insulin and free fatty acids for leptin. Heat production in sheep is also positively related to plasma insulin concentration (Table 19.1), probably as a result of anabolic responses to the hormone.

### **Leptin**

Leptin, a 146-amino acid peptide is expressed primarily in adipose tissues (Zhang *et al.*, 1994). Leptin crosses the blood–brain barrier through a saturable specific transport mechanism involving two short isoforms of its receptor, Ob-Ra and Ob-Re (Heska and Jones, 2001). Inside the central nervous system, leptin binds to cells expressing the leptin receptor in the arcuate, ventromedial, paraventricular and dorsomedial hypothalamus (Tartaglia *et al.*, 1995). It serves as an indicator of energy status especially adipose stores and is a postprandial satiety signaller (Houseknecht *et al.*, 1998). Leptin receptors (long form; Ob-Rb) are single transmembrane proteins belonging to the

**Table 19.1.** Relationship between heat production and the density of beta-adrenergic receptors (fmol/mg protein) in different tissues of sheep. Data from Ekpe and Christopherson (2000) and Ekpe *et al.* (2000a,b).

Independent variable	Intercept	Regression coefficient	r-value	Probability
Heart BAR density	2.12	0.008	0.55	0.01
Biceps femoris BAR density	4.01	−0.019	−0.34	0.05
Semitendinosus BAR density	4.21	−0.032	−0.40	0.05
Gastrocnemius BAR density	5.11	−0.055	−0.47	0.05
Liver BAR density	4.52	−0.081	−0.38	0.05
Kidney BAR density	4.45	−0.034	−0.31	NS
Plasma T3 conc. (ng/dl)	2.42	0.005	0.32	NS
Plasma insulin conc. (μIU/ml)	2.28	0.070	0.54	0.01

Regression of heat production (W/kg) on tissue beta-adrenergic receptor (BAR) density or plasma T3 or insulin concentrations.

cytokine superfamily. When activated the leptin receptor initiates autophosphorylation of Janus kinase (JAK) bound to the cytoplasmic domain of Ob-Rb, subsequent tyrosine phosphorylation of signal transduction activators of transcription (STAT) proteins can then act as transcription factors to influence cellular gene expression and metabolism (Ghilardi and Skoda, 1997). Leptin receptor mRNA is also expressed in many peripheral tissues which is unrelated to satiety but related to leptin's regulation of cellular metabolism (Murdoch *et al.*, 2003).

Leptin modulates body energy homeostasis, through both central and peripheral pathways by limiting food intake and influencing lipid and glucose metabolism and energy expenditure (Baile *et al.*, 2000). Abundant fat storage in adipose tissue is associated with increased leptin synthesis and secretion whereas fasting and weight loss are associated with decreased leptin synthesis and secretion (Houseknecht *et al.*, 1998). Leptin administration leads to loss of body fat due to an increase in the rate of metabolism coupled with reduced energy intake (Woods *et al.*, 1998). Lean animals are more sensitive to leptin than animals with large fat stores, even though circulating concentrations of leptin in the latter group are higher (Houseknecht *et al.*, 1998). Thus leptin-resistance in certain obese animals may be due to changes in leptin receptors.

The decrease in food intake induced by local injection of leptin into the arcuate nucleus region of the hypothalamus is greater than for other sites of administration. The hypothalamic arcuate nucleus is one site of action of circulating leptin as it acts as an inhibitor of orectic peptides synthesized and released there (Rahmouni and Haynes, 2001). Leptin alters the transcription of several adipose-specific genes involved in lipogenesis, lipolysis and energy metabolism, and may trigger apoptosis in white adipose tissue (Qian *et al.*, 1998). Several studies have shown that the roles played by leptin in feed intake and energy regulation in humans and rodents are similar to those in ruminant livestock.

In well-fed ruminant animals, central administration of leptin reduced food intake (Morrison *et al.*, 2001) and energy intake level was related to adipose tissue leptin mRNA levels (Amstalden *et al.*, 2000). Studies with cattle (Chilliard *et al.*, 1998; Delavaud *et al.*, 1999, 2002; Amstalden *et al.*, 2000; Luna-Pinto and Cronje, 2000; Wegner *et al.*, 2001; Ren *et al.*, 2002) and with sheep (Bocquier *et al.*, 1998; Kumar *et al.*, 1998) indicate that the amount of feed consumed and levels of body fat are closely correlated with plasma leptin concentration. Amstalden *et al.* (2000) showed that leptin gene expression and circulating concentrations were lower in fasted compared with fully fed heifers, and Luna-Pinto and Cronje (2000) observed that restricted feeding reduced plasma leptin concentration. In beef cattle, Wegner *et al.* (2001) reported that plasma leptin concentrations were 3.85, 7.50 and 8.78 ng/ml in crossbred cattle that carried 0%, 50% and 75% Wagyu genetics, respectively. Studies with cattle (Ren *et al.*, 2002) have suggested variations in leptin mRNA due to breed and also that leptin expression in the body occurs in proportion to the amount of body fat, in agreement with studies in other species (Baile *et al.*, 2000).

Both growth hormone and thyroid hormone affect leptin synthesis and/or secretion. It has also been shown that changes in leptin mRNA and serum levels may result from an effect of thyroid hormone on adipose stores (Syed *et al.*, 1999). Growth hormone treatment in rats reduced leptin mRNA levels in certain fat tissues (Woods *et al.*, 1998; Isozaki *et al.*, 1999). Actions of leptin are generally opposed by glucocorticoids, depending on species, and these two hormones exert reciprocal influences on each other's secretion. Additionally, leptin and insulin are known to process feeding-related signals from the gastrointestinal tract (GIT) such as those originating from the peptide, cholecystokinin (Forbes, 2000). A relationship has been established between plasma leptin and insulin, where insulin stimulates leptin gene expression in adipose tissue and leptin influences glucose metabolism and insulin action (Houseknecht *et al.*, 1998). There also appear to be interactions between leptin and sympathetic pathways (Bachman *et al.*, 2002).

### **Neuropeptide Y**

NPY is a 36-amino acid peptide thought to play a role in the physiological regulation of energy balance. It is a powerful central appetite stimulator (Rahmouni and Haynes, 2001). NPY is synthesized by the arcuate nucleus neurons and secreted from their terminals in the paraventricular nucleus and lateral hypothalamus in response to signals associated with a decline in body fat stores and weight loss due to caloric restriction, lactation and intense exercise (Woods *et al.*, 1998). This response is mediated, in part, by reduced negative feedback from leptin and insulin (Houseknecht *et al.*, 1998).

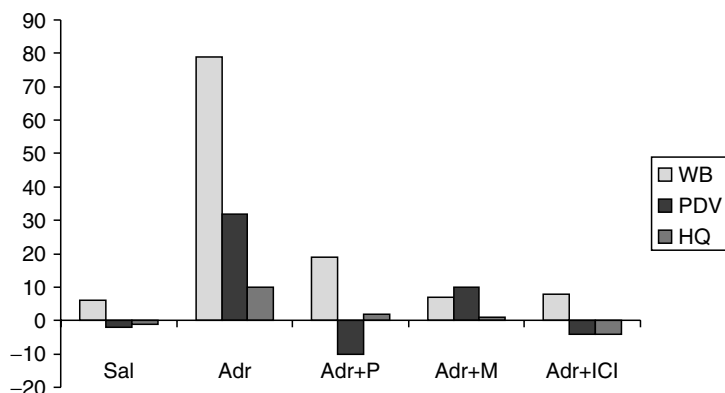
A period of weight loss is followed by activation of the NPY system to facilitate recovery of lost weight. Studies with mice have shown that cerebral ventricular or direct hypothalamic administration of NPY increases food intake and promotes obesity and that there is a dramatic increase in NPY in leptin-deficient animals (Wilding *et al.*, 1993). Leptin inhibits NPY gene expression and knockout of the NPY gene reduces many endocrine alterations resulting from leptin deficiency (Matsumara *et al.*, 2000). NPY, therefore, has key effects on the regulation of body weight and energy homeostasis by leptin (Rahmouni and Haynes, 2001). However, mice with a genetic deficiency in NPY have apparently normal food intake and body weight, thus hypothalamic interactions between NPY and leptin alone cannot account for all aspects of energy-balance regulation (Palmiter *et al.*, 1998). Other orectic (AGRP, MCH) and anorectic ( $\alpha$ -MSH) signals present in the hypothalamus serve to support the leptin/NPY mediation of nutrient intake (Woods *et al.*, 1998; Baile and Della-Fera, 2001).

Central administration of NPY in rats causes dose-dependent inhibition of growth hormone release, and corresponding reduction of plasma growth hormone concentration, through the stimulation of somatostatin (Pierroz *et al.*, 1995). In contrast, results in sheep indicate that central NPY attenuates somatostatin and enhances GH release (Gladysz *et al.*, 2001). This indicates another possible role of NPY in the regulation of growth. Additionally, it has been

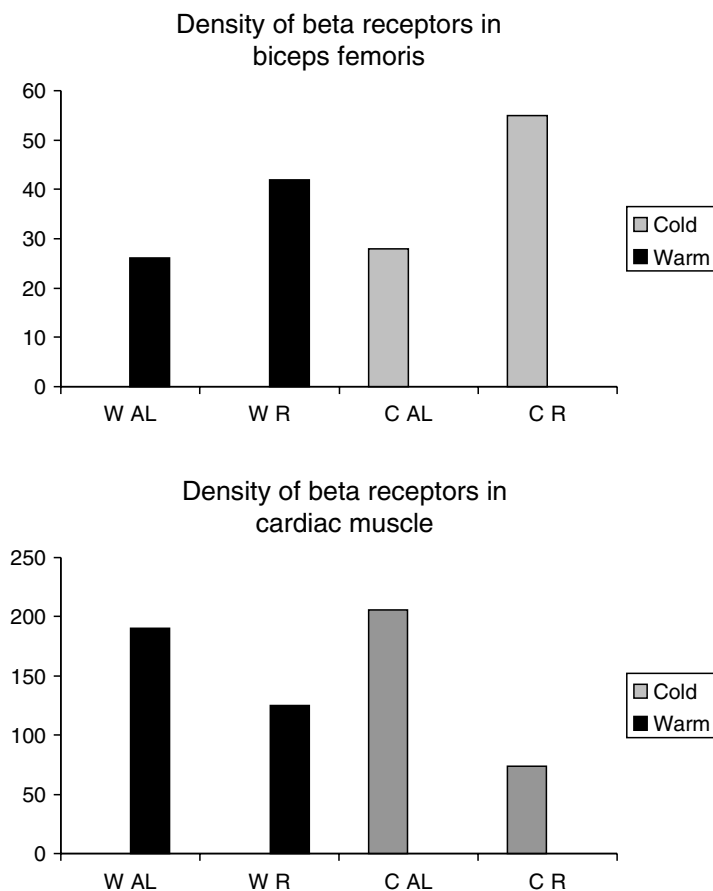
shown that, as well as stimulating food intake, NPY induces a general anabolic state by reducing energy expenditure and by stimulating the expression of genes encoding lipogenic enzymes (Woods *et al.*, 1998).

### Adrenergic receptors

Adrenergic receptors (AR) mediate the effects of endogenous catecholamines (epinephrine, norepinephrine and dopamine) released in response to stress. Generally, the effects of catecholamines on adrenergic receptors are catabolic and lead to mobilization of body energy reserves, in association with the need for increased energy expenditure. There are two broad classes of adrenergic receptors (alpha and beta), each of which may be further subdivided into several subtypes (Christopherson *et al.*, 1995). Figure 19.2 summarizes the whole body, portal-drained viscera and hindquarter changes in oxygen consumption in sheep, in response to adrenaline infusion in the presence or absence of various beta adrenergic antagonists. These results suggest that beta receptors play a major role in mediating metabolic responses to catecholamines. Beta-adrenergic receptors are linked to guanine nucleotide regulatory protein (G-stimulatory protein) that stimulates a variety of metabolic events including energy expenditure. Adrenergic receptors have also been shown to play major roles in body weight homeostasis of animals in a process known as diet-induced thermogenesis (Bachman *et al.*, 2002). Adrenergic receptor density in sheep tissues has been shown to vary in response to changes in feeding level and environmental temperature (Ekpe *et al.*, 2000a,b), as illustrated in Fig. 19.3. Variations in beta-adrenergic receptor density might be expected to influence energy metabolism. However, when data from Ekpe *et al.*



**Fig. 19.2.** Effects of 3-h infusions of physiological saline (Sal) as a control or adrenaline (Adr) in the presence or absence of beta adrenergic blocking agents (P = propranolol, M = metoprolol, ICI = ICI 118551 compound). Data represent the changes in oxygen consumption (ml/min) from pre-infusion values for the whole body (WB), portal-drained viscera (PDV) and hindquarter (HQ). Adapted from Miaron and Christopherson (1997).



**Fig. 19.3.** Density (fmol/mg protein) of beta-adrenergic receptors in biceps femoris muscle and cardiac muscle in sheep housed in warm (W) (20°C) or cold (C) (0–5°C) environments and fed either *ad libitum* (AL) or at a restricted (R) level. (Data from Ekpe *et al.*, 2000a,b.)

(2000a,b) were examined for evidence of possible relationships between heat production and tissue beta-adrenergic receptor density (Table 19.1), there was a positive relationship to heat production only in the case of cardiac muscle receptor density. The relationships were negative in the case of receptor density in skeletal muscle and liver. Synthetic analogues of catecholamines, known as beta agonists (e.g. clenbuterol, cimaterol, isoproterenol, ractopamine, L644.969), have been examined for growth promoting action (Christopherson *et al.*, 1995; Mersmann, 2002). Therefore, many beta agonists play anabolic roles in the stimulation of growth and anabolism of muscle at the expense of adipose tissue development (Christopherson *et al.*, 1995), leading to the production of leaner animals.

Dietary excess may activate the sympathetic nervous system and stimulate beta receptors on thermogenic tissues such as brown adipocytes (Bachman *et al.*, 2002). In ruminants, however, brown adipose tissue thermogenesis

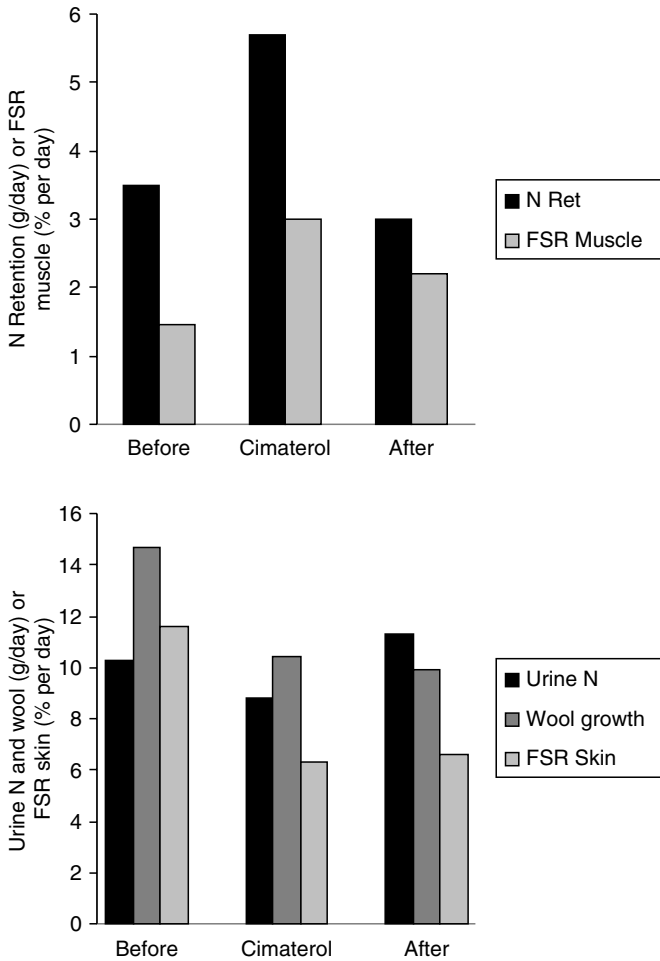
**Table 19.2.** Effect of the beta-adrenergic agonist (L-644,969) on growth, feed conversion ratio and carcass muscle and fat characteristics in sheep (from Li *et al.*, 2000).

Parameter	Control	Beta agonist	Pooled SE	Per cent change
Daily gain (g/day)	237 <sup>b</sup>	291 <sup>a</sup>	14.5	23*
Feed conversion (feed DM per gain)	6.3 <sup>a</sup>	5.4 <sup>b</sup>	0.26	-16*
Abdominal fat weight (% body weight)	5.80 <sup>a</sup>	5.03 <sup>b</sup>	0.24	-14*
Biceps fem weight (g)	327 <sup>b</sup>	380 <sup>a</sup>	10	16**
Rib eye area (mm <sup>2</sup> )	1405 <sup>b</sup>	1732 <sup>a</sup>	49	23**

<sup>a,b</sup>Treatment means are different \* ( $P < 0.05$ ), \*\* ( $P < 0.01$ ).

appears to be of significance only in very young animals (Landis *et al.*, 2002). Many beta agonists effectively reduce lipid accumulation in adipose tissues (Christopherson *et al.*, 1995) through activation of hormone-sensitive lipases to promote lipid mobilization (lipolysis) and deactivation of pathways leading to lipogenesis, as well as increase in the downregulation of lipogenesis. The net result of these apparently catabolic actions is the repartitioning of energy from fat accretion towards the support of other body tissues, especially skeletal muscle, as shown by results of Li *et al.* (2000) (Table 19.2). In addition to the repartitioning of energy from fat to muscle noted above, Nash *et al.* (1994) reported that beta agonists led to repartitioning of nitrogen from wool and skin to support muscle anabolism (Fig. 19.4). This, therefore, may partly explain the striking and preferential increase in skeletal muscle protein accretion by most catecholamine analogues, which act on beta receptors (Beermann, 2002). Oral administration of beta-adrenergic agonists usually causes an increase in daily gain accompanied, in many instances, by a slight decrease in feed intake and an improvement in efficiency of gain (Mersmann, 2002).

The repartitioning responses outlined above depend on a number of factors such as age, diet, sex, the type of agonists used and the dose (O'Connor *et al.*, 1991; Beermann, 2002). The anabolic effects on muscle include fibre hypertrophy, muscle fibre frequency changes and differential rates of muscle RNA, DNA and protein accretion. Smith *et al.* (1995) observed significant increases in myosin mRNA in cattle fed clenbuterol and ractopamine. Observed decreases in muscle proteolysis account, in part, for increased muscle protein accretion and reduced meat tenderness (Shackelford *et al.*, 1995). However, downregulation or desensitization of beta receptors is sometimes observed with chronic administration of beta agonists (Beermann, 2002) and may partly explain variations observed in the growth response to beta agonists. Also, indirect effects of beta agonists include modulation of other endocrine influences on growth. Feeding cimaterol to growing lambs increased GH and T4 concentrations and decreased IGF-I concentrations after 6 weeks, and subsequently decreased insulin concentrations by 50% (O'Connor *et al.*, 1991). In cattle, feeding of cimaterol led to an acute decrease in GH concentration, which was then followed by chronic increases in GH and a decrease in IGF-I. However, many other studies failed to show significant differences in GH or IGF-I concentrations in steers and lambs fed cimaterol (Beermann, 2002).



**Fig. 19.4.** Repartitioning of nitrogen from urine, wool and skin (lower panel) to support increased whole body N retention and muscle growth (upper panel) before, during and after beta agonist (cimaterol) administration in sheep. Data adapted from Nash *et al.* (1994).

## Gene Expression

Respiration calorimetry studies in cattle to examine gene expression for leptin, leptin receptor, NPY receptor and uncoupling proteins in Angus, Brahman-Angus and Charolais steers when fed at 1.2 times maintenance (1.2M) and 2.2 times maintenance (2.2M) have been reported by Murdoch *et al.* (2003). These studies examined gene expression in relation to growth, energy expenditure, including estimates of the ME requirement for maintenance ( $ME_m$ ), energy balance and the efficiency of energy utilization for retention above maintenance (dMER per dMEI).

### ***NPY, leptin and their receptors***

Activities of the sympathetic/adrenergic system are linked with other hormone receptor systems including leptin and NPY, which may influence energy balance (Thomas and Palmiter, 1997; Wolf, 1997).

NPY mRNA was not detectable by reverse transcription-polymerase chain reaction (RT-PCR) in any of our bovine tissue samples, except for hypothalamic tissue. Thus our bovine tissue analyses focused on leptin, leptin receptor and NPY receptor. These analyses of leptin, leptin receptor and NPY receptor have demonstrated widespread expression of these genes. Message for both leptin receptor and NPY receptor was detected in cardiac muscle, liver, rumen papillae and duodenum, although the leptin message was absent from these tissues. The abomasum did not express leptin or NPY receptor signal, but leptin receptor mRNA was expressed. The absence of leptin transcripts in bovine abomasum was surprising since it has been shown to be present in the fundus of both rat and human stomachs (Sobhani *et al.*, 2000). Perhaps this represents a species difference in the digestive tracts of ruminants compared to monogastrics. The presence of message for leptin receptor infers that circulating leptin influences these tissues. Leptin is considered to be a satiety hormone but also may be involved in the partitioning of nutrients (Scarpace *et al.*, 1998; Rouru *et al.*, 1999). Leptin mutation results in obesity (Verpoegen *et al.*, 1997), and elevates muscle fatty acid oxidation (Muoio *et al.*, 1997). Future research is needed to determine the physiological role conferred by fluctuating leptin receptor presence, in various bovine tissues.

Changes in leptin receptor may influence the sensitivity of these tissues to leptin. We have observed high levels of specific mRNA message, for leptin, within three adipose tissue depots and lower expression rates were observed in skeletal muscle (Murdoch *et al.*, 2003). The presence of message for both leptin and leptin receptors in adipose tissue and skeletal muscle suggests an autocrine role for leptin. The presence of leptin receptors in various regions of the bovine digestive tract begs the question as to the physiological relevance of such a distribution. Leptin may mediate the manner by which these digestive tract regions process and partition post-prandial substrates. The distribution of both the leptin and NPY receptors, in liver and cardiac muscle, suggests that serum leptin and NPY levels may be important mediators of whole animal metabolism in cattle.

The expression of NPY receptor in cardiac muscle was found to be negatively correlated with both efficiency of energy retention (dMER per dMEI,  $r = -0.41$ ) and ME requirement for maintenance ( $r = -0.33$ ). Accepting the principle that more receptor message, and, presumably more translated protein, would elevate the sensitivity of such a tissue to the NPY ligand, then given that NPY reduces fatty acid oxidation in cells, the effective catabolism of the cardiac muscle may be reduced resulting in improved energy retention efficiency. There was a positive correlation between the NPY receptor expression in liver and heat production (HP) ( $r = 0.40$ ). The hypothalamic release of NPY may serve to prepare the liver for the onset of nutrient intake, and thus the level of receptor expression in liver may be elevated in



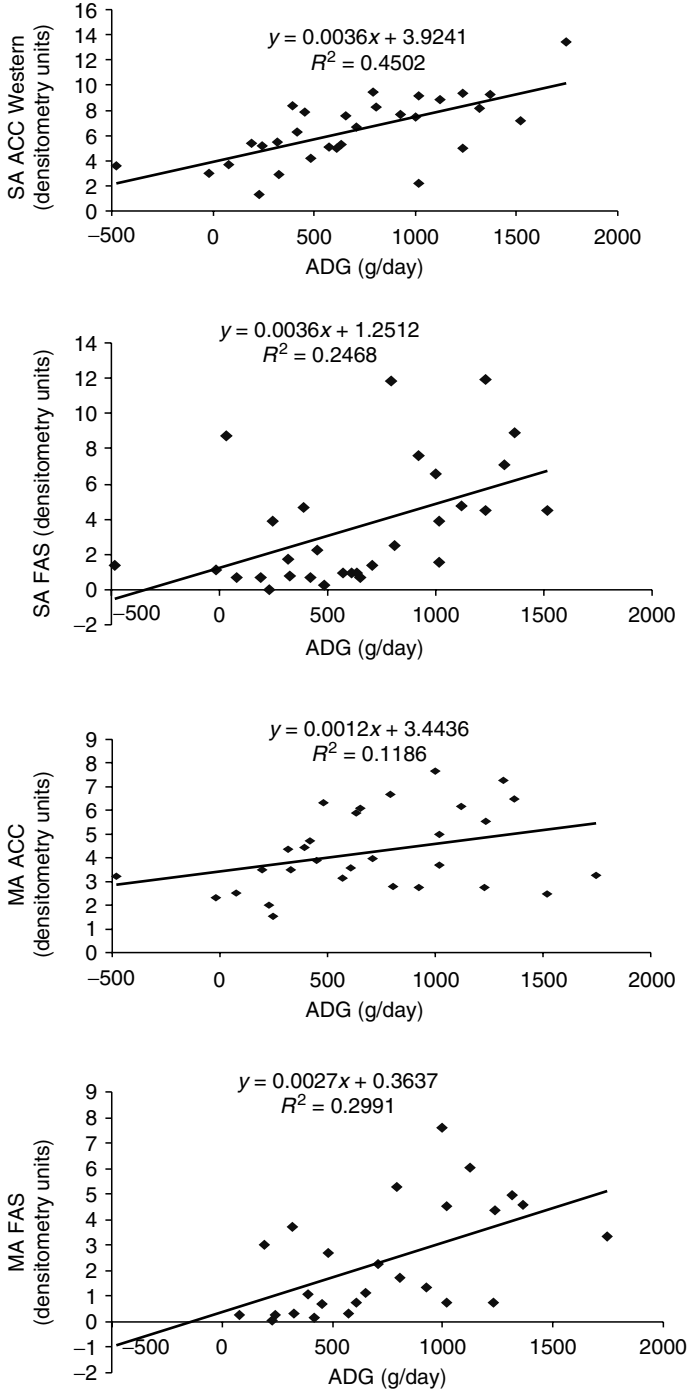
animals that have high intakes, which would also correlate to high-energy retention.

### ***Leptin, leptin receptor and NPY receptor in adipose tissue***

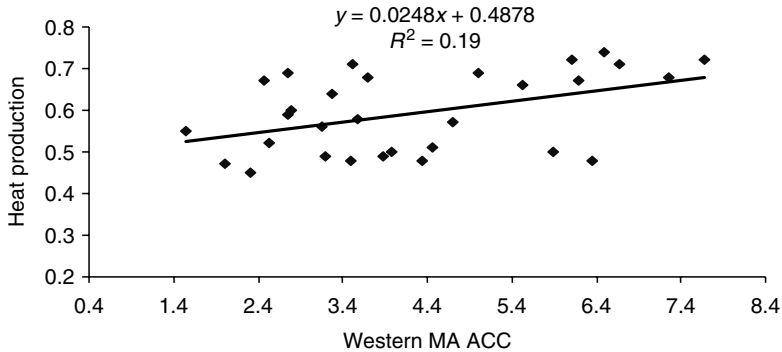
The expression of leptin message in peri-renal adipose tissue showed a small correlation with whole animal HP ( $r = 0.31$ ), and a negative relationship with efficiency of energy retention ( $r = -0.35$ ). It was hypothesized that expression of this gene may be a reflection of an individual's intake. The modest positive correlation observed between the HP and perirenal expression of leptin is the first indication that in young growing steers, expression of the leptin gene may be associated with the animals' metabolic HP. Since leptin can increase fatty acid oxidation in muscle cells, systemic release of leptin from adipose would be expected to elevate HP values. Overall though, our steers were quite lean and this may have reduced the amount of leptin expression that we characterized in our adipose tissues, somewhat obscuring correlation of this gene with indices of energy expenditure.

The leptin receptor expression in the mesenteric and subcutaneous adipose samples was positively correlated with ADG ( $r = 0.43$  and  $r = 0.30$ , respectively). Both of these adipose depots are considered as primary sources of leptin hormone in adult animals. The expression of leptin, especially by central adipose depots such as mesenteric, is believed to play a role in hypothalamic signalling of whole body adiposity. In lean animals the leptin released from adipocytes is the source of serum leptin that functions as an endocrine peptide, but expression of receptors by adipose tissue also indicates an auto-crine role for this peptide. As with other cell surface receptors, low exposure to a ligand may induce increases in receptor expression (upregulation). If a growing animal partitions more resources to muscle growth, then body weight increases would be greater than if it were depositing more adipose tissue, since adipose tissue is more energetically dense. The leaner body mass animals may thus increase in body weight and produce less leptin than animals that are less lean. The net effect may be observed as an increase in leptin receptor expression in adipose of leaner animals, which would correlate with higher ADG values.

Positive correlations were also observed between ADG ( $\text{g/day/kg}^{0.75}$ ) and the protein abundance of acetyl-CoA carboxylase (ACC) ( $r = 0.30$  to  $0.66$ ) and fatty acid synthase (FAS) ( $r = 0.54$  to  $0.62$ ), measured by Western blot analysis in subcutaneous (SA) and mesenteric (MA) adipose tissue (Fig. 19.5). These significant ( $P < 0.05$ ) regressions indicate that whole body growth was associated with increased expression of genes for lipogenic enzymes in major adipose tissue depots. This may partly represent the increased lipid synthesis associated with higher levels of feeding and/or be a reflection of the ability of the most rapidly growing animals to partition nutrients efficiently. The increased gene expression for these enzymes might also be linked to an increased turnover of lipid in the tissues of growing steers as positive correlations were also observed between lipogenic enzymes and HP (Fig. 19.6).



**Fig. 19.5.** Relationship between average daily gain (ADG) of steers and the tissue protein expression for acetyl coenzyme A (ACC) and fatty acid synthase (FAS) in subcutaneous (SA) and mesenteric (MA) adipose tissues of growing steers. (Unpublished observations of Moibi, Murdoch, Dixon and Christopherson.)

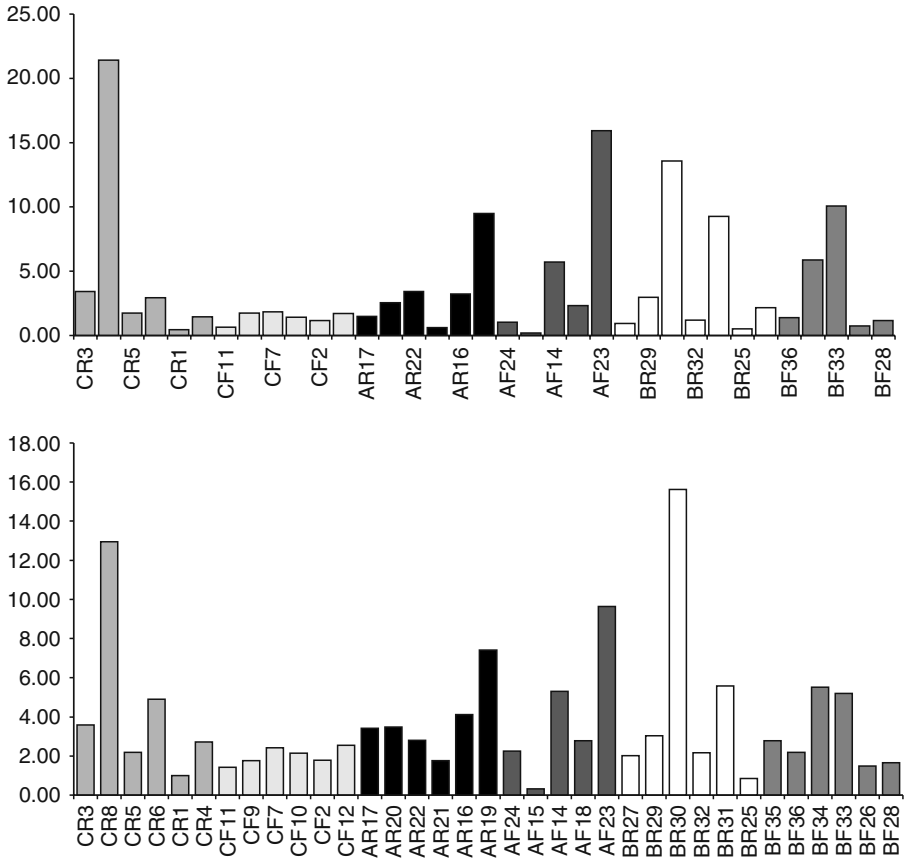


**Fig. 19.6.** Relationship between whole body heat production ( $\text{MJ}/\text{kg}^{0.75}/\text{day}$ ) and abundance of acetyl coenzyme A (ACC) (measured by Western blot analysis) in mesenteric adipose tissue of beef steers. (Unpublished observations of Murdoch, Moibi, Li, Dixon and Christopherson.)

### ***Leptin and NPY receptors in skeletal muscle***

A high and significant correlation ( $r = 0.91$ ) between leptin receptor and NPY receptor in muscle was observed in our studies with a group of 35 cattle. The leptin receptor gene and the NPY receptor gene in cattle biceps femoris tissue were, therefore, synchronously expressed in individual animals at varying levels (Fig. 19.7). These results suggest that, in the skeletal muscle of growing cattle, the sensitivity of the peripheral muscle to leptin and NPY may be regulated in a coordinated fashion. If we accept the doctrine that receptor expression level is associated with ligand sensitivity, then this finding suggests that there are individuals with high levels of sensitivity to serum leptin and NPY and other animals that are less sensitive to both. Better understanding of muscle physiology in growing steers and differences between individual animals may facilitate informed decisions in future management or selection strategies.

The expression of leptin receptor and NPY receptor in biceps muscle biopsies were highly and negatively correlated to HP measured at 1.2M,  $\text{ME}_m$  and efficiency of ME use for energy retention, but were not related to ADG or HP at the 2.2M level of feeding. This may mean that the gene expression in a muscle biopsy, taken early in the growth period, might be a good reflection of energy expenditure at maintenance and slow growth but not a good reflection of maximum growth or energy metabolism later on. Further, the perirenal leptin receptor mRNA and post-mortem skeletal muscle expression of leptin receptor mRNA, were positively related to HP at 2.2M level of feeding. The mesenteric adipose tissue leptin receptor mRNA was positively, whereas the mesenteric adipose NPY receptor mRNA was negatively related to ADG/ME. This suggests that leptin receptor and NPY receptor are not closely related in adipose tissue, which is very different from the situation observed for the skeletal muscle gene expression profiles.



**Fig. 19.7.** Coordinate expression of the m-RNA for leptin receptor (lower panel) and NPY receptor (upper panel) in biceps femoris muscle from individual steers from each of three breed groups; Charolais (C), Aberdeen Angus (A) and Brahman-Angus cross (B) fed at either 1.2 × maintenance (R) or 2.2 × maintenance (F). Each bar represents the ratio of gene expression relative to expression of the constitutively expressed gene for G3PDH for an individual steer. (From Murdoch *et al.*, 2001.)

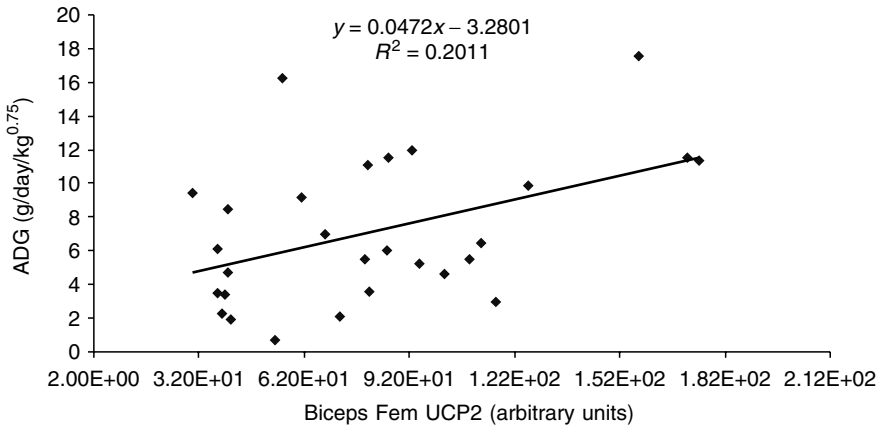
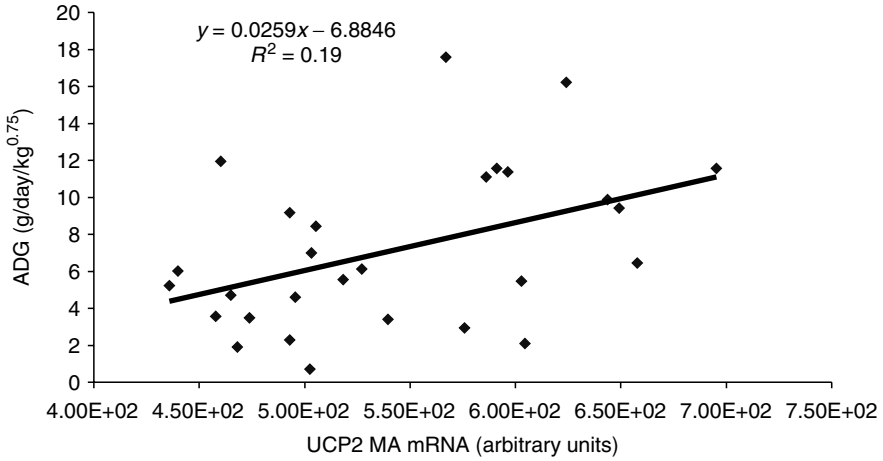
### Uncoupling proteins

Uncoupling protein-2 (UCP-2) and uncoupling protein-3 (UCP-3) may have roles in influencing energetic efficiency and maintenance (Boss *et al.*, 1997; Fleury *et al.*, 1997; Vidal-Puig, 1997). UCP-2 and UCP-3 are linked to proton-conductance pathways in the mitochondria of cells. UCP-2 is a recently discovered gene that is expressed in many tissues in mice and humans, but has not previously been studied in cattle (Fleury *et al.*, 1997). UCP-3 has also been studied recently in rodents and humans and is expressed in both skeletal muscle and brown adipose tissue but not other organs (Boss *et al.*, 1997; Vidal-Puig, 1997). It has also not been previously studied in cattle. These genes could each have an influence on maintenance requirements, energy balance and growth

efficiency in animals (Wolf, 1997). They may be of particular importance in ruminants since their energetic efficiency of growth is lower than that of monogastric animals.

UCP-2 is the most ubiquitously expressed subtype of uncoupling protein, and was present in all the bovine tissues examined except abomasum and duodenum, whereas UCP-3 was detectable only in biceps femoris skeletal muscle, perirenal adipose tissue and cardiac muscle (Murdoch *et al.*, 2003). Although UCP-3 is predominantly expressed in skeletal muscle (Vidal-Puig, 1997), its expression in other metabolically important tissues such as adipose (perirenal) and cardiac muscle may be indicative of a role in adaptive thermogenesis. In our cattle studies, the measurement of UCP-2 mRNA revealed little if any mean difference in expression due to either feeding level or between the three breeds (Murdoch *et al.*, 2003). However, large standard deviations within breed and feeding level indicated that there was substantial variability between individual animals in expression of UCP-2 message. Expression of UCP-2 is influenced by catecholamines such as norepinephrine (Thomas and Palmiter, 1997), thyroid hormones (Obregon *et al.*, 1996), peroxisome proliferator activating receptors (PPAR) (Aubert *et al.*, 1997) and leptin (Zhou *et al.*, 1997), all of which are known to vary substantially between individuals, and under differing physiological conditions. We have observed a highly significant increase ( $P < 0.01$ ) in UCP-2 expression in acutely cold exposed steers vs. controls (Murdoch *et al.*, 2003) suggesting that this gene may be of importance for cattle in cold climates. This observation is consistent with results in mice (Enerback *et al.*, 1997). The capacity of UCP-2 to be upregulated during conditions of cold stress supports the hypotheses that this gene may have a role in adaptive thermogenesis. Although UCP-2 is influenced by fasting in humans (Millet *et al.*, 1997), we did not observe a change in UCP-2 with level of feeding in our cattle experiments. Perhaps this was because our lower level of intake was an insufficient level of restriction to induce similar changes in the expression profile as that induced by fasting. Although speculative, the variability observed in the UCP-2 gene expression between individuals within and between breeds, may ultimately be related to variability in growth and energetic efficiencies observed among individual animals.

The expression of UCP-2 mRNA in skeletal muscle, subcutaneous adipose and mesenteric adipose tissues were all positively correlated with ADG (Murdoch *et al.*, 2003) (Fig. 19.8). Given that the uncoupling proteins are believed to uncouple the mitochondrial proton gradient from ATP synthesis, hence reducing efficiency of energy conversion, this trend may seem surprising. It is possible that the level of expression of these genes is indicative of the nutrient availability to these tissues. Given such a hypothesis, animals that show higher rates of ADG may represent animals that partition their nutrients to anabolic tissues such as the skeletal muscle and subcutaneous and mesenteric adipose. These same animals may also chronically adapt to express higher levels of uncoupling proteins on the basis of ultimately having higher established and more persistent proton gradients within their mitochondria associated with greater energy release. This may also be supported by the positive correlation ( $r = 0.44$ ) between UCP-2 expression in mesenteric adipose and metabolizable



**Fig. 19.8.** Relationship between uncoupling protein-2 (UCP2) mRNA expression in mesenteric adipose tissue (MA; upper panel), biceps femoris muscle (lower panel) and average daily gain (ADG) in growing steers. (Murdoch, Dixon and Christopherson, unpublished observations.)

energy intake (MEI) (MJ/day/kg<sup>0.75</sup>). In this instance the expression of UCP-2 and UCP-3 may be representative of useful markers of animals that inherently show higher growth rates on the same nutritional plane.

A modest though significant correlation ( $r = 0.33$ ) was observed between the expression profile of UCP-2 mRNA in mesenteric adipose tissue and HP across all animals regardless of treatment. This correlation might be more attributable to the capacity of UCP-2 to uncouple the oxidative phosphorylation pathway away from energy storage in terms of ATP synthesis. This correlation represents the first such evidence of a link between whole animal HP and expression of this uncoupling protein in bovine species. Assuming that the mesenteric adipose depot represents the long-term storage of lipids that accumulates in an animal provided with sufficient and/or abundant nutrients for growth, then the uncoupling of ATP synthesis in these animals should result

in increased HP. Support for this concept is provided by the demonstration that UCP is upregulated by the presence of fatty acids (Klingenberg, 1993), as would be the case in nutrient abundance in cattle.

The expression of the UCP-3 gene was less consistent across tissues than that of UCP-2, and no differences were attributable to either breed or level of feed intake (Murdoch *et al.*, 2003). We observed expression of the UCP-3 gene in skeletal muscle, cardiac muscle and perirenal adipose, all of which showed substantial individual animal variability. Individual variability was proportionally less in cardiac muscle than in the mixed fibre type skeletal muscle (biceps femoris) but it is yet unknown whether this is consistent over other skeletal muscle types. Skeletal muscle is typically considered the primary site of expression for UCP-3 (Boss *et al.*, 1997). UCP-3 is regulated in rat skeletal muscle by thyroid hormone (Larkin *et al.*, 1997), leptin (Liu *et al.*, 1997) and catecholamines (Gong *et al.*, 1997). The detection and measurement of UCP-3 in bovine cardiac muscle is the first report of such presence but is supported by observation of this gene's expression in both rats and humans. UCP-3 mRNA has been observed in piglet skeletal muscle and adipose tissue, as reported by Damon *et al.* (2000), and is implicated in affecting the energy metabolism of these tissues in rats under fasting states. The lack of change in UCP-3 expression levels with our reduced feeding level is most probably a reflection of the modest degree of restriction imposed. We observed an increase in expression of UCP-3 mRNA in biceps femoris of cattle housed outdoors during winter ( $P < 0.05$ ), suggesting a potential role during acclimation to winter. A significant negative correlation ( $r = -0.34$ ) was observed between the expression of UCP-3 in cardiac muscle and energy retention, which could suggest that the expression of this gene in the heart is inversely associated with the animal's whole body energy retention. Research in humans by Cortright *et al.* (1999) has demonstrated a positive correlation between UCP-3 gene expression in muscle and exercise, which may support the interpretation that elevations in metabolic rate result in elevated UCP-3 and reduced energy storage or retention. Assuming that cardiac fitness is related to whole animal fitness, then reduced energy retention may indicate reduced sedentary behaviour or, conversely, increased energy expenditure, and the elevation of UCP-3 in cardiac muscle may be representative of these more active though less efficient cattle.

### ***Protease systems, protein turnover and energy metabolism***

Genes that code for intracellular protease systems (including lysosomal,  $\text{Ca}^{2+}$ -dependent and ATP/ubiquitin-dependent systems) (Baracos *et al.*, 1995) and extracellular matrix-metalloproteinase, which contribute to the processes of protein turnover in the animal's tissues, may also be linked to differences in growth and efficiency of growth. Regression analysis of results with cattle revealed positive correlations between the energy and protein intake and the expression of genes of components of the muscular proteolytic systems (D. Balcerzak, V.E. Baracos, W. Dixon and others, unpublished observations).

The expression of both  $\mu$ -calpain and m-calpain large subunit was downregulated ( $P < 0.03$ ) under feed restriction, and the expression of these two genes was correlated to the level of HP and nitrogen intake. The ubiquitin gene was also downregulated ( $P < 0.001$ ) under feed restriction and its expression showed a positive correlation with the average HP, indicating energy savings during restriction. Starved or fasted rats actually showed an increase of ubiquitin expression related to food deprivation and concomitant to an activation of the proteasome (Wing and Goldberg, 1993). However, in the cattle study of Balcerzak and co-workers the animals were not fasted but were only moderately restricted. Clearly, the degree of restriction modifies the gene expression response.

A positive correlation was observed between the expression of urokinase plasminogen activator (uPa), genes of the matrix-metalloproteinase system (TIMP-3, MMP-2 and MT3-MMP genes) and the nitrogen intake, ADG and average HP of steers. There was also a positive correlation between the excretion of 3-methyl histidine (3MH) and the HP ( $r = 0.39$ ,  $P = 0.04$ ) and between the excretion of hydroxyproline and the HP ( $r = 0.51$ ,  $P = 0.006$ ). Collagen and myofibrillar proteins are the most abundant proteins in the whole body, and the excretion of hydroxyproline and 3MH in the urine (marker indicators of protein degradation) both decreased under feed restriction by 23.6% and 30.4%, respectively. Loble *et al.* (2000) reported similar results concerning the level of urinary excretion of 3MH in restricted calves (ADG: 1.0 kg/day) vs. full fed calves (ADG: 1.4 kg/day). The general reduction in the whole body protein turnover with feed restriction, would conserve energy, and perhaps contribute to compensatory growth upon a return to *ad libitum* feed intake. On the other hand, in animals experiencing an increased energy demand such as that observed in calves in a cold environment (Scott *et al.*, 1993), reduced protein accretion was associated with decreased fractional protein synthesis in several tissues and a tendency for protein degradation (as reflected by 3MH excretion) to increase (Table 19.3).

**Table 19.3.** Effects of warm (W, 20°C) or cold (C, -5°C) environmental temperature and feeding level (72 or 90 g feed/day/kg) on fractional protein synthesis rates (FSR) and 24 h urinary excretion of 3-methyl histidine (as an indicator of muscle protein degradation) in young growing calves (adapted from Scott *et al.*, 1993).

Measurement	Tissue or sample site	Treatment			SE
		W 72	C 72	C 90	
Protein FSR (% per day)	Longissimus dorsi	2.5 <sup>a</sup>	1.5 <sup>b</sup>	2.8 <sup>a</sup>	0.2
Protein FSR (% per day)	Biceps femoris	3.1 <sup>a</sup>	1.4 <sup>b</sup>	2.6 <sup>a</sup>	0.2
Protein FSR (% per day)	Kidney	32 <sup>a</sup>	28 <sup>b</sup>	32 <sup>a</sup>	2.0
Protein FSR (% per day)	Skin	12 <sup>c</sup>	6.5 <sup>d</sup>	11 <sup>c</sup>	1.9
3-methyl histidine ( $\mu$ mol/day/kg)	Urine	1.90 <sup>c</sup>	2.57 <sup>d</sup>	2.50 <sup>d</sup>	0.15

Significance: <sup>a,b</sup>( $P < 0.01$ ); <sup>c,d</sup>( $P < 0.12$ ).



## Residual Feed Intake (RFI)

The preceding sections in this chapter focused upon physiological regulation of growth through a review of relevant genes and hormones. Several significant relationships between growth and energetic parameters (based on calorimetry) and gene expression profiles of individual animals were described. Many of these genes merit further examination as potential markers in the context of selection for improved efficiency. The subsequent sections outline applied analyses of ruminant growth, with a focus on 'RFI' as a potentially useful approach to identify animals displaying differing efficiencies of growth. This approach, while less technically complex than calorimetry, has the advantage of being applicable to large populations of animals.

In ruminants, 70–75% of the total dietary energy cost in beef production is used for maintenance (NRC, 1996), and in addition, there is substantial energy demand for the synthesis of new tissues during growth. Thus, in beef production, only 5% of the total life cycle dietary energy consumption is used for protein deposition, whereas, pork and poultry are more efficient at 14% and 22%, respectively (Ritchie, 2000). This disadvantage is offset by the ability of ruminants to utilize low-cost, high-fibre diets (not readily digested by monogastrics) during much of their life cycle. Major reasons for the inefficiency of beef production include relatively large size of the animal, slow maturity and reproduction rates (Pitchford *et al.*, 2002). Thus, animal differences in converting energy and nutrients into body tissue are important in determining the efficiency of growth.

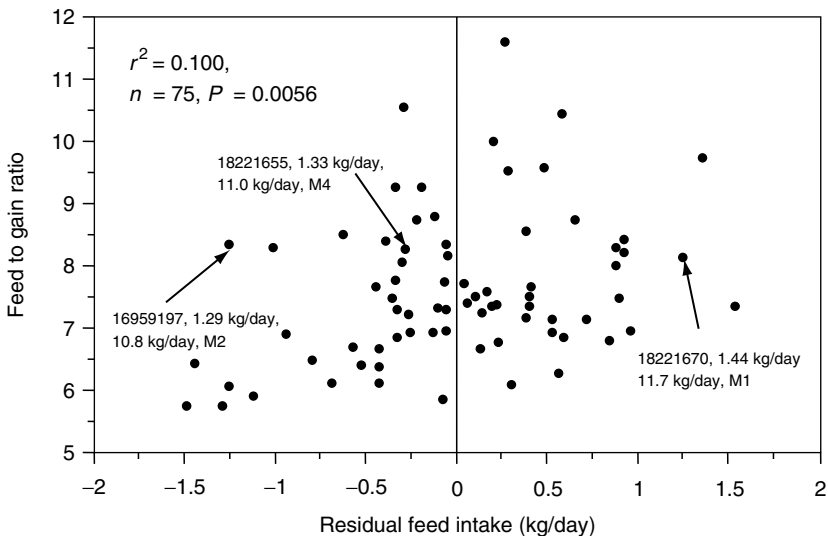
Genetic variation in the  $ME_m$  requirement of cattle is moderately heritable ( $h^2 = 0.22\text{--}0.71$ ), suggesting an opportunity to select for more efficient cattle (Carstens *et al.*, 1989; Bishop, 1992). Selection for lower maintenance requirements is technically difficult on large numbers of animals and practical measures of feed efficiency, such as feed conversion ratio (FCR), are influenced and complicated by changes in composition of gain and appetite (Arthur *et al.*, 2001a). Various other refinements have been used, including partial efficiency of growth in excess of maintenance feed requirements, relative growth and the Kleiber ratio, defined as weight gain per unit metabolic weight. However, ADG, which determines the length of time the animal requires to be fed to gain a given amount of weight, plus the ratio of intake to gain have continued to be used as easily measured variables (Arthur *et al.*, 2001b).

The rationale behind selection of cattle for increased rate of growth is based on the assumption that the maintenance feed energy requirement becomes a smaller percentage of the total energy requirement of the rapidly growing animal. A faster rate of growth also leads to a physiologically lower age at a fixed slaughter weight (Luiting *et al.*, 1991). Indeed, selection for a faster rate of growth to a fixed end point of slaughter weight favours cattle with genetically larger mature size. The larger size animals become physiologically less mature at equal slaughter weight and are thus at a lower proportion of their mature weight. This kind of strategy leads to a higher efficiency only as a result of a lower degree of maturity at slaughter. However, to be economically viable, carcasses must have minimal fat content to achieve market grade and slaughter weights have progressively increased in the industry.

The result of years of selection for growth rates support the genetic scaling theory which indicates that an increase in productivity on the growth side leads to increased mature weight, and a consequent increase in maintenance requirements (Taylor *et al.*, 1986). Thus, selection for high growth rates inevitably leads to a population of cattle with increased maintenance requirements, higher feed requirements and intake, with attendant higher feed and environmental costs.

RFI is a feed efficiency trait that is independent of body weight and weight gain (Koch *et al.*, 1963), and is defined as the difference between an animal's actual feed intake and its expected feed requirements for maintenance and growth. In practical terms, RFI estimates efficiency of use of feed consumed by subtracting observed dry matter intake (DMI) of an individual from DMI predicted by an equation developed from the relationship between DMI, daily gain and metabolic mean weight across fed contemporaries (Basarab *et al.*, 2003). It is expected that actual ME intake will equal the total predicted ME requirement for maintenance plus growth. A positive residual feed consumption means that the animal's MEI exceeds its predicted requirement for maintenance and growth, which would signify a low-efficiency animal. When residual feed consumption is negative, it means that the animal either requires less energy than what is estimated or is eating less to produce the same weight gain (a more efficient animal). The RFI trait is moderately heritable ( $h^2 = 0.29\text{--}0.46$ ), implying that improvements could be made in feed efficiency without affecting body size or growth rate (Archer *et al.*, 1998; Arthur *et al.*, 2001a) by selection based on RFI.

A further analysis of the data from Basarab *et al.* (2003) has been completed by Okine *et al.* (2003) and is depicted in Fig. 19.9. Over a finishing period



**Fig. 19.9.** Relationship between residual feed intake and feed to gain ratio (from Okine *et al.*, 2003).

ranging from 71 to 183 days, steers from five genetic strains had DMI of 10.9 kg/day, ADG of 1.46 kg/day and an RFI of 0.00 (SD = 0.66) kg/day. The steers varied in RFI values from an efficient -1.49 to an inefficient 1.54 kg/day. Thus, with similar ADG some steers had 1.49 kg/day less and 1.54 kg/day more than the expected DMI. Figure 19.9 also shows that some steers with similar feed efficiency have vastly different RFI. For example, steers numbered 16959197, 18221655 and 18221670 have similar feed to gain ratios (8.2 and 8.4:1) and similar ADG. However, their RFI values range from an efficient -1.26 to inefficient 1.26 kg/day. Steers 16959197, 18221655 and 18221670 actually weighed 584, 514 and 430 kg, respectively, at slaughter. Indeed, for similar DMI, the steer numbered 16959197 had an advantage of about 70 and 150 kg in body weight compared to steers 18221655 and 18221670.

## RFI and Animal Performance

### *Growth rate and body size*

RFI, by definition, adjusts feed intake for gain and metabolic mid-point weight (Koch *et al.*, 1963). Thus, in theory one expects that the phenotypic correlation between RFI and measures of growth and body size are automatically zero. This assertion has been established by studies in Australia (Archer *et al.*, 1998; Arthur *et al.*, 2001c), Canada (Basarab *et al.*, 2003), France (Arthur *et al.*, 2001a) and the USA (Koch *et al.*, 1963; Jensen *et al.*, 1992). These studies demonstrate that the phenotypic correlations between RFI and ADG and body size are zero or close to zero. A typical example is the work of Basarab *et al.* (2003). They measured RFI, growth rate and body components on 148 steers from five genetic strains. These steers grew at 1.52 kg/day and had a DMI of 8.5 kg/day. The RFI varied from an efficient -1.95 to an inefficient +1.82 kg/day. Basarab *et al.* (2003) did not observe any phenotypic correlations of RFI and ADG, slaughter or metabolic midpoint weight, hip height near slaughter and gain in hip height during the finishing period.

Unlike RFI, which is phenotypically independent of growth and body size, the genetic correlations ( $r_g$ ) with these performance indicators may not be close to zero. Archer *et al.* (1998) and Herd and Bishop (2000) reported genetic correlations between RFI and yearling weight of -0.25 and 0.15, respectively, while Jensen *et al.* (1992) obtained genetic correlations between RFI and ADG of 0.32 and -0.24 for two different test periods. In addition, Arthur *et al.* (2001a) reported genetic correlations between RFI and ADG of -0.10 for Charolais bulls ( $n = 792$ ) fed *ad libitum*. On the contrary, Arthur *et al.* (2001c), in a study of Angus bulls and heifers ( $n = 1180$ ), reported that RFI was genetically independent of ADG ( $r_g = -0.04$ ) and metabolic midpoint weight or body size ( $r_g = -0.06$ ). Similarly, a study by Arthur *et al.* (2001b) revealed that after two generations of divergent selection for RFI, no differences were observed in the yearling weight or ADG of progeny from efficient or inefficient parents. These data may indicate the uncertainty of the direction or magnitude of the genetic correlation between RFI and growth traits.

## **Intake and FCR**

Phenotypic correlations between RFI and DMI are moderate and positive in Hereford ( $r_p = 0.64$ ; Herd and Bishop, 2000), Charolais ( $r_p = 0.60$ ; Arthur *et al.*, 2001a), Angus ( $r_p = 0.72$ ; Arthur *et al.*, 2001c) and feedlot ( $r_p = 0.42$ ; Basarab *et al.*, 2003) cattle. Similarly, the phenotypic correlation between RFI and FCR ranged between 0.53 and 0.70 in the studies cited above. Basarab *et al.* (2003) also reported that low RFI steers consumed 10.4% less dry matter (8.00 vs.  $8.93 \pm 0.05$  kg DM/day;  $P < 0.01$ ) and had a 9.4% improvement in FCR (5.39 vs.  $5.95 \pm 0.06$  kg DM/kg gain;  $P < 0.01$ ) compared with high RFI steers. These results accord with results from Australian workers who, after two generations of divergent selection for RFI, reported that the progeny from low RFI parents consumed 11.3% less feed and had a 15.4% improvement in FCR compared to the progeny of high RFI parents (Arthur *et al.*, 2001b).

Genetically, RFI is also moderately and positively related to DMI ( $r_g = 0.69$  and 0.79) and FCR ( $r_g = 0.66$  and 0.85) (Arthur *et al.*, 2001a,c). These results suggest that selection for low or negative RFI will result in reduced feed intake and improved FCR, with potentially no adverse effect on growth rate and body size.

## **Body composition and composition of gain**

Differences in feed efficiency may be due to differences in the composition of liveweight gain (Pullar and Webster, 1977; Ferrell and Jenkins, 1998), due to the lower energy content of water and protein relative to fat and different maintenance costs associated with different visceral organ weights and altered feed intake (Ferrell and Jenkins, 1998). In addition, higher maintenance costs are more associated with body protein than with body fat (Pullar and Webster, 1977). These assertions have led to speculations that differences in RFI may be accounted for by differences in body composition. However, Basarab *et al.* (2003) found no relationship between RFI and empty body fat ( $r_p = 0.12$ ,  $P = 0.14$ ), but observed a negative trend between RFI and empty body protein ( $r_p = -0.14$ ,  $P = 0.09$ ). The phenotypic correlation between RFI and gain in empty body fat was low ( $r_p = 0.26$ ,  $P < 0.01$ ), while that between RFI and gain in empty body protein was not statistically significant. Basarab *et al.* (2003) also reported that low RFI steers had 3.1% more empty body water, 6.0% less empty body fat and 4.7% less empty body energy than high RFI steers. These differences resulted from a faster accretion rate of empty body water (12.9%) and a slower accretion rate of empty body fat (13.8%) in low RFI steers compared to high RFI steers. Thus, steers with low RFI may have a slightly slower rate of empty body fat deposition than steers with high RFI. Richardson *et al.* (2001) reported that less than 5% of the variation in parental RFI was explained by variation in body composition of their steer progeny. In their study, this small relationship in RFI to body composition appeared to trend ( $P < 0.1$ ) toward an increase in protein gain by low RFI steers as

compared with high RFI steers. Basarab *et al.* (2003) suggest that an adjustment for this bias in body composition may be achieved by measuring animals for ultrasound backfat thickness and marbling score at the beginning and end of the test period.

### **Partitioning of energy**

Differences in RFI of animals may be due to the utilization of energy and the way in which the animals partition the available energy. There was a strong, positive phenotypic correlation between RFI and MEI (MEI;  $r_p = 0.80$ ,  $P < 0.01$ ; Basarab *et al.*, 2003). Thus, high RFI steers consumed 11.3% more MEI and had 10.3% more calculated HP than low RFI steers. High RFI steers also partitioned more of the increase in MEI towards HP and less toward retained energy than either medium or low RFI steers. The low RFI steers had lower weights of liver ( $P < 0.01$ ), small and large intestine ( $P = 0.09$ ), and stomach and intestine ( $P < 0.01$ ) than high RFI steers. NRC (1996) and Ferrell and Jenkins (1998) have reported that the efficiency of ME use for retained energy is not constant, but decreases as MEI increases. Indeed, Ferrell and Jenkins (1998) suggested that a portion of non-linearity in the relationship of retained energy on MEI was due to a depression in metabolizability of the diet at high levels of intake, higher maintenance cost or heat increment of feeding at higher levels of feed intake and heavier organ weights of stomach complex, intestines, heart, lung, kidney and spleen.

### **Physical activity**

The physiological mechanisms associated with feed efficiency following selection against high RFI in cattle are many and could include variation in activities such as eating, rumination, standing, exercise, expression of genes related to thermogenesis such as uncoupling proteins, ion transport, lipid and protein turnover, among others. In poultry and pigs, the level of physical activity has been shown to be strongly associated with feed efficiency, accounting for 29–79% of the variation in maintenance requirements in chickens (Luiting *et al.*, 1991) and 47% of the variation in RFI in pigs (De Haer *et al.*, 1993). Basarab *et al.* (2003) reported that low, medium and high RFI steers did not differ ( $P > 0.1$ ) in the number of visits to the feeder or in the total time spent eating each day. Phenotypic correlations between RFI and number of visits to the feeder ( $r_p = 0.14$ ,  $P = 0.08$ ) and total time spent eating each day ( $r_p = 0.13$ ,  $P = 0.12$ ) did show a small, positive trend toward high RFI steers (inefficient) visiting the feeder more frequently and spending more time eating each day. Nkrumah *et al.* (2003) reported a strong, positive phenotypic correlation ( $r_p = 0.75$ ,  $P < 0.01$ ) between RFI and total time spent eating each day in 90 hybrid beef calves (299 kg) fed a maize-based diet.

## Implications

There is evidence to support RFI as an indicator of the maintenance energy requirements of an animal. This trait is moderately heritable, indicating that genetic progress could be made in RFI by incorporating it into already existing genetic improvement programmes. In addition, selection for lower RFI animals can be made without adversely affecting growth rate and body size. Differences in RFI may be minimally associated with differences in subcutaneous and intramuscular fat deposition, intermuscular and internal fat deposition. However, there may be a need to adjust RFI for differences in the chemical composition of gain so as not to adversely affect carcass characteristics in feeder cattle and fat deposition in breeding females. There is an opportunity to combine the use of RFI, or calorimetry measurements of energetics of growth in individual animals together with molecular measurements of gene expression in those same animals to identify animals with the most efficient growth.

## References

- Amstalden, M., Garcia, M.R. and William, S.W. (2000) Leptin gene expression, circulating leptin, and luteinizing hormone pulsatility are acutely responsive to short-term fasting in prepubertal heifers: relationships to circulating insulin and insulin-like growth factor I. *Biology of Reproduction* 63, 127–133.
- Archer, J.A., Arthur, P.F., Herd, R.M. and Richardson, E.C. (1998) Genetic variation in feed efficiency and its component traits. *Proceedings of the Sixth World Congress. Genetics Applied to Livestock Production* 25, 81–84.
- Arthur, P.F., Renand, G. and Krauss, D. (2001a) Genetic and phenotypic relationships among different measures of growth and feed efficiency in young Charolais bulls. *Livestock Production Science* 68, 131–139.
- Arthur, P.F., Archer, J.A., Herd, R.M. and Melville, G.J. (2001b) Response to selection for net feed intake in beef cattle. In: *Proceedings of the 14th Conference of the Association for Advancement of Animal Breeding and Genetics*, pp. 135–138.
- Arthur, P.F., Archer, J.A., Johnson, D.J., Herd, R.M., Richardson, E.C. and Parnell, P.F. (2001c) Genetic and phenotypic variance and covariance components for feed intake, feed efficiency and other postweaning traits in Angus cattle. *Journal of Animal Science* 79, 2805–2811.
- Aubert, J., Champigny, O., Saint-Marc, P., Negrel, R., Collins, S., Ricquier, D. and Ailhaud, G. (1997) Up regulation of UCP-2 gene expression by PPAR agonists in preadipocyte and adipose cells. *Biochemistry and Biophysics Research Communications* 238, 606–611.
- Bachman, E.S., Dhillon, H., Zhang, C.-Y., Cinti, S., Bianco, A.C., Kobilka, B.K. and Lowell, B.B. (2002)  $\beta$ AR signalling required for diet-induced thermogenesis and obesity resistance. *Science* 279, 843–845.
- Baile, C.A. and Della-Fera, M.A. (2001) The future of feed intake regulation research. *Journal of Animal Science* 79 (Suppl. E), E171–E179.
- Baile, C.A., Della-Fera, M.A. and Martin, R.J. (2000) Regulation of metabolism and body fat mass by leptin. *Annual Review of Nutrition* 20, 105–127.

- Baracos, V.E., Devivo, C., Hoyle, D.H.R. and Goldberg, A.L. (1995) Activation of different proteolytic systems in skeletal muscles of cachexic rats bearing a hepatoma. *American Journal of Physiology* 268, E996–E1006.
- Basarab, J.A., Price, M.A., Aalhus, J.L., Okine, E.K., Snelling, W.M. and Lyle, K.L. (2003) Residual feed intake and body composition in young growing cattle. *Canadian Journal of Animal Science* 83, 189–204.
- Beermann, D.H. (2002) Beta-adrenergic receptor agonist modulation of skeletal muscle growth. *Journal of Animal Science* 80 (Suppl. E), E18–E23.
- Bishop, S.C. (1992) Phenotypic and genetic variation in body weight, food intake and energy utilisation in Hereford cattle. II. Effects of age and length of performance test. *Livestock Production Science* 30, 19–31.
- Bocquier, F., Bonnet, M., Faulconnier, Y., Guerre-Millo, M., Martin, P. and Chilliard, Y. (1998) Effects of photoperiod and feeding level on peri-renal adipose tissue metabolic activity and leptin synthesis in the ovariectomized ewe. *Reproduction Nutrition Development* 38, 489–498.
- Boss, O., Samec, S., Paoloni-Giacobino, A., Rosie, C., Dulloo, A., Seydoux, J., Muzzin, P. and Giacobino, J.-P. (1997) Uncoupling protein-3: a new member of the mitochondrial carrier family with tissue specific expression. *Federation of Experimental Biological Sciences Letters* 408, 39–42.
- Breier, B.H. (1995) Regulation of growth in ruminants by the somatotrophic axis. In: von Engelhardt, W., Leonard-Marek, S., Breves, G. and Giesecke, D. (eds) *Ruminant Physiology: Digestion, Metabolism, Growth and Reproduction*. Ferdinand Enke Verlag Publishing, Stuttgart, Germany, pp. 451–473.
- Campbell, P.J., Bolli, G.B., Cryer, P.E. and Gerich, J.E. (1985) Pathogenesis of the dawn phenomenon in patients with insulin dependent diabetes mellitus. Accelerated glucose production and impaired glucose utilisation due to nocturnal surges in growth hormone secretion. *New England Journal of Medicine* 312, 1473–1479.
- Carstens, G.E., Johnson, D.E., Johnson, K.A., Hotovy, S.K. and Szymanski, T.J. (1989) Genetic variation in energy expenditures of monozygous twin beef cattle at 9 and 20 months of age. In: Van der Honing, Y. and Close, W.H. (eds) *Energy Metabolism of Farm Animals*. European Association for Animal Production, Publication No. 43, Pudoc, Wageningen, The Netherlands, p. 312.
- Chilliard, Y., Bocquier, F. and Delavaud, C. (1998) Leptin in ruminants: effects of species, breed, breed, adiposity, photoperiod, beta-agonists and nutritional status. In: *Proceedings of the Cornell Nutrition Conference for Feed Manufacturers*, October 20–22, 1998, Rochester, 65–774.
- Christopherson, R.J., Ekpe, E.D., Moibi, J.A. and Li, B.T. (1995) Roles of adrenergic receptors in regulating metabolism in ruminants. In: Ivan, M. (ed.) *Animal Science Research and Development: Moving Toward a New Century*. Canadian Society of Animal Science, Ottawa.
- Conde, R.D., Paladini, A.C., Santome, J.A. and Dellacha, J.M. (1973) Isolation, purification and characterization of equine growth hormone. *European Journal of Biochemistry* 32, 563–568.
- Cortright, R.E., Zheng, D., Jones, J.P., Fluckey, J.D., DiCarlo, S.E., Grujic, D., Lowell, B.B. and Dohm, G.L. (1999) Regulation of skeletal muscle UCP-2 and UCP-3 gene expression by exercise and denervation. *American Journal of Physiology* 276, E217–E221.
- Damon, M., Vincent, A., Lombardi, A. and Herpin, P. (2000) First evidence of uncoupling protein-2 and uncoupling protein-3 gene expression in piglet skeletal muscle and adipose tissue. *Gene* 246, 133–141.

- Davis, T.A., Burrin, D.G., Fiorotto, M.L., Reeds, P.J. and Jahoor, F. (1998) Roles of insulin and amino acids in the regulation of protein synthesis in the neonate. *Journal of Nutrition* 128, 347S–350S.
- De Haer, L.C.M., Luiting, P. and Aarts, H.L.M. (1993) Relations among individual (residual) feed intake, growth performance and feed intake pattern of growing pigs in group housing. *Livestock Production Science* 36, 233–253.
- Delavaud, C., Faulconnier, Y., Bocquier, F. and Chilliard, Y. (1999) Pre- and postprandial changes in plasma leptin and insulin concentrations during underfeeding and refeeding in dry cows. *Proceedings of the Nutrition Society* 58, 108A.
- Delavaud, C., Ferlay, A., Faulconnier, Y., Bocquier, F., Kann, G. and Chilliard, Y. (2002) Plasma leptin concentration in adult cattle: effects of breed, adiposity, feeding level, and meal intake. *Journal of Animal Science* 80, 1317–1328.
- Ekpe, E.D. and Christopherson, R.J. (2000) Metabolic and endocrine responses to cold and feed restriction in ruminants. *Canadian Journal of Animal Science* 80, 87–95.
- Ekpe, E.D., Moibi, J.A. and Christopherson, R.J. (2000a) Beta-adrenergic receptors in skeletal muscles of ruminants: effects of temperature and feed intake. *Canadian Journal of Animal Science* 80, 79–86.
- Ekpe, E.D., Moibi, J.A. and Christopherson, R.J. (2000b) Effects of temperature and plane of nutrition on beta adrenergic receptors in heart, kidney and liver of lambs. *Journal of Animal Science* 78, 1907–1916.
- Enerback, S., Jacobsson, A., Simpson, E.M., Guerra, C., Yamashita, H., Harper, M.-E. and Kozak, L.P. (1997) Mice lacking mitochondrial uncoupling protein are cold-sensitive but not obese. *Nature* 387, 90–94.
- Ferrell, C.L. and Jenkins, T.G. (1998) Body composition and energy utilisation by steers of diverse genotypes fed a high-concentrate diet during the finishing period. I. Angus, Belgian Blue, Hereford and Piedmontese sires. *Journal of Animal Science* 76, 637–646.
- Fleury, C., Neverova, M., Collins, S., Raimbault, S., Champigny, O., Levi-Meyrueis, C., Bouillaud, F., Seldin, M.F., Surwit, R.S., Ricquier, D. and Warden, C.H. (1997) Uncoupling protein-2: a novel gene linked to obesity and hyperinsulinemia. *Nature* 15, 269–272.
- Forbes, J.M. (2000) Physiological and metabolic aspects of feed intake control. In: D'Mello, J.P.F. (ed.) *Farm Animal Metabolism and Nutrition*. CAB International, Wallingford, UK, pp. 319–333.
- France, J. and Thornley, J.H.M. (1984) Growth functions. In: France, J. and Thornley, J.H.M. (eds) *Mathematical Models in Agriculture*. Butterworths, London, pp. 75–94.
- Gatford, K.L., Quinn, K.J., Walton, P.E., Grant, P.A., Hosking, B.J., Egan, A.R. and Owens, P.P. (1997) Ontogenic and nutritional changes in circulating insulin-like growth factor-I (IGF-I), IGF-II and IGF-binding proteins in growing ewe and ram lambs. *Journal of Endocrinology* 155, 47–54.
- Ghilardi, N. and Skoda, R.C. (1997) The leptin receptor activates janus kinase 2 and signals for proliferation in a factor dependent cell line. *Molecular Endocrinology* 11, 393–399.
- Gill, M. and Oldham, J.D. (1993) Growth. In: Forbes, J.M. and France, J. (eds) *Quantitative Aspects of Ruminant Digestion and Metabolism*. CAB International, Wallingford, UK, pp. 383–403.
- Gladysz, A., Kreja, P., Simunek, J. and Polkowska, Y. (2001) Effects of central infusions of neuropeptide Y on the somatotrophic axis in sheep fed on two levels of protein. *Acta Neurobiologica Experimentia* 61, 255–266.



- Gong, D.-W., He, Y., Karas, M. and Reitman, M. (1997) Uncoupling protein-3 is a mediator of thermogenesis regulated by thyroid hormone and B3 agonists and leptin. *Journal of Biological Chemistry* 272, 24129–24132.
- Hayden, J.M., Williams, J.E. and Collier, R.J. (1993) Plasma growth hormone, insulin-like growth factor, insulin, and thyroid hormone association with body protein and fat accretion in steers undergoing compensatory gain after dietary energy restriction. *Journal of Animal Science* 71, 3323–3338.
- Herd, R.M. and Bishop, S.C. (2000) Genetic variation in residual feed intake and its association with other production traits in British Hereford cattle. *Livestock Production Science* 63, 111–119.
- Heska, J.T. and Jones, P.J.H. (2001) A role for dietary fat in leptin receptor, OB-Rb, function. *Life Science* 69, 987–1003.
- Houseknecht, K.L., Baile, C.A., Matteri, R.L. and Spurlock, M.E. (1998) The biology of leptin: a review. *Journal of Animal Science* 76, 1405–1420.
- Isozaki, O., Tsushima, T., Miyakawa, M., Demura, H. and Seki, H. (1999) Growth hormone directly inhibits leptin gene expression in visceral fat tissue in fatty Zucker rats. *Journal of Endocrinology* 161, 511–516.
- Jensen, J., Mao, I.L., Andersen, B.B. and Madsen, P. (1992) Phenotypic and genetic relationships between residual energy intake and growth, feed intake, and carcass traits of young bulls. *Journal of Animal Science* 70, 386–395.
- Jorgensen, J.O. (1991) Human growth hormone replacement therapy: pharmacological and clinical aspects. *Endocrine Review* 12, 189–207.
- Kadokawa, H., Briegel, J.R., Blackberry, M.A., Blache, D., Martin, G.B. and Adams, N.R. (2003) Relationships between plasma concentrations of leptin and other metabolic hormones in GH-transgenic sheep infused with glucose. *Domestic Animal Endocrinology* 24, 219–229.
- Klingenberg, M. (1993) Nucleotide binding to uncoupling protein. Mechanisms of control by protonation. *Biochemistry* 27, 781–791.
- Koch, R.M., Swiger, L.A., Chambers, D. and Gregory, K.E. (1963) Efficiency of feed use in beef cattle. *Journal of Animal Science* 22, 486–494.
- Kumar, B., Francis, S.M., Suttie, J.M. and Thompson, M.P. (1998) Expression of obese mRNA in sheep genetically lean and fat selection lines of sheep. *Compendium of Biochemistry and Physiology* 120, 543–548.
- Landis, M.D., Carstens, G.E., McPhail, E.G., Randel, R.D., Green, K.K., Slay, L. and Smith, S.B. (2002) Ontogenic development of brown adipose tissue in Angus and Brahman foetal calves. *Journal of Animal Science* 80, 591–601.
- Larkin, S., Mull, E., Miao, W., Pittner, R., Albrandt, K., Moore, C., Young, A., Denaro, M. and Beaumont, K. (1997) Regulation of a third member of the uncoupling protein family by cold and thyroid hormone. *Biochemistry and Biophysics Research Communications* 240, 222–227.
- Li, Y., Christopherson, R.J., Li, B.T. and Moibi, J.A. (2000) Effects of a beta-adrenergic agonist (L-644,969) on performance and carcass traits of growing lambs in a cold environment. *Canadian Journal of Animal Science* 80, 459–465.
- Liu, Q., Bai, C., Chen, F., Wang, R., Macdonald, T., Gu, M., Zhang, Q., Morsy, M.A. and Caskey, C.T. (1997) Uncoupling protein-3: a muscle specific gene upregulated by leptin in ob/ob mice. *Gene* 207, 1–7.
- Lobley, G.E., Sinclair, K.D., Grant, C.M., Miller, L., Mantle, D., Calder, A.G., Warkup, C.C. and Maltin, C.A. (2000) The effects of breed and level of nutrition on whole-body and muscle protein metabolism in pure-bred Aberdeen Angus and Charolais beef steers. *British Journal of Nutrition* 84, 275–284.

- Louveau, I., Quesnel, H. and Prunier, A. (2000) GH and IGF-I binding sites in adipose tissue, liver, skeletal muscle and ovaries of feed-restricted gilts. *Reproduction Nutrition Development* 40, 571–578.
- Luft, R., Ikkos, D., Gemzell, C.A., Olivercrona, H. and Sjogren, B. (1958) The effects of growth hormone in man. *Lancet* 1, 897–901.
- Luiting, P., Schrama, J.W., Van Der Hel, W., Urff, E.M., Van Boekholt, P.G.J.J., Van Den Elsen, E.M.W. and Verstegen, M.W.A. (1991) Metabolic differences between white leghorns selected for high and low residual feed consumption. In: *Energy Metabolism of Farm Animals, Proceedings of the 12th Symposium*, Kartause Ittigen, Switzerland, pp. 384–387.
- Luna-Pinto, G. and Cronje, P.B. (2000) The roles of insulin-like growth factor system and leptin as possible mediators of the effects of nutritional restriction on age at puberty and compensatory growth in dairy heifers. *South African Journal of Animal Science* 30, 155–163.
- Matsumura, K., Tsuchihashi, T. and Abe, I. (2000) Central cardiovascular action of neuropeptide Y in conscious rabbits. *Hypertension* 36, 1040–1044.
- Mersmann, H.J. (2002) Beta-adrenergic receptor modulation of adipocyte metabolism and growth. *Journal of Animal Science* 80 (Suppl. E), E24–E29.
- Miaron, J.O.O. and Christopherson, R.J. (1997) Metabolic responses of the whole body, portal drained viscera and hind quarter to adrenaline infusion: effects of non-selective and selective beta adrenoceptor blockade. *Canadian Journal of Animal Science* 77, 307–316.
- Millet, L., Vidal, H., Andreelli, F., Larrouy, D., Riou, J-P., Ricquier, D., Laville, M. and Langin, D. (1997) Increased uncoupling protein-2 and -3 mRNA expression during fasting in obese and lean humans. *Journal of Clinical Investigation* 100, 2665–2670.
- Morrison, C.D., Daniel, J.A., Holmberg, B.J., Djiane, J., Raver, N., Gertler, A. and Keisler, D.H. (2001) Central infusion of leptin into well-fed and undernourished ewe lambs, effects on feed intake and serum concentrations of growth hormone and luteinizing hormone. *Journal of Endocrinology* 168, 317–324.
- Muoio, D.M., Dohm, G.L., Fiedorek, F.T. Jr, Tapscott, E.B., Coleman, R.A. and Dohn, G.L. (1997) Leptin directly alters lipid partitioning in skeletal muscle. *Diabetes* 46, 1360–1363.
- Murdoch, G.K., Dixon, W., Mathison, G.W., Baracos, V.E., Okine, E.K., Moibi, J.A., Li, B.T. and Christopherson, R.J. (2001) A molecular approach: understanding the variability in energy expenditure in cattle. In: Chwalibog, A. and Jakobsen, K. (eds) *Energy Metabolism in Animals. Proceedings of the 15th Symposium on Energy Metabolism in Animals*. Wageningen Pers, Wageningen, The Netherlands, pp. 301–304.
- Murdoch, G.K., Christopherson, R.J. and Dixon, W. (2003) Gene expression and energy homeostasis. In: Souffrant, W. and Metges, C.C. (eds) *Progress in Research on Energy and Protein Metabolism. Proceedings of the EEAP Symposium on Energy and Protein Metabolism*. Wageningen Academic Publishers, Wageningen, The Netherlands, pp. 377–386.
- Nash, J.E., Rocha, H.J.G., Buchan, V., Calder, G.A., Milne, E., Quirke, J.F. and Lobley, G.E. (1994) The effect of acute and chronic administration of the beta agonist, cimaterol, on protein synthesis in ovine skin and muscle. *British Journal of Nutrition* 71, 501–513.
- Nkrumah, J.D., Ammoura, A., Guercio, S., Lyle, K.L., Price, M.A., Okine, E.K., Basarab, J.A., Hansen, C., Li, C., Murdoch, B. and Moore, S.S. (2003)

- Relationships between residual feed intake, feed intake, growth traits, ultrasound carcass measurements and feeding behaviour in young hybrid beef calves. *Canadian Society of Animal Science*, June 10–13, Saskatoon, Saskatchewan, Canada. (Abstract).
- NRC (1996) *Nutrient Requirements of Beef Cattle*, 7th edn. National Academy Press, Washington, DC.
- Oregon, M.J., Calvo, R., Hernandez, A., Escobar, F. and Escobar, G.M. (1996) Regulation of uncoupling protein messenger ribonucleic acid and 5' deiodinase activity by thyroid hormones in foetal brown adipose tissue. *Endocrinology* 137, 4721–4729.
- O'Connor, R.M., Butler, W.R., Finnerty, K.D., Hogue, D.E. and Beermann, D.H. (1991) Acute and chronic hormone and metabolite changes in lambs fed the beta-agonist, cimaterol. *Domestic Animal Endocrinology* 8, 537–548.
- O'Connor, K.G., Harman, S.M., Stevens, T.E., Jayme, T.E., Bellantoni, M.F., Busby-Whitehead, M.J., Christmas, C., Munzer, T., Tobin, J.D., Roy, T.A., Cottrell, E., St. Clair, C., Pabst, K.M. and Blackman, M.R. (1999) Interrelationships of spontaneous growth axis activity, body fat, and serum lipids in healthy elderly women and men. *Metabolism* 48, 1424–1431.
- Okine, E.K., Basarab, J.A., Goonewardene, L.A., Mir, P., Mir, Z., Price, M.A., Arthur, P.F. and Moore, S.S. (2003) Residual feed intake – what is it and how does it differ from traditional concepts of feed utilisation. *Conference Proceedings of Canadian Society of Animal Science, Annual meeting June 10–13, 2003*, Saskatoon, Saskatchewan Canada (16 pp. on CD proceedings).
- Oldham, J.D. (1999) Genotype × nutrition interactions in herbivores. In: Jung, H.-J. and Fahey, G.C. Jr (eds) *Nutritional Ecology of Herbivores*. American Society of Animal Science, Savoy, pp. 482–504.
- Palmiter, R.D., Erickson, J.C., Hollopeter, G., Baraban, S.C. and Schwartz, M.W. (1998) Life without neuropeptide Y. *Recent Progress in Hormone Research* 53, 163–199.
- Pierroz, D.D., Gruaz, N.M., D'Alleves, V. and Aubert, M.L. (1995) Chronic administration of neuropeptide Y into the lateral ventricle starting at 30 days of life delays sexual maturation of the female rat. *Neuroendocrinology* 61, 293–300.
- Pitchford, W.S., Fenton, M.L., Kister, A.J. and Bottema, C.D.K. (2002) QTL for feed intake and associated traits. *Proceedings of the Seventh World Congress Genetics Applied to Livestock Production* 31, 253–256.
- Pullar, J.D. and Webster, A.J.F. (1977) The energy cost of protein and fat deposition in the rat. *British Journal of Nutrition* 37, 355–361.
- Qian, H., Hartzell, D.L., Baile, C.A., Azain, M.M., Compton, M.J. and Hausman, G.J. (1998) Brain administration of leptin causes deletion of adipocytes by apoptosis. *Endocrinology* 139, 791–794.
- Rahmouni, K. and Haynes, W.G. (2001) Leptin signalling pathways in the central nervous system: interactions between neuropeptide Y and melanocortins. *BioEssays* 23, 1095–1099.
- Ren, M.Q., Wegner, J., Bellmann, O., Brockmann, G.A., Schneider, F., Teuscher, F. and Ender, K. (2002) Comparing mRNA levels of genes encoding leptin, leptin receptor, and lipoprotein lipase between dairy and beef cattle. *Domestic Animal Endocrinology* 16, 135–143.
- Richardson, E.C., Herd, R.M., Oddy, V.H., Thompson, J.M., Archer, J.H. and Arthur, P.F. (2001) Body composition and implications for heat production of Angus steer progeny of parents selected for and against residual feed intake. *Australian Journal of Experimental Agriculture* 41, 1065–1072.

- Ritchie, H.D. (2000) Why is efficiency so important to the beef industry? *Feedstuffs* 21, 12–27.
- Rouru, J., Cusin, I., Zakrzewska, K.E., Jeanrenaud, B. and Rohner-Jeanrenaud, F. (1999) Effects of intravenously infused leptin on insulin sensitivity and on the expression of uncoupling proteins in brown adipose tissue. *Endocrinology* 140, 3688–3692.
- Scarpace, P.J., Nicolson, M. and Matheny, M. (1998) UCP2, UCP3 and leptin gene expression: modulation by food restriction and leptin. *Journal of Endocrinology* 159, 349–357.
- Scott, S.L., Christopherson, R.J., Thompson, J.R. and Baracos, V.E. (1993) The effect of a cold environment on protein and energy metabolism in calves. *British Journal of Nutrition* 69, 127–139.
- Shackelford, S.D., Wheeler, T.L. and Koohmaraie, M. (1995) The effects of *in utero* exposure of lambs to a beta-adrenergic agonist on prenatal and postnatal muscle growth, carcass cutability, and meat tenderness. *Journal of Animal Science* 73, 2986–2993.
- Smith, S.B., Davis, K.S., Wilson, J.J., Stone, R.T., Wu, F.Y., Garcia, D.K., Lunt, D.K. and Schievetta, A.M. (1995) Bovine fast-twitch myosin chain-1: cloning and mRNA amount in muscle of cattle treated with clenbuterol. *American Journal of Physiology* 268, E858–E865.
- Sobhani, I., Bado, A., Vissuzaine, C., Buyse, M., Kermorgant, S., Laigneau, J.-P., Attoub, S., Lehy, T., Henin, D., Mignon, M. and Lewin, M.J.M. (2000) Leptin secretion and leptin receptor in the human stomach. *Gut* 47, 178–183.
- Syed, M.A., Thompson, M.P., Pachucki, J. and Burmeister, L.A. (1999) The effect of thyroid hormone on size of fat depots accounts for most of the changes in leptin mRNA and serum levels in the rat. *Thyroid* 9, 503–512.
- Tartaglia, L.A., Dembski, M. and Weng, X. (1995) Identification and expression cloning of a leptin receptor, OB-R. *Cell* 83, 1263–1271.
- Taylor, St. C.S., Thiessen, R.B. and Murray, J. (1986) Inter-breed relationship of maintenance efficiency to milk yield in cattle. *Animal Production* 43, 37–61.
- Thiessen, J.P., Ketelslegers, J.M. and Underwood, L.E. (1994) Nutritional regulation of the insulin-like growth factors. *Endocrine Review* 15, 80–101.
- Thomas, S. and Palmiter, R.D. (1997) Thermoregulatory and metabolic phenotypes of mice lacking noradrenaline and adrenaline. *Nature* 387, 94–97.
- Veldhuis, J.D., Iranmanesh, A., Ho, K.K., Waters, M.J., Johnson, M.L. and Lizzarralde, G. (1991) Dual effects of pulsatile growth hormone secretion and clearance subserve the hyposomatotropism of obesity in man. *Journal of Clinical Endocrinology and Metabolism* 72, 51–59.
- Verpoegen, S.A., Plaetinck, G., Devos R., Van Der Heyden, J. and Guisez, Y. (1997) A human leptin mutant induces weight gain in normal mice. *Federation of Experimental Biological Sciences, Letters* 405, 237–240.
- Vidal-Puig, A. (1997) UCP-3: an uncoupling protein homologue expressed preferentially and abundantly in skeletal muscle and brown adipose tissue. *Biochemistry and Biophysics Research Communications* 235, 79–82.
- Wegner, J., Huff, P., Xie, C.P., Schneider, F., Teuscher, F., Mir, P.S., Mir, Z., Kazala, E.C., Weselake, R.J. and Ender, K. (2001) Relationship of plasma leptin concentration to intramuscular fat content in beef from crossbred Wagyu cattle. *Canadian Journal of Animal Science* 81, 451–457.
- Wilding, J.P., Gilbery, S.G., Bailey, C.J., Batt, R.A., Williams, G., Ghatei, M.A. and Bloom, S.R. (1993) Increased neuropeptide Y mRNA and decreased neurotensin

- mRNA in the hypothalamus of obese (*ob/ob*) mouse. *Endocrinology* 132, 1939–1944.
- Wing, S.S. and Goldberg, A.L. (1993) Glucocorticoids activate the ATP-ubiquitin-dependent proteolytic system in skeletal muscle during fasting. *American Journal of Physiology* 264, E668–E672.
- Wolf, G. (1997) Neuropeptides responding to leptin. *Nutrition Review* 55, 85–88.
- Woods, S.C., Seeley, R.J., Porte, D. Jr and Schwartz, M.W. (1998) Signals that regulate food intake and energy homeostasis. *Science* 280, 1378–1383.
- Wurzburger, M.I., Prelevic, G.M., Sonksen, P.H., Balint-Peric, L.A. and Wheeler, M. (1993) The effect of recombinant human growth hormone on regulation of growth hormone secretion and blood glucose in insulin dependent diabetes. *Journal of Clinical Endocrinology and Metabolism* 77, 267–272.
- Yambayamba, E.S.K., Price, M.A. and Foxcroft, G.E. (1996) Hormonal status, metabolic changes, and resting metabolic rate in beef heifers undergoing compensatory growth. *Journal of Animal Science* 74, 57–69.
- Zhang, Y., Proenca, R., Maffei, M., Barone, M., Leopold, L. and Friedman, J.M. (1994) Positional cloning of the mouse obesity gene and its human homologue. *Nature* 372, 425–432.
- Zhou, Y.T., Shimabukuru, M., Koyama, K., Lee, Y., Wang, M.-Y., Trieu, F., Newgard, C.B. and Unger R.H. (1997) Induction by leptin of uncoupling protein-2 and enzymes of fatty acid oxidation. *Proceedings of the National Academy of Sciences* 94, 6386–6390.

*This page intentionally left blank*

---

# 20 Pregnancy and Fetal Metabolism

A.W. Bell,<sup>1</sup> C.L. Ferrell<sup>2</sup> and H.C. Freetly<sup>2</sup>

<sup>1</sup>Department of Animal Science, Cornell University, Ithaca, NY 14853, USA;

<sup>2</sup>USDA ARS, Meat Animal Research Center, Clay Center, NE 68933, USA

---

## Introduction

This chapter deals with quantitative aspects of macronutrient metabolism and its regulation in maternal and conceptus tissues *in vivo*, emphasizing data and concepts generated or revised during the decade since publication of a similar chapter in the first edition of this book (see Bell, 1993). Recent findings on the regulation of nutrient partitioning among maternal tissues, the placenta and fetus(es) are highlighted, as is new information on placental transport mechanisms.

## Energy Cost of Pregnancy

### *Practical considerations*

Meeting the nutrient requirements of pregnant females is important to ensure an adequate nutrient supply for proper growth and development of the fetus, to ensure that the female is in an adequate body condition for birth, lactation and rebreeding, and to provide immature females with adequate nutrients for continued growth. Recognizing those needs, most feeding systems currently in use for ruminants (e.g. AFRC, 1990; CSIRO, 1990; NRC, 1996, 2001) recommend a factorial approach such that estimates of nutrient requirements for maternal maintenance, body weight gain and growth of gravid uterine (or conceptus) tissues are summed to derive total requirements for pregnant females. This approach implies that fetal nourishment will be adequate if maternal body weight, condition and growth are maintained at suitable levels. Limited or no interaction among tissues (or nutrient needs) of the gravid uterus and maternal tissues is also implied by this approach.

Recommended levels of feeding during late gestation range from about 1.7 times maintenance in cows and ewes with single fetuses to 2.2 to 2.4 times maintenance for those with twins or triplets. Unfortunately, these levels of intake are frequently not achieved, especially by polytocous animals, during late gestation. Inadequate consumption may result from inadequate availability or quality of diet and from depressed voluntary intake of cattle and sheep during late gestation (Forbes, 1986). Under many production situations, maternal body tissues must be mobilized during late gestation to sustain adequate nutrient supply and growth of gravid uterine tissues (Robinson *et al.*, 1999).

The increased energy used by the pregnant ruminant is reflected by greater rates of heat production as compared to otherwise comparable non-pregnant animals. Brody (1945) described the increase in heat production of pregnant animals relative to similar, well-fed non-pregnant animals as the 'heat increment of gestation'. He concluded (p. 429) that the heat increment of gestation includes: (i) the energy expense of maintenance of the pregnant uterus; (ii) 'work' of growth; (iii) increased work of the maternal organism (including circulatory, respiratory and excretory activities); and (iv) endocrine influences on metabolism of the mother. The physiological basis for this increased metabolism and its implications relative to apparent energetic efficiency of fetal growth are discussed in the following sections.

### ***Growth and energetic efficiency of the gravid uterus***

Energy content of the gravid uterus (allantoic and amniotic fluids, fetus, placenta and uterus) or fetus increases exponentially in the sheep (Ratray *et al.*, 1974a) and cow (Ferrell *et al.*, 1976a). Similar patterns are seen in goats and other species. This pattern of growth results in about 90% of birth weight of the calf or lamb being achieved during the last 40% of gestation. Thus, energy retention in gravid uterine tissues is small during early gestation (0.3 MJ/day at 130 days in the cow), but becomes relatively large near term (4.9 MJ/day at 280 days). In comparison, net energy required for maintenance of a 550 kg cow is expected to be 36.6 MJ/day. Several researchers have estimated the efficiency of utilization of dietary metabolizable energy (ME) for energy retention in the gravid uterus or conceptus to be about 0.13 (AFRC, 1990; CSIRO, 1990; NRC, 1996). This value does not appear to vary much with stage of gestation (Ratray *et al.*, 1974b; Ferrell *et al.*, 1976b) even though absolute rates of fetal growth differ tremendously, but varies to some extent with quality of diet (Robinson *et al.*, 1980). Comparable estimates of the efficiency of ME use for maintenance ( $k_m$ ) and postnatal growth ( $k_g$ ) are typically about 0.70 and 0.40, respectively, for good quality diets. Estimates of the ME required for pregnancy during late gestation in a 550 kg cow (37.5 MJ/day at 280 days) are about 72% of that required for maintenance (52.2 MJ/day). The difference between ME required for gestation and energy retained in the gravid uterus is reflected as heat production (or heat increment of gestation). Thus, about 87% of the ME required to support pregnancy is dissipated as heat. These observations



frequently have been interpreted to imply that gestation is energetically very inefficient.

Reynolds *et al.* (1986) reported that heat production of the gravid uterus in cows was 1.37, 2.12, 4.87 and 8.57 MJ/day at 137, 180, 226 and 250 days of gestation, whereas the heat increment of gestation at these times was 2.69, 7.36, 12.34 and 14.95 MJ/day (Brody, 1945; Ferrell *et al.*, 1976b). These data were interpreted to indicate that 30% to 57% (mean 44%) of the heat increment of gestation was attributable to the energy expenditure of the gravid uterus. It is implied that over 50% of the heat increment of gestation in the cow was associated with metabolism of maternal tissues. Freetly and Ferrell (1997) estimated that 49% of the heat increment of gestation in ewes was attributable to gravid uterine tissues. They showed that maternal hepatic oxygen consumption increased during gestation in ewes and that increased hepatic metabolism accounted for about 20% of the heat increment of gestation. Rosenfeld (1977) observed that cardiac output increased about 75% during pregnancy in ewes, supporting the suggestion of Brody (1945) that increased heart work contributes to the heat increment of gestation. Increased energy expenditure of other maternal tissues such as kidneys, pancreas, skin and mammary gland contribute to the heat increment of gestation.

Gross efficiencies of energy accretion in the uteroplacenta and fetus can be estimated as energy accretion divided by the sum of energy accretion and heat production. Resulting estimates of gross efficiency for the uteroplacenta and fetus were relatively constant across stage of gestation (Reynolds *et al.*, 1986) and averaged 15.3% and 38.5%, respectively. Fetal energetic efficiency was similarly constant at about 38% between mid- and late-gestation in sheep (Bell, 1986). Gross efficiency of fetal growth compares favourably with gross efficiency of postnatal growth. Estimates of the gross efficiency of uteroplacental tissues were much lower. The simple reason for the difference in efficiency is that oxygen consumption or energy expenditure per kg of uteroplacental tissues is nearly twofold that of the fetus, but rate of energy accretion is considerably less. Some of the reasons for the high energy expenditure of uteroplacental tissues will be discussed in subsequent sections. Thus, although growth of the fetus itself is rather efficient energetically, the entire process of producing a calf or lamb is relatively inefficient because of the inefficiency of energy accretion of the uteroplacenta, which is required to support fetal growth directly, and because of the increase in maternal metabolism that is required to support fetal growth less directly.

## Maternal Metabolic Adaptations to Pregnancy

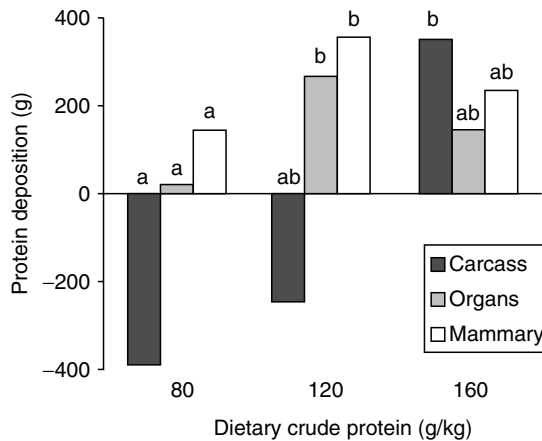
### *Patterns of macronutrient metabolism*

During late pregnancy, ruminants generally increase their voluntary intake of medium- to high-quality diets (Forbes, 1986) and, thus, the liver's access to glucogenic substrate of dietary origin (principally propionate and absorbed amino acids). However, hepatic gluconeogenesis increases in ewes during late

pregnancy even when feed intake is not increased above non-pregnant levels, to an extent that is directly related to litter size and fetal demand (Freetly and Ferrell, 1998). These results are consistent with earlier observations of the effects of feed intake and pregnancy on whole-body glucose kinetics in sheep (see Bell, 1993). Part of this increased gluconeogenesis is supported by increased hepatic uptake of lactate (Freetly and Ferrell, 1998), apparently derived from uteroplacental metabolism and increased glycolysis in maternal peripheral tissues (Bell and Ehrhardt, 2000). A further portion is supported by increased hepatic uptake of glycerol, especially if fat mobilization is increased as term approaches (Freetly and Ferrell, 2000). Amino acids mobilized from maternal carcass tissues (McNeill *et al.*, 1997) also may help sustain an increased rate of hepatic gluconeogenesis during late pregnancy.

Effects of pregnancy on the quantitative metabolism of amino acids have yet to be studied systematically in ruminants. However, the fractional rate of hepatic protein synthesis increased by 45% during late pregnancy in dairy cows, at a time when intake of dry matter and nitrogen was declining (Bell, 1995). This is consistent with the moderate increase in hepatic protein accretion (McNeill *et al.*, 1997), and an apparent decrease in hepatic deamination of amino acids (Freetly and Ferrell, 1998) observed in late-pregnant ewes. In contrast, in ditocus ewes carefully fed to maintain zero energy and nitrogen balance (CSIRO, 1990), there was a significant net loss of nitrogen from carcass tissues during late pregnancy, attributed largely to mobilization of amino acids from skeletal muscle (Fig. 20.1; McNeill *et al.*, 1997).

Interpretation of putative pregnancy-specific adaptations in maternal lipid metabolism in ruminants has been complicated by lack of experimental control



**Fig. 20.1.** Crude protein deposition between days 110 and 140 of pregnancy in maternal tissue components of ditocus ewes fed diets containing different levels of dietary crude protein. All diets were designed to meet energy requirements. Histograms are means for eight ewes. Pooled standard errors were 214 g for carcass, 84 g for organs and 44 g for mammary glands. Within tissue components, means with different letters are significantly different ( $P < 0.05$ ). Adapted from the data of McNeill *et al.* (1997) and reproduced from Bell and Ehrhardt (2000).

of nutrition and other environmental factors, such as photoperiod. For example, early suggestions of apparent upregulation of adipose tissue lipogenesis during mid-pregnancy (Vernon *et al.*, 1981) were later mostly attributed to seasonal (i.e. photoperiod) effects (Vernon *et al.*, 1985). Also, the extent to which decreased lipogenic capacity and increased fatty acid release in adipose tissue during late pregnancy (Vernon *et al.*, 1981) are due to pregnancy-specific factors has been unclear due to lack of data on accompanying changes in feed intake and energy balance. It is therefore notable that plasma concentrations of non-esterified fatty acids (NEFA), which are an excellent index of the rate of mobilization of fatty acids (see Chapter 13), were moderately elevated during late pregnancy in ditocous ewes that had been fed to maintain energy balance in non-pregnant maternal tissues (Pettersen *et al.*, 1994). On the other hand, there is little doubt that the decline in dry matter intake often observed in cows and ewes close to term leads to an exaggerated increase in fatty acid mobilization and plasma NEFA concentrations (Grummer, 1993; Freetly and Ferrell, 2000).

Whole-body rates of entry and utilization of short-chain fatty acids, especially acetate, do not seem to be influenced by pregnancy beyond predictable effects of the intake of rumen-fermentable organic matter (Bell, 1993). Similarly, pregnancy-related changes in the kinetics of ketone bodies, especially 3-hydroxybutyrate, can be explained by changes in feed intake, energy balance and the mobilization and hepatic catabolism of NEFA (see Chapter 13).

### ***Homoeorrhetic regulation of nutrient partitioning***

#### *General concept*

The concept of homoeorrhesis as applied to regulation of nutrient partitioning during different physiological states, such as pregnancy and lactation, recently has been revised and updated by one of its original proponents (Bauman, 2000). Key postulates of this concept include its simultaneous influence on multiple tissues and functional systems, implying extracellular mediation, and its operation through altered tissue responses to homoeostatic effectors such as insulin, at various levels of extracellular and intracellular signalling.

#### *Altered tissue responses to insulin and catecholamines*

In sheep, as in humans and laboratory animals, late pregnancy is associated with the development of moderate insulin resistance assessed by diminished sensitivity to insulin of several variables of whole-body glucose utilization (Pettersen *et al.*, 1993; Ehrhardt *et al.*, 2001) and decreased insulin responsiveness of lipolysis and NEFA mobilization (Pettersen *et al.*, 1994). The tissue sites of pregnancy-induced insulin resistance in sheep have not been quantitatively studied *in vivo*. However, the whole-body responses described by application of the hyperinsulinaemic, euglycaemic clamp technique are consistent with observations of increasing refractoriness of *in vitro* lipogenic responses to insulin in adipose tissue with advancing pregnancy (Vernon *et al.*, 1985; Guesnet *et al.*, 1991). This phenomenon may be partly mediated

through decreased adipose expression of the insulin-responsive glucose transport protein, GLUT-4, as demonstrated in underfed vs. well-fed, late-pregnant ewes (Ehrhardt *et al.*, 1998). The latter study also demonstrated reduced expression of GLUT-4 in skeletal muscle of underfed ewes. This is consistent with the diminished ability of insulin to promote glucose uptake by muscle *in vivo* in lactating vs. dry ewes (Vernon *et al.*, 1990), considering the similar characteristics of whole-body insulin resistance observed in ewes during late pregnancy and early lactation (Ehrhardt *et al.*, 2001).

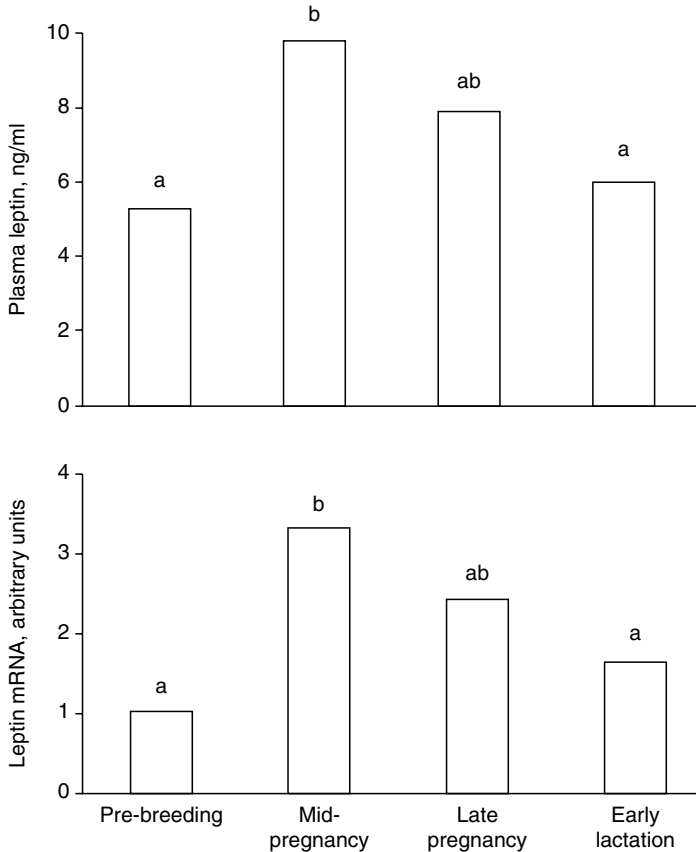
In contrast, pregnancy appears to amplify the responses of adipose tissue to lipolytic adrenergic agents. This was most conclusively demonstrated by *in vitro* studies in which lipolytic sensitivity and responsiveness to the specific  $\beta$ -adrenergic agent, isoproterenol, were progressively increased as pregnancy advanced (Guesnet *et al.*, 1987). This phenomenon has not been studied systematically *in vivo* but the increase in plasma NEFA concentration provoked by a single intravenous injection of epinephrine was significantly increased during late pregnancy in dairy cows (see Bell and Bauman, 1994).

The degree to which altered metabolic responses to insulin and catecholamines during late pregnancy are physiologically specific and not influenced by mild reductions in feed intake and energy balance requires scrutiny. It is notable that moderate undernutrition markedly exaggerated the decrease in insulin-dependent glucose utilization in late-pregnant ewes (Pettersson *et al.*, 1993). Energy deprivation also amplified the *in vivo* lipolytic response to various adrenergic agents in non-pregnant, non-lactating cattle (Blum *et al.*, 1982).

#### *Possible homoeorrhetic effectors*

Several pregnancy-related hormones, including progesterone, oestradiol and placental lactogen (PL) have been suggested as homoeorrhetic modulators of observed changes in tissue responses to insulin and catecholamines, and associated metabolic adaptations to the state of pregnancy in ruminants (Bell and Bauman, 1994; Bell and Ehrhardt, 2000). A more recently suggested candidate is leptin (Bell and Ehrhardt, 2000), whose adipose tissue expression and plasma concentration increase markedly in ewes during mid-pregnancy, independent of nutrition and energy balance (Fig. 20.2; Ehrhardt *et al.*, 2001). None of these putative regulators has been shown to have the integrative, pleiotropic influences that growth hormone (GH) has in lactating ruminants (Bauman and Vernon, 1993; Bauman, 2000). Possibly, the combined influence of these hormones is more significant than their varying individual influences at different stages of pregnancy.

Among the sex steroids, oestradiol-17 $\beta$  ( $E_2$ ) may contribute directly or indirectly to mediation of some metabolic adaptations, especially close to term when there is a pronounced surge in plasma oestrogen concentrations. Treatment of ovariectomized ewes with  $E_2$  caused a reduction in rates of adipose lipogenesis and fatty acid re-esterification *in vitro* (Green *et al.*, 1992). However, we were unable to discern any effect of a similar hormonal treatment on responses of glucose or NEFA metabolism *in vivo* to insulin or catecholamines, although basal plasma concentrations of glucose, NEFA and



**Fig. 20.2.** Effects of physiological state on plasma concentration (upper panel) and adipose tissue mRNA abundance of leptin (lower panel) in ewes fed to maintain relatively constant energy balance and body fatness. Histograms are means for the same eight ewes studied at 20–40 days before breeding (pre-breeding), 50–60 days of pregnancy (mid-pregnancy), 125–135 days of pregnancy (late pregnancy) and 15–22 days postpartum (early lactation). Pooled standard errors were 0.54 ng/ml for plasma leptin and 0.40 units for leptin mRNA abundance. Means with different letters are significantly different ( $P < 0.05$ ). Adapted from Ehrhardt *et al.* (2001).

glycerol were chronically elevated in treated animals (Andriquetto *et al.*, 1995, 1996). Oestradiol also may contribute indirectly to changes in lipid metabolism through its inhibitory effect on voluntary feed intake in late-pregnant ruminants (Forbes, 1986).

Definitive evidence of a homoeorrhetic role for PL remains elusive, but such a putative role is hard to dismiss, for several reasons. First, this uniquely placental peptide cross-reacts with both GH and prolactin receptors in ruminant tissues (Gertler and Djiane, 2002). Its specific binding in ovine adipose tissue increases with advancing pregnancy, implying increased influence on lipid metabolism (N'Guema *et al.*, 1986). Cross-reactivity with the GH receptor would be consistent with the development of insulin resistance in adipose tissue

since GH is a potent homoeorrhetic effector of this response in ruminant adipose tissue (Etherton and Bauman, 1998). Second, moderate undernutrition enhances placental gene expression and secretion of PL in late-pregnant ewes (R.A. Ehrhardt, R.V. Anthony and A.W. Bell, unpublished), coincident with the decreased expression of GLUT-4 in maternal insulin-responsive tissues (Ehrhardt *et al.*, 1998) and exaggeration of indices of whole-body insulin resistance (Pettersen *et al.*, 1993, 1994). Third, active immunization against maternal ovine PL increased lamb birth weight, possibly via enhancement of the bioactivity of PL and promotion of nutrient partitioning to favour the conceptus (Leibovich *et al.*, 2000).

The apparently pregnancy-specific increase in leptin expression and secretion by adipose tissue in sheep (Fig. 20.2; Ehrhardt *et al.*, 2001), together with increasing evidence that leptin modulates the metabolic actions of insulin in rodents (Ceddia *et al.*, 2002), suggests that this peptide should be added to the list of putative homoeorrhetic effectors of metabolic adaptations to pregnancy. In addition, the abundant placental expression of the physiologically relevant OB-Rb form of the leptin receptor (Ehrhardt *et al.*, 1999) suggests that leptin may act as a direct signal of maternal energy balance to the placenta.

## Metabolism of the Conceptus

### *Placental nutrient transport and metabolism*

As recently reviewed by Bell and Ehrhardt (2002), the energy and protein requirements of the ruminant fetus are met mostly by placental transfer of glucose and amino acids from the maternal to the fetal circulation, with the addition of lactate produced by placental glycolysis. Long-chain fatty acids and their keto-acid metabolites are poorly transported in sheep compared to species with haemochorial placentation. Also, the maternal–fetal transfer of acetate makes only a small contribution to fetal energy requirements, not withstanding the abundance of this metabolite in the maternal circulation (Bell *et al.*, 2005). Therefore, this section will consider only mechanisms for placental transport and metabolism of glucose and amino acids.

#### *Placental transport mechanisms*

Glucose is transported from the maternal to the fetal circulation by carrier-mediated, facilitated diffusion (see Bell and Ehrhardt, 2002). This process is strongly dependent on the maternal–fetal plasma glucose concentration gradient (Simmons *et al.*, 1979; DiGiacomo and Hay, 1990a). The predominant glucose transporter protein isoforms in the sheep placenta are GLUT-1 and GLUT-3 (Ehrhardt and Bell, 1997), mRNA and protein abundance of which increase with gestational age, especially for GLUT-3 (Currie *et al.*, 1997; Ehrhardt and Bell, 1997). This, together with its low  $K_m$  and localization at the apical, maternal-facing layer of the trophoblastic cell layer (Das *et al.*, 2000), suggests that ontogenic changes in GLUT-3 expression and activity may account for much of the fivefold increase in glucose transport capacity

of the sheep placenta *in vivo* between mid- and late-gestation (Molina *et al.*, 1991). Other factors must include remodelling and expansion of the placenta's effective exchange surface and the increasing maternal-fetal plasma concentration gradient (Molina *et al.*, 1991).

Most amino acids taken up by the placenta are transported against a fetal-maternal concentration gradient, implying the use of energy-dependent, active transport processes (see Bell and Ehrhardt, 2002). Studies of isolated human and rodent placental vesicles have confirmed that the transport systems in the placenta are similar to those described for plasma membranes of other tissues (see Battaglia and Regnault, 2001). These include at least six sodium-dependent and five sodium-independent systems that have been classified systematically on the basis of their affinity for neutral, acidic or basic amino acids, and their intracellular location (Battaglia and Regnault, 2001). Recent results from *in vivo* studies on sheep suggest that rapid placental transport of neutral amino acids requires both sodium-dependent transport at the maternal epithelial surface and affinity for highly reversible, sodium-independent transporters located at the fetal surface (Jozwik *et al.*, 1998; Paolini *et al.*, 2001). These researchers also demonstrated major differences in placental clearance among the essential amino acids, with the more rapidly transported branched-chain acids, plus methionine and phenylalanine, apparently sharing the same rate-limiting transport system (Paolini *et al.*, 2001).

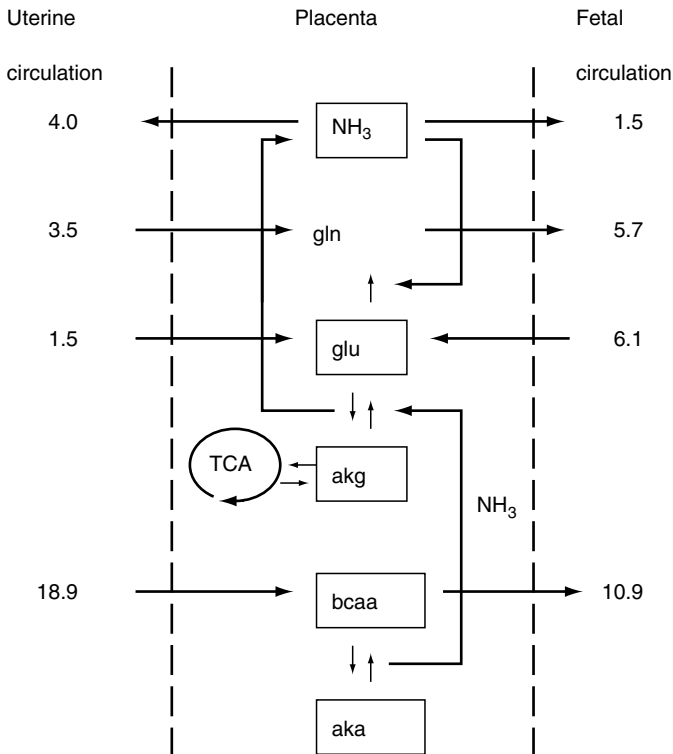
#### *Placental metabolism*

Glucose entry into the gravid uterus and its component tissues is determined by maternal arterial glucose concentration while glucose transport to the fetus is determined by the transplacental (maternal-fetal) concentration gradient (see Hay, 1995). In turn, the transplacental gradient is directly related to both placental and fetal glucose consumption, which are dependent on fetal arterial glucose concentration. Thus, as fetal glucose concentration changes relative to that of the mother, thereby changing the transplacental gradient, placental transfer of glucose to the fetus varies reciprocally with placental glucose consumption.

In addition to its quantitative impact on placental transfer of glucose, placental glucose metabolism has a major qualitative influence on the pattern of carbohydrate metabolites delivered to the fetus. Rapid metabolism to lactate (~35%), fructose (~4%) and CO<sub>2</sub> (~17%) accounted for about 56% of uteroplacental glucose consumption in late-pregnant ewes, and was directly related to placental glucose supply (Aldoretta and Hay, 1999). The fate of the remaining 44% of glucose metabolized by the placenta must include synthesis of alanine and other non-essential amino acids (Timmerman *et al.*, 1998), directly or via lactate (Carter *et al.*, 1995).

Placental metabolism also affects the quantity and composition of amino acids delivered to the fetus. The significant net consumption by uteroplacental tissues of glutamate, serine and the branched-chain amino acids (Liechty *et al.*, 1991; Chung *et al.*, 1998) implies catabolism or transamination of these acids. An additional, small fraction of this net loss of amino acids will be in the form of secreted peptides.

The ovine placenta has very little enzymatic capacity for urea synthesis, but produces considerable amounts of ammonia, much of which is released into maternal and, to a lesser extent, fetal circulations (Holzman *et al.*, 1977; Bell *et al.*, 1989). This is consistent with extensive placental deamination of branched-chain amino acids to their respective keto acids, which are released into fetal and maternal bloodstreams (Smeaton *et al.*, 1989; Loy *et al.*, 1990), and with rapid rates of glutamate oxidation in the placenta (Moores *et al.*, 1994). Transamination of branched-chain amino acids accounts for some of the net glutamate acquisition by the placenta, the remainder of which is taken up from the umbilical circulation (Moores *et al.*, 1994). That which is not quickly oxidized combines with ammonia to synthesize glutamine, which is then released back into the umbilical bloodstream (Chung *et al.*, 1998). Quantitative aspects of ovine placental metabolism and fetal–placental exchanges of branched-chain amino acids, glutamine, glutamate and their metabolites are summarized in Fig. 20.3.



**Fig. 20.3.** Net fluxes, measured *in vivo*, of the branched-chain amino acids, glutamine, glutamate and ammonia into and out of the ovine placenta. Values are  $\mu\text{mol per kg fetus per min}$ . Note the contributions of the branched-chain amino acids to both glutamate and  $\text{NH}_3$  production within the placenta. Abbreviations: gln, glutamine; glu, glutamate; akg,  $\alpha$ -ketoglutarate; TCA, tricarboxylic acid cycle; bcAA, branched-chain amino acids; aka, branched-chain  $\alpha$ -keto acids;  $\text{NH}_3$ , ammonia. From Loy *et al.* (1990), Chung *et al.* (1998), and Jozwik *et al.* (1999); reproduced from Battaglia (2000) with permission of the American Society for Nutritional Sciences.



Similarly, the placenta almost quantitatively converts serine, mostly taken up from maternal blood, to glycine (Chung *et al.*, 1998), reconciling the discrepancy between the negligible net uptake of glycine by the uterus and substantial net release of this amino acid into the umbilical circulation (Bell and Ehrhardt, 2002).

The complexity of interrelations among placental uptake, metabolism and transport of amino acids was further illustrated by a study of alanine metabolism in ewes during late pregnancy (Timmerman *et al.*, 1998). Application of tracer methodology showed that negligible net placental consumption or production of alanine masks an appreciable metabolism of maternal alanine entering the placenta which exchanges with endogenously produced alanine. Thus, most of the alanine delivered to the fetus is of placental origin, derived from placental protein turnover and transamination.

### **Fetal metabolism**

#### *Patterns of growth and nutrient accretion*

Numerous studies on pregnant cows and ewes have described the energy and nitrogen requirements for pregnancy based on heat increment of gestation of the pregnant female and/or weight, energy, nitrogen (or crude protein) and mineral accretion of the fetus, conceptus or gravid uterus (see AFRC, 1990; NRC, 1996, 2001). Those studies have been extremely valuable for describing normal patterns of growth of gravid uterine tissues and for the purposes of establishing general nutritional requirements of gestating ruminants.

Weight, energy content and nitrogen content of bovine fetuses on different days of gestation (Ferrell *et al.*, 1976a) are shown in Table 20.1. Estimated daily accretion rates and accretion rates relative to fetal body weight (relative growth rate) are also shown. In the bovine fetus, rates of accretion of weight, energy and nitrogen, increase during gestation (Ferrell *et al.*, 1976a; Bell *et al.*,

**Table 20.1.** Weight (Wt.), energy (E) and nitrogen (N) accretion of bovine fetuses.<sup>a</sup>

Day of gestation	Fetus <sup>b</sup>			Rate of gain <sup>c</sup>			Relative growth rate <sup>d</sup>		
	Wt.	E	N	Wt.	E	N	Wt.	E	N
100	0.48	0.76	5.01	17.9	38	0.2	37.05	78.14	0.415
130	1.37	2.99	16.30	45.1	130	0.6	32.82	94.61	0.437
160	3.45	9.96	47.28	98.6	372	1.6	28.57	107.76	0.463
190	7.63	27.97	122.6	185.8	883	3.6	24.34	115.68	0.472
220	14.86	66.32	283.6	298.6	1720	7.3	20.09	115.72	0.491
250	25.48	132.72	586.0	403.9	2695	12.9	15.85	105.75	0.506
280	38.47	224.18	1081.0	446.6	3285	19.8	11.61	85.39	0.515

<sup>a</sup>From Ferrell *et al.* (1976a).

<sup>b</sup>Fetal weight (kg), energy (kJ) and nitrogen (g).

<sup>c</sup>Average daily gain of fetal weight (kg/day), energy (kJ/day) and nitrogen (g/day).

<sup>d</sup>Growth rate of weight (g/day/kg), energy (kJ/day/kg) and nitrogen (g/day/kg) relative to fetal weight.

1995), but may be constrained during late gestation by maternal factors related to size or genotype (Ferrell, 1991; Ferrell and Reynolds, 1992). Maternal constraint of fetal growth, resulting primarily from limitations in uteroplacental functional capacity, has been more consistently reported, occurs earlier, and is of greater magnitude, in sheep, especially with twin or multiple fetuses, than in cattle (Ratray *et al.*, 1974a; Mellor, 1983). In cattle, rate of accretion of fetal weight relative to fetal weight decreases during gestation, whereas energy accretion relative to fetal weight increases until approximately 230 days, then declines (Table 20.1). Relative rate of N accretion increases throughout the latter half of gestation. Patterns of accretion of body tissues of the ovine fetus (Ratray *et al.*, 1974a) are similar to those of the bovine, but as previously observed, magnitudes of changes with advancing gestational age are generally greater. These differences in accretion patterns result in changes in fetal body composition (e.g. decreased water content), as noted by Bell *et al.* (1995) and others, and reflect changes in fetal metabolism, growth and development as pregnancy advances. In addition to changes in gross chemical composition, proportions of metabolically active tissues such as the liver, heart, kidney and brain decrease and those of less active tissues such as muscle, fat and bone, increase substantially during fetal development (Bell *et al.*, 1987). These observations also serve to point out that comparisons of data from different species or different stages of development should be done cautiously. In addition they indicate that alternative approaches are required to develop more definitive understanding of fetal growth and metabolism.

#### *Macronutrient uptake and metabolism*

Numerous studies of pregnant ewes have described macronutrient metabolism and requirements of the fetus in terms of net umbilical exchange of oxygen, nutrients and metabolites, and net accretion of nutrients in growing tissues. Representative data from ewes and similar data from cows are summarized in Table 20.2. Oxygen consumption of the fetus provides a useful measure of oxidative metabolism and provides a basis for establishing metabolic rate and heat production of the fetus. Fetal O<sub>2</sub> consumption increases during gestation on an absolute basis due to the rapidly increasing mass of fetal tissue (Reynolds *et al.*, 1986; Bell *et al.*, 1987). However, on a weight-specific basis, available data in cattle indicate little change during the latter half of pregnancy with heat production of the fetus (assuming 21.1 kJ/l O<sub>2</sub>) averaging 170 kJ/kg/day. Somewhat higher values have been reported for sheep with typical values being about 240 kJ/kg/day (Bell *et al.*, 1987). Reported values for heat production represent not only 'maintenance' costs but also energy costs associated with tissue accretion. While these values are higher than observed for fasted adult cattle or sheep, they are similar to values for moderate- to well-fed postnatal ruminants. When expressed relative to fetal dry weight, however, a substantial decrease in oxygen utilization rates during the latter half of gestation in ovine fetuses has been noted (Bell *et al.*, 1987). The decrease is likely due to decreased proportions of metabolically active tissues as gestation advances as previously noted, and to associated decreases in fractional protein synthetic rate (Kennaugh *et al.*, 1987). Values of urea excretion of the fetus to the

**Table 20.2.** Fetal sources and disposal of energy and nitrogen in ewes and cows during late pregnancy.

	Energy (kJ/kg/day)		Nitrogen (g/kg/day)	
	Ewe	Cow	Ewe	Cow
<i>Sources</i>				
Glucose + lactate	217 <sup>a</sup>	114 <sup>b</sup>	–	–
Amino acids	177 <sup>a</sup>	156 <sup>c</sup>	1.19 <sup>a</sup>	1.09 <sup>c</sup>
Acetate	20 <sup>d</sup>	30 <sup>e</sup>	–	–
NH <sub>3</sub>	–	–	0.05 <sup>f</sup>	ND
Total	414	300	1.24	1.09
<i>Disposal</i>				
Accretion	133 <sup>g</sup>	72 <sup>h</sup>	0.79 <sup>g</sup>	0.34 <sup>h</sup>
Heat	240 <sup>a</sup>	192 <sup>c</sup>	–	–
Urea	16 <sup>i</sup>	15 <sup>c</sup>	0.36 <sup>i</sup>	0.66 <sup>c</sup>
Glutamate + serine efflux	16 <sup>a</sup>	ND	0.11 <sup>a</sup>	ND
Total	405	279	1.26	1.00

<sup>a</sup>Chung *et al.* (1998).<sup>b</sup>Reynolds *et al.* (1986).<sup>c</sup>Ferrell (1991).<sup>d</sup>Char and Creasy (1976).<sup>e</sup>Comline and Silver (1976).<sup>f</sup>Holzman *et al.* (1977).<sup>g</sup>McNeill *et al.* (1997).<sup>h</sup>Ferrell *et al.* (1976a).<sup>i</sup>Lemons and Schreiner (1983).

placenta and subsequently to the maternal system are relatively high and are consistent with high rates of amino acid deamination and oxidation by the bovine and ovine fetus. As will be discussed in more detail subsequently, both glutamate and serine are released from the fetal liver, taken up by the placenta from fetal circulation, and metabolized within the placenta (Battaglia, 2002).

In cattle and sheep, 35–45% of the energy available to the fetus is taken up as glucose and its fetal–placental metabolites, lactate and fructose. A major portion (40–45%) of the glucose is directly oxidized and utilized as a fetal energy source (McGowan *et al.*, 1995). As discussed earlier, energy is also provided from maternal glucose indirectly via its placental metabolites, primarily lactate and fructose. As a result, about 70% of the glucose carbon available to the fetus is directly or indirectly oxidized to CO<sub>2</sub>. The remaining 30% of glucose carbon is utilized for fetal accretion and incorporated into compounds such as glycogen, glycerol and amino acids.

During mid-gestation, the ovine placenta produces significant amounts of lactate, but virtually all (>95%) of the placental production is transferred to maternal circulation (Carter *et al.*, 1993). At that time, about 70% of fetal lactate is oxidized by both fetal (60%) and fetal–placental (40%) tissues to CO<sub>2</sub> with the remaining 30% of the carbon appearing primarily in non-essential amino acids, especially glutamate, glutamine, serine and glycine (Carter *et al.*, 1995).

During late gestation, the fetal placenta becomes a major net source of fetal lactate, and a negligible contributor to fetal lactate disposal. At both stages of gestation, fetal CO<sub>2</sub> production from lactate carbon may account for 25% of fetal O<sub>2</sub> consumption.

Fructose is a major form of carbohydrate in fetal blood of ruminants and some other species (Andrews *et al.*, 1960). Fructose, as well as several polyols, is produced in conceptus (fetus and placenta) tissues from glucose (Teng *et al.*, 2002) and large fetal/maternal concentration ratios are maintained. The high production rates of fructose and polyols may be associated with the reduced redox state of fetal tissues relative to maternal tissues. Presumably the large concentration gradient between the fetus and maternal blood is maintained, in part, by very low placental permeability. Fructose does not appear to be converted to glucose by the ruminant fetus, but may be oxidized to some extent (Meznarich *et al.*, 1987). McGowan *et al.* (1995) suggested that 20–30% of the CO<sub>2</sub> derived from glucose by the fetus was derived indirectly by oxidation of fructose. Other reports have indicated the contribution of fructose to total fetal oxidative metabolism is no more than about 5% (Meznarich *et al.*, 1987). Teng *et al.* (2002) observed high concentrations of inositol, erythritol, arabitol, sorbitol, ribitol and mannitol in fetal as compared with maternal blood suggesting production within the conceptus. However, neither the site(s) of synthesis nor the biological reasons for the relatively high concentrations of these polyol compounds in fetal blood have been elucidated. Those authors also reported a small, but perhaps important net transfer of mannose from maternal to fetal circulation.

Almost all of the nitrogen acquired by the bovine and ovine fetus is in the form of amino acids. A small net umbilical uptake of ammonia is derived from placental deamination of amino acids during the latter half of gestation in the sheep fetus (Holzman *et al.*, 1977; Bell *et al.*, 1989) but, to our knowledge, this phenomenon has not been observed in cattle. In both cattle and sheep, amino acids are taken up from the placenta in considerable excess of the fetal requirements for accretion (Meier *et al.*, 1981b; Lemons and Schreiner, 1984; Reynolds *et al.*, 1986). About 60% of these amino acids are used for tissue protein synthesis, which accounts for about 18% of fetal energy expenditure (Kennaugh *et al.*, 1987). The remaining 40% are rapidly catabolized, accounting for at least 30% of the oxidative requirements of the well-nourished sheep fetus (Faichney and White, 1987), or in the cases of glutamate and serine, taken up and metabolized by the placenta (Battaglia and Regnault, 2001; Battaglia, 2002). Thus, in total, 45–55% of the energy available to the fetus may be provided as free amino acids.

For 18 amino acids, Chung *et al.* (1998) estimated that fetal uptake was 40% greater than fetal accretion in the ovine. Umbilical uptake of all essential amino acids were two- to threefold greater than expected fetal accretion rates (Chung *et al.*, 1998), suggesting that all essential amino acids were oxidized, in varying amounts, by the ovine fetus. Fetal oxidation of leucine (Kennaugh *et al.*, 1987; Loy *et al.*, 1990; Ross *et al.*, 1996), threonine (Anderson *et al.*, 1997) and lysine (Meier *et al.*, 1981a) have been confirmed by radioisotope methodology. In addition to the direct oxidation of essential amino acids, about 40% of

the branched-chain amino acids taken up from the maternal circulation are transaminated by placental tissues and the resulting keto acids (2-keto isovalerate, 2-keto isocaproate and 2-keto methylvalerate) are transferred primarily to fetal, but also to maternal circulations (Smeaton *et al.*, 1989; Loy *et al.*, 1990; Liechty *et al.*, 1991). Although the keto acids do not provide a large proportion of the fetal energy supply, they may serve to conserve the carbon skeleton of branched-chain amino acids for fetal metabolism and growth. In addition, because transamination of branched-chain amino acids results in the formation of glutamate from  $\alpha$ -ketoglutarate, branched-chain amino acid metabolism provides a mechanism, in addition to fetal liver production of glutamate from glutamine (Battaglia, 2000), for supplying glutamate to the placenta. Comparable data from other ruminant species are unavailable to our knowledge.

It is important to note that the inter-organ exchange of amino acids between the fetal liver and placenta is clearly of major importance for serine/glycine and glutamate/glutamine metabolism (Battaglia, 2000). Glycine (a potential precursor of serine) and glutamine (a potential precursor of glutamate) are delivered from the placenta to the fetal circulation and taken up by the fetal liver. Conversely, serine (a product of glycine oxidation) and glutamate (a product of glutamine deamination) are released by the fetal liver, enter the fetal circulation and are taken up by the placenta.

Acetate accounts for only 5–10% of the energy available to the prenatal ruminant (Char and Creasy, 1976), in contrast to its importance as an energy source in the weaned, postnatal ruminant. Placental capacity to transfer long-chain NEFA is even more limited (see Bell, 1993), making these maternal substrates very minor contributors to fetal energy supply.

## **Regulation of conceptus metabolism**

### *Nutrient supply*

Placental nutrient supply has a powerful, limiting influence on nutrient disposal by fetal and non-fetal conceptus tissues, especially in late gestation when fetal demands are greatest. The  $K_m$  for saturable glucose transport by the sheep placenta is  $\sim 3.9$  mM (Simmons *et al.*, 1979), which is within the physiological range of glycaemia in well-fed, adult sheep. Thus, uterine uptake, placental metabolism and transfer and fetal metabolism of glucose are very sensitive to maternal arterial glucose concentration in sheep (see Hay, 1995). In sheep and cows, fetal utilization of glucose is highly correlated with fetal plasma glucose concentration, which, in turn, is correlated with maternal glycaemia (Fowden, 1997).

Fetal glucose supply also influences fetal endogenous glucose production, presumably due to hepatic gluconeogenesis. In addition to the association of increased endogenous production with fetal hypoglycaemia in undernourished ewes (Leury *et al.*, 1990), progressive fetal hypoglycaemia induced by different levels of maternal insulin infusion caused fetal endogenous glucose production to increase linearly (DiGiacomo and Hay, 1990b). A mediating role for

fetal insulin was suggested by the incomplete suppression of endogenous glucogenesis by fetal infusion with insulin while maintaining basal fetal glycaemia (DiGiacomo and Hay, 1990b).

Effects of amino acid supply on fetal metabolism have not been studied systematically. Decreased maternal plasma concentrations of essential amino acids in fasted ewes were not associated with a significant decrease in umbilical uptake of these acids (Lemons and Schreiner, 1983). In contrast, maternal hyperglycaemia with secondary hyperinsulinaemia and hypoaminoacidaemia caused substantial reductions in uterine, uteroplacental and fetal uptakes of several amino acids, particularly the branched-chain acids, and a 60% reduction in total fetal uptake of nitrogen (Thureen *et al.*, 2000, 2001). Correction of maternal amino acid concentrations by appropriate exogenous infusion restored uterine and umbilical exchanges to normal levels (Thureen *et al.*, 2000). Maternal hyperaminoacidaemia, caused by infusion of amino acids, had little effect on the umbilical uptake of most amino acids, except for increased uptake of the branched-chain acids, and did not affect fetal total nitrogen supply (Jozwik *et al.*, 1999). However, uteroplacental production and fetal concentrations of ammonia increased moderately, implying some increase in placental deamination of amino acids.

#### *Fetal hormones and growth factors*

We have recently reviewed evidence for the roles of the pancreatic hormones (especially insulin), GH and the insulin-like growth factor (IGF) system, PL, glucocorticoids, thyroid hormones, catecholamines and leptin in the regulation of fetal metabolism and growth (Bell *et al.*, 2005). Therefore, the present section will be limited to a brief discussion of endocrine factors with major, well-defined effects on glucose and amino acid metabolism *in vivo*, mostly described in the late-gestation sheep fetus. It must be borne in mind that although most fetal endocrine organs develop the capacity to synthesize and secrete hormones early in gestation, target tissue and neuroendocrine feedback systems are variably immature until late pregnancy. As a result, there is a much greater reliance on paracrine and autocrine regulation of tissue metabolism and growth by locally expressed factors, especially during early- and mid-pregnancy.

In sheep, placental uptake and transport of glucose are unresponsive to maternal or fetal plasma insulin, consistent with the essential absence of the insulin-responsive glucose transport protein, GLUT-4, in the ovine placenta (Ehrhardt and Bell, 1997). However, the fetal pancreas becomes increasingly responsive to insulin secretagogues, including glucose, with advancing gestation (Aldoretta *et al.*, 1998) and hyperinsulinaemia has a specific, positive effect on glucose utilization by the whole fetus (Hay *et al.*, 1988) and insulin-responsive fetal tissues such as skeletal muscle (Wilkening *et al.*, 1987; Anderson *et al.*, 2001) during late gestation. Thus, fetal insulinaemia can indirectly influence placental transfer and umbilical uptake of glucose through its effect on fetal glycaemia and the maternal–fetal glucose concentration gradient (see Hay, 1995). Physiological increases in fetal plasma insulin also stimulated fetal uptake and utilization of amino acids when fetal glycaemia and aminoacidaemia were carefully controlled (Thureen *et al.*, 2000).

The quantitative metabolic effects of other fetal hormones and growth factors have been studied much less intensively. Fetal metabolic responses to GH, directly and indirectly via its influence on IGF-1 expression in liver and other tissues, are limited by immaturity of the GH receptor system until the end of gestation (see Bell *et al.*, 2005). This raises the possibility that fetal protein anabolism and growth during late gestation may be constrained by sluggish prenatal engagement of the GH/IGF system because infusion of fetal sheep with IGF-1 decreased proteolysis and amino acid catabolism (Harding *et al.*, 1994; Liechty *et al.*, 1996). Among its numerous effects on metabolic development during late gestation, fetal cortisol appears to stimulate glycogen synthesis and maturation of glucogenic capacity in the fetal liver as term approaches (Fowden *et al.*, 1998), thereby promoting glucose availability for the neonate. During late gestation, treatment with glucocorticoids reduced umbilical glucose uptake (Milley, 1996; Barbera *et al.*, 1997) and placental uptake of fetal glutamate (Barbera *et al.*, 1997; Timmerman *et al.*, 2000). The latter response was associated with decreased hepatic output of glutamate apparently due to decreased fetal hepatic uptake of glucogenic amino acids, including glutamine, and diversion of hepatic glutamine to metabolism in the TCA cycle rather than glutamate synthesis (Timmerman *et al.*, 2000).

As in postnatal life, fetal thyroid hormones stimulate fetal oxidative metabolism, expressed as rates of umbilical oxygen uptake and whole-body glucose oxidation (Fowden and Silver, 1995). They also appear to be necessary for the normal, fasting-induced increase in hepatic glucogenesis in fetal sheep (Fowden *et al.*, 2001).

During late gestation, the fetal sheep responds to acute hypoxia (Cohen *et al.*, 1982) and hypoglycaemia (Harwell *et al.*, 1990) with pronounced increases in adrenomedullary secretion of epinephrine and norepinephrine. Metabolic consequences include rapid stimulation of hepatic glucose production, presumably through increased glycogenolysis (Jones *et al.*, 1983), and mobilization of NEFA (Harwell *et al.*, 1990), associated with reduced pancreatic secretion and plasma concentrations of insulin (Bassett and Hanson, 1998), and attenuated action of IGF-1 (Hooper *et al.*, 1994). Restoration of normal insulinaemia by insulin infusion abolished most of the metabolic and growth-inhibitory effects of prolonged catecholamine infusion in the sheep fetus (Bassett and Hanson, 2000).

## Conceptus Responses to Altered Maternal States

### *Plane of nutrition*

Recent evidence indicates that the activity of placental transport mechanisms can be modulated by maternal nutrition, independent of more chronic effects on placental size. For example, moderate undernutrition of ditocus ewes during late pregnancy caused a 50% increase in capacity for maternal–fetal glucose transport *in vivo* (Ehrhardt *et al.*, 1996) that was at least partly explained by a 20% increase in total GLUT abundance, associated with a

similar increase in GLUT-3 protein abundance (Ehrhardt *et al.*, 1998). These responses help explain how placental glucose transfer remained sufficient to sustain normal fetal growth, despite chronic maternal hypoglycaemia and a 26% decrease in the maternal–fetal gradient in arterial plasma glucose concentration (Bell *et al.*, 1999).

During more severe, chronic undernutrition or starvation for several days, the development of profound fetal hypoglycaemia helps to sustain the maternal–fetal gradient in glucose concentration by restricting the reverse transfer of glucose to the placenta, and reducing placental glucose consumption (see Hay, 1995). Under these more stringent conditions, fetal gluconeogenesis is induced (Leury *et al.*, 1990), with amino acids being the presumed major substrate, consistent with increased fetal urea synthesis (Lemons and Schreiner, 1983; Faichney and White, 1987). Rapid, presumably direct oxidation of amino acids is also increased (Krishnamurti and Schaefer, 1984; Van Veen *et al.*, 1987). The ultimate consequence is reduced fetal tissue protein synthesis (Krishnamurti and Schaefer, 1984) and slowing of fetal growth to a rate that can be sustained by the reduced placental nutrient supply.

Effects of energy and/or protein supply on placental capacity for amino acid transport have been little studied. Fasting late-pregnant ewes for 5 days had an insignificant effect on umbilical net uptake of amino acids despite appreciable decreases in maternal arterial plasma concentrations of many amino acids (Lemons and Schreiner, 1983). This suggests that during short-term energy/protein deprivation, placental mechanisms for active transport of amino acids are unimpaired and may even be upregulated. Under similar fasting conditions, the uteroplacental deamination of branched-chain amino acids appeared to be increased, judging from a threefold increase in the efflux of  $\alpha$ -ketoisocaproate, the keto-acid derivative of leucine, into uterine and umbilical circulations (Liechty *et al.*, 1991). This suggests that increased amino acid catabolism may partly compensate for the likely reduction in placental glucose oxidation under these conditions.

Placental transport and metabolism of amino acids have not been studied during more prolonged restriction of energy or protein. However, in ewes fed adequate energy but insufficient protein during the last month of pregnancy, fetal growth and protein deposition over this period were decreased by 18% (McNeill *et al.*, 1997). It is also notable that in chronically hyperglycaemic ewes with secondary hyperinsulinaemia and hypoaminoacidaemia, placental and fetal uptakes of several amino acids were reduced, and fetal total nitrogen uptake declined by 60% (Thureen *et al.*, 2001).

Less attention has been paid to conceptus responses to greater than normal maternal nutrient supply, although the influence of nutrition on growth of large fetuses and incidence of dystocia in some breeds of cattle and sheep remains an important practical question. As discussed earlier, fetal ability to take advantage of surplus maternal nutrients is limited by placental transport capacity during late gestation. Thus, in monotocous ewes fed above predicted energy requirements, fetal infusion with sufficient glucose to sustain fetal glycaemia at two to three times normal for the last month of gestation increased birth weight by 18% and relative weight of adipose tissue by almost 50% (Stevens *et al.*, 1990).



Recently, it has been shown that overfeeding of primiparous ewes during early-mid gestation causes quite profound fetal growth retardation preceded by and associated with a major reduction in placental growth (Wallace *et al.*, 2000). Mechanistically, this phenomenon resembles other examples of placental insufficiency in that it is characterized by reduced placental transport of oxygen and glucose, and chronic fetal hypoxaemia and hypoglycaemia during late gestation (Wallace *et al.*, 2002).

### **Heat and cold stress**

Heat stress through mid- and late-pregnancy can cause a dramatic reduction in fetal growth in sheep and cattle (see Bell, 1987). Much of this effect is mediated by profound stunting of placental growth and functional development although maternal inappetence, when it occurs, is a complicating factor. Reduced placental size is associated with major decreases in placental transport and metabolism of glucose (Thureen *et al.*, 1992) and amino acids (Ross *et al.*, 1996; Anderson *et al.*, 1997).

Ewes exposed to cold during the final 5–6 weeks of pregnancy, and fed at the same level as controls, produced significantly heavier singleton and twin lambs (Thompson *et al.*, 1982). Maternal plasma glucose and fetal plasma glucose and insulin concentrations were persistently elevated, leading to the hypothesis that cold-induced increases in fetal growth are due to increased placental transport and fetal uptake of glucose (Thompson *et al.*, 1982; Symonds *et al.*, 1986; Revell *et al.*, 2000), perhaps reinforced by the growth-promoting effects of fetal insulin (Fowden, 1995). Shearing of ewes in mid-pregnancy also causes variable increases in later fetal growth and birth weight (Kenyon *et al.*, 2002). Mediation by enhanced placental nutrient transfer has been implied (Revell *et al.*, 2002) but requires experimental confirmation.

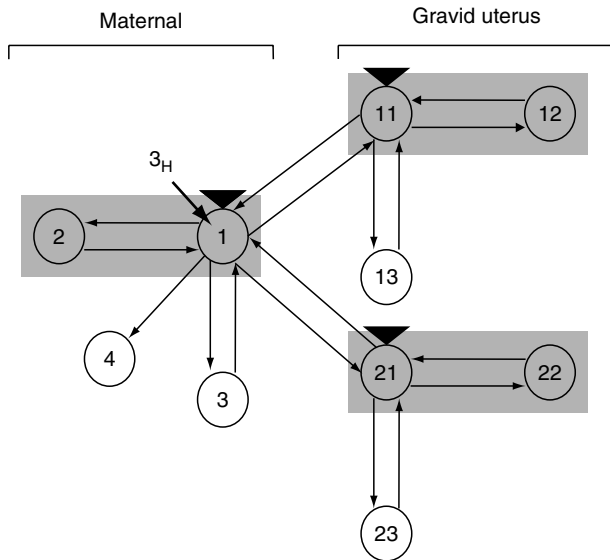
### **Exercise**

Effects of exercise on quantitative aspects of maternal and fetal glucose metabolism and its regulation were reviewed in the first edition of this book (Bell, 1993). Little has been published on this subject since then. Briefly, moderate maternal exercise ( $2\text{--}3 \times$  resting metabolic rate) causes increased maternal glucose entry rate associated with increased uterine net uptake of glucose. These responses are accompanied by increased fetal net uptake of glucose in underfed, hypoglycaemic ewes, but not in well-fed, normoglycaemic animals (Leury *et al.*, 1990).

## **Towards a Model of Maternal and Fetal Metabolism**

Existing predictive models of fetal growth in sheep (e.g. AFRC, 1990; CSIRO, 1990) and cattle (e.g. NRC, 1996, 2001) are based simply on empirical

relationships between maternal intakes of energy and nitrogen and conceptus tissue masses at different stages of pregnancy. Quantitative descriptions of maternal and fetal fluxes of glucose and amino acids in sheep are sufficiently detailed to allow development of robust, mechanistic models of fetal growth in relation to maternal nutrient supply as influenced by nutrition and other environmental factors. Preliminary approaches include application of the compartmental modelling program, SAAM (Boston *et al.*, 1981), to develop dynamic models of maternal glucose metabolism (Wastney *et al.*, 1983) and of maternal-fetal exchanges of the non-metabolizable glucose analogue, 3-O-methyl glucose (Ehrhardt, 1997). The latter model has been used to estimate bidirectional fluxes of glucose between the dam and twin fetuses (Fig. 20.4) in well-fed and underfed ewes during late pregnancy. This approach allowed estimation that moderate undernutrition for 2 weeks caused a 50% increase in placental capacity for maternal-fetal glucose transport *in vivo* (Ehrhardt *et al.*, 1996). Ideally, future models will marry these compartmental solutions of tracer kinetic data to the wealth of descriptive information on glucose and amino acid exchanges under different nutritional and physiological conditions. These models also should incorporate the growing body of information on the regulation of nutrient partitioning between maternal tissues, the placenta and fetus(es).



**Fig. 20.4.** Compartmental model of the kinetics of 3-O methyl glucose (3MG) in ditocous ewes during late pregnancy, based on maternal injection of  $^3\text{H}$ -3MG. The fetal model was validated in monotocous ewes by simultaneous maternal injection of  $^3\text{H}$ -3MG and fetal injection of  $^{14}\text{C}$ -3MG (Ehrhardt *et al.*, 1996). Represented are: blood sampling sites (filled triangles), fractional transfer rates (light arrows), compartments (numbered circles),  $^3\text{H}$ -3MG injection site (heavy arrow) and extracellular distribution of 3MG (shaded compartments). Maternal-fetal clearance of 3MG was calculated as the volume of compartment 1 cleared of tracer to compartment 11 or 21 per unit time (ml/min). Reproduced from Bell and Ehrhardt (2002).

## References

- AFRC (1990) AFRC Technical Committee on Responses to Nutrients, Report No. 5, Nutritive Requirements of Ruminant Animals: Energy. *Nutrition Abstracts and Reviews (Series B)* 60, 729–802.
- Aldoretta, P.W. and Hay, W.W. Jr (1999) Effect of glucose supply on ovine uteroplacental glucose metabolism. *American Journal of Physiology* 277, R947–R958.
- Aldoretta, P.W., Carver, T.D. and Hay, W.W. Jr (1998) Maturation of glucose-stimulated insulin secretion in fetal sheep. *Biology of the Neonate* 73, 375–396.
- Anderson, A.H., Fennessey, P.V., Meschia, G., Wilkening, R.B. and Battaglia, F.C. (1997) Placental transport of threonine and its utilisation in the normal and growth-restricted fetus. *American Journal of Physiology* 272, E892–E900.
- Anderson, M.S., He, J., Flowers-Ziegler, J., Devaskar, S.U. and Hay, W.W. Jr (2001) Effects of selective hyperglycemia and hyperinsulinemia on glucose transporters in fetal ovine skeletal muscle. *American Journal of Physiology* 281, R1256–R1263.
- Andrews, W.H.H., Britton, H.G., Huggett, A.G. and Nixon, D.A. (1960) Fructose metabolism in the isolated and perfused liver of the foetal and new-born sheep. *Journal of Physiology* 153, 199–208.
- Andriquetto, J.L., Slepetic, R., Butler, W.R. and Bell, A.W. (1995) Chronic effects of estradiol-17 $\beta$  on basal and epinephrine-stimulated lipid mobilisation in sheep. *Journal of Animal Science* 78 (Suppl. 1), 225.
- Andriquetto, J.L., Slepetic, R. and Bell, A.W. (1996) Effect of estradiol-17 $\beta$  on metabolic responses to insulin in sheep. *Journal of Animal Science* 74 (Suppl. 1), 234.
- Barbera, A., Wilkening, R.B., Teng, C., Battaglia, F.C. and Meschia, G. (1997) Metabolic alterations in the fetal hepatic and umbilical circulations during glucocorticoid-induced parturition in sheep. *Pediatric Research* 41, 242–248.
- Bassett, J.M. and Hanson, C. (1998) Catecholamines inhibit growth in fetal sheep in the absence of hypoxemia. *American Journal of Physiology* 274, R1536–R1545.
- Bassett, J.M. and Hanson, C. (2000) Prevention of hypoinsulinemia modifies catecholamine effects in fetal sheep. *American Journal of Physiology* 278, R1171–R1181.
- Battaglia, F.C. (2000) Glutamine and glutamate exchange between the fetal liver and the placenta. *Journal of Nutrition* 130, 974S–977S.
- Battaglia, F.C. (2002) *In vivo* characteristics of placental amino acid transport and metabolism in ovine pregnancy – a review. *Placenta* 23 (Suppl. A), S3–S8.
- Battaglia, F.C. and Regnault, T.R.H. (2001) Placental transport and metabolism of amino acids. *Placenta* 22, 145–161.
- Bauman, D.E. (2000) Regulation of nutrient partitioning during lactation: homeostasis and homeorhesis revisited. In: Cronjé, P.B. (ed.) *Ruminant Physiology. Digestion, Metabolism, Growth and Reproduction*. CAB International, Wallingford, UK, pp. 311–328.
- Bauman, D.E. and Vernon, R.G. (1993) Effects of exogenous bovine somatotropin on lactation. *Annual Review of Nutrition* 13, 437–461.
- Bell, A.W. (1986) Efficiency of prenatal growth and the heat increment of pregnancy. In: *Proceedings of the Cornell Nutrition Conference for Feed Manufacturers*. Cornell University Agricultural Experiment Station, Ithaca, New York, pp. 64–67.
- Bell, A.W. (1987) Consequences of severe heat stress for fetal development. In: Hales, J.R.S. and Richards, D.A.B. (eds) *Heat Stress. Physical Exertion and Environment*. Elsevier, Amsterdam, The Netherlands, pp. 313–333.

- Bell, A.W. (1993) Pregnancy and fetal metabolism. In: Forbes, J.M. and France, J. (eds) *Quantitative Aspects of Ruminant Digestion and Metabolism*. CAB International, Wallingford, UK, pp. 405–431.
- Bell, A.W. (1995) Regulation of organic nutrient metabolism during the transition from late pregnancy to early lactation. *Journal of Animal Science* 73, 2804–2819.
- Bell, A.W. and Bauman, D.E. (1994) Animal models for the study of adipose regulation in pregnancy and lactation. In: Allen, L., King, J. and Lonnerdal, B. (eds) *Nutrient Regulation during Pregnancy, Lactation, and Infant Growth*. Plenum Press, New York, pp. 71–84.
- Bell, A.W. and Ehrhardt, R.A. (2000) Regulation of macronutrient partitioning between maternal and conceptus tissues in the pregnant ruminant. In: Cronjé, P.B. (ed.) *Ruminant Physiology. Digestion, Metabolism, Growth and Reproduction*. CAB International, Wallingford, UK, pp. 275–293.
- Bell, A.W. and Ehrhardt, R.A. (2002) Regulation of placental nutrient transport and implications for fetal growth. *Nutrition Research Reviews* 15, 211–230.
- Bell, A.W., Battaglia, F.C. and Meschia, G. (1987) Relation between metabolic rate and body size in the ovine fetus. *Journal of Nutrition* 117, 1181–1186.
- Bell, A.W., Kennaugh, J.M., Battaglia, F.C. and Meschia, G. (1989) Uptake of amino acids and ammonia at mid-gestation by the fetal lamb. *Quarterly Journal of Experimental Physiology* 74, 635–643.
- Bell, A.W., Slepets, R. and Ehrhardt, R.A. (1995) Growth and accretion of energy and protein in the gravid uterus during late pregnancy in Holstein cows. *Journal of Dairy Science* 78, 1954–1961.
- Bell, A.W., Hay, W.W. Jr and Ehrhardt, R.A. (1999) Placental transport of nutrients and its implications for fetal growth. *Journal of Reproduction and Fertility* (Suppl.) 54, 401–410.
- Bell, A.W., Greenwood, P.L. and Ehrhardt, R.A. (2005) Regulation of metabolism and growth during prenatal life. In: Burrin, D.G. and Mersmann, H.J. (eds) *Biology of Metabolism in Growing Animals*. Elsevier, London, pp.3–34.
- Blum, J.W., Froehli, D. and Kunz, P. (1982) Effects of catecholamines on plasma free fatty acids in fed and fasted cattle. *Endocrinology* 110, 452–456.
- Boston, R.C., Greif, P.C. and Berman, M. (1981) Conversational SAAM – an interactive program for kinetic analysis of biological systems. *Compartmental Programming in Biomedicine* 13, 111–119.
- Brody, S. (1945) *Bioenergetics and Growth*. Reinhold Publishing Corporation, New York, 1023 pp.
- Carter, B.S., Moores, R.R. Jr, Battaglia, F.C. and Meschia, G. (1993) Ovine fetal placental lactate exchange and decarboxylation at midgestation. *American Journal of Physiology* 264, E221–E225.
- Carter, B.S., Moores, R.R. Jr, Teng, C., Meschia, G. and Battaglia, F.C. (1995) Main routes of plasma lactate carbon disposal in the midgestation fetal lamb. *Biology of the Neonate* 67, 295–300.
- Ceddia, R.B., Koistinen, H.A., Zierath, J.R. and Sweeney, G. (2002) Analysis of paradoxical observations on the association between leptin and insulin resistance. *FASEB Journal* 16, 1163–1176.
- Char, V.C. and Creasy, R.K. (1976) Acetate as a metabolic substrate in the fetal lamb. *American Journal of Physiology* 230, 357–361.
- Chung, M., Teng, C., Timmerman, C., Meschia, G. and Battaglia, F.C. (1998) Production and utilization of amino acids by ovine placenta *in vivo*. *American Journal of Physiology* 274, E13–E22.

- Cohen, W.R., Piasecki, G.J. and Jackson, B.T. (1982) Plasma catecholamines during hypoxemia in fetal lamb. *American Journal of Physiology* 243, R520–R525.
- Comline, R.S. and Silver, M. (1976) Some aspects of foetal and uteroplacental metabolism in cows with indwelling umbilical and uterine catheters. *Journal of Physiology* 260, 571–586.
- CSIRO (1990) *Feeding Standards for Australian Livestock. Ruminants*. CSIRO Publications, East Melbourne, Australia, 266 pp.
- Currie, M.J., Bassett, N.S. and Gluckman, P.D. (1997) Ovine glucose transporter-1 and -3: cDNA partial sequences and developmental gene expression in the placenta. *Placenta* 18, 393–401.
- Das, U.G., He, J., Ehrhardt, R.A., Hay, W.W. Jr and Devaskar, S.U. (2000) Time-dependent physiological regulation of ovine placental GLUT-3 glucose transporter protein. *American Journal of Physiology* 279, R2252–R2261.
- DiGiacomo, J.E. and Hay, W.W. Jr (1990a) Placental-fetal glucose exchange and placental glucose consumption in pregnant sheep. *American Journal of Physiology* 258, E360–E367.
- DiGiacomo, J.E. and Hay, W.W. Jr (1990b) Fetal glucose metabolism and oxygen consumption during sustained hypoglycemia. *Metabolism* 39, 193–202.
- Ehrhardt, R.A. (1997) Regulation of glucose transport and partitioning by the placenta in the second half of pregnancy in sheep. PhD dissertation, Cornell University, Ithaca, New York.
- Ehrhardt, R.A. and Bell, A.W. (1997) Developmental increases in glucose transporter concentration in the sheep placenta. *American Journal of Physiology* 273, R1132–R1141.
- Ehrhardt, R.A., Boston, R.C., Slepatis, R.M. and Bell, A.W. (1996) Moderate maternal undernutrition elevates placental glucose transport capacity in sheep. *Journal of Animal Science* 74 (Suppl. 1), 152.
- Ehrhardt, R.A., Slepatis, R.M. and Bell, A.W. (1998) Moderate maternal undernutrition alters glucose transporter levels in maternal insulin-responsive tissues and in the placenta. *Journal of Animal Science* 76 (Suppl. 1), 130.
- Ehrhardt, R.A., Bell, A.W. and Boisclair, Y.R. (1999) Analysis of leptin and leptin receptor mRNA expression in the sheep placenta. *Journal of Animal Science* 77 (Suppl. 1), 159.
- Ehrhardt, R.A., Slepatis, R.M., Bell, A.W. and Boisclair, Y.R. (2001) Maternal leptin is elevated during pregnancy in sheep. *Domestic Animal Endocrinology* 21, 85–96.
- Etherton, T.D. and Bauman, D.E. (1998) Biology of somatotropin in growth and lactation of domestic animals. *Physiological Reviews* 78, 745–761.
- Faichney, G.J. and White, G.A. (1987) Effects of maternal nutritional status on fetal and placental growth and on fetal urea synthesis in sheep. *Australian Journal of Biological Sciences* 40, 365–377.
- Ferrell, C.L. (1991) Maternal and fetal influences on uterine and conceptus development in the cow. II. Blood flow and nutrient flux. *Journal of Animal Science* 69, 1954–1965.
- Ferrell, C.L. and Reynolds, L.P. (1992) Uterine and umbilical blood flows and net nutrient uptake by fetuses and uteroplacental tissues of cows gravid with either single or twin fetuses. *Journal of Animal Science* 70, 426–433.
- Ferrell, C.L., Garrett, W.N. and Hinman, N. (1976a) Growth, development and composition of the udder and gravid uterus of beef heifers during pregnancy. *Journal of Animal Science* 42, 1477–1489.
- Ferrell, C.L., Garrett, W.N., Hinman, N. and Grichting, G. (1976b) Energy utilization by pregnant and non-pregnant heifers. *Journal of Animal Science* 42, 937–950.

- Forbes, J.M. (1986) The effects of sex hormones, pregnancy, and lactation on digestion, metabolism and voluntary intake. In: Milligan, L.P., Grovum, W.L. and Dobson, A. (eds) *Control of Digestion and Metabolism in Ruminants*. Prentice-Hall, Englewood Cliffs, New Jersey pp. 420–435.
- Fowden, A.L. (1995) Endocrine regulation of fetal growth. *Reproduction, Fertility and Development* 7, 351–363.
- Fowden, A. L. (1997) Comparative aspects of fetal carbohydrate metabolism. *Equine Veterinary Journal* Suppl. 24, 19–25.
- Fowden, A.L. and Silver, M. (1995) The effect of thyroid hormones on oxygen and glucose metabolism in the sheep fetus during late gestation. *Journal of Physiology* 482, 203–213.
- Fowden, A.L., Li, J. and Forhead, A.L. (1998) Glucocorticoids and the preparation for life after birth: are there long-term consequences of the life insurance? *Proceedings of the Nutrition Society* 57, 113–122.
- Fowden, A.L., Mapstone, J. and Forhead, A.J. (2001) Regulation of gluconeogenesis by thyroid hormones in fetal sheep during late gestation. *Journal of Endocrinology* 170, 461–469.
- Freetly, H.C. and Ferrell, C.L. (1997) Oxygen consumption by and blood flow across the portal-drained viscera and liver of pregnant ewes. *Journal of Animal Science* 75, 1950–1955.
- Freetly, H.C. and Ferrell, C.L. (1998) Net flux of glucose, lactate, volatile fatty acids, and nitrogen metabolites across the portal-drained viscera and liver of pregnant ewes. *Journal of Animal Science* 76, 3133–3145.
- Freetly, H.C. and Ferrell, C.L. (2000) Net flux of non-esterified fatty acids, cholesterol, triacylglycerol, and glycerol across the portal-drained viscera and liver of pregnant ewes. *Journal of Animal Science* 78, 1380–1388.
- Gertler, A. and Djiane, J. (2002) Mechanism of ruminant placental lactogen action: molecular and *in vivo* studies. *Molecular Genetics and Metabolism* 75, 189–201.
- Green, D.A., Brink, D.R., Bauer, M.L. and Wester, T.J. (1992) Estradiol-17 $\beta$  effects on lipid metabolism of adipose tissue in nutritionally induced lean and obese ovariectomized ewes. *Journal of Animal Science* 70, 2120–2129.
- Grummer, R.R. (1993) Etiology of lipid-related metabolic disorders in periparturient dairy cows. *Journal of Dairy Science* 76, 3882–3896.
- Guesnet, P., Massoud, M.J. and Demarne, Y. (1987) Effects of pregnancy and lactation on lipolysis of ewe adipocytes induced by  $\beta$ -adrenergic stimulation. *Molecular and Cellular Endocrinology* 50, 177–181.
- Guesnet, P.M., Massoud, M.J. and Demarne, Y. (1991) Regulation of adipose tissue metabolism during pregnancy and lactation in the ewe: the role of insulin. *Journal of Animal Science* 69, 2057–2065.
- Harding, J.E., Liu, L., Evans, P.C. and Gluckman, P.D. (1994) Insulin-like growth factor I alters fetoplacental protein and carbohydrate metabolism in fetal sheep. *Endocrinology* 134, 1509–1514.
- Harwell, C.M., Padbury, J.F., Anand, R.S., Martinez, A.M., Ipp, E., Thio, L. and Burnell, E.E. (1990) Fetal catecholamine responses to maternal hypoglycemia. *American Journal of Physiology* 259, R1126–R1130.
- Hay, W.W. Jr. (1995) Regulation of placental metabolism by glucose supply. *Reproduction, Fertility and Development* 7, 365–375.
- Hay, W.W. Jr, Mezmarich, H.K., DiGiacomo, J.E., Hirst, K. and Zerbe, G. (1988) Effects of insulin and glucose concentrations on glucose utilization in fetal sheep. *Pediatric Research* 23, 381–387.

- Holzman, I.R., Lemons, J.A., Meschia, G. and Battaglia, F.C. (1977) Ammonia production by the pregnant uterus. *Proceedings of the Society for Experimental Biology and Medicine* 156, 27–30.
- Hooper, S.B., Bocking, A.D., White, S.E., Fraher, L.J., McDonald, T.J. and Han, V.K. (1994) Catecholamines stimulate the synthesis and release of insulin-like growth factor binding protein-1 (IGFBP-1) by fetal sheep liver *in vivo*. *Endocrinology* 134, 1104–1112.
- Jones, C.T., Ritchie, J.W. and Walker, D. (1983) The effects of hypoxia on glucose turnover in the fetal sheep. *Journal of Developmental Physiology* 5, 223–235.
- Jozwik, M., Teng, C., Timmerman, M., Chung, M., Meschia, G. and Battaglia, F.C. (1998) Uptake and transport by the ovine placenta of neutral nonmetabolizable amino acids with different transport system affinities. *Placenta* 19, 531–538.
- Jozwik, M., Teng, C., Battaglia, F.C. and Meschia, G. (1999) Fetal supply of amino acids and amino nitrogen after maternal infusion of amino acids in pregnant sheep. *American Journal of Obstetrics and Gynecology* 180, 447–453.
- Kennaugh, J.M., Bell, A.W., Teng, C., Meschia, G. and Battaglia, F.C. (1987) Ontogenetic changes in the rates of protein synthesis and leucine oxidation during fetal life. *Pediatric Research* 22, 688–692.
- Kenyon, P.R., Morris, S.T., Revell, D.K. and McCutcheon, S.N. (2002) Maternal constraint and the birth weight response to mid-pregnancy shearing. *Australian Journal of Agricultural Research* 53, 511–517.
- Krishnamurti, C.R. and Schaefer, A.L. (1984) Effect of acute maternal starvation on tyrosine metabolism and protein synthesis in fetal sheep. *Growth* 48, 391–403.
- Leibovich, H., Gertler, A., Bazer, F.W. and Gootwine, E. (2000) Active immunization of ewes against ovine placental lactogen increases birth weight of lambs and milk production with no adverse effect on conception rate. *Animal Reproduction Science* 64, 33–47.
- Lemons, J.A. and Schreiner, R.L. (1983) Amino acid metabolism in the ovine fetus. *American Journal of Physiology* 244, E459–E466.
- Lemons, J.A. and Schreiner, R.L. (1984) Metabolic balance of the ovine fetus during the fed and fasted states. *Annals of Nutrition and Metabolism* 28, 268–280.
- Leury, B.J., Bird, A.R., Chandler, K.D. and Bell, A.W. (1990) Glucose partitioning in the pregnant ewe: effects of undernutrition and exercise. *British Journal of Nutrition* 64, 449–462.
- Liechty, E.A., Kelly, J. and Lemons, J.A. (1991) Effect of fasting on uteroplacental amino acid metabolism in the pregnant sheep. *Biology of the Neonate* 60, 207–214.
- Liechty, E.A., Boyle, D.W., Moorehead, H., Lee, W.-H., Bowsher, R.R. and Denne, S.C. (1996) Effects of circulating IGF-I on glucose and amino acid kinetics in the ovine fetus. *American Journal of Physiology* 271, E177–E185.
- Loy, G.L., Quick, A.N. Jr, Hay W.W. Jr, Meschia, G., Battaglia, F.W. and Fennessey, P.V. (1990) Fetoplacental deamination and decarboxylation of leucine. *American Journal of Physiology* 259, E492–E497.
- McGowan, J.E., Aldoretta, P.W. and Hay, W.W. Jr. (1995) Contribution of fructose and lactate produced in placenta to calculation of fetal glucose oxidation rate. *American Journal of Physiology* 269, E834–E839.
- McNeill, D.M., Slepatis, R., Ehrhardt, R.A., Smith, D.M. and Bell, A.W. (1997) Protein requirements of sheep in late pregnancy: partitioning of nitrogen between gravid uterus and maternal tissues. *Journal of Animal Science* 75, 809–816.

- Meier, P.R., Peterson, R.B., Bonds, D.R., Meschia, G. and Battaglia, F.C. (1981a) Rates of protein synthesis and turnover in fetal life. *American Journal of Physiology* 240, E320–E324.
- Meier, P.R., Teng, C., Battaglia, F.C. and Meschia, G. (1981b) The rate of amino acid nitrogen and total nitrogen accumulation in the fetal lamb. *Proceedings of the Society for Experimental Biology and Medicine* 167, 463–468.
- Mellor, D.J. (1983) Nutritional and placental determinants of foetal growth rate in sheep and consequences for the newborn lamb. *British Veterinary Journal* 139, 307–318.
- Mezmarich, H.K., Hay, W.W. Jr, Sparks, J.W., Meschia, G. and Battaglia, F.C. (1987) Fructose disposal and oxidation rates in the ovine fetus. *Quarterly Journal of Experimental Physiology* 72, 617–625.
- Milley, J.R. (1996) Fetal substrate uptake during increased ovine fetal cortisol concentration. *American Journal of Physiology* 271, E186–E191.
- Molina, R.D., Meschia, G., Battaglia, F.C. and Hay, W.W. Jr (1991) Gestational maturation of placental glucose transfer capacity in sheep. *American Journal of Physiology* 261, R697–R704.
- Moore, R.R. Jr, Vaughn, P.R., Battaglia, F.C., Fennessey, P.V., Wilkening, R.B. and Meschia, G. (1994) Glutamate metabolism in fetus and placenta of late-gestation sheep. *American Journal of Physiology* 267, R89–R96.
- N'Guema, M., Delouis, C., Kelly, P.A. and Djiane, J. (1986) Evolution of prolactin and placental lactogen receptors in ewes during pregnancy and lactation. *Endocrinology* 118, 695–700.
- NRC (1996) *Nutrient Requirements of Beef Cattle*, 7th revised edn. National Research Council, National Academy Press, Washington, DC, 242 pp.
- NRC (2001) *Nutrient Requirements of Dairy Cattle*, 7th revised edn. National Research Council, National Academy Press, Washington, DC, 381 pp.
- Paolini, C.L., Meschia, G., Fennessey, P.V., Pike, A.W., Teng, C., Battaglia, F.C. and Wilkening, R.B. (2001) An *in vivo* study of ovine placental transport of essential amino acids. *American Journal of Physiology* 280, E31–E39.
- Petterson, J.A., Dunshea, F.R., Ehrhardt, R.A. and Bell, A.W. (1993) Pregnancy and undernutrition alter glucose metabolic responses to insulin in sheep. *Journal of Nutrition* 123, 1286–1295.
- Petterson, J.A., Slepatis, R., Ehrhardt, R.A., Dunshea, F.R. and Bell, A.W. (1994) Pregnancy but not moderate undernutrition attenuates insulin suppression of fat mobilization in sheep. *Journal of Nutrition* 124, 2431–2436.
- Ratray, P.V., Garrett, W.N., East, N.E. and Hinman, N. (1974a) Growth, development and composition of the ovine conceptus and mammary gland during pregnancy. *Journal of Animal Science* 38, 613–626.
- Ratray, P.V., Garrett, W.N., East, N.E. and Hinman, N. (1974b) Efficiency of utilization of metabolizable energy during pregnancy and the energy requirements of pregnancy in sheep. *Journal of Animal Science* 38, 383–393.
- Revell, D.K., Main S.F., Breier, B.H., Cottam, Y.H., Hennies, M. and McCutcheon, S.N. (2000) Metabolic responses to mid-pregnancy shearing that are associated with a selective increase in the birth weight of twin lambs. *Domestic Animal Endocrinology* 18, 409–422.
- Revell, D.K., Morris, S.T., Cottam, Y.H., Hanna, J.E., Thomas, D.G., Brown, S. and McCutcheon, S.N. (2002) Shearing ewes at mid-pregnancy is associated with changes in fetal growth and development. *Australian Journal of Agricultural Research* 53, 697–705.



- Reynolds, L.P., Ferrell, C.L., Robertson, D.A. and Ford, S.P. (1986) Metabolism of the gravid uterus, fetus and utero-placenta at several stages of gestation in cows. *Journal of Agricultural Science, Cambridge* 106, 437–444.
- Robinson, J.J., McDonald, I., Fraser, C. and Gordon, V. (1980) Studies on reproduction of prolific ewes. 6. The efficiency of energy utilization for conceptus growth. *Journal of Agricultural Science, Cambridge* 91, 291–304.
- Robinson, J.J., Sinclair, K.D., Randel, R.D. and Sykes, A.R. (1999) Nutritional management of the female ruminant: mechanistic approaches and predictive models. In: Jung, H.G. and Fahey, G.C. Jr (eds) *Nutritional Ecology of Herbivores*. American Society of Animal Science, Savoy.
- Rosenfeld, C.R. (1977) Distribution of cardiac output in ovine pregnancy. *American Journal of Physiology* 232, H231–H235.
- Ross, J.C., Fennessey, P.V., Wilkening, R.B., Battaglia, F.C. and Meschia, G. (1996) Placental transport and fetal utilization of leucine in a model of fetal growth retardation. *American Journal of Physiology* 270, E491–E503.
- Simmons, M.A., Battaglia, F.C. and Meschia, G. (1979) Placental transfer of glucose. *Journal of Developmental Physiology* 1, 227–243.
- Smeaton, T.C., Owens, J.A., Kind, K.L. and Robinson, J.S. (1989) The placenta releases branched-chain keto acids into the umbilical and uterine circulations in the pregnant sheep. *Journal of Developmental Physiology* 12, 95–99.
- Stevens, D., Alexander, G. and Bell, A.W. (1990) Effect of prolonged glucose infusion into fetal sheep on body growth, fat deposition and gestation length. *Journal of Developmental Physiology* 13, 277–281.
- Symonds, M.E., Bryant, M.J. and Lomax, M.A. (1986) The effect of shearing on the energy metabolism of the pregnant ewe. *British Journal of Nutrition* 56, 635–643.
- Teng, C.C., Tjoa, S., Fennessey, P.V., Wilkening, R.B. and Battaglia, F.C. (2002) Transplacental carbohydrate and sugar alcohol concentrations and their uptakes in ovine pregnancy. *Experimental Biology and Medicine* 227, 189–195.
- Thompson, G.E., Bassett, J.M., Samson, D.E. and Slee, J. (1982) The effects of cold exposure of pregnant sheep on foetal plasma nutrients, hormones and birth weight. *British Journal of Nutrition* 48, 59–64.
- Thureen, P., Trembler, K.A., Meschia, G., Makowski, E.L. and Wilkening, R.B. (1992) Placental glucose transport in heat-induced fetal growth retardation. *American Journal of Physiology* 263, R578–R585.
- Thureen, P.J., Merson, S. and Hay, W.W. Jr (2000) Regulation of uterine and umbilical amino acid uptakes by maternal amino acid concentrations. *American Journal of Physiology* 279, R849–R859.
- Thureen, P.J., Padbury, J.F. and Hay, W.W. Jr (2001) The effect of maternal hypoa-aminoacidaemia on placental uptake and transport of amino acids in pregnant sheep. *Placenta* 22, 162–170.
- Timmerman, M., Chung, M., Wilkening, R.B., Fennessey, P.V., Battaglia, F.C. and Meschia, G. (1998) Relationship of fetal alanine uptake and placental alanine metabolism to maternal plasma alanine concentration. *American Journal of Physiology* 275, E942–E950.
- Timmerman, M., Teng, C., Wilkening, R.B., Fennessey, P., Battaglia, F.C. and Meschia, G. (2000) Effect of dexamethasone on fetal hepatic glutamine-glutamate exchange. *American Journal of Physiology* 278, E839–E845.
- Van Veen, L.C.P., Teng, C., Hay, W.W. Jr, Meschia, G. and Battaglia, F.C. (1987) Leucine disposal and oxidation rates in the fetal lamb. *Metabolism* 36, 48–53.

- Vernon, R.G., Clegg, R.A. and Flint, D.J. (1981) Metabolism of sheep adipose tissue during pregnancy and lactation. Adaptation and regulation. *Biochemical Journal* 200, 307–314.
- Vernon, R.G., Clegg, R.A. and Flint, D.J. (1985) Adaptation of adipose tissue metabolism and number of insulin receptors in pregnant sheep. *Comparative Biochemistry and Physiology* 81B, 909–913.
- Vernon, R.G., Faulkner, A., Hay, W.W. Jr, Calvert, D.T. and Flint, D.J. (1990) Insulin resistance of hind-limb tissues *in vivo* in lactating sheep. *Biochemical Journal* 270, 783–786.
- Wallace, J.M., Bourke, D.A., Aitken, R.P., Palmer, R.M., Da Silva, P. and Cruickshank, M.A. (2000) Relationship between nutritionally-mediated placental growth restriction and fetal growth, body composition and endocrine status during late gestation in adolescent sheep. *Placenta* 21, 100–108.
- Wallace, J.M., Bourke, D.A., Aitken, R.P., Leitch, N. and Hay, W.W. Jr (2002) Blood flows and nutrient uptakes in growth-restricted pregnancies induced by overnourishing adolescent sheep. *American Journal of Physiology* 282, R1027–R1036.
- Wastney, M.E., Wolff, J.E., Bickerstaffe, R., Ramberg, C.F. and Berman, M. (1983) Kinetics of glucose metabolism in sheep. *Australian Journal of Biological Sciences* 36, 463–474.
- Wilkening, R.B., Molina, R.D., Battaglia, F.C. and Meschia, G. (1987) Effect of insulin on glucose/oxygen and lactate/oxygen quotients across the hindlimb of fetal lambs. *Biology of the Neonate* 51, 18–23.

---

# 21 Lactation: Statistical and Genetic Aspects of Simulating Lactation Data from Individual Cows using a Dynamic, Mechanistic Model of Dairy Cow Metabolism

H.A. Johnson, T.R. Famula and R.L. Baldwin

*Department of Animal Science, University of California, Davis,  
CA 95616-8521, USA*

---

## Introduction

Empirical models are fitted to experimental data to describe relationships between dependent and independent variables. By definition, they are best representations of the input:output data from which they were created. Also by definition, testing predictions of empirical models against data not used in formulating the models often leads to failures. Thus, it is generally recognized that empirical models are only valid for specific situations and do not generalize because they do not capture underlying reasons for relationships between dependent and independent variables. In contrast with empirical models, mechanistic models are derived from theories about the nature of the system modelled and, as a result, are based upon our understanding of underlying mechanisms, which drive the system (France and Thornley, 1984; Baldwin, 1995). Also, parameter values in mechanistic equations are derived from experimental data on each mechanism and, thus, are not derived from statistical analyses of input:output observations on the total system. For example, a mechanistic model of dairy cow functions would incorporate data on nutrient uptake, nutrient utilization by tissues, metabolic pathways, enzyme activities, nutrient concentrations, regulatory systems, etc. while an empirical model would use data on intake of nutrients and amount of milk or milk components output and body weight changes. Failure of a mechanistic model to simulate new, long-term data shows where understanding incorporated into the model is lacking and what old or new knowledge and experimental data must be incorporated to further refine and develop the model.

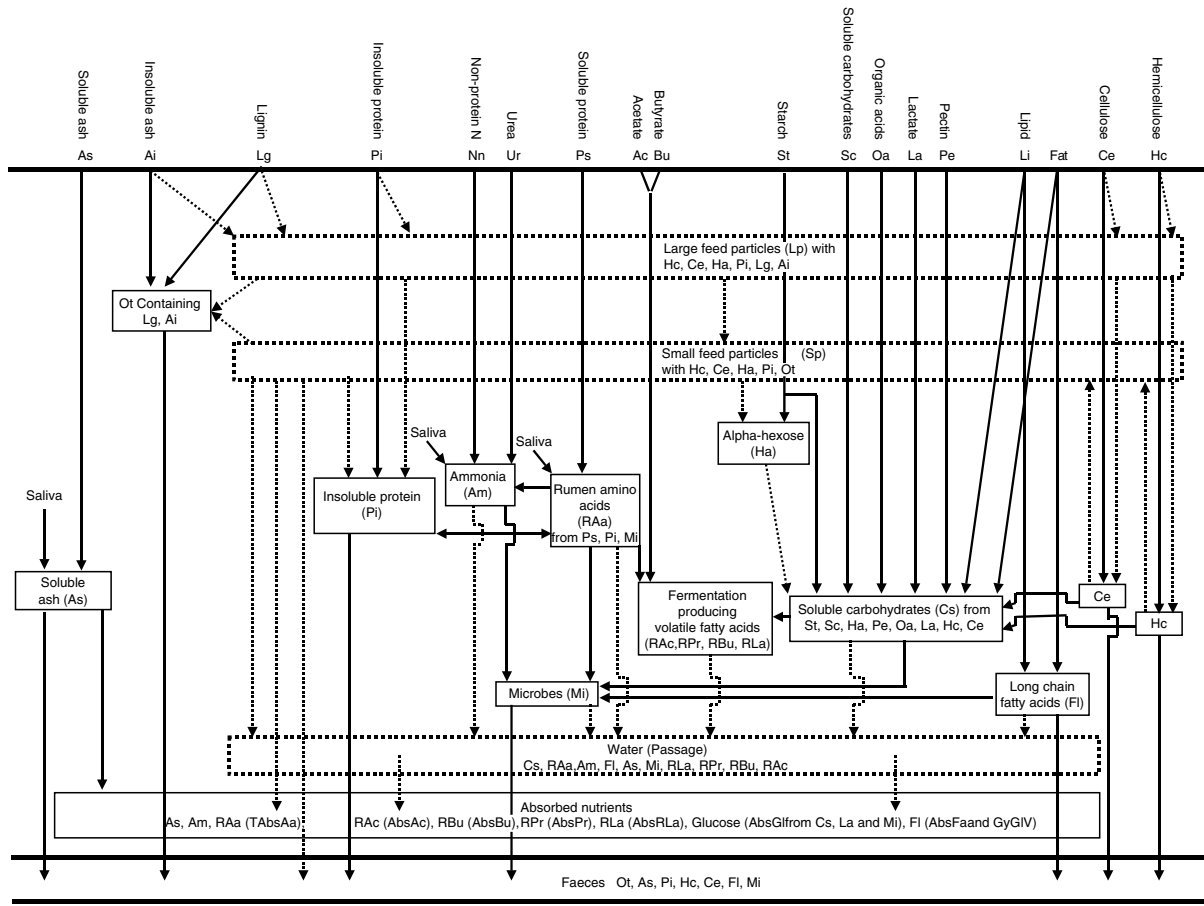
The testing of mechanistic models in biology must consider two perspectives when evaluating the suitability of a computer model to serve as a proxy for

physiological processes. The first is a statistical perspective, an evaluation of the fit of the predictive results of the model to the observed physiological phenomena. Techniques for such statistical evaluation abound, relying upon loss functions, likelihood surfaces and measures of 'goodness-of-fit' (Diggle *et al.*, 1994). In addition, investigators are asked to evaluate the statistical means by which they will draw conclusions, such as the use of computing algorithms, the parametric form of distributions to consider and the distinction between classical and Bayesian procedures (Robert and Casella, 1999). The second form, a biological perspective, concerns the assessment of the behaviour of the predictions, whether the estimates of parameters and the ensuing predictions from such models, make biological 'sense'. In other words, do animals, or populations of animals, display the same properties in nature (*in vivo*) that the model would have them display '*in silico*'? Our model testing process must, of needs, consider both. In this chapter, the underlying relationships between diet, intake, milk production and genetic potential to produce milk represented within a dynamic, mechanistic model of a dairy cow (MOLLY) are examined. First, the main equations representing the metabolic dairy cow model are described, previous evaluations of the model are presented and techniques to evaluate models are explained. Second, the sensitivity of the model to certain parameters used in model evaluation is considered. Finally a large data set of production data is used to evaluate model predictions.

## Overview of MOLLY Equations

MOLLY is the dynamic, mechanistic model of digestion and metabolism of a lactating dairy cow described in detail by Baldwin (1995) and earlier publications. The digestion element of the model (Fig. 21.1) is comprised of 15 differential equations descriptive of transactions associated with the state variables: starch (St), hemicellulose (Hc), cellulose (Ce), soluble carbohydrate (Cs) equivalents arising from the diet and hydrolysis of insoluble carbohydrates, microbes (Mi), acetate (Ac), propionate (Pr), butyrate (Bu), insoluble protein (Pi), amino acids and peptides (Aa), ammonia (Am), ash (soluble as As, insoluble as Ai), lignin (Lg) and large (Lp) and small feed particles (Sp). Chemical composition of the diet is represented by St, Hc, Ce, Lg, Cs (also as Sc), Ac, Pr, Bu, Pi, Ps (soluble protein), As, Ai, Li (lipid), Oa (organic acids), La (lactate), Pe (pectin), Nn (non-protein nitrogen), Ur (urea) and fat. Lp and Sp represent physical attributes of the diet that influence the digestion process. In general, feed particles pass from the large particle pool to the small particle pool as digestion proceeds. Passage rates of nutrients associated with feed particles are influenced by water flow through the digestion process. After hydrolysis and microbial attachment, the rumen model uses fermentation coefficients to convert starch, soluble carbohydrates and amino acids into volatile fatty acids. Microbial growth is dependent on pH, ATP, dietary fat, rumen amino acids, ammonia and particle size.

The animal element of the model (Fig. 21.2) begins with absorbed nutrients (from Fig. 21.1) and defines transactions associated with ten state variables:



**Fig. 21.1.** Basic flux relationships in the digestive element of the MOLLY model. Solid lines indicate digestion processes associated with chemical characteristics of the diet. Dashed lines represent physical processes associated with digestion.

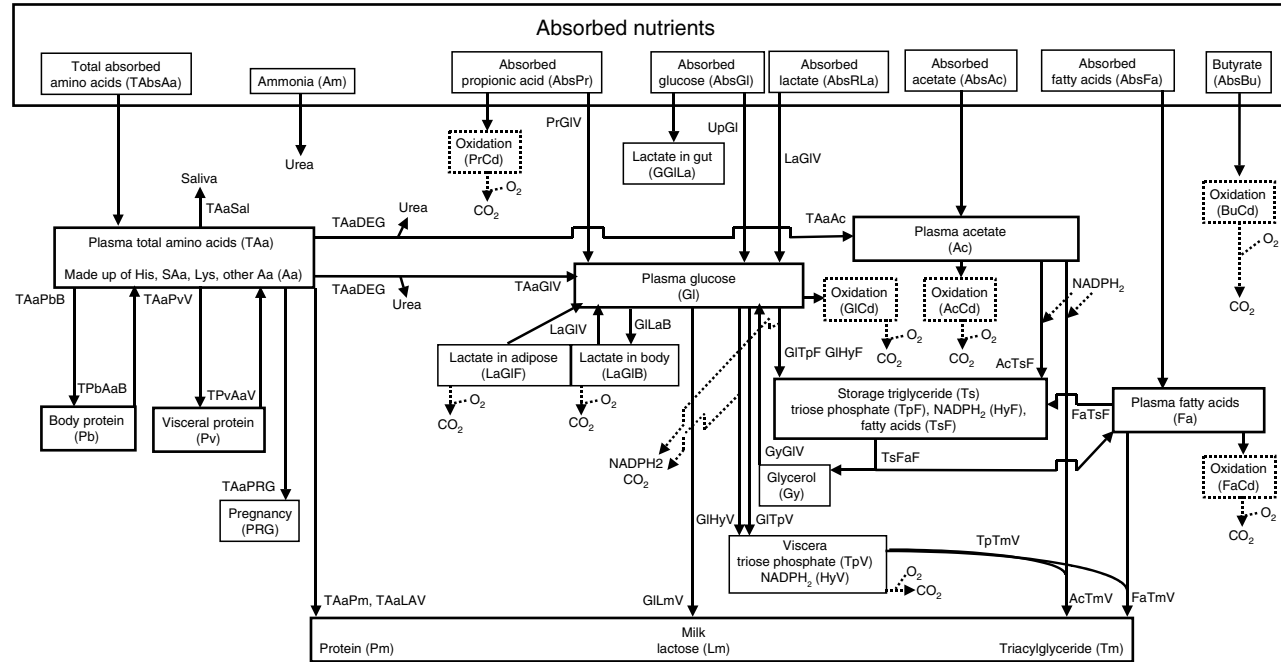


Fig. 21.2. Basic flux relationships in the animal element of MOLLY. State variables are outlined by heavy black lines.

total amino acids (*TAa*), glucose (*Gl*), acetate (*Ac*) and lipids (*Fa*), body protein (*Pb*), visceral protein (*Pv*), storage triacylglycerol (*Ts*), milk protein (*Pm*), milk lactose (*Lm*) and milk fat (*Tm*). Concentration of nutrients in blood is denoted by a lower case *c* (i.e. *cGl* is concentration of glucose in blood, *cAc* is concentration of acetate in plasma, *cTAa* is concentration of total amino acids) and is calculated by dividing the state variable by the distribution volume of glucose. Inputs into nutrient pools are influenced by absorption of the nutrient from diet and/or digestion, and conversion from other nutrients or metabolic intermediates by deamination, fermentation or synthetic processes. Outputs from nutrient pools are oxidation, synthesis of metabolic intermediates, synthesis of body tissues or secreted products (milk, milk fat, etc.). Algebraic equations are used in the model to calculate body weights, weight of viscera, weight of body fat, milk production, excretions, respiratory exchange, energy costs of individual nutrient transactions, ration metabolizable energy values, total heat production, income over feed costs and other outputs. Therefore the model predicts milk lactose (total volume milk produced), protein and milk fat based on the metabolic state of the cow, nutrients available to the udder and potential of the cow to produce milk through the parameters number of udder cells (*UCELLS*) and maximal velocities for milk fat and milk protein synthesis. There are also equations for the demands of pregnancy. To simulate a lactation, diet composition, daily dry matter intake, initial body weight, body fat per cent (or body condition score), length of the simulation (days) and *UCELLS* must be input to the model.

The original version of MOLLY treated amino acids as a single pool. The model has been rewritten to accommodate four amino acid pools: sulphur amino acids (*SAa*), lysine (*Lys*), histidine (*His*) and remaining amino acids (*Aa*). Equations for the uptake of individual amino acids by mammary tissue (Hanigan *et al.*, 1992) were incorporated. This revision allows either *SAa*, *Lys*, *His* or *Aa* to limit the synthesis of milk (*Pm*), body (*Pb*) and visceral (*Pv*) proteins and  $\alpha$ -lactalbumin and, as a result, lactose synthesis. The stoichiometric parameters, which define amino acid degradation in the model, have become dynamic variables dependent on the amount of individual amino acids entering and leaving the several pools. The sources of entering amino acids are the digestion of microbial protein, rumen bypass and abomasally infused proteins, amino acids and degradation of body and visceral proteins. Individual amino acids leave the pools for the synthesis of milk, body, visceral, salivary, fetal and placental proteins, and via amino acid degradation. Stoichiometries are calculated based upon the metabolic pathways for degradation of individual amino acids. Figure 21.3 shows in detail the equations presented in Fig. 21.2, which are of primary importance to the discussion presented in this chapter.

Equations for individual transactions such as *A* to *B* are mass action ( $k^*A$ ; where *k* is a rate constant in units of per minute, *A* is amount or concentration of substrate, *B* is amount of product, e.g. moles) or Michaelis–Menten form ( $v_{A,B} = V_{A,B}/(1 + k_{A,B}/A)$ ); where  $v_{A,B}$  is velocity of reaction *A* to *B*,  $V_{A,B}$  is maximal velocity of reaction *A* to *B* and  $k_{A,B}$  is concentration of substrate *A* at which half maximal velocity is reached). For example, a mass action equation in MOLLY is  $UpGl = 0.10^*AbsGl$ , where the proportion of absorbed glucose,

$$dAc/dt \text{ (mol/day)} = absAc + TAaAc - AcCd - AcTsF - AcTmV$$

$Ac$  = Total acetate in plasma (mol)  
 $absAc$  = Acetate absorption (mol/day)  
 $TAaAc$  = Portion of total amino acids degraded ( $TAaDEG$ ) that result in the formation of acetate (mol/day)  
 $AcCd$  = Acetate oxidation (mol/day)  
 $AcTsF$  = Acetate to triglyceride synthesis in adipose (mol/day)  
 $AcTmV$  = Acetate to milk fat synthesis in viscera – mammary (mol/day)

$$dFa/dt \text{ (mol/day)} = absFa + TsFaF - FaCd - FaTsF - FaTmV$$

$Fa$  = Total fatty acids in plasma (mol)  
 $AbsFa$  = Fatty acid absorption (mol/day)  
 $TsFaF$  = Triglyceride breakdown to fatty acids in adipose (mol/day)  
 $FaCd$  = Fatty acid oxidation (mol/day)  
 $FaTsF$  = Fatty acids to triglyceride synthesis in adipose (mol/day)  
 $FaTmV$  = Fatty acids to milk fat synthesis in viscera – mammary (mol/day)

$$dGl/dt \text{ (mol/day)} = PrGIV + UpGI + TAaGIV + LaGIV + GyGIV$$

$$- GILmV - GIHyF - GITpF - GILaB - GIHyV - GITpV - GICd$$

$Gl$  = Total glucose in plasma (mol)  
 $PrGIV$  = Portion of absorbed propionate that results in glucose formation (mol/day)  
 $UpGI$  = Portion of absorbed glucose that contributes to plasma glucose (mol/day)  
 (Note:  $PrGIV + UpGI$  = absorbed glucose ( $absGI$ ))  
 $TAaGIV$  = Total amino acids going to glucose in viscera – liver (mol/day)  
 $LaGIV$  = Lactate to glucose in viscera – liver (mol/day)  
 $GyGIV$  = Glycerol to glucose in viscera – liver (mol/day)  
 $GILmV$  = Glucose to milk lactose in viscera – mammary (mol/day)  
 $GIHyF$  = Glucose oxidized via pentose phosphate path for NADPH production in adipose (mol/day)  
 $GITpF$  = Glucose to triose phosphate (glycerol) in adipose (mol/day)  
 $GILaB$  = Glucose to lactate in the body – muscle, etc. (mol/day)  
 $GIHyV$  = Glucose oxidized via pentose phosphate path for NADPH production in viscera – mammary (mol/day)  
 $GITpV$  = Glucose to triose phosphate in viscera – mammary (mol/day)  
 $GICd$  = Glucose oxidation (mol/day)

$$dTAA/dt \text{ (mol/day)} = TabsAa + TPbAaB + TPvAaV$$

$$- TAaPbB - TAaPvV - TAaPmV - TAaSAL - TAaDEG - TAaPRG$$

$TAa$  = Total amino acids in plasma (mol)  
 $TabsAa$  = Total amino acid absorption (mol/day)  
 $TPbAaB$  = Protein degradation to total amino acids in the body – muscle (mol/day)  
 $TPvAaV$  = Protein degradation to total amino acids in viscera (mol/day)  
 $TAaPbB$  = Total amino acids to protein synthesis – muscle (mol/day)  
 $TAaPvV$  = Total amino acids to protein synthesis – viscera (mol/day)  
 $TAaPmV$  = Total amino acids to milk protein synthesis – mammary (mol/day)  
 $TAaSAL$  = Total amino acids to salivary protein synthesis (mol/day)  
 $TAaDEG$  = Total amino acids degraded i.e. to glucose and acetate in viscera (mol/day)  
 $TAaPRG$  = Total amino acids to support fetal growth/pregnancy (mol/day)

**Fig. 21.3.** Summary and definitions of metabolic transaction equations in MOLLY.

$AbsGI$ , going directly to plasma glucose,  $UpGI$  is 10%. An example of a Michaelis–Menten type equation is  $GITpF = VGITpF^*(EBW^{0.75})/(1 + kGITpF/cGI)$ , where  $GITpF$  is the velocity of the process glucose to triose phosphate in adipose ( $v_{A,B}$ ),  $VGITpF$  is the maximal velocity of glucose to triose phosphate in adipose ( $V_{A,B}$ ),  $kGITpF$  is the concentration of glucose at which half the maximal velocity of glucose to triose phosphate is reached ( $k_{A,B}$ )



and  $cG$  is the concentration of circulating glucose ( $A$ ). The factor ( $EBW^{0.75}$ ) has been added as a scalar to modify the equation for empty body weight ( $EBW$ ) differences between cows and is not included in the classical Michaelis–Menten equation form.

## Previous Evaluations of MOLLY

Evaluations of the MOLLY model have proceeded through several phases. Early evaluations were qualitative or, at best, semi-quantitative in nature. These evaluations were directed to the question, are specific equations or systems of equations adequate in direction and magnitude of responses to perturbations to allow simulations of reality (Baldwin, 1995). In these tests, the answers were often no and indicated that our understanding of specific functions was inadequate to the simulation of reality. For example, model failures led to experimental studies of factors, which cause variations in rumen microbial growth rates and yields. These studies led to the identification of amino acids (and later peptides), microbial maintenance requirements and ammonia availability as important determinants of growth yields and led to parameterization of equations to represent these effects (Maeng *et al.*, 1976; Argyle and Baldwin, 1989). Current representations of digestion products and amino acid absorption from the rumen produced the results depicted in Table 21.1. Cottrill *et al.* (1982) fed maize silage-based diets to calves weighing approximately 100 kg. The simulated data presented in Table 21.1 were produced by resetting the initial parameters of MOLLY to a dry, 100 kg cow. Although MOLLY was not intended to be used to simulate calf data, the magnitude and direction of change between observed and predicted values in Table 21.1 are similar.

Results of model simulations presented in Table 21.2 agree very well qualitatively with those reported by Clark (1975), Polan *et al.* (1991), Rulquin *et al.* (1993) and Whitelaw *et al.* (1986). In Table 21.2, responses to supplementation

**Table 21.1.** Simulated responses to urea and fishmeal supplementation of a maize silage-based diet.<sup>a,b</sup>

Diet	% CP	cAm (mol/l)	AaSI observed <sup>c</sup> (mol/day)	AaSI predicted (mol/day)	MiAa observed <sup>c</sup> (mol/day)	MiAa predicted (mol/day)
Maize silage + urea	15.0	0.043	3.50	2.76	1.95	2.05
Maize silage + urea + fishmeal	15.0	0.027	4.85	3.32	3.02	2.27

<sup>a</sup>CP, crude protein; cAm, rumen concentration of ammonia; AaSI, total amino acids entering the small intestine; MiAa, microbial amino acids entering the small intestine. In the maize silage + urea + fishmeal diet, 50% of added crude protein was from urea and 50% from fishmeal.

<sup>b</sup>Simulations were run for 100 kg calves for 25 days with dry matter intakes of 3.4 and 3.6 kg/day, respectively. Diets approximated those presented in Cottrill *et al.* (1982).

<sup>c</sup>Observed values are from Cottrill *et al.* (1982).

**Table 21.2.** Effects of base diets and supplements on model outputs on days 84 and 305 of simulated lactations.<sup>a</sup>

Treatment	At 84 days of lactation			After 305 days of lactation			
	DMILK (kg/day)	PPM (%)	cTAa (M × 10 <sup>-3</sup> )	Pm Lim. Aa	TVMLK (kg)	TDMIN (kg)	EBW (kg)
Reference diet	30.9	3.24	2.2	SAa	7313	5769	636
+ SAa	30.9	3.34	2.1	Lys	7388	5798	637
+ Lys	30.8	3.27	2.2	SAa	7298	5768	636
+ SAa + Lys	32.7	3.37	1.9	Aa	8235	6028	651
+ Casein	36.0	3.24	2.9	SAa	8507	6079	662
Maize gluten meal	25.4	3.29	2.6	Lys	6492	5551	627
+ SAa	25.4	3.29	2.5	Lys	6504	5556	628
+ Lys	27.4	3.31	2.5	SAa	6854	5651	631
+ SAa + Lys	33.0	3.37	1.9	Aa	8357	6059	653
+ Casein	33.4	3.31	3.1	SAa	8189	6007	659

<sup>a</sup>Values presented are outputs simulated for days 84 and 305 of lactation when a 50% lucerne, 50% concentrate diet (15% CP) was not supplemented or supplemented with SAa (0.1 mol/day), Lys (0.3 mol/day), SAa plus Lys or casein (1.9 mol/day) per abomasum. In the second series of runs, maize gluten meal was the primary protein source with no additional supplement or supplemented with SAa, Lys, SAa plus Lys or casein per abomasum. The NRC (1989) equation was used to calculate feed intakes for these simulations. Column codes are daily milk yield (DMILK), percentage of protein in milk (PPM), total dry matter intake (TDMIN), empty body weight (EBW), total concentrations of amino acids (cTAa), the amino acid pool most limiting to milk protein synthesis (Pm Lim. Aa) and total milk yield (TVMLK). It should be noted that simulated day 84 values were different when the supplement treatments were simulated beginning on day 70 of lactation rather than beginning the simulation at initiation of lactation due to carryover effects like those illustrated in Fig. 21.5.

with SAa alone or with Lys alone were relatively minor because both were very close to limiting (reference diet). As a result, when the concentration of one of these amino acids in blood was increased by supplementation, the other amino acid became limiting and effects upon milk (DMILK) and protein (PPM) were relatively minor. When the availabilities of both SAa and Lys were increased, milk production increased (5.8% at 84 days) and daily milk protein increased 10%. When a maize-based diet with maize gluten meal as the protein supplement was input into the model, Lys was limiting and supplementation with Lys resulted in a 7.9% increase in predicted daily milk and an 8.5% increase in daily milk protein yield at 84 days in milk.

Supplementation of the maize-based diet with Lys and SAa resulted in a 30% increase in milk and protein yields at 84 days in milk. These responses to SAa and Lys supplementation are higher than those reported by Clark (1975) and Polan *et al.* (1991), however the rates of SAa and Lys supplementation were higher than those used in the cited experiments. Polan *et al.* (1991) reported no significant increases in milk and milk protein with rumen protected methionine supplementation alone (0.11 mol/day) and 7.4% increase in milk (kg/day) and 2.4% increase in milk protein with rumen protected methionine (0.11 mol/day) and lysine (0.16 mol/day) supplementation over 22–112 days in milk. Clark (1975) showed data from two studies with an increase of 3.1% kg

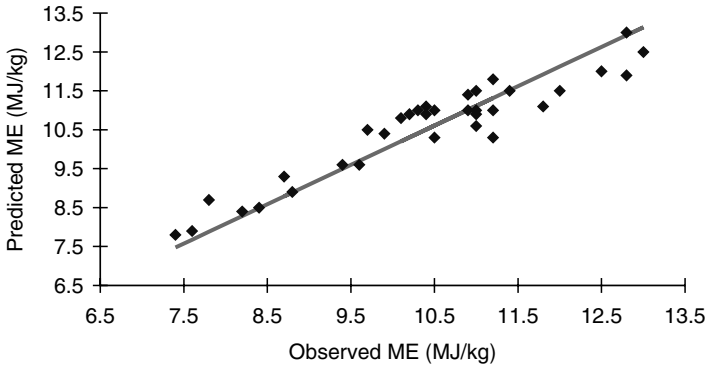
milk per day, 6% milk protein and a decrease of 8.1% kg milk per day and an increase of 1% milk protein in response to methionine supplementation. With lysine supplementation, milk yield increased 5.9% and 3.3% kg/day and protein increased 8% and 5%, respectively. Supplementation was over 7 days and levels of methionine and lysine supplementation were not listed. Rulquin *et al.* (1993) developed dose-response curves for lysine and methionine effects on milk yield. They found very little response to supplementation with increasing amounts of lysine or methionine (less than 1 kg milk per day) and changes in milk protein ranging between  $-0.4\%$  to  $+0.1\%$  protein for lysine and  $-0.15$  to  $+0.15$  for methionine supplementation.

Responses to abomasal infusion of casein were also greater than those reported by Whitelaw *et al.* (1986). With casein infusions of 1.9, 3.7 and 5.6 mol/day for 14 days, milk yield increased 17%, 27% and 32%, respectively. Milk protein increased 3.0%, 4.3% and 5.4%, respectively. Clark (1975) also summarized data from casein infusion studies in which casein infusions of 2.8, 4.05 and 8.04 mol/day resulted in increases in milk yield of 6.6%, 8.3% and 12.5% kg/day, respectively. With 2.8 mol casein infused per day, milk protein also increased 9%.

Additional comparisons of model outputs with detailed data for a 40% barley diet and a 40% maize diet showed that a large number of model outputs were within the standard errors (10%) of observed values (Baldwin and Bauman, 1984). Experimental studies of adipose tissue metabolism to define and parameterize improved equations to represent metabolite interactions, the regulation of lipogenesis, energy storage and lipolysis (Yang and Baldwin, 1973a,b), experimental studies of cow liver metabolism (Knapp *et al.*, 1992), mammary gland metabolism and nutrient uptake (Miller *et al.*, 1991; Hanigan *et al.*, 1992; Hanigan and Baldwin, 1994) were undertaken to better define and parameterize equations for the metabolism of these tissues. Detailed models of metabolism in adipose tissues (Baldwin, 1995), liver (Freetly *et al.*, 1993) and mammary glands (Hanigan and Baldwin, 1994) were constructed to support the formulation and parameterization of aggregated equations incorporated into the cow model. These are also used in formulating changes in existing cow model equations.

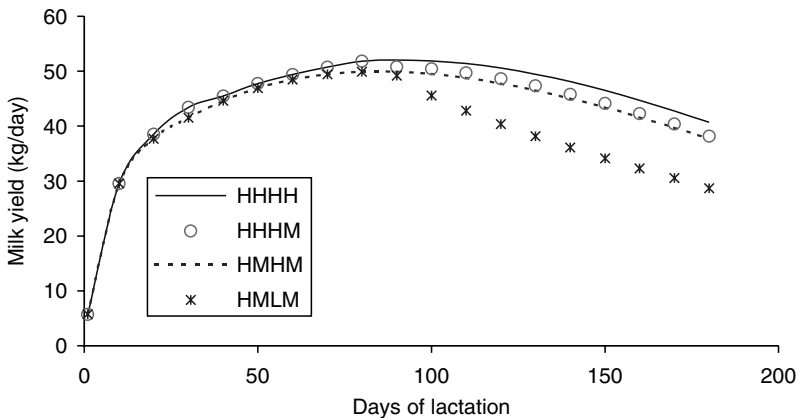
Two quantitative evaluations are presented in Figs 21.4 and 21.5. The metabolizable energy values of feeds are dependent upon many digestive and animal functions. Values predicted by the model agree with observed values, within experimental errors, for a wide range of feeds (ME values of 7.5–13 MJ/kg; Baldwin *et al.*, 1994) with no systematic errors (Fig. 21.4). Rumen and total tract digestion coefficients for starch, hemicellulose, cellulose and protein agree closely with observed values (Baldwin, 1995). Several exceptions to close agreements with data in simulations of digestion have been reported (Baldwin *et al.*, 1994). The most notable is that rumen starch digestion is significantly overestimated for cracked maize diets (20%) and at high feed intakes (20–30% at 25 kg feed per day).

Broster and Broster (1984) summarized the results of a comprehensive series of full lactation studies with cows fed a variety of diets. These studies defined very significant 'carryover' effects after feeding high-energy and

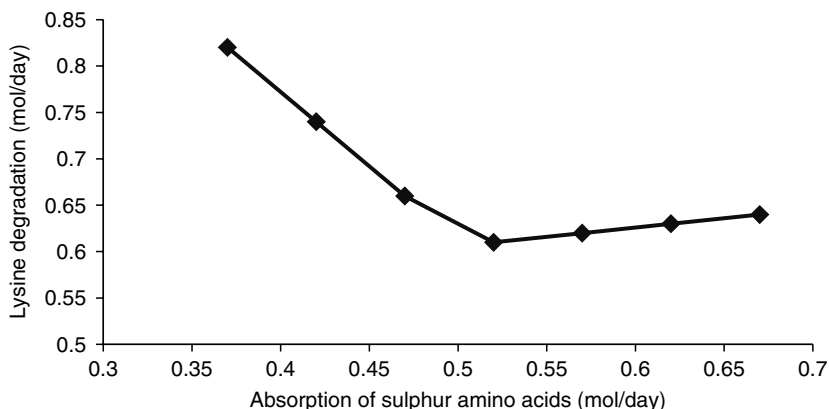


**Fig. 21.4.** Comparisons of predicted vs. observed estimates of metabolizable energy (ME). Regression equation for predicted ME on observed ME with no intercept was  $y = bx$  ( $b = 1.01$ ) with  $R^2$  values for ME of 0.84. The 34 experimental estimates were from 20 publications in the literature for diets including high- and low-quality legumes, maize silage, maize meal, soybean meal and high- and low-quality grass hays (Baldwin *et al.*, 1994).

high-protein diets during early lactation. These observations prompted the simulation analyses presented in Fig. 21.5. The model responses to low and high intakes of energy and protein during early lactation were simulated very well. More importantly, the carryover effects noted by Broster and Broster (1984) were simulated very well in terms of magnitude and duration.



**Fig. 21.5.** Effects of different feeding strategies upon lactation performance. Diets were 50% forage, 50% concentrate with fishmeal added to 15% or 18% crude protein. HHHH was fed 18% crude protein diet at a feeding rate of 10 kg/day plus 1 kg feed per 3 kg milk for 180 days. HHHM was fed 18% crude protein diet for 84 days and then fed 15% crude protein diet for the last 96 days. Feeding rate of both diets was 10 kg/day plus 1 kg feed per 3 kg milk averaged over the previous 3 weeks. HMHM was fed 15% crude protein diet at a feeding rate of 10 kg/day plus 1 kg feed per 3 kg milk averaged over the previous 3 weeks for 180 days. HMLM was fed 15% crude protein diet for 180 days. For the first 84 days, feeding rate was 10 kg/day plus 1 kg feed per 3 kg milk averaged over the previous 3 weeks. For the last 96 days, feeding rate was 13 kg/day plus 1 kg feed per 3 kg milk averaged over the previous 3 weeks. From Baldwin (1995).



**Fig. 21.6.** Simulated effect of sulphur amino acids (SAA) on whole-body degradation of Lys. The reference diet, containing 50% lucerne hay and 50% concentrate with 15% crude protein, was supplemented with Lys at 0.3 mol/day.

The relationship illustrated in Fig. 21.6 indicates that the MOLLY model can simulate the classical effect of changes in the availability of a limiting amino acid upon rates of degradation of other amino acids. In these simulations, the model predicted that processes such as milk protein production and body protein synthesis would be limited by the amount of sulphur amino acids available to the cow. According to the limiting amino acid theory, as more sulphur (i.e. limiting) amino acids become available to the cow, use of other amino acids for protein processes should increase resulting in decreases in degradation of other amino acids. Figure 21.6 shows that as the absorption of the limiting amino acids (sulphur amino acids) is increased in sequential simulations, lysine degradation is decreased due to an increase in lysine use for protein synthesis.

In the course of preliminary tests of MOLLY against full lactation data where individual animal feed intakes were specified as input, an important cumulative error became evident (Johnson *et al.*, 1999; McNamara and Baldwin, 2000). This error was a net accumulation of body fat during lactation on several but not all diets. The errors are relatively small on a daily basis (1–4% of MEI) but the cumulative error is large; up to 100 kg EBW. When the diets were fed according to the NRC equations, this accumulation of fat did not occur. This may indicate errors attributable to overestimates of feed intakes in the several experiments or the equation. Errors in model predictions of ME for the feeds (0.1–0.2 Mcal/kg) could be at fault but estimates of diet ME values from tabulated  $NE_L$  values in the NRC are in close agreement for the experiments simulated. McNamara and Baldwin (2000) examined the observed and simulated dynamics of lipid metabolism and identified some systematic errors in the regulation of adipose tissue lipogenesis and lipolysis. Modifications have been made in the model and will be tested. However, these will not correct the problem since if too much energy is input or not enough output, fat gain is the essential result. Milk energy outputs in the simulations were essentially as observed. Thus, the remaining source of error to consider is heat production. Possible errors in estimates of heat production

attributable to physiological work, protein turnover and ion (nutrient) transport were mentioned above. Whether or not changes in these are adequately simulated, particularly at high feed intakes, is an issue. Another possibility is that changes in the relative weights of high vs. low energy requiring tissues during lactation are not adequately simulated.

## Statistical Methods for Model Evaluation

Traditional problems in statistics begin with the design of an experiment, the collection of relevant data and proceed to methods of parameter estimation and hypothesis testing. Investigators in these settings build simple-to-understand linear statistical models, under assumptions of normally distributed random variables, using analytical techniques like regression and the analysis of variance (McCulloch and Searle, 2001). These methods permit estimation of unknown parameters, the variances of these estimates, and accordingly, investigators typically contrast these parameter estimates in an effort to declare 'significance' of effects.

The mechanistic model considered in this chapter is of such complexity that we turn to more computer-intensive strategies to evaluate their effectiveness (Hjorth, 1994). Such methods eventually appeal to bootstrap techniques (Efron, 1979; Efron and Tibshirani, 1993), a strategy made possible by advances in computer hardware and software. This technique should become a critical component of strategies for model validation, selection and the evaluation of parameter estimates as a complement to the more traditional methods of statistical evaluation.

### *Error and loss functions*

The statistical evaluation of models typically focuses on concern for uncertainty and error. Generically error can be thought of originating from any of several categories: uncertainty rooted in limitations of sample size, systematic error as the result of inadequacies of a statistical model to accommodate effects present in the data and prediction error, as occurs when predicting observations into the future when residuals cannot be evaluated. Another form of uncertainty, often neglected, is model selection uncertainty, that form of error which can occur when one set of data is evaluated under a variety of models, with one model selected, under some criterion, as 'best'. For example, in a regression model, which predicts milk production from dry matter intake, sample size limits would be the error associated with number of cows used to represent the true population mean for milk production. Systematic error is consistent under or over prediction of milk production by the regression equation and might be represented by not including diet composition or initial body weight in the regression equation of milk production on dry matter intake. Prediction error is the error associated with using dry matter intake to predict the cow's future milk production. Model uncertainty is error associated with the prediction of milk production using several models (milk production regressed on dry matter intake, milk production regressed on dry matter intake and diet composition, or MOLLY) to choose which model predicts milk production the 'best'.

As referred to in the prior passage, a criterion for model selection and evaluation must be agreed upon as a measure of error (described as a loss function). Though not an exhaustive list, there are several ways to measure statistical error (Mood *et al.*, 1974). Perhaps simplest is absolute error, taken as the absolute value of the difference between predicted and observed, though the statistical properties of such a measure are algebraically difficult to evaluate. More common is a measure of squared error (predicted–observed)<sup>2</sup>, which is easy to interpret and is nearly universally accepted, along with variations (e.g. Hanigan *et al.*, 1998). Other strategies have been suggested (e.g. Huber, 1964), usually as a variation on squared error, in which some weighting procedure is used, such that residuals are weighted differentially for different observed values. For example, a prediction error of 1 kg causes greater concern in a cow producing 10 kg of milk vs. a cow producing 50 kg and one may desire that model evaluation reflects that concern.

### **Validation of models**

Methods of model validation find their widest application in complex models of a multivariate character. Several strategies are available, many of which are computationally intensive. Typically they involve dismantling the entire data set (defined as DS, with notation borrowed from Hjorth, 1994) into two subsets; the estimation set (ES) from which model parameters can be estimated, and the testing set (TS), where the model parameters estimated with ES can be used to predict the observations in TS. Often, though not always, DS is the union of ES and TS (i.e.  $DS = ES \cup TS$ ).

The simplest strategy divides DS randomly into two halves for ES and TS, though there is little to recommend this strategy beyond simplicity. More commonly used is the ‘take one out strategy’, used iteratively where one data point is removed from DS and considered as TS, leaving  $N - 1$  observations in ES. This process is repeated for all  $N$  observations in DS in a strategy called PRESS, for prediction sum of squares (Allen, 1971). Moreover, there are extensions of this technique that permit parameter estimation as a component of the model validation procedure (Stone, 1974). Parenthetically, there is an extension of the PRESS technique that deals with the model selection process as well, those circumstances where the ultimate size of the model is yet to be determined.

For data on lactation, which involves time series models, we can take advantage of methods of forward validation as a means of fitting an entire lactation curve. In this method, the estimation set includes the first  $t - 1$  data points (i.e.  $y_1, y_2, \dots, y_{t-1}$ ) with the testing set containing the data point from time  $t$  (i.e.  $TS = y_t$ ). That is, we use the first  $t - 1$  observations to predict the observation at time  $t$ , in a strategy otherwise the same as cross model validation. This is an ideal method for fitting a model to time course data as in lactation curve fitting (Diggle *et al.*, 1994).

Implementation of these model selection/validation processes for complex models is also an issue. Though several strategies are available (e.g. maximum likelihood), a growing number of investigators are turning to the bootstrap

methods first developed by Efron (1979). This technique has grown in popularity because of its simplicity in application as well as its theoretically appealing properties. In essence, the technique permits evaluation of uncertainty and bias in parameter estimation, free of any distribution assumptions. For clarity in this presentation, model validation was discussed as separate and distinct from estimation of parameter uncertainty via the bootstrap. However, these processes can all be combined to allow simultaneous evaluation of models, estimation of unknown parameters, the validation of models and the estimation of uncertainty and bias in parameter estimation, all through intensive computer techniques (Hjorth, 1994).

### **Example of the bootstrap technique**

To demonstrate, on a simpler scale, the techniques that comprise the bootstrap, Table 21.3 contains a sample data set of eight observations. For this simple example, the goal is to use linear regression to predict total milk production from initial body weight and udder cells. Obviously the analysis of eight observations with linear regression does not require a bootstrap, but the process can be easily illustrated.

Using an eight-sided die, bootstrap samples 1 to 4 (also in Table 21.3) were created by 32 successive rolls of the die. The first eight results decided which observations of the original data set would appear in bootstrap sample 1. The second eight rolls of the die selected the observations for bootstrap sample 2, and so on. Thus, for example, bootstrap sample number 1 is based on three samples of observation 5 (of the original sample) and none of observation 1.

Table 21.4 presents the results of fitting the data of Table 21.3 in a multiple regression model, presenting first the results provided by least squares from the complete set of eight observations. In addition, the estimated intercept and slopes for the four bootstrap samples are also presented in Table 21.4.

**Table 21.3.** Bootstrap example data set, including the original sample data set of eight data points, followed by four randomly selected sample data sets.

Observation	Original data			Bootstrap sample number			
	TVMLK	iBW	UCELLS	1	2	3	4
1	6774.5	522.0	563.9		+		
2	8528.8	542.5	717.4		+	+	
3	8480.8	594.5	744.9	+	+	+	
4	7287.5	590.0	620.2	+			+++
5	7974.9	626.5	575.0	+++	+		++
6	9096.2	582.0	600.0		+	+	+
7	7553.1	528.5	663.2	+	++	++	+
8	9232.3	535.0	616.7	++	+	+++	+

TVMLK, total milk yield (kg); iBW, initial body weight (kg); UCCELLS, arbitrary number representing secretory cell number.



**Table 21.4.** Parameter estimates from the full data set, along with the parameter estimates from each bootstrap sample, along with the mean and standard deviation of the four bootstrap estimates.

Parameter	Original data		Bootstrap sample number				Combined bootstrap samples	
	Estimate	SE	1	2	3	4	Mean	SD
Intercept	3503.0	6654.0	13,111.8	1843.6	7753.0	57,329.4	20,009.4	25,302.0
<i>BW</i> slope	3.6	9.7	-7.6	7.6	12.0	-36.1	-6.0	21.8
<i>UCELLS</i> slope	4.1	5.6	-0.8	3.2	-8.7	-46.3	-13.1	22.6

*BW*, body weight; *UCELLS*, arbitrary number representing secretory cell number.

Of course the purpose behind this example is actually found in the final columns of Table 21.4, which are the mean and standard deviation of the four bootstrap samples. Clearly, there is a wide discrepancy between the mean bootstrap estimate of the unknown parameters and the estimates provided by ordinary least squares. However, in a limited fashion, Tables 21.3 and 21.4 illustrate the simplicity of the bootstrap process, a simplicity that will become more apparent given the complexity of non-linear models considered in this chapter. Finally, Table 21.5 provides estimates of these simple regression parameters from a sample of 10,000 bootstrap data sets. As expected, the results more closely approximate those of the full data set, though certainly are not identical.

## Biological Validation: What is Genetic Potential?

In one sense, the concept of genetic potential is contrary to the foundations of the mechanistic models considered in this chapter. ‘Genetic potential’, even as used by quantitative geneticists, is treated as an amalgam of effects, representing theorized but not identified genetic mechanisms. That is, we know that genes are active in the expression of nearly all physiological functions and production traits, but the exact genes that turn ‘on’ and ‘off’, and the quantity of their products, are only just being identified through the advancing technologies of molecular biology. Accordingly, the genetic merit or potential of an animal is often treated as a residual, the value an animal brings to its phenotype

**Table 21.5.** Parameter estimates based on the mean and standard deviation of 10,000 bootstrap estimates.

Parameter	10,000 Samples	
	Estimate	SE
Intercept	4929.7	10,816.7
<i>BW</i> slope	2.7	12.3
<i>UCELLS</i> slope	2.7	10.8

*BW*, body weight; *UCELLS*, arbitrary number representing secretory cell number.

after other terms (e.g. diet, gender and age) are accounted for, with no care or concern for the individual genetic factors that contribute to the final value. In other words, genetic potential, as treated by animal breeders, is a 'black box'.

Nevertheless, the theory of quantitative genetics does stipulate how genetic potential must behave, at least statistically. In fact the foundations of quantitative genetics are built upon these well-known, quantifiable results (Lynch and Walsh, 1998). One such measure of genetic potential is heritability, the fraction of phenotypic variance that can be traced to variation in additive genetic contributions. The milk production traits evaluated in this model have well-established estimates of heritability (Ensminger, 2002). These estimates serve as a guide for how variable we can expect genetic potential to behave in a population of cows if it is to accommodate our thoughts of 'genetic potential'. Similarly, the very nature of quantitative genetics demands that the phenotypes of relatives share a similarity not found when contrasting two independently sampled unrelated individuals. Thus, we would expect our estimates of genetic potential to be correlated among relatives, and equally as important, that the magnitude of this correlation has boundaries that can be identified by our knowledge of the quantitative genetics of production traits.

### ***Representation of genetic potential in MOLLY***

To differentiate simulations of data from different cows, genetic differences must be expressed in the model. Genetic potential to produce milk is the variable *UCELLS*, which is an arbitrary number representing secretory cell number (or DNA/udder) that differentiates udder enzyme synthetic capacity or udder metabolic capacity between cows (*UENZ*). Udder enzyme synthetic capacity determines daily milk yield depending on diet and intake. Milk synthesis equations in MOLLY are based on Neal and Thornley (1983) and listed in Fig. 21.7.

*UCELLS* and *Lhor* (lactation hormone) have the greatest effect on udder synthetic capacity (*Usyn*). *UCELLS* acts as a constant multiplier to increase *Usyn* for the whole udder. It is an arbitrary value that remains constant throughout a simulation and can be used to distinguish difference in the genetic potential of a cow to produce milk. *Lhor* causes a sequential decrease *Usyn* and results in *UENZ* following the classic shape of the lactation curve. *Udeg* represents the effect of retained milk on udder enzymes based on a 21 days average of retained milk in the udder and *UENZ*. Therefore an increase in *UCELLS* increases total potential udder enzyme synthetic capacity between simulations whereas *UENZ* changes within a simulation and represents daily changes in udder enzyme synthetic capacity. Figure 21.8 shows how *Usyn* and *Udeg* change at two different levels of *UCELLS* over a lactation.

Milk component production such as milk fat, milk protein and milk lactose, which affects total volume of milk, is affected directly through *UENZ* (Fig. 21.9). Since *UENZ* represents the activity of all enzymes to produce milk fat, protein and lactose, other parameters are used to account for genetic differences between cows' ability to produce milk components. For instance, other milk production parameters within the model that could be altered to represent

Udder enzyme synthesis

$$Usyn = VUsyn * UCELLS * Lhor * BST / (KUsyn + Lhor * BST)$$

*Usyn* = Rate of synthesis of udder enzymes (units per day)

*UCELLS* = Arbitrary number of secretory udder cells. Remains constant throughout lactation. Default is 1000 cells

*Lhor* = Lactation hormones which enhance synthesis of udder enzymes (kg). A single pulse of hormone is produced at initiation of lactation and decays exponentially with rate constant *KLhor* (per day) to give the differential equation  $dLhor/dt = -KLhor * Lhor$

*BST* = Parameter representing level of bovine somatotropin. Default is basal level at 1.0

*KUsyn* = Michaelis–Menton type constant for udder enzyme synthesis in response to lactation hormone (kg)

*VUsyn* = Enzyme synthetic capacity per cell (units per cell)

Udder enzyme degradation

$$Udeg = UENZ * (KUdeg + KUdegM * ((UMave/KMdeg)^\theta * (1.0 + UMave/KMdeg)^\theta))$$

*Udeg* = Rate of degradation of udder enzymes (units per day)

*UENZ* = Udder enzymes (units per day)

*KUdeg* = Degradation rate constant for *UENZ* (per day)

*KUdegM* = Degradation rate constant defining effect of retained udder milk on *UENZ* (per day)

*UMave* = Average milk in gland over last 21 days (kg)

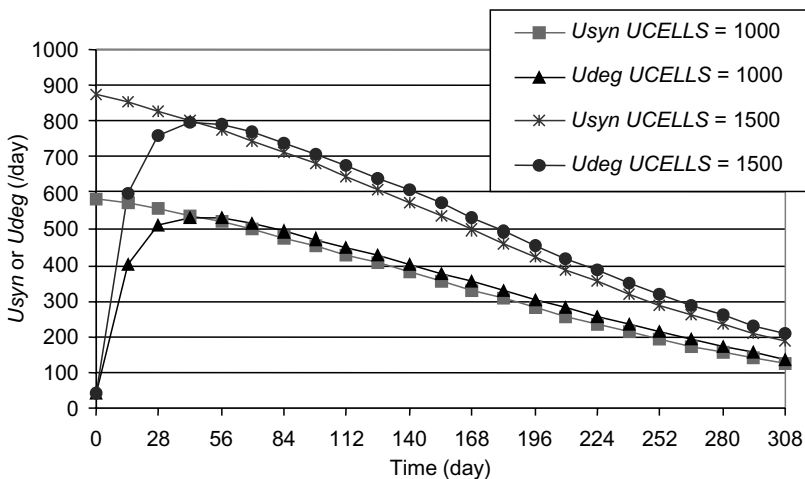
*KMdeg* = Half response point for degradation of *UCELLS* due to udder milk

$\theta$  = Constant (dimensionless) defining slope of response

Differential equation for udder enzymatic capacity

$$dUENZ/dt = Usyn - Udeg$$

**Fig. 21.7.** Relationship between *UCELLS* (secretory cell number or DNA per udder) and *UENZ* (udder enzymatic or metabolic capacity) in MOLLY.



**Fig. 21.8.** *Usyn* and *Udeg* at 1000 *UCELLS* and 1500 *UCELLS* vs. time. *Usyn*, rate of synthesis of udder enzymes; *Udeg*, rate of degradation of udder enzymes; *UCELLS*, number of secretory cells.

## Milk fat

$$FaTmV = (VFATmV * UENZ * KMinh) * INS / (1.0 + KFaTmV / cFa + K1FaTmV / cGI)$$

*FaTmV* = Fatty acids (NEFA) converted to milk fat in the udder (mol/day)

*VFATmV* = Maximal velocity of process of converting fatty acids to milk fat (mol/day)

*UENZ* = Udder synthetic or metabolic capacity

*KMinh* = Factor defining inhibition of milk synthesis by retained milk (kg/kg)

*INS* = Insulin expressed as multiple of basal, added to allow simulation of effects

*KFaTmV* = Affinity constant for fatty acids converted to milk fat in udder (mol/l)

*cFa* = Concentration of fatty acids in plasma (mol/l)

*K1FaTmV* = Affinity constant for glucose effects on fatty acid conversion to milk fat (mol/l)

*cGI* = Concentration of glucose in plasma (mol/l)

$$AcTmV = VAcTmV * UENZ * KMinh * INS / (1.0 + KAcTmV / cAc + K1AcTmV / cGI)$$

*AcTmV* = Rate of acetate used for milk synthesis (mol/day)

*VAcTmV* = Maximal velocity of process of converting acetate to milk fat (mol/day)

*KAcTmV* = Affinity constant for acetate converted to milk fat in udder (mol/l)

*cAc* = Concentration of acetate in plasma (mol/l)

*K1AcTmV* = Affinity constant for glucose effects on acetate conversion to milk fat (mol/day)

## Milk protein

$$AaPmV1 = (VAaPm * UENZ * kminh / (1.0 + ((kAaPm / cAa)^{EXPAa}))) / fPmAa$$

$$SAaPm1 = (VSAaPm * UENZ * kminh / (1.0 + ((kSAaPm / cSAa)^{EXPSAa}))) / fPmSAa$$

$$LysPm1 = (VLysPm * UENZ * kminh / (1.0 + ((kLysPm / cLys)^{EXPLys}))) / fPmLys$$

$$HisPm1 = (VHisPm * UENZ * kminh / (1.0 + ((kHisPm / cHis)^{EXPHis}))) / fPmHis$$

$$TAaPmV = \min(AaPmV1, SAaPm1, LysPm1, HisPm1)$$

*AaPmV1*, *SAaPm1*, *LysPm1*, *HisPm1* = Potential rate of amino acid, sulphur amino acids, lysine or histidine, respectively, incorporation into milk protein (mol/day)

*VAaPm*, *VSAaPm*, *VLysPm*, *VHisPm* = Maximal velocity of amino acid, sulphur amino acids, lysine or histidine, respectively, into milk protein (mol/day)

*kAaPm*, *kSAaPm*, *kLysPm*, *kHisPm* = Affinity constants of amino acids, sulphur amino acids, lysine or histidine, respectively, for incorporation into milk protein (mol/l)

*EXPAa*, *EXPSAa*, *EXPLys*, *EXPHis* = Exponents on ratio of rate constants to plasma amino acids, sulphur amino acids, lysine or histidine, respectively, to simulate the allometric uptake of each amino acid group for milk protein synthesis.

*fPmAa*, *fPmSAa*, *fPmLys*, *fPmHis* = Fraction of amino acids, sulphur amino acids, lysine and histidine, respectively, in milk protein

*cAa* = Concentration of amino acids (other than sulphur amino acids, lysine and histidine) in plasma (mol/l)

*cSAa* = Concentration of sulphur amino acids in plasma (mol/l)

*cLys* = Concentration of lysine in plasma (mol/l)

*cHis* = Concentration of histidine in plasma (mol/l)

*TAaPmV* = Total amino acids incorporated into milk protein (mol/day)

Min = Function selecting minimum of the following terms so that milk protein synthesis rate is determined by the most limiting amino acid

$$AaLAV1 = (VAaLA * UENZ * kminh / (1.0 + ((kAaLA / cAa)^{EXPAa}))) / fLAAa$$

$$SAaLA1 = (VSAaLA * UENZ * kminh / (1.0 + ((kSAaLA / cSAa)^{EXPSAa}))) / fLASAa$$

$$LysLA1 = (VLysLA * UENZ * kminh / (1.0 + ((kLysLA / cLys)^{EXPLys}))) / fLALys$$

$$HisLA1 = (VHisLA * UENZ * kminh / (1.0 + ((kHisLA / cHis)^{EXPHis}))) / fLAHis$$

$$TAaLAV = \min(AaLAV1, SAaLA1, LysLA1, HisLA1)$$

*AaLAV1*, *SAaLA1*, *LysLA1*, *HisLA1* = Potential rates of amino acids, sulphur amino acids, lysine or histidine, respectively, incorporation into  $\alpha$ -lactalbumin (mol/day)

*VAaLA*, *VSAaLA*, *VlysLA*, *VHisLA* = Maximal velocity of amino acid, sulphur amino acids, lysine or histidine, respectively, into  $\alpha$ -lactalbumin (mol/day)

*kAaLA*, *kSAaLA*, *kLysLA*, *kHisLA* = Affinity constants for amino acids, sulphur amino acids, lysine or histidine, respectively, into  $\alpha$ -lactalbumin (mol/l)

*fPmAa*, *fPmSAa*, *fPmLys*, *fPmHis* = Fractions of amino acids, sulphur amino acids, lysine and histidine, respectively, in  $\alpha$ -lactalbumin

*TAaLAV* = Total amino acids incorporated into  $\alpha$ -lactalbumin (mol/day)

Fig. 21.9. Equations in MOLLY involving genetic potential to produce milk.

## Milk lactose

$$GILmV = VGILmf * TAaLAV$$

$GILmV$  = Rate of glucose incorporation into lactose (mol/day) – see also Figs 21.2 and 21.3

$VGILmf$  = Rate constant for fraction of glucose converted into lactose in milk (mol/mol)

$TAaLAV$  = Total amino acids incorporated into  $\alpha$ -lactalbumin (mol/day) – see above

## Milk volume

$$TVMlk = TMlkLm/PCLm$$

$TVMlk$  = Total volume of milk produced in the simulation (kg)

$PCLm$  = Constant per cent of lactose in milk. Default is 4.8% based on the assumption that in dairy cattle lactose is the primary osmole in milk (excluding minerals, etc)

$TMlkLm$  = Total production of lactose (kg). Results from integration of daily milk lactose ( $dMlkLm/dt$ ) over time.

$$dMlkLm/dt = ULm * KMilK$$

$ULm$  = Udder milk lactose (kg). Differs from milk lactose due to some milk and therefore milk lactose always being retained in the udder

$KMilK$  = Rate constant for milk removal from udder (2.9 per day)

$$dULm/dt = GILmV * GILmLm * mwLm - DMLKLm$$

$GILmLm$  = Stoichiometric coefficient for conversion of glucose to lactose (0.5 mol/mol)

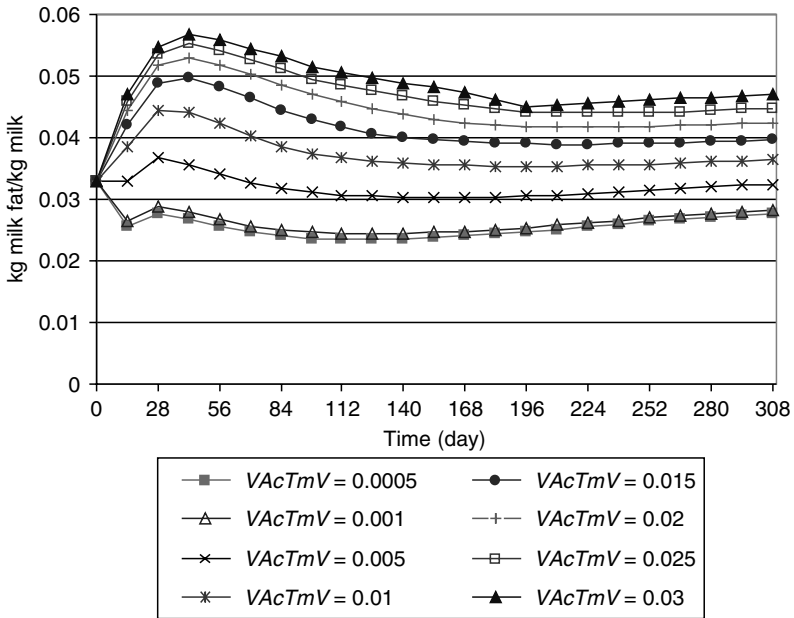
$mwLm$  = molecular weight of lactose (kg/mol)

**Fig. 21.9.** *Continued.*

differences in genetic potential are the maximal velocities for udder lipogenesis from acetate ( $VAcTmV$ ), circulating blood lipids ( $VFaTmV$ ), amino acids for milk protein synthesis ( $VTAaPm$ ) and  $\alpha$ -lactalbumin production ( $VTAaLa$ ). Since these equations represent aggregate processes and not single enzyme kinetics, an increase in the maximal velocity of the equation (or process) could be the result of the increased metabolic capacity of the cow to produce more (milk fat, milk protein or milk lactose). Figure 21.9 shows the equations representing milk component production and the inclusion of  $UENZ$ .

Milk fat is made from dietary sources such as acetate represented by  $AcTmV$  and from body fat stores represented by  $FaTmV$ . Since little data are available on how the contributions from each to milk fat change over a lactation,  $VAcTmV$  and  $VFaTmV$  are set so that approximately 50% milk fat comes from dietary sources and 50% comes from body fat stores at 84 days in milk. Therefore changes in the genetic potential to produce milk fat can be altered by changing  $UCELLS$  (through  $UENZ$ ) and altering  $VAcTmV$  and  $VFaTmV$ . Figure 21.10 shows how milk fat increases with increasing  $VAcTmV$  throughout the lactation.

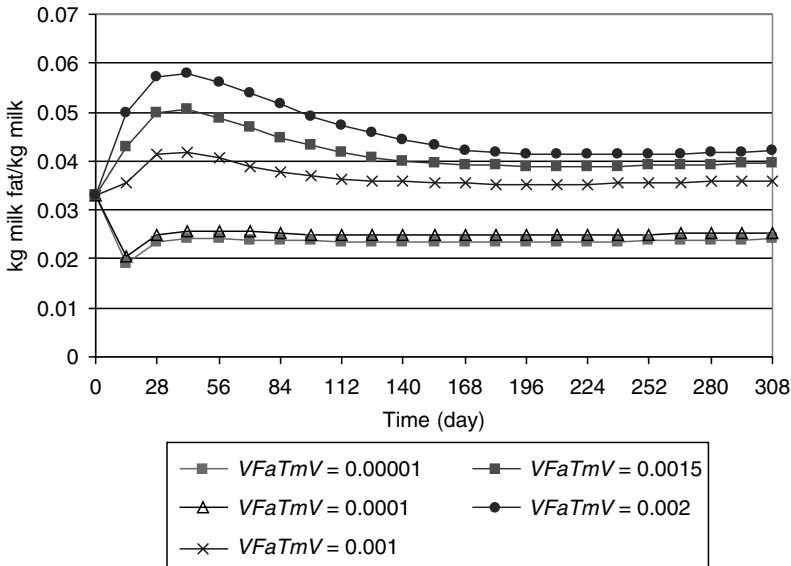
As  $VAcTmV$  is increased, more acetate is diverted from oxidation and body fat synthesis (see diagrams and equations for acetate in Figs 21.2 and 21.3), resulting in a decrease in blood acetate levels. Blood acetate levels of below 0.008 mol/l have been defined as death and would correspond to  $VAcTmV$  of 0.025–0.03 mol/day. At low levels of  $VAcTmV$ , oxidation increases, blood concentration of acetate is higher and the cow becomes fat (gaining 160 kg in body fat at  $VAcTmV$  of 0.001 mol/day). Figure 21.11 shows the effects of increasing amount of fatty acids synthesized into milk fat on milk fat production.



**Fig. 21.10.** Effect of increasing amount of acetate converted to milk fat ( $VAcTmV$  in mol/day) on milk fat production over 308 days.

Similar to acetate, as more fatty acids are diverted from oxidation and body fat synthesis to milk fat production, milk fat increases, oxidation of fatty acids decreases, body fat decreases and blood fatty acid levels decrease (see diagrams and equations for fatty acids in Figs 21.2 and 21.3). At levels of  $VFaTmV$  greater than 0.002–0.0025 mol/day, the model becomes unstable with blood concentrations of fatty acids below 0.0005 mol/day and body fat below 50 kg. At low levels of  $VFaTmV$  (0.0001 mol/day), fatty acid oxidation is high and the cow becomes fat gaining 175 kg of fat over the lactation. Therefore, by varying  $VAcTmV$  and  $VFaTmV$  independently, the MOLLY model is capable of simulating milk fat levels of approximately 2.5% to 6%. However, this range is dependent to some extent on diet and initial body composition of the cow.

For the production of milk protein, there are four amino acid groups represented in MOLLY. Each potential protein production based on amino acid level is set based on  $UENZ$  and amino acid available in blood ( $cHis$ ,  $cLys$ ,  $cSAa$ ,  $cAa$  – see Fig. 21.9). In addition, milk lactose production is dependent on amino acids available for  $\alpha$ -lactalbumin synthesis through the inclusion of  $TAaLAV$  in the  $GILmV$  equation. This reflects the necessity of  $\alpha$ -lactalbumin as a cofactor for the lactose synthetase enzyme to produce lactose in the udder. Since milk volume is directly related to per cent lactose in milk and milk lactose is dependent on amino acids available for  $\alpha$ -lactalbumin synthesis, milk volume can become overly sensitive to a change in amino acid availability in some situations. Figure 21.12 shows simulation of a high-producing cow's lactation and corresponding dependence of volume of milk on lactose and  $\alpha$ -lactalbumin production.

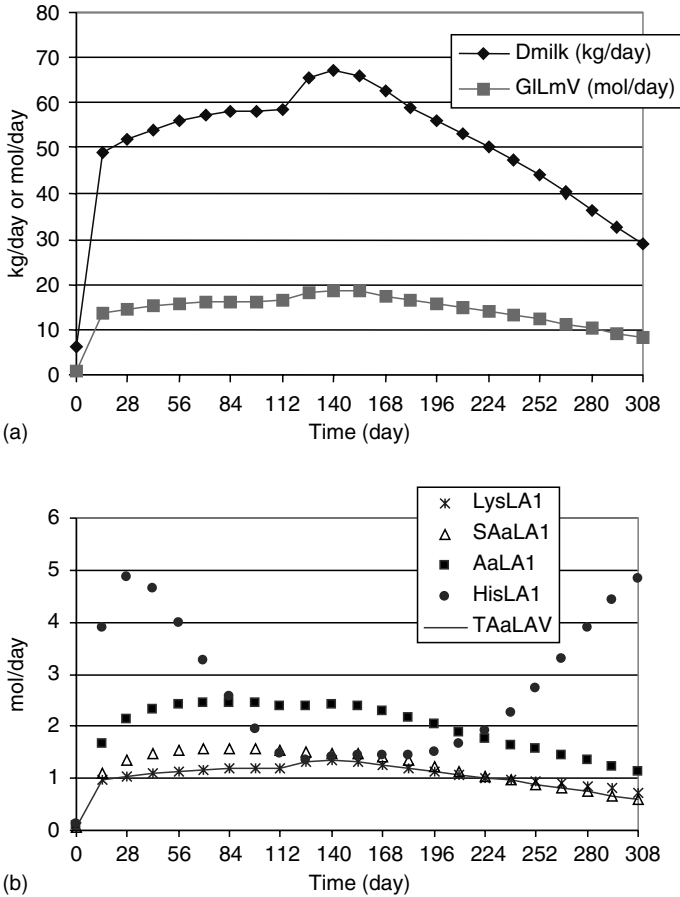


**Fig. 21.11.** Effect of increasing amount of fatty acids converted to milk fat ( $VFATmV$  in mol/day) on milk fat production over 308 days.

Unlike milk fat, increasing genetic potential by increasing maximal capacity to produce milk protein (and  $\alpha$ -lactalbumin) will not always increase MOLLY predictions of milk protein production. The milk protein synthesis equations in Fig. 21.9 are based on the limiting amino acid concept (Fig. 21.12). Milk protein synthesis cannot be greater than that allowed by the lowest availability of amino acids. Therefore only adjustments to the maximal velocity of the equation for the lowest amino acid will change milk protein production. Also, during long lactation simulations, the limiting amino acid may be different in early vs. late lactation. Figure 21.12b shows that lysine was the limiting amino acid in early lactation and sulphur amino acids were limiting in late lactation for total  $\alpha$ -lactalbumin production ( $TAA_{LAV}$ ). The transition between  $Lys_{LAI}$  and  $SAa_{LAI}$  as limiting amino acid in mid-lactation causes a small increase and decrease in  $TAA_{LAV}$ .

Similar to  $\alpha$ -lactalbumin production, production of other milk proteins (e.g. casein,  $\beta$ -lactoglobulin) represented by  $TAA_{PmV}$  is also dependent on the most limiting amino acid. Figure 21.13 shows the increase in protein per cent at only one time point in a lactation (140 days). At 140 days of lactation, other amino acids were the most limiting group of amino acids for milk protein production. Increasing the maximal velocity of the limiting amino acid group ( $VAA_{Pm}$ ) from 0.0147 to 0.0196 increased milk protein from 3% to 4%. However, increasing the maximal velocities of the other amino acid groups for milk protein synthesis ( $VSAa_{Pm}$ ,  $VHis_{Pm}$ ,  $VLys_{Pm}$ ) would not affect per cent milk protein at 140 days.

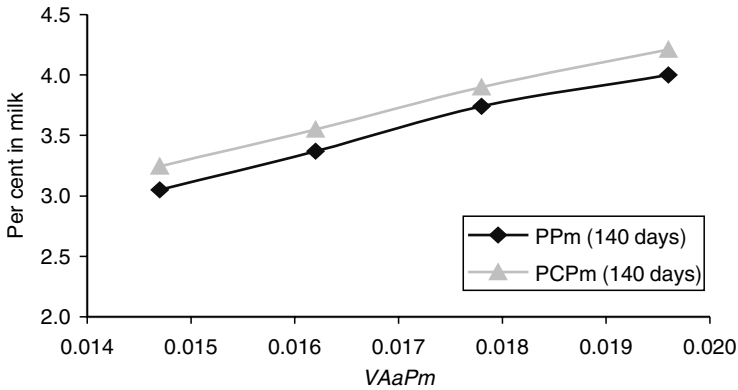
From the equations in Fig. 21.9, all of the milk protein and fat equations are affected indirectly through the parameter  $UCELLS$  (via udder metabolic



**Fig. 21.12.** Dependence of lactose production (and milk volume) on amount of amino acids converted to  $\alpha$ -lactalbumin over 308 days. Simulation was run with 1850 *UCELLS* resulting in a total milk production of 16,000 kg. (a) Daily milk production and glucose converted to lactose (*GILmV*). (b) Most limiting amino acid throughout lactation and resulting  $\alpha$ -lactalbumin synthesized from total amino acids (*TAaLAV*) which determines amount of glucose converted to lactose (*GILmV*).

capacity,  $UENZ$ ). In addition, an increase in the respective maximal velocities of each equation may result in an increase in each corresponding milk component depending on the substrate blood concentration ( $cFa$ ,  $cAc$  and  $cGl$  for milk fat synthesis and  $cAa$ ,  $cSAa$ ,  $cLys$  and  $cHis$  for milk protein and  $\alpha$ -lactalbumin synthesis). Therefore maximal velocities in addition to *UCELLS* can be adjusted to represent genetic differences between individual cows. However, interactions between genetic potential between cows (*UCELLS* through increasing maximum  $UENZ$ ) and nutrients supplied for the production of milk (from diet, body stores and blood) limits the maximum amount of milk production possible from a cow. Increasing *UCELLS* results in incrementally smaller increases in total milk volume resulting in a curvilinear relationship as

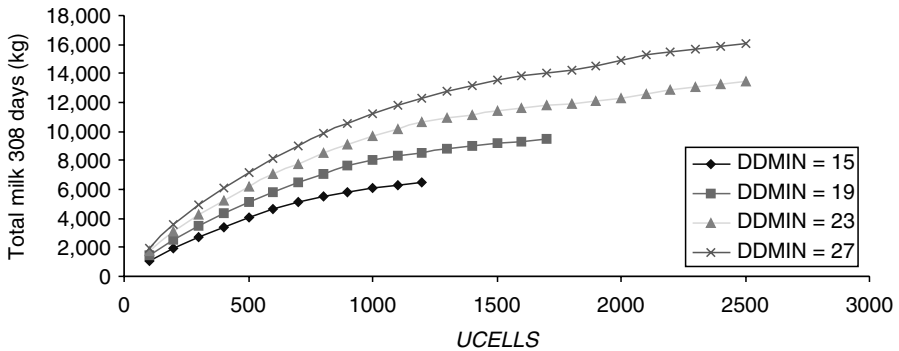




**Fig. 21.13.** Effects of sequential 10% increases in the maximal velocity for milk protein synthesis (*VAaPm* in mol/day) on per cent milk protein (PPm) and crude protein (PCPm) at 140 days of lactation.

shown in Fig. 21.14. Increasing *UCELLS* from 100 to 2500 increased total milk volume and increasing daily dry matter intake also increased total milk volume produced in a lactation (308 days). Therefore it is difficult to derive a direct relationship to set *UCELLS* to get a desired total milk production from a simulation without considering other input parameters such as body composition and dry matter intake over the simulation period.

In addition to setting genetic parameters to simulate milk production by individual cows (as illustrated in previous figures), diet also influences milk and milk component production. As illustrated in Table 21.6, changes in diet do affect milk production. Total milk (milk lactose) and milk protein increase with increasing crude protein in the diet. This is due to the influence of *TAaLAV* on *GILmV* (see Fig. 21.9) and more dietary protein available for milk protein synthesis. The exception is the 50% lucerne, 50% concentrate diet which supplied less protein but more starch increasing the contributions of microbial protein to *TAaLAV*.



**Fig. 21.14.** Predictions of total milk volume by changing *UCELLS* at different daily feed intakes (DDMIN).

**Table 21.6.** Change in total milk volume, total protein, total fat and total lactose (over 308 days) in response to different diets. Daily dry matter intake was fixed at 22 kg/day and *UCELLS* was 1000 for all simulations. Milk lactose is fixed at 4.8% of total milk.

Diet description	CP <sup>a</sup> %	Starch (%)	SC <sup>b</sup> (%)	NDF <sup>c</sup> (%)	Milk (kg)	Milk fat (kg)	Milk protein (kg)	Milk lactose (kg)
100% Maize silage	6.30	27.5	0	44.0	4597	387	140	221
60% Maize silage and 40% maize meal	9.10	23.6	1.7	46.1	6839	398	209	328
40% Lucerne and 60% concentrate	11.8	38.4	4.7	32.7	8392	341	256	403
50% Lucerne and 50% concentrate	15.0	23.0	6.0	34.0	9639	399	295	463
100% Lucerne (high quality)	17.6	4.0	6.0	48.0	9614	369	294	461

<sup>a</sup>CP, crude protein.

<sup>b</sup>SC, soluble carbohydrates.

<sup>c</sup>NDF, neutral detergent fibre.

The MOLLY model is able to simulate a wide variation in milk and milk component production. Therefore the model has the potential to predict differences in production due to genetics (differences between cows) and interactions between dry matter intake, diet, milk production and genetics through the manipulation of the constant *UCELLS* and maximal velocities (*VF<sub>a</sub>T<sub>m</sub>V*, *VAcT<sub>m</sub>V*, *VAA<sub>a</sub>P<sub>m</sub>*, *VSA<sub>a</sub>P<sub>m</sub>*, *VL<sub>ys</sub>P<sub>m</sub>*, *VH<sub>is</sub>P<sub>m</sub>*, *VAA<sub>a</sub>LA*, *VSA<sub>a</sub>LA*, *VL<sub>y</sub>sLA*, *VH<sub>is</sub>LA*). However, environmental effects, mineral or vitamin imbalances and some metabolic disorders are not accommodated in the model. As a result, adjustment of genetic parameters such as *UCELLS* to replicate individual cow records includes some of the error associated with effects not represented within MOLLY. Most of these effects do alter feed intake, which is required as an input to simulations of real cow records.

### **Validation of udder cells as genetic potential**

Presuming there exists a data set of sample day information on a herd of cows, the simplest strategy would begin through estimation of the udder cell parameter for each and every animal present in the data set. By itself, this should have merit, if only to detect significant differences between cows through the construction of confidence intervals for *UCELLS* and prediction of individual cow milk production. From the individual estimates we can then compute the variance of udder cells (defined as  $s_{uc}^2$ ). In addition, we will simultaneously arrive at a prediction of milk production and will therefore be able to compute simple estimates of the variation in udder cells, as well as the variability of the production trait (defined as  $s_T^2$ ). This will provide a crude estimate of the 'heritability' of milk production with udder cells serving as a surrogate for genetic potential (i.e.  $h^2 = s_{uc}^2/s_T^2$ ). If, for example, the trait we are evaluating is 305-day milk

production, we already know the heritability of this trait as in the neighbourhood of 0.25. Accordingly, our estimated ratio should view this as an upper limit if we are to consider udder cells as a measure of genetic potential. The fraction of total variation attributable to udder cells is likely to be smaller than 25%. First, because when dealing with predictions of random variables, models tend to regress terms back to the mean, reducing variability. In addition even if udder cells can serve as a surrogate for genetic potential it is unlikely to accommodate all of the genetic variance observed in field data on dairy cattle. After all, much of what likely generates genetic variation in quantitative genetic models is accommodated for in other terms of MOLLY (e.g. differences in feed intake, genetic variation in metabolic pathways).

The attempt to equate the model parameter of udder cells to a measure of genetic potential is equivalent in form to the evaluation of equivalent linear models in statistics (McCulloch and Searle, 2001). Two models are considered equivalent if both generate the same first and second moments for the dependent variable. Obviously, given the assumptions of sampling and underlying physiological mechanisms, a dependent variable has definable first and second moments. Any model used to analyse such information must accommodate such moments, and thus two models can be considered equivalent if they both 'capture' the means, variance and covariances among data points. In trying to equate udder cells to genetic potential, we are engaged in the same process; to ensure that the parameter of udder cells captures the assumed means, variances and covariances expected of genetic potential under models of quantitative genetics.

### ***Use of bootstrap in udder cells evaluation***

Having arrived at a suitable model, the bootstrap can assist in the validation of udder cells as a measure of genetic potential. As discussed, the bootstrap permits evaluation of the bias of estimates of udder cell as well as quantifying the precision of udder cell estimates. In addition, this approach will also allow a similar evaluation of the stability of the estimated residual. For example, consider our goal to be the prediction of 305-day total milk production from  $N$  sample days on a cow. From this starting point,  $k$  bootstrap samples can be created by randomly sampling  $N$  observations from this set of data, with replacement. Udder cells are then re-estimated from each of the  $k$  samples, providing a set of udder cell estimates. This set of estimates allows drawing confidence intervals, as well as estimation of the bias in our estimate of udder cells. The next section describes results of adjusting some of the genetic parameters within MOLLY to duplicate real cow production records.

### ***Data sets used to estimate UCELLS***

Eight data sets from seven universities, which represent over 300 individual records were used to examine adjusting genetic parameters in MOLLY to

represent individual cows. Included in the data are daily dry matter intakes, daily milk production (fat, protein and in some lactose), diet composition and body weights over a time span ranging from 6 weeks prepartum to 308 days postpartum. They represent a reasonably wide and representative range of diets and feedstuffs, management practices, environments, animals and animal histories. Table 21.7 summarizes the data sets used for simulations.

Two sets of simulations were run. Using the method of maximum likelihood in ACSL (2002) optimize software package (Advanced Continuous Simulation Language by Aegis), *UCELLS* was adjusted to correct for differences in genetic potential of the herd. In the second set of simulations, *UCELLS*, *VFaTmV* and *VAcTmV* were adjusted to replicate the individual cow data. If data were available, simulations were initiated prior to the start of specific experiments so that carryover effects attributable to prepartum and early postpartum feeding practices, preliminary standardization feeding periods, etc. could be accommodated. For the first set of simulations in which only *UCELLS* were adjusted, *UCELLS* were significantly different for different trials but only significantly different for treatments within trial for trial 2 (Table 21.8).

In the second set of simulations in which *UCELLS*, *VAcTmV* and *VFaTmV* were adjusted, *UCELLS* were significantly different between trials, but only significantly different for treatments within trial for trials 1 and 2. The

**Table 21.7.** Data sets used to simulate individual cow records and the resulting differences in genetic potential.

Trial	Data source <sup>a</sup>	Published	Treatment	Time span	No. cows
1	CA	DePeters <i>et al.</i> (1985)	Two and three times a day milking	0–308 DIM <sup>b</sup>	55
2	WI	Dhiman and Satter (1997)	Lucerne silage vs. maize silage	0–252 DIM	74
3	IN	Greenfield <i>et al.</i> (2000)	Protein (RUP <sup>c</sup> ) supplementation	28 PRE <sup>d</sup> –56 DIM	38
4	CA	Unpublished	Types of fat supplementation	21–126 DIM	47
5	PA	Unpublished	Megalac supplementation	7–147 DIM	40
6	WA	Huyler <i>et al.</i> (1999)	RUP supplementation	42 PRE–70 DIM	31
7	OH	Chalupa <i>et al.</i> (1996)	Somatotropin	35–301 DIM	36
8	PA	Dann <i>et al.</i> (1999)	Cracked maize vs. steam-flaked maize	28 PRE–63 DIM	57

<sup>a</sup>Data source is 2 letter code for state; CA, California, WI, Wisconsin, IN, Indiana, PA, Pennsylvania, WA, Washington, OH, Ohio.

<sup>b</sup>DIM, days in milk.

<sup>c</sup>RUP, rumen undegradable protein.

<sup>d</sup>PRE, days prepartum.

**Table 21.8.** Mean *UCELLS*, *VFATmv* and *VAcTmv* adjusted to duplicate individual cow data from all eight trials. *UCELLS* were adjusted alone (first set of simulations); *FaCELLS* are *UCELLS* adjusted with *VAcTmv* and *VFATmv* (second set of simulations). See Fig. 21.7 and 21.9 for explanation of abbreviations.

Parameter	N	Mean	SD
Overall			
<i>UCELLS</i>	357	735	158
<i>FaCELLS</i>	355	698	144
<i>VAcTmv</i>	355	0.0155	0.00919
<i>VFATmv</i>	355	0.00286	0.00318
Trial 1			
<i>UCELLS</i>	55	630	132
<i>FaCELLS</i>	55	585	114
<i>VAcTmv</i>	55	0.0173	0.00999
<i>VFATmv</i>	55	0.00244	0.00320
Trial 2			
<i>UCELLS</i>	62	674	87.7
<i>FaCELLS</i>	62	654	99.4
<i>VAcTmv</i>	62	0.00761	0.00295
<i>VFATmv</i>	62	0.00255	0.000570
Trial 3			
<i>UCELLS</i>	37	761	191
<i>FaCELLS</i>	36	717	165
<i>VAcTmv</i>	36	0.0181	0.00958
<i>VFATmv</i>	36	0.00496	0.00831
Trial 4			
<i>UCELLS</i>	44	696	98.3
<i>FaCELLS</i>	44	688	97.1
<i>VAcTmv</i>	44	0.0113	0.00724
<i>VFATmv</i>	44	0.00249	0.00130
Trial 5			
<i>UCELLS</i>	40	717	103
<i>FaCELLS</i>	39	703	98.7
<i>VAcTmv</i>	39	0.0168	0.00707
<i>VFATmv</i>	39	0.00283	0.000941
Trial 6			
<i>UCELLS</i>	31	751	95.0
<i>FaCELLS</i>	31	731	99.0
<i>VAcTmv</i>	31	0.0171	0.00631
<i>VFATmv</i>	31	0.00226	0.000572
Trial 7			
<i>UCELLS</i>	34	816	218
<i>FaCELLS</i>	33	729	206
<i>VAcTmv</i>	33	0.0128	0.00553
<i>VFATmv</i>	33	0.00352	0.00264
Trial 8			
<i>UCELLS</i>	54	877	154
<i>FaCELLS</i>	55	816	133
<i>VAcTmv</i>	55	0.0242	0.00949
<i>VFATmv</i>	55	0.00252	0.000916

variables *VAcTmv* and *VFaTmv* were also significantly different between trials, but *VAcTmv* was not significantly different for treatments within trial. The variable *VFaTmv* was only significantly different for treatments within trial for trials 1 and 2. The variable *UCELLS* was significantly different between the first and second sets of simulations. However, they were closely correlated with a coefficient of determination of 0.83.

For all simulations, adjusting *VFaTmv* and *VAcTmv* in addition to *UCELLS* decreased the number of *UCELLS* needed to simulate lactation curves and improved predictions of total milk and milk fat production. Milk protein prediction was essentially unchanged between both sets of simulations because no parameter (or maximal velocity) that altered milk protein production was adjusted other than *UCELLS*.

The variability of *UCELLS*, in relation to the variability of predicted milk yield (TVMILK), can be evaluated from the information in Tables 21.8 and 21.9. For example, in Table 21.9 we see that the standard deviation of predicted total milk, across all experiments when *UCELLS* is the driving parameter of MOLLY, is 3121. Table 21.8 presents the standard deviation of *UCELLS*, when estimated across all experiments, is 158. Accordingly we see that *UCELLS* accounts for less than 1% of the variation in predicted TVMILK (i.e.  $(158/3121)^2 = 0.003$ ). A term which intends to account for genetic potential should be capable of explaining as much as 25% of the phenotypic variation (based on an assumed heritability of milk production of 0.25), although realistically, this number is likely to be much lower than 25%. The equations that are MOLLY are likely to account for much of the genetic variation observed in standard linear models, so 25% is best thought of as an upper limit to the variability accommodated by 'genetic potential'. Nevertheless, a variance ratio below 1% is a sign that *UCELLS* is only scratching the surface of genetic potential. Interestingly, Table 21.9 also reveals that the variation in actual milk production (e.g. standard deviation = 2918) is less than the variability of predicted milk yield using *UCELLS* (standard deviation = 3121). Typically the variability of predicted values is less than the variability in phenotypes, though if the model were a perfect reflection of the state of nature, the two measures of variability would be identical.

**Table 21.9.** Observed and predicted total milk volume, milk fat and milk protein for *UCELLS* and *FaCELLS* (adjusting *UCELLS*, *VAcTmv* and *VFaTmv*) simulations.

Parameter	Observed mean (kg)	Observed sd	<i>UCELLS</i>		<i>FaCELLS</i> predicted mean	<i>FaCELLS</i> predicted sd
			predicted mean	predicted sd		
<i>All trials</i>						
Total milk	5542	2918	5697	3121	5422	2987
Milk fat	200	91.1	170	100	192	118
Milk protein	161	82.4	130	83.0	129	83.7

## Summary and Conclusions

The value of mechanistic models is to show where knowledge is lacking by failing to represent our understanding of underlying function. Central to this process of model development and testing is to employ appropriate statistical tests of comparison and bias for model prediction of observed data and biological assessment that model behaviour is appropriate in different physiological states and conditions. Previous evaluations have shown that MOLLY, a mechanistic model of a lactating dairy cow, is able to represent carryover effects from changing diets, metabolizable energy values for different diets and production responses to changes in amino acid and protein supplementation. Adjusting certain parameters such as udder cells and maximal velocities allows the model to simulate a range of milk volume, milk fat and milk protein levels, and different diets and feed intake levels will also affect milk production. However, over long-term simulations on some diets and production levels body fat over accumulates.

As yet, the model does not accommodate environmental effects, vitamin or mineral metabolism and many disease states' effects on cow metabolism and production. Many of these effects will affect feed intake and, since feed intake is also not predicted from within the model, will affect model predictions without any adjustment of model parameters. However, any effects not explicitly represented in the model will be absorbed in the adjustment of parameters such as udder cells to simulate individual cow milk production. Therefore, as a measure of genetic potential, udder cells is presently inadequate to the task. Though a useful first step, future versions of MOLLY will have to find other terms, along with udder cells, which can account for the significant amount of variability in production traits that can be attributed to genetic variation. No doubt our expanding understanding of the genes responsible for production traits will add to this development. This future research will also necessitate examining the relationship between *UCELLS* estimates of relatives. If this term is to serve as a surrogate for genetic potential that it must not only explain more of the variability in phenotypes, we should also be able to ensure that estimates of *UCELLS* for relatives are positively correlated to the degree expected from the theory of quantitative genetics.

## Acknowledgements

Special thanks to Dr Ed DePeters, Dr Tilak Dhiman, Dr Gabriella Varga, Dr Shawn Donkin, Dr James Ferguson, Dr Mark Huyler and Dr Donald Palmquist and their co-authors for allowing us to use their data.

## References

- ACSL (2002) *Advanced Continuous Simulation Language Reference Manual*. Aegis Simulation Inc., Huntsville, Alabama.
- Allen, D.M. (1971) Mean square error of prediction as a criterion for selecting variables. *Technometrics* 13, 469–475.

- Argyle, J.L. and Baldwin, R.L. (1989) Effects of amino acids and peptides on rumen microbial growth yields. *Journal of Dairy Science* 72, 2017–2027.
- Baldwin, R.L. (1995) *Modeling Ruminant Digestion and Metabolism*. Chapman & Hall, London.
- Baldwin, R.L. and Bauman, D.E. (1984) Partition of nutrients in lactation. In: Baldwin, R.L. and Bywater, R.C. (eds) *Modeling Ruminant Digestion and Metabolism*. University of California, Davis, California, pp. 80–88.
- Baldwin, R.L., Emery, R.S. and McNamara, J.P. (1994) Metabolic relationships in the supply of nutrients for milk protein synthesis: integrative modeling. *Journal of Dairy Science* 77, 2821–2836.
- Broster, W.H. and Broster, V.J. (1984) Reviews of the progress of dairy science: long term effects of plane of nutrition on the performance of the dairy cow. *Journal of Dairy Research* 51, 149–196.
- Chalupa, W., Vecchiarelli, B., Galligan, D.T., Ferguson, J.D., Baird, L.S., Hemken, R.W., Harmon, R.J., Soderholm, C.G., Otterby, D.E., Annexstad, R.J., Linn, J.G., Hansen, W.P., Ehle, F.R., Palmquist, D.E. and Eggert, R.G. (1996) Responses of cows supplemented with somatotropin during weeks 5 through 43 of lactation. *Journal of Dairy Science* 79, 800–812.
- Clark, J.H. (1975) Lactational responses to postprandial administration of proteins and amino acids. *Journal of Dairy Science* 58, 1178–1191.
- Cottrill, B.R., Beever, D.E., Austin, A.R. and Osbourn, D.F. (1982) The effect of protein and nonprotein nitrogen supplements to maize silage on total amino acid supply in young cattle. *British Journal of Nutrition* 48, 527–541.
- Dann, H.M., Varga, G.A. and Putnam, D.E. (1999) Improving energy supply to late gestation and early postpartum dairy cows. *Journal of Dairy Science* 82, 1765–1778.
- DePeters, E.J., Smith, N.E. and Acedo-Rico, J. (1985) Three or two times daily milking of older cows and first lactation heifers. *Journal of Dairy Science* 68, 123–132.
- Dhiman, T.R. and Satter, L.D. (1997) Yield response of dairy cows fed different proportions of alfalfa silage and corn silage. *Journal of Dairy Science* 80, 2069–2082.
- Diggle, P., Liang, K.Y. and Zeger, S.L. (1994) *Longitudinal Data Analysis*. Oxford University Press, Oxford, UK.
- Efron, B. (1979) Computers and the theory of statistics. *SIAM Review* 21, 460–480.
- Efron, B. and Tibshirani, R.J. (1993) *An Introduction to the Bootstrap*. Chapman & Hall, London.
- Ensminger, M.E. (2002) *Dairy Cattle Science*, 9th edn. Prentice-Hall, Englewood Cliffs, New Jersey.
- France, J. and Thornley, J.H.M. (1984) *Mathematical Models in Agriculture*. Butterworths, London.
- Freetly, H.C., Knapp, J.R., Calvert, C.C. and Baldwin, R.L. (1993) Development of a mechanistic model of liver metabolism in the lactating cow. *Agricultural Systems* 41, 157–195.
- Greenfield, R.B., Cecava, M.J., Johnson, T.R. and Donkin, S.S. (2000) Impact of dietary protein amount and rumen undegradability on intake, peripartum liver triglyceride, plasma metabolites, and milk production in transition dairy cattle. *Journal of Dairy Science* 83, 703–710.
- Hanigan, M.D. and Baldwin, R.L. (1994) A mechanistic model of mammary gland metabolism in the lactating cow. *Agricultural Systems* 45, 369–419.



- Hanigan, M.D., Calvert, C.C., DePeters, E.J., Reis, B.L. and Baldwin, R.L. (1992) Kinetics of amino acid extraction by lactating mammary glands in control of some tribove-treated Holstein cows. *Journal of Dairy Science* 75, 161–173.
- Hanigan, M.D., Cant, J.P., Weakley, D.C. and Beckett, J.L. (1998) An evaluation of postabsorptive protein and amino acid metabolism in the lactating dairy cow. *Journal of Dairy Science* 81, 3385–3401.
- Hjorth, J.S.U. (1994) *Computer Intensive Statistical Methods*. Chapman & Hall, London.
- Huber, P.J. (1964) Robust estimation of a location parameter. *The Annals of Mathematical Statistics* 35, 73–101.
- Huyler, M.T., Kincaid, R.L. and Dostal, D.F. (1999) Metabolic and yield responses of multiparous Holstein cows to prepartum rumen undegradable protein. *Journal of Dairy Science* 82, 527–536.
- Johnson, H.A., DePeters, E.J. and Baldwin, R.L. (1999) Evaluation of MOLLY, a dynamic, metabolic model of a dairy cow for predicting milk production. *Journal of Dairy Science* 81 (Suppl. 1), 315.
- Knapp, J.R., Freetly, H.C., Reis, B.L., Calvert, C.C. and Baldwin, R.L. (1992) Effects of somatotropin and substrates on patterns of liver metabolism in lactating dairy cattle. *Journal of Dairy Science* 75, 1025–1035.
- Lynch, M. and Walsh, B. (1998) *Genetics and Analysis of Quantitative Traits*. Sinauer Assoc., Inc., Sunderland, Massachusetts.
- Maeng, W.J., Van Nevel, C.J., Baldwin, R.L. and Morris, J.G. (1976) Rumen microbial growth rates and yields: effect of amino acids and protein. *Journal of Dairy Science* 59, 68–79.
- McCulloch, C.E. and Searle, S.R. (2001) *Generalized, Linear and Mixed Models*. John Wiley, New York.
- McNamara, J.P. and Baldwin, R.L. (2000) Estimation of critical parameters describing lipid metabolism in lactation: challenge of existing knowledge described in a model of metabolism. *Journal of Dairy Science* 83, 128–143.
- Miller, P.S., Reis, B.L., Calvert, C.C., DePeters, E.J. and Baldwin, R.L. (1991) Patterns of nutrient uptake by the mammary glands of lactating dairy cows. *Journal of Dairy Science* 74, 3791–3799.
- Mood, A.M., Boes, D.C. and Graybill, F.A. (1974) *Introduction to the Theory of Statistics*. McGraw-Hill, New York.
- National Research Council (NRC) (1989) *Nutrient Requirements of Dairy Cattle*, 6th edn. National Academy Press, Washington, DC.
- Neal, H.D.St.C. and Thornley, J.H.M. (1983) The lactation curve in cattle: a mathematical model of the mammary gland. *Journal of Agriculture Science, Cambridge* 101, 389–400.
- Polan, C.E., Cumins, K.A., Sniffen, C.J., Muscato, T.V., Vincini, J.L., Crooker, J.H., Clark, D.G., Johnson, D.E., Otterby, D.E., Guillaume, B., Muller, L.D., Varga, G.A., Murray, R.A. and Peirce-Sandner, S.B. (1991) Responses of dairy cows to supplemental rumen-protected forms of methionine and lysine. *Journal of Dairy Science* 74, 2997–3013.
- Robert, C.P. and Casella, G. (1999) *Monte Carlo Statistical Methods*. Springer-Verlag, New York.
- Rulquin, H., Pisulewski, P.M., Verite, R. and Guinard, J. (1993) Milk production and composition as a function of postruminal lysine and methionine supply: a nutrient response approach. *Livestock Production Science* 37, 69–90.
- Stone, M. (1974) Cross-validatory choice and assessment of statistical predictions. *Journal of the Royal Statistical Society (Series B)* 36, 111–147.

- Whitelaw, F.G., Milne, J.S., Orskov, E.R. and Smith, J.S. (1986) The nitrogen and energy metabolism of lactating cows given abomasal infusions of casein. *British Journal of Nutrition* 55, 537–556.
- Yang, Y.T. and Baldwin, R.L. (1973a) Preparation and metabolism of isolated cells from bovine adipose tissue. *Journal of Dairy Science* 56, 350–365.
- Yang, Y.T. and Baldwin, R.L. (1973b) Lipolysis in isolated cow adipose cells. *Journal of Dairy Science* 56, 366–374.

---

# 22 Mathematical Modelling of Wool Growth at the Cellular and Whole Animal Level

B.N. Nagorcka<sup>1</sup> and M. Freer<sup>2</sup>

<sup>1</sup>CSIRO Livestock Industries, GPO Box 1600, Canberra, ACT 2601, Australia;

<sup>2</sup>CSIRO Plant Industry, GPO Box 1600, Canberra, ACT 2601, Australia

---

## Introduction

Large variation exists both between and within sheep in the rate of growth, composition and physical characteristics of wool fibres. The rate of clean wool growth can range from less than 1 to greater than 30 g per animal per day. The mean diameter of fibres in the fleece from sheep of ultra-fine wool Merino strains can be as low as 13  $\mu\text{m}$  whereas it is greater than 40  $\mu\text{m}$  for some carpet wool breeds, and the diameter of individual fibres can range from less than 10  $\mu\text{m}$  to greater than 100  $\mu\text{m}$ . Diameter can also vary considerably along the length of individual fibres reducing the strength of the wool, causing it to become 'tender' and decreasing the commercial value of the fleece. Many fleece staples are highly crimped whereas some have little or no crimp (Reis, 1992). The amino acid composition of wool may also vary; in particular, the sulphur-containing amino acid cystine (usually quoted in units of half-cystine so that it is equivalent to the amino acid cysteine) may vary considerably (Reis, 1979).

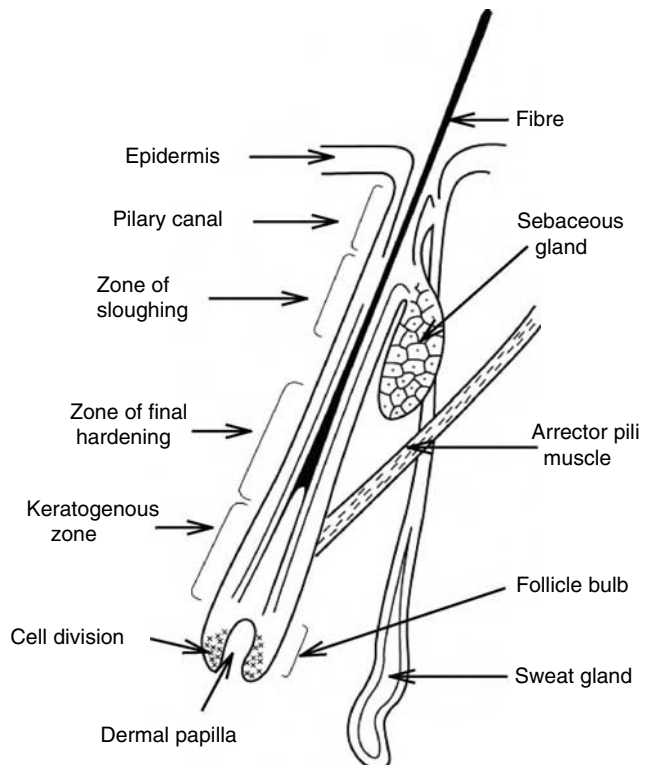
This variation in wool characteristics is due to both genetic and environmental factors. For each animal, the potential rate of wool growth and the morphology and chemical composition of wool fibres growing at their maximum rate are controlled by several genetically determined factors and mechanisms. These were outlined in an earlier publication (Black and Nagorcka, 1993). The actual rate of wool growth and the characteristics of the wool fibres are the result of the interaction between the genetic factors and the supply of nutrients to the wool follicles (Black, 1987). The latter is influenced by the quantity and type of nutrients absorbed from the digestive tract and the competition for nutrients between wool growth and the growth of other body tissues. Thus, the stage of growth and the reproductive status of an animal, the amount and composition of the diet eaten, the climatic environment, the presence of parasites and disease may all influence the amount and quality of the wool grown.

In this chapter we describe our current capacity to quantitatively predict wool growth. The mathematical models of wool growth presented here have been developed at two levels: for use in research to understand the factors controlling wool growth at a cellular level and for use by managers of wool production enterprises to optimize the quality and quantity of the wool produced. Presenting models at both these levels emphasizes the relationship between the whole animal level and the cellular level and assists readers to gain an appreciation of the approximations used at the higher level.

## Equations Describing Fibre Growth in a Mature Wool Follicle

### *Cell division and differentiation in a mature wool follicle*

Wool fibres are produced in primary and secondary wool follicles in the skin (Hardy and Lyne, 1956). Primary follicles (Fig. 22.1) are so-called because they are the earliest follicles to initiate in the skin during fetal development, and they develop with a sebaceous gland as well as an arrector pili musculature and a sweat gland attached to them. Secondary follicles initiate later in fetal development and only have a sebaceous gland attached to them. Both primary and



**Fig. 22.1.** A primary wool follicle is illustrated showing the arrector pili muscle, the sweat gland and the sebaceous gland attached to the follicle. The cells forming the fibre originate in the follicle bulb and migrate up the follicle towards the skin surface, undergoing various changes that are classified into the different zones depicted here (Hardy and Lyne, 1956; Chapman and Ward, 1979).

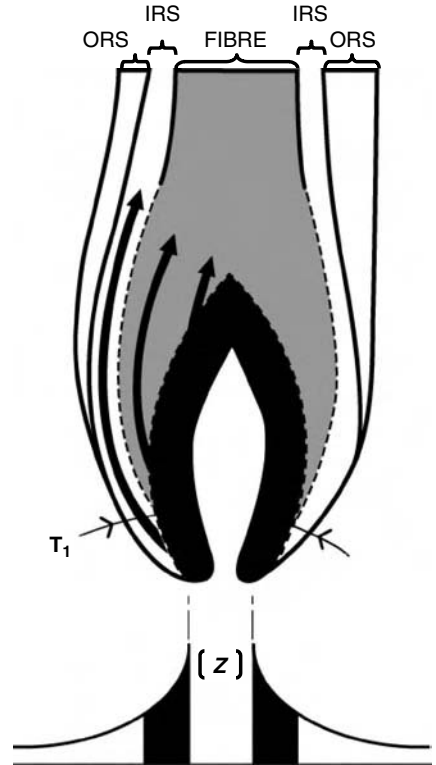
secondary follicles normally produce only one fibre and this originates at the site of highest mitotic activity in the follicle, i.e. in the follicle bulb. Cell division is concentrated in the lower part of the follicle bulb (Fig. 22.1) in a region surrounding the dermal papilla.

It has been proposed (Nagorcka and Mooney, 1982; Nagorcka, 1984) that epithelial stem cells (i.e. epithelial cells that are totipotent and divide indefinitely) are located in contact with the basement membrane that surrounds the follicle and also separates the epithelium from the dermal papilla. As the stem cells divide, a fraction of them are forced out of contact with the basement and so become committed to a path of differentiation that terminates in cell death. Once committed, the cells may undergo a limited number of further cell divisions as they differentiate. The age of a cell is defined to be the time since its commitment. A scheme for the differentiation of these cells has been proposed (Nagorcka, 1984) in which the path of differentiation chosen by committed cells depends on the concentration of two chemical factors that they experience at specific cellular ages as they migrate up and out of the follicle bulb in response to the pressure in the follicle bulb. One of the chemicals,  $Z$ , is produced in the dermal papilla and diffuses radially away from the papilla through the follicle bulb. The second chemical factor is a component,  $X$ , of a reaction-diffusion (RD) system which has been described by Nagorcka and Mooney (1982).

It has been observed that initially cells migrate up from the basement membrane at the base of the follicle bulb at different rates depending on their distance away from the dermal papilla (Fig. 22.2) (Chapman *et al.*, 1980). According to the differentiation scheme referenced above, cells at an early age, i.e. while they are still low in the bulb, differentiate as presumptive fibre cells, inner root sheath (IRS) cells or outer root sheath (ORS) cells (Fig. 22.2). At later ages and slightly higher in the bulb further differentiation occurs, which in the case of the presumptive fibre cells leads to formation of a single cell layer surrounding the fibre cortex called the fibre cuticle. The fibre cortex also differentiates into orthocortical and paracortical cells (and under some circumstances the cortex may also include mesocortical and/or metacortical cells) (Ahmad and Lang, 1957). In large diameter fibres, cells arising from the apex of the dermal papilla may also differentiate to form medullary cells, which then act as a central core to the fibre. Once IRS and fibre cells reach the apex of the bulb they migrate up at the same rate. Some migration of ORS cells also occurs but at a lower rate.

The proteins that form the fibre and IRS are synthesized mainly in the zone just above the apex of the dermal papilla called the keratogenous zone. In this zone macro- and microfibrils form in the cortical cells and are surrounded by a proteinaceous matrix that acts as a binding material. Further up the follicle, the cells reach the zone of hardening where, catalysed by copper, the thiol residues of cysteine undergo oxidative closure to form the hard disulphide linkages of keratin.

The contents of IRS cells that migrate up the follicle are resorbed to some extent and the remains are sloughed into the pilary canal in the upper part of the follicle. Wax and suint are also secreted into the pilary canal by the



**Fig. 22.2.** A schematic diagram showing the migration paths of cells out of the follicle bulb. According to the differentiation scheme of Nagorcka and Mooney (1982) and Nagorcka (1984), cells aged  $T_1$  days that have reached the level in the bulb indicated undergo the first stage of differentiation becoming either presumptive fibre, inner root sheath (IRS) or outer root sheath (ORS) cells. According to the scheme this is largely controlled by a chemical factor produced in the dermal papilla that diffuses radially away to produce a concentration gradient shown here by the plot of  $[Z]$  with distance from the centre of the dermal papilla.

sebaceous and sweat glands. Finally the fibre emerges from the pilary canal at the skin surface partially coated with 'grease' consisting of wax, suint and other contents of the pilary canal.

### ***Equations describing the cell dynamics in the follicle bulb***

A number of researchers have studied the cell division rate in wool follicle bulbs (Fraser, 1965; Wilson and Short, 1979; Hynd, 1989; Hocking-Edwards and Hynd, 1992). Their observations have recently been summarized and compared by Hynd and Masters (2002). At a maintenance level of nutrition in a medium-wool Merino a typical follicle bulb contains about 600 cells. The bulb cells have a radius  $r_{\text{cell}} \sim 4\text{--}5 \mu\text{m}$  and hence a cell volume of about  $400 \mu\text{m}^3$ . It follows that the volume of the follicle bulb is  $\sim 2.3 \times 10^5 \mu\text{m}^3$ . Assuming a hemispherical shape, the bulb has a radius  $R_{\text{Bulb}} \sim 50 \mu\text{m}$ . If the dermal papilla has cylindrical shape with a radius  $r_{\text{Derpap}} \approx (1/3)R_{\text{Bulb}}$  then the surface area of the membrane is approximately  $A_{\text{Membrane}} = 2\pi R_{\text{Bulb}}^2 + 2\pi r_{\text{Derpap}} R_{\text{Bulb}} = 2\pi R_{\text{Bulb}}^2 (1 + 1/3)$ , and the number of cells expected to be in contact with the membrane is  $2\pi R_{\text{Bulb}}^2 (1 + 1/3) / \pi r_{\text{cell}}^2 \approx 300$ , i.e. approximately half of the 600 bulb cells. If we regard the number of cells in contact with the membrane

as stem cells, denoted here as  $N_{\text{Stem}}$ , then the stem cell density on the basement membrane is given by  $d_{\text{Stem}} = N_{\text{Stem}}/A_{\text{Membrane}} (\approx 0.016 \text{ cells}/\mu\text{m}^2)$ .

The equation describing the rate of change in the number of stem cells on the basement membrane in the follicle bulb is:

$$\frac{dN_{\text{Stem}}(t)}{dt} = f_{\text{StemDiv}}N_{\text{Stem}}(t) - f_{\text{Commitment}}N_{\text{Stem}}(t) \quad (22.1)$$

where  $f_{\text{Commitment}}$  is the fraction of stem cells committed per day (i.e. breaking attachment with and migrating away from the membrane) and  $f_{\text{StemDiv}}$  is the fraction of stem cells dividing per day. If the follicle is in equilibrium all rate equations are equal to zero. As a first approximation both  $f_{\text{StemDiv}}$  and  $f_{\text{Commitment}}$  are considered to be constants determined by genotype, i.e. by factors such as growth hormones with little dependence on diet.  $f_{\text{Commitment}}$  is set to a constant value of  $1/7$ , i.e. one in seven stem cells become detached from the basement membrane per day (Potten and Lajtha, 1982).  $f_{\text{StemDiv}}$  is given by:

$$f_{\text{StemDiv}} = f_{\text{Commitment}}k_{\text{StemDensity}} \quad (22.2)$$

where

$$k_{\text{StemDensity}} = 0.016/d_{\text{Stem}} \quad (22.3)$$

It follows that Eq. (22.1) can also be written as follows:

$$\frac{dN_{\text{Stem}}(t)}{dt} = f_{\text{Commitment}}N_{\text{Stem}}(t)(0.016/d_{\text{Stem}} - 1) \quad (22.4)$$

Since  $d_{\text{Stem}}$  varies with  $N_{\text{Stem}}$ , Eq. (22.4) will build up a population of stem cells that tends to maintain  $d_{\text{Stem}}$  on the basement membrane at the level of  $0.016 \text{ cells}/\mu\text{m}^2$ .

Commitment of stem cells provides an input into the number of differentiating cells in the follicle bulb,  $N_{\text{Diff}}$ . These cells are not attached to the membrane. The number of committed or differentiating cells in the follicle bulb is assumed to divide at the fixed rate  $f_{\text{DiffDiv}}$ . If the number of differentiating cells migrating out of the bulb per day is  $N_{\text{Mig}}(t) = dN_{\text{Mig}}(t)/dt$ , then  $N_{\text{Diff}}$  is given by:

$$\frac{dN_{\text{Diff}}(t)}{dt} = f_{\text{Commitment}}N_{\text{Stem}}(t) + f_{\text{DiffDiv}}N_{\text{Diff}}(t) - \dot{N}_{\text{Mig}}(t) \quad (22.5)$$

where  $f_{\text{DiffDiv}}$  is considered to be a constant (i.e. genetically determined and independent of diet) and is set to a value of 1 (per day), i.e. each cell undergoes one division per day on average.  $\dot{N}_{\text{Mig}}$  is considered to be a proportion  $f_{\text{MigBulb}}$  of the unattached cells in the bulb, i.e.

$$\dot{N}_{\text{Mig}}(t) = f_{\text{MigBulb}} N_{\text{Diff}}(t) \quad (22.6)$$

$f_{\text{MigBulb}}$  is defined below in Eq. (22.7). Eq. (22.5) includes an additional function  $\text{Photo}(t)$  multiplying the division rate of differentiating cells. This is included to represent the effect of photoperiod on the rate of wool growth, which is discussed in a later section (see Eqs (22.18) and (22.19)). Current evidence suggests that photoperiod acts through the release of melatonin by the pineal gland, and influences the skin through prolactin (Lincoln *et al.*, 1998). Prolactin and prolactin receptors have been found distributed in the dermal papilla, the wool follicle bulb and the ORS (Choy *et al.*, 1997; Nixon *et al.*, 2002). We are assuming that prolactin regulates the division rate of the differentiating cells in the follicle bulb. If this is correct then the amplitude  $A_{\text{Photo}}$  in Eqs (22.18) and (22.19) should be reduced by the order of a factor of 10 because of the feedback occurring between the keratogenous zone and the follicle bulb, as discussed in relation to Figs 22.3 and 22.4.

The number of cells migrating out of the follicle bulb,  $\dot{N}_{\text{Mig}}(t)$  (Eq. (22.5)) is expressed as a fraction,  $f_{\text{MigBulb}}$ , of the number of differentiating cells in the bulb. The fraction of cells migrating out of the bulb is expected to increase with the pressure in the follicle bulb,  $P_{\text{Bulb}}$ , and to decrease as the resistance to flow of cells up the follicle,  $R_{\text{Mig}}$ , increases.  $f_{\text{MigBulb}}$  is therefore defined by:

$$f_{\text{MigBulb}} = f_{\text{MigBulb}}^0 \left( \frac{P_{\text{Bulb}}(t)}{P_{\text{Bulb}}^0} \right) * \left( \frac{R_{\text{Mig}}^0}{R_{\text{Mig}}(t)} \right) \quad (22.7)$$

where  $P_{\text{Bulb}}^0$  and  $R_{\text{Mig}}^0$  are normalizing constants set at a maintenance level of nutrition. The average time taken for cells to migrate out of the follicle bulb has been observed to be approximately 1 day (Chapman *et al.*, 1980). Therefore  $f_{\text{MigBulb}}^0$  is considered to be genetically determined, i.e. largely independent of diet, and is set to a constant value of 1 (per day).

The follicle, including the follicle bulb, is surrounded and contained by a net of collagenous fibres so that the pressure in the follicle bulb will increase as the number of cells in the follicle bulb, and hence the volume of the bulb,  $V_{\text{Bulb}}$ , increases. A functional form for this dependence has not been measured. It is assumed here to be of the form

$$P_{\text{Bulb}}(t) \propto (V_{\text{Bulb}}(t))^\alpha \quad (22.8)$$

where  $\alpha$  is a constant.

The resistance to cellular flow up the follicle is another aspect of follicle function that has never been studied experimentally. In the upper three-fifths of the follicle, corresponding to the zone of final hardening (Fig. 22.1), 'degradation of the IRS begins with presumed resorption of some cell contents' (Chapman and Ward, 1979). In fact, in the upper half of this region, corresponding to



the zone of sloughing and the pilary canal, the fibre becomes separated from the IRS. Therefore the main restriction to cellular flow occurs in the keratogenous zone and it is assumed here to be dependent on the total volume, i.e. the total mass of follicular material,  $M_{Ker}$ , in this zone defined by the relationship:

$$R_{Mig}(t) \propto (M_{Ker}(t))^\beta \tag{22.9}$$

where  $\beta$  is a constant.

The keratogenous zone corresponds to approximately 3 days of cellular migration (Chapman *et al.*, 1980).  $M_{Ker}$  may be calculated as follows:

$$\begin{aligned} M_{Ker}(t) &= \int \left\{ \left[ \begin{array}{l} \text{Protein synthesis in} \\ \text{the keratogenous zone} \end{array} \right] + \left[ \begin{array}{l} \text{Migration of cells into} \\ \text{the keratogenous zone} \end{array} \right] \right. \\ &\quad \left. - \left[ \begin{array}{l} \text{Migration of cells out of} \\ \text{the keratogenous zone} \end{array} \right] \right\} dt' \\ &= \int_{t-3}^t \left\{ \dot{P}_{ProtCell}(t')N_{Ker}(t') + M_{BulbCell}\dot{N}_{Mig}(t') - M_{KerCell}(t')\dot{N}_{Mig}(t' - 3) \right\} dt' \end{aligned} \tag{22.10}$$

where

$$N_{ker}(t) = \int_{t-3}^t \dot{N}_{Mig}(t') dt' \tag{22.11}$$

and

$$M_{KerCell}(t) = M_{BulbCell} + \int_{t-3}^t \dot{P}_{ProtCell}(t') dt' \tag{22.12}$$

where  $\dot{P}_{ProtCell}(t')$  is the rate of material (protein) synthesis in migrating cells that are differentiating (see Eq. (22.15)).  $M_{KerCell}(t)$  is the weight of a cell at the upper limit of the keratogenous zone, and  $M_{BulbCell}$  is the mass of a cell aged 1 day, i.e. a cell at the apex of the bulb that is about to migrate into the keratogenous zone.  $M_{BulbCell}$  has been set to a constant value since there is no clear evidence that volume of bulb cells ( $\sim 400 \mu\text{m}^3$ ) changes significantly in response to a change in the level of nutrition (Wilson and Short, 1979; Hynd and Masters, 2002). Cell volumes are observed to increase from  $\sim 400$  to  $\sim 1500 \mu\text{m}^3$  as

they migrate up the follicle through the keratogenous zone (Hynd, 1994). As a first approximation these volumes are taken to reflect the changes in the contents or mass of the cells.

### **Average rate of cell division in the wool follicle bulb**

In the cellular model described above the average rate of cell division in the follicle bulb,  $C_{Div}$ , can be calculated by summing the cell division of both stem cells and differentiating cells and dividing it by the total number of cells in the bulb, i.e.

$$C_{Div}(t) = (f_{StemDiv}N_{Stem}(t) + f_{DiffDiv}N_{Diff}(t))/N_{Bulb}(t) \quad (22.13)$$

where

$$N_{Bulb}(t) = N_{Stem}(t) + N_{Diff}(t) \quad (22.14)$$

In equilibrium at a maintenance level of nutrition we can substitute  $f_{StemDiv} = 1/7$ ,  $f_{DiffDiv} = 1$  and  $N_{Stem}/N_{Bulb} = N_{Diff}/N_{Bulb} = 0.5$  to obtain  $C_{Div} = (1/7) \times 0.5 + 1 \times 0.5 \sim 0.57$  consistent with observations at 'medium' nutrition levels (Hynd and Masters, 2002).

### **Protein synthesis in the wool fibre**

Variations in the amino acid composition of wool are known to occur between breeds and between animals within a breed; variations are also known to occur in response to changes in nutrition (see reviews by Reis (1979), Black and Reis (1979), Rogers *et al.* (1989) and Hynd and Masters (2002)). To characterize these variations wool keratins are often classed into four groups. Those in the main group are the low-sulphur (LS) keratins comprising about two-thirds of the proteins and providing the structural components of the microfibrils. A second group contains the high-sulphur (HS) proteins, which are rich in cystine, proline and serine. These proteins form the matrix surrounding the microfibrils. The proportion of the HS proteins in wool varies between 18% and 35%. The ultra-high-sulphur (UHS) proteins in a third group are especially rich in cystine. They are often considered as a sub-group of the HS proteins. The fourth group contains the high-glycine/tyrosine (HGT) proteins that make up between 1% and 12% of the total. The HGT proteins are found primarily in the matrix.

A part of the observed amino acid variation in wool is due to variations in cortical cell type determined in the follicle bulb. For example, there is more matrix in paracortical cells than in orthocortical cells. The scheme for cellular differentiation in the follicle bulb proposed by Nagorcka and Mooney (1982) and Nagorcka (1984) produces a complicated relationship between follicle bulb size and shape, and the spatial pattern of cortical cell type in the fibre cross-section. Both genotype and nutrition determine the size and shape of the follicle bulb. Since the relationship is complex we will not attempt to describe it here but rather direct readers to an earlier review (Black and Nagorcka, 1993). The predominant

cortical cell pattern in the finer wool animals is expected to be bilateral, although the proportions of ortho- and paracortex may still vary with follicle bulb size and shape. It is emphasized that variations in composition caused by changes in the size and shape of the follicle bulb are not considered in the following discussion.

A significant part of the variation in wool composition is also due to variations in wool protein synthesis caused by changes in the amount and profile of the amino acids digested and absorbed. Some of the variation in composition is, therefore, the result of competing biochemical reactions controlling the utilization of nutrients by wool follicles and other tissues. One model that has explored the effect of competition for nutrients on wool competition is that by Black and Reis (1979) (see also Black and Nagorcka (1993)), who demonstrate that it is possible to use Michaelis–Menton kinetics to quantify the rate of protein deposition,  $d \text{Prot}_j(t)/dt$ , in several protein groups in wool denoted by  $j$ . A similar approach is adopted here for each of the four protein groups in wool (discussed above) specified by  $j = \text{LS, HS, UHS, HGT}$ . The equation used here is given by:

$$\frac{d \text{Prot}_j(t)}{dt} = \text{MIN}_{i=1, n_{AA}} \left\{ \frac{d \tilde{\text{Prot}}_{ij}(t)}{dt} \right\} \tag{22.15}$$

$$\frac{d \tilde{\text{Prot}}_{ij}(t)}{dt} = \frac{V_{ij}}{\left( 1 + \frac{K_{ij}}{C_i} + \frac{K_{MEj}}{C_{ME}} \right) f_{ij}}$$

where  $i = 1, n_{AA}$  specifies a particular amino acid in a set of  $n_{AA}$  amino acids.  $d \tilde{\text{Prot}}_{ij}(t)/dt$  is the calculated rate of synthesis of group  $j$  proteins determined by the concentration,  $C_i$ , of amino acid  $i$ , and the concentration of metabolizable energy in plasma  $C_{ME}$ , given that the fraction of amino acid  $i$  in group  $j$  protein is  $f_{ij}$ . Each reaction rate  $d \tilde{\text{Prot}}_{ij}(t)/dt$  is characterized by a maximum velocity  $V_{ij}$  and a binding affinity  $K_{ij}$ .

Attempts to directly measure the size (i.e. maximum diameter and length) of cortical cells forming the mature fibre (Williams and Winston, 1987; Hynd, 1994; Hynd and Masters, 2002) suggest that the size may remain unchanged even in response to significant nutritional variation. If this is true it implies that cortical cells grow to synthesize approximately the same total weight of protein (keratins),  $\text{Prot}_{\text{Ker}}$ , so that a cell reaches a maximum volume ( $\sim 1500 \mu\text{m}^3$ , Hynd, 1994) and weight  $M_{\text{KerCell}}(t) = M_{\text{BulbCell}}(t) + \text{Prot}_{\text{Ker}} \sim 1500 (\mu\text{m}^3) \times \text{density of wool}(\text{g}/\mu\text{m}^3)$  (Eq. (22.9)). In fact, the total weight of protein synthesized in cortical cells,  $\text{Prot}_{\text{Cell}}$  is expressed as:

$$\frac{d \text{Prot}_{\text{Cell}}(t)}{dt} = \begin{cases} \sum_j \frac{d \text{Prot}_j(t)}{dt}, & \text{if } \text{Prot}_{\text{Cell}}(t) < \text{Prot}_{\text{Ker}} \\ 0 & \text{if } \text{Prot}_{\text{Cell}}(t) \geq \text{Prot}_{\text{Ker}} \end{cases} \tag{22.16}$$

Since each cortical cell grows to its maximum weight in the follicle, Eq. (22.16) is used only to calculate the protein composition of wool, and to estimate  $M_{\text{KerCell}}(t)$  in Eq. (22.10). In principle they are also required to calculate the rate at which wool is produced in the follicle as measured at the skin surface at time  $t$ . Wool growth rate of the fibre,  $\text{WGR}_{\text{Fibre}}$ , is given by:

$$\text{WGR}_{\text{Fibre}}(t) = F_{\text{Fibre}} \dot{N}_{\text{Mig}}(t - t_{\text{Fibre}}) M_{\text{KerCell}}(t - t_{\text{Fibre}} + 3) \quad (22.17)$$

where  $t_{\text{Fibre}}$  is the time taken for the cells to migrate from just above the follicle bulb to the skin surface. If it takes approximately 7 days for cells to migrate the full length of the follicle (Downes and Sharry, 1971), then  $t_{\text{Fibre}} \approx (7 - 1) = 6$  days. During the first 3 days of the migration the cells grow in size in the keratogenous zone. Observations to date (Hynd, 1994; Hynd and Masters, 2002) appear to be consistent with  $M_{\text{KerCell}}(t)$  remaining at or close to its maximum value as discussed above.  $F_{\text{Fibre}}$  is the fraction of cells migrating out of the bulb that form part of the fibre. This fraction has been measured (Hynd, 1989) and found to vary between sheep, but not to vary with the level of nutrition.  $F_{\text{Fibre}}$  is therefore considered to be genetically determined and set to a fixed value; a typical value is  $F_{\text{Fibre}} = 0.25$ .

## The Effect of Photoperiod

It has been observed in experiments where sheep are fed a uniform diet at a constant level of intake that the wool growth rate varies from a maximum in summer to a minimum in winter. Although this was initially attributed to temperature, it has since been shown to be caused by photoperiod (Hart, 1955, 1961; Morris, 1961). Photoperiod appears to have a direct effect on the wool growth rate that in some breeds of sheep causes the fleece to shed. In domestic breeds of sheep the annual rhythm of fleece shedding does not occur but a significant variation in the rate of wool growth remains.

In a review of the observations of the effect of photoperiod on wool growth Nagorcka (1979) showed that a sinusoidal function of the form:

$$\text{Photo}(t) = 1 + 0.5A_{\text{Photo}} \cos(\omega t) \quad (22.18)$$

where  $\omega = 2\pi/365$ , is sufficient to capture most of the variation in the growth rate of the fleece. The amplitude of the variation,  $A_{\text{Photo}}$ , is the difference between the maximum and the minimum growth rate expressed as a fraction of the mean.  $A_{\text{Photo}}$  was found to vary between 0.15 and 0.70 depending on breed. Examples of values for  $A_{\text{Photo}}$  are: Merinos 0.15; Southdown, Ryeland 0.45; Corriedale, Romney 0.30; Dorset, Suffolk, Border Leicester 0.55; Border Leicester  $\times$  Merino 0.35. Eq. (22.18) can also be expressed in terms of daylength,  $\text{DL}(t)$ , as follows:

$$\text{Photo}(t) = 1 + 0.1A_{\text{photo}}(\text{DL}(t) - 12) \quad (22.19)$$

## Variability in Fibre Diameter and Length

Fibre diameter is a major factor determining the price of wool. It has been well established that there is a relationship between fibre diameter,  $D_{\text{Fibre}}$ , and the diameter of the wool follicle bulb (and dermal papilla) (Hynd, 1994), which accounts for most of the observed variability whether caused by nutrition or genotype. A linear relationship of the form:

$$D_{\text{Fibre}}(t) = D_{\text{Fibre}}^0 + F_{\text{Bulb}}D_{\text{Bulb}}(t) \quad (22.20)$$

is often used (e.g. Henderson (1965)), where  $D_{\text{Fibre}}^0$  and  $F_{\text{Bulb}}$  are constants, and  $D_{\text{Bulb}}$  is the diameter of the follicle bulb. Assuming the shape of the bulb is hemispherical:

$$D_{\text{Fibre}}(t) = D_{\text{Fibre}}^0 + F_{\text{Bulb}}2\left(\frac{3V_{\text{Bulb}}(t)}{2\pi}\right)^{1/3} \quad (22.21)$$

In fact,  $D_{\text{Fibre}}$  should be calculated using a differentiation scheme such as that proposed by Nagorcka and Mooney (1982), however, in general this is much too complex. Once  $D_{\text{Fibre}}$  is calculated the fibre length growth rate can also be determined since:

$$L_{\text{Fibre}}(t) = \frac{g_{\text{Wool}}WGR_{\text{Fibre}}(t)}{\pi(D_{\text{Fibre}}(t)/2)^2} \quad (22.22)$$

given that the density of wool is  $g_{\text{Wool}} = 0.35 \times 10^3 \text{ kg/m}^3$ . Since  $WGR_{\text{Fibre}}$  is calculated independently of  $D_{\text{Fibre}}$ ,  $L_{\text{Fibre}}$  may vary at least to some extent independently of  $D_{\text{Fibre}}$ .

## Staple Strength

To produce yarn, wool is processed through many stages, for example, washing, combing, carding and spinning. Fibre breakages can occur during each of these stages of processing leading to losses of wool, called noil, and slowing of the rate of processing; both will cause the cost of fabric production to increase. An objective measure called staple strength was introduced to help buyers assess the potential for fibre breakages. Staple strength is second only to fibre diameter in determining the price of wool. Factors that influence staple strength have been reviewed by Reis (1992).

It is known that staple strength is dependent on both the coefficient of variation in fibre diameter between fibres in the staple, a characteristic that is

largely genetically determined, and on the variation in fibre diameter along the length of the fibres, i.e.  $D_{\text{Fibre}}$ , a characteristic that is largely determined by environmental factors (Petersen *et al.*, 1998). It may be possible to use the existing information to develop equations to account for the relationship between staple strength and the variation in diameter along and between fibres. Unfortunately no satisfactory model for staple strength has yet been derived from the observations. A mathematical model incorporating all the major factors contributing to staple strength still remains a missing component of our capacity to model wool growth.

## Fibre Shape

Wool fibres have a characteristic shape referred to as crimp. Crimp was originally used as a visual indicator of the diameter of the fibre. However, this has now been replaced by direct measurements of fibre diameter. Recent research (Michael Haigh and Gary Robinson, personal communication) has shown that crimp frequency is still a factor in determining fabric attributes such as pilling and shrinkage, which are less with high-crimp frequency wools, and topmaking performance, handle and softness, which are better with low-crimp frequency wools. Therefore crimp is still a factor in assessing 'wool quality' and influences the price of wool, but it is less important than either fibre diameter or staple strength.

A mechanism explaining the formation of crimp which depends on the movement of cells out of the follicle bulb and on their migration up the follicle has been proposed by Nagorcka (1981). This mechanism is based on the capacity of the fibre to bend and twist while still in the follicle and the way in which this can affect the spatial distribution of cortical cell type within the fibre cross-section. It is entirely complementary to the cellular kinetics described in Eqs (22.1) to (22.22). The mechanism for crimp establishes a causal relationship between crimp frequency and follicle length consistent with observations (Nay and Johnson, 1967), and confirms that there is no direct relationship between crimp frequency and fibre diameter.

## Performance of the Model of Cell Dynamics in the Wool Follicle

Equations (22.1) to (22.22) describing cell division and fibre growth in a mature follicle have been solved for a situation where the level of intake is doubled from a maintenance level after 30 days. The immediate effect is to cause protein synthesis in the keratogenous zone to increase. The increased protein synthesis then causes  $M_{\text{Ker}}$  (Eq. (22.10)), the total cell mass in the keratogenous zone, to increase steadily. This also causes an increase in the resistance to cell migration up the follicle. As shown in Fig. 22.3, the increased resistance causes  $N_{\text{Diff}}$  (the number of differentiating cells) and the pressure in the follicle bulb to increase, leading to an increase in the volume and surface area of the bulb so that  $N_{\text{Stem}}$  also increases. An increase in  $N_{\text{Diff}}$  and  $N_{\text{Stem}}$  causes an increase in the mitotic activity in the follicle bulb and an increase in  $N_{\text{Mig}}$ ,

leading to a further increase in  $M_{Ker}$ . This causes another sequence of changes leading to a further increase in  $M_{Ker}$ . This demonstrates that the mechanisms now represented in Eqs (22.1) to (22.22) constitute a feedback mechanism between the keratogenous zone and the follicle bulb. The effect of the feedback mechanism is to cause increases in cell numbers in the follicle bulb that are clearly lagged by approximately 20 days behind the changed level of intake as can be seen in Fig. 22.3 (a lag is defined as the time taken for a quantity to move two-thirds of the way towards its new equilibrium).

Such a lag in the response of cell number in the bulb is also seen in the number of cells migrating out of the bulb per day  $\dot{N}_{Mig}$  as is evident in the fibre growth rate,  $WGR_{Fibre}$  (Fig. 22.4, Eq. (22.17)). Wool growth as observed at the skin surface  $WGR_{Fibre}(t - t_{Fibre})$  lags even further behind any change in nutrition because of the time required,  $t_{Fibre}$ , for the fibre cells to migrate up the follicle to the skin surface (Fig. 22.4).

It has been known for some time that the rate of wool growth lags ~26 days behind any change in intake (Nagorcka, 1977). The model of fibre growth in Eqs (22.1) to (22.22) is the first biological explanation for the occurrence of such a substantial lag in the response of the wool growth rate to variations in nutrition. The response in changes of fibre diameter is also lagged (Fig. 22.4), as is the length growth rate (not shown).

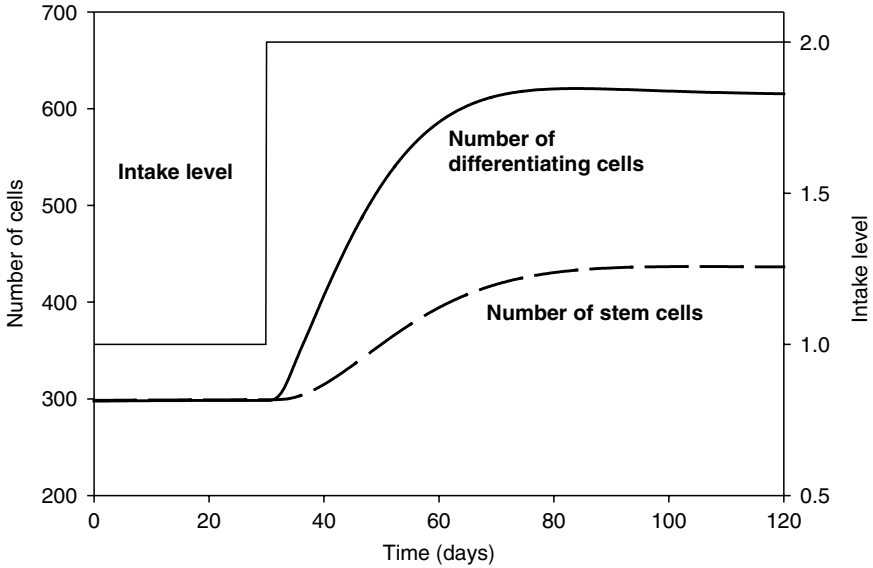
The rate of protein synthesis into the four protein groups LS, HS, UHS and HGT is regulated by Eq. (22.15). The most limiting amino acids in the case of wool growth are normally the sulphur-containing amino acids (SAA). The HS and UHS groups are much more sensitive to the availability of SAA than are the LS and HGT groups, causing the proportions of HS and UHS groups to be more variable. This has been discussed by Black and Reis (1979) and demonstrated by them using equations similar to those in Eq. (22.15). Since similar results are obtained here using Eqs (22.1) to (22.22) readers are referred to Black and Reis (1979) and the review by Black and Nagorcka (1993) where these aspects of wool growth are discussed in detail.

## Equations Describing Wool Production in a Fleece

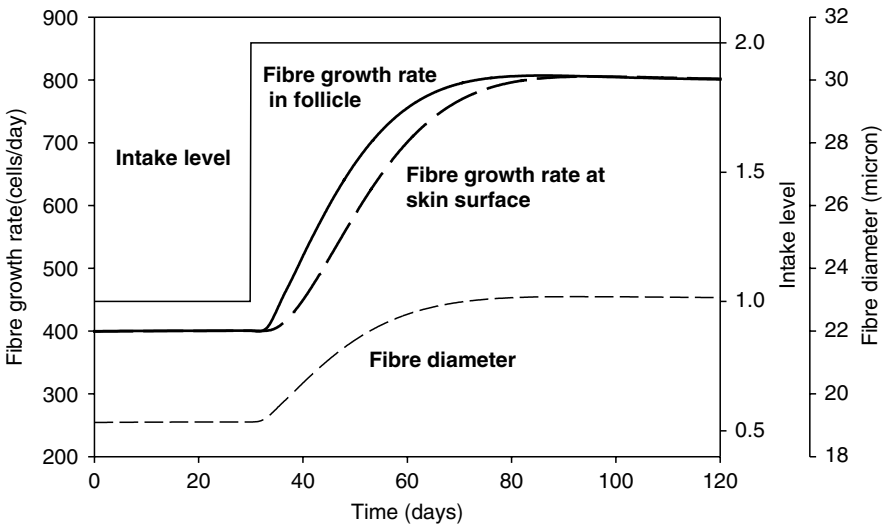
### *Wool follicle density and distribution*

The fleece is made up of millions of fibres. The actual number of fibres in a fleece is dependent on breed. For example, in Merinos this number has been estimated to be between 40 and 80 million, although extremes of ~170 million have also been observed. In coarser wool breeds, such as English longwools (e.g. Lincoln), the number is more like 10 million.

The millions of wool follicles in an animal that produces these fibres have been classified into a number of types depending on their position in the observed time sequence of events seen in the initiation of these follicles (Carter and Hardy, 1947; Hardy and Lyne, 1956). Nagorcka and Mooney have used a model based on a reaction–diffusion (RD) mechanism to predict a time



**Fig. 22.3.** The response predicted in the number of differentiating cells in the follicle bulb,  $N_{Diff}$ , and the number of stem cells in the follicle bulb,  $N_{Stem}$ , when the level of intake is doubled at 30 days. The predictions are made by solving Eqs (22.1) to (22.22) that define the cellular model.



**Fig. 22.4.** The response predicted in the fibre growth rate in the follicle,  $WGR_{Fibre}(t + t_{Fibre})$ , and at the skin surface,  $WGR_{Fibre}(t)$ , as well as the fibre diameter when the level of intake is doubled at 30 days. The predictions are made by solving Eqs (22.1) to (22.22) that define the cellular model.



sequence of spatial patterns to control follicle initiation and development (Mooney and Nagorcka, 1985; Nagorcka and Mooney, 1985; Nagorcka, 1995a,b). The mechanism used is, in fact, basically the same as that used to account for many aspects of fibre formation in the follicle bulb (Nagorcka and Mooney, 1982; Nagorcka, 1984). The follicle initiation model is important in the context of modelling wool production in that it provides a causal link between the follicle size distribution and follicle density. Such a causal link appears to be consistent with the strong genetic correlation observed between mean fibre diameter and follicle density (Davis and McGuirk, 1987), and hence between the mean fibre diameter and the total follicle density of an animal. On the basis of this causal link it is reasonable to characterize the fleece of an animal (or of a breed or strain) by the total skin surface area (containing follicles),  $A_{\text{Sur}}$ , the total follicle density,  $N_{\text{Fol}}$ , and a size distribution of the follicles. The size distribution of the follicles may itself be characterized by the distribution of fibre diameters specified by the mean diameter,  $\bar{D}_{\text{Fibre}}$ , and the coefficient of variation,  $CV_{\text{Fibre}}$ , at a maintenance level of nutrition. The specified or input value of  $\bar{D}_{\text{Fibre}}$  is required to initialize the fibre model defined above by Eqs (22.20) and (22.21) in order to calculate  $WGR_{\text{Fibre}}(t)$ . The expression for rate of wool growth in the fleece,  $WGR_{\text{Fleece}}$ , is then given by:

$$WGR_{\text{Fleece}}(t) = A_{\text{Sur}} N_{\text{Fol}} WGR_{\text{Fibre}}(t) \quad (22.23)$$

## Predictions of Wool Production using Current Models

### *Simplified models currently used in decision support tools*

The most advanced model of wool growth currently used as a component of a ruminant model to analyse the performance of wool production enterprises is available in a decision support tool called GRASSGRO, designed for the strategic management of grazing animals (Moore *et al.*, 1997). The wool growth component of GRASSGRO does not attempt to model growth at the level of the cell as in Eqs (22.1) to (22.22). Therefore it does not attempt to model cell kinetics in the follicle, or to relate fibre diameter to the changing follicle bulb size, or to make wool growth directly dependent on the profile of amino acids. GRASSGRO does, however, express the wool growth rate as a function of the total amount of absorbed amino acids. It also incorporates a lag in the wool growth rate, to represent the kinetics of cells migrating out of the follicle, and calculates the fibre diameter and length as functions of the wool growth rate.

In GRASSGRO the growth of wool is predicted on a daily time step. In the animal model within this tool (Freer *et al.*, 1997) intakes of digestible dry matter and crude protein by the sheep are predicted from the changing pattern of available pasture (driven by daily climatic data) and from supplementary feeds that may be offered to the animals. From these intakes, the metabolizable energy, ME (MJ), rumen-degraded protein, undegraded dietary true protein and microbial true protein are computed. The truly digestible fractions of the

last two components make up the digestible protein leaving the stomach (DPLS), which represents the total amount of amino acids available for synthetic processes. No attempt is made to predict the proportions of individual amino acids in the DPLS, a large part of which is usually derived from the microbial protein. The genetic potential of the sheep with respect to the growth and diameter of the fibres is deduced from the animal specification provided by the user: the standard reference weight, SRW (kg), being the weight of the shorn mature sheep in average body condition, the standard fleece weight, SFW (kg), being the average annual weight of greasy fleece and the average diameter,  $D_{\text{mean}}$  ( $\mu\text{m}$ ), of fibres in the fleece. The yield,  $Y$ , of clean wool expected from the greasy fleece must also be supplied by the user.

Daily wool growth in the fleece,  $\text{Wool}_{\text{Fleece}}(t)$  (g), is obtained by integrating the wool growth rate of the fleece (Eq. (22.24)).  $\text{WGR}_{\text{Fleece}}(t)$  estimated as a 25-day running mean (Eq. (22.25)) to allow for the lag (25 days) discussed above (Figs 22.3 and 22.4). The daily increment to this function,  $\text{Prot}_{\text{Wool}}(t)$  (g), (Eq. (22.26)) is predicted either from the DPLS,  $\text{DPLS}_{\text{Wool}}(t)$  (g), that is available for wool production, i.e. after deducting the needs for gestation or milk production (Eq. (22.28)) (see Corbett, 1979), or from the intake of ME,  $\text{ME}_{\text{Wool}}(t)$ , similarly adjusted (Eq. (22.27)), whichever is limiting. Protein that is mobilized from body tissue in sheep that are losing weight contributes to the DPLS available for wool growth, an assumption supported by the recent work of Revell *et al.* (1999). The weight of protein, PG (g), mobilized per kg of loss of empty body weight in mature sheep is predicted from the relative body condition,  $\text{BC} = W/\text{SRW}$ , where  $W$  is the current liveweight of the sheep, by the relationship  $\text{PG} = 207 - 115\text{BC}$ , derived from the results of Wright and Russel (1984) with cattle. In immature sheep, the protein content of weight loss is predicted as a function of the degree of maturity of the animal (Freer *et al.*, 1997).

$$\frac{d\text{Wool}_{\text{Fleece}}(t)}{dt} = \text{WGR}_{\text{Fleece}}(t) \quad (22.24)$$

$$\frac{d \text{WGR}_{\text{Fleece}}(t)}{dt} = \frac{\text{Prot}_{\text{Wool}}(t) - \text{WGR}_{\text{Fleece}}(t)}{\text{WLAG}} \quad (22.25)$$

where  $\text{WLAG} = 25$  days.

$$\text{Prot}_{\text{Wool}}(t) = \min(10 \times 0.116\text{DPLS}_{\text{Wool}}(t), 10 \times 1.4\text{ME}_{\text{Wool}}(t))$$

$$\times \frac{\text{SFW}}{\text{SRW}} \text{Fol}_{\text{Dev}}(t) \text{Photo}(t) \quad (22.26)$$

where

$$\text{ME}_{\text{Wool}}(t) = \max(0, \text{MEI}(t) - (\text{ME}_{\text{Conceptus}} + \text{ME}_{\text{Lactation}})) \quad (22.27)$$

$$\text{DPLS}_{\text{Wool}}(t) = \max(0, \text{DPLS}(t) - (\text{Prot}_{\text{Conceptus}} + \text{Prot}_{\text{Lactation}})) \quad (22.28)$$

and

$$Fol_{Dev}(t) = 1 - 0.75 \exp(-0.025 \text{Age}(t)) \quad (22.29)$$

Hogan *et al.* (1979) estimated that, for a wide range of Merino strains, the mean gross efficiency of conversion to wool of amino acids absorbed from roughage-based diets was 0.116, with most values lying between 0.103 and 0.133. Data analysed by Kempton (1979) suggested that synthesis of wool is limited by  $DPLS_{Wool}(t)$  until the ratio of  $DPLS_{Wool}(t):ME_{Wool}(t)$  exceeds 12. Above this point, wool synthesis is limited to  $0.116 \times 12 \text{ g/MJ } ME_{Wool}(t)$ , i.e.  $1.4 \text{ g/MJ } ME_{Wool}(t)$  (Eq. (22.26) and Fig. 22.5). This efficiency of conversion of  $DPLS_{Wool}(t)$  applies to mature Merinos in which the ratio of SFW to SRW is approximately 0.1 (Hogan *et al.*, 1979).

The ratio SFW:SRW scales  $Prot_{Wool}(t)$  and changes made by the user adjust the efficiency of wool growth for other types of sheep or for other diets that are known to provide absorbed protein with a higher proportion of sulphur-containing amino acids than would be expected from diets in which the DPLS is derived mainly from microbial crude protein.

$Prot_{Wool}(t)$  (Eq. (22.26)) also includes a dependence on daylength,  $DL(t)$  (h) given by the function  $Photo(t)$  defined in Eq. (22.19).  $Photo(t)$  describes the effect of photoperiod on wool growth and is specific to the breed (Nagorcka, 1979).

Secondary wool follicles are still developing during the first few months of life and take some time to reach their full fibre-growing potential. Consequently  $Prot_{Wool}(t)$  in Eq. (22.26) includes the factor  $Fol_{Dev}(t)$  (Eq. (22.29)) that quantifies the rate of maturation of secondary follicles with age,  $Age(t)$  (days) (Lyne, 1961).

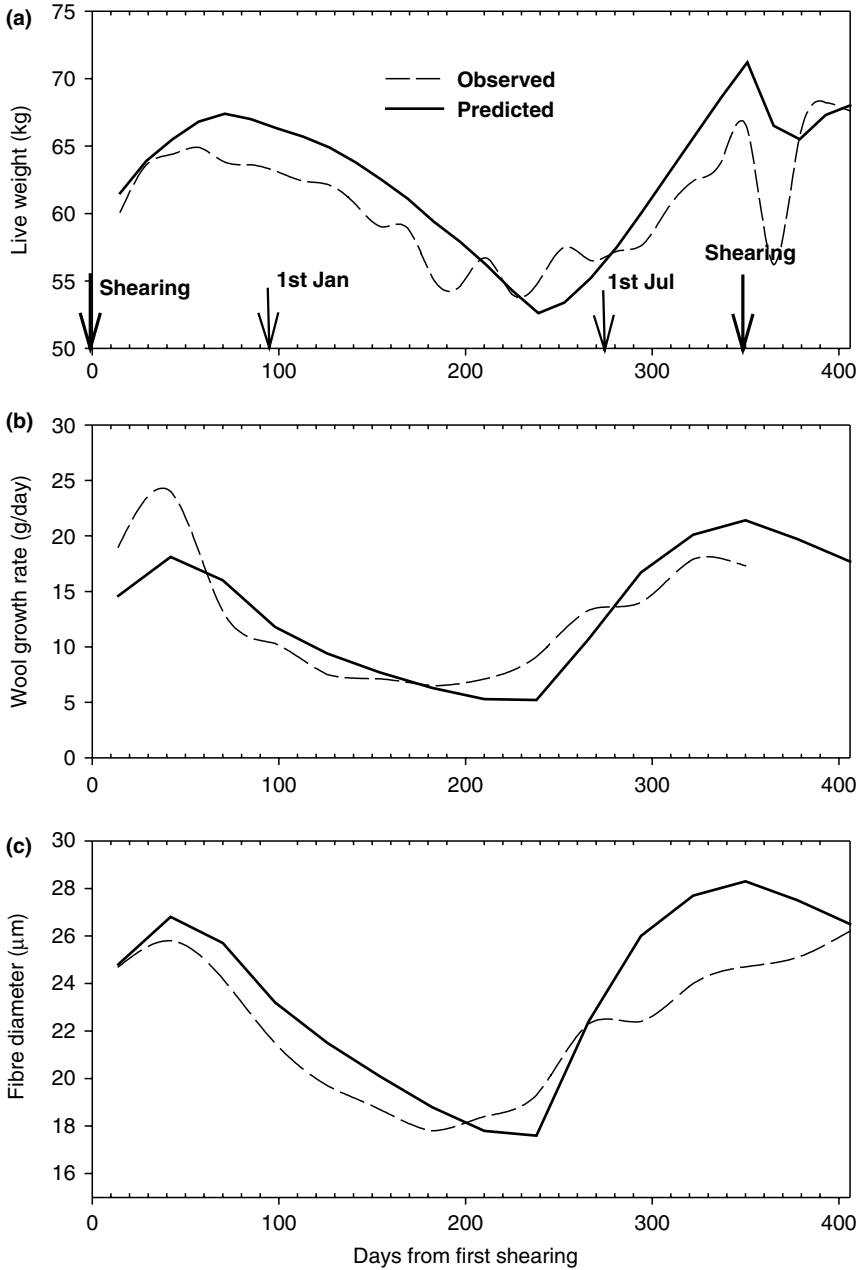
No estimate is made of the number of cells in the follicle bulb, and hence the volume of the bulb. Therefore Eqs (22.20) to (22.22) cannot be used to calculate the fibre diameter and the length growth rate. Instead it is assumed here that the ratio of the diameter of new wool to its length is constant (Downes, 1971; Reis, 1991), and the diameter of the day's new growth,  $D_{Fib}(t)$ , is estimated (Eq. (22.30)) as a proportion of the average fibre diameter specified for the animal type,  $D_{Mean}$ . This proportion is determined by the ratio of predicted wool growth to the specified average daily growth of clean wool,  $Wool_{Mean}$ , adjusted for the age of the sheep.

$$D_{Fib}(t) = D_{Mean} \left( \frac{Wool_{Fleece}(t)}{Wool_{Mean}(t)} \right)^{1/3} \quad (22.30)$$

where

$$Wool_{Mean}(t) = \text{SFW } Y \text{ } Fol_{Dev}(t)/365 \quad (22.31)$$

The predicted value of fibre length growth rate,  $L_{Fib}(t)$  (cm) (Eq. (22.32)) is derived from the day's growth, assuming that mean follicle density is  $N_{Fol} = 6 \times 10^7/\text{m}^2$  over the predicted surface area of the sheep (Eq. (22.33)).



**Fig. 22.5.** Comparison of predictions (solid curve) and observations (dashed curve) of live weight (a), wool growth rate (b) and fibre diameter (c) over a period of approximately 1 year. The observations are those of Schlink *et al.* (1999) and exhibit the seasonal variation experienced in Western Australia, a Mediterranean-like environment. As the observed rates of wool growth are estimated as proportions of the total fleece weight at the second shearing, they cease at this shearing. The predictions are made using the simplified model defined by Eqs (22.23) to (22.35).

$$L_{\text{Fib}}(t) = 100 \frac{4W_{\text{oolFleece}}(t)}{\pi g_{\text{Wool}} A_{\text{Sur}} N_{\text{Fol}} (10^{-6} D_{\text{Fib}}(t))^2} \quad (22.32)$$

where the surface area of the skin ( $\text{m}^2$ ) is given by:

$$A_{\text{Sur}} = 0.09W^{2/3} \quad (22.33)$$

To obtain the average fibre diameter of the whole fleece grown over a period of 1 year, the measure used for commercial purposes, the fibre diameter is weighted by the length, according to Eq. (22.34):

$$D_{\text{Fleece}} = \frac{\int_0^{365} L_{\text{Fib}}(t) D_{\text{Fib}}(t) dt}{L_{\text{Fleece}}} \quad (22.34)$$

where the average fibre length in the fleece is given by:

$$L_{\text{Fleece}} = \int_0^{365} L_{\text{Fib}}(t) dt \quad (22.35)$$

### **Predictions of seasonal variation in wool production in Western Australia**

Schlink *et al.* (1999) presented one of the few sets of data on seasonal variation in wool growth rate and fibre diameter in grazing sheep. These attributes were measured at 4-week intervals over 13 months in mid-side samples cut from young Merino wethers grazing an annual pasture 60 km east of Perth, Western Australia, in a Mediterranean-like environment. The sheep were also weighed at 2-week intervals. Ideally a full set of observations to test the predictions of the grazing model would include weather data, soil data and observations of pasture availability, botanical composition and nutrient composition. A complete set of observations is rarely collected, nevertheless the available information was used to simulate the grazing system, using GRASSGRO.

The comparison between observed and predicted values for the 13 months from shearing on 29 September 1992 (Fig. 22.5) shows reasonable agreement between observations and predictions of liveweight, wool growth rate and fibre diameter. Significant discrepancies do occur at times of rapid change in pasture growth. There could be various reasons for these discrepancies, e.g. incorrect predictions of pasture growth and/or quality in response to weather conditions, the need to account for variations in amino acid availability and/or for variations in amino acid absorption by the animals, or perhaps the need to account for variations in the ratio  $L_{\text{Fib}}(t)/D_{\text{Fib}}(t)$ , which is assumed to be constant in GRASSGRO. However, to examine these

possibilities and to provide an adequate test of the validity of the model much more detailed measurements would be required at the site of a future experiment.

## Summary and Discussion

### *The cellular model of fibre growth*

It has been observed that sulphur amino-acids (SAAs) are frequently limiting the rate of wool growth (reviewed by Reis, 1979) and that the mitotic activity in the follicle bulb and the rate of wool growth increase when SAAs in the metabolizable protein are increased. However, when radioactively labelled SAAs are infused into the abomasum the labelled SAAs are immediately and predominantly incorporated into the fibre in the keratogenous zone (Fratini *et al.*, 1994), while the level of incorporation of SAAs into the follicle bulb remains comparatively very low. No explanation for the substantial effect of SAAs on mitotic activity in the follicle bulb has been suggested. The model of cellular dynamics in the follicle not only provides an explanation for the effect of the rate of protein synthesis on mitotic activity and cell number in the follicle bulb, but also explains the existence of a substantial lag in the responses observed in the follicle bulb. The lag in the responses observed in cell dynamics in the follicle bulb is important in attempts to model wool growth because it also leads to a lag in the response of fibre diameter and fibre length growth rate to changes in nutrition.

In terms of the cellular dynamics model of wool growth, fibre diameter is dependent on follicle bulb size and fibre length growth rate is dependent on the cell migration rate out of the follicle bulb as well as on follicle bulb size (through fibre diameter). Fibre diameter and fibre length growth rate are therefore determined to some extent independently of one another in the cellular model. Further work is required to examine the predicted variations in fibre diameter and length growth rate in the cellular model.

### *The wool production model*

Wool growth models at the level of the whole animal can avoid the need for a model of the cellular dynamics in the follicle bulb:

1. Incorporating a 25-day lag in wool growth (Eq. (22.25)).
2. Incorporating the effect of photoperiod in the estimate of protein available for wool growth (Eq. (22.26)).
3. Assuming a fixed ratio of fibre length growth rate to fibre diameter and calculating both fibre diameter and fibre length growth rate in terms of total wool growth (Eqs (22.30) and (22.32)). As a consequence a lag is included in the response of both fibre diameter and fibre length growth rate.

#### 4. Including equations similar to Eq. (22.15) for protein synthesis.

The GRASSGRO model includes requirements (1) to (3) but does not consider the AA profile of the metabolizable protein. GRASSGRO does achieve reasonable agreement with observations as shown in Fig. 22.5, but some discrepancies still occur and these indicate problems with using requirement (3) or not accounting for the AA profile of metabolizable protein. To incorporate (4) would require information on AAs of both undigested feed protein and microbial protein leaving the rumen. The main concern with grazing models is, however, their capacity to predict the amount and quality of the available pasture.

Finally, equations or models are still required to predict staple strength in terms of variations in fibre diameter along the fibre and the distribution of mean fibre diameters across fibres in the fleece. Equations or models are also required to predict crimp and the contribution made by crimp to wool quality as assessed by wool processors.

## Acknowledgement

We thank Dr A.C. Schlink, CSIRO Livestock Industries, for making his original data available to us.

## References

- Ahmad, N. and Lang, W.R. (1957) *Ortho-para* cortical differentiation in 'anomalous' Merino wool. *Australian Journal of Biological Sciences* 10, 118–124.
- Black, J.L. (1987) Mechanisms controlling the rate of growth, composition and morphology of wool. In: McQuirk, B.J. (ed.) *Merino Improvement Programs in Australia*. Australian Wool Corporation, Melbourne, Australia, pp. 457–480.
- Black, J.L. and Nagorcka, B.N. (1993) Wool growth. In: Forbes, J.M. and France, J. (eds) *Quantitative Aspects of Ruminant Digestion and Metabolism*. CAB International, Wallingford, UK, pp. 453–478.
- Black, J.L. and Reis, P.J. (1979) Speculation on the control of nutrient partition between wool growth and other body functions. In: Black, J.L. and Reis, P.J. (eds) *Physiological and Environmental Limitations to Wool Growth*. University of New England, Armidale, Australia, pp. 223–242.
- Carter, H.B. and Hardy, M.H. (1947) Studies in the biology of the skin and fleece of sheep, I–III. Council for Scientific and Industrial Research, Australia, Bulletin No. 164.
- Chapman, R.E. and Ward, K.A. (1979) Histological and biochemical features of the wool fibre and follicle. In: Black, J.L. and Reis, P.J. (eds) *Physiological and Environmental Limitations to Wool Growth*. University of New England, Armidale, Australia, pp. 193–208.
- Chapman, R.E., Downes, A.M. and Wilson, P.A. (1980) Migration and keratinization of cells in wool follicles. *Australian Journal of Biological Sciences* 33, 587–603.
- Choy, V.J., Nixon, A.J. and Pearson, A.J. (1997) Distribution of prolactin receptor immunoreactivity in ovine skin and changes during the wool growth cycle. *Journal of Endocrinology* 155, 265–275.

- Corbett, J.L. (1979) Variation in wool growth with physiological state. In: Black, J.L. and Reis, P.J. (eds) *Physiological and Environmental Limitations to Wool Growth*. University of New England, Armidale, Australia, pp. 79–98.
- Davis, G.P. and McGuirk, B.J. (1987) Genetic relationships between clean wool weight, its components and related skin characters. In: McGuirk, B.J. (ed.) *Merino Improvement Programs in Australia*. Australian Wool Corporation, Melbourne, Australia, pp. 189–206.
- Downes, A.M. (1971) Variations in wool length and diameter with sheep nutrition. *Applied Polymer Symposium* No.18, pp. 895–904.
- Downes, A.M. and Sharry, L.F. (1971) Measurement of wool growth and its response to nutritional changes. *Australian Journal of Biological Sciences* 24, 117–130.
- Fraser, I.E.B. (1965) Cellular proliferation in the wool follicle bulb. In: Lyne, A.G. and Short, B.F. (eds) *Biology of Skin and Hair Growth*. Angus and Robertson, Sydney, Australia, pp. 427–445.
- Fratini, A., Powell, B.C., Hynd, P.I., Keough, R.A. and Rogers, G.E. (1994) Dietary cysteine regulates the levels of mRNAs encoding a family of cysteine-rich proteins of wool. *The Journal of Investigative Dermatology* 102, 178–185.
- Freer, M., Moore, A.D. and Donnelly, J.R. (1997) GRAZPLAN: Decision support systems for Australian grazing enterprises II. The animal biology model for feed intake, production and reproduction and the GrazFeed DSS. *Agricultural Systems* 54, 77–126.
- Hardy, M.H. and Lyne, A.G. (1956) The pre-natal development of wool follicles in sheep. *Australian Journal of Biological Sciences* 9, 423–441.
- Hart, D.S. (1955) The photoperiodic and hormone response of wool growth in sheep. *Proceedings of the New Zealand Society of Animal Production* 15, 57–65.
- Hart, D.S. (1961) The effect of light–dark sequences on wool growth. *Journal of Agricultural Science* 56, 235–243.
- Henderson, A.E. (1965) Relationship of wool follicle and wool fibre dimensions. In: Lyne, A.G. and Short, B.F. (eds) *Biology of Skin and Hair Growth*. Angus and Robertson, Sydney, Australia, pp. 447–460.
- Hocking-Edwards, J.E. and Hynd, P.I. (1992) Cellular characteristics of wool follicles and fibres in Finewool and Strongwool merinos. *Australian Journal of Agricultural Research* 43, 355–365.
- Hogan, J.P., Elliott, N.M. and Hughes, A.D. (1979) Maximum wool growth rates expected from Australian Merino genotypes. In: Black, J.L. and Reis, P.J. (eds) *Physiological and Environmental Limitations to Wool Growth*. University of New England, Armidale, Australia, pp. 43–59.
- Hynd, P.I. (1989) Effects of nutrition on wool follicle cell kinetics in sheep differing in efficiency of wool production. *Australian Journal of Agricultural Research* 40, 409–417.
- Hynd, P.I. (1994) Follicular determinants of the length and diameter of wool fibres. I. Comparison of sheep differing in fibre length/diameter ratio at two levels of nutrition. *Australian Journal of Agricultural Research* 45, 1137–1147.
- Hynd, P.I. and Masters, D.G. (2002) Nutrition and wool growth. In: Freer, M. and Dove, H. (eds) *Sheep Nutrition*. CAB International, Wallingford, UK, pp. 165–187.
- Kempton, T.J. (1979) Protein to energy ratio of absorbed nutrients in relation to wool growth. In: Black, J.L. and Reis, P.J. (eds) *Physiological and Environmental Limitations to Wool Growth*. University of New England, Armidale, Australia, pp. 208–222.



- Lincoln, G.A., Richardson, M. and Trudeau, V. (1998) Photo-neuroendocrine control of seasonal cycles in body weight, pelage growth and reproduction: lessons from HPD sheep model. *Comparative Biochemistry and Physiology, C, Pharmacology, Toxicology and Endocrinology* 119, 283–294.
- Lyne, A.G. (1961) The postnatal development of wool follicles, shedding and skin thickness in inbred Merino and Southdown-Merino crossbred sheep. *Australian Journal of Biological Sciences* 14, 141–156.
- Mooney, J.R. and Nagorcka, B.N. (1985) Spatial patterns produced by a reaction–diffusion in the development of primary hair follicles. *Journal of Theoretical Biology* 115, 299–317.
- Moore, A.D., Donnelly, J.R. and Freer, M. (1997) GRAZPLAN: Decision support systems for Australian grazing enterprises. III. Pasture growth and soil moisture submodels and the GRASSGRO DSS. *Agricultural Systems* 55, 535–582.
- Morris, L.R. (1961) Photoperiodicity of seasonal rhythm of wool growth in sheep. *Nature* 190, 102–103.
- Nagorcka, B.N. (1977) The description and analysis of wool growth. *Australian Journal of Agricultural Research* 28, 737–746.
- Nagorcka, B.N. (1979) The effect of photoperiod on wool growth. In: Black, J.L. and Reis, P.J. (eds) *Physiological and Environmental Limitations to Wool Growth*. University of New England, Armidale, Australia, pp. 127–137.
- Nagorcka, B.N. (1981) Theoretical mechanism for crimp. *Australian Journal of Biological Sciences* 34, 189–209.
- Nagorcka, B.N. (1984) Evidence for a reaction–diffusion system as a mechanism controlling mammalian hair growth. *Biosystems* 16, 323–332.
- Nagorcka, B.N. (1995a) The reaction–diffusion (RD) theory of wool (hair) follicle initiation and development. I. Primary follicles. *Australian Journal of Agricultural Research* 46, 333–355.
- Nagorcka, B.N. (1995b) The reaction–diffusion (RD) theory of wool (hair) follicle initiation and development. II. Original secondary follicles. *Australian Journal of Agricultural Research* 46, 357–378.
- Nagorcka, B.N. and Mooney, J.R. (1982) The role of a reaction–diffusion system in the formation of hair fibres. *Journal of Theoretical Biology* 98, 575–607.
- Nagorcka, B.N. and Mooney, J.R. (1985) The role of a reaction–diffusion system in the initiation of primary hair follicles. *Journal of Theoretical Biology* 114, 243–272.
- Nay, T. and Johnson, H. (1967) Follicle curvature and crimp size in some selected Australian Merino groups. *Australian Journal of Agricultural Research* 18, 833–840.
- Nixon, A.J., Ford, C.A., Wildermoth, J.E., Craven, A.J., Ashby, M.G. and Pearson, A.J. (2002) Regulation of prolactin receptor expression in ovine skin in relation to circulating prolactin in wool follicle growth status. *Journal of Endocrinology* 172, 605–614.
- Petersen, A.D., Gherardi, S.G. and Doyle, P.T. (1998) Components of staple strength in fine and broad wool Merino hoggets run together in a Mediterranean environment. *Australian Journal of Agricultural Research* 49, 1181–1186.
- Potten, C.S. and Lajtha, L.G. (1982) Stem cells versus stem lines. *Annals of the New York Academy of Sciences* 397, 49–61.
- Reis, P.J. (1979) Effects of amino acids on the growth and properties of wool. In: Black, J.L. and Reis, P.J. (eds) *Physiological and Environmental Limitations to Wool Growth*. University of New England, Armidale, Australia, pp. 223–242.

- Reis, P.J. (1991) Nutritional regulation of wool growth in Merino sheep. In: Hynd, P.I. (ed.) *Wool Biology*. Australian Wool Corporation, Melbourne, Australia, pp. 37–62.
- Reis, P.J. (1992) Variations in the strength of wool fibres. *Australian Journal of Agricultural Research* 43, 1337–1351.
- Revell, D.K., Baker, S.K. and Purser, D.B. (1999) Nitrogen and sulfur mobilized from body tissue can be used for wool growth. *Australian Journal of Agricultural Research* 50, 101–108.
- Rogers, G.E., Kuczek, E.S., Mackinnon, P.J., Presland, R.B. and Fietz, M.J. (1989) Special biochemical features of the hair follicle. In: Rogers, G.E., Reis, P.J., Ward, K.A. and Marshall, R.C. (eds) *The Biology of Wool and Hair*. Chapman and Hall, London, pp. 69–85.
- Schlink, A.C., Mata, G., Lea, G.M. and Ritchie, A.J.M. (1999) Seasonal variation in fibre diameter and length of wool of grazing Merino sheep with low or high staple strength. *Australian Journal of Experimental Agriculture* 39, 507–517.
- Williams, A.J. and Winston, R.J. (1987) A study of the characteristics of wool follicle and fibre in Merino sheep genetically different in wool production. *Australian Journal of Agricultural Research* 38, 743–755.
- Wilson, P.A. and Short, B.F. (1979) Cell proliferation and cortical cell production in relation to wool growth. *Australian Journal of Biological Sciences* 32, 317–327.
- Wright, I.A. and Russel, A.J.F. (1984) The composition and energy content of empty body weight change in mature cattle. *Animal Production* 39, 365–369.

---

# 23 Voluntary Feed Intake and Diet Selection

J.M. Forbes

*Centre for Animal Sciences, School of Biology, University of Leeds, Leeds LS2 9JT, UK*

---

## Introduction

Ruminant animals have evolved with digestive and metabolic mechanisms which suit them to eat forage-based diets and to thrive in situations in which animals without these adaptations have difficulty even to survive. Thus, the ruminant is a major converter of herbage into animal tissues and products both in agricultural and wildlife systems. Despite the great capacity of the digestive tract there are many situations in which ruminants do not eat sufficiently to satisfy their 'requirements' for nutrients, resulting in inefficient production in agricultural systems and failure to survive in wild habitats. For these reasons the study of what controls and limits the amount of food eaten, and the choices made when more than one food source is available, is of great importance and has been subject to a large amount of research and speculation, as summarized by Forbes (1995b).

Voluntary food intake has been viewed from a short-term perspective, i.e. individual meals and their patterns, and from a long-term point of view, i.e. intakes over periods of at least 24 h, and the first part of the chapter deals with the shorter time scales. While it is clear that intake over any period is the sum of the amounts eaten in each meal during that period, the flexibility of feeding behaviour and the relative constancy of daily intake suggest that a detailed study of the former is less important than has often been thought (Forbes, 1986). The second and major part of the discussion therefore concentrates on longer-term, typically daily, food intake. The subject is covered from the point of view of intake prediction which is required for animal management and feed formulation purposes where the output of prediction equations and systems should be accurate and robust. Also covered is the more speculative approach, in which novel ideas are explored for their usefulness in advancing our understanding, rather than for claims of accuracy. Such approaches include considerations of the role of learning in feed intake and in the selection animals make

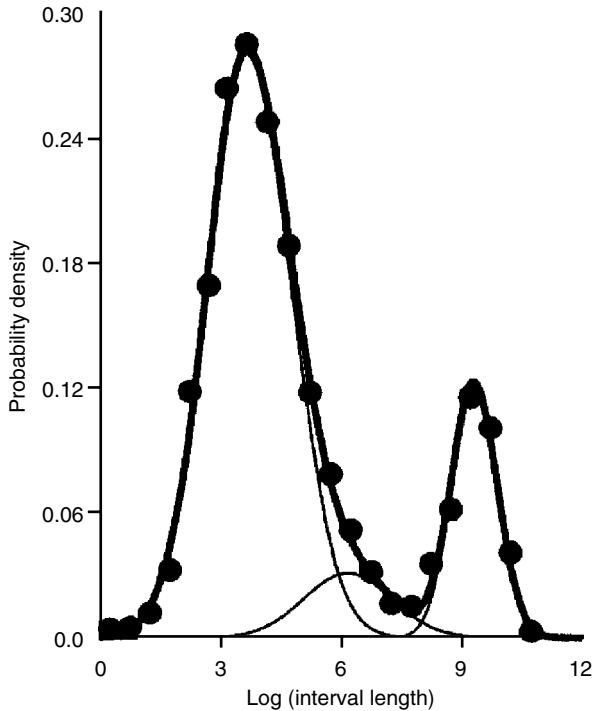
between foods. The last section is devoted to diet selection, both short- and long-term.

## Meals and their Patterns

When grazing on sparse pastures, ruminants can have difficulty in meeting their nutrient requirements and sometimes need to graze continuously for many hours in order to try to satisfy their hunger. With more easily harvested foods, however, where the rate of eating easily outpaces the rate of utilization of nutrients, meals are discrete. While any given animal exhibits a similar pattern of meals each day as long as the food, the environment and the animal itself do not change significantly, there can be considerable differences in the patterns shown by different individuals, even when conditions are similar (Barrio *et al.*, 2000). Meal size and inter-meal interval must be co-controlled in order that daily intake be regulated, and there has been considerable speculation as to which of these is modified. Are meals initiated at random and their size controlled, or is the interval between meals controlled by the size of previous meals? It is apparent that a clear definition is required of an inter-meal interval, as distinct from a pause within a meal. Previously the critical length for an inter-meal interval has been set arbitrarily or by visual inspection of the frequency distribution of all intervals to ascertain the length of interval at which there is a discontinuity in the slope of the distribution (see Tolkamp and Kyriazakis, 1999).

Tolkamp *et al.* (1998), dissatisfied with these approaches, have developed a new line of thought with regard to the definition of an inter-meal interval. They argue convincingly that if meals started at random then there would be no distinct point at which there was a change in the slope of the frequency distribution of inter-meal intervals. If, on the other hand, the concept of a meal being satiating is accepted then the probability of an animal starting to eat again after a meal should initially be low but then increase as the satiating properties of the meal declined. Thus, there would be a large number of short (within-meal) intervals, and a large number of long (inter-meal) intervals with relatively few of intermediate length. By testing this proposition with data collected from 16 dairy cows it was found that the frequency of intervals to visits to feeders was much better described by two lognormal distributions than by a random probability (Tolkamp and Kyriazakis, 1999); the fit was even better if a third distribution was included, representing intervals including drinking (Yeates *et al.*, 2001). Figure 23.1 shows the frequencies with which almost 80,000 pauses between automatically recorded meals occurred and it can be seen that these observations are fitted almost exactly by the sum of three distributions, representing: (i) intra-meal pauses; (ii) intervals between eating and drinking; and (iii) true inter-meal intervals.

The critical inter-meal interval (the minimum point between the two peaks) was estimated to be 49.1 min by this method, in contrast to very much shorter intervals estimated by the broken stick or log-transformed frequency methods. This has a big impact on the number of meals per cow per day (12.1 for the



**Fig. 23.1.** Observed frequencies of inter-meal intervals (interval length in s) for lactating cows offered concentrate/silage mixtures (dots) and probability density functions for the three Gaussian curves (thin lines), with their summation (thick line) (Tolkamp and Kyriazakis, 1999).

broken stick model; 5.7 for the three Gaussian models) giving an average meal size of 4.0 and 8.4 kg fresh matter, respectively. The observation that visit duration and meal size were distributed according to negative exponentials suggested that the termination of meals was largely random, i.e. meal ending is not tightly controlled by the animal reaching a threshold level of satiety. However, after the meal, the subsequent behaviour demonstrates satiety-like features. The use of shorter, arbitrarily defined inter-meal criteria resulted in closer correlations between meal size and pre- or post-prandial interval but this is likely to be an artefact as artificial divisions give more small meals and more short intervals. It is important, therefore, that a method with biological integrity be used for the calculation of inter-meal intervals if false conclusions are not to be drawn from data on feeding behaviour.

An example of its use is in an experiment to test the hypothesis that cows eating a 'non-limiting' feed (high concentrate, HC) would have longer inter-meal intervals and more variable meal sizes than similar animals given a diet whose intake was likely to be limited by the physical capacity of its digestive tract (high silage, HS) (Tolkamp *et al.*, 2002). It was further proposed that there would be a closer relationship between the size of a meal and the preceding inter-meal interval than with the succeeding inter-meal interval. The lognormal procedure of Tolkamp and Kyriazakis (1999) was used to determine inter-meal intervals; it was found, contrary to expectations, that the inter-meal criterion was similar for HC (28.0 min) and HS (23.8 min), as

was the number of meals (6.4 vs. 6.7 per 24 h), i.e. cows on both treatments showed very similar meal patterns. (It is to be noted that the virtually identical meal patterns for the HC and HS feeds was associated with a very highly significantly lower intake DM with HS, 17.8 kg/day vs 23.6 kg/day for HC, due to its lower DM content, smaller DMI per meal and slower rate of eating DM.) Although statistically significant, pre- and post-prandial correlations were associated with very small proportions of the variation in meal size; there was no significant effect of food type on these correlations. Pre-prandial correlations, although low ( $r = 0.182$  for HC and  $0.213$  for HS), were about four times higher than post-prandial correlations ( $0.031$  for HC and  $0.047$  for HS). This is a sign that feeding behaviour is determined more by satiety than by hunger mechanisms.

These results do not mean that a physical limit to silage intake is not involved – it means that cows manage their daily intake by means other than inter-meal interval, i.e. feeding behaviour is flexible but the longer the time over which meals are summed, the more stable and predictable is intake. Therefore, detailed studies of feeding behaviour are of little direct help in improving our understanding of the physiological mechanisms that underlie the control of voluntary food intake on a longer timescale.

## Daily Food Intake

Food is the major input into most livestock farming systems and the most important component of the diet is usually forage, offered *ad libitum* in situations in which it is not usually possible to monitor its level of intake. Therefore, the ability to predict intake from easily measured variables such as milk yield, body weight and forage composition, is of great importance. Most experimental and theoretical considerations of the control of food intake by ruminants are based on the time unit of 24 h. This is justified by the relative constancy of an animal's meal pattern from one day to the next and the fact that daily weighing of fresh and refused food is the normal practice. There is an enormous quantity of data on daily food intake in the scientific literature and several avenues have been followed for putting this into an intellectual framework:

1. Daily intake can be predicted from *multiple regression analysis*, in which observed intakes are regressed against one or more variables (usually ones that might reasonably be expected to affect intake), but no underlying mechanistic theory is usually invoked.
2. There are two main quantitative theories on which models and predictions of food intake are based. One, developed over more than 40 years proposes that ruminants eat an amount of food that meets their *nutrient (energy) requirements* unless a *constraining factor* prevents them achieving this. Constraints include a limitation of the intake of forages by gut (rumen) capacity and the inability to lose heat in a warm environment. Where this theory is applied to the relationship between food intake and food composition it has been called the *two-phase hypothesis* (TPH, Pittroff and Kothmann, 2001).

3. Another is based on the premise that more than one factor affecting intake is taken into account simultaneously and that it is a process of *optimization* rather than elimination which underlies the control of food intake.

### **Multiple regression**

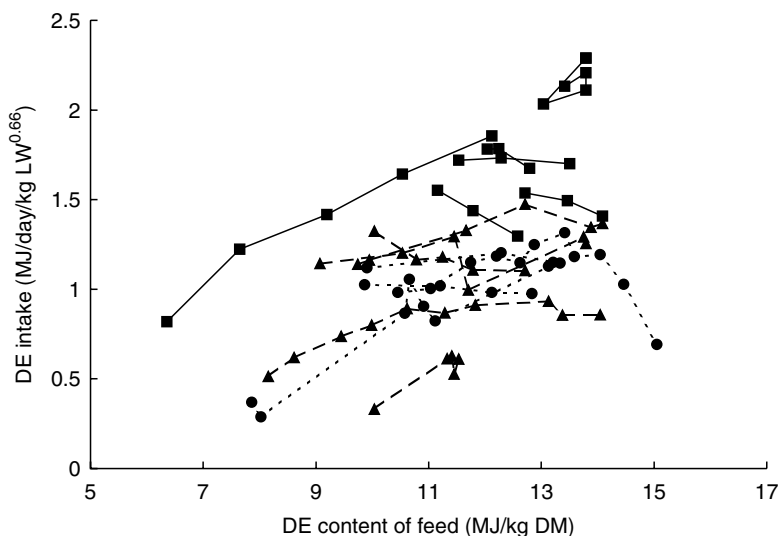
The most reliable way to predict how a system will behave is usually to see how the system, or similar systems, have behaved in the past. Thus, for example, to predict the intake of hay by dairy cows on one farm, intakes of similar cows on similar farms could be collected and used to develop prediction equations, as discussed by Forbes (1993), e.g.:

$$\begin{aligned} \text{Intake (kg DM/day)} = & 0.015LW + 0.21MY - 0.57C - 0.095WL \\ & + 4.04 \log WL - 4.14 \end{aligned} \quad (23.1)$$

where *LW* is live weight (kg); *MY* is milk yield (kg/day); *C* is concentrate intake (kg/day); *WL* is week of lactation (Vadiveloo and Holmes, 1979). The use of such equations is restricted to conditions in which data were collected, in this case black-and-white cows fed on fixed levels of concentrate supplementation and *ad libitum* grass hay. Comparison with data collected independently under similar conditions gave a mean square prediction error of 2.1 kg DM/day<sup>2</sup>, although this was improved to 1.74 kg DM/day<sup>2</sup> when only mid-lactation cows were considered (Neal *et al.*, 1984). It must be emphasized that it is not appropriate to use such equations in situations markedly different from those under which the original data were collected. Forbes (1995b) gives a fuller description of multiple regression analysis applied to food intake of farm animals.

### **Constraints theories**

The restriction on intake imposed by forages with high fibre content has been much discussed and is illustrated by the data compiled by Baumgardt (1970) and presented in Fig. 23.2. The first impression given by these data is of a general lack of correlation between the digestible energy (DE) content of the food and the weight eaten daily. However, a closer inspection reveals that, with highly fibrous foods, intake is positively related within any one experiment to DE concentration up to about 12 MJ DE/kgDM while at higher DEs the relationship tends to be inverse. The parsimonious explanation for the positive relationship is that, despite the enormous capacity of the rumen, intake is nevertheless limited by the slow rate at which fermentation allows digestion of fibre and onward passage of small particles; the signal to the central nervous system (CNS) is, therefore, from the mechanoreceptors in the rumen wall. On this basis attempts to quantify and predict the intake of fibrous foods often include rate and extent of fibre digestion in the rumen.



**Fig. 23.2.** Voluntary intake of digestible energy by sheep ( $\blacktriangle$ ), growing cattle ( $\blacksquare$ ) and lactating cows ( $\bullet$ ) against concentration of digestible energy in the feeds (plotted from data included in Baumgardt, 1970).

With more readily digestible foods (above about 12 MJ DE/kg DM in Fig. 23.2), when bulk is not limiting, intake is envisaged to be constrained to supply the animal's 'requirements', particularly for energy (Forbes, 1977; Emmans and Kyriazakis, 2001). It is argued that the combination of the two phases to give an hypothesis that an animal eats in order to meet its energy requirements unless constrained by the bulk of the food, sometimes labelled the two-phase hypothesis (TPH), allows quantitative predictions of voluntary intake even if the underlying mechanisms are not defensible physiologically. Many predictions of forage intake by ruminants are based on the TPH and some results are detailed below.

A more complex constraints approach was adopted by Poppi *et al.* (1994) and applied to growing cattle. The first 'metabolic' constraint adopted was the *genetic limit to protein deposition*. It was supposed that a supply of protein/amino acids from the diet in excess of the rate at which the animal used amino acids for growth generated a limit to intake, possibly due to build-up of ammonia in the rumen and/or the blood. A second metabolic limiting factor was *ATP degradation*, an upper level for which was speculatively included on the basis that inefficient metabolism, for example in protein deficiency, causes ATP accumulation. An imbalance of nutrients absorbed from the digestive tract results in increased ATP concentration and a rise in the ATP:ADP ratio modifies enzyme activity to limit the flux of energy-yielding substrates. Thus, excessive production of ATP is a signal of metabolic imbalance, although how it could be monitored in the body is not clear. Physical constraints on intake were: *rate of eating* – the animal was envisaged to be limited to spend no more than 12 h per day eating; *rumen fill*, because the capacity of, and the rate of



digestion in, that organ were thought to be limiting for the intake of many forages; *faecal DM output* as intake of some foods was thought to be limited by flow through the rest of the digestive tract. A sixth constraint in this model was *heat dissipation* where the animal's maximal rate of heat loss, and therefore food intake, was limited by the ability to lose heat in relation to prevailing environmental conditions.

This approach includes more factors than other models and could be seen, therefore, to be closer to the multifactorial nature of food intake control frequently accepted as being more physiologically appropriate; by including ATP degradation it also encompasses dietary imbalance which is not attempted in simpler approaches. The level of intake predicted by each of these six factors was calculated and whichever was lowest was taken as the predicted intake. The standard animal was an immature Friesian steer with an empty body weight of 100 kg and realistic values from the literature were used for such parameters as potential rates of deposition of protein and fat, and initial values for ATP concentration. Table 23.1 shows the intakes of dry matter predicted for seven feeds, for each of the six predictor factors.

It will be seen that some pathways could allow a much higher intake than that which is limiting. For example, for no feed is rate of eating even close to being the limiting factor; because of its rapid breakdown in the rumen, the legume feed could have been eaten in several-fold greater amounts if rumen turnover had been the limiting factor, than with genetic potential of ATP degradation. With some feeds, more than one factor was predicted to give similar intakes and it was conceded that more than one factor might control intake, rather than being strictly only the most limiting factor.

**Table 23.1.** Observed and predicted dry matter intake by a Friesian steer of 100 kg empty body weight consuming various feedstuffs (Poppi *et al.*, 1994).

Feed type	Dry matter intake (kg/day)						
	Observed	Predicted from:					
		Rate of intake	Faecal output	Rumen turnover	Genetic potential	Heat dissipation	ATP degradation
Concentrate	2.3–2.7	33.4	3.7	6.0	4.3	4.0	2.2*
Legume	>2.6	7.9	4.2	16.5	2.9*	4.3	2.4*
Grass	2.6	11.8	5.3	6.2	3.9	4.1	2.2*
High-D silage	>1.8	3.8	4.0	5.3	3.9	3.9	2.2*
Low-D silage	1.8	3.8	2.7*	2.9*	5.3	4.7	2.7*
High-D dried grass	2.5–2.8	11.1	4.0	5.9	4.6	4.8	2.4*
Low-D dried grass	2.2–2.4	7.7	3.1*	3.3*	4.4	5.5	3.0*

\*Limiting factor(s).

Constraints theories are not, to my mind, physiologically tenable as each limiting factor is considered to have no effect on intake until its constraining limit is reached at which point no further intake is allowed. How can we imagine that stimulation of receptors sensing rumen fill, for example, should contribute nothing to intake control until a certain degree of stretch is reached, at which point rumen fill suddenly becomes the only factor to control food intake?

There have been many attempts to build more flexible systems of prediction based on underlying biological relationships describing animal requirements, forage availability and forage quality. Many of them incorporate the TPH which has been heavily criticized by Pittroff and Kothmann (2001) on the grounds that it has been used as the basis of many models of ruminant food intake over the past 30 years and has yielded no consistently successful predictive system. They point out that there are numerous problems with the soundness of the mathematical and/or biological concepts applied and that the documentation provided in the publication of many models is not sufficient to facilitate a thorough assessment of their logic and mathematical relationships. Frequently there is lack of sufficient information with which to replicate the model and only rarely is there a serious attempt at sensitivity analysis or proper validation.

Pittroff and Kothmann (2001) reviewed 11 published prediction models for sheep and 12 for cattle, mainly for intake at pasture. They specified four types of forage and computed the predictions of these models, with the results shown in Table 23.2. It will be seen that there is a wide range of predictions for each forage type, in which the highest is approximately double the lowest. The authors highlighted this wide range and used it to dismiss the modelling approaches used, especially TPH, as unsuitable bases for predicting the voluntary intake of forage. However, each group of modellers undoubtedly had in mind specific sets of data with which they were familiar, and this would have influenced the specification of their model even where they did not conduct a formal validation exercise. Therefore, the range of intake predicted by these models is likely to be similar to that observed and reference to Fig. 23.2 shows the very wide range of intakes from different experiments, even when the results are scaled to live weight<sup>0.66</sup>. Pittroff and Kothmann (2001) were not justified in rejecting TPH just because of the variability of predictions by models based on this principle.

They were right, however, to be strongly critical of the lack of a formal approach to modelling in most of the cases cited. A common problem is a failure to state the limits within which the model is designed to operate; for example, in most models intake is positively related to body weight whereas it is commonly observed that animals which are heavy through being fat have lower intake than lighter, leaner animals. Authors should present examples of calculations from their models and discuss the goodness-of-fit with published observational data on food intake, which is rarely practised. There is a desperate need for robust, testable theory on how intake and diet selection are controlled in ruminant animals. Experiments should then be designed to test specific hypotheses, rather than just being used to collect yet more data.

**Table 23.2.** Calculations of voluntary intake (kg DM/day) of four forage qualities predicted from availability of herbage, DM digestibility and crude protein content by models designed for sheep and cattle (Pittroff and Kothmann, 2001).

Quality of forage	High	Medium 1	Medium 2	Low
<i>Sheep</i>				
Availability (kg DM/day)	3	2.5	1.9	1.6
Digestibility (g/kg DM)	750	680	640	520
Crude protein (g/kg DM)	185	150	150	100
Blaxter <i>et al.</i> (1966)	2.04	1.8	1.68	1.3
Graham <i>et al.</i> (1976)	1.69	1.69	1.69	1.69
Agricultural Research Council (1980)	1.52	1.4	1.28	1.02
Blackburn and Cartwright (1987)	2.49	2.5	1.9	1.6
Arnold <i>et al.</i> (1977)	2.2	1.81	1.44	1.1
Vera <i>et al.</i> (1977)	2.1	n/a	n/a	n/a
Christian <i>et al.</i> (1978)	2.3	1.95	1.74	1.12
<i>Cattle</i>				
Availability (kg/day)	15	13	12	10
Blaxter <i>et al.</i> (1966)	12.9	11.2	10.2	7.2
Siebert and Hunter (1977)	n/a	8	8	7.7
Sanders and Cartwright (1979)	11.6	11.3	11.4	9.7
Agricultural Research Council (1980)	10.7	9.9	9.4	7.9
Konandreas and Anderson (1982)	19	14.9	13.2	9.9
National Research Council (1984)	10.4	11.4	11.7	10.9
National Research Council (1996)	14.2	13.1	12.5	11.1
Fox <i>et al.</i> (1992)	18	16	15	11.2

### **Optimization theories**

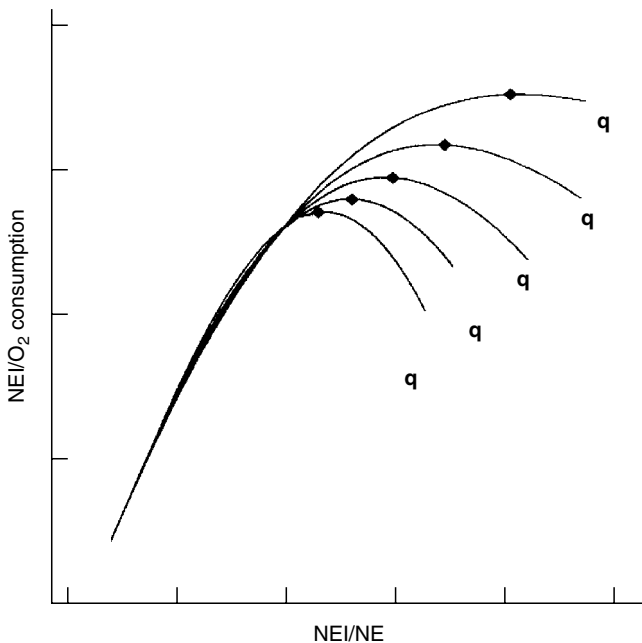
In contrast to approaches, outlined above, that invoke a first limiting constraint with intake responding to only one factor at a time, cost–benefit theories have been advanced to explain how ruminants control their food intake.

#### *Efficiency of utilization of oxygen for NE production*

Ketelaars and Tolkamp (Ketelaars and Tolkamp, 1992a,b; Tolkamp and Ketelaars, 1992) followed a line of deduction based on a balance between animals eating in order to obtain benefit (an adequate supply of net energy, i.e. dietary energy available for maintenance and production) while avoiding an excess of the harmful consequences of eating (expressed as oxygen consumption in view

of the long-term harm to cell membranes and DNA caused by the free radicals generated whenever oxygen is consumed). They proposed that ruminants have evolved to eat that amount of a food that results in the maximum yield of NE per unit of oxygen consumed, i.e. maximization of efficiency. Figure 23.3 shows the relationship between food intake (expressed as NE in multiples of maintenance) and the efficiency of utilization of oxygen for NE yield calculated from equations presented by the Agricultural Research Council (1980). It will be seen that, for metabolizabilities ranging from 0.45 to 0.65, the observed voluntary intake coincides closely with the zenith of the efficiency/intake curve in each case.

Leaving aside the difficult concept of a system within the animal for monitoring the ratio of NE/O<sub>2</sub>, Emmans and Kyriazakis (1995) have identified several problems with this approach and in a critical test of the theory, using pigs rather than ruminants, Whitemore *et al.* (2001) fed energy-dense, medium or bulky feeds to pigs kept in the thermoneutral zone of temperature and then reduced the environmental temperature to below the lower critical temperature. While the animals given the more concentrated feed increased their daily food intake, those on the bulky diet did not, strongly suggesting that intake was controlled by requirements unless some other factor (in this case digestive capacity for bulk) intervened, rather than optimization. Whatever we might



**Fig. 23.3.** Efficiency of oxygen utilization (net energy intake/O<sub>2</sub> consumption) as a function of net energy intake (NEI) scaled to net energy for maintenance (NE<sub>m</sub>), for foods with five metabolizabilities (Tolkamp and Ketelaars, 1992). ◆, Observed voluntary intakes of such feeds (Agricultural Research Council, 1980).

think about the validity of the Ketelaars and Tolcamp theory, it is a brave attempt to get the understanding and prediction of food intake onto a quantitative basis.

*Minimal total 'discomfort' (MTD)*

It is superficial to say that animals are eating to obtain the nutrients they need to survive and to ensure that their genes survive. The physiological state of the animal determines the optimum rate at which each tissue takes up each nutrient from the blood and an inability to supply these in full leads to signals whereby the state of deficiency is transmitted to the CNS. An excess leads to signals of toxicity. Moderate deficiencies or toxicities can be tolerated – the tissue in question, or another tissue(s), adapts to cope with the situation, but the more extreme the difference between supply and demand, the stronger does the message become and the more urgently is the animal driven to redress the imbalance – to reduce the discomfort. (For the purposes of this discussion we classify energy as a *nutrient* – more correctly we could encompass nutrients, energy, bulk, flavour as 'properties' of foods.) In addition factors such as the bulk of food, difficulty of losing heat to the environment fast enough, and limitations on grazing time per day (constraints) can all be viewed as generating discomforts.

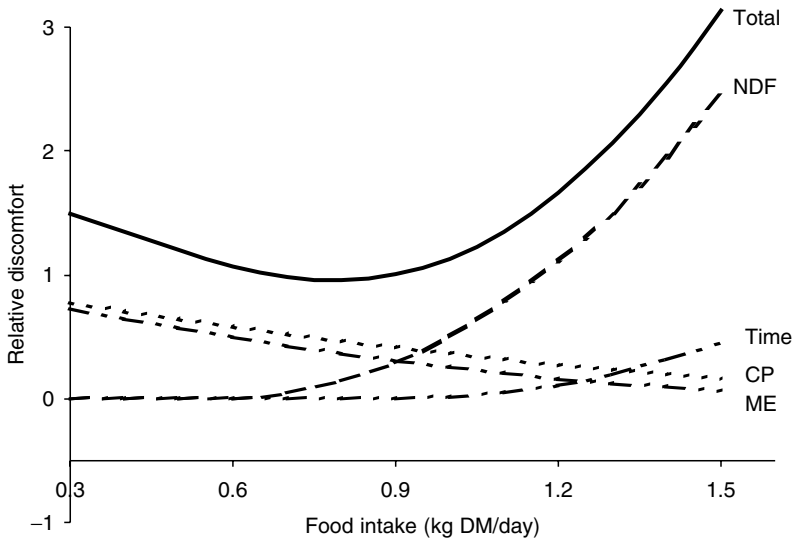
There are numerous food properties which, when eaten, can be presumed to generate negative feedback signals because experimental addition of these to the diet, or introduction directly into the rumen, generates dose-related reductions in voluntary food intake. Such effects of acetate, propionate and rumen distension have been quantified in small ruminants (Baile and Forbes, 1974) and lactating dairy cows (Anil *et al.*, 1993) and the effects of increasing the bulkiness of food have been reviewed (Forbes, 1995a). It seems likely that the signals generated by the various families of chemo- and mechano-receptors in the abdomen are integrated by the CNS in an additive manner (Forbes, 1996) but, when it comes to using this concept to predict food intake, the problem of expressing the various factors in a common currency is apparent. One possibility is to postulate that deviations in the rate at which a food property is supplied, from the optimal rate for body functioning, generate 'discomfort' in proportion to the magnitude (but not the sign) of the deviation, expressed as a proportion of the optimal rate. Thus a sheep with an optimal supply of ME of 20 MJ/day, but only eating an amount of food that provides 15 MJ/day, will have a relative discomfort from lack of ME of  $(20 - 15)/20 = 0.25$ , as would a similar sheep receiving 25 MJ/day in its diet  $((20 - 25)/20 = -0.25)$ . Squaring the relative discomfort both removes the negative values and gives relatively more emphasis to large deviations than to small ones.

Such calculations of relative mismatch between supply and demand for several food properties can then be made and the discomforts added to generate a signal of total discomfort. These calculations can be made for a range of food intakes to find at what intake the total discomfort is minimized – minimal total discomfort (MTD).

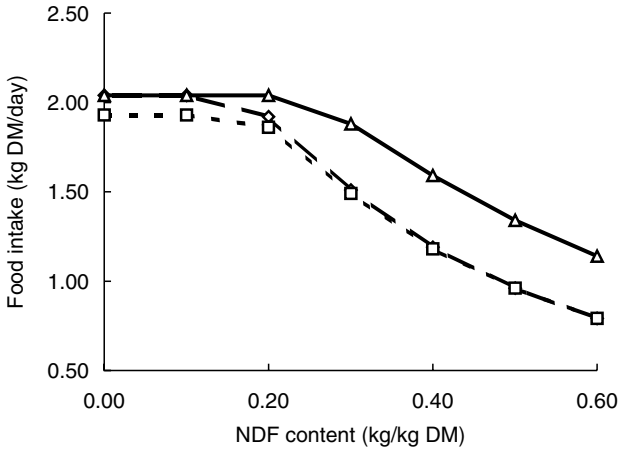
We can specify the approximate 'nutrient requirements' for a standard animal, e.g. a growing lamb of high genetic merit – 20.00 MJ ME/day,

0.25 kg crude protein/day, with an effect of bulk becoming increasingly strong above an intake of NDF of 0.35 kg/day and an increasing discomfort if the time spent eating exceeds 10 h/day. We can then specify a standard forage containing 10.00 MJ ME/kg DM, 0.10 kg CP/kg DM and 0.6 kg NDF/kg DM, eaten at a rate of 1.5 g DM/min. If the lamb were to eat 1 kg DM/day then the error due to lack of ME would be  $(20 - 1.0 \times 10) = 10$  MJ/day, giving a relative error of  $10/20 = 0.5$  and a relative discomfort of  $0.5^2 = 0.25$ . Similar calculations for CP, NDF and time spent eating give discomforts of 0.36, 0.51 and 0.01, respectively, and a total discomfort of 1.13 arbitrary units. If we now set the daily food intake at 1.1 kg/day and make the above calculations again we find that total discomfort has risen to 1.35. As we are trying to minimize discomfort we reduce daily intake to 0.9 kg DM and calculate that total discomfort is now 1.01; further iterations show that total discomfort is minimized at 0.88 when daily intake is 0.96 kg DM. A convenient way to visualize MTD is to plot discomfort on the y-axis and intake on the x-axis. Figure 23.4 shows the concept for the four food properties: ME, CP, NDF and rate of eating.

We can now change one or more of the food properties or animal 'requirements' and repeat the iterative process in order to study the behaviour of the model. For example, if a food with an ME content of 10 MJ/kg DM is specified (CP and time for eating set at 0.12 kg/kg DM and 4 g/min, respectively, so that they have no impact on the current comparison) and the calculations of MTD made for a range of NDF contents, the effect on food intake is shown in Fig. 23.5. It will be seen that NDF content has little effect on



**Fig. 23.4.** Postulated relative discomfort due to ME, CP, NDF and time spent eating, and of total discomfort, for a range of daily intakes of food by sheep; see text for details of food and animal's 'requirements'.



**Fig. 23.5.** Predicted food intake of foods containing 10 or 11 MJ ME/kg/DM by sheep with a threshold capacity for NDF of 0.35 or 0.50 kg/day, for a range of food NDF contents; see text for further details of food and animals (diamonds, squares, triangles: ME contents of 10, 11, 10 MJ/kg DM; NDF capacities of 0.35, 0.35 and 0.5 kg/day, respectively).

predicted intake at low NDF contents but a marked negative effect at high NDF contents. Increasing the capacity of the lamb to 0.5 kg NDF/day increases the predicted intake only at high NDF contents while increasing the ME content of the food to 11 MJ /kg DM increases predicted intake only at low NDF contents. This behaviour resembles that of the TPH even though MTD is an optimization approach. It is not intended that the simulations described here are realistic. For example, the daily NDF intakes above which rumen distension is assumed to exert an ever-increasing discomfort (0.35 and 0.5 kg) are arbitrary; it is difficult to know how to measure or even estimate such a parameter.

For the purposes of illustration the examples given here are kept simple – in reality a food with a high ME concentration would be likely to have a relatively low NDF content and a rapid rate of eating. Equally, changes in the rumen degradable fraction of the CP are likely to affect yield of ME and rate of digestion of NDF; excess CP can be used as a source of energy. The MTD model should, therefore, be attached to a model of rumen and animal metabolism if it is to be tested more realistically for its adequacy in predicting food intake of ruminants.

In addition, the function relating the supply of a food property to the discomfort generated, in the present case the unweighted square of the proportional deviation from the 'requirement', is not likely to be optimal. Presumably an intake of a vitamin at twice the required rate does not generate as much discomfort as twice the required ME so the difficult issue of the relative weighting to place on each factor will have to be tackled before quantitatively appropriate predictions can be generated by this approach.

Other factors generating discomfort are social pressures (whether to follow the flock or to stay eating the rich patch of herbage), heat production (the problem of heat dissipation in a hot environment and/or with a heavy covering of insulation), while other constituents to be considered include individual essential amino acids, minerals, vitamins and toxins.

The MTD hypothesis proposes that intake is varied in order to minimize total discomfort. How does an animal know whether its current level of intake is

optimal in this regard? Maybe if it ate a bit more, or a bit less, it would feel less discomfort than with its current rate of intake. Natural variation in daily intake could provide the 'experiments' from which the animal learns to optimize its diet. Graphs of day-to-day fluctuations of intake of forages by cattle (Forbes and Provenza, 2000; Forbes, 2001) show the large and irregular variations which, when smoothed over increasing numbers of days, become more stable (Forbes, 2003). Could these short-term fluctuations form the basis for the MTD hypothesis?

## Diet Selection

There has, in the last decade or so, been a great upsurge of interest in the ability of ruminants to make nutritionally sensible choices when offered more than one food. The reasons for such interest include the fact that most ruminants, be they farmed or wild, have a choice of foods, even if one is offered at less than *ad libitum*, i.e. as a supplement. The work of Provenza and colleagues in Utah, and Kyriazakis and colleagues in Scotland, has highlighted the importance of learned associations between the sensory properties of a food and the metabolic consequences of eating that food. Although experimental foods have frequently been flavoured, the identity of the flavour is not critical as animals will learn these associations irrespective of the exact nature of the flavour (or other difference in sensory properties) (see Forbes and Provenza, 2000). Several of the models analysed by Pittroff and Kothmann (2001) included diet selection but in none of these models was diet selection underpinned by detailed experimental evidence.

### **Short-term, meal-by-meal selection**

As with intake of food, so diet selection in the short term seems to be less controlled than in the longer term, and one is left wondering about the identity of the system that integrates the inventory of previous meals and selections to allow what can only be seen as compensatory behaviour in order to get a balanced diet. Is this system a physical store of material(s) or just an accumulation of memories?

Yeates *et al.* (2002) have analysed large amounts of meal data collected automatically from cows given free access to foods high (HP) and low (LP) in protein in three experiments in order to look for patterns that might lead to an explanation of how food choice is controlled at the level of the meal. The authors concluded that their cows did not attempt to select within a meal a consistent diet in terms of protein to energy ratio. There was no difference in the proportion of visits to HP and LP during meals, compared to random sequences of feeding bouts, i.e. there was no evidence that cows attempted to achieve their stable long-term average diet composition by controlling food choice within a meal. If ruminants do not control their dietary balance in the short term, then there is presumably no advantage in their doing so – they can



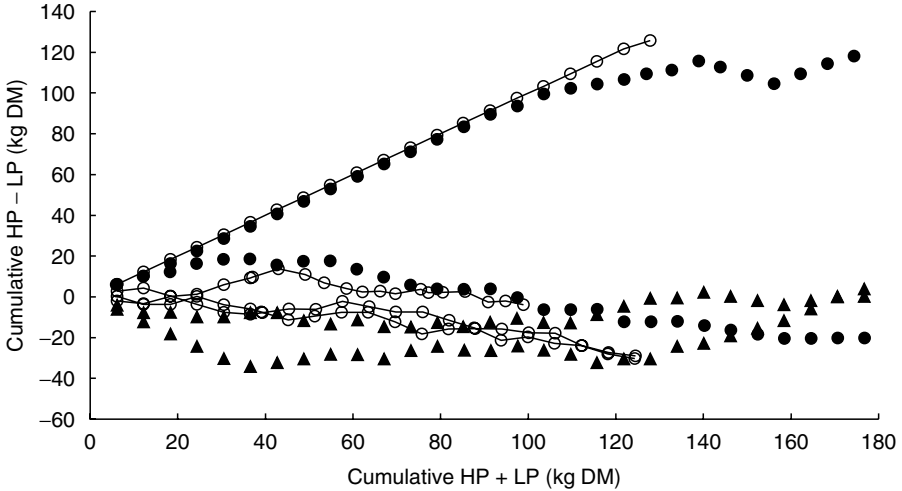
cope with the asynchrony between the supply of energy and protein from the diet, as concluded by a review of synchronization of energy and protein supply for dairy cows (Chamberlain and Choung, 1995). Yeates *et al.* (2002) state that 'our present analysis does not suggest what the most relevant time scale is, except that it must be longer than a meal'.

### ***Selection over periods of a day and more***

Over periods of a day or more there are many examples of food choice being influenced, not to say controlled, by the animal's nutrient requirements. If, as postulated by the MTD hypothesis, animals learn to eat that amount of food that is optimal in terms of minimizing discomfort then the hypothesis should also be capable of being applied to diet selection (Forbes and Provenza, 2000). Indeed it could be argued that the intake of a single food is a special case of the more general situation in which more than one food is available.

One of the difficulties in studying individual variation in food choice is the complexity of graphs with many animals' results. The 'diet selection pathway' method of plotting food choice data (Kyriazakis *et al.*, 1990) is a way of clearly showing the behaviour of individuals in a compact manner. The cumulative difference between the intakes of two foods (Food A – Food B) is plotted against the cumulative total intake of the foods, i.e. a horizontal line represents equal intakes of the two foods, a line that increases shows the animal eating more of Food A, while one declining shows a greater intake of Food B. It needs to be emphasized that this method of presentation of daily diet choice does not highlight daily variations in the proportions selected.

The example used here is that of dairy cows offered free access to grass silage and, for 3 weeks, a choice between concentrates with 90 or 39 g digestible undegradable protein per kg DM, up to a maximum of 5.4 kg DM/day (Lawson *et al.*, 2000). The amount of the high-protein food eaten as a proportion of total concentrate intake was 0.47, 0.45 and 0.50 for the three consecutive weeks, with a much higher standard deviation in the first week (0.372) than in the second (0.265) or third week (0.252). This greater initial variation in selection is shown clearly in Fig. 23.6, which includes the diet selection pathways for eight of the 24 animals. Two cows ate almost entirely HP; another cow ate almost only LP for the first 6 days; the remaining five ate closer to equal amounts of HP and LP. In all animals but one, however, the selection paths eventually became approximately horizontal, confirming that approximately equal amounts of LP and HP were being eaten once the animals had become accustomed to the choice-feeding situation (and had learned to associate the sensory properties of each food with the metabolic consequences of eating it). The fact that the preference ratio was not significantly different from 0.5 could be due to an indifference on the cows' part as to which concentrate they ate (no selection) or because a roughly equal mixture of the two provided an optimal diet. The fact that the proportion of the high-protein food eaten, as a proportion of total concentrate intake, was significantly related to the yield of milk protein before the start of the



**Fig. 23.6.** Diet selection pathways for choice between high- and low-DUP concentrates for eight cows offered HP before the choice-feeding period. For each animal the cumulative difference between the intake of HP and that of LP is plotted against the cumulative total intake of HP and LP (Lawson *et al.*, 2000).

choice-feeding period, suggests the latter explanation to be more likely to be true.

## Conclusions

The supposition that food intake by ruminants is controlled by a single factor, such as rumen fill or energy requirements, is clearly wrong. Indeed, the whole premise that we will ultimately be able to explain and predict the behaviour of a system as complex as that controlling food intake and choice by a reductionist approach alone is probably wrong. However, given the importance of optimal nutrition of farm animals it is necessary to be quantitative in our approaches to trying to understand how intake and selection are controlled. When it comes to prediction of intake we cannot avoid being quantitative but we should not reject new hypotheses just because they do not give accurate predictions, which could hardly be expected when we can only make crude estimates of some of the important variables in our calculations.

The MTD hypothesis is just one way of organizing our thinking about how ruminant animals control their intake of food and selection between foods. It is highly unlikely ever to be 'proved' right or wrong but serves as a framework for our ideas.

Finally, each approach outlined above has its merits and should be used only for the purposes for which it was conceived, i.e. robust regression equations for prediction of intake, with more theoretical approaches reserved for speculation about how intake and selection might be controlled.

## References

- Agricultural Research Council (1980) *The Nutrient Requirements of Ruminant Livestock*. CAB International, Wallingford, UK.
- Anil, M.H., Mbanya, J.N., Symonds, H.W. and Forbes, J.M. (1993) Responses in the voluntary intake of hay or silage by lactating cows to intraruminal infusions of sodium acetate or sodium propionate, the tonicity of rumen fluid or rumen distension. *British Journal of Nutrition* 69, 699–712.
- Arnold, G.W., Campbell, N.A. and Galbraith, K.A. (1977) Mathematical relationships and computer routines for a model of food intake, liveweight change and wool production in grazing sheep. *Agricultural Systems* 2, 209–226.
- Baile, C.A. and Forbes, J.M. (1974) Control of feed intake and regulation of energy balance in ruminants. *Physiological Reviews* 54, 160–214.
- Barrio, J.P., Zhang, S.Y., Zhu, Z.K., Wu, F.L., Mao, X.Z., Bermudez, F.F. and Forbes, J.M. (2000) The feeding behaviour of the water buffalo monitored by a semiautomatic feed intake recording system. *Journal of Animal and Feed Sciences* 9, 55–72.
- Baumgardt, B.R. (1970) Regulation of feed intake and energy balance. In: Phillipson, A.T. (ed.) *Physiology of Digestion and Metabolism in the Ruminant*. Oriel Press, Newcastle upon Tyne, UK, pp. 235–253.
- Blackburn, H.D. and Cartwright, T.C. (1987) Description and validation of the Texas A&M sheep simulation model. *Journal of Animal Science* 65, 373–386.
- Blaxter, K.L., Clapperton, J.L. and Wainman, F.W. (1966) The extent of differences between six British breeds in their metabolism, feed intake and utilization, and resistance to climatic stress. *British Journal of Nutrition* 20, 283–294.
- Chamberlain, D.G. and Choung, J.J. (1995) The importance of rate of ruminal fermentation of energy sources in diets for dairy cows. In: Garnsworthy, P.C. and Cole, D.J.A. (eds) *Recent Advances in Animal Nutrition – 1995*. Nottingham University Press, Nottingham, UK, pp. 3–27.
- Christian, K.R., Freer, M., Donnelly, J.R., Davidson, J.L. and Armstrong, J.S. (1978) *Simulation of Grazing Systems*. Centre for Agricultural Publishing Documentation, Wageningen, The Netherlands.
- Emmans, G.C. and Kyriazakis, I. (1995) The idea of optimisation in animals: uses and dangers. *Livestock Production Science* 44, 189–197.
- Emmans, G.C. and Kyriazakis, I. (2001) Consequences of genetic change in farm animals on food intake and feeding behaviour. *Proceedings of the Nutrition Society* 60, 115–125.
- Forbes, J.M. (1977) Interrelationships between physical and metabolic control of voluntary food intake in fattening, pregnant and lactating mature sheep: a model. *Animal Production* 24, 91–101.
- Forbes, J.M. (1986) The importance of meals in the regulation of food intake. *Proceedings of the Nutrition Society of Australia* 10, 14–24.
- Forbes, J.M. (1993) Voluntary feed intake. In: Forbes, J.M. and France, J. (eds) *Quantitative Aspects of Ruminant Digestion and Metabolism*. CAB International, Wallingford, UK, pp. 479–494.
- Forbes, J.M. (1995a) Physical limitations of feed intake in ruminants and its interactions with other factors affecting food intake. In: Von Engelhardt, W., Leonhard-Marek, S., Breves, G. and Giesecke, D. (eds) *Ruminant Physiology: Digestion, Metabolism, Growth and Reproduction*. Ferdinand Enke Verlag, Stuttgart, Germany, pp. 217–232.

- Forbes, J.M. (1995b) *Voluntary Food Intake and Diet Selection in Farm Animals*. CAB International, Wallingford, UK.
- Forbes, J.M. (1996) Integration of regulatory signals controlling forage intake in ruminants. *Journal of Animal Science* 74, 3029–3053.
- Forbes, J.M. (2001) Consequences of feeding for future feeding. *Comparative Biochemistry and Physiology* 128, 461–468.
- Forbes, J.M. (2003) The multifactorial nature of food intake control. *Journal of Animal Science* 81, E139–E144.
- Forbes, J.M. and Provenza, F.D. (2000) Integration of learning and metabolic signals into a theory of dietary choice and food intake. In: Cronje, P. (ed.) *Ruminant Physiology: Digestion, Metabolism, Growth and Reproduction*. CAB International, Wallingford, UK, pp. 3–19.
- Fox, D.G., Sniffen, C.J., O'Connor, J.D., Russell, J.B. and Van Soest, P.J. (1992) A net carbohydrate and protein system for evaluating cattle diets: III. Cattle requirements and diet adequacy. *Journal of Animal Science* 70, 3578–3596.
- Graham, N.M., Black, J.L., Faichney, G.J. and Arnold, G.W. (1976) Simulation of growth and production in sheep – Model 1: A computer program to estimate energy and nitrogen utilisation, body composition and empty liveweight change, day by day for sheep any age. *Agricultural Systems* 1, 113–138.
- Ketelaars, J.J.M.H. and Tolkamp, B.J. (1992a) Toward a new theory of feed intake regulation in ruminants. 1. Causes of differences in voluntary feed intake: Critique of current views. *Livestock Production Science* 30, 269–296.
- Ketelaars, J.J.M.H. and Tolkamp, B.J. (1992b) Toward a new theory of feed intake regulation in ruminants. 3. Optimum feed intake: in search of a physiological background. *Livestock Production Science* 31, 235–258.
- Konandreas, P.A. and Anderson, F.M. (1982) *Cattle Herd Dynamics: an Integer and Stochastic Model for Evaluating Production Alternatives*. ILCA, Addis Ababa, Ethiopia.
- Kyriazakis, I., Emmans, G.C. and Whittemore, C.T. (1990) Diet selection in pigs: choices made by growing pigs given foods of different protein concentrations. *Animal Production* 51, 189–199.
- Lawson, R.E., Redfern, E.J. and Forbes, J.M. (2000) Choices by lactating cows between concentrates high and low in digestible undegraded protein. *Animal Science* 70, 515–525.
- National Research Council (1984) *Nutrient Requirements of Beef Cattle*, 6th edn. National Academy Press, Washington, DC, USA.
- National Research Council (1996) *Nutrient Requirements of Beef Cattle*. National Academy Press, Washington, DC.
- Neal, H.D., Thomas, C. and Cobby, J.M. (1984) Comparison of equations for predicting voluntary intake by dairy cows. *Journal of Agricultural Science* 103, 1–10.
- Pittroff, W. and Kothmann, M.M. (2001) Quantitative prediction of feed intake in ruminants. III. Comparative example calculations and discussion. *Livestock Production Science* 71, 171–181.
- Poppi, D.P., Gill, M. and France, J. (1994) Integration of theories of intake regulation in growing ruminants. *Journal of Theoretical Biology* 167, 129–145.
- Sanders, J.O. and Cartwright, T.C. (1979) A general cattle production systems model. II. Procedures used for simulating animal performance. *Agricultural Systems* 4, 289–309.
- Siebert, B.D. and Hunter, R.A. (1977) Prediction of herbage intake and liveweight gain of cattle grazing tropical pastures from the composition of the diet. *Agricultural Systems* 2, 199–208.

- Tolkamp, B.J. and Ketelaars, J.J.M.H. (1992) Toward a new theory of feed intake regulation in ruminants. 2. Costs and benefits of feed consumption: an optimization approach. *Livestock Production Science* 30, 297–317.
- Tolkamp, B.J. and Kyriazakis, I. (1999) A comparison of five methods that estimate meal criteria for cattle. *Animal Science* 69, 501–514.
- Tolkamp, B.J., Allcroft, D.J., Austin, E.J., Nielsen, B.L. and Kyriazakis, I. (1998) Satiety splits feeding behaviour into bouts. *Journal of Theoretical Biology* 194, 235–250.
- Tolkamp, B.J., Friggens, N.C., Emmans, G.C., Kyriazakis, I. and Oldham, J.D. (2002) Meal patterns of dairy cows consuming mixed foods with a high or a low ratio of concentrate to grass silage. *Animal Production* 74, 369–382.
- Vadiveloo, J. and Holmes, W. (1979) The prediction of the voluntary feed intake of dairy cows. *Journal of Agricultural Science* 93, 553–562.
- Vera, R.R., Morris, J.G. and Koong, L.J. (1977) A quantitative model of energy intake and partition in grazing sheep in various physiological states. *Animal Production* 25, 133–153.
- Whittemore, E.C., Kyriazakis, I., Emmans, G.C. and Tolkamp, B.T. (2001) Tests of two theories of food intake using growing pigs – 1. The effect of ambient temperature on the intake of foods of differing bulk content. *Animal Science* 72, 351–360.
- Yeates, M., Tolkamp, B., Allcroft, D. and Kyriazakis, I. (2001) The use of mixed distribution models to determine bout criteria for analysis of animal behaviour. *Journal of Theoretical Biology* 213, 413–425.
- Yeates, M.P., Tolkamp, B.J. and Kyriazakis, I. (2002) The relationship between meal composition and long-term diet choice. *Journal of Animal Science* 80, 3165–3178.

*This page intentionally left blank*

---

# 24 Feed Processing: Effects on Nutrient Degradation and Digestibility

A.F.B. Van der Poel,<sup>1</sup> E. Prestløyken<sup>2</sup> and J.O. Goelema<sup>3</sup>

<sup>1</sup>Wageningen University, Animal Nutrition Group, Marijkeweg 40, 6709 PG Wageningen, The Netherlands; <sup>2</sup>Felleskjøpet Fôrutvikling, Department of Animal and Aquacultural Sciences, Agricultural University of Norway, PO Box 5003, N-1432 Ås, Norway; <sup>3</sup>Pre-Mervo, PO Box 40248, 3504 AA Utrecht, The Netherlands

---

## Introduction

The dynamics of nutrient degradation in the reticulorumen and of nutrient digestion in the intestines are major determinants of the utilization of diet ingredients by ruminants. These dynamics of nutrient digestion should be known and controlled to improve ruminal and total tract digestibility and to optimize production and composition of milk and meat. A careful and appropriate selection of concentrate ingredients to meet the required supplementation of the forage could fulfil this objective. Moreover, the processing of feeds can be used to manipulate the nutrient degradation characteristics in the rumen and the site of nutrient digestion, being a helpful tool to optimize ruminant diets.

Amongst other nutrients, protein and starch are important diet constituents for ruminant diets. Protein appearing in the small intestine of the ruminant originates from dietary protein escaping microbial degradation in the rumen and from protein synthesized by microbes in the rumen. Dietary starch is either degraded to volatile fatty acids in the rumen yielding energy for synthesis of microbial protein, or digested as glucose in the small intestine (see Chapters 7 and 10). The quality and the content of protein and starch may greatly affect the nutritional responses to the diet. Protein and starch account for a considerable part of the diet costs and a balanced supply of protein and total carbohydrates is important to minimize output of nitrogen in faeces and urine. Thus, optimizing the supply of these nutrients by processing can be important to maximize the financial income and to minimize the environmental impact of ruminant production. For processing, both particle size manipulation and the changes in physico-chemical properties of nutrients (e.g. gelatinization of starch, denaturation of proteins) are options to shift the site of digestion of

protein and starch from the rumen to the small intestine (Nocek and Tamminga, 1991). However, these options used in applied technology imply the manufacturers of rumen by-pass nutrients to use precision in controlling their processing methods.

The interest in manipulating the site of digestion through processing has increased during recent years. Kaufman and Lüpping (1982), Satter (1986), Broderick *et al.* (1991), Nocek and Tamminga (1991), Schwab (1995) and Mills *et al.* (1999) have published reviews on this topic. Unfortunately, some of the methods may also render proteins or starch resistant against digestion in the small intestine (Broderick *et al.*, 1991; Mills *et al.*, 1999). To meet the protein requirements of high-yielding animals, the diet is usually supplemented with rumen undegradable protein from feedstuffs high in rumen undegradable protein, either by nature, or resulting from processing. Santos *et al.* (1998), reviewing publications in the period 1985 to 1997, concluded that increasing the amount of dietary undegradable protein did not consistently improve performance. This implies that validation in the target animal of an increased protein value of diet ingredients by processing is important. Similar reasoning applies for starch value of diet ingredients. Thus, care must be taken when the *in vivo* verification of technological treatment is absent.

In this chapter, a brief description of relevant processing methods for ruminant feedstuffs is given and mechanisms and effects are discussed. The main intention is to review existing knowledge on how the most relevant processing methods quantitatively affect protein and starch digestion, whilst effects on health in ruminants are briefly discussed. The emphasis will be on nylon bag (*in situ*) studies, but *in vivo* and *in vitro* studies will be presented as well.

## Feed Processing: Mechanisms and Methods

Proteins are macromolecular polypeptides, consisting of covalently bound  $\alpha$ -amino acid residues. The sequence of these peptide-bound amino acids forms the primary structure of the protein. The secondary structure of the polypeptide chain comprises helical coil, held together by non-covalent bonds, such as hydrogen bonds. The tertiary structure is the folded and twisted positioning of the secondary structure, which is also stabilized by hydrogen bonds. When two polypeptide –SH groups containing chains are close together, covalent disulphide bonds can occur, which cannot be easily broken down. The way two or more polypeptides are merged together, often involving non-polypeptide groups, is the quarternary structure (Holum, 1982).

Starch is a storage carbohydrate in many plants, and can comprise more than 70% of dry matter (DM) in cereals. In most plants, a single starch granule is formed inside an amyloplast, whereas in some plants (e.g. oats) several small granules are formed, which aggregate to a larger complex. Starch contains two macromolecules of glucopyranose (glucose), viz. the linear amylose and the branched amylopectin, which are organized in a semi-crystalline structure (Kotarski *et al.*, 1992). Most of the starch is located in the endosperm. Three



types of endosperm are distinguished: peripheral, corneous and floury endosperm. Peripheral and corneous starch granules are surrounded by protein storage bodies, and embedded in an inaccessible matrix which consists mainly of protein and non-starch carbohydrates, whereas corneous starch has less cellular structure and a higher starch content.

## Mechanisms

### Protein

All methods that are applied to protect the protein have essentially a similar mechanism of rumen protection in that a stearic hindrance of enzymes in the rumen is established (Metcalf, 2001). The low pH in the abomasum causes the protein molecule to unwind, making the protease binding sites available again for digestion in the small intestine.

Heat treatment of protein results in structure stabilization and cross-linkages to carbohydrates, which protects them from ruminal hydrolysis or at least slows down their rate of degradation (Satter, 1986). The structure stabilization principally involves denaturation (Finley, 1989). In structural terms, denaturation is a disorganization of the overall molecular shape of a protein. It can occur as an unfolding or uncoiling of a coiled or pleated structure, or as the separation of the protein into its subunits, which may then unfold or uncoil (Holum, 1982). Any temperature change in the environment of the protein which can influence the non-covalent interactions involved in the structure may lead to an alteration of the quaternary, tertiary and secondary structures. Depending on the temperature, several processes may occur, ranging from only hydration and modification of the tertiary structure, to a complete alteration of the secondary structure and even the primary structure of the molecule (Finley, 1989). However, not only temperature plays a role during treatment, but also factors such as residence time and moisture level. Various heat processing methods are available that differ in their mechanisms in view of their time–temperature relationship and also in other factors (e.g. the use of shear).

The occurrence of Maillard reactions is very common when heat processing is involved to modify proteins. Lysine reacts with carbonyl compounds, usually originating from reducing sugars such as glucose, xylose and fructose (Cleale *et al.*, 1987). Voragen *et al.* (1995) have outlined the reactions and nutritional implications. Other reactions may also occur, including the formation of isopeptide cross-links between lysine and asparagine or glutamine. Additionally, methionine, cystine and tryptophan may be involved in the isopeptide cross-linking (Broderick *et al.*, 1991).

Metcalf (2001) has described various mechanisms for chemical treatments of dietary ingredients. In the formaldehyde–protein interaction, the mixing of formaline (aqueous formaldehyde) and – if required – subsequent heat processing will form a rumen undegradable protein. In this reaction, a precise level of formaline is attributed to a protein level and reactivity. The reaction involves the bonding of the aldehyde group in formaldehyde to the amino group from

amino acids in the peptide chain. After a certain reaction time, a pH reversible methylene bridge is formed that is responsible for blocking the binding sites of bacterial peptidases.

In the tannin–protein interaction, tannins (polyphenol compounds) act by a chemical reaction with proteins that may be either reversible or irreversible in the abomasum. Both reactions act by stearic hindrance in the rumen but the hydrolysis reaction only is susceptible to the low abomasal pH. The irreversible condensation reaction will lead to an indigestible product (D’Mello, 1992). In the xylose–protein interaction, the mixing of xylose with protein prior to a heating process will block a number of enzyme-binding sites thereby increasing the level of undegradable protein.

During chelation (metal salt–protein interaction), the mixing of soluble metal salts and protein with additional steam processing will also result in rumen undegradable protein. The underlying mechanism is the binding of metal salts to the protein, thereby blocking the binding of microbial enzymes, leading to the protection of the protein from rumen degradation.

Fat encapsulation of protein, using rumen inert fat (calcium soaps), involves the physical protection from digestion in the rumen of vegetable proteins. In the abomasum, the proteins become available again since the low pH causes the release of the fatty acids from the soap.

## **Starch**

Several physical processes play a role during the heat processing of starch, such as swelling, gelatinization and retrogradation. The magnitude of these processes depends on the particle size, but also largely on the temperature, the treatment time and the moisture level (Goelema *et al.*, 1998). The exposure of starch to water combined with gradual heating results in swelling. At low temperatures (below 60–80°C), swelling is reversible after cooling and drying. At higher temperatures, depending on the moisture level, gelatinization may take place (Lund, 1984). At this temperature, the granular structure is altered from semi-crystalline to amorphous, which results in loss of its birefringence. Gelatinization of individual starch granules occurs in a range of 1 to 2°C, but due to variation between granule fractions, it results in a 10 to 15°C range for the total starch. At low moisture contents (<35% moisture) the gelatinization temperature may increase (Colonna *et al.*, 1992). Retrogradation of starch is the reassociation of starch molecules after gelatinization, in which hydrogen bonding between amylose and amylopectin is re-established. Retrograded starch does not completely regain the native starch character, and may even result in the formation of a starch fraction being less digestible compared to native starch. On the other hand, retrograded starch may gelatinize again after subsequent (re-)heating.

## **Feed processing methods**

Ruminant diet ingredients have usually undergone several forms of processing, which are applied to make the diet ingredients suitable for storage (drying), easy

to handle (particle size reduction), more appropriate for production processes (expanding, pre-compaction) and less bulky or less dusty (pelleting or spraying a low percentage of fat). Moreover, their nutritional value can be altered by changing the shape and size to a form which facilitates intake or prevents selective intake of concentrate ingredients (pelleting), by inactivation of inherent components that hamper digestibility or absorption (heat treatment), or by shifting the digestion of nutrients from the rumen to the small intestine (heat treatment, chemical treatments). Thus, some of these treatments are intended to modify nutritional value, while others affect the nutritional value as a side effect. Primary (ingredient) processing as well as secondary processing (agglomerating of complete diets) may have significant effects. Both aspects – intended and non-intended influences on the nutritional value – are important to consider during feed formulation to ensure the desired nutritional value of the processed feed.

#### *Drying/cooling*

Many diet ingredients are cooled and/or dried, mainly to prevent microbial activity during storage. The conditions during cooling or drying vary greatly (Voragen *et al.*, 1995), from cooling pelleted feed with ambient air, to mildly drying grains after harvesting by ventilation with heated air at approximately 35°C, to more intensive treatments (80–95°C) of maize gluten, soybeans, rapeseeds and palm kernels before milling, extraction or expeller treatment. Drying temperatures for citrus pulp may even exceed 100°C.

#### *Particle size reduction*

Particle size reduction includes breaking, cracking and grinding. Diet ingredients show a different breaking behaviour during grinding, resulting in differences in mean particle size and particle size distribution. The different ways of grinding affect the mean particle size as well as the ingredient particle size distribution (Heimann, 1994). Routinely hammer-milled diet ingredients usually show a skewed particle size distribution, while roller milling generally results in a more normal distribution, with a relatively smaller portion of fine particles. It is noted, however, that particle size reduction also results from subsequent shear forces in processes such as pelleting or expander treatment (Goelema *et al.*, 1996).

#### *Steam processing*

Steam treatments are carried out in various degrees and for different reasons. A common treatment is the application of steam during conditioning of feed mashes in barrel-type conditioners and in expanders (Thomas *et al.*, 1997). After steam addition, part of the steam condenses on the colder feed mash, which results in a higher temperature and an increased moisture level. Conditioning may also involve the addition of water. Steam treatment during conditioning is performed to improve the hygienic quality, binding properties and physical quality after the down-stream pelleting process. Depending on throughput, rotation speed of the paddle bar and the degree of fill, residence time in a barrel-type conditioner may vary from 20 to 255 s. Steam is also applied during toasting and extrusion.

Toasting is a commonly used method after solvent extraction of oilseeds. The method is usually carried out at atmospheric pressure, resulting in product temperatures close to 100°C. On the other hand, it can also be performed in pressurized barrels such as an autoclave. In the latter case, there is a positive relationship between steam pressure and temperature in the autoclave. Processing times can be varied, although during autoclaving very short treatment times are difficult to achieve due to the fact that the pressure has to be built up after closing the autoclave. The same difficulty occurs during the completion of the autoclave treatment. Consequently, it is difficult to evaluate the exact processing temperature and time during autoclaving. To be able to control processing time and temperature more precisely, special equipment was developed (Van der Poel *et al.*, 1990), which enables perfect control of processing temperatures and times. Pressurized toasting is carried out with horizontal or vertical cylindrical vessels, with paddles or conveyor belts (Melcion and Van der Poel, 1993).

Steam flaking is a combined treatment of atmospheric toasting for 15–30 min and rolling between pre-heated rollers. By adjusting the roller speed and gap width, flake density can be varied.

#### *Extrusion and expander processing*

Extruders consist of barrels with one or two screws, which transport the feed mash (Melcion and Van der Poel, 1993). The screw configuration can be varied by addition of reverse screw elements, pressure rings or air locks, in order to alter the amount of shearing action during transport. Water can be used to adjust the moisture content to the required level before processing. Although friction may be sufficient to increase temperature during extrusion, the barrel wall can be additionally heated by steam or electrically. The combination of temperature, pressure, moisture and shear, followed by expansion when the material leaves the die, changes the properties of the material (proteins; starch), including its digestive behaviour in the rumen. Processing time in extruders varies from 30 to 150 s, while temperatures range from 80 to 200°C. Extrusion can be considered as a high-shear treatment.

Expanders are somewhat similar to single screw extruders, but have usually an annular discharge valve or an active disk system, instead of a fixed die. Expander treatment should be considered as an extra conditioning phase that enables the feed manufacturer to increase the length of conditioning, as well as its temperature. An electrically or hydraulically adjustable cone or disk is used to increase the pressure during operation up to 3800–4000 kPa (Pipa and Frank, 1989). Steam can be used for heating the barrel wall, as well as for injection in the feed mash to increase processing temperature. Mixing by bolts results in shear action on the feed mash. Residence time in the expander varies from 5 to 15 s, while temperatures range from 80 to 140°C. The shearing action during expander processing, however, is much less than during extrusion.

#### *Roasting and micronizing*

Roasting is a dry heat treatment, in which heat is transferred by conduction, convection and radiation. Heat can originate from gas burners or from

electrical heaters. Moisture levels should be adjusted before the treatment, for instance by soaking. Processing temperature can be up to 200°C, while residence time is unlimited for roasting. Often, heated feedstuffs are removed from the roaster and kept in an insulated holding barrel to increase the processing time (heat balance), before being cooled to ambient temperature.

Micronizing is a method of dry heating based on infrared radiation from gas burners. As in roasters, the temperatures may rise to high levels, and the temperature may continue for an extended time period in an insulated barrel. Residence time during micronizing is usually very short.

### *Agglomeration*

In addition to particle size reduction (grinding), pelleting is probably the processing method most used worldwide to agglomerate ruminant mash diets. Pelleting is the compression of a feed mash through a die. Residence time in the die does not usually exceed 15 s. The pelleted mashes are usually pre-conditioned using steam and/or water at temperatures ranging from 65 to 90°C. Conditioning influences the amount of friction between feed particles, the barrel wall and in the die. Apart from processing conditions, the physical quality of pelleted animal feeds is influenced by feed components (Thomas *et al.*, 1998). Pelleting makes the feed less bulky, which facilitates transport. In addition, pelleting reduces selective intake and ingredient segregation, it destroys pathogenic organisms and the feed becomes less dusty and more palatable. As a result it can enhance feed intake (Behnke, 1996).

Nowadays, pre-compaction methods are applied to ruminant diets prior to the pelleting process. They have been designed to increase the physical quality of pellets and equipment capacity in connection with the potential use of higher quantities of fluids (molasses, steam and fats) according to diet formulation. The applied principle is the decrease of the mash porosity (ratio of air to particles) by pre-compaction equipment prior to the actual agglomeration to pellets. Depending on the applied compaction equipment (a first pellet press, specifically designed equipment, or an expander), mash product temperatures will vary between 70 and 125°C. By using the expander in pre-compaction at the higher temperatures, certain modifications (e.g. starch gelatinization) will be increased in starch-rich diets. In general only limited research has been carried out to study the effects of pre-compaction by double pelleting or by specially designed equipment on nutrient degradation and digestion compared to research into the effects of expander processing (Goelema *et al.*, 1996; Tóthi *et al.*, 2003; Ljøkjel *et al.*, 2003a).

Finally, for the optimization of process conditions during thermal processing, precision control is required when time, temperature, moisture level and particle size are applied in the production process; this has to guarantee a balance between the minimal level of rumen degradation and a maximum level of gut digestibility.

### *Chemical treatment*

Different chemical agents (aldehyde, reducing sugars, metal ions, alcohols, acids, tannins) have been studied for their effect on digestive behaviour of

concentrate feedstuffs. The commercially most interesting ones are treatment with formaldehyde or with reducing sugars, in combination with heat. Treatment with formaldehyde has been extensively studied for soybean meal and rapeseed meal (Crooker *et al.*, 1986), but also for other feedstuffs like sunflowerseed meal, lucerne and horsebeans (Sommer *et al.*, 1995). Formaldehyde reacts with proteins to form non-ionic bonds between the active side chain groups of amino acids, like  $-SH$ ,  $-OH$ ,  $-NH_2$  and the carbonyl ( $-C=O$ ) group of formaldehyde (Antoniewicz *et al.*, 1992). For starch, the formaldehyde treatment may result in a similar protection against rumen degradation as observed for protein. The method is currently commercially used for the protection of dietary protein in many European countries. For starch, the commercial use is limited. Tannins as well as other aldehydes, like glyoxal and glutaraldehyde, were less efficient in protecting protein from degradation than formaldehyde (Zelter *et al.*, 1970; Fluharty and Loerch, 1989).

The reactions with reducing sugars were studied in the mid-1980s (Cleale *et al.*, 1987). When heat is applied, the reducing sugars react with amino acids via Maillard reactions. The method has mainly been studied with soybean meal and rapeseed meal. The chemical reaction is assumed to be reversible under the acid conditions in the abomasum, and therefore considered not to affect amino acid composition or intestinal digestibility.

## Effects of Processing on Ruminal Degradation and Intestinal Digestion of Protein and Starch

*In situ* or *in vivo* effects of processing techniques largely depend on the information that can be derived from the scientific description of these experiments. The authors fully support the view of Offner *et al.* (2003) postulating that such descriptions should include the full documentation of the used processing conditions in experiments, the variation of analytical methods used in laboratories and standardization of *in vitro* or *in situ* techniques.

For protein, rumen degradability is usually calculated according to the equation of Ørskov and McDonald (1979). Important rumen degradation characteristics are the soluble (S) or washable (W) fraction, the potential degradable fraction (D) and the fraction that is not degraded irrespective of rumen incubation time (U) (see Chapter 4 for discussion of the nylon bag method compared to other *in vitro* methods). Rumen undegraded protein (RUP) is the fraction of dietary protein that escapes fermentation in the rumen and is calculated based on the measured fractional degradation rate, D and U fractions and adopting a fractional passage rate based on literature (see Ørskov and McDonald, 1979). The calculation of the amount of intestinal digestible feed protein is based on the digestibility of RUP, as described by Hvelplund *et al.* (1992). This intestinal digestible protein (dRUP) is expressed as a fraction of the RUP. However, in several feedstuffs, ruminal pre-digestion influences intestinal digestibility (Volden and Harstad, 1995). As a consequence, the intestinal digestibility of protein should be determined after rumen pre-incubation (Stern *et al.*, 1997). Protein degradation and digestion characteristics have been described

for several feeds and these characteristics vary considerably among feedstuffs (e.g. Tamminga *et al.*, 1990; Hvelplund *et al.*, 1992; Volden and Harstad, 1995). This variation is mainly attributed to variation in particle size, solubility of proteins and presence of inhibitors (e.g. tannins).

Ruminal starch degradation can be described by similar characteristics as for protein. In some feed evaluation systems, it is assumed that a part (10%) of the starch W-fraction escapes fermentation (Tamminga *et al.*, 1994) and this may be added to the fraction of dietary starch that escapes fermentation in the rumen (RUS). Intestinal digestibility of rumen undegraded starch (dRUS) is also calculated as for protein, using the equation of Hvelplund *et al.* (1992). Investigations indicate that when the mobile bag method is adopted for measurement of intestinal starch digestion, the bags should be collected in the ileum and not from faeces (Norberg and Harstad, 2001). Moreover, ruminal pre-digestion influences intestinal starch digestibility. Thus, intestinal digestibility of starch should be determined after rumen pre-incubation as for protein.

In the following sections, processing methods commonly used will be evaluated with respect to the influence on protein and starch degradation in ruminants. Some results representative of effects of various treatments of single feed ingredients are presented in Tables 24.1 and 24.2 for RUP and Table 24.3 for RUS. The effects of pelleting and expander treatment of various compound feeds on RUP, RUS and dRUP are presented in Table 24.4. The good correlation of heat treatment effects or *in situ* parameters and laboratory parameters enables the estimation of treatment effects by relatively simple measurements. In Table 24.5 correlations are shown between the *in situ* results for protein and starch and laboratory parameters based on research with faba beans, lupins and peas (Goelma *et al.*, 1999).

### **Ruminal degradation of protein**

As described in previous sections, many processing methods affect protein degradation. However, commercially only a few methods have received interest. To be successful, a processing method needs to have a certain effect on ruminal degradation at an acceptable cost.

In general, particle size reduction increases ruminal protein degradation (Michalet-Doreau and Cerneau, 1991) by increasing surface area available for digestion and by cracking physical barriers such as the husk. Thus, protein degradation can to some extent be controlled by fineness of milling. However, ruminal degradation of protein is most commonly manipulated by heat treatments, addition of chemical agents or a combination of heat and chemicals (Kaufman and Lüpping, 1982; Satter, 1986; Broderick *et al.*, 1991; Schwab, 1995).

The amount of publications presenting effects of processing on ruminal protein degradability in oilseeds or oilseed meals is large, although some methods are less well documented than others. Commercially, toasting subsequent to solvent extraction is probably the most used method for heat treatment of oilseed proteins. Other frequently used methods are expeller processing, extruding, expanding, roasting, pressurised toasting and micronizing.

**Table 24.1.** Influence of extrusion and expander processing temperature on *in sacco* rumen undegradable protein (RUP) in various feedstuffs (temperature/RUP values are given, respectively).

Feedstuff	Treatment		Extrusion/expander processing			Reference
	Unprocessed	Pelleted	Level 1	Level 2	Level 3	
<b>Extruder treatment</b>						
Soybeans	-/2		132/37	149/50		Stern <i>et al.</i> (1985)
Soybean meal	-/44		-/51	-/64		Waltz and Stern (1989)
Horsebeans	-/9		195/42			Benchaar <i>et al.</i> (1994a)
Lupins	-/5		195/52			Benchaar <i>et al.</i> (1994b)
Peas	-/12		140/46	180/45	220/29	Walhain <i>et al.</i> (1992)
<b>Expander processing/pelleting</b>						
Soybeans	-/24	83/33	90/40	98/52		Ljøkjel <i>et al.</i> (2003a)
Soybean meal	-/38		129/46	155/54	173/50	Prestlækken (1999a)
Peas	-/24	84/33	112/43	130/52		Ljøkjel <i>et al.</i> (2003a)
Rapeseed meal	-/37		132/34	155/38	190/43	Prestlækken (1999a)
Rapeseed meal	-/35		120/56			Sommer <i>et al.</i> (1996)
Barley	-/26		-/46			Weisbjerg <i>et al.</i> (1996)
Barley	-/28		128/43	155/47	160/47	Prestlækken (1999a)
Barley	-/41	75/54	90/63	102/68	125/70	Prestlækken (1999b)
Barley	-/51	82/55	110/74	128/70		Ljøkjel <i>et al.</i> (2003a)
Wheat	-/23		-/41			Weisbjerg <i>et al.</i> (1996)
Wheat	-/35	81/49	111/62	130/61		Ljøkjel <i>et al.</i> (2003a)
Wheat bran	-/25	81/35	109/45	133/47		Ljøkjel <i>et al.</i> (2003a)
Oats	-/11		131/31	158/41	169/53	Prestlækken (1999a)
Oats	-/15	75/29	92/41	108/61	140/71	Prestlækken (1999b)
Oats	-/22	76/31	106/42	121/62		Ljøkjel <i>et al.</i> (2003a)
Maize	-/69	81/72	110/71	130/70		Ljøkjel <i>et al.</i> (2003a)
Sorghum	-/74	81/79	100/84	108/82		Ljøkjel <i>et al.</i> (2003a)



**Table 24.2.** Influence of pressure toasting, roasting, and chemical treatment (formaldehyde or lignosulphonate) on *in sacco* rumen undegradable protein (RUP) in various feedstuffs (temperature or formaldehyde concentration/RUP values are given, respectively).

Feedstuff	Heat treatment/chemical treatment					Reference
	Untreated	Level 1	Level 2	Level 3	Level 4	
<b>Pressure toasting</b>						
Phaseolus beans	-/17	102 (5 min)/31	102 (10 min)/27	136 (5 min)/52	136 (10 min)/57	Zom <i>et al.</i> (unpublished)
Soybeans	-/28	100 (7 min)/34	118 (7 min)/43	136 (7 min)/43		Goelema <i>et al.</i> (1999)
Peas	-/21	100 (7 min)/24	118 (7 min)/36	136 (7 min)/50		Goelema <i>et al.</i> (1999)
Faba beans	-/21	100 (7 min)/25	118 (7 min)/33	136 (7 min)/49		Goelema <i>et al.</i> (1999)
Lupins	-/21	100 (7 min)/31	118 (7 min)/41	136 (7 min)/47		Goelema <i>et al.</i> (1999)
<b>Roasting</b>						
Soybeans	-/28	115 (0 min)/48	115 (30 min)/55	115 (120 min)/58		Faldet <i>et al.</i> (1991)
Soybean meal	-/29	115 (0 min)/41	115 (30 min)/54	115 (120 min)/63		Faldet <i>et al.</i> (1991)
Maize	-/68	74/68	118/76			McNiven <i>et al.</i> (1994)
Wheat	-/11	93/41	149/54			McNiven <i>et al.</i> (1994)
Barley	-/11	77/24	121/45			McNiven <i>et al.</i> (1994)
Oats	-/5	77/6	121/10	168/41		McNiven <i>et al.</i> (1994)
<b>Formaldehyde treated</b>						
Soybean meal	-/38	-/76	-/69			De Jong (1997)
Soybean meal	-/44	-/74				Waltz and Stern (1989)
Rapeseed meal	-/34	-/78	-/75			De Jong (1997)
Rapeseed meal	-/35	-/78				De Jong (1997)
Soybean meal	-/34	0.30%/68	0.60%/83	1.10%/99		Møller (1983)
Rapeseed meal	-/53	0.25%/59	0.50%/65	0.70%/72		Møller (1983)
<b>Lignosulphonate treated</b>						
Soybean meal	-/38	-/68	-/57			De Jong (1997)
Soybean meal	-/44	-/69				Waltz and Stern (1989)

**Table 24.3.** Influence of extrusion, expander processing, pressure toasting and formaldehyde treatment on *in sacco* rumen undegradable starch (RUS) in various feedstuffs (temperature or formaldehyde concentration/RUS values are given, respectively).

Feedstuff	Treatment		Extrusion/expander processing		Reference
	Unprocessed	Pelleted	Level 1	Level 2	
<b>Extrusion</b>					
Peas	-/4		140/13		Walhain <i>et al.</i> (1992)
Maize	-/10		125/16		Arieli <i>et al.</i> (1995)
Sorghum	-/10		125/27		Arieli <i>et al.</i> (1995)
Barley	-/5		125/32		Arieli <i>et al.</i> (1995)
Wheat	-/0		125/16		Arieli <i>et al.</i> (1995)
<b>Expander processing/pelleting</b>					
Maize	-/10		125/18		Arieli <i>et al.</i> (1995)
Maize	-/56	81/46	110/34	130/25	Ljøkjel <i>et al.</i> (2003a)
Maize	-/40		95/28		Tóthi <i>et al.</i> (2003)
Sorghum	-/10		125/24		Arieli <i>et al.</i> (1995)
Sorghum	-/42	81/38	100/21	108/24	Ljøkjel <i>et al.</i> (2003a)
Peas	-/44	84/35	112/23	130/23	Ljøkjel <i>et al.</i> (2003a)
Barley	-/5		125/31		Arieli <i>et al.</i> (1995)
Barley	-/17	82/18	110/22	128/22	Ljøkjel <i>et al.</i> (2003a)
Barley	-/4		105/4		Tóthi <i>et al.</i> (2003)
Oats	-/12	76/15	106/10	121/8	Ljøkjel <i>et al.</i> (2003a)
Wheat	-/0		125/33		Arieli <i>et al.</i> (1995)
Wheat	-/14	81/21	111/25	130/23	Ljøkjel <i>et al.</i> (2003a)
Wheat bran	-/11	81/16	109/11	133/10	Ljøkjel <i>et al.</i> (2003a)
<b>Formaldehyde treatment</b>					
Maize	-/44		1%/48	5%/51	Michalet-Doreau <i>et al.</i> (1997)
Wheat	-/1		1%/17	5%/35	Michalet-Doreau <i>et al.</i> (1997)
<b>Pressure toasting</b>					
Whole peas	-/39		132 (3 min)/50		Goelema <i>et al.</i> (1999)
Broken peas	-/39		132 (3 min)/53		Goelema <i>et al.</i> (1999)
Whole faba beans	-/33		132 (3 min)/53		Goelema <i>et al.</i> (1999)
Broken faba beans	-/33		132 (3 min)/60		Goelema <i>et al.</i> (1999)
Barley	-/16		100 (3 min)/23		Norberg and Harstad (2001)
Barley	-/16		118 (1.5 min)/30		Norberg and Harstad (2001)
Oats	-/5		136 (7 min)/22		Norberg and Harstad (2001)

**Table 24.4.** Influence of various processing methods on rumen undegradable starch (RUS), rumen undegradable protein (RUP) and intestinal digestibility of RUP (dRUP; mobile nylon bag method) in various compound feeds.

Compound	Treatment	RUS (% of starch)	RUP (% of protein)	dRUP (% of RUP)	Reference
Dairy feed A	Mash <sup>a</sup>	37	38	76	Goelema <i>et al.</i> (1996)
	Cold pelleted	31	32	73	
	Steam pelleted	28	34	74	
	Expander treated	24	32	73	
	Expander treated and pelleted	18	32	73	
Dairy feed B	Mash	36	48	90	Tamminga <i>et al.</i> (1989)
	Cold pelleted	29	41	90	
	Steam pelleted	29	45	90	
	Expander treated	23	47	90	
	Expander treated and pelleted	14	45	90	
Maize based	Mash	49			Houtman, Kemp, Van der Velden, Hof and Tamminga, unpublished
	Pelleted	44			
Maize/barley/tapioca based	Mash	27			Houtman, Kemp, Van der Velden, Hof and Tamminga, unpublished
	Pellet	22			
Standard A	Mash	26	35		Houtman, Kemp, Van der Velden, Hof and Tamminga, unpublished
	Double pelleted	23	31		
Select-A	Mash	24	39		Houtman, Kemp, Van der Velden, Hof and Tamminga, unpublished
	Double pelleted	21	32		
High RUP	Mash	23	52		Houtman, Kemp, Van der Velden, Hof and Tamminga, unpublished
	Double pelleted	20	50		
Standard RUP	Mash	24	47		Houtman, Kemp, Van der Velden, Hof and Tamminga, unpublished
	Double pelleted	16	39		

<sup>a</sup>Mash diets were not subjected to heat treatment.

**Table 24.5.** Pearson correlation coefficient and significance levels<sup>a</sup> of laboratory parameters and *in situ* results for starch and protein of a mixture of broken peas, lupins and faba beans<sup>b</sup> (Goelma *et al.*, 1999).

	Laboratory parameters			<i>In situ</i> parameters for protein				
	NSI <sub>H<sub>2</sub>O</sub> (%)	SGD (%)	MF	W (%)	<i>k<sub>d</sub></i> (%/h)	RUP (%)	dRUP (%)	TDP (%)
<i>Laboratory parameters:</i>								
PDI (%)	0.99 <sup>***</sup>	-0.99 <sup>***</sup>	NS	NS	0.69 <sup>***</sup>	-0.62 <sup>**</sup>	0.55 <sup>*</sup>	0.62 <sup>**</sup>
NSI <sub>H<sub>2</sub>O</sub> (%)		-0.99 <sup>***</sup>	NS	NS	0.67 <sup>**</sup>	-0.61 <sup>**</sup>	0.55 <sup>*</sup>	0.62 <sup>**</sup>
MF				-0.83 <sup>***</sup>	NS	0.57 <sup>**</sup>	-0.48 <sup>*</sup>	-0.58 <sup>**</sup>
<i>In situ parameters for starch:</i>								
W (%)		-0.53 <sup>*</sup>	-0.67 <sup>**</sup>	0.79 <sup>***</sup>	0.70 <sup>***</sup>	-0.85 <sup>***</sup>		
<i>k<sub>d</sub></i> (%/h)		NS	-0.71 <sup>***</sup>	0.87 <sup>***</sup>	0.81 <sup>***</sup>	-0.87 <sup>***</sup>		
RUS (%)		NS	0.84 <sup>***</sup>	-0.95 <sup>***</sup>	-0.73 <sup>***</sup>	0.87 <sup>***</sup>		
dRUS (%)		NS	-0.63 <sup>**</sup>				0.52 <sup>*</sup>	0.38 <sup>*</sup>
TDS (%)		NS	-0.88 <sup>***</sup>				0.64 <sup>**</sup>	0.67 <sup>**</sup>

<sup>a</sup>\*\*\*,  $P < 0.001$ ; \*\*,  $P < 0.01$ ; \*,  $P < 0.05$ ; NS, not significant.

<sup>b</sup>W, washable fraction (% of total); *k<sub>d</sub>*, fractional rate of degradation of D (%/h); RUS, rumen undegradable starch (% of starch in feed); dRUS, intestinal digestibility of starch (% of RUS); TDS, total digestibility of starch (% of starch in feed); MF, modulus of fineness; NSI<sub>H<sub>2</sub>O</sub>, nitrogen solubility index (% of total N); PDI, protein dispersability index (% of feed protein); SGD, starch gelatinization degree (% of total starch); RUP, rumen undegradable protein; dRUP, intestinal digestibility of protein (% of RUP); TDP, total digestibility of protein (% of protein in feed); RUS, rumen undegradable starch; dRUS, intestinal digestibility of starch (% of RUS); TDS, total digestibility of starch (% of starch in feed).

### Heat treatments

Solvent-extracted meals usually have a treatment history involving heat, probably making effects of additional heating less pronounced. Ljøkjel *et al.* (2000), however, reported considerable reduction in protein degradability *in situ* after autoclaving solvent-extracted soybean meal at 120 and 130°C for 30 min. In another *in situ* study (Ljøkjel *et al.*, 2003b), considerable reduction in protein degradation was found by heating barley or peas at 100°C, 125°C and 150°C for 5, 15 and 30 min in a heating bath of glycerol. Thus, the potential for increasing rumen undegradable protein appears substantial if sufficient heat is added. When processing conditions are insufficient, treatments may fail to improve nutritive value (McMeniman and Armstrong, 1979).

When studying results obtained with extruders, expanders and other applications of high-temperature short time (HTST) treatments, ruminal degradation of protein is reduced in most feedstuffs, although effects may vary depending on feedstuff and processing conditions. With the possible exception of heat input, the variation in treatment effect between and within treatments is not easily explained. Waltz and Stern (1989) studied several treatments for soybean meal and found that extruding reduced *in situ* protein degradability, but not as efficiently as expeller processing, probably because total heat input is higher during expeller processing than extruding (Broderick *et al.*, 1991). When expanding at 130 to 170°C (190°C in rapeseed meal), *in situ* ruminal degradation of protein was reduced in soybean meal, but not in rapeseed meal (Prestløkken, 1999a). However, reduced ruminal degradation of rapeseed meal by expanding has been reported (Sommer *et al.*, 1995, 1996). Only minor differences in protein degradability were found by Deacon *et al.* (1988) when extruding whole oilseed rape seeds, rape meal and soybean meal.

Several *in sacco* studies have shown that extruder treatment efficiently reduces ruminal degradation of protein in legumes such as horsebeans (Cros *et al.*, 1991a; Benchaar *et al.*, 1994a), lupins (Cros *et al.*, 1991b, 1992; Benchaar *et al.*, 1991, 1994b; Kibelolaud *et al.*, 1993) and peas (Walhain *et al.*, 1992; Petit *et al.*, 1997). Reduced *in situ* rumen degradation of protein by expander treatment of peas and soybeans has also been shown (Ljøkjel *et al.*, 2003a). With respect to cereals, the amount of literature available on effect of treatments on ruminal degradation of protein is scarce. However, recent studies have shown that expander treatment efficiently reduces *in situ* protein degradability in barley, oats, wheat and wheat bran (Weisbjerg *et al.*, 1996; Prestløkken, 1999b; Tóthi, 2003; Ljøkjel *et al.*, 2003a), whereas the effect on maize and sorghum as expected is less pronounced (Ljøkjel *et al.*, 2003a).

Roasting, toasting and micronizing are heat treatments that do not involve mechanical shear and friction as expellers, extruders and expanders. The methods seem to be of greatest interest in treatment of whole or broken seed kernels, and roasting seems to be the method most used. Roasting may efficiently reduce protein degradability *in situ* in most feeds including oilseeds (Faldet *et al.*, 1991; Tice *et al.*, 1993; Aldrich *et al.*, 1995; Demjanec *et al.*, 1995), legumes (Robinson and McNiven, 1993; Zaman *et al.*, 1995) and cereals (McNiven *et al.*, 1994, 1995). Additional toasting has been reported to reduce *in situ* ruminal degradation in rapeseed meal (Dakowski *et al.*, 1996).

As an alternative to toasting at atmospheric pressure, Goelema *et al.* (1998) reported increased RUP when applying a pressure toasting method to peas, lupins and faba beans. This method is in principle comparable to autoclaving, which was shown to give similar results for several legume seeds (Aguilera *et al.*, 1992).

With respect to micronizing, reduced ruminal protein degradation *in situ* in full fat rapeseeds has been reported (Wang *et al.*, 1999).

The correlations between laboratory parameters and *in sacco* results of toasted, expander-treated or pelleted mixtures of peas, lupins and faba beans is presented in Table 24.5. The protein dispersibility index (PDI) and the nitrogen solubility index ( $NSI_{H_2O}$ ) were positively correlated with the fractional degradation rate of protein ( $k_d$ ) and, consequently, negatively with RUP. No correlations were found between these laboratory parameters and *W*. Although the starch degree of gelatinization (SGD) was negatively correlated with *W* of starch ( $r = -0.53$ ), it was not associated with other degradability or digestibility characteristics. Modulus of fineness (MF) was correlated positively with RUP and RUS due to negative correlations with the *W* of protein and with the *W* and  $k_d$  of starch, respectively. Similar associations were observed for digestion parameters. However, the observed correlations may depend on dietary ingredients used (see Goelema, 1999).

#### *Chemical treatments*

Formaldehyde treatment is mainly used for soybean meal, but the method works efficiently with other oilseed meals as well. The concentrations of formaldehyde that have been evaluated vary considerably, ranging from 0.1 to 5%. Formaldehyde does also affect microbial attachment and thereby protein degradation in cereals (McAllister *et al.*, 1990). In the study of Waltz and Stern (1989), treatment with lignosulphonate was the only treatment comparable in effectiveness with formaldehyde in respect of protein protection in soybean meal. Lignosulphonate appears to protect protein in rapeseed meal as well (Stanford *et al.*, 1995). Unfortunately, the addition of the lignosulphonate dilutes protein with 6–8% and the Maillard reactions that take place may reduce lysine with 10–15% compared to solvent-extracted soybean meal (Harstad and Prestløkken, 2000). Reduction in lysine may also take place in formaldehyde-treated meals, since formaldehyde reacts with lysine. Broderick and Lane (1978), however, observed a relatively small loss in available lysine, due to the fact that most of the reacted formaldehyde was bound to amino acids other than lysine.

#### *Treatment of compound feeds vs. individual feedstuffs*

Formulation of compound feeds is based on the assumption that individual feedstuffs give an additive contribution to the nutritive value according to their inclusion ratio. This is of particular importance when treatment effects based on individual feedstuffs are applied in practical feed production. In feedstuffs where the treatment effect is large and the effect is based on relatively strong bonds, like in lignosulphonate and formaldehyde-treated soybean meal, post-processing within 'normal' production of compounds affects the level of

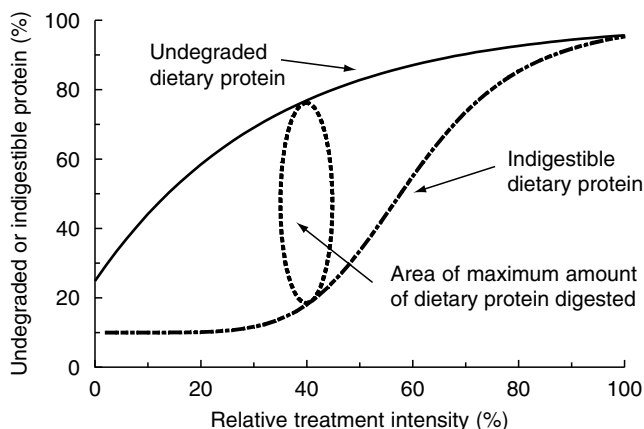
protein protection to a lesser extent than where the treatment effect is more labile and treatments effects are smaller, as has for instance been shown for toasting (De Jong, 1997; Goelema *et al.*, 1997).

Prestløkken (1999a) found good correlations between ruminal degradation measured on individually expander-processed barley, oats, soybean meal and rapeseed meal and the same feedstuffs processed as a compound in the ratio 40:40:10:10, respectively. The correlation was less satisfactory when protein feeds dominated the compound (10:10:40:40 ratio barley, oats, soybean meal and rapeseed meal, respectively). Goelema *et al.* (1998), studying pressure-toasted mixtures of peas, lupins and faba beans, concluded that protein degradability of treated mixtures can be calculated from the individual constituents. Murphy and Kennelly (1987) and DeBoever *et al.* (1995) also observed a good correlation between estimated and observed degradability of protein in untreated or pelleted mixtures, respectively. Unfortunately, other results on the topic of additivity are not consistent (untreated mixtures, Vik-Mo and Lindberg, 1985; Chapoutot *et al.*, 1990; pelleted mixtures, Van Straalen *et al.*, 1997). It must, however, be emphasized that although the topic of additivity in production of processed compound feeds is important, it is not extensively studied.

### ***Intestinal digestion of protein***

The intention of feed processing aimed at decreasing ruminal degradation of protein is at the same time to increase the amount of protein that can be digested in the small intestine. Usually, moderate heat treatment does not impair intestinal digestibility. In fact, a moderate treatment may have a positive effect on protein digestibility, but excessive heat treatment decreases digestibility of protein. Thus, treatments should be performed in a way that does not impair digestibility or at least balance the reduction in intestinal digestibility and the increase in flow of protein into the intestine. The balance between ruminal degradation and intestinal digestibility that gives the optimal window of rumen escape of intestinal digestible protein is presented in Fig. 24.1. As indicated in this figure, the amount of protein digested in the small intestine may increase although total digestibility of feed protein is reduced.

Protein digestibility in the intestine is most commonly determined by use of the mobile nylon bag method. In this method, after rumen pre-incubation small nylon bags are introduced to the small intestine through a duodenal cannula and collected, preferably in ileum, but more commonly from faeces because of its convenience. From the nylon bag residues, indigestible protein is determined (Hvelplund *et al.*, 1992). Total tract protein digestibility based on this mobile nylon bag method (TDMP) is expressed as a fraction of the original feed protein content. Some relevant results for concentrates are presented in Table 24.4. The enzymatic capacity of the small intestine to degrade protein is large (Ben-Ghedalia *et al.*, 1976), making site of collection less important, although digestibility of protein was higher in faeces than ileum in seven out of eight diet ingredients after rumen pre-incubation and in eight out of eight feedstuffs



**Fig. 24.1.** Effect of increasing treatment intensity on rumen undegraded dietary protein (RUP) (% of dietary protein) and intestinal indigestible dietary protein (% of RUP) and maximum amount of dietary protein digested in ruminants (modified from Satter, 1986).

without rumen pre-incubation (Prestløkken and Rise, 2003). However, in practice, nylon bags can be collected from faeces because magnitudes of differences were low for most ingredients.

Although many studies have been performed using the mobile nylon bag method, it appears that the number of publications discussing the effects of treatments on protein digestibility is not abundant. McNiven *et al.* (1994) found a reduction in TDMP in barley and oats after flame roasting at 168°C. In another study, flame roasting barley, oats, wheat and soybeans at 150°C for 1 to 6 min, decreased TDMP by 5 to 15 units, but not before treatment time exceeded 4 to 5 min (McNiven *et al.*, unpublished). At this stage, seed kernels started to become burned. Burning and reduced TDMP was also observed with severe roasting of sunflower meal (Schroeder *et al.*, 1996).

When expanding barley, oats, soybean meal and rapeseed meal at temperatures ranging from 130°C to more than 170°C, Prestløkken (1999a) observed no increase in total indigestible protein although RUP did increase due to the treatment, indicating increased digestibility of RUP. With respect to expander treatment, Ljøkjel *et al.* (2003a) have confirmed these results. In other studies (Ljøkjel *et al.*, 2003b,c), the indigestible protein fraction was increased by heating barley and peas at 150°C, but not at 100 and 125°C. The increase in the indigestible fraction at 150°C was enhanced by treatment time and glucose addition, indicating that Maillard products can be formed at severe conditions during heat processing.

No major negative effect on TDMP in an extensive study with pressure toasting of legumes was found (Goelma, 1999). Likewise, the study of Harstad and Prestløkken (2000) indicated that TDMP is not negatively affected in lignosulphonate-treated soybean meal. These observations indicate that such treatments can be applied without severely affecting protein disappearance



from mobile nylon bags. However, in other cases heat treatments have reduced intestinal digestibility of protein in soybean meal and rapeseed meal (McKinnon *et al.*, 1991; Moshtaghi Nia and Ingalls, 1995; Dakowski *et al.*, 1996). Reduced digestibility of protein was also observed when rapeseed meal was treated with 30 and 40 g CP formaldehyde/kg (Antoniewicz *et al.*, 1992) and when soybean meal was treated with 0.3 and 0.5% formaldehyde (Hvelplund, 1985). However, for two commercially available formaldehyde-treated rapeseed meals, the dRUP was 89% and 89%, respectively, whereas the untreated meal showed an intestinal digestibility of 79% (De Jong, 1997). Therefore, it can be concluded that protein digestibility may vary with the applied formaldehyde treatment. It must also be emphasized that, in general, specific amino acids such as lysine are reactive during processing, and might be more readily affected than the protein itself, causing a decrease of the biological value of the protein.

### ***Ruminal degradation and intestinal digestion of starch***

#### *Physical treatment*

Manipulating ruminal degradation of protein by processing is usually directed towards reduced rumen degradability. The processing effects on starch degradability may be directed towards either increased or decreased degradation depending on the type of feedstuff. However, most processing methods result in increased rates of starch degradation (Owens *et al.*, 1986; Nocek and Tamminga, 1991), which may be related to the degree of starch gelatinization due to processing.

For maize and sorghum, with a naturally high resistance against rumen degradation, steam flaking results in an improved rumen degradability and intestinal digestibility (e.g. Ørskov, 1976; Theurer, 1986). Intensity of steam flaking can be altered by varying flake density, as was shown by Alio *et al.* (2000). For processed barley, Yang *et al.* (2000) showed that for lactating dairy cows optimum steam processing degree was intermediate between coarse and flatly rolled barley. A too coarse product resulted in a lower intake, while more intensive processing did not further improve starch utilization. Ørskov (1986) concluded that processing of barley should be minimized to limit rumen fermentation. This is based on the observation that the inclusion of high amounts of rapidly degradable starch in diets of dairy cows cause problems with silage intake and rumen functioning (see Chapter 10). Therefore, the desired method of processing of starch sources should be considered in the light of their expected use.

Harstad *et al.* (1996) showed that expander treatment of barley-based concentrate increased rumen degradability *in vivo* to 86% compared to pelleting (82%), resulting in lower rumen pH and a change in volatile fatty acid pattern. In contrast, expander treatment had no effect on rumen degradability of oats-based concentrate, which may be the result of the high degradability of pelleted oats-based concentrate (94%). In contrast to the results of Harstad *et al.* (1996), in an *in sacco* study Arieli *et al.* (1995) observed after expander

treatment of wheat, barley, sorghum and maize, 34, 27, 14 and 9% reduction in ruminal starch degradability, respectively. For extrusion, *in sacco* degradability decreased by 27, 27, 17 and 6% in wheat, barley, sorghum and maize, respectively. It was unclear what caused the difference with other studies after expander treatment and extrusion.

Pelleting as well as expander treatment increased *in sacco* starch degradability of two concentrates for dairy cows in a study by Goelema *et al.* (1996) (Table 24.4). Compared to the unprocessed mash, pelleting and expander treatment resulted in a decrease in particle size, and an increase in starch gelatinization. These results are in agreement with other *in sacco* studies in The Netherlands (Tamminga and Goelema, unpublished), where the mean decrease of undegraded dietary starch (RUS) due to pelleting based on results for 11 concentrates was 12.5%. Based on these results, RUS values of concentrate ingredients in the Dutch feeding tables (CVB, 2004) are corrected by 12.5% for the effects of pelleting. In an experiment by Tóthi *et al.* (2003), however, expander treatment combined with subsequent pelleting resulted in an increased starch degradability for maize, while for barley, there was little difference. Ljøkjel *et al.* (2003a) found an increase in nylon bag degradation of starch in the rumen by pelleting and expander pelleting maize, sorghum and peas. In barley and wheat they found a small decrease in starch degradation especially by expander pelleting, whereas oats and wheat bran were mainly unaffected by the treatment.

Goelema *et al.* (1998) studied effects of pressure toasting on *in sacco* starch degradability in whole and broken peas and faba beans (Table 24.3). These authors observed an increased fraction of rumen-undegraded starch. For peas, RUS increased from 39 to 50% (whole peas) and 53% (broken peas) after pressure toasting for 3 min at 132°C. For horsebeans, RUS increased from 33 to 53% (whole beans) and 60% (broken beans). RUS increased due to a decreased washable fraction, whereas fractional rate of degradation increased. The reason for this unexpected result was due to specific processing conditions, which limited starch gelatinization, but substantially increased protein denaturation, resulting in a protective matrix around the starch granules. The differences between the effect of pressure toasting for whole and broken (by rolling) seeds illustrate the interaction between breaking and the steam treatment. When rolling cracks the seed hull and the seed itself, transfer of heat and especially of moisture is facilitated. For broken seeds, the more intensive heat treatment improved conditions for starch to undergo gelatinization, as was confirmed by the increased *in vitro* starch gelatinization degree.

The results for pressure-toasted legumes were confirmed in other *in situ* studies with peas and faba beans (Goelema, 1999), and for oats and barley, but not for maize (Goelema, Gotvassli, Harstad and Tamminga, unpublished). In that study, barley, oats and maize were pressure toasted at 100, 118 and 136°C for 1.5, 3, 7, 15 and 30 min. Effective starch degradability *in sacco* for barley decreased from 84% to a minimum of 64% after toasting for 30 min at 100°C. Toasting at a higher temperature decreased starch degradability to a lesser extent. For oats, *in sacco* starch degradability decreased from 95%,

to a minimum of 70% after toasting for 7 min at 136°C. For maize, however, toasting increased starch degradability, especially at the higher temperatures. An *in vivo* evaluation of toasted barley for lactating dairy cows confirmed the *in situ* results after pressure toasting for barley (Harstad *et al.*, 2002). With respect to processing, total tract starch digestibility was hardly affected. The intestinal starch digestibility of pressure-toasted barley and oats was higher than for the untreated cereals. For barley, dRUS increased from 82 to 85% (100°C/3 min) and 84% (118°C/1.5 min). For legumes, Goelema (1999) reported no significant effects on total tract starch digestibility after pressure toasting of faba beans and peas. However, due to the higher fraction of RUS, intestinal digestibility of starch increased numerically from 53 and 52% for untreated to 62 and 73% for toasted faba beans and peas, respectively. It can therefore be concluded that, even when steam processing decreased rumen degradability, intestinal digestibility was not decreased, but seemed to be higher than for untreated feedstuffs.

Comparing the results for peas and horsebeans with those for oats and barley after pressure toasting indicated that the protein/starch ratio, which is 0.6 and 0.7 for peas and horsebeans and only 0.22, 0.25 and 0.18 for barley, oats and maize, is not very likely to be an important factor explaining the effects on starch degradability after pressure toasting. McNiven *et al.* (1994) concluded that roasting cereals decreased effective degradability of starch and protein, although the effect was smaller for maize than for wheat, oats and barley. This is in line with results of Goelema, Gotvassli, Harstad and Tamminga (unpublished) after pressure toasting of barley and oats. In a later study, no effect on the digestibility and flow of starch in cows fed roasted barley was found (McNiven *et al.*, 1995).

The decreased rumen degradability of starch, which is observed after heat treatment, especially when no or only limited shear treatment is applied, is considered to be the resultant from structural changes in the matrix embedding the starch granules. Denaturation of the protein in this matrix reduces the degradability of the protein, and indirectly, of the starch. When shear treatment is involved, as e.g. in steamflaking, the shear forces may disrupt the protective layer around the starch, and render it more accessible for the rumen microbes. Osman *et al.* (1970) confirmed this mechanism when observing that *in vitro* starch digestion was reduced when barley and sorghum were steamed, but increased when they were flaked (Table 24.6). Results from Ljøkjel *et al.* (2003c) on heating barley and peas at 100, 125 and 150°C in brass tubes immersed in glycerol indicate that a temperature threshold exists where starch gelatinizes independent of mechanical influence.

For processed maize, Joy *et al.* (1997) recently confirmed in an *in vivo* trial that steam flaking (toasting at 103°C for 20 min, followed by rolling at a density of 0.39 kg/l) decreased apparent ruminal starch digestion from 34 to 27%. When degree of flaking was intensified to a density of 0.31 kg/l, starch digestion in the rumen increased to 45%, concomitantly decreasing the amount of postruminally digested starch. Intestinal digestion and total tract digestion of steam-flaked maize compared to untreated maize increased from 64 to 80 and 90% and from 78 to 85 and 94%, respectively.

**Table 24.6.** Influence of various processing methods on starch digestion (*in vitro*) and starch digestion after 16 h rumen incubation (*in sacco*).

Feedstuff	Treatment	Conditions	Digestion	Reference
			<i>In vitro</i>	
Barley	Untreated	–	21	Osman <i>et al.</i> (1970)
	Toasted	1.4 kg/cm <sup>2</sup>	18	
	Toasted/flaked	1.4 kg/cm <sup>2</sup>	17	
	Pressure cooked/flaked	2.8 kg/cm <sup>2</sup>	19	
	Pressure cooked/flaked	4.2 kg/cm <sup>2</sup>	31	
Sorghum	Untreated	–	–	
	Toasted	1.4 kg/cm <sup>2</sup>	16	
	Toasted/flaked	1.4 kg/cm <sup>2</sup>	12	
	Pressure cooked/flaked	2.8 kg/cm <sup>2</sup>	13	
	Pressure cooked/flaked	4.2 kg/cm <sup>2</sup>	16	
	Pressure cooked/flaked	5.6 kg/cm <sup>2</sup>	22	
			<i>In sacco</i>	
Barley	Untreated	–	95	Ljøkjel <i>et al.</i> (2003c)
	Toasted	100°C	71	
	Toasted	125°C	72	
	Toasted	150°C	88	
Peas	Untreated	–	72	Ljøkjel <i>et al.</i> (2003c)
	Toasted	100°C	48	
	Toasted	125°C	45	
	Toasted	150°C	52	

### *Chemical treatment*

In several trials, Fluharty and Loerch (1989) studied the effect of chemical agents to protect starch from ruminal degradation. Glyoxal, masonex, propion-aldehyde and tannic acid did not affect *in vitro* DM disappearance of maize, whereas increasing levels of formaldehyde were correlated with a reduced DM disappearance. In an *in vivo* evaluation, formaldehyde treatments at 1 and 2% (wt/wt) levels decreased ruminal degradation of starch by 30 and 45% compared to untreated maize. Total tract digestibility of formaldehyde-treated maize was not affected, indicating increased starch digestibility in the intestines.

Michalet-Doreau *et al.* (1997) showed that formaldehyde treatment was effective in decreasing starch and protein degradation in wheat and maize (Table 24.3). Treatment effects were larger for barley than for maize, indicating that the treatment was more efficient when cereal starch and/or protein was highly degradable. This may be related to differences in properties of the protein matrix of the two cereals.

Although *in situ* results for effects of formaldehyde treatment are consistent, evaluation in several studies showed that *in vivo* results were similar for maize (Oke *et al.*, 1991), but inconsistent for barley and wheat (Van Ramshorst and Thomas, 1988; Morgan *et al.*, 1989; Ortega-Cerrilla and Finlayson, 1991, 1994; McAllister *et al.*, 1992). This may be caused by differences between the calculated *in situ* digestibility and the measured *in vivo* digestibility.

In addition, up-scaling of thermal treatments from laboratory preparation (for *in situ* studies) to larger scale production (for *in vivo* trials) may also be a causative factor for observed differences in view of the applied apparatus dimensions, potential capacity and throughput.

McNiven *et al.* (1995) showed that starch degradability in the rumen of lactating dairy cows was decreased after sodium hydroxide treatment of barley, but the treatment had detrimental effects on feed intake, digestibility and milk production.

## Aspects of Processing on Nutritionally Active Factors and on Environment

### *Nutritionally active factors*

Nutritionally active substances have been described as naturally occurring in plant seeds used in animal nutrition. These factors at low levels may sometimes act positively on health. However, at higher levels, they may often negatively affect digestion of nutrients and are therefore referred to as antinutritional factors (ANF). They are best classified on the basis of the type of nutrients (e.g. proteins) they affect, either directly or indirectly, and the biological response (e.g. inhibition of protein digestion) of the animal. On this basis, one may distinguish factors depressing the digestion or metabolic utilization of proteins, including protease inhibitors, lectins (haemagglutinins), saponins or polyphenolic compounds (tannins), factors depressing the digestion of carbohydrates, such as amylase inhibitors, polyphenolic compounds and flatulence factors, factors inactivating vitamins or increasing the requirements of certain vitamins (antivitamins), factors that stimulate the immune system (antigenic proteins) and other factors like isoflavones, lathyrogens and glucosinolates (modified after Chubb, 1982). The type and level of ANF in different feedstuffs varies considerably. For the occurrence of ANF in seeds, the reader is referred to the articles of Chubb (1982) and Huisman and Tolman (1992). The most important *in vivo* effects caused by ANF have been summarized in Table 24.7.

In their review, Hill and Tamminga (1998) indicated that many ANF may be present in feedstuffs and their effects have been described, but only some of them may cause problems and then especially in the preruminant calf. For older ruminants, the presence of the rumen minimizes the problems associated with seed ANF in ruminant nutrition. Problems associated with ruminant nutrition were designated to ANF such as alkaloids, lectins, trypsin inhibitors and glucosinolates. For alkaloids, emphasis has been placed in research on lupin alkaloids in feeding domestic animals and ruminants in the wild. There appears to be no new evidence since 1993 (Hill and Pastuzewska, 1993) that alkaloids cause problems in ruminant feeding, apart from loss of appetite. Lectins as proteins or glycoproteins have considerable differences in their severity of effect and mode of action (Kik *et al.*, 1989), with their pathogenicity ranging from non-toxic (faba bean, pea, lentil) to growth inhibition (soybeans)

**Table 24.7.** Some *in vivo* antinutritional effects in diets for ruminants (modified from Hil and Tamminga, 1998).

Factor	<i>In vivo</i> effect in ruminants	Solution
Alkaloids	Loss of appetite by bitter lupin species	Use sweet lupin species
Antigens	Intolerances for preruminant calf	Treatment; do not use in preruminant calves
Isoflavones	No evidence for reproductive disorders	—
Lathyrogens	Not likely to be a problem	—
Lectins	Variable findings with unprocessed lectins No real problem for mature ruminants	Thermal processing of seeds
Tannins	Not likely to cause problems	—
Trypsin inhibitors	Not a major problem; some evidence that inhibitors may escape rumen degradation	Thermal processing, breeding
Glucosinolates	Marked physiological effects even at low levels; GSL by products carry-over to milk	Plant breeding; processing

to acute toxicity in certain varieties of *Phaseolus vulgaris* beans (Grant, 1991). In ruminants, lectins may be only partly inactivated in the rumen since some lectins reached the terminal ileum to affect the mucosa of the intestinal wall; this may reduce the extent of nutrient digestion and absorption and may increase cellular protein and mucin synthesis. In addition, effects on the systemic metabolism and immune system have been described. Fortunately, there are numerous methods to process lectin-containing seeds prior to their feeding so that lectins do not form a serious problem in feeding mature ruminants (Hil and Tamminga, 1998).

Various studies on effects of trypsin inhibitors on ruminants (Holmes *et al.*, 1993; Aldrich *et al.*, 1997) indicated that rumen escape of trypsin inhibitors could take place and could lower the intestinal digestibility of soybean proteins. In that case, trypsin inhibitor inactivation by processing should be studied in feedstuffs in relation to effects and treatment cost.

A special feature in ruminant nutrition is the role of phenolic compounds or chemically condensed tannins, referring to the prevention of bloat when animals eat pastures rich in soluble proteins. Also, the ability of phenolic compounds to form a complex with free protein in the rumen may protect protein against rumen degradation (D'Mello, 1992). These factors can therefore be used to manipulate rumen undegradable protein and thus can be an advantage in ruminant feeding when proper technology is applied.

Feed processing, especially thermal processing, is a classical approach that has been used to reduce the impact of ANF present in diet ingredients. The attraction of thermal processing is its wide applicability. Most ANF, especially those proteinaceous in nature, are heat-labile to varying extents. Various forms of, especially primary, processing typically involving heat, moisture and shear in various combinations and intensity are used for ANF removal or inactivation but have also a broad spectrum of potential damaging activity (Campbell and van der Poel, 1998). In the sense of destruction this is, of course, not limited to

ANF: valuable nutrients may be indiscriminately targeted as well (Voragen *et al.*, 1995).

Biotechnology offers other techniques for the elimination or inactivation of ANF with the use of (a diversity of) microbial enzymes as reviewed by Classen *et al.* (1993). Strategies for the management of ANF by enzyme applications in the nutrition of monogastric animals therefore are many. For ruminants, however, the application should be limited to those ANF hampering ruminant nutrition (Table 24.7).

### **Other aspects**

Feed processing may change nutrient degradability and digestion, thus potentially affecting nutritive value and nutrient utilization. From an environmental point of view, and also in the interest of animal health, both beneficial and harmful effects may occur. Intensive dairy industry contributes considerably to environmental problems like pollution of soil, water and air and the impairment of the ozone layer. Increasing the feeding value by processing to increase rumen bypass of nutrients, may decrease fermentation losses (CH<sub>4</sub>), whilst synchronization of the supply of energy and protein within the rumen may increase N-efficiency, resulting in decreased faecal and urinary N-output (Taminga, 1991). With respect to animal health two questions are critical. What are the effects of a nutrient deficit and what are the effects of a nutrient excess?

Ideally, protein feeding is a question of balancing the supply to the need of the animal, and that is what modern protein evaluation models intend to do (see Chapter 27). However, in practice, protein feeding is often a matter of supplying the animal with sufficient protein at the lowest possible cost, giving rise to possible underfeeding or overfeeding of protein. Through feed processing, rumen availability of protein can be affected, and thus, be used to manipulate protein supply to the animal. Kebreab *et al.* (2002) showed that especially urinary N excretion may be considerably reduced by reducing the rumen availability of protein. As described previously, most processing methods aim to reduce protein degradation in the rumen and in this respect may help to decrease N excretion to the environment by limiting the production of ammonia in the rumen. However, rumen protein availability must not be reduced to such an extent that it limits the N supply to rumen microbes. In addition to environmental problems of excess of N in faeces and urine, excess of protein may also negatively affect animal fertility (Butler, 1998; Sinclair *et al.*, 2000).

When diets are fed that have high levels of rapidly degradable carbohydrates, problems such as acidosis may occur. Depending on severity, acidosis may result in problems including reduced rumen activity and lack of appetite ultimately leading to rumen keratosis, laminitis and even death (Nocek, 1997). Technological treatments aimed at a reduction of starch degradability in the rumen may be of interest here. For example, Reinhardt *et al.* (1997) showed that increasing the flake density of sorghum resulted in a linear reduction of ruminal pH. This resulted in a higher susceptibility to sub-acute acidosis, which was accompanied with a reduced intake, poorer animal performance in feedlot

steers and higher costs of production of the steam-flaked sorghum. As described previously, most processing methods result in increased ruminal degradation of starch, thus increasing the risk of acidosis. In such situations, less thorough processing of grains is required, or techniques that may decrease starch degradation in the rumen (such as toasting) may be helpful.

As mentioned before, methods are used for routine ruminant diet processing, involving pre-compaction processing (at higher temperatures) prior to agglomeration. These methods have been developed to positively influence the pellet durability of ruminant diets after agglomeration. However, it is noted that only a few studies have been carried out to elucidate the effects of pre-compaction methods on the recovery of certain vitamins (vitamin A, not cross linked, vitamin K<sub>3</sub>, vitamin B<sub>12</sub> and, especially, the crystalline form of vitamin C) and on the utilization of minerals and trace elements (Albers *et al.*, 2003; K.D. Bos, 2004, personal communication).

## Conclusions

Several processing methods are available to effectively shift digestion from the rumen to the intestines. For protein, both dry heat treatments, such as roasting and micronizing, as well as moist heat treatments, such as toasting and autoclaving, have been shown to effectively reduce rumen protein degradation. Methods that involve a certain heat treatment, usually based on steam addition, as well as a more or less intensive shearing action, such as steam flaking, expander and extrusion treatment and pre-compaction/pelleting, can result in decreased rumen degradability due to structural changes and specific reactions of the protein fraction. On the other hand, shearing action may result in surface enlargement due to particle size reduction, which gives rise to an increased rumen protein degradability. The interaction between these effects determines the net result of the treatment. The intestinal and overall digestibility of heat-treated protein may decrease as a result of a too intensive heat treatment (treatment temperature too high and/or treatment time too long). With respect to chemical treatments, addition of formaldehyde and solutions containing reducing sugars such as lignosulphonate are widely used to protect protein from rumen degradation. For formaldehyde, studies have shown that too high concentrations may impair total tract and intestinal digestibility. For lignosulphonate treatment, dilution as well as reaction of lysine decreases the available lysine content.

For starch, processing is carried out for different reasons, related to the feedstuff and its intended use. Slowly degradable starch sources like maize and sorghum are processed to increase rumen degradability and digestibility, whereas more easily degradable starch sources such as barley, oats and wheat could be processed to decrease its rumen degradability. All these different ways of processing of starch seem to increase intestinal starch digestibility. Formaldehyde treatment may efficiently decrease ruminal starch degradability, although *in vivo* studies do not always confirm *in situ* results. Depending on the processing conditions, heat treatments may either decrease or increase ruminal



starch degradability. Conditions that favour gelatinization, which means sufficient moisture, shear and temperature, increase starch degradability whereas treatments which limit gelatinization, but result in protein denaturation, may result in an overall decreased starch degradability. This has been shown for toasting, pressurized toasting, and some specific studies with roasting and steam flaking. Choosing the right combination of concentrate ingredients and the appropriate processing conditions enables feed manufacturers to optimize nutritive value of concentrates, which is of benefit for an economical and environmentally acceptable production.

Finally, since these research results show a large variability in nutrient degradation among feedstuffs due to processing methods and conditions, proper description of the methods is required in order to implement the results in quantitative feed evaluation. Such descriptions should include the full documentation of the used processing conditions in experiments, the variation of analytical methods used in laboratories and standardization of *in vitro* or *in situ* techniques.

## References

- Aguilera, J.F., Bustos, M. and Molina, E. (1992) The degradability of legume seed meals in the rumen: effect of heat treatment. *Animal Feed Science and Technology* 36, 101–112.
- Albers, N., Heimbeck, W., Keller, Th., Seehawer, J. and Tran, T.D. (2003) *Vitamine in der Tierernährung*. Arbeitsgemeinschaft für Wirkstoffe in der Tierernährung. E.V. (AWT), Agrimedia, Bonn, Germany.
- Aldrich, C.G., Merchen, N.R., Nelson, D.R. and Barmore, J.A. (1995) The effects of roasting temperature applied to whole soybeans on site of digestion by steers: II. Protein and amino acid digestion. *Journal of Animal Science* 73, 2131–2140.
- Aldrich, C.G., Merchen, N.R., Parsons, C.M., Hussein, H.S., Ingram, S. and Clodfelter, J.R. (1997) Assessment of postruminal amino acid availability of roasted and extruded whole soybeans with the precision-fed rooster assay. *Journal of Animal Science* 75, 3046–3051.
- Alio, A., Theurer, C.B., Lozano, O., Huber, J.T., Swingle, R.S., Delgado-Elorduy, A., Cuneo, P., DeYoung, D. and Webb, K.E. Jr (2000) Splanchnic nitrogen metabolism by growing beef steers fed diets containing sorghum grain flaked at different densities. *Journal of Animal Science* 78, 1355–1363.
- Antoniewicz, A., van Vuuren, A.M., van der Koelen, C.J. and Kosmala, I. (1992) Intestinal digestibility of rumen undegraded protein of formaldehyde treated feedstuffs measured by mobile bag and *in vitro* technique. *Animal Feed Science and Technology* 39, 111–124.
- Arieli, A., Bruckental, I., Kedar, O. and Sklan, D. (1995) *In sacco* disappearance of starch, nitrogen and fat in processed grains. *Animal Feed Science and Technology* 51, 287–295.
- Behnke, K.C. (1996) Feed manufacturing technology: current issues and challenges. *Animal Feed Science and Technology* 62, 49–57.
- Benchaar, C., Bayourthe, C., Moncoulon, R. and Vernay, M. (1991) Digestion ruminale et absorption intestinale des protéines du lupin extrudé chez la vache laitière. *Reproduction Nutrition Développement* 32, 655–665.

- Benchaar, C., Vernay, M., Bayourthe, C. and Moncoulon, R. (1994a) Effects of extrusion of whole horse beans on protein digestion and amino acid absorption in dairy cows. *Journal of Dairy Science* 77, 1360–1371.
- Benchaar, C., Moncoulon, R., Bayourthe, C. and Vernay, M. (1994b) Effects of supply of raw or extruded white lupin seeds on protein digestion and amino acid absorption in dairy cows. *Journal of Animal Science* 72, 492–501.
- Ben-Ghedalia, D., Tagari, H. and Bondi, A. (1976) The ileum of the sheep as a site of protein digestion. *British Journal of Nutrition* 36, 211–217.
- Broderick, G.A. and Lane, G.T. (1978) Lactational, *in vitro* and chemical evaluation of untreated and formaldehyde treated casein supplement. *Journal of Dairy Science* 61, 932–939.
- Broderick, G.A., Wallace, R.J. and Ørskov, E.R. (1991) Control of rate and extent of protein degradation. In: Tsuda, T., Sasaki, Y. and Kawashima, R. (eds) *Physiological Aspects of Digestion and Metabolism in Ruminants*. Academic Press, London, pp. 541–592.
- Butler, W.R. (1998) Review: Effect of protein nutrition on ovarian and uterine physiology in dairy cattle. *Journal of Dairy Science* 81, 2533–2539.
- Campbell, G.L. and van der Poel, A.F.B. (1998) Use of enzymes and process technology to inactivate antinutritional factors in legume seeds and rapeseed. In: Jansman, A.J.M., Hill, G.D., Huisman, J. and van der Poel, A.F.B. (eds) *Recent Advances of Research in Antinutritional Factors in Legume Seeds and Rapeseed*. Wageningen Pers, Wageningen, The Netherlands, pp. 377–386.
- Chapoutot, P., Giger, S., Sauvant, D. and Jeantet, S. (1990) Etude de l'additivité de la dégradation *in sacco* de la matière sèche des mélanges simples d'aliments concentrés. *Reproduction Nutrition Développement* 30 (Suppl. 2), 169s–170s.
- Chubb, L.G. (1982) Anti-nutritive factors in animal feedstuffs. In: Haresign, W. (ed.) *Recent Advances in Animal Nutrition*. Butterworths, London, pp. 21–37.
- Classen, H.L., Balnave, D. and Bedford, M.R. (1993) Reduction of legume antinutritional factors using biotechnological techniques. In: Jansman, A.J.M., Hill, G.D., Huisman, J. and van der Poel, A.F.B. (eds) *Recent Advances of Research in Antinutritional Factors in Legume Seeds and Rapeseed*. Wageningen Pers, Wageningen, The Netherlands, pp. 501–516.
- Cleale, R.M., Klopfenstein, T.J., Britton, R.A., Satterlee, L.D. and Lowry, S.R. (1987) Induced nonenzymatic browning of soybean meal. I. Effects of factors controlling non-enzymatic browning on *in vitro* ammonia release. *Journal of Animal Science* 65, 1312–1318.
- Colonna, P., Leloup, V. and Buléon, A. (1992) Limiting factors of starch hydrolysis. *European Journal of Clinical Nutrition* 46, 17–32.
- Crooker, B.A., Clark, J.H., Shanks, R.D. and Hatfield, E.E. (1986) Effects of ruminal exposure on the amino acid profile of heated and formaldehyde-treated soybean meal. *Journal of Dairy Science* 69, 2648–2657.
- Cros, P., Vernay, M. and Moncoulon, R. (1991a) *In situ* evaluation of the ruminal and intestinal degradability of extruded whole horsebeans. *Reproduction Nutrition Développement* 31, 249–255.
- Cros, P., Benchaar, C., Bayourthe, C., Vernay, M. and Moncoulon, R. (1991b) *In situ* evaluation of the ruminal and intestinal degradability of extruded whole lupin seed nitrogen. *Reproduction Nutrition Développement* 31, 575–583.
- Cros, P., Moncoulon, R., Bayourthe, C. and Vernay, M. (1992) Effect of extrusion on ruminal and intestinal disappearance of amino acids in white lupin seed. *Canadian Journal of Animal Science* 72, 89–92.

- CVB (2004) *Centraal Veevoederbureau Veevoedertabel 2004*. CVB, Lelystad, The Netherlands.
- Dakowski, P., Weisbjerg, M.R. and Hvelplund, T. (1996) The effect of temperature during processing of rape seed meal on amino acid degradation in the rumen and digestion in the intestine. *Animal Feed Science and Technology* 58, 213–226.
- Deacon, M.A., de Boer, G. and Kennelly, J.J. (1988) Influence of jet-sploding and extrusion on ruminal and intestinal disappearance of canola and soybeans. *Journal of Dairy Science* 71, 745–753.
- DeBoever, J.L., Vanacker, J.M., Bogaerts, D.F. and Bouqué, Ch.V. (1995) Protein evaluation of cattle compound feeds: comparison of *in sacco* measurements and tabular values. *Netherlands Journal of Agricultural Science* 43, 297–311.
- De Jong, J. (1997) Eiweißbewertungssystem und Futterwert von Rohstoffen. *Kraftfutter* 11/97, 476–480.
- Demjanec, B., Merchen, N.R., Cremin, J.D. Jr, Aldrich, C.G. and Berger, L.L. (1995) Effects of roasting on site and extent of digestion by soybean meal by sheep: I. Digestion of nitrogen and amino acids. *Journal of Animal Science* 73, 824–834.
- D'Mello, J.P.F. (1992) Chemical constraints to the use of tropical legumes in animal nutrition. *Animal Feed Science and Technology* 38, 237–261.
- Faldet, M.A., Voss, V.L., Broderick, G.A. and Satter, L.D. (1991) Chemical, *in vitro* and *in situ* evaluation of heat-treated soybean proteins. *Journal of Dairy Science* 74, 2548–2554.
- Finley, J.W. (1989) Effects of processing on proteins: an overview. In: Phillips, R.D. and Finley, J.W. (eds) *Protein Quality and the Effects of Processing*. Dekker, New York, pp. 1–8.
- Fluharty, F.L. and Loerch, S.C. (1989) Chemical treatment of ground corn to limit ruminal starch digestion. *Canadian Journal of Animal Science* 69, 173–180.
- Goelema, J.O. (1999) Processing of legume seeds: effects on digestive behaviour in dairy cows. PhD Thesis, Wageningen University, Wageningen, The Netherlands.
- Goelema, J.O., Hof, G., van der Poel, A.F.B. and Tamminga, S. (1996) Effect of particle size, cold pelleting, steam pelleting and expander treatment on the rumen degradability of a compound feed for ruminants. *Journal of Dairy Science* 79 (Suppl. 1), 142.
- Goelema, J.O., van der Poel, A.F.B., Hof, G. and Tamminga, S. (1997) Effects of pressure toasting, expander treatment and pelleting on digestive behaviour of a dairy compound feed. In: Van Arendonk, J.A.M. (ed.) *Book of Abstracts of the 48th Annual Meeting of the European Association for Animal Production*, No. 3. Wageningen Pers, Wageningen, The Netherlands, 113 pp.
- Goelema, J.O., Spreeuwenberg, M.A.M., Hof, G., van der Poel, A.F.B. and Tamminga, S. (1998) Effect of pressure toasting on the rumen degradability and intestinal digestibility of whole and broken peas, lupins and faba beans and a mixture of these feedstuffs. *Animal Feed Science and Technology* 76, 35–50.
- Goelema, J.O., Smits, A., Vaessen, L.M. and Wemmers, A. (1999) Effect of pressure toasting, expander treatment and pelleting on *in vitro* and *in situ* parameters of protein and starch in a mixture of broken peas, lupins and faba beans. *Animal Feed Science and Technology* 78, 109–126.
- Grant, G. (1991) Lectins. In: D'Mello, J.P.F., Duffus, C.M. and Duffus, J.H. (eds) *Toxic Substances in Crop Plants*. Royal Society of Chemistry, Cambridge, UK, pp. 49–67.
- Harstad, O.M. and Prestløkken, E. (2000) Effective rumen protein degradability and intestinal digestibility of individual amino acids in solvent-extracted soybean meal (SBM) and xylose-treated SBM (SoyPass) determined *in situ*. *Animal Feed Science and Technology* 83, 31–47.

- Harstad, O.M., Prestløkken, E. and Nordheim, H. (1996) Ruminal fermentation and digestion of carbohydrate fractions in lactating cows fed pelleted or expanded barley and oat based concentrates. In: Van Arendonk, J.A.M. (ed.) *Book of Abstracts of the 47th Annual Meeting of the European Association for Animal Production*, No. 2. Wageningen Pers, Wageningen, The Netherlands, p. 82.
- Harstad, O.M., Norberg, E., Goelema, J.O and Tamminga, S. (2002) Effects of pressure toasting of barley on ruminal fermentation, amount of metabolizable starch and protein, and performance of dairy cows. In: Van der Honing, Y. (ed.) *Book of Abstracts of the 53rd Annual Meeting of the European Association for Animal Production*, No. 8. Wageningen Academic Publishers, Wageningen, The Netherlands, 53 pp.
- Heimann, M. (1994) Roller mill systems. In: McEllhiney, R.R. (ed.) *Feed Manufacturing Technology IV*. American Feed Industry Association, Arlington, Virginia, pp. 91–97.
- Hill, G.D. and Pastuzewska, B. (1993) Lupin alkaloids and their role in animal nutrition. In: Van der Poel, A.F.B., Huisman, J. and Saini, H.S. (eds) *Recent Advances of Research in Antinutritional Factors in Legume Seeds*. Wageningen Pers, Wageningen, The Netherlands, pp. 219–233.
- Hill, G.D. and Tamminga, S. (1998) The effects of antinutritional factors in legumes and rapeseed on ruminant nutrition. In: Jansman, A.J.M., Hill, G.D., Huisman, J. and van der Poel, A.F.B. (eds) *Recent Advances of Research in Antinutritional Factors in Legume Seeds and Rapeseed*. Wageningen Pers, Wageningen, The Netherlands, pp. 157–172.
- Holmes, J.H.G., Dixin, R.M., Smith, C., Chau, H., Sanpote, S. and Acharyya, B. (1993) Resistance of trypsin inhibitors to fermentation by rumen microflora. In: Van der Poel, A.F.B., Huisman, J. and Saini, H.S. (eds) *Recent Advances of Research in Antinutritional Factors in Legume Seeds*. Wageningen Pers, Wageningen, The Netherlands, pp. 183–186.
- Holum, J.R. (1982) *Fundamentals of General, Organic, and Biological Chemistry*, 2nd edn. John Wiley & Sons, New York.
- Huisman, J. and Tolman, G.H. (1992) Antinutritional factors in the plant proteins of diets for non-ruminants. In: Garnsworthy, P.C., Haresign, W. and Cole, D.J.A. (eds) *Recent Advances in Animal Nutrition*. Butterworth-Heinemann, Oxford, UK, pp. 3–31.
- Hvelplund, T. (1985) Digestibility of rumen microbial protein and undegraded dietary protein estimated in the small intestine of sheep and by *in sacco* procedure. *Acta Agriculturae Scandinavica* 25, 132–144.
- Hvelplund, T., Weisbjerg, M.R. and Andersen, L.S. (1992) Estimation of the true digestibility of rumen undegraded dietary protein in the small intestine of ruminants by the mobile bag technique. *Acta Agriculturae Scandinavica* 42, 34–39.
- Joy, M.T., DePeters, E.J., Fadel, J.G. and Zinn, R.A. (1997) Effects of corn processing on the site and extent of digestion in lactating cows. *Journal of Dairy Science* 80, 2087–2097.
- Kaufmann, W. and Lüpping, W. (1982) Protected proteins and protected amino acids for ruminants. In: Miller, E.L., Pike, I.H. and van Es, A.J.H. (eds) *Protein Contribution of Feedstuffs for Ruminants: Application to Feed Formulation*. Butterworths, London, pp. 36–75.
- Kebreab, E., France, J., Mills, J.A.N., Allison, R. and Dijkstra, J. (2002) A dynamic model of N metabolism in the lactating dairy cow and assessment of impact on N excretion on the environment. *Journal of Animal Science* 80, 248–259.

- Kibelolaud, A.R., Vernay, M., Bayourthe, C. and Moncoulon, R. (1993) Effect of extruding on ruminal disappearance and lower gastrointestinal tract digestion of white lupins. *Canadian Journal of Animal Science* 73, 571–579.
- Kik, M.J.L., Rojer, J.M., Mouwen, J.M.V.M., Koninkx, J.F.J.G., Dijk, J.E. and van der Hage, M.H. (1989) The interaction between plant lectins and the small intestinal epithelium: a primary cause of intestinal disturbance. *The Veterinary Quarterly* 11, 108–115.
- Kotarski, S.F., Waniska, R.D. and Thurn, K.K. (1992) Starch hydrolysis by the rumen microflora. *Journal of Nutrition* 122, 178–190.
- Ljøkjel, K., Harstad, O.M. and Skrede, A. (2000) Effect of heat treatment of soybean meal and fish meal on amino acid digestibility in mink and dairy cows. *Animal Feed Science and Technology* 84, 83–95.
- Ljøkjel, K., Skrede, A. and Harstad, O.M. (2003a) Effects of pelleting and expanding of vegetable feeds on *in situ* protein and starch digestion in dairy cows. *Journal of Animal and Feed Sciences* 12, 435–449.
- Ljøkjel, K., Harstad, O.M., Prestløkken, E. and Skrede, A. (2003b) *In situ* digestibility of protein in barley grain (*Hordeum vulgare*) and peas (*Pisum sativum* L.) in dairy cows: influence of heat treatment and glucose addition. *Animal Feed Science and Technology* 107, 87–104.
- Ljøkjel, K., Harstad, O.M., Prestløkken, E. and Skrede, A. (2003c) *In situ* digestibility of starch in barley grain (*Hordeum vulgare*) and peas (*Pisum sativum* L.) in dairy cows: influence of heat treatment and glucose addition. *Animal Feed Science and Technology* 107, 105–116.
- Lund, D. (1984) Influence of time, temperature, moisture, ingredients and processing conditions on starch gelatinisation. *CRC Critical Reviews in Food Science and Nutrition* 20, 249–273.
- McAllister, T.A., Cheng, K.-J., Rode, L.M. and Buchanan-Smith, J.G. (1990) Use of formaldehyde to regulate digestion of barley starch. *Canadian Journal of Animal Science* 70, 581–588.
- McAllister, T.A., Cheng, K.-J., Rode, L.M. and Buchanan-Smith, J.G. (1992) Use of formaldehyde-treated barley or escape protein on the ruminal environment and digestion in steers. *Canadian Journal of Animal Science* 72, 317–328.
- McKinnon, J.J., Olubobokun, J.A., Christensen, D.A. and Cohen, R.D.H. (1991) The influence of heat and chemical treatment on ruminal disappearance of canola meal. *Canadian Journal of Animal Science* 71, 773–780.
- McMeniman, N.P. and Armstrong, D.G. (1979) The flow of amino acids into the small intestine of cattle when fed heated and unheated beans (*Vicia faba*). *Journal of Agricultural Science, Cambridge* 93, 181–188.
- McNiven, M.A., Hamilton, R.M.G., Robinson, P.H. and de Leeuw, J.W. (1994) Effect of flame roasting on the nutritional quality of common cereal grains for non-ruminants and ruminants. *Animal Feed Science and Technology* 47, 31–40.
- McNiven, M.A., Hvelplund, T. and Weisbjerg, M.R. (1995) Influence of roasting or sodium hydroxide treatment of barley on digestion in lactating cows. *Journal of Dairy Science* 78, 1106–1115.
- Melcion, J.-P. and van der Poel, A.F.B. (1993) Process technology and antinutritional factors: principles, adequacy and process optimization. In: Van der Poel, A.F.B., Huisman, J. and Saini, H.S. (eds) *Recent Advances of Research in Antinutritional Factors in Legume Seeds*. Wageningen Pers, Wageningen, The Netherlands, pp. 419–434.
- Metcalf, J. (2001) Understanding bypass vegetable proteins. *Feed Mix* 9 (4/5), 15–16.

- Michalet-Doreau, B. and Cerneau, P. (1991) Influence of foodstuff particle size on *in situ* degradation of nitrogen in the rumen. *Animal Feed Science and Technology* 35, 69–81.
- Michalet-Doreau, B., Philippeau, C. and Doreau, M. (1997) *In situ* and *in vitro* ruminal starch degradation of untreated and formaldehyde treated wheat and maize. *Reproduction Nutrition Developpement* 37, 305–312.
- Mills, J.A.N., France, J. and Dijkstra, J. (1999) A review of starch digestion in the lactating dairy cow and proposals for a mechanistic model: 1. Dietary starch characterisation and ruminal starch digestion. *Journal of Animal and Feed Sciences* 8, 291–340.
- Møller, J. (1983) Treating feeds with formaldehyde to protect protein. *Feedstuffs* 55, 12–13.
- Morgan, D.J., Cody, R.F. and Upton, P.K. (1989) Effect of formaldehyde treatment of barley upon rumen degradability and nutrient flow to the intestine of sheep. *Irish Journal of Agricultural Research* 28, 43–48.
- Moshtaghi Nia, S.A. and Ingalls, J.R. (1995) Influence of moist heat treatment on ruminal and intestinal disappearance of amino acids from canola meal. *Journal of Dairy Science* 78, 1552–1560.
- Murphy, J.J. and Kenelly, J.J. (1987) Effect of protein concentration and protein source on the degradability of dry matter and protein *in situ*. *Journal of Dairy Science* 70, 1841–1849.
- Nocek, J.E. (1997) Bovine acidosis: implications on laminitis. *Journal of Dairy Science* 80, 1005–1028.
- Nocek, J.E. and Tamminga, S. (1991) Site of digestion of starch in the gastrointestinal tract of dairy cows and its effect on milk yield and composition. *Journal of Dairy Science* 74, 3598–3629.
- Norberg, E. and Harstad, O.M. (2001) Assessment of the mobile nylon bag technique as a method to measure ileal digestibility of starch in dairy cows. In: Van der Honing, Y. (ed.) *Book of Abstracts of the 52nd Annual Meeting of the European Association for Animal Production, No. 7*. Wageningen Academic Publishers, Wageningen, The Netherlands, p. 91.
- Offner, A., Bach, A. and Sauvant, D. (2003) Quantitative review of *insitu* starch degradation in the rumen. *Animal Feed Science and Technology* 106, 91–93.
- Oke, B.O., Loerch, S.C. and Redman, D.R. (1991) Effects of dietary level and formaldehyde treatment of corn on nutrient digestion and metabolism in sheep. *Canadian Journal of Animal Science* 71, 1197–1205.
- Ørskov, E.R. (1976) The effect of processing on digestion and utilization of cereals by ruminants. *Proceedings of the Nutrition Society* 35, 245–252.
- Ørskov, E.R. (1986) Starch digestion and utilisation in ruminants. *Journal of Animal Science* 63, 1624–1633.
- Ørskov, E.R. and McDonald, I. (1979) The estimation of protein degradability in the rumen from incubation measurements weighted according to rate of passage. *Journal of Agricultural Science, Cambridge* 92, 499–503.
- Ortega-Cerrilla, M.E. and Finlayson, H.J. (1991) The effect of formaldehyde treatment of barley on starch digestion in sheep. *Proceedings of the Nutrition Society* 50, 93A.
- Ortega-Cerrilla, M.E. and Finlayson, H.J. (1994) The effect of formaldehyde treatment of barley on the flow of starch through the gastrointestinal tract of cattle. *Journal of Animal Science* 72 (Suppl. 1), 19393A.

- Osman, H.F., Theurer, B., Hale, W.H. and Mehen, S.M. (1970) Influence of grain processing on *in vitro* enzymatic starch digestion of barley and sorghum grain. *Journal of Nutrition* 100, 1133–1140.
- Owens, F.N., Zinn, R.A. and Kim, Y.K. (1986) Limits to starch digestion in the ruminant small intestine. *Journal of Animal Science* 63, 1634–1648.
- Petit, H.V., Rioux, R. and Quelle, D.R. (1997) Milk production and intake of lactating cows fed raw or extruded peas. *Journal of Dairy Science* 80, 3377–3385.
- Pipa, F. and Frank, G. (1989) High-pressure conditioning with annular gap expander. A new way of feed processing. *Advances in Feed Technology* 2, 22–30.
- Prestløkken, E. (1999a) *In situ* ruminal degradation and intestinal digestibility of dry matter and protein in expanded feedstuffs. *Animal Feed Science and Technology* 77, 1–23.
- Prestløkken, E. (1999b) Ruminal degradability and intestinal digestibility of protein and amino acids in barley and oats expander treated at various intensities. *Animal Feed Science and Technology* 82, 157–175.
- Prestløkken, E. and Rise, O. (2003) Protein and amino acid digestibility in dairy cows measured with mobile nylon bags recovered in ileum or in faeces. *Acta Agriculturae Scandinavica* 53, 11–20.
- Reinhardt, C.D., Brandt, R.T. Jr, Behnke, K.C., Freeman, A.S. and Eck, T.P. (1997) Effects of steam-flaked sorghum grain density on performance, mill production rate, and subacute acidosis in feedlot steers. *Journal of Animal Science* 75, 2852–2857.
- Robinson, P.H. and McNiven, M.A. (1993) Nutritive value of raw and roasted sweet white lupins (*Lupinus albus*) for lactating dairy cows. *Animal Feed Science and Technology* 43, 275–290.
- Santos, F.A.P., Santos, J.E.P., Theurer, C.B. and Huber, J.T. (1998) Effects of rumen-undegradable protein on dairy cow performance: a 12-year literature review. *Journal of Dairy Science* 81, 3182–3213.
- Satter, L.D. (1986) Protein supply from undegraded protein in dairy cows. *Journal of Dairy Science* 69, 2734–2749.
- Schroeder, G.E., Erasmus, L.J. and Meissner, H.H. (1996) Chemical and protein quality parameters of heat processed sunflower oilcake for dairy cattle. *Animal Feed Science and Technology* 58, 249–265.
- Schwab, C.G. (1995) Protected proteins and amino acids for ruminants. In: Wallace, R.J. and Chesson, A. (eds) *Biotechnology in Animal Feeds and Animal Feeding*. VCH Verlagsgesellschaft mbH, Weinheim, Germany, pp. 115–141.
- Sinclair, K.D., Kuran, M., Gebbie, F.E., Webb, R. and McEvoy, T.G. (2000) Nitrogen metabolism and fertility in cattle: II. Development of oocytes recovered from heifers offered diets differing in their rate of nitrogen release in the rumen. *Journal of Animal Science* 78, 2670–2680.
- Sommer, A., Ceresnakova, Z., Szakacs, J. and Chrenkova, M. (1995) Verdaulichkeit des im Pansen nicht abbaubaren Rohproteinanteils von behandelten Eiweiß im postruminalen Teil des Verdauungstraktes beim Wiederkäuer. *Archives of Animal Nutrition* 48, 173–181.
- Sommer, A., Ceresnakova, Z. and Chrenkova, M. (1996) Effect of heat treatment of rapeseed and soya on their nutritive value for ruminants. In: Van Arendonk, J.A.M. (ed.) *Book of Abstracts of the 47th Annual Meeting of the European Association for Animal Production, No. 2*. Wageningen Pers, Wageningen, The Netherlands, p. 93.
- Stanford, K., McAllister, T.A., Xu, Z., Pickard, M. and Cheng, K.-J. (1995) Comparison of lignosulfonate-treated canola meal and soybean meal as rumen undegradable

- protein supplement for lambs. *Canadian Journal of Animal Science* 75, 371–377.
- Stern, M.D., Santos, K.A. and Satter, L.D. (1985) Protein degradation in rumen and amino acid absorption in small intestine of lactating dairy cows fed heat treated whole soybeans. *Journal of Dairy Science* 68, 45–56.
- Stern, M.D., Bach, A. and Calsamiglia, S. (1997) Alternative techniques for measuring nutrient digestion in ruminants. *Journal of Animal Science* 75, 2256–2276.
- Tamminga, S. (1991) Nutrition management of dairy cows as a contribution to pollution control. *Journal of Dairy Science* 75, 345–357.
- Tamminga, S., van der Togt, P.L., van der Koelen, C.J., Meliefste, C., Luttkhuis, M. and Claassens, G.D.H. (1989) Het gedrag van zetmelen in de pens van melkkoeien (in Dutch). In: *Zetmeel in de Melkveevoeding*, Meded. IVVO, Lelystad, The Netherlands, pp. 40–69.
- Tamminga, S., van Vuuren, A.M., van der Koelen, C.J., Ketelaar, R.S. and van der Togt, P.L. (1990) Ruminal behaviour of structural carbohydrates, non-structural carbohydrates and crude protein from concentrate ingredients in dairy cows. *Netherlands Journal of Agricultural Science* 38, 513–526.
- Tamminga, S., Van Straalen, W.M., Subnel, A.P.J., Meijer, R.G.M., Steg, A., Wever, C.J. and Blok, M.C. (1994) The Dutch protein evaluation system: the DVE/OEB-system. *Livestock Production Science* 40, 139–155.
- Theurer, C.B. (1986) Grain processing effects on starch utilization by ruminants. *Journal of Animal Science* 63, 1649–1662.
- Thomas, M., van Kol, E.M.R.A.H., Tamminga, S., Verstegen, M.W.A. and van der Poel, A.F.B. (1997) Effects of water, steam and shear conditioning on the protein quality of soy grits. *Journal of the Science of Food and Agriculture* 74, 392–400.
- Thomas, M., van Vliet, T. and van der Poel, A.F.B. (1998) Physical quality of pelleted animal feed. 3. Contribution of feedstuff components. *Animal Feed Science and Technology* 70, 59–87.
- Tice, E.M., Eastridge, L. and Firkins, J.L. (1993) Raw soybeans and roasted soybeans of different particle sizes. 1. Digestibility and utilization by lactating cows. *Journal of Dairy Science* 76, 224–235.
- Tóthi, R. (2003) Processed Grains as a Supplement to Lactating Dairy Cows. PhD Thesis, Wageningen University, Wageningen, The Netherlands.
- Tóthi, R., Lund, P., Weisbjerg, M.R. and Hvelplund, T. (2003) Effect of expander processing on fractional rate of maize and barley starch degradation in the rumen of dairy cows estimated using rumen evacuations and *in situ* techniques. *Animal Feed Science and Technology* 104, 71–93.
- Van der Poel, A.F.B., Blonk, J., van Zuilichem, D.J. and van Oort, M.G. (1990) Thermal inactivation of lectins and trypsin inhibitor activity during steam processing of dry beans (*Phaseolus vulgaris*) and effects on protein quality. *Journal of the Science of Food and Agriculture* 53, 215–228.
- Van Ramshorst, H. and Thomas, P.C. (1988) Digestion in sheep of diets containing barley chemically treated to reduce its ruminal degradability. *Journal of the Science of Food and Agriculture* 42, 1–7.
- Van Straalen, W.M., Odinga, J.J. and Mostert, W. (1997) Digestion of feed amino acids in the rumen and small intestine of dairy cows measured with nylon-bag techniques. *British Journal of Nutrition* 77, 83–97.
- Vik-Mo, L. and Lindberg, J.E. (1985) *In sacco* degradability of protein (N) and dry matter in samples of individual feeds or combinations tested with diets medium or high in protein. *Acta Agriculturae Scandinavica* 35, 117–128.



- Volden, H. and Harstad, O.M. (1995) Effect of rumen incubation on the true indigestibility of feed protein in the digestive tract determined by nylon bag techniques. *Acta Agriculturae Scandinavica* 45, 106–115.
- Voragen, A.G.J., Gruppen, H., Marsman, G.J.P. and Mul, A.J. (1995) Effect of some manufacturing technologies on chemical, physical and nutritional properties of feed. In: Garnsworthy, P.C. and Cole, D.J.A. (eds) *Recent Advances in Animal Nutrition*. Nottingham University Press, Nottingham, UK, pp. 93–126.
- Walhain, P., Foucant, M. and Théwis, A. (1992) Influence of extrusion on ruminal and intestinal disappearance *in sacco* of pea (*Pisum sativum*) proteins and starch. *Animal Feed Science and Technology* 38, 43–55.
- Waltz, D.M. and Stern, M.D. (1989) Evaluation of various methods for protecting soya-bean protein from degradation by rumen bacteria. *Animal Feed Science and Technology* 25, 111–122.
- Wang, Y., McAllister, T.A., Pickard, M.D., Xu, Z., Rode, L.M. and Cheng, K.-J. (1999) Effect of micronizing full fat canola seed on amino acid disappearance in the gastrointestinal tract of dairy cows. *Journal of Dairy Science* 82, 537–544.
- Weisbjerg, M.R., Hvelplund, T., Hellberg, S., Olsson, S. and Sanne, S. (1996) Effective rumen degradability and intestinal digestibility of individual amino acids in different concentrates determined *in situ*. *Animal Feed Science and Technology* 62, 179–188.
- Yang, W.Z., Beauchemin, K.A. and Rode, L.M. (2000) Effect of barley grain processing on extent of digestion and milk production of lactating cows. *Journal of Dairy Science* 83, 554–568.
- Zaman, M.S., McNiven, M.A., Grimmelt, B. and McLeod, J.A. (1995) Effects of roasting of lupins (*Lupinus albus*) and higher protein variety of soybeans (AC Proteus) on chemical composition and *in situ* dry matter and nitrogen disappearance in dairy cows. *Animal Feed Science and Technology* 51, 329–335.
- Zelter, S.-Z., Leroy, F. and Tissier, J.-P. (1970) Protection des protéines alimentaires contre la désamination bactérienne dans le rumen. *Annales de Biologie Animale Biochimie Biophysique* 10, 111–122.

*This page intentionally left blank*

---

# 25 Animal Interactions with their Environment: Dairy Cows in Intensive Systems

T. Mottram and N. Prescott

*Silsoe Research Institute, Wrest Park, Silsoe, Bedford MK45 4HS, UK*

---

## Introduction

Although a majority of ruminant animals will continue to be ranched for the foreseeable future, it is our premise in this chapter that a large proportion of animal products in developed countries will in future be produced in automated systems where human interaction with the animal will be minimal. It thus becomes important that we gain a fundamental understanding of how animals interact with their environment since in intensive systems the environment is entirely planned by the system designer and managed according to defined protocols. The production system, comprising housing, bedding material, feeding method, nutritional management, manure recycling, water provision and pollution control, has to be seen as an engineered system designed to be operated within certain parameters. Although there are opportunities for the system to be mismanaged, this has to be seen as an aberration beyond the control of the designer of the system: a major constraint on system design that is increasingly enacted by legislation is animal welfare.

Animal welfare is usually considered in terms of the five freedoms (Webster, 1993), which involves a continuum of freedoms ranging from completely free to express all natural behaviours (good) to unable to express behaviours (bad) at which point stereotypic behaviour becomes evidence of an unacceptable impact on welfare. The welfare of the animal is taken as a set of limits such as the maximum number of animals placed in a pen or the amount of ammonia in the atmosphere before animals are distressed (Wathes *et al.*, 2002). Webster (1993) also describes a robotic system of dairy cow milking and management that will effectively minimize the role of humans in the system to handling the cattle at calving, artificial insemination and occasionally administering veterinary treatments. In such a system the only direct point where animal welfare is not within the control of the designer is in the interaction of the individual animal with his or her companion animals.

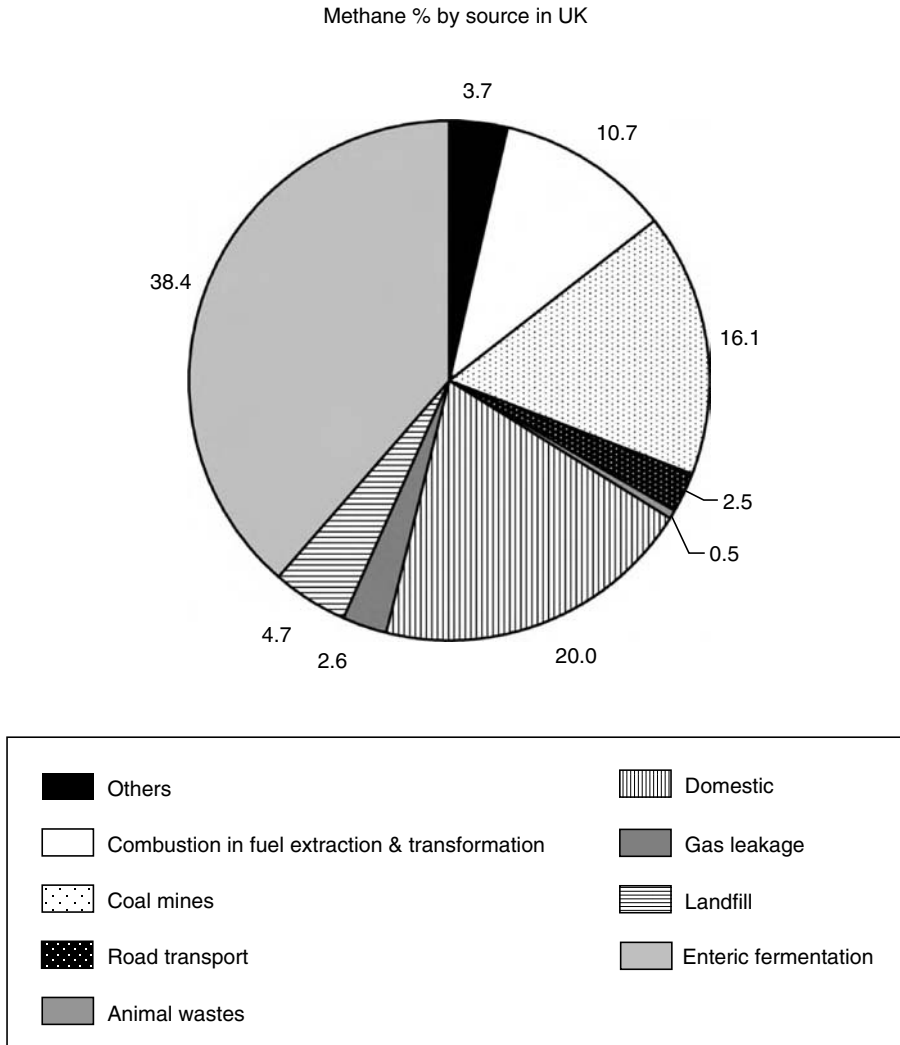
Demands for milk and meat products are increasing in all developing economies but as in the developed world they will eventually reach a plateau and the emphasis is moving from simple productivity to production efficiency, reduction in pollution (e.g. from methane, ammonia) and maintenance of high standards of animal welfare. Intensive animal housing systems are capital intensive but give such a number of advantages over extensive systems, particularly in regard to system control and the ability to limit or control methane and ammonia emissions, that they are likely to displace extensive systems. As an example that already exists in practice, modern automated housing and management systems have removed the need for manual labour for tending cattle. The development of robotic milking systems with the likely deployment of a variety of sensors for health parameters (Mottram *et al.*, 2002) removes the need for routine interactions between dairy cows and humans.

Housing animals also gives much better management control over the environmental effects of livestock such as emissions of pollutants that are becoming increasingly important as a result of Kyoto accords. Most of the world has made a commitment to reduce methane emissions that are widely believed to be a causative agent in the processes of global climatic change. Methane emissions from dairy cows amount to 40% of UK output from farm animals (Fig. 25.1) and managing the nutrition of dairy cows is seen as the best way of minimizing the emission of methane from enteric fermentation (Mills *et al.*, 2001). Methane emissions can be minimized by increasing output per individual animal so that for a given output of milk less nutrient is needed for maintenance, and also improving the efficiency by matching the animal's feed to her output.

Minor constituents of cow breath may have effects on the global environment far beyond their local importance. Hobbs and Mottram (2000) identified that dairy cows contribute about 20% of the global flux of dimethyl sulphide and that this may have an effect on atmospheric regulatory mechanisms of global climate. The main implication is that while research in dairy cow nutrition previously concentrated on increasing output per individual cow it now needs to be re-oriented to managing systems to provide food without polluting the environment more than is necessary.

Ungulate species evolved as herbivores exploiting the abundance of the planet's production of biomass as herbage and browse material and so the principal interactions of interest are in terms of diet selection at pasture and in the strategies to avoid predation. These have influenced the response of the animal to contact with man or dogs but as animals are increasingly kept in systems with very limited contact with humans, an understanding of 'natural behaviours' will become increasingly important. In the past, humans overcame the desire of cattle to avoid contact with humans (who might be conceived as predators) by strategies of habituation and by breeding animals for docility. In the foreseeable future a bovine could be born, raised, managed and milked throughout her life with her only contact with humans being for veterinary interventions such as foot trimming and artificial insemination.

This chapter will concentrate on describing how cattle interact with their environment in ways that are important for the design and management of



**Fig. 25.1.** Anthropogenic sources of methane (% of total) in the UK in 2002 (DEFRA, 2004).

cattle production systems. Some animal systems, such as the traditional New Zealand system of dairying, are geared to harvest the available forage, i.e. the environment interacts by limiting the animal’s ability to produce milk. Although this may be appropriate where capital is limited it is not discussed in this chapter, where it is assumed that the limitations of the system are the genetic potential of the animal rather than the availability of the forage.

In recent years, particularly in northern Europe, there has been an increasing social movement to criticize welfare of animals in industrial agriculture. It is often assumed by those outside the industry that cattle living in a ‘natural’ environment are healthier and have better welfare than those in industrial agricultural systems. There is an often implicit assumption that animals are

'happier' outside. Attempts are being made to establish a scientific methodology to assess animal welfare in objective terms. Most developed countries have enacted and enforce legislation to prevent animal cruelty, but since cruelty is a culturally derived concept, standards vary widely. In Sweden, legislation in force from 1999 insists that cattle are allowed to graze, which is a break with the recent tradition of production in that country where summers are short and winters long. Veal rearing systems based on restricted space and light that were once common are being phased out within the European Union on the grounds that they impinge upon good animal welfare. In some instances legislation is not based on scientific evidence of stress.

A typical approach to the problem of assessing welfare is to create indices of common production disorders in cattle and to assume that there is something wrong with the design or management of the production system if the number of cases exceeds some normal value. The retailers of milk products are increasingly demanding that their sources of supply be regularly inspected to ensure that good animal welfare practice is maintained. These quality assurance schemes are still in their infancy and use various methods of assessing disease. The principal production diseases currently assessed are mastitis and lameness.

This chapter can only summarize what is known about how dairy cows interact with the built environment and where knowledge is lacking. Detailed textbooks of dairy cow behaviour such as Phillips (1993) or Albright and Arave (1997) have been invaluable in preparing this brief chapter, which is aimed at those who wish to see where new research is needed. Each of these authors approaches the subject differently. Phillips (1993) for example states:

Unfortunately many modern production systems are designed for minimal labour input and the importance of the stockperson's role in the herd is not recognized. Abnormal behaviour problems in the herd may increase as a result, and a farmer's time and money may be wasted devising physical methods to overcome these problems without recognizing the psychological needs of the cattle for adequate social bonding.

This (and its accompanying picture of a fellahin with two cattle) implies that humans have to be present for normal behaviour to take place. This seems to contrast with the use by Albright and Arave (1997) of Whitehead's (1953) data from the Chillingham herd of wild cattle as a reference for 'natural' behaviour for cattle on the basis that they have no routine contact with humans.

## Sensory Perception

Cattle and other farmed ruminants perceive their environment in broadly similar ways to humans although possessing subtle adaptations tailoring them to their particular evolutionary niche. These subtle differences need to be considered in describing how an animal responds to its environment, since this response is mediated by its sensory perception. Features in an environment that may be barely perceptible to us may be obvious to an animal with a differently tuned sensory system. In the design of systems that are required to

interact with animals in a non-threatening manner, these considerations are of obvious importance.

## **Vision**

Vision is probably the dominant sense in cattle and of all their senses has been most widely studied. Cattle have large, laterally placed eyes allowing almost 360° field of view although, as a consequence, the degree of binocular vision is only 30°. This arrangement is characteristic of prey animals that do not predate others because it maximizes the extent of the scene that can be monitored but at the expense of more 'keen' binocular vision.

Cattle, along with sheep, goats and deer, possess the apparatus necessary for colour vision in the form of two cone species, one containing short-wavelength pigment maximally sensitive between 440 and 455 nm (blue) and another sensitive in the mid- to long-wavelength range 535–555 nm (Jacobs, 1993). Behavioural discrimination experiments equally point to colour perception that is poorer at shorter (blue and green) than longer wavelengths (red) (Gilbert and Arave, 1986; Riol *et al.*, 1989). While the bovine eye is adapted for vision in bright conditions, it also possesses adaptations for vision in dim conditions including a large pupil to gather more light, a relatively high lens to eye globe diameter ratio which increases the brightness of the retinal image, and, a gristly layer – or *tapetum lucidum* – underlying the photoreceptor layer which acts as a mirror, reflecting unused light back through the photoreceptors cells for a second pass. These adaptations are consistent with an animal that has a crepuscular habit and that needs to remain vigilant to predators during the night.

The bovine eye is near emmetropic – neither long- nor short-sighted (Piggins, 1992) – but may possess very little ability to focus objects closer than a few metres, although this distance depends critically on various eye dimensions and adaptations and may in fact be very much less. In terms of spatial acuity – or the ability to resolve detail – cattle appear to have a very poor resolving ability in comparison with other species (Entsu *et al.*, 1992) and the experimental data belie what we would expect from animals with similar eyes. Their sensitivity to objects that move – potential predators perhaps – may be more relevant to these animals than their sensitivity to static scenes as usually measured.

## **Hearing**

Cattle have good audition with a low-frequency limit at 60 dB of 23 Hz – approximately 4.5 octaves below middle C and slightly lower than humans. The high-frequency limit at 60 dB is 35 kHz, which is much higher than for humans. The most sensitive frequency is around 8 kHz – approximately four octaves above middle C and higher than for humans (Heffner and Heffner, 1993). Large animals with large interaural distances tend to have greater low-frequency sensitivity than smaller animals but correspondingly poorer

high-frequency sensitivity. In comparison though, cattle have an unexpectedly high sensitivity to high-frequency sounds and this may be adaptive to avoid pests including bats and perhaps flies. The low-frequency sensitivity matches the range of vocal communication, which may be as low as 50 Hz and rarely exceed 500 Hz (Phillips, 1993). Low-frequency sound may also be used to detect far-off storms – and perhaps, therefore, revitalized grazing. The localization of sound by cattle however is fairly poor in comparison with humans – to within 30° and 0.8°, respectively (Heffner and Heffner, 1992). Although for cattle, localization needs only to be fairly crude since they probably possess an extensive, though weakly defined, band of high visual acuity compared with humans who possess a strongly defined but small area of very high acuity (the fovea). Clearly though, since one of the main functions of sound localization is to coordinate head and/or eye movements so that the source of the sound is imaged by the eyes within the area of high acuity, less accuracy is needed in the case of cattle than for humans.

The effects of playing music during milking have been studied in short experimental studies. Evans and Albright (1989) demonstrated significant changes in milk production when cows were played different types of music and environmental noise during milking. Classical music appeared to have the best effect but, as the authors point out, it is not clear whether the effect is direct on the cows or indirect through its effect on the herdsman. If cows are directly affected by music it would imply some inherent facility for harmony, rhythm and melody that would affect their perception of the stimulus. An interesting study for the future will be to determine whether playing different forms of music during robotic milking has an effect on cow behaviour and milk output.

### **Olfaction and taste**

Olfaction and taste in cattle are well-developed and used in a variety of interactions including food preferences, oestrus detection, recognition of conspecifics and as part of the assessment of novel objects. In the case of oestrus detection, the vomeronasal organ in the roof of the mouth is used and air is passed over it by the animal adopting 'flehmen' behaviour.

In preference tests, the probabilities of a sweet, control, bitter, salty or sour diet being chosen first when presented together were 0.59, 0.36, 0.04, 0.01 and 0.003, respectively (Nombekela *et al.*, 1994). Despite this, however, cattle can both taste and apparently smell salt even at very low concentrations, a useful adaptation when consuming a diet, which might provide less than the animal's obligatory salt losses. Bell and Sly (1983) suggested that the exquisite sensitivity to salt may account for success of ruminants in many different ecological niches.

### **Thermal Environment**

The thermoneutral zone in which cattle perform best is 2–21°C for *Bos taurus* and 10–27°C for *Bos indicus*. Below these ranges there will be an increasing



loss of efficiency of food conversion as more energy is used for body maintenance. Adult lactating cows have a lower critical temperature of  $-25^{\circ}\text{C}$  and are thus capable of withstanding cold without distress. Above the thermoneutral zone and certainly above  $30^{\circ}\text{C}$  animals suffer distress and reduced appetite and therefore lower production. Buildings should be designed to keep the bedding of the animals within the thermoneutral zone, dry with air circulating freely. Dairy cows on high-energy diets have difficulty dissipating the heat generated by digestive processes in the rumen. Production systems in areas where high temperatures occur regularly should provide cooling systems such as fans or water sprays; in one case evaporative cooling reduced body temperature from  $38.2$  to  $36^{\circ}\text{C}$  in 1 h. High temperatures reduce oestrous activity (Albright and Arave, 1997).

In loose housing, areas with a poor environment will only be occupied by animals with low herd status. High-status animals will always be found where the climate is most congenial (shade in hot weather for example). If the total area available is too small, the low-status cattle will be doubly stressed by the need to avoid agonistic interaction with the dominant and by the climatic conditions they are forced into.

## Social Environment

Cattle are gregarious animals, living naturally in socially ordered groups. The dominance structure of a herd of cows prevents unnecessary aggression when there is competition for a scarce resource. Mixing unfamiliar animals leads to intense sparring until each cow knows her relationship to all other cows (Hughes, 1977). It is perhaps ambitious to believe that each cow has an understanding of her place in the whole herd, but far more likely that she retains an understanding of her particular relationship to all other individuals (Beilharz and Zeeb, 1982). Sparring may still occur as cows challenge others – usually similarly ranked – to test and retest their relationship. Dominance orders in cattle are usually linear, i.e. if cow A is dominant to cow B then she is also dominant to all the other cows over which cow B is dominant. However, non-linear relationships are also possible where, for example, cow A is dominant to B who is dominant to C, but C is dominant to A. These relationships may occur, for example, as a result of overriding familial relationships or when one cow has a superstitious fear of another. Rank orders are relatively persistent and not necessarily related to age or weight (Beilharz *et al.*, 1966). During oestrus though, a cow will often ‘forget’ her place in the dominance order.

The lowest ranking cows in a herd probably have a fairly bleak life. In any situation where they are required to compete for a resource, they invariably will have to wait until all other cows have satiated themselves. In farmed herds, perhaps more so than free-ranging herds, most resources can be limited by management objectives. Cattle may have to compete for the most desirable places to rest, the water trough, a place at the feed trough and perhaps the milking parlour if it also dispenses concentrate. Since it may be difficult to identify them and because there is little overt bullying or suffering, we have little

idea of the level of suffering endured by these animals and we may be fairly thoughtless in the design of animal facilities. New research is needed to determine how management decisions impact biological efficiency and financial efficiency.

Although the dominance order has been the most intensively studied of all social interactions, there are other sorts of interaction that may be equally or more important. Cows often form social relationships with other cows independent of the dominance order and may choose to remain close together when grazing or resting. Whether cattle indulge in other emotions affecting their social interactions such as sympathy, spite or anger is unknown.

## **Behaviour and Emotionality**

How an animal reacts to a change in its environment is mediated through its cognitive capacity, experience and its underlying emotionality. Despite their rather lugubrious appearance, cattle are able to learn a variety of complicated and abstract tasks to a similar level as a dog. Anecdotally, they also display insightful learning although whether this is chance or an actual understanding of a mechanism or process is unclear. In modern breeds, this cognitive capacity has been aided by a reduction in the emotionality of cattle, allowing them to remain calm when the behaviour of wild breeds in response to some perturbation in their environment would have generated a strong fear response. Docility is a valuable trait in cattle and perhaps the most important factor in the success of their domestication. That being said, cattle still exhibit varying degrees of timidity. We might expect that timid animals adapt less well than bold animals to changes to their environment and learn new ways of behaving less readily. However, once confident, these differences should disappear although their need for consistency may be greater.

The main periods of daily activity are lying, lying and ruminating, sleeping, standing and ruminating, walking, grazing or eating and drinking. Grazing and ruminating occupy the majority of the time for a dairy cow (Phillips, 1993). Opinion is divided about the heritability of behaviour but some behaviours can reliably be modified by training, habituation and by the environment in which cattle are placed. The daily routine imposed on cows by a production system interacts with the cow's physiology such as the natural optical triggers to crepuscular activity at dawn and dusk. Thus events such as the arrival of fresh feed or the gathering of cows for milking impose a structure on the daily cow routine that can conflict with the cow's natural rhythm.

### ***Feeding and ruminating behaviour***

The primary concern of all animals is finding and consuming food (Albright and Arave, 1997). The natural habitat of wild cattle is open grassland. In open field situations where behaviour is unconstrained by fences the distribution of cows on an area is not random. Low-status cows graze at the outside edge of the

herd. However, for most cows for most of the time space is constrained either by fences to control access to fresh grass or by barriers to prevent offered feed and forage being trampled.

In all practical loose housing situations bulk forage and total mixed ration (TMR) are distributed to groups of cows. Supplementary concentrated feed can be offered to groups but more usually to individuals through feeders at milking or where cows are individually identified by transponder systems, with free standing individual concentrate dispensers. Holstein–Friesian cattle require 0.45 m of forage trough space each to maximize the time the individual cow spends feeding but this has to be traded off against the space available (Table 25.1). One feed dispenser is needed for 30–50 cows depending on the percentage of diet that is to be fed in this way. The availability of feed and the genetic demands of metabolism obviously determine the efficiency and length of time spent feeding. A cow can be stimulated to eat by her physical hunger and also by the presence of other cows eating.

When encountering a new type of feed it is customary for cows to show neophobia. Later the feed may be sampled and if found to be palatable with no ill effects, it may eventually be readily consumed (Prescott, 1995). This process can be accelerated by training one animal to the feed prior to presentation of the new food to the rest of the herd. Feeding behaviour is both inherited and learnt so that toxic plants can be avoided (Phillips, 1993). Cattle will choose between different tastes and feeds (Klopfer *et al.*, 1981). They also exhibit some individual variation in their preferences for different feeds. Cattle show some degree of nutritional wisdom – licking a salt block, eating soil (geophagia) etc. – in response to specific metabolic deficiencies. Grazing cows will select from within the crop and avoid areas that have been recently spread with slurry or are contaminated by faeces. However, they will also initially overindulge in concentrates, leading to acidosis and perhaps even death. There is evidence that cattle will choose a ‘sensible’ diet from a range of alternative feeds (see Chapter 23). The studies of Boutflour involving introduction of a range of forages to stimulate appetite and achieve high milk outputs are widely known, despite an apparent lack of formal publication, and so it would be worth confirming this effect with modern technology to reduce the labour that was doubtless required. The daily dry matter intake is related to body

**Table 25.1.** Space requirements for dairy cows (Blowey, 1994).

Breed	Jersey	Friesian	Holstein
Body weight (kg)	350	600	700
Height to withers (m)	1.15	1.35	1.50
Body length (m)	1.40	1.62	1.72
Reach of mouth at floor level (m)	0.85	0.90	0.92
Cubicle length (m)	2.00	2.20	2.40
Feeding face width (m)	0.55	0.70	0.70
Loose housing bedded area/head (m <sup>2</sup> )	3.2	5.0	5.8

weight and thus larger animals have been favoured by intensive production systems as fewer larger animals are needed to supply the same amount of milk. There is major potential for new research to demonstrate benefits to cow welfare and production by investigating diet selection with a view to improving the presentation of food to cows.

### *Sleep/lying*

Resting in cattle is an important behaviour and typically occupies between one-third to one-half of the animal's time budget although this depends to some degree on the photoperiod. When resting and awake, cows usually ruminate, but also drowse and sleep in both rapid eye movement (REM) and non-rapid eye movement (NREM) modes (Ruckebusch, 1974). Resting may also increase blood supply to the udder and potentially improve milk yield (Metcalf *et al.*, 1992). Webster (1983) has suggested that high-yielding dairy cows are exhausted through the metabolic effort to produce milk, but also experience a conflict between the time required to eat and rest – the 'tired, hungry cow' syndrome. Whether or not this is true is unclear but restricting a cow's opportunity to rest is stressful (Metz, 1985). Presumably any effect will also be exacerbated for the lowest ranking cows, and these animals may rest for less time and have shorter resting bouts than higher ranking animals.

There are two systems for providing cow lying and resting facilities on farms: loose housing and cubicles (free stalls). There has been a trend over many years in northern latitudes in both America and Europe to build cubicle housing for cows in place of tie stalls or loose housing and this has some advantages. First, it appears possible to house more animals in the same floor area than loose housing with lower labour than is necessary to manage tie stalls. Second, by aligning the rump of the cow with a central channel it is possible to keep the cow's dung and urine away from the udder and thereby reduce the time spent cleaning the udder prior to milking. Third, it reduces the incidence of cut teats caused by a cow walking over a resting cow's udder. Fourth, the amount of straw needed to bed the cows is less and materials such as sawdust, paper or sand can be used. Finally, cubicles are easier to clean and with their straight central channel, lend themselves to automatic scrapers. However, in recent years the benefits of straw-yards in terms of the freedom they offer the cow of where to rest have been recognized and are now becoming more common. This trend is further helped by the increasing dimensional inadequacy of the original cubicles that were designed for Friesian and other small or medium-framed animals rather than the large-framed Holstein type that is increasingly popular (Cermak, 1988). Cubicles that are too small can cause damage to the legs of cows and reduce the amount of time spent lying. Two signs of an uncomfortable cubicle design are cows lying in the central dunging channel and cows standing with the front hooves in the cubicle and their rear hooves in the dunging channel. The use of cubicles can also be influenced by the substrate used to bed them (O'Connell *et al.*, 1992) and their

particular location (Keys *et al.*, 1976) – for example cubicles that are close to feeders and water troughs or located in draughts are less preferred than those located elsewhere. Cows show a high degree of fidelity for a particular cubicle and may often try to oust an incumbent if they are of higher rank or ‘loiter’ until the preferred cubicle becomes available.

One of the effects of moving from high specification buildings to providing cubicles and the infrastructure to support them is to allow more flexible building designs. As climate changes, the potential for housing cattle in open feedlots may become a possibility further north than is now possible or buildings based on lightweight plastic cladding may become acceptable and indeed the only viable option financially. Animals appear to do well in these more airy environments but evidence of this needs further examination. As dairying is increasingly likely to be based on non-foraged crops in areas further south than has been traditional and as milk products become increasingly transported over long distances, a full cost and benefit analysis of building styles is necessary.

### ***Walking and standing***

A cow’s natural habitat is not a flat expanse of concrete and these flooring systems give difficulties as the greatest proportion of the day is spent standing to eat, ruminate, drink and be milked. Where concrete becomes slippery, a worrying proportion of cows are injured slipping, particularly in the post-partum period when the hindquarter muscle groups are traumatized. However, lameness is the greatest problem of housed cattle in temperate climates and the factors influencing it include nutrition (Webster, 1993), infectious diseases, and floor quality and drainage (Wierenga and Peterse, 1987 quoted by Fraser and Broom, 1990). Cows that spend excessive time standing (presumably due to shortage of cubicles or long waiting times for milking) are more likely to develop lameness (Blowey, 1994).

### ***Breeding behaviour***

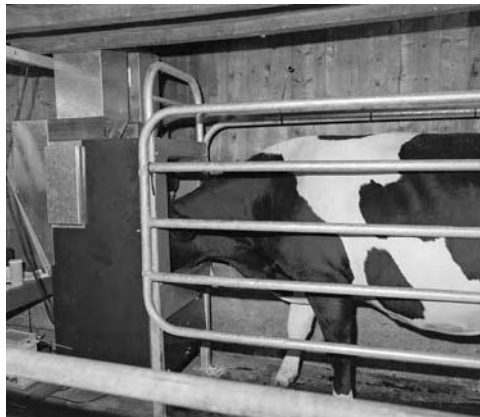
The stimulation of the endocrine system that leads to oestrus behaviour is so great that it overrides many other behavioural interactions even in predated animals in the wild and thus it is unlikely that the environment as such will alter activity. It is said that as a result of breeding for high yield, displays of oestrus are less prominent and less linked to ovulation. This may be the result of energy conservation, reducing hormonal activity or of a docility gene associated with high production. It is apparent that some management practices could alter the time budgets of the animals and suppress the ability to display oestrus. Traditional tie stalls have the effect of reducing the inter-animal contact that can stimulate oestrus. Similarly, self-locking yoke systems can lead to relatively little time for social interaction.

### *Use of motivations to interact with the environment*

This chapter has summarized much knowledge and research, some of it barely more than anecdotal, describing the behaviour of the cow and how social and environmental factors determine how cows respond to various factors. In all herd situations the bulk of animal interactions will be with other animals. However, where it is necessary for engineered systems to intervene to milk or monitor the cows, an understanding of behaviours will be essential to ensure successful system operation.

Prescott *et al.* (1998a) showed that eating outweighed all other motives for dairy cows. We can therefore use the cow's desire to eat to cause her to be present at health monitoring devices. Metz *et al.* (1999) demonstrated an ability to detect lameness by using the number of visits to a feeder and the number of steps taken per day using pedometer data. The shape of cows walking through sampling gates can be analysed by camera systems to determine some elements that could be correlated as a body condition score (Coffey *et al.*, 2003).

Motivation to eat was used by Mottram *et al.* (1999) to collect samples of cow's breath automatically when they visited a feeder (see Fig. 25.2). The learning method was based on the ability of the cow to investigate the source of a reward. Small quantities of feed were at first distributed randomly in time. This caused the cows to linger and explore the breath sampler, mounted above the trough, which had a flow sensor to detect air movement. When airflow above a threshold was detected, feed would also be dispensed from the cow's allocated ration. The airflow threshold at which feed would be dispensed was set to a low level for novice cows such that the slightest movement near the device would cause it to trigger. Progressively the flow threshold was raised so that the cow learnt to put her nose into the breath sampler and blow so as to more quickly receive her ration. Twenty cows learned to use a novel sampler/feeder and their breath emissions were monitored up to eight times per day over a period of 19 days. The cows gave samples of 4 l of breath each time



**Fig. 25.2.** A transponder-controlled feeding stall was modified to allow individual cow breath samples to be taken before feed was dispensed to the cow. Photo: Silsoe Research Institute.

they came for concentrate feed. The samples were immediately passed through an infrared gas analyser (MIRAN Sapphire5) and analysed for concentrations of carbon dioxide, methane, dimethyl sulphide and acetone. In a second experiment 18 cows (six intervention to induce ketosis, six early lactation controls, six mid-lactation controls) learned how to use the system, which was able to detect sub-clinical ketosis in four cows out of four who later showed clinical signs with a threshold of 8 ppm acetone with one false positive.

## Milking

The cow's udder serves two functions. The alveolar portion produces and can store milk, while the cisternal portion just stores milk. The cisternal milk fraction can be removed at any time but extraction of the alveolar fraction requires initiation of the milk let-down reflex. Secretion of the hormone oxytocin, which is responsible for this reflex, rises in response to a conditioned stimulus. In nature this stimulus would be the sight or sound of a hungry calf, but in production systems the stimulus may be the sound, smell or sight of the milking parlour or the 'feel' of the teat cups. While *Bos taurus* breeds can be conditioned to a variety of abstract stimuli (e.g. Willis and Mein, 1982), *Bos indicus* breeds often require the physical presence of a calf (Phillips, 1993). The reflex is, however, delicate. Unfamiliar surroundings, stray air currents and unexpected noises can influence the success of the reflex. A stress-free and consistent environment is therefore a vital aspect of any interaction with a cow during milking. Seabrook (1994) identified the stockman as the one of the most important factors contributing to the ease and efficiency of milking. Stockmen who are unfamiliar, inconsistent, handle the cows roughly or otherwise excite the herd are able to extract less milk from cows than stockmen who are familiar, consistent, gentle and handle the cows calmly.

At present, dairy cows are usually milked two or more times per day. They adapt to and prefer a routine, albeit one that has generally been created to suit the human milker. Close contact between the milker and the cow is limited in large-scale milking parlours and non-existent in robotic systems. It has often been said that cows gather to be milked as a result of the pressure of milk building up in the udder and that milk running from the teats is proof of this. However, in studies to determine cows' motivation to attend robotic milking, Prescott *et al.* (1998a) showed that motivation to be milked does not change with time since last milking. He also showed that in a maze cows would choose to be milked over not being milked randomly. In the same maze choice experiments, cows chose feed over all other motivators. Furthermore, removing feed from a robotic milking stall effectively terminated attendance of the cows.

### Robotic milking

Voluntary, automatic milking systems (VMS) are perhaps the most radical, recent development in the environment of the cow. Because of the VMS,

**Fig. 25.3.** Over 3000 robotic milking installations are now operating. Cows can now be farmed with only occasional contact with humans. This places great emphasis on designing the environment with which they interact to optimize production and welfare. Photo: Fullwood Ltd.



cows can be farmed with only occasional contact with humans. This places great emphasis on designing the environment with which they interact to optimize production and welfare (Fig. 25.3). VMS offer two main benefits. First the cow can choose when to be milked, although as mentioned earlier the motivation of a cow to be milked per se is weak. In practice, it is necessary to feed the cow in the system and it is this motivation that drives the flow of cows through the VMS. It may be difficult to integrate VMS into systems that allow grazing because the motivation to eat concentrates, silage or a TMR is low when fresh grass is available. Water may be an alternative motivator although the welfare consequences of this have not been fully explored. The second major benefit is that the cow is not required to wait to be milked. In practice, for cows that enter the parlour last this could amount to around 20% of her time. While the waiting time in a VMS is probably lower, cows may still wait to use the system, though less overtly.

One consequence of VMS is that contact between the cow and a human during milking will be lost. However, the contact available during milking is probably of fairly poor quality and, conversely, freeing the stockman from the drudgery of milking may allow for alternative higher quality contact. Milking is also an opportunity for the stockman to monitor the health of the cow. Automatic methods of detecting health conditions during the milking process are being developed (Mottram *et al.*, 2002) to replace and enhance human capabilities in this area.

A challenge for voluntary robotic milking is to overcome the variation between animals. We have discussed how social and emotional factors can affect the behaviour of individual cows and this will affect how they then interact with environment. For example, in an experiment we found that attendance rates varied from around once per day for some animals to over ten times each day (Prescott *et al.*, 1998a). While it is of course possible to cull animals from either extreme, this is not desirable and so systems requiring the participation



of the animal need to be able to cope with these extremes. One key may be to alter the value of the reward such that over-attending animals gain much less of a reward than under-attending animals.

We can use cow behaviour to ensure the successful use of robotic milking. In these systems, no human is present to enforce the required behaviour by compulsion, habit or leadership. It is considered unacceptable in welfare terms to use electric shocks to enforce behaviour and this might be counterproductive in the milking parlour in that it may disturb the endocrine system, causing the release of oxytocin for milk let-down. The principal motivation to get cows to attend milking is feed (Prescott *et al.*, 1998a) and so feed of some sort must be present to move cows both to and from the milking stall. The milking stall can be seen as part of a circulatory system, feed is the pump that ensures that they circulate around the system. Feed available in the stall is generally used as the behavioural motivation to attend but as Prescott *et al.* (1998a) demonstrated it can also cause them to delay departure from the stall. The optimal system in terms of behaviour is to feed the cows concentrate in an area that can only be accessed by passing through the robotic milker. They thus not only enter the stall successfully but also do not delay their departure (Prescott *et al.*, 1998b). The absence of feeding also tends to reduce the amount of movement during milking thus making teat cup attachment simpler.

## Discussion and Conclusions

This chapter has been set in the developed world where increasingly large numbers of animals are looked after by fewer and fewer humans. Legislative pressures are a major factor in systems design. Most technology has hitherto gone into handling of bulk materials and cow traffic management. This is leading to a dairy cow environment in intensive systems largely devoid of routine human interactions. The environment can be designed to use dairy cow motivations to ensure that routine feeding, bedding, milking and health monitoring functions are performed. The evolutionary history of cattle and its consequences on bovine visual acuity, audition and olfaction has been briefly reviewed. The environmental requirements for thermal comfort, social interaction and herd structure have been described. The effects of using feed to motivate cows for attendance at a robotic milker have been discussed in detail. The effect of changing various factors such as the auditory environment at milking time is worthy of further investigation. Bovine interactions with each other are more important than almost any other in a well-managed system and the human designer has minimal influence over these except in preventing overcrowding. In the absence of human compulsion or leadership, the motivation to feed is the principal method of getting cows to attend for milking or health monitoring procedures. A number of research questions have been identified. The influence of management on the effect of dairy cows on the global environment is now of crucial importance to achieve Kyoto treaty obligations. Most of this must be based on changing goals for nutritional management. Some welfare and behavioural aspects of the environment of

the dairy cow need further research, for example the benefits of offering a greater ability to select diet, the benefits of low-cost buildings on health and welfare, and means of monitoring health and fertility non-invasively. More philosophically the change in cow welfare due to moving from regular contact with humans to a situation more akin to the wild state of cattle needs further investigation. This would open a debate about the desirability of regular human contact with animals and how this accords with the difficulty of finding suitable labour.

## References

- Albright, J.L. and Arave, C.W. (1997) *The Behaviour of Cattle*. CAB International, Wallingford, UK.
- Beilharz, R.G. and Zeeb, K. (1982) Social dominance in dairy cattle. *Applied Animal Ethology* 8, 79–97.
- Beilharz, R.G., Butcher, D.F. and Freeman, A.E. (1966) Social dominance and milk production in Holsteins. *Journal of Dairy Science* 49, 887–892.
- Bell, F.R. and Sly, J. (1983) The olfactory detection of sodium and lithium salts by sodium deficient cattle. *Physiology and Behaviour* 31, 307–312.
- Blowey, R. (1994) Dairy cow housing. In: Wathes, C.M. and Charles, D.R. (eds) *Livestock Housing*. CAB International, Wallingford, UK, pp. 305–337.
- Cermak, J. (1988) Cow comfort and lameness – design of cubicles. *Bovine Practitioner* 23, 79–83.
- Coffey, M., Mottram, T.T. and McFarlane, N. (2003) A feasibility study on the automatic recording of condition score in dairy cows. *Proceedings of the British Society of Animal Science*, p. 131.
- DEFRA (2004) Estimated emissions of methane (CH<sub>4</sub>) by UNECE source category, type of fuel and end user: 1970–2002, <http://www.defra.gov.uk/environment/statistics/globalatmos/alltables.htm> (accessed 19 November 2004).
- Entsu, S., Dohi, H. and Yamada, A. (1992) Visual acuity of cattle determined by the method of discrimination learning. *Applied Animal Behaviour Science* 34, 1–10.
- Evans, A. and Albright, J.L. (1989) The effects of music and noise upon behavior and milk production in dairy cows. In: *105th Annual Meeting of the Indiana Academy of Science*. Indiana Academy of Science, Indiana State Library, Indianapolis, Indiana, p. 88.
- Fraser, A.F. and Broom, D.M. (1990) *Farm Animal Behaviour and Welfare*, 3rd edn. Bailliere Tindall, London.
- Gilbert, B.J. and Arave, C.W. (1986) Ability of cattle to distinguish among different wavelengths of light. *Journal of Dairy Science* 69, 825–832.
- Heffner, R.S. and Heffner, H.E. (1992) Hearing in large mammals – sound localization acuity in cattle (*Bos Taurus*) and goats (*Capra hircus*). *Journal of Comparative Physiology* 106, 107–113.
- Heffner, R.S. and Heffner, H.E. (1993) Hearing in large mammals: horses (*Equa caballus*) and cattle (*Bos taurus*). *Behavioural Neuroscience* 97, 299–309.
- Hobbs, P. and Mottram, T.T. (2000) Significant contributions of dimethyl sulphide from livestock to the atmosphere. *Atmospheric Environment* 34, 3649–3650.
- Hughes, B.O. (1977) Some implications of dominance hierarchies in intensive husbandry systems. *Applied Animal Behaviour Science* 3, 199.

- Jacobs, G.H. (1993) The distribution and nature of colour vision among the mammals. *Biological Review of the Cambridge Philosophical Society* 68, 413–471.
- Keys, J.E., Smith, L.W. and Weinland, B.T. (1976) Response of dairy cattle given a choice of free stall lactation and three bedding materials. *Journal of Dairy Science* 59, 1157–1167.
- Klopper, F.D., Kilgour, R. and Matthews, L.R. (1981) Paired comparison analysis of the palatabilities of twenty foods to dairy cows. *Proceeding of the New Zealand Society of Animal Production* 41, 242–247.
- Metcalf, J.A., Roberts, S.J. and Sutton, J.D. (1992) Variations in blood flow to and from the bovine mammary gland measured during transit time ultrasound and dye dilution. *Research in Veterinary Science* 53, 59–63.
- Metz, J.H.M. (1985) The reaction of cows to short-term deprivation of lying. *Applied Animal Behaviour Science* 13, 301–307.
- Metz, J.H.M., Maltz, E. and Mottram, T.T. (1999) Monitoring health and welfare in practice. *Cattle Practice: Journal of the British Cattle Veterinary Association* 7, 123.
- Mills, J.A.N., Dijkstra, J., Bannink, A., Cammell, S.B., Kebreab, E. and France, J. (2001) A mechanistic model of whole tract digestion and methanogenesis in the lactating dairy cow. Model development, evaluation and application. *Journal of Animal Science* 79, 1584–1597.
- Mottram, T.T., Whay, H.R., Hobbs, P., Richards, P., Short, L. and Hartung, J. (1999) Automatic cow breath sampling: an experiment to measure emissions of polluting compounds in the breath of unrestrained dairy cows. Conference on construction, engineering and environment in livestock farming, Weihenstephan, Germany: Landtechnik, pp. 45–50.
- Mottram, T.T., Velasco-Garcia, M., Berry, P., Richards, P., Ghesquiere, J. and Masson, L. (2002) Automatic on-line analysis of milk constituents (urea, ketones, enzymes and hormones) using biosensors. *Comparative Clinical Pathology* 11, 50–58.
- Nombekela, S.W., Murphy, M.R., Gonyou, H.W. and Marden, J.I. (1994) Dietary preferences in early lactation cows as affected by primary tastes and some common feed flavors. *Journal of Dairy Science* 77, 2393–2399.
- O'Connell, J.M., Giller, P.S. and Meaney, W.J. (1992) Factors affecting cubicle utilisation by dairy cattle using stall frame and bedding manipulation experiments. *Applied Animal Behaviour Science* 35, 11–21.
- Phillips, C.J.C. (1993) *Cattle Behaviour*. Farming Press Books, Ipswich, UK.
- Piggins, D. (1992) Visual Perception. In: Phillips, C.J.C. and Piggins, D. (eds) *Farm Animals and the Environment*. CAB International, Wallingford, UK, pp. 131–158.
- Prescott, N.B. (1995) Dairy cow behaviour and automatic milking. PhD thesis, Bristol University, UK.
- Prescott N.B., Mottram, T.T. and Webster, A.J.F. (1998a) Relative motivations of dairy cows to be milked or fed in a Y-maze and an automatic milking system. *Applied Animal Behaviour Science* 57, 23–33.
- Prescott, N.B., Mottram, T.T. and Webster, A.J.F. (1998b) Effect of food type and location on the attendance to an automatic milking system and the effect of feeding during milking on their behaviour and milking characteristics. *Animal Science* 67, 183–193.
- Riol, J.A., Sanchez, J.M., Eguren, V.G. and Gaudioso, V.R. (1989) Colour perception in fighting cattle. *Applied Animal Behaviour Science* 23, 207–214.
- Ruckebusch, Y. (1974) Sleep deprivation in cattle. *Brain Research* 78, 495–499.

- Seabrook, M.F. (1994) Psychological interaction between the milker and the dairy cow. In: *Dairy Systems for the 21st Century*. Proceedings of the Third International Dairy Housing Conference. American Society of Agricultural Engineers, St. Joseph, Michigan, USA, pp. 49–58.
- Wathes, C.M., Jones, J.B., Kristensen, H.H., Jones, E.K.M. and Webster, A.J.F. (2002) Aversiveness of atmospheric ammonia to pigs and domestic fowl. *Transactions of the ASAE* 45, 1605–1610.
- Webster, A.J.F. (1993) *Understanding the Dairy Cow*, 2nd edn. Blackwell, London.
- Whitehead, G.K. (1953) *The Ancient White Cattle of Britain and their Descendants*. Faber & Faber, London.
- Wierenga, H.K. and Peterse, D.J. (1987) A housing system which reduces the incidence of claw and leg disorders, and fulfils the behavioural demands of cattle; summary of discussion on strategy for the future. In: Wierenga, H.K. and Peterse, D.J. (eds) *Cattle Housing Systems, Lameness and Behaviour*. Martinus Nijhoff Publishers, Dordrecht, The Netherlands, pp. 185–187.
- Willis, G.L. and Mein, G. (1982) Classical conditioning of milk ejection using a novel conditioning stimulus. *Applied Animal Ethology* 9, 231–237.

---

# 26 Pasture Characteristics and Animal Performance

P. Chilbroste,<sup>1</sup> M. Gibb<sup>2</sup> and S. Tamminga<sup>3</sup>

<sup>1</sup>Facultad de Agronomía, Estación Experimental M. A. Cassinoni, Ruta 3 km 363, CP 60000, Paysandú, Uruguay; <sup>2</sup>Institute of Grassland and Environmental Research, North Wyke Research Station, Okehampton, Devon EX20 2SB, UK; <sup>3</sup>Animal Nutrition Group, Wageningen Institute of Animal Sciences, Marijkeweg 40, 6709 PG Wageningen, The Netherlands

---

## Introduction

Forages are extensively used to feed domesticated farm animals, notably cattle and sheep, and comprise a wide variety of plant species. They are predominantly grasses or legumes and can either be fed fresh or conserved. When fed fresh, the harvesting is usually left to the animal. Conserved forages vary from wet silage, through various degrees of wilting to hay.

The bulk component of forages is  $\beta$ -linked polysaccharides. Other components in forages include proteins, soluble sugars, lipids, minerals and vitamins. The  $\beta$ -linkages in the structural carbohydrates cannot normally be split by the hydrolytic enzymes inherently present in the digestive tract of animals. Due to a highly adapted digestive system, with holding and mixing compartments that slow down passage of the feed and accommodate dense populations of microbes, ruminants can use microbes for the breakdown of the structural carbohydrates. Hence, extraction and utilization of nutrients from forages by ruminants uses a three-way interaction between the herbivore, the plant and the microbial population. Important aspects of this interaction are characteristics of the forage and ingestive behaviour of the animal. Success depends on the extent to which this combination can accommodate the microbial population, such that it executes a maximum of activity and provides its host with sufficient quantities of the required nutrients in microbial biomass or in its waste products, the volatile fatty acids (VFA).

This chapter focuses on the utilization by farm animals of nutrients present in forages and the role played by botanical, physical and chemical characteristics of the forage on the one hand and ingestive and digestive behaviour of the animal on the other. Most emphasis will be on freshly fed forages harvested by the animal itself.

## Chemical and Biochemical Properties of Forages

The nutritive value of animal feeds is derived from the combination of chemical constituents and their digestibility, in ruminant nutrition often expressed as digestible organic matter and organic matter digestibility (OMD). The OM in forages can be divided, based on its extraction properties, into neutral (ND) and acid detergent (AD) soluble OM. The extraction with ND results in a residue (NDR) not extractable with ND, and the extractable cell contents (NDS). The NDR contains structural carbohydrates (NDF), a small fraction of inorganic matter and some N (NDIN), largely consisting of the protein extensin. The main cell wall polysaccharides are pectic substances, extractable with ND but not with AD (Van Soest, 1994); hemicellulose, extractable with AD; cellulose, extractable with sulphuric acid or with permanganate; and a remaining lignin fraction, a condensed form of phenolics. In some legume species appreciable amounts of other phenolic compounds known as condensed tannins (CT) may occur, which can be further divided into extractable CT, protein-bound CT and fibre-bound CT (Barry and McNabb, 1999). The NDF content of forages ranges between less than 300 and over 750 g/kg DM and is primarily influenced by stage of maturity, whereas the degree of lignification is also influenced by climate, particularly temperature (Van Soest, 1994).

The NDS contain proteins, non-protein N, non-structural carbohydrates, lipids and electrolytes. Between 80% and 90% of the crude protein (CP) in forages is present in the cell contents, while the remaining 10–20% is bound to the cell walls. Of the CP, 25–30% is non-protein N (NPN), a large proportion of which is nitrate. True protein in cell content is usually divided into fraction 1 protein, fraction 2 protein and chloroplast membranes. A major part of fraction 1 is the enzyme complex ribulose-1,5-biphosphate carboxylase (Rubisco), responsible for the fixation of CO<sub>2</sub>. Rubisco comprises some 40% of total leaf protein (Mangan, 1982) and is located in the chloroplasts. The proteins in fraction 2 form about 25% of the total CP and include a wide array of enzymes. The remaining proteins in the cell contents are chloroplast membrane proteins and in ryegrass form 4–5% of the total CP (Boudon and Peyraud, 2001).

The remaining cell contents are soluble sugars (SC), lipids and electrolytes. Sugar content ranges between 100 and 200 g/kg DM, and is usually inversely related to the crude protein content and in grasses is about equally distributed between free sugars and fructosans, the solubility of which depends on their chain length. Their degree of polymerization is usually between 40 and 160 fructose units (Boudon and Peyraud, 2001). The pool of SC is fed by photosynthesis and depleted by oxidation to yield energy for synthetic processes and to provide precursors for these synthetic processes. Photosynthesis depends on light intensity and during daytime, particularly during sunny days, the pool of soluble sugars shows a net growth, whereas during the night, cloudy days or in shade, the pool remains low or even decreases (Parsons and Chapman, 2000). Hence, the SC content changes in the course of the day and is usually highest in the late afternoon and early evening (Van Vuuren *et al.*, 1986). Lipids are usually between 2% and 5% and are primarily present in membranes of the

chloroplasts and in the cover of the cuticular layer. In temperate grasses lipids are extremely rich in linolenic acid.

## Grazing Behaviour and Grazing Management

The inter-relationship between pasture and the grazing ruminant is a dynamic, two-way process. As quantitative, qualitative and morphological aspects of the different plant species present in pastures influence the plant material ingested by the grazing animal, that process in turn modifies the plants remaining and their subsequent production and fate. Although differences between forage species, various organs within the plant and changes over the day and throughout their life span affect the dynamics of their digestion, it is aspects of their physical presentation within the sward that largely determine the quantity, quality and temporal pattern of ingested material.

### *Effects of forage characteristics*

The simple model adopted by Allden and Whittaker (1970), in which daily intake was considered as the product of grazing time and intake rate (IR, DM g/min), the latter being the product of bite mass and bite rate, has formed the basis of much research over the intervening decades. Because of the widespread use of intensively managed, temperate, single-species swards or mixed grass/clover swards, much of the research has been within these contexts, although there have been notable exceptions such as that conducted by Stobbs (1973) and Chacon and Stobbs (1977) on tropical pastures. Where mixed-species swards have been investigated, these have mainly been simple two-species mixtures of perennial ryegrass and white clover, rather than more complex multispecies swards. Nevertheless, such work has allowed elucidation of many of the fundamental relationships between sward state and the ingestive processes.

Black and Kenney (1984), using artificially constructed swards grazed by sheep, showed that the relationships between sward height and bite mass, bite rate and IR were modified by tiller density (plants/m<sup>2</sup>). Such a modifying effect is not surprising since intake per bite (bite mass, g DM per bite) derives from bite volume (i.e. the effective sward volume removed in a single biting action) and the bulk density of the herbage in that volume (Hodgson, 1985). Furthermore, if idealized as rectangular or cylindrical, bite volume may be defined as the product of bite area and bite depth (Milne 1991; Parsons *et al.*, 1994b). Subsequently, Laca *et al.* (1992), using similarly constructed swards offered to beef cattle, were able to demonstrate that height and bulk density are the most important sward features determining bite depth and bite area on green and leafy vegetative swards. Such artificial swards, whilst time-consuming in their construction, have proved invaluable in providing a means of manipulating sward structure and developing conceptual models of the grazing process. However, such artificial swards avoid the possible modification of bite dimensions associated with accumulated plant material in the base of natural

pastures. Thus, we should not be surprised if the precise values obtained under such contrasting scenarios differ.

Various parameters have been used to describe sward state under field conditions, including total herbage mass, green leaf mass (DM, kg/ha) and sward surface height (SSH, cm). Comparing continuous and rotational stocking management systems, Penning *et al.* (1994) showed that green leaf mass or leaf area index, rather than SSH, were a better basis for relating intake and sward state where the ratio of leaf to stem was changing rapidly. Orr *et al.* (1997) have shown both green leaf mass and SSH to be significantly correlated with bite mass ( $r = 0.71$  and  $r = 0.78$ , respectively) and with IR ( $r = 0.81$  and  $r = 0.78$ , respectively). However, since SSH is a principal determinant of bite mass (e.g. McGilloway *et al.*, 1999) and can be more easily determined than green leaf mass, it has received considerable attention and proved to be a useful descriptor of sward state for research purposes (e.g. Hutchings *et al.*, 1992) and in formulating grazing management guidelines (e.g. Mayne, 1991).

Generally, a curvilinear relationship has been shown between SSH and bite mass in sheep (Penning *et al.*, 1991a) and cattle (Gibb *et al.*, 1996), with successively smaller increments in bite mass being achieved for each increment in SSH. However, as would be expected from research with sward boards, the precise relationship is sensitive to changes in sward density (Mayne *et al.*, 2000). Such studies have also demonstrated that as bite mass increases, bite rate declines due to a reduction in the proportion of total grazing jaw movements represented by bites, rather than to an increase in the time taken to complete a bite (Penning *et al.*, 1998). The net outcome, however, is a curvilinear relationship between SSH and IR.

#### *Legumes vs. grasses*

Non-lactating (dry) (Penning *et al.*, 1991b; Orr *et al.*, 1996a) and lactating (Penning *et al.*, 1995a) ewes take greater bite masses when grazing white clover swards compared with ryegrass swards at the same height. This is accomplished, despite the lower bulk density of herbage within the grazed horizon on the clover, by the ewes having a larger bite area, but of the same depth, compared with that when grazing grass (Edwards, 1994; Edwards *et al.*, 1995). Sheep are able to collect herbage from an area larger than their open mouth area, by using their lips to gather material into their mouth before biting it from the sward and Edwards (1994) suggests that this is more easily achieved on clover than grass. However, although the time taken to execute a bite does not differ between clover and ryegrass, fewer non-biting grazing jaw movements are required per unit bite mass of DM on clover (Penning *et al.*, 1995a). Because a large proportion (> 50%) of grazing jaw movements by sheep may be non-biting (i.e. manipulative or masticative), they are able to achieve a significant increase in IR on clover compared with ryegrass (Penning *et al.*, 1995a).

In contrast, heifers have similar bite masses on clover as on grass swards (Orr *et al.*, 1996b) and, because a much lower proportion of grazing jaw movements are non-biting movements, any reduction in handling cost on clover has little impact on bite rate (Penning *et al.*, 1998). As a consequence, IR by cattle does not differ significantly between clover and grass swards.



Penning *et al.* (1991b) found that on white clover swards, dry ewes had more meals but of shorter duration and that the total time spent grazing was 165 min/day less than those grazing ryegrass. As a result, daily intakes were the same, although ruminating time on the clover was significantly lower than on the grass swards (100 vs. 259 min/day). Similar results were reported by Rutter *et al.* (2002), where heifers grazed for 100 min/day longer on grass and, although achieving higher daily DM intakes, had similar digestible OM intakes and liveweight gains compared with those on clover swards. Ruminating time was also significantly reduced on the clover (267 vs. 526 min/day) compared with grass swards.

Animals with a higher nutritional demand may, however, benefit from grazing clover. Lactating ewes take advantage of the higher intake rates and low ruminating requirement on clover and extend their grazing time to achieve higher daily DM intakes (0.5 kg) than on grass (Penning *et al.*, 1995a).

### ***Effect of grazing management***

The effect of contrasting grazing management systems, such as continuous variable stocking or rotational stocking, on forage production is outside the scope of this chapter. Parsons and Chapman (2000) argue that such differences in management are more imagined than real and that either management system imposes on the individual plant a succession of discrete defoliations, separated by variable periods of uninterrupted growth. However, the physical structure and its rate of change in swards presented to grazing animals under the two systems does affect their grazing behaviour. Under field conditions, irrespective of whether swards are managed under continuous variable stocking or rotational stocking, considerable vertical, horizontal and temporal variability in structure exists.

#### ***Continuous variable stocking management***

In temperate pastures, under continuous variable stocking management, swards are maintained short, compared with those presented to the grazing animal under rotational stocking, and are kept within a relatively narrow range of SSH (e.g. 4 to 6 cm for sheep and 5 to 8 cm for cattle). Because such sward heights constrain bite mass and consequently IR, sheep and cattle will attempt to compensate by increasing their grazing times (13 and 10.5 h/day, respectively). Although the levels of intake will invariably be below those achievable on taller swards following a period of regrowth under rotational management, the ingested herbage is mainly young leaf material with a high nitrogen content (> 3.5% in DM; Penning *et al.*, 1995a; Gibb *et al.*, 2002). Nevertheless, daily intakes cannot match those achievable on tall swards when herbage allowance is not limiting. By keeping SSH more or less constant, herbage production is approximately equal to the herbage consumed, and sward state changes little over the course of the day or from day to day. In this situation, changes in grazing behaviour over the same timescale are relatively minor. Nevertheless, despite the relative constancy in sward structure over the day, similar diurnal

patterns in bite mass, bite rate and IR have been shown by sheep (Orr *et al.*, 1996a) and dairy cows (Gibb *et al.*, 1998) grazing ryegrass swards, where the highest IR (DM, g/min) and bite mass (DM, g/bite) occur in the late afternoon or evening.

Even when maintained with a narrow range of SSH, such swards are generally characterized by a degree of spatial heterogeneity, with a varying proportion of the total area being represented by infrequently grazed patches (Gibb and Ridout, 1986, 1988). In such a grazing environment animals are confronted with a heterogeneous resource from which to select their diet, and the SSH of the frequently grazed areas will be lower than the overall mean SSH of the pasture (Gibb *et al.*, 1999).

#### *Rotational stocking management*

Under rotational stocking management the morphology of a grass sward is altered by successive defoliations over the same area over a matter of hours or days, depending upon the grazing pressure applied. This modification of the sward has important consequences for both quantitative and qualitative aspects of herbage ingestion. First, with each successive defoliation of an area the bulk density (kg/ha/cm) of the grazed horizon in the sward increases (Wade *et al.*, 1989), but the reduction in SSH constrains bite depth, to the extent that bite mass and IR are reduced (McGilloway *et al.*, 1999). When sward depletion takes place over several days, inevitably, daily intake progressively declines (Wade *et al.*, 1989). Secondly, as the animal grazes progressively down through the sward, the proportion of lamina material in what is consumed declines and the proportion of pseudostem and senescent material increases, leading to a decline in the digestibility (*in vitro*) of the herbage ingested (Penning *et al.*, 1994). Even when the digestibility of the pseudostem is high, its increasing proportion in the diet may reduce the rate of passage of digesta and limit daily intake (Laredo and Minson, 1973). Although Illius *et al.* (1995) calculated that the majority of energy expended during grazing was in chewing the ingested vegetation, rather than removing plant tissue from the sward, they found that goats would not graze into the pseudostem horizon because of the much increased bite force this would have required. However, they suggested that larger animals would be less constrained by the physical properties of the vegetation than small animals and could, therefore, graze closer to the ground.

The advantage in practice is that rotational stocking management allows a more direct and immediate control of herbage intake by animals, particularly where they are present on paddocks for a period of 1 or 2 days. Daily herbage allowance (DM or OM g/kg live weight) can be regulated by altering the area of the paddock, depending upon herbage mass (DM or OM/ha) and live weight or number of animals. The effects of herbage allowance on daily intake have been demonstrated with dairy cows (e.g. Peyraud *et al.*, 1996), calves (Jamieson and Hodgson, 1979), ewes (Gibb and Treacher, 1978) and lambs (Gibb and Treacher, 1976). Although such relationships will be modified to an extent by sward mass (Peyraud *et al.*, 1996), what they have all shown is, to achieve maximum daily intake at pasture, herbage allowance must be equivalent to three to four times daily intake.

### ***Temporal pattern of grazing***

The basic temporal pattern of grazing meals, unmodified by depletion of the herbage resource, is demonstrated under continuous variable stocking management. Although animals may increase total grazing time in attempting to compensate for constraints on IR, an underlying pattern of grazing meals is discernible. In temperate climates, this basic pattern is typically of three, possibly four, major periods of grazing activity through the day (Gibb *et al.*, 1997), although the precise timing of the meals will be modified, depending upon events such as removal for milking and times of sunrise and sunset. Similar temporal patterns of grazing meals have been demonstrated with sheep (Penning *et al.*, 1991b).

#### *Daily paddock management*

Modifications of this basic temporal pattern are demonstrated under daily paddock stocking management, depending upon the time of introduction to the area of fresh herbage. Orr *et al.* (2001) found that dairy cows provided with equal daily herbage allowances, following either morning milking or afternoon milking, spent the same total time grazing per day but showed different temporal patterns of grazing meals. Cows receiving their fresh allowance in the afternoon, however, spent a greater proportion of their total grazing activity during the late afternoon and evening period, when the sugar content of the grass and short-term intake rate (g DM/min) were higher. As a consequence, they achieved a significantly greater milk yield compared with cows offered the same herbage allowance in the morning.

#### *Restricted access for grazing*

Grazing behaviour of dairy cows can be manipulated by time and allocation of the grazing session. Soca *et al.* (1999) showed that, compared with cows given access to pasture for 8 h/day commencing at 06:00 h, cows given access for only 6 h/day commencing at 12:00 h had a longer initial grazing meal (120 vs. 82 min) and were more likely to be found grazing during the first 4 h at pasture (81% vs. 54%), although ruminating and resting time were less. A higher intake rate in the animals that started the grazing session later in the day may be seen as a strategy to optimize intake pattern to adapt to the changes in pasture DM and SC contents (Van Vuuren *et al.*, 1986; Gibb *et al.*, 1998). The incorporation of short-term fasting in grazing and feeding management strategies for cattle has been recently reviewed by Chilibroste *et al.* (2004).

#### *Effect of animal factors on bite mass and intake rate*

SIZE AND PHYSIOLOGICAL CONDITION OF THE ANIMAL. Although sward state largely constrains bite mass and IR, Penning *et al.* (1991b) found that larger animals were able to meet their greater maintenance requirements by achieving a greater bite mass, and that bite mass was related to live weight, increasing by 0.66 mg/kg live weight. Although this relationship was independent of incisor arcade width, undoubtedly arcade width and conformation have an effect on bite mass (Gordon *et al.*, 1996). Examining the effect of physiological state,

Penning *et al.* (1995a) found that lactating ewes had a greater bite mass (83 vs. 61 mg DM) and higher IR (4.5 vs. 4.1 g DM/min) than dry ewes, when grazing grass swards of 7 cm. At the same SSH, Gibb *et al.* (1999) recorded higher intake rates by lactating dairy cows than dry cows (23.5 vs. 19.8 g OM/min). Nevertheless, the major means by which ruminants respond to increased nutritional demands is to increase grazing time. For example, Penning *et al.* (1995a) recorded lactating and dry ewes grazing for 582 and 478 min/day, respectively, and Gibb *et al.* (1999) recorded lactating and dry cows grazing for 583 and 451 min/day, respectively, on 7 cm SSH grass swards. Such increases in grazing time may, however, reduce ruminative efficiency by reducing ruminating time per unit of intake (Gibb *et al.*, 1999).

**FASTING.** Prior fasting increases bite mass by cattle grazing grass (Chacon and Stobbs, 1977; Patterson *et al.*, 1998) and legume swards (Dougherty *et al.*, 1989) and by goats (Illius *et al.*, 1995). Likewise, fasting increases IR by sheep grazing grass (Allden and Whittaker, 1970) and legume swards (Newman *et al.*, 1994). The duration of such effects appears to be greater, the longer the period of fasting (Patterson *et al.*, 1998), and fasts of 24 h have affected subsequent meal duration (Newman *et al.*, 1994).

**SOCIAL STRUCTURE.** There is little evidence to distinguish between the effects of experience or social dominance and size on grazing behaviour. However, examination of the data of Peyraud *et al.* (1996) shows that when forced to compete at restrictive daily herbage allowances in mixed groups, heifers were unable to achieve the same daily intake of herbage as cows, even when expressed relative to their live weight. Only at a relatively high allowance, equivalent to about 80 g OM/kg live weight/day, were intakes similar for heifers and cows. There is evidence from observations with sheep (Penning *et al.*, 1993) and cattle (Rind and Phillips, 1999) that group size can affect social behaviour, grazing time and daily intake possibly due to the requirement for increased vigilance by individuals in small groups.

### *Environmental factors*

**PASTURE HETEROGENEITY AND DIETARY PREFERENCE.** Grazed swards frequently exhibit heterogeneity in height, morphological and physiological state, and species composition, due to modification of the sward by the presence of grazing animals and, particularly in the case of mixed swards, competition between the different plant species for nutrient resources (Schwinning and Parsons, 1996). Presented with such heterogeneity, grazing animals rarely forage in a non-selective manner, so that the relative proportion of different plant species or plant parts may not reflect their present relative abundance within a sward. Within temperate mixed perennial ryegrass/white clover swards mean partial preferences for clover of about 70% have been demonstrated for sheep (Parsons *et al.*, 1994a; Harvey *et al.*, 2000), heifers (Penning *et al.*, 1995b) and dairy cows (Rutter *et al.*, 1998), although a lower partial preference of 52% has been shown in goats (Penning *et al.*, 1997). Such differences in preference between grazing species not only influence the diet selected, but

ultimately alter sward composition (Penning *et al.*, 1996) and small differences in management, e.g. grazing severity, can affect relative abundance of the different species in the sward (Gibb *et al.*, 1989). However, it must not be assumed that such preferences are constant, either within animal species or in alternative grass/legume mixtures (Norton *et al.*, 1990). Preference may be affected by the height of the different sward components (Harvey *et al.*, 2000), fasting (Newman *et al.*, 1994), previous dietary experience (Newman *et al.*, 1992; Parsons *et al.*, 1994a) and time of day (Newman *et al.*, 1994; Parsons *et al.*, 1994a; Rutter *et al.*, 1998; Harvey *et al.*, 2000).

## Forage Ingestion

Feed intake and its regulation, size reduction and passage of feed particles are the subject of Chapters 5 and 23 and here discussion is restricted to aspects specific to forages under grazing conditions. These include aspects of the holding capacity of the rumen, the chewing efficiency as related to particle size reduction and the resulting passage of forage particles.

### *Holding capacity in the rumen (packing density)*

In forage-fed ruminants, the holding capacity of the rumen has long been considered as a constraint to dry matter intake (DMI) (Conrad, 1966). Although this hypothesis has been challenged (Grovmum, 1987; Ketelaars and Tolkamp, 1991), rumen fill as a constraint to DMI still receives attention (Dado and Allen, 1995).

The first problem to be addressed in assessing the importance of rumen fill as a constraint on DMI is to specify which fraction, if any, properly represents rumen fill. For daily DMI regulation, NDF in the feed has been suggested as the best predictor of rumen fill (Mertens, 1987). Van Soest *et al.* (1991) established that NDF is more closely related to the daily ruminating time, rumen fill and DMI, than other chemical fractions like crude fibre and acid detergent lignin (ADL). Nevertheless, when balloons are introduced in the rumen, DM rumen pool has normally been chosen as an indicator of rumen fill (Faverdin *et al.*, 1995). In detailed studies of digestion and particle breakdown kinetics (Bosch, 1991; Van Vuuren, 1993), total rumen content as well as its chemical components have been considered. Table 26.1 shows the positive correlation between total, DM, N, NDF and ADL rumen pool sizes, as observed in grazing lactating dairy cows (Chilibroste, 1999).

For DMI and other animal performance constraints, research has focused primarily on stall-fed animals with conserved forages (either silage or hay) as the fibre source. Less information is available for fresh forages (e.g. Waghorn *et al.*, 1989) and particularly for grazing animals (Chilibroste, 1999). Figure 26.1 shows the relative weights of total, DM and NDF rumen pools measured after the first grazing bout in dairy cows when grazing ryegrass (Chilibroste, 1999) or when fed cut, fresh or wilted lucerne (Danelón *et al.*, 2002), cut ryegrass (Van

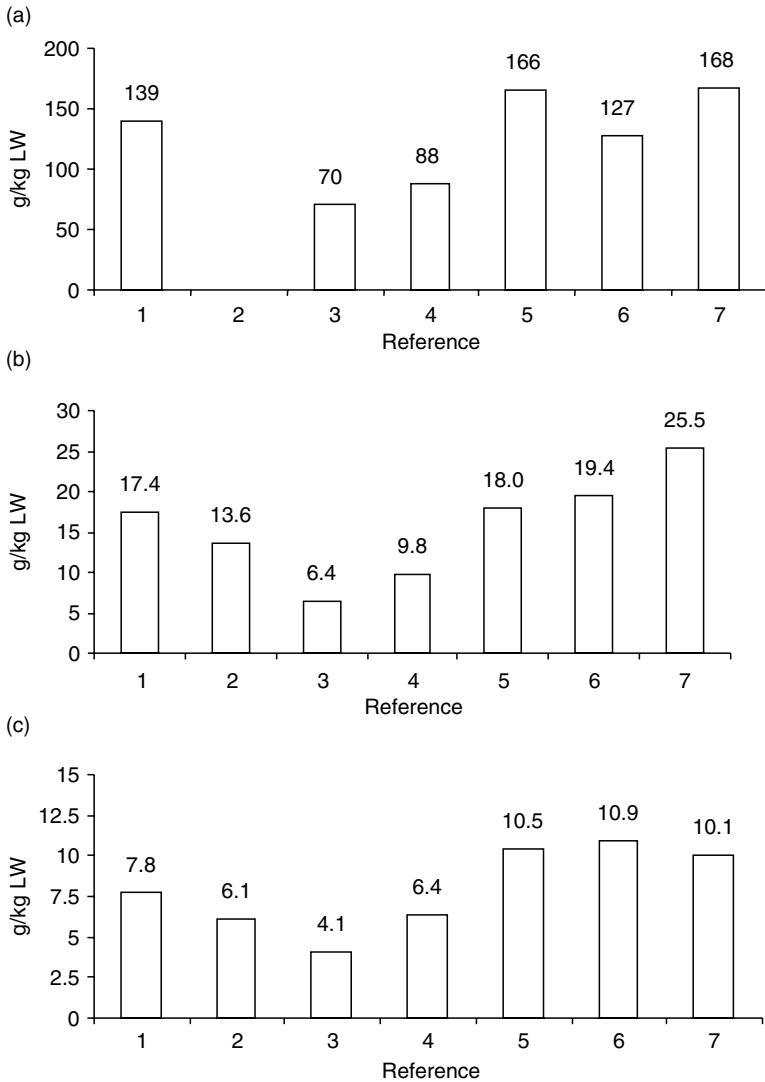
**Table 26.1.** Correlation between rumen pool sizes after grazing for three experiments ( $n = 52$ ) (Chilibröste, 1999).

	DM (kg)	NDF (kg)	ADL (kg)	N (kg)
Total (kg)	0.92***	0.91***	0.81***	0.77***
DM (kg)		0.95***	0.90***	0.88***
NDF (kg)			0.83***	0.71***
ADL (kg)				0.87***

\*\*\* $P < 0.01$ .

Vuuren *et al.*, 1992), grass silage of different maturity (Bosch *et al.*, 1992), a mixture (50:50) of grass and maize silage plus concentrate (de Visser *et al.*, 1992) or lucerne hay (Hartnell and Satter, 1979). The DM rumen pools after grazing are higher than those observed by Van Vuuren *et al.* (1992) in dairy cows fed fresh ryegrass indoors. They are similar to the figures reported by Waghorn *et al.* (1989) for fresh lucerne and ryegrass, but higher than those found by Danelón *et al.* (2002) for dry cows grazing lucerne, either directly or following cutting and wilting. All observed DM rumen pools are smaller than those reported for diets with high proportions ( $> 40\%$ ) of concentrates (Shaver *et al.*, 1986, 1988; Bosch *et al.*, 1992; De Visser *et al.*, 1992; Dado and Allen, 1995). The differences are larger when expressed as DM than NDF rumen pool sizes (Fig. 26.1).

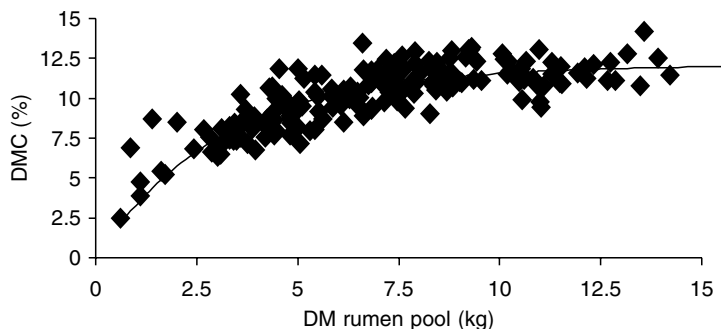
When eating fresh grass cows did not show evidence of having problems to accommodate large volumes of material in the rumen but they failed to pack it properly. The relative differences between plots (a) and (b) of Fig. 26.1 are mediated by the DM percentage of the rumen pool (DMC). Figure 26.2 shows the relationship between DMC and DM rumen pool in the grazing experiments reported by Chilibröste (1999). The model derived from it reaches an asymptote at a DMC of 12%, which means that when a certain DMC threshold is reached, the only alternative for a cow to increase its DM rumen pool is by increasing its volume. No doubt the low DMC of the fresh forages plays an important role in the low-rumen DMC and rumen fill observed. For instance, Danelón *et al.* (2002) reported values for total and DM rumen pool of 69.9 and 6.4 g/kg LW for cows grazing strips of fresh lucerne (DM 20.8%) while the values for swath grazing (DM 41.6%), were 88.3 and 9.8 g/kg LW. A close relationship between non-DM grass intake ( $29.1 \pm 10.9$  L) and changes in non-DM rumen pool sizes ( $26.2 \pm 12.6$  L) has been reported (Waghorn, 1986; Chilibröste *et al.*, 1997, 1998). As DMC of forage increases less herbage manipulation is required, due to a greater fragmentation during chewing and rumination. Because cows are able to reduce chewing during eating to increase intake rate (Laca *et al.*, 1994; Parsons *et al.*, 1994b), especially after a period of fasting, chewing efficiency during grazing seems more influenced by the rate of eating than by the type of feed.



**Fig. 26.1.** Total (a), DM (b) and NDF (c) rumen pool sizes (g/kg LW). References: 1, Chilibroste (1999) ( $n=28$ ); 2, estimated from Van Vuuren *et al.* (1991); 3 and 4, adapted from Danelón *et al.* (2002); 5, adapted from Bosch *et al.* (1992); 6, adapted from de Visser *et al.* (1992); 7, adapted from Hartnell and Satter (1979).

**Particle size reduction**

Chewing during eating serves three functions: long forages are reduced to a size small enough to be incorporated in a bolus and swallowed; soluble nutrients are released for fermentation; and the inner structure is damaged, enabling microbes to invade (Ulyatt *et al.*, 1986). Many investigations have focused on understanding chewing efficiency during eating and rumination (Ulyatt *et al.*, 1986; Boudon and Peyraud, 2001). However, due to the different methodologies



**Fig. 26.2.** Observed (symbols) and predicted (solid line) DM content (DMC, %) in the DM rumen pool (DMRP, kg) (Chilibroste, 1999). Model:  $DMC = 12.05 (\pm 0.189) (1 - e^{(-0.32(\pm 0.17)DMRP)})$ ;  $RSE = 1.24$ .

used, comparison of results is difficult. The majority of experiments were conducted with stall-fed animals, using conserved forages as fibre source. Few experiments have used fresh forages (Waghorn *et al.*, 1989; Boudon and Peyraud, 2001) and reports on ingestive mastication under grazing are rare (Nelson, 1988; Chilibroste *et al.*, 1998).

Waghorn (1986) and Waghorn *et al.* (1989) reported a chewing efficiency during eating of 46% for fresh perennial ryegrass and this efficiency was not related to intake rate. With a mix of ryegrass and lucerne, they found that 12%, 32% and 51% of the DM in rumen digesta after eating was retained on 10, 4 and 2 mm sieves, respectively. Boudon and Peyraud (2001) studied the release of intracellular constituents of fresh ryegrass during ingestive mastication in dairy cattle and found that intracellular N and NDS were released at slower rates than total soluble sugars (34% vs. 53%). The release of intracellular constituents as a whole was marginally affected by intake rate. Chilibroste *et al.* (1998) found that after 1 h of grazing, 75% of the newly ingested material was > 1.25 mm, but as the grazing session continued and contained a period of rumination, this value declined to 55%. In this study a close and inverse relationship between intake rate and ingestive mastication was observed.

It was assumed by Laca *et al.* (1994) for cattle and by Newman *et al.* (1994) for sheep that the importance of the chewing efficiency during grazing is the response variable exerted by the animal to maximize instantaneous intake rate. Time budgets during grazing have frequently been ascribed to the processes of harvesting the forage (manipulation and biting) and mastication or chewing of the ingested material. However, the functions of these two processes are not mutually exclusive. Research by Laca *et al.* (1994) has shown that cattle are able to bite and chew within the same jaw movement. As a result of the overlap between the two processes, time per bite increases linearly with bite weight, while intake rate increases asymptotically. These authors have also shown a linear relationship between chewing per bite and bite mass, which means that the degree of forage comminution decreases with increasing bite



mass. For sheep it has been proposed that the movements for prehension and mastication bites differ (Penning *et al.*, 1984), which suggests no overlap between the two components. Newman *et al.* (1994) suggested that, in addition to bite mass, animals might adjust the degree of mastication, thereby increasing bite rate and intake rate.

### **Passage rate**

Forages are usually rich in insoluble fibre, which immediately after ingestion is in particles that are too large to leave the rumen. Furthermore, they have a low functional specific gravity (FSG) of about 0.8 g/ml (Lechner-Doll *et al.*, 1991) because gases, including air, are present in their internal spaces. These particles form a floating mat on the surface of the liquid in the ventral rumen (Van Soest, 1994).

The amount of gas produced depends on the fermentation pattern and is higher with acetate or butyrate than with propionate production. Fermentation of fibre in forages results in more acetate and more gas than fermentation of cell contents. Removal of gas occurs through rumination and when microbial fermentation of a fibrous forage particle has reached a certain threshold, the removal of gases surpasses its formation. From that moment FSG increases, eventually to a level high enough to let it sink to the reticulum and pass into the omasum. Inverse relationships have been reported between particle size and fractional passage rate and between particle size and specific gravity (Kennedy and Murphy, 1988). In cattle, insoluble matter with FSG above 1.2 and a particle size below 4 mm is prone to pass out of the rumen (Van Soest, 1994). As result of the gradually increasing FSG, a high proportion of what is potentially degradable in the rumen is actually degraded (Tamminga, 1993).

### **Microbial degradation and synthesis, VFA production (pattern) and absorption**

Rumen bacteria are associated with particles (PAB) or free floating (FAB). Adhesion of bacteria to their substrate is advantageous for slow-growing bacteria that are exposed to the movement of liquids (saliva, rumen fluid), enabling them to reproduce before being washed away (Pell and Schofield, 1993). For microbes involved in fibre degradation, adhesion is believed to be a prerequisite. The delay in fibre passage caused by a slow fermentation results in a maximum extent of fermentation and ensures that the adhering microbes survive and multiply.

Due to microbial activity after ingestion, forage components are hydrolysed to monomers (sugars, amino acids, long-chain fatty acids) and further degraded to VFA and a varying but usually small proportion of branch-chained fatty acids (BCFA), the latter originating mainly from protein degradation. Degradation of forage simultaneously results in the formation of microbial biomass.

Before hydrolysis starts, FAB have to adhere to their substrate and cell walls need to be disrupted before the cell contents are released. At what point

after ingestion these components become available as nutrients for the microbial population in the rumen or for the animal depends on when the surrounding cell wall is sufficiently damaged to release its contents and on physical and/or biochemical properties that may control their subsequent hydrolysis. Disruption of the cell walls occurs as a result of ingestive mastication and subsequent rumination. The release of cell contents due to ingestive mastication is incomplete. Of the total DM in fresh ryegrass only between 0.15 and 0.20 is released and of the total N between 0.20 and 0.30. Of the components of the cell contents, i.e. free sugars, fructans, protein N, NPN and chlorophyll, proportionally 0.61, 0.42, 0.22, 0.58 and 0.28, respectively, are released. In legumes where SC are solely made up of free sugars, much higher releases of SC of up to 0.80 have been observed (Boudon and Peyraud, 2001).

Protein value and protein degradation in forages were recently reviewed (Tamminga and Südekum, 2000). Based on nylon bag incubation studies, fractional rate of degradation of crude protein in ryegrass was observed to vary between 0.078 and 0.140/h and declined with stage of maturity, but increased with level of N fertilization (Van Vuuren *et al.*, 1991). Reported fractional degradation rates of lucerne are usually higher, but white clover shows similar rates (Steg *et al.*, 1994). Fractional rate of hydrolysis also differs between fractions. Rubisco is degraded rapidly in the rumen (Aufrère *et al.*, 1994) with a rate of proteolysis observed to range between 0.04 and 0.47/h (McNabb *et al.*, 1994; Min *et al.*, 2000), varying with forage species and the presence of CT. Although proteins in fraction 2 may differ in rate of proteolysis in the rumen, their fractional rate of degradation is usually high (Mangan, 1982). Because of its insoluble nature, the degradation of chloroplast constituents like chlorophyll is much slower than that of fractions 1 and 2 (Aufrère *et al.*, 1994).

The degradation of SC is very rapid and free sugars are hydrolysed at rates of 3.0/h. Degradation of fructosans is slower, but still above 0.20/h (A. Boudon, personal communication). Structural carbohydrates are degraded much more slowly. Degradation rate of pectic substances, which are a significant proportion of cell walls in legumes, is highest and usually above 0.10/h. The fractional rate of degradation of cellulose and hemicellulose is variable but the rate seldom exceeds 0.10/h, and does not clearly differ between the two fractions. The fractional rate declines with an increased NDF content (Sauvant *et al.*, 1996) and both rate and extent of degradation depend on the degree of lignification. The size of the undegradable fraction (INDF) can be estimated from the lignin/NDF ratio (Traxler *et al.*, 1998), with the equation:

$$\text{INDF} = 4.37 \times (\text{lignin/NDF})^{0.84} \quad (26.1)$$

The size of the undegradable fraction of NDF in legumes is usually higher than in grasses, but the rate of degradation of the degradable fraction is higher (Tamminga, 1993; Steg *et al.*, 1994). Degradation of lipids is restricted to hydrolysis followed by partial hydrogenation.

## Forage Utilization

### *Ingestion and distribution of nutrients*

Dairy cows with a high milk production potential require high and balanced amounts of nutrients. Van Vuuren (1993) claims that nutrient supply from ingestion in forage-fed dairy cows is insufficient for a daily milk production above 28–30 kg, even when young highly digestible fresh grass is offered. Next to the total supply of nutrients, the ratio in which ketogenic, glucogenic and aminogenic nutrients are supplied is considered important, notably in dairy cows. Sources of nutrients are feed escaping microbial degradation, microbial biomass, fermentation end-products and mobilized body reserves.

Ketogenic nutrients originate from acetic acid (HAc), butyric acid (HBu) and long-chain fatty acids (LCFA) from either the feed, microbial biomass or body reserves. Body reserves of protein, potential suppliers of aminogenic nutrients, are small. Hence, these nutrients have to come predominantly from feed protein escaping microbial degradation and from microbial biomass. Glucogenic nutrients come from propionic acid (HPr) and  $\alpha$ -linked hexose polymers. The supply of aminogenic nutrients from forage protein escaping degradation is quite variable. Fresh forage shows a maximum of 113 g/kg DM of protein absorbed from the small intestine (Van Vuuren, 1993). In their review Beever *et al.* (2000) concluded that the efficiency of microbial N yield, expressed as per kg OM apparently digested in the rumen, is highly variable, but on average much lower for ensiled than for fresh forages. The main contributor to the supply of glucogenic nutrients from forages is propionic acid. Other sources of glucogenic nutrients in forage-fed animals are fructans, a proportion of which may escape rumen degradation, and small amounts of  $\alpha$ -linked polymers, synthesized by rumen microbes. After passing to the intestine they may contribute to the glucose supply.

Fermentation pattern largely reflects the rate of degradation. High rates yield a high proportion of HPr, whereas at low rates HAc predominates. Variation in rate of degradation of fibre of different sources is small and hence the ratio in which HAc, HPr and HBu are produced from fibrous forages shows little variation. When expressed as the non-glucogenic/glucogenic ratio [NGR = (HAc + 2HBu)/HPr], in experiments with grass silage the NGR varied in early lactation between 4.6 and 4.8, in late lactation between 4.8 and 5.3 (Bosch, 1991). On stall-fed, grass-based diets variation in NGR was between 4.1 and 4.6 (Van Vuuren, 1993), but on high concentrate diets in early lactation NGR varied between 3.4 and 4.6 (De Visser, 1993).

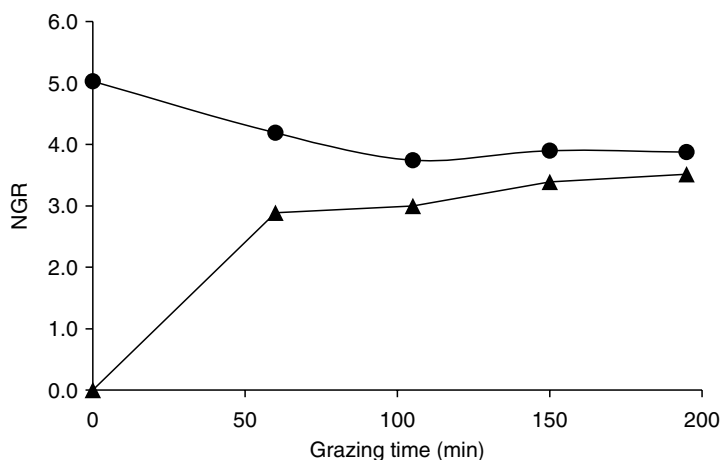
Groot *et al.* (1998) physically separated cell walls (CW) and cell contents (CC) from leaves of Italian ryegrass (*Lolium multiflorum*). Both fractions were subjected to a dynamic *in vitro* fermentation system in which gas production was measured continuously, and also other fermentation end-products, notably VFA. The results (Table 26.2) show that fermentation differed between CC and CW and much more HPr was produced when CC was fermented as compared with CW. Both substrates showed a linear increase of the proportion of HAc

**Table 26.2.** Fermentation profile of cell walls and cell contents of leaves of *Lolium multiflorum* (Groot *et al.*, 1998).

	Cell walls	Cell contents
NDF/OM (g/kg)	771	—
CP/OM (g/kg)	120	258
Total-VFA (mmol/g OM)	5.5	7.7
HAc (% t-VFA)	71	49
HPr (% t-VFA)	23	42
HBu (% t-VFA)	6	9
NGR ((HAc+2HBu)/HPr)	3.61	1.60

with time of incubation. The NGR was low, even for the fermentation of CW, but this could be expected because very young and leafy material was fermented.

Information on the VFA pattern produced in the rumen of grazing animals is scarce, but its variation may be larger than with forages fed indoors. Grazing animals have better opportunities to select and the level of SC may vary considerably between and within days. Van Vuuren *et al.* (1986) observed the total of SC to vary throughout the day between 130 and 175 g/kg DM in summer and between 80 and 120 g/kg DM in autumn. Highest values were reached in the late afternoon and evening and highest VFA concentrations appeared at midnight and coincided with a low NGR. Chilbroste *et al.* (1998) followed the VFA pattern in the rumen of dairy cows that were allowed to graze for different lengths of time after a long starvation period. The results in Fig. 26.3 show that the NGR in the total VFA pool declined but that the pool of newly added VFA started low (< 3.0) and increased with increasing grazing

**Fig. 26.3.** Development of the non-glucogenic/gluco-genic ratio (NGR) in the rumen pools of total VFA (●) and added VFA (▲).

time to a level approaching that reported by Van Vuuren (1993). After a short starvation period no such results were found, but in this experiment (Chilibroste *et al.*, 1998) the content of non-protein NDS, to which the soluble sugars contribute, was much lower than in the first experiment (172 vs. 318 g/kg DM).

### ***Manipulation of nutrient supply from forages***

Factors influencing the chemical composition and digestibility and hence the nutrient supply from forages, are forage species, growing stage, climate, season and forage management, including N fertilization. The effects of climate are complex and depend on temperature, radiation and rainfall.

#### *Forage species and management*

Grasses and legumes differ primarily in their protein content, the presence of CT, and the structure of their cell walls. Protein content is usually higher in legumes and the presence of CT is also restricted to legumes. Many tropical legume species contain high amounts of CT, but only a few temperate forages contain significant amounts. Examples are *Lotus pedunculatus*, *Lotus corniculatus*, *Hedysarum coronarium* and *Chicoricum intybus*. Consuming forages with medium concentrations of CT has nutritional advantages for ruminants. At concentrations of over 5 g/kg DM they prevent bloat when animals graze on swards that are rich in soluble proteins. Because they form complexes with forage protein, CT protect protein from degradation in the rumen. Reactivity of CT is pH-dependent and determined by their concentration, structure and molecular mass. Medium concentrations of CT (30–40 g/kg DM) increase intestinal absorption of amino acids and stimulate wool growth, milk protein output and reproduction in grazing sheep, without any negative effect on feed intake, whereas high concentrations of CT (75–100 g/kg DM) depress feed intake and digestion of NDF in the rumen (Barry and McNabb, 1999).

Crude protein content declines with increasing maturity, around 1.4 g/kg DM/day during the growing season. Nitrogen fertilization enhances the growth rate of forage and because it reaches the desired yield in a shorter period, such forages are harvested at a younger stage of maturity with a higher CP content (Van Vuuren, 1993).

Depending on the degree of encrustation of fibre with components such as lignin or silica, a variable proportion of fibre is susceptible to microbial fermentation. Regardless of its potential fermentability, 80 to 90% of fibre fermentation takes place in the rumen. The structure of the NDF in legumes differs from that in grasses. It has a higher non-fermentable fraction than grasses, but its fermentable NDF is degraded at a faster rate (Tamminga, 1993). Hot climates enhance both the content of NDF and of lignin, with usually a sharper rise in lignin, resulting in a negative effect on forage quality (Van Soest, 1994).

Forage management can also be used to manipulate nutrient supply to forage-fed animals. Possible approaches are: combinations of different forage

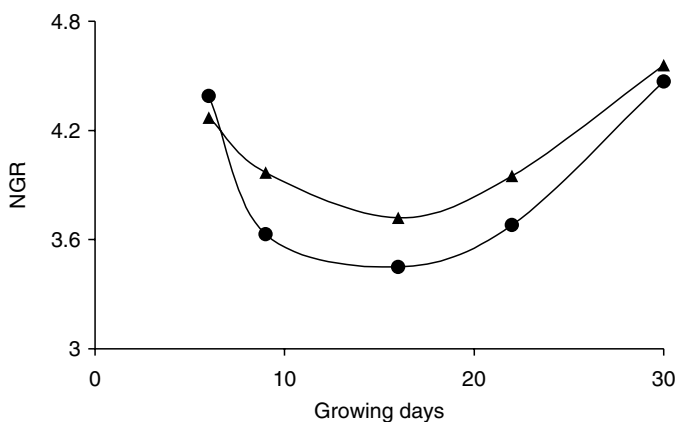
species, the application of N fertilizer, varying the harvesting height (either by cutting or grazing), or varying the harvesting time in the day. In a comparison of two levels of N fertilization (275 and 500 kg N/ha/year) and feeding the resulting grass to dairy cows, Van Vuuren *et al.* (1992) did not observe significant differences in the VFA pattern in the rumen. In an experiment where grazing was allowed on plots with an increasing number of growing days (Chilbroste *et al.*, 2000), NGR both before and after grazing initially declined, to reach a minimum after 16 growing days, after which it increased again (Fig. 26.4).

#### *Grazing management*

Increasing the proportion of the daily intake achieved during the afternoon (Chilbroste *et al.*, 1999, 2004; Orr *et al.*, 2001), results in a higher (although not significant) milk yield and a decreased milk fat content. This results from the combined effect of a higher sugar content of forage in the afternoon, a longer initial grazing bout and a faster intake rate that might impair rumen fermentation and hamper fibre digestion rate. Chilbroste *et al.* (2001) found that the milk fat depression previously observed was avoided when a limited amount of dry long fibre (hay from *Setaria italica*) was offered during the starvation time. Increasing the level of water-soluble carbohydrates was recently shown to have a positive effect on grass intake and milk yield (Miller *et al.*, 1999).

#### **Synchronization of rumen fermentation**

Productive, i.e. fast growing, grasses need an adequate presence of appropriate enzymes, notably enzymes to capture CO<sub>2</sub>. Large amounts of the easily (rumen) degradable enzyme complex Rubisco are therefore needed. Hence, an almost inevitable side effect of the intake of high-quality forage is that its fermentation in the rumen is unbalanced. The ratio between rumen degradable



**Fig. 26.4.** Effect of grass height on NGR of VFA in the rumen before (▲) and after grazing (●).

protein (RDP) and rumen degradable carbohydrates (RDC) usually has a surplus of N, resulting in high urinary N losses (Van Vuuren, 1993). Experiments with animals fed fresh grass indoors have shown that the magnitude of the N surplus as well as other rumen fermentation characteristics depend on composition and intake pattern of the grass. To what extent a better balance and synchronization between RDP and RDC depends on the nature of the RDC (i.e. WSC vs. NDF) in grass is not clearly established yet. Knowledge of the extent to which a better synchronization will result in a more efficient microbial protein synthesis is also scarce. An option may be to reduce the rumen imbalance after the ingestion of high quality, i.e. protein-rich, forages by supplementation. This can be done, either with low-protein forages like maize silage or with concentrates rich in non-structural carbohydrates or rich in rapidly degradable, i.e. pectin-rich, structural carbohydrates such as sugarbeet pulp or soybean hulls.

## Conclusions and Recommendations

Extraction and utilization of nutrients from forages by ruminants involves interaction between the herbivore, the plant and the microbial population. Important aspects of these interactions are characteristics of the forage and ingestive behaviour of the animal. Ruminants have evolved behaviour patterns as distinctive as their anatomy in adapting to their herbivorous life. Nevertheless, far from being rigid, within the grazing environment their ingestive and digestive behaviour patterns show considerable adaptability. The consequences of the behavioural adaptations during grazing on the post-ingestive behaviour by the animal and on the digestive process must be investigated. Advances in scientific understanding can contribute to improvements in grazing and feeding management practices. This chapter attempts to illustrate the nature of herbage variability and some of the adaptive responses by grazing ruminants.

## References

- Alden, W.G. and Whittaker, I.A.McD. (1970) The determinants of herbage intake by grazing sheep: Interrelationship of factors influencing herbage intake and availability. *Australian Journal of Agricultural Science* 21, 755–766.
- Aufrère, J., Boulberhane, D., Graviou, D., Andrieu, J.P. and Demarquilly, C. (1994) Characterisation of *in situ* degradation of lucerne proteins according to forage type (green forage, hay and silage) using gel electrophoresis. *Animal Feed Science and Technology* 50, 75–85.
- Barry, T.N. and McNabb, W.C. (1999) The implications of condensed tannins on the nutritive value of temperate forages fed to ruminants. *British Journal of Nutrition* 81, 263–272.
- Beever, D.E., Offer, N. and Gill, M. (2000) The feeding value of grass and grass products. In: Hopkins, A. (ed.) *Grass, its Production and Utilisation*. Blackwell Science Ltd, Oxford, UK, pp. 140–195.
- Black, J.L. and Kenney, P.A. (1984) Factors affecting diet selection in sheep. II. Height and density of pasture. *Australian Journal of Agricultural Research* 35, 565–578.

- Bosch, M.W. (1991) Influence of stage of maturity of grass silage on digestion processes in dairy cows. PhD thesis, Wageningen Agricultural University, Wageningen, The Netherlands.
- Bosch, M.W., Lammers Wienhoven, S.C.W., Bangma, G.A., Boer, H. and Van Adrichem, P.W.M. (1992) Influence of stage of maturity of grass silages on digestion processes in dairy cows. 2. Rumen contents, passage rates, distribution of rumen and faecal particle and mastication activity. *Livestock Production Science* 32, 265–281.
- Boudon, A. and Peyraud, J.-L. (2001) The release of intracellular constituents from fresh ryegrass (*Lolium perenne* L.) during ingestive mastication in dairy cows: effect of intracellular constituent, season and stage of maturity. *Animal Feed Science and Technology* 93, 229–245.
- Chacon, E.A. and Stobbs, T.H. (1977) The effects of fasting prior to sampling and diurnal variation on certain aspects of grazing behaviour in cattle. *Applied Animal Ethology* 3, 163–171.
- Chilbroste, P. (1999) Grazing time: the missing link. A study of the plant–animal interface by integration of experimental and modelling approaches. PhD thesis, Wageningen Agricultural University, Wageningen, The Netherlands.
- Chilbroste, P., Tamminga, S. and Boer, H. (1997) Effect of length of grazing session, rumen fill and starvation time before grazing on dry matter intake, ingestive behaviour and dry matter rumen pool sizes of grazing lactating dairy cows. *Grass and Forage Science* 52, 249–257.
- Chilbroste, P., Tamminga, S., Van Bruchem, J. and Van der Togt, P.L. (1998) Effect of allowed grazing time, inert rumen bulk and length of starvation before grazing, on the weight, composition and fermentative end-products of the rumen contents of lactating dairy cows. *Grass and Forage Science* 53, 146–156.
- Chilbroste, P., Soca, P. and Mattiauda, D.A. (1999) Effect of the moment and length of the grazing session on: 1. Milk production and pasture depletion dynamics. In: *Proceedings of International Symposium Grassland Ecophysiology and Grazing Ecology*. Universidade Federal do Parana, Curitiba, Brazil, pp. 292–295.
- Chilbroste, P., Tamminga, S., Boer, H., Gibb, M.J. and Den Dikken, G. (2000) Duration of regrowth of ryegrass (*Lolium perenne*) effects on grazing behavior, intake, rumen fill, and fermentation of lactating dairy cows. *Journal of Dairy Science* 83, 984–995.
- Chilbroste, P., Mattiauda, D.A. and Bruni, M.A. (2001) Efecto de la duración de la sesión de pastoreo y la inclusión de una fuente de fibra larga, sobre la producción y composición de la leche de vacas Holstein pastoreando avena (*Avena sativa*). *Revista Argentina de Producción Animal* 21, 73–75.
- Chilbroste, P., Soca, P., Mattiauda, D.A. and Bentancur, O. (2004) Incorporation of short term fasting in grazing and feeding management strategies for cattle: an integrated approach. In: *II Symposium on Grassland and Ecophysiology and Grazing Ecology*, 11 to 14 October 2004. Curitiba, Paraná, Brazil, (in press).
- Conrad, H.R. (1966) Symposium on factors influencing the voluntary intake of herbage by ruminants: physiological and physical factors limiting feed intake. *Journal of Animal Science* 25, 227–235.
- Dado, R.G. and Allen, M.S. (1995) Intake limitations, feeding behavior, and rumen function of cows challenged with rumen fill from dietary fiber or inert bulk. *Journal of Dairy Science* 78, 118–133.
- Danelón, J.L., Locatelli, M.L., Gallardo, M. and Guaita, S. (2002) Herbage intake and ruminal digestion of alfalfa: a comparison between strip and zero grazed dairy cows. *Livestock Production Science* 74, 79–91.



- De Visser, H. (1993) Influence of carbohydrates on feed intake, rumen fermentation and milk performance in high yielding dairy cows. PhD thesis, Wageningen Agricultural University, Wageningen, The Netherlands.
- De Visser, H., Van der Togt, P.L., Huisert, H. and Tamminga, S. (1992) Structural and non-structural carbohydrates in concentrate supplements of silage-based dairy cow rations. 2. Rumen degradation, fermentation and kinetics. *Netherlands Journal of Agricultural Science* 40, 431–445.
- Dougherty, C.T., Bradley, N.W., Cornelius, P.L. and Lauriault, L.M. (1989) Short-term fasts and the ingestive behaviour of grazing cattle. *Grass and Forage Science* 44, 295–302.
- Edwards, G.R. (1994) The creation and maintenance of spatial heterogeneity in plant communities: the role of plant-animal interactions. D. Phil. thesis, University of Oxford, UK.
- Edwards, G.R., Parsons, A.J., Penning, P.D. and Newman, J.A. (1995) Relationships between vegetation state and bite dimensions of sheep grazing contrasting plant species and its implication for intake rate and diet selection. *Grass and Forage Science* 50, 378–388.
- Faverdin, P., Baumont, R. and Ingvarsen, K.L. (1995) Control and prediction of feed intake in ruminants. In: Journet, M., Grenet, E., Farce, M.-H., Theriez, M. and Demarquilly, C. (eds) *Recent Developments in the Nutrition of Herbivores*. INRA Editions, Paris, France, pp. 95–120.
- Gibb, M.J. and Ridout, M.S. (1986) The fitting of frequency distributions to height measurements on grazed swards. *Grass and Forage Science* 41, 247–249.
- Gibb, M.J. and Ridout, M.S. (1988) Application of double normal height frequency distributions fitted to measurements of sward height. *Grass and Forage Science* 43, 131–136.
- Gibb, M.J. and Treacher, T.T. (1976) The effect of herbage allowance on herbage intake and performance of lambs grazing perennial ryegrass and red clover swards. *Journal of Agricultural Science, Cambridge* 86, 355–365.
- Gibb, M.J. and Treacher, T.T. (1978) The effect of herbage allowance on herbage intake and performance of ewes and their twin lambs grazing perennial ryegrass. *Journal of Agricultural Science, Cambridge* 90, 139–147.
- Gibb, M.J., Baker, R.D. and Sayer, A.M.E. (1989) The impact of grazing severity on perennial ryegrass/white clover swards stocked continuously with beef cattle. *Grass and Forage Science* 44, 315–328.
- Gibb, M.J., Huckle, C.A., Nuthall, R. and Penning, P.D. (1996) Can grazed pasture meet the needs of the high genetic merit dairy cow? In: *Grass and Forage for Cattle of High Genetic Merit*. Winter Meeting British Grassland Society. British Grassland Society, Reading, UK.
- Gibb, M.J., Huckle, C.A., Nuthall, R. and Rook, A.J. (1997) Effect of sward surface height on intake and grazing behaviour by lactating Holstein-Friesian cows. *Grass and Forage Science* 52, 309–321.
- Gibb, M.J., Huckle, C.A. and Nuthall, R. (1998) Effect of time of day on grazing behaviour and intake rate by lactating dairy cows. *Grass and Forage Science* 53, 41–46.
- Gibb, M.J., Huckle, C.A., Nuthall, R. and Rook, A.J. (1999) The effect of physiological state (lactating or dry) and sward surface height on grazing behaviour and intake by dairy cows. *Applied Animal Behaviour Science* 63, 269–287.
- Gibb, M.J., Huckle, C.A., and Nuthall, R. (2002) Effects of level of concentrate supplementation on grazing behaviour and performance by lactating dairy cows grazing continuously stocked grass swards. *Animal Science* 74, 319–335.

- Gordon, I.J., Illius, A.W. and Milne, J.D. (1996) Sources of variation in the foraging efficiency of grazing ruminants. *Functional Ecology* 10, 219–226.
- Groot, J.C.J. de, Williams, B.A., Oostdam, A.J., Boer, H. and Tamminga, S. (1998) The use of cumulative gas and volatile fatty acid production to predict *in vitro* fermentation kinetics of Italian ryegrass leaf cell walls and contents at various time intervals. *British Journal of Nutrition* 79, 1–7.
- Grovum, W.L. (1987) A new look at what is controlling feed intake. In: Owens, F.N. (ed.) *Symposium Proceedings, Feed intake by Beef Cattle*. Oklahoma State University, Stillwater, Oklahoma, pp. 1–40.
- Hartnell, G.F. and Satter, L.D. (1979) Determination of rumen fill, retention time and ruminal turnover rates of ingesta at different stages of lactation in dairy cows. *Journal of Animal Science* 48, 381–392.
- Harvey, A., Parsons, A.J., Rook, A.J., Penning, P.D. and Orr, R.J. (2000) Dietary preference of sheep for perennial ryegrass and white clover at contrasting sward heights. *Grass and Forage Science* 55, 242–252.
- Hodgson, J. (1985) The control of herbage intake in the grazing ruminant. *Proceedings of the Nutrition Society* 44, 339–346.
- Hutchings, N.J., Bolton, G.R. and Barthram, G.T. (1992) Decision rules for controlling the sward height of continuously grazed experimental pastures. *Grass and Forage Science* 47, 41–49.
- Illius, A.W., Gordon, I.J., Milne, J.D. and Wright, W. (1995) Costs and benefits of foraging on grasses varying in canopy structure and resistance to defoliation. *Functional Ecology* 9, 894–903.
- Jamieson, W.S. and Hodgson, J. (1979) The effect of daily herbage allowance and sward characteristics upon the ingestive behaviour and herbage intake of calves under strip-grazing management. *Grass and Forage Science* 34, 261–271.
- Kennedy, P.M. and Murphy, M.R. (1988) The nutritional implications of differential passage of particles through the ruminant alimentary tract. *Nutrition Research Reviews* 1, 189–208.
- Ketelaars, J.J.M.H. and Tolkamp, B.J. (1991) Toward a new theory of feed intake regulation in ruminants. PhD thesis, Wageningen Agricultural University, Wageningen, The Netherlands.
- Laca, E.A., Ungar, E.D., Seligman, N. and Demment, M.W. (1992) Effects of sward height and bulk density on bite dimensions of cattle grazing homogeneous swards. *Grass and Forage Science* 47, 91–102.
- Laca, E.A., Ungar, E.D. and Demment, M.W. (1994) Mechanisms of handling time and intake rate of a large mammalian grazer. *Applied Animal Behaviour Science* 39, 3–19.
- Laredo, M.A. and Minson, D.J. (1973) The voluntary intake, digestibility and retention time by sheep of leaf and stem fractions of five grasses. *Australian Journal of Agricultural Research* 24, 875–888.
- Lechner-Doll, M., Kaske, M. and Von Engelhardt, W. (1991) Factors affecting the mean retention time of particles in the forestomachs of ruminants and camelids. In: Tsuda, T., Sasaki, Y. and Kawashima, R. (eds) *Physiological aspects of digestion and metabolism in ruminants*. Academic Press Inc., San Diego, California, pp. 455–482.
- Mangan, J.L. (1982) The nitrogenous constituents of fresh forages. In: Thomson, D.J., Beaver, D.E. and Gunn, R.G. (eds) *Forage Protein in Ruminant Animal Protein Production*. The British Society of Animal Production, Penicuik, UK.
- Mayne, C.S. (1991) Grazing. In: Thomas, C., Reeve, A. and Fisher, G.E.J. (eds) *Milk from Grass*, 2nd edn. British Grassland Society, Reading, UK, pp. 53–71.

- Mayne, C.S., Wright, I.A. and Fisher, G.E.J. (2000) Grassland management under grazing and animal response. In: Hopkins, A. (ed.) *Grass, its Production and Utilisation*. Blackwell Science Ltd, Oxford, UK, pp. 247–291.
- McGilloway, D.A., Cushnahan, A., Laidlaw, A.S., Mayne, C.S. and Kilpatrick, D.J. (1999) The relationship between level of sward height reduction of a rotationally grazed sward and short-term intake rate of dairy cows. *Grass and Forage Science* 54, 116–126.
- McNabb, W.C., Spencer, D., Higgins, T.J. and Barry, T.N. (1994) *In vitro* rates of rumen proteolysis of ribulose-1,5-biphosphate carboxylase (Rubisco) from lucerne leaves, and of ovalbumin, vicilin and sunflower albumin 8 storage protein. *Journal of Science Food and Agriculture* 64, 53–61.
- Mertens, D.R. (1987) Predicting intake and digestibility using mathematical models of ruminal function. *Journal of Animal Science* 64, 1548–1558.
- Miller, L.A., Theodorou, M.K., MacRae, J.C., Evans, R.T., Adesogan, A.T., Humphreys, M.O., Scollan, N.D. and Moorby, J.M. (1999) Milk production and N partitioning in dairy cows offered perennial ryegrass selected for high water-soluble carbohydrate concentrations. *South African Journal of Animal Science* 29, 281–282.
- Milne, J.A. (1991) Diet selection by grazing animals. *Proceedings of the Nutrition Society* 50, 77–85.
- Min, B.R., McNabb, W.C., Barry, M.C. and Peters, J.S. (2000) Solubilisation and degradation of ribulose-1,5-biphosphate carboxylase (EC 4.1.1.39; Rubisco) protein from white clover (*Trifolium repens*) and *Lotus corniculatus* by rumen microorganisms and the effect of condensed tannins on these processes. *Journal of Agricultural Science, Cambridge* 134, 305–317.
- Nelson, M.L. (1988) Factors affecting the particle size distribution of grazed forage due to ingestive mastication by steers and wethers. *Journal of Animal Science* 66, 1256–1266.
- Newman, J.A., Parsons, A.J. and Harvey, A. (1992) Not all sheep prefer clover: diet selection revisited. *Journal of Agricultural Science, Cambridge* 119, 275–283.
- Newman, J.A., Penning, P.D., Parsons, A.J., Harvey, A. and Orr, R.J. (1994) Fasting affects intake behaviour and diet preference by grazing sheep. *Animal Behaviour* 47, 185–193.
- Norton, B.W., Kennedy, P.J. and Hales, J.W. (1990) Grazing management studies with Australian cashmere goats. 3. Effect of season on the selection of diet, by cattle, sheep and goats from two tropical grass-legume pastures. *Australian Journal of Experimental Agriculture* 30, 783–788.
- Orr, R.J., Penning, P.D., Harvey, A. and Champion, R.A. (1996a) Diurnal patterns of intake rate by sheep grazing monocultures of ryegrass or white clover. *Applied Animal Behaviour Science* 52, 65–77.
- Orr, R.J., Rutter, S.M., Penning, P.D., Yarrow, N.H. and Champion, R.A. (1996b) Grazing behaviour and herbage intake rate by Friesian dairy heifers grazing ryegrass or white clover. In: Younie, D. (ed.) *Legumes in Sustainable Farming Systems*. Occasional Symposium No. 30, British Grassland Society, Reading, UK, pp. 221–224.
- Orr, R.J., Rutter, S.M., Penning, P.D., Yarrow, N.H. and Champion, R.A. (1997) Sward state and ingestive behaviour by Friesian dairy heifers under rotational grazing. In: *Proceedings of the 5th Research Meeting, British Grassland Society, Seale Hayne*. British Grassland Society, Reading, UK, pp. 51–52.
- Orr, R.J., Rutter, S.M., Penning, P.D. and Rook A.J. (2001) Matching grass supply to grazing patterns for dairy cows. *Grass and Forage Science* 56, 352–361.

- Parsons, A.J. and Chapman, D.F. (2000) The principles of pasture growth and utilisation. In: Hopkins, A. (ed.) *Grass, its Production and Utilisation*. Blackwell Science Ltd, Oxford, UK, pp. 31–89.
- Parsons, A.J., Newman, J.A., Penning, P.D., Harvey, A. and Orr, R.J. (1994a) Diet preference of sheep: effects of recent diet, physiological state and species abundance. *Journal of Animal Ecology* 63, 465–478.
- Parsons A.J., Thornley J.H.M., Newman, J.A. and Penning, P.D. (1994b) A mechanistic model of some physical determinants of intake rate and diet selection in a two-species temperate grassland sward. *Functional Ecology* 8, 187–204.
- Patterson, D.M., McGilloway, D.A., Cushnahan, A., Mayne, C.S. and Laidlaw, A.S. (1998) Effect of duration of fasting period on short-term intake rates of lactating dairy cows. *Animal Science* 66, 299–305.
- Pell, A.N. and Schofield, P. (1993) Microbial adhesion and degradation of plant cell walls. In: Jung, H.G., Buxton, D.R., Hatfield, R.D. and Ralph, J. (eds) *Forage Cell Wall Structure and Digestibility*. American Society of Agronomy, Madison, Wisconsin, pp. 397–424.
- Penning, P.D., Steel, G.L. and Johnson, R.H. (1984) Further development and use of an automatic recording system in sheep grazing studies. *Grass and Forage Science* 39, 345–351.
- Penning, P.D., Parsons, A.J., Orr, R.J. and Treacher, T.T. (1991a) Intake and behaviour responses by sheep to changes in sward characteristics under continuous stocking. *Grass and Forage Science* 46, 15–28.
- Penning, P.D., Rook, A.J. and Orr, R.J. (1991b) Patterns of ingestive behaviour of sheep continuously stocked on monocultures of ryegrass or white clover. *Applied Animal Behaviour Science* 31, 237–250.
- Penning, P.D., Parsons, A.J., Newman, J.A., Orr, R.J. and Harvey, A. (1993) The effects of group size on grazing in sheep. *Applied Animal Behaviour Science* 37, 101–109.
- Penning, P.D., Parsons, A.J., Orr, R.J. and Hooper, G.E. (1994) Intake and behaviour responses by sheep to changes in sward characteristics under rotational grazing. *Grass and Forage Science* 49, 476–486.
- Penning, P.D., Parsons, A.J., Orr, R.J., Harvey, A. and Champion, R.A. (1995a) Intake and behaviour responses in sheep, in different physiological states, when grazing monocultures of grass or white clover. *Applied Animal Behaviour Science* 45, 63–78.
- Penning, P.D., Parsons, A.J., Orr, R.J., Harvey, A. and Yarrow, N.H. (1995b) Dietary preference of heifers for grass or clover, with and without rumensin slow-release anti-bloat boluses. *Animal Science* 60, 550.
- Penning, P.D., Johnson, R.H. and Orr, R.J. (1996) Effects of continuous stocking with sheep or goats on sward composition and animal performance from a grass and white clover pasture. *Small Ruminant Research* 21, 19–29.
- Penning, P.D., Newman, J.A., Parsons, A.J., Harvey, A. and Orr, R.J. (1997) Diet preferences of adult sheep and goats grazing ryegrass and white clover. *Small Ruminant Research* 24, 175–184.
- Penning, P.D., Gibb, M.J., Parsons, A.J., Orr, R.J. and Harvey, A. (1998) Behavioural and physiological factors limiting intake by grazing ruminants. In: *Concerted Action: CT93 – 0947, Proceedings of Joint Meeting of Pasture Ecology/ Animal Intake Working Groups*. Dublin, Irish Republic, September 1996.
- Peyraud, J.L., Comeron, E.A., Wade, M.H. and Lemaire, G. (1996) The effect of daily herbage allowance, herbage mass and animal factors upon herbage intake by dairy cows. *Annales de Zootechnie* 45, 201–217.

- Rind, M.I. and Phillips, C.J.C. (1999) The effects of group size on the ingestive and social behaviour of grazing dairy cows. *Animal Science* 68, 589–596.
- Rutter, S.M., Orr, R.J., Penning, P.D., Yarrow, N.H., Champion, R.A. and Atkinson, L.D. (1998) Dietary preference of dairy cows grazing grass and clover. In: *Proceedings of the Winter Meeting of the British Society of Animal Science, Scarborough, UK, 23–25 March 1998*. BSAS, Penicuik, UK, p. 51.
- Rutter, S.M., Orr, R.J., Penning, P.D., Yarrow, N.H. and Champion, R.A. (2002) Ingestive behaviour of heifers grazing monocultures of ryegrass or white clover. *Applied Animal Behaviour Science* 76, 1–9.
- Sauvant, D., Baumont, R. and Faverdin, P. (1996) Development of a mechanistic model of intake and chewing activities of sheep. *Journal of Animal Science* 74, 2785–2802.
- Schwinning, S. and Parsons, A.J. (1996) Interactions between grasses and legumes: understanding variability in species composition. In: Younie, D. (ed.) *Legumes in Sustainable Farming Systems*. Occasional Symposium No. 30, British Grassland Society, Reading, UK, pp. 153–163.
- Shaver, R.D., Nytes, A.J., Satter, L.D. and Jorgensen, N.A. (1986) Influence of amount of feed intake and forage physical form on digestion and passage of prebloom alfalfa hay in dairy cows. *Journal of Dairy Science* 69, 1545–1559.
- Shaver, R.D., Satter, L.D. and Jorgensen, N.A. (1988) Impact of forage fiber content on digestion and digesta passage in lactating dairy cows. *Journal of Dairy Science* 71, 1556–1565.
- Soca, P., Chilibroste, P. and Mattiauda, D.A. (1999) Effect of the moment and length of the grazing session on: 2. Grazing time and ingestive behaviour. In: *Proceedings of International Symposium Grassland Ecophysiology and Grazing Ecology*. Universidade Federal do Parana, Curitiba, Brazil, pp. 295–298.
- Steg, A., Van Straalen, W.M., Hindle, V.A., Wensink, W.A., Dooper, F.M.H. and Schils, R.L.M. (1994) Rumen degradation and intestinal digestion of grass and clover at two maturity levels during the season in dairy cows. *Grass and Forage Science* 49, 378–390.
- Stobbs, T.H. (1973) The effect of plant structure on intake of tropical pastures. I. Variation in the bite size of grazing cattle. *Australian Journal of Agricultural Research* 24, 809–819.
- Tamminga, S. (1993) Influence of feeding management on ruminant fiber digestibility. In: Jung, H.G., Buxton, D.R., Hatfield, R.D. and Ralph, J. (eds) *Forage Cell Wall Structure and Digestibility*. American Society of Agronomy, Madison, Wisconsin, pp. 571–602.
- Tamminga, S. and Südekum, K.-H. (2000) Optimise feeding value of forage protein. *Grassland Science in Europe* 5, 143–156.
- Traxler, M.J., Fox, D.G., Van Soest, P.J., Pell, A.N., Lascano, C.E., Lanna, D.P.D., Moore, J.E., Lana, R.P., Vélez, M. and Flores, A. (1998) Predicting forage indigestible NDF from lignin concentration. *Journal of Animal Science* 76, 1469–1480.
- Ulyatt, M.J., Dellow, D.W., John, A., Reid, C.S.W. and Waghorn, G.C. (1986) Contribution of chewing during eating and rumination to the clearance of digesta from the ruminoreticulum. In: Milligan, L.P., Grovum, W.L. and Dobson, A. (eds) *Control of Digestion and Metabolism in Ruminants*. Prentice-Hall, Englewood Cliffs, New Jersey, pp. 498–515.
- Van Soest, P.J. (1994) *Nutritional Ecology of the Ruminant*. Cornell University Press, Ithaca, New York.

- Van Soest, P.J., Robertson, J.B. and Lewis, B.A. (1991) Methods of dietary fiber, neutral detergent fiber, and nonstarch polysaccharides in relation to animal nutrition. *Journal of Dairy Science* 74, 3583–3597.
- Van Vuuren, A.M. (1993) Digestion and nitrogen metabolism of grass in dairy cows. PhD thesis, Wageningen Agricultural University, Wageningen, The Netherlands.
- Van Vuuren, A.M., Van der Koelen, C.J. and Vroons-de Bruin, J. (1986) Influence of level and composition of concentrate supplements on rumen fermentation patterns of grazing dairy cows. *Netherland Journal of Agricultural Science* 34, 457–467.
- Van Vuuren, A.M., Tamminga, S. and Ketelaar, R.S. (1991) *In sacco* degradation of organic matter and crude protein of fresh grass (*Lolium perenne*) in the rumen of grazing dairy cows. *Journal of Agricultural Science Cambridge* 116, 429–436.
- Van Vuuren, A.M., Krol-Kramer, F., van der Lee, R.A. and Corbijn, H. (1992) Protein digestion and intestinal amino acids in dairy cows fed fresh *Lolium perenne* with different nitrogen content. *Journal of Dairy Science* 75, 2215–2225.
- Wade, M.H., Peyraud, J.L., Lemaire, G. and Comeron, E.A. (1989) The dynamics of daily area and depth of grazing and herbage intake of cows in a five day paddock system. In: *Proceedings of the XVI International Grassland Congress*. Association Francaise pour la Production Fourragere, Versailles, France, pp. 1111–1112.
- Waghorn, G.C. (1986) Changes in rumen digesta of cows during a restricted feeding period when offered fresh red clover, lucerne, or lucerne hay. *New Zealand Journal of Agricultural Research* 29, 233–241.
- Waghorn, G.C., Shelton, I.D. and Thomas, V.J. (1989) Particle breakdown and rumen digestion of fresh ryegrass (*Lolium perenne* L.) and lucerne (*Medicago sativa* L.) fed to cows during a restricted feeding period. *British Journal of Nutrition* 61, 409–423.

---

# 27 Integration of Data in Feed Evaluation Systems

J.P. Cant

*Department of Animal and Poultry Science, University of Guelph, Guelph, Ontario N1G 2W1, Canada*

---

## Introduction

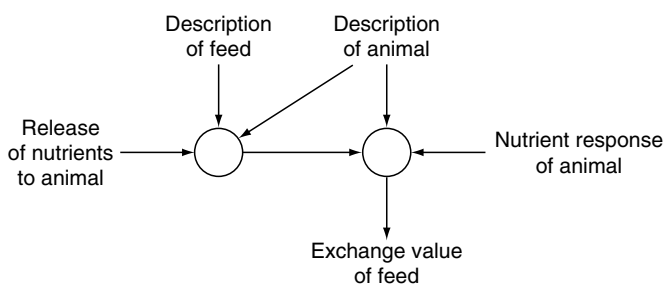
A feed evaluation system is a formal approach to predict the animal response to intake of a given set of feed ingredients. The quantitative animal response dictates the exchange value of the feedstuff, i.e. how much it is worth in trade for other feedstuffs or goods. One of the oft-cited evaluation systems of the late 18th century was that of the hay equivalent (Tyler, 1975) in which various feedstuffs were scored relative to hay in their ability to maintain a satisfactory level of performance. One hundred pounds of potatoes were said to be equivalent to 50 lb hay for growing cattle so that 'a cow fed solely on hay should have 20 lb of that substance per day, but if she is given 10 lb hay then instead of the other 10 lb she should have 20 lb of potatoes' (Thaer, 1812 translated by Tyler, 1975).

The hay equivalent system was based on data obtained in a bioassay of animal performance response to feed ingredient intake. It was soon recognized, particularly by the Liebig school of chemists, that the nutritive value of feeds resided in their digestible protein, fat and carbohydrate fractions. This appeal to underlying cause meant that, instead of conducting a prohibitively expensive animal performance bioassay on every feedstuff being considered for trade, the results of previous bioassays relating animal performance to digestible nutrient intake could be used to score new feedstuffs that had been characterized only in terms of digestible nutrient content. The first nutrient requirement table listing results of performance bioassays conducted at agricultural research institutions in terms of crude protein, fat and carbohydrate intakes needed for maintenance and production of different farm animals was published by Grouven in 1858 (Armsby, 1917). Thus was born a system of feed evaluation in which data from disparate sources were integrated to arrive at an estimate of the exchange value of a feed or set of feed ingredients.

In the ensuing 150 years, feed evaluation systems have propagated throughout the world and evolved in the array of feed and animal measurements

that can be accommodated. The integrative structure, however, remains as it was first established (Fig. 27.1). There are four sets of data that are input to the system. These are a description of the feed, a description of the animal to whom it is to be fed, the rate of release of nutrients from the feed to the animal, and the response of the animal to nutrient supply. The four data sets may be obtained under different conditions. For accurate evaluation, it is considered most appropriate that the descriptions of feedstuffs and animals are newly measured at the time of evaluation. In contrast, release of nutrients involves intake and digestibility, which are usually estimated mathematically from previous measures on feedstuffs and animals similar to those currently under consideration. The nutrient response data are, likewise, historical and expressed in the parameters of predictive equations. The multitude of feed evaluation systems in use around the world today differ primarily in what is required for the feedstuff and animal descriptions, in the structure of the predictive equations and in the variables used to express final feed value. These differences will be explored in the following sections.

A system is defined as a collection of elements that interact through cause and effect, and the representation of that system with mathematical equations constitutes a model (Close and Frederick, 1995). Accordingly, a feed evaluation system, in which data from disparate sources are integrated mathematically, is not so much a system as it is a model. The system being modelled is the animal for whom one wants to know the feed value. Thus, the term model will be used throughout this chapter, instead of system, in recognition that a specific understanding of how feed is utilized is implied in the feed evaluation calculations. It may seem unnecessary, but it is not trivial, to point out that all models with the structure shown in Fig. 27.1 are founded on the hypothesis that nutrient supplies determine animal performance. Also, Fig. 27.1 highlights the difference between nutritive and exchange value of a feedstuff; exchange value depends not only on nutrient content of the feedstuff in question, but also on that of any other feedstuffs included in the diet and on characteristics of the animal to whom it is fed. Various models take different account of these associations.



**Fig. 27.1.** Information flow in a feed evaluation model.

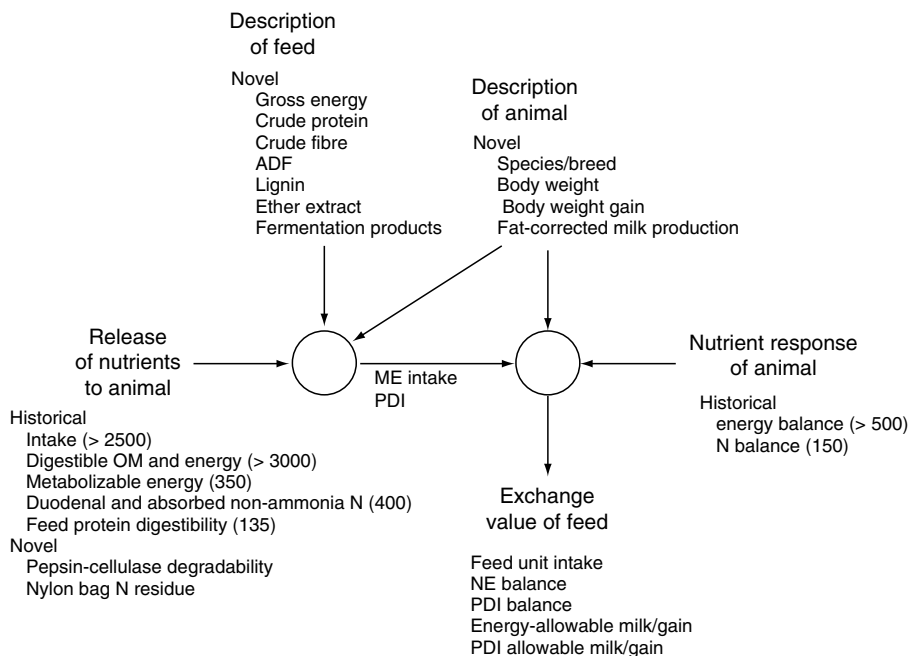


## Net Energy/Digestible Protein Models

The most common approach to feed evaluation in Western countries uses a net energy (NE)/digestible protein (DP) model. There are several variations in existence (INRA, 1987; Van der Honing and Alderman, 1988; AFRC, 1993; Weisbjerg and Hvelplund, 1993; NRC, 1996, 2001). The French INRA (1978) was one of the first implemented and the North American NRC (2001) is one of the most recently updated. The data sources and means of integration for the revised INRA (1987) model will be presented here as an example of the NE/DP approach to feed evaluation.

The goal of the INRA (1987) model is to predict intakes of NE and protein truly digested in the small intestine (PDI) for individual animals and compare them with requirements for maintenance and production to arrive at differences between intake and requirement or estimates of energy- and protein-allowable production (i.e. milk production or body weight gain). The data that are integrated for this goal are listed in Fig. 27.2. Sets of feedstuffs under consideration are analysed for gross energy, crude protein (CP), crude fibre (CF), acid-detergent fibre (ADF), lignin, ether extract and, for silages, fermentation products. The animals to be fed are defined as to species, body weight, body weight gain and fat-corrected milk production.

Data from more than 2500 feed intake studies, 3000 total tract digestibility measurements, 400 duodenal N flows, 130 small intestinal digestibilities and



**Fig. 27.2.** Data integrated in the INRA (1987) net energy/digestible protein model to arrive at feed value. Numbers of measures of each historical data class are given in parentheses.

350 ME measurements were used to predict steady-state release of nutrients from the new feedstuffs under consideration. The nutrient release data have been either provided as reference values to be obtained from a table or captured in parameters of simple and multiple linear regression equations.

Dry matter intake (DMI) data were used to develop a system of fill units (Jarrige *et al.*, 1986) where the voluntary intake of standard pasture grass (first growth, 15% CP and 25% CF) by adult sheep or cattle represents 1 fill unit ( $UE_{\text{sheep}}$  and  $UE_{\text{cattle}}$ , respectively). Voluntary DMI of other forages in the feed intake studies at INRA research stations were scaled relative to the standard pasture grass intakes and the resultant UE per kilogram DM are listed in reference tables according to forage species and stage of harvest. The majority of intake data were obtained from sheep and, for those forages not fed to cattle, a linear regression between sheep and cattle intakes of identical forages was used to estimate  $UE_{\text{cattle}}$  from  $UE_{\text{sheep}}$ . Dry matter intakes by growing and lactating animals were regressed against metabolic body weight and level of milk production to obtain equations for prediction of intake capacity, expressed in UE per day. *Ad libitum* intakes of forages being evaluated in the INRA (1987) system are calculated as the ratio of intake capacity of the animal to fill unit content of the forage, which is an integration of current animal information with historical data (Fig. 27.2).

Energy content of feedstuffs being evaluated is calculated in a series of steps from digestible organic matter (DOM) content. Digestible energy and DOM contents of more than 3000 feedstuffs have been placed in reference tables for lookup. Linear regression equations for adjustment of reference DOM values according to measured pepsin-cellulase degradation or content of CF, ADF or lignin in samples of the feedstuffs being evaluated are also provided. The ratios of ME:DE measured in 185 sheep and 162 cattle were regressed against results of feed analysis to yield a prediction equation of the following structure:

$$\text{ME/DE} = a_1 + b_1 \text{CF content} + c_1 \text{CP content} + d_1 \frac{\text{DOM intake}}{\text{DOM maintenance}} \quad (27.1)$$

where  $a_1$ ,  $b_1$ ,  $c_1$  and  $d_1$  are least-squares fitted parameters. This metabolizability equation allows ME intakes to be calculated.

In a similar fashion, parameters of the equation:

$$\begin{aligned} \text{Duodenal NAN flow} = & a_2(\text{FOM intake}) \\ & + b_2(\text{rumen undegradable N intake}) \\ & + c_2(\text{indigestible OM intake}) \end{aligned} \quad (27.2)$$

where NAN is non-ammonia N and FOM is fermentable OM, were estimated from 400 historical observations on cattle and sheep so that PDI intake could be estimated for current feedstuffs from composition data. Rumen undegradable N content of feedstuffs was estimated from the potentially degradable fraction, measured by incubation *in sacco* in the rumen, and an assumed rate

constant for passage out of the rumen according to Ørskov and McDonald (1979). Equation (27.2) splits the duodenal NAN flow into that of microbial, feed and endogenous origin so that  $a_2$  represents efficiency of microbial synthesis and  $b_2$  represents a correction of *in sacco* degradation to *in vivo*. The intestinal digestibility of nylon bag residues is collated in tables for various feedstuffs for the calculation of truly digested protein of feed origin (PDIA) as:

$$PDIA = CP \text{ content} \times 6.25b_2(\text{rumen undegradability}) \times \text{digestibility} \quad (27.3)$$

where the nylon bag residue may be a newly or historically measured value. Truly digested protein of microbial origin (PDIM) is calculated as the minimum of:

$$PDIMN = CP \text{ content}(1 - 6.25b_2(\text{rumen undegradability})) \times 0.9 \times 0.64 \quad (27.4)$$

where 0.9 represents the microbial capture of rumen-degradable N and 0.64 is the digestible true protein content of microbes and

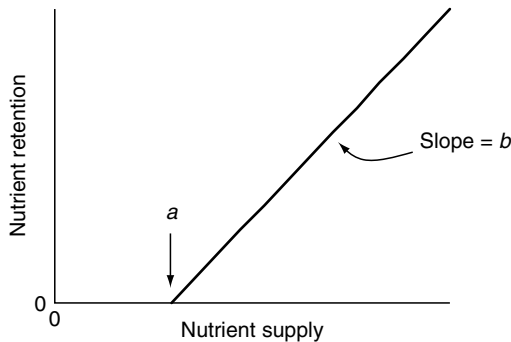
$$PDIME = 6.25a_2(\text{FOM content}) \times 0.64 \quad (27.5)$$

The total PDI supply from a given feed is the sum of feed and microbial PDI.

In a requirement-based feed evaluation system, the steady-state growth or milk production response of animals to nutrient supply (Fig. 27.3) is represented by a nutrient supply for simple maintenance of bodyweight ( $a_6$ ) and an efficiency of utilization of nutrient above maintenance for retention in product ( $b_6$ ):

$$\text{Required supply} = a_6 + \frac{\text{Nutrient retention}}{b_6} \quad (27.6)$$

In an NE system, the parameter  $b_6$  is applied to the ME intake to arrive at a prediction of nutrient retention directly from feedstuff characteristics:



**Fig. 27.3.** Idealized nutrient response curve for calculation of maintenance requirement ( $a$ ) and efficiency of retention ( $b$ ).

$$\text{NE intake} = b_6(\text{MEI} - a_6) \quad (27.7)$$

Over 500 energy balance experiments, in which energy contents of feed, faeces, urine and milk were measured by bomb calorimetry and heat production estimated from respiratory O<sub>2</sub> and CO<sub>2</sub> exchanges, were used to find least-squares estimates of  $a_6$  and  $b_6$  by linear regression (Van Es, 1975) (see Chapter 16 for calorimetry techniques). Because ME and NE intakes were expressed per unit of metabolic body weight in the analysis, the value of  $a_6$  was scaled likewise. Including feed composition data as independent variables in the regressions indicated that the value of  $b_6$  for energy retention was correlated with the ratio of ME:GE in feedstuffs. A correction to be added onto the value of  $b_6$  for energy was introduced (Vermorel *et al.*, 1987) as:

$$\text{Correction} = a_8 + b_8(\text{ME/GE}) \quad (27.8)$$

The maintenance parameter  $a_6$  for protein was obtained from a linear regression of PDI intakes on whole-body N retention observations from cattle and sheep experiments, separately, as:

$$\text{PDI} = a_9 + b_9(\text{N retention}) \quad (27.9)$$

A slightly positive N retention of 0.02 g/kg<sup>0.75</sup>/day for cattle and 0.035 g/kg<sup>0.75</sup>/day for sheep, representing hair growth and loss from skin, was assumed in solving Eq. (27.9) for the maintenance parameter (Verite *et al.*, 1979).

The protein efficiency parameter  $b_6$  was obtained from more than 50 experiments on growing animals and 24 experiments on lactating cows. In each experiment, the treatment was dietary protein allowance. For the regression analysis, data were used only from the lowest protein allowance on which protein retention in body weight or milk was greatest. Regression of these optimum protein gains against PDI intake yielded the requisite efficiency parameters.

Primary outputs of the INRA (1987) NE/DP model are NE (Eq. (27.7)) and PDI intake (Eqs (27.3) to (27.5)), the former of which is divided by a reference NE intake to arrive at a 'feed unit' value similar in concept to the old hay equivalent. However, NE and DP intakes can also be expressed in terms of allowable gain or milk production. For example, dividing NE intake (Eq. (27.7)) by the energy content of 4% fat-corrected milk of 0.74 Mcal/kg (Vermorel *et al.*, 1987) gives an energy-allowable milk yield prediction. The smaller of energy-allowable and protein-allowable milk is the expected milk production, which can be compared between various feedstuffs and rations to arrive at a decision as to which is more valuable to be fed.

In summary, an NE/MP feed evaluation model integrates novel data describing feed and animal characteristics with historical measures of feed intake, nutrient digestibility and animal response to arrive at a prediction of animal performance. Literally thousands of feeding trials in which animals were fed for long enough to reach a steady state of performance are integrated into the

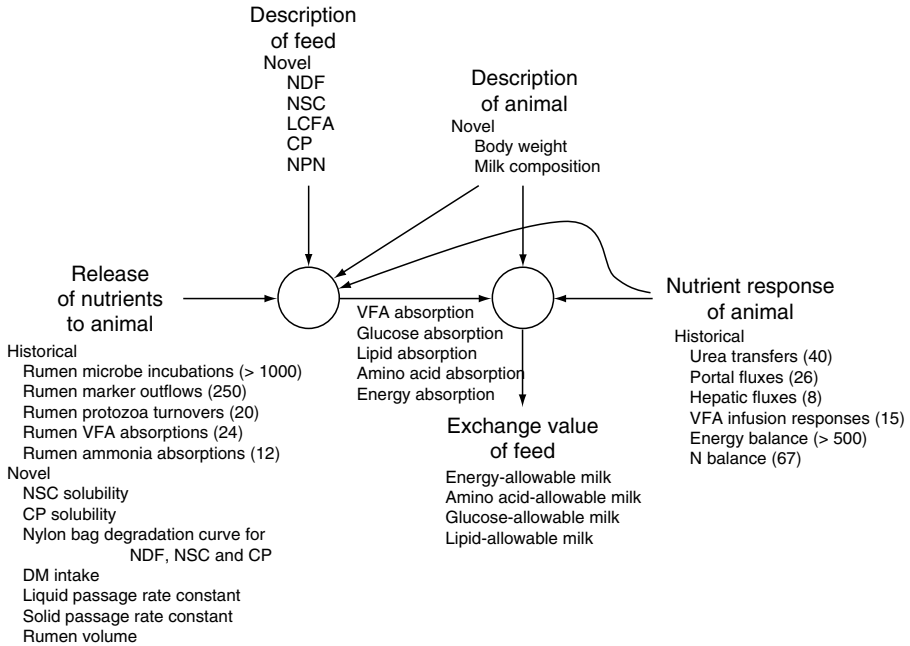
model. Cause-and-effect relationships determining steady-state daily intake, nutrient release and animal response are represented by linear regression equations in which most of the parameters have been obtained by least-squares fits to the historical data. The animal response data are often cropped before the final regression analysis to only include optimum response points, e.g. at the cusp of breakpoint curves. A few parameters have been derived from biological theory such as those in Eq. (27.4) representing capture of rumen-degradable N in microbial protein and its subsequent digestibility. The regression equations are solved in sequence so that the dependent variable of one equation becomes the independent variable in the next.

## Mechanistic Nutrient Flow Models

The use of biological theory to design and parameterize feed evaluation models has taken form in the mechanistic approach championed by Baldwin, France and colleagues (Baldwin and Smith, 1971; Black *et al.*, 1982; France and Thornley, 1984; Gill *et al.*, 1989a; Baldwin, 1995). The basic philosophy of the mechanistic approach is that animal performance can be explained by appealing to chemical and physical processes in organs and cells. Most mechanistic models in the animal sciences have been developed for the purpose of testing hypotheses of biology (e.g. Baldwin *et al.*, 1987; Gill *et al.*, 1989b; Sainz and Wolff, 1990; Sauvant, 1994; Cant and McBride, 1995a; Johnson *et al.*, 2001). However, the ability to integrate data from narrowly focused and even *in vitro* experiments and the ability to extrapolate predictions from a data set are characteristics of the mechanistic approach particularly suited to the task of new feed evaluation. Recently, Kebreab *et al.* (2001) used a mechanistic nutrient flow (MNF) model of ruminant digestion (Dijkstra *et al.*, 1996a,b) to evaluate diets for dairy cows in tropical countries. The dairy cow model of Dijkstra *et al.* (1996a,b) will be described here as an example of the MNF approach to feed evaluation.

The Dijkstra *et al.* (1996a,b) model estimates feed value as the predicted milk yield on the (mix of) feeds under consideration (Fig. 27.4). The ration is described as to its dry content of NDF, non-structural carbohydrates (NSC), CP, NPN and long-chain fatty acids. The cow is characterized by body weight and percentage of fat, protein and lactose in milk.

Release of nutrients to the cow is estimated from a combination of novel and historical data. Feedstuffs are subjected to rumen degradation in nylon bags to obtain first-order degradation rate constants and extents of degradation for NDF, starch and protein fractions (Waldo *et al.*, 1972; McDonald, 1981). Solubilities of NSC and CP are also required. First-order rate constants for passage of solid and liquid from the rumen and rumen volume itself are considered characteristics of the feed consumed and are input to the model as novel measures. Likewise, feed intake is not predicted from historical data but is a novel measure. The nutrient release data from previous experiments integrated into the feed evaluation model include more than 1000 incubations of rumen microbes *in vitro*, 250 digesta flow measures, 20 protozoal turnover



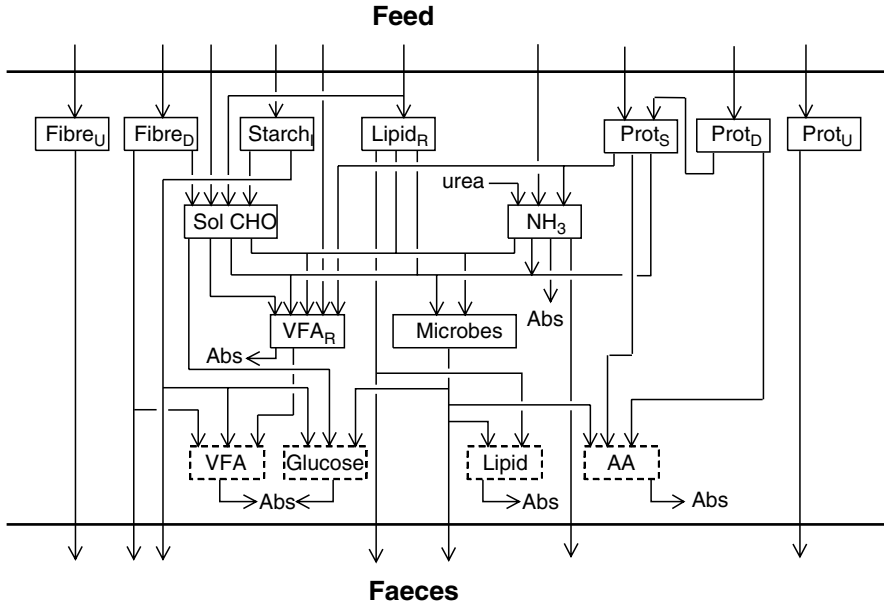
**Fig. 27.4.** Data integrated in the Dijkstra *et al.* (1996a,b) mechanistic nutrient flow model to arrive at feed value. Numbers of measures of each historical data class are given in parentheses.

estimates, 24 rumen volatile fatty acid (VFA) absorption rates and 12 rumen  $\text{NH}_3$  absorption rates.

Steady-state rates of VFA, glucose, fat and amino acid absorption are calculated from a dynamic representation of nutrient transformations in the rumen (Fig. 27.5). Again, it is unnecessary to reconstruct the entire model in these pages but a subset of equations, those relating to VFA absorption, will be shown to illustrate the integrative approach. Total VFA absorption is equal to their production in the rumen and large intestine where:

$$\begin{aligned}
 \text{Rumen VFA production} &= \text{VFA intake} + 6.75 \times 17.28 \\
 &\quad \times \text{microbial growth from } \text{NH}_3 + 8.35 \\
 &\quad \times 3.15 \times \text{microbial growth from CP} \\
 &\quad + 10.64 \times (\text{microbial maintenance} \\
 &\quad + \text{energy spilling}) + 15.67 \\
 &\quad \times \text{CP fermentation rate}
 \end{aligned} \tag{27.10}$$

The values 6.75, 8.35, 10.64 and 15.67 represent biochemical stoichiometries of VFA yield from the respective processes; 17.28 and 3.15 represent stoichiometries of carbohydrate utilization in microbial growth.



**Fig. 27.5.** Nutrient flow in the Dijkstra *et al.* (1996a,b) model. Arrows represent nutrient flows, boxes represent state variables in rumen (solid lines) or zero pools post-ruminally. Abbreviations used are: AA, amino acids; Abs, absorption into blood; Fibre<sub>U</sub>, undegradable fibre; Fibre<sub>D</sub>, degradable fibre; Lipid<sub>R</sub>, rumen lipid; Prot<sub>D</sub>, insoluble, degradable protein; Prot<sub>S</sub>, soluble protein; Prot<sub>U</sub>, undegradable protein; Sol CHO, soluble starch and sugars; Starch<sub>I</sub>, insoluble starch; VFA, volatile fatty acids; VFA<sub>R</sub>, Rumen volatile fatty acids. Adapted from Dijkstra *et al.* (1996a).

For Eq. (27.10), microbial growth from NH<sub>3</sub>, soluble carbohydrate (Sc) and lipid is predicted with a Michaelis–Menten equation in which soluble protein (Ps) is an inhibitor:

$$\text{Microbial growth from NH}_3 = \frac{a_{11} \text{microbial pool size}}{1 + (b_{11}/[\text{NH}_3]) + (c_{11}/[\text{Sc}]) + (d_{11}/[\text{lipid}]) + ([\text{Ps}]/e_{11})} \tag{27.11}$$

where microbial pool size is the integral of the difference between microbial growth and outflow. Parameters  $a_{11}$ ,  $b_{11}$  and  $e_{11}$  were each estimated separately by nonlinear regression analysis of *in vitro* responses of microbial growth to substrate concentrations. Parameter  $d_{11}$  was set to a low value to ensure less than 100% incorporation of available lipid into microbes. Parameter  $c_{11}$  was obtained as the only unknown value in Eq. (27.11) for a set of steady-state observations of all other variables. The equation:

$$\text{Microbial growth from CP} = \frac{a_{12} \text{microbial pool size}}{1 + (e_{11}/[\text{Ps}]) + (c_{11}/[\text{Sc}]) + (d_{11}/[\text{lipid}])} \tag{27.12}$$

was parameterized simultaneously from the same data set. The maximum relative growth rate of rumen microbes is twofold higher on amino acids than on  $\text{NH}_3$ , which is reflected in the values of  $a_{11}$  and  $a_{12}$ . The capability of microbes to synthesize ATP or catabolize Sc is essentially the same under the two conditions (Hespell and Bryant, 1979) so there is an uncoupling or energy spilling that is predicted as:

$$\text{Sc used in energy spilling} = \frac{a_{13} \text{ microbial pool size}}{1 + (c_{11}/[\text{Sc}]) + ([\text{Ps}]/e_{11})} \quad (27.13)$$

where  $a_{13}$  is based on  $a_{12} - a_{11}$ .

*In vitro* growth rates (fraction/hour) on glucose of five different rumen bacteria were obtained from exponential increases in cell density over time (Russell and Baldwin, 1979). More than 250 incubations were carried out. The average slope ( $a_{14}$ ) of double reciprocal plots of cell yield (g bacteria per g glucose used) against growth rate (Pirt, 1965) for the five bacteria was incorporated as a parameter in the MNF model to calculate, for Eq. (27.10), the use of Sc for microbial maintenance as:

$$\text{Microbial maintenance} = a_{14} \text{ microbial pool size} \quad (27.14)$$

Russell *et al.* (1983) presented kinetic curves of protein metabolism by mixed rumen bacteria *in vitro* in response to casein and mixed carbohydrates. The curves were used to parameterize the following equation by nonlinear regression:

$$\text{CP fermentation rate} = \frac{a_{15} \text{ microbial pool size}}{1 + (b_{15}/[\text{Ps}]) + ([\text{Sc}]/c_{15})} \quad (27.15)$$

The description of the VFA production equations shows the type of experimental data that are integrated and the means of integration into the nutrient release model of Dijkstra *et al.* (1996a,b). The complete list is given in Fig. 27.4. Pool sizes and concentrations used in Eqs (27.11) to (27.15) and throughout the entire model are obtained by numerically integrating differential equations that sum instantaneous flows in and out of those pools represented by solid-line boxes in Fig. 27.5.

Historical animal response data include 40 estimates of transfer of plasma urea to the rumen  $\text{NH}_3$  pool, 26 uptakes of blood metabolites across the portal-drained viscera and liver, 15 responses to intraruminal infusion of VFA, more than 500 energy balance measures, and 67 N balance experiments. Responses of the splanchnic bed are integrated into the feed evaluation model as part of the nutrient release calculations, according to the same rate-state formalism described above for the VFA production equations. The ultimate performance responses of animals, though, are integrated into the feed evaluation as requirements using parameters of Eq. (27.6) to capture responses to absorbed energy, amino acids, glucose and lipid (Dijkstra *et al.*, 1996b;



Kebreab *et al.*, 2001). The allowable milk yield from each of the four absorption rates is calculated and the smallest value is taken as the final prediction of feed value.

## Data Sources

At the outset of the following comparison between the NE/DP and MNF modelling approaches, it is important to point out that there is no firm line demarcating the boundary between the two; each model shares characteristics with the other. The differences are not absolute but a matter of degree.

The NE/DP model is built primarily of regression equations whose parameters capture measures of nutrient release and animal response in steady-state experiments while the MNF model is of enzyme kinetic equations parameterized from arteriovenous difference and *in vitro* experiments that may be in non-steady states. The relation of these lower level data to nutrient release and animal response is often hypothetical, which is to say, scientifically based. Where lower level data have been incorporated into the NE/DP model this is as driving variables for the prediction, not as parameters. This difference between driving variables and parameters is essentially a distinction of novel versus historical data sources.

As both model types have evolved and access of decision makers to analytical laboratories has increased, there has been a tendency to replace the historical data with novel measures. The transformation occurred first in the description of feeds and is now underway in the nutrient release arena. Variables such as rumen degradability of feed fractions and small intestinal digestibility can be measured *in vitro* (Krishnamoorthy *et al.*, 1982; Mauricio *et al.*, 1999) or *in sacco* (De Boer *et al.*, 1987; Nocek, 1988) and input as driving variables instead of being calculated from some relation to other measured inputs. The Dijkstra *et al.* (1996a) model even goes so far as to request rumen outflow rate constants and rumen volumes as novel measures for each set of ingredients under evaluation. Similarly, for the estimation of rumen protein degradability inputs for NE/DP models, as in Eqs (27.2) to (27.4), it is often recommended that different passage rate constants be used (INRA, 1987; Tamminga *et al.*, 1994), depending on feed type and intake level, for example. Because the utility of a feed evaluation model lies in it being a cheap alternative to actually measuring animal performance, the requirement for passage rate constant to be measured *in vivo a priori* may seem extravagant. At issue is the question, according to what criteria is the novel measure preferred over the historical? One criterion would be the scope of the variable; if its value is unique to individual feeds or animals, the novel measure is preferred; if its value is characteristic of all feeds or animals, the historical will suffice. In addition, if the variable, irrespective of its scope, can be shown to be dependent on some other variable, the historical will suffice. Accordingly, passage rates, which vary by feedstuff yet are notoriously difficult to predict (Mathison *et al.*, 1995), may be input as newly measured variables for feedstuff evaluation. Another criterion for selection of the data source is the sensitivity

of model outputs to the variable in question. If sensitivity is high, precise estimation of the variable will be important and, when prediction from historical data lacks precision, the novel measure is warranted. Sensitivity of a model to one component is highly dependent on its interactions with other components in the model, i.e., on the overall model structure. The expense of measuring passage rates provides incentive to improve understanding of underlying causes of its variation or to find alternative representations of animal performance that are less sensitive to rumen outflow values.

The variable to which a feed evaluation model is perhaps most sensitive, which exhibits a high variance and is dependent in an as-yet undeciphered, highly interactive manner on independent driving variables, is voluntary DMI. The characteristics of uncertainty and sensitivity imply that voluntary DMI is best input as a novel measure to feed evaluation as in the Dijkstra *et al.* (1996a) and several other (France *et al.*, 1982; Baldwin *et al.*, 1987; Gill *et al.*, 1989b) MNF models. However, voluntary DMI is under the control of the animal (see Chapter 23) and is part of the animal response to the feedstuffs on offer, so it has been argued that to bypass feed intake prediction is to ignore a large part of feed evaluation (Ørskov, 1998; Van der Honing, 1998; Zemelink and Mannetje, 2002). The INRA (1987) NE/DP model predicts DMI by a static gut fill approach using collated historical data.

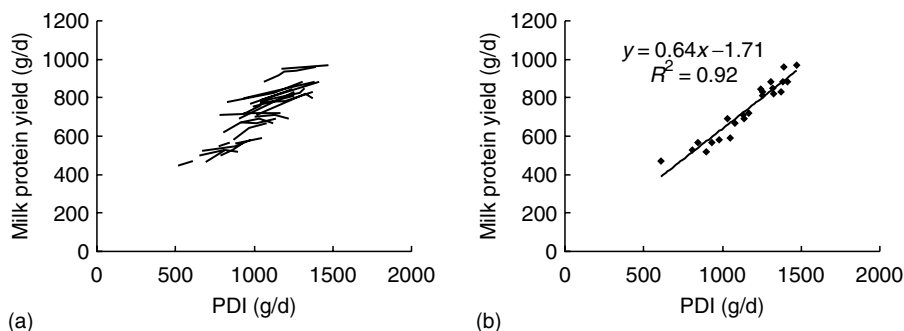
A primary difficulty of DMI prediction is the circularity of the problem. Dry matter intake is the major determinant, more than digestibility, of nutrient release to animals (Zemelink and Mannetje, 2002) and the nutrient release, in turn, invokes responses that mediate intake (Chapter 23). One could suppose that animals eat to a desired daily nutrient release and calculate DMI accordingly. Indeed, purposeful consumption has been the basis of some approaches to DMI prediction (Forbes, 1977; Mertens, 1987) but it does not solve the circularity problem, just shifts it to another location. What is the desired rate of nutrient release to which DMI is regulated? The desired rate (the requirement) is generally taken from the rate of body component gain or milk production (Eq. (27.6)) which is, once again, dependent on the DMI. Ingvarstsen (1994) reviewed several DMI prediction models for growing and lactating cattle and categorized them as multiple regression equations, fill models and complex sets of regression equations. It was concluded that none were capable of integrating the multiple factors that are known to control intake and a dynamic modelling approach should be sought. A dynamic model is particularly suited to solving circular problems by integrating differential equations to obtain, in the DMI prediction paradigm, instantaneous nutrient pool sizes and satiety signal strengths. Several MNF models that dynamically predict DMI have been developed (Forbes, 1980; Danfær, 1990; Illius and Gordon, 1991; Poppi *et al.*, 1994; Chilibroste *et al.*, 1997). The basic strategy is to simulate flows into body nutrient pools from intake and tissue mobilization, and flows out to support biological functions including growth and lactation. Outflows and intake are both, simultaneously, functions of instantaneous nutrient pool size, outflow positively and intake negatively, so that a balance is struck between the two.

## Means of Integration

The NE/DP model integrates novel and historical data in linear regression equations that describe a static balance of nutrients while the MNF model uses enzyme kinetic equations in a dynamic simulation of nutrient flows. A major consequence of the distinct approaches is the ability to extrapolate vs. interpolate predictions. Interpolation refers to prediction of new cases from within the range of old cases used to parameterize the model. The NE/DP model is highly suited to interpolation because of the large number of cases that were used in equation parameterization, but the relevance of the predictive function to cases outside of the input range remains unknown. The relevance of enzyme kinetic equations to all inputs from zero to infinity is provided by theory of protein–ligand chemistry. For accuracy in a single feed evaluation by an NE/DP model, the evaluation has to have been carried out at some time in the past and the results recorded in parameters of the model. For the MNF model, the underlying cause of the performance response must be captured in the model structure with the appropriate sensitivity attached. Birkett and de Lange (2001) recently proposed a model of nutrient flows in animals that combines the interpolation strength of parameterization from large, whole-animal data sets with the extrapolation capability of a biologically based model structure.

Nutrient release data are integrated into feed evaluation models in forward-predicting equations from which nutrient release is the calculated output. On the other hand, the most popular method to integrate animal response data into feed evaluation is by backward-predicting equations for which animal response is the input. In both the INRA (1987) and Dijkstra *et al.* (1996b) models presented here, the backward-predicting equation (27.6) has been rearranged to forward-predict nutrient-allowable gain or milk production, but it is important to recognize that the approach has its roots in a back-calculation.

An example illustrates the problem. In 23 experiments in which lactating cows were fed graded levels of PDI, the linear slope of the protein retention responses (Fig. 27.6a), according to a mixed model analysis (St.-Pierre, 2001) of the data, averaged 0.24 g/g. Cropping the data to only include the lowest PDI allowance from each experiment on which protein retention was greatest (Fig. 27.6b) yields a slope of 0.64 g/g, which was used as the efficiency parameter  $b_6$  for calculation of PDI requirement or PDI-allowable milk production in both the INRA (1987) and Dijkstra *et al.* (1996b) models. The reason for the low marginal efficiency in the full data set is presumed to be due to inadequacies in supply of nutrients other than PDI, e.g. energy (Hanigan *et al.*, 1998). Thus, the value of efficiency  $b_6$  used in calculation of PDI-allowable milk is specific to a given supply of non-protein nutrients and could be quite different at other nutrient intakes. In the back-calculation from animal response to requirement, one is setting PDI, NE and other targets for diet formulation so all nutrients can be presumed to be in balance. The same parameter values are not applicable in the opposite direction, however, because of the so-called nutrient interactions (see Chapter 15) that occur. It has been argued that a



**Fig. 27.6.** Protein output in milk of lactating cows fed graded levels of protein truly digested in the small intestine (PDI) in 23 experiments: (a) full data set with solid lines indicating response by experiment and (b) cropped data set with optimum protein output from each experiment (adapted from Verite *et al.*, 1987).

feed evaluation model should predict the efficiency, not predict from it (Cant and McBride, 1995b).

The nutrient requirement, derived as it is from the maximum rate of nutrient retention in product, is closely associated with the concept of performance potential. The potential has been conceived as being a consequence of the genotype of the animal and, when the animal does not perform to its potential, that is because the environment (e.g. nutrition, housing, temperature) has not allowed it. The expectation that an animal tries to meet its potential to perform allows voluntary DMI to be predicted (AFRC, 1991), as discussed above. If the requirement approach to integrating nutrient responses into feed evaluation is abandoned, the DMI prediction problem becomes more complex and an alternative means of representing genotype is required. In MNF models that are constructed of enzyme kinetic equations, the effect of genotype and environment on gene expression can be represented in the value of  $V_{\max}$  for selected processes (Baldwin, 1995). Currently, extensive historical data are required for genotype definition, whether for a requirement- or response-based feed value. However, it is not unreasonable to anticipate that genome and proteome analyses in the future will facilitate the evolution of more elaborate yet inexpensive novel measures on animals to be input into feed evaluation models, just as has happened for feed composition and nutrient release data in the past two decades.

## Feed Value Expression

Using a requirement approach, one can identify imbalances between the consumed and required nutrient supplies, suggesting corrective measures, but one does not obtain a value of the feed in the strict sense of the level of animal performance it will support. If nutrient release can be predicted in the forward direction, as has become common in feed evaluation models around the world

(INRA, 1987; Fox *et al.*, 1992; Ørskov, 1998; NRC, 2001), and if response of the splanchnic bed to nutrient supply can be incorporated into nutrient release calculations (Fig. 27.4), then it seems a small leap to suggest that the entire performance response to nutrient supply can be tackled in the same way. Instead of extracting just one data point, the requirement, from each nutrient response curve (Fig. 27.6b), the feed evaluation model could be constructed to predict entire response curves, like those in Fig. 27.6a. Already, there are several MNF models that predict body weight gain or milk production from the absorbed nutrient supply (Baldwin *et al.*, 1987; Gill *et al.*, 1989b; Danfær, 1990; Sainz and Wolff, 1990). Such predictions greatly expand the utility of a feed evaluation model for managing farm resources. The consequences of feeding animals below requirements for certain times of year or of their life cycle could be incorporated into management decisions.

A final point on parameterizing animal performance equations from a nutrient requirement curve as opposed to a nutrient response curve relates to the testing of feed evaluation models. Standard practice for testing a model is to simulate a set of numerical observations of some output variable and then regress predicted variable values against the observations. From a perfect model, the slope of the regression equals 1.0, the *y*-intercept equals 0 and the coefficient of determination is 1.0. While such testing is common practice with digestion and metabolism models (Oltjen *et al.*, 1986; Bateman *et al.*, 2001; Cant *et al.*, 2002; Kebreab *et al.*, 2002), a model that predicts requirements is difficult to test because observations are not easily obtained. Many levels of the nutrient in question must be fed to identical animals to obtain one measurement of a requirement. For regression testing of a model, up to 20 or 100 observations of the output variable may be needed. Prediction vs. observation testing of requirement models is rarely performed. Instead, practice has been to compare predicted requirements from different models (Waldo and Glenn, 1984; Kaustell *et al.*, 1997) to compare predicted requirements with observed intakes (Yan *et al.*, 2003), or to compare predicted minimum nutrient-allowable gains or milk yields with the observed (Kohn *et al.*, 1998; Kebreab *et al.*, 2001; Yan *et al.*, 2003).

## Conclusion

The estimation of value of a feedstuff without actually feeding it to animals has taken on several forms. The general approach is to integrate novel and historical measures of feed composition, animal characteristics, nutrient intake, digestion and absorption, and animal performance in a mathematical structure that represents the salient features of nutritive response. Novel measures as inputs are needed when sensitivity of predicted feed value to such variables is high and their variation is unexplained. The model must predict some indicator of animal performance as the estimate of feed value, which includes a prediction of voluntary DMI. Setting nutrient requirements facilitates DMI prediction but restricts the range of performance responses that can be accommodated; for example, on deficient or imbalanced feeds.

## References

- Agriculture and Food Research Council (AFRC) (1991) AFRC Technical Committee on Responses to Nutrients Report Number 7. Theory of response to nutrients by farm animals. *Nutrition Abstracts and Reviews* 61B, 683–722.
- Agriculture and Food Research Council (AFRC) (1993) *Energy and Protein Requirements of Ruminants*. CAB International, Wallingford, UK, 176 pp.
- Armsby, H.P. (1917) *The Nutrition of Farm Animals*. The MacMillan Company, New York, 743 pp.
- Baldwin, R.L. (1995) *Modeling Ruminant Digestion and Metabolism*. Chapman & Hall, London, 578 pp.
- Baldwin, R.L. and Smith, N.E. (1971) Application of a simulation modeling technique in analyses of dynamic aspects of animal energetics. *Federation Proceedings* 30, 1459–1465.
- Baldwin, R.L., France, J., Beever, D.E., Gill, M. and Thornley, J.H.M. (1987) Metabolism of the lactating cow. III. Properties of mechanistic models suitable for evaluation of energetic relationships and factors involved in the partition of nutrients. *Journal of Dairy Research* 54, 133–145.
- Bateman II, H.R., Clark, J.H., Patton, R.A., Peel, C.J. and Schwab, C.G. (2001) Accuracy and precision of computer models to predict passage of crude protein and amino acids to the duodenum of lactating cows. *Journal of Dairy Science* 84, 649–664.
- Birkett, S. and De Lange, K. (2001) Limitations of conventional models and a conceptual framework for a nutrient flow representation of energy utilization by animals. *British Journal of Nutrition* 86, 647–659.
- Black, J.L., Faichney, G.J., Beever, D.E. and Howarth, B.R. (1982) Alternative systems for assessing the nitrogen value of feeds for ruminants. In: Thomson, D.J., Beever, D.E. and Gunn, R.G. (eds) *Forage Protein in Ruminant Animal Production*. Occasional Publication No. 6. British Society of Animal Production, Penicuik, UK, pp. 107–118.
- Cant, J.P. and McBride, B.W. (1995a) Mathematical analysis of the relationship between blood flow and uptake of nutrients in the mammary glands of a lactating cow. *Journal of Dairy Research* 62, 405–422.
- Cant, J.P. and McBride, B.W. (1995b) Postabsorptive use of nutrients to optimise milk protein synthesis. In: Ivan, M. (ed.) *Animal Science Research and Development: Moving Toward a New Century*. Agriculture and Agri-Food Canada, Ottawa, pp. 225–242.
- Cant, J.P., Trout, D.R., Qiao, F. and Purdie, N.G. (2002) Milk synthetic response of the bovine mammary gland to an increase in the local concentration of arterial glucose. *Journal of Dairy Science* 85, 494–503.
- Chilibroste, P., Aguilar, C. and Garcia, F. (1997) Nutritional evaluation of diets. Simulation model of digestion and passage of nutrients through the rumen–reticulum. *Animal Feed Science and Technology* 68, 259–275.
- Close, C.M. and Frederick, D.K. (1995) *Modeling and Analysis of Dynamic Systems*, 2nd edn. John Wiley & Sons, New York, 681 pp.
- Danfær, A. (1990) A dynamic model of nutrient digestion and metabolism in lactating dairy cows. PhD thesis, National Institute of Animal Science, Foulum, Denmark.
- De Boer, G., Murphy, J.J. and Kennelly, J.J. (1987) Mobile nylon bag for estimating intestinal availability of rumen undegradable protein. *Journal of Dairy Science* 70, 977–982.

- Dijkstra, J., France, J., Neal, H.D.St.C., Assis, A.G., Aroeira, L.J.M. and Campos, O.F. (1996a) Simulation of digestion in cattle fed sugarcane: model development. *Journal of Agricultural Science* 127, 231–246.
- Dijkstra, J., France, J., Assis, A.G., Neal, H.D.St.C., Campos, O.F. and Aroeira, L.J.M. (1996b) Simulation of digestion in cattle fed sugarcane: prediction of nutrient supply for milk production with locally available supplements. *Journal of Agricultural Science* 127, 247–260.
- Forbes, J.M. (1977) Interrelationships between physical and metabolic control of voluntary food intake in fattening, pregnant and lactating sheep: a model. *Animal Production* 24, 90–101.
- Forbes, J.M. (1980) A model of the short-term control of feeding in the ruminant: effects of changing animal or feed characteristics. *Appetite* 1, 21–41.
- Fox, D.G., Sniffen, C.J., O'Connor, J.D., Russell, J.B. and Van Soest, P.J. (1992) A net carbohydrate and protein system for evaluating cattle diets: III. Cattle requirements and diet adequacy. *Journal of Animal Science* 70, 3578–3596.
- France, J. and Thornley, J.H.M. (1984) *Mathematical Models in Agriculture*. Butterworths, London, 335 pp.
- France, J., Thornley, J.H.M. and Beever, D.E. (1982) A mathematical model of the rumen. *Journal of Agricultural Science* 99, 343–353.
- Gill, M., Beever, D.E. and France, J. (1989a) Biochemical bases needed for the mathematical representation of whole animal metabolism. *Nutrition Research Reviews* 2, 181–200.
- Gill, M., France, J., Summers, M., McBride, B.W. and Milligan, L.P. (1989b) Mathematical integration of protein metabolism in growing lambs. *Journal of Nutrition* 119, 1269–1286.
- Hanigan, M.D., Cant, J.P., Weakley, D.C. and Beckett, J.L. (1998) An evaluation of postabsorptive protein and amino acid metabolism in the lactating dairy cow. *Journal of Dairy Science* 81, 3385–3401.
- Hespell, R.B. and Bryant, M.P. (1979) Efficiency of rumen microbial growth: influence of some theoretical and experimental factors on  $Y_{ATP}$ . *Journal of Animal Science* 49, 1640–1659.
- Illiis, A.W. and Gordon, I.J. (1991) Prediction of intake and digestion in ruminants by a model of rumen kinetics integrating animal size and plant characteristics. *Journal of Agricultural Science* 116, 145–157.
- Ingvarlsen, K.L. (1994) Models of voluntary food intake in cattle. *Livestock Production Science* 39, 19–38.
- Institut National de la Recherche Agronomique (INRA) (1978) *Alimentation des Ruminants*. INRA Publications, Versailles, France, 597 pp.
- Institut National de la Recherche Agronomique (INRA) (1987) *Alimentation des Ruminants: Révision des Systèmes et des Tables de l'INRA*. INRA Publications, Versailles, France, 222 pp.
- Jarrige, R., Demarquilly, C., Dulphy, J.P., Hoden, A., Robelin, J., Beranger, C., Geay, Y., Journet, M., Malterre, C., Micol, D. and Petit, M. (1986) The INRA 'fill unit' system for predicting the voluntary intake of forage-based diets in ruminants: a review. *Journal of Animal Science* 63, 1737–1758.
- Johnson, H.A., Baldwin, R.L., Klasing, K.C. and Calvert, C.C. (2001) Impact of separating amino acids between plasma, extracellular and intracellular compartments on estimating protein synthesis in rodents. *Amino Acids* 20, 389–400.
- Kaustell, K., Tuori, M. and Huhtanen, P. (1997) Comparison of energy evaluation systems for dairy cow feeds. *Livestock Production Science* 51, 255–266.

- Kebreab, E., Assis, A.G., Dijkstra, J. and France, J. (2001) Evaluating sugarcane diets for dairy cows using a digestion model. *Tropical Animal Health and Production* 33, 127–139.
- Kebreab, E., France, J., Mills, J.A.N., Allison, R. and Dijkstra, J. (2002) A dynamic model of N metabolism in the lactating dairy cow and an assessment of impact of N excretion on the environment. *Journal of Animal Science* 80, 248–259.
- Kohn, R.A., Kalscheur, K.F. and Hanigan, M. (1998) Evaluation of models for balancing the protein requirements of dairy cows. *Journal of Dairy Science* 81, 3402–3414.
- Krishnamoorthy, U., Muscato, T.V., Sniffen, C.J. and Van Soest, P.J. (1982) Nitrogen fractions in selected feedstuffs. *Journal of Dairy Science* 65, 217–225.
- Mathison, G.W., Okine, E.K., Vaage, A.S., Kaske, M. and Milligan, L.P. (1995) Current understanding of the contribution of the propulsive activities in the forestomach to the flow of digesta. In: Engelhardt, W. von, Leonhard-Marek, S., Breves, G. and Giesecke, D. (eds) *Ruminant Physiology: Digestion, Metabolism, Growth and Reproduction*. Ferdinand Enke Verlag, Stuttgart, Germany, pp. 23–41.
- Mauricio, R.M., Mould, F.L., Dhanoa, M.S., Owen, E., Channa, K.S. and Theodorou, M.K. (1999) A semi-automated *in vitro* gas production technique for ruminant feedstuff evaluation. *Animal Feed Science and Technology* 79, 321–330.
- McDonald, I. (1981) A revised model for the estimation of protein degradability in the rumen. *Journal of Agricultural Science* 96, 251–252.
- Mertens, D.R. (1987) Predicting intake and digestibility using mathematical models of rumen function. *Journal of Animal Science* 64, 1548–1558.
- Nocek, J.E. (1988) *In situ* and other methods to estimate ruminal protein and energy digestibility: a review. *Journal of Dairy Science* 71, 2051–2069.
- National Research Council (NRC) (1996) *Nutrient Requirements of Beef Cattle*, 6th edn. National Academy Press, Washington, DC, 242 pp.
- National Research Council (NRC) (2001) *Nutrient Requirements of Dairy Cattle*, 7th edn. National Academy Press, Washington, DC, 381 pp.
- Oltjen, J.W., Bywater, A.C. and Baldwin, R.L. (1986) Evaluation of a model of beef cattle growth and composition. *Journal of Animal Science* 62, 98–108.
- Ørskov, E.R. (1998) Feed evaluation with emphasis on fibrous roughages and fluctuating supply of nutrients: a review. *Small Ruminant Research* 28, 1–8.
- Ørskov, E.R. and McDonald, I. (1979) The estimation of protein degradability in the rumen from incubation measurements weighted according to rate of passage. *Journal of Agricultural Science* 92, 499–503.
- Pirt, S.J. (1965) The maintenance energy of bacteria in growing cultures. *Proceedings of the Royal Society of London, Series B* 163, 224–231.
- Poppi, D.P., Gill, M. and France, J. (1994) Integration of theories of intake regulation in growing ruminants. *Journal of Theoretical Biology* 167, 129–145.
- Russell, J.B. and Baldwin, R.L. (1979) Comparison of maintenance energy expenditures and growth yields among several rumen bacteria grown on continuous culture. *Applied and Environmental Microbiology* 37, 537–543.
- Russell, J.B., Sniffen, C.J. and Van Soest, P.J. (1983) Effect of carbohydrate limitation on degradation and utilization of casein by mixed rumen bacteria. *Journal of Dairy Science* 66, 763–775.
- Sainz, R.D. and Wolff, J.E. (1990) Evaluation of hypotheses regarding mechanisms of action of growth promotants and repartitioning agents using a simulation model of lamb metabolism and growth. *Animal Production* 51, 551–558.
- Sauvant, D. (1994) Modelling homeostatic and homeorhetic regulations in lactating animals. *Livestock Production Science* 39, 105–113.



- St-Pierre, N.R. (2001) Invited review: Integrating quantitative findings from multiple studies using mixed model methodology. *Journal of Dairy Science* 84, 741–755.
- Tamminga, S., Van Straalen, W.M., Subnel, A.P.J., Meijer, R.G.M., Steg, A., Wever, C.J.G. and Blok, M.C. (1994) The Dutch protein evaluation system: the DVE/OEB-system. *Livestock Production Science* 40, 139–155.
- Tyler, C. (1975) Albrecht Thae'r's hay equivalents: fact or fiction? *Nutrition Abstracts and Reviews* 45, 1–11.
- Van der Honing, Y. (1998) Perspectives of future feed information based on energy and nutrient availability. *Archives of Animal Nutrition* 51, 135–143.
- Van der Honing, Y. and Alderman, G. (1988) Feed evaluation and nutritional requirements. Ruminants. *Livestock Production Science* 19, 217–267.
- Van Es, A.J.H. (1975) Feed evaluation for dairy cows. *Livestock Production Science* 2, 95–107.
- Verite, R., Journet, M. and Jarrige, R. (1979) A new system for the protein feeding of ruminants: the PDI system. *Livestock Production Science* 6, 349–367.
- Verite, R., Michalet-Doreau, B., Chapoutot, P., Peyraud, J.L. and Poncet, C. (1987) Révision du système des protéines digestibles dans l'intestin (P.D.I.) In: INRA. *Alimentation des Ruminants: Révision des Systèmes et des Tables de l'INRA*. INRA Publications, Versailles, France, pp. 19–34.
- Vermorel, M., Coulon, J.B. and Journet, M. (1987) Révision du système des unités fourragères (UF). In: *Alimentation des Ruminants: Révision des Systèmes et des Tables de l'INRA*. INRA Publications, Versailles, France, pp. 9–18.
- Waldo, D.R. and Glenn, B.P. (1984) Comparison of new protein systems for lactating dairy cows. *Journal of Dairy Science* 67, 1115–1133.
- Waldo, D.R., Smith, L.W. and Cox, E.L. (1972) Model of cellulose disappearance from the rumen. *Journal of Dairy Science* 55, 125–129.
- Weisbjerg, M.R. and Hvelplund, T. (1993) *Bestemmelse af nettoenergiindhold ( $FE_k$ ) i råvarer og kraftfoderblandinger*. Forskningsrapport Statens Husdyrbrugsforsøg Nr. 3. Danmarks Jordbrugsforskning, Tjele, Denmark.
- Yan, T., Agnew, R.E., Murphy, J.J., Ferris, C.P. and Gordon, F.J. (2003) Evaluation of different energy feeding systems with production data from lactating dairy cows offered grass silage-based diets. *Journal of Dairy Science* 86, 1415–1428.
- Zemmelink, G. and Mannetje, L.'t. (2002) Value for animal production (VAP): a new criterion for tropical forage evaluation. *Animal Feed Science and Technology* 96, 31–42.

*This page intentionally left blank*

---

# Index

---

- 3-hydroxybutyrate
  - effect of pregnancy 358
  - production 328–329
- 3-methylhistidine 378–379, 508
  
- Abomasum 3
  - infusion of casein 559
  - protein metabolism in 383
- Acetate
  - absorption of 4
  - liver production of 303
  - rumen production of 2, 303
  - utilization
    - by brain 304
    - by hind limb 303
    - by mammary gland 304
- Acetic acid *see* Acetate
- Acetyl CoA carboxylase 444, 445, 446, 458
  - expression, relationship with weight gain 502
- Adipose tissue
  - adipocyte metabolism 453–454
  - energy storage in 462
  - metabolic control in 448–449, 450
  - sensitivity to adrenergic agents 528
  - substances secreted by 449
  - uptake of glucose by 297
- Adrenaline *see* Catecholamines
- Adrenergic receptors 496–499
  - relationship to heat production 493
  - temperature effects on density 497
- Aggregation, definition 16
- $\beta$ -Agonists
  - as growth promoters 390
  - interactions with growth hormone 454
  - reduction in lipid accumulation 498
- Alanine 402–405, 408
  - metabolism in pregnancy 533
- Amino acids and peptides
  - absorption 191
    - efficiency of 322–324
  - concentrations in rumen 189
  - effect on yield of ATP 240–241
  - labelled 377
  - liver metabolism of 408–409
  - non-essential 402–405
    - glucose synthesis from 404
  - sulphur, absorption of 561
  - uptake by microbes in rumen 185–187
- Ammonia
  - absorption 190–191
  - accumulation in rumen 251
  - concentrations in rumen 189
  - effect on bacterial yield 250
  - metabolism of 4, 195–196, 329–332
  - production and removal 189–190
  - recycling 190
  - utilization by microbes in rumen 187–188
- Anabolic steroids
  - estradiol in pregnancy 528–529
  - as growth promoters 391
- Antinutritional factors 649–651
- Arteriovenous difference technique
  - description 311
  - limitations of 318
  - requirements of 317–318
- ATP
  - dissipation of excess 238–240

- ATP (*cont'd*)  
 formation in rumen 230–231, 235–236  
 yield based on 236
- Attributes, definition 16
- Bacteria, rumen  
 amino acid fermenting 234–235  
 cellulose degradation 209  
 concentrations 208  
 cross-feeding 244–245  
 endogenous metabolism 243–244  
 glycogen storage 243  
 growth rates 213, 214, 215  
 proteolysis 210  
 starch degradation 209
- Bacteriocins, antimicrobial activity of 247
- Behaviour, animal 670–675  
 breeding 673  
 feeding 670–672  
 grazing 683–689  
   bite size 687–688  
   effects of forage characteristics 683–685  
   effects of management 685–686  
   temporal pattern 687–689  
 sleeping and lying 672–673  
 walking and standing 673
- Blood flow  
 p-amino-hippurate (PAH) as marker 317  
 to mammary gland 460  
 measurement 317  
 to various tissues 451
- Brain, uptake of glucose by 297, 302
- Butyrate  
 extraction by liver 305  
 metabolism of 4, 304–306  
 rumen production of 2  
 utilization by rumen wall 305
- Butyric acid *see* Butyrate
- Calcium 333, 470
- Calorimetry  
 direct, description 423  
 indirect, description 423–424
- Carbohydrate metabolism  
 by microbes 233–234  
 in rumen 158  
 soluble 264, 270–271
- Catecholamines  
 effect on fat mobilization 361–363, 364, 459  
 effect on oxygen consumption 496  
*see also*  $\beta$ -Agonists
- Cholecystokinin (CCK), 334–335
- Cimaterol 499  
*see also*  $\beta$ -Agonists
- Compartment, definition 16
- Compensatory growth 491
- Copper 479–482  
 absorption 479–480  
 diagram of movement 481  
 models 480–482
- Cornell Net Carbohydrate and Protein System (CNCPS) 179, 249–251
- Design  
 experimental, for monitoring digestion kinetics 22–24  
 sampling times 23
- Diet-induced thermogenesis 496
- Diet selection 620–622  
 examples of pathways for dairy cows 622  
 at pasture 688–689  
 for protein 620, 621–622
- Digesta flow  
 compartmental analysis 72–74  
 diagram 3  
 effect of diet 62  
 effect of pregnancy and lactation 62  
 markers  
   chromium-EDTA 60–61, 72  
   chromium sesquioxide 55–56  
   double-marker method 56–59  
   ruthenium 59–60, 72  
   ytterbium 59–60  
 measurement  
   re-entrant cannulas 54  
   simple cannulas 54–56  
 through colon 4  
 variation 62
- Digestibility techniques  
 enzymatic methods 91  
 gas production 90, 693  
 Tilley and Terry 89–90
- Digestion  
 extent of 13–15, 16  
 model, MOLLY 553  
 rate of 13–15  
 techniques  
   mobile nylon bags 643–644  
   *in situ* 20–21  
   *in vitro* 19–20
- Energy  
 digestible (DE) 421  
 gross (GE) 421  
 metabolizable *see* Metabolizable energy  
 net (NE) 421  
 partitioning of food 422  
 Energy spilling by bacteria 238–243, 250

- Epinephrine *see* Catecholamines  
 Estradiol *see* Anabolic steroids
- Fasting metabolism 425, 426  
 Fat metabolism 364  
 Fat synthesis, milk  
   efficiency of utilization of energy for 432  
   MOLLY 571  
 Fatty acids *see* Non-esterified fatty acids, Short-chain  
   fatty acids, Long-chain fatty acids  
 Fatty acid metabolism 327–329  
 Feed processing  
   drying/cooling 631  
   effects on protein structure 628  
   effects on starch 628–629  
   expansion 632, 636, 638, 644, 645  
   extrusion 632, 636, 638, 641  
   formaldehyde treatment 642  
   grinding 631  
   micronization 633  
   pelletting 633, 646  
   roasting 632–633, 641  
   steam processing 631, 645  
   toasting 632, 637, 646  
 Feeding systems  
   development of 424–428, 707–708  
   INRA model 709–713  
   protein  
     GRAZPLAN 197  
     CNCPS 197  
 Fermentation pattern, definition 159  
 Fetus  
   effect of diet 159, 161–162  
   effect of maternal exercise 541  
   effect of temperature 541  
   glucose uptake by 298  
   hormones 538–539  
   metabolism 534–537  
   nutrient supply 537–539  
   nutrients and growth 533–534  
   oxidation of amino acids 536–537  
   sources and disposal of energy and nitro-  
     gen 535  
 Fibre degradation 264–267  
 Flux  
   definition 16  
   ratio, definition 16  
 Forage composition 682–683  
 Fractional passage rate 141–142  
   effect of particle size 142–143, 693  
 Fragmentation, leaf and stem 127–128  
 Fructose 536  
 Functional specific gravity (FSG) 124–125, 138  
   effect on passage 143–147  
 Fungi, rumen 52, 135, 211–212, 229  
   numbers 208  
   species 208
- Gene expression 499–509  
 Genetic engineering of ruminal bacteria 247–248  
 Genetic potential 720  
   representation in MOLLY 565–578,  
     574–578  
 Genetic selection for growth 509  
 Glucagon 333–335  
   effects on liver 454  
 Glucagon-like peptide 334–335, 415–416  
 Gluconeogenesis 293  
   hepatic  
     in pregnancy 525–526  
 Glucose  
   absorption, efficiency of 322  
   metabolism 291–296  
     by hind limb 302  
   production 294–296  
     from amino acids 295  
     from glycerol 295  
     from lactate 295  
     from propionate 294–295, 301  
   supply to fetus 537  
   turnover in lactation 457  
   utilization 297–298  
 Glutamine 402–405, 408  
 Glycine 408  
 Gnotobiotic rumen 224  
 Grazing management 685–687  
   continuous stocking 685–686  
   GRAZFEED model 179  
   restricted access 687  
   rotational grazing 686  
 Growth hormone 490–492  
   control of protein metabolism 388–389, 415,  
     490  
   effect on fat metabolism 364, 454, 455,  
     490  
   effect of feed restriction 490–492  
   plasma levels 416
- Heat increment (HI)  
   of feeding, definition 422  
   of gestation 524  
 Heat production  
   by bacteria 236  
   by fetus 534  
 Homoeorrhesis  
   definition 457  
   in pregnancy 527–530  
 Homoeostasis 455–457  
 Hormones 333–336, 414–416

- Housing and management systems for dairy  
 cows 664  
 cubicles 672  
 straw yards 672–673
- In situ* technique  
 factors affecting 99, 102  
 filter bag 90  
 contamination 100–101  
 particle loss from 98–100  
 pore size 101  
 use in feed evaluation 104
- Indigestible residue, definition 16
- Insulin  
 deficiency, effect on acetate metabolism 304  
 effect on fat metabolism 363  
 effect on glucose utilisation 297, 452  
 effect on metabolism 446, 447  
 plasma levels 416  
 fetus 538  
 regulation of growth by 387–388, 415, 493  
 removal 334–335  
 resistance to in pregnancy 527–528  
 secretion 334–335  
 sensitivity of metabolic processes to 456  
 in undernutrition 357
- Insulin-like growth factors (IGFs) 334–335, 492–493  
 control of growth by 389–390, 415  
 plasma levels 416, 492  
 receptors 492
- Ion gradients (microbial) 232  
 sodium 232
- Ionophores  
 as feed additives 245  
 modes of action 245–247  
 resistance to 246
- Isobutyrate 306
- Isovaleric acid  
 rumen production of 2  
 metabolism 306
- Ketones  
 detection in breath 674–675  
 ketosis 463  
 in pregnancy 358  
 production, by liver 305
- Kidney, glucose metabolism in 296
- Kinetics  
 mass-action 16  
 Michaelis-Menton 16
- Lactate  
 interrelations with glucose 298–300  
 metabolism 298–300  
 production by placenta 535–536  
 turnover 298
- Lactation  
 adaptations to 458  
 fat metabolism during 359  
 glucose turnover during 457  
 increase in blood flow during 450  
 milking frequency 461
- Lactose production, MOLLY 572
- Lag phase of digestion 108
- Lameness in dairy cows 637, 674
- Large intestine 4  
 protein metabolism in 384
- Lectins, 649–650
- Legumes  
 digestion of 127–128  
 grazing behaviour 684–685
- Leptin 415, 456–457, 493–495  
 in control of food intake 462, 494  
 during pregnancy 528, 529, 530  
 modes of action 494  
 plasma levels 416, 528  
 receptors 454, 492, 500  
 in adipose tissue 501  
 in muscle 503, 504
- Lipid  
 fate of 346  
 metabolism during pregnancy 526–527
- Lipolysis, signalling cascade 447
- Liver  
 calculation of metabolism 316  
 glucose metabolism in 295  
 glucose production in 325–327  
 lactate extraction by 299  
 protein metabolism in 384–385  
 response to nutrient supply 463
- Long-chain fatty acids  
 composition in blood 346  
 efficiency of absorption 321
- Lysine, deficiency 410
- Magnesium 333
- Maintenance energy, of bacteria 237–238
- Mammary gland  
 fatty acids synthesis in 458–459  
 protein metabolism in 387  
 uptake of glucose by 297–298  
 uptake of lactate by 299
- Mastication  
 artificial 135  
 release of cell contents due to 694
- Meal patterns 608–610  
 intermeal intervals 608–609  
 critical 608

- Mean retention time (MRT)  
 animal factors 77  
 climatic factors 77  
 definition 53  
 effect of diet 74–77  
 of microbes 68–70  
 of particles 67–68, 70  
 of solutes 65–67  
 variation 77
- Metabolic control  
 enzymes involved in 444–446  
 theory 444  
 within cells 443–448
- Metabolism  
 methodology  
 arteriovenous difference 293–294  
 double isotope technique 292–293  
 isotope dilution 292–293  
 model, MOLLY 554
- Metabolizable energy (ME)  
 definition 421  
 efficiency of utilization  
 of body tissue for lactation 434–436  
 for lactation 432–436  
 for maintenance 425–428, 429–432  
 for weight gain 433–434  
 lactation requirements 427–432  
 maintenance requirement 427, 428–432  
 predictions from MOLLY 560
- Methane  
 anthropogenic sources 665  
 emissions from dairy cows 664  
 yield of 278–280  
 effect of diet 279
- Microbial  
 colonization of particles 124–136, 693  
 growth 212–215  
 efficiency of 272–273  
 metabolism 272–280  
 nitrogen utilization in 273–277  
 protein 179
- Microbial culture  
 batch cultures 92–93  
 consecutive batch culture 219–222  
 repeated fed batch culture 222–223  
 chemostat 216  
 growth-limiting substrate 217, 218  
 predator-prey interaction 218–219  
 continuous cultures 93–94  
 gas production 95–96  
 Rusitec 224
- Milk yield, predictions from MOLLY 560
- Milking 675–677  
 milk ejection reflex 675  
 robotic machines 664, 675–677
- Minerals  
 exchange across PDV 332–333  
*see also* Calcium, Copper, Phosphorus, Sodium
- Models and Modelling  
 compartmental, of pregnancy 542  
 degradation 107–112  
 of digestion 105–113  
 examples 24–38  
 dynamic, definition 17  
 empirical  
 definition 17  
 description of 7–8, 551
- errors  
 bootstrap technique 564–565  
 prediction 562  
 systematic 562
- of energy requirement by lactating cows 436–437
- evaluation, statistical methods 562–563
- fitting digestion data 38–44  
 curve peeling 38–42  
 logarithmic transformation 42–43  
 non-linear least squares 43–44
- kinetic, definition 17
- mechanistic  
 definition 17  
 description of 8–9, 551  
 of rumen function 283–284  
 testing 551–552
- nutrient flow 713–717
- physical, of microbial growth 215–223
- static, definition 17
- stochastic, definition 17
- stochastic, digesta passage 73
- teleonomic, description of 7
- validation 563–565
- of wool growth 597–601, 602  
*see also* MOLLY
- Molecular biology techniques, protein synthesis 379
- MOLLY, model of lactating cow 552–579  
 evaluation 557–562  
 metabolic transactions, summary and definition 556
- Monensin *see* Ionophores
- Muscle  
 blood flow 450  
 protein metabolism in 385–386, 409–413  
 utilization of glucose 297
- Neuropeptide Y (NPY) 495–496  
 receptors 500  
 in muscle 503, 504
- Neutral detergent fibre (NDF)  
 degradation 265–267

- Neutral detergent fibre (*cont'd*)  
 effect of soluble carbohydrate 266  
 factors affecting 265  
 relationship with NDF intake 267  
 relationship with starch intake 267–270  
 structure in legumes 697
- Nitric oxide, regulation of fat metabolism 363
- Nitrogen balance in rumen  
 definition 273  
 relationship with dietary carbohydrate 276  
 relationship with dietary nitrogen 274  
 relationship with dry matter intake 276
- Nitrogen deficiency, effect on bacterial yield 251
- Nitrogen transactions in the rumen  
 model 188  
 scheme 186
- Nitrogen transactions post-rumen  
 digestion in large intestine 195  
 digestion in small intestine 194–195
- Nitrogenous materials  
 degradation in rumen 271–272  
 digestion and metabolism 178  
 models 179
- Non-esterified fatty acids (NEFA)  
 composition of 345–346  
 effect of exercise 359–360  
 effect of feeding on 346–347  
 effect of growth 360–361  
 effect of insulin 355  
 effect of lactation 359  
 effect of pregnancy 356, 358–359  
 effects of thermal stress 357–358  
 effects of undernutrition on 356–357  
 entry rate 348–351  
 definition 348  
 fate of 346  
 hormonal control of 361–364  
 metabolism 355  
 effect of feeding 354–356  
 by hind limb 350  
 oxidation 352–354  
 relationship with plasma level 351  
 utilization 351–354
- Non-protein nitrogen (NPN), definition 181
- Nutrient demand as determinant of metabolism 461
- Oesophageal fistula 130
- Omasum 3
- Outflow rate  
 definition 53  
 fractional (FOR)
- Overfeeding 540–541
- Oxygen consumption  
 by PDV and liver 318–320  
 by various tissues 451
- Parameters, definition 17
- Particle escape from rumen 140
- Particle size  
 critical, for digesta flow 50–51  
 effects of grinding 51  
 effects of mastication 125–126, 691–693  
 wet sieving method 50, 124
- pH, rumen 5, 159, 207  
 effect on bacteria 241–242
- Phosphorus 469–479  
 blood concentration 476  
 bone 476  
 large intestine 475  
 milk 476  
 models  
 empirical 470–471  
 non-steady-state 473–479  
 predictions 478  
 sensitivity analysis 477  
 steady-state 471–473  
 recycling via saliva 476  
 rumen pool 473  
 small intestine 475
- Photoperiod, effect on wool growth 592–593
- Placenta  
 amino acid flux across 532, 536  
 metabolism 531–533  
 nutrient transport 530–531
- Placental lactogen (PL) 528, 529–530
- Pollution, nitrogen 651
- Pool, definition 17
- Portal-drained viscera  
 amino acid kinetics in 406–408  
 energetic costs of protein synthesis  
 in 405–408  
 metabolism  
 interconversion of metabolites  
 314–316  
 methodology 312–318  
 oxidation in 313–314  
 uptake of glucose by 297
- Post-ruminal particle dynamics 147–148
- Potassium 333
- Potentially digestible fraction, definition 17
- Pregnancy 523–542  
 adaptations to 525–530  
 effect on NEFA 356  
 energy cost of 523–525
- Propionate  
 absorption of 4  
 glucose synthesis from 301  
 lactate synthesis from 301–302  
 metabolism of 300–302  
 rumen production of 2
- Propionic acid *see* Propionate
- Protease systems 507–508



- Protein degradability
  - techniques
    - ammonia production 96–97
    - enzymatic methods 97
    - solubility 97
- Protein degradation
  - in body 374–375, 378–379
  - energy costs of 401
  - in rumen
    - effect of diet 181–182
    - effect of processing 180, 634–643, 636, 637, 639
    - microbial proteolytic activity 182
    - models 183–184
    - pasture protein 181
- Protein metabolism
  - control of 387–391
  - energy costs of 400–402
  - portal-drained viscera 380–382
- Protein, protected 629–630, 634
- Protein synthesis
  - amino acid regulation of 409
  - effect of ME intake 381
  - energy costs of 401
  - in GI tract 382–384
  - microbial 191–194
    - efficiency 191–192
    - effect of turnover rate 192–193
    - role of protozoa 193
  - mechanisms 374–375
  - measurement of 375–379
  - in milk, MOLLY 570–571, 573
  - in pregnancy 526
  - in wool 590–592
- Protein turnover
  - mechanisms 374–375
  - in stomach wall 280
  - tissue and organ 377–379
  - two-pool model 376
  - whole body 375–377, 379–380, 381
    - effect of age 380
- Protozoa, rumen 52, 211
  - defaunation 190, 193, 229
  - intake of bacteria 190, 211, 249
  - numbers 208
  - species 208
- Raft, rumen 138, 139, 140
  - filter bed effect 140
- Rate
  - absolute, definition 17
  - definition 17
  - first-order, definition 17
  - fractional, definition 17
- Rate of passage
  - definition 53
  - measurement 62–65
  - tabulated values 63–65
- Reaction, order of, definition 17
- Residual Feed Intake (RFI) 509–514
  - and body composition 512–513
  - definition 510
  - and efficiency 510
  - and food intake 512
  - and growth 511
  - and physical activity 513
- Reticular contractions 141
- Rumen degradable protein (RDP), definition 179
- Rumen inoculation, with bacteria 248
- Rumination
  - bolus movement 131–132
  - cattle vs sheep 130
  - chewing behaviour 129–130
  - comminution of particles 132–134
- Saliva 207
- Sedimentation rate 144, 146, 147
- Short-chain fatty acids (SCFA)
  - absorption 158–159, 280–281, 324–325
    - efficiency of 320–321
    - energy cost of 280
  - concentrations in rumen 161–162
  - metabolism 160, 300–306
    - by stomach epithelia 284
  - production
    - arteriovenous difference 164
    - estimation from methane production 164–165
    - in vitro* measurement 160, 163
    - measurement by perturbation 163–164
    - at pasture 695–697
    - single pool tracer method 165–168
    - three-pool tracer method 168–171
  - yield of 277–280
    - stoichiometry 277, 278
- Silage
  - delay in onset of digestion 139
  - evaluation 103
  - nutrient supply from 283
- Simulation, definition 17
- Skin, protein metabolism in 386–387
- Small intestine
  - description 3–4
  - protein metabolism in 383–384, 643–645
- Social dominance 669–670, 688
- Somatotropin *see* Growth hormone
- Space requirements for dairy cows 671
- Special senses
  - hearing 667–668
  - olfaction and taste 668

- Special senses (*cont'd*)  
vision 667
- Specific gravity, functional (FSG) 51–52, 693
- Starch,  
degradation of 5, 267–270, 635, 638,  
645–649  
effect on nitrogen balance in rumen 275  
protection from degradation in rumen 630
- State  
quasi-steady, definition 18  
steady, definition 18
- Stratification of particles in RR 137–141  
distribution coefficient 138
- Synchrony of supply of energy and nitro-  
gen 184–185, 282–283  
at grazing 698–699
- Tannins, condensed 650, 697
- Thermal environment for dairy cows 668–669
- Time  
retention, definition 18  
turnover, definition 18
- Trenbolone acetate *see* Anabolic steroids
- Triacylglycerol (TAG)  
composition of 345–346  
metabolism 347
- Trypsin inhibitors 650
- Uncoupling proteins (UCP) 504–507  
expression of UCP-2 505  
expression of UCP-3 507  
relationship to weight gain 506
- Undegraded protein (UDP), definition 179
- Undernutrition, effects on fetus 539–540
- Urea  
metabolism 195–196, 329–331  
recycling 272, 330–331  
synthesis in liver 196, 413–414  
transport across gut wall 196
- Uterus  
energetic efficiency of 524–525  
uptake of glucose by 297, 298
- Valerate  
metabolism 306  
rumen production of 2
- Validation, definition 18
- Variables, definition 18  
state, definition 18
- Verification, definition 18
- Volatile fatty acids (VFA) *see* Short-chain fatty acids
- Voluntary food intake 610–620  
constraints theories 611–615  
fill units in INRA system 710  
incorporation into mechanistic models 718  
minimal total discomfort (MTD) the-  
ory 617–620  
neutral detergent fibre as predictor 689–691  
optimization theories 615–620  
prediction by multiple regression 610, 611  
rumen capacity 689–691  
two-phase hypothesis (TPH) 610, 611–612,  
614–615  
*see also* Diet selection
- Water-soluble carbohydrates, pasture content 197
- Welfare, animal 663, 665–666
- Wool  
growth, description 584–586  
follicle  
cell dynamics 586–590, 595–596  
density and distribution 595–597  
rate of cell division 590  
staple strength 594