

## Preface

It has been more than a decade since the publication of the fifth edition, and understandably numerous changes have come about, not the least of which are changes in authorship as well as rapid progress in the various fields of clinical scientific endeavor. First of all, we'd like to pay tribute to a number of our previous authors who have passed away since the publication of the fifth edition. Notably, they are Drs. Duane F. Brobst (Pancreas), Charles C. Capen (Calcium), Jens G. Hauge (Genetics), and Joseph E. Smith (Iron). All succumbed to cancers of various types except for Dr. Smith, who died in a tragic auto accident. Others have retired and chose not to contribute or to contribute in a secondary role. All of these authors contributed greatly to previous editions and are sorely missed as contributors at the forefront of their respective fields. It is to all these contributors that the editors of this current edition wish to dedicate this new volume. New lead authors have been identified and have contributed ably to this edition.

As in previous editions, this edition continues to promote the concept of the Systeme International d'Unites (SI units) with the hope and expectation that ultimately it may be universally accepted.

We would also like to take this opportunity to extend our heartfelt thanks to Melissa Turner and Kristi Anderson, who have ably shepherded us through the intricacies of dealing with a new publisher, Elsevier, who purchased Academic Press, the publisher for the first five editions. Our thanks also go to Julie Ochs who has ably guided us through the final steps of the printing and publication process. They have all been extremely diligent, having been almost at our beck and call for assistance, clarification, guidance, and encouragement at every step of the way. To all three of our publisher contacts, we are extremely grateful.

Finally, we must acknowledge and express our thanks to our families who have been incredibly supportive in our almost single minded effort to bring this current edition to fruition. Without their unqualified support, this work would have been most difficult to accomplish and perhaps not even possible.

*J. Jerry Kaneko  
John W. Harvey  
Michael L. Bruss*

# Contributors

Numbers in parentheses indicate the pages on which the authors' contributions begin.

- Håkan Andersson** (635) Department of Integrative Biology, Umea University, SE-90187 Umea, Sweden
- Cleta Sue Bailey** (769) Department of Surgical and Radiological Sciences, School of Veterinary Medicine, University of California, Davis, Davis, CA 95616
- Jean-Pierre Braun** (485) Department of Physiopathology and Experimental Toxicology, National School of Veterinary Medicine of Toulouse, 31076 Toulouse, France
- Michael L. Bruss** (81, 529) Department of Anatomy, Physiology and Cell Biology School of Veterinary Medicine, University of California, Davis, Davis, CA 95616
- Hilary Burgess** (287) Department of Pathobiology, Ontario Veterinary College, University of Guelph, Guelph, Ontario, N1G2W1, Canada
- Gary P. Carlson** (529) Department of Medicine and Epidemiology, School of Veterinary Medicine, University of California, Davis, Davis, CA 95616
- Stan W. Casteel** (821) Medical Diagnostic Laboratory, College of Veterinary Medicine University of Missouri, Columbia, MO 65205
- Sharon A. Center** (379) Department of Clinical Sciences, New York State College of Veterinary Medicine, Cornell University, Ithaca, NY 14853
- P. David Eckersall** (117) Division of Animal Production and Public Health, Institute of Comparative Medicine, University of Glasgow, Glasgow G61-1QH, Scotland, UK
- Thomas B. Farver** (1) Department of Population Health and Reproduction, School of Veterinary Medicine, University of California, Davis, Davis, CA 95616
- Andrea J. Fascetti** (663, 695) Department of Molecular Biosciences, School of Veterinary Medicine, University of California, Davis, Davis, CA 95616
- Patricia Gentry** (287) Department of Biomedical Sciences, Ontario Veterinary College Guelph, University of Guelph, Ontario, N1G2W1, Canada
- Laurel J. Gershwin** (157) Department of Pathology, Microbiology and Immunology, School of Veterinary Medicine, University of California, Davis, Davis, CA 95616
- Urs Giger** (27, 731) School of Veterinary Medicine, University of Pennsylvania, Philadelphia, PA 19104-6010
- John W. Harvey** (173, 259) Department of Physiological Sciences, College of Veterinary Medicine, University of Florida, Gainesville, FL 32610
- Mark Haskins** (27, 731) Department of Pathology, School of Veterinary Medicine, University of Pennsylvania, Philadelphia, PA 19104-6010
- Walter E. Hoffmann** (351) Department of Veterinary Pathobiology, College of Veterinary Medicine, University of Illinois, Urbana, IL 61801
- William E. Hornbuckle** (413) Department of Clinical Sciences, New York State College of Veterinary Medicine, Cornell University, Ithaca, NY 14853
- J. Jerry Kaneko** (45, 241, 623) Department of Pathology, Microbiology and Immunology, School of Veterinary Medicine, University of California, Davis, Davis, CA 95616
- Carl L. Keen** (663) Department of Nutrition, College of Agriculture and Environmental Sciences, University of California, Davis, Davis, CA 95616
- Kurt V. Kreutzer** (821) Department of Biomedical Sciences, College of Veterinary Medicine, University of Missouri, Columbia, MO 65211
- Herve P. Lefebvre** (485) Department of Physiopathology and Experimental Toxicology, National School of Veterinary Medicine of Toulouse, 31076 Toulouse, France
- Michael D. Lucroy** (751) VCA Veterinary Specialty Center, Indianapolis, IN 46820
- J.T. Lumeij** (839) Department of Clinical Sciences of Companion Animals, Faculty of Veterinary Medicine, Utrecht University, 3584 CM Utrecht, The Netherlands

- Björn P. Meij** (561, 605) Department of Clinical Sciences of Companion Animals, Faculty of Veterinary Medicine, Utrecht University, 3584 CM Utrecht, The Netherlands
- Jan A. Mol** (561, 605) Department of Clinical Sciences of Companion Animals, Faculty of Veterinary Medicine, Utrecht University, 3584 CM Utrecht, The Netherlands
- James G. Morris** (695) Department of Molecular Biosciences, School of Veterinary Medicine, University of California, Davis, Davis, CA 95616
- Robert B. Rucker** (663, 695) Department of Nutrition, College of Agriculture and Environmental Sciences, University of California, Davis, Davis, CA 95616
- Kenneth W. Simpson** (413) Department of Clinical Sciences, College of Veterinary Medicine, Cornell University, Ithaca, NY 14853-6401
- Philip F. Solter** (351) Department of Veterinary Pathobiology, College of Veterinary Medicine, University of Illinois, Urbana, IL 61801
- Bud C. Tennant** (379, 413) Department of Clinical Sciences, New York State College of Veterinary Medicine, Cornell University, Ithaca, NY 14853
- James R. Turk** (821) Department of Biomedical Sciences, College of Veterinary Medicine, University of Missouri, Columbia, MO 65211
- Stephanie J. Valberg** (459) Department of Veterinary Population Medicine College of Veterinary Medicine, University of Minnesota, St. Paul, MN 55108
- Karen A. Vernau** (769) Department of Surgical and Radiological Sciences, School of Veterinary Medicine, University of California, Davis, Davis, CA 95616
- William Vernau** (769) Department of Pathology, Microbiology and Immunology School of Veterinary Medicine, University of California, Davis, Davis, CA 95616
- Bruce Walcheck** (331) Department of Veterinary and Biomedical Sciences, College of Veterinary Medicine, University of Minnesota, St. Paul, MN 55108
- Douglas J. Weiss** (331) Department of Veterinary Pathobiology, College of Veterinary Medicine, University of Minnesota, St. Paul, MN 55108
- Petra Werner** (27) Department of Medicine, Section of Medical Genetics, School of Veterinary Medicine, University of Pennsylvania, Philadelphia, PA 19104-6010
- Darren Wood** (287) Department of Pathobiology, Ontario Veterinary College, University of Guelph, Guelph, Ontario, N1G2W1, Canada

# Concepts of Normality in Clinical Biochemistry

Thomas B. Farver

*Department of Population Health and Reproduction  
School of Veterinary Medicine  
University of California, Davis  
Davis, California*

---

## I. POPULATIONS AND THEIR DISTRIBUTIONS

## II. REFERENCE INTERVAL DETERMINATION AND USE

- A. Gaussian Distribution
- B. Evaluating Probabilities Using a Gaussian Distribution
- C. Conventional Method for Determining Reference Intervals
- D. Methods for Determining Reference Intervals for Analytes Not Having the Gaussian Distribution
- E. Sensitivity and Specificity of a Decision Based on a Reference Interval
- F. Predictive Value of a Decision Based on a Reference Interval
- G. ROC Analysis

## III. ACCURACY IN ANALYTE MEASUREMENTS

## IV. PRECISION IN ANALYTE MEASUREMENTS

## V. INFERENCE FROM SAMPLES

- A. Simple Random Sampling
- B. Descriptive Statistics
- C. Sampling Distributions
- D. Constructing an Interval Estimate of the Population Mean,  $\mu$
- E. Comparing the Mean Response of Two Populations
- F. Comparing the Mean Response of Three or More Populations Using Independent Samples
- G. Efficiency in Experimental Designs
- H. Nesting Designs

## REFERENCES

---

## I. POPULATIONS AND THEIR DISTRIBUTIONS

A population is a collection of individuals or items having something in common. For example, one could say that the population of healthy dogs consists of all dogs that are free

of disease. Whether a given dog belongs to the population of healthy dogs depends on someone's ability to determine if the dog is or is not free of disease. Populations may be finite or infinite in size.

A population can be described by quantifiable characteristics frequently called *observations* or *measures*. If it were possible to record an observation for all members in the population, one most likely would demonstrate that not all members of the population have the same value for the given observation. This reflects the inherent variability in populations. For a given measure, the list of possible values that can be assumed with the corresponding frequency with which each value appears in the population relative to the total number of elements in the population is referred to as the *distribution* of the measure or observation in the population. Distributions can be displayed in tabular or graphical form or summarized in mathematical expressions. Distributions are classified as discrete distributions or continuous distributions on the basis of values that the measure can assume. Measures with a continuous distribution can assume essentially an infinite number of values over some defined range of values, whereas those with a discrete distribution can assume only a relatively few values within a given range, such as only integer values.

Each population distribution can be described by quantities known as *parameters*. One set of parameters of a population distribution provides information on the center of the distribution or value(s) of the measure that seems to be assumed by a preponderance of the elements in the population. The mean, median, and mode are three members of the class of parameters describing the center of the distribution. Another class of parameters provides information on the spread of the distribution. Spread of the distribution has to do with whether most of the values that are assumed in the population are close to the center of the distribution or whether a wider range of values is assumed. The standard deviation, variance, and range are examples



of parameters that provide information on the spread of the distribution. The shape of the distribution is very important. Some distributions are symmetric about their center, whereas other distributions are asymmetric, being skewed (having a heavier tail) either to the right or to the left.

## II. REFERENCE INTERVAL DETERMINATION AND USE

One task of clinicians is determining whether an animal that enters the clinic has blood and urine analyte values that are in the normal interval. The conventional method of establishing normalcy for a particular analyte is based on the assumption that the distribution of the analyte in the population of normal animals is the “normal” or Gaussian distribution. To avoid confusion resulting from the use of a single word having two different meanings, the “normal” distribution henceforth is referred to as the Gaussian distribution.

### A. Gaussian Distribution

Understanding the conventional method for establishing normalcy requires an understanding of the properties of the Gaussian distribution. Theoretically, a Gaussian distribution is defined by the equation

$$y = \frac{1}{\sqrt{2\pi}\sigma} e^{-(x-\mu)^2 / 2\sigma^2}$$

where  $x$  is any value that a given measurement can assume,  $y$  is the relative frequency of  $x$ ,  $\mu$  is the center of the distribution,  $\sigma$  is the standard deviation of the distribution,  $\pi$  is the constant 3.1416, and  $e$  is the constant 2.7183.

Theoretically,  $x$  can take on any value from  $-\infty$  to  $+\infty$ . Figure 1-1 gives an example of a Gaussian distribution and demonstrates that the distribution is symmetric around  $\mu$  and is bell shaped. Figure 1-1 also shows that 68% of the distribution is accounted for by measurements of  $x$  that have a value within 1 standard deviation of the mean, and 95% of the distribution includes those values of  $x$  that are within 2 standard deviations of the mean. Nearly all of the distribution (97.75%) is contained by the bound of 3 standard deviations of the mean.

Most analytes cannot take on negative values and so, strictly speaking, cannot have Gaussian distributions. However, the distribution of many analyte values is approximated well by the Gaussian distribution because virtually all the values that can be assumed by the analyte are within 4 standard deviations of the mean and, for this range of

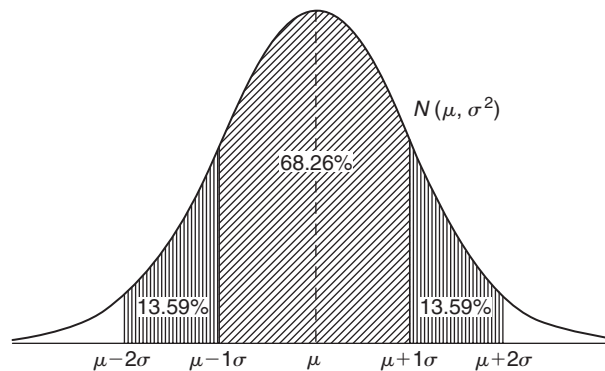


FIGURE 1-1 The Gaussian distribution.

values, the frequency distribution is Gaussian. Figure 1-2, adapted from the printout of MINITAB, Release 14.13,<sup>1</sup> gives an example of the distribution of glucose values given in Table 1-1 for a sample of 168 dogs from a presumably healthy population.

[To produce this figure, place the glucose values for the 168 dogs in one column of a MINITAB worksheet and give the following commands:

**Stat** (from the main menu) → **Basic Statistics**  
→ **Graphical Summary**

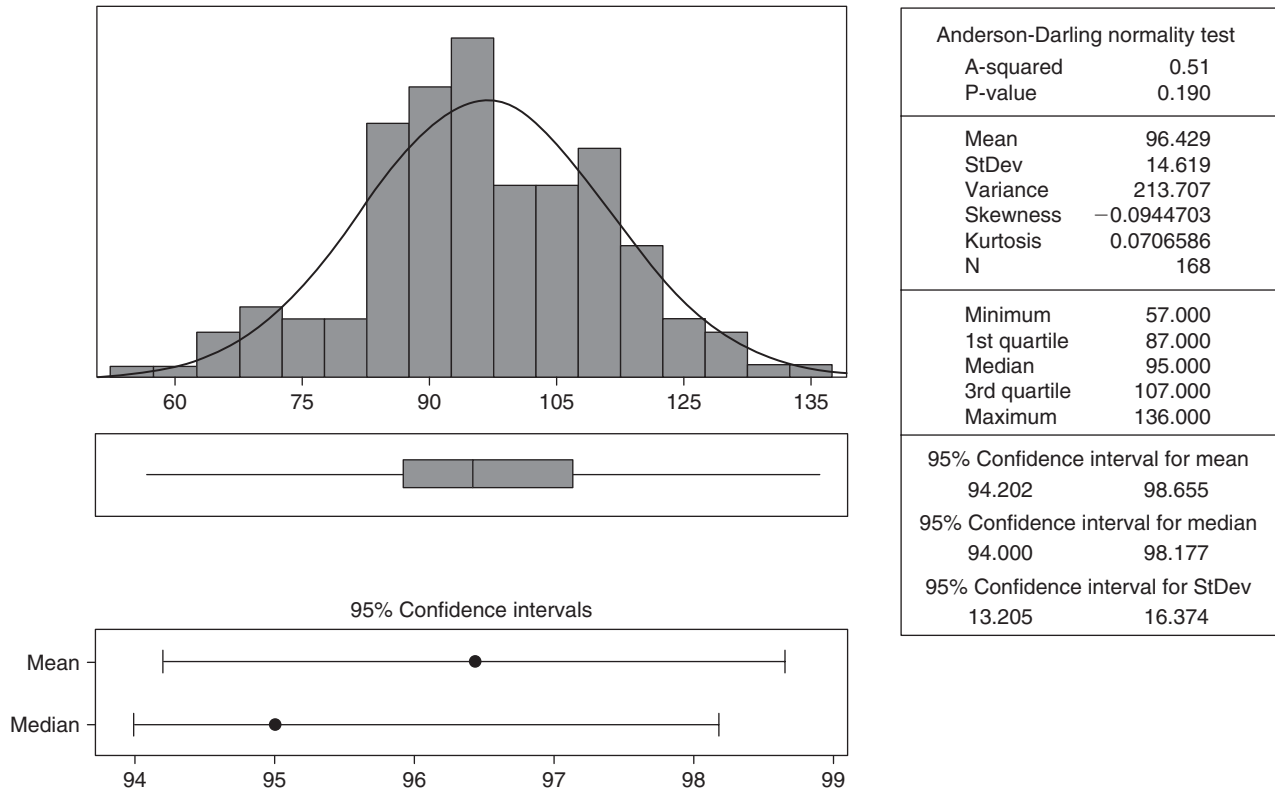
In the **Graphical Summary** dialog box, select the column of the worksheet containing the glucose values and place it in the **Variables:** box. Hit **OK**.

Though not perfectly Gaussian, the distribution is reasonably well approximated by the Gaussian distribution. Support for this claim is that the distribution has the characteristic bell shape and appears to be symmetric about the mean. Also, the mean [estimated to be 96.4mg/dl (5.34mmol/liter)] of this distribution is nearly equal to the median [estimated to be 95.0mg/dl (5.27mmol/liter)], which is characteristic of the Gaussian distribution. The estimates of the skewness and kurtosis coefficients are close to zero, also characteristic of a Gaussian distribution (Daniel, 2005; Schork and Remington, 2000; Snedecor and Cochran, 1989).

### B. Evaluating Probabilities Using a Gaussian Distribution

All Gaussian distributions can be standardized to the reference Gaussian distribution, which is called the *standard*

<sup>1</sup> MINITAB, Inc., Quality Plaza, 829 Pine Hall Road, State College, PA 16801-3008.



**FIGURE 1-2** Distribution and summary statistics for the sample of canine glucose values (mg/dl) in Table 1-1. Printout of MINITAB, Release 14.13.

*Gaussian distribution.* Standardization in general is accomplished by subtracting the center of the distribution from a given element in the distribution and dividing the result by the standard deviation of the distribution. The distribution of a standardized Gaussian distribution—that is, a Gaussian distribution that has its elements standardized in this form—has its center at zero and has a variance of unity. The elements of the standard Gaussian distribution

are traditionally designated by the letter  $z$  so that it can be said that  $z$  is  $N(0,1)$ . That all Gaussian distributions can be transformed to the standard Gaussian distribution is convenient in that just a single table is required to summarize the probability structure of the infinite number of Gaussian distributions. Table 1-2 provides an example of such a table and gives the percentiles of the standard Gaussian distribution.

**Example 1**

Suppose the underlying population of elements is  $N(4,16)$  and one element from this population is selected. We want to find the probability that the selected element has a value less than 3.0 or greater than 6.1. In solving this problem, the relevant distribution is specified:  $x$  is  $N(4,16)$ . The probability of observing  $x < 3.0$  in the distribution of  $x$  is equivalent to the probability of observing  $z < (3.0 - 4)/4 = -0.25$  in the standard Gaussian distribution. Going to Table 1-2,  $z = 0.25$  is approximately the 60th percentile of the standard Gaussian distribution and by symmetry  $z = -0.25$  is approximately the

40th percentile. Thus, the probability of observing a  $z$  value less than or equal to  $-0.25$  is approximately 0.40. The probability of observing  $x > 6.1$  is equivalent to the probability of observing  $z > (6.1 - 4)/(4) = +0.525$ . Table 1-2 gives the probability of observing a  $z < 0.525$  as approximately 0.70, so the probability of observing a  $z > 0.525$  approximately equals  $1 - 0.70$  or 0.30. The desired probability of observing a sample observation less than 3.0 or greater than 6.1 is the sum of 0.40 and 0.30, which is approximately 0.7 or 7 chances in 10.

**TABLE 1-1** Glucose (Glu, mg/dl) and Alanine Aminotransferase (ALT,U/l) for a Sample of 168 Dogs from the Population of Healthy Dogs<sup>a</sup>

Dog	Glu	ALT	Dog	Glu	ALT	Dog	Glu	ALT	Dog	Glu	ALT
1	88	60	43	86	53	85	110	54	127	108	105
2	104	79	44	86	50	86	78	54	128	90	32
3	89	138	45	115	72	87	95	37	129	100	25
4	99	58	46	98	59	88	111	25	130	96	46
5	63	34	47	98	80	89	116	115	131	86	95
6	97	43	48	99	42	90	108	60	132	100	99
7	94	47	49	94	42	91	76	36	133	122	115
8	105	77	50	104	116	92	111	102	134	109	60
9	86	102	51	107	98	93	86	62	135	77	67
10	124	34	52	107	78	94	101	43	136	88	83
11	118	64	53	119	56	95	106	73	137	94	118
12	112	184	54	114	38	96	92	99	138	92	44
13	85	82	55	94	50	97	67	50	139	121	64
14	109	35	56	109	47	98	75	24	140	86	19
15	96	46	57	110	32	99	127	110	141	84	68
16	72	29	58	99	53	100	87	65	142	86	74
17	91	117	59	105	97	101	136	44	143	105	86
18	94	132	60	102	97	102	94	40	144	91	47
19	90	68	61	100	54	103	89	18	145	92	56
20	68	50	62	83	36	104	72	30	146	89	49
21	84	95	63	83	32	105	87	75	147	123	78
22	94	140	64	108	111	106	96	66	148	109	93
23	91	38	65	114	63	107	85	113	149	117	46
24	90	146	66	105	58	108	95	63	150	115	31
25	72	68	67	74	24	109	96	61	151	83	65
26	87	42	68	92	96	110	117	62	152	94	55
27	94	43	69	97	42	111	106	33	153	92	52
28	97	84	70	85	101	112	113	99	154	109	64
29	103	44	71	83	46	113	107	97	155	92	59
30	70	84	72	86	58	114	96	131	156	93	49
31	91	108	73	110	29	115	94	44	157	92	29
32	58	28	74	121	115	116	100	68	158	101	66
33	89	75	75	87	62	117	127	37	159	113	53
34	81	38	76	88	40	118	106	52	160	92	79
35	106	38	77	114	78	119	93	113	161	110	47
36	94	26	78	96	83	120	99	142	162	116	46
37	57	89	79	107	26	121	94	45	163	111	137
38	67	35	80	101	19	122	82	80	164	111	57
39	93	69	81	90	105	123	130	53	165	70	49
40	89	44	82	110	133	124	76	87	166	94	80
41	80	47	83	65	56	125	99	36	167	106	53
42	112	41	84	95	70	126	81	31	168	102	128

<sup>a</sup>These data were provided by Dr. J. J. Kaneko, Department of Pathology, Microbiology and Immunology, School of Veterinary Medicine, University of California, Davis.

**TABLE 1-2** Percentiles of the Standard Gaussian (z) Distribution<sup>a,b</sup>

$z_{0.50} = 0$	$z_{0.90} = 1.282$	$z_{0.975} = 1.960$
$z_{0.55} = 0.126$	$z_{0.91} = 1.341$	$z_{0.98} = 2.054$
$z_{0.60} = 0.253$	$z_{0.92} = 1.405$	$z_{0.99} = 2.326$
$z_{0.65} = 0.385$	$z_{0.93} = 1.476$	$z_{0.995} = 2.576$
$z_{0.70} = 0.524$	$z_{0.94} = 1.555$	$z_{0.999} = 3.090$
$z_{0.75} = 0.674$	$z_{0.95} = 1.645$	$z_{0.9999} = 3.719$
$z_{0.80} = 0.842$	$z_{0.96} = 1.751$	$z_{0.99999} = 4.265$
$z_{0.85} = 1.036$	$z_{0.97} = 1.881$	

<sup>a</sup>This table was generated with MINITAB Release 14.13 as follows: The indicated cumulative probabilities 0.5 to 0.99999 were placed in a column of a MINITAB worksheet and the following commands given:

**Calc** (from the main menu of MINITAB) → **Probability Distributions** → **Normal Distribution**. Within the **Normal Distribution** dialog box, **Inverse cumulative probability** was selected, **Mean** was set to 0.0, **Standard deviation** was set to 1.0, and the column of the worksheet containing the cumulative probabilities was selected and placed in the **Input column**: followed by hitting **OK**.

<sup>b</sup>Example: The 75th percentile, or the z value below, which is 75% of the Gaussian distribution, equals 0.674,  $z_{0.75} = 0.674$ . Percentiles smaller than the 50th percentile can be found by noting that the Gaussian distribution is symmetric about zero so that, for example,  $z_{0.30} = -0.524$ .

### C. Conventional Method for Determining Reference Intervals

The first step in establishing a normal interval by the conventional method involves determining the mean and standard deviation of the distribution of the analyte. This can be accomplished by taking a representative sample (using a sampling design that has a random component such as simple random sampling) from the population of normal animals and computing the mean and standard deviation of the sample.

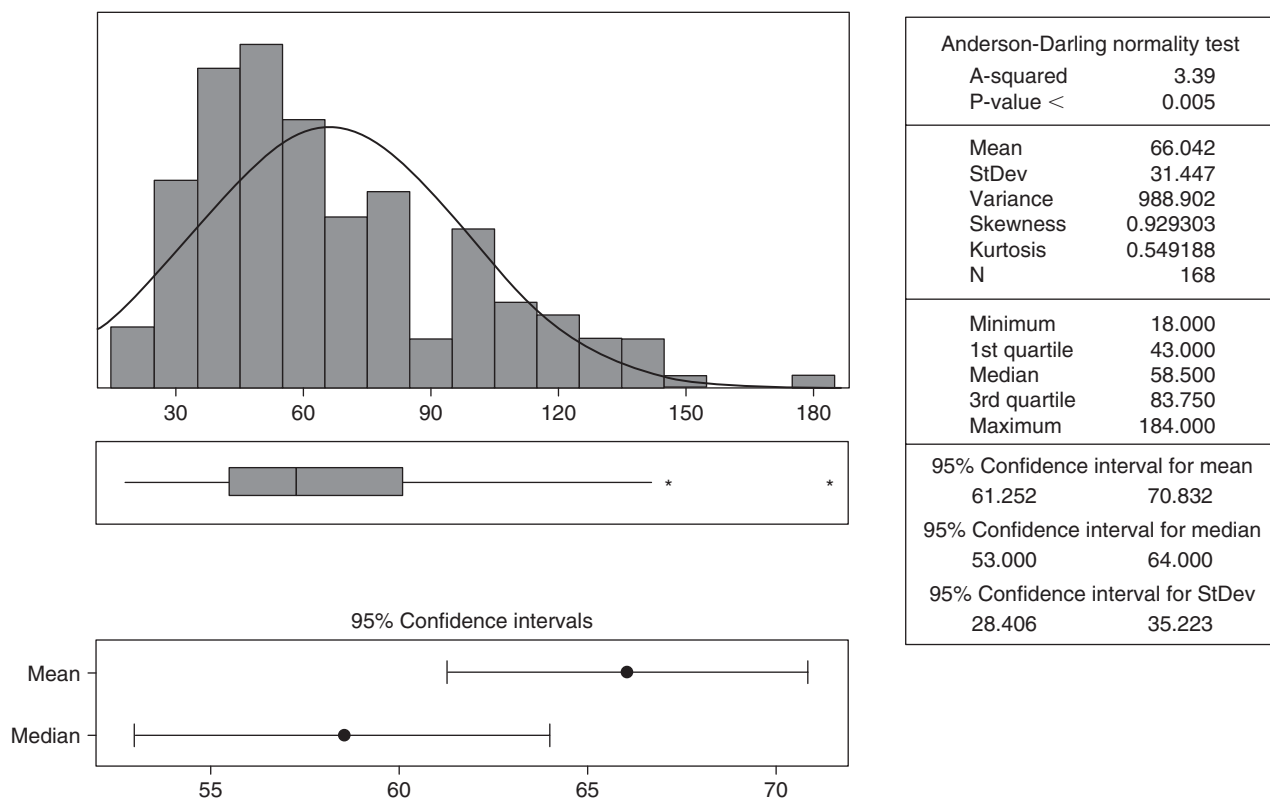
Once these estimates of  $\mu$  and  $\sigma$  are obtained, an animal coming into the clinic in the future is classified as being normal for a particular analyte if its value for the analyte is within the bound of some multiple of the standard deviation below the mean and some multiple of the standard deviation above the mean. The multiple is determined by the degree of certainty that one desires to place on the classification scheme. For example, if the multiple chosen is 2, which is the conventional choice, any animal entering the clinic with an analyte value within 2 standard deviations of the mean would be classified as normal, whereas all animals with a value of the analyte outside this boundary would be classified as abnormal. Because 95% of the Gaussian distribution is located within 1.96 or approximately 2 standard deviations of the mean, with this classification scheme, 2.5% of the normal animals would have a value of the analyte that would be below 2 standard deviations below the mean, and

2.5% of the animals would have an analyte value above 2 standard deviations above the mean. So with this classification scheme, there is a 5% chance that a true normal animal would be classified as being abnormal. Clinicians, by choosing 2 as the multiple, are willing to designate normal animals with extreme values of a particular analyte as being abnormal as the trade-off for not accepting too many abnormal animals as normals. With this methodology, no consideration is given to the distribution of abnormal animals because in fact there would be multiple distributions corresponding to the many types of abnormalities. The assumption is that for those cases where an analyte would be useful in identification of abnormal animals, the value of the analyte would be sufficiently above or below the center of the distribution of the analyte for normal animals. The reference interval for glucose based on the distribution from the sample of 168 normal dogs is  $96.42857\text{mg/dl} \pm (1.96 \times 14.61873\text{mg/dl})$  or  $67.8\text{mg/dl}$  ( $3.76\text{mmol/liter}$ ) to  $125.1\text{mg/dl}$  ( $6.94\text{mmol/liter}$ ).

Solberg (1999) gave  $1/\alpha$  as the theoretical minimum sample size for estimation of the  $100\alpha$  and  $100(1 - \alpha)$  percentiles. Thus, a minimum of 40 animals is required to estimate the 2.5th and 97.5th percentiles but many more than 40 is recommended.

### D. Methods for Determining Reference Intervals for Analytes Not Having the Gaussian Distribution

The conventional procedure for assessing normalcy works quite well provided the distribution of the analyte is approximately Gaussian. Unfortunately, for many analytes a Gaussian distribution is not a good assumption. For example, Figure 1-3 describes the distribution of alanine aminotransferase (ALT) values given in Table 1-1 for the same sample of 168 normal dogs. This distribution is visibly asymmetric. The distribution has a longer tail to the right and is said to be skewed to the right or positively skewed. The skewness value (0.93) exceeds the approximate 99th percentile of the distribution for this coefficient for random samples from a population having a Gaussian distribution. That the distribution is not symmetric and hence not Gaussian is also evidenced by the lack of agreement between the mean and median as shown in Figure 1-3. Application of the conventional procedure for computing reference intervals [ $x \pm (1.96 \times \text{SD})$ ] reveals a reference interval of 4.4 to 127.7U/liter so that all the low values of the distribution fall above the value, which is 2 standard deviations below the mean of the distribution, and more than 2.5% of the high values fall above the value, which is 2 standard deviations above the mean. The following sections give two approaches that can be followed in such a situation to obtain reference intervals.



**FIGURE 1-3** Distribution and summary statistics for the sample of canine alanine aminotransferase values (U/liter) in Table 1-1. Printout of MINITAB, Release 14.13.

### 1. Use of Transformations

Frequently, some transformation (such as the logarithmic or square root transformation) of the analyte values will make the distribution more Gaussian (Kleinbaum *et al.*, 2008; Neter *et al.*, 1996; Zar, 1999). The boundaries for the reference values are two standard deviations above and below the mean for the distribution of the transformed analyte values. These boundaries then can be expressed in terms of the original analyte values by retransformation. Figure 1-4 describes the distribution of the ALT analyte values after transformation with natural logarithms. The reference boundaries in logarithmic units are equal to  $4.08013 \pm (1.96 \times 0.47591)$  or  $(3.14734, 5.01292)$ , which correspond to  $(23.3, 150.3\text{U/liter})$ , in the original units of the analyte.

### 2. Use of Percentiles

The second approach that can be followed in the situation where an assumption of a Gaussian distribution is not tenable is to choose percentiles as boundaries (Feinstein, 1977; Herrera, 1958; Mainland, 1963; Massod, 1977; Reed *et al.*, 1971; Solberg, 1999). For example, if we wanted to misclassify only 5% of normal animals as being abnormal, the 2.5th and 97.5th percentiles could be chosen as the reference boundaries. Thus, animals would be classified as abnormal

when having analyte values either below the value of the analyte below which are 2.5% of all normal analyte values or above the value of the analyte below which are 97.5% of all normal analyte values. This method is attractive because percentiles are reflective of the distribution involved.

The 97.5th percentile is estimated as the value of the analyte corresponding to the  $(n + 1) \times 0.975$ th observation in an ascending array of the analyte values for a sample of  $n$  normal animals (Dunn and Clark, 2001; Ryan *et al.*, 2001; Snedecor and Cochran, 1989). For the ALT values from the sample of  $n = 168$  animals,  $(n + 1) \times 0.975 = 169 \times 0.975 = 164.775$ . Because there is no 164.775th observation, the 97.5th percentile is found by interpolating between the ALT values corresponding to the 164th and 165th observation in the ascending array commonly referred to as the 164th and 165th order statistics (Ryan *et al.*, 2001; Snedecor and Cochran, 1989). The 164th order statistic is 138U/liter and the 165th order statistic is 140U/liter and the interpolation is  $138 + 0.775(140 - 138) = 139.5\text{U/liter}$ . The 2.5th percentile is estimated similarly as the  $(n + 1) \times 0.025$ th order statistic, which is the 4.225th order statistic for the sample of ALT values. In this case, the 4th and 5th order statistics are the same, 24U/liter, which is the estimate of the 2.5th percentile. Note that there is reasonable agreement between this reference interval and

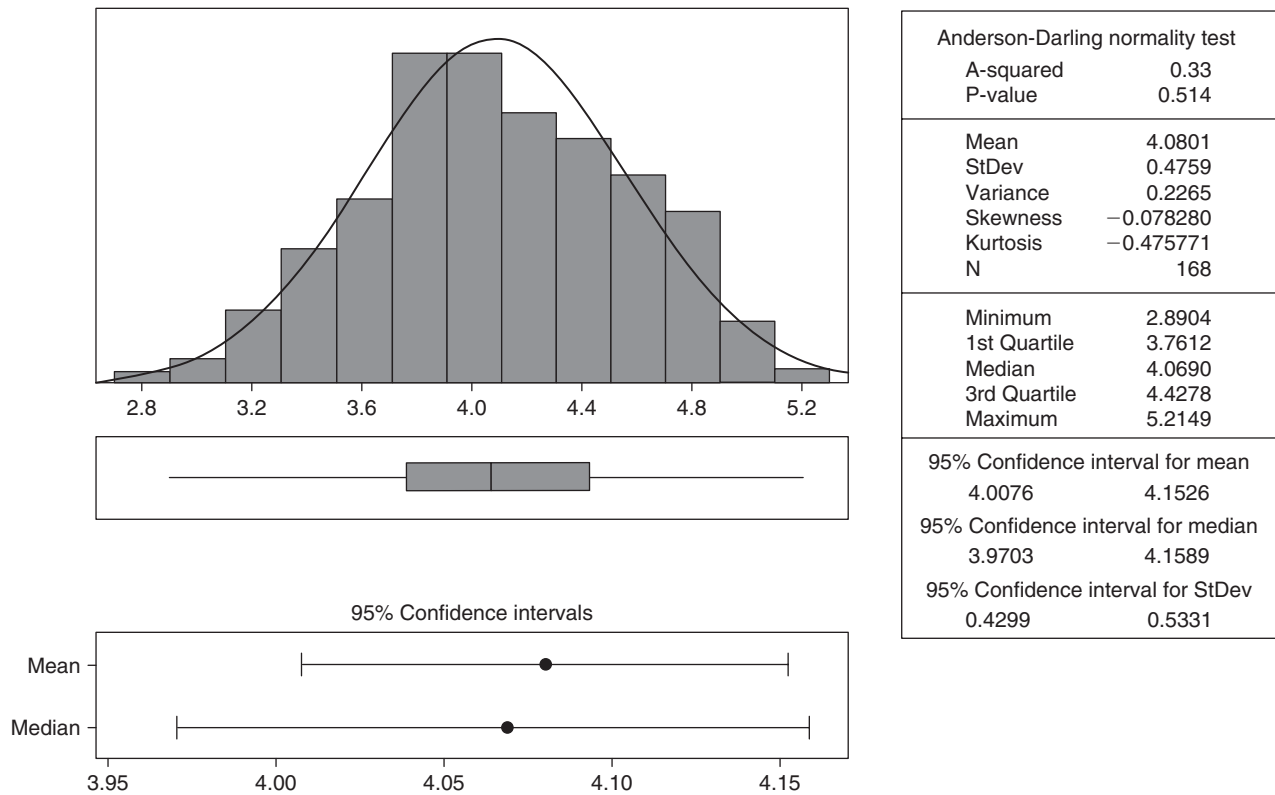


FIGURE 1-4 Distribution and summary statistics for the natural logarithm of the sample of canine alanine aminotransferase values (U/liter) in Table 1-1. Printout of MINITAB, Release 14.13.

that obtained using the logarithmic transformation. This method of using percentiles as reference values can also be used for analytes having a Gaussian distribution. The 2.5th and 97.5th percentiles for the sample of glucose values are 65.4mg/dl (3.63mmol/liter) and 126.3mg/dl (7.01mmol/liter), respectively. This interval agrees very well with that calculated earlier using the conventional method.

### E. Sensitivity and Specificity of a Decision Based on a Reference Interval

As alluded to earlier, in addition to the “normal” or healthy population, several diseased populations may be involved, each with its own distribution. Figure 1-5 depicts the distributions of one analyte for a single diseased population and for a normal healthy, nondiseased population. Note that there will be some overlap of these distributions. Little overlap may occur when the disease has a major impact on the level of the analyte, whereas extensive overlap could occur if the level of the analyte is unchanged by the disease.

Using the upper limit of the reference interval for the normal dogs as the decision (threshold) point could lead to two types of mistakes in diagnosis of patients. First, diseased patients having values within the normal interval

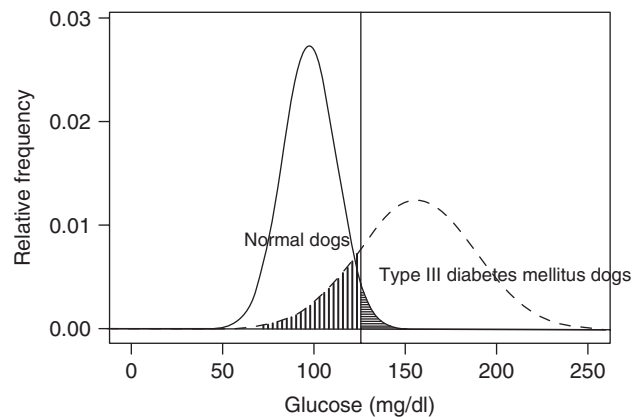


FIGURE 1-5 Overlapping Gaussian distributions of one analyte for a diseased dog population and a healthy, nondiseased dog population. Decision (threshold) point is the upper limit of the reference interval for the normal dogs. The magnitude of the vertically shaded area is the probability of misclassifying a diseased dog as being normal and the magnitude of the horizontally shaded area is the probability of misclassifying a normal dog as being diseased.

would be classified as nondiseased, the false negatives. Second, normal patients with values above the normal interval would be classified incorrectly as diseased and would be the false positives. The probabilities associated with making these two kinds of mistakes in classifying

patients on the basis of analyte values, the error rates, are shown, respectively, as vertically and horizontally shaded areas in Figure 1-5. The *sensitivity* of the diagnostic or decision process using reference values is the probability of deciding that a truly diseased animal is diseased on the basis of the given reference value and is equal to 1 minus the vertically shaded area of Figure 1-5. The *specificity* of the decision process is the probability of deciding that a truly normal animal is normal and is equal to 1 minus the horizontally shaded area of Figure 1-5. It is possible to change the reference values to increase the sensitivity of the test, but such an action will also result in a reduction in the specificity of the test.

### Example 2

Type III diabetic dogs have the chemical form of diabetes mellitus generally regarded as the first level of development of the disease offering the highest likelihood “for successful oral hypoglycemic therapy or dietary therapy” (Kaneko, 1977). Thus, it would be useful to distinguish type III diabetic dogs from normal dogs. Using the sample mean [155.6mg/dl (8.63mmol/liter)] and standard deviation [32.0mg/dl (1.77mmol/liter)] of the plasma glucose values given by Kaneko (1977) for five dogs with type III diabetes mellitus as reasonable estimates of the corresponding parameters for the population of dogs with type III diabetes mellitus, and assuming that this population distribution is approximately Gaussian, a comparison of this distribution of glucose values can be made with that for the population of normal dogs described by the approximately Gaussian distribution with parameter estimates given in Figure 1-2 [ $\mu_x = 96.4\text{mg/dl}$  (5.35mmol/liter) and  $\sigma_x = 14.6\text{mg/dl}$  (0.81mmol/liter)]. These two distributions are those shown in Figure 1-5; they have reasonably good separation with moderate overlap. Based on this information, a diagnostic procedure is proposed whereby a dog entering the clinic with a glucose value above 125.1mg/dl (6.94mmol/liter), the upper limit of the normal reference interval, will be flagged as possibly having type III diabetes mellitus thereby indicating need for more follow-up. (Note: This is an oversimplification of actual practice because a diagnostic decision of this type would be based on additional information, such as the animal’s glucose tolerance and insulin response, making the decision rule and subsequent error calculations more complex.) This is an example of a one-sided diagnostic procedure because a dog with a glucose value below the lower limit of the reference interval would not be considered as having type III diabetes mellitus. If a dog actually having type III diabetes mellitus has a glucose value below the upper limit of the reference interval, the diagnostic procedure will make a mistake in deciding that the dog is normal. The probability of making this mistake is 0.170 or 17.0%, the area to the left of a glucose value of 125.1mg/dl in the distribution of glucose values for dogs having type III diabetes mellitus or the area to the left of the corresponding  $z$ -value,  $z = (125.1 - 155.6)/32.0 \approx 0.953$ , for the standard Gaussian distribution (see Section II.B).

[This probability can be found by interpolating from Table D in Daniel (2005) or from MINITAB Release 14.13 using the reverse of the procedure described above for generating Table 1-2. The  $z$ -value  $-0.953$  is placed in a column of a MINITAB worksheet and the following commands given:

**Calc** (from the main menu of MINITAB) → **Probability Distributions** → **Normal Distribution**. Within the **Normal Distribution** dialog box, **Cumulative probability** is selected, **Mean** is set to 0.0, **Standard deviation** is set to 1.0, and the column of the worksheet containing the  $z$ -value is selected and placed in the **Input column**: Hit **OK**.]

The clinician may be interested in determining the sensitivity and the specificity of the diagnostic procedure. The sensitivity is  $1 - 0.170 = 0.830$  or 83.0%. A dog that actually is normal but has a glucose value greater than 125.1mg/dl would be incorrectly classified by the proposed diagnostic procedure as having type III diabetes mellitus. The probability of making this type of error is 0.025 or 2.5%, which is the area to the right of a glucose value of 125.1mg/dl in the distribution of glucose values for normal dogs or the area to the right of the corresponding  $z$ -value,  $z = (125.1 - 96.4)/14.6 \approx 1.96$ , for the standard Gaussian distribution (from Table 1-2 or using MINITAB as shown earlier). The specificity of the diagnostic procedure is  $1 - 0.025 = 0.975$  or 97.5%.

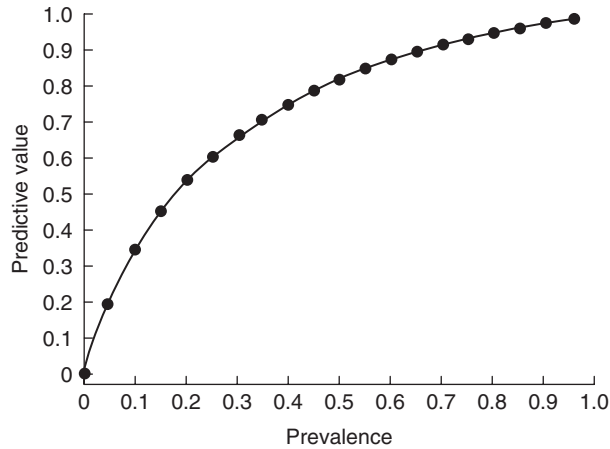
## F. Predictive Value of a Decision Based on a Reference Interval

A useful quantity is the probability that a patient having a reference value outside the normal interval actually has the disease. This is known as the *predictive value of a positive diagnosis*,  $\text{Prob}(D|+)$ . Interest could also be in determining the probability that a patient having a reference value within the normal interval is actually nondiseased or the *predictive value of a negative diagnosis*,  $\text{Prob}(D|-)$ . The predictive value depends on the sensitivity, specificity, and prevalence ( $p$ ) of the disease as is shown in the following equations:

$$\begin{aligned} \text{Prob}(D|+) &= \frac{p \times \text{sensitivity}}{p \times \text{sensitivity} + (1 - p) \times (1 - \text{specificity})} \end{aligned}$$

$$\begin{aligned} \text{Prob}(D|-) &= \frac{(1 - p) \times \text{specificity}}{(1 - p) \times \text{specificity} + p \times (1 - \text{sensitivity})} \end{aligned}$$

Figure 1-6 demonstrates the extent to which the predictive value of a positive diagnosis changes with the prevalence. In general, larger changes are seen in the predictive value of a positive diagnosis for smaller changes in the



**FIGURE 1-6** Impact of disease prevalence on the predictive value of a positive laboratory test having 95% sensitivity and 80% specificity.

prevalence for diseases with low prevalence, and smaller changes are seen in the predictive value for larger changes in the prevalence for diseases with high prevalence.

In the example of the diagnostic procedure given in the previous section, assuming the prevalence of type III diabetes mellitus in the dog population was 2%,

$$\begin{aligned} \text{Prob}(D|+) &= (0.02 \times 0.830) / \\ &\quad [(0.02 \times 0.830) + (0.98 \times 0.025)] \\ &= 0.404 \text{ or } 40.4\%, \text{ and} \end{aligned}$$

$$\begin{aligned} \text{Prob}(D|-) &= (0.98 \times 0.975) / \\ &\quad [(0.98 \times 0.975) + (0.02 \times 0.170)] \\ &= 0.996 \text{ or } 99.6\% \end{aligned}$$

To demonstrate how sensitivity and hence the predictive value of a positive test improves with greater separation of the populations, Kaneko (1977) gave estimates (based on a sample of 11 dogs) of the mean and standard deviation of the plasma glucose values of the population of dogs with type I diabetes mellitus (the juvenile or childhood form) as  $\hat{\mu} = 415.1\text{mg/dl}$  (23.02mmol/liter) and  $\hat{\sigma} = 114.3\text{mg/dl}$  (6.34mmol/liter). If we use these values in the preceding calculations with the diagnostic value remaining at 125.1mg/dl, the sensitivity improves to 99.4% and the predictive value of a positive test increases to 44.8%.

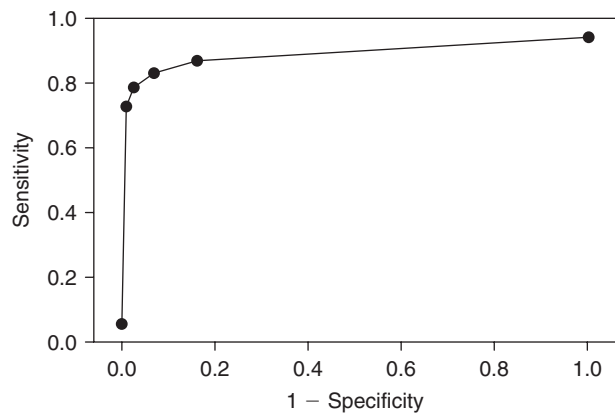
### G. ROC Analysis

The receiver operating characteristic (ROC) curve is a classic graphic for visualizing the quality of diagnostic information (Hanley and McNeil, 1982; Metz, 1978). The conventional ROC curve is the plot of the sensitivity (y-axis) versus (1 - specificity), the false positive fraction (FPF) (x-axis). As alluded to previously, the sensitivity and specificity change with a change in the decision point. Table 1-3 gives the sensitivity, specificity, and FPF

**TABLE 1-3** Sensitivity, Specificity, and False Positive Fraction (FPF)<sup>a</sup> Corresponding to Choices of a Decision (Threshold) Point in the Context of Example 2 and Used to Generate the ROC Curve in Figure 1-7

Decision Point	Sensitivity	Specificity	FPF
283.6	0.0000	1.0000	0.0000
132.9	0.7610	0.9938	0.0062
125.6	0.8257	0.9773	0.0227
118.3	0.8781	0.9332	0.0668
111.0	0.9183	0.8413	0.1587
38.0	0.9999	0.0000	1.0000

<sup>a</sup>FPF = 1 - Specificity.



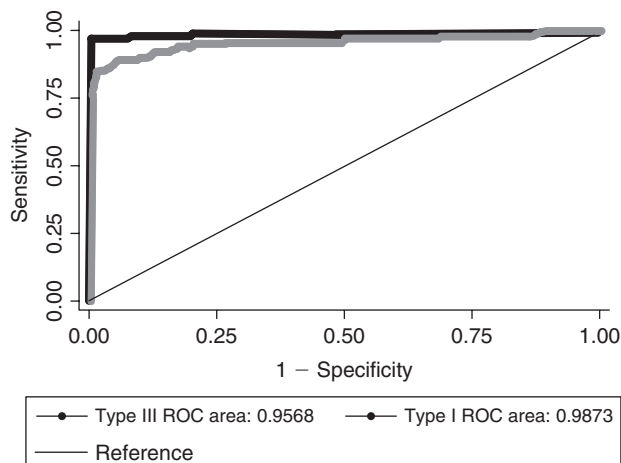
**FIGURE 1-7** The empirical ROC curve for the data in Table 1-3.

corresponding to some choices of a decision (threshold) point in the context of Example 2; Figure 1-7 gives the ROC curve generated by plotting the sensitivity versus the FPF using MINITAB's **Scatterplot** graphical option.

A nontechnical assessment of the usefulness of the diagnostic procedure can be made by comparing its ROC curve to that for the diagnostic procedure, which has no discriminating ability (DeLong *et al.*, 1988). The latter curve is the straight line diagonal extending from the coordinate (0,0) to the coordinate (1,1). The greater the separation of the ROC curve from the diagonal, the more discriminating the diagnostic procedure.

A quantitative assessment of the usefulness of the diagnostic procedure can be made by computing the area under its ROC curve. DeLong *et al.* (1988, page 838) gave the following interpretation of the area under the population ROC curve as "the probability that, when the variable is observed for a randomly selected individual from the abnormal population and a randomly selected individual from the normal population, the resulting values will be in the correct order (e.g., abnormal value higher than the normal value)."





**FIGURE 1-8** ROC curve comparison of the performance of glucose in distinguishing between normal dogs and dogs with type III diabetes mellitus and between normal dogs and dogs with type I diabetes mellitus.

This probability can be obtained as output from statistical software programs that perform ROC analysis such as STATA for Windows Release 9.2.<sup>2</sup>

As an example, we compare the performance of glucose in distinguishing between normal dogs and type III dogs and between normal dogs and type I dogs. A hundred random glucose responses were drawn from each of the type III and type I dog populations, and 1000 random glucose responses were drawn from the normal dog population. A STATA data file was made consisting of three columns. The first column (labeled **type III**) contained the 100 glucose responses from the type III dog population followed by the 1000 normal responses and the second column (labeled **type I**) contained the 100 glucose responses from the type I dog population followed by the 1000 normal responses. The third column (labeled **State**) contained “1” in the first 100 cells and “0” in the remaining 1000 cells indicating the true population membership (abnormal or normal) corresponding to the dogs in each of the first and second columns. The ROC analysis can be obtained using the following commands:

[**Graphics** (from the main menu of STATA) → **Roc analysis** → **Compare ROC curves**. Within the **Rocomp** dialog box, select **State** as the **Reference variable**, **type III** as the **Classification variable** and **type I** as the only **Additional classification variables**. Finally, select **Graph the ROC curves** and **Report the area under the ROC curves**. Hit **OK**.]

Figure 1-8 gives the results of the ROC analysis. It shows that glucose was a slightly better discriminator of type I dogs and normal dogs (the area under the ROC

curve estimated to be 0.9873) than that of type III dogs and normal dogs (the area under the ROC curve estimated to be 0.9568). This difference was marginally statistically significantly ( $p = 0.0345$ ) using a chi-square test (not shown).

### III. ACCURACY IN ANALYTE MEASUREMENTS

Accuracy has to do with the conformity of the actual value being measured to the intended true or target value. An analytical procedure having a high level of accuracy produces measurements that on average are close to the target value. An analytical procedure having a low level of accuracy produces measurements that on average are a distance from the target value. Such a procedure in effect measures something other than is intended and is said to be *biased*. Failure of analytical procedures to produce values that on average conform to the target values is due to unresolved problems, either known or unknown, in the assay.

The degree of accuracy of an analytical procedure has been difficult to quantify because the target value is unknown. It is now possible for laboratories to compare their assay results with definitive results obtained by the use of isotope dilution-mass spectrometry (Shultz, 1994). Shultz (1994) reported the results of two large surveys of laboratories in the United States (Gilbert, 1978) and Sweden (Björkhem *et al.*, 1981) in which samples from large serum pools were analyzed for frequently tested analytes (calcium, chloride, iron, magnesium, potassium, sodium, cholesterol, glucose, urea-nitrogen, urate, and creatinine). The laboratory averages were compared with the target value obtained using definitive methods, and the results of these surveys indicated that, with the exception of creatinine, all averages expressed as a percentage of the target value were within the accuracy goals published by Gilbert (1975). Results from individual laboratories naturally would vary about the average, and many of these laboratories would not have met the accuracy goal.

### IV. PRECISION IN ANALYTE MEASUREMENTS

Precision has to do with how much variability there is about the actual value being measured when the assay is replicated. If in a given laboratory a particular assay is run repeatedly on the same sample and the results obtained have little variability, the assay is said to have high precision. Large variability in the observed results indicates low assay precision. Note that precision is defined in reference to what is actually being measured and not to the target value. Clinical analysts have always had a goal of achieving the highest possible level of precision for a particular

<sup>2</sup>StataCorp, 4905 Lakeway Drive, College Station, TX 77845.

assay within a laboratory. Emphasis is presently placed on meeting an “average laboratory” level of precision (Shultz, 1994).

The level of precision is stated quantitatively in terms of the coefficient of variation ( $cv$ ). The  $cv$  is the ratio of the standard deviation to the average of a series of replicated assays, and its magnitude depends on the concentration of the analyte. Elvitch (1977) and Harris (1988) provided the guidelines on the desired level of precision in terms of the  $cv$ . In the case where the analytical results are intended to assist in the diagnostic process or to assist in monitoring a patient’s response to treatment, the level of laboratory precision of a given analyte in terms of the  $cv(cv_a)$  needs only be a function of the within-day and day-to-day variability or intrasubject variation of healthy subjects. Specifically,

$$cv_a < \frac{1}{2} cv_{\text{intrasubject}}$$

In the case where analytical test results were to be used to screen a population, the laboratory precision goal in terms of the  $cv$  should be a function of the variability in response among healthy subjects or intersubject variation. Specifically,

$$cv_a < \frac{1}{2} cv_{\text{intersubject}}$$

Use of intrasubject variability as a goal for precision has appeal because this source of variability would be considered in decision processes relating to patients. Unfortunately, a given analysis reflects not only this intrasubject variability but also imprecision in the assay. Shultz (1994) summarized the results of a large national survey of laboratory precision. With the exception of high-density lipoprotein and thyroxine ( $T_4$ ), the precision of the assay for the analytes evaluated from the “average” laboratory met or nearly met the precision goals based on the intrasubject variability. This result has to be regarded as encouraging, no doubt reflecting the tremendous emphasis that has been placed on quality control by laboratories as well as the use of automation in analytical work. On the other hand, there were some analytes for which the assay precision for the “average” laboratory was above the precision goal. It also must be remembered that many individual laboratories would not have assay precision profiles as good as the “average” laboratory. Assay precision in excess of the precision goal based on physiological variability makes it nearly impossible to rule out the possibility that very large changes in the level of an analyte reflect assay imprecision.

## V. INFERENCE FROM SAMPLES

The basis for everything that has been discussed to this point is probability and distributional theory. No other theory is relevant unless one is operating at the level where

inference is to be made on the basis of a sample from the underlying population. Most standard statistical theory assumes that the sample was obtained by simple random sampling.

### A. Simple Random Sampling

Simple random sampling (SRS) is a method of sampling whereby, at each step of the sampling process, the elements available for selection have an equally likely chance of being selected. In most applications, it is assumed that the elements are selected without replacement, although the elements could be selected with replacement. If the number of elements to be selected is small relative to the number of elements in the population, then it is unlikely that an element will be selected more than a single time using replacement sampling, so that in such situations sampling replacement produces essentially the same results as sampling without replacement. It is only when a small finite population is being sampled that differences may be noted between the two methods.

Three steps are used to select a sample by SRS without replacement: all elements in the population must first be identified by a unique number from 1 to  $N$ , the population size. Then  $n$  numbers are selected from a table of random numbers or selected by a random number generator, which give the numbers 1 to  $N$  in random order. Numbers appearing more than once are ignored after their first use. Finally, those elements having numbers corresponding to the  $n$  numbers selected constitute the sample. There are other probability-based sampling procedures that should be considered in practice; these methods are found in texts on sampling (Cochran, 1977; Jessen, 1978; Levy and Lemeshow, 1999; Lohr, 1999; Murthy, 1967; Raj, 1968, 1972; Scheaffer *et al.*, 2006).

### B. Descriptive Statistics

Once the data have been collected, so-called descriptive statistics can be computed. As the name suggests, these statistics are useful in describing the underlying populations. For example, because complete information for the entire population is not available, it is not possible to know the population mean,  $\mu = \sum x_i / N$ . (Here  $x_i$  designates the value of the  $i$ th element in the population and  $\sum$  indicates summation. Thus, the population mean  $\mu$  is found by summing the values of all  $N$  elements in the population and then dividing the sum by  $N$ .) However, a sample mean based on the sample can be computed as  $\bar{x} = \sum x_i / n$ , the sum of the values of all  $n$  elements in the sample divided by  $n$ . If the sample has been selected in a manner that results in a small bias,  $\bar{x}$  should be a reasonably good estimate of the population mean,  $\mu$ , and will be a better estimate as the sample size increases. Other estimates of the measures of central

tendency of the population can be obtained from the sample, such as the sample median and the sample mode. Also, sample-based estimates of the measures of dispersion or spread for the population can be obtained. The sample variance is computed as  $s^2 = \Sigma(\bar{x}_i - \bar{x})^2/(n - 1)$ , and the sample standard deviation,  $s$ , is obtained by taking the square root of  $s^2$ . The descriptive statistics are called *point estimates* of the parameters and represent good approximations of the parameters. An alternative to the point estimate is the *interval estimate*, which takes into account the underlying probability distribution of the point estimate called the sampling distribution of the statistic.

### C. Sampling Distributions

In actual practice, only a single sample is taken from a population and, on the basis of this sample, a single point estimate of the unknown population parameter is computed. If time and resources would permit repeated sampling of the population in the same manner—that is, with the same probability-based sampling design—one point estimate would be obtained for each sample obtained. The estimates would not be the same because the sample would contain different elements of the population. As the number of such repeated sampling operations increases, a more detailed description emerges of the distribution of possible point estimates that could be obtained by sampling the population. This is the sampling distribution of the statistic.

Some fundamental facts relating to the sampling distribution of the sample mean follow: (1) The center of the sampling distribution of  $\bar{x}$  is equal to  $\mu$ , the center of the underlying distribution of elements in the population. (2) The spread of the sampling distribution of  $\bar{x}$  is smaller than  $\sigma^2$ , the spread of the underlying distribution of elements in the population. Specifically, the variance of the sampling distribution of  $\bar{x}$  (denoted  $\sigma_{\bar{x}}^2$ ) equals  $\sigma^2/n$ , where  $n$  is the sample size. So increasing the sample size serves to increase the likelihood of obtaining an  $\bar{x}$  close to the center of the distribution because the spread of the sampling distribution is being reduced. (3) The central limit theorem (Daniel, 2005; Schork and Remington, 2000; Zar, 1999) states that regardless of the underlying distribution of the population of elements from which the sample mean is based, if the sample size is reasonably large ( $n \geq 30$ ), the sampling distribution of  $\bar{x}$  is approximated well by the Gaussian distribution. So  $\bar{x}$  drawn from any distribution has a sampling distribution that is approximately  $N(\mu, \sigma^2/n)$  for  $n \geq 30$ . If the distribution of the underlying population of elements is Gaussian or approximated well by a Gaussian distribution, the sampling distribution of  $\bar{x}$  will be approximated well by the Gaussian distribution regardless of the sample size on which  $\bar{x}$  is based.

Probabilities of the sampling distribution of  $\bar{x}$ ,  $N(\mu, \sigma^2/n)$ , can be evaluated using the method described in Section II.B.

#### Example 3

Suppose the underlying population of elements is  $N(4,16)$  and a sample of size  $n = 9$  is drawn from this population using SRS. It is desired to find the probability of observing a *sample mean* less than 3.1 or greater than 6.2. In solving this problem, the relevant sampling distribution is specified:  $\bar{x}$  is  $N(4,16/9)$ . Note that the sampling distribution of  $\bar{x}$  is Gaussian because the problem stated that the underlying population was Gaussian. (Otherwise the stated sample size would have needed to be 30 or larger to invoke the central limit theorem.) The probability of observing  $\bar{x} < 3.1$  in the distribution of  $\bar{x}$  is equivalent to the probability of observing  $z < (3.1 - 4)/(4/3) = -0.675$  in the standard Gaussian distribution. Going to Table 1-2,  $z = 0.675$  is approximately the 75th percentile of the standard Gaussian distribution, and by symmetry  $z = -0.675$  is approximately the 25th percentile. Thus, the probability of observing a  $z$  value less than or equal to  $-0.675$  is approximately 0.25. The probability of observing a sample mean greater than 6.2 is equivalent to the probability of observing  $z > (6.2 - 4)/(4/3) = +1.65$ . Table 1-2 gives the probability of observing a  $z < 1.65$  as approximately 0.95 so the probability of observing a  $z > 1.65$  equals  $1 - 0.95$  or 0.05. The desired probability of observing a sample mean less than 3.1 or greater than 6.2 is the sum of 0.25 and 0.05, which is 0.3 or 3 chances in 10.

### D. Constructing an Interval Estimate of the Population Mean, $\mu$

This brief exposure to sampling distributions and their standardized forms provides the framework for generating an interval estimate for  $\mu$ . Consider the probability statement  $\text{Prob}(-2 < z < +2) = 0.9544$ . Because  $z = (\bar{x} - \mu)/(\sigma/\sqrt{n})$ , this probability statement is equivalent to the statement  $\text{Prob}(-2 < (\bar{x} - \mu)/(\sigma/\sqrt{n}) < +2) = 0.9544$ . Some standard algebraic manipulation of the inequality within the parentheses gives  $\text{Prob}(\bar{x} + (-2\sigma/\sqrt{n}) < \mu < \bar{x} + (2\sigma/\sqrt{n})) = 0.9544$ . This is the form of the confidence statement about the unknown parameter  $\mu$ . With repeated sampling of the underlying population, 95.44% of the intervals constructed by adding and subtracting  $2\sigma/\sqrt{n}$  to and from the sample mean would be expected to cover the true unknown value of  $\mu$ . The quantities of  $\bar{x} - 2\sigma/\sqrt{n}$  and  $\bar{x} + 2\sigma/\sqrt{n}$  are called the *lower* and *upper confidence limits*, respectively, and the interval bounded below by  $\bar{x} - 2\sigma/\sqrt{n}$  and above by  $\bar{x} + 2\sigma/\sqrt{n}$ —that is,  $(\bar{x} - 2\sigma/\sqrt{n}, \bar{x} + 2\sigma/\sqrt{n})$  is the 95.44% confidence interval for  $\mu$ . In practice, only one sample is taken from the population, and thus there is a 95.44% chance that the one interval estimate obtained will cover the true value of  $\mu$ . Note that 95.44% or 0.9544 is called the *confidence level*.

The degree of confidence that is to be had is determined by the amount of error that is to be tolerated in the estimation procedure. For a 0.9544 level of confidence, the error rate is  $1 - 0.9544 = 0.0456$ . The error rate is designated by alpha,  $\alpha$ .

The size of  $\alpha$  determines the magnitude of the value of  $z$  that is multiplied by  $\sigma/\sqrt{n}$ . The convention is to apportion half of  $\alpha$  to the lower end and half of  $\alpha$  to the upper end of the sampling distribution of  $\bar{x}$  so that the relevant values of  $z$  are (1) the  $z$ -value, which has  $\alpha/2$  area to its left,  $z_{\alpha/2}$ , and (2) the  $z$ -value, which has  $\alpha/2$  to its right or equivalently (to conform to Table 1-2) the  $z$ -value, which has  $1 - (\alpha/2)$  area to its left,  $z_{1-(\alpha/2)}$ . Therefore, the most general form of the interval estimate statement is  $(\bar{x} - (z_{\alpha/2}\sigma)/\sqrt{n}, \bar{x} + (z_{1-(\alpha/2)}\sigma)/\sqrt{n})$  or  $\bar{x} \pm (z_{1-(\alpha/2)}\sigma)/\sqrt{n}$  because of the symmetry of the Gaussian distribution.

**Example 4**

Assuming the distribution in Example 3, construct a 90% confidence intervals for  $\mu$ . A 90% level of confidence implies a tolerated error rate of 10% and the relevant  $z$ -values are (1) that which has 5% of the distribution of  $z$  to its left or  $z_{0.05} = -1.645$  and (2) that which has 95% of the distribution to its left or  $z_{0.95} = 1.645$ . The 90% confidence interval for  $\mu$  is therefore  $(\bar{x} \pm (1.645 \times 4)/3)$  or  $(\bar{x} \pm 2.1933)$ , where  $\bar{x}$  is the sample mean obtained by taking a sample of size 9 from the population.

The form of the interval estimate given earlier assumes that  $\sigma$ , the standard deviation of the underlying population, is also known. Frequently this parameter, like  $\mu$ , is unknown and must be estimated from the sample drawn from the population using the estimator  $s^2 = \Sigma(\bar{x}_i - \bar{x})^2/(n - 1)$ , the sample variance. The square root of  $s^2$  is  $s$ , the sample standard deviation. For small samples ( $n < 30$ ), the standardized form of  $\bar{x}$ ,  $(\bar{x} - \mu)/(s/\sqrt{n})$ , does not have a standardized Gaussian distribution,  $N(0,1)$ , but rather has the  $t$ -distribution corresponding to the effective sample size,  $n - 1$ , the degrees of freedom. Table 1-4 gives the percentiles of several  $t$ -distributions. A given row of Table 1-4 pertains to the  $t$ -distribution with the indicated effective sample size or degrees of freedom. The entries in the row are percentiles or those points of the given  $t$ -distribution that have the indicated area to the left. For example,  $t_{0.95,10}$  is 1.8125 meaning that the 95th percentile of the  $t$ -distribution with 10 degrees of freedom is 1.8125, which is equivalent to saying that 95% of the  $t$ -distribution with 10 degrees of freedom lies to the left of the  $t$ -value 1.8125. Note that the 5th percentile of the  $t$ -distribution with 10 degrees of freedom is  $-1.8125$  because the  $t$ -distributions, like the standard Gaussian distribution, are symmetric about zero. Thus, for smaller sample sizes when the value of  $\sigma$  is unknown, the form of a confidence interval for  $\mu$  is  $\bar{x} \pm [(t_{1-\alpha/2;n-1}s)/\sqrt{n}]$ .

As with the mean, interest also centers around estimating the variance,  $\sigma^2$ , and standard deviation,  $\sigma$ , of the population. The estimates for these parameters are  $s^2$  and  $s$ , respectively. One might also be interested in constructing confidence intervals for these parameters. Because space does not permit further elaboration, the interested reader is

**TABLE 1-4** Percentiles of the Student's  $t$ -distribution with 10 Degrees of Freedom<sup>a,b</sup>

$t_{0.50,10} = 0$	$t_{0.85,10} = 1.093$
$t_{0.55,10} = 0.129$	$t_{0.90,10} = 1.372$
$t_{0.60,10} = 0.260$	$t_{0.95,10} = 1.812$
$t_{0.65,10} = 0.397$	$t_{0.975,10} = 2.228$
$t_{0.70,10} = 0.542$	$t_{0.99,10} = 2.764$
$t_{0.75,10} = 0.700$	$t_{0.995,10} = 3.169$
$t_{0.80,10} = 0.879$	$t_{0.9995,10} = 4.587$

<sup>a</sup>This table was generated with MINITAB Release 14.13. The indicated cumulative probabilities 0.5 to 0.9995 were placed in a column of a MINITAB worksheet and the following commands given: **Calc** (from the main menu of MINITAB)  $\rightarrow$  **Probability Distributions**  $\rightarrow$  **t-Distribution**. Within the **t-distribution** dialog box, **Inverse cumulative probability** was selected with **noncentrality parameter** set to 0.0, **degrees of freedom** was set at 10 and the column of the worksheet containing the cumulative probabilities was selected and placed in the **Insert column:** followed by hitting **OK**. The same procedure is followed to obtain percentiles from  $t$ -distributions with other degrees of freedom.

<sup>b</sup>Example: The 80th percentile of a  $t$ -distribution with 10 degrees of freedom or the  $t$ -value below, which is 80% of the  $t$ -distribution with 10 degrees of freedom, equals 0.879.

referred to the several introductory statistics books for the relevant formulae and their derivation (Daniel, 2005; Dunn and Clark, 2001; Schork and Remington, 2000).

**E. Comparing the Mean Response of Two Populations**

**1. Independent Samples**

The presentation thus far has focused on estimation of parameters from a single population. Frequently, interest lies in two populations. For example, in a clinical trial, one group of animals might receive some treatment ( $t$ ), whereas a second group of animals serves as a control receiving no treatment ( $c$ ). Among the several points of interest could be that of estimating the difference in central response for the two populations—that is,  $\mu_t - \mu_c$ —where the subscripts designate the groups. The point estimate of  $\mu_t - \mu_c$  is  $\bar{x}_t - \bar{x}_c$ . If we assume that the variances of the two populations,  $\sigma_t^2$  and  $\sigma_c^2$ , are unknown but equal and the common variance designated as  $\sigma^2$ , then the estimate of  $\sigma^2$  is  $s_p^2 = [(n_t - 1)s_t^2 + (n_c - 1)s_c^2]/(n_t + n_c - 2)$  (called the *pooled variance*) and  $[(\bar{x}_t - \bar{x}_c) - (\mu_t - \mu_c)]/s_p(1/n_t + 1/n_c)^{1/2}$  has a  $t$ -distribution with  $n_t + n_c - 2$  degrees of freedom. A  $100(1-\alpha)\%$  confidence interval for  $\mu_t - \mu_c$  is  $(\bar{x}_t - \bar{x}_c) \pm t_{1-\alpha/2;n_t+n_c-2} s_p (1/n_t + 1/n_c)^{1/2}$ . If the interval so constructed covers zero, it may be that there is no difference between the central responses for the two distributions; otherwise, it could be concluded that the central responses differ significantly.

**2. Nonindependent Samples**

The procedure just discussed, in addition to assuming that the variances are homogeneous, also assumes that the two samples are drawn independently. An alternative design

for comparing two responses involves using each subject as its own control. For example, a pretreatment response in an individual might be compared with a posttreatment response. Clearly in this design, the pre- and posttreatment responses may not be and most likely are not independent so the procedure given earlier for comparing two groups would not be appropriate. Rather, the differences in response (pretreatment minus posttreatment response) are formed and the population of interest is the single population of differences having as one of its parameters the mean difference,  $\mu_d$ . The quantity  $\mu_d$  is estimated by the mean difference for the sample of  $n$  differences,  $\bar{d} = \Sigma d_i/n$ , and an interval estimate is formed by  $\bar{d} \pm (t_{1-\alpha/2;n-1}s_d)/\sqrt{n}$  where  $s_d$  is an estimate of  $\sigma_d$ . If the interval so constructed covers zero, then it may be that there is no difference between the mean pre- and posttreatment values.

### F. Comparing the Mean Response of Three or More Populations Using Independent Samples

#### 1. By Extension of the 2-Sample t-Test

Comparison of more than two groups is the natural progression from the methodology discussed to this point. Consider the comparison of three independent groups. The approach that immediately comes to mind is that of estimating the three groups' means and standard deviations and then constructing three sets of confidence intervals (the first group versus the second group, the first group versus the third group, and the second group versus the third group) using the approach described earlier for two independent groups. However, some modifications need to be made. First, because we are assuming that all three groups have equal variances, pooling of the variances for the three groups provides a better estimate of the common variance than does pooling of just the variances for the two groups being compared. The form of the pooled variance is the natural extension of that for two groups, namely  $s_p^2 = [(n_1 - 1)s_1^2 + (n_2 - 1)s_2^2 + (n_3 - 1)s_3^2]/(n_1 + n_2 + n_3 - 3)$ . When the group sample

sizes are equal—that is,  $n_1 = n_2 = n_3 = s_p^2 = \Sigma s_i^2/3$ . The quantity  $s_p^2$  is used for all three interval estimates.

Second, the error rate of each comparison has to be adjusted so that the error rate over all three comparisons will be  $\alpha$ . This is required because theoretically it turns out that the error rate over all three comparisons is larger than that for a single comparison. Several approaches are suggested in the literature for circumventing this problem. One such approach, based on the Bonferroni inequality (Neter *et al.*, 1996, Stevens, 2002), is called the Bonferroni/Dunn procedure (Zar, 1999). The Bonferroni/Dunn procedure involves making each single comparison in a “family” of comparisons with an error rate of  $\alpha/m$ , where  $m$  is the total number of comparisons to be made. This approach gives an error rate of  $\alpha$  over all comparisons—that is, over all members of the family of comparisons. In the context of comparing  $k$  groups in a pairwise manner, the form of the interval estimate is  $(\bar{x}_i - \bar{x}_j) \pm [(t_{1-\alpha/2m;n_1+n_2+\dots+n_k-k})(s_p)(1/n_i + 1/n_j)^{1/2}]$ , where  $m$  is the total number of comparisons to be made and  $k$  is the total number of groups, which in the present example is three. Intervals covering zero would indicate no difference in the central value of the groups being compared.

#### 2. By One-Way Analysis of Variance

The process of deciding whether or not there are differences between groups in the central value of the response being evaluated can also be approached using the method of analysis of variance (ANOVA). ANOVA involves decomposing the total variability in a given set of data into parts reflective of the amount of variability attributable to various sources. One source of variability is that within the group. Because the groups are assumed to have the same spread, this source of variability is estimated as the pooling of the estimated variances for the  $k$  groups considered and is equal to  $s_p^2$  defined earlier. The second source of variability results from the variability among groups means. If there is no difference in the groups' means, then the  $k$  samples can be thought of as being  $k$  independent samples from a common population and the  $k$  means, therefore, represent a sample of size  $k$  from the sampling distribution of  $\bar{x}$ . Their variance represents

**TABLE 1-5** Analysis of Variance Table for Classification of Responses on Basis of One Factor, Equal Responses for Each Class<sup>a</sup>

Source of variation	Degrees of freedom	Sum of squares	Mean square	F value
Among group means	$k - 1$	$SS_A = (k - 1)MS_A$	$MS_A = \frac{n \sum_{i=1}^k [x_i - \sum_{i=1}^k (x_i/k)]^2}{k - 1}$	$MS_A/MS_W$
Within group	$k(n - 1)$	$SS_W = k(n - 1)MS_W$	$MS_W = \frac{\sum_{i=1}^k s_i^2}{k}$	
Total	$kn - 1$	$SS_T = SS_A + SS_W$		

<sup>a</sup> $k$  is the number of classes of groups,  $n$  is the number of responses per group, constant over all groups,  $s_i^2$  is the variability of the responses within the  $i$ th group.

an estimate of the variance of the sampling distribution of  $\bar{x}$ —that is,  $\hat{\sigma}^2 = \frac{\sum[x_i - \sum(x_i/k)]^2}{(k - 1)}$ , where  $\hat{\sigma}$  denotes estimate. Because  $\hat{\sigma}^2 = \hat{\sigma}^2/n$ , where  $n$  is the common sample size, inflation of  $\hat{\sigma}^2$  by  $n$  will produce a second estimate of the variance of the underlying population assuming no differences among the group means. These two estimates of  $\sigma^2$  should be about equal and their ratio close to 1.

If there is significant separation among some or all of the group means, the second variance estimate, when computed as described, will be larger than the first estimate, indicating that a component of variance is being estimated beyond that embodied only in an estimate of the within-group variability. This additional variance component being estimated is the variance among group means. ANOVA in this example involves generating the two estimates of  $\sigma^2$  (called *mean squares*) under the hypothesis that all of the group means are equal. The hypothesis is then tested by forming the ratio of the two mean squares (the second mean square divided by the first mean square) called the *F-statistic*. The *F*-statistic has a probability distribution called the *F*-distribution. If the computed *F*-value is greater than the tabled distributional value, then the hypothesis is rejected and subsequently confidence intervals are constructed as described earlier to determine which group means are different. If the hypothesis cannot be rejected, the process stops or perhaps, at most, the data from all the groups might be pooled together and the parameters of this single population estimated. Tables of the percentiles of the *F*-distributions can be found in all introductory texts on statistics (Daniel, 2005; Dunn and Clark, 2001; Schork and Remington, 2000), which also provide instruction on how to read the tables. Also, these texts give the generalization of the among group mean square when the sample size is not constant for all groups.

The results of an ANOVA are traditionally summarized in a table called the ANOVA table, and Table 1-5 is such an example. The first column of Table 1-5 shows the sources of variability into which the total variability is decomposed. In the present example, these sources are due to the variability within groups and that which is reflective of variability among group means. Column 4 gives the two independent (under a hypothesis of no difference in response among groups) estimates of  $\sigma^2$  or mean squares, mean square among group means ( $MS_A$ ), and mean square within groups ( $MS_W$ ). Columns 3 and 2 give, respectively, the numerator (called the sum of squares) and the denominator (the effective sample size or degrees of freedom) of the corresponding mean square. The sums of squares provide a check on calculations when generating an ANOVA table because the total of the sum of squares attributable to the various sources of variability is equal to the sum of squared deviations of each observation across the  $k$  samples from the grand mean of all the observations in the  $k$  samples, called the *total sum of squares*. In other words, the total sum of squares is the numerator for estimating the total variability in the data ignoring group membership. Similarly, the degrees of freedom for the sources of variability

sum to the effective sample size for estimating the total variability in the data ignoring group membership of the observations [here  $kn - 1 = (k - 1) + k(n - 1)$ ].

**Example 5**

Suppose a study is designed to determine *in vivo* effects of cytokines on *in vitro* clonogenicity assays (expansion of CD34+ progenitor cells). To this end, a total of 30 monkeys (rhesus macaque) of the same age and gender were obtained and assigned randomly as follows: 10 monkeys were administered the traditional cytokine cocktail (TCC), 10 monkeys were administered a conditioned media with anti-CD3 (ACD3S), and 10 monkeys served as controls and were administered a placebo. Both cocktails were administered to induce production of progenitor cells expressing antigen CD34. Bone marrow samples were taken from the monkeys 10 days after administration, cultured for 14 days after which the number of colonies was determined. (Expression of CD34+ cells was monitored by flow cytometry and the response is the number of colonies detected *in vitro*.) Figure 1-9 gives the counts obtained for the three groups that were compared using ANOVA for the completely randomized design. The statistical software used was SPSS for Windows Release 11.<sup>3</sup>

	cocktail	count
1	control	45.00
2	control	47.00
3	control	39.00
4	control	47.00
5	control	51.00
6	control	39.00
7	control	40.00
8	control	42.00
9	control	35.00
10	control	38.00
11	tcc	52.00
12	tcc	52.00
13	tcc	53.00
14	tcc	54.00
15	tcc	49.00
16	tcc	49.00
17	tcc	48.00
18	tcc	51.00
19	tcc	52.00
20	tcc	51.00
21	acd3s	66.00
22	acd3s	64.00
23	acd3s	62.00
24	acd3s	61.00
25	acd3s	58.00
26	acd3s	57.00
27	acd3s	56.00
28	acd3s	59.00
29	acd3s	59.00
30	acd3s	60.00

**FIGURE 1-9** SPSS worksheet for comparing the responses of the three groups of Example 6 using analysis of variance assuming a completely randomized design. Source of data: Mr. Nestor Montiel, California, National Primate Research Center, University of California, Davis.

<sup>3</sup> 3SPSS, Inc., 233 South Wacker Drive, Chicago, IL 16801-3008.

**Univariate Analysis of Variance****Descriptive Statistics**

Dependent Variable: COUNT

COCKTAIL	Mean	Std. Deviation	N
control	42.3000	5.01221	10
tcc	51.1000	1.91195	10
acd3s	60.2000	3.11983	10
Total	51.2000	8.19756	30

**Tests of Between-Subjects Effects**

Dependent Variable: COUNT

Source	Type III Sum of squares	df	Mean Square	F	Sig.
Corrected Model	1602.200 <sup>a</sup>	2	801.100	62.405	.000
Intercept	78643.200	1	78643.200	6126.274	.000
COCKTAIL	1602.200	2	801.100	62.405	.000
Error	346.600	27	12.837		
Total	80592.000	30			
Corrected Total	1948.800	29			

<sup>a</sup>R Squared = .822 (Adjusted R Squared = .809)**Multiple Comparisons**

Dependent Variable: COUNT

Bonferroni

(I) COCKTAIL	(J) COCKTAIL	Mean Difference (I-J)	Std. Error	Sig.	95% Confidence Interval	
					Lower Bound	Upper Bound
control	tcc	-8.8000*	1.60231	.000	-12.8898	-4.7102
	acd3s	-17.9000*	1.60231	.000	-21.9898	-13.8102
tcc	control	8.8000*	1.60231	.000	4.7102	12.8898
	acd3s	-9.1000*	1.60231	.000	-13.1898	-5.0102
acd3s	control	17.9000*	1.60231	.000	13.8102	21.9898
	tcc	9.1000*	1.60231	.000	5.0102	13.1898

Based on observed means.

\* The mean difference is significant at the .05 level.

**FIGURE 1-10** Partial SPSS printout of the analysis of variance for comparing the three groups of Example 5 assuming a completely randomized design.

[Instructions for the SPSS data processing: The counts are placed in one column of an SPSS worksheet (labeled here as **count**) with the corresponding cocktail administered indicated in a second column (labeled here as **cocktail**). Figure 1-9 is the SPSS worksheet that was used for this example. The SPSS commands to obtain the ANOVA are: **Analyze** (from the main menu) ⇒ **General Linear Model** ⇒ **Univariate**. This opens the **Univariate** dialog box. The column containing the counts is placed in the **Dependent Variable:** box and the column containing the cocktail administered is placed in the **Fixed Factor(s):** box within the **Univariate** dialog box. Then the **Post Hoc...** tab is pressed, which opens the **Univariate Post Hoc Multiple**

**Comparisons for Observed Means** dialog box. In this box the desired factor (here **exposure**) is moved from the **Factor(s):** box to the **Post Hoc Tests for:** box and the desired post hoc test(s) (here **Bonferroni**) selected. The **Continue** tab is hit to return to the **Univariate** dialog box. Finally, the **Options** tab is pressed to open the **Univariate: Options** box where the column containing the exposure is placed in the **Display Means for:** box and the **Display of Descriptive statistics** is selected. The **Continue** tab is hit to return to the **Univariate** dialog box and the **OK** tab is hit to get the output.]

Figure 1-10 gives a partial printout of the output. The ANOVA table shows that the total (**Corrected Total**) sum



of squares for the counts is 1948.8 with 29 degrees of freedom. This total has been decomposed into 1602.2 because of the **COCKTAIL** (reflective of the variability among exposure group means) with 2 degrees of freedom and 346.6 because of **Error** (reflective of the variability within exposure groups) with 27 degrees of freedom. The  $F$ -statistic is 62.405, considerably higher than 1, indicating highly significant separation among some or all of the group means. The column in the printout headed by *Sig.* gives the probability of observing such a large  $F$ -statistic under the hypothesis that the mean count for the three exposure groups is equal. This probability, commonly referred to as the  $p$ -value, is less than 0.0005 indicating that observing such a result is highly unlikely if the hypothesis is true.

Figure 1-10 also summarizes the multiple comparisons of the mean count for the three exposure groups. The mean count for monkeys exposed to ACD3S was significantly higher than that for monkeys exposed to TCC, which in turn was significantly higher than that for monkeys that received the placebo.

Note: The mean responses of two independent samples can be compared by using statistical software appropriate for performing a one-way analysis of variance as demonstrated earlier or by using the two-sample (independent-sample)  $t$ -test procedure available with most statistical software.

## G. Efficiency in Experimental Designs

The One-way ANOVA does not represent a superior method to that of the Bonferroni/Dunn procedure in the context in which it was presented. In fact, if a significant group effect was noted by the ANOVA, the Bonferroni/Dunn procedure or any other appropriate multiple comparison procedure would be used to identify which group differences were contributing to the overall group effect. The reason analysis of variance has been introduced is that it is a convenient method for assessing the importance of various sources of variability encountered in the complex designs of clinical laboratories.

### 1. Factorial Designs

Suppose in the context of the previous example there was interest not only in evaluating cocktail effects but also age effects. The researchers would obtain 15 infant and 15 adult monkeys (rhesus macaque) and randomly assign 5 monkeys of each age to receive TCC, 5 monkeys of each age to receive ACD3S, and 5 monkeys of each age to receive the placebo. Otherwise the experimental design is exactly like that described in Example 5. The number of colonies of CD34+ progenitor cells counted per plate for the six combinations of cocktail and age are those given in Figure 1-11.

	cocktail	age	count
1	control	infant	45.00
2	control	infant	47.00
3	control	infant	39.00
4	control	infant	47.00
5	control	infant	51.00
6	control	adult	39.00
7	control	adult	40.00
8	control	adult	42.00
9	control	adult	35.00
10	control	adult	38.00
11	tcc	infant	52.00
12	tcc	infant	52.00
13	tcc	infant	53.00
14	tcc	infant	54.00
15	tcc	infant	49.00
16	tcc	adult	49.00
17	tcc	adult	48.00
18	tcc	adult	51.00
19	tcc	adult	52.00
20	tcc	adult	51.00
21	acd3s	infant	66.00
22	acd3s	infant	64.00
23	acd3s	infant	62.00
24	acd3s	infant	61.00
25	acd3s	infant	58.00
26	acd3s	adult	57.00
27	acd3s	adult	56.00
28	acd3s	adult	59.00
29	acd3s	adult	59.00
30	acd3s	adult	60.00

FIGURE 1-11 SPSS worksheet for comparing the responses of the three groups of Example 5 using analysis of variance assuming a factorial design.

[Partial instructions for SPSS data processing: the SPSS worksheet is Figure 1-11, which includes one column providing the response (number of colonies of CD34+ progenitor cells counted per plate, **count**) information, one column providing the cocktail exposure information for each monkey (as done in Example 5), and one column providing the age of each monkey (labeled here as **age**). To get the SPSS analysis, the instructions are exactly those given in Example 5 for the One-way ANOVA with the exceptions that **age** in addition to **cocktail** is placed in the **Fixed Factor(s)** box within the **Univariate** dialog box and descriptive statistics are requested for **age** as well as for **cocktail** within the **Univariate: Options** dialog box. Note that in this particular case a post hoc multiple comparison for “age” is not requested as “age” has only two categories and thus a significant “age” effect would imply that infant and adult means are different.]

Figure 1-12 provides the ANOVA table resulting from a re-analysis of the count data for the 30 monkeys in Example 5 with their age taken into account. Note that the total (**Corrected Total**) sum of squares for the counts and



## Univariate Analysis of Variance

## Descriptive Statistics

Dependent Variable: COUNT

COCKTAIL	AGE	Mean	Std. Deviation	N
control	infant	45.8000	4.38178	5
	adult	38.8000	2.58844	5
	Total	42.3000	5.01221	10
tcc	infant	52.0000	1.87083	5
	adult	50.2000	1.64317	5
	Total	51.1000	1.91195	10
acd3s	infant	62.2000	3.03315	5
	adult	58.2000	1.64317	5
	Total	60.2000	3.11983	10
Total	infant	53.3333	7.62202	15
	adult	49.0667	8.44703	15
	Total	51.2000	8.19756	30

## Tests of Between-Subjects Effects

Dependent Variable: COUNT

Source	Type III Sum of squares	df	Mean Square	F	Sig.
Corrected Model	1772.800 <sup>a</sup>	5	354.560	48.349	.000
Intercept	78643.200	1	78643.200	10724.073	.000
COCKTAIL	1602.200	2	801.100	109.241	.000
AGE	136.533	1	136.533	18.618	.000
COCKTAIL * AGE	34.067	2	17.033	2.323	.120
Error	176.000	24	7.333		
Total	80592.000	30			
Corrected Total	1948.800	29			

<sup>a</sup>R Squared = .910 (Adjusted R Squared = .891)

## Multiple Comparisons

Dependent Variable: COUNT

Bonferroni

(I) COCKTAIL	(J) COCKTAIL	Mean Difference (I - J)	Std. Error	Sig.	95% Confidence Interval	
					Lower Bound	Upper Bound
control	tcc	-8.8000*	1.21106	.000	-11.9168	-5.6832
	acd3s	-17.9000*	1.21106	.000	-21.0168	-14.7832
tcc	control	8.8000*	1.21106	.000	5.6832	11.9168
	acd3s	-9.1000*	1.21106	.000	-12.2168	-5.9832
acd3s	control	17.9000*	1.21106	.000	14.7832	21.0168
	tcc	9.1000*	1.21106	.000	5.9832	12.2168

Based on observed means.

\* The mean difference is significant at the .05 level.

**FIGURE 1-12** Partial SPSS printout of the analysis of variance for assessing both cocktail exposure and age effects assuming a factorial design.

the Sum of Squares and Mean Square for **COCKTAIL** are the same as those obtained with the One-way ANOVA. What has changed is that the Sum of Squares for **Error** from the One-way ANOVA (346.6) has been decomposed

into the Sum of Squares for **AGE** (136.533), for the interaction between **COCKTAIL** and **AGE** (designated in the ANOVA table as **COCKTAIL \* AGE**) (34.067), and for the new refined **Error** (176.0). Figure 1-12 also shows

that the 27 degrees of freedom for **Error** in the One-way ANOVA has been decomposed into 1 degree of freedom for **AGE**, 2 degrees of freedom for **COCKTAIL \* AGE**, and 25 degrees of freedom for the new refined **Error**.

Two advantages of this factorial design are apparent from Figure 1-12. In addition to testing for the **COCKTAIL** main effect, it has become possible to test for the **AGE** main effect (statistically significant,  $p < 0.0005$ , with the infant monkeys having the higher count) and for the interaction between **COCKTAIL** and **AGE** main effects (not statistically significant,  $p = 0.12$ ). Also, the refined error term should be more reflective of the unknown error term because the effects of **AGE** and the interaction between **COCKTAIL** and **AGE** in addition to the effect of **COCKTAIL** have been removed from the error. In this particular example, adjusting the effects of **COCKTAIL** for sources of variability because of **AGE** (the **AGE** main effect and the interaction between **COCKTAIL** and **AGE**) has resulted in a substantial reduction in the error (from 12.837 to 7.333) because of the highly significant age main effect. The smaller refined **Error**, as the denominator of the variance ratio for testing the significance of the main factor of interest, here cocktail, leads to a larger variance ratio. Thus, the chance of rejecting the hypothesis of equality of means for the main factor of interest is enhanced—that is, the *power of the test* for the main factor of interest is increased.

## 2. Blocking Designs

### a. Basic Randomized Block Design

Assume that it is desired to evaluate **k** exposures in a study. Before assigning the exposure to each of the total of **n** animals available, the **n** animals are divided into **b** blocks of **k** animals each where the animals in each block are homogeneous with respect to the blocking factor. In the context of Example 5, suppose the researcher was interested in evaluating the impact of the cocktail effect only in infant monkeys but still wanted to adjust for any age effect. Here the blocking factor would be age. Thus, the 30 infant monkeys (rhesus macaque) would be placed in an array based on their birth date. Then the 3 youngest animals would form the first block, the 3 next youngest animals would constitute the second block, and so forth. Once the animals have been placed in blocks, each of the 3 exposures (TCC, ACD3S, and placebo) is assigned in a random manner to one animal within each block with each animal in a block receiving one assigned exposure. Here **k** equals 3 and **b** equals 10.

Examples of other blocking factors are breed, litter, and body weight. In the case of breed (or litter), each block consists of **k** animals of the same breed (or litter) that are as much alike as possible in all other respects. The blocking factor is a factor that represents a potentially large source of variability in terms of the response of interest. Blocking enables this source of variability to be isolated

	monkey	placebo	tcc	acd3s
1	1.00	45.00	52.00	66.00
2	2.00	47.00	52.00	64.00
3	3.00	39.00	53.00	62.00
4	4.00	47.00	54.00	61.00
5	5.00	51.00	49.00	58.00
6	6.00	39.00	49.00	57.00
7	7.00	40.00	48.00	56.00
8	8.00	42.00	51.00	59.00
9	9.00	35.00	52.00	59.00
10	10.00	38.00	51.00	60.00

**FIGURE 1-13** SPSS worksheet for comparing the responses of the three groups of Example 6 using analysis of variance assuming a repeated measures design.

from the overall error. If indeed the response is highly variable across blocks, the resulting error should be considerably smaller than that which would be obtained from an experiment using the completely randomized design. This smaller error would enhance the chance of observing an exposure effect—that is, it would lead to a more powerful test for an exposure effect.

### b. Basic Repeated Measures Design

Repeated measures designs can be thought of as designs that involve blocking carried to its limit. In these designs, the sampling units, the animals, are the blocks with multiple responses taken on each animal. In the context of the previous examples, it may be possible to subject each monkey to a sequence of multiple exposures with an appropriate time interval between exposures to minimize the chance of a carryover effect. To obtain the same number of responses as from the previous designs (30), only 10 monkeys would be required rather than 30 monkeys. Besides this saving in the number of monkeys needed, if the response is highly variable across monkeys, the resulting error from this repeated measures design should be considerably smaller than that which would be obtained from an experiment using the completely randomized design. For the present example, it is assumed that all monkeys are given the placebo first, TCC second, and ACD3S third.

[Partial instructions for SPSS data processing: the SPSS worksheet that is appropriate for the data obtained from the basic repeated measures design described previously is shown in Figure 1-13. It consists of 10 rows, one for each monkey, and 4 columns, the first giving the animal identification (labeled here as **monkey**), the second giving the counts recorded often exposure to the placebo (labeled here as **placebo**), the third giving the counts recorded after TCC exposure (labeled here as **tcc**), and the fourth giving the counts recorded after ACD3S (labeled here as **acd3s**).

The SPSS commands to obtain the ANOVA are as follows:

**Analyze** ⇒ **General Linear Model** ⇒ **Repeated Measures...** This opens the **Repeated Measures Define Factor(s)** dialog box where a name, here **cocktail**, is

## General Linear Model

## Descriptive Statistics

	Mean	Std. Deviation	N
placebo	42.3000	5.01221	10
tcc	51.1000	1.91195	10
acd	60.2000	3.11983	10

## Tests of Within-Subjects Effects

Measure: count

Source		Type III Sum of squares	df	Mean Square	F	Sig.
cocktail	Sphericity Assumed	1602.200	2	801.100	82.336	.000
	Greenhouse-Geisser	1602.200	1.283	1248.576	82.336	.000
	Huynh-Feldt	1602.200	1.404	1141.393	82.336	.000
	Lower-bound	1602.200	1.000	1602.200	82.336	.000
Error(cocktail)	Sphericity Assumed	175.133	18	9.730		
	Greenhouse-Geisser	175.133	11.549	15.164		
	Huynh-Feldt	175.133	12.634	13.863		
	Lower-bound	175.133	9.000	19.459		

## Pairwise Comparisons

Measure: count

(I) cocktail	(J) cocktail	Mean Difference (I-J)	Std. Error	Sig <sup>a</sup>	95% Confidence Interval	
					Lower Bound	Upper Bound
1	2	-8.800*	1.672	.002	-13.704	-3.896
	3	-17.900*	1.595	.000	-22.578	-13.222
2	1	8.800*	1.672	.002	3.896	13.704
	3	-9.100*	.706	.000	-11.172	-7.028
3	1	17.900*	1.595	.000	13.222	22.578
	2	9.100*	.706	.000	7.028	11.172

Based on estimated marginal means

\* The mean difference is significant at the .05 level.

<sup>a</sup> Adjustment for multiple comparisons: Bonferroni.

**FIGURE 1-14** Partial SPSS printout of the analysis of variance for comparing the three groups of Example 5 assuming a repeated measures design.

specified for the repeated measures factor in the **Within-Subject Factor Name** box. Then the number of categories of the Within-Subject Factor, here 3, is specified in the **Number of Levels** box. This information is registered [here as **cocktail(3)**] by hitting the **Add** tab. Hitting the **Define** tab opens the **Repeated Measures** dialog box where the columns of the worksheet corresponding to the levels of the repeated measures factor, here **placebo**, **tcc**, and **acd3s**, are moved into the **Within-Subject Variables** box. Hitting the **Options** tab opens the **Repeated Measures: Options** dialog box. In this dialog box, the repeated measures factor, here **cocktail**, is moved from the **Factor(s) and Factor Interactions:** box to the **Display Means for:** box. **Compare main effects** is selected, **Confidence interval adjustment** method (here **Bonferroni**) is specified,

and other display options such as the **Descriptive statistics** are requested. The **Continue** tab is hit to return to the **Repeated Measures** dialog box and the **OK** tab is hit to get the output.]

A partial printout of the SPSS output for the example is presented in Figure 1-14. The variance ratio,  $F = 82.3$ , is larger than the 62.4 obtained from the One-way ANOVA of the data obtained assuming a completely randomized design. This is due the smaller error, 9.730, obtained with the analysis of the data obtained under the repeated measures design compared to that (12.837) obtained from the One-way ANOVA. This difference is because sizable variability due to animal, the block was removed from the error in the analysis of the data assuming the repeated measures design.

Note: The mean responses of two dependent samples can be compared by using this procedure for analyzing data obtained from the basic repeated measures design or by using the paired-samples *t*-test procedure available with most statistical software.

### 3. More Complex Experimental Designs

More complex experiments can be designed having one or more between subject factors and one or more within subject (repeated measures) factors. For example, the basic

repeated measures design given previously could be modified where half of the monkeys used were infants and half were adults. Cocktail remains a within subject (repeated measures) factor, but age is included as a between subject factor because infant sampling units are distinct from adult sampling units.

The SPSS worksheet is exactly that described earlier for the example of the basic repeated measures design (see Fig. 1-13) with a column added giving the codes of the categories of the between subject factor (here **age**). The instructions for obtaining the SPSS analysis are the same

#### General Linear Model

##### Descriptive Statistics

Dependent Variable: COUNT

	Age	Mean	Std. Deviation	N
placebo	infant	45.8000	4.38178	5
	adult	38.8000	2.58844	5
	Total	42.3000	5.01221	10
tcc	infant	52.0000	1.87083	5
	adult	50.2000	1.64317	5
	Total	51.1000	1.91195	10
acd3s	infant	62.2000	3.03315	5
	adult	58.2000	1.64317	5
	Total	60.2000	3.11983	10

##### Tests of Within-Subjects Effects

Measure: count

Source		Type III Sum of squares	df	Mean Square	F	Sig.
cocktail	Sphericity Assumed	1602.200	2	801.100	90.862	.000
	Greenhouse-Geisser	1602.200	1.252	1279.709	90.862	.000
	Huynh-Feldt	1602.200	1.559	1027.719	90.862	.000
	Lower-bound	1602.200	1.000	1602.200	90.862	.000
cocktail * age	Sphericity Assumed	34.067	2	17.033	1.932	.177
	Greenhouse-Geisser	34.067	1.252	27.210	1.932	.197
	Huynh-Feldt	34.067	1.559	21.852	1.932	.189
	Lower-bound	34.067	1.000	34.067	1.932	.202
Error(cocktail)	Sphericity Assumed	141.067	16	8.817		
	Greenhouse-Geisser	141.067	10.016	14.084		
	Huynh-Feldt	141.067	12.472	11.311		
	Lower-bound	141.067	8.000	17.633		

##### Tests of Between-Subjects Effects

Measure: count

Transformed Variable: Average

Source	Type III Sum of squares	df	Mean Square	F	Sig.
Intercept	78643.200	1	78643.200	18009.893	.000
age	136.533	1	136.533	31.267	.001
Error	34.933	8	4.367		

**FIGURE 1-15** Partial SPSS printout of the analysis of variance for assessing both cocktail exposure (within subject factor) and age (between subject factor) effects.

**Estimated Marginal Means****1. Age****Estimates**

Measure: count

Age	Mean	Std. Error	95% Confidence Interval	
			Lower Bound	Upper Bound
infant	53.333	.540	52.089	54.578
adult	49.067	.540	47.822	50.311

**2. Cocktail****Estimates**

Measure: count

Cocktail	Mean	Std. Error	95% Confidence Interval	
			Lower Bound	Upper Bound
1	42.300	1.138	39.676	44.924
2	51.100	.557	49.816	52.384
3	60.200	.771	58.421	61.979

**Pairwise Comparisons**

Measure: count

(I) cocktail	(J) cocktail	Mean Difference (I-J)	Std. Error	Sig. <sup>a</sup>	95% Confidence Interval for Difference <sup>a</sup>	
					Lower Bound	Upper Bound
1	2	-8.800*	1.517	.001	-13.374	-4.226
	3	-17.900*	1.606	.000	-22.744	-13.056
2	1	8.800*	1.517	.001	4.226	13.374
	3	-9.100*	.640	.000	-11.031	-7.169
3	1	17.900*	1.606	.000	13.056	22.744
	2	9.100*	.640	.000	7.169	11.031

Based on estimated marginal means

\* The mean difference is significant at the .05 level.

<sup>a</sup> Adjustment for multiple comparisons: Bonferroni.**FIGURE 1-15** (Continued).

as those given previously for the example of the basic repeated measures design with the following additions:

1. In the **Repeated Measures** dialog box, **age** is added as a between subjects factor by moving “age” into the **Between-Subjects Factor(s)**: box.

2. In the **Repeated Measures: Options** dialog box, both the repeated measures factor, here **cocktail**, and the between subjects factor, here **age**, are moved from the **Factor(s) and Factor Interactions**: box to the **Display Means for**: box for requesting options such as the display of descriptive statistics.

3. For between subject factors having more than 2 categories, pairwise multiple comparisons of means can

be obtained by hitting the **Post-Hoc...** tab, which opens the **Repeated Measures Post Hoc Multiple Comparisons for Observe...** dialog box. In this dialog box all desired between subject factors can be moved from the **Factor(s)**: box to the **Post Hoc Test for**: box and the desired pairwise multiple comparisons procedure(s) selected.

A partial printout of the SPSS output for the example is presented in Figure 1-15. Cocktail (**COCKTAIL**), the within subject main effect, is highly significant ( $p < 0.0005$ ), age (**AGE**), the between subject main effect, is also highly significant ( $p = 0.001$ ), but the interaction between cocktail and age (**COCKTAIL \* AGE**) is nonsignificant ( $p \geq 0.177$ ).

### H. Nesting Designs

Frequently clinical studies are undertaken to quantify the magnitude of various sources of variability such as intra-animal and interanimal variability. An example of an experimental design that would provide estimates of intra-animal and interanimal variances is as follows: twenty ( $n_a = 20$ ) dogs are randomly selected over a period of time from the population of dogs identified by a clinic as having pituitary-dependent hyperadrenocorticism. At the time the dog is selected, 3 days ( $n_d = 3$ ) within the next 2 weeks are randomly selected for plasma cortisol samples to be taken at 11 A.M. from the dog. Plasma cortisol assays are replicated for each sample ( $n = 2$ ). Because the animals are sampled across time, it is rather unlikely that many and perhaps any of the 3 days that samples are drawn will be common for the 20 dogs. If the 20 dogs had no sampling days in common, there would be 60 ( $20 \times 3$ ) different days that samples were taken. Thus, the factor “days” in this design is not crossed with the factor “animals” but is said to be nested within “animals.” The total variability in this experiment can be decomposed by the method of ANOVA into three parts, that which will identify significant variability among animals and significant variability among days (nested within animals) and that which quantifies the residual variability.

Table 1-6 lists data that shall be assumed to have been generated from an experiment using the nested design described earlier. Table 1-7 gives the ANOVA table generated from these data. In addition to providing the standard entries of an ANOVA table (sum of squares, degrees of freedom, mean square and  $F$ -statistics with corresponding  $p$ -values), Table 1-7 also gives the expected mean squares, which are the quantities being estimated by the corresponding mean squares in the table. The expected mean squares are functions of the unknown population parameters. Note that each expected mean square involves one or more of the variance components of the design. The expected mean squares indicate which mean squares are appropriate as the denominator for computing the  $F$ -statistic to test the hypothesis for a given effect. For example, to test the hypothesis that the variance component giving the magnitude of the variability attributable to the effect of “days”

is not significant—that is, to test  $H_0: \sigma_{d/a}^2 = 0$ , the test statistic is  $F_{d/a} = MS_{d/a}/MS_e$ .  $MS_e$  is the correct denominator for this test statistic because if the hypothesis is true and  $\sigma_{d/a}^2 = 0$ , the expected mean square for the effect of “days” reduces to  $\sigma_e^2$  so that both  $MS_{d/a}$  and  $MS_e$  would be estimating  $\sigma_e^2$  and it would be expected that the ratio of  $MS_{d/a}$  to  $MS_e(F_{d/a})$  would not differ significantly from 1. This ratio

**TABLE 1-6** Plasma Cortisol Levels (mg/dl) in Dogs with Pituitary-Dependent Hyperadrenocorticism<sup>a</sup>

Dog	Day 1	Day 2	Day 3
1	0.8, 0.8 <sup>b</sup>	1.5, 1.4	4.0, 4.2
2	2.2, 2.5	4.7, 4.5	3.4, 3.5
3	2.3, 2.4	2.7, 2.7	2.8, 2.7
4	3.1, 3.2	2.0, 2.1	2.7, 2.8
5	4.2, 4.3	3.5, 3.5	2.3, 2.4
6	3.8, 3.7	4.0, 4.0	2.7, 2.9
7	2.6, 2.5	3.9, 4.1	2.7, 2.7
8	2.4, 2.3	4.1, 4.1	2.9, 2.9
9	2.9, 2.9	3.3, 3.5	2.7, 2.8
10	2.2, 2.3	2.0, 2.2	1.6, 1.6
11	3.1, 2.9	3.0, 2.8	2.3, 2.1
12	5.3, 5.2	4.4, 4.2	3.9, 4.0
13	3.2, 3.3	2.7, 2.5	2.7, 2.9
14	4.4, 4.3	4.8, 4.8	3.8, 3.6
15	4.2, 4.1	4.3, 4.2	3.6, 3.7
16	2.9, 3.1	3.7, 3.9	4.6, 4.8
17	3.8, 3.7	3.6, 3.4	3.5, 3.3
18	5.0, 5.2	5.1, 5.1	4.8, 4.7
19	3.7, 3.6	1.4, 1.4	2.2, 2.1
20	2.9, 3.0	2.7, 2.9	3.1, 3.1

<sup>a</sup> These data were adapted from data provided by Dr. E. C. Feldman, Department of Medicine and Epidemiology, School of Veterinary Medicine, University of California, Davis.

<sup>b</sup> Assay replicated for each sample.

**TABLE 1-7** Analysis of Variance of Canine Plasma Cortisol Level Data Assuming a Nested Experimental Design 2 (“Days” Nested within “Animals”)

Source of variation	df	Sum of squares	Mean square	F-value	Expected mean square
Among Animals	19	70.8316	3.7280	38	$\sigma_e^2 + nn_d\sigma_a^2 + n\sigma_{d/a}^2$
Days/Animals	40	43.8333	1.0958	114	$\sigma_e^2 + n\sigma_d^2$
Error	60	0.5750	0.0096		$\sigma_e^2$
Total	119	115.2399			

differing significantly from 1 would indicate that  $MS_{d/a}$  was estimating something additional to  $\sigma_e^2$ , namely,  $n\sigma_{d/a}^2$ , where  $n$  is the number of replications per sample. Based on the assumed data, the hypothesis  $\sigma_{d/a}^2 = 0$  is rejected.  $\sigma_{d/a}^2$  in this design is the true intradog variability for this response. The test result that the day effect is significant means that this intradog variability is larger than zero.

The second test is that the variance component for “animals” is equal to zero or  $\sigma_a^2 = 0$ . It can be determined by considering the expected mean squares of Table 1-14 that the test for no significant variability among animals ( $H_0: \sigma_a^2 = 0$ ) is made using  $MS_{d/a}$  in the denominator of the  $F$ -statistic. This test is also significant. This means that  $\sigma_a^2$  is not equal to zero, indicating a significant source of variability among dogs in the plasma cortisol levels recorded in the experiment.

### 1. Estimating Variance Components

Once significance has been established for one or more of the variance components in an experimental design, interest focuses on estimating the variance component(s). Estimates are readily obtainable using the appropriate expected mean squares in conjunction with the mean squares obtained from the data. For example, Table 1-7 shows that an estimate of  $\sigma_e^2$  is  $MS_e$  ( $\hat{\sigma}_e^2 = 0.0096$ ). An estimate of  $\sigma_{d/a}^2$  can be obtained by noting that  $MS_{d/a}$  estimates  $\sigma_e^2 + n\sigma_{d/a}^2$ ; solving for  $\sigma_{d/a}^2$  followed by substitution of  $MS_e$  for  $\sigma_e^2$  yields  $(MS_{d/a} - MS_e)/n$  as the estimate. Based on the data used in the example,  $\hat{\sigma}_{d/a}^2 = (1.0958 - 0.0096)/2 = 0.5431$ . An estimate of  $\sigma_a^2$ , obtained in a similar manner, is

$$(MS - MS_{d/a})/nn_d$$

where  $n_d$  is the number of days samples were taken (3). Based on the data an estimate of  $\sigma_a^2$  is 0.4387. The term  $\sigma_a^2$  is the estimate of the interanimal variability, whereas  $\sigma_{d/a}^2$  estimates the intra-animal variability in plasma cortisol level for the underlying population of dogs. Interval estimates for these variance components can be obtained using these point estimates by methods described elsewhere (Harter and Lum, 1955; Mickey *et al.*, 2004; Satterthwaite, 1941).

### 2. Estimating the Variance of the Grand Mean Response

Another way to visualize the importance of these variance components is to analyze their impact on the estimate of the variance of interest. In some applications, there would be interest in estimating the grand mean ( $\mu$ ) of the response. In the present example, this would involve estimating the mean plasma cortisol level taking into account any random animal effect and day effect. The variance of  $\hat{\mu}$ ,  $\text{Var}(\hat{\mu})$ , is given as  $\sigma_a^2/n_a + \sigma_{d/a}^2/n_a n_d + \sigma_e^2/n_a n_d n$  (Little

*et al.*, 1991; Neter *et al.*, 1996). In the present example,  $\text{Var}(\hat{\mu})$  is estimated as  $0.4387/20 + 0.5431/60 + 0.0096/120 = 0.0219 + 0.0091 + 0.0001 = 0.0311$ , and by far the greatest contribution to this variance is that due to the variability among animals in their response. The intradog variance component, although slightly larger than the interdog variance component, makes a considerably smaller impact on  $\text{Var}(\hat{\mu})$ .

### 3. Estimating the Total Variability of a Single Response

In other applications, interest centers about the total variability ( $\sigma_{\text{total}}^2$ ) associated with a single response. A single response is a linear combination of the terms in the response model and, using the assumption of the independence of terms in the model, has a variance equal simply to the sum of the variance components. Specifically,  $\sigma_{\text{total}}^2 = \sigma_a^2 + \sigma_{d/a}^2 + \sigma_e^2$  (Kringle, 1994), which in this example is estimated as  $0.4387 + 0.5431 + 0.0096 = 0.9914$ . Here the total variability of a single response is divided nearly equally between “animals” and “days nested within animals.”

Other possible designs could be considered. What has been demonstrated is that the method of analysis of variance in conjunction with experimental design can be useful in answering a variety of questions.

Nested designs are frequently used to assess sources of variability in an assay. For example, several laboratories could be involved in doing a particular assay, with several autoanalyzers in each laboratory and multiple technicians running these autoanalyzers. Inference in this context centers around being able to identify if there are significant sources of variation among the laboratories, among autoanalyzers within a given laboratory, and among technicians operating a given autoanalyzer. The goal of analyses of this sort is to identify large sources of variability. Once the larger sources of variability have been identified, changes are made in the system in an effort to reduce the variability associated with each source. The long-term objective is to have an assay with sources of variability that are as small as possible. Clinical analysts conventionally divide the square root of the estimates of the variance components (the sample standard deviations) resulting from such assay experiments by the grand mean to obtain coefficients of variation for each source of variability (Kringle, 1994). These coefficients of variability should be much smaller than those derived as intra-animal and interanimal variability. Interested readers are strongly encouraged to consult texts written on experimental design and ANOVA (Mickey *et al.*, 2004; Neter *et al.*, 1996).

## REFERENCES

- Björkhem, I., Bergman, A., and Falk, O. (1981). *Clin. Chem.* **27**, 733–735.

- Cochran, W. C. (1977). "Sampling Techniques," 3rd ed. Wiley, New York.
- Daniel, W. W. (2005). "Biostatistics: A Foundation for Analysis in the Health Sciences," 8th ed. Wiley, New York.
- DeLong, E. R., DeLong, D. M., and Clarke-Pearson, D. L. (1988). Comparing the areas under two or more correlated receiver operating characteristic curves: a nonparametric approach. *Biometrics* **44**, 837–845.
- Dunn, O. J., and Clark, V. A. (2001). "Basic Statistics: A Primer for the Biomedical Sciences," 3rd ed. Wiley, New York.
- Elevitch, F. R. (1977). Proceedings of the 1976 Conference on Analytical Goals in Clinical Chemistry, College of American Pathologists. IL: Skokie.
- Feinstein, A. R. (1977). "Clinical Biostatistics." Mosby, St. Louis, MO.
- Gilbert, R. K. (1975). *Am. J. Clin. Pathol.* **63**, 960–973.
- Gilbert, R. K. (1978). *Am. J. Clin. Pathol.* **70**, 450–470.
- Hanley, J. A., and McNeil, B. J. (1982). The meaning and use of the area under a receiver operating characteristic (ROC) curve. *Radiology* **143**, 29–36.
- Harris, E. K. (1988). *Arch. Pathol. Lab. Med.* **112**, 416–420.
- Harter, H. L., and Lum, M. D. (1955). "Partially Hierarchical Models in the Analysis of Variance." Wright Air Development Center Technical Report No. 55–33, Wright-Patterson Air Force Base, OH.
- Herrera, L. (1958). *J. Lab. Clin. Med.* **52**, 34–42.
- Jessen, R. J. (1978). "Statistical Survey Techniques." Wiley, New York.
- Kaneko, J. J., Mattheeuws, D., Rottiers, R. P., and Vereulen, A. (1978). *J. Small Anim. Pract.* **19**, 85–94.
- Kleinbaum, D. G., Kupper, L. L., Nizam, A., and Muller, K. E. (2008). "Applied Regression Analysis and Other Multivariable Methods," 4th ed. Duxbury Press, Belmont, California.
- Kringle, R. O. (1994). In "Tietz Textbook of Clinical Chemistry" (C. A. Burtis and E. R. Ashwood, Eds.), 2nd ed., pp. 384–453. Saunders, Philadelphia.
- Levy, P. S., and Lemeshow, S. (1999). "Sampling of Populations: Methods and Applications," 3rd ed. Wiley, New York.
- Little, R. C., Freund, R. J., and Spector, P. C. (1991). "SAS System for Linear Models," 3rd ed. SAS Institute, Cary, NC.
- Lohr, S. L. (1999). "Sampling: Design and Analysis." Duxbury Press, Pacific Grove, CA.
- Mainland, D. (1963). "Elementary Medical Statistics," 2nd ed. Saunders, Philadelphia.
- Massod, M. F. (1977). *Am. J. Med. Technol.* **43**, 243–252.
- Metz, C. E. (1978). Basic principles of ROC analysis. *Semin. Nucl. Med.* **8**(4), 283–298.
- Mickey, R. M., Dunn, O. J., and Clark, V. A. (2004). "Applied Statistics: Analysis of Variance and Regression," 3rd ed. Wiley-Interscience, Hoboken, NJ.
- Murthy, M. N. (1967). "Sampling Theory and Methods." Statistical Publication Society, Calcutta.
- Neter, J., Kutner, M. H., Nachtsheim, C. J., and Wasserman, W. (1996). "Applied Linear Statistical Models," 4th ed. Irwin, Chicago.
- Raj, D. (1968). "Sampling Theory." McGraw-Hill, New York.
- Raj, D. (1972). "The Design of Sampling Surveys." McGraw-Hill, New York.
- Reed, A. H., Henry, R. J., and Mason, W. B. (1971). *Clin. Chem.* **17**(4), 275–284.
- Ryan, B. F., Joiner, B. L., and Ryan, T. A. (2001). "Minitab Handbook," 4th ed. Duxbury Press, Pacific Grove, CA.
- Satherthwaite, F. E. (1941). *Psychometrika* **6**, 309–316.
- Scheaffer, R. L., Mendenhall, W., and Ott, L. (2006). "Elementary Survey Sampling," 6th ed. Duxbury Press, Belmont, CA.
- Schork, M. A., and Remington, R. D. (2000). "Statistics with Applications to the Biological and Health Sciences," 3rd ed. Prentice-Hall, Upper Saddle River, NJ.
- Shultz, E. K. (1994). In "Tietz Textbook of Clinical Chemistry" (C. A. Burtis and E. R. Ashwood, Eds.), 2nd ed., pp. 485–507. Saunders, Philadelphia.
- Snedecor, G. W., and Cochran, W. G. (1989). "Statistical Methods," 8th ed. Iowa State University Press, Ames.
- Solberg, H. E. (1999). In "Tietz Textbook of Clinical Chemistry" (C. A. Burtis and E. R. Ashwood, Eds.), 3rd ed., pp. 336–356. Saunders, Philadelphia.
- Stevens, J. P. (2002). "Applied Multivariate Statistics for the Social Sciences," 4th ed. Erlbaum, Mahwah, NJ.
- Zar, J. H. (1999). "Biostatistical Analysis," 4th ed. Prentice-Hall, Upper Saddle River, NJ.



# Comparative Medical Genetics

Petra Werner

*Department of Clinical Studies  
Section of Medical Genetics  
School of Veterinary Medicine  
University of Pennsylvania  
Philadelphia, Pennsylvania*

Mark Haskins

*Department of Pathology  
School of Veterinary Medicine  
University of Pennsylvania  
Philadelphia, Pennsylvania*

Urs Giger

*School of Veterinary Medicine  
University of Pennsylvania  
Philadelphia, Pennsylvania*

---

## I. INTRODUCTION

- A. Genome Sequences
- B. Mapping the Genome
- C. Disease Gene Mapping
- D. Genetic Diseases
- E. Gene Therapy

## REFERENCES

---

## I. INTRODUCTION

### A. Genome Sequences

All the genetic information needed for the creation, maintenance, and reproduction of an organism is called the genome. For most organisms, this information is encoded in the DNA (deoxyribonucleic acid) or for some viruses in the RNA. A first step in the gigantic endeavor to understand this genetic information is to learn about the complete nucleotide sequence of a genome. Such genome projects have been or will be undertaken for many different organisms.

The progress made with the Human Genome Project around the turn of the century has not only produced an extraordinary resource for genetic research in human medicine, but it has also created the means for sequencing additional genomes. Following the completion of the high-density human genome sequence, these tools and sequencing capacities have been used for a variety of species, starting with that of model organisms. The mouse, as one of the most relevant models for genetic research, was the second mammal to be sequenced; however, genome sequences from rat, fruit fly, and zebra fish were soon to follow. The next group of genomes included those of domestic animals, such as the dog, cow, chicken, and pig, which were chosen because they also serve as model organisms and are of special interest as either companion or food animals. Genomes of other animals, including cat

and horse, were chosen to help with the annotation of the human and other mammalian genomes (comparative annotation). They were sequenced at lower genome coverage and are expected to provide important information about genome evolution. Alignment and comparison of the available animal genomes to the human will help identify evolutionarily conserved regions, which mostly likely represent important functional elements. This is a critical step for the annotation of the human and animal genomes and the understanding of genomic function. Completed genome sequences for several domestic animals are now available (Table 2-1) and semiannual updates on the status of current sequencing projects are listed on the National Institutes of Health (NIH) website ([www.genome.gov/10002154](http://www.genome.gov/10002154)).

Many aspects of the canine genome and its impact on comparative and medical genetics are covered in *The Dog and Its Genome* (Ostander *et al.*, 2006). The knowledge about the genomes of companion animals will have an enormous impact on veterinary medicine by facilitating the identification of genes underlying breed characteristics including behavior, coat color, body type, disease predispositions, and the detection of disease-causing mutations. This knowledge will lead to great advances in genetic screening for desirable and disease-causing traits as well as breed-specific vaccine and drug development (custom drug design). It will also change livestock breeding and production through identification of productivity and disease-resistance genes.

### B. Mapping the Genome

The nuclear genome is composed of a species-specific number of linear DNA molecules, which are packaged into chromosomes. The number of chromosomes varies greatly among eukaryotes (for haploid chromosome numbers, see Table 2-1) but appears to be unrelated to genome size and its biological features. During cell division, DNA is

**TABLE 2-1** Genome Sequencing Projects

	Genome	Coverage	Size (Gb)	Haploid Chromosomes
Cat	<i>Felis catus</i>	1.9-fold	3	19
Chicken	<i>Gallus gallus</i>	6.6-fold	1.2	40
Cow	<i>Bos Taurus</i>	6-fold	3	30
Dog	<i>Canis lupus familiaris</i>	7.6-fold	2.4	39
Horse	<i>Equus caballus</i>	6.8-fold	2.1	32
Human	<i>Homo sapiens</i>	Finished	3	23
Mouse	<i>Mus musculus</i>	Finished	2.5	20
Pig	<i>Sus scrofa</i>	In process	2.8	19

<sup>a</sup> One set of autosomes and one sex.



**FIGURE 2-1** Male domestic cat (*Felis catus*) karyotype: 18 autosomal pairs and XY (at the lower right; the X is significantly larger than the Y).

duplicated and then condensed into the more compact forms of chromosomes. The varying sizes, location of centromeres, and the characteristic banding patterns revealed by staining techniques allow for the identification of individual chromosomes. For each organism, the arrangement of chromosomes by pairs (homologous chromosomes), according to standard classifications, is referred to as the karyotype (see the example in Fig. 2-1) and can also be depicted as a drawing called an ideogram.

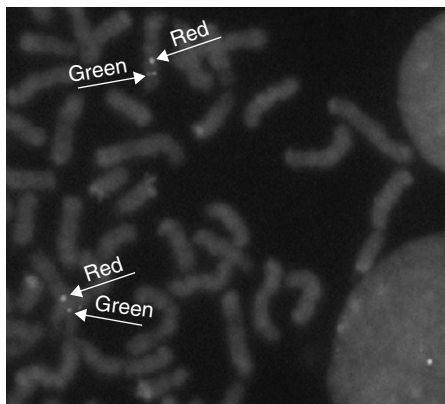
The two types of genome maps (i.e., physical and genetic maps) are important tools for the sequencing and assembly of whole genome sequences. Once established, they are great resources for locating and sequencing genes, such as those involved in diseases. A *physical map* depicts the position of a specific DNA segment in a genome—for example, its location on a specific chromosome. A *genetic map* describes the order and distance between specific DNA sequences in terms of the rate of DNA recombination between homologous chromosomes during meiosis, and it is determined from breeding experiments and pedigree analyses. *Integrated maps* use DNA segments as markers that are mapped to both maps and display information from both.

### 1. Physical Mapping

Different techniques have been applied to construct physical maps as new techniques were made available.

#### a. Fluorescent *In Situ* Hybridization (FISH)

FISH enables the assignment of a DNA molecule directly to a chromosome. Hybridization of several DNA fragments simultaneously reveals not only their individual location but also their relative order to each other. To perform a traditional FISH experiment, cells are harvested in the metaphase stage of mitosis and their chromosomes are fixed onto a glass slide. Individual chromosomes can be distinguished by their distinct banding patterns and other cytological features. A specific DNA molecule (also referred to as a probe) is labeled with a fluorescent dye and hybridized to the denatured chromosomes. The single-stranded DNA probe anneals to its complementary strand in the chromosome in a sequence-specific manner, and the physical location of the probe is microscopically visible as



**FIGURE 2-2** Fluorescent *in situ* hybridization. Two color FISH on canine metaphase chromosomes. Two loci labeled red and green are assigned to canine chromosome 9 (CFA9).



**FIGURE 2-3** Restriction site for the restriction enzyme *Eco* RI. The double-stranded DNA is cleaved along the line.

a bright fluorescent signal. With the development of fluorescent labels that have specific emission spectra, multiple DNA probes can be hybridized simultaneously to a single chromosome preparation, allowing their ordering on a chromosome (Fig. 2-2). Another useful application of multi-color FISH is called *chromosome painting*: multiple probes distributed throughout the length of one chromosome are labeled with the same color dye at a density such that the entire chromosome is covered by fluorescence. As chromosome-specific probe sets are hybridized with different colors, each chromosome reveals its unique color, which is particularly useful to examine chromosomal abnormalities like deletions, duplications, and translocations of chromosomal segments. Because FISH allows only low-resolution mapping (probes >1Mb apart), other techniques need to be applied for finer, high-resolution mapping.

### b. Restriction Enzyme Mapping

Restriction endonucleases are enzymes isolated from various strains of bacteria that recognize and cleave specific double-stranded DNA sequences, called restriction sites, with the majority of sites consisting of only four to seven nucleotides (see the example in Fig. 2-3). A DNA segment, digested by a specific restriction enzyme, is cut into smaller DNA fragments of different sizes depending on the number and location of the recognition sites present within the DNA sequence. The differently sized fragments can be separated by agarose or polyacrylamide gel electrophoresis. A simple way to create a restriction map of a smaller genome is to first cut the DNA using two separate reactions, each with a different restriction enzyme, and then in

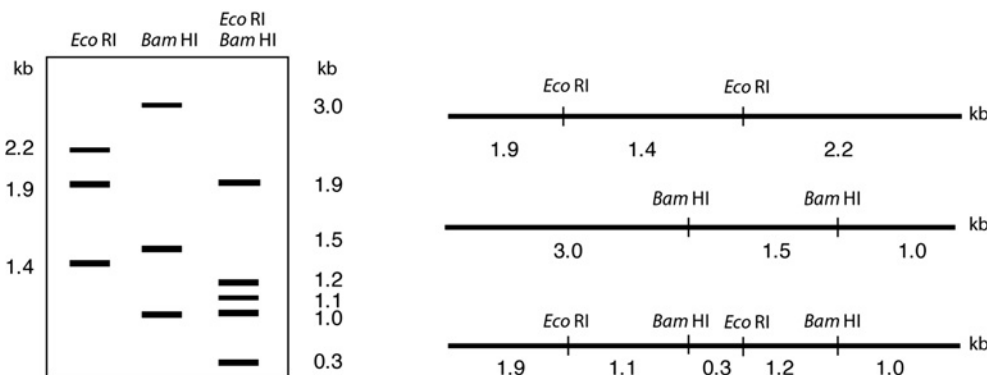
an additional reaction simultaneously with both enzymes to compare the resulting fragment size patterns. This will allow one to assess the number of restriction sites for each enzyme by single digests and then the relative positions to each other by the double digest (Fig. 2-4). However, with an increasing size of the DNA segment to be mapped, the number, sizes, and order of resulting fragments become too complex. Then analysis requires cloning smaller fragments or other mapping techniques.

### c. Sequence Tagged Site (STS) Mapping

STSs are short nonrepetitive DNA segments that are located at unique sites in the genome and can be easily amplified by the polymerase chain reaction (PCR). Common sources to obtain STSs represent expressed sequence tags (ESTs), microsatellites (discussed later), and known genomic sequences that have been deposited in databanks. ESTs are short sequences obtained by converting mRNA into complementary DNA (cDNA). They are unique and valuable sequences, because they represent parts of expressed genes of the cells or tissue used for the mRNA extraction. To construct a genome map using STSs, different DNA resources, sometimes called a mapping reagent, can be used. The most common resources are radiation hybrid panels or clone libraries, both of which can be constructed using either whole genome sequences or a single chromosome.

**i. Radiation Hybrid (RH) Mapping** Radiation cell hybrids are typically constructed using cells from two different species. Cells from the organism whose genome is to be mapped (donor) are irradiated with a lethal dose and then usually fused with rodent (recipient) cells. The irradiated chromosomes break at random sites and, after cell fusion with the recipient cells, the donor chromosome fragments are incorporated into the recipient chromosomes. Consequently each hybrid cell line derived from a single cell contains different parts of the donor's chromosomes, which were incorporated at random.

Radiation hybrid mapping is based on this artificially induced random breaking of the genomic DNA into smaller fragments. The original order of these fragments to each other is determined by ascertaining that specific DNA sequences are found to be in the same clones, which means that they segregate together because of their close physical proximity in the genome. For detailed mapping, fewer than 100 hybrid cell lines are necessary. For example, irradiated canine cells were fused with recipient hamster cells, and 88 cell lines were selected (Hitte *et al.*, 2005). To map the canine genome, DNA from each cell line is being tested for the presence or absence of unique canine markers, like STSs. If two markers are originally located closely on a chromosome, a break between the markers is unlikely, and, therefore, they will mostly be found together in the same cell line. In contrast, if they are farther apart or even on



**FIGURE 2-4** Restriction mapping. A 5.5kb DNA segment is cut with enzymes *Eco* RI and *Bam* HI to assess the number of restriction sites for each of the enzymes. (*Eco* RI and *Bam* HI single digests each produce three bands indicating two restriction sites for each of the enzymes) (as depicted as an agarose gel on the left). The double digest using both enzymes allows the inference of the relative location of the restriction sites to each other (schematic position of restriction sites on the right).

different chromosomes, the separation of the two markers into different cell lines is likely. Hence, the actual distance between two markers on a chromosome is proportional to the probability of the markers being separated and found in different cell lines. Analysis of hundreds to thousands of markers allows for the determination of the order and distance between markers. Higher resolution RH maps can be achieved by increasing the intensity of the initial radiation of the donor cells leading to increased chromosomal breaks and smaller average fragment sizes. The probability of separation between closely located markers increases, thereby permitting the ordering of more markers.

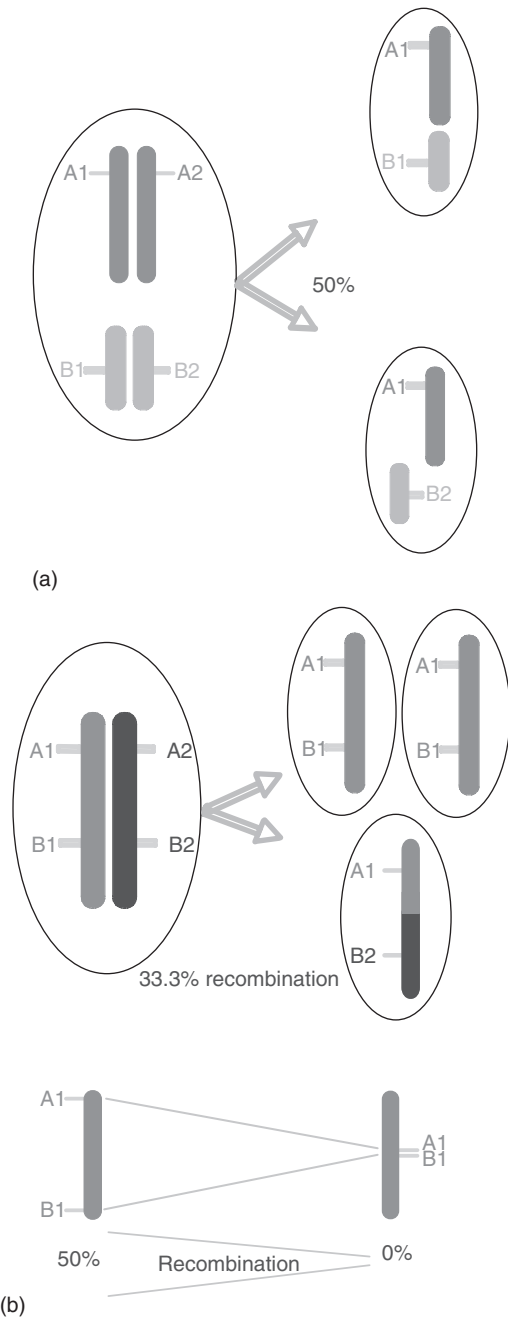
**ii. Clone Library** A *clone library* consists of DNA fragments, representing the total DNA from a specific chromosome or whole genome, inserted into some type of vector that can be grown in bacteria, yeast, or mammalian cells. To construct a library, the source DNA is cut into random fragments, usually by a restriction enzyme that has a 4bp recognition site and therefore cuts the DNA frequently. However, the digestion of the DNA is purposely prevented to go to completion, leaving randomly larger uncut fragments that partially overlap. These fragments are then cloned into vectors, for example, plasmids, which incorporate the DNA and allow for easy amplification and isolation in bacteria. Different types of vectors accommodate DNA fragments of different sizes, ranging from hundreds to thousands of base pairs (bp). As with the radiation hybrids, the individual clones are analyzed for the presence or absence of STSs, which allows the ordering of these markers depending on their common presence in the same clones. Again, the resolution of the STS map can be raised by decreasing the size of the DNA fragments used for construction of the library. The STS markers are also used to identify overlapping clones to build contigs (a number of overlapping clones representing a region of a particular sequence). Because sequences obtained from each clone can be precisely

anchored to the physical map, clone libraries are critical in the assembly of whole genome sequences.

## 2. Genetic Linkage Mapping

Breeding experiments or pedigree analyses can be used to genetically map genes or molecular markers. The basis for genetic mapping is that the distance between two markers on a chromosome is directly correlated with the probability of *recombination* between them during meiosis. Because each diploid cell has two copies of each locus (two alleles), it is by chance that half the time the alleles of two different loci on different chromosomes are inherited together (Fig. 2-5a). In other words, in 50% of offspring (or meioses), the same alleles of the two loci are found together, although they are located on different chromosomes. However, if the two loci are located on the same chromosome, it is less likely that their alleles will be separated and, therefore, should segregate together in >50% of the offspring. If they are found separated in some of the individuals, then they are said to have recombined. The frequency of recombination is correlated with the distance between the two loci. If they are closely located, then recombination between the two markers will happen less often and will be <50%, and approaching 0% for very closely located markers (Fig. 2-5b). Markers are said to be linked if recombination between them is <50%.

To be able to follow the inheritance of different alleles of a genetic marker in a pedigree, they need to be polymorphic for a DNA variation (discussed later). Hundreds to thousands of these genetic markers are then analyzed in a number of families. Likelihood calculations for linkage based on the percentage of recombination between any two markers permit the ordering of the markers to each other into linkage groups and ultimately into a genetic map. The distance between markers on a genetic map is based on the recombination rate and expressed in centiMorgans (cM; 1cM = 1% recombination). The resolution of a



**FIGURE 2-5** Schematic representation of recombination during meiosis. (a) Independent assortment. The chance for two alleles from two loci located on two different chromosomes to be inherited together is 50%. Therefore, the same alleles will be found together in 50% of the offspring, although the two loci are inherited independently of each other. (b) Recombination: If the loci are located on the same chromosome one would expect to find the same alleles together in all the offspring, but because of recombination the alleles rearrange in some of the offspring. For example, if one offspring out of three shows recombination, then the recombination is said to be 33.3%. The distance between the two loci on the chromosome is correlated with the probability of interchromosomal recombination between the two during meiosis. Although located on the same chromosome, recombination between two loci can reach 50% if the loci are far apart. In other words, the chance of the two loci being separated during meiosis is the same as if they were located on two different chromosomes. If the two loci are located very close together, few to no recombinant animals are found (recombination rate approaches 0) and the loci are said to be linked.

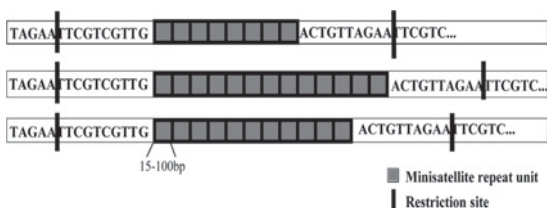
genetic map depends on the number of individuals as well as how informative the markers tested are.

#### a. Genetic Markers

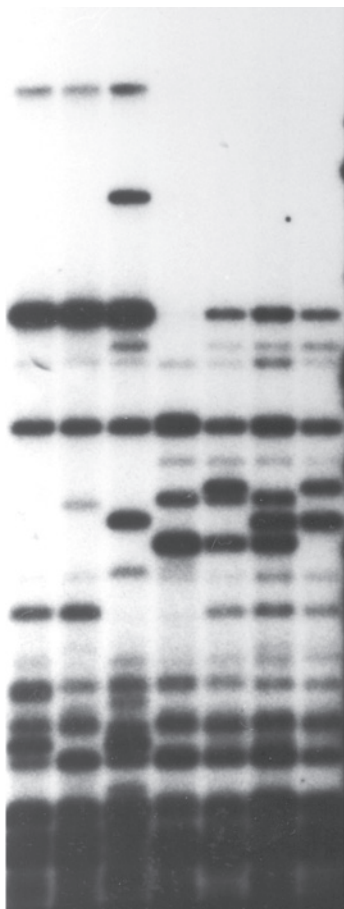
Although more than 99% of the DNA sequence is identical between individuals of any mammalian species, much variation remains. These sequence differences are known as polymorphisms, contribute to breed and individual differences, and have been useful for many practical applications, including genome mapping, screening for genetic diseases, and forensic applications such as DNA fingerprinting. Most variations are located outside of genes and generally do not affect any gene function. However, some of these polymorphisms may contribute toward physical characteristics or disease susceptibility. In contrast, polymorphisms within a regulatory or coding sequence of a gene can have deleterious effects on gene function. These polymorphisms have a lower frequency within a population and are referred to as mutations. Mutant alleles of genes are often associated with a genetic disease or disease predisposition and are referred to as disease genes or alleles.

**i. Restriction Length Polymorphisms (RFLPs)** One of the first widely used techniques to detect DNA variations in a population was the analysis of RFLPs. Polymorphisms between individual DNAs can either destroy existing or create new endonuclease recognition sites and, thereby, lead to different fragment size patterns following restriction enzyme digestion. To test for a specific RFLP, a DNA region is amplified by PCR and subsequently digested with a particular restriction enzyme. The resulting DNA fragments can be separated by gel electrophoresis and visualized by staining with ethidium bromide. A difference in number or size of fragments between individuals tested indicates a polymorphism within the restriction site of the enzyme used. Before the advent of automated PCR, RFLP analysis methods included the extraction and digestion of genomic DNA of each individual tested, separation by gel electrophoresis, transfer of the DNA to a nylon membrane, and subsequent hybridization with a radioactively labeled DNA probe that bound to a known region in the genome. If a variation within a restriction site of the enzyme used was located within or close to the region of a locus binding to the probe, the labeled bands would differ either in size or number between individuals. Although extraordinarily laborious and not very informative, these RFLPs were used as markers to construct the first human genetic linkage map.

**ii. Minisatellite or Variable Number of Tandem Repeats (VNTRs)** Minisatellites or VNTRs, succeeding the RFLPs, are noncoding DNA sequences of <20kb long, containing a variable number of 15 to 100-bp long repeat units (Fig. 2-6a), and are distributed throughout the whole genome. If genomic



(a)



(b)

**FIGURE 2-6** (a) Illustration of a single minisatellite location within the genome of three different animals depicting a varying number of repeat units. The sizes of the fragments differ depending on the number of repeat units when cut with a restriction enzyme, with restriction sites surrounding the minisatellite locus. (b) DNA fingerprints from Bernese mountain dogs. Each lane represents the banding pattern of one dog depicting the differently sized fragments of several locations of one specific minisatellite distributed throughout the genome. The DNA from each dog was digested with the same restriction enzyme and hybridized with a labeled probe binding to the minisatellite repeat unit.

DNA is cut by a restriction enzyme that has no recognition site within the repeat unit but cuts the remaining DNA fairly frequently, a large number of different-sized fragments can be identified. Because the numbers of the repeat units at most of the minisatellite loci vary among individuals, the resulting pattern of differently sized fragments is unique to each individual and is, therefore, called a *DNA fingerprint*

(Fig. 2-6b). Although minisatellites are more informative than RFLPs, their analysis still is time consuming.

### iii. Microsatellites or Simple Tandem Repeats (STRs)

With the advent of PCR, microsatellites soon replaced minisatellites as well as RFLPs as genetic markers. Microsatellites or STRs are composed of simple sequence repeats of 2 to 7 nucleotides. The number of repeat units may greatly differ among individuals resulting in alleles of varying lengths. PCR primers flanking the repeat are located in genome-wide unique sites and, therefore, allow for unique and easy amplification of one specific marker. Although initially radioactively labeled primers were used, fluorescent labels, automated DNA sequencers, and analysis software now allow for fast and inexpensive analyses. The abundance of STRs throughout the genome and ease of analysis greatly improved genetic maps in humans and animals with ever-increasing resolution.

### iv. Single Nucleotide Polymorphisms (SNPs)

The most frequent, evenly distributed genome sequence variations (e.g., >4.5 million in humans) are SNPs, where a single nucleotide (A, T, G, or C) at a locus differs between individuals in a biallelic fashion. A small fraction of SNPs gave rise to the RFLPs described previously. However, current technologies allow for automated analysis of tens of thousands of SNPs per sample simultaneously, making it the preferred tool for genome-wide analysis in the search for mutations responsible for diseases. The commercially available high-density oligonucleotide *microarrays* or *DNA chips* contain thousands of different oligonucleotides representing different sequence variants. Hybridization of labeled sample DNA to the chip and subsequent analysis with a fluorescent scanner will result in a typical hybridization pattern. Because the representative genomic location of each oligonucleotide on the chip is known, the assessment of the pattern permits genotyping of several thousand SNPs per sample. SNP maps and chips, developed for humans and some domestic animals, are most useful to find the sequence variations that affect gene function associated with health, production, and disease.

### 3. Integrated Maps

Because some markers can be analyzed on both physical and genetic maps, they serve as anchors to compare and combine data from both maps. The resulting integrated map lists the order of the markers and gives their distances in both genetic and physical scales.

### 4. Comparative Maps

Comparative genomics, utilizing information about different genomes, is particularly important in the understanding



of genomes of various organisms. If two organisms have a recent ancestor, their genomes will be related. Comparative maps display similarities between two organisms by aligning genes and their order on a chromosome of one species and then comparing it to the location and order found in another species. This knowledge is useful for mapping, identifying and isolating genes, and gaining more information about principles of evolution. Comparison of the actual genome sequences of different species allows the detection of highly conserved regions within or around genes that, besides representing exonic sequences, most likely serve as important regulatory elements in gene expression and function.

### C. Disease Gene Mapping

A major objective of genetic research is the identification of DNA mutations that is involved in disease or genetic predisposition. A small sequence change located within a gene can alter or eliminate gene or protein function. These mutations either arise during imperfect DNA replication or are caused by mutagens and are distinguished by the type of change in the nucleotide sequence. A replacement of a single nucleotide with another base is called a *point mutation*, which can either be silent (the amino acid remains unchanged), a *missense* (changes the amino acid), or *nonsense point mutation* (producing a stop codon). Insertion or deletions refer to varied numbers of nucleotides that are added or deleted, respectively. Nonsense point mutations and deletions or insertions unequal to an exact multiple of 3bp can result in an early stop codon and consequently in a shortened, unstable, or malfunctioning protein. Protein function can also be impaired by the change or addition/deletion of amino acids because of a mutation within the coding region (missense). Additionally, mutations within noncoding sequences that are necessary for correct gene regulation and function can also lead to a change in expression or nonfunctional proteins.

In single gene disorders such a specific mutation that is severe enough to cause disease by itself and often shows a *simple (Mendelian) inheritance* pattern. If the inheritance is said to be *dominant*, only one mutant allele is sufficient for the development of the disease in an affected individual. Because the second allele is a normal (wild-type) allele, the affected individual is considered to be heterozygous. If both alleles have to be mutated to cause clinical disease, then the inheritance pattern is said to be *recessive* and the affected animal is homozygous for the mutant allele. If the mutation is located on the X chromosome, the affected male is considered to be *hemizygous*. Complex or polygenic disorders are caused by sequence variations in only a few or numerous genes and are more difficult to evaluate. The influences of environmental factors are being recognized and explain some of the variation in

disease presentations of simple and complex inherited traits. To identify mutant alleles, various methods have been applied.

#### 1. Candidate Gene Approach

If the phenotype or metabolic basis of the disease to be studied is well characterized or previous research has been done in humans or in other animal species with a similar disease, there might be potential genes (known as *candidate genes*) that can be suspected to be involved based on the previous findings or known function. Candidate genes can be evaluated for their involvement by testing for linkage or association (discussed later) or direct sequencing of coding regions, exon/intron boundaries, and promoter regions from unaffected and affected animals. For example, symptoms seen in human patients with phosphofructokinase (PFK) deficiency closely resembled those in other glycogen storage diseases and extensive biochemical analyses revealed the deficiency of the key regulatory glycolytic enzyme muscle-type phosphofructokinase (PFK) (Tarui *et al.*, 1965). The gene was then cloned. Based on this information the canine PFK gene was sequenced in English springer spaniel dogs affected with PFK deficiency and a nonsense mutation identified (Smith *et al.*, 1996), which is different from published mutations responsible for PFK deficiency in humans (reviewed in Nakajima *et al.*, 2002). Protein-based functional assays are another common way to determine if a candidate gene is involved in the development of a disease. This approach led to the diagnosis of PFK deficiency in English springer spaniel dogs experiencing hemolysis and myopathy (Giger *et al.*, 1985).

If there is no candidate gene, a linkage approach involving a whole genome scan utilizing the molecular tools described earlier is an option to identify a chromosomal region or gene linked to the disease. This approach requires medical and pedigree information and a source to isolate DNA from a fairly large number of affected and nonaffected animals. Animal breeding data should make it possible to acquire the necessary data (pedigrees) and samples from three-generation pedigrees for linkage studies. If more than one breed is affected with the same disease, the different genetic background found in different breeds may further assist in narrowing the DNA region of interest. Generally, association studies require an equal number of affected and unaffected (control) animals from a population.

#### 2. Genetic Analysis

The development of genome maps allowed for the mapping of genes without further knowledge of their function. Thousands of genetic markers mapped throughout the genome enable genome-wide linkage or association studies

looking for at least one of these markers to segregate with the disease. Because the location of the disease gene is initially not known, genetic markers, such as microsatellites and SNPs, covering the whole genome should be analyzed. The greater the number of markers analyzed, usually between several hundreds or thousands of markers, the higher the likelihood of finding one of these markers close to the disease locus. Most linkage or association analyses in animals are currently based on microsatellites, but with the increasing number of animal genomes sequenced and analyzed for SNP markers, faster and easier analysis with SNP microarray chips will soon be available for animals, as with the current human Genechip.

#### a. Linkage Analysis

Linkage analysis is based on the same principle of recombination used for genetic linkage mapping. However, unlike a genetic marker, the genotype of the disease locus is not known. Therefore, it is important to know the mode of inheritance of the disorder. Pedigree analysis or experimental breeding can help to identify how a disease is inherited. Single gene diseases are usually easier to evaluate and are commonly classified into Mendelian inheritance patterns as described earlier: autosomal recessive, autosomal dominant, and X-linked inheritance. More complex inheritance patterns are due to the involvement of two or more genes (polygenic) necessary to cause disease, variable penetrance, variable expressivity, and influences from the environment.

Once a mode of inheritance is established, the underlying genotype at the disease locus is inferred and analyzed for linkage with all genetic markers that were tested, which is mostly done with the help of computer programs. If a marker is located close to the disease locus, the result will show no or a very small recombination fraction between the marker and the disease locus. Based on this recombination fraction, a numeric value, called the LOD score, is calculated. This value expresses the likelihood that the result is due to linkage between the tested marker and the disease locus rather than by chance. For example, if the LOD score has a value of 3, this indicates that obtained results are a thousand times ( $10^3$ ) more likely due to linkage between the tested marker and disease than by chance. In most cases, an LOD score  $\geq 3$  is statistically significant. Once linkage is established to a marker, the chromosomal region surrounding the marker can be analyzed for potential candidate genes (positional candidate gene approach). Frequently, more markers will have to be analyzed in that area to confirm and further narrow the genome region of interest.

#### b. Association Study

Genotyping data from hundreds of markers analyzed in groups of affected and unaffected animals can be evaluated

for differences in allele frequencies in the two groups, thus demonstrating association between a genetic marker and the disease phenotype. If the marker and the disease locus are located close to each other, both loci will be inherited together, through several generations, and recombination between the two will be rare. Consequently, specific alleles of the marker and the disease locus will mostly be found together within the group of affected animals, which means they are associated (they are said to be in *linkage disequilibrium*). Therefore, an association study compares the frequency of marker alleles within the two groups, and an increased occurrence of a specific marker allele in the group of affected animals indicates that this marker is located at or close to the disease gene.

#### c. Positional Candidate Gene Approach

A major goal of a genome-wide linkage analysis is to find the gene or genes responsible for the development of the disease or phenotype that was used for the study. The markers found to be linked allow the assignment of the disease locus to a chromosomal area, and the more markers that are tested, the narrower the region will become. A small region is desirable to minimize the number of possible candidate genes that needs to be analyzed for mutations. Because the approximate location of the candidate gene is known, this method is called the positional candidate gene approach. Genes coding for products with a known function that could be involved in the development of the disease will be considered first for analysis.

### 3. Genetic Tests

#### a. Linked Marker Test

Once significant linkage to a disease has been found, a linked marker test can be offered to breeders using one of the polymorphic markers used to find or refine linkage. Because the actual disease locus is not known at this point, one has to keep in mind that genetic test results using a linked marker can in a few cases lead to an incorrect conclusion about the animal's genetic status at the disease locus as a result of possible recombination between the marker and the disease allele.

#### b. Mutation Test

A DNA-based test offered for a specific genetic disease that is based on the disease-causing mutation offers an accurate diagnosis and has the advantage that it is not age or phenotype dependent. Buccal (cheek) swabs or blood samples can be used for DNA extraction even from very young animals before any disease phenotype has developed. Deletions and insertions can readily be detected by size differences of the amplified DNA segment. A common method to detect single nucleotide changes is a restriction digest of a PCR-amplified DNA product, which requires





of the FVII protein, leaving affected animals with <4% of normal FVII plasma activity (Callan *et al.*, 2006).

Furthermore, many enzyme functions depend on the availability of a vitamin or high-energy intermediate compound (which are also known as cofactors). Therefore, in addition to those diseases in which a mutation affects the protein function directly, alterations of the affinity of an enzyme for the cofactor or impairments in the normal absorption or conversion to the active form of the required cofactors can result in dysfunction (see the discussion of methylmalonic aciduria and cobalamin deficiency, presented later in this chapter). Of the metabolic disorders, these are the most amenable to therapeutic interventions (e.g., parenteral or megadose vitamin supplementation).

Because genetic alterations are possible at any gene locus, inborn errors of metabolism constitute a large heterogeneous group of monogenic (and in the future likely polygenic) disorders. Thus, any mutation affecting the expression or coding sequence in some way can produce any of a variety of malfunctions of the mature protein. Indeed, with the advanced biochemical and molecular characterization of hereditary disorders, most of the genetic defects could be considered to be “inborn errors of metabolism” including malformations and susceptibility to various simple and complex disease traits.

### c. Genetic Predisposition to Disease

Increased susceptibility to disease has been recognized more recently to have a genetic basis. Single gene defects for a variety of genetic predispositions have been identified. For instance, mutations in the beta chain of the integrin leukocyte adhesion protein predispose to overwhelming bacterial infections in red Holstein calves and Irish and red and white setter puppies (Fouremant *et al.*, 2002; Kijias *et al.*, 1999; Shuster *et al.*, 1992). A single common mutation in the ryanodine receptor in various breeds of pigs is responsible for the development of malignant hyperthermia (Fujii *et al.*, 1991). A defect in the mutlidrug-resistant gene 1 is responsible for serious adverse drug reactions in collies and related dog breeds (Mealey *et al.*, 2001; Neff *et al.*, 2004). Moreover, predispositions caused by complex/polygenic traits are being currently characterized and include common predispositions to infections, inflammation, immune disorders, degenerative disorders, drug reactions (pharmacogenetics), and neoplasia.

## 2. Inheritance of Genetic Diseases

Genetic diseases are generally produced by defects in nuclear DNA and only rarely from anomalies in mitochondrial DNA (maternal pattern of inheritance such as with some myopathies). In contrast to humans where dominant traits seem to prevail, hereditary diseases are more often recessively inherited in domestic animals. Although inbreeding practices preserve and propagate desirable characteristics

for meat and milk production in food animals or agility, behavior, and morphological traits in companion animals, they bear the risk of passing on deleterious mutations to their offspring and ending up with animals that are homozygous for the mutant allele and thus affected with a genetic disease. As there is pressure to increase health, fertility, and productivity in food animals, deleterious traits are rapidly eliminated with proper breeding practices. Furthermore, the diagnostic evaluations and characterizations of genetic diseases have been facilitated by the recent advances in medicine and comparative genetics, pet owner's interest, and financial support from the National Institutes of Health, other government sources, and foundations, as these animals may also serve as models of human disease. However, in companion animals, breeding is done less scientifically, emphasizing looks and character, leaving many animals at risk of carrying mutant alleles that may produce affected offspring in future generations. Because of these inbreeding practices, some mutations seem to be surprisingly prevalent in certain breeds of dogs and cats. Whereas a mutant allele frequency of 1% is considered to be high in humans, mutant allele frequencies of >10% have been reported for several diseases in several breeds of domestic animals, likely because of founder and popular sire effects. Moreover, X-chromosomal recessive traits such as hemophilia A and B, dystrophin deficiency, and X-linked severe combined immunodeficiency seen in different breeds may result from new mutations in oocytes and, thus, may well be limited to a particular family.

It is important to recognize that the Mendelian concepts of dominant and recessive modes of inheritance refer to the phenotypic presentation of heterozygous and homozygous animals for a particular trait. With recessive disorders, the presence of one normal/wild-type allele is sufficient to assure adequate activity to complete a certain function, whereas with a dominant trait the presence of one mutant allele is already deleterious. For instance, mutant and normal collagen strands will not make a functional fibril for normal joint, ligament, and skin structure. Furthermore, at the DNA level any polymorphism or disease-causing mutation is “codominant” and hence the terms dominant and recessive should be reserved for phenotypes and disorders and not be used for genes. Finally, it is being noted that single gene defects can exhibit variations in clinical signs and disease progression that are likely caused by yet to be determined modifying genes or environmental factors. Hence, simply inherited disorders may ultimately be found to have a more complex metabolic and molecular genetic basis.

## 3. Screening for Hereditary Diseases

Genetic screening generally requires more than clinical physical examination, routine blood and urine tests, and imaging studies to detect and definitively diagnose animals with genetic diseases. A variety of specific laboratory tests, such as hematological, biochemical/metabolic, and DNA

analyses, have been developed, some of which not only can identify affected/diseased animals but also can identify asymptomatic carriers of recessively inherited disorders (Giger and Jezyk, 1992; Sewell *et al.*, 2007).

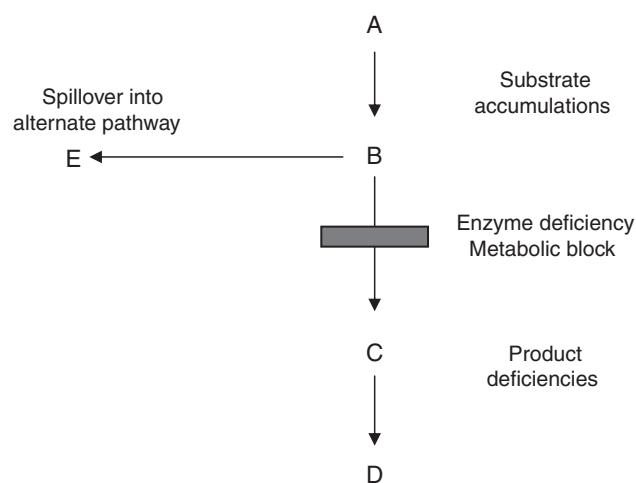
a. Metabolic Genetic Testing

Inborn errors of metabolism may lead to the dysfunction of a biological system or pathway either under normal conditions or during more demanding situations, such as the presence of concurrent disease or during intense work loads, as many defects occur in catabolic pathways. Screening tests should lead to the detection of the failing biological system. Routine tests such as a complete blood count and a chemistry screen may reveal a specific metabolic problem such as inclusions in white blood cells (lysosomal storage disease) or hyperlipidemia (hyperchylomicronemia). Clinical imaging techniques, gastrointestinal and liver function investigations, as well as renal clearance function studies may more clearly define an organ failure, whereas for others the first clue is found only after pathological examination of tissues or at necropsy.

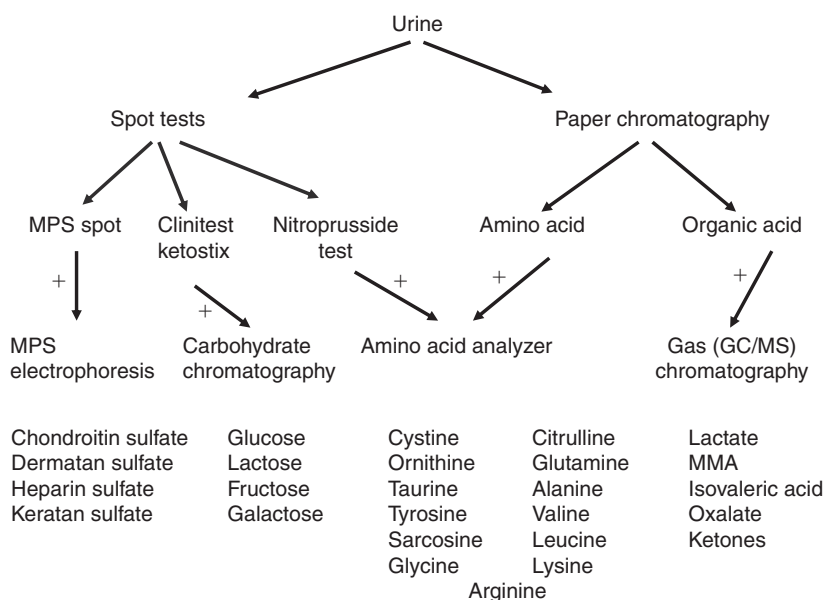
When a metabolic pathway is blocked by an enzyme deficiency, the substrate of that enzyme and other proximal metabolites either accumulate or divert into an alternate pathway (Fig. 2-8). In contrast, the products or distal metabolites subsequent to the enzyme deficiency will be reduced. In some cases, abnormal metabolites or excessive amounts of normal metabolites affect other metabolic pathways by acting as competitive substrates of another enzyme. Depending on the gene mutation, the deficiency can be complete or can lead to more or less severe clinical signs. One of the best examples of a common clinical diagnostic workup based on metabolic pathways is done clinically when

suspecting a specific coagulopathy localizing the defect to the intrinsic (e.g., hemophilia A and B [FVIII and IX]), extrinsic (FVII deficiency), or common pathway (fibrinogen deficiency; see the chapter on hemostatic disorders).

The metabolic diagnosis of an enzyme deficiency can often be accomplished by detecting abnormal metabolites or metabolite concentrations in urine, serum, or cerebrospinal fluid. This was the basis of Garrod's initial urinary metabolite studies on alkaptonuria (homogentisic acid, a defect in the catabolism of phenylalanine and tyrosine), cystinuria, and pentosuria. Although more sophisticated techniques of analysis can now be used, examination of proximal and distal metabolites is still the mainstay of the efforts to diagnose and characterize novel metabolic diseases (Fig. 2-9).



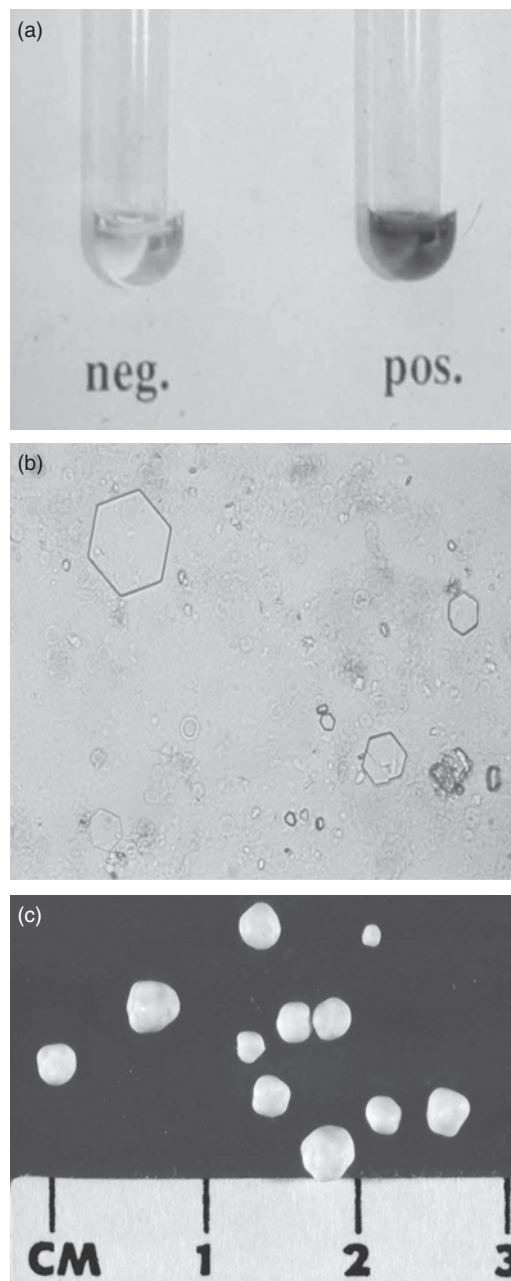
**FIGURE 2-8** Metabolic consequences of an enzyme deficiency. Changes in substrates and product concentrations are shown when step B→C is dysfunctional.



**FIGURE 2-9** Metabolic Genetic Screening Scheme to detect inborn errors of metabolism involving amino and organic acids as well as carbohydrates.

One proceeds from metabolite identification to the demonstration of an enzyme or other gene product defect by assaying the functions of candidate proteins chosen based on the knowledge of metabolic pathways and the previous descriptions of metabolic diseases in the same or other species. Metabolic disorders are often named according to the aberrant substrate associated with the pathological condition rather than the truly defective (deficient) enzyme or cofactor (e.g., cystinuria, lactic aciduria, methylmalonic aciduria, porphyria, and mucopolysaccharidosis). Urine as a metabolic screening specimen is preferred, because abnormal metabolites in the blood will be filtered through the glomeruli but then fail to be reabsorbed, as no specific renal transport systems exist for most abnormal metabolites (Fig. 2-10). In those cases in which normal metabolites accumulate, their quantities usually exceed the renal threshold. As a consequence the amount of such compounds in a given volume of urine is often several fold greater than in blood. The renal tubules do not have the capacity to reabsorb abnormal metabolites or excess normal metabolites, and they become concentrated as water is conserved (Giger and Jezyk, 2000; Sewell *et al.*, 2007).

**i. Examples of Amino Acidurias** The cyanide nitroprusside reaction, which detects any compound containing a sulfhydryl group, is used to screen for cystinuria (and homocystinuria). Cystinuria and other aminoacidurias can be detected by simple spot (nitroprusside) test, paper chromatography using butanol/acetic acid/water as a solvent and ninhydrin stain, and high-pressure liquid chromatography. Cystinuria is caused by defects in renal basic amino acid transporters, which also affect the reabsorption of other amino acids, easily recalled as COLAs: cystine, ornithine, lysine, and arginine. Because cystine precipitates in acidic urine, cystine calculi are formed in the kidney, ureters, bladder, and urethra, leading to life-threatening urinary obstruction (Figure 2-10). The molecular defect has been defined in affected Newfoundland and Labrador retriever dogs, but in the many other dog breeds where the disease is milder and only appears to affect males, the molecular basis still needs to be elucidated. Cystinuria has been identified as a common renal transport defect in a variety of canine breeds, domestic shorthair cats, and also some wild carnivores (Henthorn and Giger, 2006). Interestingly in cats, which completely depend on arginine intake from their diet, the urinary loss in arginine can result in arginine deficiency and ensuing hyperammonemia and neuropathy. In addition, the most severe renal tubular defect involves glucosuria, lactic aciduria, and generalized amino aciduria and is known as Fanconi syndrome. Originally discovered and still common in Basenji dogs, it is now recognized in many other canine breeds, but can also be induced by dietary supplements.



**FIGURE 2-10** Cystinuria caused by renal amino acid transport defects. (a) Urinary nitroprusside screening test to detect cystine (magenta red discoloration indicates a positive reaction). (b) Characteristic hexagonal cystine crystals in urine sediment. (c) Cystine calculi removed from the urinary bladder.

**ii. Screening for Organic Acids** Methylmalonic aciduria is a prime example of an organic aciduria. Methylmalonic acid is a metabolite of an alternative pathway that only accumulates when there is a block in the catabolism of various amino acids, fatty acids, and cholesterol in the tricarboxic cycle. It may be caused by either an intermediary enzyme deficiency or cobalamin (vitamin B<sub>12</sub>) deficiency, because cobalamin is a cofactor of the

intermediary mutase step. In several breeds of dog, a selective malabsorption of cobalamin has been identified because of a lack of expression of cubulin or amnionless, the intrinsic-cobalamin receptor on the surface of the brush border of the enterocytes in the ileum. Cobalamin is also involved in transmethylation reactions along with folate and its deficiency affects cell growth and hematopoiesis. Hence affected animals fail to thrive, and can become lethargic and cachectic. Fortunately, this serious metabolic disorder can be readily treated by regular parenteral supplementation of cobalamin, thereby circumventing the ileal resorption defect (Fyfe *et al.*, 2004; He *et al.*, 2005). There are several other organic acidurias described in animals, including lactic acidurias causing mitochondrial myopathies and primary hyperoxaluria with kidney calculi and renal failure.

#### b. Protein Function in Affected and Carrier Animals

Usually the biochemical phenotype of an enzyme deficiency is associated with the disease phenotype, and, as traits, they are inherited recessively, because most enzyme activities are present in excessive amounts than what is minimally necessary to process sufficient substrate for normal development and health. Enzyme activity is expressed in units or as a percentage of control, which is set at 100%. Generally, activity levels of at least 25% are still sufficient for most biological functions. The most immediate effects are seen with key regulatory enzymes in important intermediary pathways such as anaerobic glycolysis. One can often demonstrate the coexpression, or gene dosage effect, of the normal and mutant allele by measuring the activity or quantity of the protein (enzyme) in question in tissues of the affected individual, parent, and littermates compared to normal unrelated control animals. In autosomal recessively inherited diseases, the affected individuals will have enzyme activities of <20% and often 0% to 5% of the normal, whereas some littermates and possibly unrelated healthy appearing animals, and the (clinically unaffected) parents of affected animals will have an enzyme activity somewhere around half (30% to 75%) of normal control values. This forms the basis of many carrier detection programs for hereditary diseases. However, the efficiency of carrier detection by protein quantification or function can be seriously affected by various parameters (tissue-specific expression, labile activity, control samples, special shipping and handling). *In vitro* enzyme activity may also not really reflect the *in vivo* expression and function but may depend on substrate and cofactor availability and affinity and is usually measured using artificial substrates. Despite the lack of functional activity of a protein in a disorder, the dysfunctional protein may or may not be present and may be detected through immunological techniques. Thereby animals with and without a protein can be differentiated into cross-reacting material (CRM) positive and negative.

#### c. Molecular Genetic Testing

More recently, DNA testing for the disease-causing gene mutation can most accurately diagnose many metabolic diseases. Disease-causing mutations have been found in all domestic mammals. These tests are based on amplifying the DNA segment around the disease-causing mutation and differentiating the mutant from the normal by sequencing or identifying fragment size differences with a restriction enzyme digest (discussed previously). Such molecular tests can be accomplished with ethylene diamine tetraacetic acid (EDTA) blood or cheek swabs, and they readily permit the identification of normal, carrier, and affected animals for recessive traits as well as any dominant mutation in the heterozygous, hemizygous, and homozygous presentation. However, mutation-specific DNA tests are generally species and typically breed specific. For instance, different mutations have been found to cause pyruvate kinase deficiency in the basenji, West Highland white (and Cairn) terrier, and beagle breeds (Giger, in press; Skelly *et al.*, 1999; Whitney *et al.*, 1994). In contrast, a single missense mutation seems to be responsible for factor VII deficiency in beagles, Alaskan klee kai, and Scottish deerhounds (Callan *et al.*, 2006).

### E. Gene Therapy

Gene therapy refers to the novel treatment of disease by introducing a new gene into a cell; usually the new gene provides a function that is missing because of a defective gene such as for the many hereditary diseases. In general, the defective gene remains, although techniques to repair defective genes are also possible. There are many reviews of gene therapy for metabolic diseases including both general and specific disease-related overviews (Biffi and Naldini, 2005; Brady, 2006; Hodges and Cheng, 2006; Pastores and Barnett, 2005; Sawkar *et al.*, 2006) and those involving large animals (Casal and Haskins, 2006; Ellinwood *et al.*, 2004). This section discusses gene therapy for lysosomal storage diseases (LSDs), primarily in domestic animals, as an example of the field. Clinicopathological and biochemical characteristics of LSDs are presented in a later chapter in this book (Haskins and Giger, in press). Guiding principles for treating LSDs and other inborn errors of metabolism include the following: (1) The earlier the treatment can be instituted, the better the outcome. Thus, prevention of central nervous system or bone disease is more successful than reversing existing lesions. (2) In those disorders with multiple organ involvement, some tissues respond better than others. Thus, in general, liver function is relatively easy to improve, whereas articular cartilage and bone functions are more difficult to change. Because of the blood-brain barrier, the brain and spinal cord present a unique set of challenges. (3) Novel approaches are being developed and assessed regarding efficacy and safety of gene therapy in dogs and

cats as an intermediate between the murine models and applications in humans. Hence, gene therapy, though promising for humans and animals alike and potentially simple to administer, is still an experimental approach for inborn errors of metabolism.

There are several ways to introduce a new gene into a cell. One of the more common current approaches uses viruses that act as vectors to target and transport DNA into a cell, often into the nuclear DNA. The viral vectors are modified to make them replication incompetent and contain additional genetic material, usually including at least a promoter in addition to the cDNA of the gene of interest. Many viruses have been used for gene transfer, including recombinant herpesviruses, lentiviruses, adeno-associated viruses (AAV), adenoviruses (Ad), and Sendai virus (reviewed in Verma and Weitzman, 2005). Although gene therapy is a promising technique for therapy for the LSDs, concerns remain, particularly those involving carcinogenesis. Integration can interfere with the normal function of nearby genes (Hacein-Bey-Abina *et al.*, 2003; Schmidt *et al.*, 2005) with ensuing deleterious effects. Thus, although recombinant retroviral vector gene therapy cured 80% of X-linked Severe-Combined Immunodeficiency (SCID) patients, the development of leukemia in some patients made real what had been a hypothetical risk since the early experiments in the 1990s. Also, the development of tumors in aged Mucopolysaccharidosis (MPS) VII mice that received recombinant adeno-associated viral vectors at birth have been reported (Donsante *et al.*, 2001). Other limitations have included an immune response to the vector or the transgenes they encode, particularly when individuals have a null mutation resulting in no protein production. In general, viral vectors are made replication incompetent by various techniques, such as removing genes encoding structural viral genes, limiting concerns about shedding vector for extended periods, and reducing the potential immune responses against the virus. However, readministration of a vector has a significant potential to induce an immune response. The search for new vectors and ways to modify existing vectors to reduce these limitations is ongoing. Three viral vectors currently in common use include the following:

1. Retroviruses are RNA viruses that reverse transcribe their single-stranded genome and can integrate into host chromosomes (Fields and Knipe, 1986). Some murine retrovirus vectors—for example, those based on murine leukemia viruses—transduce only dividing cells. Lentiviruses can also transduce nonreplicating cells (Fields and Knipe, 1986) and have been generated from the human immunodeficiency virus and feline immunodeficiency virus (Johnston *et al.*, 1999; Stein and Davidson, 2002) among others. The tropism of retroviruses can be modified by providing an alternative envelope glycoprotein during virus production, leading to broader cell-type targeting and enhanced stability upon enrichment (Stein *et al.*, 2005; Wong *et al.*, 2004).

2. Adenoviruses are nonenveloped double-stranded DNA viruses (Fields and Knipe, 1986), which can infect a variety of both quiescent and proliferating cells. The vectors have space for large transgenes; however, transgene expression is often transient because of host immune responses to the vector (Stein *et al.*, 1998; Yang *et al.*, 1996).

3. Adeno-associated viruses (AAV) are small single-stranded DNA viruses that do not produce disease but are, as the name implies, associated with adenoviruses (Fields and Knipe, 1986). This relationship renders AAV's replication incompetent without a helper virus, usually an adenovirus or a herpesvirus. Many serotypes have been developed (Chiorini *et al.*, 1997; Schmidt *et al.*, 2004), with most showing distinct tissue tropism (Gao *et al.*, 2005).

### 1. Approaches for Gene Therapy Using Lysosomal Storage Diseases as Examples

#### a. *Ex Vivo* Gene Therapy

The usual strategy in this approach is to modify autologous patient cells *in vitro*, returning them to the patient to create an “enzyme factory” to secrete a specific enzyme into the extracellular fluid to be taken up by other cells elsewhere in the body, thereby “cross-correcting” them. The most common therapeutic target is the pluripotent hematopoietic stem cell. Not only can these cells secrete enzyme into the circulation, they can repopulate fixed macrophages in liver, lung, brain, and elsewhere allowing widely distributed sites of local enzyme production. The rationale for this approach has been from the experience of heterologous bone marrow transplantation in animals and children (Birkenmeier *et al.*, 1991; Breider *et al.*, 1989; Consiglio *et al.*, 2004; Follenzi *et al.*, 2002; Hoogerbrugge *et al.*, 1988; Miranda *et al.*, 1998; Sands *et al.*, 1993; Taylor *et al.*, 1986; Walkley *et al.*, 1994; Yeager *et al.*, 1984). Gene therapy of autologous cells avoids the difficulties of finding a histocompatible bone marrow donor, and if engineered to have very high gene expression, the transduced cells will deliver substantially larger amounts of enzyme than normal cells (Biffi *et al.*, 2004).

*Ex vivo* transduction and transplantation into enzyme-deficient mouse models of LSDs has shown efficacy *in vivo* using murine retroviruses (Miranda *et al.*, 2000; Wolfe *et al.*, 1992). Thus, hematopoietic-directed gene therapy may be effective for the treatment of the systemic disease associated with a number of LSDs. However, thus far, this approach has not achieved the success in clinical trials that was seen in the animal models (Dunbar *et al.*, 1998), possibly because of a lack of conditioning to reduce resident bone marrow. Lentiviral vectors may be a better choice over murine retroviruses, because they transduce nondividing cells and show persistent *in vivo* expression.

### b. Direct *In Vivo* Gene Therapy

As an alternative to *ex vivo* therapy, direct *in vivo* gene therapy is the injection of a gene transfer vector directly into a tissue or into the blood circulation. There are many examples in small and large animal models of LSD using a variety of vectors (Daly *et al.*, 1999a, 1999b, 2001; Gao *et al.*, 2000; Hartung *et al.*, 2004; Jung *et al.*, 2001; Ponder *et al.*, 2002, 2006; Xu *et al.*, 2005). As described earlier, each vector has advantages and disadvantages for tissue tropism, longevity of expression, and immune response and other side effects. Issues of long-term safety (greater than 10 years) have not been fully evaluated. The studies in neonates demonstrate the utility of early (disease prevention) rather than delayed (disease reversal) intervention for these progressive disorders. One of the most dramatic examples of neonatal, intravenous gene therapy in a large animal was reported in dogs with mucopolysaccharidosis VII, where the corneal clouding and mitral valve regurgitation were prevented and the dogs, now 6 years old, continue to be able to stand, walk, and run (albeit without a completely normal gait), whereas untreated dogs cannot stand by 6 months of age (Ponder *et al.*, 2002).

Retinal degeneration is a relatively common clinical sign associated with a number of LSDs. Viral-mediated gene transfer by direct subretinal or vitreous injection has resulted in histological or functional improvements in mice and cats (Griffey *et al.*, 2005; Hennig *et al.*, 2004; Ho *et al.*, 2002).

The central nervous system (CNS) is a particularly challenging tissue. Over half of LSDs have CNS signs of mental retardation in children, and some also present with progressive ataxia in animals leading to early mortality. A large series of experiments have been performed using injections of a variety of vectors directly into the brain of mice with LSDs (Brooks *et al.*, 2002; Elliger *et al.*, 1999; Ellinwood *et al.*, 2004; Haskell *et al.*, 2003; Passini and Wolfe, 2001; Passini *et al.*, 2002, 2003; Stein and Davidson, 2002; Stein *et al.*, 2005; Vogler *et al.*, 1998). Selected areas of the brain have been injected with minute amounts of the gene construct, and the clinical, pathological, and biochemical effects have shown variable success. For instance, a remarkable reduction in neuronal storage and delayed onset of clinical signs was seen in cats with alpha-mannosidosis (Vite *et al.*, 2005). An alternate intravenous approach with a high dose of purified enzyme apparently crossed the blood-brain barrier in MPS VII mice (Vogler *et al.*, 2005) and is currently being tested in large animals.

As the examples for lysosomal storage diseases illustrate, gene therapy is moving forward with therapies for many metabolic diseases. Promising results have also been seen in dogs with hemophilia (Arruda *et al.*, 2005) and a form of progressive retinopathy (Acland *et al.*, 2001). As research continues into safe and effective approaches of

providing genes with appropriate expression, a new era in therapeutics will begin.

## REFERENCES

- Acland, G. M., Aguirre, G. D., Ray, J., Zhang, Q., Aleman, T. S., Cideciyan, A. V., Pearce-Kelling, S. E., Anand, V., Zeng, Y., Maguire, A. M., Jacobson, S. G., Hauswirth, W. W., and Bennett, J. (2001). Gene therapy restores vision in a canine model of childhood blindness. *Nat. Genet.* **28**(1), 92–95.
- Arruda, V. R., Stedman, H. H., Nichols, T. C., Haskins, M. E., Nicholson, M., Herzog, R. W., Couto, L. B., and High, K. A. (2005). Regional intravascular delivery of AAV-2-FIX to skeletal muscle achieves long-term correction of hemophilia B in a large animal model. *Blood* **105**(9), 3458–3464.
- Biffi, A., De Palma, M., Quattrini, A., Del Carro, U., Amadio, S., Visigalli, I., Sessa, M., Fasano, S., Brambilla, R., Marchesini, S., Bordignon, C., and Naldini, L. (2004). Correction of metachromatic leukodystrophy in the mouse model by transplantation of genetically modified hematopoietic stem cells. *J. Clin. Invest.* **113**, 1118–1129.
- Biffi, A., and Naldini, L. (2005). Gene therapy of storage disorders by retroviral and lentiviral vectors. *Hum. Gene Ther.* **16**, 1133–1142.
- Birkenmeier, E. H., Barker, J. E., Vogler, C. A., Kyle, J. W., Sly, W. S., Gwynn, B., Levy, B., and Pegors, C. (1991). Increased life span and correction of metabolic defects in murine mucopolysaccharidosis type VII after syngeneic bone marrow transplantation. *Blood* **78**, 3081–3092.
- Brady, R. O. (2006). Emerging strategies for the treatment of hereditary metabolic storage disorders. *Rejuvenation Res.* **9**, 237–244.
- Breider, M. A., Shull, R. M., and Constantopoulos, G. (1989). Long-term effects of bone marrow transplantation in dogs with I. *Am. J. Pathol.* **134**, 677–692.
- Brooks, A. I., Stein, C. S., Hughes, S. M., Heth, J., McCray, P. M., Jr., Sauter, S. L., Johnston, J. C., Cory-Slechta, D. A., Federoff, H. J., and Davidson, B. L. (2002). Functional correction of established central nervous system deficits in an animal model of lysosomal storage disease with feline immunodeficiency virus-based vectors. *Proc. Natl. Acad. Sci. USA* **99**(9), 6216–6221.
- Buckley, R. H. (2002). Gene therapy for SCID: a complication after remarkable progress. *Lancet* **360**, 1185–1186.
- Callan, M. B., Aljamali, M. N., Margaritis, P., Griot-Wenk, M. E., Pollak, E. S., Werner, P., Giger, U., and High, K. A. (2006). A novel missense responsible for factor VII deficiency in research Beagle colonies. *J. Thrombo. Haemost.* **4**, 1616–2622.
- Casal, M., and Haskins, M. (2006). Large animal models and gene therapy. *Eur. J. Hum. Genet.* **14**, 266–272.
- Chiorini, J. A., Yang, L., Liu, Y., Safer, B., and Kotin, R. M. (1997). Cloning of adeno-associated virus type 4 (AAV4) and generation of recombinant AAV4 particles. *J. Virol.* **71**, 6823–6833.
- Collins, F. S., Green, E. D., Guttacher, A. E., and Guyer, M. S. (2003). A vision for the future of genomics research. *Nature* **422**(6934), 835–847.
- Consiglio, A., Gritti, A., Dolcetta, D., Follenzi, A., Bordignon, C., Gage, F. H., Vescovi, A. L., and Naldini, L. (2004). Robust *in vivo* gene transfer into adult mammalian neural stem cells by lentiviral vectors. *Proc. Natl. Acad. Sci. USA* **101**, 14835–14840.
- Daly, T. M., Ohlemiller, K. K., Roberts, M. S., Vogler, C. A., and Sands, M. S. (2001). Prevention of systemic clinical disease in MPS VII

- mice following AAV-mediated neonatal gene transfer. *Gene Ther.* **8**, 1291–1298.
- Daly, T. M., Okuyama, T., Vogler, C., Haskins, M. E., Muzyczka, N., and Sands, M. S. (1999a). Neonatal intramuscular injection with recombinant adeno-associated virus results in prolonged beta-glucuronidase expression in situ and correction of liver pathology in mucopolysaccharidosis type VII mice. *Hum. Gene Ther.* **10**, 85–94.
- Daly, T. M., Vogler, C., Levy, B., Haskins, M. E., and Sands, M. S. (1999b). Neonatal gene transfer leads to widespread correction of pathology in a murine model of lysosomal storage disease. *Proc. Natl. Acad. Sci. USA* **96**, 2296–2300.
- Donsante, A., Vogler, C., Muzyczka, N., Crawford, J. M., Barker, J., Flotte, T., Campbell-Thompson, M., Daly, T., and Sands, M. S. (2001). Observed incidence of tumorigenesis in long-term rodent studies of rAAV vectors. *Gene Ther.* **8**, 1343–1346.
- Dunbar, C. E., Kohn, D. B., Schiffmann, R., Barton, N. W., Nolte, J. A., Esplin, J. A., Pensiero, M., Long, Z., Lockey, C., Emmons, R. V., Csik, S., Leitman, S., Krebs, C. B., Carter, C., Brady, R. O., and Karlsson, S. (1998). Retroviral transfer of the glucocerebrosidase gene into CD34+ cells from patients with Gaucher disease: in vivo detection of transduced cells without myeloablation. *Hum. Gene Ther.* **9**, 2629–2640.
- Elliger, S. S., Elliger, C. A., Aguilar, C. P., Raju, N. R., and Watson, G. L. (1999). Elimination of lysosomal storage in brains of MPS VII mice treated by intrathecal administration of an adeno-associated virus vector. *Gene Ther.* **6**(6), 1175–1178.
- Ellinwood, N. M., Vite, C. H., and Haskins, M. E. (2004). Gene therapy for lysosomal storage diseases: the lessons and promise of animal models. *J. Gene Med.* **6**, 481–506.
- Fields, B. N., and Knipe, D. M. (1986). "Fundamental Virology." Raven Press, New York.
- Follenzi, A., Sabatino, G., Lombardo, A., Boccaccio, C., and Naldini, L. (2002). Efficient gene delivery and targeted expression to hepatocytes in vivo by improved lentiviral vectors. *Hum. Gene Ther.* **13**, 243–260.
- Fourman, P., Whiteley, M., and Giger, U. (2002). Canine leukocyte adhesion deficiency: presence of the Cys36Ser beta 2 integrin mutation in an affected Irish setter cross-bred dog and in Irish Red and White setters in the US. *J. Vet. Intern. Med.* **16**, 518–521.
- Fujii, J., Otsu, K., Zorzato, F., de Leon, S., Khanna, V. K., Weiler, J. E., O'Brien, P. J., and MacLennan, D. H. (1991). Identification of a mutation in porcine ryanodine receptor associated with malignant hyperthermia. *Science* **253**(5018), 448–451.
- Fyfe, J. C., Madsen, M., Hojrup, P., Christensen, E. I., Tanner, S. M., de la Chapelle, A., He, Q., and Moestrup, S. K. (2004). The functional cobalamin (vitamin B12)-intrinsic factor receptor is a novel complex of cubilin and amnionless. *Blood* **103**, 1573–1579.
- Gao, C., Sands, M. S., Haskins, M. E., and Ponder, K. P. (2000). Delivery of a retroviral vector expressing human beta-glucuronidase to the liver and spleen decreases lysosomal storage in mucopolysaccharidosis VII mice. *Mol. Ther.* **2**, 233–244.
- Gao, G., Vandenberghe, L. H., and Wilson, J. M. (2005). New recombinant serotypes of AAV vectors. *Curr. Gene Ther.* **5**, 285–297.
- Giger, U. Hereditary ethocyte disorders. In "Kirk's Current Veterinary Therapy XIV (J. D. Bonagura, Ed.), Saunders, Philadelphia, in press.
- Giger, U., Harvey, J. W., Yamaguchi, R. A., McNulty, P. K., Chiapella, A., and Beutler, E. (1985). Inherited phosphofructokinase deficiency in dogs with hyperventilation-induced hemolysis: increased in vitro and in vivo alkaline fragility of erythrocytes. *Blood* **65**, 345–351.
- Giger, U., and Jezyk, P. F. (1992). Diagnosis of inherited diseases in small animals. In "Current Veterinary Therapy XI Small Animal Practice" (R. W. Kirk and J. D. Bonagura, Eds.), pp. 18–22. Saunders, Philadelphia.
- Giger, U., Sargan, D. R., and McNeil, E. A. (2006). Breed-specific hereditary diseases and genetic screening. In "The Dog and Its Genome" (E. A. Ostrander, U. Giger, and K. Lindblad-Toh, Eds.) pp. 249–289. Cold Spring Harbor Laboratory Press, New York.
- Griffey, M., Macauley, S. L., Ogilvie, J. M., and Sands, M. S. (2005). AAV2-mediated ocular gene therapy for infantile neuronal ceroid lipofuscinosis. *Mol. Ther.* **12**, 413–421.
- Hacein-Bey-Abina, S., von Kalle, C., Schmidt, M., Le Deist, F., Wulffraat, N., McIntyre, E., Radford, I., Villeval, J. L., Fraser, C. C., Cavazzana-Calvo, M., and Fischer, A. (2003). A serious adverse event after successful gene therapy for X-linked severe combined immunodeficiency. *N. Engl. J. Med.* **348**, 255–256.
- Hartung, S. D., Frandsen, J. L., Pan, D., Koniar, B. L., Graupman, P., Gunther, R., Low, W. C., Whitley, C. B., and McIvor, R. S. (2004). Correction of metabolic, craniofacial, and neurologic abnormalities in MPS I mice treated at birth with adeno-associated virus vector transducing the human alpha-L-iduronidase gene. *Mol. Ther.* **9**, 866–875.
- Haskell, R. E., Hughes, S. M., Chiorini, J. A., Alisky, J. M., and Davidson, B. L. (2003). Viral-mediated delivery of the late-infantile neuronal ceroid lipofuscinosis gene, TPP-I to the mouse central nervous system. *Gene Ther.* **10**(1), 34–42.
- Haskins, M. E., and Giger, U. Lysosomal storage diseases. In "Biochemistry in Domestic Animals" (J. Kaneko, Ed.), Elsevier Academic Press, Boston, in press.
- He, Q., Madsen, M., Kilkenney, A., Gregory, B., Christensen, E. I., Vorum, H., Hojrup, P., Schaffer, A. A., Kirkness, E. F., Tanner, S. M., de la Chapelle, A., Giger, U., Moestrup, S. K., and Fyfe, J. C. (2005). Amnionless function is required for cubilin brush-border expression and intrinsic factor-cobalamin (vitamin B12) absorption in vivo. *Blood* **106**, 1447–1453.
- Hennig, A. K., Ogilvie, J. M., Ohlemiller, K. K., Timmers, A. M., Hauswirth, W. W., and Sands, M. S. (2004). AAV-mediated intravitreal gene therapy reduces lysosomal storage in the retinal pigmented epithelium and improves retinal function in adult MPS VII mice. *Mol. Ther.* **10**, 106–116.
- Henthorn, P. S., and Giger, U. (2006). Cystinuria. In "The Dog and Its Genome" (E. A. Ostrander, U. Giger, and K. Lindblad-Toh, Eds.), pp. 349–364. Cold Spring Harbor Laboratory Press, New York.
- Hitte, C., Madeoy, J., Kirkness, E. F., Priat, C., Lorentzen, T. D., Senger, F., Thomas, D., Derrien, T., Ramirez, C., Scott, C., Evanno, G., Pullar, B., Cadieu, E., Oza, V., Lourgant, K., Jaffe, D. B., Tacher, S., Dreano, S., Berkova, N., Andre, C., Deloukas, P., Fraser, C., Lindblad-Toh, K., Ostrander, E. A., and Galibert, F. (2005). Facilitating genome navigation: survey sequencing and dense radiation-hybrid gene mapping. *Nat. Rev. Genet.* **6**(8), 643–648.
- Ho, T. T., Maguire, A. M., Aguirre, G. D., Surace, E. M., Anand, V., Zeng, Y., Salvetti, A., Hopwood, J. J., Haskins, M. E., and Bennett, J. (2002). Phenotypic rescue after adeno-associated virus-mediated delivery of 4-sulfatase to the retinal pigment epithelium of feline mucopolysaccharidosis VI. *J. Gene Med.* **4**, 613–621.
- Hodges, B. L., and Cheng, S. H. (2006). Cell and gene-based therapies for the lysosomal storage diseases. *Curr. Gene Ther.* **6**, 227–241.
- Hoogerbrugge, P. M., Suzuki, K., Suzuki, K., Poorthuis, B. J., Kobayashi, T., Wagemaker, G., and van Bekkum, D. W. (1988). Donor-derived cells in the central nervous system of twitcher mice after bone marrow transplantation. *Science* **239**, 1035–1038.



- Johnston, J. C., Gasmi, M., Lim, L. E., Elder, J. H., Yee, J. K., Jolly, D. J., Campbell, K. P., Davidson, B. L., and Sauter, S. L. (1999). Minimum requirements for efficient transduction of dividing and nondividing cells by feline immunodeficiency virus vectors. *J. Virol.* **73**, 4991–5000.
- Jung, S. C., Han, I. P., Limaye, A., Xu, R., Gelderman, M. P., Zervas, P., Tirumalai, K., Murray, G. J., During, M. J., Brady, R. O., and Qasba, P. (2001). Adeno-associated viral vector-mediated gene transfer results in long-term enzymatic and functional correction in multiple organs of Fabry mice. *Proc. Natl. Acad. Sci. USA* **98**, 2676–2681.
- Kijas, J. M., Bauer, T. R. Jr., Marklund, S., Trowald-Wigh, G., Johannisson, A., Hedhammar, A., Binns, M., Juncja, R. K., Hickstein, D. D., and Andersson, L. (1999). A missense mutation in the beta-2 integrin gene (ITGB2) causes canine leukocyte adhesion deficiency. *Genomics*. **61**, 101–107.
- Mealey, K. L., Bentjen, S. A., Gay, J. M., and Cantor, G. H. (2001). Ivermectin sensitivity in collies is associated with a deletion mutation of the *mdr1* gene. *Pharmacogenetics* **11**, 727–733.
- Miranda, S. R., Erlich, S., Friedrich, V. L., Jr., Gatt, S., and Schuchman, E. H. (2000). Hematopoietic stem cell gene therapy leads to marked visceral organ improvements and a delayed onset of neurological abnormalities in the acid sphingomyelinase deficient mouse model of Niemann-Pick disease. *Gene Ther.* **7**, 1768–1776.
- Miranda, S. R., Erlich, S., Friedrich, V. L., Jr., Haskins, M. E., Gatt, S., and Schuchman, E. H. (1998). Biochemical, pathological, and clinical response to transplantation of normal bone marrow cells into acid sphingomyelinase-deficient mice. *Transplantation* **65**, 884–892.
- Nakajima, H., Raben, N., Hamaguchi, T., and Yamasaki, T. (2002). Phosphofructokinase deficiency: past, present and future. *Curr. Mol. Med.* **2**(2), 197–212.
- Neff, M. W., Robertson, K. R., Wong, A. K., Safra, N., Broman, K. W., Slatkin, M., Mealey, K. L., and Pedersen, N. C. (2004). Breed distribution and history of canine *mdr1*-1Delta, a pharmacogenetic mutation that marks the emergence of breeds from the collie lineage. *Proc. Natl. Acad. Sci. USA* **101**, 11725–11730.
- Olivier, M., Aggarwal, A., Allen, J., Almendras, A. A., Bajorek, E. S., Beasley, E. M., Brady, S. D., Bushard, J. M., Bustos, V. I., Chu, A., Chung, T. R., De Witte, A., Denys, M. E., Dominguez, R., Fang, N. Y., Foster, B. D., Freudenberg, R. W., Hadley, D., Hamilton, L. R., Jeffrey, T. J., Kelly, L., Lazzaroni, L., Levy, M. R., Lewis, S. C., Liu, X., Lopez, F. J., Louie, B., Marquis, J. P., Martinez, R. A., Matsuura, M. K., Mishergchi, N. S., Norton, J. A., Olshen, A., Perkins, S. M., Perou, A. J., Piercy, C., Piercy, M., Qin, F., Reif, T., Sheppard, K., Shokoohi, V., Smick, G. A., Sun, W. L., Stewart, E. A., Fernando, J., Tejada, Tran, N. M., Trejo, T., Vo, N. T., Yan, S. C., Zierten, D. L., Zhao, S., Sachidanandam, R., Trask, B. J., Myers, R. M., and Cox, D. R. (2001). A high-resolution radiation hybrid map of the human genome draft sequence. *Science* **291**(5507), 1298–1302.
- Olson, M., Hood, L., Cantor, C., and Botstein, D. (1989). A common language for physical mapping of the human genome. *Science* **245**(4925), 1434–1435.
- Ostrander, E. A., Giger, U., and Lindblad-Toh, K. (2006). “The Dog and Its Genome.” Cold Spring Harbor Laboratory Press, New York.
- Passini, M. A., Lee, E. B., Heuer, G. G., and Wolfe, J. H. (2002). Distribution of a lysosomal enzyme in the adult brain by axonal transport and by cells of the rostral migratory stream. *J. Neurosci.* **22**(15), 6437–6446.
- Passini, M. A., Watson, D. J., Vite, C. H., Landsburg, D. J., Feigenbaum, A. L., and Wolfe, J. H. (2003). Intraventricular brain injection of adeno-associated virus type 1 (AAV1) in neonatal mice results in complementary patterns of neuronal transduction to AAV2 and total long-term correction of storage lesions in the brains of beta-glucuronidase-deficient mice. *J. Virol.* **77**, 7034–7040.
- Passini, M. A., and Wolfe, J. H. (2001). Widespread gene delivery and structure-specific patterns of expression in the brain after intraventricular injections of neonatal mice with an adeno-associated virus vector. *J. Virol.* **75**(24), 12382–12392.
- Pastores, G. M., and Barnett, N. L. (2005). Current and emerging therapies for the lysosomal storage disorders. *Expert Opin. Emerg. Drugs* **10**, 891–902.
- Ponder, K. P., Melniczek, J. R., Xu, L., Weil, M. A., O’Malley, T. M., O’Donnell, P. A., Knox, V. W., Aguirre, G. D., Mazrier, H., Ellinwood, N. M., Sleeper, M., Maguire, A. M., Volk, S. W., Mango, R. L., Zweigle, J., Wolfe, J. H., and Haskins, M. E. (2002). Therapeutic neonatal hepatic gene therapy in mucopolysaccharidosis VII dogs. *Proc. Natl. Acad. Sci. USA* **99**, 13102–13107.
- Ponder, K. P., Wang, B., Wang, P., Ma, X., Herati, R., Wang, B., Cullen, K., O’Donnell, P., Ellinwood, N. M., Traas, A., Primeau, T. M., and Haskins, M. E. (2006). Mucopolysaccharidosis I cats mount a cytotoxic T lymphocyte response after neonatal gene therapy that can be blocked with CTLA4-Ig. *Mol. Ther.* **14**, 5–13.
- Sands, M. S., Barker, J. E., Vogler, C., Levy, B., Gwynn, B., Galvin, N., Sly, W. S., and Birkenmeier, E. (1993). Treatment of murine mucopolysaccharidosis type VII by syngeneic bone marrow transplantation in neonates. *Lab. Invest.* **68**, 676–686.
- Sawkar, A. R., D’Haeze, W., and Kelly, J. W. (2006). Therapeutic strategies to ameliorate lysosomal storage disorders—a focus on Gaucher disease. *Cell. Mol. Life. Sci.* **63**, 1179–1192.
- Schmidt, M., Hacein-Bey-Abina, S., Wissler, M., Carlier, F., Lim, A., Prinz, C., Glimm, H., Andre-Schmutz, I., Hue, C., Garrigue, A., Le Deist, F., Lagresle, C., Fischer, A., Cavazzana-Calvo, M., and von Kalle, C. (2005). Clonal evidence for the transduction of CD34+ cells with lymphomyeloid differentiation potential and self-renewal capacity in the SCID-X1 gene therapy trial. *Blood* **105**, 2699–2706.
- Schmidt, M., Katano, H., Bossis, I., and Chiorini, J. A. (2004). Cloning and characterization of a bovine adeno-associated virus. *J. Virol.* **78**, 6509–6516.
- Scriver, C. R., Beaudet, A. L., Sly, W. S., and Valle, D. (2001). “The Metabolic and Molecular Bases of Inherited Disease.” 8th ed. McGraw-Hill, New York. Available at [www.ommbid.com](http://www.ommbid.com)
- Sewell, A., Haskins, M. E., and Giger, U. (2007). Inherited metabolic disease in companion animals: searching for nature’s mistakes. *Vet. J.* **174**, 252–259.
- Shuster, D. E., Kehrl, M. E., Ackermann, M. R., and Gilbert, R. O. (1992). Identification and prevalence of a genetic defect that causes leukocyte adhesion deficiency in Holstein cattle. *Proc. Natl. Acad. Sci. USA* **89**, 9225–9229.
- Skelly, B. J., Wallace, M., Rajpurohit, Y., Wang, P., and Giger, U. (1999). Identification of a 6 base pair insertion in West Highland White Terriers with erythrocyte pyruvate kinase deficiency. *Am. J. Vet. Res.* **60**, 1169–1172.
- Smith, B. F., Stedman, H., Rajpurohit, Y., Henthorn, P. S., Wolfe, J. H., Patterson, D. F., and Giger, U. (1996). Molecular basis of canine muscle type phosphofructokinase deficiency. *J. Biol. Chem.* **271**(33), 20070–20074.
- Stein, C. S., and Davidson, B. L. (2002). Gene transfer to the brain using feline immunodeficiency virus-based lentivirus vectors. *Methods Enzymol.* **346**, 433–454.
- Stein, C. S., Martins, I., and Davidson, B. L. (2005). The lymphocytic choriomeningitis virus envelope glycoprotein targets lentiviral gene

- transfer vector to neural progenitors in the murine brain. *Mol. Ther.* **11**, 382–389.
- Stein, C. S., Pemberton, J. L., van Rooijen, N., and Davidson, B. L. (1998). Effects of macrophage depletion and anti-CD40 ligand on transgene expression and redosing with recombinant adenovirus. *Gene Ther.* **5**, 431–439.
- Stewart, E. A., McKusick, K. B., Aggarwal, A., Bajorek, E., Brady, S., Chu, A., Fang, N., Hadley, D., Harris, M., Hussain, S., Lee, R., Maratukulam, A., O'Connor, K., Perkins, S., Piercy, M., Qin, F., Reif, T., Sanders, C., She, X., Sun, W. L., Tabar, P., Voyticky, S., Cowles, S., Fan, J. B., Mader, C., Quackenbush, J., Myers, R. M., and Cox, D. R. (1997). An STS-based radiation hybrid map of the human genome. *Genome Res.* **7**(5), 422–433.
- Tarui, S., Okuno, G., Ikura, Y., Tanaka, T., Suda, M., and Nishikawa, M. (1965). Phosphofructokinase deficiency in skeletal muscle. A new type of glycogenosis. *Biochem. Biophys. Res. Commun.* **19**, 517–523.
- Taylor, R. M., Farrow, B. R., Stewart, G. J., and Healy, P. J. (1986). Enzyme replacement in nervous tissue after allogeneic bone-marrow transplantation for fucosidosis in dogs. *Lancet* **2**, 772–774.
- Van de Sluis, B., Wijmenga, C., and van Oost, B. (2006). Copper toxicosis in Bedlington terriers. In "The Dog and Its Genome" (E. A. Ostrander, U. Giger, and K. Lindblad-Toh, Eds.), pp. 348–377. Cold Spring Harbor Laboratory Press, New York.
- Verma, I. M., and Weitzman, M. D. (2005). Gene therapy: twenty-first century medicine. *Annu. Rev. Biochem.* **74**, 711–738.
- Vite, C. H., McGowan, J. C., Niogi, S. N., Passini, M. A., Drobatz, K. J., Haskins, M. E., and Wolfe, J. H. (2005). Effective gene therapy for an inherited CNS disease in a large animal model. *Ann. Neurol.* **57**, 355–364.
- Vogler, C., Levy, B., Grubb, J. H., Galvin, N., Tan, Y., Kakkis, E., Pavloff, N., and Sly, W. S. (2005). Overcoming the blood-brain barrier with high-dose enzyme replacement therapy in murine mucopolysaccharidosis VII. *Proc. Natl. Acad. Sci. USA* **102**(41), 14777–14782.
- Vogler, C., Sands, M. S., Galvin, N., Levy, B., Thorpe, C., Barker, J., and Sly, W. S. (1998). Murine mucopolysaccharidosis type VII: the impact of therapies on the clinical course and pathology in a murine model of lysosomal storage disease. *J. Inherit. Metab. Dis.* **21**(5), 575–586.
- Walkley, S. U., Thrall, M. A., Dobrenis, K., Huang, M., March, P. A., Siegel, D. A., and Wurzelmann, S. (1994). Bone marrow transplantation corrects the enzyme defect in neurons of the central nervous system in a lysosomal storage disease. *Proc. Natl. Acad. Sci. USA* **91**, 2970–2974.
- Whitney, K. M., Goodman, S. A., Bailey, E. M., and Lothrop, C. D. (1994). The molecular basis of canine pyruvate kinase deficiency. *Exp. Hematol.* **22**, 866–874.
- Wolfe, J. H., Sands, M. S., Barker, J. E., Gwynn, B., Rowe, L. B., Vogler, C. A., and Birkenmeier, E. H. (1992). Reversal of pathology in murine mucopolysaccharidosis type VII by somatic cell gene transfer. *Nature* **360**, 749–753.
- Wong, L. F., Azzouz, M., Walmsley, L. E., Askham, Z., Wilkes, F. J., Mitrophanous, K. A., Kingsman, S. M., and Mazarakis, N. D. (2004). Transduction patterns of pseudotyped lentiviral vectors in the nervous system. *Mol. Ther.* **9**, 101–111.
- Xu, F., Ding, E., Migone, F., Serra, D., Schneider, A., Chen, Y. T., and Amalfitano, A. (2005). Glycogen storage in multiple muscles of old GSD-II mice can be rapidly cleared after a single intravenous injection with a modified adenoviral vector expressing hGAA. *J. Gene Med.* **7**, 171–178.
- Yang, Y., Jooss, K. U., Su, Q., Ertl, H. C., and Wilson, J. M. (1996). Immune responses to viral antigens versus transgene product in the elimination of recombinant adenovirus-infected hepatocytes in vivo. *Gene Ther.* **3**, 137–144.
- Yeager, A. M., Brennan, S., Tiffany, C., Moser, H. W., and Santos, G. W. (1984). Prolonged survival and remyelination after hematopoietic cell transplantation in the twitcher mouse. *Science* **225**, 1052–1054.

# Carbohydrate Metabolism and Its Diseases

J. Jerry Kaneko

*Department of Pathology, Microbiology, and Immunology*

*School of Veterinary Medicine*

*University of California, Davis*

*Davis, California*

- 
- I. INTRODUCTION**
  - II. DIGESTION**
  - III. ABSORPTION**
  - IV. METABOLISM OF ABSORBED CARBOHYDRATES**
    - A. General
    - B. Storage as Glycogen
    - C. Glycogen Metabolism
    - D. Catabolism of Glucose
  - V. INTERRELATIONSHIPS OF CARBOHYDRATE, LIPID, AND PROTEIN METABOLISM**
    - A. Lipid Metabolism
    - B. Influence of Glucose Oxidation on Lipid Metabolism
  - VI. INSULIN AND CARBOHYDRATE METABOLISM**
    - A. Proinsulin and Insulin
    - B. Insulin Transport
    - C. Glucose Transport
    - D. Insulin Action on Biochemical Systems
    - E. Physiological Effects of Insulin
    - F. Other Pancreatic Islet Hormones
  - VII. BLOOD GLUCOSE AND ITS REGULATION**
    - A. General
    - B. Glucose Supply and Removal
    - C. Role of the Liver
    - D. Glucose Tolerance
  - VIII. METHODOLOGY**
    - A. Blood Glucose
    - B. Indirect Monitoring of Blood Glucose
    - C. Tolerance Tests
    - D. Ketone Bodies
  - IX. DISORDERS OF CARBOHYDRATE METABOLISM**
    - A. Diabetes Mellitus
    - B. Hyperinsulinism
    - C. Hypoglycemia of Baby Pigs
    - D. Glycogen Storage Diseases
  - X. DISORDERS OF RUMINANTS ASSOCIATED WITH HYPOGLYCEMIA**
    - A. General
    - B. Carbohydrate Balance
    - C. Biochemical Alterations in Body Fluids

---

**REFERENCES**

## I. INTRODUCTION

The biochemical mechanisms by which the chemical energy contained in foodstuffs are made available to the animal are collectively described as metabolism. Thus, the description of the metabolism of a foodstuff encompasses the biochemical events that occur from the moment of ingestion to its final breakdown and excretion. Classically, these biochemical events have been divided into the metabolism of the three major constituents of food; carbohydrates, proteins, and lipids. The metabolism of the lipids and proteins is discussed in their individual chapters.

The major function of ingested carbohydrates is to serve as energy sources, and their storage function is relatively minor. Carbohydrates are also precursors of essential intermediates for use in synthetic processes. When the metabolic machinery of an animal is disrupted, a disease state prevails (e.g., diabetes). The literature of the biochemistry of metabolism and disease continues to expand as the minute details of individual and overall reaction mechanisms are continually clarified. Additionally, modern molecular approaches have significantly increased our understanding of disease mechanisms and remain fertile fields for investigations into the disease processes. This chapter presents a basis for the better understanding of the biochemical mechanisms underlying those diseases associated with carbohydrate metabolism. The intricate details of carbohydrate metabolic reactions may be found in the many books on fundamental biochemistry.

## II. DIGESTION

The digestion of carbohydrates in the animal begins with the initial contact of the carbohydrates in their foodstuffs with the enzymes of salivary juice. Starch of plant foods and glycogen of meat are split into their constituent

monosaccharides by the action of amylase and maltase. This activity ceases as the food matter passes into the stomach, where the enzymatic action is destroyed by the hydrochloric acid. Within the stomach, acid hydrolysis may occur, but the stomach empties too rapidly for complete hydrolysis to take place. Thus, only a small portion of the ingested carbohydrate is hydrolyzed before passing into the small intestine. In the small intestine, digestion of carbohydrate takes place quickly by the carbohydrate splitting enzymes contained in the pancreatic juice and in the succus entericus. Starch and glycogen are hydrolyzed to glucose by amylase and maltase; lactose to glucose and galactose by lactase; and sucrose to glucose and fructose by sucrase. The monosaccharide products of enzymatic hydrolysis of carbohydrates, glucose, fructose, and galactose, are the principal forms in which absorption occurs in the monogastric animal.

### III. ABSORPTION

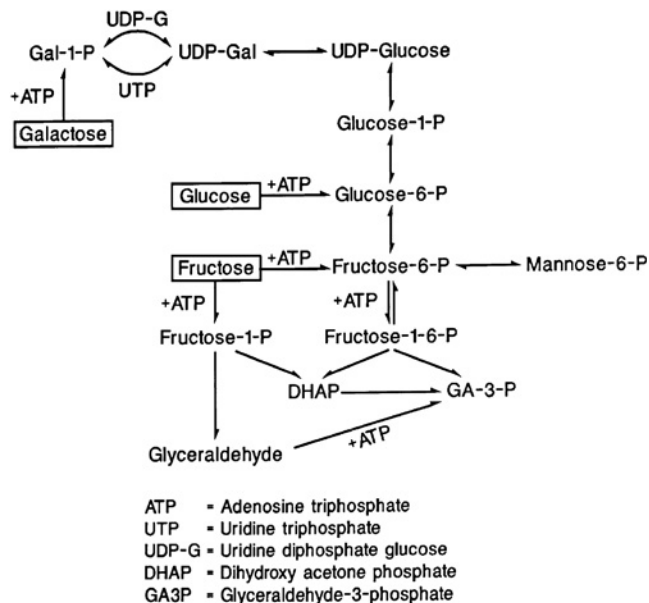
The monosaccharides are almost completely absorbed through the mucosa of the small intestine and appear in the portal circulation as the free sugars. Absorption into the mucosal cell occurs by a sodium-dependent active transport mechanism using a glucose co-transporter. The absorbed glucose then leaves the mucosal cell by a facilitated diffusion process in the presence of a glucose transporter, GLUT-2. Glucose and galactose are absorbed rapidly, whereas fructose is absorbed at about half the rate of glucose with a portion being converted to glucose in the process. Other monosaccharides (e.g., mannose) are absorbed slowly at a rate consistent with a diffusion process. As a result, free sugars appear in the portal circulation for transport to the liver.

Glucose transporters (GLUT) are known to be involved in many tissues—for example, GLUT-1 is the hepatocyte/RBC transporter and is widely distributed; GLUT-2 is in hepatocytes,  $\beta$  cells, and mucosal cells; GLUT-3 is the brain transporter; GLUT-4 is the only insulin-responsive glucose transporter; GLUT-5 is in the intestine; GLUT-6 is not available; and GLUT-7 is within cell organelles (Winter and Signorino, 2002). Glucose transporters have been identified and numbered beyond GLUT-8 and up to GLUT-12 (Piroli *et al.*, 2004) but remain to be confirmed.

## IV. METABOLISM OF ABSORBED CARBOHYDRATES

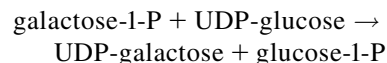
### A. General

Liver cells are readily permeable to glucose. This process is facilitated by glucose transporter (GLUT) proteins within the plasma membrane, in particular, GLUT-2 is the transporter in the liver cell plasma membrane (Thorens *et al.*, 1988).



**FIGURE 3-1** Pathways for hexose metabolism. Abbreviations: ATP, adenosine triphosphate; UTP, uridine triphosphate; UDP-G, uridine diphosphate glucose; DHAP, dihydroxy acetone phosphate; GA-3-P, glyceraldehyde-3-phosphate.

Within the liver, there are several pathways by which the immediate fate of the hexoses is determined. Glucose, fructose, and galactose first enter the general metabolic scheme through a series of complex reactions to form glucose phosphates (Fig. 3-1). The enzyme, galactose-1-P uridylyl transferase, which catalyzes the reaction



is blocked or deficient in congenital galactosemia of humans. The glucose phosphates are then converted to and stored as glycogen, catabolized to  $\text{CO}_2$ , and water or, as free glucose, returned to the general circulation. Essentially, intermediate carbohydrate metabolism of animals evolves about the metabolism of glucose, and the liver is the organ of prime importance.

### B. Storage as Glycogen

Glycogen is the chief storage form of carbohydrate in animals and is analogous to the storage of starch by plants. It is found primarily in liver and in muscle, where it occurs at about 3% to 6% and about 0.5%, respectively (Table 3-1). Glycogen is composed solely of  $\alpha$ -D-glucose units linked together through carbon atoms 1 and 4 or 1 and 6. Straight chains of glucose units are formed by the 1–4 links and these are cross-linked by the 1–6 links. The result is a complex ramification of chains of glucosyl units with branch

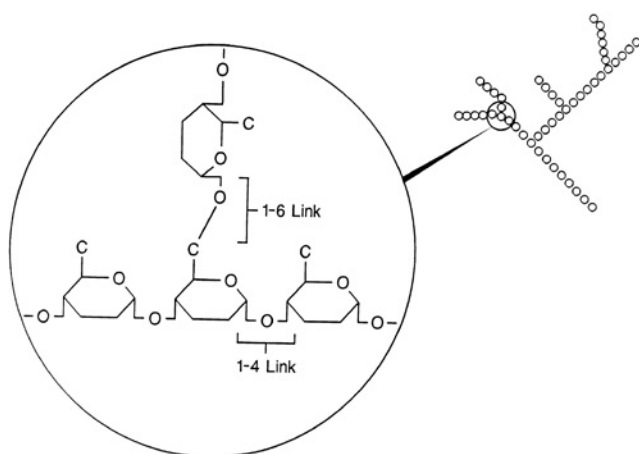
**TABLE 3-1** Liver Glycogen Content of Animals

Species	Glycogen in Liver (%)	Reference
Dog	4.3	Barrett <i>et al.</i> (1994)
Sheep	3.82	Kaneta <i>et al.</i> (1991)
Cow (lactating)	1.0	Kronfeld <i>et al.</i> (1960)
Cow (nonlactating)	3.0	Kronfeld <i>et al.</i> (1960)
Baby pig	5.2	Morrill (1952)
Baby pig (newborn)	14.8	Swiatek <i>et al.</i> (1968)

**TABLE 3-2** Carbohydrate Content of a Dog<sup>a</sup>

Muscle glycogen (0.5%)	25.0g
Liver glycogen (6%)	18.0g
Carbohydrate in fluids 5.5mmol/l (100mg/dl)	2.2g
	45.2g
Caloric value (45.2 × 4kcal/g) =	181kcal
Caloric requirement (70kg <sup>3/4</sup> = 70 × 5.6) =	392kcal/day
$\frac{181}{392} \times 24$ hours =	11 hours

<sup>a</sup> Body weight, 10kg; liver weight, 300g; muscle weight, 5kg; volume of blood and extracellular fluid, 2.2 liters.



**FIGURE 3-2** Glycogen structure. Note that hydrolysis of a 1–6 link by the debrancher enzyme yields a mole of free glucose.

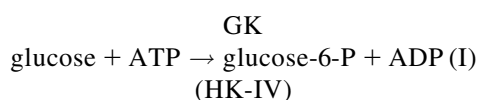
points at the site of the 1–6 links (Fig. 3-2). The internal chains of the glycogen molecule have an average length of four glucosyl units. The external chains beyond the last 1–6 link are longer and contain between 7 and 10 glucose units. The molecular weight of glycogen may be as high as  $4 \times 10^6$  Mr and contain about 20,000 glucosyl units.

In Table 3-2, the amount of carbohydrate available to meet the theoretical requirements of a hypothetical dog is shown. The amount present is sufficient for about half a day. It is apparent that the needs of the body that must be met continually are satisfied by alternate means and not solely dependent on continuous ingestion of carbohydrates. During and after feeding (postprandial), absorbed hexoses are converted to glucose by the liver and enter the general circulation. Excesses are stored as glycogen or as fat. During the fasting or postabsorptive state, glucose is supplied by the conversion of protein (gluconeogenesis) and by the breakdown of glycogen (glycogenolysis). The continued rapid synthesis and breakdown of glycogen, (i.e., turnover) is well illustrated by the biological half time of glycogen, which is about a day.

## C. Glycogen Metabolism

### 1. Glycogenesis

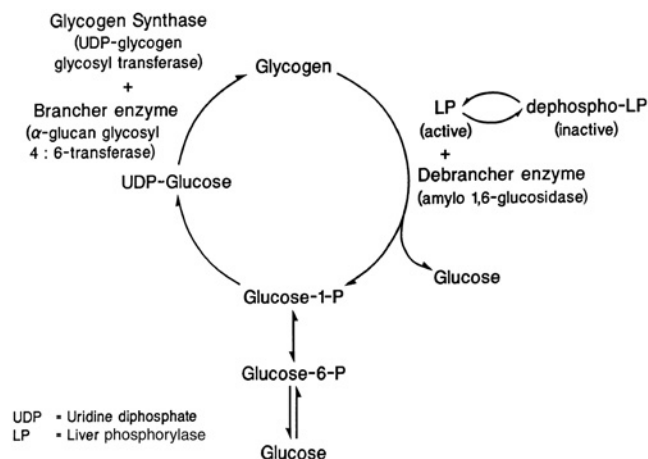
The initial reaction required for the entrance of glucose into the series of metabolic reactions, which culminate in the synthesis of glycogen, is the phosphorylation of glucose at the C-6 position. Glucose is phosphorylated with adenosine triphosphate (ATP) in liver by an irreversible enzymatic reaction catalyzed by a specific glucokinase (GK):



Glucokinase (GK) (also called hexokinase-IV [HK-IV]) is one of the four hexokinase isoenzymes that occurs in all tissues. Glucokinase (GK) or HK-IV, which is glucose specific, is the predominant isoenzyme found in liver. The nonspecific hexokinase-I (HK-I) is the isoenzyme found in red cells, brain, and nerve tissue.

Liver contains both GK (HK-IV) and HK-I, but GK is the predominant isoenzyme. GK has a high Michaelis constant ( $K_m = 2 \times 10^{-2}$  mol G/l) indicating a low affinity for glucose. The rate of the phosphorylation reaction catalyzed by GK is therefore controlled by the glucose concentration. The activity of GK is increased by glucose feeding and by insulin and is decreased during fasting and in insulin lack (i.e., diabetes). In this regard, GK is an inducible enzyme whose activity is increased by glucose or by insulin. The nonspecific HK-I is found in all tissues including liver, brain, and erythrocytes and has a low Michaelis constant ( $K_m = 5 \times 10^{-5}$  mol G/l), indicating a high affinity for glucose. HK-I catalyzes phosphorylation in all tissues, therefore, it is not controlled by glucose concentration. The activity of HK-I is not affected by fasting or by carbohydrate feeding, diabetes, or by insulin. Therefore, in contrast to GK, HK-I is not an inducible enzyme.





**FIGURE 3-3** Summary of liver glycogen metabolism. In muscle, phosphorylase a is the active form and phosphorylase b is the inactive form. Abbreviations: UDP, uridine diphosphate; LP, liver phosphorylase.

out of the hepatic cell and enter the general circulation, thereby contributing directly to the blood glucose pool. In muscle tissue, there is no G-6-Pase, and muscle glycogen cannot supply glucose directly to the circulation by glycogenolysis. Muscle glycogen contributes to blood glucose indirectly via the lactate or Cori cycle (Section IV.D). The series of reactions described are illustrated schematically in Figure 3-3.

### 3. Hormonal Influences on Glycogen Metabolism

The biochemical basis of the glycogenolytic and hyperglycemic action of glucagon and epinephrine was discussed in Section IV.C.2. These hormone actions are the bases for the epinephrine and glucagon stimulation tests, which are used to assess the availability of liver glycogen and the sensitivity of the carbohydrate regulatory mechanisms to these hormones. Many other hormones influence carbohydrate metabolism to a greater or lesser degree in keeping with the concept that carbohydrate metabolism is a totally integrated metabolic mechanism.

One of the results of successful insulin therapy is a restoration of the depleted glycogen reserve. The mechanism of insulin action on carbohydrate metabolism continues to be a subject for intense study and is discussed more fully in Section VI. Briefly, the primary role of insulin is to promote glucose entry into peripheral cells, mainly muscle and fat cells, and to enhance glucose utilization by liver cells by its effect on enzyme systems at control points in the glycolytic pathways. In the presence of insulin, glucose removal from the blood is enhanced by shifting the direction of glucose metabolism toward utilization by increasing glycogen synthesis and glucose uptake and oxidation. The result is a hypoglycemia.

Promotion of liver glycogen storage is also one of the effects of the glucocorticoids. This effect may be attributed to their enhancement of gluconeogenesis, hyperglycemia, decreased glycogenolysis, and decreased glucose oxidation. A tendency toward a mild hyperglycemia is also present in hyperthyroid states, as the result of an overall increase in carbohydrate metabolism. Thyroxine is thought to increase the sensitivity of the liver cell to the action of epinephrine, thereby increasing glycogenolysis and promoting hyperglycemia. Increased glycogenolysis, gluconeogenesis, and the hyperglycemia may also be the compensatory result of an increased rate of tissue metabolism. In rats made hyperthyroid, hepatic G-6-Pase activities are increased, which would enhance hepatic glucose production and hyperglycemia in the hyperthyroid states. An additional factor contributing to the overall tendency for hyperglycemia is the stimulation of glucose absorption by the gastrointestinal tract by thyroxine.

### 4. Glycogen in Disease

In systemic disease, changes in glycogen concentrations in tissues or organs are generally observed as decreases. Depletion of liver glycogen stores is seen in diabetes mellitus, starvation, bovine ketosis, ovine pregnancy toxemia, or in any condition with nutritional carbohydrate deficiency or increased carbohydrate turnover. Pathological increases in liver glycogen occur in the rare glycogen storage diseases (GSD) and are described in Section IX.D.

## D. Catabolism of Glucose

Carbohydrate in the form of glucose is the principal source of energy for the life processes of the mammalian cell. All cells require a constant supply of this indispensable nutrient, and only relatively small changes are tolerated without adverse effects on the health of the animal. Glucose is not oxidized directly to  $\text{CO}_2$  and  $\text{H}_2\text{O}$  but rather through a series of stepwise reactions involving phosphorylated intermediates. The chemical energy of glucose is “stored” through the synthesis of “high-energy” phosphate bonds during the course of these reactions and used in other metabolic reactions. The details of the individual reactions in the pathways of glucose catabolism have been largely elucidated, but emphasis here is being placed on the interrelationships of the pathways rather than on the details of the individual reactions.

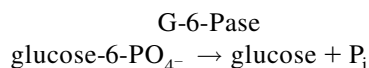
### 1. Pathways of Glucose-6-Phosphate Metabolism

The fundamental conversion required to initiate the oxidation of glucose by a cell is its phosphorylation to form G-6-P. This reaction has been described in Section IV.C.1.

The G-6-P formed as a result of the GK (HK-IV) catalyzed reaction is central to glucose catabolism. There are at least five different pathways that G-6-P can follow: free glucose, glycogenesis, glycolysis, hexose monophosphate, and glucuronate pathway.

#### a. Free Glucose

The simplest direction for G-6-P is a reversal of phosphorylation by a separate enzyme catalyzed reaction in which G-6-P is hydrolyzed to form free glucose and inorganic phosphate. This reaction is catalyzed by the enzyme G-6-Pase:



This is an irreversible reaction that opposes the previously described unidirectional GK (HK-IV) reaction. These two opposing and independently catalyzed enzyme reactions are the site of metabolic control for glucose because the balance of these enzyme activities regulates the net direction of the reaction. Significant amounts of G-6-Pase are found only in liver and to a lesser extent in the kidney. This is in accord with the well-known function of the liver as the principal source of supply of glucose for the maintenance of blood glucose concentration. The G-6-Pase activity is generally higher than the GK activity for most of a 24-hour day except for a few hours after each meal. This means that for most of the day, the liver is supplying glucose rather than using glucose.

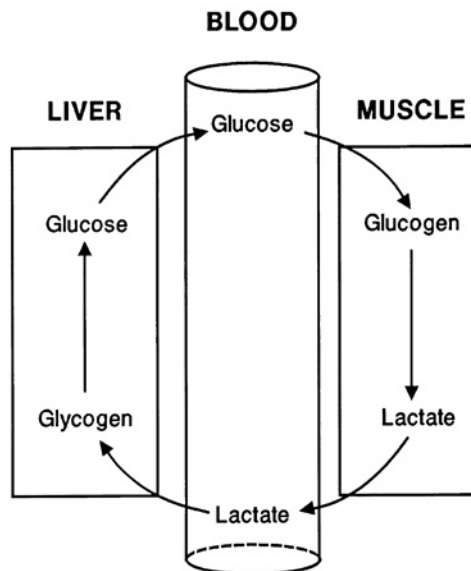
Muscle G-6-P, however, because of the absence of G-6-Pase, does not contribute glucose from its glycogen to blood directly. Muscle G-6-P does, however, contribute glucose to blood indirectly via the lactate or Cori cycle. Lactate formed in muscle by glycolysis is transported to the liver, where it is resynthesized to glucose and its precursors as outlined in Figure 3-4.

#### b. Glycogenesis

This pathway for G-6-Pase leading to the synthesis of glycogen is discussed in Section IV.C.1.

#### c. Anaerobic Glycolysis

One of the three oxidative pathways of G-6-P is the classic anaerobic glycolytic or Embden-Meyerhof pathway (EMP). The intermediate steps involved in this pathway of breakdown of G-6-P into two three-carbon compounds are summarized in Figure 3-5. A mole of ATP is used to phosphorylate fructose-6-phosphate (F-6-P) to form fructose-1,6-diphosphate (F-1,6-P). This phosphorylation reaction is also irreversible and catalyzed by a specific kinase, phosphofructokinase (PFK). The opposing unidirectional reaction is catalyzed by a specific phosphatase, fructose-1,6-diphosphatase (F-1,6-Pase). These opposing PFK and



**FIGURE 3-4** The lactate or Cori cycle. Muscle cells are devoid of glucose-6-phosphatase, therefore muscle glycogen contributes indirectly to blood glucose by this pathway.

F-1,6-Pase catalyzed reactions are a second site of metabolic control regulated by the activities of these two highly specific enzymes. At this point in the process, starting from glucose, a total of two high-energy phosphates from ATP have been donated to form a mole of F-1,6-P.

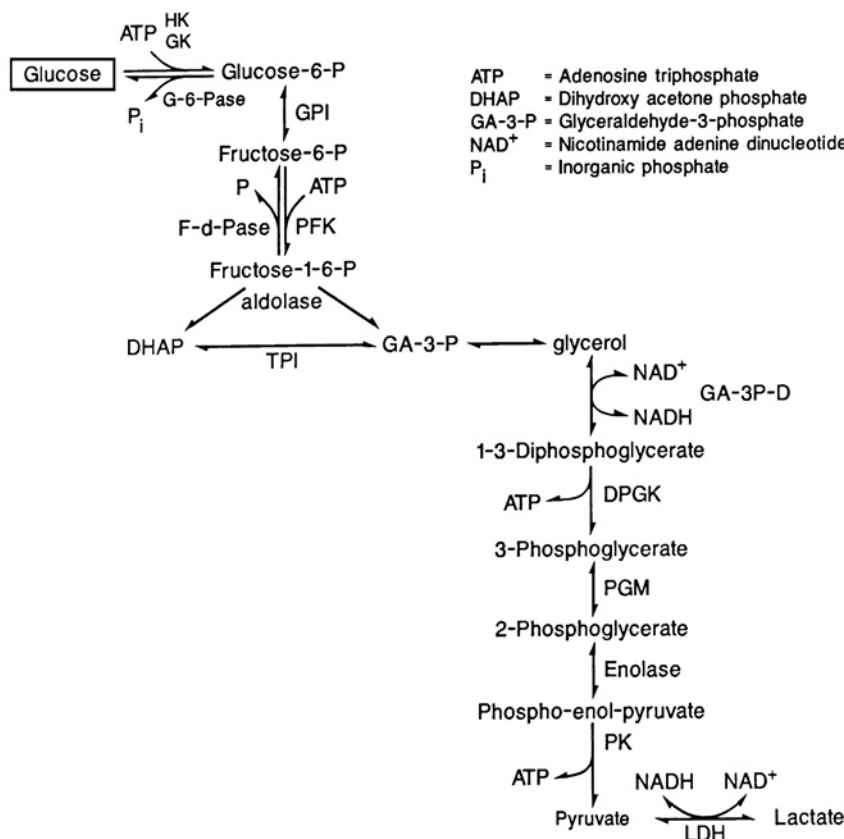
F-1,6-P is next cleaved to form two three carbon compounds as shown in Figure 3-5. The next step is an oxidative step catalyzed by the enzyme glyceraldehyde-3-phosphate dehydrogenase (GA-3-PD) with oxidized nicotinamide adenine dinucleotide ( $\text{NAD}^+$ ) as the hydrogen acceptor. During the process, the molecule is phosphorylated. In the succeeding steps, the molecule is dephosphorylated at the points indicated, and a mole of ATP is generated at each point.

A third site of control of glycolysis is the irreversible formation of pyruvate catalyzed by the enzyme pyruvate kinase (PK). In the reverse direction, two enzymatic reactions operate. Pyruvate carboxylase (PC) first catalyzes the carboxylation of pyruvate to oxaloacetate (OAA), and the OAA is then converted to phospho-enol-pyruvate (PEP) by the enzyme PEP carboxykinase (PEP-CK) (Figs. 3-5 and 3-8).

Thus, the overall conversion of a mole of glucose to 2 moles of pyruvate requires 2 moles of ATP for the initial phosphorylations and a total of 4 moles of ATP are generated in the subsequent dephosphorylations. This net gain of 2 moles of ATP represents the useful energy of anaerobic glycolysis.

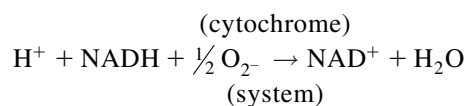
For repeated function of the glycolytic pathway, a supply of  $\text{NAD}^+$  must be available for use in the oxidative (GA-3-PD) step. Normally in the presence of molecular  $\text{O}_2$





**FIGURE 3-5** The glycolytic or classic Embden-Meyerhof pathway (EMP). Note that 2 moles of ATP are used and 4 moles of ATP are generated. Abbreviations: ATP, adenosine triphosphate; DHAP, dihydroxy acetone phosphate; GA-3-P, glyceraldehyde-3-phosphate; NAD<sup>+</sup>, nicotinamide adenine dinucleotide; P<sub>i</sub>, inorganic phosphate.

(i.e., aerobic glycolysis), reduced NADH is reoxidized via the cytochrome system:



which provides a continuous source of NAD<sup>+</sup>.

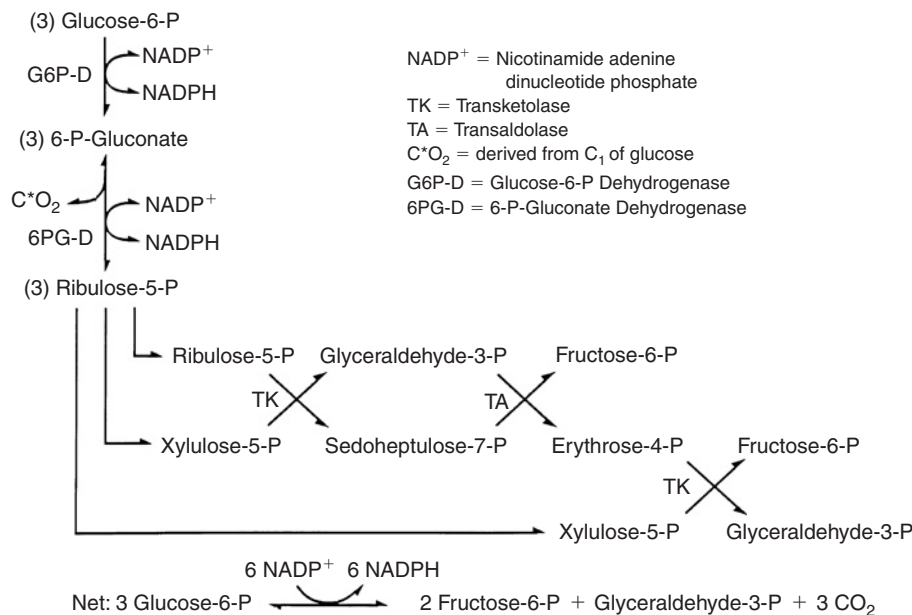
In the absence of O<sub>2</sub> (i.e., anaerobic glycolysis), NADH is reoxidized to NAD<sup>+</sup> in the reaction catalyzed by lactate dehydrogenase (LDH) where pyruvate is reduced to lactate and the NADH is the H<sup>+</sup> donor. Therefore, by this “coupling” of the LDH system to the GA-3-PD system, anaerobic breakdown of glucose to lactate proceeds in the absence of O<sub>2</sub>. As noted earlier, this anaerobic system generates only 2 moles of ATP and when compared to the 36 moles of ATP generated in aerobic glycolysis, anaerobic glycolysis is not very efficient.

#### d. Hexose Monophosphate Pathway

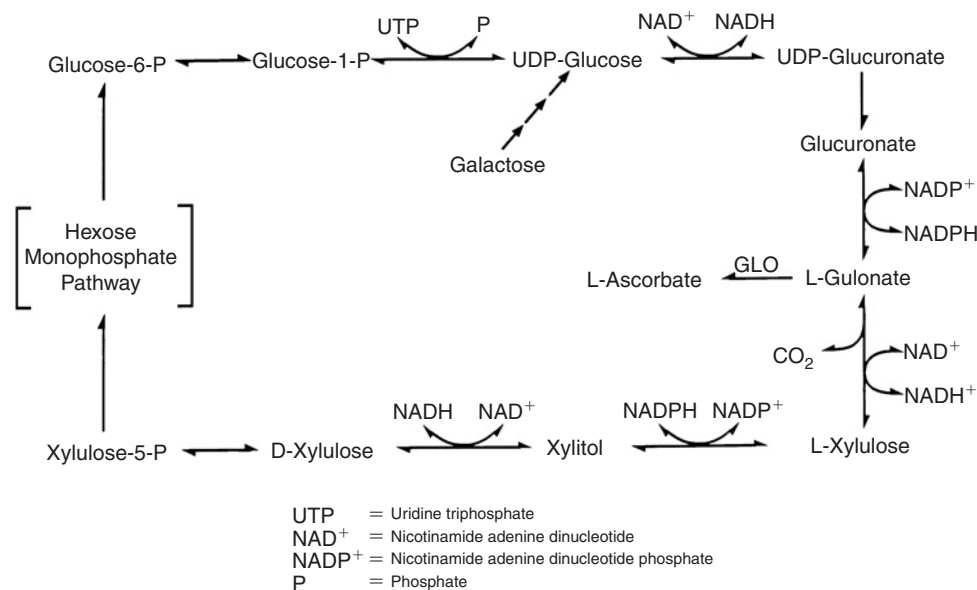
This alternate route of G-6-P oxidation has been variously referred to as the pentose phosphate pathway (PPP), direct oxidative pathway, Warburg-Dickens scheme, the hexose monophosphate pathway (HMP), or the hexose monophosphate shunt. The initial step of the shunt pathway involves

the oxidation of G-6-P at the C-1 position to form 6-phosphogluconate (6-PG) as summarized in Figure 3-6. The reaction is catalyzed by glucose-6-phosphate dehydrogenase (G-6-PD) and in this pathway, oxidized nicotinamide adenine dinucleotide phosphate (NADP<sup>+</sup>) serves as the hydrogen acceptor. In the second oxidative step, 6-P-G is oxidatively decarboxylated by 6-phosphogluconate dehydrogenase (6-P-GD) to yield a pentose phosphate, ribulose-5-phosphate (Rib-5-P), again in the presence of NADP<sup>+</sup>. Thus, in the initial reactions, which are essentially irreversible, 2 moles of NADPH are formed. In this pathway, only the C-1 carbon atom of the glucose molecule is evolved as CO<sub>2</sub>. By contrast, glucose catabolism via the glycolytic scheme results in the loss of both the C-1 and C-6 carbon atoms as CO<sub>2</sub> when pyruvate is oxidatively decarboxylated to form acetyl-CoA. This difference in CO<sub>2</sub> evolution is used to study partitioning of glucose metabolism through the glycolytic (EMP) pathway and the HMP shunt pathway in domestic animals. The subsequent metabolism of the Rib-5-P in the HMP shunt is also shown in Figure 3-6. As a result of the series of transformations, F-6-P and GA-3-P are formed, which serve as recycling links into the glycolytic pathway.

For continued functioning of the HMP shunt pathway, a supply of NADP<sup>+</sup> must be available to act as the hydrogen



**FIGURE 3-6** The pentose phosphate pathway (PPP) or the hexose monophosphate pathway (HMP). Abbreviations: NADP<sup>+</sup>, nicotinamide adenine dinucleotide phosphate; TK, transketolase; TA, transaldolase; C\*O<sub>2</sub>, is derived from C<sub>1</sub> of glucose.



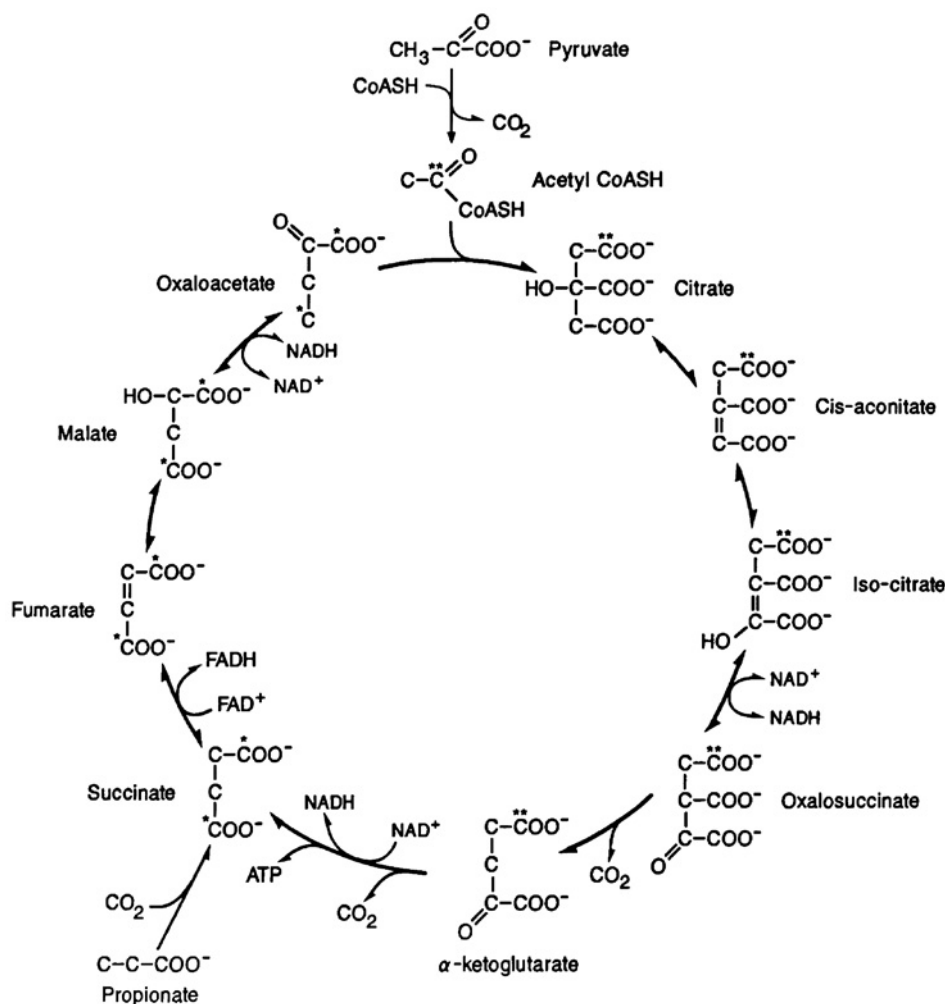
**FIGURE 3-7** Glucuronate pathway or the C<sub>6</sub> oxidation pathway. Note that vitamin C is synthesized via this pathway.

acceptor. Oxidized NADP<sup>+</sup> is regenerated from NADPH via the cytochrome system in the presence of O<sub>2</sub> so the HMP pathway is an aerobic pathway of glucose oxidation. Reduced NADPH is also required as a hydrogen donor in the synthesis of fatty acids. Through generation of NADPH, the HMP shunt route of carbohydrate metabolism is linked to that of fat synthesis. Accordingly, glucose oxidation through the HMP shunt pathway is essential for the synthesis of fat. In general, the HMP pathway is the major source of the NADPH, which maintains the reductive environment for all biosynthetic processes using NADPH as a cofactor.

#### e. Glucuronate Pathway

This is an alternate pathway of G-6-P oxidation, which has been named the uronate pathway, the glucuronate pathway, or the C<sub>6</sub> oxidative pathway. This pathway is shown in Figure 3-7. The initial steps of this pathway involve the formation of uridine diphosphoglucose (UDPG), which, as noted earlier, is an intermediate in glycogen synthesis. G-6-P is first converted to G-1-P, which then reacts with uridine triphosphate (UTP) to form UDPG. This product is then oxidized at the C<sub>6</sub> position of the glucose moiety in contrast to the C<sub>1</sub> position, which is oxidized in the HMP





**FIGURE 3-9** Tricarboxylic acid cycle. The pathway for the entry of propionate into the metabolic scheme is also included. The asterisks give the distribution of carbon in a single turn of the cycle starting with acetyl-CoA. Note the randomization of carbon atoms at the succinate step.

by pyruvate carboxylase (PC). OAA formed by either route may then be phosphorylated and decarboxylated to form PEP in a reaction catalyzed by PEP carboxykinase (PEPCK). Thus, a pathway in the reverse direction of the PK reaction is present for gluconeogenesis from lower intermediates. These pathways for pyruvate metabolism are outlined in Figure 3-8, which includes the dicarboxylic acid cycle.

#### b. Tricarboxylic Acid Cycle

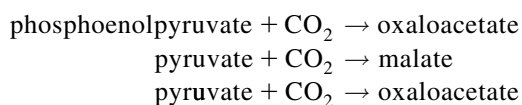
AcCoA formed by the oxidative decarboxylation of pyruvate also has a number of metabolic routes available. AcCoA occupies a central position in synthetic and in oxidative pathways as shown in Figure 3-8. The oxidative pathway leading to the breakdown of AcCoA to  $\text{CO}_2$  and  $\text{H}_2\text{O}$  follows a cyclical pathway that is the tricarboxylic acid (TCA) cycle, citric acid cycle, or the Krebs's cycle. The major steps involved are given in Figure 3-9. In a single turn of the cycle, a mole of AcCoA enters, 2 moles of  $\text{CO}_2$  are evolved, and a mole of OAA is regenerated. The

regenerated OAA may then condense with another mole of AcCoA, and the cycle continues. Citric acid is a symmetrical molecule that behaves asymmetrically as shown in Figure 3-9. Also, the  $\text{CO}_2$  that is evolved is derived from that portion of the molecule contributed by OAA during each turn of the cycle. The expected distribution of carbon atoms from AcCoA in one turn of the cycle is also given in Figure 3-9. During one turn of the cycle, a randomization of carbon atoms occurs at the succinate level such that  $\text{CO}_2$  derived from the carboxyl group of acetate will be evolved during the next turn of the cycle.

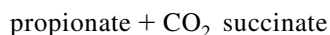
In the process, 3 moles of  $\text{NAD}^+$  and a mole of a flavin nucleotide (FAD) are reduced, and a mole of ATP is generated as noted in Figure 3-9. In animal tissues, there is a cytoplasmic  $\text{NADP}^+$ -linked isocitric dehydrogenase (ICD), which is not associated with the mitochondrial  $\text{NAD}^+$ -linked ICD or other enzymes of the TCA cycle. The  $\text{NADP}^+$ -ICD is another enzyme used as an aid to diagnose liver disease.

### 3. Carbon Dioxide Fixation in Animals

According to Figure 3-9, the TCA cycle is a repetitive process based on the regeneration of OAA at each turn. In addition, other metabolic pathways are available for intermediates in the cycle. Reversal of the transamination reactions previously described to form aspartate or glutamate would result in a withdrawal of OAA and  $\alpha$ -KG, respectively, from the cycle. By decarboxylation, OAA may also be withdrawn to form PEP, and malate may form pyruvate and thence other glycolytic intermediates as shown in Figure 3-8. Continued losses of these intermediates into other metabolic pathways would theoretically result in a decrease in the rate of operation of the cycle. A number of metabolic pathways are known whereby the losses of cycle intermediates may be balanced by replacement from other sources and are shown in Figure 3-8. The amino acids, aspartate and glutamate, may function as sources of supply as well as routes for withdrawal. The  $\text{CO}_2$  fixation reactions, which are the reversal of the reactions previously described,



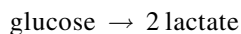
may also function as important sources of supply. A fourth  $\text{CO}_2$ -fixing reaction



is especially important in ruminants because propionate is a major product of rumen fermentation and is a major supplier of intermediates for the TCA cycle. Propionate is one of the three major fatty acids, with acetate and butyrate, involved in ruminant metabolism.

### 4. Energy Relationships in Carbohydrate Metabolism

The energy of carbohydrate breakdown must be converted to high-energy phosphate compounds to be useful to the organism; otherwise the energy is dissipated as heat. The total available chemical energy in the reaction



is about 50kcal/mole or about 7% of the 690kcal/mole, which is available from the complete oxidation of glucose to  $\text{CO}_2$  and water. The useful energy of anaerobic glycolysis is represented by the net gain of 2moles of ATP and the available energy of each is about 7kcal. Thus, the efficiency of glycolytic breakdown of glucose to pyruvate is 14kcal or 28% of the available 50kcal or only 2% of the total available 690kcal in glucose.

The major portion of the energy of glucose is generated in the further aerobic oxidation of pyruvate to  $\text{CO}_2$  and  $\text{H}_2\text{O}$ . In the oxidative or dehydrogenation steps, NADH or NADPH (FAD in the succinate step) is formed. In the

**TABLE 3-3** ATP Yield in Glucose Oxidation

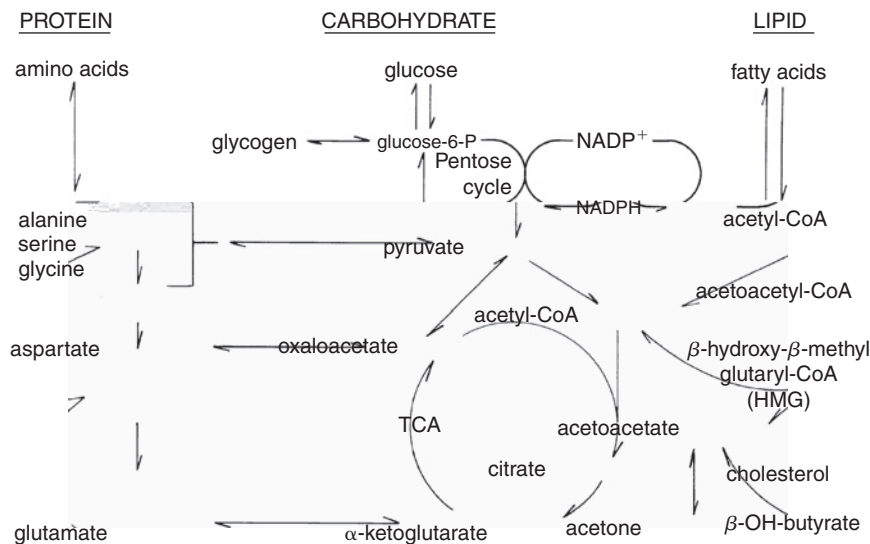
Glucose	ATP
↓ ATP (2X)	-2
↓ fructose-1-6-diphosphate	
↓ → NADH → 3 ATP (2X)	+6
ATP (4X)	+4
↓ 2 pyruvate	
NADH → 3 ATP (2X)	+6
↓ 2 acetyl-CoA	
NADH → 3 ATP (6X)	+18
ATP (2X)	+2
FADH → 2 ATP (2X)	+4
↓ 4 $\text{CO}_2$	
Net: Glucose → 6 $\text{CO}_2$	+38 ATP

presence of molecular  $\text{O}_2$ , these compounds are reoxidized to  $\text{NAD}^+$  or  $\text{NADP}^+$  in the cytochrome system. In the sequence of reactions of this system, 3 moles of ATP are formed per mole of NADH or NADPH oxidized to  $\text{NAD}^+$  or  $\text{NADP}^+$ . This transfer of energy to ATP is known as oxidative phosphorylation, or ox-phos. The yield of high-energy phosphate bonds in the form of ATP in the system per atom of oxygen consumed ( $\frac{1}{2} \text{O}_2$ ) is conventionally referred to as the P:O ratio, which in this case is 3.

Table 3-3 presents a balance sheet of the ATPs formed in the various steps, and 36 of the total 38 ATPs are generated in aerobic glycolysis. The complete oxidation of a mole of glucose to  $\text{CO}_2$  and water yields 690kcal, and therefore the net gain of 38 ATPs in anaerobic plus aerobic glycolysis represents 266kcal for an overall efficiency of 38%. In comparison, the efficiency of the modern internal combustion engine is about 20%.

## V. INTERRELATIONSHIPS OF CARBOHYDRATE, LIPID, AND PROTEIN METABOLISM

The pathways by which the breakdown products of lipids and proteins enter the common metabolic pathway have been described in previous sections. The principal points at which carbohydrate carbon may be interconverted between amino acids and fatty acids are outlined in Figure 3-10. Thus, certain amino acids (glycogenic) can serve as precursors of carbohydrate through the transamination reactions, and by reversal of these transaminations, carbohydrates can serve as precursors of amino acids.



**FIGURE 3-10** Interrelationships of carbohydrate, protein, and lipid metabolism.

The relationship between carbohydrate and lipid metabolism deserves special mention for the carbohydrate economy, and the status of glucose oxidation strongly influences lipid metabolism. A brief description of lipid metabolism follows, and greater detail may be found in the chapter on lipid metabolism.

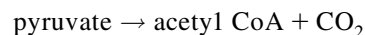
## A. Lipid Metabolism

### 1. Oxidation of Fatty Acids

Intracellular fatty acids are either synthesized in the cytoplasm or taken up as free fatty acids. Fatty acid oxidation begins in the cytoplasm with the activation of fatty acids to form fatty acyl-CoA. The activated fatty acyl-CoA is bound to carnitine for transport into the mitochondria where fatty acyl-CoA is released for intramitochondrial oxidation.

The classical  $\beta$ -oxidation scheme for the breakdown of fatty acids whereby two-carbon units are successively removed is a repetitive process involving four successive reactions. After the initial activation to form a CoA derivative, there is (1) a dehydrogenation, (2) a hydration, (3) a second dehydrogenation, and (4) a cleavage of a two-carbon unit. The result is the formation of AcCoA and a fatty acid residue shorter by two carbon atoms. The residue can then recycle to form successive AcCoA molecules until final breakdown is achieved. In the case of odd-chain fatty acids, propionyl-CoA is formed in the final cleavage reaction. The hydrogen acceptors in the oxidative steps are  $\text{NAD}^+$  and FAD. The further oxidation of AcCoA to  $\text{CO}_2$  and water proceeds in the common pathway of the TCA cycle. In the process, 2 moles of  $\text{CO}_2$  are evolved per mole of AcCoA entering the cycle. Therefore, fatty acids could not theoretically lead to a net synthesis of carbohydrate. Net synthesis of carbohydrate from fatty acids would

require the direct conversion of AcCoA into some glucose precursor (i.e., pyruvate). The reaction



however, is irreversible and the only route by which fatty acid carbon could theoretically appear in carbohydrate is through the TCA cycle intermediates, and this occurs without a net synthesis.

### 2. Synthesis of Fatty Acids

The pathway for fatty acid synthesis is separate from that of the  $\beta$ -oxidation mechanism for fatty acid breakdown. Malonyl-CoA is first formed by the addition of  $\text{CO}_2$ . Subsequently, two carbon units from malonyl-CoA are sequentially added to the growing chain with a loss of  $\text{CO}_2$  at each addition. At each step, there is also a reduction, dehydration, and a final reduction to form a fatty acid that is two carbons longer than the previous one.

The synthesis of fatty acids also requires NADPH as the hydrogen donor rather than NADH or FADH. The major source of NADPH is during the oxidation of glucose in the HMP shunt pathway. NADPH concentration is also high in the cytoplasm of liver and adipose cells where HMP shunt activity is also high. The availability of this NADPH is the basis for the linkage of carbohydrate oxidation to lipid synthesis.

### 3. Synthesis of Cholesterol and Ketone Bodies

AcCoA is also the precursor of cholesterol and the ketone bodies: AcAc, 3-OH-B, and acetone. The synthesis of cholesterol proceeds through a series of reactions beginning with the stepwise condensation of 3 moles of AcCoA to

form  $\beta$ -hydroxy- $\beta$ -methyl glutaryl-CoA (HMG-CoA). As shown in Figure 3-10, HMG-CoA is a common intermediate for the synthesis of cholesterol and ketone bodies in the liver cell. In liver, a deacylating enzyme is present, which cleaves HMG-CoA to yield AcCoA and free AcAc. This is the HMG-CoA cycle. The free AcAc then diffuses out of the cell and enters the general circulation. For further oxidations to occur, AcAc is "reactivated" with CoA in extrahepatic tissues (muscle) by the transfer of CoA from succinyl-CoA to form AcAcCoA. Increased ketogenesis and ketonemia are the net result of alterations in metabolic pathways or enzymes that favor the accumulation of AcAcCoA. Prime examples are diabetes mellitus and bovine ketosis.

The increased mobilization and utilization of fatty acids are a well-known requisite for ketogenesis under conditions of starvation and diabetes. Under these same conditions, lipid synthesis from AcCoA is also depressed. The net effect of either or both of these alterations favors the accumulation of AcCoA and thus ketogenesis.

Increased ketogenesis is always associated with an increased rate of gluconeogenesis in association with an increased activity of the key gluconeogenic enzyme, PEP-carboxykinase (PEP-CK). The increased rate of gluconeogenesis in turn depletes OAA. There is an increase in the NADH/NAD ratio, which would promote the conversion of OAA to malate, thereby depleting OAA. With the depletion of OAA and subsequent OAA deficiency, there is an insufficient condensing partner for AcCoA for the Krebs's cycle. The AcCoA is then readily diverted to ketone bodies.

Hepatic ketogenesis is regulated by the rate limiting transfer of FFA across the mitochondrial membrane. Carnitine acyl transferase, the enzyme system responsible for the mitochondrial uptake of FFA, is increased in diabetes and contributes to the ketogenesis.

## B. Influence of Glucose Oxidation on Lipid Metabolism

In addition to the separation of the biochemical pathways for lipid oxidation and lipid synthesis, an anatomical separation of lipid metabolism is also present. The liver is the major site of fatty acid oxidation and the adipose tissue is the major site of lipid synthesis. Adipose tissue, *in vitro*, converts glucose carbons to fatty acids faster than does liver tissue.

It is well known that, with excessive carbohydrate feeding, fat depots in the body increase. Fasting, on the other hand, depresses the respiratory quotient (R.Q.) indicating that the animal is now using body fat as the energy source. During fasting, plasma FFA also increase, and when carbohydrate is supplied, they decrease. The presence of glucose both stimulates lipogenesis and spares fatty acid from oxidation. In diseases with an inability to utilize glucose

(e.g., diabetes), depression of lipogenesis is a characteristic finding. When there is adequate glucose oxidation (e.g., successful insulin therapy in diabetes), lipid synthesis is restored and the animal regains its weight.

In those conditions with decreased glucose use or availability (e.g., diabetes, starvation, ruminant ketosis), there is an increased release of glucose precursors (amino acids) from muscle and FFA from adipose tissues mediated by activated hormone-sensitive lipases (HSL) (Khoo *et al.*, 1973). The amino acids and FFA are transported to the liver where the amino acids follow gluconeogenic pathways. Fatty acids follow pathways toward oxidation and ketogenesis and, additionally, glucagon promotes hepatic ketogenesis. There is also an underutilization of ketones in the peripheral tissues of dogs (Balasse and Havel, 1971; Foster and McGarry, 1982). The net result is an overproduction of glucose and ketones in liver and an underutilization of both in the peripheral tissues.

## VI. INSULIN AND CARBOHYDRATE METABOLISM

The internal secretions of the anterior pituitary, adrenal cortex and medulla, and the pancreas are closely associated with carbohydrate metabolism. The pituitary and adrenal factors were discussed in Section IV.C, together with glucagon. More detailed information is available in the chapters on pituitary and adrenal function. Since the successful extraction of insulin by Banting and Best in 1921, a vast amount of literature has accumulated on its role in carbohydrate metabolism and continues to this day. The fine details of insulin action are still being studied, and a basic understanding of the major biochemical events that occur in animals with and without insulin has evolved.

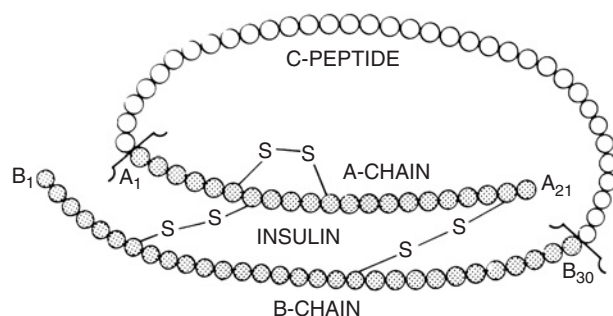
### A. Proinsulin and Insulin

The elucidation of the insulin structure by Sanger in 1959 was soon followed by the discovery of its precursor, proinsulin, and its structure was quickly known. It has been the subject of many reviews (Raptis and Dimitriadis, 1985; Steiner, 2004). Proinsulin is a single-chain looped polypeptide linked by disulfide bridges (Fig. 3-11). It varies in length from 78 amino acid residues in the dog to 86 for the human, horse, and rat. Its m.w. is near 9000 daltons. Proinsulin is synthesized in the pancreatic  $\beta$ -cells on the rough endoplasmic reticulum (RER) and transported and stored in the secretory granules on the Golgi apparatus. There, the central connecting polypeptide or C-peptide is cleaved from the chain by proteolytic enzymes, and the two linked end fragments are the monomeric insulin molecule. C-peptide has an m.w. of 3600 daltons and is devoid of biological activity.



Insulin and C-peptide are released into the circulation in equimolar amounts but C-peptide's circulatory concentration is higher than that of insulin because of its slower clearance half-time of 20 min as compared to 5 to 10 min for insulin. C-peptide is primarily degraded by the kidney and a portion is excreted in the urine (Duckworth and Kitabchi, 1981).

In the pancreatic cells, as the insulin moiety is cleaved from the proinsulin, it crystallizes with zinc for storage in the  $\beta$ -cell granules. The dense central inclusions of these insulin secretory granules consist mainly of crystalline insulin. Insulin release is stimulated by glucose, amino acids, hormones (glucagon, gastrin, secretin, pancreaticozymin), and drugs (sulfonyl ureas, isoproterenol).



**FIGURE 3-11** Insulin and proinsulin. Proinsulin is the coiled polypeptide. When the connecting C-peptide (open circle) is removed, the insulin molecule (solid circle) is released.

Insulin release is inhibited by hypoglycemia, somatostatin, and many drugs, such as dilantin and phenothiazines. The liver is the primary site of insulin degradation, and the kidney is a secondary site. The half-life of insulin in the circulation is between 5 and 10 min (Steiner, 1977).

The A chain of insulin consists of 21 amino acids and the B chain of 30 amino acid residues (Fig. 3-11). The m.w. of the insulin monomer is 6000 daltons and is the smallest unit possessing biological activity. Under physiological conditions, 4 molecules of insulin are linked together to form a tetramer, the active molecule. Insulin obtained from various species differs in amino acid composition in Chain A or Chain B or both (Table 3-4). Differences occur within species also as rats and mice (Markussen, 1971) have two nonallelic insulins. These structural differences among the various species of animals are not located at critical sites, however, because they do not affect their biological activity. They do, however, affect their immunological behavior.

The amount of insulin stored in the pancreata of various species also differs. The dog stores about 3.3 units per gram of pancreas, which amounts to about 75 I.U. in a 10-kg dog. This amount, if suddenly released, would be fatal.

Insulin release is affected by glucose, mannose, leucine, other amino acids, ketone bodies, and fatty acids. This release is mediated by glucagon, a hormone, which increases cAMP and potentiates the insulin response. The sulfonylureas are effective as pharmacological agents to release insulin, the basis for their therapeutic use.

**TABLE 3-4** Species Variation in Amino Acid Sequences of Insulin<sup>a</sup>

Species	Position <sup>a</sup>						
	A Chain				B Chain		
	A-4	A-8	A-9	A-10	B-3	B-29	B-30
Human	Glu	Thr	Ser	Ileu	Asp	Lys	Thr
Monkey	Glu	Thr	Ser	Ileu	Asp	Lys	Thr
Dog	Glu	Thr	Ser	Ileu	Asp	Lys	Ala
Pig	Glu	Thr	Ser	Ileu	Asp	Lys	Ala
Sperm Whale	Glu	Thr	Ser	Ileu	Asp	Lys	Ala
Rabbit	Glu	Thr	Ser	Ileu	Asp	Lys	Ser
Horse	Glu	Thr	Gly	Ileu	Asp	Lys	Ala
Cow	Glu	Ala	Ser	Val	Asp	Lys	Ala
Sheep	Glu	Ala	Gly	Val	Asp	Lys	Ala
Sei Whale	Glu	Ala	Ser	Thr	Asp	Lys	Ala
Rat 1	Asp	Thr	Ser	Ileu	Lys	Lys	Ser
Rat 2	Asp	Thr	Ser	Ileu	Lys	Met	Ser

From Renold and Cahill (1966) and Naithani et al. (1984).

<sup>a</sup> These are the sites of variation on the A chains and the B chains. Ala = alanine; Asp = aspartic acid; Glu = glutamic acid; Ileu = isoleucine; Met = methionine; Ser = serine; Thr = threonine.



Blood glucose is the primary regulator of both insulin release and its biosynthesis. This is a highly selective process, and only insulin, C-peptide, and proinsulin are released and released rapidly. The insulin response curve to a glucose load (IVGTT) exhibits 2 peaks in humans, the early 5-min peak representing release and the second 10- to 30-min peak representing *de novo* insulin synthesis and release. This bimodal curve is not clear in dogs (see Fig. 3-14, presented later) but it is likely to occur.

During proinsulin hydrolysis, C-peptide also accumulates in the granules. Therefore, when the granule contents are released by glucose stimulation, insulin, C-peptide, and proinsulin all appear in plasma and each can be measured by radioimmunoassay (RIA). Whereas studies in humans have focused on all three, in animals, the focus has been on insulin, and little is known of proinsulin or C-peptide in health or disease.

The influence of the various gastrointestinal hormones on insulin secretion is of considerable interest because plasma insulin levels are higher at a given plasma glucose level after an oral glucose load as compared to an intravenous load. The oral glucose tolerance test (OGTT) is known to elicit larger total insulin response than the intravenous glucose tolerance test (IVGTT). A number of GI hormones are known to influence insulin secretion to varying degrees and are sufficient to form an entero-insular axis (Buchanan, 1975). The hormones implicated are secretin, cholecystokinin-pancreozymin (CCK-PZ), gastrin, glucagon-like activity (GLA) of the gut, and gastric inhibitory peptide (GIP). GIP is a powerful stimulator of insulin secretion in humans and dogs and this is associated with a rise in blood glucose (Ross *et al.*, 1977). Thus, GIP is central to the entero-insular axis.

## B. Insulin Transport

Insulin is transported in the circulation bound to a  $\beta$ -globulin. At a tissue, insulin binds to receptors on the cell membrane. The insulin receptor is a very large glycoprotein on the surface of virtually all cells, including liver, kidney, fat, muscle, erythrocytes, and monocytes. The receptor is a posttranslational derivative of a gene product and is a tetramer of 2  $\alpha$  and 2  $\beta$  subunits. The internal  $\beta$  subunit of the receptor anchors the receptor to the membrane. As a result, insulin moves through the plasma membrane and into the cytoplasmic compartment, but the mechanism is unclear. All cells, in particular liver and kidney, are able to inactivate insulin by reductive cleavage of the disulfide bonds. Liver inactivates about 50% of the total insulin.

## C. Glucose Transport

Insulin binding also activates receptors both on the plasma membrane surface and in the cytoplasm. This activation

induces a variety of reactions—for example, phosphorylations—but the details and their implications are not yet known. However, the end result of these interactions—that is, glucose transport across the membrane and into the cell—is defined. Glucose transport proteins (glucose transporters [GLUT-1-7]) are characterized. They are small membrane proteins, 40 to 50kd, and the different transporters are distributed in different cells; GLUT-1 is widely distributed (brain, RBC, placenta, kidney), as are GLUT-2 (liver, pancreatic  $\beta$  cells, mucosal cells), GLUT-3, (brain), and GLUT-4 (skeletal muscle, heart muscle, fat). GLUT-5 is in the intestine, GLUT-6 is not available, and GLUT-7 is within cell organelles (Winter and Signorino, 2002). GLUT-4 is the only insulin-responsive glucose transporter, and for this reason has been studied extensively. Insulin mobilizes GLUT-4 to the membrane, thereby facilitating glucose transport into the cell. Glucose transport activity was studied in the erythrocytes of trained and untrained racehorses (Arai *et al.*, 1994). Horses in training had glucose transport activities 2 to 3.5 times greater than those of untrained horses. The specific glucose transporter was not identified but presumably is GLUT-1 as in other animals.

## D. Insulin Action on Biochemical Systems

The principal sites of insulin action are in the initial phases of glucose metabolism. Insulin first binds to insulin receptors of the target cell plasma membranes and then facilitates glucose entry into cells such as muscle and fat by activation of glucose transporters, in this case GLUT-4. There is also a high degree of stereo-specificity because D-glucose is transported but L-glucose is not. With increased accumulation of glucose in the cells, the movement of glucose into the metabolic scheme is enhanced and glucose utilization increases.

Insulin influences the metabolism of glucose by the liver cells, the central organ of glucose homeostasis, but with a slightly different focus. GLUT-2 is not significantly regulated by insulin, so the liver cell is freely permeable to glucose. Therefore, the major action of insulin in liver is after the initial transport step. The principal step is the first phosphorylation of glucose to form G-6-P in the reaction catalyzed by glucokinase (GK). This GK reaction is rate limiting and GK activity is influenced by insulin. Additionally, the effect of insulin on other key unidirectional phosphorylative steps directs glucose metabolism toward utilization and FA synthesis. An important effect of insulin is to increase the activity of the pyruvate dehydrogenase (PD) system, which increases AcCoA, thereby promoting increased FA synthesis and oxidation to CO<sub>2</sub> via the Krebs TCA cycle. These and other reactions are described in Section VII.C. Thus, there are two major roles for insulin, promoting (1) glucose transport across the membranes of muscle and fat cells and (2) glucose

utilization by increasing enzyme catalyzed reactions in liver cells.

In nerve cells, insulin binds to receptors and promotes membrane transport of glucose, but in this case, the membrane transport system itself appears to be the limiting factor. Thus, even though the HK system is operating maximally ( $K_m(G) = 5 \times 10^{-5}$ ), the limited glucose transport of about 1.5 mmols/l (27 mg glucose/dl) induces the symptoms of hypoglycemia: incoordination, disorientation, and weakness when there is insufficient glucose to compensate by mass action.

In other cells such as the red blood cell, which also has the HK system, insulin does not affect glucose metabolism or limit transport. The HK system is operating maximally and glucose utilization is sufficient to meet the needs of the blood cell at all times.

## E. Physiological Effects of Insulin

The principal effects of insulin administration to an animal are summarized in Table 3-5. The most characteristic finding following insulin administration is a hypoglycemia. This occurs regardless of the nutritional state, age, and other characteristics of the animal and is a net result of the increased removal of glucose from the plasma into the tissues. The respiratory quotient (R.Q.) increases toward unity, indicating that the animal is primarily utilizing carbohydrate. The consequences of this increased utilization of glucose follow a pattern of an increase in those constituents derived from glucose and a decrease in those that are influenced by increased glucose oxidation. The conversion of glucose to glycogen, fat, and protein is enhanced, whereas gluconeogenesis and ketogenesis are inhibited. The decreases in serum phosphate and potassium levels that parallel those of blood glucose are presumably due to their involvement in the phosphorylating mechanisms.

## F. Other Pancreatic Islet Hormones

Numerous hormones oppose the action of insulin and, by doing so, prevent or correct the hypoglycemic effects of insulin. Hypoglycemia stimulates a number of counterregulatory hormones including glucagon, epinephrine, and growth hormone. Norepinephrine and cortisol are less responsive than the three mentioned.

### 1. Glucagon

Glucagon is a polypeptide hormone ( $M_r = 3485$  daltons) secreted by the  $\alpha$  (A) cells of the islets. Release of glucagon is stimulated by hypoglycemia. Glucagon acts only in the liver where it stimulates glycogenolysis and gluconeogenesis, thereby increasing blood glucose. The most important physiological role of glucagon is to promote

hyperglycemia in response to a hypoglycemia. Glucagon acts only on liver glycogen, unlike epinephrine, which acts on both liver and muscle glycogen. Like most hormones, glucagon is first bound to surface receptors on a cell, in this case, the hepatocyte. Acting through these receptors, adenylate cyclase is activated, which in turn increases the amount of cyclic AMP (cAMP). cAMP then activates a phosphorylase kinase, which activates phosphorylase A, which in turn hydrolyzes glycogen. Additionally, glucagon is an insulin secretagogue second only to glucose in the magnitude of the insulin response it elicits. This insulin-releasing action of glucagon is the basis for the glucagon stimulation test (GST), which has been used to evaluate diabetes in cats (Kirk *et al.*, 1993).

### 2. Somatostatin

Somatostatin is secreted by many cells, including the hypothalamus, but its major source is the pancreatic  $\delta$  (D) cells.

**TABLE 3-5** Effects of Insulin on Animals

Tissue	Increase	Decrease
Whole animal	Anabolism Food intake Respiratory quotient	
Blood		Glucose Ketones Fatty acids Phosphate Potassium Amino acids Ketone bodies
Enzymes	Glucokinase Phosphofructokinase Pyruvate kinase Lipoprotein lipase AcCoA carboxylase	Glucose-6-phosphatase Fructose 1-6-diphosphatase Pyruvate carboxylase PEP-carboxykinase Carnitine acyltransferase Hormone-sensitive lipase
Liver	Glucose oxidation Glycogen synthesis Lipid synthesis Protein synthesis	Glucose production Ketogenesis
Muscle	(Skeletal/Heart) Glucose uptake Glucose oxidation Glycogen synthesis Amino acid uptake Protein synthesis Potassium uptake	
Adipose	Glucose uptake Glucose oxidation Lipid synthesis Potassium uptake	

Somatostatin has broad inhibitory effects on the release of many hormones, including growth hormone, glucagon, and insulin. Therefore, it has a modulating effect on the actions of these two hormones. Administration of somatostatin blocks the secretion of glucagon; in this way, somatostatin exacerbates an insulin-induced hypoglycemia.

## VII. BLOOD GLUCOSE AND ITS REGULATION

### A. General

The blood glucose concentration depends on a wide variety of factors and its concentration at any time is the net result of an equilibrium between the rates of entry and of removal of glucose in the circulation. As such, all the factors that exert influence on entry or removal become important in the regulation of blood glucose concentration. Furthermore, when the renal reabsorptive capacity for glucose is exceeded (renal threshold), urinary loss of glucose becomes an additional factor influencing the maintenance of the blood glucose concentration. The blood glucose levels at which this occurs vary between species and are listed in Table 3-6.

### B. Glucose Supply and Removal

Glucose is supplied by intestinal absorption of dietary glucose or by hepatic glucose production from its precursors, for example, carbohydrates (glycogen, fructose, galactose) and amino acids (gluconeogenesis). The dietary sources of supply of carbohydrates are especially variable among the various species. The absorptive process varies with the degree of systemic hormonal activity (e.g., thyroid) and gastrointestinal hormone activity (e.g., secretin). All conditions affecting gastrointestinal digestive processes (e.g., gastrointestinal acidity, digestive enzymes, disease) substantially affect absorption of glucose. Hence, it is important to evaluate the blood glucose in virtually all diseases.

**TABLE 3-6** Renal Thresholds for Glucose in Domestic Animals

	Species		Reference
	(mg/dl)	(mmol/l)	
Dog	180–220	10.0–12.2	Shannon <i>et al.</i> (1941)
Horse	180–200	10.0–11.1	Stewart and Holman (1940)
Cow	98–102	5.4–5.7	Bell and Jones (1945)
Sheep	160–200	8.9–11.1	McCandless <i>et al.</i> (1948)
Goat	70–130	3.9–7.2	Cutler (1934)

In the postabsorptive state, hepatic production is the major source of supply for maintaining blood glucose. The hormones epinephrine and glucagon promote the release of glucose from glycogen as described in Section IV.C.2. The glucocorticoids promote gluconeogenesis and oppose the hypoglycemic action of insulin.

Removal of glucose is governed by a variety of factors, most of which ultimately relate to the rate of utilization of glucose. All tissues constantly utilize glucose either for energy purposes or for conversion into other products (glycogen, pentoses, lipids, amino acids). Therefore, an outflow of glucose from the circulation, which is governed by the rate of utilization of glucose by a tissue, occurs at all times. The level of blood glucose itself partially governs the rate of utilization and therefore, in a sense, is autoregulatory. At high levels, the rate of glucose uptake by tissues such as muscle and liver increases because of mass action. The presence of insulin increases the rate of glucose utilization, either by increased transport via GLUT-4 (muscle, fat) or increased phosphorylation (liver). The action of insulin is opposed by the diabetogenic factors, growth hormone, glucagon, cortisol, and epinephrine.

The liver occupies a central position in the regulatory mechanism of blood glucose concentration because it supplies as well as removes glucose from the system. The major direction of liver glucose metabolism is directed toward supplying rather than using glucose. When liver takes up glucose, 25% is oxidized to lactate or CO<sub>2</sub> and the remainder forms glycogen. This glycogen is the source of the glucose supplied by the liver to the system during the better part of a day. Muscle, on the other hand, does not contain G-6-Pase, so it cannot provide free glucose and is therefore primarily a glucose-utilizing tissue.

### C. Role of the Liver

The glucose transporter system (GLUT-4) across the membrane is rate limiting in peripheral tissues that are sensitive to insulin (muscle, fat). In the liver, however, glucose moves freely across the plasma membrane, so this process is not rate limiting at this point. At a blood glucose level of approximately 8.33 mmol/l (150 mg/dl), the liver does not take up or supply glucose to the circulation. This level is termed the “steady state” or the “glucostatic level” at which the mechanisms of normal supply and removal of glucose are operating at equal rates. Above 8.33 mmol/l (150 mg/dl), glucose removal is greater than supply, and below 8.33 mmol/l (150 mg/dl), glucose supply is greater than removal. But the fasting blood glucose level in most animals is about 5 mmol/l (90 mg/dl). This means that the liver supplies glucose throughout most of a day except for the few periods during the day when blood glucose is greater than the steady-state level of 8.33 mmol/l (150 mg/dl). These periods are the few hours after each meal during a day.

Insulin decreases liver glucose production, output, and glycogenolysis while increasing liver glucose utilization. The net result is an increase in glucose uptake by the liver with increased glucose oxidation, glycogenesis, and hypoglycemia. This directional control is due to the action of insulin on key enzymes of glucose metabolism.

Directional control for glucose production or utilization is governed by coupled sets of opposing and irreversible enzyme reactions at three control points of glucose metabolism. These “key enzyme” couples are GK/G-6-Pase, PFK/F-1-6-Pase, and PK/PEP-CK, PC. The kinases direct metabolism toward glycolysis utilization because they are phosphorylating enzymes and the opposing enzymes reverse the direction so they are gluconeogenic.

The insulin sensitivity of the rate limiting GK reaction in liver promotes glucose utilization. The opposing G-6-Pase reaction increases during fasting or starvation, which favors liver glucose production. In diabetes mellitus, even though there is a hyperglycemia  $>8.33$  mmol/l (150 mg/dl), G-6-Pase is increased. Increases in the other key enzymes of gluconeogenesis, F-1-6-Pase, PEP-CK, and PC, are also observed in diabetes. Increases in activity of these gluconeogenic enzymes in insulin deficiency direct metabolic pathways toward excessive production of glucose by the diabetic liver.

The amelioration of diabetes in an experimental animal by hypophysectomy (Houssay animal) is well established. The pituitary factor, which opposes the action of insulin, is growth hormone. The glucocorticoids increase gluconeogenesis and intracellular G-6-P and, by their insulin opposing effect, increase free glucose. An increase also results from the glycogenolytic action of epinephrine and glucagon, and the equilibrium is shifted to favor of glucose production. Therefore, it is the balance of hormones that directly (insulin) or indirectly (epinephrine, growth hormone, glucagon, cortisol) affects glucose metabolism, which sets the “steady-state blood glucose” at which the liver neither uses glucose or produces glucose.

## D. Glucose Tolerance

The regulatory events that occur in response to changes in blood glucose concentration are best summarized by a description of the events following ingestion of a test dose of glucose. When administered orally to a normal animal, a typical change in blood glucose concentration with time is observed as shown in Figure 3-12. During the absorptive phase, phase I, the rate of entry of glucose into the circulation exceeds that of removal and the blood glucose rises. As the blood glucose rises, hepatic glucose output is inhibited and the release of insulin from the pancreas is stimulated by the rising blood glucose. This release of insulin is also influenced by the insulin releasing effect of the GI hormones: secretin, cholecystokinin-pancreozymin (CCK-PZ),

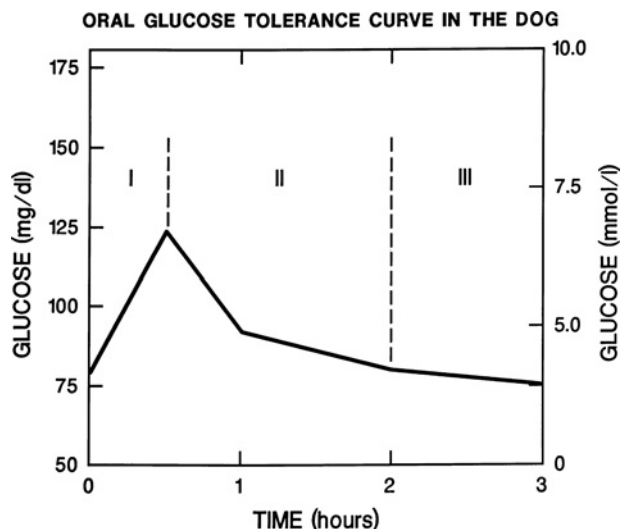


FIGURE 3-12 Oral glucose tolerance in the dog; I, II, and III are phases of the curve.

gastrin, and by pancreatic glucagon. In 30 to 60 min, the peak level of blood glucose is reached, after which it begins to fall. During this phase of falling blood glucose, phase II, the rates of removal now exceed those of entry and the regulatory mechanisms directed toward removal of glucose are operating maximally. At the same time, hepatic glucose output decreases and the blood glucose falls rapidly. When the blood glucose reaches its baseline level, it continues to fall below the original level for a short time and then returns to its baseline level. This hypoglycemic phase, phase III, is due to the inertia of the regulatory mechanisms because, in general, the higher the glycemia, the greater the subsequent hypoglycemia. Clinically, this postinsulin hypoglycemia can be marked if there is a defect in the secretion of glucagon.

## VIII. METHODOLOGY

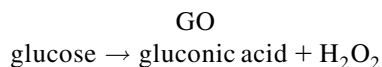
A large number of tests have been devised to evaluate the status of the carbohydrate economy of animals but the principal focus continues to lie with the determination of blood glucose levels. The hexokinase (HK), glucose dehydrogenase (GD), and the glucose oxidase (GO) methods are currently the most widely used methods for blood glucose and are used in manual, automated, and in point-of-care testing modules.

### A. Blood Glucose

#### 1. Methods

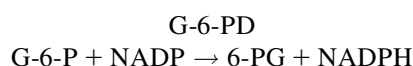
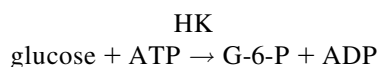
Three glucose-specific enzyme methods are in use: the GO, HK, and the GD methods. The GO method is coupled with

peroxidase and a dye. GO catalyzes the conversion of glucose to gluconic acid:

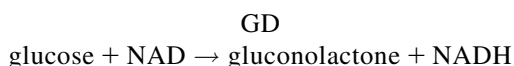


The hydrogen peroxide, with peroxidase, oxidizes a dye to form a colored product. This principle is also used in the glucose-specific paper strips for urine glucose.

In the HK method, HK catalyzes the phosphorylation of glucose and the reaction is coupled to a reaction such as G-6-PD for assay:



Either NADP or NADPH is measured spectrophotometrically. In the GD method, GD catalyzes



and NAD or NADH is measured spectrophotometrically.

Of these enzymatic methods, the method of Banauch *et al.* (1975) was found to be best for the quantitative assay of urine glucose (Kaneko *et al.*, 1978a).

No matter how accurate the method for blood glucose, it cannot compensate for loss of glucose in an improperly handled blood sample. Glucose breakdown (i.e., glycolysis) by red blood cells takes place very rapidly, about 10% per hour loss, at room temperature and is even more rapid if microorganisms contaminate the sample. For these reasons, the plasma or serum must be separated from the RBCs as quickly as possible, within the half hour; otherwise, the glucose in the blood sample must be protected from glycolysis. This is best accomplished through refrigeration or by the use of sodium fluoride (NaF) (10mg/ml blood). The NaF acts both as an anticoagulant and a glucose preservative. The NaF can also be added to a blood sample vial containing an anticoagulant.

## 2. Blood Glucose in Animals

The reference ranges for blood glucose are given in Table 3-7 and in Appendices VII, VIII, and IX. A standard sampling procedure must be used to obtain optimum results and to minimize variations in blood glucose, especially those resulting from diet. This is best accomplished in the nonruminant and in the young ruminant by a standard overnight (12 to 16h) fast before sampling. This is not necessary in the mature ruminant, because feeding elicits no blood glucose response. Methods for establishing statistically valid

**TABLE 3-7** Blood Glucose Levels in Domestic Animals<sup>a</sup>

Species	Glucose (Reference Range and Mean $\pm$ SD)	
	mmol/liter	mg/d
Horse	4.2–6.4 (5.3 $\pm$ 0.4)	75–115 (95 $\pm$ 8)
Cow	2.5–4.2 (3.2 $\pm$ 0.4)	45–75 (57 $\pm$ 7)
Sheep	2.8–4.4 (3.8 $\pm$ 0.3)	50–80 (68 $\pm$ 6)
Goat	2.8–4.2 (3.5 $\pm$ 0.4)	50–75 (63 $\pm$ 7)
Pig	4.7–8.3 (6.6 $\pm$ 0.9)	85–150 (119 $\pm$ 17)
Dog	3.6–6.5 (5.0 $\pm$ 0.4)	65–118 (90 $\pm$ 8)
Cat	2.8–4.2 (3.5 $\pm$ 0.4)	50–75 (63 $\pm$ 7)
Monkey ( <i>Macaca</i> sp.)	4.7–7.3 (5.9 $\pm$ 0.7)	85–130 (107 $\pm$ 13)
Llama	5.7–8.9 (7.1 $\pm$ 0.9)	103–160 (128 $\pm$ 16)
Rabbit	2.8–5.2 (4.1 $\pm$ 0.5)	50–93 (73 $\pm$ 10)

<sup>a</sup> Plasma or serum, glucose oxidase method, adult animals.

reference ranges for analytes such as blood glucose, with examples, are given in Chapter 1.

## B. Indirect Monitoring of Blood Glucose

The phenomenon of glucose molecules irreversibly binding to proteins is widespread in biological systems, and the products are known as glycated proteins. The glucose molecules are covalently bound to free amino groups of a protein (i.e., lysine) valine by a nonenzymatic glycation mechanism. The glycated intermediate in the reaction is unstable and immediately undergoes a classic Amadori rearrangement to form a stable ketoamine. The carbon backbone of this ketoamine is identical to fructose. When the protein of the protein-ketoamine complex is hemoglobin (Hb), the product is called hemoglobin A1c (HbA1c) because it was first identified as a fast-moving minor Hb component by electrophoresis. When the protein of the complex is albumin or total serum protein, the product is called fructosamine (FrAm) (Armbruster, 1987). When the albumin-ketoamine is specifically measured, the product is sometimes called glycoalbumin (Galb).

The binding of glucose to proteins occurs firmly and constantly over the life span of a particular protein. Therefore, these glycosylated proteins reflect the average blood glucose concentration over the half-life of the protein. Thus, they offer a means and are used to evaluate long-term average blood glucose levels in diabetics.

### 1. Hemoglobin A1c

In the case of canine HbA1c where the canine erythrocyte has a life span of 100 days and a half-life of about 60 days, HbA1c reflects the average blood glucose over the previous 2 months before sampling. In the cat, with an erythrocyte life span of 70 days and a half-life of about 40 days, HbA1c could be used as a measure of the average blood glucose over the previous 6 weeks. This means that bimonthly samplings for the dog and 6 weekly intervals in the cat for HbA1c could be used to monitor long-term blood glucose control. The use of HbA1c is a well-established means for monitoring long-term average blood glucose in human diabetics. The techniques for measuring HbA1c, however, have not been applicable to animals. The methods are complex as well as labor and equipment intensive. The methods all rely on the structural properties of HbA1c for their separation so that methods for human HbA1c are not directly applicable to animal HbA1c. Methods used for human HbA1c are affinity and ion-exchange high performance liquid chromatography (HPLC), electrophoresis, immunoassay, and colorimetrically to measure 5-hydroxymethylfurfural-thiobarbituric acid (HMF-TBA). Of these, the HPLC method is most widely used in humans. A report evaluating a number of methods for canine HbA1c indicated that the HMF-TBA method is the most promising (Hooghuis *et al.*, 1994).

Because HbA1c is directly related to the amount of red cells, anemias or polycythemia must be ruled out. Also, bimonthly samplings may not detect the long-term changes in glucose in a timely manner.

### 2. Fructosamine

The total serum proteins or albumin have half-lives of 2 to 3 weeks and 7 to 9 days, respectively. This means that FrAm or Galb could be used as indicators of the average blood glucose over the previous 2 weeks. This biweekly time interval has the advantage of detecting changes in glucose control more quickly than HbA1c and allows for timely clinical intervention. Furthermore, the FrAm assay is a colorimetric assay based on its reducing properties, so it is an assay readily performed in any clinical laboratory. An improved version of the original kit is now available from the manufacturer (Roche Diagnostic Systems, Inc., Rahway, New Jersey). Using this improved version, Jensen and Aaes (1992) reported a reference range for FrAm of 259 to 344  $\mu\text{mol/l}$  ( $301 \pm 21.3 \mu\text{mol/l}$ ). This result is lower

than that originally reported by Kawamoto *et al.* (1992) for dogs by a factor of about 10. By extrapolation, the reference range for cats as reported by Kaneko *et al.* (1992) would be 219 to 347  $\mu\text{mol/l}$  ( $283 \pm 32 \mu\text{mol/l}$ ).

In an extensive study of 253 diabetic dogs either treated or nontreated with insulins, Davison *et al.* (2005) found that FrAm and HbA1c concentrations compared similarly regardless of type of insulin, insulin injection regime, duration, or treatment or dose.

## C. Tolerance Tests

### 1. Glucose Tolerance Tests

Glucose tolerance (GT) in its original definition referred to the amount of glucose that could be ingested by an animal without producing a glucosuria, hence, tolerance for glucose. Because, in the normal animal, the absence of a glucosuria indicates only a limited rise in blood glucose where the renal threshold is not exceeded, GT now refers to the blood glucose curve following glucose administration. Accordingly, an animal with an increased glucose tolerance is one that has a limited rise and rapid fall in blood glucose (i.e., can tolerate extra glucose). The animal with a decreased tolerance has an excessive rise and a slow return to its baseline level (i.e., cannot tolerate extra glucose). This is the typical diabetic type of GT curve.

It is important to ascertain the nature of the animal's diet, especially in the omnivores and carnivores, before performing this test. A carbohydrate-only diet favors a minimum rise in the tolerance curve, whereas a carbohydrate-free diet (meat only) favors a high or diabetic type of glucose tolerance curve. Therefore, for optimum results, the diet must be standardized by placing the dog on a standard diet of 100 to 200gm carbohydrate plus fat and protein per day for 3 days before performance of the test. The GT curve is also affected by the status of the intestinal absorptive process (i.e., inflammation, increased motility, thyroxine). Furthermore, the variations that result from absorption, the excitement attending intubation, or tranquilization can be avoided by use of the intravenous test.

#### a. Oral Glucose Tolerance Test

Section VII.D described the blood glucose curve following the oral administration of a test dose of glucose. The oral glucose tolerance test (OGTT) is ineffective in the ruminant because the ingested carbohydrate is almost totally fermented by the rumen microflora. The OGTT has been used in dogs by feeding of a test meal consisting of 4gm glucose/kg b.w. mixed with a few grams of horse meat. A fasting blood sample is taken, the test meal is given, and blood samples are taken at 30-min intervals for 3h. The OGTT curves in dogs receiving a standard daily diet of either glucose or galactose with meat had normal curves as described in Section VII.D. The maximum

level, 6.6 to 7.7 mmol/l (120 to 140 mg/dl) was reached at 1 h and returned to the fasting level, 3.6 to 5.3 mmol/l (65 to 95 mg/dl), in 2 to 3 h. The OGTT may be simplified by taking a single sample at 2 h after giving the glucose (i.e., 2 h postprandial glucose). A normal blood glucose level at 2 h postprandially indicates that diabetes is unlikely. A hyperglycemia at 2 h is indicative of a diabetic curve and should be confirmed with the complete GTT. The insulin response curve during the OGTT can also be evaluated. In the OGTT, for a given level of blood glucose, the total insulin secretion (TIS) is greater than in the IVGTT. This is most likely due to the insulin releasing effect of the gut hormones (Section VII.D).

**b. Intravenous Glucose Tolerance Test and the Insulin Response**

The intravenous glucose tolerance test (IVGTT) in animals must also be standardized for best results (Kaneko *et al.*, 1978a). This is necessary because glucose clearance half-times ( $T_{1/2}$ ) and urinary glucose losses are directly proportional to the glucose dose. The recommended method gives optimal results because (1) it does not overload the animal with glucose, (2) the infusion can be given easily within the time limits, (3) the blood glucose level is high enough to give a maximal insulin response, and (4) urinary loss of glucose is minimal. After a standard overnight (12 to 16 h) fast (except for an adult ruminant), a zero-time heparinized blood sample is taken. Next, 0.5 gm glucose/kg b.w. is infused I.V. as a sterile 50% solution in 30 s. Timing of the test is begun at the midpoint or at 15 s after start of the injection. In large animals, the glucose is given within 2 to 3 min or more quickly if possible. Subsequent blood samples are taken at 5, 15, 25, 35, 45, and 60 min. The results are plotted on semilogarithmic coordinates from which the time required for the glucose concentration to fall by half, the  $T_{1/2}$ , is graphically estimated between 15 and 45 min postinfusion. From the  $T_{1/2}$ , the fractional turnover rate,  $k$ , can also be calculated:

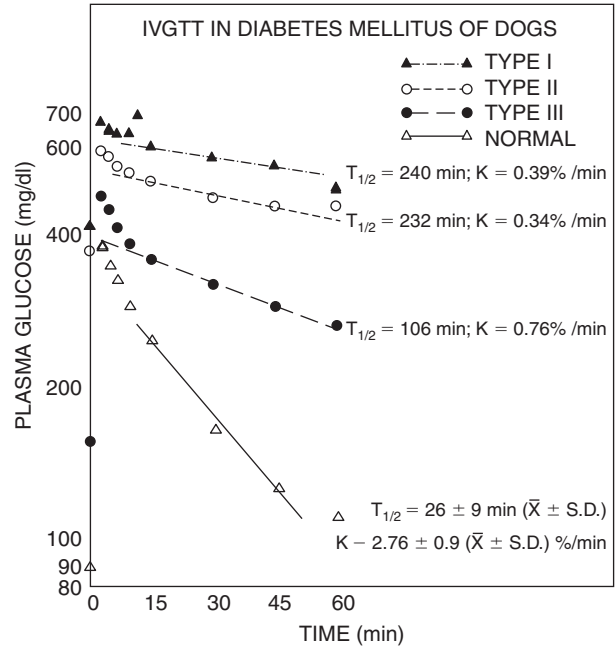
$$k = \frac{0.693}{T_{1/2}} \times 100 \times \% / m$$

The fractional turnover rate,  $k$ , can also be calculated without graphing the data and using the relationships:

$$k = \frac{\text{Ln } 1 - \text{Ln } 2}{T_2 - T_1} \times 100 = \% / m$$

from the  $k$  value, the  $T_{1/2}$  may be calculated:

$$T_{1/2} = \frac{0.693}{k} \times 100 = m$$



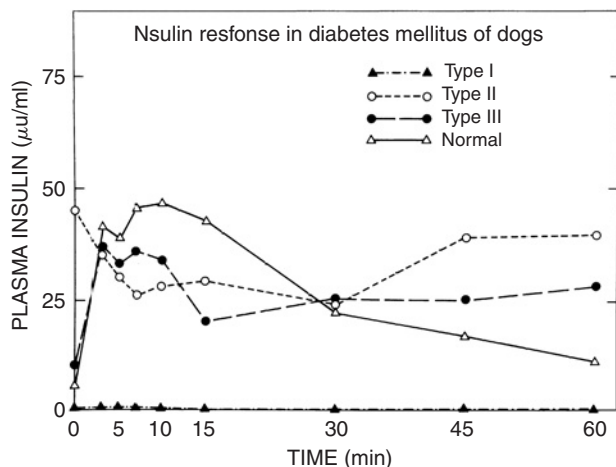
**FIGURE 3-13** The intravenous glucose tolerance test (IVGTT) in normal dogs and in dogs with various types of diabetes mellitus. From Kaneko *et al.* (1977).

The fractional turnover rate has been variously expressed as the glucose turnover rate, the glucose disappearance rate, the glucose disappearance coefficient, or simply as the  $k$ -value. The normal  $T_{1/2}$  and  $k$  in dogs are  $25 \pm 8$  min and  $2.76 \pm 0.91\%/min$ , respectively (Kaneko *et al.*, 1977). The diabetic animal with a decreased glucose tolerance has a longer  $T_{1/2}$  and lower  $k$ .

The method is equally applicable to and the only practical method in large animals. The  $k$ -value in a spontaneously diabetic cow was  $0.38\%/m$  ( $T_{1/2} = 182m$ ) as compared to a reference value of  $1.98\%/m$  ( $T_{1/2} = 35m$ ) (Kaneko and Rhode, 1964) and was comparable to the  $k$ -values obtained using  $^{14}C$ -glucose (Kaneko *et al.*, 1966).

Standardization of the IVGTT as described also has the advantages that an adequate insulin response is provoked, the influence of urinary glucose loss is minimized, and reproducible clearance values are obtained (Fig. 3-13). Other areas of the IVGTT with diagnostic significance for diabetes are the 5-m peak, which is inordinately high, and the 60-m glucose level, which has not returned to the preinfusion level.

The insulin response curve to the glucose load is obtained from the same samples as for glucose (Fig. 3-14). In the normal response curve to a glucose load, the peak insulin response occurs at 5 min followed by a return to normal at 60 min (Kaneko *et al.*, 1977). The early 5-min peak is due to the stimulation of release of stored insulin by the beta cells by glucose. In humans, a second peak is seen at 20 to 30 min, which is attributed to the *de novo* synthesis of insulin by the beta cells. This peak has not been experimentally discernible in dogs (Kaneko *et al.*, 1978b).



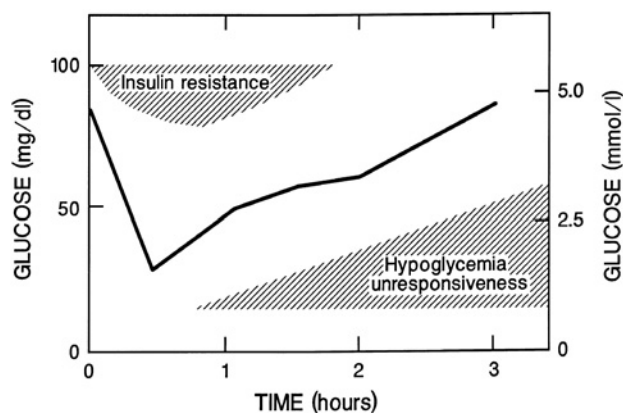
**FIGURE 3-14** The insulin response during the IVGTT in normal dogs and in dogs with various types of diabetes mellitus. Key:  $\blacktriangle$  type I;  $\circ$ , type II;  $\bullet$ , type III;  $\triangle$  normal (Kaneko *et al.*, 1977).

The IVGTT and the insulin response are of greatest value in the diagnosis of diabetes, particularly those cases with a mild hyperglycemia and without persistent glucosuria. Furthermore, the insulin response to the IVGTT allows for the accurate differentiation of the different types of diabetes. This has great significance because the type II diabetic can potentially respond to oral hypoglycemic therapy. Decreased tolerance is also observed, though less consistently, in hyperthyroidism, hyperadrenalism, hyperpituitarism, and in severe liver disease. An increased tolerance is observed in hypofunction of the thyroids, adrenals, pituitary, and in hyperinsulinism.

## 2. Insulin Tolerance Test

The blood glucose response of a normal animal after the administration of a test dose of insulin exhibits a characteristic response as shown in Figure 3-15. After obtaining a fasting blood sample, 0.1 unit of crystalline zinc insulin per kilogram body weight is injected intramuscularly or subcutaneously, and blood samples are taken every 30 min for 3 hours. The test measures (1) the sensitivity of the blood glucose level to a test dose of insulin and (2) the response of the animal to the insulin-induced hypoglycemia. Normally, the blood glucose level falls to 50% of its fasting level in 20 to 30 min and returns to its fasting level in 1½ to 2 h. Two types of abnormal responses are seen. If the blood glucose level does not fall by 50% or requires longer than 30 min to reach the maximum hypoglycemic level, the response is described as “insulin insensitive” or “insulin resistant.” Insulin resistance is found, though inconsistently, in hyperfunction of the pituitary and adrenals. This test has not been used in the type II diabetic dog or cat but may be of value in evaluating insulin resistance in this type.

If the hypoglycemia is prolonged and fails to return to the fasting level in 2 h, the response is described as



**FIGURE 3-15** Insulin tolerance in the dog. Curves falling in the shaded areas are described as noted.

“hypoglycemia unresponsiveness.” This type of response may be observed in hyperinsulinism, hypopituitarism, and hypoadrenalism and is most often used in suspected cases of the latter two diseases. An inability to secrete sufficient glucagon by the pancreatic delta cells may also be a significant factor in the unresponsiveness. In carrying out this test, because a hypoglycemia is being induced, a glucose solution should be readily available for injection.

## 3. Glucagon Stimulation Test

Glucagon via hepatic glycogenolysis and gluconeogenesis has a hyperglycemic effect, which in turn evokes an insulin response. In addition, glucagon is an insulin secretagogue second only to glucose. These are the bases for the glucagon stimulation test (GST), which has been used for the diagnosis of diabetes in cats (Kirk *et al.*, 1993). The test is performed by the I.V. injection of 30- $\mu$ g glucagon/kg body weight. Samples for blood glucose and insulin are obtained before injection (0 time) and at 5, 10, 15, 30, 45, and 60 min after injection. In cats, the peak insulin response was observed at 15 min followed by a rapid decline to baseline levels at 60 min. The insulin response curve was flat in the type I diabetic cats whereas controls, obese, and type II diabetic cats had comparable 15-min peaks and declines to baseline at 60 min.

Samplings at half-hour intervals can be continued for up to 3 hours in suspected hyperinsulinism. An exaggerated 15-min insulin response followed by a marked hypoglycemia at 2 to 3 h or longer are characteristic of pancreatic islet cell tumors (Johnson and Atkins, 1977). However, Kruth *et al.* (1982) found that the GST was not diagnostic for these cases.

## 4. Epinephrine Tolerance Test

Epinephrine also has a postinjection hyperglycemic effect via hepatic glycogenolysis. The blood glucose level rises



to a maximum of 50% above the fasting level in 40 to 60 min and returns to the original level in 1½–2 h. The test is performed by obtaining a fasting blood sample (0 time), injecting 1 ml of 1:1000 epinephrine-HCL (in the dog) intramuscularly and obtaining blood samples every 30 min for 3 h.

The characteristic increase in blood glucose is used as an index of the availability of liver glycogen for the production of blood glucose. On the basis of a lowered response to epinephrine, liver glycogen can indirectly be shown to be depleted in bovine ketosis. This can be confirmed directly by measurement of glycogen in biopsy samples. A lowered glycemic response is also a characteristic response of the glycogen storage diseases where glycogenolysis is inhibited by enzyme deficiencies.

### 5. Leucine-Induced Hypoglycemia

The oral administration of L-leucine induces a marked and persistent hypoglycemia in hyperinsulinism because of pancreatic islet cell tumors. The hypoglycemia is associated with a rise in plasma insulin because of increased release of insulin by the tumorous islet cells. The test is performed by the oral administration of 150 mg L-leucine/kg body weight as an aqueous suspension to the fasting dog. A fasting blood glucose sample is taken before administration (0 time) and every 30 min for 6 h. A hypoglycemic effect is seen quickly at 30 min to 1 h and may persist for as long as 6 h in hyperinsulinism. The normal dog exhibits no hypoglycemic effect.

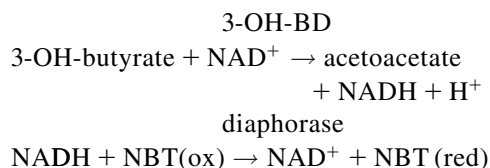
### 6. Tolbutamide Test

The intravenous administration of tolbutamide, an oral hypoglycemic agent, induces the release of insulin from the pancreas and is used as a test of the availability of insulin from the pancreas. The blood glucose curve during the test parallels the insulin tolerance test. This test has not been used in animals.

## D. Ketone Bodies

The methodology and role of ketone bodies in the carbohydrate economy of animals in health and disease are discussed in the chapter on lipid metabolism. The major ketone bodies are acetone, acetoacetate (AcAc), and 3-OH-butyrate (3-OH-B). The 3-OH-B is the precursor of acetone and AcAc so that the measurement of any or all in body fluids is a standard method to evaluate ketosis and ketoacidosis. Additionally, 3-OH-B constitutes half or more of the total ketone bodies. The quantitative assay for 3-OH-B is based on the use of the enzyme 3-OH-B dehydrogenase (3-OH-B-D). A point-of-care enzymatic and colorimetric method for the assay of plasma 3-OH-B is

based on the enzyme 3-OH-B-D and nitroblue tetrazolium (NBT):



## IX. DISORDERS OF CARBOHYDRATE METABOLISM

Although alterations in blood glucose levels occur in a wide variety of disease states, they are of particular importance in the endocrine disorders. Normal blood glucose levels are the result of a finely balanced system of hormonal interaction affecting the mechanisms of supply and removal from the circulation. When a hormonal imbalance occurs, a new equilibrium is established. Whether this equilibrium is clinically evident as a persistent hypoglycemia or hyperglycemia depends on the total interaction of the hormonal influences on carbohydrate metabolism. Further discussions concerning the disorders of the pituitary, adrenals, and the thyroids are presented in their respective chapters. The following sections discuss the conditions in which the principal manifestations are closely related to derangements in carbohydrate metabolisms.

### A. Diabetes Mellitus

Although diabetes mellitus has been reported in virtually all laboratory animals (gerbils, guinea pigs, hamsters, mice, rats, nonhuman primates) and in horses, cattle, sheep, and pigs, it is most frequently found in dogs and cats. Estimates of the incidence of diabetes range as high as 1:66 (1.52%) for dogs and 1:800 for cats. Diabetes mellitus in animals has been frequently reviewed (Engerman and Kramer, 1982; Kaneko and Howard, 1989).

#### 1. Natural History of Diabetes

The disease in dogs occurs most frequently in the mature or older female, often in association with estrus and in all breeds. In contrast, male cats appear to be more commonly affected than females. In the dog, it is frequently associated with obesity and it is now known that obesity is the single most important contributing factor to the development of diabetes (Mattheeuws *et al.*, 1984). In the obese cat, the GTT is significantly impaired, suggesting that obesity also predisposes cats to diabetes (Nelson *et al.*, 1990). The obese cat also has a GST response like that of the type II diabetic (Kirk *et al.*, 1993). Little is known of the genetic aspects of diabetes in animals as compared to humans in which the



animal to utilize this inability is corrected by insulin glucose and is clearly shown in its inability to convert glucose- $^{14}\text{C}$  to  $^{14}\text{CO}_2$ . This inability is corrected by insulin. The inability to utilize glucose is reflected in the clinical signs of diabetes, loss of weight, polyuria, polydipsia, and, in the advanced stages, ketoacidosis.

Several reports have suggested that the development of diabetes mellitus is the result of the interaction of several hormones, principally insulin and glucagon (Unger and Orci, 1975, 1976). Although excess glucagon is observed in diabetes and it can induce glucose intolerance or changes in diabetic control, it can do so only as long as insulin deficiency is present and pharmacological levels of glucagon are induced (Felig *et al.*, 1976). Thus, insulin deficiency is *sine qua non* the cause of diabetes, and although glucagon may modify the consequences, it is neither necessary nor sufficient for the development of diabetes (Felig *et al.*, 1976). The modifying action of glucagon on diabetes, however, has important implications because excess glucagon will tend to exacerbate the posthypoglycemic hyperglycemia (e.g., the Somogyi effect). A deficiency of glucagon will tend to increase the effect of insulin and contribute to a prolonged hypoglycemia after treatment. Thus, glucagon plays a significant role in the variability of diabetes.

The complex nature of the development of type II diabetes is further illustrated by the ongoing controversy as to the nature and value of the so-called metabolic syndrome as a clinical disease entity (Reaven, 2005) in an effort to link insulin resistance to increased risk of cardiovascular disease (CVD). Insulin resistance is a feature of type II diabetes and the metabolic syndrome in effect describes the interaction of the various hormones involved in carbohydrate metabolism. Its usefulness as a clinical disease entity is open to question (Reaven, 2006).

### 3. Hyperglycemia

A persistent fasting hyperglycemia is the single most important diagnostic criteria of diabetes mellitus. In the normal animal, the homeostatic level of blood glucose is maintained by the equilibrium between glucose supply and removal, which in turn is based on the endocrine balance. The effect of insulin tends to lower blood glucose, whereas the opposing effects of growth hormone, glucagon, and adrenal cortical hormones tend to raise it. In the diabetic animal with an absolute or relative lack of insulin, the equilibrium is shifted to a higher level of blood glucose. Glucose utilization in the peripheral tissues decreases while at the same time hepatic glucose production increases as a result of increases in their gluconeogenic enzyme activities.

In the diabetic, the hyperglycemia itself tends to compensate in part for the decrease in peripheral utilization. This occurs as a mass action effect that promotes the flow of glucose into the peripheral tissues. In this way, the

diabetic can continue to use some glucose when insulin is decreased, but only at the expense of increased glucose production and hyperglycemia. As the deficiency of insulin progressively becomes more severe, the equilibrium level of blood glucose is established at higher and higher levels, and ultimately the equilibrium is never established without therapeutic intervention. Blood glucose levels in canine diabetics have reached 70 mmol/l (1260 mg/dl). When the renal threshold of 11.1 mmol/l (200 mg/dl) for glucose is exceeded, the diabetic is faced with excessive loss of glucose in the urine. It is evident that the blood glucose level is exquisitely sensitive to insulin and, conversely, the blood glucose level is the mainstay for monitoring the success of diabetes therapy. However, a marked posthypoglycemic hyperglycemia or the Somogyi effect has long been known to occur in humans after insulin therapy (Bolli *et al.*, 1984), which indicates that glucose regulation by insulin is not complete. This hyperglycemic effect is thought to be due to an excess of glucagon, growth hormone, adrenal cortical hormones, or epinephrine. This phenomenon has been seen in diabetic cats given an inadvertent insulin overdose (McMillan and Feldman, 1986), which points to the need for effective monitoring of diabetes.

### 4. Glycated Proteins

The biochemical and physiological bases for using glycated proteins as a monitor for long-term glucose control are now commonplace in human diabetology (Section VIII.B). Successful management of diabetes depends on the reliable evaluation of blood glucose levels, and any blood glucose sample only reflects the blood glucose level at the moment of sampling. An effective method for estimating the average blood glucose over an extended time period offers a way of evaluating successful insulin therapy. This can be done by use of the glycated proteins, HbA1c or FrAm. Of these, FrAm offers the most cost effective method for evaluating the average blood glucose over the preceding 2 weeks. However, although HbA1c is the test of choice for indirect glucose monitoring by many academic programs, Davison *et al.* (2005) have found that either test is efficacious.

#### a. Hemoglobin A1c

The glycated hemoglobin, HbA1c, is known to reflect the average blood glucose level over the preceding 60 days and is now widely used to monitor human diabetics (Nathan *et al.*, 1984). Several studies in diabetic dogs (Mahaffey and Cornelius 1982; Wood and Smith, 1980) have also shown that HbA1c is potentially useful for monitoring purposes. Although the reference values for % HbA1c differed in the two studies, 2.29% and 6.43%, the means for the diabetics were increased in each to 4.97% and 9.63%, respectively. Hooghuis *et al.* (1994), using thiobarbituric acid colorimetry

(HMF-TBA), reported a reference range of 1.4% to 3.2 % HbA1c ( $2.3 \pm 1.96$  SD). Previous assays for HbA1c have been time, labor, and equipment intensive as well as giving variable results. The colorimetric HMF-TBA method shows promise of being a clinically viable method.

#### b. Fructosamine

The fructosamines (FrAm) reflect the average blood glucose over the preceding 2 weeks in a manner analogous to HbA1c. This means that FrAm could be used to monitor the average blood glucose on a biweekly interval. This has the advantage that changes in blood glucose can be detected more quickly than with HbA1c and allows for timely clinical intervention. Furthermore, the FrAm assay is a colorimetric assay that can be readily performed in any clinical laboratory. An improved version of the original kit is now available from the manufacturer (Roche Diagnostic Systems, Inc., Rahway, New Jersey). Using this improved version, Jensen and Aaes (1992) reported a reference range for FrAm for dogs of 259 to 344  $\mu\text{mol/l}$  ( $301 \pm 21.3$  SD). This result is 10-fold lower than that originally reported by Kawamoto *et al.* (1992) using the older method. By extrapolation, the reference range for cats as reported by Kaneko *et al.* (1992) is 219 to 347  $\mu\text{mol/l}$  ( $283 \pm 32$  SD). In all cases, FrAm was shown to be significantly elevated in diabetes indicating that they can be of clinical value to monitor glucose control in treated diabetics. On occasion, especially in cats, hyperglycemia or glucosuria is seen on initial presentation and without other indications of diabetes. A FrAm sample taken at this time can be used to differentiate a transient from a persistent hyperglycemia.

### 5. Glucose Tolerance and the Insulin Response

The glucose tolerance test (GTT) is the most important test of carbohydrate function and is of particular value in those cases of diabetes in which the fasting blood glucose is only moderately elevated and the diagnosis is equivocal (Section VIII.C). The diabetic oral GGT curve is high and relatively flat, indicating a decreased tolerance for glucose (Fig. 3-12). The nature of the diabetic curve can be quantitated by using the intravenous GTT. The diabetic curve is characterized by a long  $T_{1/2}$  or low  $k$ -value, which reflects the inability of the animal to use the test dose of glucose. The insulin response curve in type I (absolute insulin deficiency) diabetes clearly demonstrates the inability of the pancreas to release insulin in response to the glucose load. It is in the absence of an insulin response, which is responsible for the failure of the diabetic to utilize the added glucose, that the prolonged hyperglycemia occurs. An important factor adding to the hyperglycemia is the overproduction of glucose by the liver. The test dose of glucose is in effect added to the already existing oversupply of glucose. Because the steady-state level at which

the liver ceases to supply or remove glucose is elevated in diabetes, the liver continues to oversupply glucose, which contributes to the slow return of the tolerance curve to its original level.

In types II and III diabetes (see the following discussion), there is also glucose intolerance, but this occurs in the presence of a normal to elevated insulin. This would mean that the insulin in the plasma of these types is unusable or ineffective (i.e., relative deficiency) because of a number of factors including insufficient receptors, receptor blockage, abnormal receptor structure, or antibody binding, all of which lead to the glucose intolerance and the phenomenon of insulin resistance. Therefore, glucose intolerance is seen in all types of diabetes whether there is an absolute (type I) or relative (types II, III) deficiency of insulin. The insulin response must be evaluated in order to establish the type of diabetes.

### 6. Insulin and the Insulin Response

Serum insulin is characteristically very low or absent in type I diabetes, whereas it is normal to very high in type II or III. Type I diabetes can be readily differentiated from the other types by an absent or low fasting insulin level. On the other hand, about 40% of diabetics have normal to very high insulins. The classification of these diabetic types is based on the nature of the insulin response curve in the IVGTT. Type II has a normal to high insulin with no increment of insulin response to the glucose load. Type III also has a normal to high insulin; the insulin response is inadequate and there is a delayed return to preinjection levels (Kaneko *et al.*, 1977). Types II and III have been further subdivided on the basis of obesity or nonobesity (Mattheeuws *et al.*, 1984), and their insulin levels are given in Table 3-9.

The classification of diabetes into types has important therapeutic and prognostic implications. Thus far, insulin replacement therapy is the only effective treatment for the type I and the type II nonobese diabetic, even though islet

**TABLE 3-9** Insulin Concentrations in the Various Types of Canine Diabetes

	Serum Insulin ( $\mu\text{U/ml}$ )
Normal	5–20
Type	0–5
Type II nonobese	5–20
Type II obese	20–130
Type III nonobese	5–20
Type III obese	8–60

cell transplantation has corrected these diabetics for a short time. Type II obese and the type III dogs with even a small insulin reserve would be the most likely subjects for successful oral hypoglycemic therapy. The early detection of diabetes and being able to treat these patients using oral drugs would have obvious advantages. Nelson *et al.* (1993) have successfully treated cats with diabetes using oral hypoglycemic drugs. Prognostically, the severity of the diabetes can be assessed by the degree of glucose intolerance and the nature of the insulin response.

Atkins *et al.* (1979) identified diabetes in dogs less than 1 year of age, and Atkins and Chin (1983) examined their insulin responses to glucose loading. All dogs were glucose intolerant but could mount a minimal insulin response somewhat akin to the type II diabetic dogs. It could also be that these young diabetic dogs were identified during the early stages of their natural history of progression of their diabetes to type I or II.

### 7. Glucagon Stimulation and the Insulin Response

The GST has been used in humans and cats to differentiate type I from type II diabetes. Type I diabetic cats have a minimal or no insulin response to glucagon. Type II diabetic cats have a significant insulin response in the GST. Nondiabetic obese cats also have an insulin response that is similar to that observed in the type II diabetic cats. Thus, obesity is predisposing to the development of diabetes in animals as well as in humans. Type II diabetes is known to be characterized by various forms of insulin resistance (Section VIII.C.2).

### 8. Ketonemia and Lipemia

As the utilization of glucose progressively decreases in the diabetic, the utilization of fatty acids for energy purposes progressively increases to compensate. The supply of fatty acids for hepatic utilization is obtained by mobilization from the body fat depots. Mobilization of fatty acids progressively increases as insulin deficiency becomes more severe, and this is due to increases in hormone sensitive lipase. This enzyme is separate and distinct from the hepatic lipoprotein lipase.

In severe diabetes, lipid mobilization is so intense that the subsequent hyperlipemias are often so marked that the blood appears as tomato soup. A cream layer may separate out on storage overnight in the cold because of hyperchylomicronemia. The plasma is turbid due to the presence of lipoproteins (very low density lipoproteins [VLDLs]). On chemical analysis, total triglycerides and cholesterol are elevated (Rogers *et al.*, 1975). Diabetic hyperlipemia appears to be caused by impaired lipolysis of chylomicra secondary to a deficiency of hepatic lipoprotein lipase rather than to an overproduction of VLDL.

Concurrently with increased fatty acid oxidation in liver, a progressive decrease in fatty acid synthesis occurs. The net effect of the alterations in hepatic fatty acid metabolism is that AcCoA is generated in excess by the liver because of the increased rate of fatty acid  $\beta$ -oxidation catalyzed by the increased activity of the enzyme carnitine acyltransferase. Fatty acyl-CoA from fat mobilization is also a strong inhibitor of citrate synthase, which removes another route for disposal of AcCoA. The accumulated AcCoA units are then diverted into alternate pathways as described in Section V.B, and with the activation of ketogenic mechanisms, excessive synthesis of ketone bodies (Kreisberg, 1978) and cholesterol results. In the peripheral tissues, there is an underutilization of ketone bodies in the diabetic dog (Balasse and Havel, 1971). Ketosis is thus the result of an overproduction of ketone bodies by the liver and an underutilization by the peripheral (muscle) tissues. The type I diabetic has a greater tendency to develop ketoacidosis than does the type II diabetic. The pathophysiology of the ketoacidosis in the type II diabetic remains unclear, but the most likely mechanism is the depth of the insulinopenia (Linfoot *et al.*, 2005).

It has been suggested that the development of ketosis requires both a deficiency of insulin and an excess of glucagon (Foster and McGarry, 1982). Dobbs *et al.* (1975) and Unger and Orci (1975) proposed that diabetes develops as a result of a bihormonal interaction of insulin and glucagon because glucagon levels are high in insulin deficiency. The excess glucagon is thought to be caused by an abnormality in the alpha cell. There is also an excessive secretion of glucagon after protein ingestion or amino acid infusions (Unger, 1981). The excess glucagon may then exacerbate the insulin deficiency and lead to the ketoacidosis.

In the ketoacidotic state, marked cholesterolemias as high as 18mmol/l (700mg/dl) have been observed in clinical diabetes of the dog. Net gluconeogenesis from fatty acid does not occur, and the precursors for gluconeogenesis are the proteins. Excesses of glucagon, cortisol, and growth hormone in the diabetic also contribute to protein catabolism and gluconeogenesis. The cofactors that provide the reductive environment required for gluconeogenesis can be provided by the increased production of reduced cofactors during the increased fatty acid oxidation. This increase in the reductive environment of the cell is the mechanism that stimulates gluconeogenesis, which is corollary to the development of ketoacidosis.

### 8. Electrolyte Balance and Ketoacidosis

A mild glucosuria with only a few grams of glucose loss per day does not in itself precipitate the acidotic state because some compensation occurs. The liver increases its production and output of glucose even though there is a hyperglycemia, so glucose metabolism continues. However, with continued and severe loss of glucose, all

the attendant phenomena of attempts to compensate are exaggerated. Liver glycogen stores are depleted, but liver glucose production continues to be increased because of increased protein breakdown and gluconeogenesis. The oxidation of fatty acids is accelerated and, with it, the overproduction of the acidic ketone bodies, AcAc, 3-OH-B, and acetone occurs. The vapor pressure of acetone (b.p. 56.5°C) is high at body temperature, and thus this volatile compound is often detected in the breath of the severely ketotic animal. AcAc and 3-OH-B are acidic anions, which increase the "anion gap" and reduce the concentrations of  $\text{HCO}_3^-$ ,  $\text{Cl}^-$ ,  $\text{Na}^+$ , and  $\text{K}^+$ . Acidosis develops as the  $\text{HCO}_3^-$  is reduced and respiratory compensation is inadequate. In addition, there is an underutilization of ketone bodies in starvation (Garber *et al.*, 1974) and a similar underutilization of ketone bodies occurs in diabetes (Sherwin *et al.*, 1976). A rapid point-of-care method for quantifying 3-OH-B is now available and is useful in managing ketoacidosis (Section VIII.D).

In hyperketonemia, large amounts of ketones are wasted in the urine with the large losses of water and  $\text{HCO}_3^-$ . The acidic ketones are buffered by ammonium ions derived from glutamine in the renal tubules, but large amounts of ketones are ultimately lost with  $\text{Na}^+$  and  $\text{K}^+$  in the urine. Even without ketonuria, the loss of electrolytes in the polyuria of diabetes may be considerable. Thus, the acidosis of the diabetic is a primary base deficit fundamentally related to the ketonemia and to the loss of ketones and  $\text{HCO}_3^-$  in the urine.

Excess glucose in the glomerular filtrate provokes an osmotic diuresis leading to loss of water and dehydration. The progressively severe loss of water and electrolytes, the dehydration, and ketoacidosis ultimately lead to collapse, coma, and death. The condition is aggravated by renal impairment, which fortunately is not a common finding in diabetes of the dog. Not all the extracellular sodium deficit is due to urinary loss, however, because as  $\text{H}^+$  increases, it enters the cells. In exchange,  $\text{K}^+$  leaves the intracellular compartment and some  $\text{Na}^+$  enters the cells. As the dehydration progresses, extracellular  $\text{K}^+$  concentration may be very high even though there may be a total body deficit. This is an important consideration in the insulin, fluid, and electrolyte replacement therapy of diabetic ketoacidosis. The electrolyte replacement must include  $\text{K}^+$  because correction of the acidosis and the rapid expansion of the extracellular fluid compartment lead to the reverse exchange of  $\text{K}^+$ , and this results in hypokalemia.

## 10. Urinalysis

The renal threshold for glucose in the dog is about 11.1mmol/l (200mg/dl) so that the detection of even trace amounts of glucose in the urine is an important finding and warrants further consideration. In virtually all cases of diabetes suspected on the basis of persistent glycosuria

alone, the diagnosis can be later confirmed. Renal diabetes (i.e., low renal threshold for glucose) is an extremely rare occurrence and, if it does occur, can be detected by finding a normal blood glucose in the presence of the glucosuria. Transient glucosurias may occur for 1 to 1½h after a heavy carbohydrate meal, but a 2-h postprandial glucosuria is a strong indication of diabetes.

Currently, detection of glucosuria using the urinalysis sticks is the most common method of point-of-care evaluation of the clinical success of insulin therapy. There are disadvantages to this system because of owner difficulties, inconsistencies, and inaccuracies. The FrAm method, whereby only biweekly blood samplings need be taken, can have decided advantages in following the course of insulin therapy.

An elevated urinary specific gravity (SG) has in the past been considered to be a good indicator of glucosuria and, hence, of diabetes. SG is a measure of the concentration of solutes in the urine, principally the cations ( $\text{Na}^+$ ,  $\text{K}^+$ ,  $\text{NH}_4^+$ ), anions ( $\text{PO}_4^-$ ,  $\text{SO}_4^-$ ,  $\text{HCO}_3^-$ ,  $\text{Cl}^-$ ), and urea. The observed SG of urine is the result of the additive effect of the contributions of all these solutes. It is for this reason that the osmolality of any fluid, urine or plasma, can be estimated by simply adding up the major anions and cations expressed in mmols/l (see the chapter on acid-base). Albumin in urine increases the SG by 0.003 units for each 10g/l (1g/dl), whereas glucose increases it by 0.004 units for each 55mmol/l (1g/dl). Even though the presence of glucose does increase the SG linearly, a 4<sup>+</sup> reaction, 140mmol/l (2.5g/dl) would increase the SG by only 0.010 unit, an insignificant value on the refractometer. Therefore, although SG is a valuable measure of renal function, it is of no value with respect to the glucosuria of diabetes or to proteinuria. Conversely, by subtracting the contributions of protein and glucose from the observed SG, a more accurate measure of renal function in diabetes may be obtained.

Proteinuria is a common sign of renal disease and is often observed in diabetes in dogs. There is doubt whether this is associated with chronic nephritis or whether it is due to renal failure as an aftermath of diabetes.

Diabetic nephropathies resulting from microangiopathies of the glomerular tufts and basement membrane injuries are frequent and serious complications of the chronic, poorly controlled, human diabetic. A degree of renal arteriosclerosis is common in diabetic dogs, but this lesion is not comparable to the Kimmelstiel-Wilson lesion seen in humans. Also, only 1 of 10 diabetic dogs at necropsy had a significant renal lesion although most had some degree of nephritis (Cotton *et al.*, 1971). In renal function studies of experimental streptozotocin diabetes (Kaneko *et al.*, 1978b) and in spontaneous diabetes (Kaneko *et al.*, 1979), the urea, creatinine, and phosphate clearances were normal. The blood urea and creatinine concentrations were only slightly elevated, and it was concluded that renal disease is not a significant complication in the dog.

The ketone bodies are very low renal threshold substances, and their appearance in the urine is an early and significant sign of developing ketonemia and acidosis. They are not, however, diagnostic of diabetes because ketonuria is observed in starvation or any form of increased fat catabolism. Ketonuria is also absent in mild diabetes, but ketonurias of varying degrees are common in the advanced diabetic state. Therefore, ketonurias can be useful for prognostication. Generally, the type I diabetic is prone to ketonuria because there is an absence of insulin. In the type II diabetic, ketonuria occurs less frequently because there is ample insulin and ketonuria is seen only when the diabetes has advanced to the point of complete failure of production. Urine pH is of little value in detecting acidosis because only in extreme cases does the pH reflect acidosis.

### 11. Summary

The alterations in blood plasma that have been described are summarized in Figure 3-16. In the diabetic state, the uptake and hence utilization of glucose by muscle and adipose tissue is depressed. In these tissues, protein and lipid breakdown is enhanced, and increased amounts of their constituent amino acids and fatty acids are released to the circulation and carried to the liver. Increased hepatic urea

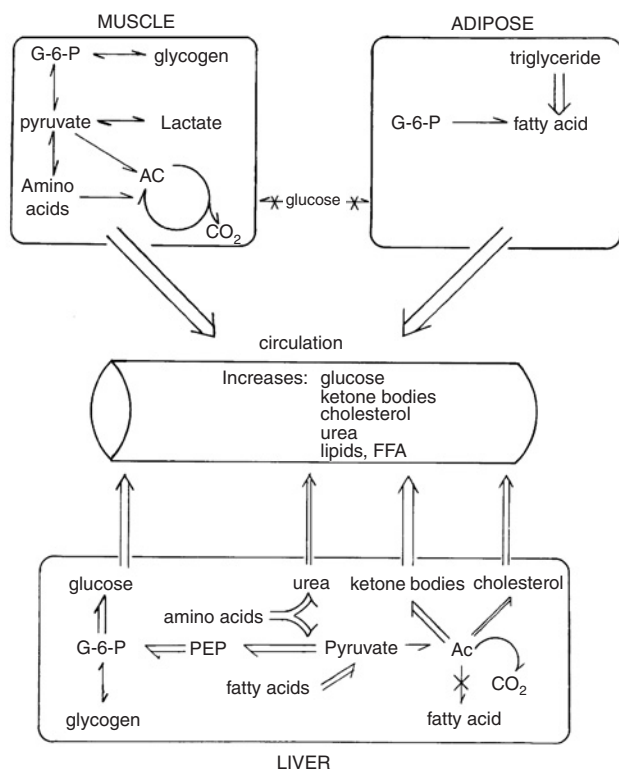
production results from the catabolism of these amino acids. Increases in the key gluconeogenic enzymes of the liver, G-6-Pase, PEP-CK, and PC direct glucose metabolism toward an overproduction of glucose. Simultaneously, lipogenesis is suppressed and with the increased mobilization of fatty acids, AcCoA accumulates and is followed by increased cholesterogenesis and ketogenesis. In the peripheral tissues, there is an underutilization of ketones, all of which results in a net increase in blood ketones and subsequent ketoacidosis. Thus, diabetes mellitus is characterized by a fundamental overproduction of and an underutilization of both glucose and ketones as the result of the absolute or relative deficiency of insulin.

### B. Hyperinsulinism

After the discovery of insulin, a clinical state with marked similarities to insulin overdose was recognized as a disease entity in humans and named hyperinsulinism. The disease is now known to be due to a persistent hyperactivity of the pancreas as the result of insulin secreting islet cell tumors. Excess insulin can be extracted from metastatic foci in liver as well as from the pancreatic tumor. There are many reports on this disease in dogs (Hill *et al.*, 1974; Mattheeuws *et al.*, 1976). Priester (1974) and Kruth *et al.* (1982) reviewed pancreatic islet cell tumors in animals in the United States and Canada. In humans, more than 90% of insulinomas are said to be benign, and in those active tumors, complete surgical resection is required to effect a cure (deHerder, 2004).

Hyperinsulinism is characterized by a persistent hypoglycemia with periods of weakness, apathy, fainting, and during hypoglycemic crises, convulsions, and coma. A history relating the attacks to periods after fasting or exercise provides a clinical basis for further investigations. Establishment of the diagnosis depends on finding a hypoglycemia of  $<3$  mmol/l ( $<55$  mg/dl) at the time of symptoms and a hyperinsulinemia, usually  $>20$   $\mu$ U/ml. The symptoms are also relieved by glucose administration. In mild cases, the fasting glucose level may be within the reference range, in which case, diagnostic hypoglycemia may be provoked by sequentially (1) placing on a low carbohydrate diet (meat only) with frequent feedings for 1 week, (2) placing on a 24-hour fast, and finally (3) adding moderate to stressful exercise (e.g., running on a lease for 15min). Blood glucose is determined at the end of each step, and if hypoglycemia is seen at any step, the provocation should be terminated. Serum insulin is determined at this time and a hyperinsulinemia is generally diagnostic of insulinoma. Calculations of ratios—insulin/glucose, glucose/insulin, amended insulin/glucose—do not offer any advantages over the individual insulin and glucose values.

The glucose tolerance curve is generally characteristic of an increased tolerance if the test is modified: (1) the dog



**FIGURE 3-16** Summary of metabolic alterations in tissues of major importance in the diabetic animal. Increased flow in the metabolic pathways is noted by larger arrows. FFA = free fatty acids.

is on a standard carbohydrate diet for 3 days; (2) the intravenous test is used, and, most important; (3) blood sampling is continued for 6 to 8 hours. A prolongation of the hypoglycemic phase (phase III, Fig. 3-12) is the most significant portion of the curve.

A dog with a tendency toward persistent hypoglycemia is likely to have an abnormal response in the insulin tolerance test, but this is not a reliable test of insulinoma. The tolerance curve may have a minimal drop in blood glucose and remain below the original level for a prolonged length of time. Therefore, the curve has “insulin resistance” and “hypoglycemia unresponsiveness.” Use of this test carries some risk for a hypoglycemic crisis, so a glucose solution for intravenous administration should be at hand. Similarly, the glucagon stimulation test has not been a reliable test for hyperinsulinism.

The hypoglycemia that follows oral administration of leucine in children has been used in human patients with islet cell tumors. Marked hypoglycemia occurs within 30 to 60 min after L-leucine administration. Leucine-induced hypoglycemia is also associated with a rise in plasma insulin. In patients with islet cell tumors, leucine sensitivity disappeared after surgical excision of the tumor, which indicates that the tumorous islet cells alone were being stimulated by the leucine. This test has been used successfully in pancreatic islet cell tumors of dogs.

Currently, the most useful tests are the serum insulin and the fasting plasma glucose taken as described earlier. There is an inappropriately high level of insulin ( $>20 \mu\text{U/l}$ ) with a hypoglycemia of  $<3\text{mmol/l}$  ( $<55\text{mg/dl}$ ).

### C. Hypoglycemia of Baby Pigs

Hypoglycemia of baby pigs occurs during the first few days of life and is characterized by hypoglycemias of  $<2.2\text{mmol/l}$  ( $<40\text{mg/dl}$ ), apathy, weakness, convulsions, coma, and finally death.

The newborn baby pig is particularly susceptible to hypoglycemia. At birth, the blood glucose level is  $>6\text{mmol/l}$  ( $>110\text{mg/dl}$ ) and, unless the pig is fed or suckles shortly after birth, its blood glucose drops rapidly to hypoglycemic levels within 24 to 36 hours. The liver glycogen, which is high (14.8%) at birth, is almost totally absent at death. In contrast, newborn lambs, calves, and foals are able to resist starvation hypoglycemia for more than a week. If the baby pig suckles, its ability to withstand starvation progressively increases from the day of birth. A 10-day-old baby pig can be starved up to 3 weeks before symptoms of hypoglycemia occur.

Gluconeogenic mechanisms are undeveloped in the newborn pig, which indicates that the gluconeogenic enzymes of the baby pig are inadequate at birth. This also indicates that these enzymes need to be induced by feeding so they can reach their maximal activities within 1 or

2 weeks after birth. The precise hepatic gluconeogenic enzymes and their inducibility by feeding have not yet been identified.

The association of baby pig hypoglycemia with complete or partial starvation is shown by the findings that their stomachs are empty at necropsy, and the syndrome itself is indistinguishable from experimental starvation of the newborn baby pig. Starvation of the newborn pig under natural conditions can occur because of factors relating to the sow (agalactia, metritis, etc.) or to the health of the baby pig (anemia, infections, etc.), either case resulting in inadequate food intake. The requirement for feeding to induce the hepatic gluconeogenic mechanisms in the newborn baby pig explains its inability to withstand starvation in contrast to the newborn lamb, calf, or foal, which is born with fully functioning hepatic gluconeogenesis.

### D. Glycogen Storage Diseases

The glycogen storage diseases (GSD) are characterized by the pathological accumulation of glycogen in tissues. Based on their patterns of glycogen accumulation, their clinical pathological findings, their enzymes of glycogen metabolism, and the structural analyses of their glycogen, the GSDs in humans have been classified into types I through X and 0 and into their various subtypes (Shin, 2006). All have an autosomal recessive mode of inheritance except for GSD VIII, which is sex linked. Their glycogen structures are normal except in types III and IV.

Type I or classical von Gierke's disease is characterized by increased liver glycogen leading to a marked hepatomegaly. There is a marked hypoglycemia and the blood glucose response to epinephrine or glucagon is minimal or absent. The liver glycogen structure is normal. The defect in this disease is a deficiency of the enzyme G-6-Pase. Type II or Pompe's disease is a generalized glycogenosis with lysosomal accumulation of glycogen and early death. The defect in this disease is a deficiency of acid- $\alpha$ -glucosidase (AAGase). In type III or Cori's disease, the debrancher enzyme is deficient, which leads to the accumulation of glycogen of abnormal structure. The branches are abnormally short, and there are an increased number of branch points; it is a limit dextrin, and the disease is sometimes called a limit dextrinosis. There is a variable hypoglycemia, little or no response to epinephrine or glucagon, hepatomegaly, cardiomegaly, and early death. In type IV or Andersen's disease, the brancher enzyme is deficient, which leads to a glycogen with abnormally long branches and few branch points. It is clinically similar to type III. In type V or McArdle's disease, muscle phosphorylase (MPase) is deficient, whereas in type VI, it is liver phosphorylase (LPase) that is deficient. Type VII or Tarui's disease is characterized by a deficiency of muscle phosphofructokinase (PFK) with accumulation of glycogen in



muscle, and type VIII is deficient in leukocyte or hepatic phosphorylase b kinase (PBK). This disease is uniquely sex linked.

Of these 11 types in humans, only types I, II, III, and VIII are found in animals. Other forms of glycogen storage in animals are described as GSD-like based on their pathological patterns of glycogen accumulation. GSD in animals has been reviewed by Walvoort (1983).

There is an inherited PFK deficiency in the springer spaniel dog, but unlike human type VII GSD, there is no muscle pathology or glycogen accumulation in muscle. The deficiency in the dog is expressed as a hemolytic anemia caused by a deficiency of the PFK isoenzyme in the erythrocytes and is rightly considered to be an inherited erythrocyte enzyme deficiency rather than a GSD (Giger *et al.*, 1985). Mammalian PFK is present in tissues as tetramers composed of combinations of three different subunits: PFK-M (muscle), PFK-L (liver), and PFK-P (platelets). Human and dog muscle and liver have homogenous tetrameric PFK-M<sub>4</sub> and PFK-L<sub>4</sub>, respectively. Human erythrocyte PFK is a mixed tetramer, PFK-L<sub>2</sub>/PFK-M<sub>2</sub>, whereas the dog erythrocyte PFK is a mixed tetramer, PFK-M<sub>2</sub>/PFK-P<sub>2</sub> (Vora *et al.*, 1985). In PFK-M subunit deficiency in the dog erythrocyte, PFK-L replaces PFK-M; PFK-L<sub>2</sub>/PFK-P<sub>2</sub>. In the human erythrocyte, PFK-P replaces PFK-M; PFK-L<sub>2</sub>/PFK-P<sub>2</sub>. Although the substituted PFK in the erythrocyte is the same in dog or human, the deficiency in the human is expressed as a GSD, whereas in the dog it is expressed as an exertional hemolytic anemia. The anemia occurs after heavy exertional respiratory stress as in vigorous hunting or exercise. Hyperventilation induces a respiratory alkalosis, which in turn increases the fragility of the erythrocyte and the hemolytic anemia occurs (Giger *et al.*, 1985).

A radiation induced type I GSD occurs as an autosomal recessive condition in the C3H mouse and is characterized by hypoglycemia, early death, and a deficiency of liver G-6-Pase (Gluecksohn-Welch, 1979).

Type II GSD has been described in Brahman cattle (O'Sullivan *et al.*, 1981), the Lapland dog (Walvoort *et al.*, 1982), and the Japanese quail (Murakami *et al.*, 1980). In the Brahman cattle, type II is characterized by early death, generalized glycogen deposition, and a marked decrease in AAGase activity. It is inherited as an autosomal recessive. In the Lapland dog, there is also early death, generalized glycogen deposition, hepatomegaly, and cardiomegaly. There is also a marked decrease in heart and liver AAGase. The Japanese quail with type II is also characterized by early death; glycogen deposition in the heart, liver, and muscles; and decreased AAGase.

Type III occurs in the German Shepherd dog and is characterized by early death, little or no response to epinephrine or glucagon, hepatomegaly, and cardiomegaly with glycogen accumulation. The glycogen has a limit dextrin structure, and there is a very low debrancher enzyme activity in

liver and muscle (Ceh *et al.*, 1976; Rafaguzzaman *et al.*, 1976).

Type VIII is seen in the rat and the mouse. In the rat, the disease is inherited as an autosomal recessive, it appears healthy but is hypoglycemic, has hepatomegaly because of glycogen accumulation in the liver, and has a very low liver phosphorylase kinase activity (Clark *et al.*, 1980). The affected mouse is apparently healthy but has increased glycogen accumulation in the muscle with a very low muscle PBK. The inheritance is sex linked (Gross, 1975).

## X. DISORDERS OF RUMINANTS ASSOCIATED WITH HYPOGLYCEMIA

### A. General

The principal disorders of domestic ruminants in which hypoglycemia is a salient feature are bovine ketosis and ovine pregnancy toxemia. Pregnancy toxemia characteristically is a widespread disease of high mortality occurring in the pregnant ewe just before term, the time when carbohydrate demands are highest, especially in those ewes carrying more than one fetus. Bovine ketosis, on the other hand, occurs in the high producing dairy cow, characteristically during the early stages of lactation when milk production is generally the highest. Abnormally high levels of the ketone bodies, acetone, AcAc, 3-OH-B, and isopropanol appear in blood, urine, and in the milk. The clinical signs of ketosis accompany these alterations: loss of appetite, weight loss, decrease in milk production, and nervous disturbances.

The energy metabolism of the ruminant is focused on the utilization of the volatile fatty acids produced by rumen fermentation rather than on carbohydrates as in the nonruminant. The carbohydrate economy of the ruminant is significantly different from that of the nonruminant, and an appreciation of these differences is important to the understanding of these metabolic disorders of the ruminant.

### B. Carbohydrate Balance

#### 1. Glucose Requirements

The heavy demands for glucose in early lactation and in late pregnancy are well known. Kleiber (1959) calculated that about 60% of the lactating cow's daily glucose requirement is for the production of milk. The balance sheet (Table 3-10) indicates a total daily glucose requirement of 1140g of which 700g appear in the milk. For sheep in late pregnancy, the fetus utilizes about one-third to one-half of the daily glucose turnover of 100g.

A good approach to assess the glucose requirements of an animal is to measure its turnover rate or the rate at which glucose enters or leaves the circulation. This is best

**TABLE 3-10** Carbohydrate Balance Sheet<sup>a</sup>

## A. Cow's daily glucose flux

1. In 12.5 kg milk:		Carbohydrate carbon
610 g lactose		257 g C/day
462 g milk fat with 58 g glycerol		23 g C/day
Carbohydrate carbon in milk/day		280 g C/day

## 2. Daily glucose catabolism

Cow produced daily 3288 liters CO<sub>2</sub> = 1762 g CTransfer quotient plasma glucose → CO<sub>2</sub> is 0.1Thus glucose to CO<sub>2</sub>/day = 176 g C/day

1 + 2 = daily flux of glucose 456 g C/day

$$\frac{180}{72} \times 456 = 1140 \text{ g glucose/day}$$

## B. Cow's glucose sources

Cow secreted daily in urine 34 g N,

indicating catabolism of 213 g protein = 100 g C/day

Less C in urea = 14 g C/day

Maximum available for glucose synthesis from protein = 96 g C/day

Glucose flow in milk and respiration = 456 g C/day

Thus glucose flow from nonprotein sources = 360 g C/day

$$\frac{180}{72} \times 360 = 900 \text{ g glucose daily must have been supplied from a nonprotein source}$$

<sup>a</sup> From Kleiber (1959).

measured by the use of isotopically labeled glucose and has been used in lactating cows. It has been estimated to be 1440 g/day (60 g/h) in cows and about 144 g/day (6 g/h) in normal pregnant ewes just before term.

## 2. Glucose Sources

The large amounts of indigestible carbohydrates ingested by ruminants are fermented to volatile fatty acids by the rumen microflora. Little, if any, of the digestible carbohydrates (starch, glucose) in the diet escapes this fermentation, so that glucose absorption from the digestive tract accounts for virtually none of the daily glucose requirement of ruminants. However, if any glucose escapes rumen fermentation (e.g., in gastrointestinal disease), it is readily absorbed.

An indirect source of blood glucose is ruminal lactic acid. Lactic acid is a product of many fermentation reactions, and ruminal lactate can be absorbed. The blood lactate can be a source of blood glucose via the lactic acid cycle

(Fig. 3-4). However, the principal source of blood lactate is the breakdown of muscle glycogen. Therefore, some of the ruminant's glucose requirement may be met by lactate, but this is minimal because excess lactic acid in the rumen is toxic.

The carbohydrate balance sheet (Table 3-10) provides the contribution of protein as a source of carbohydrate for the lactating cow. Because glucose absorption in the ruminant is minimal, the balance sheet also illustrates the importance of an alternate nonprotein source of carbohydrate carbon. These sources are the ruminal volatile fatty acids. The principal products of rumen fermentation are the volatile fatty acids, acetate, propionate, and butyrate. These acids are absorbed across the rumen wall and are the major source of nutriment for the ruminant. Various authors have used a variety of techniques to estimate the amounts of production and absorption of these acids. These fatty acids are found in blood in approximately the following proportions: acetate, 65; propionate, 20; and butyrate, 10. Further details of fatty acid production and absorption by the ruminant may be found in the chapter on lipid metabolism. In general, carbon atoms of acetate, although they appear in carbohydrate (blood glucose, milk lactose) through the mechanism of rearrangement in the TCA cycle (Fig. 3-9), cannot theoretically contribute to the net synthesis of carbohydrate. Thus, acetate is not a glucogenic compound. The large amounts of acetate provided by rumen fermentation are utilized for energy purposes and for the synthesis of fat. A possible mechanism for the direct incorporation of acetate into a glucose precursor is the so-called glyoxylate pathway, which occurs in plants but not in animals.

Propionate, on the other hand, is a well-known precursor of carbohydrate. The pathway leading to a net synthesis of glucose from propionate is available via the reaction



as shown in Figure 3-9. According to the scheme, two moles of propionate are required for the synthesis of a mole of glucose, so 1 g of propionate theoretically can provide 1.23 g of glucose. The amounts of propionate available from rumen fermentation can theoretically supply the glucose requirements not accounted for by protein sources.

Butyrate, the third major fatty acid of rumen fermentation, influences glucogenesis but does not contribute carbon directly to glucose. Butyrate stimulates glucose production by liver by increasing phosphorylases and gluconeogenesis. The AcCoA derived from  $\beta$ -oxidation of butyrate also activates pyruvate carboxylase, a key gluconeogenic enzyme, which further promotes gluconeogenesis.

## 3. Utilization of Glucose

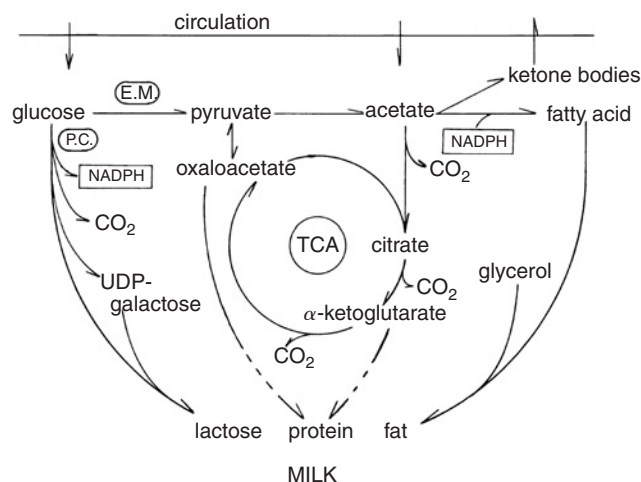
The overall utilization of glucose by the ruminant has significant differences from that of other animals. Acetate

oxidation rather than glucose plays the important role in energy metabolism of the ruminant. Only about 10% of the respiratory  $\text{CO}_2$  arises from glucose oxidation, which is considerably less than the 25% to 60% for the rat, dog, and human. The glucose tolerance of the cow, however, is the same as in other animals. The plasma clearance  $T_{1/2}$  of 33 min in the cow is similar to that of dogs (Kaneko *et al.*, 1977) and humans.

About 60% of the glucose oxidized in the mammary gland of the lactating cow occurs via the HMP pathway (Fig. 3-6), the same as in the rat mammary gland. HMP pathway activity in the ruminant mammary gland is also evidenced by the high activities of the HMP enzymes, G-6-PD and 6-P-GD, in sheep and cows mammary glands. Thus, even though overall glucose utilization is lower in ruminants, their pathways of glucose catabolism are the same as in other animals. As in other animals, the HMP pathway is the major provider of the reductive atmosphere for the synthetic processes of the mammary gland.

Through the TCA cycle pathway, carbons from acetate, from whatever source, appear in milk products (Fig. 3-17). Glucose carbon atoms may be given off as  $\text{CO}_2$ , appear in the amino acids of milk protein via transamination of oxaloacetate and  $\alpha$ -ketoglutarate, or appear in milk fat. The short chain fatty acids of butterfat are synthesized from acetate in the mammary gland, whereas the long chain acids of butterfat are derived from blood lipids. The synthetic pathway for fatty acids in the gland is the same as that in other animal tissues (see Section IX).

The major portion of the glucose uptake by the mammary gland provides for the biosynthesis of milk. The glucose and galactose moieties of lactose are derived from blood glucose. The rate of lactose synthesis is also constant over a wide range of blood glucose concentrations of 1.1 to 4.4 mmol/l (20–80 mg/dl), which indicates that lactose synthesis is maximal even under hypoglycemic conditions.



**FIGURE 3-17** Summary of some metabolic pathways in the mammary gland.

The mammary gland, therefore, is a glucose-utilizing tissue, principally for biosynthesis and considerably less is oxidized. The principal metabolic pathways involved are summarized in Figure 3-17.

Ruminant nervous tissue (i.e., brain) is also similar to that of other animals in being an obligatory glucose-utilizing tissue. The HK activity of sheep brain, however, is significantly lower than that of rat brain. This means that even though there is the same obligatory glucose requirement between the ruminant and nonruminant, glucose utilization by ruminant nervous tissue is lower than in the nonruminant. Similarly, ruminant intestine and muscle use less glucose than nonruminants.

With regard to organ distribution of gluconeogenic enzymes, highest G-6-Pase activities are found in ruminant livers as compared to other organs of ruminants and are generally equal to or slightly lower than the activities found in nonruminant livers. During early lactation, the period when a cow's glucose requirement is highest, hepatic G-6-Pase does not increase. Similarly, cow liver PEP-CK, a key gluconeogenic enzyme, is already very high in comparison to that of rat liver. All of this is in keeping with the concept that liver is primarily a glucose producing tissue. This also means that the high producing dairy cow that has been genetically selected for these qualities is already synthesizing glucose maximally under normal conditions. It follows that any additional demands for glucose from physical stress, disease, and so on are unlikely to be met by increased glucose production. This glucose shortage leads to ketosis, the primary form from excess milk production or secondary form from the stress of a disease.

To summarize, the ruminant appears to be an animal well adapted to a carbohydrate economy based on the endogenous synthesis of glucose from noncarbohydrate sources (gluconeogenesis). The enzymatic mechanisms for gluconeogenesis are already operating at near maximal levels in the high producing dairy cow. Glucose oxidation by individual tissues as well as by the intact animal is lower in ruminants than in nonruminants. Although overall partitioning of glucose oxidation may be different in ruminants, the pathways by which this oxidation is accomplished are similar to those of other animals (Fig. 3-17). The endocrine relationships of ruminants are also qualitatively similar to those of nonruminants so that the normally low blood glucose concentrations of ruminants are a reflection of their degree of influence or balance rather than their type of action.

## C. Biochemical Alterations in Body Fluids

### 1. Hypoglycemia and Ketonemia

Hypoglycemia is such a consistent finding in bovine ketosis and in ovine pregnancy toxemia that "hypoglycemia"

has been suggested as another name for bovine ketosis. This hypoglycemia has played an important role in ketosis, as a rationale for therapy and as a basis for the concept of ketosis and pregnancy toxemia as manifestations of a carbohydrate deficiency, which occurs under conditions of excessive and insurmountable demands.

The ketone bodies are the same as those previously mentioned (Section V.3): AcAc, 3-OH-B, and acetone. A fourth compound, isopropanol, is included for the ruminant, and interconversions can occur between these ketone bodies. The fundamental mechanism and pathogenesis of ketosis are covered in the lipids and ketones chapter.

## REFERENCES

- Arai, T., Washizu, T., Hamada, S., Sako, T., Takagi, S., Yashiki, K., and Motoyoshi, S. (1994). Glucose transport and glycolytic enzyme activities in erythrocytes of two year old thoroughbreds undergoing training exercise. *Vet. Res. Comm.* **18**, 417–422.
- Armbruster, D. A. (1987). Fructosamine: structure, analysis, and clinical usefulness. *Clin. Chem.* **33**, 2153–2163.
- Atkins, C. E., and Chin, H. P. (1983). Insulin kinetics in juvenile diabetics after glucose loading. *Am. J. Vet. Res.* **44**, 596–600.
- Atkins, C. E., Hill, J. R., and Johnson, R. K. (1979). Diabetes mellitus in the juvenile dog: a report of 4 cases. *J. Am. Vet. Med. Assoc.* **175**, 362–365.
- Balasse, E. O., and Havel, R. J. (1971). Evidence for an effect of insulin on the peripheral utilization of ketone bodies in dogs. *J. Clin. Invest.* **50**, 801–813.
- Banauch, D., Brummer, W., Ebeling, W., Metz, H., Rinfrey, H., Leybold, K., and Rick, W. (1975). A glucose dehydrogenase for the determination of glucose concentration in body fluids. *Z. Klin. Chem. Klin. Biochem.* **13**, 101–107.
- Barrett, E. J., Bevilacqua, S., DeFronzo, R. A., and Ferannini, E. (1994). Glycogen turnover during refeeding in the postabsorptive dog: implications for the estimation of glycogen formation using tracer methods. *Metabolism.* **43**, 285–292.
- Bolli, G. B., Gottesman, I. S., Campbell, P. J., Haymond, M., Cryer, P. E., and Gerich, J. E. (1984). Glucose counterregulation and waning of insulin in the Somogyi phenomenon. *N. Engl. J. Med.* **311**, 1214–1219.
- Buchanan, K. D. (1975). "Diabetes: Its Physiological and Biochemical Bases." MTP Press, Lancaster, UK.
- Bunn, H. F., Gabbay, K. H., and Gallop, P. M. (1978). The glycosylation of hemoglobin: relevance to diabetes mellitus. *Science* **200**, 21–27.
- Cherrington, A. D., and Exton, J. H. (1976). Studies on the role of cAMP-dependent protein kinase in the actions of glucagon and catecholamine on liver glycogen metabolism. *Metabolism* **25**, 1351–1354.
- Clark, D. G., Topping, D. L., Illman, R. J., Trimble, R. P., and Malthus, R. S. (1980). A glycogen storage disease (gsd/gsd) rat: studies on lipid metabolism, lipogenesis, plasma metabolites and bile acid secretion. *Metabolism* **29**, 415–420.
- Cotton, R. B., Cornelius, L. M., and Theran, P. (1971). Diabetes mellitus in the dog: a clinicopathologic study. *J. Am. Vet. Med. Assoc.* **159**, 863–870.
- Davison, L. J., Herrtage, M.E., and Catchpole, B. (2005). Study of 253 dogs in the United Kingdom with diabetes mellitus. *Vet. Rec.* **156**, 467–471.
- deHerder, W. W. (2004). Insulinoma. *Neuroendocrinology* **80(suppl 1)**, 20–22.
- Dobbs, R., Sakurai, H., Sakai, H., Faloona, G., Valverde, I., Baetens, D., Orci, L., and Unger, R. (1975). Glucagon: role in the hyperglycemia of diabetes mellitus. *Science* **187**, 544–547.
- Duckworth, W. C., and Kitabchi, A. E. (1981). Insulin metabolites and degradations. *Endocrine Rev.* **2**, 210–233.
- Eisenbarth, G. S. (1986). Type I diabetes mellitus: a chronic autoimmune disease. *N. Engl. J. Med.* **314**, 1360–1368.
- Engerman, R. L., and Kramer, J. W. (1982). Dogs with induced or spontaneous diabetes mellitus as models for the study of human diabetes mellitus. *Diabetes* **31**, 26–29.
- Felig, P., Wahren, J., Sherwin, R., and Hendler, R. (1976). Insulin, glucagon and somatostatin: normal physiology and diabetes mellitus. *Diabetes* **25**, 1091–1099.
- Foster, D. W., and McGarry, J. D. (1982). The regulation of ketogenesis. *Ciba Found. Symp.* **87**, 120–131.
- Garber, A. J., Menzel, P. H., Boden, G., and Owen, O. E. (1974). Hepatic ketogenesis and gluconeogenesis in humans. *J. Clin. Invest.* **54**, 981–989.
- Gershwin, L. J. (1975). Familial canine diabetes mellitus. *J. Am. Vet. Med. Assoc.* **167**, 479–480.
- Giger, U., Harvey, J. W., Yamaguchi, R. A., McNulty, P. K., Chiapella, A., and Beutler, E. (1985). Inherited phosphofructokinase deficiency in dogs with hyperventilation induced hemolysis, increased in vitro and in vivo alkaline fragility of erythrocytes. *Blood* **65**, 345–351.
- Gluecksohn-Waelsch, S. (1979). Genetic control of morphogenetic and biochemical differentiation: lethal albino deletion in the mouse. *Cell* **16**, 225–239.
- Gross, S. R. (1975). Animal models of glycogen storage conditions: their relation to human disease. *West. J. Med.* **123**, 194–200.
- Hill, F. W. G., Pearson, H., Kelly, D. F., and Weaver, B. M. Q. (1974). Functional islet cell tumor in the dog. *J. Small Anim. Pract.* **15**, 119–127.
- Hooghuis, H., Rodriguez, M., and Castao, M. (1994). Ion exchange chromatography and thiobarbiturate acid colorimetry for the measurement of canine glycosylated hemoglobins. *Vet. Clin. Pathol.* **23**, 110–116.
- Jensen, A. L., and Aaes, H. (1992). Reference interval and critical difference for canine fructosamine concentrations. *Vet. Res. Commun.* **16**, 317–325.
- Johnson, R. K., and Atkins, C. E. (1977). Hypoglycemia in the dog. In "Current Veterinary Therapy" (R. W. Kirk, Ed.), Vol. 6, pp. 1010–1016. Saunders, Philadelphia.
- Kaneko, J. J., and Howard, C. F., Jr (1989). Carbohydrate metabolism. In "Clinical Chemistry of Laboratory Animals" (W. F. Loeb and F. W. Quinby, Eds.), pp. 73–94. Pergamon Press, New York.
- Kaneko, J. J., Kawamoto, M., Heusner, A. A., Feldman, E. C., and Koizumi, I. (1992). Evaluation of serum fructosamine concentration as an index of blood glucose control in cats with diabetes mellitus. *Am. J. Vet. Res.* **53**, 1797–1801.
- Kaneko, J. J., Mattheeuws, D., Rottiers, R. P., and Vermeulen, A. (1977). Glucose tolerance and insulin response in diabetes mellitus in dogs. *J. Small Anim. Pract.* **18**, 85–94.
- Kaneko, J. J., Mattheeuws, D., Rottiers, R. P., Van Der Stock, J., and Vermeulen, A. (1978a). The effect of urinary glucose excretion on the plasma clearances and insulin responses to intravenous glucose loads in unanesthetized dogs. *Acta Endocrinol.* **87**, 113–138.
- Kaneko, J. J., Mattheeuws, D., Rottiers, R. P., and Vermeulen, A. (1978b). Renal function, insulin secretion, and glucose tolerance in mild streptozotocin diabetes in the dog. *Am. J. Vet. Res.* **39**, 807–809.
- Kaneko, J. J., Mattheeuws, D., Rottiers, R. P., and Vermeulen, A. (1979). Renal clearance, insulin secretion and glucose tolerance in spontaneous diabetes mellitus in dogs. *Cornell Vet.* **69**, 375–383.

- Kaneko, J. J., Luick, J. R., and Rhode, E. A. (1966). The metabolism of <sup>14</sup>C-labeled glucose in the diabetic cow. *Cornell Vet.* **56**, 401–408.
- Kaneko, J. J., and Rhode, E. A. (1964). Diabetes mellitus in a cow. *J. Am. Vet. Med. Assn.* **144**, 367–373.
- Kaneta, M., Liechty, E. A., Moorehead, H. C., and Lemmon, J. A. (1991). Ovine fetal and maternal glycogen during fasting. *Biol. Neonate* **60**, 215–220.
- Kawamoto, M., Kaneko, J. J., Heusner, A. A., Feldman, E. C., and Koizumi, I. (1992). Relation of fructosamine to serum protein, albumin and glucose concentration in healthy and diabetic dogs. *Am. J. Vet. Res.* **53**, 851–855.
- Khoo, J. C., Steinberg, D., Thompson, D., and Mayer, S. E. (1973). Hormonal regulation of adipocyte enzymes: the effects of epinephrine and insulin on the control of lipase, phosphorylase kinase, phosphorylase and glycogen synthase. *J. Biol. Chem.* **248**, 3823–3830.
- Kirk, C. C., Feldman, E. C., and Nelson, R. W. (1993). Diagnosis of naturally acquired type I and type II diabetes mellitus in cats. *Am. J. Vet. Res.* **54**, 463–467.
- Kleiber, M. (1959). Milk formation in intact cows with radiocarbon as a metabolic tracer. In "Proc. 2d Interam. Symp. on Peaceful Applications of Nuclear Energy," pp. 161–171. Pan American Union, Washington, DC.
- Kramer, J. W., Nottingham, S., Robinette, J., Leaz, G., Sylvester, S., and Dessouky, M. (1980). Inherited early onset, insulin requiring diabetes mellitus in Keeshond dogs. *Diabetes* **29**, 558–563.
- Kramer, J. W., Klaassen, J. K., Baskin, B. G., Prieur, B. G., Rantenen, N. W., and Robinette, J. J. (1988). Inheritance of diabetes mellitus in Keeshond dogs. *Am. J. Vet. Res.* **49**, 428–431.
- Kreisberg, R. A. (1978). Diabetic ketoacidosis: new concepts and trends in pathogenesis and treatment. *Ann. Intern. Med.* **88**, 681–695.
- Kronfeld, D. S., Simesen, M. G., and Dungworth, D. L. (1960). Liver glycogen in normal and ketotic cows. *Res. Vet. Sci.* **1**, 242–247.
- Kruth, S. A., Feldman, E. C., and Kennedy, P. C. (1982). Insulin secreting islet cell tumor: establishing a diagnosis and the clinical cause. *J. Am. Vet. Med. Assoc.* **181**, 54–58.
- Linfoot, P., Bergstrom, C., and Ipp, E. (2005). Pathophysiology of ketoacidosis in type 2 diabetes mellitus. *Diabet. Med.* **22**, 1414–1419.
- McMillan, F. D., and Feldman, E. C. (1986). Rebound hyperglycemia following overdosing of insulin in cats with diabetes mellitus. *J. Am. Vet. Med. Assoc.* **188**, 1426–1431.
- Mahaffey, E. A., and Cornelius, L. M. (1982). Glycosylated hemoglobin in diabetic and non-diabetic dogs. *J. Am. Vet. Med. Assoc.* **180**, 635–637.
- Markussen, J. (1971). Mouse insulins separation and structures. *Int. J. Protein Res.* **3**, 149–155.
- Mattheeuws, D., Rottiers, R., Derijcke, J., DeRick, A., and DeSchepper, J. (1976). Hyperinsulinism in the dog due to pancreatic islet-cell tumour: a report of 3 cases. *J. Small Anim. Pract.* **7**, 313–318.
- Mattheeuws, D., Rottiers, R., Kaneko, J. J., and Vermeulen, A. (1984). Diabetes mellitus in dogs: relationship of obesity to glucose tolerance and insulin response. *Am. J. Vet. Res.* **45**, 98–105.
- Morrill, C. C. (1952). Studies on baby pig mortality, VIII: chemical observations on the newborn pig, with special reference to hypoglycemia. *Am. J. Vet. Res.* **13**, 164–170.
- Murakami, H., Takagi, A., Nonaka, S., Ishiura, S., Sugita, H., and Mizutani, M. (1980). Glycogenesis II in Japanese quail. *Exp. Anim.* **29**, 475–478.
- Naithani, G., Steffans, G., Tager, H. S., Buse, G., Rubenstein, A. F., and Steiner, D. F. (1984). Isolation and amino acid sequence determination of monkey insulin and proinsulin. *Hoppe-Seyler's Z. Physiol. Chem.* **365**, 571–575.
- Nathan, D. M., Singer, D. E., Hurxthal, K., and Goodson, J. D. (1984). The clinical informative value of the glycosylated hemoglobin assay. *N. Engl. J. Med.* **310**, 341–346.
- Nelson, R. W., Feldman, E. C., and Ford, S. L. (1993). Effect of an orally administered sulfonylurea, glipizide, for treatment of diabetes mellitus in cats. *J. Am. Vet. Med. Assn.* **203**, 821–827.
- Nelson, R. W., Himsel, C. A., and Feldman, E. C. (1990). Glucose tolerance and insulin response in normal weight and obese cats. *Am. J. Vet. Res.* **51**, 1357–1362.
- O'Brien, T. D., Hayden, D. W., Johnson, K. W., and Stevens, J. B. (1985). High dose intravenous glucose tolerance test and serum insulin and glucagon levels in diabetic and non-diabetic cats: relationship to insular amyloidosis. *Vet. Pathol.* **22**, 250–261.
- O'Sullivan, B. M., Healy, P. J., Fraser, I. R., Nieper, R. E., Whittle, R. J., and Sewell, C. A. (1981). Generalized glycogenesis in Brahman cattle. *Aust. Vet. J.* **57**, 227–229.
- Piroli, G. G., Grillo, C. A., Charron, M. J., McEwen, B. S., and Reagan, L. P. (2004). Biphasic effects of stress upon GLUT 8 glucose transporter expression and trafficking in the diabetic rat hippocampus. *Brain Res.* **1006**, 28–35.
- Priester, W. A. (1974). Pancreatic islet cell tumors in domestic animals: data from 11 colleges of veterinary medicine in the United States and Canada. *J. Natl. Cancer Inst.* **53**, 227–229.
- Rafaguzzaman, M., Svenkerud, R., Strande, A., and Hauge, J. G. (1976). Glycogenesis in the dog. *Acta Vet. Scand.* **17**, 196–209.
- Raptis, S., and Dimitriadis, G. (1985). Human insulin. *Clin. Physiol. Biochem.* **3**, 29–42.
- Reaven, G. M. (2005). The metabolic syndrome: requiescat in pace. *Clin. Chem.* **51**, 931–938.
- Reaven, G. M. (2006). The metabolic syndrome: is this diagnosis necessary? *Am. J. Clin. Nutr.* **83**, 1248–1251.
- Renold, A. E., and Cahill, G. F., Jr. (1966). Diabetes mellitus. In "The Metabolic Basis of Inherited Disease" (J. B. Stanbury, J. B. Wyngaarden, and D. S. Fredrickson, Eds.), pp. 69–108. McGraw-Hill, New York.
- Rogers, W. A., Donovan, E. F., and Kociba, G. J. (1975). Lipids and lipoproteins in normal dogs and in dogs with secondary hyperlipoproteinemia. *J. Am. Vet. Med. Assoc.* **166**, 1092–1100.
- Ross, S. A., Brown, J. C., and Dupre, J. (1977). Hypersecretion of gastric inhibitory polypeptide following oral glucose in diabetes mellitus. *Diabetes* **26**, 525–529.
- Sherwin, R. S., Fisher, M., Hendler, R., and Felig, P. (1976). Hyperglucagonemia and blood glucose regulation in normal, obese, and diabetic subjects. *N. Engl. J. Med.* **294**, 455–461.
- Shin, Y. S. (2006). Glycogen storage disease: clinical, biochemical, and molecular heterogeneity. *Sem. in Pediat. Neurol.* **13**, 115–120.
- Steiner, D. F. (1977). The Banting memorial lecture. Insulin today. *Diabetes* **26**, 332–340.
- Steiner, D. F. (2004). The proinsulin C-peptide—a multirole model. *Exp. Diabetes Res.* **5**, 7–14.
- Steinke, J., and Taylor, K. W. (1974). Viruses and the etiology of diabetes. *Diabetes* **23**, 631–633.
- Swiatek, K. R., Kipnis, D. M., Mason, G., Chao, K., and Cornblath, M. (1968). Starvation hypoglycemia in newborn pigs. *Am. J. Physiol.* **214**, 400–405.
- Taniyama, H., Ushiki, T., Tajima, M., Kurosawa, T., Kitamura, N., Takahashi, K., Matsukawa, K., and Itokura, C. (1995). Spontaneous diabetes mellitus associated with persistent viral diarrhea (RVD) virus infection in young cattle. *Vet. Pathol.* **32**, 221–229.
- Thorens, B., Sakhar, H. K., Kaback, H. R., and Lodish, H. F. (1988). Cloning and functional expression in bacteria of a novel glucose

- transporter present in liver, intestine, kidney, and beta pancreatic cells. *Cell* **55**, 281–290.
- Unger, R. H. (1981). The milieu interieur and the islets of Langerhans. *Diabetologia* **20**, 1–11.
- Unger, R. H., and Orci, L. (1975). The essential role of glucagon in the pathogenesis of diabetes mellitus. *Lancet* **1**, 14–16.
- Unger, R. H., and Orci, L. (1976). Physiology and pathophysiology of glucagon. *Physiol. Rev.* **56**, 778–826.
- Walvoort, H. C. (1983). Glycogen storage diseases in animals and their potential value as models of human disease. *J. Inher. Metab. Dis.* **6**, 3–16.
- Walvoort, H. C., Slee, R. G., and Koster, J. F. (1982). Canine glycogen storage disease type II: a biochemical study of an acid alpha-glucosidase deficient Lapland dog. *Biochim. Biophys. Acta* **715**, 63–69.
- Winter, W. E., and Signorino, M. R. (2002). “Diabetes Mellitus: Pathophysiology, Etiologies, Complications, Management, and Laboratory Testing.” AACC Press, Washington, DC.
- Wood, P. A., and Smith, J. E. (1980). Glycosylated hemoglobin and canine diabetes mellitus. *J. Am. Vet. Med. Assoc.* **176**, 1267–1268.
- Vora, S., Giger, U., Tinchen, S., and Harvey, J. W. (1985). Characterization of the enzymatic lesion in inherited phosphofructokinase deficiency in the dog: an animal analog of human glycogen storage disease type VII. *Proc. Natl. Acad. Sci. USA* **82**, 8109–8113.
- Yoon, J-W., Austin, M., Onodera, T., and Notkins, A. L. (1979). Isolation of a virus from the pancreas of a child with diabetic ketoacidosis. *N. Engl. J. Med.* **300**, 1173–1179.

# Lipids and Ketones

Michael L. Bruss

*Department of Anatomy, Physiology, and Cell Biology*

*School of Veterinary Medicine*

*University of California, Davis*

*Davis, California*

## I. INTRODUCTION

### II. LONG CHAIN FATTY ACIDS

- A. Structure, Properties, and Assay of Long Chain Fatty Acids
- B. Synthesis of Long Chain Fatty Acids
- C. Catabolism of Long Chain Fatty Acids

### III. TRIACYLGLYCEROL

- A. Structure, Properties, and Assay of Triacylglycerol
- B. Synthesis of Triacylglycerol
- C. Catabolism of Triacylglycerol

### IV. PHOSPHOLIPIDS

- A. Structure and Properties of Phospholipids
- B. Synthesis of Phospholipids
- C. Catabolism of Phospholipids

### V. CHOLESTEROL

- A. Structure, Properties, and Assay of Cholesterol
- B. Metabolism of Cholesterol

### VI. LIPOPROTEINS

- A. Structure, Properties, and Assay of Lipoproteins
- B. Apolipoproteins
- C. Digestion of Fat and Formation of Chylomicrons
- D. Very Low Density Lipoprotein: Synthesis, Export, and Metabolism
- E. Metabolism of High-Density Lipoproteins

### VII. HYPERLIPIDEMIA

- A. Introduction
- B. Canine Fasting Hyperlipidemias
- C. Feline Fasting Hyperlipidemias
- D. Equine Fasting Hyperlipidemia

### VIII. KETOGENESIS AND KETOSIS

- A. Introduction
- B. Chemistry of Ketones
- C. Synthesis of Ketones
- D. Catabolism of Ketones
- E. Pathophysiology of Ketonemia
- F. Fasting Ketosis
- G. Diabetic Ketosis
- H. Ketosis Associated with Pregnancy and Lactation
- I. Postexercise Ketosis

## REFERENCES

## I. INTRODUCTION

This chapter covers the biochemistry and clinical chemistry of long chain fatty acids, triacylglycerols, phospholipids, cholesterol, and ketones, a list that includes the majority of lipids found in vertebrates. The only remaining major classes are sphingolipids and waxes, which are not discussed here. Although lipids have many functions, two of the most important are energy storage and membrane structure. Triacylglycerols are by far the most important lipid with regard to energy storage, and phospholipids and cholesterol are the most important lipid membrane constituents. Lipids serve other functions, including being precursors for steroids and bile acids (cholesterol), thermal insulation (triacylglycerols), and electrical insulation (various lipids). Virtually all lipids are insoluble in water, which greatly complicates their handling in the body. Because of their insolubility, lipids must rely on proteins for transport for any significant distance in the body, and various proteins have evolved to provide this function. The insolubility of lipids is an asset as well as a liability. Because of their insolubility, lipids generate no osmotic force, so large amounts of triacylglycerol can be stored in adipose without the weight gain from water that would accompany it if it were soluble. The insolubility of lipids is vital to many of their functions in membranes.

## II. LONG CHAIN FATTY ACIDS

### A. Structure, Properties, and Assay of Long Chain Fatty Acids

Long chain fatty acids (LCFA), frequently called free fatty acids or nonesterified fatty acids, are straight chain fatty acids containing twelve or more carbon atoms. Because LCFA are usually synthesized in animals or plants from acetyl-CoA and are then degraded two carbons at a time via  $\beta$ -oxidation in animals, the LCFA found most commonly in animals have an even number of carbon atoms. LCFA having

carbon chain lengths of 16 and 18 constitute the greatest bulk of fatty acids in animal tissues and most animal diets. The saturated 16-carbon LCFA is palmitic acid, and the saturated 18-carbon LCFA is stearic acid. Unsaturated 18-carbon LCFA are common, with double bonds occurring at C<sub>9</sub>—C<sub>10</sub> (oleic acid); at C<sub>9</sub>—C<sub>10</sub> and C<sub>12</sub>—C<sub>13</sub> (linoleic acid); and at C<sub>9</sub>—C<sub>10</sub>, C<sub>12</sub>—C<sub>13</sub>, and C<sub>15</sub>—C<sub>16</sub> (linolenic acid). The double bonds found in fatty acids in nature are mostly of the *cis* configuration. Ruminant fat contains more *trans*-LCFA than that of nonruminants because rumen microbes isomerize some plant *cis*-LCFA to *trans* isomers. Unsaturated LCFA have a lower melting point than saturated LCFA with the same number of carbons and are more susceptible to spontaneous oxidation (Gurr *et al.*, 2002). The 20-carbon polyunsaturated fatty acids, arachidonic acid (double bonds at C<sub>5</sub>—C<sub>6</sub>, C<sub>8</sub>—C<sub>9</sub>, C<sub>11</sub>—C<sub>12</sub>, C<sub>14</sub>—C<sub>15</sub>) and eicosapentaenoic acid (also called timnodonic acid), which is arachidonic acid with an additional double bond at C<sub>17</sub>—C<sub>18</sub>, are the precursors of the eicosanoids (prostaglandins, leukotrienes, thromboxanes).

Long chain fatty acids are relatively insoluble in water at physiological pH. They dissolve readily in highly alkaline solutions, forming soaps. LCFA are amphiphilic, being quite polar (hydrophilic) at their carboxyl end and quite nonpolar (hydrophobic) at the methyl end. All LCFA must bind to proteins in order to be transported for any significant distance, and albumin is the primary transport protein in plasma (Gurr *et al.*, 2002).

Plasma LCFA concentrations can be determined spectrophotometrically with a specific enzymatic reaction, which involves direct reaction of plasma LCFA to form LCFA-CoA. Then, LCFA-CoA is oxidized using LCFA-CoA oxidase, which produces hydrogen peroxide. The hydrogen peroxide is used to produce a colored product under the catalysis of peroxidase (Demacker *et al.*, 1982; Shimizu *et al.*, 1980). If a sample contains triacylglycerol and lipase, which is not uncommon, LCFA may be released if the sample is allowed to stand. Falsely high LCFA may be avoided by centrifuging blood samples and freezing the plasma immediately after collection or by adding paraoxon, a lipase inhibitor (Degen and Van der Vies, 1985).

## B. Synthesis of Long Chain Fatty Acids

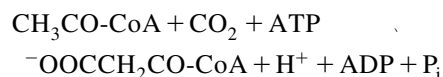
LCFA may be synthesized in most tissues, but only liver, adipose, or mammary tissue does it on a large scale. Synthesis occurs in the cytosol from acetyl-CoA. The precursor of the acetyl-CoA used for LCFA synthesis is usually acetate or glucose, with the former being important in ruminants and the latter being important in nonruminant mammals. When acetate is the acetyl-CoA precursor, it is formed from plasma acetate in the cytosol, the same cellular location as the enzymatic machinery needed to manufacture the LCFA. However, when glucose is the precursor, it must go through glycolysis, which has its terminal

enzyme, pyruvate dehydrogenase, located in the mitochondria. Thus, the acetyl-CoA is produced in the mitochondria, which is a problem if it is to be used for LCFA synthesis because the inner mitochondrial membrane is relatively impermeable to acetyl-CoA (Rangan and Smith, 2002).

This problem has been solved by a mechanism known as the citrate shuttle, which is shown in Figure 4-1. Acetyl-CoA in the mitochondria combines with oxaloacetate under the catalysis of citrate synthase to form citrate. Citrate is translocated across the mitochondrial membrane where it is cleaved into acetyl-CoA and oxaloacetate by ATP-citrate lyase. Thus, acetyl-CoA has been effectively transported from mitochondrion to cytosol. What remains is for the oxaloacetate to reenter the mitochondria to complete the cycle. However, the inner mitochondrial membrane is also impermeable to oxaloacetate, so it is first converted to malate by malate dehydrogenase or aspartate by aspartate aminotransferase in the cytosol. The malate or aspartate is translocated into the mitochondrion where it can be converted back to oxaloacetate by reversal of the reactions that occurred in the cytosol. Alternately, malate in the cytosol can be converted to pyruvate by malic enzyme, and the pyruvate can enter the mitochondrion and be converted to oxaloacetate by pyruvate carboxylase (Rangan and Smith, 2002).

Once acetyl-CoA reaches or has been formed in the cytosol, it must be carboxylated to produce malonyl-CoA via acetyl-CoA carboxylase if it is to be used for LCFA synthesis. This biotin-containing enzyme catalyzes the following reaction:

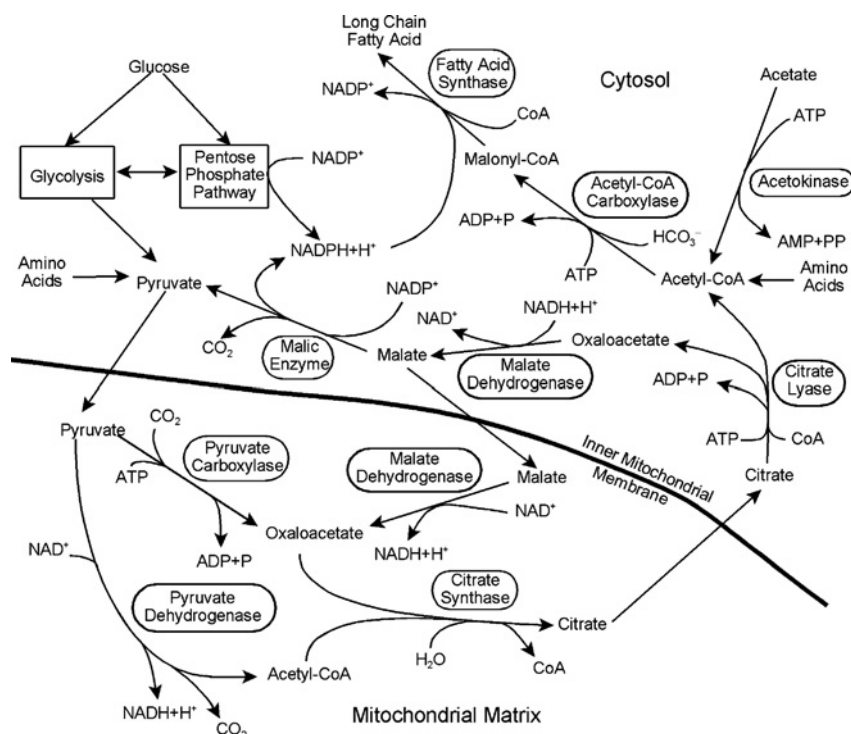
Acetyl-CoA Carboxylase



Acetyl-CoA carboxylase is the main regulatory site in the synthesis of LCFA, which makes sense because the cell has little use for malonyl-CoA other than the synthesis of LCFA. The enzyme is activated by citrate, which is logical because citrate will be abundant only when there is a plentiful supply of mitochondrial acetyl-CoA. In addition, acetyl-CoA carboxylase is directly inhibited by LCFA-CoA, which can be derived from the synthetic process itself or from uptake and activation of plasma LCFA. Acetyl-CoA carboxylase is also regulated by hormones via phosphorylation of the enzyme itself. Glucagon and LCFA-CoA stimulate phosphorylation, which inhibits the enzyme. Insulin activates the enzyme quickly by stimulating dephosphorylation (Rangan and Smith, 2002). These controls make sense in that a fasting or exercising animal will have its capacity for LCFA synthesis suppressed by increased plasma glucagon and LCFA levels, decreased plasma insulin, and increased intracellular LCFA-CoA. Conversely, in a recently fed animal, these controls will all be reversed to promote LCFA synthesis.

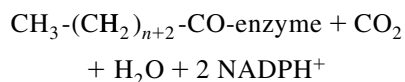
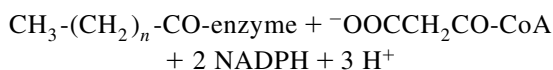
Malonyl-CoA is used as the building block for LCFA in the cytosol by a large, complex, multiunit enzyme called





**FIGURE 4-1** Fatty acid synthesis. Acetyl-CoA is generated in the mitochondria from pyruvate but cannot penetrate the mitochondrial membrane to reach fatty acid synthesizing enzymes in the cytosol. Citrate is formed from acetyl-CoA and oxaloacetate and migrates to the cytosol where it is cleaved to regenerate acetate and oxaloacetate. The acetyl-CoA is converted into malonyl-CoA and used for fatty acid synthesis. The oxaloacetate cannot penetrate the mitochondrial membrane but must be converted to malate or pyruvate, which can penetrate the membrane and be converted back to oxaloacetate in the mitochondria. NADPH needed for fatty acid synthesis is generated by the pentose phosphate pathway and malic enzyme.

fatty acid synthase. Fatty acid synthase uses malonyl-CoA to add two carbon units at a time to a growing LCFA chain that is attached to the enzyme itself, and it uses NADPH to reduce the oxygen that was attached to what was the end carbon of the old LCFA chain. The reaction proceeds in a series of distinct steps, which all occur on the same enzyme complex. The overall reaction is as follows:



The subscript, *n*, in the structural formula for the growing LCFA is an even number ranging from zero (i.e., the starting acetyl group) to usually no more than eight (stearate). The process begins when an acetyl group binds to the enzyme complex and usually ends when a palmityl (16-carbon) group has been formed on the enzyme, at which point the LCFA is detached from the enzyme. New carbons are added to the carboxyl end, not the methyl end, of the growing LCFA. The carbon atom in the carbon dioxide produced in the fatty acid synthase reaction is the same carbon atom in the carbon dioxide used to form malonyl-CoA from acetyl-CoA.

Cellular synthesis of the enzymes directly involved in LCFA synthesis (acetyl-CoA carboxylase and fatty acid synthase) and the enzymes involved in the generation of NADPH and acetyl-CoA translocation is stimulated

by diets that are high in carbohydrate and low in fat and suppressed by fasting, high-fat/low-carbohydrate diets, and diabetes. These changes appear to be brought about, in part, by alterations in plasma insulin and glucagon that accompany diet changes or diabetes (Gurr *et al.*, 2002; Rangan and Smith, 2002).

Fatty acid synthesis is expensive energetically. To add a single acetyl-CoA to a growing LCFA chain, one ATP is used directly and six more are used indirectly (each of the two NADPH is equivalent to three ATP). Because fatty acid synthesis occurs in the cytosol and requires NADPH, there must be a generous source of that cofactor when fatty acid synthesis is active. The main source of NADPH for fatty acid synthesis is the hexose monophosphate pathway in the cytosol. This pathway utilizes plasma glucose in the case of adipose or mammary tissue, whereas in the liver, it can use plasma glucose, glycogen, or gluconeogenesis as the hexose source. Another source of NADPH in the cytosol is the malic enzyme reaction. These sources of NADPH are illustrated in Figure 4-1.

Although the most common length for nascent LCFA when they are released from fatty acid synthase is 16 carbons, they can be 18 carbons or, in the case of fat synthesis in the mammary gland, as short as 4 carbons. When LCFA are detached from fatty acid synthase, they are rapidly thioesterified to CoA by LCFA-CoA synthetase, an enzyme found in the endoplasmic reticulum and outer mitochondrial membrane. Most of the palmitate produced by fatty acid synthase will be elongated to produce stearate by fatty acid elongase, an enzyme found mainly in the endoplasmic reticulum but also in mitochondria. This enzyme adds

2 new carbons at the carboxyl end of the existing LCFA. Fatty acid elongase uses the same substrates (malonyl-CoA and NADPH) as fatty acid synthase, but it is located in a different part of the cell and prefers palmitoyl-CoA as its substrate. However, fatty acid elongase can use longer LCFA-CoA as substrates to a limited degree to produce LCFA-CoA with a length of as great as 24 carbons (Cook and McMaster, 2002).

Nonruminant mammals synthesize LCFA in liver, adipose, and mammary tissue. Ruminants synthesize LCFA primarily in adipose and mammary tissue with acetate being the most important precursor. Ruminants generally have a low capacity for LCFA synthesis in liver, but after eating large amounts of high-starch diets, they may synthesize some LCFA in the liver from acetate and propionate (Hanson and Ballard, 1967; Ingle, 1972a, 1972b; Liepa 1978).

## C. Catabolism of Long Chain Fatty Acids

### 1. Desaturation

Most animals are capable of desaturating LCFA only at the  $\Delta^4$ ,  $\Delta^5$ ,  $\Delta^6$ , and  $\Delta^9$  positions (counting from the carboxyl end). Animals are able to desaturate palmitoyl-CoA and stearyl-CoA between  $C_9$  and  $C_{10}$  by means of  $\Delta^9$  desaturase system located in the endoplasmic reticulum to produce palmitoleyl-CoA and oleyl-CoA, respectively. However, animals are not able to create additional double bonds beyond  $C_9$  in these products to any significant extent, so linoleic and linolenic acids must be absorbed from the intestinal tract (Cook and McMaster, 2002). By a combination of the actions LCFA elongase and  $\Delta^4$ ,  $\Delta^5$ , and  $\Delta^6$  desaturase systems, the livers of most mammals can synthesize arachidonic acid and eicosapentaenoic acid from linoleic and linolenic acids, respectively. However, the cat has very low levels of  $\Delta^6$  desaturase in its liver and must have arachidonic acid in its diet (MacDonald *et al.*, 1984).

### 2. $\beta$ -Oxidation

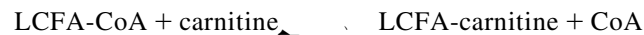
The main catabolic route for LCFA is  $\beta$ -oxidation. Most tissues can perform  $\beta$ -oxidation (erythrocytes are an exception), but those most adept at it are liver, skeletal muscle, and heart. In addition, the liver can partially oxidize LCFA to ketones, an important process that will be discussed extensively later. Before LCFA can be subjected to  $\beta$ -oxidation, they must be esterified to CoA, which is accomplished by the following reaction:



The reaction is catalyzed by LCFA-CoA synthetase, an enzyme bound to the endoplasmic reticulum and the outer mitochondrial membrane. The pyrophosphate (PP) is rapidly hydrolyzed, so the reaction effectively consumes two

ATP. The activation of LCFA is not rate limiting for  $\beta$ -oxidation (Pande, 1971).

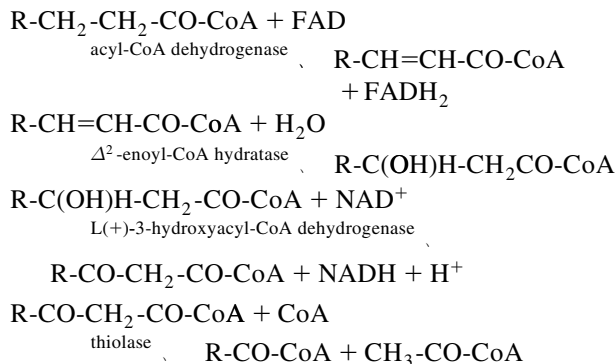
For LCFA-CoA to be catabolized, it must pass into the mitochondrion, which is a problem because the inner mitochondrial membrane is impermeable to it. The CoA must be exchanged for a carnitine moiety, a reaction catalyzed outside the mitochondrion by carnitine acyltransferase I (Fig. 4-2):



LCFA-carnitine passes readily through the inner mitochondrial membrane and is acted on by carnitine acyltransferase II, which converts the LCFA-carnitine back to LCFA-CoA (Kopec and Fritz, 1973).

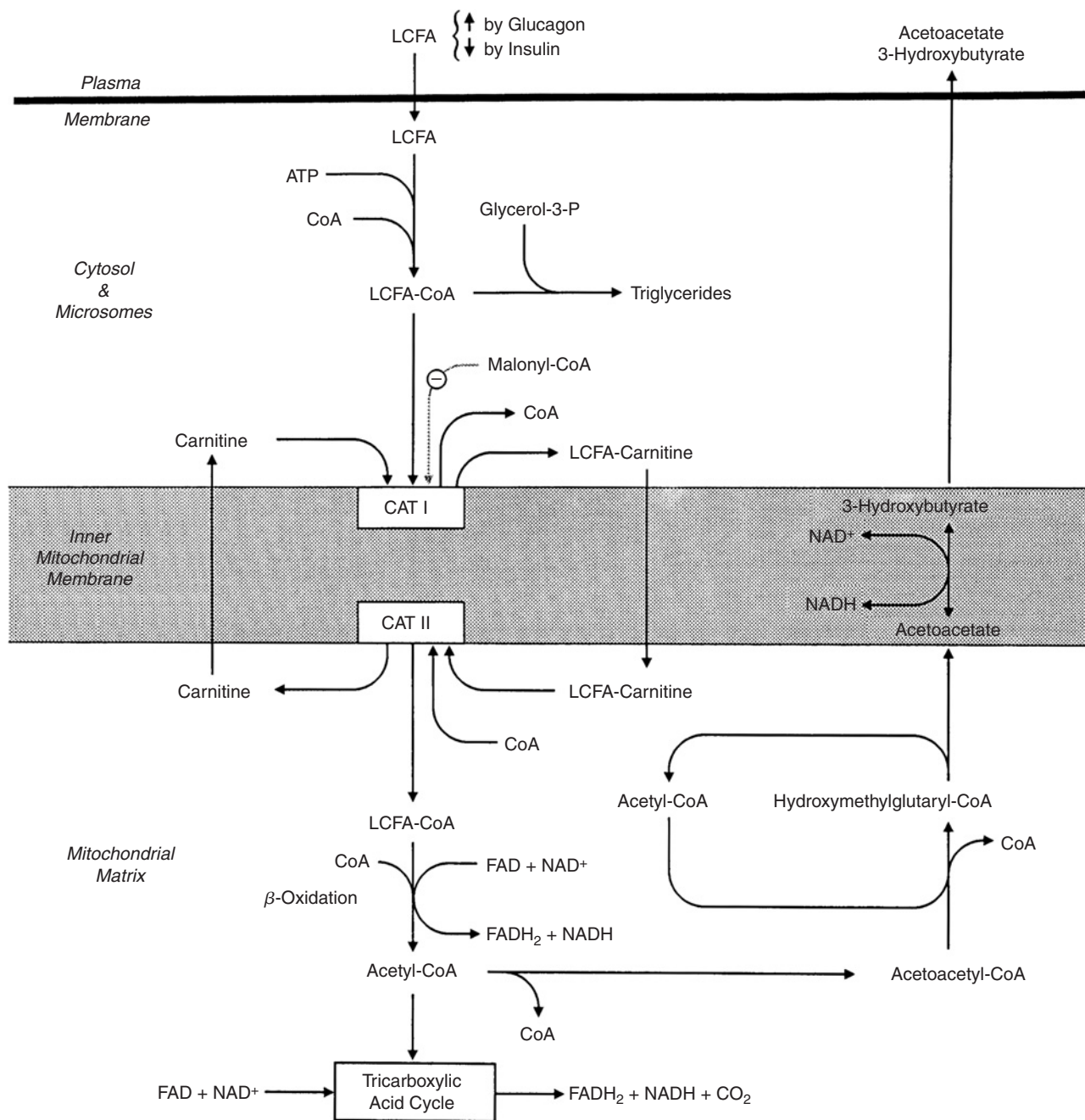
Carnitine acyltransferase I appears to be controlled by inhibition by malonyl-CoA (McGarry *et al.*, 1977), and it is logical that when lipogenesis is stimulated, the LCFA that are produced should be prevented from entering the mitochondrion where they will be catabolized.

In the mitochondrion, the process of  $\beta$ -oxidation per se cleaves the LCFA into acetyl-CoA units. The reaction sequence is as follows:



The resulting acyl-CoA is two carbons shorter and can recycle through the pathway. Each trip of an acyl-CoA through the pathway generates one  $\text{FADH}_2$  and one  $\text{NADH} + \text{H}^+$ , which can generate 5 ATP via oxidative phosphorylation. If the LCFA has an odd number of carbons, which is rare, the final product of  $\beta$ -oxidation will be propionyl-CoA. The double bond produced by the acyl-CoA dehydrogenase reaction is of trans configuration, not the cis configuration occurring in unsaturated LCFA found free or esterified to glycerol.

Unsaturated LCFA can proceed through  $\beta$ -oxidation to within three carbons of the double bond. As this point,  $\Delta^2$ -enoyl-CoA hydratase cannot act because it requires a trans, rather than a cis, configuration in its substrates, and it requires that the double bond be between  $C_2$  and  $C_3$  rather than between  $C_3$  and  $C_4$ . At this point,  $\Delta^3$ ,  $\Delta^2$ -enoyl-CoA isomerase will convert the  $\Delta^3$ -cis double bond to a  $\Delta^2$ -trans double bond, which will allow  $\beta$ -oxidation to proceed



**FIGURE 4-2** Long chain fatty acid (LCFA) oxidation and ketogenesis in the liver. Abbreviations: CAT, carnitine acyltransferase.

(Kilponen *et al.*, 1991). Polyunsaturated LCFA require an additional enzyme, 2,4-dienoyl-CoA reductase, because after enoyl-CoA isomerase acts, the new trans double bond will still have the second cis double bond in close proximity, which will prevent  $\Delta^2$ -enoyl-CoA hydratase from acting. 2,4-Dienoyl-CoA reductase effectively eliminates the second double bond by reducing it with NADPH (Roe *et al.*, 1990).

$\beta$ -Oxidation in the mitochondria appears to be controlled mainly by substrate availability. The acetyl-CoA units can

be oxidized in the citric acid cycle provided there is sufficient oxaloacetate to condense with them to form citrate. Alternatively, acetyl-CoA units can be recondensed to form ketones, which will occur when there is not sufficient oxaloacetate for citrate formation or when citrate synthase is inhibited by high levels of citrate. Although  $\beta$ -oxidation occurs mostly in mitochondria, the process occurs to a minor extent in peroxisomes as well (Wanders *et al.*, 1992).

Although the main catabolic route for LCFA is  $\beta$ -oxidation, there are two quantitatively minor alternatives.

$\alpha$ -Oxidation, in which carbons are removed one at a time from the carboxyl end of the LCFA, is used by brain tissue to produce LCFA of varying lengths for synthesis of complex lipids.  $\omega$ -Oxidation, which is oxidation that occurs at the methyl, rather than at the carboxyl, end is conducted to a limited extent by the cytochrome P-450 system in the endoplasmic reticulum of liver. The resulting dicarboxylic acid can then undergo  $\beta$ -oxidation to a chain length of six carbons (adipate), most of which will be excreted in the urine (Gurr *et al.*, 2002; Mortensen, 1990).

### III. TRIACYLGLYCEROL

#### A. Structure, Properties, and Assay of Triacylglycerol

The main storage forms of LCFA are the triacylglycerols (also called triglycerides), in which three LCFA are esterified to glycerol. Triacylglycerols are even less soluble than LCFA and also must be bound to proteins in complexes called lipoproteins for transport through plasma.

Assay of triacylglycerol in plasma or serum is best accomplished by enzymatic hydrolysis using lipase followed by enzymatic determination of the released glycerol (Klotzsch and McNamara, 1990; McGowan *et al.*, 1983). If high plasma glycerol levels are likely, as it is in animals that have not eaten lately, a plasma blank must be run. Older methods that use alkaline hydrolysis require caustic reagents, consume more time, and may assay phospholipids plus triacylglycerol. Contamination of samples with glycerol, which is sometimes used to lubricate stoppers of blood collecting tubes, or with soap, which may contain glycerol or fatty acids, will lead to falsely elevated values. If the sample contains lipase, which is not uncommon, triacylglycerol levels will decrease if it is allowed to stand. Prompt centrifugation of blood samples followed by rapid analysis or freezing of the plasma will prevent falsely low triacylglycerol levels.

#### B. Synthesis of Triacylglycerol

Although most cells can synthesize triacylglycerols, liver, adipose, mammary gland, and small intestine are particularly adept at it. LCFA-CoA are the building blocks for triacylglycerol synthesis, and it should be realized that there are two sources of LCFA-CoA for triacylglycerol synthesis: LCFA in the plasma and LCFA synthesized locally. Generally, physiological or pathological circumstances, such as starvation or diabetes, which promote high plasma levels of LCFA, suppress LCFA synthesis. Physiological circumstances that promote LCFA synthesis, such as eating a carbohydrate meal, also inhibit lipolysis in adipose, so plasma LCFA levels are not elevated.

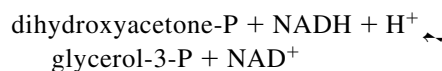
To form triacylglycerols, LCFA-CoA are esterified to glycerol-3-P. Glycerol-3-P can be produced in the liver

from glycerol, which is absorbed from the plasma, and ATP in a reaction catalyzed by glycerol kinase:

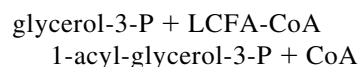


Glycerol is normally plentiful in plasma only when there is active lipolysis occurring in adipose tissue.

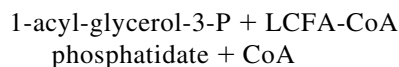
When glucose is plentiful in the plasma and LCFA are being synthesized from glucose via acetyl-CoA, glycerol-3-P is also synthesized from glucose in liver, mammary gland, and adipose. This process occurs via glycolysis to dihydroxyacetone-P followed by a reduction catalyzed by glycerol-3-P dehydrogenase:



LCFA-CoA is esterified to glycerol-3-P by glycerol-P acyltransferase:



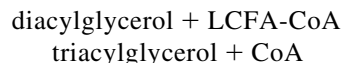
This reaction occurs in both mitochondria and smooth endoplasmic reticulum, but the smooth endoplasmic reticulum enzyme is more plentiful and most important in triacylglycerol synthesis. Next, another LCFA-CoA is esterified by the enzyme, acylglycerol-P acyltransferase, which is located in the smooth endoplasmic reticulum:



Phosphatidate (the ionized form of phosphatidic acid) is 1,2-diacyl-glycerol-3-P. Next, the phosphate is hydrolyzed from phosphatidate by phosphatidate phosphohydrolase to produce a diacylglycerol:



This reaction occurs in the smooth endoplasmic reticulum and cytosol. Finally, a last LCFA-CoA is esterified by the enzyme diacylglycerol acyltransferase, an enzyme located in the smooth endoplasmic reticulum (Bernlohr *et al.*, 2002):



If the triacylglycerol has been synthesized in adipose, it will migrate into the large storage vesicle that each adipocyte possesses. Most of the triacylglycerol synthesized in liver normally will be incorporated into and exported from the liver as part of very low density lipoproteins (VLDL). However, if triacylglycerol synthesis exceeds hepatic export capacity, triacylglycerol will accumulate in vesicles in hepatocytes, leading to fatty liver. If the triacylglycerol has been synthesized in mammary gland, the resulting triacylglycerols will accumulate in vesicles of secretory cells, and the vesicles will be extruded into the lumina of the gland acini.

The regulation of triacylglycerol synthesis is not fully understood and differs among tissues. In small intestine, substrate availability is most important because triacylglycerol synthesis in that organ is an integral part of triacylglycerol absorption. In mammary gland, substrate availability and the hormones that support lactation regulate triacylglycerol synthesis.

In liver, the limiting enzyme in the pathway appears to be phosphatidate phosphohydrolase. This enzyme is subject to an interesting control mechanism in which it is switched between a less active and more active state by the enzyme itself being translocated between the cytosol and endoplasmic reticulum, respectively. Intracellular cAMP, which increases with high plasma glucagon or low plasma insulin levels (e.g., fasting or diabetes), inhibits binding of the enzyme to the endoplasmic reticulum, whereas LCFA or LCFA-CoA promote binding of the enzyme to the endoplasmic reticulum (Bernlohr *et al.*, 2002; Gurr *et al.*, 2002). The role of LCFA and LCFA-CoA in promoting synthesis of triacylglycerols in the liver is important and explains how fat synthesis and fatty liver can occur in the fasting state when hormonal changes would oppose triacylglycerol synthesis.

In adipose tissue, the synthesis of triacylglycerol is very much regulated by hormones, especially glucagon, catecholamines, and insulin. The first two hormones increase intracellular cAMP, and the latter tends to decrease it, although insulin probably has effects independent of cAMP. In conditions in which glucagon would be elevated and insulin would be decreased (e.g., fasting), hormone-sensitive lipase will be activated and lipolysis will be occurring. It is important that fat synthesis not be operative during lipolysis, so as not to waste energy. Low insulin and elevated catecholamine or glucagon levels decrease the level of lipoprotein lipase (LPL) in adipose tissue. Fat cells need LPL in order to hydrolyze plasma triacylglycerol so that the resulting LCFA can be absorbed and used for triacylglycerol synthesis. Decreased plasma insulin levels will decrease entry of glucose into adipocytes, which will result in less glycerolphosphate being synthesized. Increased intracellular cAMP in adipose tissue decreases the activity of several key enzymes in fat synthesis, including fatty acyl-CoA synthetase, glycerolphosphate acyltransferase, phosphatidate transferase, and diacylglycerol acyltransferase; however, the mechanism of inhibition is uncertain (Saggerson, 1988).

### C. Catabolism of Triacylglycerol

Catabolism of triacylglycerol involves the action of lipases, which are specialized esterases that hydrolyze glyceride bonds. The major lipases are pancreatic lipase, hepatic lipase, hormone-sensitive lipase of adipose, lipoprotein lipase found on endothelial cells, and lysosomal lipases contained in most cells. Pancreatic lipase is the essential lipase for digestion of triacylglycerol in the GI tract and is discussed later. Hepatic lipase is synthesized in hepatocytes

from where it migrates to the surface of hepatic endothelial cells. Hepatic lipase primarily attacks triacylglycerol in the plasma, which are part very low density lipoprotein (VLDL) remnants to produce low-density lipoproteins (LDL), and it attacks triacylglycerol in high-density lipoproteins (HDL) as well.

Lipoprotein lipase attacks triacylglycerol in chylomicrons and VLDL in plasma and is found on the endothelium of many organs and tissues, but it is in greatest quantity in adipose, heart, skeletal muscle, and mammary gland. Lipoprotein lipase is synthesized by the underlying tissue and migrates to the capillary endothelium where it is anchored on the cell surfaces to glycoproteins, which have polysaccharide chains structurally similar to heparin. If heparin is injected into an animal, lipoprotein lipase can switch its attachment from cell surface glycoproteins to the free injected heparin and, thus, appears in the plasma. If the animal had a lipemia before injecting the heparin, the large amount of lipoprotein lipase released into the plasma will clear the lipemia. Phospholipids and apolipoprotein C-II must be present for lipoprotein lipase to have full activity (Fielding and Fielding, 2002).

## IV. PHOSPHOLIPIDS

### A. Structure and Properties of Phospholipids

Most of the phospholipids found in the body consist of a core of glycerol, which has LCFA esterified to its 1 and 2 carbons and phosphate esterified to its 3 carbon, a compound called phosphatidate. In addition, the phosphate is often esterified to a hydroxyamino compound such as choline, ethanolamine, or serine to produce phosphatidylcholine (also called lecithin), phosphatidylethanolamine, and phosphatidylserine, respectively. Inositol may be esterified to the phosphate to produce phosphatidylinositol. Because of the phosphate group, phospholipids are very polar on one end but are nonpolar on the other end and still must be part of lipoproteins for transport through the plasma. Phospholipids are constituents of all cellular membranes, lipoproteins, and bile micelles. The fatty acid portion of the molecule is oriented toward the center of the membrane or micelle, and the phosphatidyl group is oriented toward the outer surface (i.e., toward the aqueous medium). In micellar structures, like lipoproteins and bile micelles, the surface coating of the polar ends of constituent phospholipids provides a surface charge that helps to keep the micelles in suspension.

### B. Synthesis of Phospholipids

Phospholipids are synthesized either from phosphatidate (e.g., phosphatidylinositol) or diacylglycerol (e.g., phosphatidylcholine and phosphatidylethanolamine), both of

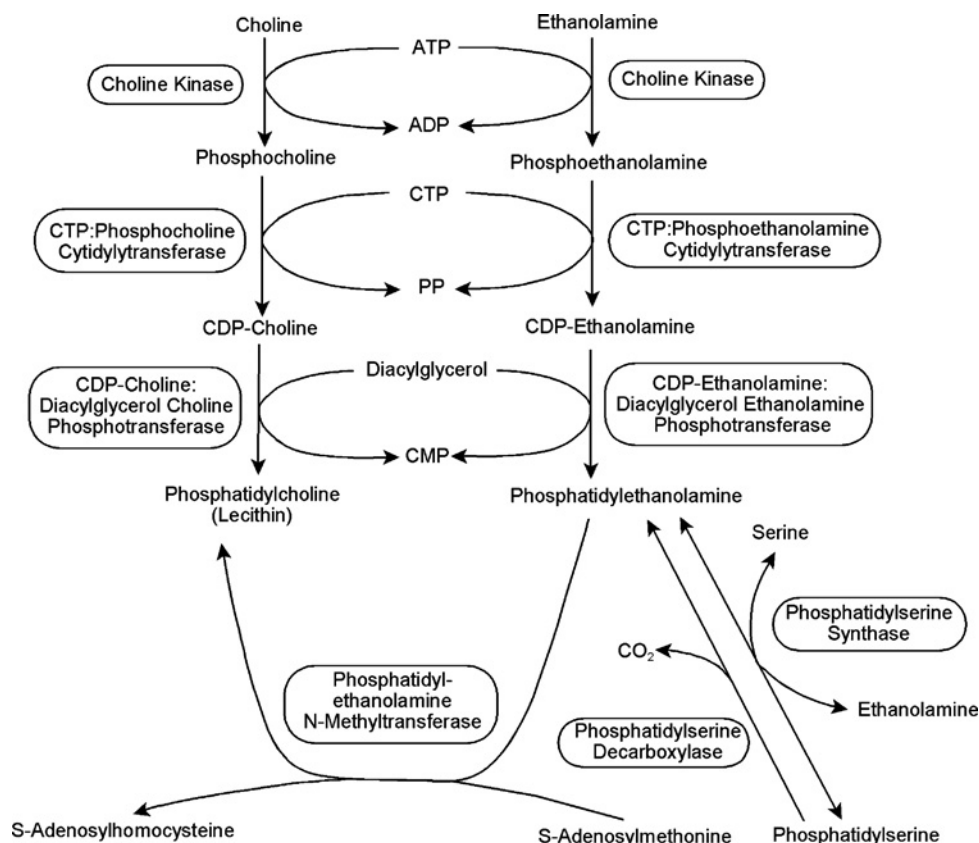
which are intermediates in the synthesis of triacylglycerol. In all cases, cytidine triphosphate (CTP), a high-energy organophosphate that derives its phosphates from ATP, plays an important role. In the case of phosphatidylinositol, CTP reacts with phosphatidate to form CDP-diacylglycerol, which then reacts with inositol to form phosphatidylinositol and CMP. In the case of choline or ethanolamine, it must first be phosphorylated by reaction with ATP. Then the phosphocholine or phosphoethanolamine reacts with CTP to form CDP-choline or CDP-ethanolamine, respectively, which then reacts with diacylglycerol to produce phosphatidylcholine and phosphatidylethanolamine, respectively. Phosphatidylserine is formed by serine replacing ethanolamine in phosphatidylethanolamine. In the endoplasmic reticulum of the liver, a methyl group from S-adenosylmethionine can be transferred to phosphatidylethanolamine to produce phosphatidylcholine (Vance, 2002a). Figure 4-3 illustrates the synthesis of phospholipids.

The enzymes that synthesize CDP-choline and CDP-ethanolamine (cytidylyltransferases) appear to be rate limiting for the synthesis of phosphatidylcholine and phosphatidylethanolamine, respectively. Phosphocholine cytidylyltransferase is subject to regulation similar to that

of phosphatidate phosphohydrolase, the control enzyme in triacylglycerol synthesis. When phosphocholine cytidylyltransferase is bound to the endoplasmic reticulum, it is relatively active, but when it is free in the cytosol, it is relatively inactive. Factors that increase binding of the enzyme to the endoplasmic reticulum are decreased levels of phosphatidylcholine, increased levels of diacylglycerol or LCFA, and dephosphorylation of the enzyme. Opposite changes in these factors inhibit binding of the enzyme to the endoplasmic reticulum forcing it to remain inactive (Vance, 2002a).

### C. Catabolism of Phospholipids

Phospholipids are hydrolyzed by phospholipases, which can be found in lysosomes of most tissues and in pancreatic secretion. Mammalian phospholipases are primarily of the A type, meaning that they hydrolyze the glycerol-LCFA ester bond at either position 1 ( $A_1$  type) or 2 ( $A_2$  type), but not both (Gurr *et al.*, 2002; Waite, 2002). Phospholipase types B, C, and D, which hydrolyze at other locations in the molecule, exist in mammalian tissues, but with lower activities.

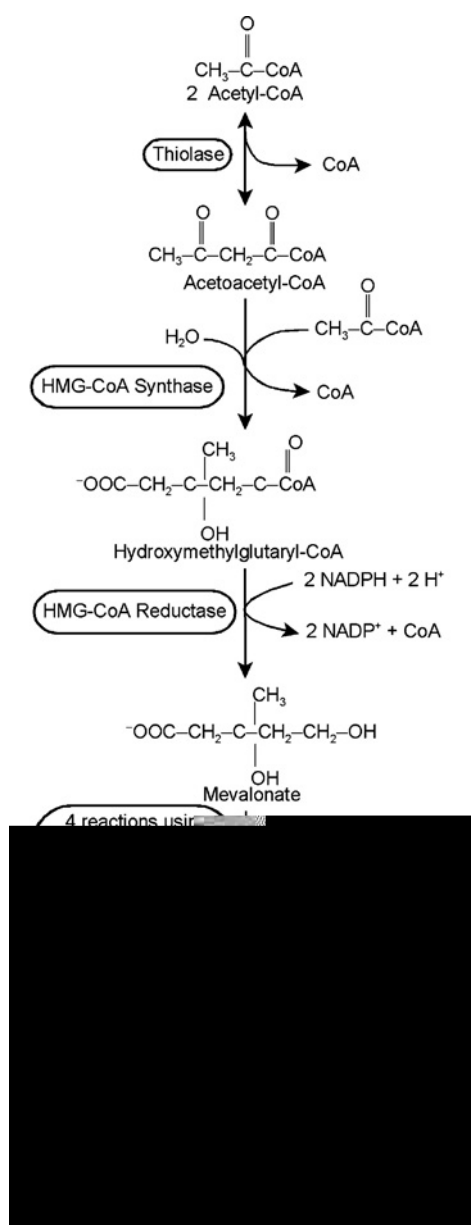


**FIGURE 4-3** Synthesis of phospholipids. Diacylglycerol is the lipid to which organic bases and phosphate are transferred via CDP derivatives. Abbreviations: CTP, CDP, CMP, cytidine tri-, di-, and mono-phosphate, respectively.

## V. CHOLESTEROL

### A. Structure, Properties, and Assay of Cholesterol

Structurally, cholesterol is composed of a core of phenanthrene to which a cyclopentane ring is attached, and there is an eight-carbon side chain attached to the cyclopentane ring (Fig. 4-4). Cholesterol is found only in animals and is not present in plants or microorganisms. Cholesterol is the precursor of steroid hormones, vitamin D, and the bile acids, and is a constituent of cell membranes and bile micelles. Cholesterol can be obtained from the diet if it contains animal products, or it can be synthesized.



**FIGURE 4-4** Synthesis of cholesterol. The first two reactions occur in the cytosol and the remainder in the smooth endoplasmic reticulum.

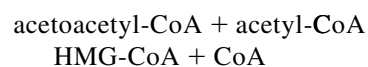
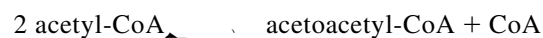
The chief synthetic and catabolic organ for cholesterol is the liver. Steroidogenic endocrine organs (adrenal cortex, testis, ovary, placenta) can synthesize small amounts of cholesterol; however, these organs utilize hepatically synthesized cholesterol for most of their steroid synthesis (Pedersen, 1988). Pure cholesterol and cholesterol esters are insoluble waxy white solids and must be transported through plasma as part of lipoproteins.

Enzymatic methods are used almost universally for assay of cholesterol (Stein and Meyers, 1994). Older non-enzymatic methods used harsh reagents and lack specificity. The key enzymes in the assay are cholesterol esterase, which hydrolyses cholesterol esters, and cholesterol oxidase. The latter enzyme is of microbial origin and has an action analogous to that of glucose oxidase (i.e., it uses dissolved oxygen to oxidize cholesterol to produce cholest-4-ene-3-one and hydrogen peroxide). In the presence of added peroxidase, hydrogen peroxide will oxidize an added organic dye (e.g., dianisidine, ABTS, 4-aminoantipyrine plus phenol) to generate a colored product that can be quantified spectrophotometrically. If cholesterol esterase is included in the reagent, then total cholesterol will be determined. If cholesterol esterase is omitted from the reagent, then only nonesterified (i.e., free) cholesterol will be determined. If the assay is done with and without cholesterol esterase, then cholesterol ester concentration can be determined by subtraction.

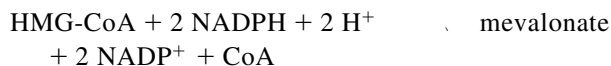
Because virtually all of the cholesterol and cholesterol esters in plasma are part of lipoproteins, they must be liberated before they can be acted on by the enzymes of the reagent. This liberation can be accomplished by extracting cholesterol and its esters with an organic solvent before the assay or, more conveniently, by including small amounts of detergents (bile acids or artificial detergents) in the reagent (Stein and Meyers, 1994).

### B. Metabolism of Cholesterol

As is the case for LCFA and ketones, the substrate for cholesterol synthesis is acetyl-CoA. The beginning site of cholesterol synthesis is in the cytosol, so acetyl-CoA, which is generated primarily in the mitochondria, must be transferred to the cytosol via the citrate shuttle mechanism discussed earlier. The process of cholesterol synthesis is shown diagrammatically in Figure 4-4. In the cytosol, the first two steps of cholesterol synthesis are identical to the first two steps of ketone synthesis except that the process occurs in the cytosol rather than in the mitochondria. The enzymes that catalyze the first two steps are acetyl-CoA: acetoacetyl-CoA thiolase and hydroxymethylglutaryl-CoA (HMG-CoA) synthase:



The remaining enzymes of cholesterol synthesis are located in the endoplasmic reticulum, perhaps because of decreasing solubility of succeeding products formed in the pathway. Next, HMG-CoA is reduced to mevalonate under the catalysis of HMG-CoA reductase:



HMG-CoA reductase is the primary control point for cholesterol synthesis, and its control mechanisms will be discussed later. Next, via three steps, isopentenylpyrophosphate is formed. Six of these molecules, often called the active isoprenoid units, are linked to form cholesterol in a long and complex pathway, which is only partially understood (Faust *et al.*, 1988; Liscum, 2002).

The control of HMG-CoA reductase is complex and not completely understood. Artificially increasing plasma cholesterol levels *in vivo* decreases the activity of the enzyme in liver. However, cholesterol does not inhibit the enzyme directly, but represses synthesis of the enzyme mRNA (Liscum, 2002). Thus, if the amount of cholesterol consumed in the diet increases, the amount synthesized by the liver will decrease. This reciprocal relationship between cholesterol consumed and hepatic synthesis limits the extent to which plasma cholesterol levels can be decreased by restricting the amount of cholesterol in the diet.

Hepatic HMG-CoA reductase is inhibited by phosphorylation of the enzyme and reactivated by dephosphorylation. The protein kinase system responsible for the phosphorylation of HMG-CoA reductase is stimulated by intracellular cAMP (Liscum, 2002). Hepatic intracellular cAMP levels are controlled in part by plasma glucagon, which increases it, and by insulin, which decreases it. Thus, conditions that increase insulin (e.g., eating) will increase cholesterol synthesis, and conditions that decrease insulin (e.g., diabetes) or increase glucagon (e.g., fasting) will decrease cholesterol synthesis. Other hormones that affect hepatic HMG-CoA reductase activity, but probably not by altering intracellular cAMP levels, are thyroid hormones (increase HMG-CoA reductase activity) and glucocorticoids (decrease HMG-CoA reductase activity). Some drugs, such as lovastatin and mevastatin, used in humans to decrease plasma cholesterol levels, operate by inhibiting HMG-CoA reductase (Brown and Goldstein, 1990).

Once cholesterol has been synthesized in the hepatocyte, it can be secreted into the plasma as part of lipoproteins (mostly in VLDL), it can be secreted into the canaliculi and become part of bile micelles, it can be degraded to bile acids, or it can be esterified to an LCFA by acyl-CoA:cholesterol acyltransferase (ACAT), which is located in the smooth endoplasmic reticulum. Cholesterol esters are even less soluble than cholesterol and are found in membranes and micelles wherever cholesterol itself is

found. Cholesterol ester can be exported as part of lipoproteins, or it can be converted back to cholesterol plus LCFA by cholesterol ester hydrolases, which are found in the cytosol, endoplasmic reticulum, and lysosomes. De-esterification is mandatory before cholesterol can be catabolized to bile acids. Because enzymes for the final steps of cholesterol synthesis and the first steps of its degradation are collocated in the endoplasmic reticulum, it might seem that most newly synthesized cholesterol would be immediately degraded. However, the negative feedback of bile acids on cholesterol degradation keeps this process in check.

HDL contains lecithin:cholesterol acyltransferase (LCAT), which esterifies cholesterol by transferring an LCFA moiety from lecithin (phosphatidylcholine). The cholesterol to be esterified by LCAT can be then secreted with HDL at the time of its synthesis, or it can be cholesterol from other lipoproteins or cell membranes that come in contact with HDL at a later time.

## VI. LIPOPROTEINS

### A. Structure, Properties, and Assay of Lipoproteins

Lipoproteins are very large noncellular conglomerations (micelles) of lipids and proteins, which are suspended in plasma or lymph. Their main function is to transport most lipids (steroid hormones and LCFA being notable exceptions) among tissues. Another function of lipoproteins is the esterification of cholesterol. Lipoproteins have a micellar structure in which the least polar molecules (triacylglycerol and cholesterol) occupy the center and more polar molecules (proteins and phospholipids) coat the exterior. Lipoproteins are synthesized almost exclusively by liver and the small intestine.

The main classes of lipoprotein are defined by their density as determined by ultracentrifugation and are chylomicrons ( $d < 0.94$  g/ml), very low density lipoproteins (VLDL,  $d = 0.94$  to  $1.006$  g/ml), low-density lipoproteins (LDL,  $d = 1.006$  to  $1.063$  g/ml), and high-density lipoproteins (HDL,  $d = 1.063$  to  $1.21$  g/ml). Less commonly considered are very high density lipoproteins (VHDL,  $d > 1.21$  g/ml), which are usually very low in concentration in plasma. It is common to designate the lighter LDL ( $d = 1.006$  to  $1.019$  g/ml) as intermediate density lipoproteins (IDL), and some schemes subdivide the HDL into HDL<sub>1</sub>, HDL<sub>2</sub>, and HDL<sub>3</sub>. (Chapman, 1986; Gotto *et al.*, 1986).

The lipid component of lipoproteins is less dense than the protein component, but the lipids have similar densities, and the proteins have similar densities. Therefore, the density of a lipoprotein is almost entirely dependent on its ratio of lipid to protein, with the chylomicrons having the



**TABLE 4-1** Composition of Lipoproteins of Domestic Animals<sup>a</sup>

	Free Cholesterol				
	Triacylglycerol (% by weight)	Cholesterol (% by weight)	Esters (% by weight)	Phospholipid (% by weight)	Protein (% by weight)
Cattle					
Chylomicrons	87	4	2	4	3
VLDL	60	5	4	25	6
LDL	1	5	35	36	23
HDL	4	4	30	20	42
Dogs					
VLDL	68	6	2	10	14
LDL	27	5	25	22	21
HDL	1	5	23	33	38
Horses					
VLDL	57	5	6	18	14
LDL	6	8	36	23	27
HDL	0	2	20	28	50

<sup>a</sup> Cattle: From Ferreri and Elbein (1982) (chylomicrons) and Stead and Welch (1975) (other lipoproteins). Dogs: From Blomhoff et al. (1978) and Mahley and Weisgraber (1974). Horses: From Le Goff et al. (1989) and Watson et al. (1993).

highest ratio and, on the other end of the spectrum, the HDL having the lowest ratio (Table 4-1). More than one-half of the lipid in chylomicrons and VLDL is triacylglycerol, whereas in LDL and HDL the majority of the lipids are not triacylglycerol (Table 4-2). In domestic species, HDL is normally the most abundant plasma lipoprotein in the fasting state.

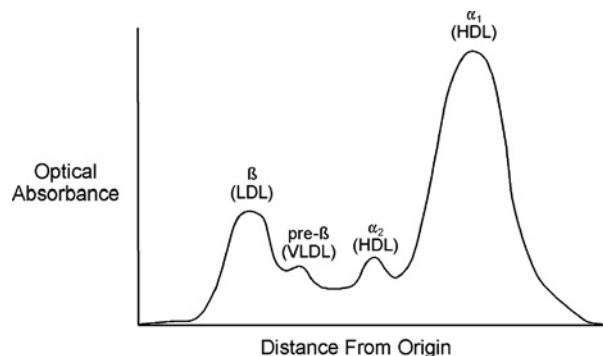
Chylomicrons and VLDL particles are large enough to refract light significantly, so they make plasma appear turbid or creamy if in high enough concentration (lipemic plasma). The chylomicrons have a low enough density that they will rise to the top of an undisturbed refrigerated plasma sample in 6 to 12 hours. This phenomenon is the basis of the "chylomicron test," in which a milky plasma sample is placed in the refrigerator overnight. If a "cream layer" has formed at the top, then hyperchylomicronemia is present, and if the bottom portion of the plasma is turbid, then elevated levels of VLDL are present.

Because of the expense, time, and complexity involved with ultracentrifugation, electrophoresis in an alkaline medium has been used as an alternate method of lipoprotein classification. A variety of electrophoretic supports, ranging from paper to acrylamide gels, have been used. The sample is applied at the cathode end of the support, voltage is applied for a variable time, and the proteins are fixed and stained with a lipid stain such as oil red O. A densitometer is used to quantify the lipoprotein fractions on the stained electrophoretogram.

Typically, three to five bands of lipoproteins can be discerned; however, additional bands may be present depending

on the species of animal, electrophoretic technique, and presence of abnormal lipoproteins. The fastest moving band is HDL, which is designated as  $\alpha$ -lipoprotein. The next fastest moving band is VLDL, which is designated pre- $\beta$ -lipoprotein followed by the LDL band, which is designated as  $\beta$ -lipoprotein. The slowest moving band, which is still at the origin and seen primarily in the post-prandial period, is composed of chylomicrons. With some electrophoresis systems, a separate IDL band, designated as slow pre- $\beta$ -lipoproteins, can be discerned between the VLDL and LDL bands, and sometimes subbands of the HDL can be discerned. The correlation of electrophoretic and ultracentrifuge fractions established for humans does not always apply to animals. For example, bovine LDL can appear as  $\alpha$ - or  $\beta$ -bands on electrophoresis (Puppione, 1983). Usually, two HDL bands can be discerned for dog plasma (Rogers, 1977). Figure 4-5 illustrates the distribution of lipoproteins in dog plasma.

Although easier and cheaper to perform than ultracentrifugation, lipoprotein electrophoresis still requires considerable time and expense. Consequently, methods have been developed that involve precipitation of one or more lipoprotein classes followed by analysis of a particular lipid, usually cholesterol, in the remaining supernatant. For example, chylomicrons can be removed by low-speed centrifugation (they rise to the top), and then precipitation of VLDL and LDL in human plasma can be accomplished by treatment with magnesium and dextran sulfate. The main lipoprotein remaining in the supernatant will be HDL, and if cholesterol is determined, it will mostly be HDL



**FIGURE 4-5** Densitometric scan of an electrophoretogram of canine plasma lipoproteins. The scan is typical of a fasted dog. In a fed dog, an additional peak as a result of chylomicrons would be present at the origin. Abbreviations: HDL, LDL, and VLDL, high-, low-, very low density lipoproteins, respectively.

cholesterol (Stein and Meyers, 1994). Such empirical methods may be species specific. For example, the preceding method, though valid for human plasma, does not work for dog plasma (Rhodes *et al.*, 1992).

## B. Apolipoproteins

The protein components of lipoproteins are called apolipoproteins. Some apolipoproteins are found in only one class of lipoproteins, whereas others can be found in multiple classes. Although there are species variations in the amino acid sequences of apolipoproteins, individual apolipoproteins in the domestic species are quite similar. The main classes of apolipoproteins are designated with a letter (A through E), sometimes followed by a number to indicate a distinct subclass. The main classes and subclasses of apolipoproteins found in domestic animals are A-I, A-II, A-IV, B<sub>48</sub>, B<sub>100</sub>, C-I, C-II, C-III, C-IV, and E. Characteristics of these apolipoproteins are listed in Table 4-2.

The B<sub>100</sub> apolipoprotein, synthesized in the liver and part of VLDL, is one of the largest polypeptide chains in mammals, having a molecular weight of 527,000 in horses (Watson *et al.*, 1991). B<sub>48</sub> apolipoprotein is about one-half the size of B<sub>100</sub> and contains a subset of the B<sub>100</sub> amino acid sequence (i.e., they are probably coded by the same gene); however, B<sub>48</sub> is synthesized in the small intestine and is part of chylomicrons. The origin of the “48” and “100” designations stems from the fact that human B<sub>48</sub> is exactly 48% of the mass of human B<sub>100</sub>. Both B<sub>48</sub> and B<sub>100</sub> are glycoproteins and have a variety of carbohydrates attached to them (Chapman, 1986).

In addition to apolipoproteins, HDL contains an additional protein in the form of the enzyme lecithin:cholesterol acyltransferase (LCAT), which esterifies cholesterol esters by transferring an LCFA moiety from phosphatidylcholine (lecithin) to cholesterol. LCAT is activated by lipoprotein A-I.

## C. Digestion of Fat and Formation of Chylomicrons

The largest lipoproteins are the chylomicrons, and to understand their formation, the digestion of triacylglycerol must be discussed. The main site of digestion and absorption of triacylglycerol is the small intestine, and the chief enzyme involved is pancreatic lipase. The pancreas not only supplies lipase to attack triacylglycerol but also supplies cholesterol esterase to hydrolyze cholesterol esters and phospholipase A<sub>2</sub> to attack phospholipids. For any of these enzymes to be effective, the lipids in food must first be emulsified with bile. Bile contains micelles composed mostly of bile acids, phospholipids, and cholesterol. Fats in food become part of these micelles, and then the enzymes can attack them on the outer surface of the micelles. The fatty acids, monoacylglycerols, and cholesterol resulting from the attack of the enzymes become part of the lipids of the brush border of the intestinal cells. The intestinal cells then use the monoacylglycerols and fatty acids to resynthesize triacylglycerol. Globules of triacylglycerol coated with protein are extruded from the basolateral membranes into the interstitium as chylomicrons. The lymphatic capillaries of the microvilli are called lacteals and have many large openings between the endothelial cells that line them. Consequently, the chylomicrons can enter the lymphatics, but not the blood capillaries. From the small intestine, the lymph flows to larger abdominal ducts to the thoracic duct and enters the right atrium. Thus, unlike most other nutrients, most of the absorbed fat bypasses the portal system and liver (Gurr *et al.*, 2002; Vance, 2002b).

The main apolipoproteins in chylomicrons are A-series, B<sub>48</sub>, C-series, and E. The A-series and B<sub>48</sub> apolipoproteins are added by the small intestine, but the C-series and E apolipoproteins, which are synthesized in the liver, appear to transfer from HDL to nascent chylomicrons soon after they are released into the circulation.

Chylomicrons are attacked by lipoprotein lipase, which resides on the surface of endothelial cells and hydrolyzes triacylglycerol. Most of the resulting LCFA are absorbed by the tissue cells. As the chylomicron diminishes in size, some of the apolipoproteins, mostly A-series and C-series, transfer to HDL. Finally, a much diminished chylomicron remnant is left and will attach to an apolipoprotein-E receptor on hepatocytes. The remnant will be absorbed and its components hydrolyzed within the hepatocytes (Fielding and Fielding, 2002; Schneider, 2002). The transport and metabolism of chylomicrons are illustrated in Figure 4-6.

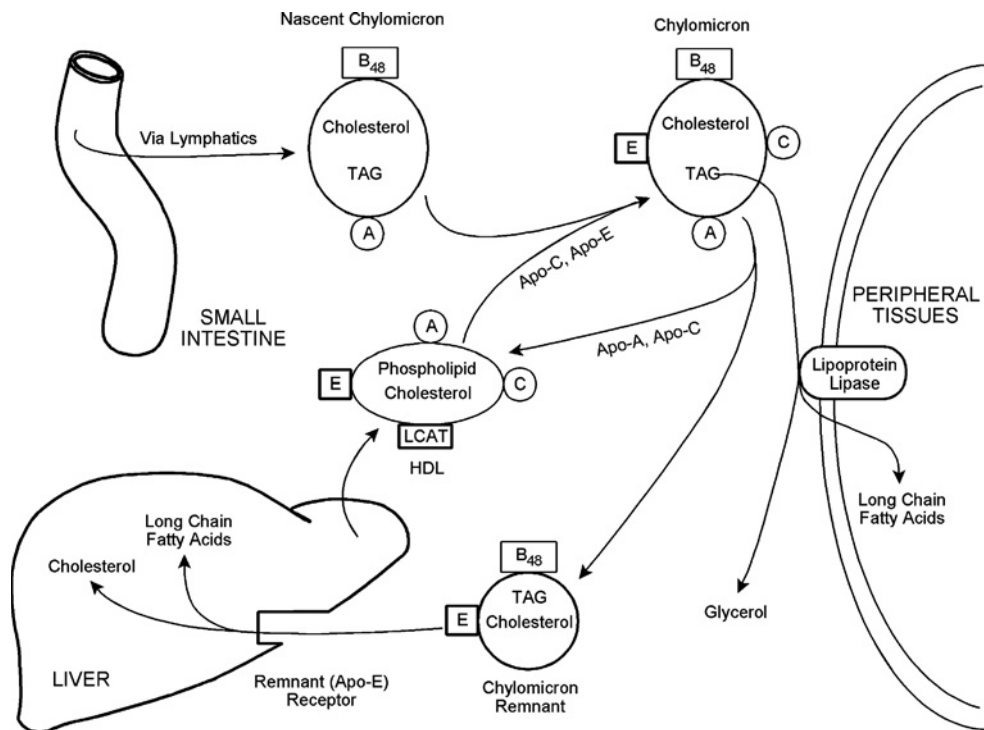
## D. Very Low Density Lipoprotein: Synthesis, Export, and Metabolism

Secretion of very low density lipoproteins (VLDL) into the plasma is the main method by which hepatocytes export

**TABLE 4-2** Apolipoproteins of Domestic Animals<sup>a</sup>

Apolipoprotein	Molecular		Major Synthetic Lipoprotein	Constituent of Special Properties
	Weight	Organ		
A-I	28 kd (all species)	Small intestine	Chylomicrons, HDL	Activates lecithin: cholesterol acyltransferase
A-II (monomer)	8.5 kd (cattle, dog)	Small intestine	Chylomicrons, HDL	Exists mostly as a dimer 6.5 kd (horse)
A-IV	43 kd (cattle, dog)	Small intestine	Nascent chylomicrons, HDL	Activates lecithin: cholesterol acyltransferase?
B <sub>48</sub>	270 kd (cattle, horse)	Small intestine	Chylomicrons	
B <sub>100</sub>	534 kd (cattle, horse)	Liver	VLDL, LDL	Binds to LDL receptor 325 kd (swine)
C-I	8.0 kd (cattle)	Liver	VLDL, LDL, HDL, chylomicrons	
C-II	9.5 kd (cattle, pig) 14 kd (horse)	Liver	VLDL, LDL, HDL, chylomicrons	Activator of lipoprotein lipase
C-III	8.0 kd (cattle) 12 kd (horse)	Liver	VLDL, LDL, HDL	
C-IV	10 kd (cattle)	Liver	VLDL, LDL, HDL, chylomicrons	
E	37 kd (all species)	Liver	VLDL, LDL, HDL, chylomicrons	Binds to LDL and chylomicron remnant receptor

<sup>a</sup> From Bauchart (1993), Chapman (1986), Demacker et al. (1987), Watson et al. (1991), and Watson and Barrie (1993).



**FIGURE 4-6** Metabolism and transport of chylomicrons. Abbreviations: A, B<sub>48</sub>, C, E, apolipoproteins; HDL, high-density lipoprotein; TAG, triacylglycerol.

triacylglycerol. Its main apolipoproteins are B<sub>100</sub>, C-series, and E, but some A-series is present as well. The A-series apolipoproteins, which are synthesized in the small intestine, transfer from HDL to VLDL soon after its secretion. Some C-series and E apolipoprotein may transfer from HDL to newly secreted VLDL as well. Like chylomicrons, the main lipid component of VLDL is triacylglycerol (see Table 4-1). VLDL and chylomicrons both serve as a means to distribute triacylglycerol to tissues. In the case of chylomicrons, the triacylglycerol is a product of fat digestion, whereas in the case of VLDL, the triacylglycerol is synthesized in the liver.

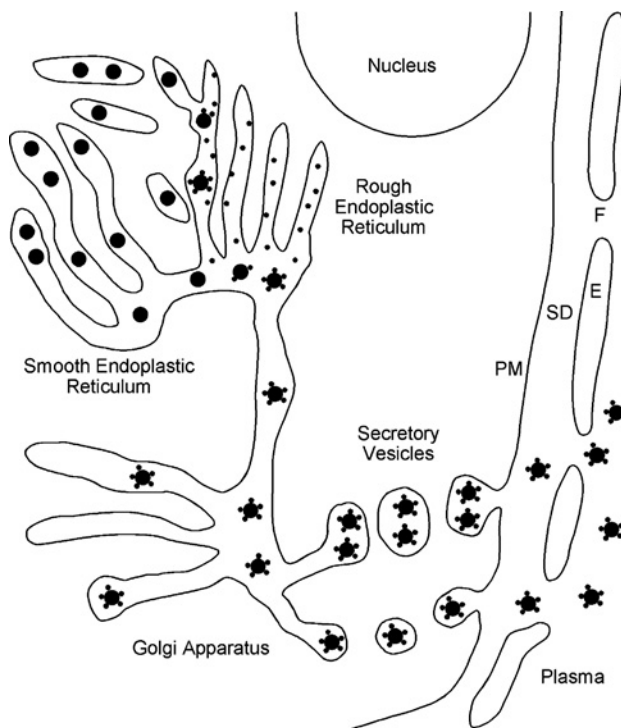
The assembly process for VLDL is complex (Fig. 4-7). Final steps in the synthesis of triacylglycerol, phospholipid, and cholesterol occur in the smooth endoplasmic reticulum. Microdroplets containing these three lipids and cholesterol esters move toward the confluence of the rough and smooth endoplasmic reticuli where they are joined by apolipoproteins synthesized on the rough endoplasmic reticulum to form the nascent VLDL.

The nascent VLDL particles move through microtubular membranes to the Golgi apparatus where the apolipoproteins are glycosylated. In the Golgi apparatus, the nascent VLDL particles reach final composition and are surrounded by membranes to form secretory granules. The secretory granules merge with the plasma membrane and spill their contents into the plasma (Alexander, 1976; Vance, 2002b).

The capacity of the liver to synthesize the protein components of VLDL is stimulated by a diet high in carbohydrate. It has been hypothesized that this stimulation is due to increased insulin and decreased glucagon levels in plasma. Most studies have shown that glucagon partially inhibits hepatic VLDL secretion, whereas insulin stimulates it (Gibbons, 1990). Estrogens (Crook and Seed, 1990; Haffner and Valdez, 1995; Sacks and Walsh, 1994) and glucocorticoids (Gibbons, 1990; Martin-Sanz *et al.*, 1990) stimulate VLDL secretion.

The inherent capacity of the liver to synthesize the lipid components exceeds its inherent capacity to synthesize the protein components, a fundamental factor in the development of fatty liver. In addition, phosphatidylcholine is essential for lipoprotein assembly, so animals having a deficiency of choline tend to develop fatty livers (Vance, 2002a, 2002b).

Triacylglycerol in plasma VLDL is hydrolyzed by lipoprotein lipase just like triacylglycerol of chylomicrons, and most of the released LCFA is absorbed by the underlying tissue cells. As the VLDL shrink, some of the apolipoproteins (C-series and E) transfer to HDL. Finally, the shrinking VLDL becomes an IDL and then an LDL. The LDL will attach to an apoprotein B<sub>100</sub> or E receptor on hepatocytes or extrahepatic tissues and be taken into the cell where its component parts will be hydrolyzed. The transport and metabolism of VLDL are illustrated in Figure 4-8.



**FIGURE 4-7** Synthesis of very low density lipoprotein (VLDL) in liver. Triacylglycerol and phospholipid synthesis occurs in the smooth endoplasmic reticulum to generate lipid particles (large dots), which acquire small amounts of cholesterol and its esters as well. Apolipoproteins (small dots) are synthesized on the rough endoplasmic reticulum. Lipid particles acquire apolipoproteins at the convergence of the rough and smooth endoplasmic reticulum or by merging of sections of the two organelles. The nascent VLDL move through tubular membranes to the Golgi apparatus where apolipoproteins are glycosylated, and the nascent VLDL are collected in secretory vesicles. The secretory vesicles migrate to and merge with the plasma membrane (PM) and spill VLDL into the space of Dissé (SD). The VLDL migrate through the fenestrae (F) between endothelial cells (E) to enter the plasma in hepatic sinusoids.

## E. Metabolism of High-Density Lipoproteins

HDL is synthesized by both liver and small intestine. Nascent HDL produced in the small intestine has only A-series apolipoproteins and gains C-series and E apolipoproteins and LCAT, which are synthesized in the liver, from other lipoproteins after it enters the circulation. Nascent HDL produced in the liver gains its A-series apolipoprotein, which is synthesized in the small intestine, from other lipoproteins after it enters the circulation. HDL serves two main functions. It is a repository for A-series, C-series, and E apolipoproteins, and it transports cholesterol from peripheral tissues to liver. LCAT is important in this latter function. The conversion of cholesterol-to-cholesterol ester within HDL creates a favorable concentration gradient from tissue cell to HDL, which promotes migration of cholesterol from tissue cells to HDL (Fielding and Fielding, 2002; Gurr *et al.*, 2002).

**FIGURE 4-8** Metabolism and transport of very low density lipoprotein (VLDL). Abbreviations: A, B<sub>100</sub>, C, E, apolipoproteins; HDL, IDL, and LDL, high-, intermediate-, and low-density lipoproteins, respectively; LCAT, lecithin:cholesterol acyltransferase; LCFA, long chain fatty acid; TAG, triacylglycerol.

HDL is removed from the circulation primarily by the liver, and its component parts can be metabolized within the hepatocyte or some of its lipid components can be incorporated into VLDL and enter the plasma again. Cholesterol can migrate from HDL into hepatocytes without the entire HDL being removed, and as mentioned earlier, apolipoproteins can migrate from HDL to chylomicrons, VLDL, and other HDL.

In summary, chylomicrons and VLDL distribute triacylglycerol, cholesterol, and phospholipids from the small intestine and liver, respectively, to other tissues. IDL and LDL are effectively remnants of VLDL. HDL is a reservoir of some apolipoproteins and transports cholesterol from peripheral tissues to liver.

## VII. HYPERLIPIDEMIA

### A. Introduction

Hyperlipidemia refers to increased plasma levels of cholesterol (hypercholesterolemia) and triacylglycerols (hypertriacylglycerolemia or hypertriglyceridemia). Note that increased plasma levels of LCFA alone do not constitute hyperlipidemia. Because cholesterol and triacylglycerols must reside within lipoproteins in plasma, hyperlipidemia is synonymous with hyperlipoproteinemia. *Lipemia* is a

term denoting that hyperlipidemia is severe enough that the plasma looks milky (i.e., lactescent). If lipemia is marked, whole blood may have a light red color or “tomato soup” appearance. The most common form of hyperlipidemia is postprandial hyperlipidemia, which is observed after an animal consumes a meal containing fat and is due primarily to increased chylomicron levels. For evaluation of possible abnormalities in lipid metabolism, it is important that blood samples be taken from fasting animals to avoid confusion caused by postprandial hyperlipidemia. One exception is adult ruminants, which are usually on a very low fat diet and, because of the volume of the rumen and fermentative nature of digestion there, have absorption spread over a considerable time period.

### B. Canine Fasting Hyperlipidemias

Healthy dogs normally do not develop significant hyperlipidemia upon fasting. Therefore, fasting hyperlipidemia in a dog usually is an abnormal sign with potential causes being hypothyroidism, diabetes, pancreatitis, hyperadrenocorticism, hepatic disease, nephrotic syndrome, and inherited defects in lipid metabolism. Hyperlipidemia is commonly observed in dogs with hypothyroidism, whether of congenital or acquired origin (Barrie *et al.*, 1993; DeBowes, 1987; Liu *et al.*, 1986; Manning *et al.*, 1973; Medaille *et al.*, 1988; Watson and

Barrie, 1993). The main lipid that is increased is cholesterol, but triacylglycerol may be increased too, and most of the increased lipid is in LDL and HDL, but some animals have increased VLDL or chylomicron levels as well (Rogers, 1977; Whitney, 1992). The mechanism by which hypothyroidism causes hyperlipidemia in dogs is unknown; however, a similar phenomenon occurs in humans, and in that species, it appears that hypothyroidism decreases lipoprotein lipase and hepatic lipase activities (Valdemarsson *et al.*, 1983). The prolonged hypercholesterolemia associated with chronic hypothyroidism in dogs may lead to atherosclerosis (Liu *et al.*, 1986; Patterson *et al.*, 1985), although other factors may be involved as well.

Dogs with naturally occurring pancreatitis frequently have hyperlipidemia (Hardy, 1992; Whitney *et al.*, 1987). Because the pancreatitis in some of these animals causes diabetes, the hyperlipidemia in those individuals may be due to diabetes. Plasma lipid levels of dogs with pancreatitis induced by injecting bile into or ligating the pancreatic duct are comparable to control dogs (Bass, 1976; Whitney *et al.*, 1987; Zieve, 1968). In some cases, hyperlipidemia may play a role in the pathogenesis of pancreatitis rather than being a result of pancreatitis. This proposition is supported by the fact that humans with some forms of hyperlipidemia have increased risk of pancreatitis (Cameron *et al.*, 1974; Greenberger, 1973). One proposed mechanism is that increased lipids, especially chylomicrons, entering the pancreatic capillaries will be hydrolyzed by pancreatic lipase, and the resultant LCFA may injure endothelial or acinar cells (Havel, 1969). Once the initial damage occurs, there is a positive feedback in which more lipase enters the circulation and hydrolyses more triacylglycerol leading to more LCFA release and more damage. In support of this theory, when dog pancreata were perfused with a medium containing high levels of triacylglycerol or LCFA, they became edematous and hemorrhagic and released large amounts of amylase compared to pancreata perfused without these additions (Saharia *et al.*, 1977). In a related proposed mechanism, large amounts of chylomicrons or VLDL may impede the microcirculation of the pancreas, leading to partial stasis, which allows blood lipids and their hydrolysis products more contact with pancreatic cells (Hardy, 1992).

Dogs with uncontrolled diabetes frequently have hyperlipidemia (Medaille *et al.*, 1988; Rogers, 1977; Whitney, 1992). In naturally occurring cases, plasma triacylglycerol levels are increased with concomitant increases in VLDL levels and often hyperchylomicronemia is present as well (DeBowes, 1987; Ford, 1995; Rogers, 1977; Rogers *et al.*, 1975b). The increase in VLDL is due in part to increased mobilization of LCFA from adipose. The liver removes LCFA from plasma and reissues some of them to the plasma as triacylglycerol in VLDL. In addition, synthesis of lipoprotein lipase by peripheral tissues is partially dependent

on insulin, so less of this enzyme is available to remove triacylglycerol from the circulation (Brown and Goldstein, 1994).

Hyperlipidemia with increases in plasma triacylglycerol and cholesterol levels have been noted in dogs with cholestasis (Bauer *et al.*, 1989; Meyer and Chiapella, 1985). The increase in cholesterol can be explained in part by the inability of the liver to remove and catabolize cholesterol. However, there is evidence of production of an abnormal LDL, called lipoprotein-X, which is rich in cholesterol (Bauer *et al.*, 1989; Blomhoff *et al.*, 1978; Danielsson *et al.*, 1977; Meyer and Chiapella, 1985).

Dogs with hyperadrenocorticism (Cushing's disease) often have hyperlipidemia with increased total plasma cholesterol levels (Barrie *et al.*, 1993; Feldman, 1995; Ling *et al.*, 1979; Medaille *et al.*, 1988; Scott, 1979). Most of the increased plasma cholesterol is associated with LDL, and although the mechanism of the hyperlipidemia is unclear, it may be related to a decrease in activity of hepatic LDL receptors (Barrie *et al.*, 1993).

Dogs with nephrotic syndrome often have hyperlipidemia (Ford, 1995; Lewis and Center, 1984; McCullagh, 1978; Medaille *et al.*, 1988). Hypercholesterolemia is present most commonly, but hypertriacylglycerolemia may be present as well, especially in more severe cases (McCullagh, 1978). In humans with nephrotic syndrome, the hyperlipidemia appears to be related to the loss of albumin or regulatory factors in the urine, and infusion of albumin or dextran into afflicted patients lowers lipid levels (Glasscock *et al.*, 1991). Albumin or regulatory factors may inhibit VLDL production by the liver, and without this inhibition, more VLDL will be released to the plasma increasing VLDL and LDL levels (Glasscock *et al.*, 1991).

Idiopathic hyperlipidemia, which is probably inherited, occurs in some miniature schnauzers (Ford, 1993; Richardson, 1989; Rogers *et al.*, 1975a). Animals present with abdominal pain, diarrhea, and vomiting, and sometimes with seizures and pancreatitis. Affected animals have hypertriacylglycerolemia, hypercholesterolemia, and increased chylomicron levels and often have increased levels of other lipoproteins as well. The animals often have elevated liver enzymes as well (Xenoulis *et al.*, 2008). It has been proposed that these animals may have low levels of lipoprotein lipase or perhaps deficient apolipoprotein C-II, the activator of lipoprotein lipase. However, some dogs have shown clearing of the plasma following heparin injection, so the mechanism remains unknown. The primary treatment is to place the animal on a low-fat diet. A similar syndrome has been reported in mixed-breed dogs (Baum *et al.*, 1969; Rogers *et al.*, 1975a) and in Brittany spaniels (Hubert *et al.*, 1987). Hypercholesterolemia, which is probably inherited, has been reported in rough collie dogs (Jeusette *et al.*, 2004) and Shetland sheepdogs (Sato *et al.*, 2000). Corneal lipidosis, which responded to dietary manipulation, was observed in the former, and

possibly increased incidence of atherosclerosis was observed in the latter.

### C. Feline Fasting Hyperlipidemias

Not surprisingly, some of the same diseases that are associated with hyperlipidemia in dogs are associated with hyperlipidemia in domestic cats, including diabetes and nephrotic syndrome (Jones, 1995; McCullagh, 1978; Watson and Barrie, 1993). Some cats, however, have a well-characterized familial hyperlipidemia because of lipoprotein lipase deficiency (Brooks, 1989; Jones, 1993, 1995; Jones *et al.*, 1983; Watson *et al.*, 1992b; Whitney, 1992). There is lipemia with hyperchylomicronemia and increases in plasma levels of cholesterol and triacylglycerol (Jones, 1993, 1995; Whitney, 1992). The high plasma levels of lipids lead to deposition in tissues (xanthoma formation) in the skin, nerve sheaths, and other locations (Jones, 1993; Whitney, 1992). Pressure on spinal or other nerves from xanthomas or subsequent granulomas may lead to peripheral neuropathy (Jones *et al.*, 1986). The disease appears to be autosomal recessive, and homozygotes apparently manufacture a defective lipoprotein lipase and do not have a defective or missing apolipoprotein C-II activator (Peritz *et al.*, 1990; Watson *et al.*, 1992b).

### D. Equine Fasting Hyperlipidemia

The phenomenon of equine hyperlipidemia was reported in horses with maxillary myositis (Hadow, 1962) and equine infectious anemia (Gainer *et al.*, 1966). It is likely that the hyperlipidemia described in these early reports was due to anorexia, and it has been shown that fasting alone causes hyperlipidemia in horses and that pregnancy, lactation, and obesity accentuate the effect (Eriksen and Simesen, 1970; Schotman and Kroneman, 1969; Schotman and Wagenaar, 1969; Schotman and Wensing, 1977). Total plasma triacylglycerol may increase from a normal fed value of less than 500 mg/l to more than 2000 mg/l (Morris *et al.*, 1972; Naylor *et al.*, 1980) and, in severe cases, may exceed 10,000 mg/l (Freestone *et al.*, 1991; Naylor *et al.*, 1980; Schotman and Wensing, 1977). Although most horses are susceptible to this effect of calorie deprivation, it is harmless for the majority, and only becomes pathological for a few. Ponies and females are more susceptible to the pathological syndrome, which can be fatal (Hughes *et al.*, 2004). Survival rates are inversely proportional to plasma triacylglycerol concentrations (Schotman and Wagenaar, 1969), and severe fatty liver and increased plasma levels of liver enzymes have been reported (Schotman and Wagenaar, 1969). Like in other mammals, fasting increases plasma levels of LCFA in horses and ponies (Baetz and Pearson, 1972; Naylor *et al.*, 1980; Watson *et al.*, 1992a), and the

hyperlipidemia in horses and ponies is due to increased VLDL levels (Bauer, 1983; Morris *et al.*, 1972; Watson *et al.*, 1992a). Presumably, horse liver is removing LCFA from plasma and reesterifying them into triacylglycerol, which are released to the plasma as VLDL. It appears that the liver of fasting horses has a high capacity for reesterification of LCFA into triacylglycerol, which is exported as VLDL. Horses do have increased plasma ketone levels when fasting (Rose and Sampson, 1982), so some of the LCFA removed from plasma by liver are converted to ketones, but additional LCFA are reesterified to glycerol and are recycled to the plasma as triacylglycerol in VLDL.

The mechanism of fasting equine lipemia is uncertain; it could be increased secretion or decreased uptake of VLDL or a combination thereof. In one study, fasting horses were injected with Triton WR 1339, a compound shown to inhibit lipoprotein lipase in rats, and the rate of increase in plasma triacylglycerol levels was observed (Morris *et al.*, 1972) and compared with the preinjection level of triacylglycerol. The authors claimed that the rate of increase was not related to the level of triacylglycerol concentration. However, only four horses were used, which may not have been enough given the high variation in fasting triacylglycerol levels observed among them. On close examination of the data, it is apparent that three horses showed a perfect rank correlation of fasting triacylglycerol level and rate of triacylglycerol increase after Triton injection, with the fourth being a considerable outlier to the trend. In addition, the dose of Triton was such that all the horses developed anemia because of intravascular hemolysis. Thus, elucidation of the mechanism of fasting equine lipemia will have to await additional kinetic or enzyme studies.

There are reports of apparent therapeutic success with intravenous glucose and oral carbohydrates (Dunkel and McKenzie, 2003; Durham, 2006; Hallebeek and Beynen, 2001; Mogg and Palmer, 1995; Watson and Love, 1994). This therapy makes sense in that increasing plasma glucose levels should lead to increased insulin and decreased glucagon levels, which should inhibit lipolysis in adipose which is generating plasma LCFA used for triglyceride synthesis. In addition, the hormonal changes may stimulate lipoprotein lipase activity. Although supplemental insulin has been used with carbohydrate therapy, its efficacy and safety have not been adequately evaluated, and one report indicates that hyperlipemic horse have hyperinsulinemia as well (Oikawa *et al.*, 2006).

## VIII. KETOGENESIS AND KETOSIS

### A. Introduction

The ketones or ketone bodies, which are composed of acetoacetic acid, 3-hydroxybutyric acid (also known as

$\beta$ -hydroxybutyric acid), and acetone, are important compounds in the metabolism of birds and mammals. Ketosis simply means that ketones are present in body fluids in elevated concentrations. Ketones are important clinically and have a rather sinister reputation because of the ketoacidosis that is often present when their plasma levels are high. In recent years though, the survival value of ketogenesis has become clearer, and although increased levels of ketones in biological fluids will continue to be regarded as a pathological sign in many situations, perhaps the beneficial aspects of ketogenesis will be more widely appreciated.

## B. Chemistry of Ketones

### 1. Structure and Properties

The ketones, acetone, 3-hydroxybutyric acid, and acetoacetic acid, are relatively simple chemical structures. Of the three, only 3-hydroxybutyric acid can exist as stereoisomers, having L-(+) and D-(-) forms. Only the D-(-) form is produced in a free state in intermediary metabolism. The L-(+) form exists only as its CoA thioester produced and destroyed in  $\beta$ -oxidation (Newsholme and Leach, 1983). Acetone is relatively volatile, whereas the other two ketones are not. Acetone has a characteristic organic solvent odor that may be detectable in the exhaled breath of animals with elevated blood ketone levels. Anecdotal evidence indicates that people vary greatly in their olfactory sensitivity for acetone.

Acetone does not ionize appreciably, whereas 3-hydroxybutyric acid and acetoacetic acid do readily ionize. Acetoacetic acid has a pKa of 3.58, and 3-hydroxybutyric acid has a pKa of 4.41 (Dean, 1985). Consequently, at normal plasma pH of 7.40, 99.9% of either compound exists in its ionized form. Therefore, the compounds will usually be referenced by the names of their ions whenever their metabolism is discussed. Acetoacetic and 3-hydroxybutyric acids are more powerful acids than the volatile fatty acids (VFA; acetic, propionic, and butyric acids), which have pKa's of 4.76 to 4.87 (Dean, 1985). Acetoacetic acid is more powerful, and 3-hydroxybutyric acid is less powerful as an acid than lactic acid, which has a pKa of 3.86 (Dean, 1985).

Acetone and acetoacetic acid are miscible in water in all proportions, and 3-hydroxybutyric acid is exceedingly soluble, but not in all proportions (Dean, 1985). The common metallic salts of acetoacetic acid and 3-hydroxybutyric acid are soluble in water. Acetone and 3-hydroxybutyric acid and its salts are relatively stable compounds. Acetoacetic acid spontaneously decomposes to acetone and carbon dioxide. This reaction occurs readily without catalysis, and its rate is accelerated by increased temperature and hydrogen ion concentration. Apparently, there can be some nonspecific catalysis of acetoacetate decarboxylation by cellular proteins (Williamson, 1978). The lithium, sodium, and potassium salts of acetoacetic acid are relatively stable if stored in dry form below 0°C.

### 2. Detection and Assay

#### a. Qualitative

The most common qualitative test for ketones is the alkaline nitroprusside test, which is also known as the Rothera test (Rothera, 1908). This test has been used for decades in clinical practice and is still exceedingly useful today. The test relies on the reaction of nitroprusside with acetone or acetoacetate to produce a purple chromogen. The nitroprusside test has been used for virtually every body fluid imaginable including whole blood, serum, plasma, urine, and milk. The test is most sensitive for acetoacetate (0.5 mmol/l can be detected), gives only a slight response to acetone, and is completely insensitive to 3-hydroxybutyrate.

The nitroprusside test is available commercially in the form of strips, tablets, and powders. The maximum sensitivity of all three forms is approximately 0.5 mmol/l, although specific formulations may have a sensitivity less than this value. The strip form is commonly used for urine. The powder form and strips are both commonly used for milk. The tablet form is used for serum, plasma, and whole blood and can be used for milk and urine as well. The test is often used in a semiquantitative manner with the result expressed in adjectival form (negative, weak, strong) or as a series of pluses (-, +, ++, etc.).

A number of drugs or other substances may appear in urine and give a false positive with the nitroprusside test. Some compounds react with nitroprusside to yield a purple or near purple color. Included in this group are phenylketones, levodopa, methyl dopa, acetaldehyde, paraldehyde (Caraway and Kammeyer, 1972), cysteine, cysteamine, penicillamine, and mesna (Csako, 1987). In general, substances with keto, aldehyde, or sulfhydryl groups have the potential for reacting with nitroprusside. Because the nitroprusside test is performed in an alkaline medium, some substances, like sulfobromophthalein and phenolsulfonphthalein, which may exist in urine and are otherwise colorless, may yield a purple or near purple color simply because of the alkaline pH (Caraway and Kammeyer, 1972).

More recently a semiquantitative color test for 3-hydroxybutyrate in milk has been used for diagnosis of clinical and subclinical ketosis in dairy cows (Gutzwiller, 1998; Jorritsma *et al.*, 1998). This test, which is quite specific, is based on the same enzymatic method used for quantitative determination of 3-hydroxybutyrate (see the next section) except that a color visible to the human eye is produced.

#### b. Quantitative

Commonly used means of quantitative assay for ketone concentrations in biological fluids include microdiffusion methods, used primarily for assay of acetone, and enzymatic methods, used primarily for assay of acetoacetate and 3-hydroxybutyrate. Regardless of the method to be used for analysis, proper handling of the samples before



analysis is crucial for obtaining representative results. In particular, the volatility of acetone and instability of acetoacetate must be respected.

Blood samples should be cooled immediately after collection. Ketones can be determined on whole blood or plasma. Serum is not recommended because of losses, particularly of acetoacetate, that may occur during the time required for clotting. Any of the common anticoagulants (heparin, fluoride, oxalate, citrate, or EDTA) may be used. If whole blood is to be used, it should be mixed with perchloric acid immediately after collection to precipitate proteins. The tube should be chilled on ice until centrifuged, which should be performed within a few hours. The supernatant should be frozen until analyzed. If plasma is to be used, the red cells should be spun down within a few hours, and the plasma proteins precipitated with perchloric acid. The supernatant should be frozen until analyzed.

The microdiffusion method can be used to determine the concentration of acetone or acetone plus acetoacetate in any biological fluid. The reagents are relatively simple and inexpensive although rather corrosive. The diffusion step requires specialized, but inexpensive, apparatus and adds to the complexity and time to complete the assay. The method relies on the reaction of acetone with vanillin (Henry *et al.*, 1974) or salicylaldehyde (Nadeau, 1952) to produce a colored product that can be quantified in a spectrophotometer. In the author's experience, vanillin provides more sensitivity than salicylaldehyde, but variability in the purity of vanillin batches from commercial sources makes salicylaldehyde the reagent of choice. Salicylaldehyde must be stored under nitrogen or argon to preserve its purity.

The method as described by Henry *et al.* (1974) was shown to determine acetone, and there was speculation that it would also detect acetoacetate simultaneously. In fact, the method as described by Henry *et al.* (1974) is specific for acetone. It has been found in the author's laboratory that to use the method for acetone plus acetoacetate, it is necessary to preincubate the sample with an equal volume of 10N sulfuric acid for 4 hours at 50°C in a sealed container to decarboxylate all of the acetoacetate. The method can be adapted to measure 3-hydroxybutyrate as well by introducing a step in which 3-hydroxybutyrate is oxidized to acetoacetate with potassium dichromate (Procos, 1961). However, if the primary interest is the determination of acetoacetate or 3-hydroxybutyrate, rather than acetone, the enzymatic method described later should be used. For determination of acetone on large numbers of samples, flow injection analysis (Marstorp *et al.*, 1983) or infrared spectroscopy (Hansen, 1999) has been used.

The enzymatic method for assay of acetoacetate or 3-hydroxybutyrate in biological fluids is accurate and precise (Williamson *et al.*, 1962) and is probably the most common method used for quantitative assay of ketone concentrations. The method has been successfully adapted to a

variety of automated analysis systems (Harano *et al.*, 1985; Ozand *et al.*, 1975; Työppönen and Kauppinen, 1980) and is a relatively straightforward spectrophotometric or fluorometric method. For a detailed step-by-step practical description of the method, see Mellanby and Williamson (1974) and Williamson and Mellanby (1974).

The method relies on the reversible reaction catalyzed by 3-hydroxybutyrate dehydrogenase:



The reaction is run in the forward direction by including an excess of NAD<sup>+</sup> in the reaction mixture to assay 3-hydroxybutyrate and in the backward direction by including an excess of NADH in the reaction mixture to assay acetoacetate. The equilibrium constant of the reaction is  $1.42 \times 10^{-9}$  and therefore, is highly favorable toward the reduction of acetoacetate at pH 7.0 (Krebs *et al.*, 1962). To force the reaction to completion in the direction of oxidizing 3-hydroxybutyrate, hydrazine is used as a trapping agent to remove acetoacetate as it is formed, and the reaction mixture is buffered at an alkaline pH. The change in NADH concentration is measured by the change in absorbance at 340 nm in either case. Alternately, a fluorometer can be used to measure the change in NADH concentration. To avoid interference from lactate or pyruvate in the sample, the 3-hydroxybutyrate dehydrogenase should be free of lactate dehydrogenase, or alternately, the lactate dehydrogenase inhibitor, oxamic acid, can be added to the reaction mixture (Harano *et al.*, 1985).

Table 4-3 lists normal blood and plasma ketone concentrations for several domestic species. The values are for healthy fed animals. It is assumed that plasma and blood ketone concentrations should be similar because of the generally high permeability of cell membranes to ketones and lack of protein binding of ketones; however, reports of definitive studies on this problem are not apparent in the literature. For clinical purposes, there is no lower normal limit for ketone concentrations.

### C. Synthesis of Ketones

Ketones are primarily products of intermediary metabolism. Only under unusual circumstances would more than trace amounts be absorbed from the contents of the gastrointestinal tract. The real source of ketones is fatty acids including those with short (1 to 4 carbons), medium (5 to 11 carbons), and long (>11 carbons) chains. Of course, any compound (glucose, lactate, glycerol, amino acids, etc.) that can be converted to fatty acids can be considered as a source of ketones, but for the purposes of this discussion, the origin of ketones will be considered to be fatty acids, either esterified or nonesterified.

**TABLE 4-3** Blood and Plasma Ketone Concentrations of Domestic Animals<sup>a</sup>

Species	3-Hydroxy-Butyrate		Sample	Reference
	(mmol/l)	Acetoacetate (mmol/l)		
Cow (lactating)	0.41 ± 0.03	0.043 ± 0.00	plasma	Hibbit <i>et al.</i> , 1969
	0.95 ± 0.18	0.13 ± 0.03	blood	Gröhn, 1985
Cow (nonlactating)	0.27 ± 0.04	0.011 ± 0.003	plasma	Baird <i>et al.</i> , 1968
Dog	0.033 ± 0.015	0.018 ± 0.010	blood	Balasse, 1970
	0.030 ± 0.006	—	plasma	Lammerant <i>et al.</i> , 1985
Goose	0.042 ± 0.015	0.023 ± 0.003	plasma	Maho <i>et al.</i> , 1981
Horse	0.11 ± 0.01	—	blood	Snow and Mackenzie, 1977
	0.064 ± 0.006	0.029 ± 0.003	plasma	Rose <i>et al.</i> , 1980
Sheep	0.27 ± 0.04	0.051 ± 0.005	blood	Brockman, 1976
	0.55 ± 0.04	0.030 ± 0.002	blood	Heitman <i>et al.</i> , 1986

<sup>a</sup> Values are means ± standard errors for healthy fed animals. Ketone concentrations were determined by the method of Williamson *et al.* (1962) or a modification thereof.

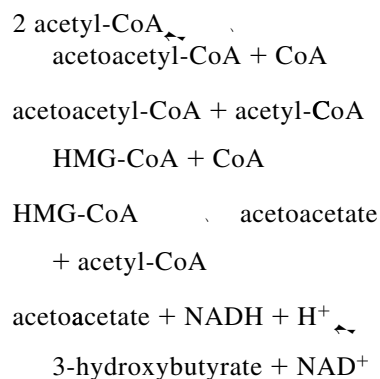
The predominant source of ketones in healthy animals is long chain fatty acids (LCFA) released during lipolysis in adipose tissue. When plasma insulin levels decrease and plasma glucagon levels increase, cAMP levels in adipose cells increase. Increased cAMP levels lead to activation of hormone-sensitive lipase, which hydrolyses triacylglycerols to LCFA and glycerol. The LCFA bind to plasma albumin for transport to other tissues, whereas glycerol freely dissolves in plasma water (McGarry, 1979; Newsholme and Leach, 1983; Spector and Fletcher, 1978).

### 1. Ketogenesis by Liver

The liver has an enormous capacity to remove LCFA from plasma. LCFA unbind from albumin, diffuse through the hepatocyte plasma membrane, and bind to fatty acid binding protein in the cytosol (Burnett *et al.*, 1979). In the cytosol, LCFA are converted to LCFA-CoA as discussed earlier. The LCFA-CoA can be used to synthesize triacylglycerol or can go through  $\beta$ -oxidation to acetyl-CoA in the mitochondrion, a process discussed earlier. Mitochondrial acetyl-CoA can have a number of fates, but under circumstances that elevate plasma LCFA levels, the two main fates are combustion in the TCA cycle or conversion to ketones. Two acetyl-CoA units can be recondensed to form ketones, which will occur when there is not sufficient oxaloacetate for citrate formation or when high levels of citrate inhibit citrate synthase.

There are four enzymes involved in ketogenesis from acetyl-CoA: acetoacetyl-CoA thiolase, hydroxymethylglutaryl-CoA (HMG-CoA) synthase, HMG-CoA lyase, and

D-3-hydroxybutyrate dehydrogenase. These four enzymes catalyze the following four reactions, respectively:



Thiolase occurs in both cytosol and mitochondria, whereas the other three enzymes are mainly restricted to the mitochondrion. However, there is some HMG-CoA synthase in the cytosol, which is involved in cholesterol synthesis. The first three enzymes are in the mitochondrial matrix, whereas 3-hydroxybutyrate dehydrogenase is in the inner membrane of the mitochondrion, and membrane lipids are required for full activity of the enzyme. Interestingly, livers of ruminants have lower apparent activities of 3-hydroxybutyrate dehydrogenase than the livers of other species (Nielsen and Fleischer, 1969; Watson and Lindsay, 1972), a situation that has not been explained adequately. Because ruminant liver is continuously presented with 3-hydroxybutyrate synthesized by the rumen epithelium, the low hepatic activity of 3-hydroxybutyrate dehydrogenase may be beneficial because more of the

compound will reach peripheral tissues in an unoxidized state.

Acetoacetyl-CoA thiolase and 3-hydroxybutyrate dehydrogenase catalyze reactions that are at or near equilibrium (i.e., the rates of these reactions are controlled by the concentrations of the substrates and products). HMG-CoA synthase and lyase catalyze reactions that are far removed from equilibrium, and these enzymes may be subject to regulatory controls other than the concentrations of substrates and products. The synthase is considered to be the rate-limiting enzyme and appears to be restricted almost exclusively to the liver (Duee *et al.*, 1994; McGarry and Foster, 1969; Valera *et al.*, 1994). Physiological controls of the enzyme are not completely understood; however, the concentration of enzyme molecules in the mitochondria is increased by cAMP, so fasting and diabetes increases it, and refeeding decreases it (Serra *et al.*, 1993). In addition, succinyl-CoA inhibits the enzyme (Quant *et al.*, 1990). Glucagon usually decreases mitochondrial succinyl-CoA, whereas an abundance of glucose or glucose precursors, like propionate, increases it. A summary of ketogenesis in the liver is depicted diagrammatically in Figure 4-1.

Ketogenesis can occur from VFA and medium chain fatty acids. Medium chain fatty acids are normally in quite low concentration in the diet or in triacylglycerols of mammals and, therefore, are not usually quantitatively important in ketogenesis. Except in unusual circumstances, nonherbivores do not absorb large quantities of VFA from the gastrointestinal tract. Among the herbivores, the metabolism of VFA has been studied most thoroughly in ruminants. Propionate is the major gluconeogenic precursor and is not an important precursor of ketones, and, in fact, propionate inhibits ketogenesis in ruminant liver (Faulkner and Pollock, 1991). The propionate inhibition probably is due to inhibition of carnitine acyltransferase I in ruminant liver by methylmalonyl-CoA, a metabolite of propionate (Brindle *et al.*, 1985). Without active carnitine acyltransferase I, LCFA cannot enter mitochondria and be oxidized to ketones.

Butyrate is converted to 3-hydroxybutyrate by the rumen epithelium and will be discussed later. Acetate must be covalently bound to CoA under the catalysis of acetokinase before it can be catabolized further. Acetokinase is found in the cytosol and mitochondria of most cells in most organs. In ruminants, the liver has a relatively low concentration of acetokinase, and most absorbed acetate passes through the liver and is removed from the plasma by other tissues, particularly heart, skeletal muscle, kidney, and mammary gland (Bauman and Davis, 1975; Cook *et al.*, 1969).

## 2. Ketogenesis by the Alimentary Tract

Butyrate, which is produced during fermentation of feedstuffs in the rumen, is readily absorbed by the rumen wall (Stevens, 1970). The rumen epithelial cells possess high activities of butyryl-CoA synthetase, which can convert

butyrate to butyryl-CoA (Cook *et al.*, 1969). By  $\beta$ -oxidation, butyryl-CoA is converted to L-3-hydroxybutyryl-CoA, which is oxidized to acetoacetyl-CoA followed by cleavage of the CoA and reduction of the resulting acetoacetate to 3-hydroxybutyrate (Emmanuel, 1980). Rumen epithelium does have HMG-CoA synthase, HMG-CoA lyase and 3-hydroxybutyrate dehydrogenase activities, although in lesser concentration than in liver (Baird *et al.*, 1970; Emmanuel, 1980). It is possible that rumen epithelium can cleave CoA from acetoacetyl-CoA directly because it contains acetoacetyl-CoA deacylase (Bush and Milligan, 1971). In addition, rumen epithelium possesses 3-ketoacid CoA-transferase, an enzyme to be discussed later when ketone oxidation is discussed (Bush and Milligan, 1971). This enzyme can catalyze the transfer of CoA from acetoacetyl-CoA to succinate, thus liberating acetoacetate. This latter route may be the predominant pathway in rumen epithelium (Bush and Milligan, 1971).

3-Hydroxybutyrate appears in portal blood (Katz and Bergman, 1969; Stevens, 1970). At least 50% of absorbed butyrate is oxidized to ketones in the rumen wall, and of the butyrate that does appear in portal blood, nearly all of it is removed on the first pass through the liver (Bergman *et al.*, 1965; Bergman and Wolfe, 1971; Fell and Weekes, 1975; Ramsey and Davis, 1965). Ruminal production of 3-hydroxybutyrate is probably the main reason why fed ruminants normally have a higher plasma concentration of this compound than fed nonruminants (see Table 4-3).

## 3. Ketogenesis by Other Organs

It has been claimed that mammary gland may synthesize appreciable ketones in ketotic dairy cows; however, the evidence is weak. Arteriovenous concentration differences and mammary blood flow have been used to estimate mammary ketone production and uptake in dairy cows (Kronfeld *et al.*, 1968). It was found that the mammary gland utilized small quantities of acetoacetate and larger quantities of 3-hydroxybutyrate in healthy cows, whereas the mammary gland of ketotic cows produced large quantities of acetoacetate. The increased uptake of 3-hydroxybutyrate by mammary in ketotic cows equaled almost exactly mammary production of acetoacetate. There was no significant difference in mammary uptake of acetate between healthy and ketotic cows.

In yet another study on ketotic cows (Schwalm *et al.*, 1969), arteriovenous concentration differences across the mammary glands of acetoacetate and 3-hydroxybutyrate were observed. A positive AV difference was noted for 3-hydroxybutyrate, which was almost equal in magnitude to the negative AV difference noted for acetoacetate. The foregoing results point toward mammary conversion of 3-hydroxybutyrate to acetoacetate, which increases in ketosis. This process cannot really be called ketogenesis; perhaps *ketoconversion* would be the appropriate term.

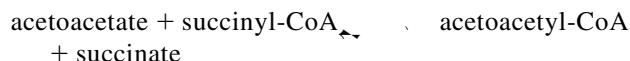
## D. Catabolism of Ketones

### 1. Reduction and Oxidation

Reduction is a possibility for acetoacetate, and, of course, the reduction product is 3-hydroxybutyrate. 3-Hydroxybutyrate is a metabolic cul de sac because it can be metabolized only by being reconverted to acetoacetate. In comparison to acetoacetate, 3-hydroxybutyrate should be viewed as a means by which the liver can export reducing power (hydrogen) to the peripheral tissues for combustion and energy generation there.

Both acetoacetate and 3-hydroxybutyrate can be reduced by being converted to LCFA. This fate is more likely to occur in mammary gland than in adipose tissue. Plasma 3-hydroxybutyrate has been shown to be a milk fat precursor in cows (Palmquist *et al.*, 1969), goats (Linzell *et al.*, 1967), and rabbits (Jones and Parker, 1978). A substantial portion of 3-hydroxybutyrate used for milk fat synthesis in ruminants is incorporated as a four-carbon unit (Kinsella, 1970; Palmquist *et al.*, 1969).

Ultimately, the fate of most 3-hydroxybutyrate and acetoacetate is oxidation in the peripheral tissues. Once 3-hydroxybutyrate has been oxidized to acetoacetate, the acetoacetate is converted to acetoacetyl-CoA by the following reaction:



This reaction is catalyzed by 3-ketoacid CoA-transferase, and viewed from the point of converting succinyl-CoA to succinate, it effectively bypasses the succinyl-CoA synthetase reaction of the citric acid cycle. Because the reaction catalyzed by succinyl-CoA synthetase produces one GTP from GDP, the 3-ketoacid CoA-transferase reaction effectively consumes 1 mole of ATP. The reaction also pushes succinyl-CoA toward oxaloacetate in the citric acid cycle, and oxaloacetate will be needed to form citrate from the acetyl-CoA derived from the acetoacetyl-CoA.

3-Ketoacid CoA-transferase is found in spleen, skeletal muscle, brain, adipose, heart, lung, and kidney of rodents and sheep although the activities are very low in sheep heart and brain (Williamson *et al.*, 1971). In general, though, the highest activities are in the heart and kidney. Activity of 3-ketoacid CoA-transferase is absent in liver (Williamson *et al.*, 1971). The absence of the enzyme from liver is logical because if there were a need for NADH for combustion in the liver, it could be obtained directly from acetyl-CoA in the citric acid cycle rather than shunting the acetyl-CoA units into ketones and back again.

Acetyl-CoA is produced from acetoacetyl-CoA via the acetoacetyl-CoA thiolase reaction, which was discussed under ketogenesis. All tissues have thiolase, and it is in greatest activity in heart, liver, and kidney (Williamson *et al.*, 1971). Heart and brain of sheep have significantly

less thiolase than in rodents. The activities of 2-ketoacid CoA-transferase and acetoacetyl-CoA thiolase are relatively stable in fasting, fed state, high-fat diet, and diabetes except that in rodents, thiolase increases upon feeding a high-fat diet (Williamson *et al.*, 1971). In general, it appears that the ketone utilizing capacity of the body is relatively constant, and ketone availability controls ketone oxidation.

For many years, acetone was viewed as a metabolic dead end, a substance destined to be excreted in the urine or exhaled in the breath. Although much acetone does indeed wind up in the breath and urine, evidence has accumulated that indicates that some acetone is metabolized (Kalapos *et al.*, 1994; Luick *et al.*, 1967; Owen *et al.*, 1982; Vander Jagt *et al.*, 1992). Furthermore, evidence for the catabolic pathway for acetone metabolism indicates that it is metabolized to pyruvate, apparently via hydroxyacetone and pyruvaldehyde (Vander Jagt *et al.*, 1992). Thus, by this mechanism, it is possible that small amounts of fat can be converted to glucose.

Labeling patterns of milk glutamate carbons following injection of 2-<sup>14</sup>C-acetone into cows, indicated that acetone was metabolized via pyruvate (Black *et al.*, 1972; Luick *et al.*, 1967). Labeling patterns of glucose in humans injected with radiolabeled acetone also indicate metabolism via pyruvate (Owen *et al.*, 1981). In rats, however, labeling patterns of glucose following radiolabeled acetone injection indicate that acetone can be metabolized via pyruvate and acetate, but that the latter pathway predominates (Kosugi *et al.*, 1986). Thus, there appear to be real species differences in acetone metabolism. In humans, at least, the fraction of acetone that is metabolized versus excreted varies inversely with acetone concentration (Owen *et al.*, 1982), so it appears that the catabolizing pathways for acetone are not capable of handling large quantities.

### 2. Renal Metabolism and Excretion

The kidney cannot synthesize ketones to any appreciable extent (Lynen *et al.*, 1958; Weidman and Krebs, 1969) but is a voracious consumer of ketones as an energy source in ruminants (Kaufman and Bergman, 1971, 1974) and nonruminants (Baverel *et al.*, 1982; Weidman and Krebs, 1969). It is interesting though that in fasting sheep, the kidney removes from the plasma and catabolizes both acetoacetate and 3-hydroxybutyrate (Kaufman and Bergman, 1974), whereas in fasting humans, there is substantial removal of 3-hydroxybutyrate and a slight production of acetoacetate (Owen *et al.*, 1969).

Ketones are freely filterable in the glomerulus. There appears to be in humans and dogs, at least, a direct or indirect energy-consuming tubular transport system for acetoacetate and 3-hydroxybutyrate, which approaches saturation at relatively low plasma concentrations of ketones such as encountered in the fed state or a one day

fast. Neither ketone is excreted at these lower concentrations, but they do begin to appear in the urine as plasma levels begin to rise (Sapir and Owen, 1975; Schwab and Lotspeich, 1954; Visscher, 1945; Wildenhoff, 1977). However, as the ketone concentrations increase in the glomerular filtrate, the primary mode of reabsorption is by diffusion down a concentration gradient as water is reabsorbed from the tubular lumen. Acetone begins to appear in the urine as soon as it begins to appear in the plasma (Widmark, 1920); presumably, this effect is due to great lipid solubility of acetone, which allows it to penetrate cell membranes with relative ease.

Renal excretion and reabsorption of ketones is approximately proportional to their filtration rates (or plasma concentrations if glomerular filtration rate remains constant) at concentrations found after more than a 1-day fast in humans and in ruminants (Kaufman and Bergman, 1974; Wildenhoff, 1977). At least some parts of the nephron, probably beyond the proximal tubule, are less permeable to ketones than to water because when plasma ketone levels are substantially increased, the urinary concentration exceeds the plasma concentration.

The dual mode of ketone reabsorption has an advantage in that none of this valuable energy source is lost at lower plasma concentrations; however, there is no transport maximum for the kidney as a whole, so 80% to 90% of filtered ketones are reabsorbed regardless of how concentrated ketones become in the plasma during pathological conditions or prolonged starvation. Mammals presumably could have evolved a greater activity of the energy-consuming ketone transport system. However, the energy cost of continuously maintaining the system at a higher activity probably outweighed the survival value of having the system available during rare periods of prolonged starvation.

### E. Pathophysiology of Ketonemia

As discussed earlier, the acetoacetate and 3-hydroxybutyrate are more powerful acids than the VFA, and in the case of acetoacetate, they are more powerful than lactic acid. Not surprisingly, then, a high concentration of ketones in the plasma results in a metabolic acidosis known as ketoacidosis. The most significant ketoacidoses commonly encountered in domestic animals are in diabetes mellitus and ovine pregnancy toxemia. The ketoacidosis encountered in these syndromes may cause plasma bicarbonate to be below 10 mmol/l (Ling *et al.*, 1977; Reid, 1968) and is a chief contributor to mortality.

The ketoacidosis in diabetes of dogs and cats can be severe with blood pH being 7.2 or less (Edwards, 1982; Ling *et al.*, 1977; Schaer, 1976). Because plasma ketone concentrations in diabetic dogs have been reported to average 3.2 mmol/l with some individuals having levels of 7 to 8 mmol/l (Balasse *et al.*, 1985), the base deficit in extracellular fluids would be greater than that concentration

for two reasons. First, the distribution space of the ketones is greater than that of extracellular fluid; second, some acetoacetate and 3-hydroxybutyrate anions may have been lost in the urine without equal losses of hydrogen ion (a mineral ion such as sodium or potassium would have balanced the electrical charge). Base deficits of more than 15 mmol/l have been reported in spontaneously diabetic dogs (Edwards, 1982; Ling *et al.*, 1977).

As the metabolic acidosis of diabetes progresses in dogs, there is increased catabolism of muscle protein (Balasse *et al.*, 1985). Much of the nitrogen from protein degradation is diverted into ammonia rather than urea, and it is ammonium ion that balances most of the electrical charge on excreted acetoacetate and 3-hydroxybutyrate.

Ketones are really an alternate form of lipid, comparable to triacylglycerols, LCFA, or VFA, and should be considered as such in caloric balance (Williamson, 1971). VFA and ketones are effectively water-soluble forms of lipids; however, only the ketones can be produced in large quantities in tissue metabolism.

In fed animals, only a nominal caloric production is derived from oxidation of ketones; however, in fasted animals or in some pathological conditions, ketone oxidation accounts for a substantial quantity of expended calories. For example, only 3% to 4% of expired carbon dioxide is derived from 3-hydroxybutyrate in fed cows (Palmquist *et al.*, 1969), whereas 30% of expired carbon dioxide is derived from ketones in fasted pregnant ewes (Pethick and Lindsay, 1982).

It has been demonstrated in canine perfused liver (Shaw and Wolfe, 1984) and *in vivo* in humans (Binkiewicz *et al.*, 1974; Mebane and Madison, 1964; Miles *et al.*, 1981) and dogs (Balasse *et al.*, 1967; Paul *et al.*, 1966) by infusing acetoacetate or 3-hydroxybutyrate that both ketones inhibit gluconeogenesis. In most of these experiments, there has been evidence of increased plasma insulin concentrations, which could account for the diminution in plasma glucose concentration. The survival value of having ketones inhibit gluconeogenesis is that in starvation, as ketone concentrations increase and become available for tissue energy needs, the rate at which body protein must be catabolized to supply glucose precursors can decrease.

Not surprisingly in view of the increased insulin levels usually observed, decreased levels of LCFA were noted during ketone infusions in some of the experiments mentioned previously. Thus, increased ketone levels may serve a negative feedback on rate of lipolysis in adipose and, therefore, on the plasma levels of ketones themselves.

### F. Fasting Ketosis

During fasting, hormonal changes occur that promote lipolysis. Most important, as less glucose is available from the gut or from gluconeogenesis in the liver, plasma glucose concentrations will decrease. Responding to the hypoglycemia,

pancreatic islet cells will release less insulin and more glucagon, so that plasma insulin concentrations will decrease and plasma glucagon concentrations will increase. These hormonal changes will increase cAMP concentrations in adipose cells, which leads to the activation of hormone-sensitive lipase.

Through the action of hormone-sensitive lipase, triacylglycerols are hydrolyzed with release of LCFA and glycerol. LCFA are utilized directly by tissues for energy but are also taken up by the liver in proportion to their plasma concentration. During fasting, hepatic concentrations of malonyl-CoA and methylmalonyl-CoA are relatively low, so carnitine acyltransferase I activity is relatively high, and LCFA-CoA are quickly converted to LCFA-carnitine, which is translocated into the mitochondrion (McGarry *et al.*, 1977). Once in the mitochondrion LCFA-carnitine is converted to LCFA-CoA again.

Following  $\beta$ -oxidation of ketones, some acetyl-CoA is combusted in the citric acid cycle. However, during fasting, gluconeogenesis is quite active in the liver, and much of the mitochondrial oxaloacetate is used for that purpose and is unavailable for citrate formation with acetyl-CoA; consequently, large quantities of acetyl-CoA are shunted into ketogenesis.

Acetoacetate and 3-hydroxybutyrate can be utilized by most extrahepatic tissues. Because peripheral tissues can also use LCFA, the utility of hepatic production of ketones from LCFA was not clear originally. However, many tissues have as great or greater capacity for utilizing plasma ketones as for utilizing plasma LCFA. Among these tissues are heart and kidney (Hall, 1961; Little *et al.*, 1970; Owen *et al.*, 1969; Williamson and Krebs, 1961). In some species, such as the rat (Hawkins *et al.*, 1971) and human (Owen *et al.*, 1967), ketones constitute a major energy source for the brain during fasting. In some other species though, it appears that the brain prefers glucose and utilizes only small quantities of ketones in the fed or fasted state in the sheep (Jones *et al.*, 1975; Lindsay and Setchell, 1976; Pell and Bergman, 1983), the dog (Wiener *et al.*, 1971), and the pig (Tildon and Sevdalian, 1972). Resting skeletal muscle utilizes ketones preferentially as a fuel during short-term starvation (Owen and Reichard, 1971); however, LCFA are preferred during long-term starvation (Owen and Reichard, 1971) or exercise (Hagenfeldt and Wahren, 1968a, 1968b).

Ketones are quite soluble, require no protein carrier, and diffuse (in their un-ionized form) or are transported rapidly through biological membranes including the blood-brain barrier (Hawkins *et al.*, 1971; Persson *et al.*, 1972). The liver has an advantage over other tissues regarding uptake of LCFA from plasma albumin because of its unique sinusoidal vascular system. Therefore, the liver can be regarded as a machine that can rapidly remove LCFA from plasma and convert them to a form, the ketones, that other tissues can utilize rapidly.

Because they must be bound to albumin if they are to be nontoxic, the maximum safe plasma concentration of LCFA is fixed by the albumin concentration. Furthermore, in prolonged fasting, albumin concentration decreases, which lessens the number of LCFA carriers. Generally, LCFA concentrations do not rise above 2 mmol/l in fasting, whereas ketone concentrations can increase to 3 to 4 mmol/l or more. Thus, ketones can have a greater concentration gradient to allow their entry into the cell.

Although the acid nature of ketones has received much attention in the clinical literature, less well recognized is the toxic potential of LCFA. If LCFA are released into the plasma in excess of hepatic uptake, albumin-binding capacity will be exceeded (Spector and Fletcher, 1978). Unbound fatty acids may damage endothelial cells, perhaps because of detergent action, oxidation of unsaturated LCFA, or changes in cell metabolism (Ramasamy *et al.*, 1991). Such damage to endothelial cells has been proposed as a mechanism in the development of atherosclerotic plaque (Zilvermit, 1973). There is some evidence in humans and guinea pigs that high levels of LCFA within the heart may predispose it to arrhythmias (Cowen and Vaughn-Williams, 1977; Oliver *et al.*, 1968). The possible role of LCFA in causing some cases of pancreatitis was discussed earlier.

Ketogenesis in fasting should be viewed as an evolved mechanism with specific survival value for peripheral tissues and not a burden that the liver is placing on the rest of the body. It is important to remember that fasting animals should be expected to have a degree of ketonemia, ketonuria, and ketolactia. Thus, any disease condition which causes anorexia will usually be accompanied by increased ketone levels in body fluids that have no significance other than the fact that the animal has a subnormal caloric intake.

## G. Diabetic Ketosis

Although diabetes mellitus is covered in more depth elsewhere in this book, no discussion of ketones would be complete without a mention of this disease. Diabetes is diagnosed more frequently in dogs and cats than other domestic species, and the ketoacidosis that occurs can be fatally severe and was discussed under acid-base balance above.

In experimental diabetes in dogs, plasma total ketone concentrations are 3.2 mmol/l as compared with 0.1 mmol/l in healthy dogs (Balasse *et al.*, 1985). Diabetes is accompanied by hyperglycemia, whereas most other ketotic syndromes occurring in domestic animals are usually accompanied by normoglycemia or hypoglycemia. The ketonemia in diabetes is due to increased lipolysis in adipose plus accelerated hepatic gluconeogenesis, both brought about by a lack of insulin. Thus, there are abundant plasma LCFA as ketogenic substrates and metabolic conditions in the liver that favor ketone synthesis.

## H. Ketosis Associated with Pregnancy and Lactation

These ketoses are most commonly observed in ruminants although they have been documented in dogs and humans. Before specific syndromes are discussed, a general picture of ketogenesis in pregnancy and lactation will be presented.

Fetal demands for glucose are high, and the placenta can transport glucose from maternal to fetal plasma (Setchell *et al.*, 1972; Warnes *et al.*, 1977). When an imbalance occurs between the maternal ability to synthesize or absorb glucose and fetal consumption, hypoglycemia results. Under these circumstances, hypoglycemia will lead to lipolysis in adipose tissue and release of LCFA as discussed earlier. The LCFA will be taken up by the liver and converted to ketones with resulting ketosis.

Ketosis in lactation is somewhat more complex than ketosis occurring during pregnancy. The volume of milk produced is almost totally dependent on the rate of lactose synthesis by the mammary gland because milk volume formation is an osmotic phenomenon, and lactose is the predominant molecular species in milk (Peaker, 1977). There is virtually only one precursor of lactose, and that precursor is plasma glucose (Bickerstaffe *et al.*, 1974; Kleiber *et al.*, 1955). Therefore, a female that is in heavy lactation will have a heavy drain on plasma glucose. There are two sources of plasma glucose: absorption from the gut and gluconeogenesis.

In ruminants, little glucose is absorbed from the gut, so the overwhelming bulk of it is synthesized (Lindsay, 1959; Otchere *et al.*, 1974). Most (approximately 90%) of this synthesis occurs in the liver with the remainder occurring in the kidney (Bergman, 1982). The chief substrates are propionate and amino acids, with the former being most important in animals on a high-grain diet. Other precursors are branched chain VFA and lactate absorbed from the rumen and glycerol released during lipolysis (Bergman, 1975). If there is a mismatch between mammary drain of glucose for lactose synthesis and gluconeogenesis in the liver, hypoglycemia will result. Under these circumstances, hypoglycemia will lead to ketosis as explained in the discussion on fasting ketosis.

### 1. Bovine Ketosis

Bovine ketosis is actually at least three different syndromes that occur in cows during lactation (Kronfeld, 1980; Kronfeld *et al.*, 1983). The syndromes are characterized by anorexia, depression (usually), ketonemia, ketolactia, ketonuria, hypoglycemia, and decreased milk production. The three syndromes are underfeeding ketosis, alimentary ketosis, and spontaneous ketosis.

Underfeeding ketosis occurs when a dairy cow receives insufficient calories to meet lactational demands plus body maintenance. This version of ketosis can be conveniently

divided into nutritional underfeeding ketosis and secondary (or complicated) ketosis. The former occurs when the cow has a normal appetite but is given an insufficient quantity of feed or a diet with low metabolic energy density. The latter occurs when a cow has some other disease, such as hypocalcemia, mastitis, and metritis, which suppresses appetite and causes the cow to consume insufficient nutrients. In most respects, underfeeding ketosis resembles starvation ketosis explained earlier, except that there is the additional caloric and glycemic burden of milk production.

Alimentary ketosis occurs when cattle have been fed spoiled silage that contains excessive amounts of butyric acid (Adler *et al.*, 1958; Brouwer and Kijkstra, 1938). As discussed previously, the rumen epithelium has a high capacity to activate butyrate to acetoacetate and 3-hydroxybutyrate. Under conditions where excessive butyrate is presented to the rumen epithelium, large amounts of 3-hydroxybutyrate will be produced and released to the circulation with resulting ketosis. Alimentary ketosis then is really butyrate toxicosis.

Spontaneous ketosis is probably the most common, the most researched, the most controversial, and the least understood form of bovine ketosis. It occurs in high producing dairy cows that are near the peak of lactation, that have access to abundant high-quality feed, and that have no other disease (Baird, 1982; Kronfeld, 1980). The disease is not accompanied by severe acidosis (Sykes *et al.*, 1941), and spontaneous recovery is common although there is a large decrease in milk production (Baird, 1982; Kronfeld, 1980). There are several schemes proposed for the molecular pathogenesis of the syndrome. As these schemes are discussed, it will become evident that they are not necessarily mutually exclusive, and more than one of them may be correct and may be present simultaneously in the same animal.

The most widely accepted theory of bovine ketosis is the hypoglycemia theory (Baird, 1982). In this theory, hypoglycemia is the driving force in the syndrome and ultimately causes the ketonemia. Dairy cows are selected for remaining in the herd more for milk production than for any other factor. Thus, dairy cows have been selected for many generations to have a metabolically aggressive mammary gland. This selection criterion has dictated that the mammary produce a maximum amount of milk with secondary regard for the metabolic consequences for the rest of the animal. It is not surprising, therefore, that occasionally the mammary gland might withdraw glucose from the plasma more rapidly than the liver can resupply it, which leads to hypoglycemia even in a well-fed animal. The hypoglycemia will lead to ketonemia by mechanisms discussed earlier and later in this discussion. The hypoglycemia and ketonemia may cause the cow to be ill enough that she will decrease her feed intake. At this point, the syndrome will resemble underfeeding ketosis.

As explained previously, high milk production equates to a high rate of plasma glucose utilization by the mammary gland, which equates to a high rate of hepatic

gluconeogenesis. In a lactating cow, plasma glucose concentration represents the balance point between hepatic glucose production and peripheral glucose utilization, with the mammary gland being the chief user. If peripheral glucose utilization should leap ahead of hepatic glucose production, hypoglycemia will result. In theory, hypoglycemia under these circumstances should lead to a decrease in plasma insulin and an increase in plasma glucagon levels. Lower plasma insulin and higher plasma glucagon should increase the activity of hormone-sensitive lipase in adipose tissue, which will lead to increased plasma levels of LCFA. Consequently, more LCFA will reach the liver and exceed its capacity to oxidize them completely or to reesterify them, and increased ketogenesis will result.

What evidence supports this theory? First, the vast majority of cows with clinical spontaneous ketosis are indeed hypoglycemic (Baird *et al.*, 1968; Gröhn *et al.*, 1983; Schwalm and Schultz, 1976). Second, cows with spontaneous ketosis usually are hypoinsulinemic (Hove, 1974; Schwalm and Schultz, 1976). Third, compared to the pre-lactation period, postparturient dairy cows have been found to have elevated levels of plasma immunoreactive glucagon (De Boer *et al.*, 1985; Manns, 1972), which is even greater in cows with ketosis (Sakai *et al.*, 1993). Fourth, ketotic cows have elevated levels of plasma LCFA (Baird *et al.*, 1968; Ballard *et al.*, 1968; Schwalm and Schultz, 1976).

Some investigation of molecular mechanisms of ketogenesis in the liver ketotic cows has been performed (Baird *et al.*, 1968; Ballard *et al.*, 1968). In particular, there has been interest in hepatic mitochondrial oxaloacetate levels. In the discussion of ketogenesis presented earlier, it was noted that when increased levels of plasma LCFA occur, the liver can reesterify them or can oxidize them to acetyl-CoA. The acetyl-CoA can be oxidized to carbon dioxide provided there is sufficient oxaloacetate to permit entry into the citric acid cycle as citrate. For the citric acid cycle to operate, there must also be a sufficient amount of ADP available for phosphorylation as well, or accumulation of NADH will slow the cycle. If acetyl-CoA accumulates, the excess will be diverted into ketogenesis.

Two studies have attempted to investigate oxaloacetate concentrations in the livers of ketotic cows (Baird *et al.*, 1968; Ballard *et al.*, 1968). Different methodologies were used to estimate oxaloacetate concentrations; one study (Ballard *et al.*, 1968) concluded that there was no change in oxaloacetate concentration during ketosis, and the other concluded that oxaloacetate concentrations were lower in ketotic than in healthy cows (Baird *et al.*, 1968). Actually, both studies measured total hepatic oxaloacetate rather than mitochondrial oxaloacetate, which may be critical in ketogenic control. However, there has been no evidence to indicate that the ruminant liver should be any different from the nonruminant liver with regard to the concept that if the liver is presented with sufficient LCFA, ketogenesis will result. There has been insufficient research on the control of lipolysis in adipose in

ruminants. In particular, there has been insufficient research in differences in plasma levels of lipogenic and lipolytic hormones and sensitivity of adipose to these hormones in cow populations that are susceptible and nonsusceptible to ketosis. No matter how low mitochondrial oxaloacetate levels might be in the liver, ketogenesis will not occur at a significant rate without a sufficient precursor in the form of LCFA, and conversely, ketogenesis could occur with normal oxaloacetate levels if the liver were presented with a sufficiently high concentration of LCFA.

It has been noticed, however, that dairy cattle can become ketonemic without the presence of significant hypoglycemia (Ballard *et al.*, 1968; Gröhn *et al.*, 1983). This is often the case with subclinical ketosis in which ketonemia exists without other signs of ketosis. It has been postulated that there is a lipolytic signal of unknown identity for lipolysis to meet mammary demand for LCFA, which is independent of plasma glucose concentration (Kronfeld, 1982; Kronfeld *et al.*, 1983). The increased plasma LCFA lead directly to increased hepatic ketogenesis.

When it was first observed that glucocorticoids appeared to be an effective treatment for spontaneous ketosis, it was hypothesized that the disease was due to adrenal cortical insufficiency (Shaw, 1956). This theory has fallen into disfavor because it has been shown that ketotic cows have higher plasma levels of glucocorticoids than healthy cows (Robertson *et al.*, 1957). Glucocorticoids are efficacious and probably have their effect by stimulating proteolysis and inhibiting glucose use in muscle, thereby providing gluconeogenic precursors and glucose (Bassett *et al.*, 1966; Braun *et al.*, 1970; Reilly and Black, 1973; Robertson, 1966; Ryan and Carver, 1963).

The efficacy of glucose or glucose precursors as ketosis treatments favors the hypoglycemic theory. Parenteral glucose provides nearly immediate relief although relapses are common (Kronfeld, 1980). Gluconeogenic precursors, such as propylene glycol, glycerol, and sodium propionate, have been shown to be efficacious (Emery *et al.*, 1964; Kauppinen and Gröhn, 1984; Schultz, 1952; Simesen, 1956). Treatment of cows with bovine somatotropin in one lactation appears to decrease the likelihood of ketosis in the next lactation (Lean *et al.*, 1994). Cows treated with somatotropin appear to have less body fat and more skeletal muscle, so after calving, there is less fat to mobilize to LCFA and more protein to mobilize as a glucose precursor. Therefore, hypoglycemia and subsequent fatty acidemia and ketonemia are less likely to occur.

## 2. Ovine Pregnancy Toxemia

This syndrome occurs in pregnant ewes that are carrying more than one fetus and that have been subjected to caloric deprivation or stress. Because of intense genetic selection for twinning, the syndrome is, to a large extent, a man-made disease. Susceptibility increases as ewes approach



term because fetal glucose demands increase with increasing body size. The ovine placenta is capable of extracting glucose from maternal plasma at concentrations below 1mmol/l and readily does so. It might seem biologically useless for the fetuses to cause a fatal hypoglycemia in the ewe, which will also lead to their own demise, but the fetuses are highly dependent on glucose as a caloric and synthetic source and would expire without it anyway.

Fetal lambs normally maintain a very low plasma glucose concentration of approximately 0.6mmol/l compared to 2.7mmol/l in a ewe (Warnes *et al.*, 1977). Thus, the transplacental glucose gradient greatly favors movement from dam to fetus. Curiously, the most concentrated carbohydrate in fetal sheep plasma is fructose (5.1mmol/l), which is synthesized from glucose in the placenta by reducing glucose to sorbitol followed by oxidation to fructose (Hers, 1960; Warnes *et al.*, 1977). Despite the abundance of fructose in the plasma of the fetal sheep, glucose constitutes its primary energy supply (Lindsay and Pethick, 1983; Warnes *et al.*, 1977), and the fetuses normally consumed 60% to 70% of maternal glucose production (Prior and Christenson, 1978; Setchell *et al.*, 1972).

The ovine placenta appears to have a low permeability for acetoacetate. When acetoacetate loads have been infused into pregnant sheep, the concentrations in fetal blood have remained low. Further, *in vitro* experiments with perfused sheep placenta have also demonstrated a low permeability for acetoacetate (Alexander *et al.*, 1966, 1969). Thus, it appears that maternal acetoacetate, and perhaps 3-hydroxybutyrate, cannot be a major energy source for the ovine fetus.

The disease is characterized by depression and weakness in the ewes, which are associated with hypoglycemia, ketonemia, and ketonuria (Henze, 1998; Reid, 1968). The ketonemia is severe enough to cause acidosis, which can be severe (Holm, 1958; Reid, 1968). There is also considerable fatty deposition in the liver to the extent that it may interfere with liver function (Cornelius *et al.*, 1958; Snook, 1939). Eventually, the ewes are unable to rise, become comatose, and die if untreated.

Mild cases respond to intravenous glucose, glucocorticoids, glucose precursors such propylene glycol or glycerol coupled with removal of stress, and improved nutrition (Henze *et al.*, 1998; McClymont and Setchell, 1955a, 1955b; Thompson, 1956). Severe cases, in which the ewes are unable to rise, usually respond only to delivery of the lambs, and even then, a high mortality will occur (Holm, 1958; Reid, 1968).

### 3. Syndromes in Other Species

Ketosis associated with lactation can occur in dairy goats (Morand-Fehr *et al.*, 1984). The syndrome has also been reported in beef cows with caloric deprivation and nursing two calves (Khan *et al.*, 1986). Pregnancy toxemia

has been reported in goats carrying multiple fetuses (East, 1983; Morand-Fehr *et al.*, 1984; Rindsig, 1980; Thedford, 1983). The syndrome can be produced with calorie deprivation, particularly if coupled with stress, and almost always occurs in does carrying more than one fetus. Obesity also may be a predisposing factor in does (Morand-Fehr *et al.*, 1984; Thedford, 1983). Generally, the syndrome in does appears entirely similar to that in ewes.

Pregnancy toxemia has been reported in beef cows in the last 2 months of gestation (Caple *et al.*, 1977; Kingrey *et al.*, 1957; Sampson *et al.*, 1945; Tyler *et al.*, 1994). The disease occurs predominantly in cows that are carrying twins. The cows may be in good or even obese body condition, but sudden food deprivation or decrease in quality or imposition of stress such as water deprivation may precipitate the syndrome. The disease resembles pregnancy toxemia in sheep in most respects. Pregnancy toxemia has been reported in pregnant bitches (Irvine, 1964; Jackson *et al.*, 1980) and appears similar to the disease in sheep. Hypoglycemia is severe in canine cases, and the animals respond readily to intravenous glucose. If the animals will eat a carbohydrate-containing diet, a relapse is unlikely; otherwise, removal of the fetuses is required for a cure. There is a report of diabetic ketosis developing in pregnant dogs, which may resolve after delivery; however, these dogs are hyperglycemic and are treated with fluids and insulin (Norman *et al.*, 2006). Pregnancy toxemia occurs in pregnant guinea pigs and, like in pregnant ewes, the syndrome can be precipitated by inadequate calories and stress (Bergman and Sellers, 1960; Wagner, 1976). The syndrome in guinea pigs is similar to that in sheep. There is marked ketonemia and acidosis, and the animals become weak and depressed with eventual coma (Wagner, 1976).

### I. Postexercise Ketosis

Postexercise ketosis, which was first documented in 1909 (Forssner, 1909), has been investigated most extensively in humans and rats. Neither trained nor untrained humans or rats show much increase in ketones during exercise, but only untrained individuals exhibit a significant ketonemia and ketonuria after exercise (Johnson *et al.*, 1969; Koeslag, 1982; Winder *et al.*, 1975). The experiments of Winder *et al.* (1975) demonstrated a greater enzymatic capacity of muscles of trained rats to catabolize ketones. It also appears that trained athletes have a greater capacity to oxidize LCFA in muscle than nonathletes (Johnson *et al.*, 1969). A high-carbohydrate diet in conjunction with training also decreases the magnitude of postexercise ketosis (Koeslag *et al.*, 1980).

From the foregoing, it appears that a number of factors are involved in postexercise ketosis. During exercise, all forms of fuel, including LCFA, ketones, and glucose, are oxidized. Postexercise, there is a diminution of LCFA release from adipose tissue; however, plasma LCFA concentrations decrease little at first because of an even greater

diminution in LCFA oxidation, and more LCFA may be converted to ketones. Ketone oxidation by muscle is decreased postexercise, which will allow ketones to accumulate. In the postexercise period, there is gluconeogenesis as lactate is cycled back into glucose and glycogen, which may lead to decreased mitochondrial oxaloacetate levels and increased ketogenesis. Finally, compared to the exercise period, in the postexercise period, relatively more of the cardiac output will flow through the portal system, and the rate at which LCFA are presented to the liver may increase.

Postexercise ketosis undoubtedly occurs in most mammalian species, but among the domestic species, it has been best documented in dogs and horses. Postexercise increases in plasma levels of ketones have been observed in racing sled dogs (Hammel *et al.*, 1977). Postexercise ketosis has been reported several times in the horse (Dybdal *et al.*, 1980; Lucke and Hall, 1980; Rose and Sampson, 1982). In these studies, horses were subjected to endurance rides of 80 to 160 km. Plasma 3-hydroxybutyrate concentrations increased two- to three-fold 5 to 60 minutes postexercise compared to preexercise levels. Plasma LCFA concentrations increase five-fold or more in horses during exercise (Lucke and Hall, 1980; Rose and Sampson, 1982) and decrease little during 30 to 60 minutes postexercise. Thus, abundant LCFA are available to the liver postexercise when muscle utilization of LCFA and ketones is decreased, a situation that results in ketonemia.

## REFERENCES

- Adler, J. A., Roberts, S. J., and Dye, J. A. (1958). Further observations on silage as an etiological factor in bovine ketosis. *Am. J. Vet. Res.* **19**, 314–318.
- Alexander, C. A., Hamilton, R. L., and Havel, R. J. (1976). Subcellular localization of B apoprotein of plasma lipoproteins in rat liver. *J. Cell Biol.* **69**, 241–263.
- Alexander, D. P., Britton, H. G., and Nixon, D. A. (1966). Metabolism of ketone bodies by the sheep foetus. *J. Physiol.* **186**, 100P–101P.
- Alexander, D. P., Britton, H. G., Cohen, N. M., and Nixon, D. A. (1969). Foetal metabolism. In "Foetal Autonomy" (C. E. W. Wolstenholme and M. O'Connor, Eds.), pp. 95–112. J & A Churchill, London.
- Baetz, A. L., and Pearson, J. E. (1972). Blood constituent changes in fasted ponies. *Am. J. Vet. Res.* **33**, 1941–1946.
- Baird, G. D., Hibbitt, K. G., Hunter, G. D., Lund, P., Stubbs, M., and Krebs, H. A. (1968). Biochemical aspects of bovine ketosis. *Biochem. J.* **107**, 683–689.
- Baird, G. D. (1982). Primary ketosis in the high-producing dairy cow: clinical and subclinical disorders, treatment, prevention, and outlook. *J. Dairy Sci.* **65**, 1–10.
- Baird, G. D., Hibbitt, K. G., and Lee, J. (1970). Enzymes involved in acetoacetate formation in various bovine tissues. *Biochem. J.* **117**, 703–709.
- Balasse, E. O. (1970). Inhibition of free fatty acid oxidation by acetoacetate in normal dogs. *Europ. J. Clin. Invest.* **1**, 155–160.
- Balasse, E., Courturier, E., and Franckson, J. (1967). Influence of sodium  $\beta$ -hydroxybutyrate on glucose and free fatty acid metabolism in normal dogs. *Diabetologia* **3**, 488–493.
- Balasse, E. O., De Graef, J., and Neef, M. A. (1985). Alanine turnover in normal and diabetic dogs. *Horm. Metabol. Res.* **17**, 554–558.
- Ballard, F. J., Hanson, R. W., Kronfeld, D. S., and Raggi, F. (1968). Metabolic changes in liver associated with spontaneous ketosis and starvation in cows. *J. Nutr.* **95**, 160–172.
- Barrie, J., Watson, T. D. G., Stear, M. J., and Nash, A. S. (1993). Plasma cholesterol and lipoprotein concentrations in the dog: the effects of age, breed, gender and endocrine disease. *J. Small. Anim. Pract.* **34**, 507–512.
- Bass, V. D., Hoffmann, W. E., and Dörner, J. L. (1976). Normal canine lipid profiles and effects of experimentally induced pancreatitis and hepatic necrosis on lipids. *Am. J. Vet. Res.* **37**, 1355–1357.
- Bassett, J. M., Mills, S. C., and Reid, R. L. (1966). The influence of cortisol on glucose metabolism in sheep. *Metabol.* **15**, 922–932.
- Bauchart, D. (1993). Lipid absorption and transport in ruminants. *J. Dairy Sci.* **76**, 3864–3881.
- Bauer, J. E. (1983). Plasma lipids and lipoproteins of fasted ponies. *Am. J. Vet. Res.* **44**, 379–384.
- Bauer, J. E., Meyer, D. J., Goring, R. L., Beauchamp, C. H., and Jones, J. (1989). Lipoprotein cholesterol distribution in experimentally induced canine cholestasis. In "Nutrition of the Dog and Cat" (I. H. Burger and J. P. W. Rivers, Eds.), pp. 343–352. Cambridge University Press, New York.
- Baum, D., Schweid, A. I., Porte, D., and Bierman, E. L. (1969). Congenital lipoprotein lipase deficiency and hyperlipemia in the young puppy. *Proc. Soc. Exp. Biol. Med.* **131**, 183–185.
- Bauman, C. E., and Davis, C. L. (1975). Regulation of lipid metabolism. In "Digestion and Metabolism in the Ruminant" (I. W. McDonald and A. C. I. Warner, Eds.), pp. 496–509. University of New England Publishing Unit, Armidale, New South Wales.
- Baverel, G., Forissier, M., and Pellet, M. (1982). Characteristics of ketone-body metabolism in dog renal cortex and outer medulla. In "Biochemistry of Kidney Functions" (F. Morel, Ed.), pp. 177–185. Elsevier, Amsterdam.
- Bergman, E. N. (1975). Production and utilization of metabolites by the alimentary tract as measured in portal and hepatic blood. In "Digestion and Metabolism in the Ruminant" (I. W. McDonald and A. C. I. Warner, Eds.), pp. 292–305. University of New England Publishing Unit, Armidale, New South Wales.
- Bergman, E. N. (1982). Hypoglycemia associated with pregnancy. In "Comparative Aspects of Nutritional and Metabolic Diseases" (J. C. Woodard and M. Bruss, Eds.), pp. 1–23. CRC Press, Boca Raton, FL.
- Bergman, E. N., and Sellers, A. F. (1960). Comparison of fasting ketosis in pregnant and nonpregnant guinea pigs. *Am. J. Physiol.* **198**, 1083–1086.
- Bergman, E. N., and Wolfe, J. E. (1971). Metabolism of volatile fatty acids by liver and portal-drained viscera in sheep. *Am. J. Physiol.* **221**, 586–592.
- Bergman, E. N., Reid, R. S., Murray, M. G., Brockway, J. M., and Whitelaw, F. G. (1965). Interconversions and production of volatile fatty acids in the sheep rumen. *Biochem. J.* **97**, 53–58.
- Bernlohr, D. A., Jenkins, A. E., and Bennaars, A. A. (2002). Adipose tissue and lipid metabolism. In "Biochemistry of Lipids, Lipoproteins and Membranes" (D. E. Vance and J. Vance, Eds.), pp. 263–290. Elsevier, New York.
- Bickerstaffe, R., Anison, E. F., and Linzell, J. L. (1974). The metabolism of glucose, acetate, lipids and amino acids in lactating dairy cows. *J. Agric. Sci. Camb.* **82**, 71–85.
- Binkiewicz, A., Sadeghi-Nejad, A., Hochman, H., Loidan, L., and Senior, B. (1974). An effect of ketones on the concentrations of glucose and

- of free fatty acids in man independent of the release of insulin. *J. Pediatr.* **84**, 226–231.
- Black, A. L., Luick, J. R., Lee, S. L., and Knox, K. (1972). Glucogenic pathway for acetone metabolism in the lactating cow. *Am J. Physiol.* **222**, 1575–1580.
- Blomhoff, J. P., Holme, R., and Östrem, J. (1978). Plasma cholesterol esterification and plasma lipoproteins in bile-duct-ligated dogs. *Scand. J. Gastroenterol.* **13**, 693–702.
- Braun, R. K., Bergman, E. N., and Albert, T. F. (1970). Effects of various synthetic glucocorticoids on milk production and blood glucose and ketone body concentrations in normal and ketotic cows. *J. Am. Vet. Med. Assoc.* **157**, 941–946.
- Brindle, N. P. J., Zammit, V. A., and Pogson, C. I. (1985). Regulation of carnitine palmitoyltransferase activity by malonyl-CoA in mitochondria from sheep liver, a tissue with a low capacity for fatty acid synthesis. *Biochem. J.* **232**, 177–182.
- Brockman, R. P. (1976). Effects of glucagon and insulin on lipolysis and ketogenesis in sheep. *Can. J. Comp. Med.* **40**, 166–170.
- Brooks, K. D. (1989). Idiopathic hyperlipoproteinaemia in a cat. *Compan. Anim. Pract.* **19**, 5–9.
- Brouwer, E., and Dijkstra, N. D. (1938). On alimentary acetonuria and ketonuria in dairy cattle induced by feeding grass silage of the butyric acid type. *J. Agric. Sci.* **28**, 695–700.
- Brown, M. S., and Goldstein, J. L. (1990). Drugs used in the treatment of hyperlipoproteinemias. In “Goodman and Gilman’s The Pharmacological Basis of Therapeutics” (A. G. Gilman, T. W. Rall, A. S. Nies, and P. Taylor, Eds.), 8th ed., pp. 874–896. Pergamon, New York.
- Brown, M. S., and Goldstein, J. L. (1994). The hyperlipoproteinemias and other disorders of lipid metabolism. In “Harrison’s Principles of Internal Medicine,” 13th ed. (K. J. Isselbacher, E. Braunwald, J. D. Wilson, J. B. Martin, A. S. Fauci, and D. L. Kaspar, Eds.), vol. 2, pp. 2058–2069. McGraw-Hill, New York.
- Burnett, D. A., Lysenko, N., Manning, J. A., and Ockner, R. K. (1979). Utilization of long chain fatty acids by rat liver: studies of the role of fatty acid binding protein. *Gastroenterology* **77**, 241–249.
- Bush, R. S., and Milligan, L. P. (1971). Enzymes of ketogenesis in bovine rumen epithelium. *Can. J. Anim. Sci.* **51**, 129–133.
- Cameron, J. L., Capuzzi, D. M., Zudema, G. D., and Margolis, S. (1974). Acute pancreatitis with hyperlipemia: evidence for a persistent defect in lipid metabolism. *Am. J. Med.* **56**, 482–487.
- Caple, I. W., Pemberton, D. H., Harrison, M. A., and Halpein, C. G. (1977). Starvation ketosis in pregnant beef cows. *Austral. Vet. J.* **53**, 289–291.
- Caraway, W. T., and Kammeyer, C. W. (1972). Chemical interference by drugs and other substances with clinical laboratory test procedures. *Clin. Chim. Acta* **41**, 395–434.
- Chapman, M. J. (1986). Comparative analysis of mammalian lipoproteins. In “Methods in Enzymology. Plasma Lipoproteins. Part A. Preparation, Structure, and Molecular Biology” (J. P. Segrest and J. J. Albers, Eds.), vol. 128, pp. 70–143. Academic Press, San Diego, CA.
- Cook, H. W., and McMaster, C. R. (2002). Fatty acid desaturation and chain elongation in eukaryotes. In “Biochemistry of Lipids, Lipoproteins and Membranes” (D. E. Vance and J. Vance, Eds.), pp. 181–204. Elsevier, New York.
- Cook, R. M., Liu, S.-C. C., and Quraishi, S. (1969). Utilization of volatile fatty acids in ruminants. 3. Comparison of mitochondrial acyl coenzyme A synthetase activity and substrate specificity in different tissues. *Biochem.* **8**, 2966–2969.
- Cornelius, C. E., Holm, L. W., and Jasper, D. E. (1958). Bromsulphthalein clearance in normal sheep and in pregnancy toxemia. *Cornell Vet.* **48**, 305–312.
- Cowan, P. J., and Vaughn-Williams, E. N. (1977). The effects of palmitate on intracellular potentials recorded from Langendorff-perfused guinea-pig hearts in normoxia and hypoxia, and during perfusion at reduced flow rate. *J. Molec. Cell. Cardiol.* **9**, 327–342.
- Crook, D., and Seed, M. (1990). Endocrine control of plasma lipoprotein metabolism: effects of gonadal steroids. *Bailliere’s Clin. Endocrinol. Metabol.* **4**, 851–875.
- Csako, G. (1987). False-positive results for ketone with the drug mesna and other free-sulfhydryl compounds. *Clin. Chem.* **33**, 289–292.
- Danielsson, B., Ekman, R., Johansson, B. G., and Petersson, B. G. (1977). Plasma lipoprotein changes in experimental cholestasis in the dog. *Clin. Chim. Acta* **80**, 157–170.
- Dean, J. A. (1985). “Lange’s Handbook of Chemistry,” 13th ed., chap. 7, pp. 84, 443. McGraw-Hill, New York.
- De Boer, G., Trenkle, A., and Young, J. W. (1985). Glucagon, insulin, growth hormone, and some blood metabolites during energy restriction ketonemia of lactating cows. *J. Dairy Sci.* **68**, 326–337.
- DeBowes, L. J. (1987). Lipid metabolism and hyperlipoproteinemias in the dog. *Compend. Contin. Educ. Pract. Vet.* **9**, 727–736.
- Degen, A. J. M., and Van der J. Vies, (1985). Enzymatic microdetermination of free fatty acids in plasma of animals using paraoxon to prevent lipolysis. *Scand. J. Clin. Invest.* **45**, 283–285.
- Demacker, P. N., Hijmans, A. G., and Jansen, A. P. (1982). Enzymic and chemical-extraction determinations of free fatty acids in serum compared. *Clin. Chem.* **28**, 1765–1768.
- Demacker, P. N. M., van Heijst, P. J., Hak-Lemmers, H. L. M., and Stalenhoef, A. F. H. (1987). A study of the lipid transport system in the cat (*Felis domesticus*). *Atherosclerosis* **66**, 113–123.
- Duee, P. H., Pegorier, J. P., Quant, P. A., Herbin, C., Kohl, C., and Girar, J. (1994). Hepatic ketogenesis in newborn pigs is limited by low mitochondrial 3-hydroxy-3-methylglutaryl-CoA synthase activity. *Biochem. J.* **298**, 207–212.
- Dunkel, B., and McKenzie, H. C. (2003). Severe hypertriglyceridaemia in clinically ill horses: diagnosis, treatment and outcome. *Equine Vet. J.* **35**, 590–595.
- Durham, A. E. (2006). Clinical application of parenteral nutrition in the treatment of five ponies and one donkey with hyperlipaemia. *Vet. Rec.* **158**, 159–164.
- Dybdal, N. O., Gribble, D., Madigan, J. E., and Stabenfeldt, G. H. (1980). Alterations in plasma corticosteroids, insulin and selected metabolites in horses used in endurance rides. *Equine Vet. J.* **12**, 137–140.
- East, N. (1983). Pregnancy, toxemia, abortions, and periparturient diseases. *Vet. Clin. N. Am. Large Anim. Pract.* **5**, 601–618.
- Edwards, D. F. (1982). Transient diabetes mellitus and ketoacidosis in a dog. *J. Am. Vet. Med. Assoc.* **180**, 68–70.
- Emery, R. S., Burg, N., Brown, L. D., and Blank, G. N. (1964). Detection, occurrence, and prophylactic treatment of borderline ketosis with propylene glycol feeding. *J. Dairy Sci.* **47**, 1074–1079.
- Emmanuel, B. (1980). Oxidation of butyrate to ketone bodies and CO<sub>2</sub> in the rumen epithelium, liver, kidney, heart and lung of camel (*Camelus dromedarius*), sheep (*Ovis aries*) and goat (*Capra hircus*). *Comp. Biochem. Physiol.* **65B**, 699–704.
- Eriksen, L., and Simesen, M. G. (1970). Hyperlipaemia in ponies. *Nord. Vet. Med.* **22**, 273–284.
- Faulkner, A., and Pollock, H. T. (1991). Effect of lactation on gluconeogenesis and ketogenesis in ovine hepatocytes. *Comp. Biochem. Physiol.* **98B**, 283–286.
- Faust, J. R., Trzaskos, J. M., and Gaylor, J. L. (1988). Cholesterol biosynthesis. In “Biology of Cholesterol” (P. L. Yeagle, Ed.), pp. 19–68. CRC Press, Boca Raton, FL.

- Feldman, E. C. (1995). Hyperadrenocorticism. In "Textbook of Veterinary Internal Medicine," 4th ed. (S. J. Ettinger and E. C. Feldman, Eds.), vol. 2, pp. 1538–1578. Saunders, Philadelphia.
- Fell, B. F., and Weekes, T. E. C. (1975). Food intake as a mediator of adaptation in the ruminal epithelium. In "Digestion and Metabolism in the Ruminant" (I. W. McDonald and A. C. I. Warner, Eds.), pp. 101–118. University of New England Publishing Unit, Armidale, New South Wales.
- Ferreri, L. F., and Elbein, R. C. (1982). Fractionation of plasma triglyceride-rich lipoproteins of the dairy cow: evidence of chylomicron-size particles. *J. Dairy Sci.* **65**, 1912–1920.
- Fielding, P. E., and Fielding, C. J. (2002). Dynamics of lipoprotein transport in the human circulatory system. In "Biochemistry of Lipids, Lipoproteins and Membranes" (D. E. Vance and J. Vance, Eds.), pp. 527–552. Elsevier, New York.
- Ford, R. B. (1993). Idiopathic hyperchylomicronaemia in miniature Schnauzers. *J. Small Anim. Pract.* **34**, 488–492.
- Ford, R. B. (1995). Canine hyperlipidaemia. In "Textbook of Veterinary Internal Medicine," 4th ed. (S. J. Ettinger and E. C. Feldman, Eds.), vol. 2, pp. 1414–1419. Saunders, Philadelphia.
- Forschner, G. (1909). Über die Einwirkung der Muskelarbeit auf die Acetonkörperausscheidung bei kohlenhydratarmer Kost. *Skand. Arch. Physiol.* **22**, 393–405.
- Freestone, J. F., Wolfsheimer, K. J., Ford, R. B., Church, G., and Bessin, R. (1991). Triglyceride, insulin, and cortisol responses of ponies to fasting and dexamethasone administration. *J. Vet. Int. Med.* **5**, 15–22.
- Gainer, J. H., Amster, R. L., Needham, J. W., and Schilling, K. F. (1966). Altered serum lipoproteins in equine infectious anemia: comparisons of values among normal horses and horses infected with *Babesia caballi*. *Am. J. Vet. Res.* **27**, 1611–1621.
- Gibbons, G. F. (1990). Assembly and secretion of hepatic very-low-density lipoprotein. *Biochem. J.* **268**, 1–13.
- Glasscock, R. J., Adler, S. G., Ward, H. J., and Cohen, A. H. (1991). Primary glomerular disease. In "The Kidney," 4th ed. (B. M. Brenner and G. V. Rector, Eds.), vol. 1, pp. 1182–1279. Saunders, Philadelphia.
- Gotto, A. M., Pownall, H. J., and Havel, R. J. (1986). Introduction to the plasma lipoproteins. In "Methods in Enzymology. Plasma Lipoproteins. Part A. Preparation, Structure, and Molecular Biology" (J. P. Segrest and J. A. Albers, Eds.), vol. 128, pp. 3–41. Academic Press, San Diego, CA.
- Greenberger, N. J. (1973). Pancreatitis and hyperlipidemia. *New Engl. J. Med.* **289**, 586–587.
- Gröhn, Y. (1985). Propionate loading test for liver function in spontaneously ketotic dairy cows. *Res. Vet. Sci.* **39**, 24–28.
- Gröhn, Y., Lindberg, L.-A., Bruss, M. L., and Farver, T. B. (1983). Fatty infiltration of liver in spontaneously ketotic dairy cows. *J. Dairy Sci.* **66**, 2320–2328.
- Gurr, M. I., Harwood, J. L., and Frayn, K. N. (2002). "Lipid Biochemistry," 5th ed., pp. 19–70, 117–123, 180–182, 277–283. Blackwell Science, Oxford.
- Gutzwiller, A. (1998). Bestimmung von  $\beta$ -Hydroxybutyrat in der Milch mit Teststreifen: ein neues Hilfsmittel zur Diagnose der subklinischen und klinischen Ketose der Kuh. *Schweiz Arch. Tierheilk* **140**, 120–124.
- Hadlow, W. J. (1962). Diseases of skeletal muscle. In "Comparative Neuropathology" (J. R. M. Innes and L. Z. Saunders, Eds.), pp. 147–243.
- Haffner, S. M., and Valdez, R. A. (1995). Endogenous sex hormones: impact on lipids, lipoproteins, and insulin. *Am. J. Med.* **98**, 40S–47S.
- Hagenfeldt, L., and Wahren, J. (1968a). Human forearm muscle metabolism during exercise. II. Uptake, release and oxidation of individual FA and glycerol. *Scand. J. Clin. Lab Invest.* **21**, 263–276.
- Hagenfeldt, L., and Wahren, J. (1968b). Human forearm muscle metabolism during exercise. III. Uptake, release and oxidation of  $\beta$ -hydroxybutyrate and observations on the  $\beta$ -hydroxybutyrate ratio. *Scand. J. Clin. Lab Invest.* **21**, 314–320.
- Hall, L. M. (1961). Preferential oxidation of acetoacetate by the perfused heart. *Biochem. Biophys. Res. Comm.* **6**, 177–179.
- Hallebeek, J. M., and Beynan, A. C. (2001). A preliminary report on a fat-free diet formula for nasogastric enteral administration as treatment for hyperlipaemia in ponies. *Vet. Quart.* **23**, 201–205.
- Hammel, E. P., Kronfeld, D. S., Ganjam, V. K., and Dunlap, H. L. (1977). Metabolic responses to exhaustive exercise in racing sled dogs fed diets containing medium, low, or zero carbohydrate. *Am. J. Clin. Nutr.* **30**, 409–418.
- Hansen, P. W. (1999). Screening of dairy cows for ketosis by use of infrared spectroscopy and multivariate calibration. *J. Dairy Sci.* **82**, 2005–2010.
- Hanson, R. W., and Ballard, F. J. (1967). The relative significance of acetate and glucose as precursors for lipid synthesis in liver and adipose tissue from ruminants. *Biochem. J.* **105**, 529–536.
- Harano, Y., Ohtsuki, M., Ida, M., Kojima, H., Harada, M., Okanishi, T., Kashiwagi, A., Ochi, Y., Uno, S., and Shigeta, Y. (1985). Direct automated assay method for serum or urine levels of ketone bodies. *Clin. Chim. Acta* **151**, 177–183.
- Hardy, R. M. (1992). The pancreas; inflammatory pancreatic disease. In "Veterinary Gastroenterology" (N. V. Anderson, Ed.), 2nd ed., pp. 275–292. Lea & Febiger, Philadelphia.
- Havel, R. J. (1969). Pathogenesis, differentiation and management of hypertriglyceridemia. *Adv. Intern. Med.* **15**, 117–154.
- Hawkins, R. A., Williamson, D. H., and Krebs, H. A. (1971). Ketone-body utilization by adult and suckling rat brain *in vivo*. *Biochem. J.* **122**, 13–18.
- Heitman, R. N., Sensenig, S. C., Reynolds, C. K., Fernandez, J. M., and Dawes, D. J. (1986). Hepatic ketogenesis and peripheral ketone body utilization in the ruminant. *J. Nutr.* **116**, 2516–2524.
- Henry, R. J., Cannon, D. C., and Winkelman, J. W. (1974). "Clinical Chemistry: Principles and Techniques," 2nd ed., pp. 1354–1369. Harper & Row, Hagerstown, MD.
- Henze, P., Bickhardt, K., Fuhrmann, H., and Sallman, H. P. (1998). Spontaneous pregnancy toxemia (ketosis) in sheep and the role of insulin. *J. Vet. Med. A* **45**, 255–266.
- Hers, H. G. (1960). Le mchanisme de la formation du fructose seminal et du fructose fetal. *Biochim. Biophys. Acta* **37**, 127–138.
- Hibbitt, K. G., Neill, D., and Radford, R. (1969). The effect of diet on the incidence of induced ketosis in the lactating dairy cow. *Res. Vet. Sci.* **10**, 245–253.
- Holm, L. W. (1958). Studies on the treatment of ovine pregnancy toxemia with corticosteroids and ACTH. *Cornell Vet.* **48**, 348–357.
- Hove, K. (1974). Nocturnal plasma insulin levels in cows with varying levels of plasma ketone bodies. Relations to plasma sugar and acetoacetate. *Acta Endocrinol.* **76**, 513–524.
- Hubert, B., de La Farge, F., Braun, J. P., and Magnol, J. P. (1987). Hypertriglyceridemia in two related dogs. *Companion Anim. Pract.* **1**, 33–35.
- Hughes, K. J., Hodgson, D. R., and Dart, A. J. (2004). Equine hyperlipaemia: a review. *Vet. J.* **82**, 136–142.
- Ingle, D. L., Bauman, D. E., and Garrigus, U. S. (1972a). Lipogenesis in the ruminant: *in vitro* study of tissue sites, carbon source and

- reducing equivalent generation for fatty acid synthesis. *J. Nutr.* **102**, 609–616.
- Ingle, D. L., Bauman, D. E., and Garrigus, U. S. (1972b). Lipogenesis in the ruminant: *in vivo* site of fatty acid synthesis in sheep. *J. Nutr.* **102**, 617–624.
- Irvine, C. H. G. (1964). Hypoglycaemia in the bitch. *New Zealand Vet. J.* **12**, 140–143.
- Jackson, R. F., Bruss, M. L., Growney, P. J., and Seymour, W. G. (1980). Hypoglycemia-ketonemia in a pregnant bitch. *J. Am. Vet. Med. Assoc.* **177**, 1123–1127.
- Jeusette, I., Grauwells, M., Cuvelier, C., Tonglet, C., Istasse, L., and Diez, M. (2004). Hypercholesterolaemia in a family of rough collie dogs. *J. Small Anim. Pract.* **45**, 319–324.
- Johnson, R. H., Walton, J. L., Krebs, H. A., and Williamson, D. H. (1969). Post-exercise ketosis. *Lancet* **2**, 1383–1385.
- Jones, B. R. (1993). Inherited hyperchylomicronaemia in the cat. *J. Small Anim. Pract.* **34**, 493–499.
- Jones, B. R. (1995). Feline hyperlipidemias. In “Textbook of Veterinary Internal Medicine,” 4th ed. (S. J. Ettinger and E. C. Feldman, Eds.), vol. 2, pp. 1410–1414. Saunders, Philadelphia.
- Jones, B. R., Johnstone, A. C., Cahill, J. I., and Hancock, W. S. (1986). Peripheral neuropathy in cats with inherited primary hyperchylomicronaemia. *Vet. Rec.* **119**, 268–272.
- Jones, B. R., Wallace, A., Harding, D. R. K., Hancock, W. S., and Campbell, C. H. (1983). Occurrence of idiopathic, familial hyperchylomicronaemia in a cat. *Vet. Rec.* **112**, 543–547.
- Jones, C. S., and Parker, D. S. (1978). Uptake of substrates for milk fat synthesis by lactating rabbit mammary gland. *Biochem. J.* **174**, 291–296.
- Jones, M. D., Burd, L. I., Makowski, E. L., Meschia, G., and Battaglia, F. C. (1975). Cerebral metabolism in sheep: a comparative study of the adult, the lamb, and the fetus. *Am. J. Physiol.* **229**, 235–239.
- Jorritsma, R., Baldée, S. J. C., Schukken, Y. H., Wensing, T., and Wentink, G. H. (1998). Evaluation of a milk test for detection of sub-clinical ketosis. *Vet. Quart.* **20**, 108–110.
- Kalapos, M. P., Mandl, J., Banhegyi, G., Antoni, F., and Garzo, T. (1994). Net glucose formation from acetone in isolated murine hepatocytes. The effect of different pretreatments of mice. *Int. J. Biochem.* **26**, 1069–1079.
- Katz, M. L., and Bergman, E. N. (1969). Hepatic and portal metabolism of glucose, free fatty acids, and ketone bodies in the sheep. *Am. J. Physiol.* **216**, 953–960.
- Kaufman, C. F., and Bergman, E. N. (1971). Renal glucose, free fatty acid, and ketone body metabolism in the unanesthetized sheep. *Am. J. Physiol.* **221**, 967–972.
- Kaufman, C. F., and Bergman, E. N. (1974). Renal ketone body metabolism and gluconeogenesis in normal and hypoglycemic sheep. *Am. J. Physiol.* **226**, 827–832.
- Kauppinen, K., and Gröhn, Y. (1984). Treatment of bovine ketosis with invert sugar, glucocorticoids and propylene glycol. *Acta Vet. Scand.* **25**, 467–479.
- Khan, M. A. S., Topps, J. H., Broadbent, P. J., and Stephen, N. H. (1986). Ketosis in beef cows with two suckling calves. *Proc. 6th Int. Conf. Prod. Dis. Farm Anim.*, pp. 39–42.
- Kilponen, J. M., Palosaari, P. M., Sormunen, R. T., Vihinen, M., and Hiltunen, J. K. (1991). Isoenzymes of delta 3, delta 2-enoyl-CoA isomerase in rat liver. In “New Developments in Fatty Acid Oxidation” (P. M. Coates and K. Tanaka, Eds.), pp. 33–40. Wiley-Liss, New York.
- Kingrey, B. W., Ladwig, V. D., Monlux, W. S., and Ramsey, F. K. (1957). Pregnancy disease of cows. *N. Am. Vet.* **38**, 321–328.
- Kinsella, J. E. (1970). Biosynthesis of lipids from (2-14C)acetate and D(-)-beta-hydroxy(1,3-14C)butyrate by mammary cells from bovine and rat. *Biochim. Biophys. Acta* **210**, 28–38.
- Kleiber, M., Black, A. L., Brown, M. A., Baxter, C. F., Luick, J. L., and Stadtman, F. H. (1955). Glucose as a precursor of milk constituents in the intact dairy cow. *Biochim. Biophys. Acta* **17**, 252–260.
- Klotzsch, S. G., and McNamara, J. R. (1990). Triglyceride measurements: a review of methods and interferences. *Clin. Chem.* **36**, 1605–1613.
- Koeslag, J. H. (1982). Post-exercise ketosis and the hormone response to exercise: a review. *Med. Sci. Sports Exercise* **14**, 327–334.
- Koeslag, J. H., Noakes, T. D., and Sloan, A. W. (1980). Post-exercise ketosis. *J. Physiol. (Lond.)* **301**, 79–90.
- Kopec, B., and Fritz, I. B. (1973). Comparison of properties of carnitine palmitoyltransferase I with those of carnitine palmitoyltransferase II, and preparation of antibodies to carnitine palmitoyltransferases. *J. Biol. Chem.* **248**, 4069–4074.
- Kosugi, K., Scofield, R. F., Chandramouli, V., Kumaran, K., Schumann, W. C., and Landau, B. R. (1986). Pathways of acetone’s metabolism in the rat. *J. Biol. Chem.* **261**, 3952–3957.
- Krebs, H. A., Mellanby, J., and Williamson, D. H. (1962). The equilibrium constant of the 3-hydroxybutyric dehydrogenase system. *Biochem. J.* **82**, 96–98.
- Kronfeld, D. S. (1980). Metabolic disorders. In “Bovine Medicine and Surgery” (H. E. Amstutz, Ed.), vol. 1, pp. 537–592. American Veterinary Publications, Santa Barbara, California.
- Kronfeld, D. S. (1982). Major metabolic determinants of milk volume, mammary efficiency, and spontaneous ketosis in dairy cows. *J. Dairy Sci.* **65**, 2204–2212.
- Kronfeld, D. S., Raggi, F., and Ramberg, C. F. (1968). Mammary blood flow and ketone body metabolism in normal, fasted, and ketotic cows. *Am. J. Physiol.* **215**, 218–227.
- Kronfeld, D. S., Donoghue, S., Naylor, J. M., Johnson, K., and Bradley, C. A. (1980). Metabolic effects of feeding protected tallow to dairy cows. *J. Dairy Sci.* **63**, 545–552.
- Kronfeld, D. S., Chalupa, L., and Sklan, D. (1983). Ketosis, lactational efficiency and feeding fat. *Anim. Nutr. Health* **38**(6), 28–33.
- Lammerant, J., Huynh-Thu, T., and Kolanowski, J. (1985). Inhibitory effects of the D(-) isomer of 3-hydroxybutyrate on cardiac non-esterified fatty acid uptake and oxygen demand induced by norepinephrine in the intact dog. *J. Molec. Cell. Cardiol.* **17**, 421–433.
- Lean, I. J., Bruss, M. L., Trout, H. F., Galland, J. C., Farver, T. B., Rostami, J., Holmberg, C. A., and Weaver, L. D. (1994). Bovine ketosis and somatotrophin: risk factors for ketosis and effects of ketosis on health and production. *Res. Vet. Sci.* **57**, 200–209.
- Le Goff, D., Pastier, D., Hannan, Y., Petit, E., Ayrault-Jarrier, M., and Nouvelot, A. (1989). Lipid and apolipoprotein distribution as a function of density in equine plasma lipoprotein. *Comp. Biochem. Physiol.* **93B**, 371–377.
- Lewis, R. M., and Center, S. A. (1984). Primary diseases affecting glomeruli. In “Canine Nephrology” (K. C. Bovée, Ed.), pp. 461–479. Harwal, Media, PA.
- Liepa, G. U., Beitz, D. C., and Linder, J. R. (1978). Fatty acid synthesis in ruminating and nonruminating goats. *J. Nutr.* **108**, 1733–1739.
- Lindsay, D. B. (1959). The significance of carbohydrate in ruminant nutrition. *Vet. Rev. Annot.* **5**, 103–128.
- Lindsay, D. B., and Setchell, B. P. (1976). The oxidation of glucose, ketone bodies and acetate by the brain of normal and ketonaemic sheep. *J. Physiol.* **259**, 801–823.
- Lindsay, D. B., and Pethick, D. W. (1983). Adaptation of metabolism to various conditions: metabolic disorders. In “Dynamic Biochemistry

- of Animal Production" (P. M. Riis, Ed.), pp. 431–480. Elsevier, New York.
- Ling, G. V., Lowenstine, L. J., Pulley, T., and Kaneko, J. J. (1977). Diabetes mellitus in dogs: a review of initial evaluation, immediate and long-term management, and outcome. *J. Am. Vet. Med. Assoc.* **170**, 521–530.
- Ling, G. V., Stabenfeldt, G. H., Comer, K. M., Gribble, D. H., and Schechter, R. D. (1979). Canine hyperadrenocorticism: pretreatment clinical and laboratory evaluation of 117 cases. *J. Am. Vet. Med. Assoc.* **174**, 1211–1215.
- Linzell, D. B., Annison, E. F., Fazakerley, S., and Leng, R. A. (1967). The incorporation of acetate, stearate and D(-)  $\beta$ -hydroxybutyrate into milk fat by perfused mammary gland of the goat. *Biochem. J.* **104**, 34–42.
- Liscum, L. (2002). Cholesterol biosynthesis. In "Biochemistry of Lipids, Lipoproteins and Membranes" (D. E. Vance and J. Vance, Eds.), pp. 409–432. Elsevier, New York.
- Little, J. R., Goto, M., and Spitzer, J. J. (1970). Effect of ketones on metabolism of FFA by dog myocardium and skeletal muscle *in vivo*. *Am. J. Physiol.* **219**, 1458–1463.
- Liu, S., Tilley, L. P., Tappe, J. P., and Fox, P. R. (1986). Clinical and pathologic findings in dogs with atherosclerosis: 21 cases (1970–1983). *J. Am. Vet. Med. Assoc.* **189**, 227–232.
- Lucke, J. N., and Hall, G. M. (1980). Long distance exercise in the horse: Golden Horseshoe Ride 1978. *Vet. Rec.* **106**, 405–407.
- Luick, J. R., Black, A. L., Simesen, M. G., and Kronfeld, D. S. (1967). Acetone metabolism in normal and ketotic cows. *J. Dairy Sci.* **50**, 544–549.
- Lynen, F., Henning, U., Bublitz, C., Sorbö, B., and Kröplin-Rueff, L. (1958). Der chemische Mechanismus der Acetessigsäurebildung in der Leber. *Biochem. Z.* **330**, 269–295.
- McClymont, G. L., and Setchell, B. P. (1955a). Ovine pregnancy toxæmia. I. Tentative identification as a hypoglycemic encephalopathy. *Austral. Vet. J.* **31**, 53–68.
- McClymont, G. L., and Setchell, B. P. (1955b). Ovine pregnancy toxæmia. II. Experimental therapy with glycerol and glucose. *Austral. Vet. J.* **31**, 170–174.
- McCullagh, K. G. (1978). Plasma lipoproteins in animal health and disease. *Vet. Ann.* **18**, 41–50.
- McGarry, J. D. (1979). New perspectives in the regulation of ketogenesis. *Diabetes* **28**, 517–523.
- McGarry, J. D., and Foster, D. W. (1969). Ketogenesis and cholesterol synthesis in normal and neoplastic tissues of the rat. *J. Biol. Chem.* **254**, 4251–4256.
- McGarry, J. D., Mannaerts, G. P., and Foster, D. W. (1977). A possible role for malonyl-CoA in the regulation of hepatic fatty acid oxidation and ketogenesis. *J. Clin. Invest.* **60**, 265–270.
- McGowan, M. W., Artiss, J. D., Standbergh, D. R., and Zak, B. (1983). A peroxidase-coupled method for the colorimetric determination of serum triglycerides. *Clin. Chem.* **29**, 538–542.
- MacDonald, M. L., Anderson, B. D., Rogers, Q. R., Buffington, C. A., and Morris, J. G. (1984). Essential fatty acid requirement of cats: pathology of essential fatty acid deficiency. *Am. J. Vet. Res.* **45**, 1310–1317.
- Mahley, R. W., and Weisgraber, K. H. (1974). Canine lipoproteins and atherosclerosis. *Circ. Res.* **35**, 713–721.
- Maho, Y. L., Kha, H. V. V., Koubi, H., Dewasmes, G., Girard, J., Ferrè, P., and Cagnard, M. (1981). Body composition, energy expenditure and plasma metabolites in long-term fasting geese. *Am. J. Physiol.* **241**, E342–E354.
- Manning, P. J., Corwin, L. A., and Middleton, C. C. (1973). Familial hyperlipoproteinemia and thyroid dysfunction of beagles. *Exp. Molec. Path.* **19**, 378–388.
- Manns, J. G. (1972). Pancreatic hormones and metabolites in normal cows during early pre- and post-partum: implications of these studies in bovine ketosis. *Can. Vet. J.* **13**, 151–155.
- Marstorp, P., Anfelt, T., and Andersson, L. (1983). Determination of oxidized ketone bodies in milk by flow injection analysis. *Anal. Chim. Acta* **149**, 281–289.
- Martin-Sanz, P., Vance, J. E., and Brindley, D. N. (1990). Stimulation of apolipoprotein secretion in very-low-density and high-density lipoproteins from cultured rat hepatocytes by dexamethasone. *Biochem. J.* **271**, 575–583.
- Mebane, D., and Madison, L. L. (1964). Hypoglycemic action of ketones. I. Effects of ketones on hepatic glucose output and peripheral glucose utilization. *J. Lab. Clin. Med.* **63**, 177–192.
- Medaille, C., de La Farge, F., Braun, J. P., Valdiguie, P., and Rico, A. G. (1988). Serum lipids and lipoproteins in dogs: frequent values and changes with disease. In "Animal Clinical Biochemistry: the Future" (D. J. Blackmore, Ed.), pp. 287–290. Cambridge University Press, New York.
- Mellanby, J., and Williamson, D. H. (1974). Acetoacetate. In "Methods of Enzymatic Analysis 2nd English ed." (H. U. Bergmeyer, Ed.), vol. 4, pp. 1840–1843. Academic Press, Orlando, FL.
- Meyer, D. J., and Chiappella, A. M. (1985). Cholestasis. *Vet. Clin. N. Am. Small Anim. Pract.* **15**, 215–227.
- Miles, J. M., Haymond, M. W., and Gerich, J. E. (1981). Suppression of glucose production and stimulation of insulin secretion by physiological concentrations of ketone bodies in man. *J. Clin. Endo. Metabol.* **52**, 34–37.
- Mogg, T. D., and Palmer, J. E. (1995). Hyperlipidemia, hyperlipemia and hepatic lipidosis in American miniature horses: 23 cases (1990–1994). *J. Am. Vet. Med. Assoc.* **207**, 604–607.
- Morand-Fehr, P., Bas, P., Hervieu, J., and Sauvart, D. (1984). Observations de cas de cétose chez la chèvre. Etiologie et état métabolique. In "Les Maladies de la Chèvre" (P. Yvone and G. Perrin, Eds.), pp. 379–391. Institut National de la Recherche Agronomique, Versailles.
- Morris, M. D., Zilversmit, D. B., and Hintz, H. F. (1972). Hyperlipoproteinemia in fasting ponies. *J. Lipid Res.* **13**, 383–389.
- Mortensen, P. B. (1990). Mechanism of dicarboxylic aciduria and dicarboxylic acid metabolism. In "Fatty Acid Oxidation: Clinical, Biochemical, and Molecular Aspects" (K. Tanaka and P. M. Coates, Eds.), pp. 249–264. Alan R. Liss, New York.
- Nadeau, G. (1952). Blood acetone estimation. *Can. Med. Assoc. J.* **67**, 158–159.
- Naylor, J. M., Kronfeld, D. S., and Acland, H. (1980). Hyperlipaemia in horses: effects of undernutrition and disease. *Am. J. Vet. Res.* **41**, 899–905.
- Newsholme, E. A., and Leach, A. R. (1983). "Biochemistry for the Medical Sciences," pp. 259–284. John Wiley & Sons, New York.
- Nielsen, N. C., and Fleischer, S. (1969).  $\beta$ -hydroxybutyrate dehydrogenase: lack in ruminant liver mitochondria. *Science* **166**, 1017–1019.
- Norman, E. J., Wolsky, K. G., and MacKay, G. A. (2006). Pregnancy-related diabetes mellitus in two dogs. *N. Zeal. Vet. J.* **54**, 360–364.
- Oikawa, S., McGuiirk, S., Nishibe, K., Higuchi, T., Kurosawa, T., Watanuki, M., and Satoh, H. (2006). Changes of blood biochemical values in ponies recovering from hyperlipemia in Japan. *J. Vet. Med. Sci.* **68**, 353–359.

- Oliver, M. F., Kurien, V. A., and Greenwood, T. W. (1968). Relation between serum free fatty acid and arrhythmia and death after myocardial infarction. *Lancet* **1**, 710–715.
- Otchere, E. O., McGilliard, A. D., and Young, J. D. (1974). Quantitation of  $\alpha$ -linked glucose polymers passing to the small intestine in cattle. *J. Dairy Sci.* **57**, 1189–1195.
- Owen, O. E., Morgan, A. P., Kemp, H. G., Sullivan, J. M., Herrera, M. G., and Cahill, G. F. (1967). Brain metabolism during fasting. *J. Clin. Invest.* **46**, 1589–1595.
- Owen, O. E., Felig, A. P., Morgan, J., and Cahill, G. F., Jr. (1969). Liver and kidney metabolism during prolonged starvation. *J. Clin. Invest.* **48**, 547–553.
- Owen, O. E., and Reichard, G. A. (1971). Human forearm metabolism during progressive starvation. *J. Clin. Invest.* **50**, 1536–1545.
- Owen, O. E., Reichard, G. A., Trapp, V. E., Skutches, C. L., Mozzoli, M. A., Hoeldtke, R. D., and Boden, G. (1981). Acetone metabolism during diabetic ketoacidosis (DKA): gluconeogenesis from fat. *Diabetes* **30**, 62A.
- Owen, O. E., Trapp, V. E., Skutches, C. L., Mozzoli, M. A., Hoeldtke, R. D., Boden, G., and Reichard, G. A. (1982). Acetone metabolism during diabetic ketoacidosis. *Diabetes* **31**, 242–248.
- Ozand, P. T., Hawkins, R. L., Collins, R. M., Tildon, J. T., and Cornblath, M. (1975). A micro-analytic procedure developed for the determination of ketone bodies, gluconeogenic amino acids, pyruvate, lactate, and glucose in metabolic studies. *Biochem. Med.* **14**, 170–183.
- Palmquist, D. L., Davis, C. L., Brown, R. E., and Sachan, D. S. (1969). Availability and metabolism of various substrates in ruminants. V. Entry rate into the body and incorporation into milk fat of D(-)  $\beta$ -hydroxybutyrate. *J. Dairy Sci.* **52**, 633–638.
- Pande, S. V. (1971). On rate-controlling factors of long chain fatty acid oxidation. *J. Biol. Chem.* **246**, 5384–5390.
- Patterson, J. S., Rusley, M. S., and Zachary, J. F. (1985). Neurologic manifestations of cerebrovascular atherosclerosis associated with primary hypothyroidism in a dog. *J. Am. Vet. Med. Assoc.* **186**, 499–503.
- Paul, P., Issekutz, B., and Miller, H. I. (1966). Interrelationship of free fatty acids and glucose metabolism in the dog. *Am. J. Physiol.* **211**, 1313–1320.
- Peaker, M. (1977). The aqueous phase of milk: ion & water transport. *Symp. Zool. Soc. Lond.* **41**, 113–134.
- Pedersen, R. C. (1988). Cholesterol biosynthesis, storage, and mobilization in steroidogenic organs. In “Biology of Cholesterol” (P. L. Yeagle, Ed.), pp. 39–69. CRC Press, Boca Raton, FL.
- Pell, J. M., and Bergman, E. N. (1983). Cerebral metabolism of amino acids and glucose in fed and fasted sheep. *Am. J. Physiol.* **244**, E282–E289.
- Peritz, L. N., Brunzell, J. D., Harvey-Clarke, C., Pritchard, P. H., Jones, B. R., and Hayden, M. R. (1990). Characterization of a lipoprotein lipase class III type defect in hypertriglyceridemic cats. *Clin. Invest. Med.* **13**, 259–293.
- Persson, B., Settergren, G., and Dahlquist, G. (1972). Cerebral arteriovenous difference of acetoacetate and D-beta-hydroxybutyrate in children. *Acta Paediatr. Scand.* **61**, 273–278.
- Pethick, D. W., and Lindsay, D. B. (1982). Metabolism of ketone bodies in pregnant sheep. *Brit. J. Nutr.* **48**, 549–563.
- Prior, R. L., and Christenson, R. K. (1978). Insulin and glucose effects on glucose metabolism in pregnant and nonpregnant ewes. *J. Anim. Sci.* **46**, 201–209.
- Procos, J. (1961). Modification of the spectrophotometric determination of ketone bodies in blood enabling the total recovery of beta-hydroxybutyric acid. *Clin. Chem.* **7**, 97–106.
- Puppione, D. L. (1983). Bovine serum lipoproteins. In “Handbook of Electrophoresis” (L. A. Lewis and H. K. Naito, Eds.), vol. 4, p. 185. CRC Press, Boca Raton, FL.
- Quant, P. A., Tubbs, P. K., and Brand, M. D. (1990). Treatment of rats with glucagon or mannoheptulose increases mitochondrial 3-hydroxy-3-methylglutaryl-CoA synthase activity and decreases succinyl-CoA content in liver. *Europ. J. Biochem.* **187**, 169–174.
- Ramasamy, S., Boissonneault, G. A., Decker, E. A., and Henning, B. (1991). Linoleic acid-induced cell injury: role of membrane-bound enzyme activities and lipid oxidation. *J. Biochem. Toxicol.* **6**, 29–35.
- Ramsey, H. A., and Davis, C. L. (1965). Metabolism of n-butyrate by the adult goat. *J. Dairy Sci.* **48**, 381–390.
- Rangan, V. S., and Smith, S. (2002). Fatty acid synthesis in eukaryotes. In “Biochemistry of Lipids, Lipoproteins and Membranes” (D. E. Vance and J. Vance, Eds.), pp. 151–179. Elsevier, New York.
- Reid, R. L. (1968). The physiopathology of undernourishment in pregnant sheep, with particular reference to pregnancy toxemia. *Adv. Vet. Sci.* **12**, 163–237.
- Reilly, P. E. B., and Black, A. L. (1973). Early effects of cortisol on glucose and alanine metabolism in adrenalectomized sheep. *Am. J. Physiol.* **225**, 689–695.
- Rhodes, D. C., Meyer, D. J., Fish, C. J., and Kerns, W. D. (1992). Evaluation of methods for the determination of high-density lipoprotein (HDL)-cholesterol in normal dogs and dogs with hypercholesterolemia by polyanion precipitation and density-gradient ultracentrifugation. *Vet. Clin. Path.* **21**, 34.
- Richardson, M. (1989). Idiopathic hyperlipoproteinemia in a miniature schnauzer. *Companion Anim. Pract.* **19**, 33–37.
- Rindsig, R. B. (1980). Prevention of metabolic diseases through proper feeding and management: a review. *Int. Goat Sheep Res.* **1**, 113–117.
- Robertson, J. M. (1966). The evaluation of results from a therapeutic trial on bovine ketosis. *J. Am. Vet. Med. Assoc.* **149**, 1620–1623.
- Robertson, W. G., Lennon, H. D., Bailey, W. W., and Mixner, J. P. (1957). Interrelationships among plasma 17-hydroxycorticosteroid levels, plasma protein-bound iodine levels, and ketosis in dairy cattle. *J. Dairy Sci.* **40**, 732–738.
- Roe, C. R., Millington, D. S., Norwood, D. L., Kodo, N., Sprecher, H., Mohammed, B. S., Nada, M., Schulz, H., and McVie, R. (1990). 2,4-Dienoyl-coenzyme A reductase deficiency: a possible new disorder of fatty acid oxidation. *J. Clin. Invest.* **85**, 1703–1707.
- Rogers, W. A. (1977). Lipemia in the dog. *Vet. Clin. N. Am.* **7**, 637–647.
- Rogers, W. A., Donovan, E. F., and Kociba, G. J. (1975a). Idiopathic hyperlipoproteinemia in dogs. *J. Am. Vet. Med. Assoc.* **166**, 1087–1091.
- Rogers, W. A., Donovan, E. F., and Kociba, G. J. (1975b). Lipids and lipoproteins in normal dogs and in dogs with secondary hyperlipoproteinemia. *J. Am. Vet. Med. Assoc.* **166**, 1092–1100.
- Rose, R. J., and Sampson, D. (1982). Changes in certain metabolic parameters in horses associated with food deprivation and endurance exercise. *Res. Vet. Sci.* **32**, 198–202.
- Rose, R. J., Ilkiw, J. E., Sampson, D., and Backhouse, J. W. (1980). Changes in blood gas, acid-base and metabolic parameters in horses during three-day event competition. *Res. Vet. Sci.* **28**, 393–395.
- Rothera, A. C. H. (1908). Note on the sodium nitroprusside reaction for acetone. *J. Physiol.* **37**, 491–494.
- Ryan, W. L., and Carver, M. J. (1963). Immediate and prolonged effects of hydrocortisone on the free amino acids of rat skeletal muscle. *Proc. Soc. Exp. Biol. Med.* **114**, 816–819.
- Sacks, F. M., and Walsh, B. W. (1994). Sex hormones and lipoprotein metabolism. *Curr. Opin. Lipidol.* **5**, 236–240.

- Saggerson, E. D. (1988). Phosphatidate phosphohydrolase: its role in glycerolipid synthesis. In "Phosphatidate Phosphohydrolase" (D. N. Brindley, Ed.), vol. 1, pp. 79–124. CRC Press, Boca Raton, FL.
- Saharia, P., Margolis, S., Zuidema, G. D., and Cameron, J. L. (1977). Acute pancreatitis with hyperlipidemia: studies with an isolated perfused canine pancreas. *Surgery* **82**, 60–67.
- Sakai, T., Hayakawa, T., Hamakawa, M., Ogura, K., and Kubo, S. (1993). Therapeutic effects of simultaneous use of glucose and insulin in ketotic dairy cows. *J. Dairy Sci.* **76**, 109–114.
- Sampson, J., Morrill, C. C., and Alberts, J. O. (1945). Ketonemia in fetuses of a heifer and a ewe affected with severe ketosis. *Cornell Vet.* **35**, 365–369.
- Sato, K., Agoh, H., Kaneshige, T., Hikasa, Y., and Kagota, K. (2000). Hypercholesterolemia in Shetland sheepdogs. *J. Vet. Med. Sci.* **62**, 1297–1301.
- Sapir, D. G., and Owen, O. E. (1975). Renal conservation of ketone bodies during starvation. *Metabolism* **24**, 23–33.
- Schaer, M. (1976). Feline diabetes mellitus. *Vet. Clin. N. Am.* **6**, 453–461.
- Schneider, W. J. (2002). Lipoprotein receptors. In "Biochemistry of Lipids, Lipoproteins and Membranes" (D. E. Vance and J. Vance, Eds.), pp. 553–572. Elsevier, New York.
- Schotman, A. J. H., and Kroneman, J. (1969). Hyperlipaemia in ponies. *Neth. J. Vet. Sci.* **2**, 60–64.
- Schotman, A. J. H., and Wagenaar, G. (1969). Hyperlipemia in ponies. *Zbl. Vet. Med. A* **16**, 1–7.
- Schotman, A. J. H., and Wensing, T. (1977). Biochemical aspects of hyperlipemia in ponies. *Vet. Sci. Commun.* **1**, 337–347.
- Schwab, L., and Lotspeich, W. D. (1954). Renal tubular reabsorption of acetoacetate in the dog. *Am. J. Physiol.* **176**, 195–200.
- Schwalm, J. W., and Schultz, L. H. (1976). Relationship of insulin concentration to blood metabolites in the dairy cow. *J. Dairy Sci.* **59**, 255–261.
- Schwalm, J. W., Waterman, R., Shook, G. E., and Schultz, L. H. (1969). Blood metabolite interrelations and mammary A-V differences in ketotic cows. *J. Dairy Sci.* **52**, 915.
- Schultz, L. H. (1952). Treatment of ketosis in dairy cattle with sodium propionate. *Corn. Vet.* **42**, 148–155.
- Scott, D. W. (1979). Hyperadrenocorticism (hyperadrenocorticoidism, hyperadrenocorticalism, Cushing's disease, Cushing's syndrome). *Vet. Clin. N. Am.* **9**, 3–28.
- Serra, D., Casals, N., Asins, G., Royo, T., Ciudad, C. J., and Hegardt, F. G. (1993). Regulation of mitochondrial 3-hydroxy-3-methylglutaryl-CoA synthase protein by starvation, fat feeding, and diabetes. *Arch. Biochem. Biophys.* **307**, 40–45.
- Setchell, B. P., Bassett, J. M., Hinks, N. T., and Graham, N. M. (1972). The importance of glucose in the oxidative metabolism of the pregnant uterus and its contents in the conscious sheep with some preliminary observations on the oxidation of fructose and glucose by fetal sheep. *Quart. J. Exp. Physiol.* **57**, 257–266.
- Shaw, J. C. (1956). Ketosis in dairy cattle. A review. *J. Dairy Sci.* **39**, 402–434.
- Shaw, J. H. F., and Wolfe, R. R. (1984). Glucose production in the perfused dog liver: effect of free fatty acids and ketones. *J. Surg. Res.* **37**, 437–442.
- Shimizu, S., Tani, Y., Yamada, H., Tabata, M., and Murachi, T. (1980). Enzymatic determination of serum-free fatty acids: a colorimetric method. *Anal. Biochem.* **107**, 193–198.
- Simesen, M. G. (1956). Investigations on the therapy of ketosis. *Nord. Veterinarmotet.* **8**, 1.
- Snook, L. C. (1939). Fatty infiltration of the liver in pregnant ewes. *J. Physiol.* **97**, 238–249.
- Snow, D. H., and Mackenzie, G. (1977). Effect of training on some metabolic changes associated with submaximal endurance exercise in the horse. *Equine Vet J.* **9**, 226–230.
- Spector, A. A., and Fletcher, J. E. (1978). Transport of fatty acid in the circulation. In "Disturbances in Lipid and Lipoprotein Metabolism" (J. M. Dietschy, A. M. Gotto, and J. A. Ontko, Eds.), pp. 229–250. American Physiological Society, Bethesda, MD.
- Stead, D., and Welch, V. A. (1975). Lipid composition of bovine serum lipoproteins. *J. Dairy Sci.* **58**, 122–127.
- Stein, E. A., and Meyers, G. L. (1994). Lipids, lipoproteins, and apolipoproteins. In "Tietz Textbook of Clinical Chemistry" (C. A. Burtis and E. R. Ashwood, Eds.), 2nd ed., pp. 1002–1093. Saunders, Philadelphia.
- Stevens, C. E. (1970). Fatty acid transport through the rumen epithelium. In "Physiology of Digestion and Metabolism in the Ruminant" (A. T. Phillipson, Ed.), pp. 101–112. Oriel Press, Newcastle upon Tyne, England.
- Sykes, J. F., Duncan, C. W., and Huffman, C. F. (1941). Blood sugar and carbon dioxide combining power of the plasma in relation to ketosis in dairy cattle. *J. Dairy Sci.* **24**, 193–197.
- Thedford, T. R. (1983). "Goat Health Handbook" pp. 63–65. Winrock International, Morrilton, AK.
- Thompson, G. G. (1956). Observations on some treatments of ovine pregnancy toxemia. *New Zeal. Vet. J.* **4**, 136–144.
- Tildon, J. T., and Sevdalian, D. A. (1972). CoA transferase in the brain and other mammalian tissues. *Arch. Biochem. Biophys.* **148**, 382–390.
- Tyler, J. W., Dowling, P. M., Spano, J. S., McKnight, A. L., and Wolfe, D. F. (1994). Severe prepartum ketosis in an obese beef cow. *J. Am. Vet. Med. Assoc.* **204**, 1665–1667.
- Työppönen, J., and Kauppinen, K. (1980). The stability and automatic determination of blood samples taken in field conditions. *Acta Vet. Scand.* **21**, 55–61.
- Valdemarsson, S., Hansson, P., Hedner, P., and Nilsson-Ehle, P. (1983). Relations between thyroid function, hepatic and lipoprotein lipase activities, and plasma lipoprotein concentrations. *Acta Endocrinol.* **104**, 50–56.
- Valera, A., Pelegrin, M., Asins, G., Fillat, C., Sabater, J., Pujol, A., Hegardt, P. G., and Bosch, F. (1994). Overexpression of mitochondrial 3-hydroxy-3-methylglutaryl-CoA synthase in transgenic mice causes hepatic hyperketogenesis. *J. Biol. Chem.* **269**, 6267–6270.
- Vance, D. E. (2002a). Phospholipid biosynthesis in eukaryotes. In "Biochemistry of Lipids, Lipoproteins and Membranes" (D. E. Vance and J. Vance, Eds.), pp. 205–232. Elsevier, New York.
- Vance, J. E. (2002b). Assembly and secretion of lipoproteins. In "Biochemistry of Lipids, Lipoproteins and Membranes" (D. E. Vance and J. Vance, Eds.), pp. 205–232. Elsevier, New York.
- Vander Jagt, D. L., Robinson, B., Taylor, K. K., and Hunsaker, L. A. (1992). Reduction of trioses by NADPH-dependent aldo-keto reductases. Aldose reductase, methylglyoxal, and diabetic complications. *J. Biol. Chem.* **267**, 4364–4369.
- Visscher, F. E. (1945). Renal clearance of  $\beta$ -hydroxybutyric acid in a dog. *Proc. Soc. Exp. Biol. Med.* **60**, 296–297.
- Wagner, J. E. (1976). Miscellaneous disease conditions in the guinea pig. In "The Biology of the Guinea Pig" (J. E. Wagner and P. J. Manning, Eds.), pp. 252–267. Academic Press, Orlando, FL.
- Waite, M. (2002). Phospholipases. In "Biochemistry of Lipids, Lipoproteins and Membranes" (D. E. Vance and J. Vance, Eds.), pp. 269–295. Elsevier, New York.
- Wanders, R. J. A., van Roermund, C. W. T., Denis, S., Schutgens, R. B. H., Ijlst, L., and Tager, J. M. (1992). Molecular analysis of disorders



- of peroxisomal  $\beta$ -oxidation. In "New Developments in Fatty Acid Oxidation" (P. M. Coates and K. Tanaka, Eds.), pp. 507–519. Wiley-Liss, New York.
- Warnes, D. M., Seamark, R. F., and Ballard, F. J. (1977). Metabolism of glucose, fructose and lactate in vivo in chronically cannulated foetuses and in suckling lambs. *Biochem. J.* **162**, 617–626.
- Watson, H. R., and Lindsay, D. B. (1972). 3-Hydroxybutyrate dehydrogenase in tissues from normal and ketonaemic sheep. *Biochem. J.* **128**, 53–57.
- Watson, T. D. G., and Barrie, J. (1993). Lipoprotein metabolism and hyperlipidaemia in the dog and cat: a review. *J. Small Anim. Pract.* **34**, 479–487.
- Watson, T. D. G., Burns, L., Love, S., Packard, C. J., and Shepherd, J. (1991). The isolation, characterization and quantification of the equine plasma lipoproteins. *Equine Vet. J.* **23**, 353–359.
- Watson, T. D. G., Burns, L., Love, S., Packard, C. J., and Shepherd, J. (1992a). Plasma lipids, lipoproteins and post-heparin lipases in ponies with hyperlipaemia. *Equine Vet. J.* **24**, 341–346.
- Watson, T. D. G., Gaffney, D., Mooney, C. T., Thompson, H., Packard, C. J., and Shepherd, J. (1992b). Inherited hyperchylomicronaemia in the cat: lipoprotein lipase function and gene structure. *J. Small Anim. Pract.* **33**, 207–212.
- Watson, T. D. G., and Love, S. (1994). Equine hyperlipidemia. *Compend. Contin. Educ. Pract. Vet.* **16**, 91–98.
- Watson, T. D. G., Packard, C. J., and Shepherd, J. (1993). Plasma lipid transport in the horse (*Equus caballus*). *Comp. Biochem. Physiol. B* **106**, 27–34.
- Weidman, M. J., and Krebs, H. A. (1969). The fuel of respiration of rat kidney cortex. *Biochem. J.* **112**, 149–166.
- Wiener, R., Hirsch, H. J., and Spitzer, J. J. (1971). Cerebral extraction of ketones and their penetration into CSF in the dog. *Am. J. Physiol.* **220**, 1542–1546.
- Whitney, M. S. (1992). Evaluation of hyperlipidemias in dogs and cats. *Sem. Vet. Med. Surg. Small Anim.* **7**, 292–300.
- Whitney, M. S., Boon, G. D., Rebar, A. H., and Ford, R. B. (1987). Effects of acute pancreatitis on circulating lipids in dogs. *Am. J. Vet. Res.* **48**, 1492–1497.
- Widmark, E. M. P. (1920). Studies in the acetone concentration in blood, urine, and alveolar air. The passage of acetone and acetoacetic acid into the urine. *Biochem. J.* **14**, 364–378.
- Willdenhoff, K. E. (1977). Tubular reabsorption and urinary excretion of acetoacetate and 3-hydroxybutyrate in normal subjects and juvenile diabetics. *Acta Med. Scand.* **201**, 63–67.
- Williamson, D. H. (1961). Acetoacetate as fuel of respiration in the perfused rat heart. *Biochem. J.* **80**, 540–547.
- Williamson, D. H. (1971). Physiological ketoses, or why ketone bodies? *Postgrad. Med. J. June Suppl.*, 371–375.
- Williamson, D. H. (1978). Discussion. In "Biochemical and Clinical Aspects of Ketone Body Metabolism" (H.-D. Söling and C.-D. Seufert, Eds.), p. 190. Georg Thieme, Stuttgart.
- Williamson, D. H., and Krebs, H. A. (1961). Acetoacetate as fuel of respiration in the perfused rat heart. *Biochem. J.* **80**, 540–547.
- Williamson, D. H., and Mellanby, J. (1974). D(-)-3-Hydroxybutyrate. In "Methods of Enzymatic Analysis," 2nd English ed. (H. U. Bergmeyer, Ed.), vol. 4, pp. 1836–1839. Academic Press, Orlando, FL.
- Williamson, D. H., Mellanby, J., and Krebs, H. A. (1962). Enzymic determination of D(-)-beta-hydroxybutyric acid and acetoacetic acid in blood. *Biochem. J.* **82**, 90–96.
- Williamson, D. H., Bates, M. W., Page, M. A., and Krebs, H. A. (1971). Activities of enzymes involved in acetoacetate utilization in adult mammalian tissues. *Biochem. J.* **121**, 41–47.
- Winder, W. W., Baldwin, K. M., and Holloszy, J. O. (1975). Exercise-induced increase in the capacity of rat skeletal muscle to oxidize ketones. *Can. J. Physiol. Pharmacol.* **53**, 86–91.
- Xenuolis, P. G., Schodolsk, J. S., Levinski, M. D., and Steiner, J. M. (2008). Serum liver enzyme activities in healthy miniature schnauzers with and without hypertriglyceridemia. *J. Amer. Vet. Med. Assoc.* **232**, 63–67.
- Zieve, L. (1968). Relationship between acute pancreatitis and hyperlipemia. *Med. Clin. N. Am.* **52**, 1493–1501.
- Zilversmit, D. B. (1973). A proposal linking atherogenesis to the interaction of endothelial lipoprotein lipase with triglyceride-rich lipoproteins. *Circ. Res.* **33**, 633–638.

# Proteins, Proteomics, and the Dysproteinemias

P. David Eckersall

*Division of Animal Production & Public Health*

*Institute of Comparative Medicine*

*University of Glasgow*

*Glasgow, Scotland*

*United Kingdom*

---

## I. INTRODUCTION

## II. CLASSIFICATION OF PROTEINS

- A. Structural Classification
- B. Chemical Classification
- C. Physical Classification

## III. METABOLISM OF PROTEINS

- A. General
- B. Synthesis of Proteins
- C. Catabolism of Proteins

## IV. PLASMA PROTEINS

- A. Sites of Synthesis
- B. Functions of the Plasma Proteins
- C. Factors Influencing the Plasma Proteins
- D. Handling and Identification of Proteins

## V. METHODOLOGY

- A. Total Protein
- B. Fractionation of the Serum Proteins
- C. Electrophoretic Fractionation of the Serum Proteins
- D. Specific Protein Analysis

## VI. NORMAL PLASMA AND SERUM PROTEINS

- A. Albumin
- B. Acute Phase Proteins
- C. Complement Proteins
- D. Immunoglobulins
- E. Lipoproteins
- F. Other Serum Proteins
- G. Multiplex Assays, Protein Arrays, and Acute Phase Index

## VII. INTERPRETATION OF SERUM PROTEIN

### PROFILES

- A. Physiological Influences
- B. The Dysproteinemias

## REFERENCES

---

## I. INTRODUCTION

Protein is the most abundant component of plasma. There is in the region of 6 to 7 g/dl (60 to 70 g/liter) of protein in plasma in comparison to 0.1 g/dl (1.0 g/liter) of glucose (5.5 mmol/liter) or 0.35 g/dl (3.50 g/liter) of sodium (150 mmol/liter). However, this large mass of protein consists of many different individual protein molecules. Complete analysis of this complex mixture of different proteins is not possible at present in the diagnostic laboratory. Proteins contain approximately 95% of all nitrogenous material in blood in the form of chains of amino acids linked by peptide bonds. Protein can be separated from the nonprotein nitrogen (NPN) component of plasma by precipitation with reagents such as trichloroacetic acid. The NPN consists of nucleic acids along with low molecular weight compounds such as urea (50% of NPN), free amino acids (25% of NPN), glutathione, and creatinine.

Analysis of serum protein is an area of clinical biochemistry of domestic animals, which has seen a rapid advance since the 1990s, and with current developments in analytical technology and interpretation, the rate of advance is likely to accelerate rather than decline. At the forefront of these advances in the diagnostic application of serum protein analysis has been the development of specific assays for individual proteins. In particular, it has been recognized that quantification of a group of serum protein called the acute phase proteins (APP) can greatly assist the assessment of infection, inflammation, and trauma in animals. These advances are now being applied in clinical biochemistry laboratories for the immediate benefit in the diagnosis, prognosis, and monitoring of treatment of domestic animals.

In the future, technology may be developed to characterize all proteins (the proteome) of serum, which would

make a major contribution to the diagnosis of disease. However, it is a salutary lesson that currently only a limited number of the many plasma proteins are used for diagnostic analysis (Anderson and Anderson, 2002).

This chapter focuses on the biochemistry, the diagnostic methodology, and use in disease diagnosis of measuring the concentration of serum or plasma proteins, but it will exclude a number of groups of proteins where the interpretation of results is more appropriate for other chapters. Immunoglobulins and complement will be covered in Chapter 6, lipoproteins in Chapter 4, and fibrinogen in Chapter 10. Studies on the proteins of blood have been performed on serum or plasma. Where appropriate, a distinction is made between these fluids, although apart from the absence of fibrinogen in serum, most diagnostic investigations can be applied to either. Nevertheless serum is the preferred sample for most of the diagnostic assays used to investigate the proteins of blood.

## II. CLASSIFICATION OF PROTEINS

### A. Structural Classification

The structure of proteins is defined by increasing levels of complexity. The primary structure of a protein is the sequence of amino acids that makes up the unique composition of the individual protein. The amino acids are joined together by peptide bonds linking the carboxylic acid group of one amino acid to the amino group of the neighboring amino acid in the chain. With 20 different amino acids occurring in proteins and with the possibility of more than a hundred or more amino acids making up the primary structure of each protein, there are an almost infinite number of potential proteins that could be present in cells and tissues. However, the sequence of the amino acids in a particular protein is predetermined by the order of nucleotide bases in nuclear DNA, which contains the genetic code for that protein.

Secondary structure is the presence in protein of regular structures formed by the linked amino acids giving identifiably similar three-dimensional conformations. These may be repeated at intervals in the three-dimensional molecular structure of the protein. The most important of these structures are the  $\alpha$ -helix and the  $\beta$ -sheet. The  $\alpha$ -helix is a right-handed helix stabilized by hydrogen bonds between the C = O group of one amino acid residue and the N-H group of another amino acid located four residues along the peptide chain. The  $\beta$ -sheet is also stabilized by hydrogen bonds between carboxyl and amino groups of amino acid residues, but the interacting residues are at different parts of the same chain. An example of the  $\alpha$ -helix is shown by the structure of albumin (Section IV.A), whereas the contribution of  $\beta$ -sheets to protein structure is illustrated by the structure of C-reactive protein (CRP) (Section IV.B.1). The  $\alpha$ -helices and  $\beta$ -sheets can associate together into

supersecondary structures forming recognized motifs among which the  $\beta$ -meander, Greek key, and  $\beta$ -barrel structures have been described (Walsh, 2002)

The tertiary structure of proteins is the three-dimensional structure of the protein and is dependent on its primary and secondary structures. This native conformation of the protein is essential for its activity and depends on the correct folding of the protein after synthesis. Most proteins above a certain size can be subdivided into domains, which are independent folding units. The conformation of the protein is held together by weak forces between amino acid side chains such as hydrogen bonds, electrostatic and hydrophobic interaction, and also by covalent disulphide bonds between cysteine residues. Great strides have been made in determining the structure of proteins using X-ray crystallography and nuclear magnetic resonance (NMR). Structures of many proteins, including serum protein, can be obtained from online, open-access databases such as the Research Collaboratory for Structural Bioinformatics Protein Data Base located on the Internet at [www.rcsb.org/pdb](http://www.rcsb.org/pdb). The structures can be manipulated by protein modeling software, among which Protein Explorer or RasMol can be downloaded from [www.umass.edu/microbio/rasmol](http://www.umass.edu/microbio/rasmol).

The quaternary structure of proteins is the combination of protein subunits to create a multisubunit complex. Thus, hemoglobin requires the combination of four subunits (two  $\alpha$ -chains and two  $\beta$ -chains) into a tetramer for the fully functional protein. Examples of serum proteins that have quaternary structure include immunoglobulins, formed from two light chains and two heavy chains, and CRP, in which five subunits combine to form a pentameric structure.

A further classification of protein based on their structure is between “fibrous” and “globular” proteins. The former adopt elongated three-dimensional shapes in their quaternary structure and are usually involved in structural roles in biological systems such as  $\alpha$ -keratin, collagen, and elastin. Apart from fibrinogen (Section VI.B.5), which has as its function the formation of fibrin, fibrous proteins are not found in plasma protein. Thus, the majority of plasma proteins are globular proteins, adopting complex three-dimensional shapes by folding of the polypeptide chain.

### B. Chemical Classification

Proteins are also classified as “simple” or “conjugated.” Simple proteins contain only a polypeptide chain of linked amino acids, whereas conjugated proteins contain nonamino acid components. These can be carbohydrate residues (glycoprotein and proteoglycan), metal ions such as  $\text{Fe}^{2+}$  or  $\text{Ca}^{2+}$  (metalloproteins), phosphate (phosphoproteins), lipid (lipoproteins), and nucleic acids (nucleoproteins such as histones). Many plasma proteins are conjugated to carbohydrate and are present in the circulation as glycoproteins.

### C. Physical Classification

Proteins can be classified by physical properties and behavior, by their size (relative molecular mass,  $M_r$ ), or by the charge on the protein. The charge on a protein results from a combination of the acidic and basic groups on free side chains of the amino acids of the protein and is dependent on the pH of the aqueous environment. For every protein, there is a specific pH where the protein has an equal number of negative and positive charges on its side chains and the protein has a net charge of zero. This is the isoelectric point of the protein (pI). The higher the proportion of basic amino acids, such as lysine or arginine, the higher the pI of the protein will be, whereas with more acidic amino acids, such as glutamate or aspartate, the protein will have a low pI. The proportion of aromatic amino acids tyrosine, tryptophan, or phenylalanine contained by a protein influences its spectral properties because these amino acids absorb light at 280nm, which can be measured in a spectrophotometer. The spectral property can also be influenced by factors such as the presence of heme groups and the binding of metal ions. The proportion of hydrophobic amino acids defines the hydrophobicity of a protein, which can be predicted from the primary sequence. Chemical composition in terms of the primary structure and the physical properties of proteins that have been sequenced are available from online databases such as the UniProt database at [www.ebi.uniprot.org](http://www.ebi.uniprot.org).

## III. METABOLISM OF PROTEINS

### A. General

The metabolism of nitrogenous compounds in animals is largely related to the processes of anabolism and catabolism of amino acids and proteins. Proteins in the diet are broken down by protease digestion to yield free amino acids and small peptides, the latter being finally degraded in the intestinal cells during absorption. The products of protein digestion enter the portal vein as amino acids. In the healthy animal, an equilibrium is established between intake and synthesis of amino acids, on the one hand, and breakdown and excretion of excess nitrogenous material, in the form of urea, on the other. Excessive loss of nitrogenous material can occur in illness because of cellular breakdown, lactation with production of milk protein, and in urinary or gut losses. During growth, pregnancy, and recovery from disease, there is a positive nitrogen balance as amino acids and other nitrogenous compounds are supplied to meet the body's requirements.

### B. Synthesis of Proteins

Proteins are made from amino acids in the cytoplasm of cells when the appropriate mix of amino acids is present. Among the 20 naturally occurring amino acids found in

**TABLE 5-1** Natural Amino Acids

#### Essential Amino Acids

Histidine	Lysine	Threonine
Isoleucine	Methionine	Tryptophan
Leucine	Phenylalanine	Valine

#### Nonessential Amino Acids

Alanine	Cysteine	Proline
Arginine	Glycine	Serine
Asparagine	Glutamate	Tyrosine <sup>a</sup>
Aspartate	Glutamine	

<sup>a</sup> By conversion from phenylalanine.

protein, nearly half cannot be synthesized by mammalian cells. These are the essential amino acids that have to be obtained in the diet (Table 5-1). The nonessential amino acids can be synthesized by transamination reactions in which the amino group of glutamate is transferred to a carbon skeleton in the form of an  $\alpha$ -ketoacid. An example of this is the action of alanine transaminase, which catalyzes the transfer of the amino group of glutamate to the  $\alpha$ -ketoacid, pyruvate, with the formation of alanine and  $\alpha$ -ketoglutarate. Alanine transaminase (ALT; EC 2.6.1.2) is an important diagnostic enzyme, used as a marker of liver damage (Chapter 12) in small animals. The nonessential amino acids can be synthesized in animals from components of the central metabolic pathways, whereas the essential amino acids have to be present in the diet. However, in ruminants, the symbiotic relationship with ruminant microbes allows production of the full range of amino acids so that these species do not require all the essential amino acids in their dietary intake.

The intricate process of synthesis of protein in the ribosomes of the rough endoplasmic reticulum, under the instruction of messenger ribonucleic acid (mRNA), is a major part of the discipline of molecular biology and will not be described here in detail as authoritative texts are devoted to the subject (Alberts *et al.*, 2002). The primary structure of the protein is determined by the gene sequence of nuclear DNA on a chromosome in the nucleus. The genetic code, which is the sequence of nucleotides in DNA (adenine, cytosine, guanine, thymine), controls the sequence of amino acids in the protein. During protein synthesis, the code is transcribed from DNA to mRNA, which moves from the nucleus to the ribosomes in the cytoplasm. Here, specific amino acids are added to the growing peptide chain following linkage to a specific transfer RNA (tRNA). The specificity of production of the amino acid chain during this process of translation is dependent on the triplet of nucleic acids in the mRNA (codon) binding accurately to the anticodon of the tRNA. By this means, the

genetic code in nuclear DNA directs the primary sequence of amino acids during protein synthesis. Formation of the peptide bonds between the amino acids of the protein is followed by folding of the protein into its natural conformation. With up to 20 different amino acids in protein chains of 100 residues or more, several million structural arrangements are feasible for any one protein. It is essential for protein function that they form the correct native conformation, and protein folding is an essential process following synthesis. Folding is the responsibility of chaperones, which guide the growing protein chain to produce the single structure that will ensure its full activity (Walsh, 2002).

## C. Catabolism of Proteins

### 1. Turnover of Proteins

Throughout an animal's body, proteins are continually being synthesized and broken down, resulting in a continuous turnover of protein. In a healthy animal, the rates of synthesis and degradation are in equilibrium, but during disease these can alter. Plasma proteins are subject to the same process, and a function of albumin, the most abundant plasma protein, is to provide amino acid for the natural turnover of protein in peripheral tissues. Albumin is taken up by pinocytosis into tissues where lysosomal proteases hydrolyze the protein, releasing the amino acids for utilization by the cells for synthesis of their own proteins (Evans, 2002). There is no storage capability in the body for protein. As a result, amino acid in excess of requirement for cellular protein synthesis is utilized for the central pathways of metabolism. The carbon skeleton of amino acids can be used for provision of energy via the tricarboxylic acid cycle and oxidative phosphorylation or may be converted to glucose or lipid and stored for later use. Carnivores derive as much as 40% to 50% of their energy from dietary protein, whereas omnivores and herbivores derive from 10% to about 20% from this source.

The rate of degradation of the plasma proteins is expressed as their turnover, fractional clearance, or as their half-life, which is the time taken for their concentration to fall by 50%. Plasma half-lives were originally determined by measurement of the rate of disappearance of radioisotope labeled protein. More recently, proteins labeled with stable isotopes and measured by mass spectrometry have been used for this purpose (Preston *et al.*, 1998; Prinsen and de Sain-van der Velden, 2004). Clearance half-lives for cellular proteins range from a few hours (enzymes) to as long as 160 days for hemoglobin in bovine red cells. The clearance half-life for plasma protein can be as long as 3 weeks. Plasma albumin in humans has a normal half-life of 19 days,  $\alpha_1$ -acid glycoprotein has a half-life of 5.5 days (Putnam, 1975), and  $\gamma$ -globulins have a half-life of 7 days

**TABLE 5-2** Albumin Turnover in Animals

Species	T <sub>1/2</sub> (days)	Reference
Mouse	1.9	(Allison, 1960)
Rat	2.5	(Allison, 1960)
Dog	8.2	(Dixon <i>et al.</i> , 1953)
Sheep	14.3	(Campbell <i>et al.</i> , 1961)
Cow	16.5	(Cornelius <i>et al.</i> , 1962)
Human	19.0	(Putnam, 1975)
Horse	19.4	(Mattheeuws <i>et al.</i> , 1966)

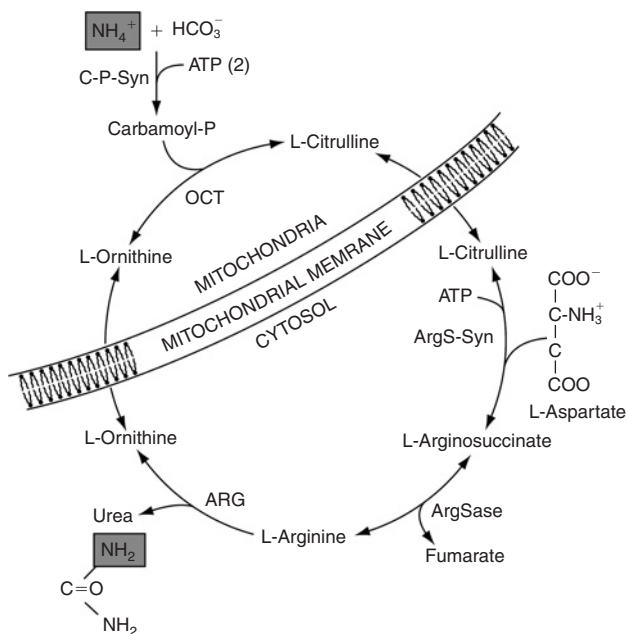
(Andersen *et al.*, 1963). The plasma half-life of albumin shows considerable variation between species (Table 5-2). It is associated with the size of the species with murine albumin having a T<sub>1/2</sub> of 1.9 days, whereas equine albumin has a T<sub>1/2</sub> of 19.4 days.

### 2. Urea Cycle

During digestion, protein is not only broken down to amino acid, but gut bacteria can degrade the amino acids releasing ammonia, which is absorbed along with the amino acids. This is an important consideration in the management of liver disease, as sterilization of the gut by antibiotics can reduce the ammonia load on the liver. Once absorbed, amino acids, along with ammonia, are transported in the portal vein to the liver and then to other tissues where the amino acids are utilized for protein synthesis.

The liver is the central processing organ for nitrogen metabolism, and approximately 75% of the amino acid (and ammonia) absorbed from the intestine is transported into the hepatocytes. Transaminase reactions facilitate the transfer of amino groups to appropriate  $\alpha$ -ketoacids in the formation of the required balance of nonessential amino acids. If not required for protein synthesis, amino acids undergo deamidation by mitochondrial enzymes including glutamate dehydrogenase and glutaminase. Amino groups are also transferred to oxaloacetate, with the formation of aspartate, which along with an ammonium ion and a carbonate group are the precursors of urea. In this way, amino groups from excess amino acids are transferred into urea for safe excretion.

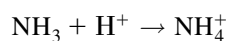
In the urea cycle (Fig. 5-1), which takes place in hepatocytes, the initial step is the formation of carbamoyl phosphate in the mitochondria from an ammonium ion, a carbonate ion, and ATP. This step, which is under metabolic control and is activated by an increase in the cellular arginine concentration, occurs when there is an excess of amino acids in the hepatocyte. The carbamoyl phosphate combines with ornithine to form citrulline. This metabolite



**FIGURE 5-1** The urea cycle. Formation of urea from precursors of aspartate,  $\text{NH}_4^+$ , and  $\text{COO}^-$  with part of the cycle taking place in the cytoplasm and part in the mitochondria. Abbreviations: C-P-Syn, carbamoyl phosphate synthase; OCT, ornithine citrulline transferase; ArgS-Syn, argininosuccinate synthase; ArgSase, argininosuccinase; ARG, arginase.

leaves the mitochondria and combines with aspartate to form argininosuccinate, which separates into arginine and fumarate. Urea is then released from arginine leaving ornithine, which reenters the mitochondria and the cycle repeats. There is a close link between the urea cycle and the tricarboxylic acid (TCA) cycle as the fumarate released from argininosuccinate is converted to malate and then oxaloacetate in reactions of the TCA cycle. Aspartate transaminase catalyses the transfer of an amino group for production of aspartate from the oxaloacetate, thus providing the amino group for further urea production. Division of the urea cycle between mitochondria and cytoplasm aids in coordination between cycles. The urea produced in the liver is transported in the circulation to the kidney where it is excreted by the kidney tubules and eliminated in urine. Other routes for the excretion of nitrogenous material, such as uric acid or nucleic acid, are relatively minor in mammalian species.

All animals are quite intolerant of free ammonia ( $\text{NH}_3$ ), but at physiological pH the protonated ammonium ion form predominates:



The ammonium ion does not readily transfer across membranes unlike free ammonia, which readily enters cells where it is reconverted to the ammonium ion. Ammonia is particularly toxic to cells of the central nervous system where it acts by reducing the activity of the TCA cycle by

removing a critical intermediate,  $\alpha$ -ketoglutarate. Increased ammonia leads to the production of glutamate from  $\alpha$ -ketoglutarate by the action of glutamate dehydrogenase. The  $\alpha$ -ketoglutarate is lost to the TCA cycle, causing ATP production in the neurons to be restricted. Ammonia may also be directly toxic as it can decrease neurotransmitter concentrations. Ammonia is associated with hepatic encephalopathies of humans, horses (Hasel *et al.*, 1999), and dogs (Reisdesmerie *et al.*, 1995), possibly by affecting the expression of neuron proteins such as glial fibrillary acidic protein, glutamate transporters, and peripheral-type benzodiazepine receptors (Butterworth, 2002).

## IV. PLASMA PROTEINS

### A. Sites of Synthesis

Apart from the immunoglobulins, produced by B-lymphocytes, the major plasma proteins are synthesized and secreted from hepatocytes. Control of secretion is exerted by varied mechanisms. The secretion of albumin is stimulated by a fall in osmotic pressure (Evans, 2002) but can also be affected by pathophysiological changes such as during infectious or inflammatory disease when the secretion is reduced. This is caused by proinflammatory cytokines such as interleukin (IL)-1, IL-6, and tumor necrosis factor- $\alpha$  (TNF). These cytokines are simultaneously responsible for the increased synthesis and secretion of the APP (see Section VI.B). The immunoglobulins are produced by B-lymphocytes in the spleen, lymph nodes and bone marrow following stimulation by the presence of pathogen in the circulation or tissues.

Use of molecular biological techniques such as Northern blots and the polymerase chain reaction (PCR) has revealed that nonhepatic tissues have the capability to synthesize some of the plasma proteins and that in certain circumstances the expression of their mRNA is up-regulated. Thus, in tissues such as intestine, lung, and adipose tissue, the mRNA for the plasma proteins haptoglobin and serum amyloid A are increased during infections and inflammation (Friedrichs *et al.*, 1995; Vreugdenhil *et al.*, 1999; Yang *et al.*, 1995). The proportion of the proteins in the circulation derived from these nonhepatic sources has not been determined. A further site of nonhepatic synthesis is the mammary gland, which has been shown to produce a mammary associated serum amyloid A and haptoglobin during mastitis. However, the protein produced in the mammary gland does not appear in plasma but is secreted in the milk during the disease (Eckersall *et al.*, 2001; Jacobsen *et al.*, 2005b).

The origin of low-abundance plasma proteins is varied. They may be made and secreted for specific functions such as the protein and peptide hormones. For example, the gonadotropins and adrenocorticotropin are released into the circulation from the pituitary gland, insulin and glucagon

from the pancreas, and parathyroid hormone and calcitonin from the parathyroid gland. Similarly, the adipose tissue releases adiponectin and leptin, peptides affecting the appetite and nutritional status, whereas the cytokines are derived from cells of the immune system. The plasma also contains tissue proteins lost during normal turnover of cells, which can be valuable biomarkers of disease in identifying when pathological events occur. For example, enzymes determined in clinical enzymology for liver or muscle damage and the troponins released from cardiac or skeletal muscle are minor plasma proteins.

## B. Functions of the Plasma Proteins

The functions of proteins in the body of animals are innumerable and include forming the basis of structure of cells, organs, and tissues; maintaining colloid osmotic pressure; catalyzing biochemical reactions; and buffering acid-base balance. The proteins are also multifunctional in plasma. The functions of specific plasma proteins will be described later in this chapter, but main functions of protein in blood are in blood coagulation (fibrinogen), in host defenses against pathogens (immunoglobulins, complement), in transport of metabolites (transferrin, albumin), in regulation of cellular metabolism (hormones), in prevention of proteolysis ( $\alpha_1$ -antitrypsin), in provision of nitrogen balance for nutrition (albumin), and in maintaining osmotic pressure (albumin). The biological activities of the plasma proteins in these functions depend ultimately on their primary, secondary, tertiary, and quaternary structures.

## C. Factors Influencing the Plasma Proteins

### 1. Age

At birth, plasma proteins of most species are low because of minimal quantities of immunoglobulins. As the newborn animal ingests colostrum, a rapid rise in immunoglobulins occurs as a result of absorbed maternal immunoglobulins. As the maternal immunoglobulins reduce in concentration because of natural turnover, the neonate rapidly gains immunocompetence and begins to synthesize its own immunoglobulins. Upon reaching young adulthood, adult levels of globulins are reached. In contrast to this general trend,  $\alpha_1$ -acid glycoprotein is elevated in serum at birth in piglets but declines over the first few months of life (Itoh *et al.*, 1993b). With increasing age, the plasma protein concentration increases as a result of a small decrease in albumin and a progressive increase in globulins.

### 2. Hormones, Pregnancy, and Lactation

In some species, the total plasma protein concentration in the maternal blood decreases during gestation because of a decline in albumin, even though there is a slight increase

in globulins. In a number of species pregnancy associated proteins have been observed during pregnancy. The only one in regular diagnostic use is equine chorionic gonadotropin (formerly pregnant mare serum gonadotropin) used to confirm pregnancy in mares (Henderson *et al.*, 1998). In pregnant bitches, an acute phase reaction occurs about 21 days after fertilization and acute phase proteins, especially C-reactive protein, increase in the maternal serum (Eckersall *et al.*, 1993; Vannucchi *et al.*, 2002). In cattle approaching term, there is a rise in  $\gamma$ -globulins and a corresponding rise in total plasma protein, but at term a fall occurs in this fraction because of transfer to colostrum (Weaver *et al.*, 2000). The acute phase protein, serum amyloid A (SAA), also increases in the maternal plasma around parturition in cows (Alsemgeest *et al.*, 1993). During lactation, the total plasma protein decreases in some species because of albumin decrease.

Some hormones (testosterone, estrogens, growth hormone) promote an increase in total plasma protein because of their anabolic effects, whereas others (thyroxine, cortisol) tend to decrease the total plasma protein because of their catabolic effects.

## D. Handling and Identification of Proteins

Protein denaturation is the net effect of alterations in the biological, chemical, and physical properties of the protein by mild disruption of its structure. When blood samples are taken for protein analysis, it is important that they are handled correctly so that no artifacts are introduced that could affect the investigation and its interpretation. If the protein is allowed to even partially degrade, the assay will not be accurate. Therefore, it is essential that denaturation is avoided. The ability of plasma proteins to resist denaturation in a blood sample taken for diagnostic analysis varies between proteins; consequently, the sample should be handled according to the analysis required. Fortunately, most major plasma proteins are relatively resistant to denaturation and can be assayed in samples that have been handled carefully and have been kept away from elevated temperatures. However, separation of plasma or serum from the blood cells by centrifugation should be performed as early as possible. Thereafter, many proteins are stable at 4°C for several days and at -20°C for much longer (months to years). Some proteins are less stable, with enzymes being particularly susceptible to loss of activity with time, while the stability of the peptide hormone ACTH is so low that samples should be snap-frozen immediately to preserve the intact peptide.

For identification and quantification of serum protein, the protein component in serum must either be separated or individual proteins must be measured independently. The primary separation of the proteins in serum is between albumin and the globulins. Albumin is a water-soluble, globular protein that is usually identifiable as a single discrete

molecule. The globulins are also globular proteins, but many of them, in contrast to albumin, precipitate in pure water and require salts to maintain their solubility. The globulins are a mix of proteins of various types, which migrate in groups in an electric field (electrophoresis) as families of proteins identified as  $\alpha$ -,  $\beta$ -, or  $\gamma$ -globulins. The nomenclature of the globulin fractions is based on their location during separation by electrophoresis. Albumin has the most rapid migration of the major proteins (in some species it is preceded by prealbumin), followed by the  $\alpha$ -globulin,  $\beta$ -globulin, and  $\gamma$ -globulin fractions, respectively. The  $\gamma$ -globulins are largely composed of immunoglobulins, the antibodies that bind to invading pathogens or other foreign matter. In contrast, the  $\alpha$ - and  $\beta$ -globulin fractions contain a great variety of different proteins.

Electrophoresis is a well-established diagnostic method that was first introduced to the clinical biochemistry laboratory with cellulose acetate as the support medium for the separation. This has largely been replaced with agarose, so that serum protein electrophoresis (SPE) in agarose gels, followed by protein staining and densitometry to quantify the protein in each of the main fractions, is common in clinical biochemistry laboratories. This has evolved into an extremely useful technique because aberrations are observed in many disease states though there are only a few diseases where the electrophoretic pattern can provide a definitive diagnosis.

Interest has advanced the investigation armory for serum protein analysis with the development of specific analytical methods for individual proteins. Though specific assays have been used for a long time for determination of proteins such as albumin and fibrinogen, it is only relatively recently that specific assays for other diagnostically useful proteins such as haptoglobin, CRP, SAA, and  $\alpha_1$ -acid glycoprotein (AGP) have become commonly available. In most cases, this has been achieved by the use of immunoassays, which has often required the development and validation of species-specific methodology.

## V. METHODOLOGY

### A. Total Protein

Assays for total protein can be performed on serum or plasma. The method employed to measure the total amount of protein in solution varies with the amount of dissolved protein and is therefore chosen according to the biological fluid under investigation. The technology used to measure total protein can be based on chemical or physical measurements. In the diagnostic laboratory, chemical methodologies are used because they can be readily adapted to automated analyses. On the other hand, point-of-care determination of total protein, for instance, in a veterinary practice, can be performed by use of refractometry, which depends on the physical properties of protein in solution.

### 1. Chemical Methods

#### a. Biuret Reaction

The biuret reaction, in which protein forms a complex with copper ( $\text{Cu}^{2+}$ ) in alkaline solution, has become the standard chemical test for total serum or plasma protein. This complex, which is dependent on the presence of peptide bonds, is blue-purple in color. This method is used in automated wet biochemical analyzers and is also the basis for total protein assays in dry chemistry analyzers. The biuret method is highly accurate for the range of total protein found in serum (1 to 10 g/dl, 10 to 100 g/liter) but is not sensitive enough for the protein concentrations found in other body fluids where the concentration range is lower, for example, cerebrospinal fluid. More sensitive protein assays should be used for these fluids.

#### b. Precipitation Methods

Proteins in solution are sensitive to changes in the pH of the environment that result in alteration of the ionization of the side groups of acidic and basic amino acids. This distorts the electrostatic forces between residues, which normally keep the protein in its native conformation. Changing the pH, especially to the extremes of the pH range, therefore disrupts the tertiary and quaternary structures of proteins leading to reduced solubility and causing precipitation of the protein from solution. Reagents such as trichloroacetic acid, sulphosalicylic acid, and tungstic acid cause the precipitation of protein and are used to quantify the total protein concentration in biological fluids when the protein concentration is in a range of 0.1 to 1 g/dl (1 to 10 g/liter).

#### c. Sensitive Chemical Methods

For measurement of total protein in fluids at concentrations less than 0.1 g/dl (1 g/liter), more sensitive protein assays have to be used. For many years, the Phenol-Folin-Ciocalteau method (Lowry *et al.*, 1951) was the method of choice to measure low concentrations of protein. This method is based on the reaction of the phenolic group of tryptophan and tyrosine with the Folin-Ciocalteau reagent yielding a blue chromogen. A less laborious modification of this method, which is even more sensitive, has been developed using bicinchonic acid (Smith *et al.*, 1985), whereas methods based on the binding of the dye, Coomassie blue to protein in acidic solution, are also useful in quantifying dilute protein solutions (Bradford, 1976). These sensitive methods are conveniently performed in microtiter plates, but their use is mainly restricted to the research laboratory. These sensitive methods depend on the reactions between reagent and a number of specific amino acids in the proteins, such as with the phenolic group of aromatic amino acids. Results vary depending on the proportion of these amino acids in the proteins being measured. The protein used to calibrate the assay may have a significant effect on results. Conventionally, bovine serum albumin is used as calibrant.



## 2. Physical Methods

### a. Refractometric

Light is refracted when it passes from air to liquid, and if the liquid contains dissolved proteins, the degree of refraction (refractive index) changes in proportion to the concentration of protein. With appropriate instruments and careful use, determination of the refractive index of serum can give an accurate assessment of total protein concentration. The use of hand-held refractometers allows rapid determination of protein in serum, plasma, or other body fluid and is one of the most widespread point-of-care methods in use. It is important to frequently check the calibration of the refractometer, as this may be a source of error. Most refractometers are scaled to read directly both total serum protein and urine-specific gravity. Studies have shown that results for protein estimates from hand-held refractometers correlate well with results from the biuret method, though there are reports of major discrepancies in samples from avian species (George, 2001). Because of the dependence on the transmission of light, it is important that the sample is clear, nonturbid, nonlipemic, and nonhemolyzed. In a comparison of refractometry to the biuret method for the determination of the total protein in plasma from dogs and cats, the correlation coefficients were high, but there were differences between the methods of 0.6g/dl (6g/liter) and 0.2g/dl (2g/liter) for dog and cat plasma, respectively (Briend-Marchal *et al.*, 2005). Although the internal scales on most refractometers limit the measurement of protein to a minimum of 2.5g/dl (25g/liter), it has been shown that a close correlation to total protein determined by the biuret method can be obtained to concentrations as low as 0.6g/dl (6g/liter), allowing the use of the method to estimate the protein content in most body fluid samples (George and O'Neill, 2001).

### b. Fibrinogen

Refractometry can be used to determine the concentration of fibrinogen in plasma. This large protein (340kDa) constitutes about 5% of the total plasma protein, and its concentration can be estimated from the difference in protein content before and after heat treatment of plasma at 56°C for 3 minutes, which causes fibrinogen to precipitate. A refractometer is used to determine the protein concentrations before and after heating with the fibrinogen being estimated from the difference between the two readings. Fibrinogen has also been estimated by measurement of the height of fibrin clot in microhematocrit tubes or the assessment of the weight or the protein content of fibrin clots (Davey *et al.*, 1972). Monitoring the fibrin formation spectrophotometrically via enzymic action of thrombin or the snake venom, batroxobin, on fibrinogen allows the assay to be automated (Messmore *et al.*, 1997; Oosting and Hoffmann, 1997) and has been used to monitor canine fibrinogen (Mischke *et al.*, 2005). Thrombin time, as

described in Chapter 10 on hemostasis, is also used to estimate fibrinogen concentration.

## B. Fractionation of the Serum Proteins

The total protein content of serum is made up of a large number of individual proteins, and diagnostic information can be obtained by detecting changes in the component proteins or in different fractions of proteins. It has been suggested (Anderson and Anderson, 2002) that virtually all diseases affect the proteins found in serum and that diagnosis would be advanced by using proteomics methods (Section V.C.4) to monitor change in many serum proteins at the same time. This is likely to be in the distant future for routine applications in veterinary clinical pathology laboratories. Nevertheless, considerable valuable diagnostic information can be obtained using current methods to fractionate serum to determine the concentration of its major proteins or groups of proteins.

Most of these methods require the initial determination of the total serum protein concentration, which is then used in calculation of the protein content of different fractions. In its simplest form, the globulin fraction can be estimated if the total protein and albumin concentrations are known. The globulin concentration is the difference between the total protein and albumin concentrations. For quantitative estimation of the subdivided globulin fractions ( $\alpha$ -,  $\beta$ -, or  $\gamma$ -globulins), the percentage of each fraction in a serum sample can be determined by electrophoresis and the concentration of each fraction calculated from the total protein by proportion.

### 1. Salt, Acid, and Glutaraldehyde Fractionation

The weak bonds that hold together the secondary, tertiary, and quaternary structures of proteins can be disrupted by a variety of changes in the aqueous environment leading to reduced solubility. Because of the different amino acid composition of proteins, alterations in the environment have differential effects on individual proteins, and salt fractionation of serum protein exploits this property. The addition of salts to serum increases the ionic concentration causing the flocculation and precipitation of the globulins (particularly  $\gamma$ -globulins), whereas albumin is more resistant to increased ionic charge and remains in solution. Precipitation with ammonium sulphate is a widespread technique used in the purification of serum (and other) proteins.

For diagnostic test use in animals, the most common application of salt precipitation is in assessment of the transfer of antibody ( $\gamma$ -globulins) from colostrum to the serum of the neonate (Weaver *et al.*, 2000). The optimal concentrations of sodium sulphite (Pfeiffer and Mcquire, 1977) or zinc sulphate (McEwan *et al.*, 1970) have been determined, which, when added to a serum sample, will only precipitate the  $\gamma$ -globulin fraction. Thus, serum from calves or foals in which passive transfer of immunoglobulin

has occurred will show an increase in turbidity, whereas a sample from a neonatal animal that has not absorbed colostrum antibody will remain clear. The simplicity of these methods has allowed their use as point-of-care methods. A recent reevaluation of the use of sodium sulphite found that a concentration of 18% (w/v) provided the optimal diagnostic value. With zinc sulphate as the precipitant, a similar diagnostic value was found, but it was affected by hemolysis and the test solution was not stable when exposed to atmospheric carbon dioxide (Tyler *et al.*, 1999).

An alternative approach to assessment of antibody transfer, which also causes the precipitation of the  $\gamma$ -globulin fraction, is the glutaraldehyde coagulation test (Sandholm and Kivisto, 1975). Glutaraldehyde reacts with free amino groups on proteins causing cross-links to form between protein chains and, if sufficient numbers are produced, will cause aggregation of the proteins and visible precipitate formation.  $\gamma$ -Globulins have the highest proportion of the basic amino acids (lysine, arginine), which have free amino groups available for reaction with glutaraldehyde. Therefore when mixed with glutaraldehyde at a predetermined concentration, a serum sample with a high  $\gamma$ -globulin concentration will form cross-links and precipitate formation will be visible, whereas a sample with low  $\gamma$ -globulin will not produce a precipitate. However, fibrinogen can also form cross-links with glutaraldehyde (Liberg *et al.*, 1975) and can cause interference with the test when it is used for antibody detection in plasma, especially in cases of hyperfibrinogenemia. Indeed, though the glutaraldehyde test was deemed to have poor sensitivity and specificity for detection of failure of passive transfer in calves (Tyler *et al.*, 1996), it was found to be a useful screening test able to distinguish between acute and chronic disease in horses (Brink *et al.*, 2005) because of this reaction with fibrinogen in plasma.

The seromuroid fraction of serum is a group of highly soluble glycoproteins that have the ability to remain in solution in the presence of perchloric acid while other proteins are precipitated. Methods have been developed to estimate this "acid soluble glycoprotein" fraction by addition of perchloric acid to aliquots of serum (Nagahata *et al.*, 1989). As most of the glycoproteins in the seromuroid (acid soluble glycoprotein) fraction are APP, this was an early means for monitoring the acute phase reaction.

## 2. Dye Binding and the Albumin:Globulin Ratio

Albumin has the highest concentration of any of the individual serum proteins, and valuable diagnostic information can be obtained by measurement of its concentration. Various dyes have been found that, after binding to albumin, change their absorbance and are used as a means to measure the protein in a spectrophotometer, in automatic analyzers, or in dry chemistry systems. The dyes used most widely for this procedure are bromocresol green (BCG)

and bromocresol purple (BCP). BCG has become the favored dye to utilize in dye-binding assays for albumin (Keay and Doxey, 1983), although BCP has been recommended for equine serum albumin (Blackmore and Henley, 1983). Accuracy of the dye-binding methods is generally acceptable within the albumin concentration reference ranges found in animals. However, the accuracy decreases outside the reference ranges and may be unacceptable at very low or very high albumin concentrations. With heparinized canine plasma, it is possible that interference from fibrinogen can lead to overestimation of the albumin concentration when using BCG (Stokol *et al.*, 2001).

Once the albumin and total protein concentrations have been determined, the globulin fraction can be calculated by subtraction of the albumin from the total protein concentrations. The albumin:globulin ratio can then be calculated (albumin concentration/globulin concentration). This provides a means of assessing the relative contribution of the albumin or the globulins to the total serum protein, which complements the analysis of either analyte alone (Section VII.B).

## C. Electrophoretic Fractionation of the Serum Proteins

Electrophoresis is the method of choice for analytical separation of protein. Serum protein electrophoresis (SPE) is currently regarded as the standard of reference for fractionation of serum protein. Serum rather than plasma is used as the sample for electrophoretic separation because it reduces the complexity of interpretation by the removal of fibrinogen. Many modifications have been made to the basic principles of electrophoresis since the separation of protein in an electric field was first pioneered by Tiselius (Tiselius, 1937). Many of these methods have been applied to serum proteins, but only a few have been employed in clinical biochemistry. A major difference between methods is the nature of the support material for the protein separation. From the mid-20th century, the cellulose acetate membrane was utilized for this purpose for SPE (Kohn, 1957). Toward the end of the century, electrophoresis on agarose gel was introduced and has become more popular in diagnostic laboratories. In contrast, biochemical research laboratories almost universally use polyacrylamide gel as the separation medium. Major advances have been made in the ability to separate protein with the introduction of two-dimensional electrophoresis (2DE) and associated proteomic techniques. Whereas SPE on agarose can separate serum into seven or eight fractions, it is claimed that proteomic methodologies can separate and also identify several hundred proteins simultaneously. Although these new methods have not been validated for use in domestic animal clinical biochemistry, it is valuable to be aware of the possibilities that could be available by application of these methods.

### 1. Principle of Electrophoresis

The principle for all protein electrophoresis is based on the movement of charged protein molecules in an electric field. In original studies in the early 20th century, electrophoresis was carried out in solution. This “free electrophoresis” was subsequently replaced by methods in which the proteins are separated in the matrix of a support medium in which the charged proteins and buffer ions are still able to move. The use of support medium has the benefit of reducing interfering problems and allows greater reproducibility. The choice of support can have direct consequences on the separation obtained during electrophoresis. As well as the nature of the support media, the migration of proteins depends on their size and charge, the pH and ionic composition of the buffer, and the strength of the electric field. The charge on the protein is dependent on the balance of acidic and basic amino acids in its primary structure and varies with pH. Thus, at a neutral pH, protein with a high proportion of acidic amino acids will have an overall negative charge, whereas a protein with a preponderance of basic amino acids will have an overall positive charge. SPE is usually performed at a basic pH (pH 8.6) so that most protein will have a negative charge. Molecules with a negative charge move toward the anode (positive electrode) when an electric current is passed through the solution. A side effect of agarose electrophoresis is that electroendosmosis occurs because of impurities in the agarose, causing the migration of the more basic ( $\gamma$ -globulins) proteins to the cathode (negative electrode).

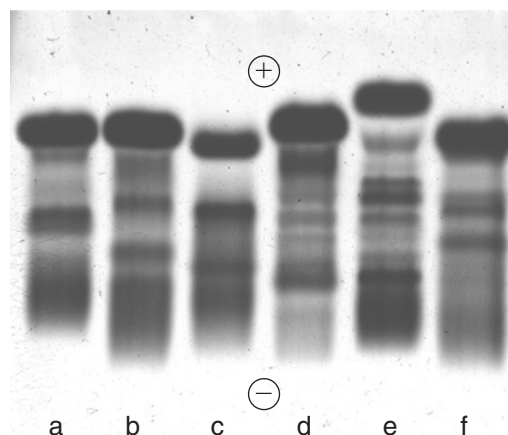
Interestingly, one of the most recent innovations in electrophoretic separation has been to revert to electrophoresis in the absence of support media, but in this case using a very narrow bore capillary column. This “capillary zone electrophoresis” has the benefit of providing more rapid and reproducible analyses for individual samples, but the equipment is more specialized than that for SPE. These methods have been applied to canine serum protein fractionation (Martinez-Subiela *et al.*, 2002b) with results analogous to conventional SPE, though hemolysis and lipemia were found to cause interference in the  $\beta$  and  $\alpha$  regions, respectively. Specific proteins such as haptoglobin can also be measured using capillary zone electrophoresis (Pirlot *et al.*, 1999).

### 2. Cellulose Acetate and Agarose Electrophoresis

For several decades, cellulose acetate was the method used in diagnostic laboratories for SPE, but the easier use, greater reproducibility, and commercial availability of agarose gels specifically produced for SPE have meant that use of the latter method is now more common. Agarose is a polysaccharide-based material derived from seaweed. When used for electrophoresis at a concentration of  $\sim 1\%$  (w/v), the agarose forms a gel through which serum protein

can move relatively freely. The introduction of plastic backed previously prepared gels meant that the handling, staining, and quantification of results could be easily undertaken.

Typically in an SPE run, serum samples are diluted 1:5 in buffer, and 5  $\mu$ l are placed close to the center of the gel, slightly on the cathodal side; after the sample has diffused into the agarose, a voltage is applied across the agarose and the proteins are allowed to separate. The mobility of the proteins is based on a mix of their charge at the pH of the buffer (usually pH 8.6) and the size of the protein. Albumin has a high negative charge under these conditions and is also relatively small, so it is one of the most mobile proteins in moving toward the anode. At the other extreme the immunoglobulins (especially  $\gamma$ -globulins) have the least negative charge and are affected by electroendosmosis and migrate toward the cathode. The  $\alpha$ - and  $\beta$ -globulins have intermediate mobility between albumin and the  $\gamma$ -globulins. Agarose SPE allows the subdivision of these groups, and  $\alpha_1$ ,  $\alpha_2$ ,  $\beta_1$ ,  $\beta_2$ ,  $\gamma_1$ , and  $\gamma_2$  fractions of proteins may be observed (Trumel *et al.*, 1996), though this can vary between samples and between species. Following electrophoresis the proteins are fixed in the gel and visualized by staining with a stain such as amido black. Usually 10 samples will be run on one agarose gel with each sample in a different “track.” After staining and clearing the gel, the proportion of proteins in each fraction can be estimated by densitometry. In most instruments a computer-generated printout will provide a graphical representation of the absorbance readings from the densitometer and will also calculate the percentage of protein per fraction. This allows the calculation of the protein content of each fraction based on the total serum protein concentration. Examples of agarose SPE and densitometer scans of the major domestic animal species are illustrated in Figures 5-2 and 5-3.

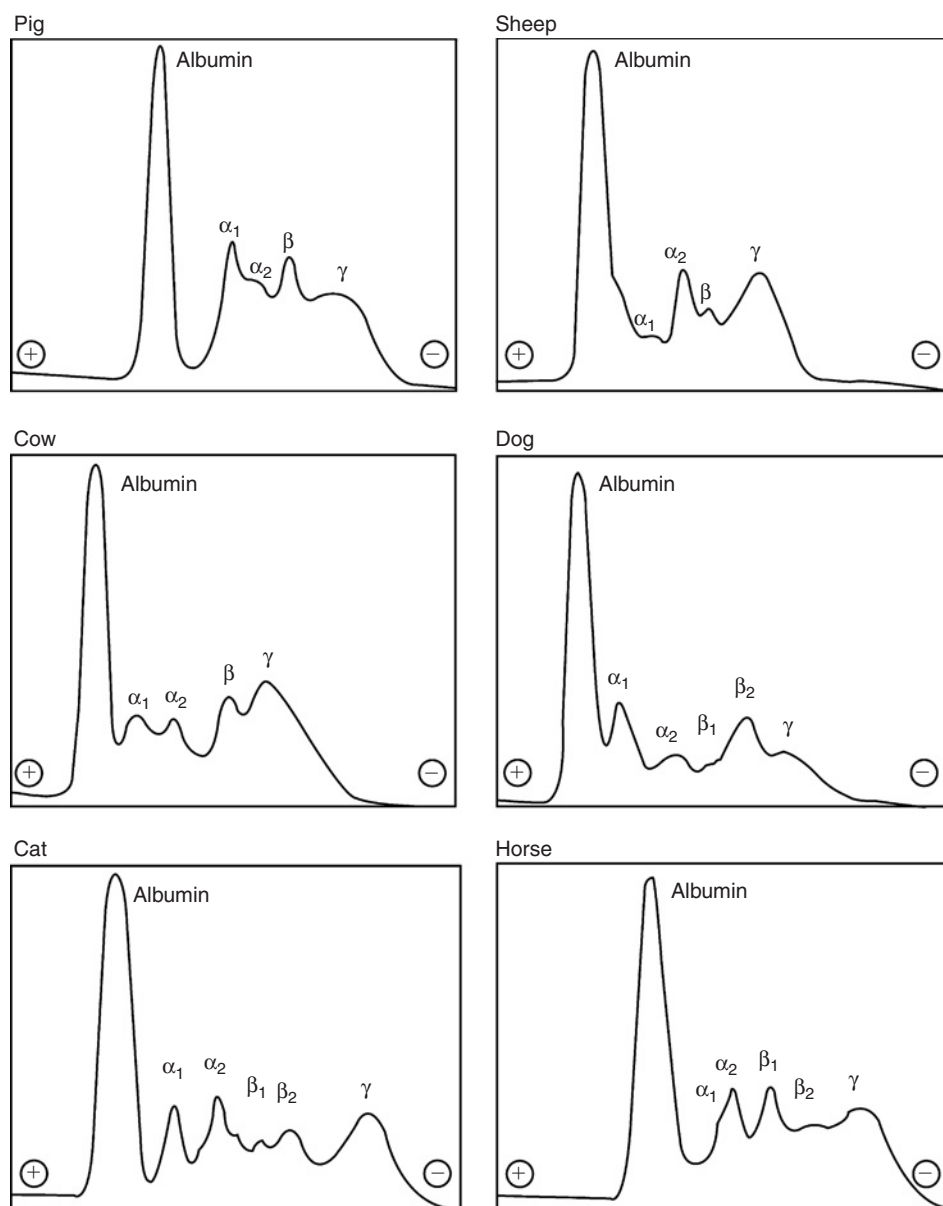


**FIGURE 5-2** Agarose gel serum protein electrophoresis showing the separation of normal serum protein from healthy animals. Samples are from (a) sheep, (b) cow, (c) pig, (d) dog, (e) cat, and (f) horse.

Although attempts have been made to classify the serum protein peaks in an electrophoretogram into more fractions (Keay, 1982; Keay and Doxey, 1982), it is the division into albumin,  $\alpha_1$ -,  $\alpha_2$ -,  $\beta_1$ -,  $\beta_2$ -,  $\gamma_1$ -, and  $\gamma_2$ -globulin fractions (Trumel *et al.*, 1996) that is predominantly used in the diagnosis of the dysproteinemias (Section VII.B). Agarose gel electrophoresis can therefore separate serum protein into several fractions, but apart from albumin, each of these is composed of a number of different proteins. This produces a frustrating limit to the usefulness of SPE in disease diagnosis. More advanced methods of protein separation have been developed but are not at present practical for a routine clinical biochemistry laboratory because of cost, reproducibility, and the ability to analyze

the amount of data that can be generated. However, if these obstacles could be overcome, protein separation would become even more useful than at present.

A recently introduced modification to the commercially available agarose gel allows high-resolution electrophoresis (HRE) to be employed for SPE. This method has been applied to canine serum and was able to localize specific serum proteins within the different subfractions. Thus, haptoglobin and  $\alpha_2$ -macroglobulin were identified in the  $\alpha_2$  fraction,  $\beta$ -lipoprotein and complement C3 were located in the  $\beta_1$  region, and transferrin and IgM were located in the  $\beta_2$  region (Abate *et al.*, 2000). The use of HRE may become more widespread as it is as user-friendly as conventional agarose electrophoresis.



**FIGURE 5-3** Electrophoretogram of agarose gel serum protein electrophoresis of serum from healthy animals.

### 3. Polyacrylamide Gel Electrophoresis and Isoelectric Focusing

The most widely used support medium for protein electrophoresis outside the diagnostic laboratory is polyacrylamide gel (PAGE). The use of this medium brings a further factor to the electrophoretic separation of protein. During the polymerization of acrylamide to form the gel used in electrophoresis, the proportion of cross-links between polymer chains can be controlled, and the gel forms a molecular sieve that slows the migration of proteins depending on size. In its original version of discontinuous polyacrylamide gel electrophoresis (Davis, 1964), a strategic use of different buffer systems in the gel, in the sample, and in running buffer caused the proteins in the sample to focus into a sharp band before entering the gel. Once in the gel, separation was based on a balance of mass and charge on the protein. The most widely used modification of this system is to pretreat the proteins by heating in a solution of detergent (sodium dodecyl sulphate, SDS) and a reducing agent such as  $\beta$ -mercaptoethanol. These have the effect of separating any subunits held together by disulphide bonds and coating all the proteins with negative charge so that separation, with the same detergent also in the gel and buffers, is based on size alone as all protein will move to the anode because of their negative charge. This is the SDS-PAGE system introduced by Laemmli (Laemmli, 1970). Separation of serum protein on SDS-PAGE increases the complexity for interpretation of the electrophoretogram. The proteins are no longer grouped in the familiar globulin regions but are in a series of bands defined by relative molecular mass ( $M_r$ ). The treatment and breakdown of complex proteins into their component subunits complicate interpretation. The high abundance of just a few of the proteins, such as albumin and the immunoglobulins, causes further difficulty in interpretation. Added to this are the more technically demanding methods required for SDS-PAGE such that this method is largely confined to the research laboratory. Nevertheless, separation of serum protein by SDS-PAGE has revealed disease-related changes in protein bands (Fagliari *et al.*, 1998; Kiral *et al.*, 2004), but there has not been a widespread application of the method in diagnostic biochemistry.

A further separation technique for electrophoretic fractionation of protein mixtures, introduced in the 1970s (Righetti and Drysdale, 1971), is isoelectric focusing (IEF). This technique, which can be performed in agarose or polyacrylamide gels, differs from other forms of electrophoresis by separating the proteins solely on the basis of their charge. The presence of special reagents, called ampholytes, in the buffer creates a pH gradient once an electric voltage is set up across the gel. Proteins in the gel move because of their relative charge, but once they reach their isoelectric point (pI) on the pH gradient, they become stationary, as they now have zero charge. Thus, an acidic protein with a negative charge will move toward the anode,

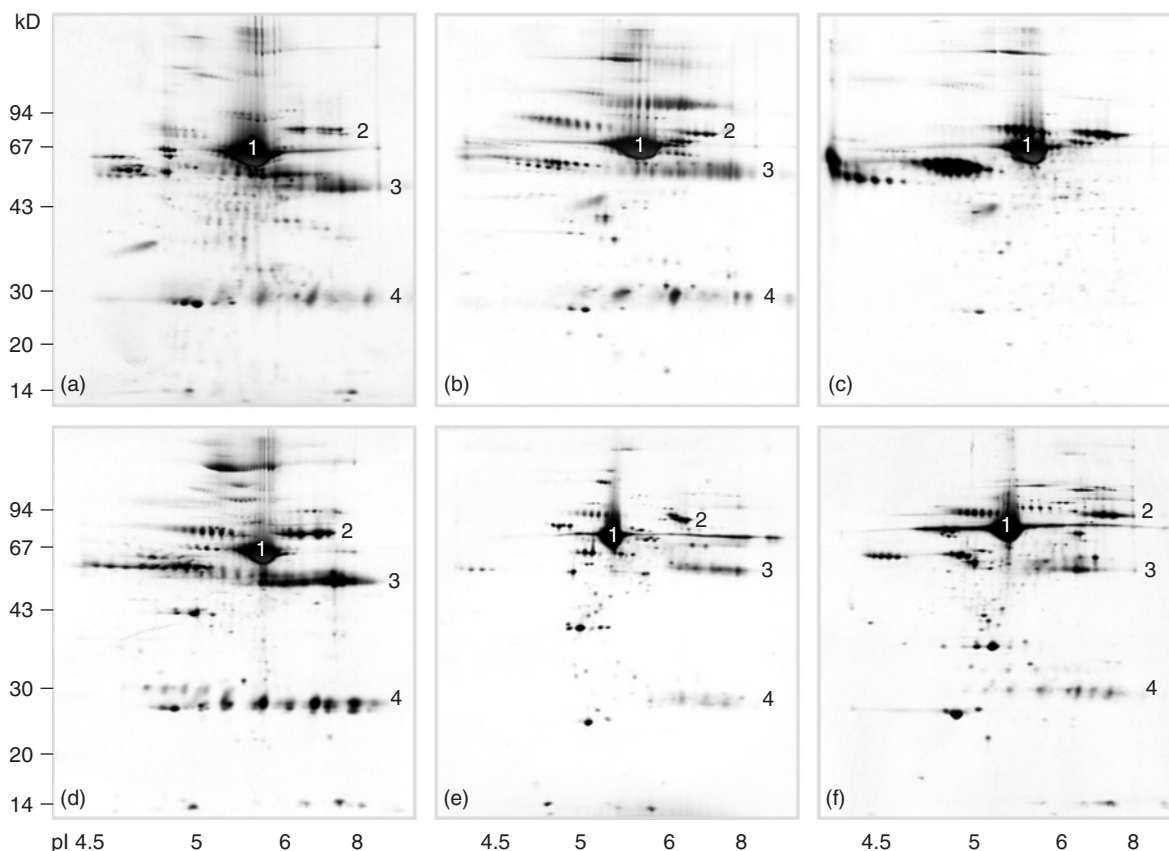
but as it moves down the pH gradient the protein becomes less charged until it reaches the point where it has no net charge and it is "focused" at their pI. This method has a high resolution and can separate protein isoforms that have only slight charge differences caused, for instance, by glycosylation or phosphorylation of proteins. This greatly increases the potential number of bands that can be seen on IEF gels, but the method has not been adopted by diagnostic clinical biochemistry laboratories for separation of serum proteins, possibly because of this great complexity. However, IEF has been used in examination of enzyme isoforms (Eckersall and Nash, 1983) and can be used to identify microheterogeneity in specific serum proteins, for instance, being able to differentiate multiple forms of AGP that are caused by different degrees of glycosylation (Itoh *et al.*, 1993a; Yoshida *et al.*, 1997).

### 4. Proteomics

Protein analysis is currently going through rapid evolution that could impact the veterinary diagnostic laboratory in the not-too-distant future and is being driven by advances in proteomics. Technological developments in different disciplines have converged to produce an approach to the separation, identification, and quantification of individual proteins within a complex mixture. The objective of a proteomic investigation is to be able to identify all proteins in a tissue or fluid and to detect even small changes taking place in its composition. Although this goal is still beyond the reach of all but the best-funded research laboratories, it is probable that proteomic techniques will eventually be used in diagnosis of disease. Analysis of serum or plasma protein will be at the forefront of these advances. It has been suggested that the human plasma proteome could be used to detect virtually all pathological processes because every diseased tissue is in contact with the circulation and interchanges material with plasma (Anderson and Anderson, 2002). As many as 1175 distinct gene products have been reported in human plasma by a combination of methods (Anderson *et al.*, 2004), whereas 289 proteins have been directly detected. However, only 117 of these have been registered in the United States by the Food and Drug Administration under the Clinical Laboratory Improvement Amendment for use in diagnostic investigation of plasma (Anderson and Anderson, 2002). Investigation of the diagnostic potential of animal serum or plasma proteomes is at a much earlier stage, but it has the potential to yield many novel diagnostic applications.

#### a. Two-Dimension Gel Electrophoresis

The new science of proteomics (James, 1997) initially developed from methods in which the electrophoretic techniques of IEF and SDS-PAGE were combined into two-dimensional electrophoresis (2DE) (O'Farrell, 1975). Combination of these methods leads to a protein map,



**FIGURE 5-4** Two-dimensional electrophoresis of serum protein from (a) horse, (b) cow postcolostrum, (c) cow precolostrum, (d) sheep, (e) cat, and (f) dog. Labeled proteins are 1: albumin, 2: transferrin, 3: IgG heavy chain, and 4: IgG light chain. Gels were run on an IPG gradient from pH 4-10 (nonlinear) and then on SDS-PAGE. Gels courtesy of Ingrid Miller, Institute of Medical Chemistry, Department of Natural Sciences, University of Veterinary Medicine, Vienna, Austria.

where a protein mixture is separated horizontally by charge (IEF) and vertically by molecular mass (SDS-PAGE) yielding a two-dimensional map with each protein present as a single spot. An innovation that meant that these protein maps were much more reproducible was the introduction of immobilized pH gradients for use in the IEF step (Gorg *et al.*, 2000, 2004). In 2DE, the protein sample is subjected to IEF in a gel strip containing the immobilized pH gradient, and then the strip with the focused protein is placed on the top of an SDS-PAGE gel. After electrophoresis, the separated proteins are stained, using either Coomassie blue or the more sensitive silver or fluorescent stains. The amount of data generated by a 2DE gel can be vast, and a computer program is required to handle the analysis.

The serum proteomes of a number of domestic animals are illustrated in Figure 5-4. It is noticeable that albumin is the most abundant protein in adult serum and that the IgG spots are missing in serum from a precolostral calf (Fig. 5-4c). The serum proteomes of cattle and horse have been more fully determined with 30 and 50 proteins identified,

respectively (Miller *et al.*, 2004; Wait *et al.*, 2002). Identification of protein spots following 2DE was originally performed with antibody detection, specific stains (e.g., for lipoprotein), or by comparison to the proteins of other species. A further advance that greatly facilitated proteomic research was the use of mass spectrometry to identify protein spots on gels.

#### b. Mass Spectrometry for Protein Identification

Mass spectrometry has been used for many years in investigations to measure the mass of molecules to a high degree of accuracy, but for a long time it was restricted to low-molecular-weight compounds. In the 1980s and 1990s, methods were introduced to determine the mass of larger molecules such as peptides and smaller protein. This was achieved with the introduction of electro spray ionization (ESI) (Fenn *et al.*, 1989) and matrix-assisted laser desorption/ionization (MALDI) (Karas and Hillenkamp, 1988). These methods are central to alternative approaches to identify the protein on 2DE gels and have accelerated the development

of proteomics. Mass spectrometry actually measures the mass-to-charge ratio ( $m/z$ ) of ions under vacuum. To perform this process, a means of generating the necessary ions, a mass analyzer and a detector are required (Patterson and Aebersold, 1995). In proteomic investigation, the most widespread approach is the MALDI time-of-flight (TOF) mass spectrometer, which is used in combination with database searches to identify the protein in a specific spot on 2DE protein maps.

Protein identification by MALDI-TOF mass spectrometry is based on some prior knowledge of the amino acid sequences of likely proteins to be identified or of equivalent proteins in other species. It is dependent on enzymic cleavage of the protein into shorter peptides, the size of which is defined by their component amino acids. Before mass spectrometry, the protein spot to be identified is cut out of the polyacrylamide gel and subjected to hydrolysis by a specific protease, usually trypsin. The site of action of trypsin is at the peptide bond of the basic amino acids lysine and arginine. The trypsin digest products of any proteins whose primary structure is held on international protein databases such as UniProt ([www.ebi.uniprot.org](http://www.ebi.uniprot.org)) or NCBI ([www.ncbi.nlm.nih.gov](http://www.ncbi.nlm.nih.gov)) can be predicted from the position along the protein sequence of the arginine or lysine residues. The tryptic digest product of any protein whose primary structure can be derived from genetic (DNA) databases can also be determined. These tryptic digest "fingerprints" are characteristic of each protein and identify protein spots after 2DE.

The trypsin-digested sample is mixed with a matrix compound and dried on a metal slide, which is inserted into the mass spectrometer. Bombardment of the slide by a laser results in the ionization of the peptides and application of a high voltage causes the ions to travel rapidly to the detector with smaller ions having a greater velocity. Thus, small peptides have a shorter time of flight than larger peptides, and from this the mass of each peptide is determined to a high degree of accuracy. The data generated by the MALDI-TOF are thus the mass of each of the peptides produced by the trypsin digest of the protein excised from the 2DE gel.

Identification of the protein is completed by comparison of the masses of all the peptides produced by trypsin digest to the protein and gene databases. This is especially useful in species where the whole genome has been sequenced such as human or mouse. There are means to identify proteins by this peptide fingerprint approach even where the genome has not been determined (Wait *et al.*, 2002), though a number of genomes of the domestic species (cow, dog, chicken) are close to being fully sequenced, which will simplify the proteomic investigation of samples from these species. More advanced mass spectrometry using ESI in tandem MS with quadruple instrumentation can directly determine sequences of peptides, but these methods are more time consuming. An advantage of MALDI-TOF is that it can be used in robotic systems where computer-controlled workstations can excise

multiple spots from a 2DE gel and automatically perform the trypsin digest, transfer the hydrolysate to the mass spectrometer, and identify the protein as a probability score of the most likely candidate protein.

### c. Non-Gel-Based Proteomic Analysis

When first developed, proteomics combined protein separation on 2DE and mass spectrometry. However, for use in diagnostic investigations, 2DE is an expensive, time-consuming, and difficult technique to reproduce precisely. It is likely to remain a research tool unless major advances are made in the robustness of the methodology. Interest is shifting to non-gel-based approaches to proteomics in which alternatives to 2DE are used for protein and peptide separation but with mass spectrometry still being used for identification. These methods have a greater potential for automation, throughput, precision, and accuracy, which may in the future allow their use in disease diagnosis.

One such approach is surface enhanced laser desorption ionization mass spectrometry (SELDI-MS). In this method, a sample such as serum is preincubated with a "protein chip," which has one of a variety of surfaces to which proteins bind with differing affinity. These surfaces are designed to bind with protein by ion-exchange, hydrophobic, or metal chelate interaction. After washing away unbound protein, the protein chip is placed in the SELDI-MS instrument and subjected to mass spectrometry. The system is optimized to identify biomarkers for disease by contrasting samples from healthy and diseased animals. This approach can identify peptide or protein peaks in the mass spectrogram that have potential as biomarkers and has been used to identify biomarkers for ovarian cancer and other diseases in humans (Petricoin *et al.*, 2002). A drawback of the current SELDI-TOF system is that identification of the protein biomarkers requires further investigation by traditional protein biochemistry methods.

Another approach to non-gel-based proteomics is nano liquid chromatography coupled to mass spectrometry. Native proteins are in general too large for mass spectrometry, so before separation the sample is treated with trypsin, producing shorter peptides. The peptides are separated by high-pressure liquid chromatography (HPLC) with the output coupled to an ESI mass spectrometer (Gaskell, 1997; Mehlis and Kertscher, 1997). The results can be plotted with elution volume from the HPLC against the mass/charge ( $m/z$ ) ratio of the peptide and the size of the peptides compared to protein and gene databases.

An interesting finding from a number of proteomic investigations using gel and nongel approaches designed to identify cancer biomarkers has been that many of the identified candidate biomarkers have already been identified with many of them being APP (Diamandis and van der Merwe, 2005). It will be fascinating over the next few years to see if these advanced techniques can earn a role in the veterinary diagnostic laboratory.



## D. Specific Protein Analysis

Serum protein is composed of many different individual proteins with current electrophoretic fractionation in routine diagnostic use (SPE) only providing a guide to the disease-related changes affecting serum proteins as only a small number of protein fractions can be consistently characterized. Undoubtedly the ideal diagnostic approach would be to monitor the changes in concentration of most if not all serum proteins, and this is the ultimate objective of proteomic investigation. However, until the technology advances sufficiently, the only means to measure changes in individual serum proteins is to use assays that directly measure the specific proteins. In recent years, there has been increasing success in identifying proteins with sufficient diagnostic value to develop suitable assays to perform routine analysis. Some serum proteins can be measured by methods where physical, chemical, or biological activities can be exploited (Sections V.A.2.b and V.B.2). However, most serum proteins are measured by immunoassay requiring a specific antibody raised against the target serum protein. Though there is cross reactivity between species for a number of serum proteins, it is advisable to use species-specific antiserum or to thoroughly validate assays developed with antisera to species other than the one under investigation.

### 1. Immunoassays for Serum Proteins

Immunoassays have become an established weapon in the arsenal of the clinical biochemistry laboratory, especially where the exquisite specificity of antibody can be harnessed for diagnostic procedures. Antibodies for use in immunoassays for serum proteins can be polyclonal or monoclonal. They are usually raised against the proteins purified from serum, though a recombinant protein may be produced if the gene sequence is known. There are several ways in which antibodies can be incorporated in immunoassays to provide qualitative or quantitative data with the choice of method being dependent on several factors. The range of analyte concentration, time taken to run an assay, and ease of automation are among the considerations taken into account when setting up an immunoassay for a specific serum protein.

#### a. Radial Immunodiffusion

One of the simplest methods for measurement of specific serum protein is radial immunodiffusion (RID). This method requires polyclonal antibody. The method is based on the precipitation in agarose gel of antigen-antibody complexes, and this does not occur with monoclonal antibodies as more than one binding site on the antigen is required for complex formation. The RID plates are prepared with agarose gel containing antibodies to the protein antigen at an optimized concentration. Sample is placed in a well in the agarose and allowed to diffuse for 24 to 48 hours. A precipitin ring forms because of the antibody-antigen reaction, the

diameter of which is dependent on the analyte concentration. The concentration of the protein in the sample is determined by comparison to standards. Radial immunodiffusion assays have been used to measure immunoglobulin and complement in serum and can distinguish between the different classes of antibody (see Chapter 6), and RID assays for acute phase proteins have also been developed (Ohwada and Tamura, 1995; Tamura *et al.*, 1989).

#### b. Immunospectrophotometry

Immunospectrophotometry (IT) and the related method of immunonephelometry also make use of the formation of antigen-antibody complexes, but in solution rather than in agarose gel. With the correct balance of antigen and antibody, the formation of antigen-antibody complexes can be followed in a spectrophotometer as flocculation occurs and absorbance increases. As the reaction takes as little as a few minutes, this is the method of choice for automation of analysis, but it is only suitable for protein concentrations above 0.5 to 1.0 mg/dl (5 to 10 mg/liter). This method is widely used in human clinical biochemistry for determination of protein such as CRP, but availability of suitable reagents has held back applications in veterinary medicine. However, IT methods for canine CRP (Eckersall *et al.*, 1991) and feline AGP (Bence *et al.*, 2005) have been described. Although commercial kits for human CRP based on IT have been validated for use in serum from some animal species (Kjelgaard-Hansen *et al.*, 2003), care has to be taken in their use, especially as antiserum batches may have differing cross-reactivities with animal protein so that batch-to-batch variation may occur. Immunonephelometry is a related method where reflected rather than absorbed light is measured, which aids in reducing interference. Another modification of the IT test is to make use of antibody-coated latex particles, which can make assays more sensitive as well as stabilizing the antibodies. A method using latex particles coated with antibody to human serum amyloid A has been validated to detect this protein in horses (Jacobsen *et al.*, 2005a; Stoneham *et al.*, 2001).

#### c. Enzyme-, Luminescent-, and Fluorescent-Linked Immunosorbent Assays

Enzyme-linked immunosorbent assay (ELISA) are a common format for many immunoassays and are used to detect or measure a wide variety of serum analytes including steroid and protein hormones, drug residues, immunoglobulins, and pathogen antigens. They can be performed in a number of formats with antigen or antibody absorbed onto the plastic surface of microtiter plate wells and with primary or secondary antibody being conjugated to a variety of labels to allow sensitive detection. Labels that have been used include enzymes such as horseradish peroxidase or alkaline phosphatase, whereas more recent developments have replaced enzyme labeling with fluorescent



or luminescent labels (Parra *et al.*, 2005a, 2005b). These labels extend the sensitivity and reproducibility of assays. Most immunoassays for specific serum proteins are based on ELISA formats and include assays for canine CRP, porcine and bovine Hp and a cross-species SAA immunoassay that can be used in most species as the antibody shows cross-species specificity for SAA (Eckersall *et al.*, 1989; Eckersall *et al.*, 2001; Hiss *et al.*, 2003; Sheffield *et al.*, 1993; Yule *et al.*, 1997). Immunoassays based on ELISA or related formats have been developed for low-abundance proteins found in serum that are used as biomarkers for disease in particular tissues. Thus, assays have been developed for biomarkers such as troponin I (Spratt *et al.*, 2005) as a cardiac biomarker and trypsin-like immunoreactivity as a biomarker for pancreatic disease and intestinal malabsorption (Fetz *et al.*, 2004; Steiner *et al.*, 2000; Williams and Batt, 1988).

#### d. Immunochromatography

Attempts have been made to produce immunoassays in formats that can be used in practice or on a farm as point-of-care assays. Latex agglutination has been used in tests in which visible agglutination can be observed and has been used in assays for IgG for confirmation of transfer of antibody from colostrum. A more recent innovation has been the development of immunochromatography in which application of a sample to a test slide leads to diffusion of a sample and reagent along a membrane and appearance of a colored line for a positive result. A test method based on this principle for canine CRP has been produced and was assessed for identification of animals with an acute phase response (McGrotty *et al.*, 2004). This technology should be able to produce rapid, in practice, testing for proteins, particularly when there is a large difference in concentration between health and disease states.

## 2. Biochemical Assays

Apart from albumin and fibrinogen (see Sections V.A and V.B), assays for a number of other serum proteins have been developed based on their chemical, physical, or biological activity. These generally have the advantage that they can be performed on automated biochemical analyzers, do not need the instrumentation required for the more sensitive immunoassays, and are usually applicable in all species.

Haptoglobin, an acute phase protein, can be measured by making use of its high affinity for hemoglobin and subsequent preservation of the peroxidase activity of this protein at low pH. Interference by albumin in this assay was eliminated by use of a novel reagent, which also incorporated the chromogen (Eckersall *et al.*, 1999). Ceruloplasmin, a copper-containing acute phase protein, can be estimated by measuring its endogenous oxidase activity (Ceron and Martinez-Subiela, 2004). Methods

have been described for measuring the protease inhibitors,  $\alpha_1$ -antitrypsin and  $\alpha_1$ -antichymotrypsin (Conner *et al.*, 1988a, 1988b, 1989), based on the specificity of their action, though these assays have not been automated.

### 3. Quality Assurance and Quality Control

An impediment to the greater use of specific protein assays is the lack of primary reference standards for calibration, quality control material, and the availability of quality assurance schemes. None of these is presently available from commercial sources. However, the European Union has funded a project to establish reference material for bovine and porcine serum proteins and to establish a quality assurance scheme, but at the time of the project too few laboratories were running specific protein assays to enable a scheme to be viable (Skinner, 2001). As more interest in the use of specific assays expands, this could be reactivated. Laboratories running the tests routinely should prepare their own material for internal quality control.

## VI. NORMAL PLASMA AND SERUM PROTEINS

Although 289 proteins have been reported in human plasma (Anderson and Anderson, 2002), only 70 assays have been validated to the extent of reporting reference intervals. Of these, only about 10 are currently employed for diagnostic testing in domestic animals. Table 5-3 gives an overview of serum proteins, but as proteins are under genetic control, variations occur between individuals and especially between species. Biochemical and pathophysiological features of albumin and several globulins that are being used for diagnosis of disease are described next, grouped by their function(s).

### A. Albumin

#### 1. Biochemistry

Albumin is the major single protein found in serum and constitutes 35% to 50% of the total serum protein. Bovine serum albumin, when synthesized and secreted by the hepatocytes, is a nonglycosylated protein of 583 amino acids with a molecular weight of 66.4 kDa and a pI of pH 5.6 (accession number P02769, UniProt database at [www.ebi.uniprot.org](http://www.ebi.uniprot.org)). Based on X-ray crystallographic studies on human serum albumin, the structure is a heart-shaped protein with three homologous domains (Fig. 5-5) (Nakajou *et al.*, 2003) containing 67% of the protein as  $\alpha$ -helix with no  $\beta$ -sheet (Curry *et al.*, 1998). A notable feature of the primary structure of albumin is that there is an odd number of cysteine residues (35 in total) so that, after the formation of 14 cysteine-cysteine internal disulfide

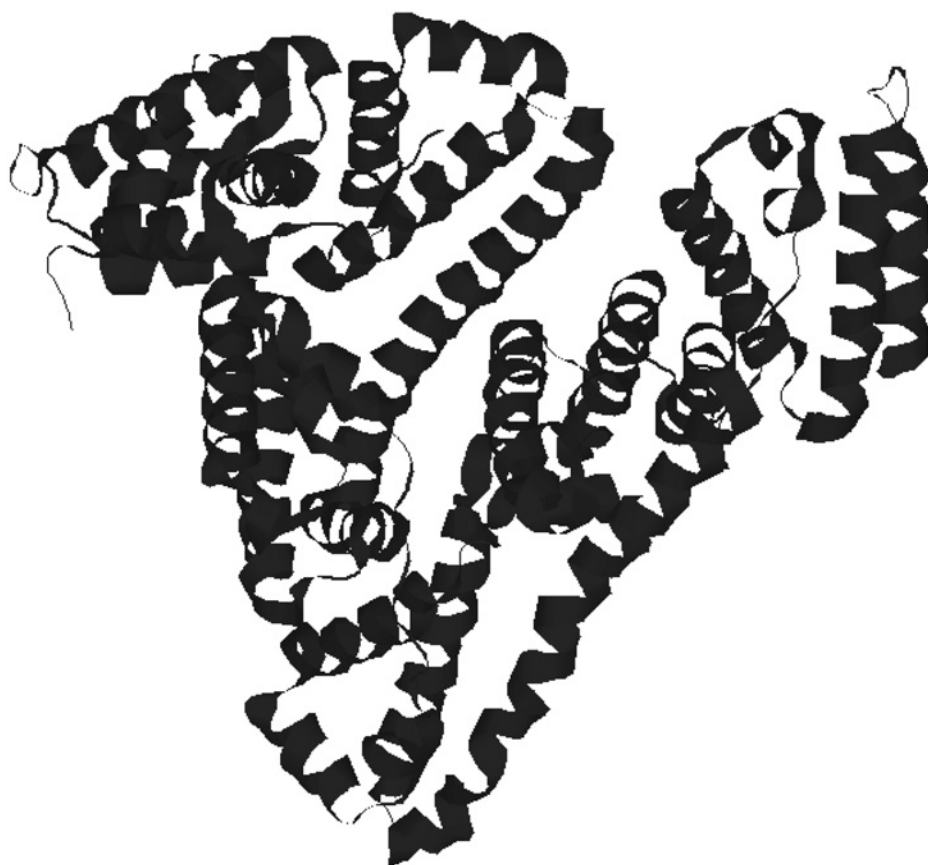
**TABLE 5-3** Common Serum Proteins, Their Functions, and Changes in Disease

Protein	M <sub>r</sub> (Da)	Function	Change in Disease
Prealbumin/Transthyretin	54,500	Thyroxine transport	Increase: nephrotic syndrome, Decrease: liver disease, protein deficiency, acute phase
Albumin	66,400	Osmotic pressure regulation, general transport	Increase: dehydration, Decrease: liver, kidney, gastrointestinal disease, acute phase response, malnutrition, blood, and plasma loss
<i>α</i> -Globulins ( <i>α</i> <sub>1</sub> and <i>α</i> <sub>2</sub> )			
Thyroxine-binding globulin (TBG)	54,000	Thyroxine transport	Increase: pregnancy
<i>α</i> <sub>1</sub> -Fetoprotein	65,000	Unknown	Increase: hepatoma, pregnancy, Decrease: liver disease, chronic pulmonary disease
<i>α</i> <sub>1</sub> -Protease inhibitor	45,000	Protease inhibitor	Increase: acute phase response, Decrease: liver disease, chronic pulmonary disease
<i>α</i> <sub>1</sub> -Acid glycoprotein (orosomucoid, seromucoid)	43,000	Immunomodulator, binds ligands, and drugs	Increase: acute phase response, Decrease: liver disease, nephrotic syndrome, malnutrition
<i>α</i> <sub>1</sub> -Antithrombin III	65,000	Thrombin inhibitor	Increase: possible acute phase response in cats Decrease: disseminated intravascular coagulation, protein-losing nephropathies, and enteropathies sepsis
<i>α</i> <sub>1</sub> -Lipoprotein (HDL, <i>α</i> -lipoprotein)	200,000	Lipid transport	Decrease: acute phase response
<i>α</i> <sub>2</sub> -Lipoprotein (VLDL, pre- <i>β</i> -lipoprotein)	1,000,000	Lipid transport	Increase: nephrotic syndrome, diabetes mellitus, hypothyroidism, steroid therapy
<i>α</i> <sub>2</sub> -Macroglobulin	62,000	Insulin binding, protease inhibitor	Increase: nephrotic syndrome, chronic active liver disease
Ceruloplasmin	151,000	Copper transport, ferroxidase	Increase: acute phase response
Haptoglobin	100,000	Hemoglobin binding	Increase: acute phase response, glucocorticoids in dogs Decrease: intravascular hemolysis
Protein C	62,000	Protease, anticoagulant	Increase: acute phase response
<i>β</i> -Globulins ( <i>β</i> <sub>1</sub> and <i>β</i> <sub>2</sub> )			
<i>β</i> <sub>2</sub> -Lipoprotein (LDL, <i>β</i> -lipoprotein)	2,750,000	Lipid transport	Increase: nephrotic syndrome, hypothyroidism, hepatocellular disease
Transferrin	76,000	Iron transport	Increase: iron deficiency, acute liver disease, nephrotic syndrome, chronic hepatopathy, Decrease: iron storage disease, acute phase response, inflammatory disease
Ferritin	465,000	Iron transport	Increase: iron storage disease, acute phase response Decrease: iron deficiency
Hemopexin	80,000	Heme transport	Decrease: hemolytic anemia, chronic active liver disease
C3 complement	75,000	Complement C3 factor	Increase: acute inflammatory disease, atopic dermatitis Decrease: autoimmune disease
C-reactive protein	100,000	Activate complement	Increase: acute phase response
C4 complement		Complement C4 factor	Increase: acute phase respons, Decrease: autoimmune disease
Plasminogen		Proenzyme of plasmin, fibrinolysis	Increase: disseminated intravascular coagulation
Fibrinogen	340,000	Fibrin precursor, coagulation	Increase: acute phase response, Decrease: disseminated intravascular coagulation, hereditary afibrinogenemia

(continued)

TABLE 5-3 Continued

Protein	M <sub>r</sub> (Da)	Function	Change in Disease
$\gamma$ -Globulins ( $\gamma_1$ and $\gamma_2$ )			
Immunoglobulin G (IgG)	150,000	Major antibody formed in response to infective agents, toxins	Increase: infectious disease, connective tissue disease, liver disease, myelomas and other lymphoid tumors Decrease: fetuses, newborn animals before intake of colostrum, immune deficiency disease, hereditary agammaglobulinemia
Immunoglobulin A (IgA)	150,000	Secretory antibodies in the fluids of the respiratory, gastrointestinal, and the genitourinary tracts	Increase: infectious disease, connective tissue disease, liver disease, myelomas and other lymphoid tumors Decrease: fetuses, newborn animals before intake of colostrum, immune deficiency diseases
Immunoglobulin E (IgE)	200,000	Antibodies in allergy	Increase: allergies, anaphylaxis
Immunoglobulin M (IgM)	900,000	Antibody formed early in response to infective agents, cold agglutinin, initiator	Increase: inflammatory disease, primary cell reactions, macroglobulinemia (Waldemstrom's)
Light chains (Bence-Jones protein)	30,000	Part of the immunoglobulin molecule	Increase: myeloma



**FIGURE 5-5** The molecular structure of human serum albumin (Curry *et al.*, 1998). Note the high proportion of  $\alpha$ -helices. Figure generated by Rasmol from UniProt Accession number P02768 and protein database entry 1N5U.

bonds, there is a free cysteine residue, which is important for certain functions of the protein.

Following SPE, albumin is the most prominent band and has the most anodal mobility of the serum proteins in most

species resulting from its high proportion of acidic amino acids and a relatively small size. There is variation between species in the mobility of albumin on agarose SPE (see Fig. 5-2), which does correspond to their proportion of

acidic and basic amino acid residues. Porcine albumin has 97 acidic and 83 basic amino acid residues, whereas feline albumin has 100 acidic and 75 basic amino acid residues, and these proportions result in a relatively high mobility for feline albumin and low mobility for porcine albumin.

Albumin is synthesized in the cytoplasm of the hepatocyte, being transferred from bound ribosomes to rough membrane to cisterna, then via the smooth endoplasmic reticulum to the Golgi complex, and through the membrane to the sinusoid (Prinsen and de Sain-van der Velden, 2004). The rate of albumin synthesis is controlled by the colloid osmotic pressure, although it can be influenced by hormones such as insulin, thyroxine, and cortisol (Evans, 2002). Only about 30% to 40% of albumin is in the blood; the remainder is in the interstitial space. Once secreted into the circulation, albumin is modified by covalent, irreversible, but nonenzymic glycation of lysine residues such that 6% to 10% of albumin is in reality glycoalbumin following conjugation to glucose or galactose. This can rise to 20% to 30% in (human) hyperglycemic patients (Nakajou *et al.*, 2003). Catabolism of albumin occurs in various tissues where it enters cells by pinocytosis at a rate related to atrial natriuretic peptide concentration (Evans, 2002) and is then degraded by protease action. Muscle, liver, and kidney are the main contributors to albumin catabolism with 40% to 60% of the total albumin being broken down in these tissues (Prinsen and de Sain-van der Velden, 2004). The turnover of albumin differs with species but is related to the body size (see Table 5-2). The half-time for clearance of albumin varies from 1.9 days in the mouse to 19.4 days in the horse. Whereas originally radioactive isotopes such as  $I^{131}$  were required for studies on protein turnover, a new generation of markers based on stable isotopes (Preston *et al.*, 1998; Prinsen and de Sain-van der Velden, 2004) have been introduced, and it could be that diagnostic applications of serum protein turnover rates will prove to be valuable in the future.

## 2. Function and Physiology

Maintaining the colloid osmotic pressure and the blood volume is an important action for albumin and is a function that is disproportionate to its serum concentration. Although albumin is only about 50% of the total protein mass in the circulation, it is responsible for 80% of the colloid osmotic pressure. This is because it has a lower molecular mass (67kDa) than the mean of the globulins (170kDa) and also because of its contribution to the Donnan effect from its high net negative charge (Prinsen and de Sain-van der Velden, 2004). Another major function of albumin is as a transport protein. A number of metabolites circulate in blood bound to this protein. Binding to albumin assists the transport of substances that are sparingly soluble in aqueous media and also prevents loss through the kidney of important small molecules. Thus,

fatty acids, cholesterol, bilirubin, nitric oxide, and metal ions circulate bound to albumin (Evans, 2002). As well as metabolites, a variety of pharmacological compounds bind to albumin and four discrete sites have been identified on the molecule. Drugs such as phenytoin, digoxin, nonsteroidal anti-inflammatories, and antibiotics interact via these binding sites (Evans, 2002). The exposed cysteine residue of albumin, which does not form an internal disulfide bond, has an important role in the action of albumin as an antioxidant. The free cysteine is an avid scavenger of reactive oxygen and peroxynitrite radicals such that albumin may actually be the major and predominating antioxidant in the circulation (Anraku *et al.*, 2001). Albumin is a negative acute phase protein and its concentration falls gradually during infectious and inflammatory disease.

## B. Acute Phase Proteins

Studies on individual serum proteins of domestic animals have expanded greatly since the 1990s (Ceron *et al.*, 2005; Murata *et al.*, 2004; Paltrinieri, in press; Petersen *et al.*, 2004). This has largely been caused by the realization that monitoring the levels of the acute phase proteins (APP) can provide a means to assess the innate immune system's response to disease and in the ability of the APP to provide a "molecular thermometer." As these proteins change their serum concentration by >25% in response to inflammation, infection, and trauma, many conditions can cause their elevation or decrease. Therefore, as quantitative markers for disease they can be used for prognosis and monitoring responses to therapy, for general health screening, as well as for diagnosis of disease. The APP are highly sensitive for the presence of pathological lesions while having a low specificity for a particular disease. The APP are now recognized as having an important role to play in the diagnosis of disease in animals, but there are major differences between species in the pathophysiological change in their concentrations during an acute phase reaction. Furthermore, although initial interest focused on proteins that increase in concentration during this response (positive APP), a number of serum proteins decrease in concentration and can be considered to be negative APP.

In any one species, positive APP have been found that have major, moderate, or minor responses. A major APP has a low concentration in the serum of healthy animals, often at <0.1  $\mu\text{g}/\text{dl}$  (<1  $\mu\text{g}/\text{liter}$ ) but with the concentration increasing over 100- or 1000-fold on stimulation, reaching a peak 24 to 48 hours after the insult and falling rapidly during recovery. A moderate APP is present in the blood of healthy animals, but on stimulation the concentration will increase 5- to 10-fold, reach a peak concentration 2 to 3 days after stimulation, and decrease more slowly than the major APP. A minor APP shows a gradual increase and only increases in concentration by 50% to 100% of the

**TABLE 5-4** Acute Phase Protein: Major and Moderate Responders in Various Animal Species

Species	Major APP	Moderate APP
Cat	SAA	AGP, Hp
Cow	Hp, SAA	AGP
Dog	CRP, SAA	Hp, AGP, Cp
Horse	SAA	Hp
Mouse	SAA	Hp, AGP
Pig	CRP, MAP	Hp, Cp
Rat	$\alpha_2$ -macroglobulin	Hp, AGP

resting level. The major and moderate APPs for domestic species are given in Table 5-4.

Production of APP is controlled by cytokines, with the proinflammatory cytokines interleukin-1, interleukin-6, and tumor necrosis factor- $\alpha$  released from the site of pathogenic or inflammatory damage stimulating the production of the APP. The mechanism of production has been elucidated (Jensen and Whitehead, 1998; Moshage, 1997) and involves cytokine receptor, signaling pathways, and induction of mRNA for the APP, which are released 6 to 12 hours after stimulation. The liver is the main site of synthesis of the APP, but there have been recent reports of nonhepatic tissues such as lung, adipocyte, and intestine increasing expression of mRNA for APP following stimulation (Friedrichs *et al.*, 1995; Urieli-Shoval *et al.*, 1998; Vreugdenhil *et al.*, 1999; Yang *et al.*, 1995). The mammary gland has been shown to be the source of significant amounts of the APP haptoglobin and mammary-associated serum amyloid A during infection of the gland in cattle (Eckersall *et al.*, 2001; Gronlund *et al.*, 2003; Hiss *et al.*, 2004).

The functions of the APPs are varied but generally relate to the defense of the animal to pathological damage and restoration of homeostasis. Indeed the acute phase response is an integral component of the innate immune response (Beutler, 2004) forming the first reaction of the host to pathogens and tissue damage. The innate response and the APP predate the acquired immune response during evolution. Though varied, the functions of many APP can be grouped together. A number of the APP ( $\alpha_1$ -antitrypsin,  $\alpha_2$ -macroglobulin) have antiprotease activity designed to inhibit proteases released by phagocytes and other cells of the immune system to minimize damage to normal tissues. A number of APP (haptoglobin, SAA, CRP) have scavenging activities and bind metabolites released from cellular degradation so they can reenter host metabolic processes rather than be utilized by pathogen. Other APP actions include

antibacterial activity and the ability to influence the course of the immune response (AGP, SAA, CRP).

## 1. C-Reactive Protein

### a. Biochemistry

C-reactive protein (CRP) was the first acute phase protein to be recognized (Pepys, 1981). It is named from its ability to bind to C-polysaccharide of Gram + bacteria, but it has since been shown that CRP has a high affinity for phosphorylcholine and related membrane lipids as well as for DNA (Marnell *et al.*, 2005). The protein is a pentraxin, being composed of five subunits (~20 kDa) combining in the same plane to form a pentameric structure (Fig. 5-6), which can be seen as a distinct structure using an electron microscope (Thompson *et al.*, 1999). Each subunit of CRP contains a binding site for ligand. Human CRP is nonglycosylated and the subunits migrate as a single band on SDS-PAGE, whereas canine CRP migrates as a double band and two of the five subunits are glycosylated (Caspi *et al.*, 1987).

### b. Function and Pathophysiology

Following bacterial infection, CRP binds to pathogen and activates the classical complement pathway leading to the opsonization of the bacteria. Binding of CRP to pathogen also interacts with specific receptors on phagocytes, induces anti-inflammatory cytokine production, and modulates neutrophil function (Du Clos and Mold, 2001).

There is considerable species variation in the pathophysiology of CRP. In a number of species such as dog and pig, CRP is a major APP, and its serum concentration can increase rapidly from <0.5 mg/dl (<0.5 mg/liter) to more than 10 mg/dl (100 mg/liter). In other species such as cow and cat, CRP has been reported to be a constitutive serum protein with only a minor increase during disease. A number of infectious diseases lead to an increase in CRP in the dog including babesiosis, leishmaniasis, leptospirosis, parvoviruses, trypanosomiasis, and infection with *Bordetella bronchiseptica*, *Ehrlichia canis*, and *Escherichia coli* sepsis (Ceron *et al.*, 2005). Relatively moderately raised levels of CRP have been found in inflammatory bowel disease (Jergens *et al.*, 2003) and in hematological and neoplastic diseases of the dog (Tecles *et al.*, 2005). Elevated levels of canine CRP have been observed in serum from mid-gestation of pregnant bitches with its appearance coinciding with the implantation of the embryo in the endometrium (Eckersall *et al.*, 1993; Vannucchi *et al.*, 2002). It has been postulated that sufficient damage is caused to the endometrium by this process to stimulate the acute phase response in the maternal circulation.

In the pig, CRP concentration increases following aseptic inflammation (Lampreave *et al.*, 1994) and with experimental infection with *Actinobacillus pleuropneumoniae* where plasma



**FIGURE 5-6** The molecular structure of C-reactive protein (Thompson *et al.*, 1999). It is a pentraxin with five identical subunits, each of which has a binding site for ligands such as phosphorylcholine. Figure generated by Rasmol from UniProt accession number P02741 and protein database entry 1B09.

levels also correlated with clinical findings and were reduced following antibiotic treatment (Lauritzen *et al.*, 2003).

## 2. Haptoglobin

### a. Biochemistry

Haptoglobin is a glycoprotein composed of  $2\alpha$  and  $2\beta$  subunits with the  $\alpha$  subunit having a molecular weight of 16 to 23 kDa and the  $\beta$  subunit 35 to 40 kDa. The subunits combine in the form of a  $\beta$ - $\alpha$ - $\alpha$ - $\beta$  chain. Human Hp has three subtypes known to be genetic polymorphisms (Hp 1-1, Hp 1-2, Hp 2-2). Canine Hp is thought to be similar to human Hp 1-1, whereas bovine Hp has closer similarities to Hp 2-2. Bovine and ruminant Hp in general have noticeable species differences from the Hp in carnivores and omnivores. In the ruminants, Hp tetramers form polymers with other Hp tetramers and a macromolecular complex with a molecular mass of 1000 to 2000 kDa is formed (Morimatsu *et al.*, 1991). The mechanism of polymer formation in ruminant serum is thought to depend on the presence of a gene duplication in the  $\alpha$ -chain, which results in a free cysteine residue capable of forming disulfide bridges

between Hp tetramers as occurs in the human Hp 2-2 phenotype (Bowman, 1992). Another difference between Hp in ruminants and many other species is that this protein is not present in serum from healthy animals, only appearing during the acute phase response.

### b. Function and Pathophysiology

The primary function of Hp is to bind free hemoglobin in the blood. The affinity of Hp for hemoglobin is one of the highest among transport proteins (Bowman, 1992), and by removing from the circulation any free hemoglobin, which has inherent peroxidase activity, Hp prevents it causing oxidative damage to tissues (Yang *et al.*, 2003). The Hp-hemoglobin binding also reduces the availability of the heme residue and its iron from bacterial use, and therefore Hp has an indirect antibacterial activity (Eaton *et al.*, 1982). The Hp-hemoglobin complex is recognized by CD163, a surface receptor on macrophages, which leads to its rapid removal from the circulation (Graversen *et al.*, 2002). A number of immunomodulatory activities have been ascribed to haptoglobin (Murata *et al.*, 2004). In knockout mice, in which the Hp gene was removed, the

major lesions were related to hemoglobin-derived lipid peroxidation (Lim *et al.*, 1998), confirming that Hp has a role in the antioxidant defenses of the body.

The acute phase profile of Hp differs between species. In ruminants, it is a major APP with circulating levels below 2 mg/dl (20 mg/liter) but it can increase in concentration to reach 0.2 g/dl within a couple of days of infection. In dogs, cats, horses, and pigs, the normal level is in the range of 0.10 g/dl to 0.2 g/dl (1 to 2 g/liter), whereas during infectious or inflammatory disease this may rise to 5g/liter or more. Haptoglobin has been the main APP studied in ruminants because of its reaction during the acute phase response and also because of its ease of analysis. In cattle, it has been shown to be an effective marker for the presence, severity, and recovery in cattle with mastitis, enteritis, peritonitis, pneumonia, endocarditis, and endometritis, and for monitoring processes such as tail docking and surgical castration (Murata *et al.*, 2004; Petersen *et al.*, 2004). Elevations have also been reported in cows with fatty liver syndrome, at parturition, during starvation, and following the stress of road transport (Ametaj *et al.*, 2005; Bionaz *et al.*, 2007; Katoh and Nakagawa, 1999; Nakagawa *et al.*, 1997; Uchida *et al.*, 1993). Increases of APP during noninfectious disease that involve lipid metabolism may be explained by the release of cytokines from adipose tissue or adipose tissue macrophages that have been implicated in human obesity-related diseases (Tilg and Moschen, 2006).

In pigs, raised Hp was found to be associated with clinical signs of lameness, respiratory disease, diarrhea, tail bite, and ear necrosis, and at slaughter it was found to be related to the presence of lesions and chronic abnormalities. Experimental or natural infection with *Actinobacillus pleuropneumoniae*, *Mycoplasma hyorhinis*, *Toxoplasma gondii*, *Bordetella bronchiseptica*, *Pasteurella multocida*, and porcine reproductive and respiratory syndrome virus leads to increased Hp concentration in serum (Petersen *et al.*, 2004).

Haptoglobin is a moderate APP in dogs and responds to inflammatory and infectious disease. However, canine Hp is particularly sensitive to glucocorticosteroids, and elevated levels of Hp are found both after treatment with glucocorticosteroids and during naturally occurring hyperadrenocorticism (Harvey and West, 1987; Martinez-Subiela *et al.*, 2004; McGrotty *et al.*, 2005). This is a disadvantage in monitoring inflammatory disease with canine Hp, but a full understanding of this process may reveal novel uses for the Hp assay, possibly as a screening method for Cushing's syndrome. The glycosylation of canine Hp alters during the acute phase reaction (Andersson and Sevelius, 2001; Andersson *et al.*, 1998), but methodology is currently too cumbersome to allow such changes to be used for diagnostic purposes. In horses, Hp has been found elevated in animals with systemic inflammatory responses, alimentary laminitis, and grass sickness (Fagliari *et al.*, 1998; Hulten *et al.*,

2002; Milne *et al.*, 1991). Little information is available on the pathophysiology of Hp in cats. It is removed from blood within a few hours after binding free hemoglobin in plasma (Harvey and Gaskin, 1978), and levels are elevated in feline infectious peritonitis and other inflammatory disorders (Duthie *et al.*, 1997).

### 3. Serum Amyloid A

#### a. Biochemistry

Serum amyloid A (SAA) is a small hydrophobic protein (9 to 14 kDa) that is found in serum associated with high-density lipoprotein (HDL). In humans, four isoforms have been identified that are separate gene products (Jensen and Whitehead, 1998). Of these, SAA1 and SAA2 respond to an acute phase reaction with increasing production from the liver. In contrast, SAA4 is a constitutive protein that is produced normally at a low level and is not affected by the acute phase response. The SAA3 is expressed in nonhepatic tissues during the acute phase response with increases found in lung (Wilson *et al.*, 2005), adipose tissue (Fasshauer *et al.*, 2004), ovarian granulosa (Son *et al.*, 2004), and in the mammary gland (Weber *et al.*, 2006). This isoform has also been detected in bovine colostrum (McDonald *et al.*, 2001). Serum amyloid A is the precursor of amyloid A and is therefore implicated in the pathogenesis of amyloidosis (Uhlir and Whitehead, 1999).

#### b. Function and Pathophysiology

A number of functions have been ascribed to SAA including reverse transport of cholesterol from tissue to hepatocytes, inhibition of phagocyte oxidative burst, platelet activation, and a number of *in vitro* immune responses (Petersen *et al.*, 2004). A direct antibacterial action of SAA was described in which SAA was found to bind to Gram-negative bacteria leading to opsonization of the target bacteria (Hari-Dass *et al.*, 2005). It has been demonstrated that the M-SAA3 isoform found in colostrum stimulates the production of mucin from intestinal cells assisting the initiation of secretions from the neonatal intestine and helping to prevent bacterial colonization (Larson *et al.*, 2003; Mack *et al.*, 2003).

It is only relatively recently that immunoassays became available for measuring the concentration of SAA, but it is already apparent that this analyte will be of great value in monitoring the acute phase response, especially in species in which CRP is not a major APP. Therefore, in ruminants, horses, and cats, SAA assay may become a routine analysis included in the assessments of infection and inflammation. In cattle, SAA has been identified as a marker of inflammation being elevated more in acute rather than chronic conditions (Horadagoda *et al.*, 1999). It was raised also by experimental infection with *Mannheimia haemolytica*, with bovine respiratory syncytial virus, and in experimental and natural cases of mastitis (Eckersall *et al.*, 2001; Gronlund

*et al.*, 2003; Heegaard *et al.*, 2000; Horadagoda *et al.*, 1994). The mammary isoform of SAA (M-SAA3), which is expressed and secreted in milk from mammary glands of dairy cows with mastitis (Eckersall *et al.*, 2001; Jacobsen *et al.*, 2005b; Nielsen *et al.*, 2004; Winter *et al.*, 2003), is also found in milk from ewes with this condition (Winter *et al.*, 2003).

In the horse, SAA is a major APP with a large dynamic range between the resting level in the healthy animal and the concentrations obtained in serum from horses with infection or inflammation (Jacobsen and Andersen, 2007; Pepys *et al.*, 1989; Stoneham *et al.*, 2001). Increased SAA concentrations have been observed in horses following surgery, with aseptic inflammation or arthritis, septicemia, enteritis, pneumonia, and diarrhea (Petersen *et al.*, 2004). Measurement of the SAA concentration was found to be of value in diagnosis of horses with colic, especially where inflammation was the primary component of the pathogenesis (Vandenplas *et al.*, 2005). Experimental infections with equine herpesvirus and influenza virus have also resulted in an increase in the SAA concentration (Hulten *et al.*, 1999; Pepys *et al.*, 1989).

Determination of the SAA concentration may be similarly useful in cats as it was shown to be the most rapidly responding APP in a variety of inflammatory and infectious conditions (Kajikawa *et al.*, 1999), and the cat is another species where CRP does not show a major response. In the dog, the circulating concentration of SAA does increase during an acute phase response and has been observed in experimental parvovirus infection (Yule *et al.*, 1997) and in leishmaniasis (Martinez-Subiela *et al.*, 2002a). However, with CRP becoming the primary canine APP, it is likely that SAA will be used in a secondary role in monitoring the acute phase response in this species. The relationship of serum concentration of SAA with familial amyloidosis as encountered in Siamese and Abyssinian cats and Chinese shar-pei dogs remains to be fully elucidated (Johnson *et al.*, 1995; Niewold *et al.*, 1999).

#### 4. $\alpha$ -1 Acid Glycoprotein

##### a. Biochemistry

Alpha-1 acid glycoprotein (AGP) is one of the most highly glycosylated proteins in serum with a molecular mass of around 43kD, of which approximately 45% is covalently linked carbohydrate. These branched carbohydrate side chains are composed of linked monosaccharides such as mannose, galactose, and glucose with the final group in the chain usually being sialic acid (N-acetyl-neuraminic acid). Thus, negatively charged groups are located at the end of each chain leading to the low pI of AGP of 2.8 to 3.8. The sialic acid residues are also important for the structure of the protein. Studies on feline AGP have revealed that its branching degree was very low and that a decrease in sialic acid expression occurred during infection with

feline infectious peritonitis virus (Ceciliani *et al.*, 2004). In feline leukemia virus infections, the degree of sialylation was reduced in cats diagnosed with lymphoma (Pocacqua *et al.*, 2005). In contrast, feline AGP from cats with feline immunodeficiency virus infection showed a wide range of variation of the glycan chains.

##### b. Function and Pathophysiology

Though the precise role of AGP is not clear, it does bind to a number of endogenous metabolites such as heparin, histamine, serotonin, steroids, and catecholamines (Israili and Dayton, 2001). A related action of AGP is its ability to bind to pharmacological compounds. This ability to bind to drugs may have therapeutic implications as the amount of drug bound can affect the free concentration of drug, which is the metabolically active fraction. Increased AGP because of an acute phase response may reduce the concentration of free drug and could therefore affect pharmacokinetics (Ikenoue *et al.*, 2000). The ability of AGP to bind low-molecular-weight ligands may also have a general protective role as it binds to toxic lectins and endotoxins. AGP also has several putative roles in the innate defense against infection and modulating the immune reaction. It can inhibit the attachment of *Mycoplasma pneumoniae* to alveolar macrophages and can inhibit some strains of influenza-virus. Furthermore, phagocytosis, neutrophil activation, and platelet aggregation are inhibited by AGP, and it may have a role in the maturation of T- and B-lymphocytes. (Israili and Dayton, 2001). A biologically important alteration of the glycosyl residue on AGP is the expression during inflammatory disease of the sialyl Lewis-X antigen, which is one of the major groups expressed on leukocytes and is involved in leukocyte migration across the endothelium (Degraaf *et al.*, 1993).

In most species, AGP is a moderate APP increasing more slowly but also remaining elevated for longer than the major APP such as canine CRP or bovine SAA and Hp. However, this may be advantageous in diagnosis in that inclusion of AGP in an acute phase profile would provide information on conditions as they move from acute to chronic. In a study of inflammatory disease in cattle, serum from animals with chronic conditions had a higher proportion of raised AGP than either SAA or Hp (Horadagoda *et al.*, 1999). Indeed the term "acute phase protein" is in some ways a misnomer as it is not just acute conditions that lead to the elevation of APP. Continued production of at least some APP in chronic or subclinical disease may be of equal importance to their appearance in acute conditions, which can be more obvious to diagnose.

Feline AGP was found to be raised, though not as rapidly as SAA, in a variety of inflammatory and infectious diseases as well as postsurgery (Kajikawa *et al.*, 1999). The measurement of AGP in feline serum and peritoneal fluid has become a recognized differential test for the identification of feline infectious peritonitis (Duthie *et al.*, 1997;



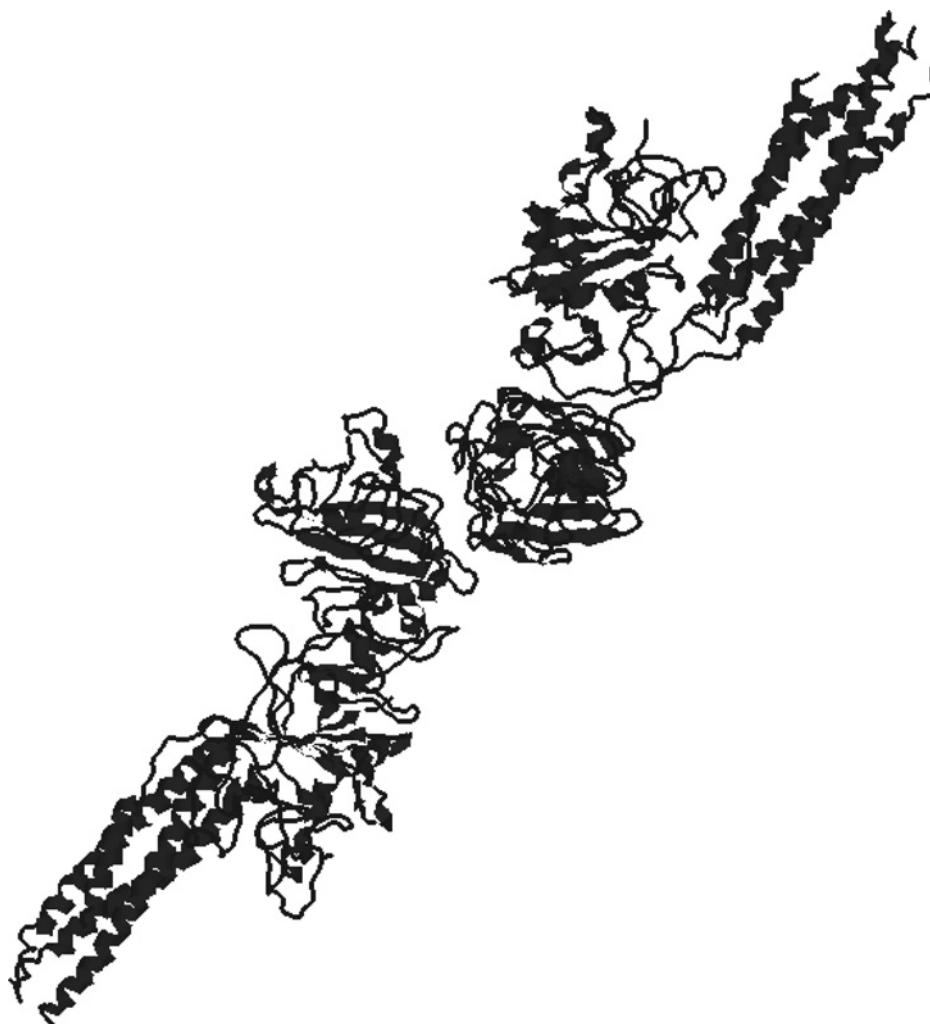
Giordano *et al.*, 2004). Raised levels of AGP have also been reported in tumor-bearing cats (Selting *et al.*, 2000) including those with lymphoma (Correa *et al.*, 2001), though in the latter study the AGP concentration was not prognostic for survival.

In the pig, AGP has been the subject of contrasting experience. AGP concentration was shown to be raised in pigs with naturally occurring pneumonia and meningitis (Itoh *et al.*, 1993b), but in studies where aseptic inflammation caused an acute phase reaction, the AGP concentration was not significantly affected (Eckersall *et al.*, 1996; Lampreave *et al.*, 1994). Furthermore, an experimental model of porcine reproductive and respiratory syndrome virus showed no increase in serum concentration of AGP, whereas Hp increased (Asai *et al.*, 1999). However, AGP was elevated and negatively correlated to body weight in a study of the effects of stress and immune function (Grellner *et al.*, 2002). In the newborn pig, AGP is present at 40 times the adult level with the concentration falling more rapidly in specific

pathogen-free animals than in animals exposed to the normal pathogens encountered in production (Itoh *et al.*, 1993b). It is important to interpret AGP levels in the pig with regard to age as the elevated levels found at birth take about 20 weeks to fall to adult levels.

### 5. Fibrinogen

Fibrinogen is a large protein of 340 kDa that constitutes nearly 5% of the total plasma protein and migrates with a  $\beta$  mobility, though it is usually excluded from electrophoretic analysis as serum is the preferred sample. It is composed of three domains linked by disulfide bridges and contains 3% to 5% carbohydrate (Doolittle *et al.*, 1998) (Fig. 5-7). Fibrinogen is a moderate APP such that in a study of arthritis in the horse, the rise in fibrinogen was 0.87 times the baseline concentration, whereas Hp was increased by 1.14 times and SAA by 227 times (Hulten *et al.*, 2002). However, in terms of mass of protein it



**FIGURE 5-7** The molecular structure of D-fragment of fibrinogen (Doolittle *et al.*, 1998). Fibrin formation occurs with formation of bonds between adjacent chains following removal of fibrinopeptides by thrombin action. Figure generated by Rasmol from UniProt accession number P02671 and protein database entry 1FZA.

represents the greatest proportion of plasma protein synthesized during an acute phase response. Calculations have been made in human medicine that during an acute phase reaction approximately 12g of muscle tissue has to be degraded to provide the amino acids for 1g of fibrinogen, which, in common with most APP, has a higher proportion of aromatic amino acids than muscle protein (Preston *et al.*, 1998). Assays for plasma fibrinogen have been available for a long time. It is more consistently increased during inflammation in horses and cattle than it is in dogs and cats. The measurement of low plasma fibrinogen supports a diagnosis of disseminated intravascular coagulation (Mischke *et al.*, 1998), but it is not consistently decreased in disseminated intravascular coagulation.

#### 6. Pig Major Acute Phase Protein (Inter-Alpha-Trypsin Inhibitor Heavy Chain 4)

During the acute phase response in pigs, a major acute phase protein (pig MAP) can be detected (Lampreave *et al.*, 1994) and has been identified as porcine inter-alpha-trypsin inhibitor heavy chain 4 by comparison to the equivalent human protein (Gonzalez-Ramon *et al.*, 2000). This protein of molecular mass 120kDa is inducible by IL-6 in hepatocyte culture. In serum during the acute phase response, its concentration can increase by a factor of 30 compared to healthy levels. Increases have been shown during infection with *A. pleuropneumonia* (Heegaard *et al.*, 1998), in post-weaning multisystemic wasting disorder (Segales *et al.*, 2004), and following transport (Saco *et al.*, 2003). A bovine equivalent of this protein has been described that also displays an acute phase response (Pineiro *et al.*, 2004).

#### 7. Negative Acute Phase Proteins

Negative acute phase proteins are serum proteins that decrease in concentration by greater than 25% during the acute phase in response to infection, inflammation, and trauma. The mechanism for the decrease in concentration is not clear, but it can be rapid with significant reduction found after 24 hours or it may be a more gradual decrease over a period of days. Serum albumin is a negative acute phase protein, and the concentration of this protein falls gradually with the reduction in concentration being more noticeable in chronic inflammatory disease. Transferrin, the iron transport protein of serum (Gomme and McCann, 2005), has also been described as a negative APP, but the major diagnostic application of measuring its serum concentration is in relation to its role in diseases of iron metabolism (Chapter 9). Its analogue in chickens, ovotransferrin, is a positive APP (Tohjo *et al.*, 1995; Xie *et al.*, 2002a, 2002b).

More rapidly reacting negative APP have been identified. Porcine apolipoprotein A-1 (Navarro *et al.*, 2004)

decreased in concentration by 50% to 80% within 2 to 5 days of experimental infection with *Streptococcus suis* or *A. pleuropneumoniae* (Carpintero *et al.*, 2005). As this apolipoprotein is associated with HDL, it appears to have a reverse relation with SAA (which also binds to this lipoprotein). Transthyretin (TTR) and retinal binding protein (RBP) are related transport proteins, which in rats show a decrease during the acute phase reaction (Rosales *et al.*, 1996), but their pathophysiology has not been fully elucidated in domestic animals. In addition, the interpretation of a fall in serum concentration of these proteins is complicated because they are also affected by nutritional status. TTR is a thyroxine binding protein, which in human serum has a higher electrophoretic mobility than albumin and was therefore originally known as prealbumin. However, in most domestic species, TTR has a lower mobility and no prealbumin is observed (see Fig. 5-2). In the circulation it forms a complex with RBP, which in turn binds to retinol (vitamin A). Infection of pigs with *S. suis* caused a significant reduction of the TTR concentration in serum, showing that it was a negative APP in this species (Campbell *et al.*, 2005).

### C. Complement Proteins

Complement is a group of interacting serum proteins that participate in a cascade of reactions, resulting in opsonization of foreign cells and particles (Gorman and Halliwell, 1989a). Complement is activated by the “classical” or “alternative” pathways, terminology based on the time frame of discovery rather than on the relative importance of the pathway concerned. The complement proteins are a series of zymogens, which on activation are able to specifically activate another member of the cascade by proteolytic cleavage. Activation of the classical pathway occurs by binding of complement C1q to initiating factors such as antigen-antibody complexes or C-reactive protein bound to bacterial pathogen. The alternative pathway does not need antibody for activation but can be stimulated by mediators such as parasites, viruses, bacteria, and tumor cells. Both pathways lead to the formation of a membrane attack complex composed of components C5, C6, C7, C8, and C9, which cause lysis of cell membranes. More than a dozen complement proteins have been identified, but apart from a minor positive acute phase response that has been observed for component C3, the most use in diagnosis of disease is in assessment of complement deficiency in relation to immune function. These are covered in Chapter 6 as part of the discussion on clinical immunology.

### D. Immunoglobulins

On SPE, most immunoglobulins are found in the  $\gamma$ -globulin fraction, which can be differentiated into  $\gamma_1$  and  $\gamma_2$ . Of

the immunoglobulins observed in animals, IgA, IgM, and IgE are found primarily in the  $\gamma_1$  region (and to some extent in the  $\beta_2$  region), and IgG is found primarily in the  $\gamma_2$  region. The specific identification and quantification of the immunoglobulins require the use of immunochemical techniques (Section V.D.1). A brief description of the immunoglobulins is given here as a basis for understanding the interpretation of dysproteinemias visualized on SPE. More thorough coverage is given in Chapter 6 on clinical immunology.

### 1. Source of Immunoglobulins

Immunoglobulins act as antibodies and are produced in response to antigens. They are highly specific if only one antigenic determinant is involved. In nature, however, multiple antigenic determinants are usually involved. The lymphocytic cell line plays the central role in the immune system. There are two subpopulations, the B lymphocytes (bursa) and the T lymphocytes (thymus), which can be identified by special immunological means. The T cells are found in blood and in lymph nodes in the deep cortical areas and paracortical sinuses. They are associated with cell-mediated immunity. The B cells were originally identified in the bursa of Fabricius of the chicken. In the adult, they are found in the blood and in the germinal centers of lymph nodes. The B cells respond to antigenic stimuli with the proliferation of plasma cells that produce the specific antibody against the stimulating antigen. Five immunoglobulin classes, IgG, IgA, IgM, IgD, and IgE, have been identified in humans but in most domestic animal species only IgG, IgA, IgM, and IgE are evident, although IgD may be rarely expressed (Gorman and Halliwell, 1989b).

A specific plasma cell population of defined genetic origin—a clone—produces a specific immunoglobulin. Uncontrolled growth of a single B-cell clone (malignancy) results in the overproduction of a single chemical species of immunoglobulin, which appears as a sharp “monoclonal” spike or monoclonal gammopathy on an electrophoretogram. Occasionally, a “biclonal” or “triclinal” gammopathy can be identified. A group of clones, each of a different genetic origin, can also overproduce a heterogeneous mixture of immunoglobulins, which appears as a diffuse or broad hyperglobulinemic region on the electrophoretogram. This region is described as a “polyclonal” gammopathy.

### 2. Structure of Immunoglobulins

The immunoglobulins are glycoproteins whose basic structure is comprised of two heavy (H) and two light (L) chains linked by disulphide bridges with a molecular mass of 150kDa. The structure of the H chain governs the class of immunoglobulin and is named by corresponding Greek letters:  $\gamma$  in IgG,  $\mu$  in IgM,  $\alpha$  in IgA,  $\epsilon$  in IgE, and  $\delta$  in IgD. The structure of the L chain is either kappa ( $\kappa$ ) or lambda ( $\lambda$ )

and denotes type. Structural variations in the variable regions of H or L chains provide a basis for further subdivision into subtypes and subclasses. To date, four subclasses of IgG have been identified in humans (IgG1, IgG2, IgG3, and IgG4), with two identified in cattle (IgG1 and IgG2), four in dogs (IgG1, IgG2a, IgG2b, and IgG2c), and three in horses (IgGa, IgGb, and IgGc). The horse also has IgG(T). This was originally recognized in horses used to produce antitetanus toxoid, and although it has a higher mobility than  $\gamma$ -globulins, its amino acid sequence showed it was more closely related to IgG (Gorman and Halliwell, 1989b).

IgG, IgD, and IgE are monomers; IgA is a dimer; and IgM is a pentamer. Most viral, bacterial, and toxin antibodies are of the IgG type and are present in all animals. IgE is involved in allergic and anaphylactic reactions, whereas IgA is found in the secretions of the respiratory, genitourinary, and gastrointestinal tracts. IgA is a dimer of two basic units joined by a secretory piece. IgM is a cyclic pentamer of five basic units that forms a high-molecular-weight unit. These are the macroglobulins or “M” components.

The Bence-Jones proteins are light-chain units, and their presence reflects the asynchronous synthesis of H chains so that excess L chains appear and are secreted in urine. They are not detected on SPE, but they can be detected by immunochemical techniques and are often found to accompany gammopathies (Solomon, 1976), especially multiple myelomas.

### E. Lipoproteins

A significant amount of protein in serum is associated with lipid in the form of lipoproteins. These microscopic particles are composed of a lipid core containing hydrophobic molecules such as triglyceride and cholesterol ester with a phospholipid monolayer on the surface. The apolipoproteins are proteins that help to stabilize the structure of the lipoproteins and also have biological activity related to their function of transporting the immiscible lipids through the aqueous environment of the circulation. Lipoproteins can be characterized according to their electrophoretic mobility ( $\alpha$ -,  $\beta$ -lipoprotein) but are now mainly classified by their density as determined by ultracentrifugation. The main classes are very low density lipoprotein (VLDL), low-density lipoprotein (LDL), and high-density lipoprotein (HDL). These are involved with lipid transport between the liver and peripheral tissues. There is a further class of lipoprotein, the chylomicrons, which are involved in the transport of dietary lipid from the intestine. Lipoproteins are the subject of extensive research in human medicine, especially in relation to diagnosis of diseases of the cardiovascular system, but in domestic animals their analysis is not a frequently requested test. The lipoprotein profile in horses and dogs has been established (Watson, 1996; Watson and Love, 1994) and can be altered in disease,

but these aspects are more fully explored in Chapter 4 lipids.

## F. Other Serum Proteins

A number of other serum proteins of domestic animals have been studied but have not been fully investigated for diagnostic purposes.

The antiproteases,  $\alpha_1$ -antitrypsin and  $\alpha_1$ -antichymotrypsin have moderate acute phase responses in cattle and dogs, and an antielastin was also identified in dogs (Conner *et al.*, 1988b). Ceruloplasmin, a copper-containing serum protein that has inherent oxidase activity, is involved in iron metabolism and is also a moderate APP (Ceron and Martinez-Subiela, 2004; Martinez-Subiela *et al.*, 2002b).

Among the collectins (Gabius, 1997), mannan-binding protein, conglutinin, and collectin-43 have been investigated in cattle (Kawai *et al.*, 1997; Krogh-Meibom *et al.*, 2004a, 2004b). A low level of conglutinin was found to be associated with reduced resistance to disease and could be used as a breeding trait to produce animals with increased resistance (Holmskov *et al.*, 1998). Lipopolysaccharide-binding protein, which as its name suggests is able to bind to bacterial endotoxin (lipopolysaccharide), has been shown to be a moderate APP in cattle (Horadagoda *et al.*, 1995; Schroedl *et al.*, 2001).

## G. Multiplex Assays, Protein Arrays, and Acute Phase Index

Advances in proteomics and in genomics have stimulated investigations of multiple analytes in an organism, cell, tissue, or biological fluid. Gene arrays have been developed that can monitor the expression of several thousand genes in a tissue sample at the same time. An objective of proteomics is to be able to perform a similar feat for protein, but the technology is still some distance from use in the clinical biochemistry laboratory (Anderson and Anderson, 2002). A step toward the examination of the complete serum proteome would be made if it were possible to measure the concentration of a number of proteins in the same aliquot of sample. To achieve this goal, multiplex assay systems are being developed in which numerous immunoassays can be run simultaneously. One such system uses fluorescently labeled beads with differing emission characteristics for different proteins, which can be quantified simultaneously (Pang *et al.*, 2005). Another novel multiplex system uses an array of antibody-based reagents for different protein analytes immobilized on a biochip surface (Molloy *et al.*, 2005). These multiplex assays may find a role in the clinical biochemistry of domestic animals if they can be developed and validated for individual species.

Interpretation of data from multiple assays will be a challenge for the clinical biochemist involved in serum

protein analysis. It is possible that the relative change in concentrations of groups of proteins will provide more useful diagnostic information than that obtained by simply interpreting the changes in concentration of individual proteins. Advanced statistical methods—for instance, using neural network analysis (Chen *et al.*, 2004)—may be needed for implementation of such analysis, but bioinformatics is exploiting the application of mathematics, statistics, and computing to biological systems. However, combination of results from individual analyte tests is not new. Use of the albumin-globulin ratio to improve diagnosis is a simple example of this approach. Combination of results from individual acute phase proteins can increase the diagnostic value of the tests involved. This has been developed as an “acute phase index” with a formula proposed of (major positive APP)  $\times$  (moderate positive APP) divided by (major negative APP)  $\times$  (moderate negative APP), which increased the sensitivity and specificity of analysis (Toussaint *et al.*, 1995).

## VII. INTERPRETATION OF SERUM PROTEIN PROFILES

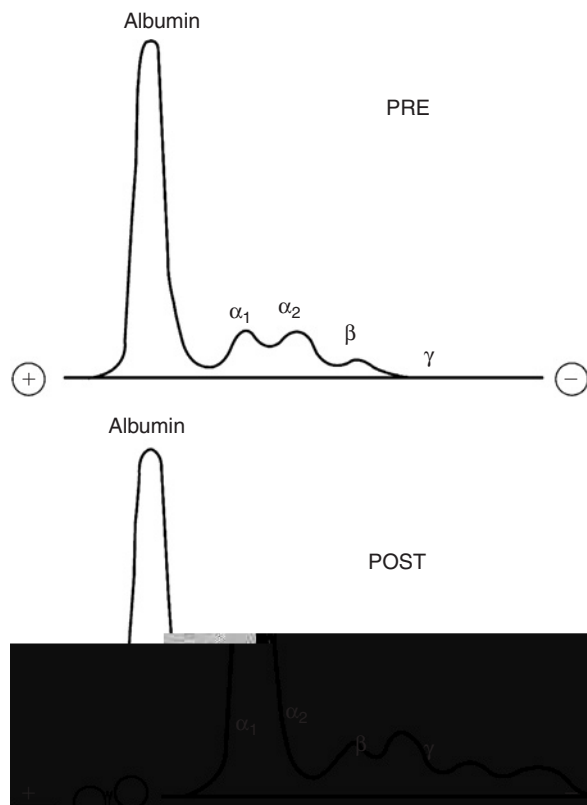
The determinations of serum proteins and their SPE profiles are important diagnostic aids in clinical biochemistry, even though a specific diagnosis can seldom be made with SPE. Abnormal serum protein profiles can be identified with general types of disease processes and in this way provide the rationale for further definitive studies of the patient. Various electrophoretograms illustrating some common applications in different species are given in Figures 5-8 and 5-9. Inclusion of total protein and albumin assays in automated systems to provide the albumin-to-globulin ratio (A:G) enhances the analysis. A change in the A:G ratio is often the first signal of a protein dyscrasia, which leads to further study of the proteins by SPE. Reference values for total serum protein and its fractions in animals and birds are given in Appendices VIII, IX, and X.

### A. Physiological Influences

Abnormalities of SPE must be interpreted in light of the many influences not associated with disease. However, normal physiological variations within an individual are relatively constant over a considerable period of time; therefore, even minor changes in the SPE profile can be of significance and warrant close scrutiny.

#### 1. Influence of Age, Development, and Breed

In the fetus, the concentration of total protein and albumin progressively increases with little change in total globulins and an absence of  $\gamma$ -globulin. After birth, and with colostral uptake during the first 24 hours, the SPE changes to reflect



**FIGURE 5-8** Densitometer trace of serum protein electrophoresis on agarose gel from calf before feeding with colostrum (upper) and after feeding with colostrums (lower).

the absorption of immunoglobulins. Baby pigs acquired large amounts of  $\gamma$ -globulin, which progressively decreased to 5% of the total serum protein by 4 weeks of age (Rutqvist, 1958). In the calf, precolostral serum normally contains no  $\gamma$ -globulin, but within a few hours after ingestion of colostrum,  $\gamma$ -globulin appears in serum (see Fig. 5-8) and absorption continues for up to 36 hours after birth after which closure occurs (Weaver *et al.*, 2000). In colostrum-deprived calves, immunoglobulins increase only minimally. In the developing foal from birth to 12 months of age, progressive increases in albumin, globulins, and total proteins are also seen (Bauer *et al.*, 1984; Rumbaugh and Adamson, 1983).

Over the life span of animals, there is a general increase in total protein, a decrease in albumin, and an increase in globulins with advancing age. However, in the very old, the total plasma proteins again decline. Thus, age is an important consideration in the interpretation of the SPE. Breed may also affect serum proteins. Retired greyhounds were found to have significantly decreased  $\alpha$ - and  $\beta$ -globulins in comparison to age- and gender-matched nongreyhound controls (Fayos *et al.*, 2005).

## 2. Hormonal and Sexual Influences

Hormones can have anabolic or catabolic effects on serum proteins. Testosterone and estrogens are generally anabolic in

all species. Growth hormone is another well-known anabolic hormone with similar effects. On the other hand, thyroxine decreases total serum protein, most likely because of its catabolic effect. The glucocorticoids have not been reported to have a major effect on SPE except in the dog where prednisolone injection was shown to cause an increase in  $\alpha_2$ -globulins with the rise shown to be due to the induction of haptoglobin (Harvey and West, 1987). Otherwise hormonal effects of serum proteins are slight even though their effects on weight gains or body composition may be quite marked.

## 3. Pregnancy and Lactation

During gestation, maternal albumin decrease and the globulins increase in some species. In ewes, albumin decreases to a minimum at midgestation and returns to near normal at term, whereas globulins and the total serum protein progressively decrease throughout gestation (Dunlap and Dickson, 1955). In cows, the total serum protein and  $\gamma_1$ - and  $\beta_2$ -globulins begin to increase at 2 months before term, reach maximum values at 1 month, and then rapidly decline toward term (Larson and Kendall, 1957). This reflects the transport of immunoglobulins from serum to the mammary gland that begins several weeks before parturition, reaching a peak 1 to 3 days before birth of the calf (Weaver *et al.*, 2000). Lactation and egg production impose further stresses on protein reserves, and metabolism and changes similar to pregnancy may also occur. However, no changes in serum albumin or total globulin concentrations were measured in horses during gestation or lactation (Harvey *et al.*, 2005).

## 4. Nutritional Influences

The plasma proteins are sensitive to nutritional influences, but the changes are often subtle and difficult to detect and interpret. In a study in Holstein heifers, increasing the proportion of crude protein in the diet from 8% to 15% increased total serum protein and albumin, but the albumin:globulin ratio stayed the same at 1.09 (Hoffman *et al.*, 2001). Increases in  $\alpha$ -globulin and decreases in  $\gamma$ -globulin fractions were found in ostriches fed a high-protein diet (Polat *et al.*, 2004). In contrast, total serum protein was not affected in pregnant mares by substantial differences in dietary protein quantity and quality, even though the foal mass decreased by 25% (vanNiekerc and vanNiekerc, 1997).

## 5. Stress and Fluid Loss

Temperature stress, either fever or hypothermia, is associated with nitrogen loss, increased adrenal activity, and increased protein turnover. These stresses cause a decrease in total serum protein and albumin, but they often cause an increase in  $\alpha_2$ -globulin associated with the acute phase response. Similar findings are observed in crushing injuries, bone fractures, and extensive surgery. In the inflammatory

process, fluids and proteins move into the tissues, inducing edema and contributing to a decrease in plasma albumin. Hemorrhage or massive exudation with large external losses of plasma is followed by a rapid movement of interstitial fluid (without protein) into the plasma compartment to induce an acute hypoproteinemia. Conversely, dehydration leads to hemoconcentration through reduction in fluid volume and consequent hyperproteinemia. During splenic contraction in the horse, a large mass of erythrocytes moves into the circulation with little or no change in the serum protein.

## B. The Dysproteinemias

The current method of choice for the overall evaluation of protein status remains SPE on cellulose acetate or agarose gel. The SPE profile and the absolute values of the individual fractions provide an excellent basis for presumptive diagnoses and for additional studies of the patient. The A:G ratio derived from chemistry panels or from the SPE is the basis on which the SPE can be interpreted.

Classification of the SPE profile in conjunction with the A:G ratio provides a systematic approach to the interpretation of protein dyscrasias. Table 5-5 gives such a classification of the SPE results based on the A:G ratio and the nature of the profile. This table provides a useful vehicle for alerting the clinical biochemist and the clinician to the underlying significance of the specific dysproteinemia.

### 1. Normal A:G—Normal Profile

#### a. Hyperproteinemia

Simple dehydration with water loss is essentially the only instance when a simple hyperproteinemia without change in profile or A:G occurs. In this case, all protein fractions increase proportionately, including albumin, because only water has been removed from the system.

#### b. Hypoproteinemia

Overhydration through vigorous fluid therapy or excess water intake is a common cause of simple hypoproteinemia. This is simply a dilution of the system. In other instances, for example, after acute blood loss, interstitial fluid moves rapidly into the plasma compartment, thus diluting the system. This dilution may be further intensified by the ingestion of water to satisfy the thirst commonly seen in acute blood loss. Similarly, after acute plasma loss, whether internal or external, by exudation or extravasation, simple hypoproteinemia occurs because movement of interstitial water into the plasma compartment rapidly replaces the water losses.

### 2. Decreased A:G—Abnormal Profile

#### a. Decreased Albumin

Decreased albumin is a common form of dysproteinemia. Fundamentally, the decrease can be attributed to either

albumin loss or failure of albumin synthesis. Depending on the stage of the disease, it can be associated with either slight hyperproteinemia (acute stage), normoproteinemia (progressive stage), or, in its advanced stages, hypoproteinemia. Therefore, the total serum protein is not a reliable index of albumin status and albumin must be determined.

Because of its small size and osmotic sensitivity to fluid movements, albumin is selectively lost in renal disease (Grauer, 2005), gastrointestinal disease, (Kaneko *et al.*, 1965; Meuten *et al.*, 1978), and in intestinal parasitism (Dobson, 1965). The hypoalbuminemia of intestinal parasitism is aggravated by increased albumin catabolism (Cornelius *et al.*, 1962; Halliday *et al.*, 1968; Holmes *et al.*, 1968). Furthermore, because of the sensitivity of albumin synthesis to protein and nitrogen loss such as that occurring in some forms of gastrointestinal disease, albumin loss impairs albumin synthesis and further compounds the hypoalbuminemia. Because of this same sensitivity of albumin synthesis to protein and nitrogen availability, decreased albumin concentration precedes the development of generalized hypoproteinemia in dietary protein deficiencies. Classic human protein-calorie malnutrition, kwashiorkor, is characterized by hypoalbuminemia and hypoproteinemia.

The liver is the only site of albumin synthesis, and hypoalbuminemia is an important feature of chronic liver disease and when accompanied by marked decrease in total protein is indicative of terminal liver cirrhosis (Sevelius and Andersson, 1995). In the horse, a unique postalbumin shoulder with or without a hypoalbuminemia suggests liver disease. Additionally, albumin is a negative APP and extensive inflammation accompanying any of the aforementioned conditions may compound the hypoalbuminemia.

#### b. Increased Globulins

**i.  $\alpha$ -Globulins**  $\alpha_1$ -Globulin but mainly  $\alpha_2$ -globulin increases are commonly found and are of diagnostic significance. Many of the APPs (Section VI.B) migrate in the  $\alpha_1$ - and  $\alpha_2$ -globulin regions (Table 5-5) so that increases in these globulins are a common finding in acute inflammatory diseases and represent an acute phase response. Increases in  $\alpha$ -globulins can be accompanied by increased  $\beta$ - or  $\gamma$ -globulins (Fig. 5-9a and 5-9c). In the nephrotic syndrome,  $\alpha_2$ -globulins increase due in part to increases in  $\alpha_2$ -macroglobulin and the lipoproteins. The triad of azotemia, hypoalbuminemia, and hypercholesterolemia is a characteristic of the nephrotic syndrome. Increased  $\alpha$ -globulin, identified as  $\alpha_1$ -antitrypsin, and Hp have been described in dogs with chronic liver disease, many of which recovered (Sevelius and Andersson, 1995).

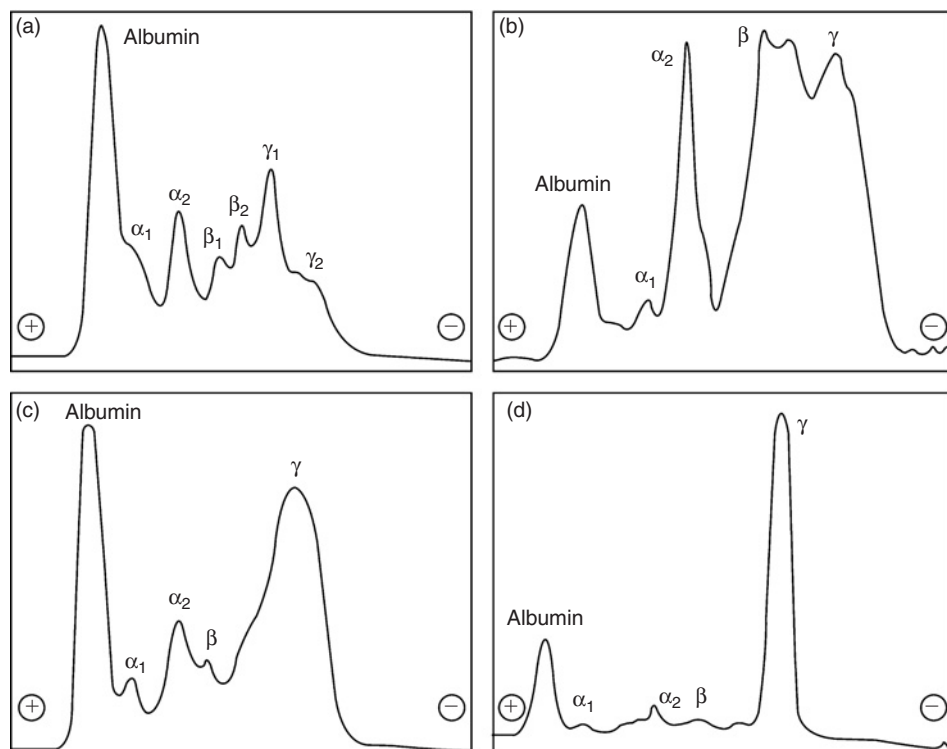
**ii.  $\beta$ -Globulins** Increases in  $\beta$ -globulins alone are infrequent in most species and found in association with active liver disease, suppurative dermatopathies, and in the

**TABLE 5.5** Classification of the Dysproteinemias Based on the Albumin-to-Globulin Ratio and the Serum Protein Electrophoretic Profile

A. Normal A:G—normal SPE profile	
1.	Hyperproteinemia: dehydration
2.	Hypoproteinemia
a.	Overhydration
b.	Acute blood loss
c.	External plasma loss: extravasation from burns, abrasions, exudative lesions, exudative dermatopathies, external parasites; gastrointestinal disease including parasites
d.	Internal plasma loss: vasculitis
B. Decreased A:G—abnormal SPE profile	
1.	Decreased albumin
a.	Selective loss of albumin: glomerulonephritis, nephrosis, nephrotic syndrome, gastrointestinal disease including parasites
b.	Decreased synthesis of albumin: chronic liver disease, malnutrition, chronic inflammatory disease
2.	Increased globulins
a.	Increased $\alpha_1$ -globulin
i.	Acute inflammatory disease: $\alpha_1$ -antitrypsin, $\alpha_1$ -acid glycoprotein (orosomucoid, seromucoid)
b.	Increased $\alpha_2$ -globulin
i.	Acute inflammatory disease: $\alpha_2$ -macroglobulin, ceruloplasmin, haptoglobin
ii.	Severe active hepatitis: $\alpha_2$ -macroglobulin
iii.	Acute nephritis: $\alpha_2$ -macroglobulin
iv.	Nephrotic syndrome: $\alpha_2$ -macroglobulin, $\alpha_2$ -lipoprotein (VLDL)
v.	Glucocorticoids: haptoglobin in dogs
c.	Increased $\beta$ -globulin
i.	Acute hepatitis: transferrin, hemopexin
ii.	Nephrotic syndrome: $\beta_2$ -lipoprotein (LDL), transferrin
iii.	Suppurative dermatopathies: IgM, C3
d.	Bridging
i.	Chronic active hepatitis: IgA, IgM
e.	Increased $\gamma$ -globulin (broad increase)—polyclonal gammopathies: IgG, IgM, IgA
i.	Chronic inflammatory disease, infectious disease, collagen disease
ii.	Chronic hepatitis
iii.	Hepatic abscess
iv.	Suppurative disease: feline infectious dermatitis, suppurative dermatitis, tuberculosis
v.	Immune-mediated disease: autoimmune hemolytic anemia, autoimmune thrombocytopenia, Aleutian disease of mink, equine infectious anemia, systemic lupus erythematosus, autoimmune polyarthritis, autoimmune glomerulonephritis, autoimmune dermatitis, allergies
vi.	Lymphoid tumors
f.	Increased $\gamma$ -globulin (sharp increase)—monoclonal gammopathies: IgG, IgM, IgA
i.	Lymphoid tumors
ii.	Plasma cell dyscrasias: multiple myeloma, Aleutian disease of mink
iii.	Macroglobulinemia
iv.	Canine ehrlichiosis (usually polyclonal)
v.	Benign
C. Increased A:G—abnormal profile	
1.	Increased albumin: does not occur except in dehydration
2.	Decreased globulins
a.	Fetal serum
b.	Precolostral neonate
c.	Combined immunodeficiency of Arabian foals
d.	A gammaglobulinemia

nephrotic syndrome. Transferrin appears to be a major component that rises in active liver disease together with hemopexin and complement, but as transferrin is a negative acute phase protein, it may decrease during infectious or inflammatory disease. IgM can also rise in active liver disease in response to the antigenic stimulus of infectious

agents. In the suppurative dermatopathies, a similar antigenic stimulus is thought to account for the IgM and complement increases in the  $\beta$  fraction. In the nephrotic syndrome, increases in  $\beta$ -globulins are associated with increases in transferrin. Most increases in  $\beta$ -globulins are polyclonal with accompanying increases in  $\gamma$ -globulins (Fig. 5-9b)



**FIGURE 5-9** Densitometer trace of serum protein electrophoresis on agarose gel from (a) a dog with malignant lymphoma showing increases in  $\alpha$ -,  $\beta$ -, and  $\gamma$ -globulins, A:G ratio 0.67; (b) a dog with B cell tumor showing hypoalbuminemia, a spike in  $\alpha_2$ -globulins, increased  $\beta$ -globulins, and a polyclonal immunoglobulinemia, A:G ratio 0.15; (c) a cat with feline infectious peritonitis showing increased  $\alpha_2$ -globulins and a polyclonal gammopathy, A:G ratio 0.36; (d) a cat with hypoalbuminemia and an IgG monoclonal gammopathy A:G ratio 0.20.

and only occasionally the sharp monoclonal spikes of multiple myeloma, Waldenström's macroglobulinemia, or lymphoma are seen (Macewen *et al.*, 1977). Waldenström's-type macroglobulinemia with hyperviscosity and IgM monoclonal spikes have been reported in dogs (Hurvitz *et al.*, 1971; Macewen *et al.*, 1977).

In the horse, increased levels of  $\beta$ -globulins have been observed on SPE of serum from animals infected with the intestinal parasites *Strongylus vulgaris* and *Strongyloides westeri*. The peak can appear as a monoclonal gammopathy in which an equine-specific immunoglobulin, IgG(T), is produced (Mair *et al.*, 1993). This immunoglobulin may also migrate in SPE with an  $\alpha_2$  mobility (Kent and Roberts, 1990).

**iii.  $\beta$ - $\gamma$  Bridging** The phenomenon of  $\beta$ - $\gamma$  bridging suggests chronic active hepatitis. In this case, there is no clear separation between the  $\beta_2$  and  $\gamma_1$ -fraction, which results from an increase of IgA, IgM, or both. Rarely a low-grade gammopathy of lymphoma may result in a  $\beta$ - $\gamma$  bridge.

**iv. Increased  $\gamma$ -Globulin (Broad Increase): Polyclonal Gammopathy** The diffuse or broad increases in the  $\gamma$ -globulins that characterize polyclonal gammopathies are a result of the heterogeneity of the clones of B lymphocytes and plasma cells, which produce a heterogeneous mix of immunoglobulins. Any one or all of the immunoglobulins IgM, IgG, or IgA can be present, but a preponderance of one is usually observed.

The chronic inflammatory disease profile may be manifested by a variety of disease states such as malignancies in general (Fig. 5-9b), chronic infections (Fig. 5-9c), and collagen diseases. There is a concomitant decrease in albumin as a result of decreased synthesis (Fig. 5-9b).

Chronic hepatitis, hepatic abscesses, and suppurative disease processes also exhibit changes characteristic of chronic disease (Rumbaugh *et al.*, 1978). In these cases, the polyclonal increase is more marked and the hypoalbuminemia more severe than in other chronic inflammatory diseases. This phenomenon may reflect the severity of the disease process and the more intense antigenic response generated.

Immunologically mediated disease processes are also characterized by polyclonal increases. These may be immune processes directed against "self," that is, autoimmune disease, or against external antigenic stimuli. In either case, a multiple immunological response is elicited, one or more organs may be affected, and polyclonal increases are observed on the electrophoretogram. Immune complexes trapped in the glomeruli and reacting with antigens are thought to be involved in the glomerulonephritis often seen with heartworms, pyometra, and systemic lupus erythematosus (SLE). SLE is a multifaceted disease in the dog often found in association with autoimmune hemolytic anemia, thrombocytopenia, glomerulonephritis, and polyarthritis. The basic abnormality in SLE is the LE factor, an antinuclear antibody, and the widespread dissemination of nuclear-antinuclear complexes throughout highly vascular structures.



Lymphomas can elicit either a polyclonal or monoclonal hyperglobulinemia. The hyperglobulinemic peaks can occur anywhere between the  $\beta_1$  and  $\gamma_2$  regions and range from very broad, diffuse peaks to very sharp, monoclonal spikes. The polyclonal peaks of lymphoma are thought to be the result of a tumorous group of distantly related clones in contrast to the single discrete clones, which give rise to the monoclonal spikes.

**v. Increased  $\gamma$ -Globulin (Sharp Increases): Monoclonal Gammopathy** The monoclonal forms are characterized by sharp spikes of immunoglobulin. They may occur in the  $\beta$  region, but are frequently limited to the  $\gamma$  region (Fig. 5-9d). A useful guideline for interpretation is to compare visually the sharpness of these spikes to the albumin peak. One or the other slope of the monoclonal spike is as steep or steeper than one of the slopes of the albumin peak. The monoclonal spike is the result of a single clone producing a single class of immunoglobulin usually abnormal in nature. Thus, the monoclonal immunoglobulins are of identical structure and move as one on the SPE. These immunoglobulins have been described as “paraproteins.” The characteristic monoclonal spike in the  $\gamma$  region, Bence-Jones proteinuria, and plasma cell tumors have been general findings in multiple myelomas reported in the horse (Geelen *et al.*, 1997; Pusterla *et al.*, 2004), dog (Giraudel *et al.*, 2002), and cat (Farrow and Penny, 1971; Patel *et al.*, 2005). Light-chain disease with Bence-Jones proteins in the plasma and urine has been observed in dogs (Hurvitz *et al.*, 1971).

Lymphomas may present with monoclonal spikes depending on the degree of cloning of the tumor cells. The dominant monoclonal protein was identified as IgM in a case of lymphocytic leukemia in a dog (Braund *et al.*, 1978). A biconal gammopathy has been observed in a dog with a combined myeloma and cutaneous lymphoma (Jacobs *et al.*, 1986).

A retrospective study of 18 cases of monoclonal gammopathies in the dog confirmed that most were associated with lymphoproliferative tumors, including multiple myelomas, Waldenström’s macroglobulinemia, lymphoma, chronic lymphocytic leukemia, and mucocutaneous plasmacytoma (Giraudel *et al.*, 2002). However, nonmyelomatous monoclonal gammopathies were identified in cases of leishmaniasis and ehrlichiosis in this and other studies (Breitschwerdt *et al.*, 1987). Monoclonal gammopathies have also been reported in canine amyloidosis (Schwartzman, 1984).

Generally, the clinical characteristics of the monoclonal gammopathies are referable to the magnitude of lymphocyte or plasma cell proliferation, the extent of organ infiltration, and production of abnormal protein. Thus, immunologically associated diseases tend to be multifaceted and can present with bleeding tendencies, glomerulonephritis, polyarthritis, arteritis, hepatitis, and SLE. All monoclonal gammopathies are not necessarily pathological,

however, because they can be benign. Consequently, care must be exercised in the final evaluation of a monoclonal gammopathy.

### 3. Increased A:G—Abnormal Profile

#### a. Increased Albumin

True overproduction of albumin does not occur in any animal. Therefore, any rise in albumin is only a relative hyperalbuminemia because of hemoconcentration as a result of water loss and dehydration.

#### b. Decreased Globulins

The absence of  $\gamma$ -globulins in fetal serum or in serum from precolostral or colostrum-deprived neonatal animals (Weaver *et al.*, 2000) can be readily demonstrated on SPE (see Fig. 5-8). Hypo- $\gamma$ -globulinemia occurred in about 15% of foals less than 2 weeks of age and was attributed to failure of colostrum transfer even though most had nursed (Mcguire *et al.*, 1975a; Sellon, 2000). Combined immunodeficiency of Arabian foals is thought to be an inherited autosomal recessive disease. The disease is characterized by lymphopenia, failure to synthesize IgG, IgM, and IgA and early death (Davis and Jones, 2003; Mcguire *et al.*, 1975b; Perryman, 2000). A selective IgM deficiency has been reported (Perryman *et al.*, 1977).

## REFERENCES

- Abate, O., Zanatta, R., Malisano, T., and Dotta, U. (2000). Canine serum protein patterns using high-resolution electrophoresis (HRE). *Vet. J.* **159**, 154–160.
- Alberts, B., Johnson, A., Lewis, J., Raff, M., Roberts, K., and Walter, P. (2002). “Molecular Biology of the Cell.” Garland, New York.
- Allison, A. C. (1960). Turnovers of erythrocytes and plasma proteins in mammals. *Nature* **188**, 37–40.
- Alsemgeest, S. P. M., Taverne, M. A. M., Boosman, R., Vanderweyden, B. C., and Gruys, E. (1993). Peripartum acute-phase protein serum amyloid-A concentration in plasma of cows and fetuses. *Amer. J. Vet. Res.* **54**, 164–167.
- Ametaj, B. N., Bradford, B. J., Bobe, G., Nafikov, R. A., Lu, Y., Young, J. W., and Beitz, D. C. (2005). Strong relationships between mediators of the acute phase response and fatty liver in dairy cows. *Can. J. Anim. Sci.* **85**, 165–175.
- Andersen, S. B., Wallevik, K., and Glenert, J. (1963). Gamma globulin turnover and intestinal degradation of gamma globulin in dog. *J. Clin. Invest.* **42**, 1873.
- Anderson, N. L., and Anderson, N. G. (2002). The human plasma proteome. *Molec. Cell. Proteom.* **1**, 845–867.
- Anderson, N. L., Polanski, M., Pieper, R., Gatlin, T., Tirumalai, R. S., Conrads, T. P., Veenstra, T. D., Adkins, J. N., Pounds, J. G., Fagan, R., and Lobley, A. (2004). The human plasma proteome: a nonredundant list developed by combination of four separate sources. *Molec. Cell. Proteom.* **3**, 311–326.
- Andersson, M., and Sevelius, E. (2001). Abnormal microheterogeneity of haptoglobin in serum from dogs with various diseases. *Vet. Rec.* **148**, 14–17.

- Andersson, M., Stenstrom, M., Vatne, M., Sevelius, E., and Jonsson, L. (1998). Disease-related variations of the glycosylation of haptoglobin in the dog. *J. Comp. Path.* **119**, 227–238.
- Anraku, M., Yamasaki, K., Maruyama, T., Kragh-Hansen, U., and Otagiri, M. (2001). Effect of oxidative stress on the structure and function of human serum albumin. *Pharma. Res.* **18**, 632–639.
- Asai, T., Mori, M., Okada, M., Uruno, K., Yazawa, S., and Shibata, I. (1999). Elevated serum haptoglobin in pigs infected with porcine reproductive and respiratory syndrome virus. *Vet. Immunol. Immunopath.* **70**, 143–148.
- Bauer, J. E., Harvey, J. W., Asquith, R. L., McNulty, P. K., and Kivipelto, J. (1984). Clinical-chemistry reference values of foals during the 1st year of life. *Equine Vet. J.* **16**, 361–363.
- Bence, L. M., Addie, D. D., and Eckersall, P. D. (2005). An immunoturbidimetric assay for rapid quantitative measurement of feline alpha-1-acid glycoprotein in serum and peritoneal fluid. *Vet. Clin. Path.* **34**, 335–340.
- Beutler, B. (2004). Innate immunity: an overview. *Molec. Immunol.* **40**, 845–859.
- Bionaz, M., Trevisi, E., Calamari, L., Librandi, F., Ferrari, A., and Bertoni, G. (2007). Plasma paraoxonase, health, inflammatory conditions, and liver function in transition dairy cows. *J. Dairy Sci.* **90**, 1740–1750.
- Blackmore, D. J., and Henley, M. I. (1983). Colorimetric measurement of albumin in horse sera. *Equine Vet. J.* **15**, 373–374.
- Bowman, B. H. (1992). "Hepatic Plasma Proteins." Academic Press, New York.
- Bradford, M. M. (1976). Rapid and sensitive method for quantitation of microgram quantities of protein utilizing principle of protein-dye binding. *Analyt. Biochem.* **72**, 248–254.
- Braund, K. G., Everett, R. M., and Albert, R. A. (1978). Neurologic manifestations of monoclonal igm gammopathy associated with lymphocytic-leukemia in a dog. *J. Amer. Vet. Med. Assoc.* **172**, 1407–1410.
- Breitschwerdt, E. B., Woody, B. J., Zerbe, C. A., Debuyscher, E. V., and Barta, O. (1987). Monoclonal gammopathy associated with naturally-occurring canine ehrlichiosis. *J. Vet. Inter. Med.* **1**, 2–9.
- Briend-Marchal, A., Medaille, C., and Braun, J. P. (2005). Comparison of total protein measurement by biuret method and refractometry in canine and feline plasma. *Revue Med. Vet.* **156**, 615–619.
- Brink, P., Wright, J. C., and Schumacher, J. (2005). An investigation of the ability of the glutaraldehyde test to distinguish between acute and chronic inflammatory disease in horses. *Acta Vet. Scand.* **46**, 69–78.
- Butterworth, R. F. (2002). Pathophysiology of hepatic encephalopathy: a new look at ammonia. *Metab. Brain Dis.* **17**, 221–227.
- Campbell, F. M., Waterston, M., Andresen, L. O., Sorensen, N. S., Heegaard, P. M. H., and Eckersall, P. D. (2005). The negative acute phase response of serum transthyretin following *Streptococcus suis* infection in the pig. *Vet. Res.* **36**, 657–664.
- Campbell, R. M., Sudsaneh, S., Phillipson, A. T., Cuthbertson, D. P., Mackie, W., Mcfarlane, A. S., and Mackie, W. M. (1961). Passage of plasma albumin into intestine of sheep. *J. Physiol.-London* **158**, 113.
- Carpintero, R., Pineiro, M., Andres, M., Iturralde, M., Alava, M. A., Heegaard, P. M. H., Jobert, J. L., Madec, F., and Lampreave, F. (2005). The concentration of apolipoprotein A-I decreases during experimentally induced acute-phase processes in pigs. *Infect. Immun.* **73**, 3184–3187.
- Caspi, D., Snel, F. W. J. J., Batt, R. M., Bennett, D., Rutteman, G. R., Hartman, E. G., Baltz, M. L., Gruys, E., and Pepys, M. B. (1987). C-reactive protein in dogs. *Amer. J. Vet. Res.* **48**, 919–921.
- Ceciliani, F., Grossi, C., Giordano, A., Pocacqua, V., and Paltrinieri, S. (2004). Decreased sialylation of the acute phase protein alpha 1-acid glycoprotein in feline infectious peritonitis (FIP). *Vet. Immunol. Immunopath.* **99**, 229–236.
- Ceron, J. J., Eckersall, P. D., and Martinez-Subiela, S. (2005). Acute phase proteins in dogs and cats; current knowledge and future perspectives. *Vet. Clin. Path.* **34**, 85–99.
- Ceron, J. J., and Martinez-Subiela, S. (2004). An automated spectrophotometric method for measuring canine ceruloplasmin in serum. *Vet. Res.* **35**, 671–679.
- Chen, Y. D., Zheng, S., Yu, J. K., and Hu, X. (2004). Artificial neural networks analysis of surface-enhanced laser desorption/ionization mass spectra of serum protein pattern distinguishes colorectal cancer from healthy population. *Clin. Cancer Res.* **10**, 8380–8385.
- Conner, J. G., Eckersall, P. D., and Douglas, T. A. (1988a). Inhibition of elastase by canine serum: demonstration of an acute phase response. *Res. Vet. Sci.* **44**, 391–393.
- Conner, J. G., Eckersall, P. D., Ferguson, J., and Douglas, T. A. (1988b). The acute phase response in the dog following surgical trauma. *Res. Vet. Sci.* **45**, 107–110.
- Conner, J. G., Eckersall, P. D., Wiseman, A., Bain, R. K., and Douglas, T. A. (1989). The acute phase response in calves following infection with *Pasteurella haemolytica* and *Ostertagia ostertagii* and endotoxin administration. *Res. Vet. Sci.* **47**, 203–207.
- Cornelius, C. E., Douglas, J. R., Baker, N. F., and Kaneko, J. J. (1962). Distribution and turnover of I-131-tagged bovine albumin in normal and parasitized cattle. *Amer. J. Vet. Res.* **23**, 837.
- Correa, S. S., Mauldin, G. N., Mauldin, G. E., and Mooney, S. C. (2001). Serum alpha 1-acid glycoprotein concentration in cats with lymphoma. *J. Amer. Anim. Hosp. Assoc.* **37**, 153–158.
- Curry, S., Mandelkow, H., Brick, P., and Franks, N. (1998). Crystal structure of human serum albumin complexed with fatty acid reveals an asymmetric distribution of binding sites. *Nature Struct. Biol.* **5**, 827–835.
- Davey, F. R., Nelson, D. A., and Carringt, C. E. (1972). Comparison of rapid clottable fibrinogen assays. *Clin. Chem.* **18**, 1360.
- Davis, B. J. (1964). Disc electrophoresis .2. Method and application to human serum proteins. *Annals NY Acad. Sci.* **121**, 404.
- Davis, J. L., and Jones, S. L. (2003). Equine primary immunodeficiencies. *Compendium on Continuing Education for the Practicing Veterinarian* **25**, 548–556.
- Degraaf, T. W., Vanderstelt, M. E., Anbergen, M. G., and Vandijk, W. (1993). Inflammation-induced expression of sialyl Lewis x-containing glycan structures on alpha-1-acid glycoprotein (orosomucoid) in human sera. *J. Exper. Med.* **177**, 657–666.
- Diamandis, E. P., and van der Merwe, D.-E. (2005). Plasma protein profiling by mass spectrometry for cancer diagnosis: opportunities and limitation. *Clin. Cancer Res.* **11**, 963–965.
- Dixon, F. J., Maurer, P. H., and Deichmiller, M. P. (1953). Half-lives of homologous serum albumins in several species. *Proc. Soc. Exper. Biol. Med.* **83**, 287–288.
- Dobson, C. (1965). Serum protein changes associated with *Oesophagostomum columbianum* infections in sheep. *Nature* **207**, 1304.
- Doolittle, R. F., Spraggon, G., and Everse, S. J. (1998). Three-dimensional structural studies on fragments of fibrinogen and fibrin. *Curr. Opin. Struct. Biol.* **8**, 792–798.
- Du Clos, T. W., and Mold, C. (2001). The role of C-reactive protein in the resolution of bacterial infection. *Curr. Opin. Infect. Dis.* **14**, 289–293.
- Dunlap, J. S., and Dickson, W. M. (1955). The effect of age and pregnancy on ovine blood protein fractions. *Amer. J. Vet. Res.* **16**, 91–95.
- Duthie, S., Eckersall, P. D., Addie, D. D., Lawrence, C. E., and Jarrett, O. (1997). Value of alpha 1-acid glycoprotein in the diagnosis of feline infectious peritonitis. *Vet. Rec.* **141**, 299–303.

- Eaton, J. W., Brandt, P., Mahoney, J. R., and Lee, J. T. (1982). Haptoglobin: a natural bacteriostat. *Science* **215**, 691–693.
- Eckersall, P. D., Conner, J. G., and Harvie, J. (1991). An immunoturbidimetric assay for canine C-reactive protein. *Vet. Res. Comm.* **15**, 17–24.
- Eckersall, P. D., Conner, J. G., and Parton, H. (1989). An enzyme-linked immunosorbent assay for canine C-reactive protein. *Vet. Rec.* **124**, 490–491.
- Eckersall, P. D., Duthie, S., Safi, S., Moffatt, D., Horadagoda, N. U., Doyle, S., Parton, R., Bennett, D., and Fitzpatrick, J. L. (1999). An automated biochemical assay for haptoglobin: prevention of interference from albumin. *Comp. Haem. Inter.* **9**, 117–124.
- Eckersall, P. D., Harvey, M. J., Ferguson, J., Renton, J. P., Nickson, D., and Boyd, J. (1993). Acute phase proteins in canine pregnancy (*Canis familiaris*). *J. Reprod. Fert. (suppl)* **47**, 159–164.
- Eckersall, P. D., and Nash, A. S. (1983). Isoenzymes of canine plasma alkaline-phosphatase: an investigation using isoelectric-focusing and related to diagnosis. *Res. Vet. Sci.* **34**, 310–314.
- Eckersall, P. D., Saini, P. K., and McComb, C. (1996). The acute-phase response of acid-soluble glycoprotein, alpha(1)-acid glycoprotein, ceruloplasmin, haptoglobin and c-reactive protein, in the pig. *Vet. Immunol. Immunopath.* **51**, 377–385.
- Eckersall, P. D., Young, F. J., McComb, C., Hogarth, C. J., Safi, S., Weber, A., McDonald, T., Nolan, A. M., and Fitzpatrick, J. L. (2001). Acute phase proteins in serum and milk from dairy cows with clinical mastitis. *Vet. Rec.* **148**, 35–41.
- Evans, T. W. (2002). Review article: albumin as a drug: biological effects of albumin unrelated to oncotic pressure. *Aliment. Pharmacol. Therap.* **16**, 6–11.
- Fagliari, J. J., McClenahan, D., Evanson, O. A., and Weiss, D. J. (1998). Changes in plasma protein concentrations in ponies with experimentally induced alimentary laminitis. *Amer. J. Vet. Res.* **59**, 1234–1237.
- Farrow, B. R. H., and Penny, R. (1971). Multiple myeloma in a cat. *J. Amer. Vet. Med. Assoc.* **158**, 606.
- Fasshauer, M., Klein, J., Kralisch, S., Klier, M., Lossner, U., Bluher, M., and Paschke, R. (2004). Serum amyloid A3 expression is stimulated by dexamethasone and interleukin-6 in 3T3-L1 adipocytes. *J. Endocrin.* **183**, 561–567.
- Fayos, M., Couto, C. G., Iazbik, M. C., and Wellman, M. L. (2005). Serum protein electrophoresis in retired racing Greyhounds. *Vet. Clin. Path.* **34**, 397–400.
- Fenn, J. B., Mann, M., Meng, C. K., Wong, S. F., and Whitehouse, C. M. (1989). Electrospray ionization for mass-spectrometry of large biomolecules. *Science* **246**, 64–71.
- Fetz, K., Ruaux, C. G., Steiner, J. M., Suchodolski, J. S., and Williams, D. A. (2004). Purification and partial characterization of feline alpha(1)-proteinase inhibitor (f alpha(1)-PI) and the development and validation of a radioimmunoassay for the measurement of f alpha(1)-PI in serum. *Biochimie* **86**, 67–75.
- Friedrichs, W. E., Navarijoashbaugh, A. L., Bowman, B. H., and Yang, F. (1995). Expression and inflammatory regulation of haptoglobin gene in adipocytes. *Biochem. Biophys. Res. Comm.* **209**, 250–256.
- Gabius, H. J. (1997). Animal lectins. *Euro. J. Biochem.* **243**, 543–576.
- Gaskell, S. J. (1997). Electrospray: principles and practice. *J. Mass Spect.* **32**, 677–688.
- Geelen, S. N. J., Bernadina, W. E., Grinwis, G. C. M., and Kalsbeek, H. C. (1997). Monoclonal gammopathy in a Dutch warmblood mare. *Vet. Quart.* **19**, 29–32.
- George, J. W. (2001). The usefulness and limitations of hand-held refractometers in veterinary laboratory medicine: an historical and technical review. *Vet. Clin. Path.* **30**, 201–210.
- George, J. W., and O'Neill, S. L. (2001). Comparison of refractometer and biuret methods for total protein measurement in body cavity fluids. *Vet. Clin. Path.* **30**, 16–18.
- Giordano, A., Spagnolo, V., Colombo, A., and Paltrinieri, S. (2004). Changes in some acute phase protein and immunoglobulin concentrations in cats affected by feline infectious peritonitis or exposed to feline coronavirus infection. *Vet. J.* **167**, 38–44.
- Giraudel, J. M., Pages, J. P., and Guelfi, J. F. (2002). Monoclonal gammopathies in the dog: a retrospective study of 18 cases (1986–1999) and literature review. *J. Amer. Anim. Hosp. Assoc.* **38**, 135–147.
- Gomme, P. T., and Mccann, K. B. (2005). Transferrin: structure, function and potential therapeutic actions. *Drug Discovery Today* **10**, 267–273.
- Gonzalez-Ramon, N., Hoebe, K., Alava, M. A., van Leengoed, L., Pineiro, M., Carmona, S., Iturralde, M., Lampreave, F., and Pineiro, A. (2000). Pig MAP/ITIH4 and haptoglobin are interleukin-6-dependent acute-phase plasma proteins in porcine primary cultured hepatocytes. *Euro. J. Biochem.* **267**, 1878–1885.
- Gorg, A., Obermaier, C., Boguth, G., Harder, A., Scheibe, B., Wildgruber, R., and Weiss, W. (2000). The current state of two-dimensional electrophoresis with immobilized pH gradients. *Electrophoresis* **21**, 1037–1053.
- Gorg, A., Weiss, W., and Dunn, M. J. (2004). Current two-dimensional electrophoresis technology for proteomics. *Proteomics* **4**, 3665–3685.
- Gorman, N. T., and Halliwell, R. E. W. (1989a). Complement. In “Veterinary Clinical Immunology” (N. T. Gorman and R. E. W. Halliwell, Eds.), pp. 74–96. Saunders, London.
- Gorman, N. T., and Halliwell, R. E. W. (1989b). The immunoglobulins: structure, genetics and function. In “Veterinary Clinical Immunology” (R. E. W. Halliwell and N. T. Gorman, Eds.), pp. 19–54. Saunders, London.
- Grauer, G. F. (2005). Canine glomerulonephritis: new thoughts on proteinuria and treatment. *J. Small Anim. Pract.* **46**, 469–478.
- Graversen, J. H., Madsen, M., and Moestrup, S. K. (2002). CD163: a signal receptor scavenging haptoglobin-hemoglobin complexes from plasma. *Inter. J. Biochem. Cell Biol.* **34**, 309–314.
- Grellner, G. F., Fangman, T. J., Carroll, J. A., and Wiedmeyer, C. E. (2002). Using serology in combination with acute phase proteins and cortisol to determine stress and immune function of early-weaned pigs. *J. Swine Health Prod.* **10**, 199–204.
- Gronlund, U., Hulten, C., Eckersall, P. D., Hogarth, C., and Waller, K. P. (2003). Haptoglobin and serum amyloid A in milk and serum during acute and chronic experimentally induced *Staphylococcus aureus* mastitis. *J. Dairy Res.* **70**, 379–386.
- Halliday, G. J., Mulligan, W., and Dalton, R. G. (1968). Parasitic hypoalbuminaemia: studies on type 2 ostertagiasis of cattle. *Res. Vet. Sci.* **9**, 224.
- Hari-Dass, R., Shah, C., Meyer, D. J., and Raynes, J. G. (2005). Serum amyloid A protein binds to outer membrane protein A of Gram-negative bacteria. *J. Biol. Chem.* **280**, 18562–18567.
- Harvey, J. W., and Gaskin, J. M. (1978). Feline haptoglobin. *Amer. J. Vet. Res.* **39**, 549.
- Harvey, J. W., Pate, M. G., Kivipelto, J., and Asquith, R. L. (2005). Clinical biochemistry of pregnant and nursing mares. *Vet. Clin. Path.* **34**, 248–254.
- Harvey, J. W., and West, C. L. (1987). Prednisolone-induced increases in serum alpha-2-globulin and haptoglobin concentration in dogs. *Vet. Path.* **24**, 90–92.
- Hasel, K. M., Summers, B. A., and de Lahunta, A. (1999). Encephalopathy with idiopathic hyperammonaemia and Alzheimer type II astrocytes in Equidae. *Equine Vet. J.* **31**, 478–482.
- Heegaard, P. M. H., Godson, D. L., Toussaint, M. J. M., Tjørnehoj, K., Larsen, L. E., Viuff, B., and Ronsholt, L. (2000). The acute phase

- response of haptoglobin and serum amyloid A (SAA) in cattle undergoing experimental infection with bovine respiratory syncytial virus. *Vet. Immunol. Immunopath.* **77**, 151–159.
- Heegaard, P. M. H., Klausen, J., Nielsen, J. P., Gonzalez-Ramon, N., Pineiro, M., Lampreave, F., and Alava, M. (1998). The porcine acute phase response to infection with *Actinobacillus pleuropneumoniae*. Haptoglobin, C-reactive protein, major acute phase protein and serum amyloid A protein are sensitive indicators of infection. *Comp. Biochem. Physiol.* **119B**, 365–373.
- Henderson, K., Stevens, S., Bailey, C., Hall, G., Stewart, J., and Wards, R. (1998). Comparison of the merits of measuring equine chorionic gonadotrophin (eCG) and blood and faecal concentrations of oestrone sulphate for determining the pregnancy status of miniature horses. *Reprod. Fert. Develop.* **10**, 441–444.
- Hiss, S., Knura-Deszczka, S., Regula, G., Hennies, M., Gymnich, S., Petersen, B., and Sauerwein, H. (2003). Development of an enzyme immuno assay for the determination of porcine haptoglobin in various body fluids: testing the significance of meat juice measurements for quality monitoring programs. *Vet. Immunol. Immunopath.* **96**, 73–82.
- Hiss, S., Mielenz, M., Bruckmaier, R. M., and Sauerwein, H. (2004). Haptoglobin concentrations in blood and milk after endotoxin challenge and quantification of mammary Hp mRNA expression. *J. Dairy Sci.* **87**, 3778–3784.
- Hoffman, P. C., Esser, N. M., Bauman, L. M., Denzine, S. L., Engstrom, M., and Chester-Jones, H. (2001). Short communication: effect of dietary protein on growth and nitrogen balance of Holstein heifers. *J. Dairy Sci.* **84**, 843–847.
- Holmes, P. H., Dargie, J. D., Maclena, J. M., and Mulligan, W. (1968). Albumin and globulin turnover in chronic ovine fascioliasis. *Vet. Rec.* **83**, 227.
- Holmskov, U., Jensenius, J. C., Tornoe, I., and Lovendahl, P. (1998). The plasma levels of conglutinin are heritable in cattle and low levels predispose to infection. *Immunology* **93**, 431–436.
- Horadagoda, A., Eckersall, P. D., Hodgson, J. C., Gibbs, H. A., and Moon, G. M. (1994). Immediate responses in serum TNF $\alpha$  and acute phase protein concentrations to infection with *Pasteurella haemolytica* A1 in calves. *Res. Vet. Sci.* **57**, 129–132.
- Horadagoda, N. U., Eckersall, P. D., Andrew, L., Gallay, P., Heumann, D., and Gibbs, H. A. (1995). Characterization of bovine lipopolysaccharide-binding protein and the in vivo acute phase response to *Pasteurella-haemolytica* type A. *Vet. Immunol. Immunopath.* **49**, 61–74.
- Horadagoda, N. U., Knox, K. M. G., Gibbs, H. A., Reid, S. W. J., Horadagoda, A., Edwards, S. E. R., and Eckersall, P. D. (1999). Acute phase proteins in cattle: discrimination between acute and chronic inflammation. *Vet. Rec.* **144**, 437–441.
- Hulten, C., Gronlund, U., Hirvonen, J., Tulamo, R. M., Suominen, M. M., Marhaug, G., and Forsberg, M. (2002). Dynamics in serum of the inflammatory markers serum amyloid A (SAA), haptoglobin, fibrinogen and alpha(2)-globulins during induced noninfectious arthritis in the horse. *Equine Vet. J.* **34**, 699–704.
- Hulten, C., Sandgren, B., Skioldebrand, E., Klingeborn, B., Marhaug, G., and Forsberg, M. (1999). The acute phase protein serum amyloid A (SAA) as an inflammatory marker in equine influenza virus infection. *Acta Vet. Scand.* **40**, 323–333.
- Hurvitz, A. I., Kehoe, J. M., Capra, J. D., and Prata, R. (1971). Bence Jones proteinemia and proteinuria in a dog. *J. Amer. Vet. Med. Assoc.* **159**, 1112.
- Ikenoue, N., Saito, Y., Shimoda, M., and Kokue, E. (2000). Disease-induced alterations in plasma drug-binding proteins and their influence on drug binding percentages in dogs. *Vet. Quart.* **22**, 43–49.
- Israilli, Z. H., and Dayton, P. G. (2001). Human alpha-1-glycoprotein and its interactions with drugs. *Drug Metab. Rev.* **33**, 161–235.
- Itoh, H., Tamura, K., Izumi, M., Motoi, Y., and Funayama, Y. (1993a). Characterization of serum alpha-1-acid glycoprotein in fetal and newborn calves during development. *Amer. J. Vet. Res.* **54**, 591–595.
- Itoh, H., Tamura, K., Izumi, M., Motoi, Y., Kidoguchi, K., and Funayama, Y. (1993b). The influence of age and health-status on the serum alpha-1-acid glycoprotein level of conventional and specific pathogen-free pigs. *Can. J. Vet. Res.-Revue Can. Rech.Vet.* **57**, 74–78.
- Jacobs, R. M., Couto, C. G., and Wellman, M. L. (1986). Biclonal gammopathy in a dog with myeloma and cutaneous lymphoma. *Vet. Path.* **23**, 211–213.
- Jacobsen, S., and Andersen, H. J. (2007). The acute phase protein serum amyloid A (SAA) as a marker of inflammation in horse. *Equine Vet. Educ.* **19**, 38–46.
- Jacobsen, S., Jensen, J. C., Frei, S., Jensen, A. L., and Thoenner, M. B. (2005a). Use of serum amyloid A and other acute phase reactants to monitor the inflammatory response after castration in horses: a field study. *Equine Vet. J.* **37**, 552–556.
- Jacobsen, S., Niewold, T. A., Kornalijnslipjer, E., Toussaint, M. J. M., and Gruys, E. (2005b). Kinetics of local and systemic isoforms of serum amyloid A in bovine mastitic milk. *Vet. Immunol. Immunopath.* **104**, 21–31.
- James, P. (1997). Of genomes and proteomes. *Biochem. Biophys. Res. Comm.* **231**, 1–6.
- Jensen, L. E., and Whitehead, A. S. (1998). Regulation of serum amyloid A protein expression during the acute phase response. *Biochem. J.* **334**, 489–503.
- Jergens, A. E., Schreiner, C. A., Frank, D. E., Niyo, Y., Ahrens, F. E., Eckersall, P. D., Benson, T. J., and Evans, R. (2003). A scoring index for disease activity in canine inflammatory bowel disease. *J. Vet. Int. Med.* **17**, 291–297.
- Johnson, K. H., Sletten, K., Hayden, D. W., O'Brien, T. D., Rossow, K. D., and Westermark, P. (1995). AA amyloidosis in Chinese shar-pei dogs: immunohistochemical and amino-acid-sequence analyses. *Amyloid-Inter. J. Exper. Clin. Invest.* **2**, 92–99.
- Kajikawa, T., Furuta, A., Onishi, T., Tajima, T., and Sugii, S. (1999). Changes in concentrations of serum amyloid A, alpha(1)-acid glycoprotein, haptoglobin and C-reactive protein in feline sera due to induced inflammation and surgery. *J. Vet. Med. Sci.* **68**, 91–98.
- Kaneko, J. J., Moulton, J. E., Brodey, R. S., and Perryman, V. D. (1965). Malabsorption syndrome resembling nontropical sprue in dogs. *J. Amer. Vet. Med. Assoc.* **146**, 463.
- Karas, M., and Hillenkamp, F. (1988). Laser desorption ionization of proteins with molecular masses exceeding 10000 daltons. *Anal. Chem.* **60**, 2299–2301.
- Katoh, N., and Nakagawa, H. (1999). Detection of haptoglobin in the high-density lipoprotein and the very high-density lipoprotein fractions from sera of calves with experimental pneumonia and cows with naturally occurring fatty liver. *J. Vet. Med. Sci.* **61**, 119–124.
- Kawai, T., Suzuki, Y., Eda, S., Ohtani, K., Kase, T., Fujinaga, Y., Sakamoto, T., Kurimura, T., and Wakamiya, N. (1997). Cloning and characterization of a cDNA encoding bovine mannan-binding protein. *Gene* **186**, 161–165.
- Keay, G. (1982). Serum-protein values from clinically normal cats and dogs determined by agarose-gel electrophoresis. *Res. Vet. Sci.* **33**, 343–346.

- Keay, G., and Doxey, D. L. (1982). Species characteristics of serum-proteins demonstrated after agarose-gel electrophoresis. *Vet. Res. Comm.* **5**, 263–270.
- Keay, G., and Doxey, D. L. (1983). Serum-albumin values from healthy cattle, sheep and horses determined by the immediate bromocresol green reaction and by agarose-gel electrophoresis. *Res. Vet. Sci.* **35**, 58–60.
- Kent, J. E., and Roberts, C. A. (1990). Serum protein changes in four horses with monoclonal gammopathy. *Equine Vet. J.* **22**, 375–376.
- Kiral, F. K., Seyrek, K., Pasa, S., Ertabaklar, H., and Unsal, C. (2004). Some haematological, biochemical and electrophoretic findings in dogs with visceral leishmaniasis. *Revue Med. Vet.* **155**, 226–229.
- Kjelgaard-Hansen, M., Jensen, A. L., and Kristensen, A. T. (2003). Evaluation of a commercially available human C-reactive protein (CRP) turbidometric immunoassay for determination of canine serum CRP concentration. *Vet. Clin. Path.* **32**, 81–87.
- Kohn, J. (1957). A cellulose acetate supporting medium for zone electrophoresis. *Clin. Chim. Acta* **2**, 297–303.
- Krogh-Meibom, T., Holmskov, U., Lovendahl, P., and Ingvarsen, K. L. (2004a). A time-resolved immunofluorometric assay for quantification of collectin-43. *J. Immunol. Meth.* **295**, 161–167.
- Krogh-Meibom, T., Holmskov, U., Lovendahl, P., Nielsen, N. I., and Ingvarsen, K. L. (2004b). A time-resolved immunofluorometric assay for quantification of the bovine collectin conglutinin. *J. Immunol. Meth.* **286**, 87–96.
- Laemmli, U. K. (1970). Cleavage of structural proteins during the assembly of the head of bacteriophage T4. *Nature (London)* **227**, 680–685.
- Lampreave, F., Gonzalez-Ramon, N., Martinez-Ayensa, S., Hernandez, M.-A., Lorenzo, H.-K., Garcia-Gil, A., and Pineiro, A. (1994). Characterisation of the acute phase serum protein response in pigs. *Electrophoresis* **15**, 672–676.
- Larson, B. L., and Kendall, K. A. (1957). Changes in specific blood serum protein levels associated with parturition in the bovine. *J. Dairy Sci.* **40**, 659–666.
- Larson, M. A., Wei, S. H., Weber, A., Mack, D. R., and McDonald, T. L. (2003). Human serum amyloid A3 peptide enhances intestinal MUC3 expression and inhibits EPEC adherence. *Biochem. Biophys. Res. Comm.* **300**, 531–540.
- Lauritzen, B., Lykkesfeldt, J., Skaanild, M. T., Angen, O., Nielsen, J. P., and Friis, C. (2003). Putative biomarkers for evaluating antibiotic treatment: an experimental model of porcine *Actinobacillus pleuropneumoniae* infection. *Res. Vet. Sci.* **74**, 261–270.
- Liberg, P., Pehrson, B., and Sandholm, M. (1975). Value of glutaraldehyde and formaldehyde tests in evaluation of globulin level in bovine blood. *Acta Vet. Scand.* **16**, 236–243.
- Lim, S. K., Kim, H. K., Lim, S. K., bin Ali, A., Lim, Y. K., Wang, Y. P., Chong, S. M., Costantini, F., and Baumman, H. (1998). Increased susceptibility in Hp knockout mice during acute hemolysis. *Blood* **92**, 1870–1877.
- Lowry, O. H., Rosebrough, N. J., Farr, A. L., and Randall, R. J. (1951). Protein measurement with the folin phenol reagent. *J. Biol. Chem.* **193**, 265–275.
- Macewen, E. G., Hurvitz, A. I., and Hayes, A. (1977). Hyperviscosity syndrome associated with lymphocytic-leukemia in 3 dogs. *J. Amer. Vet. Med. Assoc.* **170**, 1309–1312.
- Mack, D. R., McDonald, T. L., Larson, M. A., Wei, S., and Weber, A. (2003). The conserved TFLK motif of mammary-associated serum amyloid A3 is responsible for up-regulation of intestinal MUC3 mucin expression in vitro. *Pediatr. Res.* **53**, 137–142.
- Mair, T. S., Cripps, P. J., and Ricketts, S. W. (1993). Diagnostic and prognostic value of serum-protein electrophoresis in horses with chronic diarrhea. *Equine Vet. J.* **25**, 324–326.
- Marnell, L., Mold, C., and Du Clos, T. W. (2005). C-reactive protein: ligands, receptors and role in inflammation. *Clin. Immunol.* **117**, 104–111.
- Martinez-Subiela, S., Ginel, P. J., and Ceron, J. J. (2004). Effects of different glucocorticoid treatments on serum acute phase proteins in dogs. *Vet. Rec.* **154**, 814–817.
- Martinez-Subiela, S., Tecles, F., Eckersall, P. D., and Ceron, J. J. (2002a). Serum concentrations of acute phase proteins in dogs with leishmaniasis. *Vet. Rec.* **150**, 241–244.
- Martinez-Subiela, S., Tecles, F., Montes, A., Gutierrez, C., and Ceron, J. J. (2002b). Effects of haemolysis, lipaemia, bilirubinaemia and fibrinogen on protein electropherogram of canine samples analysed by capillary zone electrophoresis. *Vet. J.* **164**, 261–268.
- Mattheeuws, D. R., Kaneko, J. J., Loy, R. G., Cornelius, C. E., and Wheat, J. D. (1966). Compartmentalization and turnover of <sup>131</sup>I-labeled albumin and gamma globulin in horses. *Amer. J. Vet. Res.* **27**, 699.
- McDonald, T. L., Larson, M. A., Mack, D. R., and Weber, A. (2001). Elevated extrahepatic expression and secretion of mammary-associated serum amyloid A 3 (M-SAA3) into colostrum. *Vet. Immunol. Immunopath.* **83**, 203–211.
- McEwan, A. D., Fisher, E. W., Selman, I. E., and Penhale, W. J. (1970). A turbidity test for the estimation of immune globulin levels in neonatal calf serum. *Clin. Chim. Acta* **27**, 155–163.
- McGroddy, Y. L., Arteaga, A., Knottenbelt, C. M., Ramsey, I. K., and Eckersall, P. D. (2005). Haptoglobin concentrations in dogs undergoing trilostane treatment for hyperadrenocorticism. *Vet. Clin. Path.* **34**, 255–258.
- McGroddy, Y. L., Knottenbelt, C. M., Ramsey, I. K., Reid, S. W. J., and Eckersall, P. D. (2004). Evaluation of a rapid assay for canine C-reactive protein. *Vet. Rec.* **154**, 175–176.
- McGuire, T. C., Banks, K. L., and Poppie, M. J. (1975a). Animal-model of human disease: combined immunodeficiency (severe), Swiss-type agammaglobulinemia. *Amer. J. Path.* **80**, 551–554.
- McGuire, T. C., Poppie, M. J., and Banks, K. L. (1975b). Hypogammaglobulinemia predisposing to infection in foals. *J. Amer. Vet. Med. Assoc.* **166**, 71–75.
- Mehlis, B., and Kertscher, U. (1997). Liquid chromatography mass spectrometry of peptides of biological samples. *Analyt. Chim. Acta* **352**, 71–83.
- Messmore, H., Sung, G., Farid, S., Iqbal, O., and Fabbrini, N. (1997). Fibrinogen assay in plasma utilizing *Bothrops atrox* venom. *Thromb. Haemost.* **1788**.
- Meuten, D. J., Butler, D. G., Thomson, G. W., and Lumsden, J. H. (1978). Chronic enteritis associated with malabsorption and protein-losing enteropathy in horse. *J. Amer. Vet. Med. Assoc.* **172**, 326–333.
- Miller, I., Friedlein, A., Tsangaris, G., Maris, A., Fountoulakis, M., and Gemeiner, M. (2004). The serum proteome of *Equus caballus*. *Proteomics* **4**, 3227–3234.
- Milne, E. M., Doxey, D. L., Kent, J. E., and Pemberton, A. (1991). Acute phase proteins in grass sickness (equine dysautonomia). *Res. Vet. Sci.* **50**, 273–278.
- Mischke, R., Fehr, M., and Nolte, I. (2005). Efficacy of low molecular weight heparin in a canine model of thromboplastin-induced acute disseminated intravascular coagulation. *Res. Vet. Sci.* **79**, 69–76.
- Mischke, R., Wohlsein, P., Busse, L., and Pohlenz, J. (1998). Disseminated intravascular coagulation and hyperfibrinolysis in

- dogs with metastasized mammary carcinoma. *Schweizer Archiv fur Tierheilkunde* **140**, 497–505.
- Molloy, R. M., McConnell, R. I., Lamont, J. V., and FitzGerald, S. P. (2005). Automation of biochip array technology for quality results. *Clin. Chem. Lab. Med.* **43**, 1303–1313.
- Morimatsu, M., Syuto, B., Shimada, N., Fujinaga, T., Yamamoto, S., Saito, M., and Naiki, M. (1991). Isolation and characterisation of bovine haptoglobin from acute phase sera. *J. Biol. Chem.* **266**, 11833–11837.
- Moshage, H. (1997). Cytokines and the hepatic acute phase response. *J. Path.* **181**, 257–266.
- Murata, H., Shimada, N., and Yoshioka, M. (2004). Current research on acute phase proteins in veterinary diagnosis: an overview. *Vet. J.* **168**, 28–40.
- Nagahata, H., Taguchi, K., and Noda, H. (1989). Preliminary studies on the acid soluble glycoproteins in serum and their diagnostic value for acute inflammatory disease in cattle. *Vet. Res. Comm.* **13**, 257–263.
- Nakagawa, H., Yamamoto, O., Oikawa, S., Higuchi, H., Watanabe, A., and Katoh, N. (1997). Detection of serum haptoglobin by enzyme-linked immunosorbent assay in cows with fatty liver. *Res. Vet. Sci.* **62**, 137–141.
- Nakajou, K., Watanabe, H., Kragh-Hansen, U., Maruyama, T., and Otogiri, M. (2003). The effect of glycation on the structure, function and biological fate of human serum albumin as revealed by recombinant mutants. *Biochim. Biophys. Acta-Gen. Subj.* **1623**, 88–97.
- Navarro, M. A., Acin, S., Iturralde, M., Calleja, L., Carnicer, R., Guzman-Garcia, M. A., Gonzalez-Ramon, N., Mata, P., Isabel, B., Lopez-Bote, C. J., Lampreave, F., Pineiro, A., and Osada, J. (2004). Cloning, characterization and comparative analysis of pig plasma apolipoprotein A-IV. *Gene* **325**, 157–164.
- Nielsen, B. H., Jacobsen, S., Andersen, P. H., Niewold, T. A., and Heegaard, P. M. (2004). Acute phase protein concentrations in serum and milk from healthy cows, cows with clinical mastitis and cows with extramammary inflammatory conditions. *Vet. Rec.* **154**, 361–365.
- Niewold, T. A., Van der Linde-Sipman, J., Murphy, C., Tooten, P. C. J., and Gruys, E. (1999). Familial amyloidosis in cats: Siamese and Abyssinian AA proteins differ in primary sequence and pattern of deposition. *Amyloid-J. Protein Fold. Disord.* **6**, 205–209.
- O'Farrell, P. H. (1975). High-resolution 2-dimensional electrophoresis of proteins. *J. Biol. Chem.* **250**, 4007–4021.
- Ohwada, K., and Tamura, K. (1995). Usefulness of alpha 1 acid glycoprotein (a1-AG) values in screening pound dogs acquired from animal shelters for experimental use. *Exp. Anim.* **42**, 627–630.
- Oosting, J. D., and Hoffmann, J. J. M. L. (1997). Evaluation of an automated photometric fibrinogen assay. *Blood Coagul. Fibrinolysis* **8**, 321–326.
- Paltrinieri, S. The feline acute phase reaction. *Vet. J.*, (in press).
- Pang, S., Smith, J., Onley, D., Reeve, J., Walker, M., and Foy, C. (2005). A comparability study of the emerging protein array platforms with established ELISA procedures. *J. Immunol. Meth.* **302**, 1–12.
- Parra, M. D., Tuomola, M., Cabezas-Herrera, J., and Ceron, J. J. (2005a). Use of a time-resolved immunofluorometric assay for determination of canine C-reactive protein concentrations in whole blood. *Amer. J. Vet. Res.* **66**, 62–66.
- Parra, M. D., Vaisanen, V., and Ceron, J. J. (2005b). Development of a time-resolved fluorometry based immunoassay for the determination of canine haptoglobin in various body fluids. *Vet. Res.* **36**, 117–129.
- Patel, R. T., Caceres, A., French, A. F., and McManus, P. M. (2005). Multiple myeloma in 16 cats: a retrospective study. *Vet. Clin. Path.* **34**, 341–352.
- Patterson, S. D., and Aebersold, R. (1995). Mass-spectrometric approaches for the identification of gel-separated proteins. *Electrophoresis* **16**, 1791–1814.
- Pepys, M. B. (1981). C-reactive protein fifty years on. *Lancet*, 653–657.
- Pepys, M. B., Baltz, M. L., Tennent, G. A., Kent, J., Ousey, J., and Rosedale, P. D. (1989). Serum amyloid A protein (SAA) in horses: objective measurement of the acute phase response. *Equine Vet. J.* **21**, 106–109.
- Perryman, L. E. (2000). Primary immunodeficiencies of horses. *Vet. Clin. N. Amer.-Equine Pract.* **16**, 105.
- Perryman, L. E., Mcguire, T. C., and Hilbert, B. J. (1977). Selective immunoglobulin-M deficiency in foals. *J. Amer. Vet. Med. Assoc.* **170**, 212–215.
- Petersen, H. H., Nielsen, J. P., and Heegaard, P. M. H. (2004). Application of acute phase protein measurement in veterinary clinical chemistry. *Vet. Res.* **35**, 163–187.
- Petricoin, E. F., Zoon, K. C., Kohn, E. C., Barrett, J. C., and Liotta, L. A. (2002). Clinical proteomics: translating benchside promise into bedside reality. *Nat. Rev. Drug Discov.* **1**, 683–695.
- Pfeiffer, N. E., and Mcguire, T. C. (1977). Sodium sulfite precipitation test for assessment of colostral immunoglobulin transfer to calves. *J. Amer. Vet. Med. Assoc.* **170**, 809–811.
- Pineiro, M., Andres, M., Iturralde, M., Carmona, S., Hirvonen, J., Pyorala, S., Heegaard, P. M. H., Tjornehoj, K., Lampreave, F., Pineiro, A., and Alava, M. A. (2004). ITIH4 (inter-alpha-trypsin inhibitor heavy chain 4) is a new acute-phase protein isolated from cattle during experimental infection. *Infect. Immun.* **72**, 3777–3782.
- Pirlot, A., Janssens, J., Skinner, G., and Godeau, J. M. (1999). Quantitative determination of haptoglobin (HAP) in human and bovine sera by capillary zone electrophoresis (CZE). *Vet. Res.* **30**, 483–493.
- Pocacqua, V., Provasi, E., Paltrinieri, S., Gelain, E., Comunian, C., and Cecilian, F. (2005). Glycan moiety modifications of feline alpha 1-acid glycoprotein in retrovirus (FIV, FeLV) affected cats. *Vet. Immunol. Immunopath.* **107**, 17–26.
- Polat, U., Cetin, M., Ak, I., and Balci, F. (2004). Detection of serum protein fractions and their concentrations in laying and non-laying ostriches (*Struthio camelus*) fed with different dietary protein levels. *Revue Med. Vet.* **155**, 570–574.
- Preston, T., Slater, C., McMillan, D. C., Falconer, J. S., Shenkin, A., and Fearon, K. C. H. (1998). Fibrinogen synthesis is elevated in fasting cancer patients with an acute phase response. *J. Nutr.* **128**, 1355–1360.
- Prinsen, B. H. C. M., and de Sain-van der Velden, M. (2004). Albumin turnover: experimental approach and its application in health and renal diseases. *Clin. Chim. Acta* **347**, 1–14.
- Pusterla, N., Stacy, B. A., Vernau, W., De Cock, H. E. V., and Magdesian, K. G. (2004). Immunoglobulin A monoclonal gammopathy in two horses with multiple myeloma. *Vet. Rec.* **155**, 19–23.
- Putnam, F. W. (1975). "The Plasma Proteins." Academic Press, New York.
- Reisdesmerie, L., Dossin, O., Concorde, D., Guelfi, J. F., Eclache, D., and Braun, J. P. (1995). Diagnostic-significance of plasma ammonia in dogs. *Revue Med. Vet.* **146**, 421–426.
- Righetti, P., and Drysdale, J. W. (1971). Isoelectric focusing in polyacrylamide gels. *Biochimica et Biophysica Acta* **236**, 17.
- Rosales, F. J., Ritter, S. J., Zolfaghari, R., Smith, J. E., and Ross, A. C. (1996). Effects of acute inflammation on plasma retinol, retinol-binding protein, and its mRNA in the liver and kidneys of vitamin A-sufficient rats. *J. Lipid Res.* **37**, 962–971.
- Rumbaugh, G. E., and Adamson, P. J. W. (1983). Automated serum chemical-analysis in the foal. *J. Amer. Vet. Med. Assoc.* **183**, 769–772.

- Rumbaugh, G. E., Smith, B. P., and Carlson, G. P. (1978). Internal abdominal abscesses in horse: study of 25 cases. *J. Amer. Vet. Med. Assoc.* **172**, 304–309.
- Rutqvist, L. (1958). Electrophoretic patterns of blood serum from pig fetuses and young pigs. *Amer. J. Vet. Res.* **19**, 25–31.
- Saco, Y., Docampo, M. J., Fabrega, E., Manteca, X., Diestre, A., Lampreave, F., and Bassols, A. (2003). Effect of transport stress on serum haptoglobin and Pig-MAP in pigs. *Anim. Welf.* **12**, 403–409.
- Sandholm, M., and Kivisto, A. K. (1975). Determination of gamma-globulin in dog serum by glutaraldehyde. *J. Small Anim. Pract.* **16**, 201–205.
- Schroedl, W., Fuerll, B., Reinhold, P., Krueger, M., and Schuett, C. (2001). A novel acute phase marker in cattle: lipopolysaccharide binding protein (LBP). *J. Endotox. Res.* **7**, 48–51.
- Schwartzman, R. M. (1984). Cutaneous amyloidosis associated with a monoclonal gammopathy in a dog. *J. Amer. Vet. Med. Assoc.* **185**, 102–104.
- Segales, J., Pineiro, C., Lampreave, F., Nofrarias, M., Mateu, E., Calsamiglia, M., Andres, M., Morales, J., Pineiro, M., and Domingo, M. (2004). Haptoglobin and pig-major acute protein are increased in pigs with postweaning multisystemic wasting syndrome (PMWS). *Vet. Res.* **35**, 275–282.
- Sellon, D. C. (2000). Secondary immunodeficiencies of horses. *Vet. Clin. N. Amer.-Equine Pract.* **16**, 117.
- Selting, K. A., Ogilvie, G. K., Lana, S. E., Fettman, M. J., Mitchener, K. L., Hansen, R. A., Richardson, K. L., Walton, J. A., and Scherk, M. A. (2000). Serum alpha 1-acid glycoprotein concentrations in healthy and tumor-bearing cats. *J. Vet. Inter. Med.* **14**, 503–506.
- Sevelius, E., and Andersson, M. (1995). Serum protein electrophoresis as a prognostic marker of chronic liver disease in dogs. *Vet. Rec.* **137**, 663–667.
- Sheffield, C. L., Stanker, L. H., and Deloach, J. R. (1993). Development of an elisa based test for bovine haptoglobin using the monoclonal-antibody hap1. *FASEB J.* **7**, 596.
- Skinner, J. G. (2001). International standardization of acute phase proteins. *Vet. Clin. Path.* **30**, 2–7.
- Smith, P. K., Krohn, R. I., Hermanson, G. T., Mallia, A. K., Gartner, F. H., Provenzano, M. D., Fujimoto, E. K., Goeke, N. M., Olson, B. J., and Klenk, D. C. (1985). Measurement of protein using bicinchoninic acid. *Analyt. Biochem.* **150**, 76–85.
- Son, D. S., Roby, K. F., and Terranova, P. F. (2004). Tumor necrosis factor-alpha induces serum amyloid A3 in mouse granulosa cells. *Endocrinology* **145**, 2245–2252.
- Spratt, D. P., Mellanby, R. J., Drury, N., and Archer, J. (2005). Cardiac troponin I: evaluation of a biomarker for the diagnosis of heart disease in the dog. *J. Small Anim. Pract.* **46**, 139–145.
- Steiner, J. M., Williams, D. A., Moeller, E. M., and Melgarejo, T. (2000). Development and validation of an enzyme-linked immunosorbent assay for feline trypsin-like immunoreactivity. *Amer. J. Vet. Res.* **61**, 620–623.
- Stokol, T., Tarrant, J. M., and Scarlett, J. M. (2001). Overestimation of canine albumin concentration with the bromocresol green method in heparinized plasma samples. *Vet. Clin. Path.* **30**, 170–176.
- Stoneham, S. J., Palmer, L., Cash, R., and Rosedale, P. D. (2001). Measurement of serum amyloid A in the neonatal foal using a latex agglutination immunoturbidimetric assay: determination of the normal range, variation with age and response to disease. *Eq. Vet. J.* **33**, 599–603.
- Tamura, K., Yatsu, T., Itoh, H., and Motoi, Y. (1989). Isolation, characterization and quantitative measurement of serum alpha 1-acid glycoprotein in cattle. *Jpn. J. Vet. Sci.* **51**, 987–994.
- Teclès, F., Spiranelli, E., Bonfanti, U., Ceron, J. J., and Paltrinieri, S. (2005). Preliminary studies of serum acute-phase protein concentrations in hematologic and neoplastic diseases of the dog. *J. Vet. Inter. Med.* **19**, 865–870.
- Thompson, D., Pepys, M. B., and Wood, S. P. (1999). The physiological structure of human C-reactive protein and its complex with phosphocholine. *Structure* **7**, 169–177.
- Tilg, H., and Moschen, A. R. (2006). Adipocytokines: mediators linking adipose tissue, inflammation and immunity. *Nature Rev. Immunol.* **6**, 772–783.
- Tiselius, A. (1937). Electrophoresis of serum globulin II. Electrophoretic analysis of normal and immune sera. *Biochem. J.* **31**, 1464–1477.
- Tohjo, H., Miyoshi, F., Uchida, E., Niiyama, M., Syuto, B., Moritsu, Y., Ichikawa, S., and Takeuchi, M. (1995). Polyacrylamide-gel electrophoretic patterns of chicken serum in acute-inflammation induced by intramuscular injection of turpentine. *Poult. Sci.* **74**, 648–655.
- Toussaint, M. J. M., Van Ederen, A. M., and Gruys, E. (1995). Implication of clinical pathology in assessment of animal health and in animal production and meat inspection. *Comp. Haem. Inter.* **5**, 149–157.
- Trumel, C., Schelcher, F., Braun, J. P., and Guelfi, J. F. (1996). Serum protein electrophoresis: guidelines for diagnosis evaluation in the dog, cat, and horse. *Revue Med. Vet.* **147**, 123–130.
- Tyler, J. W., Besser, T. E., Wilson, L., Hancock, D. D., Sanders, S., and Rea, D. E. (1996). Evaluation of a whole blood glutaraldehyde coagulation test for the detection of failure of passive transfer in calves. *J. Vet. Inter. Med.* **10**, 82–84.
- Tyler, J. W., Parish, S. M., Besser, T. E., Van Metre, D. C., Barrington, G. M., and Middleton, J. R. (1999). Detection of low serum immunoglobulin concentrations in clinically ill calves. *J. Vet. Inter. Med.* **13**, 40–43.
- Uchida, E., Katoh, N., and Takahashi, K. (1993). Appearance of haptoglobin in serum from cows at parturition. *J. Vet. Med. Sci.* **55**, 893–894.
- Uhlar, C. M., and Whitehead, A. S. (1999). Serum amyloid A, the major vertebrate acute-phase reactant. *Eur. J. Biochem.* **265**, 501–523.
- Urieli-Shoval, S., Cohen, P., Eisenberg, S., and Matzner, Y. (1998). Widespread expression of serum amyloid A in histologically normal human tissues: predominant localization to the epithelium. *J. Histochem. Cytochem.* **46**, 1377–1384.
- Vandenplas, M. L., Moore, J. N., Barton, M. H., Roussel, A. J., and Cohen, N. D. (2005). Concentrations of serum amyloid A and lipopolysaccharide-binding protein in horses with colic. *Amer. J. Vet. Res.* **66**, 1509–1516.
- vanNiekerk, F. E., and vanNiekerk, C. H. (1997). The effect of dietary protein on reproduction in the mare .2. Growth of foals, body mass of mares and serum protein concentration of mares during the anovulatory, transitional and pregnant periods. *J. S. Afric. Vet. Assoc.* **68**, 81–85.
- Vannucchi, C. I., Mirandola, R. M., and Oliveira, C. M. (2002). Acute-phase protein profile during gestation and diestrous: proposal for an early pregnancy test in bitches. *Anim. Reprod. Sci.* **74**, 87–99.
- Vreugdenhil, A. C. E., Dentener, M. A., Snoek, A. M. P., Greve, J.-W. M., and Buurman, W. A. (1999). Lipopolysaccharide binding protein and serum amyloid A secretion by human intestinal epithelial cells during the acute phase response. *J. Immunol.* **163**, 2792–2798.
- Wait, R., Miller, I., Eberini, I., Cairolì, F., Veronesi, C., Battocchio, M., Gemeiner, M., and Gianazza, E. (2002). Strategies for proteomics with incompletely characterized genomes: the proteome of *Bos taurus* serum. *Electrophoresis* **23**, 3418–3427.
- Walsh, G. (2002). "Proteins, Biochemistry and Biotechnology." John Wiley & Sons, New York.

- Watson, T. D. G. (1996). Lipoprotein metabolism in dogs and cats. *Comp. Haem. Inter.* **6**, 17–23.
- Watson, T. D. G., and Love, S. (1994). Equine hyperlipidemia. *Compendium on Continuing Education for the Practicing Veterinarian* **16**, 89–98.
- Weaver, D. M., Tyler, J. W., VanMetre, D. C., Hostetler, D. E., and Barrington, G. M. (2000). Passive transfer of colostral immunoglobulins in calves. *J. Vet. Inter. Med.* **14**, 569–577.
- Weber, A., Weber, A. T., McDonald, T. L., and Larson, M. A. (2006). *Staphylococcus aureus* lipoteichoic acid induces differential expression of bovine serum amyloid A3 (SAA3) by mammary epithelial cells: implications for early diagnosis of mastitis. *Vet. Immunol. Immunopath.* **109**, 79–83.
- Williams, D. A., and Batt, R. M. (1988). Sensitivity and specificity of radioimmunoassay of serum trypsin-like immunoreactivity for the diagnosis of canine exocrine pancreatic insufficiency. *J. Amer. Vet. Med. Assoc.* **192**, 195–201.
- Wilson, T. C., Bachurski, C. J., Ikegami, M., Jobe, A. H., and Kallapur, S. G. (2005). Pulmonary and systemic induction of SAA3 after ventilation and endotoxin in preterm lambs. *Pediatr. Res.* **58**, 1204–1209.
- Winter, P., Fuchs, K., Walshe, K., and Colditz, I. G. (2003). Serum amyloid A in the serum and milk of ewes with mastitis induced experimentally with *Staphylococcus epidermidis*. *Vet. Rec.* **152**, 558–562.
- Xie, H., Huff, G. R., Huff, W. E., Balog, J. M., Holt, P., and Rath, N. C. (2002a). Identification of ovotransferrin as an acute phase protein in chickens. *Poultry Science* **81**, 112–120.
- Xie, H., Newberry, L., Clark, F. D., Huff, W. E., Huff, G. R., Balog, J. M., and Rath, N. C. (2002b). Changes in serum ovotransferrin levels in chickens with experimentally induced inflammation and diseases. *Avian Dis.* **46**, 122–131.
- Yang, F. M., Friedrichs, W. E., Navarijoashbaugh, A. L., DeGraffenried, L. A., Bowman, B. H., and Coalson, J. J. (1995). Cell-type-specific and inflammatory-induced expression of haptoglobin gene in lung. *Lab. Invest.* **73**, 433–440.
- Yang, F. M., Haile, D. J., Berger, F. G., Herbert, D. C., Van Beveren, E., and Ghio, A. J. (2003). Haptoglobin reduces lung injury associated with exposure to blood. *Amer. J. Physiol.-Lung Cell. Molec. Physiol.* **284**, L402–L409.
- Yoshida, H., Arthur, H., and Bell, K. (1997). Genetic polymorphism of cat (*Felis catus*) plasma orosomucoid. *Biochem. Genet.* **35**, 303–314.
- Yule, T. D., Roth, M. B., Dreier, K., Johnson, A. F., Palmer-Densmore, M., Simmons, K., and Fanton, R. (1997). Canine parvovirus vaccine elicits protection from the inflammatory and clinical consequences of the disease. *Vaccine* **15**, 720–729.



# Clinical Veterinary Immunology

Laurel J. Gershwin

*Department of Pathology, Microbiology, and Immunology*

*School of Veterinary Medicine*

*University of California, Davis*

*Davis, California*

- 
- I. INTRODUCTION**
  - II. INNATE IMMUNITY**
  - III. ACQUIRED IMMUNITY**
    - A. Humoral Immunity
    - B. Cellular Immunity
  - IV. EVALUATION OF THE IMMUNE RESPONSE**
    - A. Evaluation of Neutrophil Function
    - B. Evaluation of Complement
    - C. Evaluation of Humoral Immunity
    - D. Evaluation of Cellular Immunity
  - V. METHODS FOR EVALUATION OF THE IMMUNE RESPONSE TO INFECTIOUS AGENTS**
    - A. Agglutination and Passive Agglutination
    - B. Hemagglutination and Hemagglutination-Inhibition
    - C. Virus Serum Neutralization Assay
    - D. Agar Gel Double Immunodiffusion
    - E. Indirect and Direct Immunofluorescence (IFA) Test
    - F. Flow Cytometry
    - G. Enzyme-Linked Immunosorbent Assay (ELISA)
    - H. Immunohistochemistry/Immunoperoxidase Techniques
    - I. Western Blot Analysis
    - J. How Do the Sensitivities of Different Immunoassays Compare?
    - K. Interpretation of Immune Responses to Pathogens
  - VI. LABORATORY DIAGNOSIS OF DISEASES WITH AN IMMUNOLOGICAL PATHOGENESIS**
    - A. Autoimmune Diseases
    - B. Primary Immune Deficiency Diseases
    - C. Secondary Immunodeficiency
    - D. Hypersensitivity Diseases
  - VII. MODULATION OF THE IMMUNE RESPONSE**
  - VIII. SUMMARY**
  - REFERENCES**
- 

## I. INTRODUCTION

The field of clinical immunology has evolved from serological testing for the presence of antibodies to infectious agents to a multifaceted discipline that utilizes some of the traditional techniques in addition to many newer more sensitive assay systems. Yet it is still involved with evaluation of the immune system of patients and the ability of the immune system to respond to antigenic stimuli. Assays developed to target specific parts of the immune system enable the clinician not only to determine if a patient has normal immune responsiveness but also to target those parts of the immune system that are suspect of inadequate function. Serology has historically been used to determine retrospectively if a patient were infected with a particular disease agent; antibody titers continue to have importance in diagnostics.

Current technologies have created expanded opportunities to diagnose infectious, autoimmune, and allergic diseases with new tools. Diagnostic quantitative reverse transcriptase polymerase chain reaction (RT-PCR) has shifted the focus from the immunology laboratory for the identification of infecting pathogens. Yet growing concern that veterinarians may be overvaccinating their patients has provided a new incentive for the development of sensitive and specific immunoassays to measure the immune response to vaccine antigens. Another increasing trend since the previous edition of this book is the use of diagnostic flow cytometry. This technique can evaluate multiple parameters on cells using multicolor analysis. The current availability of antibodies to many cytokines makes it now possible to determine not only cell phenotype but also the intracellular cytokines being made. Production of monoclonal antibodies specific to some leukocyte antigens expressed on leukemic cells has allowed diagnosis of these conditions to be achieved through flow cytometry. Flow cytometry is currently being used for detection of autoantibodies to platelets and erythrocytes. The traditional antinuclear antibody

test is often supplemented with more specific assays for evaluation of the presence of autoantibodies in animal patients. Diagnosis of allergic conditions is now commonplace because of the development of reagents and assays to measure IgE in dogs, horses, and cats.

This chapter reviews some basic principles of immunology and presents current methodologies used in the clinical immunology laboratory.

## II. INNATE IMMUNITY

Entry into the body of a pathogen is the first stimulus for immunity. Pathogens contain pattern recognition receptors called pathogen associated molecular patterns (PAMP), which are recognized by Toll-like receptors (TLR) on the surface of host cells. There are at least 10 such receptors, each recognizing a different motif. For example, TLR 2 recognizes the peptidoglycan of the Gram-positive bacterial cell wall, TLR 4 recognizes lipopolysaccharide from the Gram-negative bacterial cell wall, TLR 6 recognizes flagella protein present on motile bacteria, and TLR 9 recognizes DNA containing cytosine-guanine repeating motifs (CpG). The binding of these TLRs with their ligands stimulates production of proinflammatory cytokines that jumpstart the immune response (Takeda, 2005).

The immune response is generally divided into innate and acquired responses. This division is based on the need for the host to have previously been exposed to the antigen/pathogen in order to rapidly mount a protective response. Innate immunity does not require previous exposure to a pathogen for it to be effective. It is thus not an antigen-specific response. Innate immunity is a broad category that includes protective barriers such as skin and mucosa. Reflexes are included, such as the cough coupled with the anatomical/physiological function of the mucociliary apparatus, which moves inhaled material out of the respiratory system. Dogs with inherited ciliary dyskinesia have non-functional cilia and suffer from repeated respiratory infections because of their inability to remove inhaled particles (such as bacteria) from the lung.

Phagocytes are important components of innate immunity. The initial responder to infection is usually the polymorphonuclear leukocyte or neutrophil. These cells participate in phagocytosis and killing of bacteria. Dogs with inherited cyclic neutropenia develop cyclic bouts of bacterial disease that coincide with the episodes during which the bone marrow shuts down its production of these essential phagocytes. Other defects, such as that seen in calves with bovine leukocyte adhesion deficiency (BLAD), occur when production is good, but the neutrophils lack the CD18 part of the adhesion molecule that allows them to adhere to blood vessel endothelium and then exit into the tissue by diapedesis. These animals develop even more critical disease because their defect is not cyclic, but constant. These calves generally succumb to overwhelming bacterial

disease within the first 6 months of life. These experiments in nature demonstrate the importance of the innate defense provided by the neutrophil.

The other population of phagocyte is the macrophage. This cell plays a role not only as a phagocyte, generally entering an area of inflammation after the neutrophil, but also as a vital link to the acquired immune response. Macrophages function as antigen-presenting cells. As such they engulf a pathogen, digest it within a vacuole, and then display peptides generated from the engulfed organism on their cell surface. This antigen presentation function relies on the presence of a cell surface molecule called major histocompatibility complex antigen class II (MHC II). Lymphoid cells of the CD4+ T cell lineage then bind to the peptide and to the MHC II for initiation of the immune response. This is a critical step in immune responses. However, there is another cell type, the dendritic cell, that performs the antigen presentation function more efficiently than the macrophage. These cells are pivotal to induction of the acquired immune response and serve as an effector for innate immunity.

The need for acquired immunity is demonstrated by certain bacterial species that are able to live and divide after being ingested by a macrophage. These organisms, called facultative intracellular bacteria, are able to overcome the macrophage and prevent their own digestion in the phagosome. To overcome the infection, the macrophages infected with these bacteria require signals from cytokines that are secreted by T cells stimulated in an acquired immune response. Infection of cattle with *Mycobacterium bovis subspecies paratuberculosis* causes a chronic wasting disease because of the ability of the bacteria to overcome the killing function of the macrophages. The acquired immune response required for killing these organisms is discussed with cellular immunity.

There is a population of lymphocytes that are neither T nor B cells; they lack the receptors for antigen recognition. These cells are natural killer cells (NK cells). The NK cells have the ability to recognize cells that lack or have depressed levels of the MHC class I molecule on the cell surface. Many tumor cells and some viral infected cells fall into this category. It is an evasion technique employed by some viruses to down-regulate the expression of the MHC molecules, which are required for recognition of the effector cells of the immune system. These NK cells are part of the innate immune system, because they are available to act on target cells without prior exposure.

## III. ACQUIRED IMMUNITY

Acquired immunity is specific for the stimulatory antigen; and the acquired response has memory. Thus, once a host has encountered an antigen and initiated an immune response, the next time the antigen is encountered by that host, the response is more rapid and more robust. The antigen can be from a pathogen (bacteria, virus, parasite, fungal) or it can

be a protein (as in an injected biological or an ingested or inhaled protein). Initially an antigen is taken up by a dendritic cell and is carried in the lymph to a local lymph node. In that site it is presented to the T cells in the body to initiate the response. When the T cell with the appropriate receptor recognizes the antigenic peptide on the surface of the antigen-presenting cell, it binds and begins a process of activation. Ultimately the activated T cell secretes cytokines that enhance the development of the T cell response and others that stimulate the growth and differentiation of B lymphocytes. There are multiple signals involved in antigen stimulation of T and B lymphocytes; these are receptor binding, cytokine binding, and binding of co-stimulatory molecules. Once this has been accomplished, a B cell can differentiate into a plasma cell to make antibody with the same specificity as that which stimulated the original B cell.

There are two major types of T cells: CD4+ helper T cells and CD8+ cells, usually called cytotoxic T cells. This latter group has the capacity to kill target cells that are infected with antigens, such as viruses. There are two main subsets of CD4+ T helper cells: T helper 1 and T helper 2. The Th1 cells assist in cellular immune responses, such as activation of the macrophages infected with facultative intracellular bacteria. The Th2 cells provide “help” to B cells by provision of cytokines and co-stimulatory molecules (as described earlier). This T cell help initiates clonal expansion into mature B cells and ultimately into memory B cells and plasma cells. The plasma cells are the end cell that makes the immunoglobulin (antibody) that is so important in humoral immunity.

These Th1 and Th2 cells are primarily identified by the cytokines that they produce. Th1 cells make IL-2, IL-12, and interferon  $\gamma$ . The former activates T cells to divide and proliferate, and the latter activates macrophages to become more efficient killers. Cytokines produced by the Th2 subset include IL-4, IL-5, and IL-13. IL-4 is a B cell growth factor; and in conjunction with IL-13, they can facilitate development of an allergic type response (in which plasma cells produce lots of IgE). The T helper cell subsets were originally described in the inbred mouse, where the division between the two is distinct. However, in many of our bred species, such as humans and cattle, the distinction is less clear, with a T helper 1 or 2 skew more commonly identified than a complete polarization of the immune response.

One additional T cell subset that is described is the regulatory T cell (T reg). These cells are CD4+ and CD25+ and contain the nuclear activation factor FoxP3. T regs produce IL-10 and TGF- $\beta$ , which depress the T helper 2 response. These cells may have a role in control of autoimmunity and allergy.

## A. Humoral Immunity

Electrophoretic separation of serum proteins separates the proteins into four broad categories: albumin, alpha globulins, beta globulins, and gamma globulins. The antibody activity

is present in the gamma globulin fraction, with a slight amount in the beta fraction. These immunoglobulins are heterogeneous, having different molecular weights and functional properties.

There are five classes (isotypes) of immunoglobulins: IgG, IgM, IgA, IgD, and IgE. They share a basic structure, which consists of four polypeptide chains bound together by disulfide bonds. Two of these chains are called light chains, because with a molecular weight of about 22K each they are lighter than the other two heavy chains (approximately 55K each). At the nitrogen terminal of the polypeptide chains on all four chains is a portion of variable amino acid sequences. This is the antigen-binding end of the immunoglobulin. The hinge region of the immunoglobulin provides for flexibility of the molecule for binding to antigenic epitopes.

In the serum, IgG is the antibody class with the greatest concentration, approximately 1 to 2 g/100ml, with some species differences (Tizard, 2008). Subclasses of IgG are recognized in most species. IgG has a four polypeptide-chain structure with a total molecular weight of 180,000 daltons. The heavy chains in IgG are called gamma chains and are unique to IgG. Immunoglobulin G is important in host defense because it can exit the vascular system and distribute throughout the extravascular tissue fluid where it has many protective functions. For example, IgG can agglutinate bacteria, causing them to clump; it can opsonize bacteria, by binding to the bacteria by the Fab fragment and to the phagocyte by receptors for the Fc fragment, thereby facilitating engulfment of the bacteria by the phagocyte. The complement system (a series of serum proteins to be discussed later in this chapter) can be activated by two IgG molecules bound near each other on a cell membrane and target cells can be lysed by this mechanism. In addition, IgG can participate with several different effector cells in antibody-dependent cellular cytotoxicity (ADCC). This mechanism allows destruction of virus-infected cells by lymphocytes that lack specific antigen receptors. The ability of IgG to neutralize toxins, such as those produced by *Clostridium tetani*, is an important protective mechanism for bacterial diseases.

Immunoglobulin M (IgM) is the first antibody to be synthesized in response to an immunogenic stimulus and is the first antibody seen in ontogeny. In serum, IgM is present in the second greatest concentration, generally between 100 and 400mg/100ml (species dependent). The structure of IgM consists of five of the basic four polypeptide units held together by a J chain. The large size of IgM (900,000 daltons) keeps it confined to the intravascular space. There are a total of 10 potential antigen-binding sites on IgM. Even though in reality, because of steric hindrance, only five to seven of the antigen-binding sites are functionally active, this large capacity to bind antigens makes IgM an efficient antibody at agglutination, precipitation, opsonization, complement fixation, and virus neutralization.

Immunoglobulin A exists primarily in two forms, as a monomer (160,000 daltons) in the blood-vascular compartment and in a dimeric secretory form (390,000 daltons).

Less commonly, polymers of greater number occur. The dimeric form consists of two monomers, each containing a heavy chain (alpha) and a light chain. These are held together by J chain and include an additional component called secretory piece. The secretory piece is produced by mucosal epithelial cells and functions to assist in transport of IgA dimers from the lamina propria of the intestine through into the lumen where it then protects the IgA dimer from proteolysis by intestinal enzymes. In domestic animals, IgA is important as a secretory antibody both within the intestinal tract and the lung. It is capable of neutralizing virus and preventing adherence of bacterial pathogens to target tissues. It does not function as an opsonin and is unable to fix complement.

IgD is usually of not generally quantitated in the serum, although serum levels are reported for humans are greater than those measured for IgE. IgD is a four-polypeptide chain configuration (heavy chains are called  $\delta$ ) with a molecular weight of 180,000 daltons. IgD serves as a B cell receptor for antigen. Early in an immune response, immature B cells express IgD. As the cell matures in response to antigen, the IgD is replaced with monomeric IgM. Although IgD has been demonstrated in humans, mice, pigs, horses, cattle, dogs, and chickens, information is lacking in the cat. The existence of IgD in the animal species (other than the mouse) is based primarily on genome sequencing.

Immunoglobulin E is recognized and characterized in dogs, cattle, sheep, pigs, horses, and functionally recognized in cats. IgE has never been documented in avian species. IgE occurs normally in very small amounts in the serum (nanogram quantities). In allergic or parasitized individuals, the serum concentration of IgE is greatly increased. The basic four-polypeptide chain structure of IgE, with epsilon heavy chains that contain one additional domain, has a molecular weight of 196,000 daltons. Functions of IgE are mediated through its ability to bind via the high affinity Fc $\epsilon$  receptors on tissue mast cells and blood basophils. When an antigen cross-links these cell-bound antibodies, the cell degranulates, releasing vasoactive amines, stimulating leukotriene synthesis, and resulting in potent pharmacological effects. IgE can also bind to the low-affinity IgE receptor, CD23. Binding of IgE to the CD23 stimulates a regulatory function. IgE can participate in parasite killing by binding to low-affinity IgE receptors on eosinophils and then to the parasite by specific Fab regions. This allows the eosinophils to deposit their toxic granule contents on the cuticle of the worm.

## B. Cellular Immunity

The cellular immune response is important for viral pathogens, tumor immunity, and for defense against bacterial pathogens that are able to evade killing by macrophages (these are facultative intracellular bacteria). The T cell response is important for cellular immunity. The CD8+ T cells are cytotoxic cells. They are able to recognize

peptides derived from antigens that grow in an intracellular location and are processed and “presented” on the cell surface with the major histocompatibility molecule (MHC class I). Once the T cell has recognized the peptide from the antigen, it is able to respond by killing the infected cell and others infected with the same pathogen. The killing is mediated by interaction of surface molecules called “death receptors,” Fas and Fas-ligand to initiate apoptosis. The polymerization of perforins from the T cell onto the surface of the infected target cell allows for the entry of granzymes, which are molecules that are able to initiate cell death. This mechanism of immunity is particularly effective for viruses such as herpesviruses that are primarily cell associated and therefore not very accessible to antibodies.

The immune response to the facultative intracellular pathogens is primarily mediated by the T helper 1 subset of CD4+ T cells. These cells make interferon  $\gamma$ , which activates the macrophage and helps it to become a better killer. It does this by increasing a variety of metabolic activities, such as synthesis of cytokines (tumor necrosis factor  $\alpha$ , IL-1, IL-12), by increasing the ruffled membrane activity and increasing nitric oxide production.

## IV. EVALUATION OF THE IMMUNE RESPONSE

When the clinician is concerned that there may be some defect in the innate immune system of a patient, the concern is usually initiated by repeated infection in the patient. If the infection is primarily bacterial, the focus of the immune system investigation will be on phagocytes and humoral immunity. Other types of innate defenses that may be perturbed, such as the ciliary dyskinesia described earlier, require other diagnostic assays such as bronchial biopsy and radio isotopic clearance studies.

### A. Evaluation of Neutrophil Function

Evaluation of neutrophil function includes number, expression of adhesion molecules, response to chemotactic factors, and phagocytosis (engulfment and killing). There are assays available to examine each of these functions. In addition to assessment of neutrophil function, the importance of appropriate opsonins cannot be ignored. Hence, the presence of antibody specific for the pathogen to be engulfed or C3b is required for optimum engulfment. Table 6-1 lists the functions of neutrophils that should be evaluated and the assays available.

### B. Evaluation of Complement

The components of complement can be activated by innate mechanisms as well as by antibody. The multiple pathways

of complement activation diminish the effect of deficiency of some components. However, the importance of the third component of complement C3 to all pathways means that a deficiency in C3 can affect overall complement function. One assay for complement function is called the *CH50* (hemolytic complement 50). This assay measures the ability of the patient's plasma to participate in completion fixation and the terminal lytic pathway.

### C. Evaluation of Humoral Immunity

The acquired immune response generates antibodies after stimulation with antigen. Each animal species has a normal range for each antibody class. There may be some interlaboratory variation in normal ranges, but they should be generally similar. Normal concentrations of immunoglobulin classes for each species are shown in Table 6-2 (Tizard, 2008). The method used for quantitative evaluation of total levels of IgG, IgM, and IgA concentration is the single radial immunodiffusion assay (SRD). In single radial diffusion, the antisera is placed into the agar and the serum sample is placed into a well. This assay requires a serum sample, and it takes 2 days for results to be available. Known standards are compared with patient samples

by generation of a standard curve. A typical SRD test for IgA in dog serum is shown in Figure 6-1.

It is sometimes useful to evaluate the antibody response to a specific antigen. It is usually possible to use one of the common vaccine antigens to accomplish this goal. In species that are routinely vaccinated for tetanus, tetanus toxoid is a good antigen to use because it elicits a strong immune response in all normal vaccinates. Failure to respond to a dose of tetanus toxoid indicates a problem with humoral immunity and potentially performance of T helper lymphocytes.

Immunoelectrophoresis (IEP) is another technique used to visualize in a semiquantitative manner the immunoglobulin molecules in serum. This technique combines electrophoretic separation with gel diffusion. The serum is first separated in the gel according to charge; next antiserum is added to the trough followed by its diffusion and formation of precipitin arcs with the antibodies in the serum. A normal IEP pattern is shown in Figure 6-2a. It is easy to detect an agammaglobulinemia (Fig. 6-2b), and an abundant amount of identical immunoglobulin as seen with a myeloma protein (Fig. 6-2c).

### D. Evaluation of Cellular Immunity

Cellular immunity is generally considered to encompass both the T helper cell type 1 response that activates macrophages and the T cytotoxic cell response that performs killing of virus infected cells. The Th1 response can most easily be evaluated by *in vitro* detection of interferon gamma production after antigen stimulation. For most species, ELISA is possible for measurement of IFN in the supernatant. Detecting the presence of CD8+ cytotoxic lymphocytes (CTL) is more difficult. A chromium release assay can be performed, but this requires preparation of virus infected target cells from the patient. This technique is often used in research situations, but it is rarely practical in the hospital setting. As an alternative, cell-mediated responses are most often evaluated by lymphocyte stimulation tests.

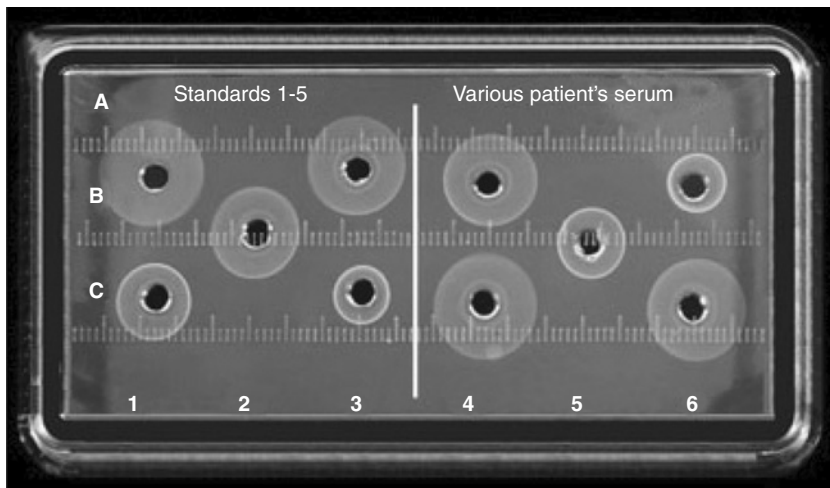
**TABLE 6-1** Evaluation of Neutrophil Function

Neutrophil Function	Assay
Adhesion	Flow cytometry, RT-PCR
Chemotaxis	Chemotaxis assay: agarose gel or Boyden chamber
Engulfment	Phagocytic index
Oxidative killing	Nitroblue tetrazolium, chemiluminescence
Killing (oxidative and nonoxidative)	Bacteriocidal assay

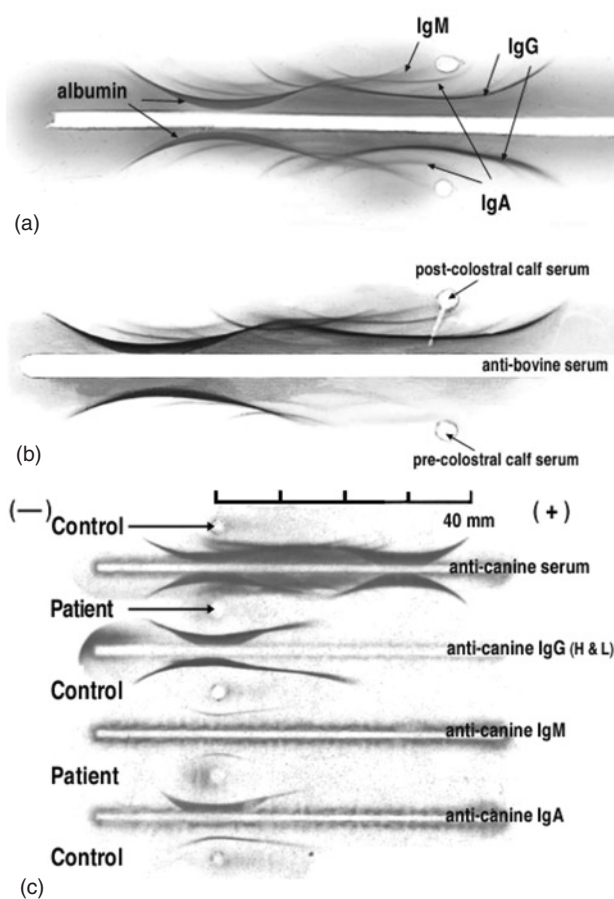
**TABLE 6-2** Normal Ranges for Immunoglobulin Concentrations (mg/dl)

Species	IgG	IgM	IgA	IgE
Bovine	1700–2700	250–400	10–50	NA
Canine	1000–2000	70–270	20–150	2.3–4.2
Equine	1000–1500	100–200	60–350	8.4–9.09
Feline	400–2000	30–150	30–150	NA
Ovine	1700–2000	150–250	10–50	NA
Porcine	1700–2900	150–250	10–50	NA

Data from Takeda and Akira (2005).



**FIGURE 6-1** Single radial immunodiffusion test for determination of IgA levels in serum.



**FIGURE 6-2** (a) Normal serum immunoelectrophoresis (IEP) showing IgG, IgM, and IgA. (b) IEP showing lack of gamma globulins. (c) IEP demonstrating an IgA myeloma protein in patient's serum.

This technique is performed by incubating peripheral blood lymphocytes with mitogens or specific antigen for several days. The addition of tritiated thymidine or a nonradioactive dye that incorporates into dividing cells provides a signal that is commensurate with the degree of cell division. Comparison of the stimulated cells with unstimulated cells

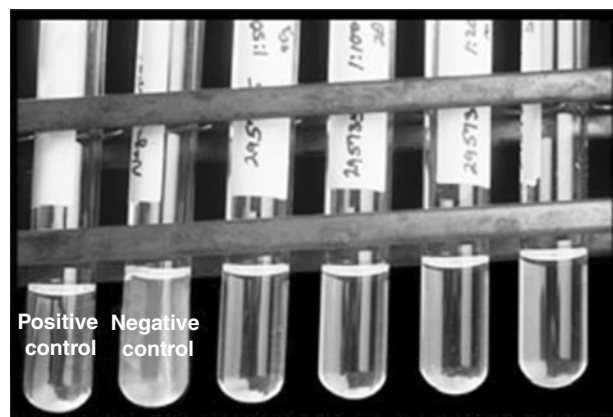
from the same animal provides a stimulation index, which indicates the amount of responsiveness inherent in the cells of the patient. Usually the assay is used to determine whether or not a patient has suppressed or diminished T cell function in general. It can be used to measure the T cell response to specific antigen.

Multicolor flow cytometry can be used to demonstrate the presence of T cells making either Th1 or Th2 cytokines. This technique utilizes surface staining to distinguish CD4 or CD8 T cell populations followed by permeabilization, incubation with a reagent that prevents newly synthesized protein from leaving the Golgi apparatus, and staining for intracellular cytokine using antibodies conjugated with different fluorochromes.

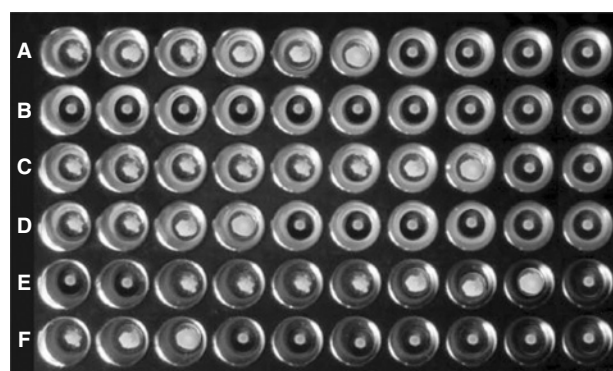
## V. METHODS FOR EVALUATION OF THE IMMUNE RESPONSE TO INFECTIOUS AGENTS

### A. Agglutination and Passive Agglutination

The antibody response to a specific antigen can be evaluated by a variety of assays. For a particulate antigen, an agglutination test can be performed. In this test, serum is serially diluted, and the dilutions are then mixed with an antigen suspension. The tubes are observed for agglutination. The titer is the inverse of the dilution in the last tube that shows a positive agglutination response. This is a traditional assay that is still used for detection of antibodies to a variety of bacterial antigens. It is possible to use this method to evaluate titers for soluble antigens by binding them to latex particles. Figure 6-3 shows a tube agglutination test used to measure the titer of antibodies against *Brucella canis* in canine serum. When a soluble antigen is linked to a particle, it becomes a passive agglutination test. The microagglutination test for antibodies to *Toxoplasma gondii* is performed this way. Figure 6-4 shows an example of the Toxotest, run in microtiter plate wells. Both of these assays



**FIGURE 6-3** Tube agglutination test for antibodies to *Brucella canis*. Serial dilutions of patient serum are compared with positive and negative sera.



**FIGURE 6-4** Microagglutination test for antibodies *Toxoplasma gondii*, performed using latex agglutination. Serum is diluted serially beginning at 1:16.

measure a titer of antibody and require serial dilution of the test serum. A simple positive or negative is sufficient for some purposes, such as the test for canine rheumatoid factor shown in Figure 6-5.

## B. Hemagglutination and Hemagglutination-Inhibition

Some viruses have receptors for erythrocytes and when incubated in their presence cause them to agglutinate. This phenomenon is called hemagglutination. Specifics of the erythrocyte source, mammalian or avian, and optimum temperature and time for reaction vary depending on the virus of interest. Myxoviruses, paramyxoviruses, enteroviruses, and adenoviruses are several virus groups with members of veterinary interest that are capable of hemagglutination. The hemagglutination procedure is itself of little immunological interest. However, the ability of antiserum to inhibit the hemagglutination caused by virus receptors for erythrocytes has been utilized to develop a serological test called hemagglutination inhibition (HI). The antibodies bind to receptor sites for erythrocytes and thus block the hemagglutination reaction. The test is used to measure antibody titers to the virus.

Alternatively, with a known source of antiserum, one can use the HI test as a preliminary step in viral identification.

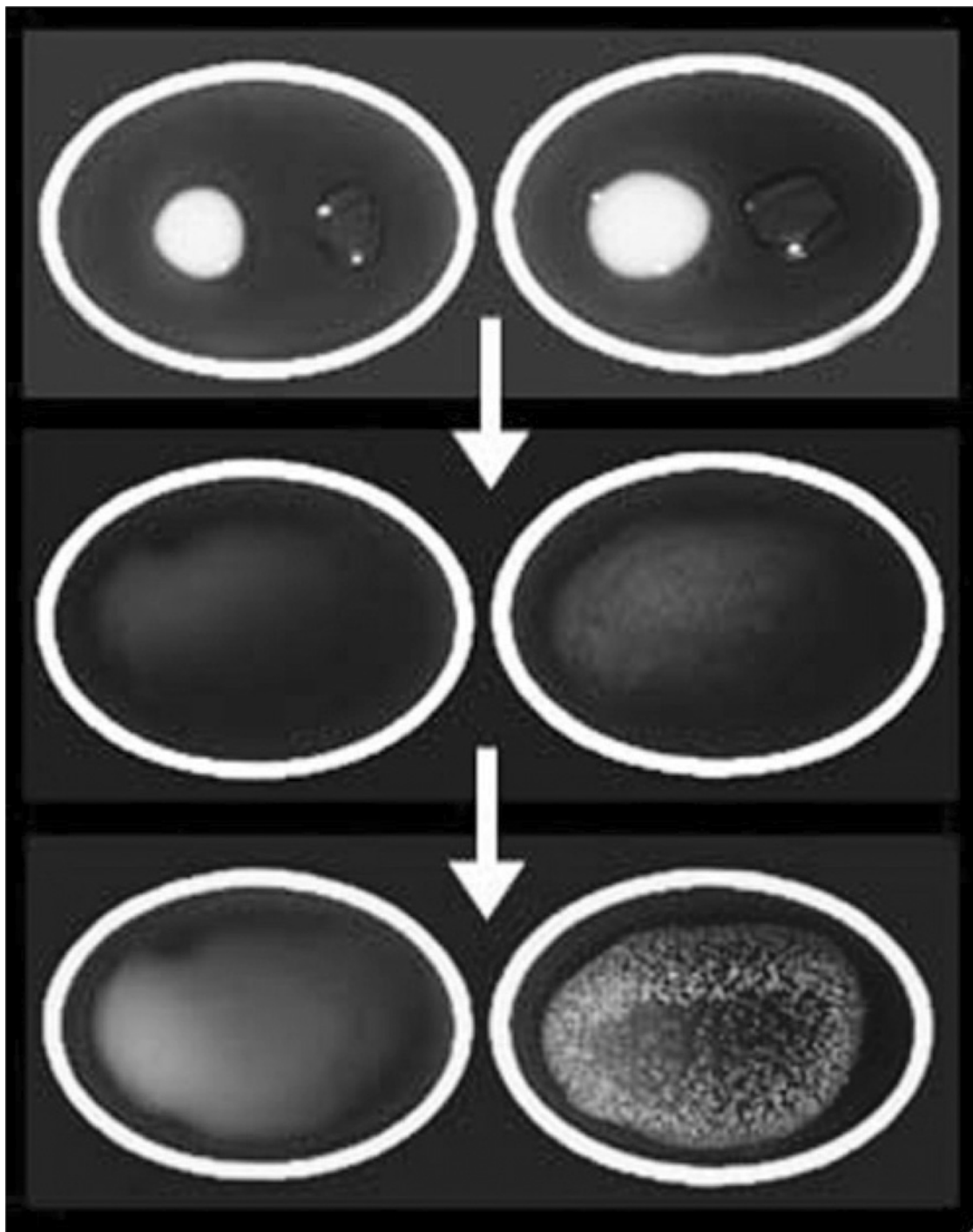
To perform the hemagglutination-inhibition test, serial two-fold dilutions of heat-inactivated serum are prepared in saline. A 0.25-ml aliquot of each dilution is then mixed with a similar amount of viral suspension that contains 4 hemagglutinating units. These are mixed and incubated. Next 0.25 ml of a 1% erythrocyte suspension is added, and the tubes are mixed again and incubated at the appropriate temperature and time for the virus of interest. The agglutination or absence thereof is read, and the HI titer of the serum is assigned as the reciprocal of the highest serum dilution that completely prevents hemagglutination. Alternatively, one can perform the test by making serial dilutions of the virus suspension and using a standard amount of serum. Test sera are then compared with known negative and positive sera. The former HI test is called the alpha procedure, and the latter is called the beta procedure. Appropriate controls must be included in either procedure, particularly to prevent false positive results from the presence of hemagglutinating substances in test sera.

## C. Virus Serum Neutralization Assay

Evaluation of the protective antibody response to viral agents is most often done using a serum virus neutralization assay. This assay is performed by incubation of serum dilutions with virus followed by inoculation of cell culture with the virus/serum mixture. The cells are observed for the development of cytopathic effect (CPE). Control cells inoculated with virus that has been incubated with a negative serum will show positive CPE and serve as a basis for comparison with the test sera. Performance of dilutions allows for the determination of a titer. Because the antibodies that are active in this assay prevent viral entry to the cell, they are protective. This is not necessarily true for antibodies detected by enzyme-linked immunosorbent assay (ELISA) or indirect immunofluorescence assay (IFA).

## D. Agar Gel Double Immunodiffusion

Agar gel immunodiffusion has been used routinely to identify horses infected with the equine infectious anemia virus has been demonstrated by the “gold standard” Coggin’s test. In this assay, serum samples from positively infected horses are alternated with samples to be tested around the outside wells. In the center well, EIA antigen is placed. The development of a line showing continuity with the adjacent lines of precipitation between viral antigen and positive control sera (called identity) confirms that the serum is from an infected horse. Although this assay is extremely reliable, it is much less sensitive than other methods (such as ELISA). Sometimes a horse newly infected will not be positive on an initial sample but on retesting will demonstrate the appropriate line of identity. The same horse would



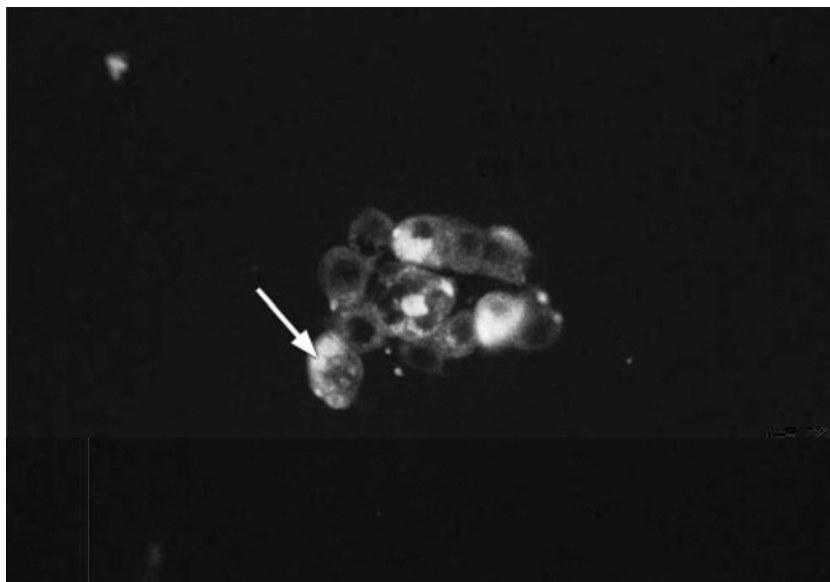
**FIGURE 6-5** Plate agglutination test for rheumatoid factor, using a test kit that couples IgG to latex beads. Serum is mixed with beads and examined for agglutination and compared with controls.

likely show up as positive on the ELISA because of the increased sensitivity of the latter assay. This type of double immunodiffusion (Ouchterlony) is also used in the demonstration of precipitating antibodies against some fungal pathogens, such as *Aspergillus fumigatus* and *Coccidioides immitis*. In both cases, positive control sera are used to demonstrate identity with potentially positive sera.

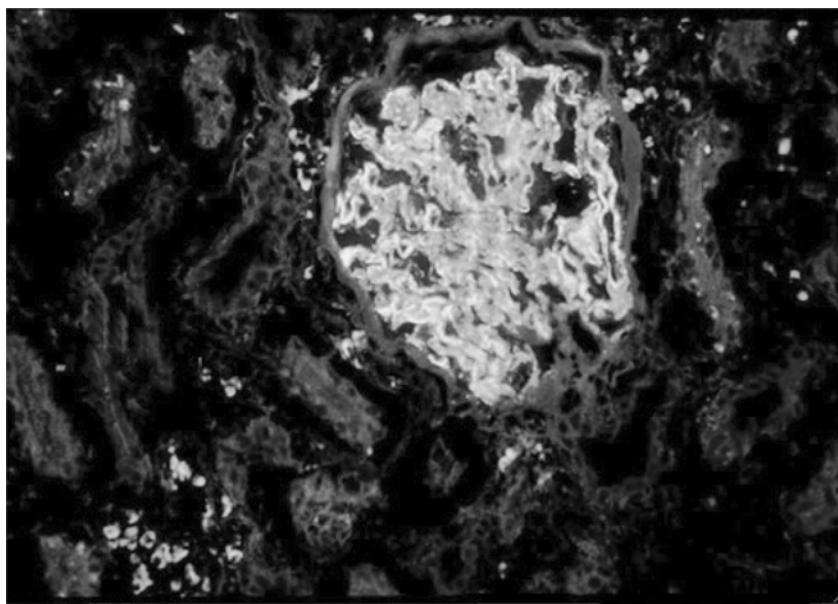
### E. Indirect and Direct Immunofluorescence (IFA) Test

The indirect immunofluorescence assay (IFA) is a technique that is used to diagnose some protozoan and viral diseases. It is also the basis of the antinuclear antibody test, used to diagnosis autoimmune disease. It is useful when





**FIGURE 6-6** Direct immunofluorescence demonstrates herpesvirus in a feline conjunctival smear. Arrow shows fluorescent intracellular virus.

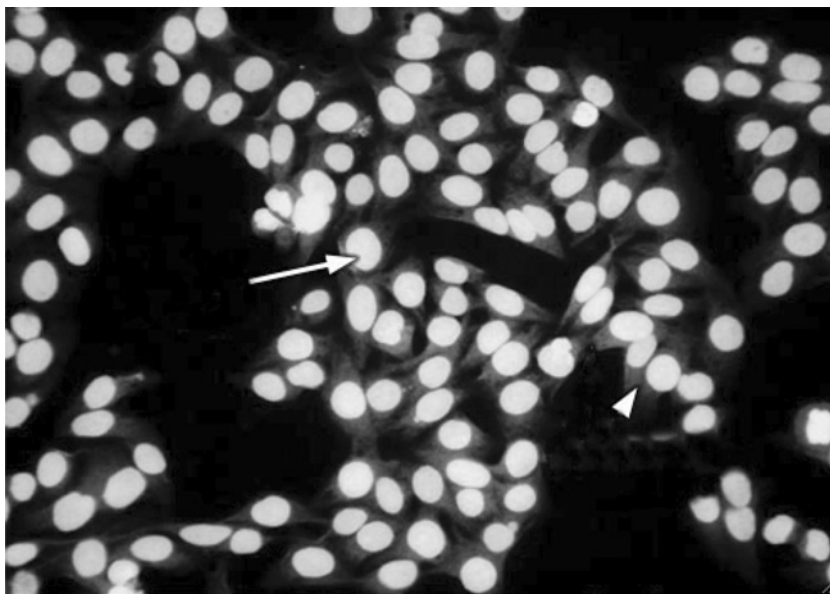


**FIGURE 6-7** Direct immunofluorescence demonstrates deposition of IgG in a glomerulus of a dog with immune complex mediated kidney disease.

a pathogen is intracellular and can easily be propagated in culture. Indirect immunofluorescence is performed to detect and quantitate titer of antibodies specific for these cell-associated antigens. When IFA is used, it is not necessary to purify the antigen. Cell-associated antigen, such as pathogens that are intracellular or nuclear antigen (in the case of the antinuclear antibody test), are present in cells that are fixed onto slides. The serum to be evaluated is then diluted serially and applied to wells containing the cells. The application of a fluorescein-conjugated secondary antibody then allows binding of the conjugate to antibodies present in the serum that have recognized epitopes present on the antigen. Several washing steps must be properly performed for this technique to yield reliable information.

The technique of direct immunofluorescence also has diagnostic application. In direct immunofluorescence, the

sample comes from the patient and consists of cells or tissues rather than serum. A known fluorochrome-conjugated serum is used to detect the antigen of interest. For example, conjunctival cells or transitional epithelial cells from the bladder of canine distemper-infected dogs can be stained with FITC-antidistemper antibodies to demonstrate viral infection. Another application of this technique involves diagnosis of autoimmune disease and is included under the discussion of autoimmunity. Figure 6-6 shows conjunctival cells from a cat infected with herpesvirus (direct FA). For detection of IgG or C3, deposition in blood vessels of patient's that have immune complex disease direct FA is often used. Deposition of IgG in a kidney glomerulus is shown in Figure 6-7. Indirect immunofluorescence is used to demonstrate the presence and measure the titer of antinuclear antibodies, as shown in Figure 6-8.



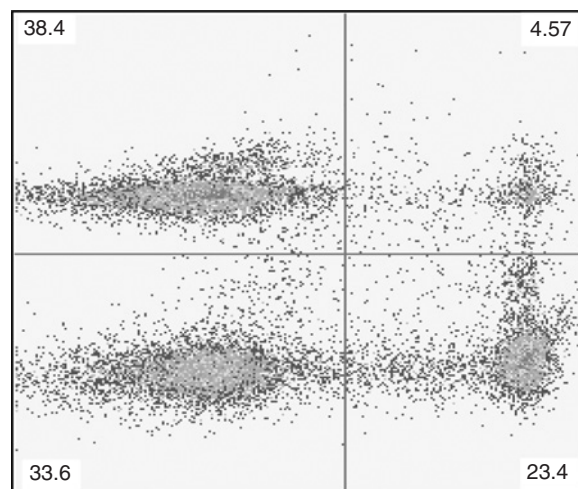
**FIGURE 6-8** Indirect immunofluorescence demonstrates the presence of antinuclear antibodies in serum of a dog with systemic lupus erythematosus. Arrow points to nuclear fluorescence in HEP-2 cells; arrowhead shows nonfluorescence of cytoplasm.

## F. Flow Cytometry

Flow cytometry uses fluorochromes conjugated to specific antisera to identify and quantitate cells of various types. This is an application of immunofluorescence. It is most commonly used to identify populations of cells, such as T cells and dendritic cells. The availability of antisera specific for activation markers, such as CD25 (IL-2 receptor), makes it possible to evaluate activated versus resting cells. This technique has broad application for diagnosis of a variety of immunological, neoplastic, and infectious diseases. Diagnosis of viral immunodeficiency (SAIDS, FIV) often utilizes flow cytometry to determine ratios of CD4+ to CD8+ cells. An example of data from flow cytometry is shown in Figure 6-9.

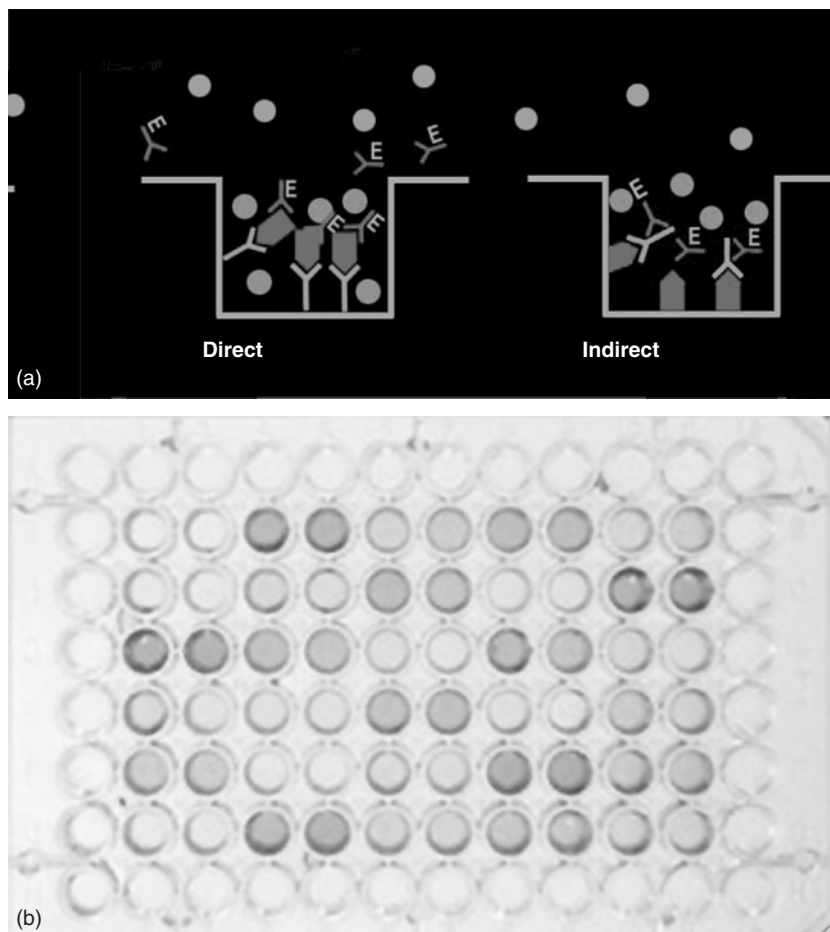
## G. Enzyme-Linked Immunosorbent Assay (ELISA)

Enzyme-linked immunosorbent assay (ELISA) is the primary binding assay that has become a standard for many diagnostic tests since the 1980s. It is used both as a quantitative assay for serum antibodies to a variety of antigens and as a quick test for a simple positive or negative answer to the question of whether or not a patient is infected with a particular pathogen. Because the ELISA is a primary binding assay, it is very sensitive. The specificity of each ELISA depends on the quality and specificity of the reagents used. The technique has the ability to be both very specific and very powerful if appropriately configured. There are two main configurations, one for detection of antibody and the other for detection of antigen (Fig. 6-10a). In the indirect form of ELISA, antigen is detected using a “catching” antibody attached to a solid substrate, most often a microtiter plate. The sample is added



**FIGURE 6-9** Plot from flow cytometry analysis. The plot shows cells stained for CD4 and CD8. The y-axis shows cells stained for CD4 with the fluorochrome FITC, and the x-axis shows cells stained to detect CD8+ cells with another fluorochrome, Alexa 647. These cells are from bovine afferent lymph. This sample has 38.4% CD4+ cells and 23.4% CD8+ cells. A population of cells (33.6%) is neither CD4 nor CD8 cells.

and it is detected after a series of incubation and wash steps by another antibody specific for the antigen, either conjugated with an enzyme, or another variation, such as biotin (which is followed with addition of an enzyme attached to avidin). Addition of the substrate for the enzyme produces a colored product, whose optical density is determined by spectrophotometry. In the direct format, the antigen coats the solid substrate and serum is added to that. Antibodies present bind the antigen and are then detected by specific antisera recognizing the species-specific antibody. This technique has the advantage of allowing for selection of a particular class of antibody, such as IgM or IgE, by using heavy



**FIGURE 6-10** (a) Schematic demonstrating direct and indirect ELISA. Direct ELISA measures antigen-specific antibody; indirect ELISA measures antigen. (b) Photograph of 96 well ELISA plate: darkest color indicates most positive reaction. Quantitation is performed by measuring optical density of well contents.

chain-specific antisera as detection reagents. The appearance of both direct and indirect ELISA in which intense color equates with a positive result is shown in Figure 6-10b. A less commonly used configuration of ELISA is the competitive ELISA. This type of ELISA can be constructed to detect either antigen or antibody. It utilizes an enzyme-labeled ligand (antigen or antibody), which then competes with its unlabeled counterpart in the patient's serum. Such an assay shows color (higher O.D.) when the sample is negative. Thus, it is important for those interpreting ELISA to fully understand what constitutes a negative and a positive sample. The use of appropriate controls makes this of minor concern.

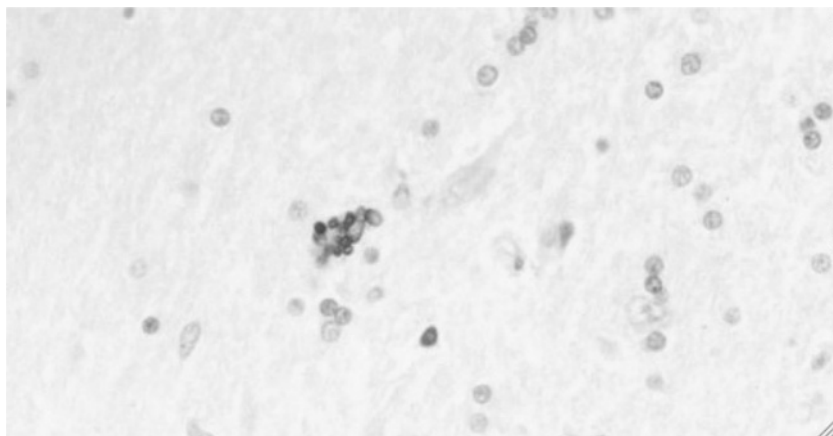
## H. Immunohistochemistry/ Immunoperoxidase Techniques

Just as immunofluorescence can be used to evaluate serum antibodies or antigen present in tissue or on cells, the technique of enzyme immunoassay is also applied to tissue sections for identification of cell populations and demonstration of antigens in tissues. Immunoperoxidase detection of antigens has the advantage that the tissue sections can be examined with a standard microscope, whereas the immunofluorescence-based testing requires utilization

of mercury lamps, dichroic mirrors, and special filters for excitation of the fluorochrome and for visualization of the emitted fluorescence. For immunoperoxidase evaluation of tissue antigens, an enzyme tagged antiserum is used to bind the antigen, then the substrate for the enzyme is added. The substrate is chosen so that it changes color when hydrolyzed by the enzyme. Thus, a colored product is deposited permanently in the tissue. In general, direct immunofluorescence and immunohistochemistry can be used for the same type of determinations. Figure 6-11 shows a canine lung section infected with canine distemper virus using immunoperoxidase staining with anti-canine distemper virus (CDV) antibody.

## I. Western Blot Analysis

Western blot immunoassay is performed when it is desirable to determine which antigens in a mixture are binding with antibodies in test sera. It has great value when it is necessary to discriminate between antibodies produced in response to vaccination and those produced as a result of infection. If a subunit vaccine is used, this technique can be successfully applied. Some of the newer "designer" vaccines use only one or two protective epitopes to immunize.



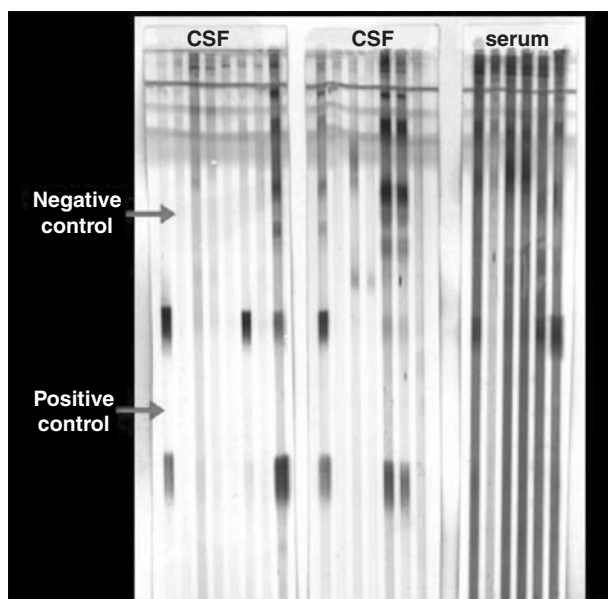
**FIGURE 6-11** Immunoperoxidase staining of dog lung infected with canine distemper virus. Brown staining indicates the presence of intracellular virus as shown with horseradish peroxidase conjugated anti-CDV and substrate.

In this case, it is possible to evaluate serum using the Western blot method to identify to which of multiple proteins present in a pathogen a patient has responded. For example, in the vaccine for Lyme disease, if a dog has bands on Western blot for numerous *Borrelia burgdorferi* proteins, it is likely to be infected. However, the presence of only antibodies to Osp A (the protein containing protective epitopes that is present in the vaccine) indicates a vaccinated uninfected dog. The Western blot has also been used to differentiate between *Sarcocystis neurona* exposed and infected horses in patients suspected of having equine protozoal myelitis (EPM). Figure 6-12 shows an EPM Western blot.

To perform a Western blot assay, the antigen preparation must first be separated into its protein components using polyacrylamide gel electrophoresis (PAGE). This technique denatures the disulfide bonds and causes proteins to move through the gel according to their molecular weight. After the antigen is separated, the gel is blotted electrophoretically onto a nitrocellulose membrane, which is then probed with the patient sera and ultimately an enzyme-conjugated secondary antibody and substrate to visualize the bands representing proteins recognized by antibodies in the patient's serum. It is possible, by using specific conjugated antisera, to identify which antibody isotypes are binding (IgM, IgG, IgA, or IgE).

### J. How Do the Sensitivities of Different Immunoassays Compare?

Generally the gel diffusion-based assays such as double and single radial diffusion are much less sensitive than the primary binding assays like ELISA. This is because the former require not only binding of antigen to antibody but also the formation of an appropriate size insoluble precipitate for detection visually. Recently an ELISA kit has been developed to test for antibodies to equine infectious anemia. The traditional gold standard EIA assay is based



**FIGURE 6-12** Western blot for equine protozoal myelitis. *Sarcocystis neurona* antigen was separated by SDS-PAGE, blotted to nitrocellulose, and probed with either sera or CSF. Bands on positive and negative control strips are compared to those on test strips.

on gel diffusion. The use of these two tests represents an interesting comparison in sensitivity between test methods, as the gel diffusion-type tests are far less sensitive than the primary binding assays like ELISA. Generally a negative ELISA for EIA is an acceptable result, but a positive is tested again by the Coggin's test to avoid false positives in the diagnosis of this important reportable equine infectious disease. The agglutination assays are generally between the gel diffusion and ELISA-type assays in sensitivity, and the immunofluorescence assays are less sensitive than ELISA but more sensitive than the gel diffusion-type assays. These comments are generalities, and each test will depend on the quality of the reagents used for both sensitivity and specificity.

## K. Interpretation of Immune Responses to Pathogens

Diagnosis of infection with viral, bacterial, or parasitic pathogens can be determined by isolation of the agent, identification of pathogen nucleic acid using PCR methods, or by examination of the immune response to the suspected pathogen. The assays performed to detect an immune response to pathogens utilize the immunological principles described previously in this chapter. When immunological methods are used, it is most often necessary to obtain paired serum samples. These are acute and convalescent; samples are taken when the animal is first presented to the veterinarian and again in 2 to 3 weeks. Performance of the assay on both samples at the same time eliminates much variation from day-to-day fluctuations. Generally an increase in titer that is greater than two dilutions is evidence for induction of an immune response and hence (in the absence of recent vaccination) infection. When the initial sample is negative for antibodies to the pathogen and then becomes strongly positive, the patient is said to have undergone seroconversion.

Evaluation of the immune response to vaccination is currently of particular interest because immunologists are advising against routine vaccination annually. Yet it is important that immunity to diseases for which vaccination is performed is present. Thus, monitoring the titer of the antibody response has become more common (Schultz, 2006). When evaluating the immune response to virus, the ELISA is often used and so is the serum neutralization test. These assays evaluate different aspects of the immune response. The ELISA is a primary binding assay, which evaluates antibody levels without regard to function. The serum neutralization assay measures functional antibody and is better suited to determine protective levels of antibody to viral pathogens. Thus, for determination of protective antibody in response to vaccination, use of the serum neutralization (SVN) assay is most likely to equate to protection.

Many reference laboratories now have data that allow for a prediction for immune status based on serological titers.

Determination of antibody levels against *Sarcocystis neurona* is done using a combination of Western blot on serum and cerebrospinal fluid and indirect immunofluorescence with patient serum for diagnosis of equine protozoal myelopathy. For this disease, the presence of antibodies against *S. neurona* in the serum indicates exposure but not necessarily infection. Evaluation of the cerebrospinal fluid for the presence of antibody is preferable to detect infection.

## VI. LABORATORY DIAGNOSIS OF DISEASES WITH AN IMMUNOLOGICAL PATHOGENESIS

### A. Autoimmune Diseases

The use of the diagnostic clinical immunology tools is generally focused on the diagnosis or prevention of infectious

disease, diagnosis of immune deficiency, detection of autoimmune responses, and diagnosis of hypersensitivity conditions. A variety of immune tests are used to help establish a diagnosis of autoimmune disease. Several examples follow.

Autoimmune hemolytic anemia is characterized by the presence of a Coombs' positive anemia. The Coombs' test evaluates the presence of autoantibody bound to patient erythrocytes by provision of a cross-linking antibody to facilitate agglutination of the antibody-bearing cells. This assay allows for the detection of so-called incomplete antibody. In the indirect Coombs' test, the patient's serum is examined for the presence of antibody that will bind to erythrocytes and agglutinate them when a secondary anti-globulin is added. Both tests can be employed to evaluate immune-mediated anemia.

The often-related disease autoimmune thrombocytopenia (AITP) can be tested for by staining a bone marrow biopsy with fluorescein-conjugated antisera specific for immunoglobulin (from the species of interest). The stained section is then observed for fluorescence of megakaryocytes, indicating the presence of antimegakaryocyte antibodies.

The systemic autoimmune disease systemic lupus erythematosus (SLE) requires a positive antinuclear antibody test diagnosis. Although the ANA test is sensitive, it is not specific. Nevertheless, antinuclear antibody titers of greater than 50 are present in SLE. Sometimes a lupus erythematosus (LE) cell may be observed; these are neutrophils that have engulfed opsonized nuclei. Such an observation is essentially pathognomic for SLE. In human medicine, a variety of other measurements for the presence of antinuclear antibodies are made. Some of these have been occasionally reported in domestic animal species (Gershwin, 2005; Smeets, 2007).

Development of autoantibodies against components of the thyroid gland is associated with hypothyroidism caused by autoimmune thyroiditis, although sensitized T lymphocytes are also important in pathogenesis of the disease. Recognition of the antithyroid antibodies using indirect immunofluorescence with serum from the patient and normal thyroid tissue has been used to demonstrate the presence and titer of these antibodies. Similar assays can be performed on pancreas to detect the presence of anti-islet cell antibodies in patients with type I diabetes mellitus. One form of the neuromuscular disease myasthenia gravis develops as a result of immune destruction of the acetylcholine receptor at the neuromuscular junction. Detection of autoantibodies binding these receptors can be accomplished using patient sera in indirect immunofluorescence or immunohistochemistry.

### B. Primary Immune Deficiency Diseases

Primary immune deficiency diseases are caused by a genetic defect that creates a malfunction or absence of a component or components of the immune system. Several such diseases were discussed previously in this chapter. Clinical signs of the disease generally in the young animal

**TABLE 6-3** Evaluation of Cell Mediated Immunity

Function	Assay	Description
General T cell responsiveness	Lymphocyte stimulation	Peripheral blood lymphocytes (PBL) are stimulated <i>in vitro</i> with T cell mitogens or antigen
T cell subset enumeration	Flow cytometry	CD4 and CD8 specific monoclonal antibodies label PBL; intracellular cytokine production is measured with anti-IL-4 and anti-IFN
<i>In vitro</i> production of interferon	ELISPOT or ELISA for IFN	Cells are evaluated for production of TH1 cytokine IFN after <i>in vitro</i> incubation with antigen
NK cell assay	Chromium release assay	Chromium <sup>51</sup> -labeled tumor cell line is incubated with patient's lymphocytes with tumor cell line (not from patient)

provide the stimulus for initiation of testing to determine the nature of the problem. For diseases such as bovine leukocyte adhesion deficiency (BLAD), the use of flow cytometry on patient cells can demonstrate the lack of the CD18 molecule (Gu, 2004).

Other primary deficiencies requiring laboratory diagnosis include the combined immunodeficiency disease severe combined immunodeficiency (SCID) that occurs in Arabian horses. This disease results from a defect in the DNA-dependent protein kinase gene caused by a mutation (Perryman, 2000). This mutation prevents the production of a functional enzyme that is required for formation of the B and T cell antigen receptors. Without these receptors, foals are unable to respond to antigenic stimuli. Clinical signs begin to appear as the maternal immunity wanes, usually at about 8 weeks of age. Immunological diagnosis requires SRD testing of serum for IgM levels and enumeration of lymphocytes in the peripheral blood. Confirmation of the genetic defect can be accomplished using polymerase chain reaction (PCR) to detect the five-base-pair deletion. The homozygous condition is present in clinically affected foals. A similar defect has been identified in the Jack Russell terrier breed of dogs.

Other primary immune defects such as selective immunodeficiencies are recognized in various animal species. These include selective immunoglobulin deficiencies, such as IgA deficiency, seen in German shepherd and shar-pei dogs, or IgM deficiency in horses. Single radial diffusion quantitation is the assay of choice for diagnosis of these conditions. The patient with selective complete or partial deficiency of IgA will have levels of IgA less than normal (see Table 6-1).

T cell deficiencies have also been reported in several species. Functional T cell defects are most commonly identified using the lymphocyte stimulation assay (Table 6-3). Stimulation of patient and control peripheral blood lymphocytes with plant mitogens, such as concanavalin A or phyto-hemagglutinin, cause proliferation, which is measurable either by incorporation of tritiated thymidine or

with a colorimetric readout. Comparison of the stimulated cells of the patient with unstimulated cells of the patient yields a stimulation index. The same data are collected from the normal control for comparison. Although it is a fairly crude measure of T cell function, this assay has been successfully used to demonstrate diminished T cell function in animal patients.

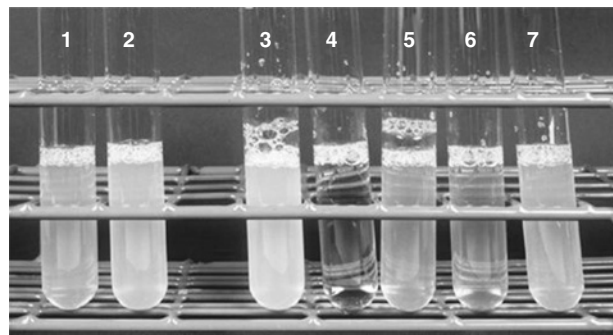
Another method for evaluation of the T cell response involves incubation of the patient's T cells with specific antigen, or mitogen, *in vitro*. ELISA is later used to evaluate the supernatant from the cultured cells for the presence of interferon. This technique was initially introduced as a kit for diagnosis of *Mycobacterium paratuberculosis* infection (Johne's disease), but it is easily adaptable to other antigens.

### C. Secondary Immunodeficiencies

Secondary immunodeficiency is not a genetic disease. Patients that develop secondary immunodeficiency are often adult at onset. A common cause of secondary immunodeficiency is viral infection. Immunodeficiency viruses, such as feline immunodeficiency virus, cause a loss of CD4+ helper T cells, which prevents the patient from mounting a normal immune response. Infection with a variety of organisms that are not normally important as pathogens is common for immunosuppressed patients. Other viruses such as canine distemper and bovine viral diarrhea virus cause lymphocyte depletion and depressed immunity. Other causes of secondary immunodeficiency include parasitism, poor nutrition, and neoplasia. Diagnosis of depressed immune function can be accomplished using lymphocyte stimulation for T cell function and response to antigen challenge (such as increase in titer following routine vaccination). Depression of total immunoglobulin levels may not be helpful for short-term immunosuppression because of the relatively long half-life of IgG.

Failure of passive antibody transfer is a form of immune deficiency, albeit temporary. When a foal, calf,





**FIGURE 6-13** Tubes containing a solution of zinc sulfate are incubated with serum from neonatal foals to evaluate the quantity of passively transferred maternal IgG. Increased turbulence correlates with more IgG.

or piglet fails to suckle or obtains insufficient antibody, it will be susceptible to disease during the neonatal period. It is imperative to determine if sufficient antibody has been acquired. If this is done before the intestinal epithelium closes (before 18 hours of age), oral supplementation can be used. There are several tests to evaluate serum IgG levels in a semiquantitative but quick way. Several companies make kits based on ELISA technology, but a simple method that uses zinc sulfate turbidity is adequate. Serum of the foal is mixed with a solution of zinc sulfate. This test relies on binding of the sulfate to the IgG and formation of a precipitate. The more IgG in the serum, the greater the opacity of the mixture in the tube. An example is shown in Figure 6-13. The SRD is far more accurate, but the zinc sulfate test provides a rough estimate within less than an hour, thereby allowing oral supplementation of colostrums to occur within the window of time that it can be effective. An example of this method is shown in Figure 6-13.

#### D. Hypersensitivity Diseases

The diseases known collectively as hypersensitivities are grouped into four categories based on the mechanism that causes the pathology. These are types I to IV (Gell and Coombs). Type I hypersensitivity is the classic allergy, characterized by clinical signs ranging from systemic anaphylactic shock to allergic rhinitis and asthma. The mechanism involved in the pathogenesis of type I disease is IgE mediated. IgE antibodies, having a high affinity for mast cell receptors, bind to these cells and release mediators, such as histamine, upon contact with antigen/allergen. Arachidonic acid metabolism is also initiated through phospholipase activation and leukotriene and prostaglandin mediator synthesis occurs subsequent to the allergic stimulation. Laboratory diagnosis of type I hypersensitivity relies on testing serum for allergen-specific IgE, generally by ELISA. The availability of anti-IgE reagents for the various domestic animal species has made this diagnostic tool available in recent years. In addition, there is a commercially available service that uses a cloned alpha chain of

the human IgE receptor to detect IgE bound to allergen in an ELISA format. Traditionally, intradermal skin testing has been used to determine which allergens are causing the allergic response. Many veterinary dermatologists use this method with good success.

Type II hypersensitivity occurs when IgG or IgM antibodies bind to a cell surface and fix complement. When the cell is an erythrocyte, the ultimate result is immune-mediated anemia. The *Coombs' test* described on page 169 for antibody bound to erythrocyte surfaces is the standard agglutination-type assay used to detect incomplete antibodies causing erythrocyte destruction. Erythrocyte destruction in the affected patient results from either complement-mediated lysis or removal by fixed phagocytes lining splenic sinusoids. Other type II hypersensitivities that do not involve erythrocytes include the skin diseases of the pemphigus complex and the neuromuscular disease, myasthenia gravis (both are autoimmune). For laboratory diagnosis of these diseases, immunofluorescence or immunohistochemistry is often used to demonstrate the deposition of immunoglobulin or complement within the lesion of affected skin (pemphigus) or on cells with acetylcholine receptors within the neuromuscular junction (myasthenia gravis).

Type III hypersensitivities are caused by immune complex formation. The antigens involved are soluble. Most commonly immune complexes form in chronic diseases in which antigen persists in the circulation despite a vigorous immune response (e.g., equine infectious anemia) and in certain autoimmune diseases (e.g., systemic lupus erythematosus) in which antinuclear antibodies are made and bind to various nuclear components from cell debris. In these cases, deposition of immune complexes within the small blood vessels, such as the kidney glomerulus as shown in Figure 6-7, is common. Detection of immune complex deposition by immunofluorescence is diagnostic for their presence.

Type IV hypersensitivity, unlike the previously discussed types I to III, is not mediated by antibody but is caused by development of sensitized T lymphocytes specific for the antigen. The classic example is the intradermal skin test for tuberculosis, which shows an erythemic-indurated lesion at the site of injection of tuberculin after 48 to 72 hours in infected individuals. The ELISA for interferon gamma can be used to evaluate T cell reactivity to antigens thought to be responsible for a type IV response.

## VII. MODULATION OF THE IMMUNE RESPONSE

Adjuvants in vaccines have been used for many years to increase the immune response to vaccine antigen. In recent years, increased understanding of the immune response has resulted in the emergence of new modalities for immune modulation, not only for responses to vaccine antigens but

also for therapy of disease. Toll-like receptors (specifically TLR 10), described previously in this chapter, bind to nucleotides. The oligonucleotides containing cytosine-quanine motifs in the unmethylated form as they occur in bacteria modulate the immune response toward the T helper type 1 response. Thus, recent experiments have been performed using these synthetic CpG oligonucleotides to either alter the response in a vaccine toward cellular rather than humoral immunity or in some cases to attempt to alter the strong T helper cell type 2 response that occurs in allergy (Wilson, 2006).

Another recent advance in immune modulation is the use of recombinant cytokines or their receptors to alter the immune response. For example, inclusion of the gene for interferon  $\gamma$  in a vectored viral vaccine facilitates the development of a cellular immune response to the antigens expressed by the vaccine. Therapy for tumor patients has utilized recombinant IL-2 (the cytokine that stimulates growth and proliferation of T cells) to enhance development of T cells specific for tumor antigens. This technique usually involves *in vitro* incubation of the patient's T cells with the recombinant IL-2 then readministration of the cells to the patient (Tizard, 2008).

The field of immune modulation is advancing rapidly and should be expected to yield useful prophylactic and therapeutic regimens for the future. Receptor antagonists, such as for interleukin 4, may diminish the progress of type 1 hypersensitivity. Similarly antagonists for some of the proinflammatory cytokines show promise for control of arthritic conditions.

## VIII. SUMMARY

The current status of clinical immunology in veterinary medicine is better than it has ever been. The availability of

species-specific reagents has made it possible to develop and apply a variety of immune assays previously only possible in humans and laboratory mice. These advances facilitate recognition of previously undiagnosable diseases in domestic animals and further the understanding of the pathogenesis of immune-mediated, neoplastic, and infectious diseases of domestic animals.

## REFERENCES

- Gershwin, L. J. (2005). Antinuclear antibodies in domestic animals. *Ann. NY Acad. Sci.* **1050**, 364–370.
- Gu, Y. C., Bauer, T. R., Jr., Ackermann, M. R., Smith, C. W., Kehrli, M. E., Jr., Starost, M. F., and Hickstein, D. D. (2004). The genetic immunodeficiency disease, leukocyte adhesion deficiency, in humans, dogs, cattle, and mice. *Comp. Med.* **54**(4), 363–372.
- Perryman, L. E. (2000). Primary immunodeficiencies of horses. *Vet. Clin. North. Am. Equine Pract.* **16**(1), 105–116.
- Schultz, R. D. (2006). Duration of immunity for canine and feline vaccines: a review. *Vet. Microbiol.* **117**(1), 75–79.
- Smee, N. M., Harkin, K. R., and Wilkerson, M. J. (2007). Measurement of serum antinuclear antibody titer in dogs with and without systemic lupus erythematosus: 120 cases (1997–2005). *J. Am. Vet. Med. Assoc.* **230**(8), 1180–1183.
- Takeda, K., and Akira, S. (2005). Toll-like receptors in innate immunity. *Immunology* **17**(1), 1–14.
- Tizard, I. R. (2008). “Veterinary Immunology: An Introduction,” 8th ed., pp 147. Elsevier (Saunders), Philadelphia.
- Wilson, H. L., Dar, A., Napper, S. K., Marianela, Lopez, A., Babiuk, L. A., and Mutwiri, G. K. (2006). Immune mechanisms and therapeutic potential of CpG oligodeoxynucleotides. *Int. Rev. Immunol.* **25**(3–4), 183–213.



# The Erythrocyte: Physiology, Metabolism, and Biochemical Disorders

John W. Harvey

*Department of Physiological Sciences  
College of Veterinary Medicine  
University of Florida  
Gainesville, Florida*

## I. INTRODUCTION

- A. Species Differences in Erythrocyte Shape
- B. Functions of RBCs

## II. HEMATOPOIESIS

- A. Stem Cells and Progenitor Cells
- B. Hematopoietic Microenvironment
- C. Hematopoietic Growth Factors
- D. Erythropoiesis

## III. DEVELOPING ERYTHROID CELLS

- A. Morphological and Metabolic Changes
- B. Iron Metabolism
- C. Hb Synthesis
- D. Reticulocytes
- E. Abnormalities in Erythroid Development

## IV. MATURE RBC

- A. Membrane Structure
- B. Shape and Deformability
- C. Blood Group Isoantigens
- D. Membrane Transport
- E. Metabolism of Adenine Nucleotides
- F. Carbohydrate Metabolism
- G. Embden-Meyerhof Pathway
- H. Diphosphoglycerate Pathway
- I. Hb Oxygen Affinity
- J. Pentose Phosphate Pathway
- K. Nature of Oxidants in Biology
- L. Metabolic Protection against Oxidants

## V. DETERMINANTS OF RBC SURVIVAL

- A. Oxidative Injury
- B. RBC Aging and Normal Life Spans
- C. Anemia of the Newborn

## VI. INHERITED DISORDERS OF RBCs

- A. Cytosolic Enzyme Deficiencies
- B. Membrane Abnormalities
- C. Miscellaneous Abnormalities

## REFERENCES

## I. INTRODUCTION

Mammalian erythrocytes or red blood cells (RBCs) are anucleate cells that normally circulate for several months in blood despite limited synthetic capacities and repeated exposures to mechanical and metabolic insults. Their primary purpose is to carry hemoglobin (Hb), a heme-containing protein that accounts for more than 90% of the protein within RBCs (Quigley *et al.*, 2004). The benefits of having Hb contained within cells, as opposed to free in plasma, include the much slower turnover in blood (free Hb has a half-life of only a few hours), the metabolic capability of RBCs to maintain iron in Hb in the functional ferrous state, and the ability to control Hb oxygen affinity by altering the concentrations of organic phosphates, especially 2,3-diphosphoglycerate (2,3DPG). In addition, the presence of free Hb in plasma in concentrations normally found in whole blood would exert an osmotic pressure several times greater than that normally exerted by plasma proteins, profoundly affecting the movement of fluid between the vascular system and tissues.

### A. Species Differences in Erythrocyte Shape

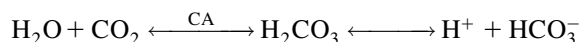
Most RBCs in normal dogs, cats, horses, cattle, and sheep occur in the shape of biconcave disks (discocytes). The degree of biconcavity is most pronounced in dogs and less so in cats and horses. RBCs from goats generally have a flat surface with little surface depression; a variety of irregularly shaped RBCs (poikilocytes) may be present in clinically normal goats (Jain, 1986). The apparent benefit of the biconcave shape is that it gives RBCs high surface area-to-volume ratios and allows for deformations that must take place as they circulate.

Marked acanthocytosis is reported to occur in young goats (Holman and Drew, 1964) and some young cattle (McGillivray *et al.*, 1985; Sato and Mizuno, 1982). Acanthocytosis of young goats reportedly occurs as a result of the presence of HbC at this stage of development (Jain *et al.*, 1980). Normal adult angora goats (Jain *et al.*, 1980; Jain and Kono, 1977) and some breeds of British sheep (Evans, 1968) have variable numbers of fusiform or spindle-shaped RBCs that resemble sickle cells (drepanocytes) in normal deer and people with sickle cell anemia (Taylor, 1983). Drepanocyte formation in deer depends on the Hb types present. It is an *in vitro* phenomenon that occurs when oxygen tension is high and pH is between 7.6 and 7.8 (Taylor, 1983). The proportion of fusiform cells in angora goats varies depending on the individual and *in vitro* alterations in temperature, pH, and oxygenation, but the tendency to form fusiform cells could not be attributed to differences in Hb type (Jain and Kono, 1977). Echinocytosis is a consistent artifact in stained blood films from pigs (Harvey, 2001).

## B. Functions of RBCs

The RBC functions of oxygen transport, carbon dioxide transport, and hydrogen ion buffering are interrelated. Each Hb tetramer can bind four molecules of oxygen when fully saturated, forming oxyhemoglobin (OxyHb). Assuming a normal arterial pO<sub>2</sub> of 100mmHg and an Hb concentration of 150g/l (15g/dl) in blood, the presence of Hb-containing RBCs increases the oxygen carrying capacity of blood approximately 70 times that which could be transported dissolved in plasma (West, 1985).

Approximately 10% of CO<sub>2</sub> is transported dissolved in blood, 5% to 10% is transported bound to amine groups of blood proteins, and 80% to 85% is transported in the form of bicarbonate in normal individuals (Hsia, 1998; Jensen, 2004). Carbonic acid is formed when dissolved CO<sub>2</sub> combines with water. This reaction occurs nonenzymatically but is accelerated by the presence of the carbonic anhydrase (CA), also called carbonate dehydratase, enzyme in RBCs. Bicarbonate is formed by the rapid spontaneous dissociation of carbonic acid as shown:



Hb potentiates the formation of bicarbonate by buffering hydrogen ions and shifting the equilibrium of the reaction to the right. Carbamino groups are formed by the combination of CO<sub>2</sub> with the terminal groups of proteins. The globin of Hb is the most important blood protein in this regard. The transportation of CO<sub>2</sub> from the tissues to the lungs as carbamino groups is potentiated because deoxyhemoglobin (DeoxyHb) binds twice as much CO<sub>2</sub> as OxyHb. The formation of carbamino groups can be represented as follows:



Hb is the most important protein buffer in blood because it occurs in high concentration, has a relatively low molecular weight, and has a large number of histidine residues with pK<sub>a</sub> values close to 7.4, enabling them to function as effective buffers. It has about six times the buffering capacity of the plasma proteins. An additional factor of importance in contributing to the effectiveness of Hb as a blood buffer is the fact that DeoxyHb is a weaker acid than OxyHb. As a result, most of the H<sup>+</sup> produced in the tissues under normal conditions is buffered as a direct result of the H<sup>+</sup> uptake by DeoxyHb owing to an increase in effective pK<sub>a</sub> of Hb following release of oxygen to the tissues (West, 1985).

## II. HEMATOPOIESIS

### A. Stem Cells and Progenitor Cells

Primitive hematopoietic stem cells (HSCs) appear to develop in the embryo from a common precursor cell for both endothelial and hematopoietic lineages. The first HSCs appear to develop as clusters of cells in the wall of the dorsal aorta, with subsequent development in the yolk sac, placenta, and fetal liver (Baron and Fraser, 2005). Beginning in mid-gestation and continuing throughout postnatal life, mammalian blood cells are produced continuously from HSCs within extravascular spaces of the bone marrow. HSCs are capable of proliferation, life-long self-renewal, and differentiation. HSCs replicate only once every 8 to 10 weeks (Abkowitz *et al.*, 2002). The term *hematopoietic progenitor cell* (HPC) refers to cells that form colonies in bone marrow culture like HSCs but do not have long-term self-renewal capacities. HSCs and HPCs are mononuclear cells that cannot be distinguished morphologically from lymphocytes. The presence of a transmembrane glycoprotein termed *cluster of differentiation antigen 34* (CD34) has been used to identify HSCs and early HPCs, but some HSCs (possibly inactive ones) lack CD34 (Gangenahalli *et al.*, 2006). In addition, CD34 is also present on the surface of nonhematopoietic stem cells and vascular endothelial cells (Kucia *et al.*, 2005; Wu *et al.*, 2005). CD34 is believed to play a role in cell adhesion (Gangenahalli *et al.*, 2006).

The most primitive HSC has the capacity to differentiate into HPCs of all blood cell lineages and several cell types in tissue. The frequency of HSCs in the marrow is estimated to be <0.01% of nucleated marrow cells in adult mice and <0.0001% of nucleated marrow cells in adult cats (Abkowitz *et al.*, 2002). HSCs produce HPCs that can give rise to one or more blood cell types. HPCs are much more numerous in marrow than are HSCs. Less than 2% of nucleated bone marrow cells in adult dogs are CD34<sup>+</sup>, but up to 18% CD34<sup>+</sup> cells have been reported in neonatal pups (Faldyna *et al.*, 2003; Suter *et al.*, 2004). A common lymphoid progenitor cell is believed to give rise to B lymphocytes, T lymphocytes, lymphoid dendritic cells, and natural killer cells (Blom and Spits, 2006). A common myeloid

progenitor cell is believed to give rise to all nonlymphoid blood cells, as well as macrophages, myeloid dendritic cells, osteoclasts, and mast cells (Kaushansky, 2006a). HPCs proliferate with higher frequency than do HSCs, but the self-renewal capabilities of HPCs decrease as progressive differentiation and cell lineage restrictions occur. When measured in an *in vitro* cell culture assay, HPCs are referred to as colony-forming units (CFUs). HPCs that rapidly proliferate, retain their ability to migrate, and form multiple sub-colonies around a larger central colony in culture are called burst-forming units (BFUs). Colony-forming unit-granulocyte, RBC, macrophage, megakaryocyte (CFU-GEMM) is a tetrapotential HPC that has been studied extensively *in vitro*. The existence of a bipotential HPC (CFU-GM) that is the precursor of both neutrophils (and possibly other granulocytes) and monocytes is well established, and recent studies indicate the likelihood of a bipotential HPC for RBCs and megakaryocytes (Kaushansky, 2006a).

## B. Hematopoietic Microenvironment

Blood cell production occurs throughout life in the bone marrow of adult animals because of the unique microenvironment present there. The hematopoietic microenvironment is a complex meshwork composed of stromal (fibroblast-like) cells, endothelial cells, adipocytes, macrophages, subsets of lymphocytes, natural killer cells, and osteoblasts; extracellular matrix components; and glycoprotein growth factors that profoundly affect HSC and HPC engraftment, survival, proliferation, and differentiation (Abboud and Lichtman, 2006).

Stromal cells and endothelial cells produce components of the extracellular matrix (ECM), including collagen fibers, basement membranes of vessels and vascular sinuses, proteoglycans, and glycoproteins. In addition to providing structural support, the ECM is important in the binding of hematopoietic cells and soluble growth factors to stromal cells and other cells in the microenvironment so that optimal proliferation and differentiation can occur by virtue of these cell-cell interactions.

Collagen fibers produced by stromal cells may not have direct stimulatory effects on hematopoiesis but rather are permissive, promoting hematopoiesis by forming an inert scaffolding around which the other elements of the microenvironment are organized. Hematopoietic cells can adhere to collagen types I and VI.

Adhesion molecules (most importantly  $\beta_1$ -integrins) on the surface of hematopoietic cells bind to ECM glycoproteins such as vascular cell adhesion molecule-1 (VCAM-1), hemonectin, fibronectin, laminin, tenascin, vitronectin, and thrombospondin. The spectrum of expression of adhesion molecules on hematopoietic cells that will differentially bind to these ECM glycoproteins varies with the type, maturity, and activation state of the hematopoietic cells. In

addition to anchoring cells to a given microenvironmental niche, binding of adhesion molecules on hematopoietic cells also plays a role in cell regulation by direct activation of signal pathways for cell growth, survival, and differentiation or by modulating responses to growth factors.

Proteoglycans consist of a protein core with repeating carbohydrate glycosaminoglycans (GAGs) attached. Major proteoglycans in the marrow include heparan sulfate, chondroitin sulfate, hyaluronic acid, and dermatan sulfate. Proteoglycans enhance hematopoiesis by trapping soluble growth factors in the vicinity of hematopoietic cells and by strengthening the binding of hematopoietic cells to the stroma.

Hematopoietic cells develop in microenvironmental niches within the marrow. HSCs are concentrated near trabecular bone where osteoblasts help regulate their numbers (Yin and Li, 2006). Erythroid cells develop around macrophages, megakaryocytes form adjacent to sinusoidal endothelial cells, and granulocyte development is associated with stromal cells located away from the vascular sinuses (Abboud and Lichtman, 2006; Kaushansky, 2006a).

## C. Hematopoietic Growth Factors

Proliferation of HSCs and HPCs cannot occur spontaneously but requires the presence of specific hematopoietic growth factors (HGFs) that may be produced locally in the bone marrow (paracrine or autocrine) or produced by peripheral tissues and transported to the marrow through the blood (endocrine). All cells in the hematopoietic microenvironment, including the hematopoietic cells themselves, produce HGFs or inhibitors of hematopoiesis. Some HGFs have been called poietins (erythropoietin and thrombopoietin). Other growth factors have been classified as colony-stimulating factors (CSFs) based on *in vitro* culture studies. Finally, some HGFs have been described as interleukins (ILs) (Kaushansky, 2006b).

Hematopoietic cells coexpress receptors for more than one HGF on their surface. The number of each receptor type present depends on the stage of cell activation and differentiation. Binding of an HGF to its receptor results in a series of enzymatic reactions that generate signals that promote the synthesis of molecules that inhibit apoptosis, the formation of cell-cycle regulators (cyclins), and the synthesis of additional HGFs and their receptors (Kaushansky, 2006b).

HGFs vary in the type(s) of HSCs or HPCs that they can stimulate to proliferate. Factors are often synergistic in their effects on hematopoietic cells. In some instances, an HGF may not directly stimulate the proliferation of a given cell type but may potentiate its proliferation by inducing the expression of membrane receptors for HGFs that do stimulate proliferation. Some glycoproteins such as IL-1 and tumor necrosis factor- $\alpha$  (TNF- $\alpha$ ) can modulate hematopoiesis indirectly by stimulating marrow stromal cells,

endothelial cells, and T cells to produce HGFs. Different combinations of HGFs regulate the growth of different types of HSCs or HPCs (Kaushansky, 2006a).

Early-acting HGFs are involved with triggering dormant ( $G_0$ ) primitive HSCs to begin cycling. Stem cell factor (SCF), flt3 ligand (FL), and thrombopoietin are important early factors that act in combination with one or more other cytokines such as IL-3, IL-6, IL-11, and granulocyte-CSF (G-CSF).

Intermediate-acting HGFs have broad specificity. IL-3 (multi-CSF), granulocyte-macrophage-CSF (GM-CSF), and IL-4 support proliferation of multipotent HPCs. These factors also interact with late-acting factors to stimulate proliferation of a wide variety of committed progenitor cells. Late-acting HGFs have restricted specificity. Macrophage-CSF (M-CSF), G-CSF, erythropoietin, thrombopoietin, and IL-5 are more restrictive in their actions. They have their most potent effects on committed progenitor cells and later stages of development when cell lines can be recognized morphologically (Kaushansky, 2006b).

## D. Erythropoiesis

### 1. Primitive Erythropoiesis

Primitive RBC production begins and predominates in the yolk-sac but also occurs later in the liver and bone marrow. Primitive RBCs are large ( $>400$  fl in humans) generally nucleated cells with high nuclear-to-cytoplasmic ratios. Their nuclei have open (noncondensed) chromatin, and their cytoplasm contains predominantly embryonal Hb with high oxygen affinity (Segel and Palis, 2006; Tiedemann, 1977; Tsuji-Takayama *et al.*, 2006). Like nonmammalian species, primitive RBCs enter blood as nucleated cells, but in contrast to nonmammalian species, enucleation can eventually occur in the circulation (Kingsley *et al.*, 2004). Primitive RBCs appear to be generated in an erythropoietin (Epo)-independent manner, but their expansion and survival require Epo (Tsuji-Takayama *et al.*, 2006). A switch to definitive erythropoiesis occurs during fetal development. Definitive erythropoiesis results in the production of smaller cells that generally extrude their nuclei before entering blood, produce fetal Hb (in some species) and adult Hb, and are highly dependent on Epo (Tsuji-Takayama *et al.*, 2006).

### 2. Definitive Erythropoiesis

Oligopotent progenitor cells (including CFU-GEMM cells) are stimulated to proliferate and differentiate into BFU-E by SCF, IL-3, and GM-CSF in the presence of Epo. BFU-E proliferation and differentiation into CFU-E results from the presence of these same factors and may be further potentiated by additional growth factors. Epo is the primary growth factor involved in the proliferation and differentiation of CFU-E into rubriblasts, the first morphologically recognizable

erythroid cells. CFU-E cells are more responsive to Epo than are BFU-E cells because CFU-E cells exhibit greater numbers of surface receptors for Epo (Sawada *et al.*, 1990).

Marrow macrophages are important components of the hematopoietic microenvironment involved with erythropoiesis. Both early and late stages of erythroid development occur with intimate membrane apposition to central macrophages in so-called blood islands. Several adhesion molecules are important in forming these blood islands (Chasis, 2006). These central macrophages may regulate basal RBC production by producing both positive growth factors, including Epo, and negative factors such as IL-1, TNF- $\alpha$ , transforming growth factor- $\beta$ , and interferon- $\alpha$ , - $\beta$ , and - $\gamma$  (Chasis, 2006; Weiss and Goodnough, 2005; Zermati *et al.*, 2000). The finding that Epo can also be produced by erythroid progenitors suggests that these cells may support erythropoiesis by autocrine stimulation (Stopka *et al.*, 1998). Although some degree of basal regulation of erythropoiesis occurs within the marrow microenvironment, humoral regulation is important, with Epo production occurring primarily within peritubular interstitial cells of the kidney and various inhibitory cytokines being produced at sites of inflammation throughout the body.

### 3. Erythropoietin

Epo is a 34kDa glycoprotein hormone that exhibits a high degree of sequence homology among mammals (Wen *et al.*, 1993). It is the principal HGF that promotes the viability, proliferation, and differentiation of erythroid progenitor cells expressing specific cell surface Epo receptors. The main mechanism used to achieve these effects is inhibition of apoptosis. The binding of Epo to its receptor results in autophosphorylation of the receptor and the activation of several kinases that initiate multiple signaling pathways (Eckardt and Kurtz, 2005). Early BFU-E cells do not express Epo receptors, but more mature BFU-E cells express Epo receptors and are responsive to Epo. Epo receptor copies on cell surfaces increase to maximum values in CFU-E cells and then decline in rubriblasts and continue to decrease in later stages of erythroid development (Porter and Goldberg, 1993; Prchal, 2006). Because of their Epo receptor density, CFU-E cells readily respond to Epo, promoting their proliferation, differentiation, and transformation into rubriblasts, the first morphologically recognizable erythroid cell type. High concentrations of Epo may accelerate rubriblast entry into the first mitotic division, shortening the marrow transit time and resulting in the early release of stress reticulocytes (Prchal, 2006).

In the presence of Epo, other hormones including androgens, glucocorticoid hormones, growth hormone, insulin, and insulin-like growth factors (IGFs) can enhance the growth of erythroid progenitor cells *in vitro* (Leberbauer *et al.*, 2005; Miyagawa *et al.*, 2000). However, growth factors may have additional effects *in vivo*. For example,

growth hormone and IGF-1 are reported to decrease Epo synthesis in rat kidneys (Sohmiya and Kato, 2005). Glucocorticoids promote the differentiation of embryonic stem cells to hematopoietic cells and prolong the proliferation of erythroid progenitor cells but reduce the rate of spontaneous differentiation and terminal maturation of erythroid cells (Leberbauer *et al.*, 2005; Srivastava *et al.*, 2006). Glucocorticoids appear to be important in stress erythropoiesis (e.g., following hemorrhage or increased RBC destruction) when a substantial increase in erythropoiesis is required (Bauer *et al.*, 1999). The thyroid hormone 3,5,3'-triiodothyronine (T3) promotes the differentiation and maturation of erythroid cells toward enucleated RBCs (Leberbauer *et al.*, 2005). Thyroid hormones may also promote the synthesis of Epo in the kidney (Ma *et al.*, 2004).

Epo production in adult mammals occurs primarily within peritubular interstitial cells that are located within the inner cortex and outer medulla of the kidney. The liver is an extrarenal source of Epo in adults and the major site of Epo production in the mammalian fetus (Jelkmann, 2007). Bone marrow macrophages and erythroid progenitor cells themselves have also been shown to produce Epo, suggesting the possibility of short-range regulation of erythropoiesis (Stopka *et al.*, 1998; Vogt *et al.*, 1989).

The ability to deliver oxygen to the tissues depends on cardiovascular integrity, oxygen content in arterial blood, and Hb oxygen affinity. Low oxygen content in the blood can result from low partial pressure of oxygen ( $pO_2$ ) in arterial blood, as occurs with high altitudes or with congenital heart defects in which some of the blood flow bypasses the pulmonary circulation. Low oxygen content in blood can also be present when arterial  $pO_2$  is normal, as occurs with anemia and methemoglobinemia. An increased oxygen affinity of Hb within RBCs results in a decreased tendency to release oxygen to the tissues (McCully *et al.*, 1999).

Epo production is stimulated by tissue hypoxia, which is mediated by hypoxia-inducible factors (HIFs) that are heterodimers consisting of  $\alpha$  and  $\beta$  subunits. An  $\alpha$  subunit denoted  $2\alpha$  is most important in Epo production, at least for definitive erythropoiesis. Both  $\alpha$  and  $\beta$  subunits are continuously translated, but  $\alpha$  subunits are labile and regulated by tissue oxygen levels. At normal tissue oxygen levels in tissue ( $pO_2 > 36$  mmHg),  $\alpha$  subunits are hydroxylated by prolyl hydroxylases, polyubiquitinated, and removed by proteasomal degradation. When tissue oxygen levels are low ( $pO_2 < 36$  mmHg),  $\alpha$  subunits are no longer hydroxylated and degraded, allowing them to translocate into the nucleus and combine with  $\beta$  subunits to form heterodimeric transcription factors. These HIF heterodimers activate the transcription of the Epo gene, and many other target genes, by binding to the hypoxia responsive elements (HREs) in their promoter/enhancer regions. Binding to the Epo gene results in increased Epo synthesis when tissue hypoxia is present (Gruber *et al.*, 2007; Jelkmann, 2007).

Other tissues also exhibit Epo receptors, and Epo also stimulates nonhematopoietic actions including promoting proliferation and migration of endothelial cells, enhancing neovascularization, stimulating the production of modulators of vascular tone, and exerting cardioprotective and neuroprotective effects (Jelkmann, 2007).

### III. DEVELOPING ERYTHROID CELLS

#### A. Morphological and Metabolic Changes

Rubriblasts are large cells (approximately 900 fl in humans) that are continuously generated from progenitor cells in the extravascular space of the bone marrow. The division of a rubriblast initiates a series of approximately 5 divisions over a period of 3 to 5 days to produce about 32 metarubricytes that are no longer capable of division (Prchal, 2006). These divisions are called maturational divisions because there is a progressive maturation of the nucleus and cytoplasm concomitant with the divisions. Each division yields a smaller cell with greater nuclear condensation and increased Hb synthesis. An immature RBC, termed a *reticulocyte*, is formed following extrusion of the nucleus (Harvey, 2001).

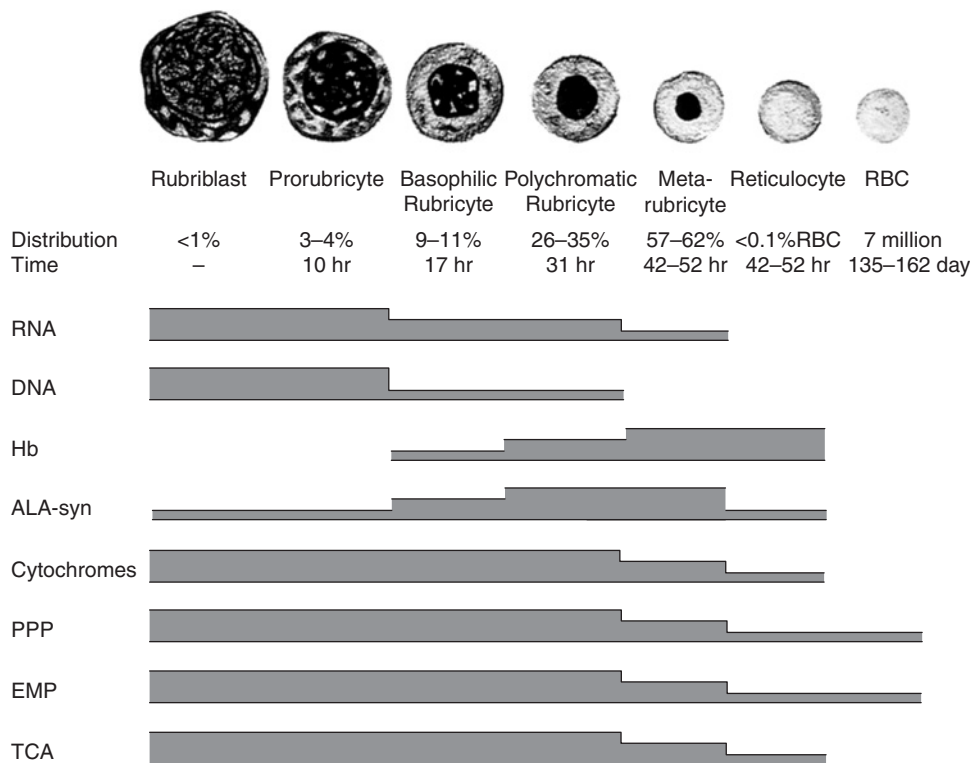
Early precursors have intensely blue cytoplasm, when stained with Romanowsky-type bloodstains, owing to the presence of many basophilic ribosomes and polyribosomes that are actively synthesizing globin chains and smaller amounts of other proteins. As the cells are nonsecretory, rough endoplasmic reticulum is scant and limited to early erythroid precursors (Bessis, 1973). Hb progressively accumulates in these cells, imparting a red coloration to the cytoplasm. Cells with both red and blue coloration are described as having polychromatophilic cytoplasm (Harvey, 2001). Kinetics of erythroid cells and changes in biochemical and metabolic pathways are depicted in Figure 7-1; time intervals were determined for cattle (Rudolph and Kaneko, 1971).

#### B. Iron Metabolism

Erythroid precursors have iron requirements that far exceed the iron requirements of any other cell type because of the need for Hb synthesis. Developing erythroid cells generally extract about 75% of the iron circulating in plasma (Smith, 1997).

##### 1. Transferrin and Transferrin Receptors

Plasma iron is bound to apotransferrin, a beta globulin that can maximally bind two atoms of ferric iron per molecule. The proportion of apo-, mono-, and diferric forms of transferrin present in serum depends on the percentage saturation of transferrin with iron. Diferric transferrin is more efficient than monoferric transferrin in delivering iron



**FIGURE 7-1** Summary of metabolic activities of the erythroid series. Maturation progresses from left to right. The time intervals indicated are for cattle. From Kaneko, 1980, with permission.

to cells, because it binds with higher affinity to receptors and can deliver twice the iron per molecule of transferrin incorporated (Huebers *et al.*, 1985). Transferrin molecules transport iron to erythroid cells and bind to transferrin receptor-1 (TfR1) on cell surfaces. Transferrin-TfR1 complexes localize to clathrin-coated pits, which invaginate to initiate endocytosis (Beutler, 2006). After the complexes are internalized as endosomes, a proton pump decreases the pH in the endosome, resulting in conformational changes in the proteins and subsequent release of  $\text{Fe}^{+3}$  ions from transferrin. Following reduction with NADPH-dependent ferrireductase,  $\text{Fe}^{+2}$  is exported from the endosome using divalent metal transporter-1 (Ohgami *et al.*, 2005). The resultant apotransferrin-TfR1 complex is recycled to the cell membrane, where apotransferrin is released from the cell, and the receptor is again available for binding additional transferrin molecules.

## 2. Intracellular Iron Transport

A direct interorganelle transfer of iron occurs between endosomes and mitochondria (Sheftel *et al.*, 2007). Most iron within mitochondria is incorporated into protoporphyrin IX to form heme, but some mitochondrial iron is used to synthesize iron-sulfur complexes that are important prosthetic groups for numerous proteins involved in electron transfer, metabolic, and regulatory processes (Lill *et al.*, 2006). Some iron is presumably released from endosomes into a cytoplasmic labile iron pool (LIP). Various chaperone

molecules have been proposed, but the nature of the iron in the LIP remains enigmatic (Beutler, 2006).

## 3. Ferritin

Iron not required for iron-sulfur complex or heme synthesis is stored as ferritin within the cytoplasm. Each ferritin molecule is composed of a protein shell of 24 apoferritin subunits surrounding a central core containing as many as 4000 iron atoms as ferric hydroxide (Arosio and Levi, 2002). Individual ferritin molecules can be visualized by electron microscopy, and large aggregates of ferritin molecules can be visualized by light microscopy when stained for iron using the Prussian blue reaction. When membrane bound, ferritin aggregates have been called siderosomes (Bessis, 1973). Iron stored as ferritin is not available for Hb synthesis in erythroid cells (Ponka *et al.*, 1998).

## 4. Iron Regulation of Transferrin Receptor and Ferritin Expression

Apoferritin, TfR1, and erythroid-specific 5-aminolevulinic acid synthase (eALAS) synthesis are regulated by the LIP concentration. An increase in the LIP stimulates apoferritin synthesis and inhibits TfR1 expression to minimize the potential of iron toxicity to the cell. A decrease in the cytoplasmic LIP results in decreased apoferritin synthesis and increased TfR1 expression on cell surfaces to maximize iron uptake and use for heme synthesis (Beutler, 2006). RBCs

coordinate protoporphyrin IX formation with the availability of iron by increasing the synthesis of  $\epsilon$ ALAS (rate limiting enzyme in porphyrin synthesis) when the LIP is high and decreasing  $\epsilon$ ALAS synthesis when the LIP is low.

### 5. Siderotic Inclusions in Erythroid Cells

Anucleated RBCs containing siderotic (iron-positive) inclusions are called siderocytes. Nucleated siderocytes have been called sideroblasts in human hematology, in which terminology used for RBC precursors is generally different from that conventionally used in veterinary hematology (Bottomley, 2004). Siderotic inclusions in erythroid cells may consist of cytoplasmic ferritin aggregates or iron-loaded mitochondria. Ferritin aggregates can occur normally in nucleated erythroid cells of humans (Cartwright and Deiss, 1975), dogs (Feldman *et al.*, 1981), and pigs (Deiss *et al.*, 1966), but the presence of iron-loaded mitochondria is a pathological finding (Cartwright and Deiss, 1975). Electron microscopy is used to definitively identify the nature of siderotic inclusions (Fresco, 1981; Hammond *et al.*, 1969); however, the location of iron-positive inclusions in a ring around the nucleus of a nucleated siderocyte (termed *ringed sideroblast* in human hematology) strongly suggests the presence of iron-loaded mitochondria (Bottomley, 2004). Conditions resulting in the pathological iron accumulation in mitochondria may induce the synthesis of a novel mitochondrial ferritin (Torti and Torti, 2002).

Except for iron deficiency, disorders in heme synthesis have the potential to cause excess iron accumulation in mitochondria (Beutler, 1995b; Fairbanks and Beutler, 1995). Experimental pyridoxine deficiency and experimental chronic copper deficiency have both resulted in mitochondrial iron overload in nucleated erythroid cells in bone marrow of deficient pigs (Hammond *et al.*, 1969; Lee *et al.*, 1968a). Drugs or chemicals reported to cause siderocytes or nucleated siderocytes in dogs include chloramphenicol (Harvey *et al.*, 1985), lead, hydroxyzine, zinc (Harvey, 2001), and an oxazolidinone antibiotic (Lund and Brown, 1997).

Siderotic inclusions in erythroid cells have been recognized in some dogs and cats with myeloproliferative disorders (Blue *et al.*, 1988; Weiss and Lulich, 1999). Acquired dyserythropoiesis with siderocytes have been reported in dogs in which specific etiologies could not be determined, although some of these animals had inflammatory disorders (Canfield *et al.*, 1987; Weiss, 2005). Congenital anemias with ringed nucleated siderocytes have been reported in humans (Bottomley, 2006). Persistent siderotic inclusions have been recognized in microcytic hypochromic erythrocytes from an English bulldog. Erythrocytes also contained Heinz bodies and rare hemoglobin crystals (Harvey *et al.*, 2007). A congenital defect resulting in mitochondrial iron overload and secondary oxidant injury was suspected, but not identified. Refer to Chapter 9 for more information concerning iron metabolism.

## C. Hb Synthesis

Hb is a tetrameric protein consisting of four polypeptide globin chains each of which contains a heme prosthetic group within a hydrophobic pocket. The molecule consists of two identical alpha and two nonalpha chains that are generally classified as beta chains in adults.

### 1. Heme Synthesis and Metabolism

Heme is a planar molecule composed of the tetrapyrrole protoporphyrin IX, containing a central ferrous molecule. The initial rate-controlling step in heme synthesis, the  $\epsilon$ ALAS reaction, occurs within mitochondria (see Chapter 8). Glycine and the Krebs cycle intermediate succinyl-CoA are utilized as substrates, and vitamin B<sub>6</sub>, as pyridoxal phosphate, is required as a cofactor. The ALA formed is transported to the cytoplasm where a series of reactions results in the formation of coproporphyrinogen III, which must enter the mitochondria, presumably using an ATP-binding cassette transporter ABCB6 (Krishnamurthy *et al.*, 2006) for the final steps in heme synthesis. The final reaction, catalyzed by heme synthetase, involves the insertion of ferrous iron into protoporphyrin IX.

Following synthesis, heme must be transferred from mitochondria to the cytoplasm for combination with globin chains to complete the synthesis of Hb. The mitochondrial heme exporter has not been identified at this time. Free heme is poorly soluble in water and can bind to and damage cellular components (Kumar and Bandyopadhyay, 2005). It apparently is bound to cytosolic proteins for transport to sites of globin chain synthesis (Kumar and Bandyopadhyay, 2005; Taketani *et al.*, 1998). Sometime after its synthesis, the iron moiety of heme is oxidized (presumably spontaneously) to the ferric state and is then more specifically called ferriheme (Schulman *et al.*, 1974).

Heme affects erythroid cell metabolism in different ways depending on the stage of maturation. It stimulates iron uptake and heme synthesis in early erythroid cells, but it inhibits iron uptake and heme synthesis in reticulocytes (Abraham, 1991; Battistini *et al.*, 1991). A cellular heme exporter termed *feline leukemia virus subgroup C cellular receptor* (FLVCR) is up-regulated on colony-forming units-erythroid (CFU-E) progenitor cells. It may provide a safety mechanism to prevent the accumulation of toxic amounts of cytoplasmic heme before globin synthesis is initiated.

### 2. Globin Synthesis

The synthesis of polypeptide globin monomers occurs in association with ribosomes and polyribosomes in the cytoplasm. Evidence has been provided indicating that binding of a partially unstructured apo- $\beta$  chain to a tightly folded holo- $\alpha$  chain to form a heme-deficient dimer is the initial step of Hb assembly. Such binding locks the  $\beta$  chain in a highly ordered conformation, which allows for an efficient

heme acquisition by the  $\beta$  chain. (Griffith and Kaltashov, 2003). Free  $\alpha$  globin chains are highly unstable and tend to aggregate within the cell and generate reactive oxygen species through chemical reactions catalyzed by their heme-bound iron molecules. Fortunately, free  $\alpha$  globin chains are stabilized by binding to alpha Hb stabilizing protein (AHSP) until they combine with free  $\beta$  globin chains to form stable  $\alpha$ - $\beta$  dimers (Weiss *et al.*, 2005). Two like  $\alpha$ - $\beta$  dimers spontaneously combine in a readily reversible manner to form Hb tetramers (Bunn, 1987). Newly synthesized Hb is in the form of methemoglobin (MetHb) (Schulman *et al.*, 1974).

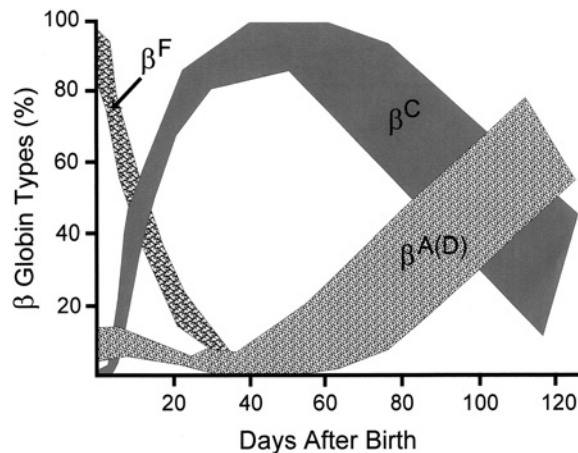
### 3. Control of Hb Synthesis

Even though three different pathways are required for Hb synthesis in RBC precursors and reticulocytes, minimal intermediates (iron, globin chains, or heme) accumulate in the cytoplasm of these cells. Several positive and negative feedback mechanisms account for the balanced production of these Hb components. As already discussed, an increase in the LIP limits the uptake of additional iron by decreasing TfR1 synthesis. The availability of iron also limits and, thereby controls, heme synthesis. Free “uncommitted” heme inhibits iron uptake by erythroid cells and consequently heme synthesis. In addition, free heme is essential for the synthesis of globin chains at both the transcriptional and translational levels (Koury and Ponka, 2004). Consequently, globin synthesis does not occur in the absence of heme.

### 4. Hb Types in Animals

Hb types are different in animal and human embryos than in fetuses or in adults. Embryonal Hbs are composed of either one or two pairs of peptide chains not found in adult Hbs (Kitchen and Brett, 1974). In higher primates, embryonal Hbs are replaced by fetal Hb composed of 2  $\alpha$  chains and 2  $\gamma$  chains (HbF) in the fetus, followed by Hbs with 2  $\alpha$  chains and 2  $\beta$  chains (HbA) or 2  $\alpha$  chains and 2  $\delta$  chains (HbA<sub>2</sub>) after birth. The  $\gamma$  globin gene was deleted during evolution in artiodactyls (even-toed ungulates). The  $\gamma$  globin gene functions as an embryonic gene in other nonartiodactyl mammals. Among nonprimate mammals, a specific fetal globin gene is expressed only in artiodactyls. In this lineage, a duplicated  $\beta$  globin gene ( $\beta^F$ ) is expressed in the fetus, rather than a  $\gamma$  globin gene. The entire  $\beta$  globin gene locus was duplicated in cattle and HbB sheep and triplicated in goats and HbA sheep during evolution (Gumucio *et al.*, 1996). Most fetal Hb in cattle ( $\alpha_2\beta_2^F$ ) is replaced by adult Hb types during the first 3 weeks after birth (Lee *et al.*, 1971). Embryonal Hbs are replaced by adult Hb types during the fetal period in cats, dogs, horses, and pigs. Consequently, Hb types present in fetuses are identical to those found in adults in these species (Bunn and Kitchen, 1973; Kitchen and Brett, 1974).

In addition to expressing fetal Hb ( $\alpha_2\beta_2^F$ ) in the fetus, most goats and some sheep express a juvenile Hb ( $\alpha_2\beta_2^C$ )



**FIGURE 7-2** Changes in proportion of  $\beta$  globin types in Hb from five newborn goats during the first 120 days of life. Fetal Hb contains  $\beta^F$ . HbC contains  $\beta^C$ . HbD differs from HbA by a single amino acid substitution in position 21 of their  $\beta$  chains,  $\beta^D$  and  $\beta^A$ , respectively. Modification of a figure by Huisman *et al.*, 1969.

called HbC during the neonatal period that is subsequently replaced with adult Hb types. Sheep that produce adult HbA ( $\alpha_2\beta_2^A$ ) express variable amounts (generally less than 10%) of HbC during the neonatal period, but sheep that produce adult HbB ( $\alpha_2\beta_2^B$ ) do not express HbC in the neonatal period (Huisman *et al.*, 1969; Yu *et al.*, 2005). Fetal Hb in the newborn goat is replaced almost entirely by HbC during the first 40 days of life (Fig. 7-2), and then HbC is gradually replaced by adult Hbs (Huisman *et al.*, 1969).

The switch from production of fetal Hb to the production of adult Hb appears to result from an inherent programming of hematopoietic stem cells (Wood *et al.*, 1985). In contrast, HbC synthesis appears to be mediated by Epo, which is low at birth and increases after birth as the hematocrit decreases (see Section V.C) (Barker *et al.*, 1980; Huisman *et al.*, 1969). Adult sheep RBCs contain little or no HbC, but adult goat RBCs may have as much as 10% HbC (Huisman *et al.*, 1969). Sheep and goats that synthesize HbC during the neonatal period will also increase HbC synthesis in anemic adults and in nonanemic adults treated with Epo (Vestri *et al.*, 1983; Yu *et al.*, 2005). Most goats and sheep with HbA have 12 genes in the  $\beta$ -globin locus, including the  $\beta^C$  gene. Cattle and sheep with HbB have 8 genes in the  $\beta$ -globin locus and lack the  $\beta^C$  gene (Garner and Lingrel, 1988). HbC was not reported to occur in three breeds of Omani goats after birth even though they were reported to be either homozygous for HbA or heterozygous for HbA and HbB (Johnson *et al.*, 2002). The composition of the  $\beta$ -globin locus was not investigated in these animals.

The  $\alpha$ -globin genes have been duplicated in humans and other mammals. Triplication of  $\alpha$ -globin genes is relatively common in sheep and quadruplication of genes also occurs. There is an expression gradient of  $\alpha$ -globin protein and  $\alpha$ -globin mRNA levels produced by duplicated and triplicated



$\alpha$ -globin genes, based on their location in the  $\alpha$ -globin gene cluster. Gene expression progressively decreases from 5' to 3' (Vestri *et al.*, 1994). Compared to sheep with duplicated  $\alpha$ -globin genes, sheep with triplicated  $\alpha$ -globin genes produce excess  $\alpha$ -globin, resulting in an unbalanced alpha/beta ratio and larger RBCs with increased osmotic fragility (Pieragostini *et al.*, 2003).

Considerable heterogeneity of Hb types occurs in adult animals. Two or more Hb types are reported to occur in domestic animal species (Braend, 1988; Kitchen, 1974; Kohn *et al.*, 1998, 1999; Pirastru *et al.*, 2003; Rando and Masina, 1985). Most polymorphism of animal Hbs is determined genetically and is usually caused by multiple amino acid interchanges (Kitchen, 1974). Hb types were initially classified based on electrophoretic mobility in gels. Electrophoretic differences can result from differences in  $\alpha$  or  $\beta$  chain structure. For example, HbA and HbB in sheep are attributable to differences in  $\beta$  chains (Garner and Lingrel, 1988), but HbA and HbB in goats are attributed to differences in  $\alpha$  chains (Huisman and Kitchens, 1968; Pieragostini *et al.*, 2005). Electrophoretic mobility in gels is not sensitive enough to identify many  $\alpha$  and  $\beta$  chain variants, and distinctly different Hb tetramers can migrate with similar mobilities, resulting in misleading information. For example, HbB ( $\alpha_2^B\beta_2^A$ ) and HbD ( $\alpha_2^A\beta_2^D$ ) in goats have almost the same mobility at alkaline pH (Pieragostini *et al.*, 2005).

Nongenetic alterations in Hb structure can also contribute to apparent Hb heterogeneity. Examples include the N-acetylation of beta chains in cat HbB (Taketa *et al.*, 1972) and glycosylation of Hb, a function of intracellular glucose concentration and RBC life span (Higgins *et al.*, 1982; Rendell *et al.*, 1985). Increased glycosylation of Hb has been reported in diabetic dogs and cats (Elliott *et al.*, 1997, 1999). Similar to the glycosylation of Hb by glucose, cyanate combines spontaneously and irreversibly with Hb to form carbamylated Hb. Cyanate forms spontaneously from urea. Dogs with chronic renal failure and long-term increases in urea concentration have larger amounts of carbamylated Hb than dogs with acute renal failure (Heiene *et al.*, 2001).

## D. Reticulocytes

### 1. Formation

Most reticulocytes are formed from metarubricytes within the extravascular space of the bone marrow by a process of nuclear extrusion that requires functional microtubules (Chasis *et al.*, 1989) and is likened to mitosis (Bessis, 1973; Simpson and Kling, 1967). The erythroblast macrophage protein (Emp) associates with F-actin and is important in denucleation of metarubricytes, as well as blood island formation (Soni *et al.*, 2006). Extruded nuclei quickly expose phosphatidylserine on their surfaces, which promotes their binding to, and phagocytosis by, blood island macrophages (Yoshida *et al.*, 2005).

Reticulocyte cytoplasm contains ribosomes, polyribosomes, and mitochondria necessary for the completion of Hb synthesis. Reticulocytes derive their name from a network or reticulum that appears when stained with basic dyes such as methylene blue and brilliant cresyl green. That network is not preexisting but is an artifact formed by the precipitation of ribosomal ribonucleic acids and proteins. As reticulocytes mature, the amount of ribosomal material decreases until only a few basophilic specks can be visualized with reticulocyte staining procedures. These mature reticulocytes have been referred to as type IV (Houwen, 1992) or punctate reticulocytes (Alsaker, 1977; Perkins *et al.*, 1995). To reduce the chance that a staining artifact would result in misclassifying a mature RBC as a punctate reticulocyte using a reticulocyte stain, the cell being evaluated should have two or more discrete blue granules that are visible without requiring fine focus adjustment of the cell to be classified as a punctate reticulocyte.

### 2. Metabolism

Reticulocyte metabolism and maturation have been reviewed by Rapoport (1986) and are summarized here. Immature reticulocytes continue to synthesize protein (primarily globin chains) with residual mRNA, tRNA, and rRNA formed before denucleation. About 30% of total Hb is synthesized after nuclear extrusion (Geminard *et al.*, 2002). Synthesis of fatty acids is minimal, but phospholipids are synthesized from preformed fatty acids. Substrates for protein and lipid synthesis and for energy metabolism are provided from endogenous sources (breakdown of mitochondria and ribosomes) as well as from plasma. The reticulocyte can synthesize adenine and guanine nucleotides *de novo* (Rapoport, 1986).

Most ATP is generated in reticulocytes by oxidative phosphorylation in mitochondria. Glucose is the major substrate, but amino acids and fatty acids can also be utilized for energy (Rapoport, 1986).

### 3. Maturation into RBCs

Reticulocyte maturation into mature RBCs is a gradual process that requires a variable number of days depending on the species involved. Consequently, the morphological and physiological properties of reticulocytes vary with the stage of maturation. Early reticulocytes have polylobulated surfaces. The cell surface undergoes extensive remodeling with loss of membrane material and ultimately the formation of the biconcave shape of mature RBCs (Bessis, 1973). The loss of membrane protein and lipid components requires ATP and involves the formation of intracellular multivesicular endosomes that fuse with the plasma membrane releasing vesicles (exosomes) extracellularly (Geminard *et al.*, 2002). This is a highly selective process in which some proteins (e.g., TfR1 and fibronectin receptor) are lost and cytoskeletal proteins (e.g., spectrin) and firmly bound transmembrane

proteins (e.g., the anion transporter and glycophorin A) are retained and concentrated (Geminard *et al.*, 2002; Ponka *et al.*, 1998). The heat shock protein 70 (Hsp70) is concentrated in exosomes and may promote the formation of exosomes during reticulocyte maturation (Jeong *et al.*, 2005). Some membrane proteins such as the nucleoside transporter, glucose transporter, Na,K-ATPase, insulin receptor, and adrenergic receptors decrease to variable degrees depending on the species involved (Chasis *et al.*, 1989; Geminard *et al.*, 2002). Examples of reticulocytes from a species that exhibit a complete or nearly complete loss of a protein that is retained in mature RBCs from other species include the adenosine transporter in sheep (Jarvis and Young, 1982), the glucose transporter in pigs (Zeidler and Kim, 1982), and Na,K-ATPase in dogs (Maede and Inaba, 1985).

Although loss of membrane components accounts for much of the change in membrane protein composition during reticulocyte maturation, certain proteins such as protein 4.1 and glycophorin C increase because they are still being synthesized in reticulocytes (Chasis *et al.*, 1989). These membrane alterations result in increased mechanical stability of blood reticulocyte and RBC membranes compared to marrow reticulocyte and nucleated erythroid cell membranes (Waugh *et al.*, 2001).

Mitochondria undergo degenerative changes in a programmed death phenomenon (mitoptosis) owing to 15-lipoxygenase attack and subsequent ATP-dependent proteolysis (Geminard *et al.*, 2002). Degenerating mitochondria are either digested or extruded following entrapment in structures resembling autophagic vacuoles (Simpson and Kling, 1968). The polysomes separate into monosomes and decrease in number and disappear as reticulocytes mature into RBCs. The degradation of ribosomes appears to be energy dependent; it presumably involves proteases and RNAases (Rapoport, 1986).

#### 4. Species Differences in Marrow Release

Reticulocyte maturation begins in the bone marrow and is completed in the peripheral blood and spleen in dogs, cats, and pigs. As reticulocytes mature, they lose the surface receptors needed to adhere to fibronectin and thrombospondin components of the extracellular matrix, presumably facilitating their release from the bone marrow (Telen, 2000). Residual adhesion molecule receptors on newly released reticulocytes may explain their tendency to concentrate in the reticular meshwork of the spleen (Patel *et al.*, 1985).

Reticulocytes become progressively more deformable as they mature, a characteristic that also facilitates their release from the marrow (Waugh *et al.*, 2001). To exit the extravascular space of the marrow, reticulocytes press against the abluminal surfaces of endothelial cells that make up the sinus wall. Cytoplasm thins and small pores (0.5 to 2  $\mu\text{m}$ ) develop in endothelial cells, which allow reticulocytes to be pushed through by a small pressure gradient across the

sinus wall (Lichtman and Santillo, 1986; Waugh, 1991). Pores apparently close after cell passage.

Relatively immature aggregate-type reticulocytes are released from canine bone marrow; consequently, most of these cells appear polychromatophilic when viewed following routine blood film staining procedures (Laber *et al.*, 1974). Absolute reticulocyte counts oscillate with a periodicity of approximately 14 days in some dogs, suggesting that canine erythropoiesis may have a homeostatically controlled physiological rhythm (Morley and Stohlman, 1969). Reticulocytes are normally not released from feline bone marrow until they mature to punctate-type reticulocytes; consequently, few or no aggregate reticulocytes (<0.4%), but up to 10% punctate reticulocytes, are found in blood from normal adult cats (Cramer and Lewis, 1972). The high percentage of punctate reticulocytes results from a long maturation time with delayed degradation of ribosomes (Fan *et al.*, 1978). Reticulocytes are generally absent in peripheral blood of healthy adult cattle and goats, but a small number of punctate types (0.5%) may occur in adult sheep (Jain, 1986). Based on microscopic examination of blood films stained with new methylene blue, equine reticulocytes are absent from blood normally and rarely released in response to anemia. However, low numbers of reticulocytes have been reported in the blood of normal and anemic horses using an Advia 120 (Siemens Medical Solutions Diagnostics, Tarrytown, New York) automated analyzer (Cooper *et al.*, 2005). Either the instrument is more sensitive than microscopic evaluation, or values reported in normal horses represent “noise” in the instrument.

#### 5. “Stress” Reticulocytes

Except for horses, increased numbers of reticulocytes are released in response to anemia, with better responses to hemolytic anemia than to hemorrhage. When the degree of anemia is severe, basophilic macroreticulocytes, or so-called stress reticulocytes, may be released into blood. It is proposed that a generation in the maturation sequence is skipped and immature reticulocytes, about twice the normal size, are released (Rapoport, 1986). Increased Epo results in a diminution in the adventitial cell and endothelial cell barrier separating marrow hematopoietic cells from the sinus, thereby potentiating the premature release of stress reticulocytes from the marrow (Chamberlain *et al.*, 1975). Although a portion of these macroreticulocytes apparently is rapidly removed from the circulation (Noble *et al.*, 1990), it is clear from studies in cats that some can mature into macrocytic RBCs with relatively normal life spans (Weiser and Kociba, 1982).

### E. Abnormalities in Erythroid Development

#### 1. Ineffective Erythropoiesis

*Ineffective erythropoiesis* is a term used to describe the destruction of developing erythroid cells in marrow.

Normally, few die within the marrow (Odartchenko *et al.*, 1971), but ineffective erythropoiesis is prominent in disorders of nucleic acid, heme, or globin synthesis. Examples include folate deficiency, iron deficiency, vitamin B<sub>6</sub> deficiency, lead poisoning, and thalassemia in humans (Jandl, 1987). Ineffective erythropoiesis also occurs in association with myeloproliferative and myelodysplastic disorders (Meyer and Harvey, 2004) and congenital dyserythropoiesis (Holland *et al.*, 1991; Steffen *et al.*, 1992).

## 2. Vitamin and Mineral Deficiencies

Folate is required for normal DNA synthesis. Folate deficiency impairs the activity of the folate-requiring enzyme thymidylate synthase (Jandl, 1987). Not only is deoxythymidylate triphosphate (dTTP) synthesis decreased, but deoxyuridylate triphosphate (dUTP) accumulates secondarily in the cell such that some becomes incorporated into DNA in place of dTTP. Cycles of excision and attempts to repair these copy errors, with limited thymidine available, result in chromosomal breaks and malformations and slowing of the S phase in the cell cycle. Consequently, erythroid precursors are often large with deranged-appearing nuclear chromatin; such cells are classified as megaloblastic cells. Folate deficiency in people causes macrocytic anemia because fewer divisions occur as a result of retarded nucleic acid synthesis in the presence of normal protein synthesis (Jandl, 1987). Possible causes of folate deficiency include dietary deficiency, impaired absorption, and drugs that interfere with folate metabolism.

Macrocytic anemias resulting from folate deficiency are rarely reported in animals. A possible case was reported in a dog on anticonvulsant therapy (Lewis and Rebar, 1979), but serum folate was not measured. Megaloblastic precursors were present in bone marrow of cats with experimental dietary folate deficiency, but hematocrits and mean cell volumes (MCVs) remained normal (Thenen and Rasmussen, 1978). However, macrocytic anemia with dyserythropoiesis was reported in a cat that appeared to have both a folate-deficient diet and defective folate absorption (Myers *et al.*, 1996). Macrocytic anemia has been reported in folate-deficient pigs (Bush *et al.*, 1956), but not lambs (Stokstad, 1968).

Vitamin B<sub>12</sub> (cobalamin) deficiency in people causes hematological abnormalities similar to folate deficiency because vitamin B<sub>12</sub> is necessary for normal folate metabolism in humans (Chanarin *et al.*, 1985). In contrast, vitamin B<sub>12</sub> deficiency does not cause macrocytic anemia in any animal species (Chanarin *et al.*, 1985). Anemia has been reported in some experimental animal studies, but RBCs were of normal size (Stokstad, 1968; Underwood, 1977), although slight increases in MCV have been reported in B<sub>12</sub>-deficient goats fed diets deficient in cobalt (Mgongo *et al.*, 1981). Cobalamin deficiency has been reported secondary to an inherited malabsorption of cobalamin in giant schnauzer dogs (Fyfe, 2000). Affected animals have normocytic,

nonregenerative anemia with increased anisocytosis and poikilocytosis, neutropenia with hypersegmented neutrophils, and giant platelets. Megaloblastic changes in the bone marrow were particularly evident in the myeloid cell line. The malabsorption of cobalamin in these dogs apparently results from the absence of an intrinsic factor-cobalamin receptor in the apical brush border of the ileum. No blood or bone marrow abnormalities were recognized in kittens fed a B<sub>12</sub>-deficient diet for several months (Morris, 1977), but a normocytic nonregenerative anemia was present in a cobalamin-deficient cat that probably had an inherited disorder of cobalamin absorption (Vaden *et al.*, 1992).

A number of disorders exhibit macrocytic anemias with megaloblastic abnormalities in the marrow that mimic findings in human folate or cobalamin deficiency but have had normal serum levels of these vitamins when measured. Examples include cats infected with the feline leukemia virus (Dunn *et al.*, 1984; Weiser and Kociba, 1983a), cattle with congenital dyserythropoiesis (Steffen *et al.*, 1992), and myelodysplastic syndromes (Harvey, 2001). In addition, some miniature and toy poodles exhibit macrocytosis without anemia and variable megaloblastic abnormalities in the bone marrow with normal serum folate and cobalamin values (Canfield and Watson, 1989).

Abnormalities in heme or globin synthesis can result in the formation of microcytic hypochromic RBCs. Cellular division is normal, but Hb synthesis is delayed; consequently, one or more extra divisions occur in RBC development, resulting in smaller cells than normal.

Pyridoxine, vitamin B<sub>6</sub>, is required for the first step in heme synthesis. Although natural cases of pyridoxine deficiency have not been documented in domestic animals, microcytic anemias with high serum iron values have been produced experimentally in dogs (McKibbin *et al.*, 1942), cats (Bai *et al.*, 1989; Carvalho da Silva *et al.*, 1959), and pigs (Deiss *et al.*, 1966) with dietary pyridoxine deficiency. Erythroid cells with iron-loaded mitochondria, secondary to impaired heme synthesis, have been demonstrated in pigs fed a pyridoxine-deficient diet (Hammond *et al.*, 1969).

With the exception of young growing animals, iron deficiency in domestic animals usually results from blood loss. Milk contains little iron; consequently, nursing animals can easily deplete their body iron store as they grow (Furugouri, 1972; Harvey *et al.*, 1987; Holter *et al.*, 1991; Siimes *et al.*, 1980). Microcytic RBCs are produced in response to iron deficiency (Holman and Drew, 1966; Holter *et al.*, 1991; Reece *et al.*, 1984), but a low MCV may not develop postnatally in species where the MCV is above adult values at birth (Weiser and Kociba, 1983b). The potential for development of severe iron deficiency in young animals appears to be less in species that begin to eat food at an early age.

Chronic iron deficiency anemia with microcytic RBCs is common in adult dogs in areas where hookworm and flea infestations are severe (Harvey *et al.*, 1982; Weiser and O'Grady, 1983). Severe iron deficiency appears to be

rare in adult cats (French *et al.*, 1987; Fulton *et al.*, 1988) and horses (Smith *et al.*, 1986), but it occurs frequently in ruminants that are heavily parasitized with blood-sucking parasites such as *Haemonchus contortus*. Much more information concerning iron deficiency is given in Chapter 9.

Prolonged copper deficiency generally results in anemia in mammals (Auclair *et al.*, 2006; Brewer, 1987; Lahey *et al.*, 1952), although anemia was not a feature of experimental copper deficiency in the cat (Doong *et al.*, 1983). The anemia is generally microcytic hypochromic; however, normocytic anemia has been reported in experimental studies in dogs, and normocytic or macrocytic anemias have been reported in cattle and adult sheep (Brewer, 1987). Copper deficiency results in impaired iron metabolism (Lee *et al.*, 1968b). In experimental studies in pigs, serum iron concentration is low in early copper deficiency when iron stores are normal (Lahey *et al.*, 1952; Lee *et al.*, 1968b). Functional iron deficiency occurs because copper-containing proteins hephaestin and ceruloplasmin are required for normal iron transport (Lee *et al.*, 1968a; Wessling-Resnick, 2006).

If experimental copper deficiency is prolonged in pigs, hyperferremia occurs and nucleated erythroid cells with cytoplasmic siderotic (iron-positive) inclusions increase in bone marrow (Lee *et al.*, 1968a). Reticulocyte mitochondria from copper-deficient pigs are unable to synthesize heme at the normal rate using  $\text{Fe}^{+3}$  (Williams *et al.*, 1976). A deficiency in copper-containing cytochrome oxidase within mitochondria may slow the reduction of  $\text{Fe}^{+3}$  to  $\text{Fe}^{+2}$  within mitochondria. That would limit heme synthesis, which requires iron in the  $\text{Fe}^{+2}$  state (Porra and Jones, 1963).

### 3. Deficiencies in Globin Synthesis

Hereditary deficiencies in synthesis of the globin  $\alpha$  chain ( $\alpha$ -thalassemia) and  $\beta$  chain ( $\beta$ -thalassemia) cause microcytic hypochromic anemias in humans with variable degrees of poikilocytosis (Weatherall, 2006). Both  $\alpha$ - and  $\beta$ -thalassemia occur in mice, but thalassemias have not been reported in domestic animals.

### 4. Aplastic Anemia

Aplastic anemia is generally used to describe anemias where granulocytic, megakaryocytic, and erythrocytic cell lines are markedly reduced in the bone marrow. When only the erythroid cell line is reduced or absent, terms such as *pure red cell aplasia*, *selective erythroid aplasia*, or *selective erythroid hypoplasia* are used.

Many drugs have been incriminated in the production of aplastic anemia in humans (Shadduck, 1995). Drug-induced causes of aplastic anemia or generalized marrow hypoplasia in animals include estrogen toxicity in dogs, phenylbutazone toxicity in dogs and possibly a horse, trimethoprim-sulfadiazine administration in dogs, bracken fern poisoning in cattle and sheep, trichloroethylene-extracted soybean

meal in cattle, albendazole toxicity in dogs and cats, griseofulvin toxicity in cats, various cancer chemotherapeutic agents, and radiation. Thiacetarsamide, meclufenamic acid, and quinidine have also been incriminated as potential causes of aplastic anemia in dogs. In addition to exogenous estrogen toxicity, high levels of endogenous estrogens, produced by estrogen secreting tumors and functional cystic ovaries in dogs and prolonged estrus in ferrets, can result in aplastic anemia (Harvey, 2001). Parvovirus infections can cause erythroid hypoplasia, as well as myeloid hypoplasia in canine pups (Potgieter *et al.*, 1981; Robinson *et al.*, 1980), but animals may not become anemic, because of the long life spans of RBCs. Although some degree of marrow hypoplasia or dysplasia often occurs in cats with feline leukemia virus (FeLV) infections (Cotter, 1979), true aplastic anemia is not a well-documented sequela (Rojko and Olsen, 1984). Hypocellular bone marrow has been reported in cats experimentally co-infected with FeLV and feline parvovirus (Lutz *et al.*, 1995). Dogs with acute *Ehrlichia canis* infections may spontaneously recover or develop chronic disease that generally exhibits some degree of marrow hypoplasia. Although rare, aplastic anemia may develop in association with severe chronic ehrlichiosis in dogs (Neer, 1998).

A retrospective review of cats with aplastic anemia identified 13 cases in which the clinical diagnoses included chronic renal failure ( $n = 5$ ), FeLV infection ( $n = 2$ ), hyperthyroidism treated with methimazole ( $n = 1$ ), and idiopathic aplastic anemia ( $n = 5$ ). The author suggested that starvation may have played a role in the development of marrow aplasia in some of these cats (Weiss, 2006). Idiopathic aplastic anemia has also been reported in dogs and horses (Harvey, 2001). CFU-E were not detected in bone marrow culture from a dog with an idiopathic aplastic anemia (Weiss and Christopher, 1985).

Other potential causes of aplastic anemia include congenital defects and primary immune-mediated disorders. Most cases of aplastic anemia in adult humans are immune mediated, with activated type 1 cytotoxic T cells implicated in the pathogenesis (Young *et al.*, 2006). The aberrant immune response may be triggered by environmental exposures, such as to chemicals and drugs or viral infections, and possibly by endogenous antigens generated by genetically altered bone marrow cells (Young, 2002).

### 5. Selective Erythroid Aplasia

Selective erythroid aplasia (pure red cell aplasia) occurs as either a congenital or acquired disorder in people. Acquired erythroid aplasia is often associated with abnormalities of the immune system. Erythroid aplasia may also occur secondary to disorders such as B-19 parvovirus infection, lymphoid malignancies, and drug or chemical toxicities (Erslev and Soltan, 1996).

Acquired erythroid hypoplasia or aplasia occurs in dogs (Stokol *et al.*, 2000; Weiss, 1986). Some cases have

immune-mediated etiologies based on positive responses to immunosuppressive therapy and the presence of antibodies that inhibit CFU-E development in marrow cultures (Weiss, 1986). Acquired, presumably immune-mediated, erythroid aplasia has also been reported in FeLV-negative cats (Stokol and Blue, 1999).

Selective erythroid aplasia occurs in cats infected with FeLV subgroup C (FeLV-C), but not in cats infected only with subgroups A or B (Riedel *et al.*, 1986). CFU-E numbers are markedly decreased but BFU-E numbers are normal in infected cats, indicating that FeLV-C inhibits differentiation of BFU-E into CFU-E (Abkowitz, 1991). The cell surface receptor for FeLV-C is called FLVCR. This receptor has recently been demonstrated to be a heme exporter (Quigley *et al.*, 2004). Free heme is toxic to cells, and it is hypothesized that the binding of FeLV-C to FLVCR on CFU-E progenitor cells inhibits heme export from these cells, resulting in their destruction (Quigley *et al.*, 2004).

High doses of chloramphenicol cause reversible erythroid hypoplasia in some dogs (Watson, 1977) and erythroid aplasia in cats (Watson and Middleton, 1978). Marked erythroid hypoplasia has been reported in dogs, cats, and horses given recombinant human erythropoietin (Cowgill *et al.*, 1998; Piercy *et al.*, 1998; Woods *et al.*, 1997). Antibodies made against this human recombinant glycoprotein apparently cross-react with the animals' endogenous erythropoietin.

## IV. MATURE RBC

Values for RBC glucose utilization, ion concentrations, and survival times in normal animals are given in Table 7-1. Enzyme activities are given in Tables 7-2 and 7-3, and chemical constituents in RBCs are given in Tables 7-4 and 7-5. These are not, however, comprehensive lists. Other values are provided by Friedemann and Rapoport (1974) and in various chapters of a reference book edited by Agar and Board (1983). Anemia induced by phlebotomy or by hemolytic drugs produces changes in many of the previously stated values owing to the influx of young RBCs into the circulation in response to the anemia (Agar and Board, 1983). Methods for enzyme assays vary considerably; consequently, each laboratory will need to establish its own reference intervals if enzyme studies are to be done.

### A. Membrane Structure

The RBC membrane is composed of a hydrophobic lipid bilayer with a protein skeletal meshwork attached to its inner surface by binding to integral (transmembrane) proteins (Fig. 7-3). Membrane proteins from RBCs have been numbered by their migration location (Smith, 1987) on sodium dodecyl sulfate-polyacrylamide gel electrophoresis (SDS-PAGE); some have also been given one or more

**TABLE 7-1** Erythrocyte Glucose Utilization, Ion Concentrations, and Survival Times of Various Mammals<sup>a</sup>

Species	RBC Glucose Utilization ( $\mu\text{mol/h/ml}$ )	RBC Na <sup>+</sup> (mmol/liter)	RBC K <sup>+</sup> (mmol/liter)	RBC Survival (Days)
Human	1.48 $\pm$ 0.11 (1)	6.2 $\pm$ 0.8 (7)	102 $\pm$ 3.9 (7)	120 (11)
Dog	1.33 $\pm$ 0.12 (1)	92.8 $\pm$ 11.1 (8)	5.7 $\pm$ 1.0 (8)	100 (11)
Cat	0.94 $\pm$ 0.09 (1)	105.8 $\pm$ 14.4 (8)	5.9 $\pm$ 1.9 (8)	72 (11)
Horse	0.64 $\pm$ 0.10 (1)	10.4 $\pm$ 1.8 (9)	120 $\pm$ 11.1 (9)	143 (11)
Cattle	0.56 $\pm$ 0.05 (2)	79.1 $\pm$ 14.6 (8)	22.0 $\pm$ 4.5 (8)	130 (11)
Sheep	0.69 $\pm$ 0.19 (3)	HK <sup>+</sup> , 17.1 (10) LK <sup>+</sup> , 73.7 (10)	HK <sup>+</sup> , 98.7 (10) LK <sup>+</sup> , 39.4 (10)	135 (11)
Goat	1.94 (4)	13.4 (4)	76.1 (4)	115 (11)
Pig	0.09 (5)	15.6 $\pm$ 1.8 (8)	105.9 $\pm$ 12.7 (8)	67 (11)
Rabbit	2.26 $\pm$ 0.30 (2)	16.8 $\pm$ 6.3 (8)	110.1 $\pm$ 6.0 (8)	57 (11)
Guinea pig	1.44 (6)	24.4 $\pm$ 5.4 (8)	107.2 $\pm$ 10.1 (8)	80 (11)
Mouse	2.85 $\pm$ 0.20 (2)			43 (11)
Hamster		17.2 (12)	92.0 (12)	50 (11)
Rat	2.38 $\pm$ 0.20 (2)	33.5 $\pm$ 3.5 (8)	104.7 $\pm$ 15.4 (8)	56 (11)

<sup>a</sup>Mean values have been recalculated at times to permit direct comparisons between species. Standard deviation values are given where indicated. Abbreviation: RBC, red blood cell. Figures in parentheses are the references cited as follows: (1) Harvey and Kaneko, 1976a; (2) Magnani *et al.*, 1980; (3) Leng and Annison, 1962; (4) Harkness *et al.*, 1970; (5) Kim and McManus, 1971; (6) Laris, 1958; (7) Beutler, 1995a; (8) Coldman and Good, 1967; (9) Contreras *et al.*, 1986; (10) Tucker and Ellory, 1971; (11) Vacha, 1983; (12) Miseta *et al.*, 1993.

**TABLE 7-2** Erythrocyte Enzymes of Various Animal Species<sup>a</sup>

Enzyme	Human	Dog	Cat	Horse
HK	1.78 ± 0.38 (1)	0.92 ± 0.47 (2)	2.01 ± 0.35 (2)	1.45 ± 0.22 (2)
GPI	24.1 ± 1.0 (3)	16.3 ± 1.8 (3)	49.0 ± 8.3 (3)	27.3 ± 5.9 (3)
PFK	11.0 ± 2.3 (1)	9.7 ± 1.3 (2)	2.2 ± 0.7 (2)	8.7 ± 2.5 (2)
Aldolase	3.19 ± 0.86 (1)	2.36 ± 0.32 (4)		2.71 ± 0.98 (9)
TPI	2111 ± 397 (1)	436 ± 70 (4)		
GAPD	226 ± 42 (1)	54.4 ± 2.8 (4)	59.0 (6)	57.2 ± 14.2 (9)
PGK	320 ± 36 (1)	89.6 ± 9.4 (4)	29.2 (6)	69.1 ± 19.8 (9)
MPGM	37.7 ± 5.6 (1)	4.04 ± 1.19 (4)	6.35 (6)	5.7 (6)
Enolase	5.39 ± 0.83 (1)	0.84 ± 0.16 (4)		13.6 ± 3.9 (9)
PK	15.0 ± 2.0 (1)	8.4 ± 2.0 (2)	24.5 ± 7.2 (2)	1.7 ± 0.8 (2)
LDH	200 ± 26 (1)	52.2 ± 5.0 (4)	15.1 ± 2.2 (8)	32.3 ± 3.6 (9)
AST	3.02 ± 0.67 (1)	3.14 ± 1.10 (2)		1.53 ± 0.27 (7)
DPGM	2.00 (6)	1.02 (6)	0.08 (6)	0.6 (6)
DPGP	0.021 (6)	0.010 (6)	0.005 (6)	0.006 (6)
G6PD	8.3 ± 1.6 (1)	11.3 ± 2.0 (2)	15.3 ± 3.2 (2)	18.6 ± 3.3 (2)
6PGD	8.78 ± 0.78 (1)	6.73 ± 1.30 (2)	6.88 ± 1.11 (2)	2.61 ± 0.68 (2)
GR (-FAD)	7.18 ± 1.09 (1)	3.60 ± 0.96 (2)	9.31 ± 2.31	2.69 ± 0.99 (2)
GR (+FAD)	10.40 ± 1.50 (1)	5.59 ± 1.05 (2)	20.31 ± 2.21	4.28 ± 1.31 (2)
GPx	31 ± 5 (1)	213 ± 82 (2)	330 ± 54 (2)	149 ± 62 (2)
GST	6.7 ± 1.8 (1)	3.2 ± 0.9 (2)	35.6 ± 8.5 (2)	6.4 ± 1.7 (2)
SOD	2352 (5)	2118 (5)	2885 (5)	
Catalase (×10 <sup>3</sup> )	153 ± 24 (1)	10 ± 2 (2)	161 ± 43 (2)	105 ± 21 (2)
Cb <sub>5</sub> R	19.2 ± 3.8 (1)	11.3 ± 1.6 (2)	9.8 ± 2.1 (2)	13.0 ± 3.0 (2)
NADPH-D	0.51 ± 0.12 (3)	0.33 ± 0.06 (3)	0.39 ± 0.06 (3)	0.70 ± 0.06 (3)
Na <sup>+</sup> , K <sup>+</sup> -ATPase	8 ± 2 (10)	nil (10)	nil (10)	5 ± 2 (10)

<sup>a</sup>All enzyme units are U/g Hb, except ATPase given in μmoles phosphorus liberated/g Hb/h. Mean values have been recalculated at times to permit direct comparisons between species. Standard deviation values are given where indicated. Abbreviations: HK, hexokinase; GPI, glucose phosphate isomerase; PFK, phosphofructokinase; TPI, triosephosphate isomerase; GAPD, glyceraldehyde-3-phosphate dehydrogenase; PGK, phosphoglycerate kinase; MPGM, monophosphoglycerate mutase; PK, pyruvate kinase; LDH, lactate dehydrogenase; AST, aspartate aminotransferase; DPGM, diphosphoglycerate mutase; DPGP, diphosphoglycerate phosphatase; G6PD, glucose-6-phosphate dehydrogenase; 6PGD, 6-phosphogluconate dehydrogenase; FAD, flavin adenine dinucleotide; GR (+FAD), glutathione reductase with FAD added to assay; GR (-FAD), glutathione reductase without FAD added to assay; GPx, glutathione peroxidase; GST, glutathione S-transferase; SOD, superoxide dismutase; Cb<sub>5</sub>R, cytochrome-b<sub>5</sub> reductase; NADPH-D, reduced nicotinamide adenine dinucleotide phosphate diaphorase; Na<sup>+</sup>-K<sup>+</sup>-ATPase, Na<sup>+</sup>-K<sup>+</sup>-adenosine triphosphatase. Temperatures above 25°C are included in reference citations. Figures in parentheses are the references cited as follows: (1) Beutler, 1984 (at 37°C, except Cb<sub>5</sub>R at 30°C); (2) Harvey et al., unpublished, 2007 (at 37°C, except Cb<sub>5</sub>R at 30°C); (3) Harvey and Kaneko, 1975a; (4) Maede and Inaba, 1987 (at 37°C); (5) Kurata et al., 1993; (6) Harkness et al., 1969; (7) Franken and Schotman, 1977; (8) Schechter et al., 1973; (9) Smith et al., 1972a; (10) Gupta et al., 1974 (at 44°C).

names. Electrophoretic patterns of membrane proteins on SDS-PAGE are species variable (Gillis and Anastassiadis, 1985; Kobylka *et al.*, 1972; Smith *et al.*, 1983a; Whitfield *et al.*, 1983).

### 1. Lipids

The lipid bilayer and associated transmembrane proteins chemically isolate and regulate the cell interior. The bilayer

consists of phospholipids arranged with hydrophobic hydrocarbon chains of fatty acids to the center of the bilayer and the polar ends of the molecules in contact with both intracellular and extracellular aqueous environments. Molecules of unesterified cholesterol are intercalated between fatty acid chains in molar concentrations approximately equal to the sum of the molar concentrations of phospholipids. Phospholipids are asymmetrically arranged, with anionic amino-containing phospholipids (phosphatidylserine and

**TABLE 7-3** Erythrocyte Enzymes of Various Animal Species<sup>a</sup>

Enzyme	Cattle	Sheep	Goat	Pig
HK	0.36 ± 0.14 (1)	0.58 ± 0.07 (3)	0.52 ± 0.15 (4)	0.18 ± 0.12 (5)
GPI	17.0 ± 1.0 (1)	19.8 ± 2.6 (3)	79.1 ± 8.5 (4)	90.9 ± 16.3 (5)
PFK	2.43 ± 1.26 (1)	1.53 ± 0.14 (3)	2.33 ± 0.46 (4)	1.23 ± 0.85 (5)
Aldolase	1.46 (2)	1.28 ± 0.13 (3)	1.44 ± 0.71 (4)	0.78 ± 0.67 (5)
TPI		300 ± 17 (3)	589 ± 122 (4)	719 ± 211 (5)
GAPD	43.3 (2)	57.2 ± 5.2 (3)	73.7 ± 10.2 (4)	40.6 (5)
PGK	16.2 ± 7.3 (1)	49.6 ± 2.6 (3)	87.8 ± 18.3 (4)	94.2 ± 63.7 (5)
MPGM	10.0 ± 4.5 (1)	18.7 ± 1.5 (3)	19.3 ± 6.7 (4)	27.3 ± 12.6 (5)
Enolase	3.15 ± 0.98 (1)	8.15 ± 0.51 (3)	13.9 ± 2.0 (4)	8.58 ± 6.45 (5)
PK	5.72 ± 1.13 (1)	2.82 ± 0.22 (3)	5.00 ± 1.23 (4)	12.5 ± 4.8 (5)
LDH	23 (2)	33.6 ± 3.5 (3)	17.5 ± 3.05 (4)	28.7 ± 5.9 (5)
DPGM	0.42 (6)		0.04 (6)	0.58 (6)
DPGP	0.03 (6)		0.01 (6)	0.01 (6)
G6PD	5.40 ± 0.49 (1)	0.76 ± 0.13 (3)	2.06 ± 0.46 (4)	17.3 ± 1.2 (5)
6PGD	0.84 ± 0.19 (1)		0.58 ± 0.24 (4)	3.3 ± 1.4 (5)
GR	0.69 ± 0.47 (7)	2.60 ± 0.22 (3)	3.87 ± 1.57 (4)	2.6 ± 0.8 (7)
GPx	165 (8)	164 ± 21 (3)	179 ± 55 (4)	
GST	4.7 ± 0.5 (9)	7.8 ± 1.0 (9)	8.0 (13)	1.4 ± 0.2 (9)
SOD	2060 ± 75 (10)	1910 ± 100 (10)		1240 ± 100 (10)
Catalase (×10 <sup>3</sup> )	81 (8)	16.6 ± 1.5 (12)		
Cb <sub>5</sub> R	1.83 ± 0.24 (1)	2.00 ± 0.12 (3)		
Na <sup>+</sup> , K <sup>+</sup> -ATPase	nil (11)	HK <sup>+</sup> , 3 ± 1 (11) LK <sup>+</sup> , nil		10 ± 2 (11)

<sup>a</sup>All enzyme units are U/g Hb, except ATPase given in μmoles phosphorus liberated/g Hb/h. Mean values have been recalculated at times to permit direct comparisons between species. Standard deviation values are given where indicated. Abbreviations: HK, hexokinase; GPI, glucose phosphate isomerase; PFK, phosphofructokinase; TPI, triosephosphate isomerase; GAPD, glyceraldehyde-3-phosphate dehydrogenase; PGK, phosphoglycerate kinase; MPGM, monophosphoglycerate mutase; PK, pyruvate kinase; LDH, lactate dehydrogenase; AST, aspartate aminotransferase; DPGM, diphosphoglycerate mutase; DPGP, diphosphoglycerate phosphatase; G6PD, glucose-6-phosphate dehydrogenase; 6PGD, 6-phosphogluconate dehydrogenase; FAD, flavin adenine dinucleotide; GR, glutathione reductase; GPx, glutathione peroxidase; GST, glutathione S-transferase; SOD, superoxide dismutase; Cb<sub>5</sub>R, cytochrome-b<sub>5</sub> reductase; Na<sup>+</sup>-K<sup>+</sup>-ATPase, Na<sup>+</sup>-K<sup>+</sup>-adenosine triphosphatase. Temperatures above 25°C are included in reference citations. Figures in parentheses are the references cited as follows: (1) Zinkl and Kaneko, 1973b; (2) Smith et al., 1972b; (3) Agar and Smith, 1973; (4) Agar and Smith, 1974; (5) McManus, 1967; (6) Harkness et al., 1969; (7) Agar et al., 1974a; (8) Kurata et al., 1993; (9) Del Boccio et al., 1986; (10) Maral et al., 1977; (11) Gupta et al., 1974 (at 44°C); (12) Suzuki and Agar, 1983; (13) Board and Agar, 1983.

most of the phosphatidylethanolamine) located in the inner layer or leaflet of the bilaminar membrane. After uptake from plasma, these phospholipids are shuttled (flipped) from the outer leaflet to the inner leaflet by an ATP-dependent aminophospholipid-specific translocase or flippase (Zwaal *et al.*, 1993). Most of the cationic choline-containing phospholipids, phosphatidylcholine (lecithin) and sphingomyelin, are located in the outer layer (Delaunay, 2007). These choline-containing phospholipids are readily exchangeable with plasma phospholipids, whereas the aminophospholipids are not (Reed, 1968). RBCs also contain a Ca<sup>+2</sup>-dependent

phospholipid scramblase that is activated by a protein kinase C catalyzed phosphorylation. This scramblase accelerates the bidirectional transbilayer movement of phospholipids. The inhibition of the flippase or the activation of the scramblase can result in increased phosphatidylserine in the outer layer, which promotes coagulation and erythrophagocytosis (Delaunay, 2007; Mandal *et al.*, 2005).

Species vary in RBC membrane phospholipid compositions (Garnier *et al.*, 1984; Nelson, 1967; Wessels and Veerkamp, 1973). Cattle, sheep, and goat RBCs are unique in that their membranes contain little or no phosphatidylcholine

**TABLE 7-4** Erythrocyte Chemical Constituents of Various Species<sup>a</sup>

Analyte	Human	Dog	Cat	Horse
G6P	27.8 ± 7.5 (1)	17.1 ± 1.8 (3)		9.1 ± 2.6 (4)
F6P	9.3 ± 2.0 (1)	5.4 ± 0.5 (3)		3.5 ± 1.1 (4)
FDP	1.9 ± 0.6 (1)	1.4 ± 0.2 (3)		3.9 ± 1.8 (4)
DHAP	9.4 ± 2.8 (1)	6.7 ± 1.0 (3)		7.8 ± 4.5 (4)
3PG	44.9 ± 5.1 (1)	48.8 ± 4.2 (3)		22.4 ± 6.6 (4)
2PG	7.3 ± 2.5 (1)	17.6 ± 4.6 (3)		24.4 ± 4.5 (4)
PEP	12.2 ± 2.2 (1)	20.7 ± 4.1 (3)		5.3 ± 1.3 (4)
Pyruvate	53 ± 22 (1)	24 ± 9 (6)		
Lactate	932 ± 211 (1)	940 ± 517 (6)		600 ± 100 (8)
AMP	21.2 ± 3.4 (1)	35 ± 6 (3)		2.3 ± 1.3 (4)
ADP	216 ± 36 (1)	211 ± 50 (3)	82 (5)	16 ± 3 (4)
ATP	1438 ± 99 (1)	639 ± 140 (2)	529 ± 176 (2)	370 ± 74 (2)
2,3DPG	4171 ± 636 (1)	5989 ± 632 (2)	874 ± 317 (2)	6220 ± 1071 (2)
Pi	480 (5)	350 (5)	260 (5)	210 (5)
GSH	2234 ± 354 (1)	2027 ± 346 (2)	2117 ± 272 (2)	2455 ± 372 (2)
GSSG	4.2 ± 1.5 (1)	6.9 ± 1.7 (7)		

<sup>a</sup> Given in nmole/ml RBC, except lactate and pyruvate, which are given in nmole/ml whole blood. Mean values have been recalculated at times to permit direct comparisons between species. Standard deviation values are given where indicated. Abbreviations: G6P, glucose 6-phosphate; F6P, fructose 6-phosphate; FDP, fructose 1,6-diphosphate; DHAP, dihydroxyacetone phosphate; 3PG, 3-phosphoglycerate; 2PG, 2-phosphoglycerate; PEP, phosphoenolpyruvate; AMP, adenosine monophosphate; ADP, adenosine diphosphate; ATP, adenosine triphosphate; 2,3-DPG, 2,3-diphosphoglycerate; P<sub>i</sub>, inorganic phosphate; GSH, reduced glutathione; GSSG, oxidized glutathione. Figures in parentheses are the references cited as follows: (1) Beutler, 1984; (2) Harvey et al., unpublished, 2007 (using methods of Beutler, 1984); (3) Harvey et al., 1992b; (4) Smith and Agar, 1976; (5) Harkness et al., 1969; (6) Maede and Inaba, 1987; (7) Maede et al., 1982; (8) Snow and Martin, 1990.

and high sphingomyelin levels (Nouri-Sorkhabi *et al.*, 1996). Another anomaly recognized in bovine RBCs is an extreme asymmetry of phosphatidylethanolamine, with only 2% of the total present in the outer leaflet (Florin-Christensen *et al.*, 2001). Although RBC cholesterol/phospholipid ratios remain relatively constant, differences occur in membrane phospholipid composition between neonate and adult RBCs (Marin *et al.*, 1990).

A small amount of glycolipid is also located in the outer layer. Species differ in the dominant glycolipids of RBCs (Eberlein and Gercken, 1971; Yamakawa, 1983). Based on studies of human blood group antigens, it is assumed that many animal blood group antigens are also glycolipids and that specificity resides in the carbohydrate moieties.

## 2. Integral Membrane Proteins

Integral membrane proteins penetrate the lipid bilayer. These glycoproteins express carbohydrate residues on the outside surface of the cell. They contribute negative charge to the cell surface, function as receptors or transport

proteins, and carry RBC antigens (Chasis and Mohandas, 1992; Mohandas and Chasis, 1993; Schrier, 1985). Band 3 (anion exchanger 1) is the major integral protein. It accounts for approximately one-fourth of the total membrane protein, with about 10<sup>6</sup> copies/RBC (Delaunay, 2007; Schrier, 1985). It is important as an anion transporter and provides a site for binding of the cytoskeleton internally. Additional transmembrane glycoproteins called glycoporphins also help anchor and stabilize the cytoskeleton (Chasis and Mohandas, 1992).

## 3. Membrane Skeletal Proteins

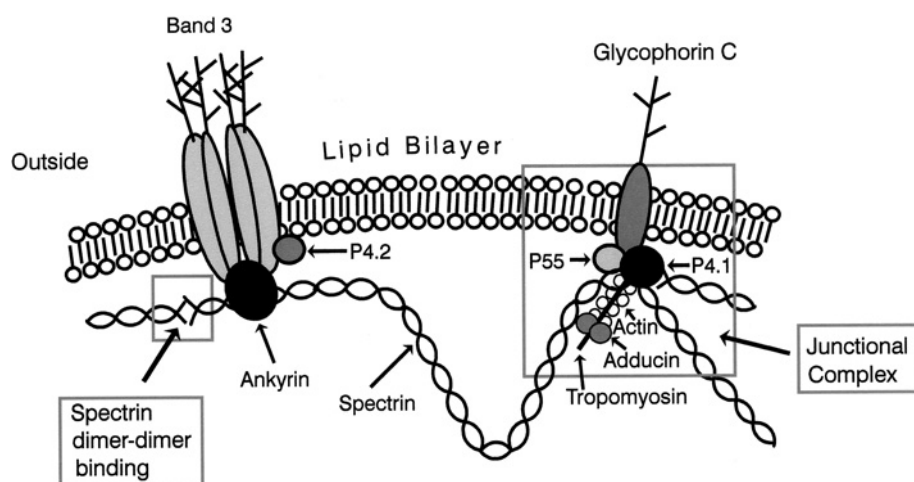
The membrane skeleton appears as a dense sweater-like meshwork bound to the inner surface of the lipid bilayer. It is a major determining factor of membrane shape, deformability, and durability (Mohandas and Chasis, 1993). A simplified cross section of the RBC membrane is shown in Figure 7-3. Spectrin is a heterodimer of long, flexible alpha and beta chains twisted around one another. Heterodimers are bound together by self-association at their head ends



**TABLE 7.5** Erythrocyte Chemical Constituents of Various Species<sup>a</sup>

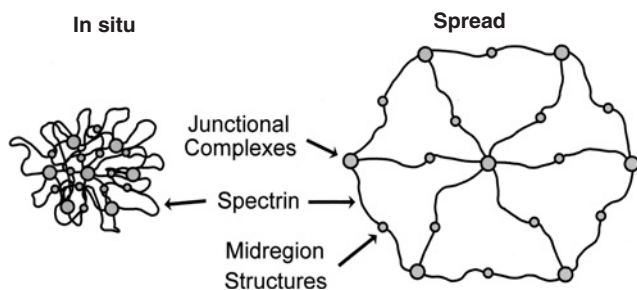
Analyte	Cattle	Sheep	Goat	Pig
G6P	52 ± 15 (1)	28 ± 10 (2)	3.2 ± 0.8 (3)	11 (4)
F6P	28 ± 11 (1)	11 ± 2 (2)	1.2 ± 0.7 (3)	4.5 (4)
FDP	16 ± 12 (1)	25 ± 10 (2)		2 (4)
DHAP	35 ± 11 (1)	10 ± 3 (2)	1.0 ± 0.5 (3)	1 (4)
3PG	32 ± 12 (1)	11 ± 21 (2)		53 (4)
2PG	9 ± 4 (1)	14 ± 10 (2)		12 (4)
PEP	19 ± 7 (1)	19 ± 14 (2)	1.0 ± 0.4 (3)	8 (4)
Pyruvate	54 ± 24 (1)	87 ± 21 (2)		22 (4)
Lactate	1989 ± 758 (1)	1623 ± 1203 (2)		14,800 (4)
AMP		40 ± 23 (2)	8 ± 2 (3)	250 (4)
ADP	73 ± 22 (1)	138 ± 31 (2)	17 ± 4 (3)	500 (4)
ATP	633 ± 115 (1)	532 ± 126 (8)	363 ± 52 (3)	1670 (4)
2,3DPG	289 (5)	21 ± 16 (8)	59 ± 28 (3)	9500 (4)
Pi	400 (6)	666 ± 206 (9)	850 (6)	870 (6)
GSH	2490 ± 350 (7)	2257 ± 130 (10)	2500 ± 360 (7)	
GSSG		<5 (10)		

<sup>a</sup> Given in nmole/ml RBC, except lactate and pyruvate, which are given in nmole/ml whole blood. Mean values have been recalculated at times to permit direct comparisons between species. Standard deviation values are given where indicated. Abbreviations: G6P, glucose 6-phosphate; F6P, fructose 6-phosphate; FDP, fructose 1,6-diphosphate; DHAP, dihydroxyacetone phosphate; 3PG, 3-phosphoglycerate; 2PG, 2-phosphoglycerate; PEP, phosphoenolpyruvate; AMP, adenosine monophosphate; ADP, adenosine diphosphate; ATP, adenosine triphosphate; 2,3-DPG, 2,3-diphosphoglycerate; Pi, inorganic phosphate; GSH, reduced glutathione; GSSG, oxidized glutathione. Figures in parentheses are the references cited as follows: (1) Zinkl and Kaneko, 1973b; (2) Noble et al., 1983; (3) Agar and Smith, 1974; (4) Magnani et al., 1983; (5) Agar et al., 1983; (6) Harkness et al., 1969; (7) Agar et al., 1974a; (8) Travis et al., 1985; (9) Battaglia et al., 1970; (10) Srivastava and Beutler, 1969.

**FIGURE 7-3** Schematic model of the organization of the RBC membrane skeleton.

to form tetramers. Multiple spectrin tail ends (an average of six) are joined together by binding to common short filaments of actin and a variety of other proteins, including tropomyosin and adducin, to form an anastomosed meshwork of polygons (Fig. 7-4). These junctional complexes with actin are stabilized by other proteins, including

protein 4.1 and protein 55. Protein 4.1 binds the meshwork to one or more integral membrane glycoproteins (Delaunay, 2007). The meshwork is also bound to transmembrane band 3 by ankyrin in regions of spectrin self-association, and protein 4.2 may strengthen the ankyrin to band 3 linkage (Mohandas and Chasis, 1993; Rybicki *et al.*, 1996).



**FIGURE 7-4** Schematic model of a hexagon of condensed and fully extended (spread) cytoskeletal meshwork. Spectrin dimer-dimer interactions and binding to band 3 occur in the midregions. See Figure 7-3 for components of junctional complexes.

Band 4.2 has not been demonstrated in some species including horses (Guerra-Shinohara and Barretto, 1999).

The cytoskeletal meshwork assumes a condensed configuration in nondeformed discocytes, with spectrin tetramer fibers existing in folded or coiled states (Fig. 7-4). When fully extended (accomplished by removal of lipid from the membrane), the cytoskeleton meshwork extends over an area several times the normal RBC surface area (Liu and Derick, 1992; Palek and Sahr, 1992). Because of the spectrin structure, membrane skeletons have extensional elasticity and can be stretched more than twice the normal RBC diameter without rupture.

## B. Shape and Deformability

The normal biconcave shape of most mammalian RBCs (discocytes) represents the resting unstressed geometry of the cell. The biconcave shape results in a large surface area-to-volume ratio compared to that of a sphere, allowing RBCs to undergo marked deformation while maintaining a constant surface area (Lenard, 1974). This is important because an increase of 3% to 4% of surface area results in cell lysis (Mohandas and Chasis, 1993).

The RBC spends little time in a discoid shape in the microcirculation. Except for goats, RBCs from domestic animals have diameters (Jain, 1986) greater than those of capillaries (approximately  $4\ \mu\text{m}$ ) (Henquell *et al.*, 1976; Sobin and Tremer, 1972); consequently, they must be deformable to flow through capillaries. RBCs must pass through even smaller spaces in the sinus wall of the spleen (Chen and Weiss, 1973). The biconcave shape is generally more pronounced in species with larger RBCs (Harvey, 2001), presumably because the degree of deformation required to flow through capillaries is greater. RBC deformability also reduces bulk viscosity of blood in large vessels (Smith, 1991).

RBC deformability is a function of surface-to-volume ratio, viscosity of intracellular contents (determined primarily by intracellular Hb concentration), and viscoelastic properties of the membrane (Mohandas and Chasis, 1993).

RBC shape and viscoelastic properties result from interactions between the fluid lipid bilayer and the underlying cytoskeleton, which stabilizes the lipid bilayer and provides both rigid support and elasticity. Membrane lipid fluidity varies with the cholesterol composition, concentration of phospholipids present, and the degree of saturation of fatty acids and length of acyl chains (Yawata *et al.*, 1984). Comparisons of RBC deformability among various animal species using ektacytometry have been reported (Smith *et al.*, 1979). Large RBCs are generally more deformable than small ones. RBCs from species in the family Camelidae are flat, thin, and not deformable; they apparently flow through vessels by orienting to the direction of flow.

In addition to mechanically induced deformations, a wide variety of chemical perturbations, genetic defects, and oxidative injury can result in shape changes (Mohandas and Chasis, 1993; Smith, 1987). Small changes in the surface areas of the inner or outer lipid monolayers can result in transformations of discocytes into echinocytes or stomatocytes. Biochemical abnormalities associated with certain RBC shape abnormalities follow in this text. Consult a reference text for additional information about these and other RBC shape abnormalities (Harvey, 2001).

### 1. Echinocytes

Echinocytes are spiculated RBCs in which the spicules are relatively evenly spaced and of similar size. When observed in stained blood films, echinocytosis is usually an artifact that results from excess EDTA, improper smear preparation, or prolonged sample storage before blood film preparation. Echinocytes form when the surface area of the outer lipid monolayer increases relative to the inner monolayer. Echinocytic transformation occurs in the presence of fatty acids, lysophospholipids, and amphiphatic drugs that distribute preferentially in the outer half of the lipid bilayer (Mohandas and Chasis, 1993; Smith, 1987). Transient echinocytosis occurs in horses with *Clostridium perfringens* infection and in dogs following coral snake (Marks *et al.*, 1990) and rattlesnake (Brown *et al.*, 1994a; Hackett *et al.*, 2002) envenomation, presumably secondary to the action of phospholipases present in venom (Walton *et al.*, 1997). Echinocytes also form when RBCs are dehydrated (Weiss and Geor, 1993), pH is increased, intracellular calcium is increased (Smith, 1987), and RBC ATP is depleted (Backman *et al.*, 1998; Jacob *et al.*, 1973). Echinocytes are the predominant RBC shape abnormality in human burn patients (Harris *et al.*, 1981).

Echinocytosis occurs in horses in which total body depletion of cations has occurred. Increased numbers have been reported in horses during endurance exercise (Boucher *et al.*, 1981), following furosemide-induced electrolyte depletion (Weiss *et al.*, 1992b), and in ill horses with systemic electrolyte depletion and hyponatremia (Geor *et al.*, 1993).

Echinocyte formation in sheep RBCs after ATP-depletion has been attributed to the degradation of membrane phosphoinositides (Backman *et al.*, 1998). Echinocytes and other shape abnormalities have been recognized in dogs with RBC pyruvate kinase deficiency, which results in a decreased ability to generate ATP (Chandler *et al.*, 1975; Muller-Soyano *et al.*, 1986; Schaer *et al.*, 1992).

Although the mechanism(s) is unknown, ATP is required for maintenance of normal shape and deformability of RBCs (Jacob *et al.*, 1973). Because ATP concentrations must be depleted for a number of hours to demonstrate changes in shape and deformability *in vitro*, the concentration does not directly control these properties; rather, the processes occurring secondary to ATP depletion alter the shapes of cells (Feo and Mohandas, 1977).

ATP is required for a number of reactions involving the RBC membrane (Cohen and Gascard, 1992). It is used as the phosphoryl donor in a wide variety of phosphorylation reactions involving membrane proteins and for the phosphorylation of membrane phosphoinositides. It provides the energy needed to pump  $\text{Ca}^{+2}$  out of cells. Increased  $\text{Ca}^{+2}$  activates neutral proteases (calpains), which can degrade membrane skeletal proteins, and phospholipase C, which cleaves phosphoinositides. ATP is required for the transport of aminophospholipids to the inner half of the lipid bilayer, presumably assisting in the maintenance of the asymmetry of membrane phospholipids. The relative importance of each of these ATP-dependent reactions to the maintenance of RBC shape and deformability remains to be determined (Cohen and Gascard, 1992).

## 2. Acanthocytes

Acanthocytes (spur cells) are RBCs with irregularly spaced, variably sized spicules. They can form when RBC membranes contain excess cholesterol compared to phospholipids. If cholesterol and phospholipids are increased to a similar degree, codocyte formation is more likely than acanthocyte formation (Cooper *et al.*, 1972). Alterations in RBC membrane lipids can result from increased blood cholesterol content (Cooper *et al.*, 1980) or the presence of abnormal plasma lipoprotein composition (Ulibarrena *et al.*, 1994). Another possible contributing factor is the defective repair (acylation of lysophospholipids) of oxidant-damaged RBC phospholipids reported in human patients with cirrhosis and acanthocytosis (Allen and Manning, 1994). Acanthocytes have been recognized in animals with liver disease, possibly because of alterations in plasma lipid composition, which can alter RBC lipid composition (Christopher and Lee, 1994; Shull *et al.*, 1978). They have also been reported in dogs with disorders such as hemangiosarcoma and disseminated intravascular coagulation that result in RBC fragmentation (Weiss *et al.*, 1993).

Marked acanthocytosis is reported to occur in young goats (Holman and Drew, 1964) and some young cattle (McGillivray

*et al.*, 1985; Sato and Mizuno, 1982). Acanthocytosis of young goats has been attributed to the presence of HbC at this early stage of development (Jain *et al.*, 1980).

Acanthocytosis in blood is associated with a heterogeneous group of inherited neurodegenerative disorders in humans (neuroacanthocytosis), resulting in defects of at least four different proteins (Stevenson and Hardie, 2001). Deficient proteins appear to be important in membranes of neural or muscular tissues in addition to RBCs.

## 3. Stomatocytes

Cup-shaped RBCs that have oval or elongated areas of central pallor when viewed in stained blood films are called stomatocytes. They most often occur as artifacts in thick blood film preparations. Stomatocytes form when pH is decreased (Gedde *et al.*, 1997) and when amphiphatic drugs are present that distribute preferentially in the inner half of the lipid bilayer (Smith, 1987; Suwalsky *et al.*, 1999, 2000). Stomatocytes also form when RBC water content is increased, as occurs in hereditary stomatocytosis in dogs (Giger *et al.*, 1988a; Paltrinieri *et al.*, 2007; Pinkerton *et al.*, 1974; Slappendel *et al.*, 1994).

## 4. Eccentrocytes

Eccentrocytes are RBCs in which the Hb is localized to part of the cell, leaving an Hb-poor area visible in the remaining part of the cell. Other terms used to refer to eccentrocytes include hemighosts, irregularly contracted cells, double-colored cells, and cross-bonded RBCs (Arese and De Flora, 1990; Chan *et al.*, 1982). They are formed by the adhesion of opposing areas of the cytoplasmic face of the RBC membrane (Fischer, 1986). Denatured spectrin is believed to be of primary importance in the cross bonding of membranes (Arese and De Flora, 1990; Fischer, 1988). Eccentrocytes that have become spherical with only a small tag of cytoplasm remaining may be called pyknotocytes. Eccentrocytes have been seen in animals ingesting or receiving oxidants (Caldin *et al.*, 2005; Harvey, 2001; Harvey *et al.*, 1986; Harvey and Rackear, 1985; Lee *et al.*, 2000; Reagan *et al.*, 1994) and in horses with severe burns (Norman *et al.*, 2005). Eccentrocytes have also been seen in horses with glucose-6-phosphate dehydrogenase (G6PD) deficiency (Stockham *et al.*, 1994) and glutathione reductase deficiency secondary to RBC flavin adenine dinucleotide (FAD) deficiency (Harvey *et al.*, 2003). Both of these disorders decreased the ability of RBCs to protect against endogenous oxidants.

## 5. Spherocytes and Elliptocytes

Defects in ankyrin, band 3, protein 4.2, and certain defects in  $\alpha$ -spectrin and  $\beta$ -spectrin result in hereditary spherocytosis in mice and humans (Delaunay, 2007). A complete

absence of band 3 results in hereditary spherocytosis in Japanese black cattle (Ban *et al.*, 1995; Inaba *et al.*, 1996). Hereditary spherocytosis has been reported in golden retriever dogs with reductions in RBC membrane spectrin (Slappendel, 1998). RBCs from these dogs exhibited increased osmotic fragility, but spherocytes were not recognized in stained blood films (Slappendel *et al.*, 2005).

Hereditary elliptocytosis occurs with certain defects in  $\alpha$ -spectrin,  $\beta$ -spectrin, band 3, and protein 4.1 deficiency in humans (Bruce, 2006; Delaunay, 2007). Hereditary elliptocytosis has been reported in a dog with protein 4.1 deficiency (Smith *et al.*, 1983a) and in a dog with mutant  $\beta$ -spectrin (Di Terlizzi *et al.*, 2007).

### C. Blood Group Isoantigens

Large numbers of protein and complex carbohydrate antigens occur on the external surface of RBCs. Some antigens are present on RBCs from all members of a species, and others (including blood group isoantigens) segregate genetically, appearing in some but not all members of a species. Blood group isoantigens are detected serologically on the surface of RBCs using agglutination or hemolysis tests. With detailed genetic studies, these isoantigens can be placed into blood groups (RBC isoantigen systems). Blood groups have individual chromosomal loci, and each locus has from two to many allelic genes. Most blood groups (such as the ABO system in humans) derive their antigenicity from the carbohydrate composition of membrane-associated glycolipids and glycoproteins. The amino acid sequence of membrane proteins accounts for the antigenic determinants in other blood groups, such as the complex Rh system in humans (Agre and Cartron, 1991). Most isoantigens are produced by erythroid cells, but some, such as the J group in cattle, the DEA-7 (Tr) group in dogs, the R group in sheep, and the A and O groups in pigs, are produced by other tissues and adsorbed from plasma (Andrews, 2000; Penedo, 2000).

Blood groups in domestic animals have been reviewed (Andrews, 2000; Bowling, 2000; Penedo, 2000). They have been most extensively characterized in horses and cattle, in which blood typing was routinely used for animal identification and parentage testing. Blood typing for these purposes is being phased out in favor of assays based on DNA sequence.

#### 1. Blood Group Isoantigens of Clinical Significance

Isoantigens vary in their potential to cause transfusion reactions when mismatched blood is given. Many isoantigens are weak (do not induce antibodies of high titer) or induce antibodies that do not act at normal body temperature. Fortunately only a few isoantigens appear to be

important in producing hemolytic disease in animals. More than 13 canine blood groups have been described. DEA 1.1 antibody-antigen interactions result in most of the acute hemolytic transfusion reactions in dogs (Andrews, 2000), but transfusion reactions have been reported against DEA 1.2 (Hale, 1995), DEA 4 (Melzer *et al.*, 2003), and an unclassified common antigen (Callan *et al.*, 1995) on dog RBCs. A new blood type termed *Dal* has been reported in a low percentage of Dalmatian dogs (Blais *et al.*, 2007). Dalmatians lacking the *Dal* antigen develop alloantibodies after being transfused with *Dal*-positive RBCs. Sensitized animals are likely at risk for delayed or acute hemolytic reactions when transfused again with *Dal*-positive RBCs.

Incompatibilities in the AB blood group of cats have been recognized to cause transfusion reactions and neonatal isoerythrolysis (Auer and Bell, 1983; Giger and Akol, 1990; Giger and Bücheler, 1991; Hubler *et al.*, 1987). The A and B isoantigens (blood types) result from the action of two different alleles at the same gene locus, with A being dominant over B (Andrews, 2000). Type A cat RBCs have glycolipids with terminal N-glycolyneuraminic acid (NeuGc) on their surface, whereas type B cat RBCs have glycolipids with terminal N-acetylneuraminic acid (NeuAc) on their surface (Andrews *et al.*, 1992). Because the enzyme CMP-N-acetylneuraminic hydroxylase converts NeuAc to NeuGc, it has been proposed that type B cats lack this enzyme. Cats rarely express both type A and type B antigens (type AB) on RBCs. The frequency of blood types varies with location and breed of cat. From 0.3% (northeast) to 4.7% (west coast) of domestic short- and long-hair cats in the United States are type B, but up to 50% of purebred cats in certain breeds in the United States are type B (Andrews, 2000). In contrast to the low prevalence of type B in mixed-breed cats in the United States, about one-third of the mixed-breed cats in Australia are type B (Malik *et al.*, 2005). A new blood group antigen, termed *Mik*, has been reported in domestic shorthair cats that is capable of inducing a hemolytic transfusion reaction when *Mik*-positive RBCs are transfused into a *Mik*-negative recipient cat that has naturally occurring anti-*Mik* alloantibodies in its plasma (Weinstein *et al.*, 2007).

Horse RBC isoantigens are recognized to occur at seven blood group loci. The frequency of expression of RBC isoantigens varies by breed of horse (Bowling, 2000). Historically, Aa and Qa have been the most common antigens associated with neonatal isoerythrolysis in foals. Mares negative for one of these antigens develop antibodies against them and transfer these antibodies to their foals through colostrum. Hemolysis occurs when the foal inherits the respective antigen from the sire (Bowling, 2000). Other isoantigens associated with neonatal isoerythrolysis in foals include Db, Dg, Pa, Qb, Qc, and a combination of Qa, Qb, and Qc (Boyle *et al.*, 2005; MacLeay, 2001). Neonatal isoerythrolysis has been reported in mule foals because of an RBC antigen not found in horses but present in some donkeys and mules (Boyle *et al.*, 2005; McClure *et al.*, 1994).

Pig RBC isoantigens are recognized to occur in 16 blood groups numbered A to P (Penedo, 2000). A-negative pigs exhibit intravascular hemolysis when transfused with A-positive blood. Neonatal isoerythrolysis has been recognized in pigs, with antibodies usually directed against isoantigens of the E blood group (Tizard, 2000).

Naturally occurring neonatal isoerythrolysis has not been reported in cattle, but it occurs in some calves born to cows previously vaccinated for anaplasmosis or other bovine origin vaccines containing RBC membranes (Dimmock and Bell, 1970; Luther *et al.*, 1985). Several blood group isoantigens have been incriminated, but the most important blood group isoantigens involved in this disorder are uncertain (Dimmock and Bell, 1970). Based on experimentally produced disease, the B isoantigen group appears to generate potent hemolysins (Dimmock *et al.*, 1976).

## 2. Natural Antibodies

Some blood group systems, such as the ABO group in humans, the AB group and *Mik* group in cats, and the A group in pigs, are characterized by “naturally occurring” antibodies (i.e., antibodies occur in plasma in the absence of prior exposure to blood from another individual) (Tizard, 2000; Weinstein *et al.*, 2007). In other blood groups, such as the Rh system in humans and most blood groups in animals, antibody formation results from prior exposure to different RBC isoantigens via transfusion, pregnancy, or vaccination with products containing blood group antigens (Stormont, 1982). Fortunately, naturally occurring antibodies of clinical significance seldom occur in animals; consequently, adverse transfusion reactions to unmatched RBCs generally do not occur at the time of the first blood transfusion. However, exceptions may occur as in the case of the AB group in cats where B-positive cats have naturally occurring anti-A antibodies with high hemolytic titer (Bücheler and Giger, 1993).

## D. Membrane Transport

The lipid bilayer is impermeable to most molecules. Consequently, various membrane protein transport systems are utilized for movement of molecules into and out of RBCs.

### 1. Anions and Water

Water and CO<sub>2</sub> are transported across RBC membranes using water channels called aquaporins (Endeward *et al.*, 2006; Kuchel and Benga, 2005). Band 3 appears to function as a channel for the movement of anions, especially bicarbonate and chloride, certain nonelectrolytes, and probably cations to some extent (Bruce, 2006; Solomon

*et al.*, 1983). Gruber and Deuticke studied phosphate as a model for anion exchange in RBCs from several species. There was a positive correlation between phosphate influx and the proportion of phosphatidylcholine in membrane phospholipids (Gruber and Deuticke, 1973).

### 2. Sodium and Potassium

Major interspecies, and in some cases intraspecies, differences occur in cation transport and subsequently in intracellular Na<sup>+</sup> and K<sup>+</sup> concentrations (Ellory and Tucker, 1983). There is a strong positive correlation between intracellular K<sup>+</sup>/Na<sup>+</sup> ratio and ATP concentration when RBCs of different species are compared. The cause of this relationship is unknown, but it is not related to differences in glucose utilization (Miseta *et al.*, 1993).

Like humans, those animal species with high intracellular K<sup>+</sup> concentrations, horse, pig, and some ruminants, have an active Na<sup>+</sup>,K<sup>+</sup>-pump that exchanges intracellular Na<sup>+</sup> for extracellular K<sup>+</sup> with the hydrolysis of ATP. This Na<sup>+</sup>,K<sup>+</sup>-activated ATPase activity is often used as a measure of Na<sup>+</sup>,K<sup>+</sup>-pump activity. In addition to individuals with high potassium (HK<sup>+</sup>) RBCs, some sheep, goats, buffalo, and most cattle have relatively low potassium (LK<sup>+</sup>), and consequently high sodium, RBCs. These LK<sup>+</sup> RBCs have low Na<sup>+</sup>,K<sup>+</sup>-pump activity and high passive K<sup>+</sup> permeability (i.e., high K<sup>+</sup>-Cl<sup>-</sup> cotransport) (Dunham and Blostein, 1997; Tosteson and Hoffman, 1960). Studies in sheep and goats have demonstrated that HK<sup>+</sup>/LK<sup>+</sup> polymorphism is determined by a single autosomal genetic locus with 2 alleles, the LK<sup>+</sup> allele being dominant (Tunon *et al.*, 1987; Xu *et al.*, 1994). In sheep, this polymorphism is associated with an M and L blood group antigen polymorphism. The HK<sup>+</sup> cells exhibit M antigens and the homozygous LK<sup>+</sup> cells exhibit L antigens, with heterozygous LK<sup>+</sup> sheep exhibiting M and L antigens. There are two classes of L antigen (Lp and Ll) that assort together. The Lp antigen inhibits the Na<sup>+</sup>,K<sup>+</sup>-pump, mainly by promoting nonspecific inhibition by intracellular K<sup>+</sup>. This antigen also modulates pump differentiation in immature cells. In contrast, the Ll antigen stimulates K<sup>+</sup>-Cl<sup>-</sup> cotransport (Dunham and Blostein, 1997).

RBCs from cats, ferrets, and most dogs do not have Na<sup>+</sup>,K<sup>+</sup>-pump activity and have Na<sup>+</sup> and K<sup>+</sup> concentrations near, but not at, those predicted for the Donnan equilibrium with plasma (Mairbaur and Herth, 1996; Parker, 1977). Some clinically normal Japanese Akita dogs (Degen, 1987), mongrel dogs from Japan (Inaba and Maede, 1984), and Korean Jindo dogs (Yamato *et al.*, 1999) have HK<sup>+</sup> RBCs. RBCs from the HK<sup>+</sup> mongrel dogs have substantial Na<sup>+</sup>,K<sup>+</sup>-ATPase activity and altered amino acid metabolism which are discussed later. Dog, ferret, and bear RBCs have a unique Na<sup>+</sup>-Ca<sup>2+</sup> countertransport system that can remove sodium (Parker, 1992). The calcium that enters the cell is subsequently pumped out by an ATP-dependent calcium pump.

Other pathways of sodium and potassium transport occur to variable degrees in certain species. These pathways include passive diffusion,  $\text{Na}^+$ ,  $\text{K}^+$ ,  $\text{Cl}^-$  cotransport,  $\text{Na}^+ \times \text{Na}^+$  countertransport, band 3 anion transport as  $\text{NaCO}_3^-$ ,  $\text{Na}^+$ -dependent amino acid transport,  $\text{K}^+$ ,  $\text{Cl}^-$  cotransport,  $\text{Na}^+$ ,  $\text{H}^+$  exchange, and a calcium-dependent  $\text{K}^+$  channel (Contreras *et al.*, 1986; Ellory and Tucker, 1983; Haas, 1989; Maher and Kuchel, 2003). A negative linear correlation between internal sodium concentration and membrane protein-to-lipid ratio was found by comparison of RBC values from nine mammalian species, the significance of which is unknown (Garnier *et al.*, 1984).

RBC volumes influence cation fluxes. Sodium flux increases when cells are shrunken, and potassium flux increases when cells are swollen. The  $\text{Na}^+$ ,  $\text{K}^+$ ,  $\text{Cl}^-$  cotransport and  $\text{Na}^+$ - $\text{H}^+$  exchange are activated by cell shrinkage and  $\text{K}^+$ - $\text{Cl}^-$  cotransport is activated by cell swelling (Dunham, 2004; Haas, 1989; Mairbaurl and Herth, 1996). Volume changes are believed to be detected from alterations in cytoplasmic macromolecules (Parker, 1992).

Early nucleated erythroid precursors in dog bone marrow have  $\text{HK}^+$  content, whereas mature RBCs are of the  $\text{LK}^+$  type. The switch from  $\text{HK}^+$  to  $\text{LK}^+$  content occurs during the maturation from early to late nucleated erythroid cells (Kirk *et al.*, 1983). When erythropoiesis is dramatically stimulated in response to a hemolytic anemia, much of the  $\text{HK}^+$  to  $\text{LK}^+$  transition does not occur until after denucleation. Consequently, stress reticulocytes, produced in response to anemia, have potassium contents much higher than reticulocytes normally released into blood. The high potassium concentration in canine stress reticulocytes results from membrane  $\text{Na}^+$ ,  $\text{K}^+$ -ATPase activity that is lost during maturation into RBCs, possibly by ATP-dependent proteolysis (Inaba and Maede, 1986). Stress reticulocytes produced by  $\text{LK}^+$ -type ruminants (Israel *et al.*, 1972; Kim *et al.*, 1980; Tucker and Ellory, 1971) also have high potassium concentrations as a result of high  $\text{Na}^+$ ,  $\text{K}^+$ -ATPase activities (Blostein and Grafova, 1990). The decline in the number of  $\text{Na}^+$ ,  $\text{K}^+$  pumps on  $\text{LK}^+$  sheep reticulocytes during maturation is modulated by the Lp antigen (Xu *et al.*, 1994). Fetal and neonatal RBCs examined from mammals with  $\text{LK}^+$  RBCs have higher potassium concentrations than adult RBCs, but the difference in dogs was not as dramatic as that in ruminants (Coulter and Small, 1973; Ellory and Tucker, 1983).

### 3. Calcium

Excessive intracellular  $\text{Ca}^{+2}$  is deleterious to RBCs; consequently, they actively extrude  $\text{Ca}^{+2}$  using a calcium pump having  $\text{Ca}^{+2}$ -activated,  $\text{Mg}^{+2}$ -dependent ATPase activity. A calcium-binding protein called calmodulin activates the calcium pump (Bababunmi *et al.*, 1991; Hinds and Vincenzi, 1986). This pump, working in conjunction with

a  $\text{Na}^+$ - $\text{Ca}^{+2}$  countertransport system, appears to be important in RBC volume regulation in dogs (Parker, 1992).

### 4. Amino Acids

Amino acid transport in RBCs provides amino acids for synthesis of reduced glutathione (GSH). In addition, amino acid transporters may be responsible for efflux of amino acids during reticulocyte maturation (Tunnicliff, 1994).

Several amino acid transport systems have been recognized in mammalian RBCs, each with its own characteristic species distribution, ion requirements, and substrate specificity (Fincham *et al.*, 1987; Young, 1983). In addition, the band 3 anion transporter can transport glycine and some other amino acids (Fincham *et al.*, 1987). A  $\gamma$ + transport system that transports cationic amino acids has been described in human RBCs. This system is distinct from that of the  $\gamma + \text{L}$  system, which is a cationic amino acid transporter that also accepts neutral amino acids with high affinity in the presence of  $\text{Na}^+$  (Rojas and Deves, 1999). A  $\text{Na}^+$ -independent C amino acid transporter has been described in sheep whose optimal substrates are cationic amino acids and small neutral amino acids (Young, 1983). Sheep deficient in this transporter have low RBC GSH, because of impaired cysteine transport (Tucker *et al.*, 1981). A similar asc transport system occurs in most equine RBCs, and deficient horses are predisposed to GSH deficiency (Fincham *et al.*, 1987, 1988). A transport system for cationic amino acids in cat RBCs has been called the  $\text{Ly}^+$  system (Young, 1983). Dog and cat RBCs have a  $\text{Na}^+$ -dependent acidic amino acid transporter that optimally transports glutamate and aspartate. The transport of 1 glutamate into dog RBCs is accompanied by 2  $\text{Na}^+$  and by the countertransport of 1  $\text{K}^+$  and 1 anion (Sato *et al.*, 1994). A  $\text{Na}^+$ -dependent anionic amino acid transporter, termed *excitatory amino acid carrier 1* (EAAC1), has been reported in rat RBC membranes (Novak *et al.*, 2002).

### 5. Glucose

Species vary in their permeability to glucose, with human RBCs being very permeable and pig RBCs being poorly permeable (McManus, 1967). RBCs of other domestic animals appear to be intermediate between these extremes (Arai *et al.*, 1992; Bolis, 1973; Widdas, 1955). Facilitative glucose transporter 1 (GLUT-1) mediates the passive diffusion of glucose into RBCs (Jiang *et al.*, 2006). Glucose movement into RBCs is not regulated by insulin (Baldwin, 1993). RBCs from adult pigs lack a functional glucose transporter (Craik *et al.*, 1988) and, therefore, have limited ability to utilize glucose for energy (Kim and McManus, 1971; Magnani *et al.*, 1983). In contrast, RBCs from neonatal piglets and pig reticulocytes have the transporter (Craik *et al.*, 1988) and, consequently, exhibit substantial glucose transport (Kim and Luthra, 1977). A similar phenomenon

occurs in chickens, in which erythroid cells in bone marrow transport glucose, but circulating RBCs do not (Johnstone *et al.*, 1998). With the exception of cats, fetal and neonatal RBCs studied from humans and animals have higher glucose transport than RBCs from adults (Mooney and Young, 1978; Widdas, 1955).

#### 6. Adenine, Adenosine, and Inosine

RBC membranes from most animal species have a nucleoside transporter (Young, 1983). The adenosine transporter from human and pig RBCs migrates in the band 4.5 region on SDS-PAGE (Kwong *et al.*, 1986). Rabbit, pig, and human RBCs exhibit substantially more adenosine uptake than those of other species studied (Van Belle, 1969). RBCs from dogs exhibit more adenosine uptake than cats, goats, or cattle, and RBCs from horses and most sheep appear to be nearly impermeable to adenosine. A low percentage of sheep have RBCs with a high affinity nucleoside transport system with a broad specificity for both purine and pyrimidine nucleosides (Young, 1983). RBCs from most horses have a Na<sup>+</sup>-dependent hypoxanthine transporter. Although dog RBCs are permeable to adenosine, they are impermeable to inosine (Duhm, 1974). Dog and cat RBCs exhibit adenine uptake and incorporation into nucleotides, but values are much lower than those of human, rabbit, or rodent RBCs (Lalanne and Willemot, 1980).

### E. Metabolism of Adenine Nucleotides

Adenine nucleotides in RBCs contain adenine, ribose, and one or more phosphate groups. Mature RBCs cannot synthesize adenine nucleotides *de novo* but can produce these compounds utilizing so-called salvage pathways (Brewer, 1974; Eaton and Brewer, 1974). AMP can be synthesized from adenine or from adenosine, both of which may be supplied to RBCs as they pass through the liver. One molecule of ATP interacts with one molecule of AMP to generate two molecules of ADP in the adenylate kinase reaction. ATP is generated from ADP in glycolysis.

AMP is synthesized from adenine and phosphoribosyl pyrophosphate (PRPP), utilizing the adenine phosphoribosyltransferase enzyme. Adenine is converted to ATP at a slower rate in dog and cat RBCs than in those of humans, rodents, or rabbits (Lalanne and Willemot, 1980). AMP degradation to inosine monophosphate and ammonia is catalyzed by AMP-deaminase. The activity of this enzyme is generally lower in mammalian RBCs compared to nucleated RBCs from birds, reptiles, amphibians, and fish (Kruckeberg and Chilson, 1973).

Adenosine can be phosphorylated to AMP using ATP in the adenosine kinase reaction. A competing reaction, adenosine deaminase, converts adenosine to inosine, which cannot be incorporated into AMP. The uptake or deamination of adenosine varies considerably by species (Van

Belle, 1969). Not only are dog, cat, and cattle RBCs poorly permeable to inosine, but inosine produced by adenosine deamination cannot be readily used for energy in these species because of low purine nucleoside phosphorylase activity, which converts inosine to ribose 1-phosphate and hypoxanthine (Duhm, 1974).

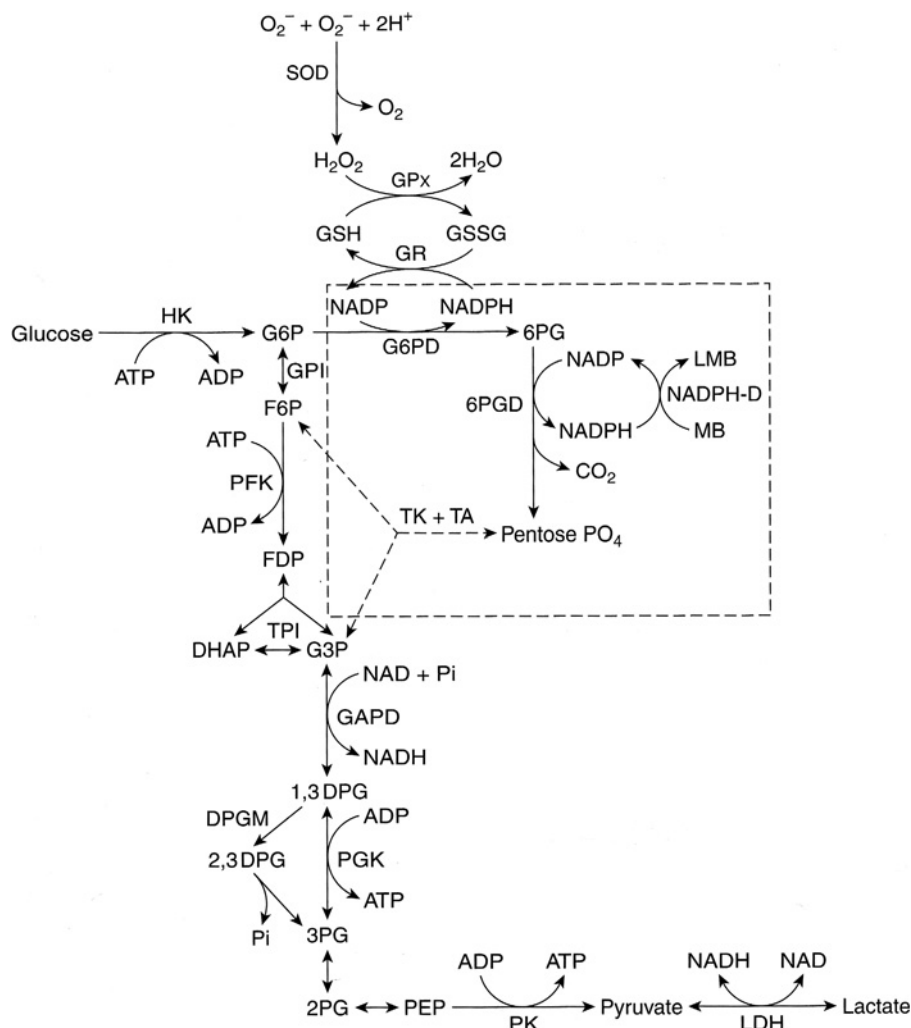
NAD and NADP can apparently be synthesized from nicotinate by way of a series of reactions in RBCs (Eaton and Brewer, 1974). In addition to ATP, PRPP and NH<sub>3</sub>, or glutamine, are required. Comparative studies of the synthesis of these compounds in domestic animals have not been reported.

### F. Carbohydrate Metabolism

RBCs require energy in the form of ATP for maintenance of shape and deformability, phosphorylation of membrane phospholipids and proteins, active membrane transport of various molecules, partial synthesis of purine and pyrimidine nucleotides, and synthesis of GSH (Nakao, 1974; Reimann *et al.*, 1981). Reducing potential in the form of NADH and NADPH is needed to counteract oxidative processes. Although substrates such as ribose, fructose, mannose, galactose, dihydroxyacetone, glyceraldehyde, adenosine, and inosine may be metabolized to some extent, depending on the species, glucose is the primary substrate for energy needs of RBCs from all species except the pig (Agar and Board, 1983; Kim, 1983).

RBCs from adult pigs utilize glucose at lower rates than other species (Magnani *et al.*, 1983) because they lack a functional glucose transporter (Craik *et al.*, 1988; Zeidler and Kim, 1982). Inosine appears to be the major substrate for pig RBCs; its production by the liver is sufficient to meet their energy requirements (Young *et al.*, 1985; Zeidler *et al.*, 1985). Inosine can be used because nucleoside phosphorylase converts it to ribose 1-phosphate and hypoxanthine (Sandberg *et al.*, 1955). Ribose 1-phosphate is converted to ribose 5-phosphate, an intermediate of the pentose phosphate pathway (PPP), by phosphoribomutase (Brewer, 1974).

Glucose utilization rates of RBCs vary by species (Table 7-1). Factors such as pH, phosphate concentration, temperature, and leukocyte and platelet contamination of RBC incubations can have substantial effects on glucose utilization rates measured *in vitro*. Consequently, species comparisons of values determined in different laboratories may be misleading. Harvey and Kaneko (1976a) approximated physiological conditions *in vitro* and measured mean glycolytic rates of 0.64, 0.94, 1.33, and 1.48  $\mu\text{moles}/\text{hour}/\text{ml}$  RBC for the horse, cat, dog, and human, respectively. Once glucose enters the cell, it is phosphorylated to glucose 6-phosphate (G6P) utilizing the hexokinase (HK) enzyme. The G6P is then metabolized through either the Embden-Meyerhof pathway (EMP) or the pentose phosphate pathway (PPP) as shown (Fig. 7-5).



**FIGURE 7-5** Metabolic pathways of the mature erythrocyte. Abbreviations: HK, hexokinase; GPI, glucose phosphate isomerase; PFK, phosphofructokinase; TPI, triosephosphate isomerase; GAPD, glyceraldehyde-3-phosphate dehydrogenase; PGK, phosphoglycerate kinase; MPGM, monophosphoglycerate mutase; DPGM, diphosphoglycerate mutase; PK, pyruvate kinase; G6PD, glucose-6-phosphate dehydrogenase; 6PGD, 6-phosphogluconate dehydrogenase; LDH, lactate dehydrogenase; LMB, leukomethylene blue; MB, methylene blue; GR, glutathione reductase; GPx, glutathione peroxidase; TK, transketolase; TA, transaldolase; GSSG, oxidized glutathione; G6P, glucose 6-phosphate; F6P, fructose 6-phosphate; FDP, fructose 1,6-diphosphate; DHAP, dihydroxyacetone phosphate; GAP, glyceraldehyde 3-phosphate; 1,3-DPG, 1,3-diphosphoglycerate; 2,3-DPG, 2,3-diphosphoglycerate; 3PG, 3-phosphoglycerate; 2PG, 2-phosphoglycerate; PEP, phosphoenolpyruvate; ADP, adenosine diphosphate; ATP, adenosine triphosphate; NAD, nicotinamide adenine dinucleotide; NADH, reduced nicotinamide adenine dinucleotide; NADP, nicotinamide adenine dinucleotide phosphate; NADPH, reduced nicotinamide adenine dinucleotide phosphate; NADPH-D, reduced nicotinamide adenine dinucleotide phosphate diaphorase; GSH, reduced glutathione; P<sub>i</sub>, inorganic phosphate; SOD, superoxide dismutase.

## G. Embden-Meyerhof Pathway

Most of the species variations in glucose utilization appear to result from variations in EMP metabolism, with PPP metabolism being relatively constant when not stimulated by oxidants (Harvey and Kaneko, 1976a). In addition to the phosphorylation of glucose, one molecule of ATP is used to phosphorylate fructose 6-phosphate, and one molecule of ATP is generated for each three-carbon molecule metabolized through the phosphoglycerate kinase (PGK) and pyruvate kinase (PK) reactions (Fig. 7-5). Consequently a net of two molecules of ATP is produced for each molecule

of glucose metabolized to two molecules of lactate in the EMP. Because mature RBCs lack mitochondria, the EMP is the only source of ATP production in these cells.

In human RBCs, reactions catalyzed by HK, phosphofructokinase (PFK), and PK appear to be rate-limiting steps in glycolysis, because these reactions are far displaced from equilibrium (Minakami and Yoshikawa, 1966). Under physiological steady-state conditions, the PFK enzyme reaction controls glycolysis through the EMP (Rapoport, 1968). Its activity is influenced by a variety of effectors, with ATP being the most important inhibitor and AMP and



inorganic phosphate ( $P_i$ ) being the most influential activators. ADP is a less potent activator (Jacobasch *et al.*, 1974). Most of the adenine nucleotide pool in RBCs is maintained as ATP under normal conditions, with less as ADP and even less as AMP (Tables 7-4 and 7-5). Glycolysis is ultimately controlled by the demand for production of ATP. As ATP is utilized, concentrations of ADP, AMP, and  $P_i$  increase. These changes result in the activation of PFK and increased EMP metabolism. Other potential activators of PFK include ammonium ions (Debski and Rynca, 1985; Shimizu *et al.*, 1988), glucose 1,6-bisphosphate (Accorsi *et al.*, 1985; Harvey *et al.*, 1992b), fructose 2,6-bisphosphate (Gallego and Carreras, 1990; Harvey *et al.*, 1992b; Sobrino *et al.*, 1987), and  $K^+$  (Ogawa *et al.*, 2002).

When PFK is activated, HK is activated secondarily because the concentration of G6P is reduced, and G6P competitively inhibits HK (Rapoport *et al.*, 1976). Although the HK reaction is normally not a rate-controlling step in glycolysis of human RBCs, conceivably it is more important in animal species with lower HK activity (Rapoport, 1968). The glycolytic rate is correlated with HK activity when RBCs of various species are compared at pH values above 8.0. Comparisons may be less reliable when measurements are made at pH 7.4 (Harvey and Kaneko, 1976a). In human RBCs, the PK reaction becomes limiting when the PFK reaction is markedly stimulated (i.e., at pH values above 7.6) (Jacobasch *et al.*, 1974). The pH values listed earlier are external values. The pH within RBCs is generally about 0.2 units lower than the external pH (Waddell and Bates, 1969).

In addition to ATP/ADP and ADP/AMP ratios, various other factors influence EMP metabolism. Alterations in pH of plasma or *in vitro* buffers affect glycolysis. As pH is increased above 7.2, PFK is activated and glucose utilization and EMP metabolism increase (Burr, 1972; Rapoport, 1968).

At physiological pH values, high concentrations of  $P_i$  stimulate glycolysis through the EMP by reducing the ATP inhibition of PFK. Conversely, glycolysis is inhibited by short-term phosphate deficiency, primarily by decreasing intracellular  $P_i$  for glyceraldehyde-3-phosphate dehydrogenase (GAPD) (Jacobasch *et al.*, 1974; Ogawa *et al.*, 1989; Wang *et al.*, 1985). Decreased glycolytic rates result in decreased RBC ATP concentrations and hemolytic anemia in experimental dogs made severely hypophosphatemic by hyperalimentation (Jacob *et al.*, 1973; Yawata *et al.*, 1974). Hemolytic anemia associated with hypophosphatemia has also been reported in diabetic cats and a diabetic dog following insulin therapy (Adams *et al.*, 1993; Perman and Schall, 1983; Willard *et al.*, 1987), in a cat with hepatic lipidosis (Adams *et al.*, 1993), and in postparturient cattle in which decreased RBC ATP concentrations have been measured (Ogawa *et al.*, 1987, 1989). In addition to having low ATP concentrations, dog RBCs might hemolyze as a result of decreased RBC 2,3DPG concentration, because dog RBCs with low 2,3DPG are more alkaline fragile than those of normal dogs and may hemolyze at physiological pH values (Harvey *et al.*, 1988).

Several glycolytic enzymes, including PFK, GAPD, and aldolase, bind to the cytoplasmic domain of band 3, forming multimeric complexes on the inner RBC membrane. Other enzymes, including PK and lactate dehydrogenase (LDH), are associated with these complexes but do not directly bind to band 3 (Campanella *et al.*, 2005; Chu and Low, 2006). The binding of enzymes to the cytoplasmic domain of band 3 results in their inhibition, which presumably also has an inhibitory effect on RBC glycolysis (Weber *et al.*, 2004). The assembly of these glycolytic enzyme complexes appears to be regulated by band 3 phosphorylation and Hb oxygenation. The phosphorylation of tyrosine in the cytoplasmic domain of band 3 by protein tyrosine kinases prevents the binding of glycolytic enzymes, which presumably enhances glycolysis (Campanella *et al.*, 2005). The deoxygenation of RBCs also dislodges the glycolytic enzymes from the membrane, consistent with the established ability of DeoxyHb, but not OxyHb, to bind the  $NH_2$  terminus of the band 3, which may contribute to the increased glycolytic rate present in deoxygenated RBCs compared to oxygenated RBCs (Weber *et al.*, 2004).

There is a strong positive correlation between intracellular  $Mg^{+2}$  and ATP concentrations in RBCs from various species because of the presence of the  $Mg^{+2}$ -ATP complex within cells (Miseta *et al.*, 1993). RBCs of rats and dogs with short-term magnesium deficiency have lowered glycolytic rates, because adenine nucleotide substrates in four glycolytic kinase reactions (HK, PFK, PGK, and PK) must be complexed with  $Mg^{+2}$  (Rapoport, 1968). Dogs and rats on magnesium-deficient diets become anemic (Elin and Alling, 1978; Kruse *et al.*, 1933), owing to shortened RBC life spans.

The saturation of Hb with oxygen has an effect on glucose utilization. Human RBCs utilize more glucose when incubated anaerobically under nitrogen than under aerobic conditions (Asakura *et al.*, 1966). OxyHb is a stronger acid than DeoxyHb; consequently, the intracellular pH of human RBCs is lower in oxygenated blood than in deoxygenated blood (Takano *et al.*, 1976). The PFK reaction is inhibited as blood is oxygenated due to the pH effect. In human RBCs, 2,3DPG is bound to DeoxyHb and released on oxygenation. Based on studies of glycolytic intermediates, the increased unbound 2,3DPG in oxygenated RBCs may have additional inhibitory effects on glycolysis (Hamasaki *et al.*, 1970). The effect of oxygenation on glycolysis of RBCs from domestic animals remains to be determined. It may not be important in ruminants because oxygenation results in insignificant decreases in intracellular pH values (Takano *et al.*, 1976). As discussed earlier, deoxygenation of RBCs dislodges certain glycolytic enzymes from the cytoplasmic domain of band 3, which may contribute to the increased glycolytic rate present in deoxygenated RBCs compared to oxygenated RBCs (Weber *et al.*, 2004).

2,3DPG inhibits glycolysis in part because of its reduction of intracellular pH as a consequence of the Donnan effect of this nonpenetrating anion (Duhm, 1975). 2,3DPG

also inhibits glycolysis by inhibiting HK, PFK, and PK in a manner different from its pH effect on these enzymes (Duhm, 1975; Jacobasch *et al.*, 1974). In addition, 2,3DPG inhibits 6-phosphofructokinase-2-kinase, the enzyme responsible for the synthesis of the positive PFK effector fructose-2,6-bisphosphate (Sobrinho *et al.*, 1987).

The RBC glycolytic rate is higher in dogs with HK<sup>+</sup> RBCs compared to dogs with LK<sup>+</sup> RBCs. Glycolysis was stimulated by increasing intracellular K<sup>+</sup> concentration in both types of RBCs, at least in part by the activation of PFK and PK by K<sup>+</sup> (Ogawa *et al.*, 2002).

Glycolysis increases in human RBCs with increasing temperature to a maximum at 45°C, with a Q<sub>10</sub> of 2 (Rapoport, 1968). Based on measurements of glycolytic intermediates, the major effect of temperature appears to be on the PFK reaction (Jacobasch *et al.*, 1974).

## H. Diphosphoglycerate Pathway

Molecules of 1,3-diphosphoglycerate (1,3DPG), produced by the GAPD reaction, may be utilized by the PGK reaction in the EMP or may be converted to 2,3DPG by the diphosphoglycerate mutase (DPGM) reaction (Fig. 7-5). 2,3DPG degradation to 3-phosphoglycerate (3PG) is catalyzed by diphosphoglycerate phosphatase activity (DPGP). A single protein is responsible for both the DPGM and DPGP activities (Sasaki *et al.*, 1977). The DPG pathway or shunt (Rapoport-Luebering cycle) bypasses the ATP-generating PGK step in glycolysis; consequently, no net ATP is generated when glucose is metabolized through this pathway (Brewer, 1974).

Normally, from 10% to 30% of triose phosphate metabolism in human RBCs is shunted through this pathway (Jacobasch *et al.*, 1974; Mulquiney *et al.*, 1999; Oxley *et al.*, 1984). The proportion of 1,3DPG metabolized by PGK and DPGM is determined mostly by the concentration of ADP (Rapoport, 1968). ATP and 2,3DPG influence the relative amount of flow through each route by product inhibition of their own synthesis.

The absolute flow is also determined by the overall glycolytic rate. 2,3DPG inhibits HK, PFK, and GAPD in human RBCs (Srivastava and Beutler, 1972). The formation of 2,3DPG is stimulated by increased P<sub>i</sub> concentration and increased pH, which stimulate glycolysis by activating PFK greater than PK (Jacobasch *et al.*, 1974). Hypoxic conditions stimulate 2,3DPG synthesis primarily by inducing hyperventilation, which results in alkalosis; however, intracellular pH also increases in hypoxia because DeoxyHb binds more H<sup>+</sup> than OxyHb (Duhm and Gerlach, 1971). Conversely, acidosis and hypophosphatemia result in decreased 2,3-DPG concentrations (Haglin *et al.*, 1994; Ibrahim *et al.*, 2005).

The concentration of 2,3DPG can be affected by a decrease in PK activity. When PK activity is reduced relative to PFK activity, as occurs in PK deficiency, phosphorylated

intermediates between the PK and GAPD reactions increase in concentration (Harvey, 2006; Mueggler and Black, 1982). The synthesis of 2,3DPG is increased as a result of the increased concentration of the 1,3DPG substrate. Thyroid hormones can increase 2,3DPG in human (Snyder *et al.*, 1970) and sheep (Studzinski *et al.*, 1982) RBCs, possibly by a direct effect on the DPGM enzyme.

RBCs of dogs, horses, pigs, and humans normally contain high concentrations of 2,3DPG, whereas those of cats and domestic ruminants have low concentrations (Tables 7-4 and 7-5). Based on results from a large number of mammalian species, only cats, hyenas, and civets among carnivores, and deer, giraffe, antelope, and the cattle family among artiodactyls have low RBC 2,3DPG concentrations (Bunn, 1981; Bunn *et al.*, 1974). Low concentrations of 2,3DPG in cat, goat, and sheep RBCs result primarily from low RBC DPGM activities, whereas RBCs of cattle have relatively high DPGP activity in association with moderately low DPGM activity (Chemtob *et al.*, 1980; Harkness *et al.*, 1969; Pons *et al.*, 1985).

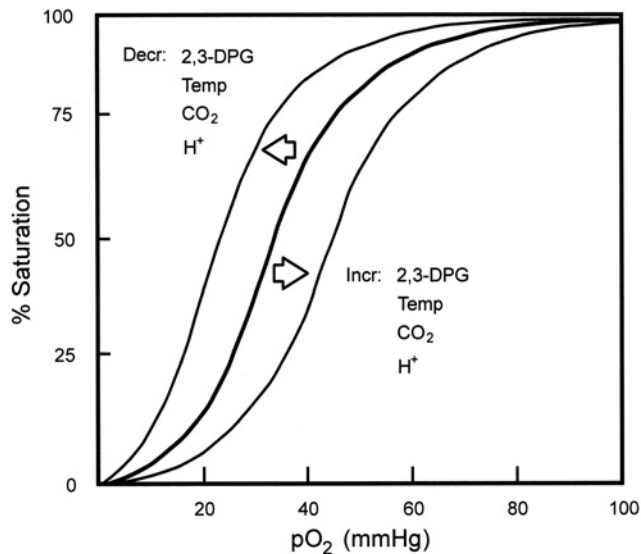
The concentration of 2,3DPG increases more than two-fold during reticulocyte maturation in rats and rabbits, which are species that naturally have high 2,3DPG concentrations in their RBCs (Gallego *et al.*, 1991). In contrast to these species, sheep reticulocytes have low 2,3DPG concentration, which decreases even further during reticulocyte maturation to mature RBCs (Gallego and Carreras, 1990).

## I. Hb Oxygen Affinity

### 1. Oxygen Dissociation Curve

DeoxyHb exists in a low affinity “tense” structure. With oxygenation it undergoes a transition to OxyHb with a “relaxed” structure that has a lower binding capacity for CO<sub>2</sub>, H<sup>+</sup>, Cl<sup>-</sup>, and organophosphates (Barvitenko *et al.*, 2005). The initial binding of a molecule of O<sub>2</sub> to a monomer of tetrameric, deoxygenated Hb facilitates further binding of additional O<sub>2</sub> molecules to the Hb molecule. Because the O<sub>2</sub> binding of one heme group influences the affinity of other heme groups for O<sub>2</sub>, this characteristic has been called the heme-heme interaction. The changing oxygen affinity of Hb with oxygenation results in a sigmoid oxygen dissociation curve (Fig. 7-6) when the percentage saturation of Hb with oxygen is plotted against the partial pressure of oxygen (pO<sub>2</sub>). The pO<sub>2</sub> at which Hb is 50% saturated is the P<sub>50</sub>. The steepness of the middle portion of the curve is of great physiological significance, because it covers the range of oxygen tensions present in tissues. Consequently, relatively small decreases in oxygen tension can result in substantial oxygen release from Hb (Benesch *et al.*, 1975).

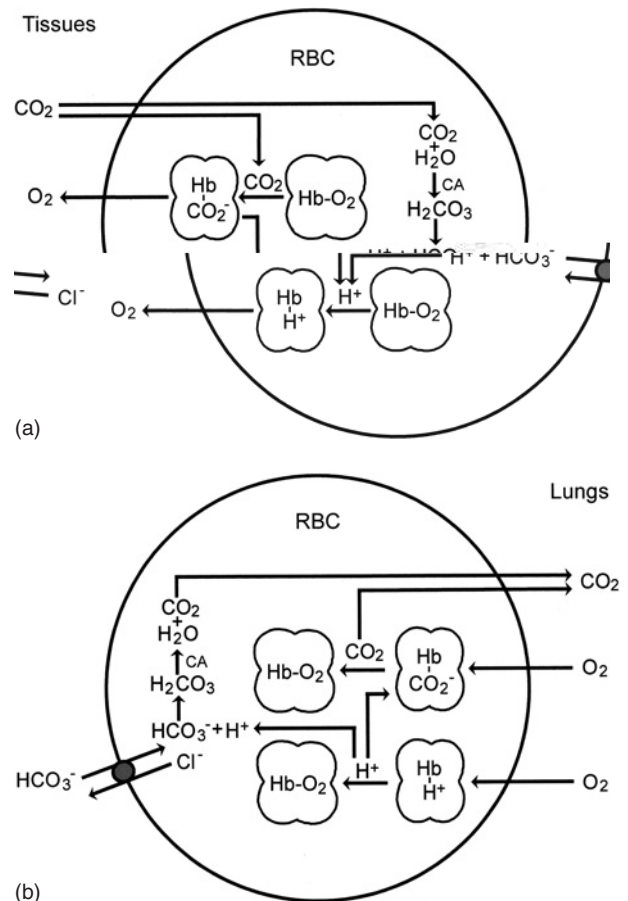
When blood from many mammalian species is studied, an inverse linear correlation is recognized between the log P<sub>50</sub> of whole blood and the log of body weight (Scott *et al.*,



**FIGURE 7-6** The hemoglobin-oxygen dissociation curve and factors influencing the position of the curve.

1977). There is an inverse relationship between metabolic rate (oxygen consumption per gram of tissue) and body weight (Kleiber, 1961). Consequently, the higher  $P_{50}$  in smaller animals should be beneficial in meeting tissue oxygen requirements associated with their higher metabolic rates. The RBCs of most mammal species adapted to living at high altitude exhibit greater Hb oxygen affinity than those living at low altitudes, and RBCs from animals of the same species adapted to living at high altitude may have greater Hb oxygen affinity than their counterparts living at low altitude (León-Velarde *et al.*, 1996).

A number of factors, including innate Hb oxygen-binding characteristics,  $H^+$  concentration,  $pCO_2$ , organic phosphate concentrations,  $Cl^-$  concentrations, and temperature, influence the oxygen affinity of Hb within RBCs. In addition to their innate Hb oxygen-binding characteristics, different Hb types respond to differing degrees to these various effectors (Bårdgard *et al.*, 1997; Haskins and Rezende, 2006). Fetal Hbs in ruminants have higher oxygen affinities than their respective adult Hbs (Battaglia *et al.*, 1970; Blunt *et al.*, 1971). HbC-containing RBCs from neonatal or anemic adult goats exhibit lower oxygen affinity, with a greater Bohr effect, than RBCs containing only adult Hb (Huisman *et al.*, 1969). Both factors should potentiate the delivery of oxygen to the tissue in goats with HbC. The presence of MetHb (iron in the ferric state) in one or more of the Hb monomers not only results in decreased oxygen carrying capacity but also in increased oxygen affinity of the remaining monomers (Hrinczenko *et al.*, 2000). The binding of Hb to the cytoplasmic domain of band 3 decreases the oxygen affinity of bound Hb, but a human RBC membrane has about 1 million copies of band 3 compared to 471 million Hb tetramers (Jensen, 2004).



**FIGURE 7-7** Coupled  $O_2$  and  $CO_2$  transport and  $H^+$  buffering in RBCs. Reactions taking place in the tissues (a) and lungs (b) are shown.  $Hb-CO_2^-$  denotes carbamino Hb, and  $Hb-H^+$  denotes Hb binding  $H^+$ . Abbreviation: CA, carbonic anhydrase.

## 2. Effects of $H^+$ , $CO_2$ , and Temperature

The addition of  $H^+$  to a suspension of RBCs results in a decrease in oxygen affinity of Hb (Bohr effect), an increase in  $P_{50}$ , and a shift of the oxygen dissociation curve to the right (Fig. 7-6). The magnitude of the Bohr effect is defined numerically as  $\Delta \log P_{50} / \Delta pH$ . There is an inverse relationship between the magnitude of the Bohr effect and average body size of various animal species (Riggs, 1960).

In capillaries of metabolizing tissues,  $CO_2$  enters RBCs and about 80% is rapidly converted to  $H_2CO_3$  by carbonic anhydrase (Hsia, 1998). This carbonic acid spontaneously ionizes to  $H^+$  and  $HCO_3^-$ . The increased  $H^+$  concentration decreases the oxygen affinity of Hb and facilitates oxygen delivery to the tissues. DeoxyHb is a weaker acid than OxyHb; therefore, DeoxyHb binds the excess  $H^+$  and limits the decrease in pH. The increased  $HCO_3^-$  diffuses out of the cell down a concentration gradient and  $Cl^-$  moves in (chloride shift) to maintain electrical neutrality (Fig. 7-7a).

The direct binding of  $CO_2$  to Hb in carbamino groups lowers oxygen affinity, but this effect is generally considered to be of minor importance. An exception appears to be in

goats and some sheep with HbC, a Hb type prominent in the neonate and induced in anemic and hypoxemic adults (see Section III.C.4). HbC binds twice as much CO<sub>2</sub> as does HbA in goats (Winslow *et al.*, 1989), and CO<sub>2</sub> decreases the oxygen affinity of HbC in goats and sheep more than it does the oxygen affinity of normal adult Hbs (Huisman and Kitchens, 1968). The carbamino formation also produces H<sup>+</sup>, which further lowers Hb oxygen affinity (see Section I.B).

The processes discussed previously are reversed at the lungs (Fig. 7-7b). O<sub>2</sub> enters RBCs and the resultant binding of O<sub>2</sub> to Hb promotes the release of Hb-bound CO<sub>2</sub> and H<sup>+</sup> that were buffered by DeoxyHb. The H<sup>+</sup> binds to HCO<sub>3</sub><sup>-</sup> to form H<sub>2</sub>CO<sub>3</sub>, which dissociates to form CO<sub>2</sub> and water. The lungs expel the CO<sub>2</sub>, and the resultant decreases in CO<sub>2</sub> and H<sup>+</sup> concentrations increase the Hb oxygen affinity of RBCs passing through pulmonary capillaries. Because CO<sub>2</sub> and H<sup>+</sup> effects are interrelated and additive, the combined change in Hb oxygen affinity has been called the “classical Bohr effect,” whereas the change in Hb oxygen affinity produced only by H<sup>+</sup> is called the “Bohr effect” (Zhang *et al.*, 2003).

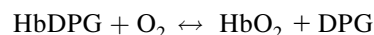
Increased temperature decreases the oxygen affinity of Hb, a response that appears physiologically appropriate considering that increased heat production accompanies increased oxygen consumption in tissues (Benesch *et al.*, 1975). Body temperature increases during prolonged strenuous exercise (Hsia, 1998), with muscle temperature increasing more than pulmonary arterial temperature (Fenger *et al.*, 2000). Increased muscle temperature, increased CO<sub>2</sub> production, and increased H<sup>+</sup> production (from lactic acidosis and transport of CO<sub>2</sub>) decrease the Hb oxygen affinity and promote the release of O<sub>2</sub> to muscles during prolonged heavy exercise. Oxygen extraction from the blood of horses increases from 20% at rest to 80% at maximal exercise (Fenger *et al.*, 2000). Increased cardiac output and higher blood Hb concentrations (from splenic contraction) are equally important for maximal oxygen delivery to muscles in exercising horses (Fenger *et al.*, 2000).

Breed differences in P<sub>50</sub> have been described in dogs (Clerbaux *et al.*, 1993), horses, and goats (Haskins and Rezende, 2006). The P<sub>50</sub> for greyhound RBCs in whole blood is lower than that for mongrel dogs, yet the groups have similar 2,3DPG concentrations (Sullivan *et al.*, 1994). The cause of this difference remains to be determined, but it is suggested that the higher hematocrit found in greyhound dogs may represent a compensatory response to a higher oxygen affinity of Hb in this species.

### 3. Effects of 2,3DPG

In RBCs from most mammalian species, 2,3DPG decreases the oxygen affinity of Hb, resulting in an increase in P<sub>50</sub> (Bunn *et al.*, 1974). In contrast, poikilothermic animals generally use ATP or GTP (primarily fish), and birds typically use inositol pentaphosphate, to decrease the oxygen

affinity of Hb (Barvitenko *et al.*, 2005; Val, 2000). 2,3DPG reacts with Hb in a ratio of one molecule per Hb tetramer. Negatively charged groups of 2,3DPG bind to specific positively charged groups in the N-terminal region of Hb beta chains. There is a marked preference for binding to DeoxyHb as compared to OxyHb because of differences in the conformation of the molecules. The interaction of 2,3DPG with Hb is represented as follows:



When 2,3DPG is increased the reaction is displaced to the left, and when pO<sub>2</sub> is increased the reaction is displaced to the right. ATP has a similar effect on Hb oxygen affinity but is generally much less important than 2,3DPG in mammals, because it usually occurs in lower concentration and is complexed with Mg<sup>+2</sup> (Bunn, 1971).

When the oxygen affinity of Hb is studied in hemolysates dialyzed to remove 2,3DPG and ATP, the “stripped” Hb from species with low 2,3DPG RBCs has considerably lower oxygen affinities than stripped Hb from species with high 2,3DPG RBCs (Bunn, 1971; Bunn *et al.*, 1974). The Hb oxygen affinity of most mammalian Hbs is decreased in the presence of chloride ions and, to a lesser extent, phosphate ions (Bårdgard *et al.*, 1997; Fronticelli, 1990; Gustin *et al.*, 1994; Haskins and Rezende, 2006). Consequently, the oxygen affinities of stripped Hbs can vary depending on the buffer system used for these assays. The oxygen affinity of stripped cattle Hb is lower in buffers containing NaCl than in buffers without NaCl. Although the addition of 2,3DPG to stripped cattle Hb causes a prominent increase in P<sub>50</sub> in the absence of Cl<sup>-</sup>, it causes only a tiny additional increase in P<sub>50</sub> in the presence of physiological concentrations of Cl<sup>-</sup> (Marta *et al.*, 1998). In contrast, the addition of 2,3DPG to stripped dog Hb results in a prominent increase in P<sub>50</sub>, even in the presence of physiological concentrations of Cl<sup>-</sup> (Bårdgard *et al.*, 1997). Because stripped Hbs from species such as dogs with high 2,3DPG RBCs naturally have high oxygen affinities, 2,3DPG is needed within RBCs of these species to maintain Hb oxygen affinity within a physiologically useful range (Benesch *et al.*, 1975).

When blood from many mammalian species is studied, an inverse linear correlation is recognized between the log P<sub>50</sub> of whole blood and the log of body weight (Scott *et al.*, 1977); however, oxygen affinity of stripped Hb from various mammals does not correlate with body weight (Nakashima *et al.*, 1985). The maintenance of 2,3DPG in mammals is energetically expensive because the ATP-generating PGK reaction is bypassed. 2,3DPG apparently allows for an evolutionary adaption of blood Hb oxygen affinity to metabolic rate.

Mammals with naturally high 2,3DPG in RBCs may alter their Hb oxygen affinity to meet metabolic needs. The significance of (and in some cases the appropriateness of) alterations in 2,3DPG in disease states is not always clear.

RBC 2,3DPG increases in some anemic animals (Agar *et al.*, 1977; King *et al.*, 1992; Paltrinieri *et al.*, 2000; Studzinski *et al.*, 1978). The resultant increase in  $P_{50}$  would seem to be beneficial in response to anemia. Increased 2,3DPG has also been reported in RBCs from horses with hypoxic conditions (Giordano *et al.*, 2004). When humans and animals enter higher altitude, their ventilation frequency increases. This hyperventilation decreases the  $p\text{CO}_2$  and increases arterial pH, which increases the oxygen affinity for Hb. However, the increased pH stimulates RBC glycolysis and 2,3DPG synthesis, which tends to counteract the effect of increased pH. This response is appropriate as long as the increased ventilation can maintain alveolar  $\text{O}_2$  tension sufficient for  $\text{O}_2$  loading in the lungs (Nikinmaa, 2001). In the case of severe hypoxic hypoxemia the response might be detrimental, because Hb cannot be fully saturated (Jensen, 2004). Various studies in dogs indicate that cardiac output and microcirculation adjustments are much more important than changes in Hb oxygen affinity in adapting to hypoxia (Liard and Kunert, 1993; Schumacker *et al.*, 1985; Zachara *et al.*, 1981). However, a reduction in Hb oxygen affinity secondary to increased 2,3DPG can be beneficial, because it is far less energy demanding than is an increase in cardiac output (Liard and Kunert, 1993; Mairbäurl, 1994; Teisseire *et al.*, 1985). RBC 2,3DPG increases in hibernating mammals, but the effect of the decrease in body temperature associated with hibernation on Hb oxygen affinity *in vivo* would more than offset the effect of increased 2,3DPG (Bunn, 1981). Because pH has a substantial effect on Hb oxygen affinity, changes in RBC 2,3DPG concentration, in response to acidosis and alkalosis, produce effects on Hb oxygen affinity that counteract alterations induced by the respective changes in pH (Bellingham *et al.*, 1971).

Aged human RBCs lose  $\text{K}^+$ , organic phosphates (especially 2,3DPG), and water. The loss of organic phosphates results in increased Hb oxygen affinity in these older RBCs (Schmidt *et al.*, 1987).

#### 4. Maternal-Fetal Oxygen Transport

Except for in the domestic cat, the oxygen affinity of Hb in fetal blood is higher than that of maternal blood when measured under standard conditions (Bunn and Kitchen, 1973; Novy and Parer, 1969). This difference in oxygen affinity probably enhances the transport of oxygen across the placenta to the fetus (Comline and Silver, 1974; Hebbel *et al.*, 1980). Oxygen is adequately transported to cat fetuses, without the advantage of increased oxygen affinity, because of the nature of the placentation and a countercurrent arrangement of blood flows (Novy and Parer, 1969).

During late gestation, mean umbilical venous  $p\text{O}_2$  values of 48, 38, 35, and 30 mmHg have been reported for horses, cattle, sheep, and pigs, respectively (Comline and Silver, 1974). Fetal systemic arterial  $p\text{O}_2$  values may be even lower, especially in species such as the pig and horse,

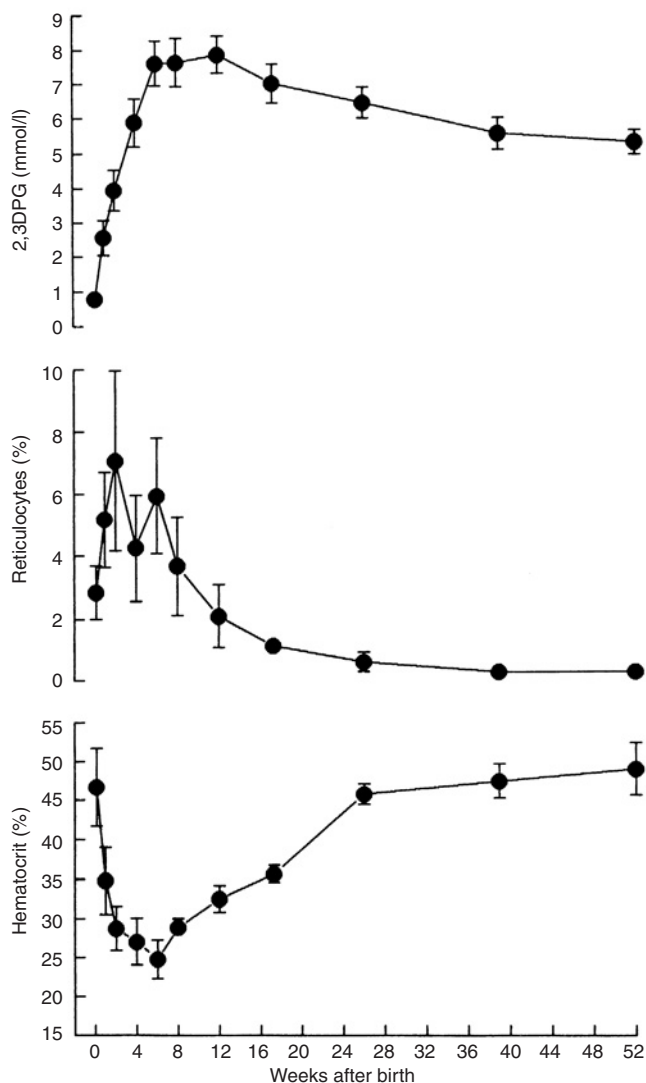
which lack a ductus venosus, requiring that all returning umbilical venous blood pass through the liver. These  $p\text{O}_2$  values are considerably lower than normal adult arterial  $p\text{O}_2$  values of about 100 mmHg. Because Hb in adult RBCs of these species is only partially saturated at these low arterial  $p\text{O}_2$  values (Schmidt-Neilsen and Larimer, 1958), the increased oxygen affinity of fetal blood would result in a greater saturation of Hb and, therefore, a greater oxygen-carrying capacity of blood than would otherwise be present.

Fetal RBCs maintain Hb oxygen affinities higher than those of the mother by one of three mechanisms (Bunn and Kitchen, 1973). (1) Ruminants have structurally distinct fetal Hbs that have higher oxygen affinities than adult Hbs in the absence of organic phosphates (Battaglia *et al.*, 1970; Blunt *et al.*, 1971). Interactions between 2,3DPG and both fetal and adult Hbs in ruminants are weak when  $\text{Cl}^-$  is present (Bunn and Kitchen, 1973). (2) A structurally distinct fetal Hb (HbF) also occurs in humans, but the oxygen affinity of stripped HbF and adult human Hb is about the same. Differences in whole blood oxygen affinity occur primarily because HbF interacts weakly with 2,3DPG, in contrast to the strong interaction with adult Hbs (Oski and Gottlieb, 1971). (3) Animals without structurally distinct fetal Hbs, such as dog, horse, and pig, have much lower 2,3DPG concentrations in fetal RBCs than in adult RBCs, thereby creating higher oxygen affinities in fetal RBCs (Bunn and Kitchen, 1973; Comline and Silver, 1974; Dhindsa *et al.*, 1972; Tweeddale, 1973). The actual *in vivo* difference in oxygen affinity between fetal and maternal RBCs is presumably less than suggested by differences in  $P_{50}$  values measured *in vitro* at pH 7.4, because fetal blood pH is lower than that of maternal blood (Comline and Silver, 1974). However, the diffusion of  $\text{CO}_2$  from fetal blood to maternal blood helps increase the pH and oxygen affinity in fetal blood, and it simultaneously decreases the pH and oxygen affinity in maternal blood. This “double Bohr effect” enhances the mother-to-fetus  $\text{O}_2$  transfer (Zhang *et al.*, 2003).

#### 5. Postnatal Changes in 2,3DPG and Oxygen Affinity

Although the higher oxygen affinity of Hb in fetal RBCs may be beneficial in the uterus, it would seem to be disadvantageous to the newborn animal breathing air. Whole blood  $P_{50}$  values and RBC 2,3DPG concentrations (Fig. 7-8) increase after birth in most domestic animals.

RBC 2,3DPG concentrations are higher in fetuses than in adult ruminants, and they increase markedly within a few days after birth (Aufderheide *et al.*, 1980; King and Mifsud, 1981; Zinkl and Kaneko, 1973a). Because neither fetal nor adult Hbs from ruminants bind 2,3DPG to any extent (at least in the presence of physiological concentrations of  $\text{Cl}^-$ ), 2,3DPG decreases oxygen affinity primarily by lowering intracellular pH (Aufderheide *et al.*, 1980; Battaglia *et al.*, 1970; Blunt, 1972). Several mechanisms are involved



**FIGURE 7-8** Changes in hematocrit, uncorrected reticulocyte count, and RBC 2,3DPG content in dogs following birth. Values are mean  $\pm$  standard deviation (Harvey, unpublished, 1994).

in the 10-fold increase in RBC 2,3DPG during the first 5 days of life in lambs (Noble *et al.*, 1983). (1) Plasma glucose increases from 40 to 100 mg/dl during the first 2 days of life and allows for an increased consumption of glucose by the glucose-permeable neonatal RBC. (2) The blood pH increases during the first day of life and activates the PFK enzyme, as evidenced by changes in RBC intermediates. (3) Plasma  $P_i$  concentration increases to a level sufficient to increase GAPD activity at 3 days of age. (4) DPGM activity in neonatal RBCs is 12-fold higher than that of adults. (5) RBC PFK activity is still above adult values, but PK activity has decreased to adult values by birth.

The decline in 2,3DPG in postnatal ruminant RBCs is more gradual, requiring 1 to 2 months to reach adult values. The whole blood  $P_{50}$  is maintained, however, because of concomitant decreases in fetal Hb and increases in adult Hb types (Aufderheide *et al.*, 1980; Blunt *et al.*, 1971;

Lee *et al.*, 1971; Zinkl and Kaneko, 1973b). In goat RBCs, HbC replaces most of the fetal Hb initially, but after 2 months, other adult Hbs begin to replace HbC (Huisman *et al.*, 1969). Goat RBCs containing predominantly HbC have lower Hb oxygen affinity with a moderately increased Bohr effect compared to RBCs containing other adult Hbs (e.g., HbA, HbB, HbD) (Huisman *et al.*, 1969). Only a small percentage of HbC is present in lambs up to 2 months of age. The percentage of fetal Hb at birth varies from 70% to 100%. The signal to switch production of fetal Hb to HbA in lambs appears to result from an inherent programming of hematopoietic stem cells (Wood *et al.*, 1985).

Rapid, but modest, increases in 2,3DPG and  $P_{50}$  occur after birth in horse RBCs (Bunn and Kitchen, 1973). As in ruminants, blood pH increases significantly within 1 h after birth (Rose *et al.*, 1982). Plasma  $P_i$  concentration also increases during the first 2 weeks of life (Bauer *et al.*, 1984). Gradual, but large, increases in 2,3DPG and  $P_{50}$  occur postnatally in blood of dogs (Dhindsa *et al.*, 1972; Harvey and Reddy, 1989; Mueggler *et al.*, 1980) and pigs (Baumann *et al.*, 1973; Kim and Duhm, 1974; Watts and Kim, 1984). A decreasing activity of PK has been reported to account for the increasing 2,3DPG concentration during the first 60 days of life in dogs (Mueggler and Black, 1982), but activation of PFK may also play a role in this increase.

In human RBCs, 2,3DPG increases slightly after birth, but most of the increase in  $P_{50}$  that occurs during the first 6 months of life results from the replacing of HbF with adult Hbs (Oski and Gottlieb, 1971). Whereas  $P_{50}$  values changed slightly in kittens after birth, RBC 2,3DPG values remained in the normal adult range (Dhindsa and Metcalfe, 1974). Data concerning changes in these and other species have been compiled by Isaacks and Harkness (1983).

## 6. RBCs as Sensors and Effectors of Local $O_2$ Delivery

RBCs may also have a role in the regulation of local  $O_2$  delivery to tissues that is mediated by Hb  $O_2$  saturation ( $SO_2$ ). In addition to releasing  $O_2$  from Hb in the tissues, one or more signals are released from RBCs that trigger vasodilation and increased blood flow to the feeding arterioles (Jagger *et al.*, 2001; Singel and Stamler, 2005). Nitric oxide ( $NO$ ), generated from L-arginine by  $NO$  synthases in the endothelium and in other cells, is a potent vasodilator. Some evidence suggests that  $NO$  can be transported by RBCs to microvascular sites of action in a protected form as an S-nitrosothiol on the highly conserved Hb  $\beta$ -93 cysteine residue. On the release of oxygen, this S-nitrosoHb purportedly delivers  $NO$  to arterioles (Singel and Stamler, 2005). An alternate mechanism of  $NO$  delivery has been proposed that reutilizes nitrite formed when  $NO$  reacts with OxyHb (Crawford *et al.*, 2006). Nitrite is stored within RBCs and reduced back to  $NO$  by DeoxyHb, which serves as a nitrite reductase (Rifkind *et al.*, 2006). Both



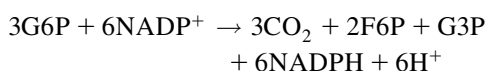
mechanisms would result in  $\text{NO}$  production, vasodilation, and increased blood flow at sites where  $\text{SO}_2$  in RBCs is low (Crawford *et al.*, 2006).

RBCs also promote vasodilation by the release of micromolar amounts of ATP, an endothelium-dependent vasodilator, when  $\text{SO}_2$  is low. As oxygen is released from OxyHb, the increased concentration of DeoxyHb binds to the cytoplasmic domain of band 3, displacing PFK and other glycolytic enzymes. It is hypothesized that this results in a stimulation of glycolysis (see Section IV.G), which results in increased production and release of ATP (Jagger *et al.*, 2001). The precise mechanism of ATP release is unknown, but band 3 and nucleoside transporter band 4.5 have been implicated in transport (Jagger *et al.*, 2001). In addition, a member of the ATP-binding cassette, the cystic fibrosis transmembrane conductance regulator (CFTR), appears to mediate a deformation-induced release of ATP from RBCs (Gov and Safran, 2005; Sprague *et al.*, 2005), and this transport mechanism may also play a role in  $\text{SO}_2$ -mediated ATP release (Jagger *et al.*, 2001). Blood levels of ATP rise and fall within minutes, compared to seconds for  $\text{NO}$  effects. Consequently,  $\text{NO}$  and ATP may have complementary roles in acute local and prolonged systemic hypoxia, respectively (Singel and Stamler, 2005).

## J. Pentose Phosphate Pathway

The pentose phosphate pathway (PPP) generates NADPH, the major source of reducing equivalents in the protection of RBCs against oxidative injury. This pathway also produces ribose 5-phosphate (R5P), which is required for adenine nucleotide synthesis (Eaton and Brewer, 1974). The PPP competes with the EMP for the G6P substrate (Fig. 7-5). Normally only about 5% to 13% of glucose metabolized by RBCs flows through the PPP (Harvey and Kaneko, 1976a), but this flow can be accelerated markedly by oxidants (Harvey and Kaneko, 1977).

The first step in the metabolism of glucose through the PPP generates NADPH from the oxidation of G6P in the glucose-6-phosphate dehydrogenase (G6PD) reaction. An additional NADPH is generated from the oxidative decarboxylation of 6-phosphogluconate (6PG) to ribulose 5-phosphate in the 6-phosphogluconate dehydrogenase (6PGD) reaction. This is the only known reaction producing  $\text{CO}_2$  in mature RBCs. The remaining reactions in the PPP are non-oxidative and freely reversible. R5P is produced from ribulose 5-phosphate by the R5P isomerase reaction. The net effect of the metabolism of 3 molecules of G6P through the PPP is as follows (Eaton and Brewer, 1974):



G6PD is the rate-limiting reaction in the PPP under physiological conditions. Normally, the G6PD reaction in

intact human RBCs operates at only 0.1% to 0.2% of the maximal enzyme activity, as determined in hemolysates under optimal conditions. The low rate of this reaction in RBCs occurs because of limited substrate availability (especially  $\text{NADP}^+$ ) and because G6PD is strongly inhibited by NADPH and ATP at physiological concentrations (Yoshida, 1973). The maximal G6PD activities measured in hemolysates from goat and sheep RBCs are much lower than those of humans or of other domestic animals (Tables 7-2 and 7-3). However, this comparatively low enzyme activity does not render sheep RBCs unduly susceptible to the hemolytic effects of oxidant drugs (Maronpot, 1972; Smith, 1968), in part because ATP does not inhibit G6PD in this species (Smith and Anwer, 1971).

About 91% of total NADP is in the reduced form in horse RBCs (Stockham *et al.*, 1994) and 92% to 99% of total NADP is NADPH in human RBCs (Kirkman *et al.*, 1986; Zerez *et al.*, 1987). NADPH is utilized to reduce oxidized glutathione to GSH, the substrate for the glutathione peroxidase reaction, and it is bound to catalase, preventing and reversing the accumulation of an inactive form of catalase that is generated when catalase is exposed to  $\text{H}_2\text{O}_2$  (Kirkman *et al.*, 1987). In the presence of oxidants, NADPH is oxidized and the PPP is stimulated because the activities of G6PD and 6PGD are directly related to the concentration of NADP and inversely related to that of NADPH (Yoshida, 1973). Glutathione metabolism affects PPP activity via the glutathione reductase (GR) enzyme, which generates NADP as a result of the reduction of GSSG with NADPH (Fig. 7-5).

## K. Nature of Oxidants in Biology

Reactive oxygen species (ROS) and reactive nitrogen species (RNS) are produced as products of normal cellular metabolism. They play dual roles as beneficial and deleterious species. At low to moderate concentrations,  $\text{NO}$  and superoxide ( $\text{O}_2^-$ ) free radicals are involved in signal transductions between cells (Valko *et al.*, 2007). A free radical is defined as any species with one or more unpaired electrons. When generated at higher concentrations in diseased states, these free radicals (and even more potent oxidative metabolites they produce) can overwhelm protective systems within the body, producing cellular injury or destruction (Valko *et al.*, 2007). The oxidants generated vary in their overall reactivities, and some are fairly selective for certain biomolecules (e.g., tyrosine, glutathione, linoleic acid, and ascorbate) (Pryor *et al.*, 2006).

Increased amounts of endogenous oxidants are generated in association with various disorders including inflammation (Lykkesfeldt, 2002; Spickett *et al.*, 1998; Weiss *et al.*, 1992a; Weitzman and Gordon, 1990), RBC parasites (Otsuka *et al.*, 2001; Shiono *et al.*, 2003), neoplasia (Christopher, 1989; Della Rovere *et al.*, 2000), diabetes (Christopher, 1995), intense exercise (Hargreaves *et al.*,

2002; Lykkesfeldt, 2002), and ischemia/reperfusion (Valko *et al.*, 2007).

### 1. Reactive Oxygen Species

From a thermodynamic standpoint, oxygen is a strong oxidant, but its reactivity is limited by virtue of its unusual electronic configuration (Green and Hill, 1984). Although it is relatively unreactive, oxygen can be metabolized *in vivo* to form highly reactive derivatives. A single-electron reduction of  $O_2$  yields the superoxide ( $O_2^-$ ) free radical. The major source within RBCs appears to be the autoxidation of OxyHb (Johnson *et al.*, 2005). There are a wide variety of other sources of  $O_2^-$  production in various tissues; examples include the ubiquinone-cytochrome *b* region in mitochondria; uncoupled cytochrome *P*-450 reactions; autoxidation of adrenaline, certain flavins, and SH groups; enzyme reactions such as xanthine oxidase and tryptophan deoxygenase; and the oxidant burst of activated neutrophils and mononuclear phagocytes (Freeman and Crapo, 1982). In the absence of inflammation, the major source of  $O_2^-$  production in nonerythroid cells is the mitochondrion (Johnson *et al.*, 2005). Superoxide undergoes spontaneous and enzyme catalyzed dismutation to  $H_2O_2$ . In the presence of a metal ion such as iron or copper,  $O_2^-$  and  $H_2O_2$  interact to form the highly reactive hydroxyl radical ( $OH$ ). Additional ROS include singlet  $O_2$  (an excited state of  $O_2$ ), ozone ( $O_3$ ) and hypochlorous acid (HOCl), generated by myeloperoxidase in neutrophils from  $H_2O_2$ , and  $Cl^-$  (Pryor *et al.*, 2006).

### 2. Reactive Nitrogen Species

Nitric oxide is a stable free radical generated from arginine by the nitric oxide synthase (NOS) reaction. Three isoforms of NOS exist. The endothelial enzyme (eNOS) and the neuronal enzyme (nNOS) are constitutively expressed. The third form (iNOS) is induced in a variety of cells, often as a result of immunologic/inflammatory stimulation (Pryor *et al.*, 2006). Nitric oxide is a second messenger involved in a variety of biological functions. Within the vasculature, it promotes vasodilation and inhibits platelet aggregation and leukocyte adhesion to the endothelium. It also functions as a neurotransmitter and has antimicrobial functions in phagocytes. The half-life of  $NO$  in the circulation is believed to be  $<0.1$ sec (Rifkind *et al.*, 2006). It combines with oxygen to produce additional oxidants, nitrogen dioxide ( $NO_2$ ) and dinitrogen trioxide ( $N_2O_3$ ), which are eventually converted to nitrite ( $NO_2^-$ ). Nitric oxide reacts with  $O_2^-$ , to form the strong oxidant peroxynitrite ( $ONOO^-$ ). Peroxynitrite combines with  $CO_2$  to form  $ONOOCO_2^-$ , which decomposes to form  $NO_2$  and the carbonate radical ( $CO_3$ ).

Nitric oxide exhibits complex interactions with Hb to form several products, including nitrosylhemoglobin [Hb(II)NO], S-nitrosylated Hb, MetHb, and nitrate, depending on whether it reacts with OxyHb or DeoxyHb (Rifkind *et al.*,

2006). The RBC was considered to be an important  $NO$  scavenger in earlier literature, but much of the  $NO$  apparently does not enter the cytoplasm of RBCs, primarily because their membranes and associated cytoskeleton layers limit its uptake (Han *et al.*, 2005). However, free Hb in plasma scavenges  $NO$  up to 600 times more readily than Hb within RBCs. Consequently, intravascular hemolysis disrupts  $NO$  homeostasis, which may lead to vasoconstriction, decreased blood flow, platelet activation, increased endothelin-1 expression, and organ injury (Gladwin *et al.*, 2004).

### 3. Drugs, Environmental Agents, and Metabolic Intermediates

A wide variety of drugs, environmental agents, and metabolic intermediates either exist as free radicals or can be converted to free radicals by cellular metabolic processes (Freeman and Crapo, 1982; Mason, 1982). These free radicals can be more damaging than the ROS and RNS species listed previously.

## L. Metabolic Protection against Oxidants

### 1. Superoxide Dismutase

Superoxide dismutase (SOD) is a copper- and zinc-containing enzyme that was first isolated from cattle blood (McCord and Fridovich, 1969). It promotes the dismutation of two  $O_2^-$  molecules to  $H_2O_2$  and  $O_2$  (Fig. 7-5). SOD helps prevent the buildup of superoxide, which can act as an oxidant by itself, or combine with  $H_2O_2$  to form the  $OH$  radical, or combine with  $NO$  to form peroxynitrite (Pryor *et al.*, 2006). The activity of SOD in RBCs of domestic animals is about the same as or higher than that in humans (Harvey and Kaneko, 1977; Suzuki *et al.*, 1984). RBC SOD activity is reduced in animals fed diets deficient in copper (Andrewartha and Caple, 1980; Williams *et al.*, 1975). Zinc is also needed for optimal activity, and consequently, SOD activity may also be low in zinc-deficient animals (Hirose *et al.*, 1992).

### 2. Glutathione

Reduced glutathione (GSH) is of central importance in the protection against oxidant injury. It is a tripeptide of glutamic acid, cysteine, and glycine that occurs in approximately 2mM concentrations in RBCs. It is synthesized *de novo* in RBCs of humans and animals from constituent amino acids via two ATP-requiring reactions, utilizing gamma-glutamylcysteine synthetase and glutathione synthetase (Beutler, 1989). GSH has a highly reactive (easily oxidizable) sulfhydryl (SH) group that, like other thiols, may act nonenzymatically as a free radical acceptor to counteract oxidant damage (Prins and Loos, 1969). GSH can also bind free hemin (containing iron as  $Fe^{+3}$ ) that may be



released during Hb oxidative denaturation, thereby reducing the potential of hemin for membrane injury (Shviro and Shaklai, 1987). GSH functions as an electron donor in various reductive enzyme reactions including glutathione peroxidase (GPX), phospholipid hydroperoxide glutathione peroxidase, glutathione S-transferase, and glutaredoxin (discussed subsequently).

Although GSH is constantly being oxidized to a disulfide (GSSG) within RBCs, most glutathione is maintained in its reduced form by the glutathione reductase reaction. RBCs increase PPP metabolism to provide the NADPH necessary for the regeneration of GSH by the GR reaction (Eaton and Brewer, 1974). The selective oxidation of a renewable SH group helps limit irreversible damage to RBCs that would otherwise occur. GSSG accounts for only about 0.2% of the total glutathione in normal human RBCs (Beutler, 1984). GSH is easily oxidized during the process of sample preparation and handling for GSSG assays; therefore, care must be taken not to produce artifactual increases in GSSG concentration (Rossi *et al.*, 2002). RBC membranes are not permeable to GSH, but GSSG is exported from RBCs using an ATP-dependent multidrug resistance protein (MRP) transporter (Keppler *et al.*, 1998). The half-life of glutathione in dog and rabbit RBCs (2 to 5 days) is similar to that in human RBCs (4 days), whereas longer times (10 to 12 days) are reported in sheep RBCs. The GSSG transport rate may be the main determinant of glutathione turnover in RBCs (Smith, 1974). Intracellular GSSG that is not exported from RBCs or reduced to GSH reacts with protein SH (PSH) groups to form glutathione-protein mixed disulfides (GS-SP) according to the reaction  $GSSG + PSH \rightarrow GS-SP + GSH$  (Di *et al.*, 1998).

### 3. Glutathione Reductase

GSSG produced by the various oxidative reactions is reduced to GSH by NADPH and the flavin adenine dinucleotide (FAD)-dependent glutathione reductase (GR) reaction. Riboflavin metabolism affects the availability of FAD and the fraction of the protein that exhibits activity (Beutler, 1989; Harvey and Kaneko, 1975b). GR activity is unmeasurable in RBCs from horses that are deficient in FAD secondary to a defect in RBC riboflavin metabolism (Harvey *et al.*, 2003). NADPH is produced by the initial enzyme reactions of the pentose phosphate pathway, and RBCs increase pentose phosphate pathway metabolism in response to oxidants to provide the NADPH necessary for the regeneration of GSH. Excepting the cat, RBCs of domestic animals have lower GR activity than those of humans (Agar *et al.*, 1974b; Harvey and Kaneko, 1975b). RBCs from horses are slower than RBCs from other species studied in their ability to regenerate GSH after it has been oxidized *in vitro*. Horses also appear less able to protect their RBCs against oxidative injury induced by incubation with high levels of ascorbate, which stimulates the GR reaction by the oxidation of GSH.

These reduced abilities may be related to the finding that horses have lower RBC GR activities than RBCs from humans and most domestic animal species. In addition, the  $K_m$  of GSSG for GR is higher in horses than in three other species measured (Harvey and Kaneko, 1975b).

### 4. Glutathione S-Transferase

Glutathione S-transferase (GST) catalyzes the formation of glutathione S-conjugates between GSH and certain electrophilic substrates. The same ATP-dependent MRP transport system appears to transport GSSG and glutathione S-conjugates out of RBCs (Keppler *et al.*, 1998). GST is susceptible to inactivation by electrophilic compounds; consequently, RBC GST activity may provide a marker for certain types of chemical exposure (Ansari *et al.*, 1987). GST activity is present in RBCs of all mammalian species studied thus far, but natural electrophilic substrates and the potential involvement of these glutathione S-conjugates in glutathione turnover in normal animals are unknown (Board and Agar, 1983; Vodela and Dalvi, 1997). A direct correlation between GST activity and GSH concentration has been reported in sheep and dog RBCs (Goto *et al.*, 1992). This is probably related to the fact that GST is stabilized by GSH.

The GST-mediated conjugation of various carcinogens and other electrophilic drugs in the liver is important in the protection of the body against these agents (Chasseaud, 1979), but the importance of this activity in protecting RBCs against xenobiotics remains to be documented. The distribution of GST isozymes varies in tissues, including RBCs. As a result, RBCs from different individuals (even within the same species) may vary in their conjugating abilities with various xenobiotics (Ploemen *et al.*, 1995). GST can also bind free hemin that is released during Hb oxidation, presumably reducing damage to RBC membranes (Harvey and Beutler, 1982).

### 5. Glutathione Peroxidase

Low levels of  $H_2O_2$  are produced in the course of normal cellular events and higher levels may be generated by exogenously administered redox active compounds (Saltman, 1989). GPx catalyzes the conversion of  $H_2O_2$  to  $H_2O$  (Fig. 7-5). It also catalyzes the reduction of fatty acid hydroperoxides, and 1-monoacylglycerol hydroperoxides (Thomas *et al.*, 1990). Another GPx in RBCs termed *phospholipid hydroperoxide glutathione peroxidase* participates in the reduction of more complex phospholipid hydroperoxides using GSH (Fujii *et al.*, 1984).

Selenium is incorporated as selenocysteine at the active site of a wide range of selenoproteins, including GPx, phospholipid hydroperoxide glutathione peroxidase, and thioredoxin reductase in RBCs (Brown and Arthur, 2001). GPx activity in RBCs correlates directly with blood selenium concentration in ruminants, horses, and rats but not in pigs or higher primates (Anderson *et al.*, 1978; Beilstein

and Whanger, 1983; Caple *et al.*, 1978; Thompson *et al.*, 1976). Selenium deficiency can be diagnosed by measuring decreased RBC GPx activity in some species (Anderson *et al.*, 1978; Caple *et al.*, 1978); however, caution is indicated in using this activity as a direct indicator of selenium status because polymorphism in GPx activity may be present, as occurs in Finn sheep (Sankari and Atroschi, 1983). A wide variety of abnormalities or lesions (most notably in skeletal and cardiac muscle) have been described in association with selenium deficiency in animals (Shamberger, 1986), but hemolytic anemia rarely, if ever, occurs in the absence of external oxidant stress. Heinz body (HzB) hemolytic anemia has been reported during the summer months in selenium-deficient cattle grazing on St. Augustine grass growing on peaty muck soils in South Florida (Morris *et al.*, 1984). Although HzB formation was greatly reduced by selenium supplementation, it is likely that these animals were also exposed to a seasonal oxidant, possibly incorporated in the grass.

#### 6. Thioredoxin, Glutaredoxin, and Peroxyredoxin

Thioredoxin (Trx) and glutaredoxin (Grx) are small proteins with two closely associated cysteines in their active sites (Lillig and Holmgren, 2007). They may be present in either oxidized disulfide forms or reduced dithiol forms. The reduced forms of these proteins interact with and reduce intramolecular protein disulfides that form in oxidatively damaged proteins. Resultant oxidized Trx is reduced to the dithiol form by NADPH and thioredoxin reductase (together called the thioredoxin system) (Cha and Kim, 1995; Mendiratta *et al.*, 1998). In contrast, oxidized Grx is reduced by GSH, and the GSSG formed is reduced by NADPH and GR (together called the glutaredoxin system) (Papov *et al.*, 1994). Reduced Grx can also reduce mixed disulfides that form between glutathione and oxidized protein SH groups (S-glutathionylation) (Klatt and Lamas, 2000). These various reactions regenerate SH groups, presumably protecting proteins such as Hb and enzymes with reactive SH groups from irreversible denaturation. Trx is also important in the scavenging of free radicals (both directly and indirectly) and as an electron donor for peroxyredoxins. Grx is also utilized in the reduction of dehydroascorbate. Both Trx and Grx have additional functions in other cell types (Lillig and Holmgren, 2007).

Peroxyredoxins are an emerging family of multifunctional SH-dependent enzymes that reduce  $H_2O_2$  and alkyl hydroperoxides to water and alcohol, respectively. Oxidized peroxyredoxins are regenerated using the Trx system (Lee *et al.*, 2003). Peroxyredoxin 2 (Prx2) is the third most abundant protein in human RBCs, in which it has been shown to be an efficient scavenger of  $H_2O_2$  generated endogenously at low concentrations (Low *et al.*, 2007). Knockout mice lacking Prx2 have severe hemolytic anemia characterized by an increase in RBC reactive oxygen species, leading to

protein oxidation, HzB formation, and decreased RBC life span (Lee *et al.*, 2003).

#### 7. Catalase

Catalase is a heme-containing homotetrameric enzyme that also destroys  $H_2O_2$  by conversion to  $H_2O$  and  $O_2$  (Kirkman and Gaetani, 2007). Except in dogs, mammalian RBCs generally have high catalase activities (Allison *et al.*, 1957; Nakamura *et al.*, 1998; Paniker and Iyer, 1965; Suzuki *et al.*, 1984). Catalase is linked metabolically to the PPP because NADPH is tightly bound to catalase in mammals (Kirkman and Gaetani, 2007). The oxidation of bound NADPH to bound  $NADP^+$  results in the accumulation of an inactive form of catalase (compound II). This inactive catalase can be returned to normal function by reduction of bound  $NADP^+$  with unbound NADPH and (to a lesser degree) unbound NADH using reductase and transhydrogenase activities, respectively, inherent in catalase (Gaetani *et al.*, 2005). This may explain the finding of normal catalase activity in RBCs from a horse with extremely low NADPH concentration secondary to G6PD deficiency (Stockham *et al.*, 1994). In addition to its benefit to RBCs, the presence of catalase in RBCs may help protect somatic cells exposed to high levels of  $H_2O_2$ , such as in sites of active inflammation (Agar *et al.*, 1986).

The relative importance of catalase versus GPx in the detoxification of low levels of endogenous  $H_2O_2$  produced *in vivo* has been controversial (Gaetani *et al.*, 1994; Nagababu *et al.*, 2003; Scott *et al.*, 1993). Dogs have been identified that lack catalase within their RBCs but have catalase in other tissues (Nakamura *et al.*, 1999). RBCs from acatalasemic humans, mice, and dogs have not been reported to exhibit increased oxidative damage *in vivo* (Goth, 2001; Kirkman and Gaetani, 2007). RBCs from mice with GPx deficiency exhibit nearly normal defenses against  $H_2O_2$  *in vitro*, although some loss of membrane sulfhydryls occurs *in vivo* (Ho *et al.*, 2004; Johnson *et al.*, 2000). Based on information available at this time, it appears that Prx2 is the most important enzyme in protecting RBCs against the low levels of  $H_2O_2$  normally produced *in vivo* (Lee *et al.*, 2003). Catalase appears to be important in protecting RBCs against higher levels of exogenous  $H_2O_2$  (Johnson *et al.*, 2005; Stagsted and Young, 2002). The primary physiological role of GPx in RBCs appears to be the detoxification of organic peroxides (Johnson *et al.*, 2000).

#### 8. Vitamin E ( $\alpha$ -Tocopherol)

Vitamin E is lipid soluble and the most important antioxidant in the cell membrane. It donates reducing equivalents to lipid peroxy radicals, converting them to less toxic lipid hydroperoxides (May, 1998; Valko *et al.*, 2007). GSH-dependent phospholipid hydroperoxidase can reduce the lipid hydroperoxides that form. Oxidized vitamin E can be

reduced by ascorbate, presumably at the aqueous-lipid interface of the lipid bilayer (May, 1998). Vitamin E deficiency increases the susceptibility of RBCs to peroxidative hemolysis (Duthie *et al.*, 1989; Pillai *et al.*, 1992). Its location in the membrane provides little protection against cytosolic oxidative injury (Rotruck *et al.*, 1972). Vitamin E also inhibits hemolysis induced by hemin, purportedly by functioning as a membrane-stabilizing agent (Wang *et al.*, 2006).

### 9. Vitamin C (Ascorbate)

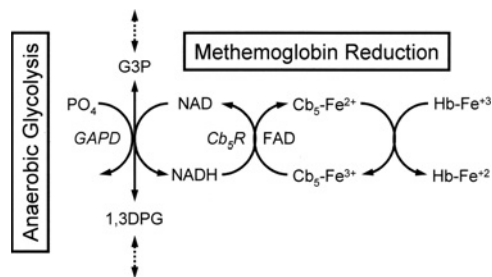
Vitamin C is an antioxidant with high reducing potential. It donates one or two electrons to a variety of oxidants, including oxygen free radicals and peroxides. It also appears to have an important function in the reduction of oxidized vitamin E within RBC membranes (May, 1998). The single electron-oxidized form is a stable free radical that can either donate or accept electrons. Dehydroascorbate, the two electron-oxidized form, can be reduced back to ascorbate non-enzymatically by GSH and enzymatically via the glutaredoxin reaction and by a separate GSH-dependent dehydroascorbate reductase enzyme (Xu *et al.*, 1996). Dehydroascorbate can also be reduced by the NADPH-dependent thioredoxin reductase reaction (May, 1998). Ascorbate enters and leaves cells slowly, but dehydroascorbate is rapidly taken up by RBCs by facilitated diffusion on the glucose transport protein (GLUT-1) and reduced to ascorbate within RBCs. Ascorbate is a major antioxidant in plasma. Ascorbate within human RBCs readily donates electrons to extracellular ascorbate free radicals via a plasma membrane redox system (possibly involving a membrane cytochrome b561), which helps prevent depletion of extracellular ascorbate. However, this membrane redox system appears to be less active in mouse RBCs (Su *et al.*, 2006).

### 10. Lipoic Acid

Lipoic acid is a sulfur-containing compound that is absorbed from the diet and synthesized in mitochondria (Smith *et al.*, 2004). Upon entering cells, it can be reduced to the dithiol form dihydrolipoic acid by the thioredoxin system (Smith *et al.*, 2004). Reduction of lipoic acid in human RBCs is reported to occur via GSH and glutathione reductase (Constantinescu *et al.*, 1995). Dihydrolipoic acid scavenges various ROS and RNS and chelates heavy metals; however, it is present in much lower concentrations in tissues compared to GSH and ascorbate. Consequently, the importance of its function as an antioxidant *in vivo* is questionable (Smith *et al.*, 2004).

### 11. MethHb Reduction

MetHb differs from Hb only in that the iron moiety of the heme groups is in the ferric rather than the ferrous state. MetHb forms *in vivo* at low levels normally and at much



**FIGURE 7-9** Methemoglobin reduction pathway. Abbreviations: G3P, glyceraldehyde-3-phosphate; GAPD, glyceraldehyde-3-phosphatedehydrogenase; PO<sub>4</sub>, inorganic phosphate; 1,3DPG, 1,3-diphosphoglycerate; NAD, nicotinamide adenine dinucleotide; NADH, reduced nicotinamide adenine dinucleotide; Cb<sub>5</sub>R, cytochrome b<sub>5</sub> reductase; FAD, flavin adenine dinucleotide; Cb<sub>5</sub>-Fe<sup>+3</sup>, ferricytochrome b<sub>5</sub>; Cb<sub>5</sub>-Fe<sup>+2</sup>, ferrocyanochrome b<sub>5</sub>; Hb-Fe<sup>+3</sup>, methemoglobin; and Hb-Fe<sup>+2</sup>, deoxyhemoglobin. From Harvey, 2006, with permission.

higher levels in the presence of oxidative compounds (Bodansky, 1951).

MetHb is unable to bind oxygen and must be reduced to Hb to be functional. MetHb is primarily reduced by cytochrome-b<sub>5</sub> reductase (Cb<sub>5</sub>R), also called MetHb reductase. In this reaction, electrons are transferred from NADH to ferricytochrome-b<sub>5</sub> using FAD as the enzyme-bound prosthetic group; then the resulting ferrocyanochrome-b<sub>5</sub> reduces MetHb nonenzymatically to Hb (Higasa *et al.*, 1998) (Fig. 7-9). MetHb reduction is more corrective than protective.

RBCs contain another enzyme, NADPH diaphorase (NADPH MetHb reductase, NADPH dehydrogenase) that is capable of MetHb reduction when appropriate electron carriers are present. In addition to redox dyes, such as methylene blue, various flavins may function as substrates for reduction by NADPH, prompting investigators to classify the enzyme as an NADPH flavin reductase (Yubisui *et al.*, 1980). The contribution of this enzyme to MetHb reduction in human RBCs is believed to be insignificant because flavin concentrations are normally low (Hultquist *et al.*, 1993). The finding that this protein also binds heme, porphyrins, and fatty acids raises additional questions about its possibly physiological role in RBCs (Xu *et al.*, 1992).

Following the oxidation of Hb to MetHb with nitrite *in vitro*, horse RBCs reduce MetHb at a slower rate than those of other domestic animals (except pigs) when glucose is added as the substrate for energy (Robin and Harley, 1966). RBCs from adult pigs cannot reduce MetHb with glucose as the substrate because they lack a membrane glucose transporter (Kwong *et al.*, 1986). In contrast to NADP, only about half of the total NAD is normally present in the reduced (NADH) form (Zerez *et al.*, 1987). Horse (Medeiros *et al.*, 1984; Robin and Harley, 1967) and pig (Rivkin and Simon, 1965) RBCs utilize lactate better than glucose to generate NADH (by the LDH reaction) for the reduction of MetHb. Because lactate occurs in blood and easily diffuses into RBCs, it may be an important substrate of MetHb reduction *in vivo*.

Methylene blue (MB) is used to treat toxic methemoglobinemia because it causes MetHb to be reduced faster than occurs by the relatively slow  $Cb_5R$  reaction. MB is reduced to leukomethylene blue (LMB) by the NADPH-dependent diaphorase discussed previously (Fig. 7-5), and LMB reacts spontaneously with MetHb, reducing it to Hb and regenerating MB (Sass *et al.*, 1969). MB was suggested to be of limited value in the treatment of methemoglobinemia in horses, as it had a limited ability to stimulate MetHb reduction in horse RBCs *in vitro* using glucose as the substrate (Robin and Harley, 1966). However, MB was subsequently found to be effective in reducing methemoglobinemia in horses *in vivo* (Dixon and McPherson, 1977; Harvey *et al.*, 2003).

Being a redox dye, MB can participate in various oxidative reactions on entering RBCs. It is important that it be used judiciously lest it potentiate Hb body formation and hemolysis that might result from the original oxidative insult (Harvey and Keitt, 1983).

## V. DETERMINANTS OF RBC SURVIVAL

A wide variety of conditions, including immune-mediated hemolytic anemias and infectious diseases, result in shortened RBC survival. Readers are referred to *Schalm's Veterinary Hematology* (Feldman *et al.*, 2000) for information concerning conditions beyond the scope of this chapter.

### A. Oxidative Injury

Oxidants produce different patterns of intracellular and membrane damage. For example, nitrite produces MetHb with minimal damage to Hb or membranes (May *et al.*, 2000); onion toxicity produces Heinz bodies and membrane damage with minimal methemoglobinemia in dogs (Harvey and Rackear, 1985); and acetaminophen toxicity results in significant methemoglobinemia, Heinz body formation, and membrane damage in cats (Finco *et al.*, 1975). Different patterns may be related to differences in lipid solubility, redox potentials, reactivity with SH groups, binding to heme, and the source or site of oxidant generation. Extracellularly produced oxidants can damage the membrane before reaching the cytosolic protective mechanisms. Oxidants that are generated intracellularly in coupled reactions with OxyHb tend to produce more Hb injury than membrane injury. Hb has been described as a "frustrated" oxidase, because it potentiates the generation of oxidants by a variety of drugs (Carrell *et al.*, 1977).

#### 1. MetHb Formation

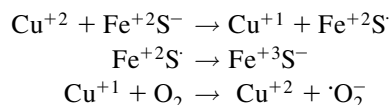
Although MetHb formation is reversible and does not enhance RBC destruction per se, it is a component of oxidative injury to RBCs and is generally involved as a step in Hb body formation. Clinical signs associated with methemoglobinemia are the result of hypoxia because MetHb cannot

bind  $O_2$ . Lethargy, ataxia, and semistupor do not become apparent until MetHb content exceeds 50%, with a coma-like state and death ensuing when it exceeds 80% (Bodansky, 1951). The cyanotic appearance of mucous membranes associated with this condition may not be easily recognized in heavily pigmented animals. MetHb content is quantified spectrophotometrically, but a spot test can determine whether clinically significant levels of MetHb are present. One drop of blood from the patient is placed on a piece of absorbent white paper and a drop of normal control blood is placed next to it. If the MetHb content is 10% or greater the patient's blood should have a noticeably brown coloration.

Approximately 3% of Hb is spontaneously oxidized to MetHb each day in normal people (Mansouri and Lurie, 1993) and dogs (Harvey *et al.*, 1991). A similar rate of MetHb formation (4%) has been calculated for mice (Johnson *et al.*, 2005). This MetHb formation results primarily from spontaneous autoxidation of OxyHb (Johnson *et al.*, 2005).

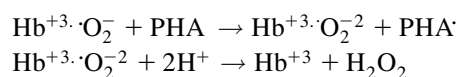
Although the iron moiety of DeoxyHb is in the ferrous state, in OxyHb it exists in (or near) the ferric state, with an electron being transferred to the  $O_2$  molecule to give a bound superoxide ( $\cdot O_2^-$ ) ion (Mansouri and Lurie, 1993). During deoxygenation, the electron returns to the iron moiety and  $O_2$  is released. Autoxidation to MetHb with the release of  $\cdot O_2^-$  occurs when the bound  $\cdot O_2^-$  is replaced by a nucleophile such as  $Cl^-$  (Wallace *et al.*, 1974).

Oxidants such as hexavalent chromates, chlorates, cobalt, and copper oxidize Hb iron by extracting electrons (Umbreit, 2007). Cupric ions oxidize the reactive SH group on the beta chains of human and animal Hbs (Taketa and Antholine, 1982), and then an electron is transferred from heme iron to regenerate the SH group. Cupric ion is regenerated by interaction with oxygen. The series of reactions by which copper catalyzes Hb oxidation to MetHb (Carrell *et al.*, 1978) are as follows:



These reactions occur rapidly but continue only until about 50% of total hemes are oxidized because alpha chains are resistant to oxidation (Taketa and Antholine, 1982). Additional oxidative reactions involving copper can denature Hb and damage membranes (Hochstein *et al.*, 1978).

Rather than extracting electrons, many oxidant drugs produce MetHb by donating electrons to OxyHb (Carrell *et al.*, 1977), as is shown below for phenylhydroxylamine (PHA):



Drug free radicals, such as PHA, that are generated can donate the unpaired electron to molecular oxygen to form

superoxide or to another OxyHb molecule to form more MetHb and  $H_2O_2$ . To achieve greater stability, free radicals may also extract electrons by oxidizing SH groups of Hb, enzymes, membrane proteins, or GSH; by oxidizing membrane unsaturated fatty acids; by oxidizing NADPH or NADH; and possibly by extracting an electron from DeoxyHb to form MetHb.

Nitrite quickly enters RBCs and equilibrates across their membranes and then continues to enter RBCs as a consequence of its intracellular removal. This involves the formation of nitrate and MetHb in the presence of OxyHb and the formation of NO and MetHb in the presence of DeoxyHb (Jensen, 2005). The reactions involved in MetHb formation in the presence of nitrite are complex (Titov and Petrenko, 2005; Umbreit, 2007). MetHb formation by nitrite is significantly higher in oxygenated than deoxygenated pig RBCs (Jensen, 2005). Nitrite produces MetHb within RBCs, but otherwise does not exert strong oxidant stress on these cells (May *et al.*, 2000). Methemoglobinemia occurs in ruminants eating nitrate-accumulating plants, especially when the plants have been fertilized with nitrogenous compounds. Nitrate is relatively nontoxic, but it is reduced to nitrite by ruminal microorganisms (Burrows, 1980).

Methemoglobinemia can occur in animals following the topical application of benzocaine-containing products to skin (Harvey *et al.*, 1979; Wilkie and Kirby, 1988), or in laryngeal (Krake *et al.*, 1985) or nasopharyngeal sprays (Davis *et al.*, 1993; Lagutchik *et al.*, 1992). Benzocaine appears to have only a limited ability to produce other forms of RBC injury, although HzB formation can occur (Harvey *et al.*, 1979).

Many compounds can produce MetHb (Ash-Bernal *et al.*, 2004; Bodansky, 1951; Umbreit, 2007), and most of them also produce variable degrees of Hb denaturation and membrane injury. Acetaminophen and phenazopyridine toxicity in cats (Harvey, 1995), red maple toxicity in horses (Alward *et al.*, 2006), copper toxicity in sheep (Soli and Froslic, 1977), and skunk musk absorption in dogs (Zaks *et al.*, 2005) are examples of drugs or chemicals that produce prominent methemoglobinemia and Heinz body hemolytic anemia. Following exposure to oxidants, MetHb forms within minutes, but HzB take hours to form. If the oxidant is rapidly metabolized, MetHb content will generally be reduced to values approaching normal within 24 h (Harvey and Keitt, 1983).

Low levels of MetHb may form in response to endogenous oxidant generation during inflammation (Morita *et al.*, 1996; Ohashi *et al.*, 1998; Weiss and Klausner, 1988). Remarkable methemoglobinemia, with evidence of RBC membrane oxidant damage, has been described in cattle infected with *Theileria sergenti* (Shiono *et al.*, 2003).

## 2. HzB Formation

HzB are composed of oxidized denatured Hb. They are often not recognized on routinely stained blood films,

because they either are not stained or stain similarly to the remaining intact Hb. If they are of sufficient size (1 to  $2\mu\text{m}$ ), they may appear as pale inclusions within RBCs or as nipple-like projections from the surface of RBCs. HzB can be visualized as dark, refractile inclusions in new methylene blue “wet” preparations and as light blue inclusions with reticulocyte stains (Harvey, 2001).

The following sequence of oxidant-triggered biochemical events leading to HzB formation is proposed (Allen and Jandl, 1961; Chiu and Lubin, 1989; Hebbel and Eaton, 1989; Low, 1989; Mawatari and Murakami, 2004): (1) ferrohemes are oxidized to ferrihemes (MetHb). (2) Reactive SH groups of MetHb are oxidized (cysteine 93 of the human Hb  $\beta$  chain) and mixed disulfide bonds form following interaction with GSSG (also generated in response to oxidative stress). This glutathionylation of MetHb may be protective, because these globin SH groups can be regenerated via the glutaredoxin, and possibly thioredoxin, systems (Klatt and Lamas, 2000). (3) As further oxidation continues, normally “buried” SH groups of MetHb are oxidized causing additional glutathionylation reactions and presumably disulfide bond formation between globin chains. These reactions are probably not reversible (Mawatari and Murakami, 2004). (4) Conformational changes in globin chains result in dissociation of the tetramer to dimers and monomers and hemichrome formation (hemichromes have both the ferric iron’s fifth and sixth coordinate positions occupied by a ligand provided by the globin chain). (5) Hemichromes bind to band 3 and to a lesser degree other membrane components, forming clusters of copolymers. (6) The precipitation and accumulation of denatured globin molecules result in HzB formation. Precipitation is potentiated by the dissociation of the ferriheme (hemin) moieties from the hemichromes because the resultant free globin chains are unstable.

Hemolytic anemias associated with HzB formation in domestic animals have resulted from a variety of compounds. Dietary causes include consumption of onions by cattle (Lincoln *et al.*, 1992), sheep (Kirk and Bulgin, 1979; Knight *et al.*, 2000; Verhoeff *et al.*, 1985), horses (Pierce *et al.*, 1972), cats (Kobayashi, 1981), and dogs (Harvey and Rackear, 1985; Ogawa *et al.*, 1986), consumption of garlic by dogs and horses (Lee *et al.*, 2000; Pearson *et al.*, 2005; Yamato *et al.*, 2005), and consumption of kale and other *Brassica* species by ruminants (Greenhalgh *et al.*, 1969; Smith, 1980; Suttle *et al.*, 1987). Dipropyl and diallyl di-, tri-, and tetrasulfides and possibly other organosulfur compounds derived from plants in the *Allium* genus (onions, garlic, and chives) cause oxidative damage to RBCs. ROS are formed during redox recycling of these compounds or their metabolites in the presence of GSH and OxyHb (Munday *et al.*, 2003). The role of GSH as a source of electrons in this redox cycle may explain why dogs with high RBC GSH concentrations are more susceptible to onion-induced RBC damage than dogs with normal RBC GSH concentrations (Yamoto and Maeda, 1992). In the

case of *Brassica* species, the hemolytic factor is reported to be dimethyl disulfide, produced by the action of rumen microbes on S-methylcysteine sulfoxide contained within the plants (Smith, 1980).

HzB hemolytic anemia occurs in Florida in cattle grazing on lush rye (*Secale cereale*) pastures in the winter (Simpson and Anderson, 1980) and in selenium-deficient cattle grazing on St. Augustine grass pastures in the summer (Morris *et al.*, 1984). The nature of oxidants involved is unknown. Methemoglobinemia, HzB formation, severe intravascular hemolysis, and death have followed the consumption of red maple leaves by horses (Alward *et al.*, 2006; George *et al.*, 1982; Tennant *et al.*, 1981) and alpacas (Dewitt *et al.*, 2004). Wilted or dried leaves are toxic, but freshly harvested leaves are not. Gallic acid and other compounds have been identified in the leaves that are capable of inducing oxidative damage (Boyer *et al.*, 2002).

Postparturient hemoglobinuria with HzB formation occurs in cattle in New Zealand grazing primarily on perennial ryegrass (*Lolium perenne*) (Martinovich and Woodhouse, 1971). Postparturient cattle may be more susceptible to the development of anemia because increased food consumption associated with lactation could increase exposure to an unidentified dietary oxidant. Both hypocuprosis (Gardner *et al.*, 1976) and hypophosphatemia (Jubb *et al.*, 1990) have been considered to contribute to the severity of the anemia in these cattle. An apparently different syndrome of postparturient hemoglobinuria has also been reported in hypophosphatemic cattle of North America (MacWilliams *et al.*, 1982). HzB have not been reported in affected animals, and the anemia appears to develop because affected animals have decreased RBC ATP concentrations (Ogawa *et al.*, 1987, 1989).

Methemoglobinemia and HzB hemolytic anemia occur acutely when large amounts of copper are released from the liver of ruminants that have accumulated excessive amounts of liver copper secondary to increased dietary intake (Brewer, 1987; Kerr and McGavin, 1991; Soli and Froslic, 1977). Zinc toxicity has primarily resulted from the consumption and retention of zinc-containing objects within the stomach of dogs. Sources of zinc include U.S. pennies minted after 1982, metallic hardware, toys, and ointment containing zinc oxide (Bexfield *et al.*, 2007; Breitschwerdt *et al.*, 1986). The mechanism(s) by which zinc produces hemolytic anemia is unclear, but HzB have been recognized in some clinical cases (Bexfield *et al.*, 2007; Hammond *et al.*, 2004; Harvey, 2001; Houston and Myers, 1993; Luttgen *et al.*, 1990). HzB anemia was also reported in a dog following possible naphthalene ingestion (Desnoyers and Hebert, 1995).

Clinical cases of HzB hemolytic anemias have occurred following the administration of a variety of drugs including methylene blue in cats (Schechter *et al.*, 1973) and dogs (Fingerroth and Smeak, 1988; Osuna *et al.*, 1990), phenazopyridine in a cat (Harvey and Kornick, 1976), acetaminophen in cats (Finco *et al.*, 1975; Gaunt *et al.*, 1981; Hjelle

and Grauer, 1986) and dogs (Harvey *et al.*, 1986; Houston and Myers, 1993), methionine in cats (Maede *et al.*, 1987), menadione (vitamin K<sub>3</sub>) in dogs (Fernandez *et al.*, 1984), and phenothiazine in horses (McSherry *et al.*, 1966). The application of benzocaine to inflamed dog skin can result in methemoglobinemia and Heinz body formation (Harvey *et al.*, 1979). Heinz body hemolytic anemia has been reported in a dog that had been sprayed with skunk musk (Zaks *et al.*, 2005). A variety of additional oxidants produce HzB hemolytic anemias experimentally in animals (Fertman and Fertman, 1955).

Cats are generally recognized as the species most susceptible to HzB formation. Although species differences in metabolism and excretion of various drugs may partially account for this increased susceptibility, cat Hb generally appears more susceptible to oxidative denaturation than do Hbs of other species (Harvey and Kaneko, 1976b). The presence of 8 to 10 reactive SH groups per Hb tetramer in cat Hb may render it more susceptible to oxidation (Mauk and Taketa, 1972); apparently no other species has more than 4 reactive SH groups per tetramer (Snow, 1962).

HzB are rarely recognized in RBCs from most species, but are frequently present in cat RBCs because of the susceptibility of cat Hb to form HzB, combined with a poor ability of the cat spleen to remove HzB from RBCs (Jain, 1986). Even normal cats may have low numbers of HzB (<5%), and increased HzB numbers have been seen in kittens fed fish-based diets (Hickman *et al.*, 1990), in cats fed commercial soft-moist diets containing propylene glycol (Christopher *et al.*, 1989; Hickman *et al.*, 1990), and in cats fed baby food containing onion powder (Robertson *et al.*, 1998). Increased HzB formation can occur in cats with repeated propofol anesthesia (Andress *et al.*, 1995; Matthews *et al.*, 2004). Increased HzB numbers have also been documented in cats with diabetes mellitus, hyperthyroidism, and lymphoma (Christopher, 1989). Diabetic cats with ketoacidosis have more HzB and lower hematocrits than do nonketotic diabetic cats (Christopher *et al.*, 1995). Although RBC survival tends to be shortened, anemia is either absent or mild in the preceding conditions. The oxidative reactions involved in these conditions are not clearly defined.

### 3. Membrane Injury

Various types of oxidant-induced membrane injury have been recognized. These include oxidation of membrane SH groups, lipid peroxidation, cross-linking of spectrin, inhibition of enzymes and membrane transport systems, and band 3 clustering. Glutathionylation of oxidized SH groups in actin-, spectrin-, and membrane-associated GAPD is present. It is unclear whether this is a protective reaction or simply a biochemical reaction that occurs with excessive oxidative stress (Mawatari and Murakami, 2004). Damaged cells exhibit increased membrane rigidity, decreased deformability, and impaired ability to maintain ion gradients (Baskurt

and Meiselman, 1999; Chiu and Lubin, 1989). The relative importance of HzB formation, hemin release, and the generation of various free radicals remains to be clarified.

The binding of HzB to the inner surface of the RBC membrane and clustering of band 3 and other components alter the normal membrane organization. Potential negative effects include weakening or disruption of the cytoskeleton, altered distribution of membrane phospholipids, altered cell surface charges, and formation of abnormal external cell surface antigens that can be recognized by autologous antibodies (Low, 1989). HzB cause focal membrane rigidity but do not affect global cellular deformability until they nearly cover the entire internal surface of RBCs (Reinhart *et al.*, 1986).

Hemin released during HzB formation binds to and causes damage to RBC membranes. Evidence has been presented that hemin can mediate the dissociation of RBC cytoskeletal proteins, impair the ability of the RBC membrane to maintain ionic gradients, oxidize membrane sulfhydryl proteins, and potentiate peroxide-induced membrane lipid peroxidation (Chiu and Lubin, 1989; Hebbel and Eaton, 1989; Jarolim *et al.*, 1990). The molecular mechanism(s) has not been clearly defined, but hemin may exert its toxic effects via catalysis of the formation of reactive oxygen species (Vincent, 1989). Iron may also be released from hemin when oxidative damage results in porphyrin degradation, and free iron may be a catalyst for the generation of more oxidants (Umbreit, 2007).

Oxidative injury to RBC membranes is sometimes recognized by the appearance of eccentrocytes in stained blood films. Eccentrocytes are formed by the adhesion of opposing areas of the cytoplasmic face of the RBC membrane (Fischer, 1986). Denatured spectrin is believed to be of primary importance in the cross bonding of membranes (Arese and De Flora, 1990; Fischer, 1988). These cells have been reported to occur in horses with red maple toxicity (Reagan *et al.*, 1994) and in dogs exposed to acetaminophen and other nonsteroidal anti-inflammatory drugs, onions, garlic, naphthalene, propofol, vitamin K, and vitamin K anticoagulant drugs (Caldin *et al.*, 2005; Ham *et al.*, 1973; Harvey *et al.*, 1986; Harvey and Rackear, 1985; Lee *et al.*, 2000). Eccentrocytes have also been reported in the blood of dogs with ketoacidotic diabetes, inflammation, and neoplasia (especially lymphoma), secondary to increased endogenous oxidants (Caldin *et al.*, 2005). Eccentrocytes occur in RBC G6PD-deficient and FAD-deficient horses with inadequate metabolic protection against endogenous oxidants (Harvey *et al.*, 2003; Stockham *et al.*, 1994).

#### 4. RBC Destruction

Following extreme oxidative injury, RBCs may lyse within the circulation. Hb released to plasma dissociates into dimers, and is bound to haptoglobin for removal by macrophages. Free Hb in plasma also scavenges NO

(Rifkind *et al.*, 2006), which may lead to vasoconstriction, decreased blood flow, platelet activation, increased endothelin-1 expression, and organ injury (Gladwin *et al.*, 2004; Minneci *et al.*, 2005). Free Hb in plasma spontaneously oxidizes to MetHb, which activates endothelial cells by stimulating the production of IL-6 and IL-8 cytokines and the expression of E-selectin (Liu and Spolarics, 2003). Hemin released from MetHb is bound by hemopexin for removal by the liver. Free hemin, like MetHb, promotes inflammation. It increases vascular permeability, adhesion molecule expression, and the infiltration of leukocytes (Wagener *et al.*, 2001). Hemoglobinuria occurs if intravascular hemolysis is of sufficient magnitude to saturate the haptoglobin-binding capacity of plasma and exceed the ability of renal tubules to reabsorb filtered Hb.

In most cases, however, enhanced RBC destruction results primarily from increased phagocytosis of injured RBCs by macrophages of the spleen, liver, and bone marrow. Of the organs of the mononuclear phagocyte system, the spleen is most adept at recognizing and removing damaged RBCs. In most species, RBCs must pass through narrow slits between endothelial cells lining venous sinus walls of the spleen to reenter the general circulation. As a consequence, oxidant-induced decreased RBC deformability tends to result in increased transit time of RBCs in the splenic reticular meshwork, thereby enhancing the likelihood of phagocytosis by resident macrophages (Baerlocher *et al.*, 1994; Weiss, 1984).

When HzB are larger than openings in walls of splenic venous sinuses, they are retained within the trabecular meshwork of the spleen. The whole cell may be phagocytized, or the HzB and closely associated membrane may be removed. The remainder of the RBC reseals and passes through the sinus wall. This removal of HzB is the so-called pitting function of the spleen (Weiss, 1984). Cat spleens have poor pitting capabilities (Jain, 1986) owing to the presence of large openings in venous sinus walls (Blue and Weiss, 1981).

Macrophages can recognize damaged RBCs by antibody-dependent and by antibody-independent mechanisms; however, the relative importance of the different mechanisms remains to be defined. Macrophages do not recognize less-deformable cells per se, but phagocytize them at a higher rate because of their slower transit time or entrapment in the spleen as discussed earlier (Baerlocher *et al.*, 1994).

Oxidative damage to RBCs can induce suicidal death of RBCs (eryptosis), with reactions similar to some of those that occur during apoptosis of nucleated cells. Eryptosis is characterized by  $\text{Ca}^{+2}$  entry, RBC shrinkage, membrane blebbing, activation of proteases, and exposure of phosphatidylserine in the outer membrane leaflet. The exposed phosphatidylserine is recognized by receptors on macrophages that phagocytize and degrade the affected cells (Lang *et al.*, 2006). Phosphatidylserine exposure has been reported in RBCs from humans with hemolytic anemia secondary to PK deficiency and unstable Hbs, but it does not

appear to be a death signal for most causes of hemolytic anemia (Boas *et al.*, 1998). Macrophages contain a number of antibody-independent receptors that can bind to oxidized lipoproteins, anionic phospholipids, polysaccharides, and polyribonucleotides (Sambrano *et al.*, 1994). Evidence has been presented to indicate that several scavenger receptors may be involved in the recognition and phagocytosis of oxidatively damaged RBCs (Terpstra and van Berkel, 2000).

The cross-linking of band 3 molecules by hemichromes during oxidative denaturation of Hb results in clustering of band 3 molecules and greatly enhanced binding of autologous IgG (Cappellini *et al.*, 1999; Low, 1991). Because macrophages contain Fc receptors on their surfaces, the damaged RBCs would presumably become bound to the surface of macrophages once a sufficient number of clusters of band 3 had formed. Sheep with chronic copper toxicity may become direct Coombs' test positive, indicating a possible *in vivo* role of antibody-mediated removal of oxidatively injured RBCs (Wilhelmsen, 1979).

## B. RBC Aging and Normal Life Spans

Most RBCs circulate in blood for a finite period (survival time or life span) that varies from 2 to 5 months in domestic animals, depending on the species (Table 7-1). Methods for measurement of RBC life spans and results of life span determinations from many species have been compiled (Vacha, 1983). RBC life spans are related to body weight (and consequently metabolic rate) with the smallest animals (highest metabolic rate) having the shortest RBC life spans (Vacha, 1983). The RBC life span can be prolonged by reducing the metabolic rate within an individual animal. Examples include thyroidectomy in rats, hibernation in hibernating mammals, and reduced ambient temperatures in poikilotherms (Landaw, 1988). A variety of changes occur in RBCs as they get older (Kosower, 1993; Low, 1991; Siems *et al.*, 2000), but the nature of the factor(s) that initiates age-related changes and the mechanism(s) of removal of senescent RBCs from the circulation require further clarification. Exposure of phosphatidylserine on the external surface, modified external membrane carbohydrate residues (e.g., desialation of sialoglycoproteins), or modified membrane proteins (e.g., partially degraded band 3) are possible signals for removal (Boas *et al.*, 1998; Kay, 2005; Kosower, 1993).

### 1. Metabolic Impairment

Because RBCs cannot synthesize new enzymes, one theory is that one or more critical enzymes, involved in generating ATP or in the protection against oxidants, may decrease to a point that metabolic impairment results in irreversible RBC membrane changes (Piomelli and Seaman, 1993). Although the inability to maintain normal ATP and NADPH concentrations appears to account for premature destruction of RBCs in patients with hereditary enzyme

deficiencies of the EMP and PPP, respectively, the theory that metabolic impairment occurs as a result of age-related decreases in critical enzymes has been questioned (Beutler, 1985; Zimran *et al.*, 1990). Much of the decline in activities of enzymes, considered in the past to be correlated with RBC age, occurs as reticulocytes mature into RBCs. Even if metabolic impairment is not the primary factor responsible for RBC senescence, it may render the aged RBC vulnerable to events in the circulation that require a burst of metabolic activity (Piomelli and Seaman, 1993).

### 2. Cumulative Oxidant Damage

Oxidative injury, especially near the end of their life span, appears to be responsible for normal RBC aging and removal (Kay, 2005; Kiefer and Snyder, 2000; Rettig *et al.*, 1999; Seppi *et al.*, 1991). Senescent dog RBCs exhibit increased membrane-bound, denatured globin and only 30% of normal GSH (Rettig *et al.*, 1999). Even reported decreases in RBC enzymes may be the result of oxidative damage (Stadtman, 1992). The presence of HzB in RBCs from splenectomized humans, horses, and dogs, and in RBCs from nonsplenectomized cats (Jain, 1986; Low, 1989), provides evidence for ongoing oxidant injury *in vivo*. The inverse correlation between RBC life span and metabolic rate discussed previously may result from differences in endogenous oxidant generation, but other factors such as differing amounts of mechanical stress should also be considered as a possible cause of this relationship (Landaw, 1988).

Oxidative stress promotes eryptosis that leads to externalization of phosphatidylserine. The damaged RBCs can be phagocytized by macrophages following binding to phosphatidylserine receptors such as CD36 (Kiefer and Snyder, 2000; Terpstra and van Berkel, 2000). An increased exposure of phosphatidylserine on the surface of aged rabbit RBCs correlates with their removal from the circulation (Boas *et al.*, 1998).

### 3. Senescent Cell Antigen

The appearance of a senescent cell antigen may be an important signal in the removal of senescent RBCs (Kay, 2005). This senescent cell antigen is derived from the band 3 anion transporter. The specific alteration required for band 3 to become antigenic remains to be clarified, but oxidative mechanisms are probably involved. Low (1991) has demonstrated copolymerization between hemichromes and band 3 and has suggested that the senescent antigen represents clusters of band 3. In contrast, studies by Kay (2005) suggest that the senescent cell antigen results from band 3 degradation rather than clustering.

A natural antibody against the senescent cell antigen is present in human plasma. This antibody binds to senescent cell antigens on the surface of aged cells and, together with bound complement, promotes the phagocytosis of aged RBCs by macrophages that exhibit Fc and C3b surface



receptors (Lutz *et al.*, 1991). Senescent dog RBCs accumulate surface-associated immunoglobulin, which is believed to promote their removal by macrophages (Rettig *et al.*, 1999). The relative importance of the immune- and nonimmune-mediated phagocytosis of senescent RBCs remains to be clarified.

### C. Anemia of the Newborn

Animals are generally born with hematocrits near values for adults. Following birth, there is a rapid decrease in hematocrit that is followed by a gradual increase to adult values (Jain, 1986). Factors involved to variable degrees in the development of the anemia of the newborn include the following: (1) absorption of colostrum proteins during the first day of life, which increases plasma volume through an osmotic effect (Harvey *et al.*, 1987; Mollerberg *et al.*, 1975); (2) decreased RBC production during the early neonatal period; (3) shortened life span of RBCs formed *in utero* (Kim and Luthra, 1977; Landaw, 1988; Lee *et al.*, 1976; Mueggler *et al.*, 1979); and (4) rapid growth with hemodilution resulting from expansion of total plasma volumes more rapidly than total RBC mass (Mueggler *et al.*, 1979).

In some species, production of RBCs is decreased because of low Epo concentrations at birth (Halvorsen and Halvorsen, 1974; Huisman *et al.*, 1969; Meberg, 1980; Meberg *et al.*, 1980; Schwartz and Gill, 1983). The decreased stimulus for Epo production may occur as a result of a placental blood transfusion that increases RBC mass immediately after birth (Rossdale and Ricketts, 1980), a rapid increase in  $pO_2$  associated with breathing air, and an increase in  $P_{50}$  as discussed previously.

Much of the postnatal anemia of dogs occurs as a physiological response to increased RBC 2,3DPG and subsequent improved oxygen transport (Mueggler *et al.*, 1981). The "anemia" of childhood in humans is also associated with RBC 2,3DPG above adult values. In children this increase appears to occur secondarily to increased plasma  $P_i$  concentrations (Card and Brain, 1973). Serum  $P_i$  values are also above adult values in young dogs (Pickrell *et al.*, 1974).

Although not involved in the early, rapid decrease in hematocrit, iron availability may limit the response to anemia in some rapidly growing animals (Chausow and Czarnecki-Maulden, 1987; Dhindsa *et al.*, 1971; Harvey *et al.*, 1987; Holman and Drew, 1966; Mollerberg *et al.*, 1975; Siimes *et al.*, 1980; Weiser and Kociba, 1983b).

## VI. INHERITED DISORDERS OF RBCS

Many hereditary disorders of RBCs have been described in humans, but a limited number of inherited RBC disorders have been identified in laboratory and domestic animals. RBC enzyme deficiencies in dogs, cats, and horses have recently been reviewed (Harvey, 2006). Congenital porphyrias are discussed elsewhere in this volume (Chapter 8).

## A. Cytosolic Enzyme Deficiencies

### 1. Phosphofructokinase Deficiency in Dogs

Autosomal recessive inherited PFK deficiency occurs in English springer spaniel (Giger *et al.*, 1985; Giger and Harvey, 1987; Harvey and Giger, 1991), American cocker spaniel (Giger *et al.*, 1992), mixed-breed (Giger, 2000), whippet (Hayes *et al.*, 2007), and wachtelhund (Tvedten and Rowe, 2007) dogs. Canine PFK is genetically controlled by three separate loci. They code for muscle (M)-, liver (L)-, and platelet (P)-type subunits (Vora *et al.*, 1985). Random tetramerization of the subunits produces various isozymes. PFK in normal dog RBCs consists of 86% M-type, 2% L-type, and 12% P-type subunits, and normal dog muscle is composed exclusively of M-type subunits (Mhaskar *et al.*, 1992).

Studies of brain and RBCs from homozygous-deficient dogs indicated that native M-type subunits were not present, but small amounts of a structurally unstable truncated M-type subunit were found (Mhaskar *et al.*, 1991, 1992). A single mutation in the M-type gene of deficient dogs converted a tryptophan codon to a stop codon, resulting in a loss of 40 amino acid residues (Smith *et al.*, 1996). As would be expected from the subunit composition of normal tissues, total RBC and muscle PFK activities are markedly reduced in affected dogs (Giger and Harvey, 1987; Vora *et al.*, 1985). Changes in concentrations of glycolytic intermediates in muscle and RBCs reflect the block at the PFK step (Harvey *et al.*, 1992a, 1992b). RBCs from affected dogs also exhibit altered enzyme kinetic properties because of the loss of the M-type subunit (Harvey *et al.*, 1992b).

Homozygously affected dogs have persistent compensated hemolytic anemias and sporadic episodes of intravascular hemolysis with hemoglobinuria (Giger *et al.*, 1985; Giger and Harvey, 1987; Harvey and Giger, 1991; Skibild *et al.*, 2001). RBC mean cell volumes are usually between 80 and 90fl. Reticulocyte counts are generally between 10% and 30%, with hematocrit values between 30% and 40% (Harvey and Smith, 1994), except during hemolytic crises when the hematocrit may decrease to 15% or less. Lethargy, weakness, pale or icteric mucous membranes, mild hepatosplenomegaly, muscle wasting, and fever as high as 41°C may occur during hemolytic crises (Giger and Harvey, 1987).

Hemolytic crises occur secondary to hyperventilation-induced alkalemia *in vivo*, and PFK-deficient dog RBCs are extremely alkaline fragile *in vitro* (Giger and Harvey, 1987). For unknown reasons, normal dog RBCs are more alkaline fragile than those of humans and other mammals studied (Iampietro *et al.*, 1967; Waddell, 1956). The even greater alkaline fragility of PFK-deficient dog RBCs results from decreased 2,3DPG, which is formed below the PFK reaction (Harvey *et al.*, 1988). Because 2,3DPG is the major impermeant anion in dog RBCs, a substantial decrease in its concentration results in a higher intracellular pH (Hladky and Rink, 1977) and thereby greater alkaline fragility than

normal dog RBCs. As expected, the low 2,3DPG concentration also results in an increased oxygen affinity of Hb in affected dog RBCs (Giger and Harvey, 1987).

Hematological parameters of affected dogs are similar to normal dogs at birth, because all newborn dogs have RBC PFK activities about three times that of normal adult dogs (Harvey and Reddy, 1989). This high PFK activity results from the presence of the L-type subunit of PFK, which is negligible in normal adult canine RBCs (Harvey and Reddy, 1989; Mhaskar *et al.*, 1992). Both total PFK activities and the amounts of L-type subunit present decrease dramatically during the first 6 to 8 weeks of life. The M-type subunit is low at birth, but increases as the L-type decreases in normal dogs. These changes result from the replacement of RBCs formed in the fetus with those formed after birth.

Deficient dogs generally exhibit less evidence of myopathy than is observed in PFK-deficient people, probably because canine skeletal muscle is less dependent on anaerobic glycolysis than human skeletal muscle, owing to a lack of the classical fast-twitch glycolytic (type IIB) fibers in dogs (Snow *et al.*, 1982). Affected dogs appear to tire more easily than normal, and *in vivo* muscle studies of PFK-deficient dogs indicate altered muscle function in these animals (Brechue *et al.*, 1994; Giger *et al.*, 1988b; McCully *et al.*, 1999). A severe progressive myopathy with associated abnormal polysaccharide deposits in skeletal muscle has been recognized in an aged PFK-deficient dog (Harvey *et al.*, 1990a). In contrast to PK deficiency, myelofibrosis and liver failure have not been recognized in dogs with PFK deficiency.

Homozygous affected animals over 3 months of age can easily be identified by measuring RBC PFK activity. Heterozygous carrier dogs have approximately one-half normal enzyme activities in RBCs (Harvey and Reddy, 1989). A DNA test using polymerase chain reaction technology has been developed that can clearly differentiate normal, carrier, and affected English springer spaniel dogs regardless of age (Giger *et al.*, 1995). This test is also positive in American cocker spaniel and whippet dogs with PFK deficiency (Giger *et al.*, 1992; Hayes *et al.*, 2007).

## 2. Pyruvate Kinase Deficiency in Dogs and Cats

PK deficiency occurs in basenji (Giger and Noble, 1991; Searcy *et al.*, 1971, 1979), beagle (Giger *et al.*, 1991; Harvey *et al.*, 1977; Prasse *et al.*, 1975), West Highland white terrier (Chapman and Giger, 1990), Cairn terrier (Schaer *et al.*, 1992), miniature poodle, Chihuahua, pug, dachshund, and toy American Eskimo dogs (Giger, 2000; Harvey, 1996). PK deficiency is transmitted as an autosomal recessive trait. Homozygously affected animals have decreased exercise tolerance, pale mucous membranes, tachycardia, and splenomegaly.

Affected animals have mild to moderate anemia with marked reticulocytosis when young (Harvey, 2006). Myelofibrosis and osteosclerosis develop in the bone marrow,

and hemochromatosis and cirrhosis develop in the liver as the dogs age (Searcy *et al.*, 1979; Weiden *et al.*, 1981). Hematocrit and reticulocyte counts decrease as myelofibrosis and osteosclerosis become severe (Whitney and Lothrop, 1995). Affected dogs generally die between 1 and 5 years of age because of bone marrow failure or liver failure (Giger, 2000; Zaucha *et al.*, 2001). It is proposed that the marrow fibrosis, like the cirrhosis, occurs in response to damage caused by iron overload (Zaucha *et al.*, 2001). However, factors associated with marked erythropoiesis may also contribute to the development of myelofibrosis (Bader *et al.*, 1992).

RBCs of affected dogs lack the normal adult R isozyme of PK but have a persistence of an M<sub>2</sub> isozyme that is normally present in many fetal and adult tissues, including erythroid precursor cells, but not in mature RBCs (Becker *et al.*, 1986; Black *et al.*, 1978; Whitney *et al.*, 1994). Consequently, many affected dogs have normal or increased PK activity, making it difficult to diagnose this defect based solely on total RBC PK activity. Heterozygous animals have approximately 50% of normal RBC PK activity.

The enzyme activity in hemolysates of affected dogs is unstable and decreases rapidly when samples are kept at room temperature (Standerfer *et al.*, 1974). If the M<sub>2</sub>-isozyme is unstable *in vivo*, as it is *in vitro*, its rapid loss of activity would explain the dramatically shortened life span of RBCs in this disorder (Dhindsa *et al.*, 1976).

Because the defect in glycolysis occurs below the diphosphoglycerate shunt, RBCs from PK-deficient dogs have increased concentrations of 2,3DPG (Harvey, 2006). As a consequence, the whole blood P<sub>50</sub> is higher than that of normal dogs (Dhindsa *et al.*, 1976).

Additional assays (an enzyme heat stability test, measurement of RBC glycolytic intermediates, electrophoresis of isozymes, and enzyme immunoprecipitation) may be used to reach a diagnosis of PK deficiency in dogs in which the total enzyme activity is not decreased (Giger and Noble, 1991; Harvey *et al.*, 1990b; Schaer *et al.*, 1992). The defect in basenji dogs is the result of a single nucleotide deletion in the R-type PK gene (Whitney *et al.*, 1994; Whitney and Lothrop, 1995). Unfortunately, different mutations in the R-type PK gene have been identified in other dog breeds (Giger, 2000; Skelly *et al.*, 1999). Consequently, different DNA-based diagnostic assays must be developed or validated for each affected dog breed. Fortunately, DNA-based tests for PK deficiency have been developed for several breeds of dogs (Giger, 2005).

RBC PK deficiency has been characterized in Abyssinian, Somali, and domestic shorthair cats (Ford *et al.*, 1992; Giger *et al.*, 1997; Mansfield and Clark, 2005). Affected cats have intermittent mild to moderate anemia that may be slightly macrocytic and hypochromic. Reticulocyte counts are slightly to markedly increased. Splenectomy may reduce the severity of the anemia in cats. In contrast to dogs in which the anemia is typically first recognized in young animals, some cats have not been diagnosed until they were old aged

(Giger, 2000). Total RBC PK activity is markedly reduced in deficient cats, with no evidence of the persistent M<sub>2</sub> isozyme reported in dogs (Ford *et al.*, 1992), and all PK-deficient cats identified thus far have had the same mutation (Giger, 2000; Giger *et al.*, 1997; Mansfield and Clark, 2005). Also in contrast to dogs, osteosclerosis has not been recognized in cats (Giger, 2000).

### 3. *Cytochrome- $\beta_5$ Reductase Deficiency in Dogs and Cats*

Persistent methemoglobinemia associated with RBC Cb<sub>5</sub>R deficiency has been recognized in chihuahua, borzoi, English setter, terrier-mix, cockapoo, coonhound, poodle, corgi, Pomeranian, toy American Eskimo, cocker-toy American Eskimo, and pit bull-mix dogs and in domestic shorthair cats (Atkins *et al.*, 1981; Fine *et al.*, 1999; Giger *et al.*, 1999; Harvey, 2000; Harvey *et al.*, 1974, 1991, 1994, Letchworth *et al.*, 1977). The deficiency appears to be an inherited autosomal recessive disorder, as it is in humans (Harvey, 2000). The nature of the enzyme deficiency is unknown; however, it does not appear to be the result of an FAD cofactor deficiency in dogs, because RBC glutathione reductase (another enzyme that requires FAD as a cofactor) activities were normal in three affected dogs assayed (Harvey, 2006).

Affected animals have cyanotic appearing mucous membranes and may exhibit lethargy or exercise intolerance at times, but they usually have no clinical signs of disease. Blood samples appear dark, suggesting hypoxemia, but arterial pO<sub>2</sub> values are normal. MetHb content in dogs with Cb<sub>5</sub>R deficiency varies from 13% to 41%. The MetHb content in five deficient domestic shorthair cats varied from 44% to 52% (Harvey, 2006). There is an inverse correlation between RBC enzyme activity and MetHb content in deficient dogs (Harvey, 2000). The hematocrit is usually normal in deficient dogs, but usually slightly to moderately increased in deficient cats, secondary to the chronic methemoglobinemia and resultant decreased blood oxygen content. Animals with Cb<sub>5</sub>R deficiency do not require treatment and have normal life expectancy (Harvey, 2006).

### 4. *Glucose-6-Phosphate Dehydrogenase Deficiency in a Dog and Horse*

G6PD deficiency is a very common X-linked inherited defect of human RBCs, affecting millions of people worldwide (Beutler, 1994). Smith *et al.* (1976) screened more than 3000 dogs for G6PD activity and found one male dog to have approximately 44% of normal activity. The enzyme was partially purified and characterized, and it was found to be similar to that of normal dogs. The deficient dog was not anemic and exhibited no clinical signs; studies were not done to determine whether his RBCs were more sensitive to oxidant damage than normal.

In contrast, a persistent hemolytic anemia and hyperbilirubinemia have been described in an American standard-bred colt with <1% of normal G6PD activity (Stockham *et al.*, 1994). Morphological abnormalities of RBCs included eccentrocytosis, pyknocytosis, increased anisocytosis, increased Howell-Jolly bodies, and rare Hb crystals. The presence of eccentrocytes in the absence of exposure to external oxidants indicated that the deficient RBCs did not have adequate metabolic capabilities to defend themselves against endogenous oxidants. Biochemical abnormalities in RBCs included low GSH, markedly reduced NADPH, and increased NADP<sup>+</sup>. RBC catalase activity was normal even though NADPH concentration was <1% of normal. It was suggested that catalase activity may have been maintained by the action of NADH. Polymerase chain reaction amplification of segments of the G6PD gene of the affected colt revealed a G to A mutation, converting an arginine codon to a histidine codon (Nonneman *et al.*, 1993).

### 5. *RBC FAD Deficiency and Resultant Enzyme Deficiencies in Horses*

RBC FAD deficiency has been recognized in an adult Spanish mustang mare (Harvey *et al.*, 2003) and in a 7-year-old Kentucky mountain saddle horse gelding (Harvey, 2006). FAD-deficient horses have persistent methemoglobinemia (25% to 46%), eccentrocytosis, pyknocytosis, and variable numbers of Hb crystals. No Heinz bodies were observed in RBCs stained with new methylene blue. Hematocrits were normal or slightly decreased. The presence of eccentrocytes and pyknocytes in the absence of administered or consumed oxidants indicates deficient metabolic protection against endogenously generated oxidants. RBC biochemical abnormalities measured include decreased Cb<sub>5</sub>R activity (about 40% of normal), decreased GSH concentration (about 60% of normal), and undetectable GR activity. The GR activity increased to near-normal values after addition of FAD to the enzyme assay, indicating a severe deficiency of FAD in RBCs. FAD is a cofactor for GR and Cb<sub>5</sub>R enzymes; consequently, both RBC enzyme deficiencies in these horses can be attributed to decreased RBC FAD concentrations.

The presence of eccentrocytes and pyknocytes were attributed to inadequate metabolic protection against endogenously generated oxidants, resulting from a marked deficiency in GR and resultant decreased GSH concentration within RBCs. The methemoglobinemia was attributable to Cb<sub>5</sub>R deficiency.

Following transport into RBCs, riboflavin is first converted to flavin mononucleotide (FMN) by riboflavin kinase and then to FAD by FMN adenylyltransferase. Measurements of RBC flavin concentrations suggest a defect in the riboflavin kinase reaction. Systemic signs attributable to a generalized defect in riboflavin metabolism are absent, suggesting that the defect may be limited to RBCs.

Laboratory findings in these horses were similar to those from two related trotter mares that were reported to have persistent hemolytic anemia, methemoglobinemia, GR deficiency, and decreased GSH concentrations within RBCs (Dixon and McPherson, 1977). However, the GR deficiency did not appear to result from FAD deficiency, and the Cb<sub>5</sub>R activity was reportedly normal.

### 6. Gamma-Glutamylcysteine Synthetase Deficiency in Sheep

An autosomal dominant inherited deficiency in RBC GSH in Corriedale and Merino sheep results from low levels of gamma-glutamylcysteine synthetase (GCS), the first enzyme involved in GSH synthesis (Fisher *et al.*, 1986; Smith *et al.*, 1973). Although the specific activity of the enzyme is low, the molecular weight,  $K_m$  values for glutamate and cysteine,  $K_i$  for GSH, and other characteristics of purified GCS from deficient sheep are remarkably similar to those from normal sheep (Board *et al.*, 1980). Deficient sheep have only about 20% to 30% of normal RBC GSH but exhibit no clinical signs, are not anemic, and have normal RBC life spans (Smith *et al.*, 1973). A similar RBC GSH-deficient syndrome has been reported in Spanish Churra sheep (Bayon *et al.*, 1994). Although RBCs from these low-GSH sheep do not appear to have greater susceptibility to injury by superoxide or hydrogen peroxide than do RBCs from high-GSH sheep (Eaton *et al.*, 1989), they do exhibit greater HzB formation when exposed to acetylphenylhydrazine *in vitro* (Goto *et al.*, 1993) and kale feeding *in vivo* (Tucker *et al.*, 1981).

## B. Membrane Abnormalities

### 1. Hereditary Stomatocytosis in Dogs

Stomatocytes are uniconcave or cup-shaped RBCs that have slitlike areas of central pallor on stained blood films. Stomatocytosis is recognized in association with three different inherited syndromes in dogs. All disorders appear to be transmitted as autosomal recessive traits. Hereditary stomatocytosis also consists of a heterogeneous group of disorders in humans (Delaunay, 2004).

No clinical signs occur in miniature schnauzers (Brown *et al.*, 1994b; Giger *et al.*, 1988a), standard schnauzers (Bonfanti *et al.*, 2004), or a Pomeranian (Harvey, 2001) with stomatocytosis. Chondrodysplasia (short-limbed dwarfism) occurs along with stomatocytosis in Alaskan malamutes (Fletcher *et al.*, 1975; Pinkerton *et al.*, 1974). This disorder is deforming but not life threatening. The syndrome in Drentse patrijshond dogs has been termed *familial stomatocytosis-hypertrophic gastritis* (Slappendel *et al.*, 1991). Affected animals have polysystemic disease with growth retardation, diarrhea, polyuria/polydipsia, hind limb weakness, pale or icteric mucous membranes, and a somnolent mental state.

Pathological findings include hypertrophic gastritis, progressive liver disease, polyneuropathy, and renal cysts. Affected Drentse patrijshond dogs are usually euthanized by the time they reach young adulthood because of a progressive deterioration in clinical condition.

Hb values and RBC counts are low-normal or slightly reduced, but hematocrits are normal in malamutes, schnauzers, and Pomeranians. The MCV is increased and MCHC decreased even though reticulocyte counts are normal or only slightly increased. Affected Drentse patrijshond dogs have lower hematocrits and higher reticulocyte counts than those found in the other breeds (Slappendel *et al.*, 1991; Slappendel *et al.*, 1994). The MCHC is moderately decreased, but the MCV is normal or only slightly increased. RBCs from all breeds have increased osmotic fragility and shortened RBC survival.

Although the specific defects are not known, the pathogenesis of stomatocyte formation in malamutes, schnauzers, and Pomeranians is attributed to an increase in monovalent cations, and consequently increased water content of RBCs caused by abnormal membrane permeability (Giger *et al.*, 1988a; Paltrinieri *et al.*, 2007; Pinkerton *et al.*, 1974). The swelling associated with water accumulation accounts for the increased MCV and decreased MCHC values in affected dogs. Stomatocytosis in these breeds resembles overhydrated hereditary stomatocytosis in humans, a disease characterized by a reduced or absent stomatin expression (Fricke *et al.*, 2003). However, standard schnauzers with hereditary stomatocytosis exhibit normal stomatin expression (Paltrinieri *et al.*, 2007). The GSH content in affected RBCs is about 50% to 60% of normal (Giger *et al.*, 1988a; Harvey, 2001; Pinkerton *et al.*, 1974). This GSH deficiency appears to occur from increased catabolism, but the mechanism responsible is unknown (Smith *et al.*, 1983b).

In contrast to malamutes and schnauzers with stomatocytosis, RBCs from affected Drentse patrijshond dogs do not have increased total monovalent cations, and cell water is only slightly increased; consequently, stomatocyte formation appears to be caused by a different mechanism (Slappendel *et al.*, 1994). The composition of phospholipids and cholesterol in plasma and RBC membranes is abnormal in these dogs (Slappendel *et al.*, 1994). The authors suggest that a defect in lipid metabolism results in altered membrane lipid composition and a loss or contracture of membrane components.

### 2. Hereditary Elliptocytosis in Dogs

Hereditary elliptocytosis is a common disorder of RBC shape in humans of African and Mediterranean ancestry. There is a mechanical weakness or fragility of the RBC membrane skeleton resulting from defects in  $\alpha$ -spectrin,  $\beta$ -spectrin, or protein 4.1 (Gallagher, 2004).

Persistent elliptocytosis and microcytosis have been described in a crossbred dog that lacked RBC membrane

protein 4.1 (Smith *et al.*, 1983a). Although the animal was not anemic, the reticulocyte count was about twice normal in compensation for a shortened RBC life span. This dog was an offspring of a father-daughter mating. Both parents had decreased band 4.1 and some elliptocytes.

Persistent marked elliptocytosis was recognized as an incidental finding in a Labrador-chow crossbred dog (Di Terlizzi *et al.*, 2007). Occasional microspherocytes and rare RBCs containing Hb crystals were also present. RBC membrane mechanical stability and deformability were reduced. Further analysis revealed a decreased ability of spectrin to form tetramers because of a defect in  $\beta$ -spectrin.

### 3. Hereditary Spherocytosis in Cattle

Severe hemolytic anemia with icterus and splenomegaly is present shortly after birth in Japanese black cattle that lack band 3 in their RBC membranes (Inaba, 2000). The mortality rate is high in affected animals, especially during the first week of life. Those that survive exhibit persistent mild hemolytic anemia (hematocrit 25% to 35%) with marked spherocytosis and anisocytosis, but not reticulocytosis (Inaba, 2000; Inaba *et al.*, 1996). Slight acidosis and growth retardation are present. Affected RBCs also have reduced amounts of other membrane proteins, including spectrin, ankyrin, actin, and protein 4.2. RBCs exhibit defective anion transport and a disrupted membrane skeletal network that makes them extremely unstable. Spherocyte formation results from a loss of surface area by invagination, vesiculation, and extrusion of microvesicles, and fragmentation. This defect is inherited as an autosomal dominant trait. RBCs from carrier cattle that are heterozygous for this defect have decreased band 3 (about 30% of normal), impaired anion transport, and mild spherocytosis, but hematocrits are generally normal. Osmotic fragility was increased in both heterozygous and homozygous cattle. This defect demonstrates the functional importance of the association of band 3 with skeletal proteins in maintaining membrane stability.

### 4. Hereditary Spectrin Deficiency in Dogs with Increased Osmotic Fragility

Increased RBC osmotic fragility secondary to spectrin deficiency (50% to 70% of normal) has been reported as a common autosomal dominant trait in golden retriever dogs in the Netherlands (Slappendel *et al.*, 2005). Hematocrits and reticulocyte counts are within reference intervals. Although originally reported as hereditary spherocytosis (Slappendel, 1998), spherocytes are not recognizable on stained-blood films. Rather, RBCs from affected dogs exhibited abundant echinospherocytes after 24h of incubation at room temperature. In contrast, control dog RBCs exhibited only slight echinocyte formation after incubation. The nature of the spectrin defect has not been reported, but it is presumably different from the  $\beta$ -spectrin defect described in a dog that caused elliptocyte formation (Di Terlizzi *et al.*, 2007).

### 5. Hemolytic Anemia with Increased RBC Osmotic Fragility in Cats

A hemolytic anemia with markedly increased osmotic fragility has been reported in Abyssinian and Somali cats (Kohn *et al.*, 2000). Splenomegaly and polyclonal hyperglobulinemia were common. The hematocrit was generally between 15% and 25%, but values as low as 5% were recognized. A macrocytosis with mild to moderate reticulocytosis was present in most cats. Most samples exhibited extreme hemolysis after 1 day of refrigeration; however, *in vivo* hemolysis also occurred, as evidenced by hemoglobinuria in some cats. An RBC membrane defect was suspected, but none was identified using conventional membrane protein electrophoresis.

### 6. Amino Acid Transport Deficiency in Sheep and Horses

A second type of GSH deficiency, inherited as an autosomal recessive trait, occurs in Finnish Landrace sheep (Tucker and Kilgour, 1970). Although affected animals are not anemic, the life span of deficient RBCs is shortened (Tucker, 1974), possibly from increased oxidant injury as evidenced by the presence of HzB. These sheep are more likely to become anemic following the administration of oxidants *in vivo* (Tucker *et al.*, 1981).

The amino acid transporter normally responsible for cysteine transport (system C) into RBCs is defective (Young *et al.*, 1975), thereby limiting cysteine uptake and restricting GSH synthesis. As a consequence, GSH concentrations in RBCs are about 30% of normal (Young *et al.*, 1975). Intracellular  $\text{Na}^+$  and  $\text{K}^+$  are decreased, because dibasic and other amino acids accumulate in this disorder (Ellory *et al.*, 1972). The transport deficiency appears to develop during reticulocyte maturation, and intracellular amino acids accumulating in these cells are believed to come from protein degradation during reticulocyte maturation (Tucker and Young, 1980). When RBCs are separated by age, using density gradients, intracellular GSH decreases and HzB numbers increase in older RBCs from system C-deficient sheep, but not from normal or GCS-deficient sheep (Tucker and Young, 1980). This decreasing GSH with RBC age may explain why system C-deficient sheep are more susceptible to oxidants than are GCS-deficient ones, even though they have similar whole blood GSH levels.

About 30% of Thoroughbred horses and 3% of ponies are deficient in a similar amino acid transporter. The lesion results in increased amino acid levels and GSH deficiency in some cases (Fincham *et al.*, 1985).

### 7. High Membrane $\text{Na}^+, \text{K}^+$ -ATPase Activity in Dogs

Although dog reticulocytes have considerable membrane  $\text{Na}^+, \text{K}^+$ -ATPase ( $\text{Na}^+, \text{K}^+$ -pump) activity, it is rapidly lost

during maturation into mature RBCs in most dogs (Maede and Inaba, 1985). Consequently, RBCs from most dogs have low potassium concentrations owing to the absence of  $\text{Na}^+, \text{K}^+$ -pump activity (Parker, 1977). However, some Japanese mongrel dogs, some Japanese Akita dogs, some Japanese Shiba dogs, and some Korean dogs (especially Jindo dogs) have  $\text{HK}^+$  RBCs, because the  $\text{Na}^+, \text{K}^+$ -pump is retained in mature RBCs (Degen, 1987; Fujise *et al.*, 1997a; Maede *et al.*, 1983, 1991; Yamato *et al.*, 1999). Clinically, these dogs appear normal. This trait is inherited in an autosomal recessive manner.  $\text{HK}^+$  dog RBCs have higher MCV, lower MCHC, and similar MCH values compared to  $\text{LK}^+$  dogs of the same breed, suggesting an increase in cell water (Maede *et al.*, 1983). Although dogs with  $\text{HK}^+$  RBCs are not anemic, their RBCs have shortened life spans (Maede and Inaba, 1987), and some dogs have slightly increased reticulocyte counts (Maede *et al.*, 1983). The osmotic fragility was increased in mongrel dogs (Maede *et al.*, 1983), but not in Jindo dogs (Yamato *et al.*, 1999).

RBCs from most of these dogs also have high GSH, glutamate, glutamine, and aspartate concentrations secondary to increased glutamate and aspartate uptake. GSH concentration is increased five to seven times normal because the feedback inhibition of GCS by GSH is released by the markedly increased glutamate concentration (Maede *et al.*, 1982). These  $\text{HK}^+$ , high GSH RBCs promote *Babesia gibsoni* replication compared to  $\text{LK}^+$ , normal GSH RBCs (Yamasaki *et al.*, 2005).

Dog RBCs have a high affinity  $\text{Na}^+$ -dependent transport system for glutamate and aspartate (Young, 1983). The increased transport of these amino acids into RBCs of affected dogs apparently occurs as a consequence of the  $\text{Na}^+$  and  $\text{K}^+$  concentration gradients produced by the presence of a  $\text{Na}^+, \text{K}^+$ -ATPase activity three times higher than that of human RBCs (Inaba and Maede, 1984). The glycolytic rate of  $\text{HK}^+$  dog RBCs is about twice that of  $\text{LK}^+$  cells, because greater ATP production is required to provide energy for active cation transport by the  $\text{Na}^+, \text{K}^+$ -pump and for increased GSH synthesis (Maede and Inaba, 1987).

The high GSH concentration in the  $\text{HK}^+$  dog RBCs provides increased protection against oxidative damage induced by acetylphenylhydrazine (Ogawa *et al.*, 1992) but increased susceptibility to oxidative damage induced by 4-aminophenyl disulfide (Maede *et al.*, 1989), n-propylthiosulfate (Inaba, 2000), and onions (Yamato and Maede, 1992). Evidence suggests that the increased GSH concentration potentiates the generation of superoxide through its redox reaction with organosulfur compounds present in onions (Munday *et al.*, 2003).

A variant of this  $\text{HK}^+$  RBC disorder has been reported in dogs that lack GSH accumulation (Fujise *et al.*, 1993, 1997b). It was suggested that these dogs had a defect in amino acid metabolism in addition to the persistence of the  $\text{Na}^+, \text{K}^+$ -pump. Potassium concentration was estimated to be increased in RBCs from a Chinese shar-pei dog that was evaluated to determine the cause of pseudohyperkalemia (Battison,

2007). Increased osmotic fragility was present along with some macrocytic hypochromic RBCs. RBC  $\text{Na}^+, \text{K}^+$ -ATPase activity and GSH concentration were not assayed.

## C. Miscellaneous Abnormalities

### 1. Familial Nonspherocytic Hemolytic Anemia in Poodles

A nonspherocytic hemolytic anemia occurs in poodles (Randolph *et al.*, 1986). An autosomal dominant trait with incomplete penetrance mode of transmission was suggested. Affected animals had severe persistent macrocytic hypochromic anemia (hematocrits 13% to 31%) with marked reticulocytosis. As in dogs with PK deficiency, myelofibrosis, osteosclerosis, and excess iron deposition in hepatocytes and mononuclear phagocytes were observed at necropsy. One dog died when 2.5 years old with liver failure. Despite extensive studies, the defect in this disorder could not be determined, but PK deficiency cannot be ruled out.

### 2. Hereditary Nonspherocytic Hemolytic Anemia in Beagles

A mild hemolytic anemia with reticulocytosis, slightly increased RBC osmotic fragility, shortened RBC life span, and normal RBC morphology have been reported in beagle dogs (Maggio-Price *et al.*, 1988). Studies of RBC enzymes, membrane protein electrophoresis, and Hb failed to identify a defect. Decreased calcium pump ATPase activity (Hinds *et al.*, 1989) and accelerated RBC swelling under osmotic stress (Pekow *et al.*, 1992) have been reported in RBCs from anemic dogs, but these abnormalities may be the consequence of an unknown membrane defect rather than representing primary abnormalities. Although the etiology remains elusive, this abnormality appears to be transmitted as an autosomal recessive trait.

### 3. Familial Erythrocytosis in Cattle

Marked erythrocytosis (hematocrits 60% to 80%) has been described in calves from a highly inbred Jersey herd (Tennant *et al.*, 1967, 1969). Affected calves had normal Hb types and arterial blood gas values. As with normal calves, hematocrits were within the adult range at birth, fell during the first month of life, and then increased during the next 2 months. In contrast to normal calves, however, the hematocrit continued to increase in affected calves until 6 to 7 months of age. The majority of affected calves died during this time. Hematocrits of surviving animals returned slowly to normal by maturity. Serum of affected calves lacked measurable Epo but contained a growth factor that appeared to enhance Epo activity *in vitro* (Van Dyke *et al.*, 1968). The pathogenesis of this disorder may involve an abnormally controlled increased RBC production in response to the anemia of the neonate (Tennant *et al.*, 1969). A variety of familial and congenital erythrocytosis syndromes have been

described in people. They include altered hypoxia sensing, Epo receptor gene mutations, high affinity Hbs, and 2,3DPG deficiency (Gordeuk *et al.*, 2005; Rives *et al.*, 2007).

## REFERENCES

- Abboud, C. N., and Lichtman, M. A. (2006). Structure of the marrow and the hematopoietic microenvironment. In "Williams Hematology" (M. A. Lichtman, E. Beutler, T. J. Kipps, U. Seligsohn, K. Kaushansky, and J. T. Prchal, Eds.), pp. 35–72. McGraw-Hill, New York.
- Abkowitz, J. L. (1991). Retrovirus-induced feline pure red blood cell aplasia: Pathogenesis and response to suramin. *Blood* **77**, 1442–1451.
- Abkowitz, J. L., Catlin, S. N., McCallie, M. T., and Gutter, P. (2002). Evidence that the number of hematopoietic stem cells per animal is conserved in mammals. *Blood* **100**, 2665–2667.
- Abraham, N. G. (1991). Molecular regulation: biological role of heme in hematopoiesis. *Blood Rev.* **5**, 19–28.
- Accorsi, A., Fazi, A., Ninfali, P., Piatti, E., Palma, F., Piacentini, M. P., and Fornaini, G. (1985). Glucose-1,6-P2 synthesis, phosphoglucomutase and phosphoribomutase correlate with glucose-1,6-P2 concentration in mammals red blood cells. *Comp. Biochem. Physiol. [B]* **80**, 839–842.
- Adams, L. G., Hardy, R. M., Weiss, D. J., and Bartges, J. W. (1993). Hypophosphatemia and hemolytic anemia associated with diabetes mellitus and hepatic lipidosis in cats. *J. Vet. Intern. Med.* **7**, 266–271.
- Agar, N. S., and Board, P. G. (1983). Red cell metabolism. In "Red Blood Cells of Domestic Mammals" (N. S. Agar and P. G. Board, Eds.), pp. 227–251. Elsevier, Amsterdam.
- Agar, N. S., Gruca, M., and Harley, J. D. (1974a). Studies on glucose-6-phosphate dehydrogenase, glutathione reductase and regeneration of reduced glutathione in the red blood cells of various mammalian species. *Aust. J. Exp. Biol. Med. Sci.* **52**, 607–614.
- Agar, N. S., Gruca, M., and Harley, J. D. (1974b). Studies on glucose-6-phosphate dehydrogenase, glutathione reductase and regeneration of reduced glutathione in the red blood cells of various mammalian species. *Aust. J. Exp. Biol. Med. Sci.* **52**, 607–614.
- Agar, N. S., Harley, J. D., Gruca, M. A., and Roberts, J. (1977). Erythrocyte 2,3-diphosphoglycerate in anaemic sheep. *Experientia* **33**, 275–277.
- Agar, N. S., Sadrzadeh, S. M. H., Hallaway, P. E., and Eaton, J. W. (1986). Erythrocyte catalase. A somatic oxidant defense? *J. Clin. Invest.* **77**, 319–321.
- Agar, N. S., and Smith, J. E. (1973). Erythrocyte enzymes and glycolytic intermediates of high- and low-glutathione sheep. *Anim. Blood Groups Biochem. Genet.* **4**, 133–140.
- Agar, N. S., and Smith, J. E. (1974). Erythrocyte metabolism in the goat. *Int. J. Biochem.* **5**, 49–52.
- Agar, N. S., Suzuki, T., Roberts, J., and Evans, J. V. (1983). Effect of anaemia on red cell metabolism in cattle. *Comp. Biochem. Physiol. [B]* **75B**, 445–449.
- Agre, P., and Cartron, J. P. (1991). Molecular biology of the Rh antigens. *Blood* **78**, 551–563.
- Allen, D. W., and Jandl, J. H. (1961). Oxidative hemolysis and precipitation of hemoglobin. II. Role of thiols in oxidant drug action. *J. Clin. Invest.* **40**, 454–475.
- Allen, D. W., and Manning, N. (1994). Abnormal phospholipid metabolism in spur cell anemia: decreased fatty acid incorporation into phosphatidylethanolamine and increased incorporation into acylcarnitine in spur cell anemia erythrocytes. *Blood* **84**, 1283–1287.
- Allison, A. C., Reese, W. A., and Burn, G. P. (1957). Genetically-controlled differences in catalase activity of dog erythrocytes. *Nature* **180**, 649–650.
- Alsaker, R. D. (1977). The formation, emergence, and maturation of the reticulocyte: a review. *Vet. Clin. Pathol.* **6**(3), 7–12.
- Alward, A., Corriher, C. A., Barton, M. H., Sellon, D. C., Blikslager, A. T., and Jones, S. L. (2006). Red maple (*Acer rubrum*) leaf toxicosis in horses: a retrospective study of 32 cases. *J. Vet. Intern. Med.* **20**, 1197–1201.
- Anderson, P. H., Berrett, S., and Patterson, D. S. (1978). Glutathione peroxidase activity in erythrocytes and muscle of cattle and sheep and its relationship to selenium. *J. Comp. Pathol.* **88**, 181–189.
- Address, J. L., Day, T. K., and Day, D. (1995). The effects of consecutive day propofol anesthesia on feline red blood cells. *Vet. Surg.* **24**, 277–282.
- Andrewartha, K. A., and Caple, I. W. (1980). Effects of changes in nutritional copper on erythrocyte superoxide dismutase activity in sheep. *Res. Vet. Sci.* **28**, 101–104.
- Andrews, G. A. (2000). Red blood cell antigens and blood groups in the dog and cat. In "Schalm's Veterinary Hematology" (B. F. Feldman, J. G. Zinkl, and N. C. Jain, Eds.), pp. 767–773. Lippincott Williams & Wilkins, Philadelphia.
- Andrews, G. A., Chavey, P. S., Smith, J. E., and Rich, L. (1992). N-glycolylneuraminic acid and N-acetylneuraminic acid define feline blood group A and B antigens. *Blood* **79**, 2485–2491.
- Ansari, G. A., Singh, S. V., Gan, J. C., and Awasthi, Y. C. (1987). Human erythrocyte glutathione S-transferase: a possible marker of chemical exposure. *Toxicol. Lett.* **37**, 57–62.
- Arai, T., Washizu, T., Sako, T., Sasaki, M., and Motoyoshi, S. (1992). D-glucose transport activities in erythrocytes and hepatocytes of dogs, cats and cattle. *Comp. Biochem. Physiol. [A]* **102A**, 285–287.
- Arese, P., and De Flora, A. (1990). Denaturation of normal and abnormal erythrocytes II. Pathophysiology of hemolysis in glucose-6-phosphate dehydrogenase deficiency. *Semin. Hematol.* **27**, 1–40.
- Arosio, P., and Levi, S. (2002). Ferritin, iron homeostasis, and oxidative damage. *Free Radic. Biol. Med.* **33**, 457–463.
- Asakura, T., Sato, Y., Minakami, S., and Yoshikawa, H. (1966). Effect of deoxygenation of intracellular hemoglobin on red cell glycolysis. *J. Biochem.* **5**, 524–526.
- Ash-Bernal, R., Wise, R., and Wright, S. M. (2004). Acquired methemoglobinemia: a retrospective series of 138 cases at 2 teaching hospitals. *Medicine (Baltimore)* **83**, 265–273.
- Atkins, C. E., Kaneko, J. J., and Congdon, L. L. (1981). Methemoglobin reductase deficiency and methemoglobinemia in a dog. *J. Am. Anim. Hosp. Assoc.* **17**, 829–832.
- Auclair, S., Feillet-Coudray, C., Coudray, C., Schneider, S., Muckenthaler, M. U., and Mazur, A. (2006). Mild copper deficiency alters gene expression of proteins involved in iron metabolism. *Blood Cells Mol. Dis.* **36**, 15–20.
- Auer, L., and Bell, K. (1983). Transfusion reactions in cats due to AB blood group incompatibilities. *Res. Vet. Sci.* **35**, 145–152.
- Aufderheide, W. M., Parker, H. R., and Kaneko, J. J. (1980). The metabolism of erythrocyte 2,3-diphosphoglycerate in the developing sheep (*Ovis aries*). *Comp. Biochem. Physiol. [A]* **65A**, 393–398.
- Bababunmi, E. A., Olorunsogo, O. O., and Bewaji, C. O. (1991). Comparative properties of erythrocyte calcium-transporting enzyme in different mammalian species. *World Rev. Nutr. Diet.*

- Bader, R., Bode, G., Rebel, W., and Lexa, P. (1992). Stimulation of bone marrow by administration of excessive doses of recombinant human erythropoietin. *Pathol. Res. Pract.* **188**, 676–679.
- Baerlocher, G. M., Schlappritzi, E., Straub, P. W., and Reinhart, W. H. (1994). Erythrocyte deformability has no influence on the rate of erythrophagocytosis *in vitro* by autologous human monocytes/macrophages. *Br. J. Haematol.* **86**, 629–634.
- Bai, S. C., Sampson, D. A., Morris, J. G., and Rogers, Q. R. (1989). Vitamin B-6 requirement of growing kittens. *J. Nutr.* **119**, 1020–1027.
- Baldwin, S. A. (1993). Mammalian passive glucose transporters: members of a ubiquitous family of active and passive transport proteins. *Biochim. Biophys. Acta* **1154**, 17–49.
- Ban, A., Ogata, Y., Kato, T., Watanabe, D., Sakai, J., Okada, K., Sako, T., Suzuki, K., and Motoyoshi, S. (1995). Erythrocyte morphology and the frequency of spherocytes in hereditary erythrocyte membrane protein disorder in Japanese black cattle. *Bull. Nippon Vet. Anim. Sci. Univ.* **44**, 21–27.
- Bårdgard, A. J., Strand, I., Nuutinen, M., Jul, E., and Brix, O. (1997). Functional characterisation of eskimo dog hemoglobin .1. Interaction of Cl<sup>-</sup> and 2,3-DPG and its importance to oxygen unloading at low temperature. *Comp. Biochem. Physiology. A: Comp. Physiol.* **117A**, 367–373.
- Barker, J. E., Pierce, J. E., and Nienhuis, A. W. (1980). Hemoglobin switching in sheep: a comparison of the erythropoietin-induced switch to HbC and the fetal to adult hemoglobin switch. *Blood* **56**, 488–494.
- Baron, M. H., and Fraser, S. T. (2005). The specification of early hematopoiesis in the mammal. *Curr. Opin. Hematol.* **12**, 217–221.
- Barvitenko, N. N., Adragna, N. C., and Weber, R. E. (2005). Erythrocyte signal transduction pathways, their oxygenation dependence and functional significance. *Cell Physiol Biochem.* **15**, 1–18.
- Baskurt, O. K., and Meiselman, H. J. (1999). Susceptibility of equine erythrocytes to oxidant-induced rheologic alterations. *Am. J. Vet. Res.* **60**, 1301–1306.
- Battaglia, F. C., McGaughey, H., Makowski, E. L., and Meschia, G. (1970). Postnatal changes in oxygen affinity of sheep red cells: a dual role of diphosphoglyceric acid. *Am. J. Physiol.* **219**, 217–221.
- Battison, A. (2007). Apparent pseudohyperkalemia in a Chinese Shar Pei dog. *Vet. Clin. Pathol.* **36**, 89–93.
- Battistini, A., Coccia, E.-M., Marziali, G., Bulgarini, D., Scalzo, S., Fiorucci, G., Romeo, G., Affabris, E., Testa, U., Rossi, G. B., and Peschle, C. (1991). Intracellular heme coordinately modulates globin chain synthesis, transferrin receptor number, and ferritin content in differentiating Friend erythroleukemia cells. *Blood* **78**, 2098–2103.
- Bauer, A., Tronche, F., Wessely, O., Kellendonk, C., Reichardt, H. M., Steinlein, P., Schutz, G., and Beug, H. (1999). The glucocorticoid receptor is required for stress erythropoiesis. *Genes Dev.* **13**, 2996–3002.
- Bauer, J. E., Harvey, J. W., Asquith, R. L., McNulty, P. K., and Kivipelto, J. (1984). Clinical chemistry reference values of foals during the first year of life. *Equine Vet. J.* **16**, 361–363.
- Baumann, R., Teischel, F., Zoch, R., and Bartels, H. (1973). Changes in red cell 2,3-diphosphoglycerate concentration as cause of the postnatal decrease of pig blood oxygen affinity. *Resp. Physiol.* **19**, 153–161.
- Bayon, Y., Arranz, J. J., and San, P. F. (1994). Red cell reduced glutathione concentrations in Spanish Churra sheep. *Anim Genet.* **25**, 277–279.
- Becker, K. J., Geyer, H., Eigenbrodt, E., and Schoner, W. (1986). Purification of pyruvate kinase isoenzymes type M<sub>1</sub> and M<sub>2</sub> from dog (*Canis familiaris*) and comparison of their properties with those from chicken and rat. *Comp. Biochem. Physiol. [B]* **83B**, 823–829.
- Beilstein, M. A., and Whanger, P. D. (1983). Distribution of selenium and glutathione peroxidase in blood fractions from humans, rhesus and squirrel monkeys, rats and sheep. *J. Nutr.* **113**, 2138–2146.
- Bellingham, A. J., Detter, J. C., and Lenfant, C. (1971). Regulatory mechanisms of hemoglobin oxygen affinity in acidosis and alkalosis. *J. Clin. Invest.* **50**, 700–706.
- Benesch, R., Benesch, R. E., and Bauer, C. (1975). Interaction of oxygen and carbon dioxide with hemoglobin at the molecular level. In “The Red Blood Cell” (D. M. Surgenor, Ed.), pp. 825–839. Academic Press, New York.
- Bessis, M. (1973). “Living Blood Cells and Their Ultrastructure.” Springer-Verlag, New York.
- Beutler, E. (1984). “Red Cell Metabolism. A Manual of Biochemical Methods.” Grune & Stratton, Orlando.
- Beutler, E. (1985). How do red cell enzymes age? A new perspective. *Br. J. Haematol.* **61**, 377–384.
- Beutler, E. (1989). Nutritional and metabolic aspects of glutathione. *Ann. Rev. Nutr.* **9**, 287–302.
- Beutler, E. (1994). G6PD deficiency. *Blood* **84**, 3613–3636.
- Beutler, E. (1995a). Composition of the erythrocyte. In “Williams Hematology” (E. Beutler, M. A. Lichtman, B. S. Collier, and T. J. Kipps, Eds.), pp. 364–369. McGraw-Hill, New York.
- Beutler, E. (1995b). Hereditary and acquired sideroblastic anemias. In “Williams Hematology” (E. Beutler, M. A. Lichtman, B. S. Collier, and T. J. Kipps, Eds.), pp. 747–750. McGraw-Hill, New York.
- Beutler, E. (2006). Disorders of iron metabolism. In “Williams Hematology” (M. A. Lichtman, E. Beutler, T. J. Kipps, U. Seligsohn, K. Kaushansky, and J. T. Prchal, Eds.), pp. 511–553. McGraw-Hill, New York.
- Bexfield, N., Archer, J., and Herrtage, M. (2007). Heinz body haemolytic anaemia in a dog secondary to ingestion of a zinc toy: a case report. *Vet. J.* **174**, 414–417.
- Black, J. A., Rittenberg, M. B., Standerfer, R. J., and Peterson, J. S. (1978). Hereditary persistence of fetal erythrocyte pyruvate kinase in the basenji dog. *Prog. Clin. Biol. Res.* **21**, 275–290.
- Blais, M. C., Berman, L., Oakley, D. A., and Giger, U. (2007). Canine Dal blood type: a red cell antigen lacking in some Dalmatians. *J. Vet. Intern. Med.* **21**, 281–286.
- Blom, B., and Spits, H. (2006). Development of human lymphoid cells. *Annu. Rev. Immunol.* **24**, 287–320.
- Blostein, R., and Grafova, E. (1990). Decrease in Na<sup>+</sup>-K<sup>+</sup>-ATPase associated with maturation of sheep reticulocytes. *Am. J. Physiol. Cell Physiol.* **259**, C241–C250.
- Blue, J., and Weiss, L. (1981). Vascular pathways in nonsinusoidal red pulp: an electron microscope study of the cat spleen. *Am. J. Anat.* **161**, 135–168.
- Blue, J. T., French, T. W., and Kranz, J. S. (1988). Non-lymphoid hemopoietic neoplasia in cats: a retrospective study of 60 cases. *Cornell Vet.* **78**, 21–42.
- Blunt, M. H. (1972). Hemoglobin function in the developing goat and sheep. *Anim. Blood Groups Biochem. Genet.* **3**, 211–217.
- Blunt, M. H., Kitchens, J. L., Mayson, S. M., and Huisman, T. H. J. (1971). Red cell 2,3-diphosphoglycerate and oxygen affinity in newborn goats and sheep. *Proc. Soc. Exp. Biol. Med.* **138**, 800–803.
- Board, P. G., and Agar, N. S. (1983). Glutathione metabolism in erythrocytes. In “Red Blood Cells of Domestic Mammals” (N. S. Agar and P. G. Board, Eds.), pp. 253–270. Elsevier, Amsterdam.
- Board, P. G., Smith, J. E., Moore, K., and Ou, D. (1980). Erythrocyte  $\gamma$ -glutamylcysteine synthetase from normal and low-glutathione sheep. *Biochim. Biophys. Acta*, **613**, 534–541.



- Boas, F. E., Forman, L., and Beutler, E. (1998). Phosphatidylserine exposure and red cell viability in red cell aging and in hemolytic anemia. *Proc. Natl. Acad. Sci. USA* **95**, 3077–3081.
- Bodansky, O. (1951). Methemoglobinemia and methemoglobin-producing compounds. *Pharmacol. Rev.* **3**, 144–196.
- Bolis, L. (1973). Comparative transport of sugars across red blood cells. In “Comparative Physiology” (L. Bolis, K. Schmidt-Neilsen, and S. H. P. Maddrell, Eds.), pp. 583–590. North-Holland, Amsterdam.
- Bonfanti, U., Comazzi, S., Paltrinieri, S., and Bertazzolo, W. (2004). Stomatocytosis in 7 related Standard Schnauzers. *Vet. Clin. Pathol.* **33**, 234–239.
- Bottomley, S. S. (2004). Sideroblastic anemias. In “Wintrobe’s Clinical Hematology” (J. P. Greer, J. Foerster, J. N. Lukens, G. M. Rogers, and F. Paraskevas, Eds.), pp. 1011–1033. Lippincott Williams & Wilkins, Philadelphia.
- Bottomley, S. S. (2006). Congenital sideroblastic anemias. *Curr. Hematol. Rep.* **5**, 41–49.
- Boucher, J. H., Ferguson, E. W., Wilhelmsen, C. L., Statham, N., and McMeekin, R. R. (1981). Erythrocyte alterations during endurance exercise in horses. *J. Appl. Physiol.* **51**, 131–134.
- Bowling, A. T. (2000). Red blood cell antigens and blood groups in the horse. In “Schalm’s Veterinary Hematology” (B. F. Feldman, J. G. Zinkl, and N. C. Jain, Eds.), pp. 774–777. Lippincott Williams & Wilkins, Philadelphia.
- Boyer, J. D., Breeden, D. C., and Brown, D. L. (2002). Isolation, identification, and characterization of compounds from *Acer rubrum* capable of oxidizing equine erythrocytes. *Am. J. Vet. Res.* **63**, 604–610.
- Boyle, A. G., Magdesian, K. G., and Ruby, R. E. (2005). Neonatal iserythrolysis in horse foals and a mule foal: 18 cases (1988–2003). *J. Am. Vet. Med. Assoc.* **227**, 1276–1283.
- Braend, M. (1988). Hemoglobin polymorphism in the domestic dog. *J. Hered.* **79**, 211–212.
- Brechue, W. F., Gropp, K. E., Ameredes, B. T., O’Drobinak, D. M., Stainsby, W. N., and Harvey, J. W. (1994). Metabolic and work capacity of skeletal muscle of PFK-deficient dogs studied *in situ*. *J. Appl. Physiol.* **77**, 2456–2467.
- Breitschwerdt, E. B., Armstrong, P. J., Robinette, C. L., Dillman, R. C., and Karl, M. L. (1986). Three cases of acute zinc toxicosis in dogs. *Vet. Hum. Toxicol.* **28**, 109–117.
- Brewer, G. J. (1974). General red cell metabolism. In “The Red Cell” (D. M. Surgenor, Ed.), pp. 387–433. Academic Press, New York.
- Brewer, N. R. (1987). Comparative metabolism of copper. *J. Am. Vet. Med. Assoc.* **190**, 654–658.
- Brown, D. E., Meyer, D. J., Wingfield, W. E., and Walton, R. M. (1994a). Echinocytosis associated with rattlesnake envenomation in dogs. *Vet. Pathol.* **31**, 654–657.
- Brown, D. E., Weiser, M. G., Thrall, M. A., Giger, U., and Just, C. A. (1994b). Erythrocyte indices and volume distribution in a dog with stomatocytosis. *Vet. Pathol.* **31**, 247–250.
- Brown, K. M., and Arthur, J. R. (2001). Selenium, selenoproteins and human health: a review. *Public Health Nutr.* **4**, 593–599.
- Bruce, L. (2006). Mutations in band 3 and cation leaky red cells. *Blood Cells Mol. Dis.* **36**, 331–336.
- Bücheler, J., and Giger, U. (1993). Alloantibodies against A and B blood types in cats. *Vet. Immunol. Immunopathol.* **38**, 283–295.
- Bunn, H. F. (1971). Differences in the interaction of 2,3-diphosphoglycerate with certain mammalian hemoglobins. *Science* **172**, 1049–1050.
- Bunn, H. F. (1981). Evolution of mammalian hemoglobin function. *Blood* **58**, 189–197.
- Bunn, H. F. (1987). Subunit assembly of hemoglobin: an important determinant of hematologic phenotype. *Blood* **69**, 1–6.
- Bunn, H. F., and Kitchen, H. (1973). Hemoglobin function in the horse: the role of 2,3-diphosphoglycerate in modifying the oxygen affinity of maternal and fetal blood. *Blood* **42**, 471–479.
- Bunn, H. F., Seal, U. S., and Scott, A. F. (1974). The role of 2,3-diphosphoglycerate in mediating hemoglobin function of mammalian red cells. *Ann. NY Acad. Sci.* **241**, 498–512.
- Burr, M. J. (1972). The relationship between pH and aerobic glycolysis in human and canine erythrocytes. *Comp. Biochem. Physiol. [B]* **41**, 687–694.
- Burrows, G. E. (1980). Nitrate intoxication. *J. Am. Vet. Med. Assoc.* **177**, 82–83.
- Bush, J. A., Jensen, W. N., Ashenbrucker, H., Cartwright, G. E., and Wintrobe, M. M. (1956). The kinetics of iron metabolism in swine with various experimentally induced anemias. *J. Exp. Med.* **103**, 161–171.
- Caldin, M., Carli, E., Furlanello, T., Solano-Gallego, L., Tasca, S., Patron, C., and Lubas, G. (2005). A retrospective study of 60 cases of eccentricity in the dog. *Vet. Clin. Pathol.* **34**, 224–231.
- Callan, M. B., Jones, L. T., and Giger, U. (1995). Hemolytic transfusion reactions in a dog with an alloantibody to a common antigen. *J. Vet. Intern. Med.* **9**, 277–279.
- Campanella, M. E., Chu, H., and Low, P. S. (2005). Assembly and regulation of a glycolytic enzyme complex on the human erythrocyte membrane. *Proc. Natl. Acad. Sci. USA* **102**, 2402–2407.
- Canfield, P. J., and Watson, A. D. J. (1989). Investigations of bone marrow dyscrasia in a poodle with macrocytosis. *J. Comp. Pathol.* **101**, 269–278.
- Canfield, P. J., Watson, A. D. J., and Ratcliffe, R. C. C. (1987). Dyserythropoiesis, sideroblasts/siderocytes and hemoglobin crystallization in a dog. *Vet. Clin. Pathol.* **16**(1), 21–28.
- Caple, I. W., Edwards, S. J. A., Forsyth, W. M., Whiteley, P., Selth, R. H., and Fulton, L. J. (1978). Blood glutathione peroxidase activity in horses in relation to muscular dystrophy and selenium nutrition. *Aust. Vet. J.* **54**, 57–60.
- Cappellini, M. D., Tavazzi, D., Duca, L., Graziadei, G., Mannu, F., Turrini, F., Aresè, P., and Fiorelli, G. (1999). Metabolic indicators of oxidative stress correlate with haemichrome attachment to membrane, band 3 aggregation and erythrophagocytosis in  $\beta$ -thalassaemia intermedia. *Br. J. Haematol.* **104**, 504–512.
- Card, R. T., and Brain, M. C. (1973). The “anemia” of childhood: evidence for a physiologic response to hyperphosphatemia. *N. Engl. J. Med.* **288**, 388–392.
- Carrell, R. W., Krishnamoorthy, R., and Winterbourn, C. C. (1978). Hemoglobin autoxidation: the risk to the red cell and the contribution of copper. *Progr. Clin. Biol. Res.* **21**, 687–695.
- Carrell, R. W., Winterbourn, C. C., and French, J. K. (1977). Haemoglobin: a frustrated oxidase? Implications for red cell metabolism. *Haemoglobin* **1**, 815–827.
- Cartwright, G. E., and Deiss, A. (1975). Sideroblasts, siderocytes, and sideroblastic anemia. *N. Engl. J. Med.* **292**, 185–193.
- Carvalho da Silva, A., Fajer, A. B., De Angelis, R. C., Pontes, M. A., Giesbrecht, A. M., and Fried, R. (1959). The domestic cat as a laboratory animal for experimental nutrition studies. VII. Pyridoxine deficiency. *J. Nutr.* **68**, 213–229.
- Cha, M. K., and Kim, I. H. (1995). Thioredoxin-linked peroxidase from human red blood cell: evidence for the existence of thioredoxin and thioredoxin reductase in human red blood cell. *Biochem. Biophys. Res. Commun.* **217**, 900–907.

- Chamberlain, J. K., Weiss, L., and Weed, R. I. (1975). Bone marrow sinus cell packing: a determinant of cell release. *Blood* **46**, 91–102.
- Chan, T. K., Chan, W. C., and Weed, R. I. (1982). Erythrocyte hemighosts: a hallmark of severe oxidative injury *in vitro*. *Br. J. Haematol.* **50**, 575–582.
- Chanarin, I., Deacon, R., Lumb, M., Muir, M., and Perry, J. (1985). Cobalamin-folate interactions: a critical review. *Blood* **66**, 479–489.
- Chandler, F. W., Prasse, K. W., and Callaway, C. S. (1975). Surface ultrastructure of pyruvate kinase-deficient erythrocytes in the basenji dog. *Am. J. Vet. Res.* **36**, 1477–1480.
- Chapman, B. L., and Giger, U. (1990). Inherited erythrocyte pyruvate kinase deficiency in the West Highland white terrier. *J. Small Anim. Pract.* **31**, 610–616.
- Chasis, J. A. (2006). Erythroblastic islands: specialized microenvironmental niches for erythropoiesis. *Curr. Opin. Hematol.* **13**, 137–141.
- Chasis, J. A., and Mohandas, N. (1992). Red blood cell glycoporphorins. *Blood* **80**, 1869–1879.
- Chasis, J. A., Prenant, M., Leung, A., and Mohandas, N. (1989). Membrane assembly and remodeling during reticulocyte maturation. *Blood* **74**, 1112–1120.
- Chasseaud, L. F. (1979). The role of glutathione and glutathione S-transferases in the metabolism of chemical carcinogens and other electrophilic agents. *Adv. Cancer Res.* **29**, 175–274.
- Chausow, D. G., and Czarnecki-Maulden, G. L. (1987). Estimation of the dietary iron requirement for the weanling puppy and kitten. *J. Nutr.* **117**, 928–932.
- Chemtob, S., Gibb, W., and Bard, H. (1980). Relationship of 2,3-diphosphoglycerate and 2,3-diphosphoglycerate mutase in various mammals. *Biol. Neonate* **38**, 36–39.
- Chen, L.-T., and Weiss, L. (1973). The role of the sinus wall in the passage of erythrocytes through the spleen. *Blood* **41**, 529–537.
- Chiu, D., and Lubin, B. (1989). Oxidative hemoglobin denaturation and RBC destruction: The effect of heme on red cell membranes. *Semin. Hematol.* **26**, 128–135.
- Christopher, M. M. (1989). Relation of endogenous Heinz bodies to disease and anemia in cats: 120 cases (1978–1987). *J. Am. Vet. Med. Assoc.* **194**, 1089–1095.
- Christopher, M. M. (1995). Hematologic complications of diabetes mellitus. *Veterinary Clinics of North America, Small Animal Practice* **25**, 625–637.
- Christopher, M. M., Broussard, J. D., and Peterson, M. E. (1995). Heinz body formation associated with ketoacidosis in diabetic cats. *J. Vet. Intern. Med.* **9**, 24–31.
- Christopher, M. M., and Lee, S. E. (1994). Red cell morphologic alterations in cats with hepatic disease. *Vet. Clin. Pathol.* **23**, 7–12.
- Christopher, M. M., Perman, V., and Eaton, J. W. (1989). Contribution of propylene glycol-induced Heinz body formation to anemia in cats. *J. Am. Vet. Med. Assoc.* **194**, 1045–1056.
- Chu, H., and Low, P. S. (2006). Mapping of glycolytic enzyme-binding sites on human erythrocyte band 3. *Biochem. J.* **400**, 143–151.
- Clerbaux, T., Gustin, P., Detry, B., Cao, M. L., and Frans, A. (1993). Comparative study of the oxyhaemoglobin dissociation curve of four mammals: man, dog, horse and cattle. *Comp. Biochem. Physiol. [A]* **106A**, 687–694.
- Cohen, C. M., and Gascard, P. (1992). Regulation and post-translational modification of erythrocyte membrane and membrane-skeletal proteins. *Semin. Hematol.* **29**, 244–292.
- Coldman, M. F., and Good, W. (1967). The distribution of sodium, potassium and glucose in the blood of some mammals. *Comp. Biochem. Physiol.* **21**, 201–206.
- Comline, R. S., and Silver, M. (1974). A comparative study of blood gas tensions, oxygen affinity and red cell 2,3 DPG concentrations in foetal and maternal blood in the mare, cow and sow. *J. Physiol.* **242**, 805–826.
- Constantinescu, A., Pick, U., Handelman, G. J., Haramaki, N., Han, D., Podda, M., Tritschler, H. J., and Packer, L. (1995). Reduction and transport of lipoic acid by human erythrocytes. *Biochem. Pharmacol.* **50**, 253–261.
- Contreras, A., Martinez, R., Deves, R., and Marusic, E. T. (1986). An unusual pattern of Na<sup>+</sup> and K<sup>+</sup> movements across the horse erythrocyte membrane. *Biochim. Biophys. Acta* **856**, 388–391.
- Cooper, C., Sears, W., and Bienzle, D. (2005). Reticulocyte changes after experimental anemia and erythropoietin treatment of horses. *J. Appl. Physiol.* **99**, 915–921.
- Cooper, R. A., Diloy-Puray, M., Lando, P., and Greenberg, M. S. (1972). An analysis of lipoproteins, bile acids, and red cell membranes associated with target cells and spur cells in patients with liver disease. *J. Clin. Invest.* **51**, 3182–3192.
- Cooper, R. A., Leslie, M. H., Knight, D., and Detweiler, D. K. (1980). Red cell cholesterol enrichment and spur cell anemia in dogs fed a cholesterol-enriched atherogenic diet. *J. Lipid Res.* **21**, 1082–1089.
- Cotter, S. M. (1979). Anemia associated with feline leukemia virus infection. *J. Am. Vet. Med. Assoc.* **175**, 1191–1194.
- Coulter, D. B., and Small, L. L. (1973). Sodium and potassium concentrations of erythrocytes from perinatal, immature, and adult dogs. *Cornell Vet.* **63**, 462–468.
- Cowgill, L. D., James, K. M., Levy, J. K., Browne, J. K., Miller, A., Lobingier, R. T., and Egrie, J. C. (1998). Use of recombinant human erythropoietin for management of anemia in dogs and cats with renal failure. *J. Am. Vet. Med. Assoc.* **212**, 521–528.
- Craik, J. D., Good, A. H., Gottschalk, R., Jarvis, S. M., Paterson, A. R., and Cass, C. E. (1988). Identification of glucose and nucleoside transport proteins in neonatal pig erythrocytes using monoclonal antibodies against band 4.5 polypeptides of adult human and pig erythrocytes. *Biochem. Cell Biol.* **66**, 839–852.
- Cramer, D. V., and Lewis, R. M. (1972). Reticulocyte response in the cat. *J. Am. Vet. Med. Assoc.* **160**, 61–67.
- Crawford, J. H., Isbell, T. S., Huang, Z., Shiva, S., Chacko, B. K., Schechter, A. N., Darley-Usmar, V. M., Kerby, J. D., Lang, J. D., Jr., Kraus, D., Ho, C., Gladwin, M. T., and Patel, R. P. (2006). Hypoxia, red blood cells, and nitrite regulate NO-dependent hypoxic vasodilation. *Blood* **107**, 566–574.
- Davis, J. A., Greenfield, R. E., and Brewer, T. G. (1993). Benzocaine-induced methemoglobinemia attributed to topical application of the anesthetic in several laboratory animal species. *Am. J. Vet. Res.* **54**, 1322–1326.
- Debski, B., and Rynca, J. (1985). ATP and 2,3-diphosphoglycerate changes in the erythrocytes of hyperammonaemic sheep. *Acta Physiol. Pol.* **36**, 345–351.
- Degen, M. (1987). Pseudohyperkalemia in Akitas. *J. Am. Vet. Med. Assoc.* **190**, 541–543.
- Deiss, A., Kurth, D., Cartwright, G. E., and Wintrobe, M. M. (1966). Experimental production of siderocytes. *J. Clin. Invest.* **45**, 353–364.
- Del Boccio, G., Casalone, E., Sacchetta, P., Pennelli, A., and Di Ilio, C. (1986). Isoenzyme patterns of glutathione transferases from mammalian erythrocytes. *Biochem. Med. Metab. Biol.* **36**, 306–312.
- Delaunay, J. (2004). The hereditary stomatocytoses: genetic disorders of the red cell membrane permeability to monovalent cations. *Semin. Hematol.* **41**, 165–172.
- Delaunay, J. (2007). The molecular basis of hereditary red cell membrane disorders. *Blood Rev.* **21**, 1–20.

- Della Rovere, F., Granata, A., Saija, A., Broccio, M., Tomaino, F., Zirilli, A., De Caridi, G., and Broccio, G. (2000). -SH groups and glutathione in cancer patient's blood. *Anticancer Res.* **20**, 1595–1598.
- Desnoyers, M., and Hebert, P. (1995). Heinz body anemia in a dog following possible naphthalene ingestion. *Vet. Clin. Pathol.* **24**, 124–125.
- Dewitt, S. F., Bedenice, D., and Mazan, M. R. (2004). Hemolysis and Heinz body formation associated with ingestion of red maple leaves in two alpacas. *J. Am. Vet. Med. Assoc.* **225**, 578–583.
- Dhindsa, D. S., Black, J. A., Koler, R. D., Rigas, D. A., Templeton, J. W., and Metcalfe, J. (1976). Respiratory characteristics of blood from basenji dogs with classical erythrocyte pyruvate kinase deficiency. *Resp. Physiol.* **26**, 65–75.
- Dhindsa, D. S., Hoversland, A. S., Neill, W. A., and Metcalfe, J. (1971). Changes in blood oxygen affinity and hemodynamics in anemic dogs. *Resp. Physiol.* **11**, 346–353.
- Dhindsa, D. S., Hoversland, A. S., and Templeton, J. W. (1972). Postnatal changes in oxygen affinity and concentrations of 2,3-diphosphoglycerate in dog blood. *Biol. Neonate* **20**, 226–235.
- Dhindsa, D. S., and Metcalfe, J. (1974). Post-natal changes in oxygen affinity and the concentration of 2,3-diphosphoglycerate in cat blood. *Resp. Physiol.* **21**, 37–46.
- Di Terlizzi, R., Mohandas, N., Gallagher, P. G., Dolce, K. S., Wilkerson, M. L., and Stockham, S. L. (2007). Elliptocytosis in a dog with mutant  $\beta$ -spectrin. *Submitted*.
- Di, S. P., Cacace, M. G., Lusini, L., Giannerini, F., Giustarini, D., and Rossi, R. (1998). Role of protein -SH groups in redox homeostasis: the erythrocyte as a model system. *Arch. Biochem. Biophys.* **355**, 145–152.
- Dimmock, C. K., and Bell, K. (1970). Haemolytic disease of the newborn in calves. *Aust. Vet. J.* **46**, 44–47.
- Dimmock, C. K., Clark, I. A., and Hill, M. W. M. (1976). The experimental production of haemolytic disease of the newborn in calves. *Res. Vet. Sci.* **20**, 244–248.
- Dixon, P. M., and McPherson, E. A. (1977). Familial methaemoglobinemia and haemolytic anaemia in the horse associated with decreased erythrocytic glutathione reductase and glutathione. *Equine Vet. J.* **9**, 198–201.
- Doong, G., Keen, C. L., Rogers, Q. R., Morris, J. G., and Rucker, R. B. (1983). Selected features of copper metabolism in the cat. *J. Nutr.* **113**, 1963–1971.
- Duhm, J. (1974). Inosine permeability and purine nucleoside phosphorylase activity as limiting factors for the synthesis of 2,3-diphosphoglycerate from inosine, pyruvate, and inorganic phosphate in erythrocytes of various mammalian species. *Biochim. Biophys. Acta* **343**, 89–100.
- Duhm, J. (1975). Glycolysis in human erythrocytes containing elevated concentrations of 2,3-P<sub>2</sub>-glycerate. *Biochim. Biophys. Acta* **385**, 68–80.
- Duhm, J., and Gerlach, E. (1971). On the mechanisms of the hypoxia-induced increase in 2,3-diphosphoglycerate in erythrocytes. *Pflugers Arch.* **326**, 254–269.
- Dunham, P. B. (2004). Cell shrinkage activates Na<sup>+</sup>/H<sup>+</sup> exchange in dog red cells by relieving inhibition of exchange by Na<sup>+</sup> in isotonic medium. *Blood Cells Mol. Dis.* **32**, 389–393.
- Dunham, P. B., and Blostein, R. (1997). L antigens of sheep red blood cell membranes and modulation of ion transport. *Am. J. Physiol. Cell Physiol.* **272**, C357–C368.
- Dunn, J. K., Hirsch, V. M., and Searcy, G. P. (1984). Serum folate and vitamin B<sub>12</sub> levels in anemic cats. *J. Am. Anim. Hosp. Assoc.* **20**, 999–1002.
- Duthie, G. G., Arthur, J. R., Nicol, F., and Walker, M. (1989). Increased indices of lipid peroxidation in stress-susceptible pigs and effects of vitamin E. *Res. Vet. Sci.* **46**, 226–230.
- Eaton, J. W., and Brewer, G. J. (1974). Pentose phosphate metabolism. In “The Red Blood Cell” (D. M. Surgenor, Ed.), pp. 436–471. Academic Press, New York.
- Eaton, J. W., Hallaway, P. E., and Agar, N. S. (1989). Erythrocyte glutathione: A dispensable oxidant defense? *Prog. Clin. Biol. Res.* **319**, 23–38.
- Eberlein, K., and Gercken, G. (1971). Thin-layer chromatography of red cell glycosphingolipids from various mammalian species. *J. Chromatogr.* **61**, 285–293.
- Eckardt, K. U., and Kurtz, A. (2005). Regulation of erythropoietin production. *Eur. J. Clin. Invest* **35**(suppl 3), 13–19.
- Elin, R. J., and Alling, D. W. (1978). Survival of normal and magnesium-deficient diet vs splenectomy. *J. Lab. Clin. Med.* **91**, 666–672.
- Elliott, D. A., Nelson, R. W., Feldman, E. C., and Neal, L. A. (1997). Glycosylated hemoglobin concentrations in the blood of healthy dogs and dogs with naturally developing diabetes mellitus, pancreatic  $\beta$ -cell neoplasia, hyperadrenocorticism, and anemia. *J. Am. Vet. Med. Assoc.* **211**, 723–727.
- Elliott, D. A., Nelson, R. W., Reusch, C. E., Feldman, E. C., and Neal, L. A. (1999). Comparison of serum fructosamine and blood glycosylated hemoglobin concentrations for assessment of glycemic control in cats with diabetes mellitus. *J. Am. Vet. Med. Assoc.* **214**, 1794–1798.
- Ellory, J. C., and Tucker, E. M. (1983). Cation transport in red blood cells. In “Red Blood Cells of Domestic Mammals” (N. S. Agar and P. G. Board, Eds.), pp. 291–314. Elsevier, Amsterdam.
- Ellory, J. C., Tucker, E. M., and Deverson, E. V. (1972). The identification of ornithine and lysine at high concentrations in the red cells of sheep with an inherited deficiency of glutathione. *Biochim. Biophys. Acta* **279**, 481–483.
- Endeward, V., Musa-Aziz, R., Cooper, G. J., Chen, L. M., Pelletier, M. F., Virkki, L. V., Supuran, C. T., King, L. S., Boron, W. F., and Gros, G. (2006). Evidence that aquaporin 1 is a major pathway for CO<sub>2</sub> transport across the human erythrocyte membrane. *FASEB J.* **20**, 1974–1981.
- Erslev, A. J., and Soltan, A. (1996). Pure red-cell aplasia: a review. *Blood Rev.* **10**, 20–28.
- Evans, E. T. R. (1968). Sickling phenomenon in sheep. *Nature* **217**, 74–75.
- Fairbanks, V. F., and Beutler, E. (1995). Iron deficiency. In “Williams Hematology” (E. Beutler, M. A. Lichtman, B. S. Coller, and T. J. Kipps, Eds.), pp. 490–511. McGraw-Hill, New York.
- Faldyna, M., Sinkora, J., Knotigova, P., Rehakova, Z., Moravkova, A., and Toman, M. (2003). Flow cytometric analysis of bone marrow leukocytes in neonatal dogs. *Vet. Immunol. Immunopathol.* **95**, 165–176.
- Fan, L. C., Dorner, J. L., and Hoffman, W. E. (1978). Reticulocyte response and maturation in experimental acute blood loss anemia in the cat. *J. Am. Anim. Hosp. Assoc.* **14**, 219–224.
- Feldman, B. F., Kaneko, J. J., and Farver, T. B. (1981). Anemia of inflammatory disease in the dog: clinical characterization. *Am. J. Vet. Res.* **42**, 1109–1113.
- Feldman, B. F., Zinkl, J. G., and Jain, N. C. (2000). “Schalm's Veterinary Hematology.” Lippincott Williams & Wilkins, Philadelphia.
- Fenger, C. K., McKeever, K. H., Hinchcliff, K. W., and Kohn, C. W. (2000). Determinants of oxygen delivery and hemoglobin saturation during incremental exercise in horses. *Am. J. Vet. Res.* **61**, 1325–1332.
- Feo, C., and Mohandas, N. (1977). Clarification of role of ATP in red-cell morphology and function. *Nature* **265**, 166–168.
- Fernandez, F. R., Davies, A. P., Teachout, D. J., Krake, A., Christopher, M. M., and Perman, V. (1984). Vitamin K-induced Heinz body formation in dogs. *J. Am. Anim. Hosp. Assoc.* **20**, 711–720.

- Fertman, M. H., and Fertman, M. B. (1955). Toxic anemias and Heinz bodies. *Medicine* **34**, 131–192.
- Fincham, D. A., Mason, D. K., Paterson, J. Y., and Young, J. D. (1987). Heterogeneity of amino acid transport in horse erythrocytes: a detailed kinetic analysis of inherited transport variation. *J. Physiol. (Lond.)* **389**, 385–409.
- Fincham, D. A., Mason, D. K., and Young, J. D. (1988). Dibasic amino acid interactions with Na<sup>+</sup>-independent transport system asc in horse erythrocytes: kinetic evidence of functional and structural homology with Na<sup>+</sup>-dependent system ASC. *Biochim. Biophys. Acta* **937**, 184–194.
- Fincham, D. A., Young, J. D., Mason, D. K., Collins, E. A., and Snow, D. H. (1985). Breed and species comparison of amino acid transport variation in equine erythrocytes. *Res. Vet. Sci.* **38**, 346–351.
- Finco, D. R., Duncan, J. R., Schall, W. D., and Prasse, K. W. (1975). Acetaminophen toxicosis in the cat. *J. Am. Vet. Med. Assoc.* **166**, 469–472.
- Fine, D. M., Eyster, G. E., Anderson, L. K., and Smitley, A. (1999). Cyanosis and congenital methemoglobinemia in a puppy. *J. Am. Anim. Hosp. Assoc.* **35**, 33–35.
- Fingeroth, J. M., and Smeak, D. D. (1988). Intravenous methylene blue infusion for intraoperative identification of parathyroid gland tumors in dogs. Part III: clinical trials and results in three dogs. *J. Am. Anim. Hosp. Assoc.* **24**, 673–678.
- Fischer, T. M. (1986). Transcellular cross bonding of red blood cell membrane. *Biochim. Biophys. Acta* **861**, 277–286.
- Fischer, T. M. (1988). Role of spectrin in cross bonding of the red cell membrane. *Blood Cells* **13**, 377–394.
- Fisher, T. J., Tucker, E. M., and Young, J. D. (1986). Relationship between cell age, glutathione and cation concentrations in sheep erythrocytes with a normal and a defective transport system for amino acids. *Biochim. Biophys. Acta* **884**, 211–214.
- Fletch, S. M., Pinkerton, P. H., and Brueckner, P. J. (1975). The Alaskan Malamute chondrodysplasia (dwarfism-anemia) syndrome: in review. *J. Am. Anim. Hosp. Assoc.* **11**, 353–361.
- Florin-Christensen, J., Suarez, C. E., Florin-Christensen, M., Wainszelbaum, M., Brown, W. C., McElwain, T. F., and Palmer, G. H. (2001). A unique phospholipid organization in bovine erythrocyte membranes. *Proc. Natl. Acad. Sci. USA* **98**, 7736–7741.
- Ford, S., Giger, U., Duesberg, C., Beutler, E., and Wang, P. (1992). Inherited erythrocyte pyruvate kinase (PK) deficiency causing hemolytic anemia in an Abyssinian cat (abstract). *J. Vet. Intern. Med.* **6**, 123.
- Franken, P., and Schotman, J. H. (1977). Studies on a number of erythrocytic enzymes and intermediate products of equine erythrocyte metabolism. *Tijdschr. Diergeneesk.* **102**, 1197–1203.
- Freeman, B. A., and Crapo, J. D. (1982). Free radicals and tissue injury. *Lab. Invest.* **47**, 412–426.
- French, T. W., Fox, L. E., Randolph, J. F., and Dodds, W. J. (1987). A bleeding disorder (von Willebrand's disease) in a Himalayan cat. *J. Am. Vet. Med. Assoc.* **190**, 437–439.
- Fresco, R. (1981). Electron microscopy in the diagnosis of the bone marrow disorders of the erythroid series. *Semin. Hematol.* **18**, 279–292.
- Fricke, B., Argent, A. C., Chetty, M. C., Pizzey, A. R., Turner, E. J., Ho, M. M., Iolascon, A., von, D. M., and Stewart, G. W. (2003). The “stomatatin” gene and protein in overhydrated hereditary stomatocytosis. *Blood* **102**, 2268–2277.
- Friedemann, H., and Rapoport, S. M. (1974). Enzymes of the red cell: a critical catalogue. In “Cellular and Molecular Biology of Erythrocytes” (H. Yoshikawa and S. M. Rapoport, Eds.), pp. 181–249. University Park Press, Baltimore.
- Fronticelli, C. (1990). A possible new mechanism of oxygen affinity modulation in mammalian hemoglobins. *Biophys. Chem.* **37**, 141–146.
- Fujii, S., Dale, G. L., and Beutler, E. (1984). Glutathione-dependent protection against oxidative damage of the human red cell membrane. *Blood* **63**, 1096–1101.
- Fujise, H., Higa, K., Nakayama, T., Wada, K., Ochiai, H., and Tanabe, Y. (1997a). Incidence of dogs possessing red blood cells with high K in Japan and East Asia. *J. Vet. Med. Sci.* **59**, 495–497.
- Fujise, H., Hishiyama, N., and Ochiai, H. (1997b). Heredity of red blood cells with high K and low glutathione (HK/LG) and high K and high glutathione (HK/HG) in a family of Japanese Shiba Dogs. *Exp. Anim.* **46**, 41–46.
- Fujise, H., Mori, M., Ogawa, E., and Maede, Y. (1993). Variant of canine erythrocytes with high potassium content and lack of glutathione accumulation. *Am. J. Vet. Res.* **54**, 602–606.
- Fulton, R., Weiser, M. G., Freshman, J. L., Gasper, P. W., and Fettman, M. J. (1988). Electronic and morphologic characterization of erythrocytes of an adult cat with iron deficiency anemia. *Vet. Pathol.* **25**, 521–523.
- Furugouri, K. (1972). Plasma iron and total iron-binding capacity in piglets in anemia and iron administration. *J. Anim. Sci.* **34**, 421–426.
- Fyfe, J. C. (2000). Hematology of selective intestinal cobalamin malabsorption. In “Schalm's Veterinary Hematology” (B. F. Feldman, J. G. Zinkl, and N. C. Jain, Eds.), pp. 965–970. Lippincott Williams & Wilkins, Philadelphia.
- Gaetani, G. F., Ferraris, A. M., Sanna, P., and Kirkman, H. N. (2005). A novel NADPH:(bound) NADP<sup>+</sup> reductase and NADH:(bound) NADP<sup>+</sup> transhydrogenase function in bovine liver catalase. *Biochem. J.* **385**, 763–768.
- Gaetani, G. F., Kirkman, H. N., Mangerini, R., and Ferraris, A. M. (1994). Importance of catalase in the disposal of hydrogen peroxide within human erythrocytes. *Blood* **84**, 325–330.
- Gallagher, P. G. (2004). Hereditary elliptocytosis: spectrin and protein 4.1R. *Semin. Hematol.* **41**, 142–164.
- Gallego, C., and Carreras, J. (1990). 2,3-Bisphosphoglycerate, fructose, 2,6-bisphosphate and glucose 1,6-bisphosphate during maturation of reticulocytes with low 2,3-bisphosphoglycerate content. *Mol. Cell. Biochem.* **99**, 21–24.
- Gallego, C., Graña, X., and Carreras, J. (1991). Increase of 2,3-bisphosphoglycerate synthase/phosphatase during maturation of reticulocytes with high 2,3-bisphosphoglycerate content. *Mol. Cell. Biochem.* **102**, 183–188.
- Gangenahalli, G. U., Singh, V. K., Verma, Y. K., Gupta, P., Sharma, R. K., Chandra, R., and Luthra, P. M. (2006). Hematopoietic stem cell antigen CD34: role in adhesion or homing. *Stem Cells Dev.* **15**, 305–313.
- Gardner, D. E., Martinovich, D., and Woodhouse, D. A. (1976). Haematological and biochemical findings in bovine postparturient haemoglobinuria and the accompanying Heinz-body anaemia. *N. Z. Vet. J.* **24**, 117–122.
- Garner, K. J., and Lingrel, J. B. (1988). Structural organization of the beta-globin locus of B-haplotype sheep. *Mol. Biol. Evol.* **5**, 134–140.
- Garnier, M., de Preville, G., Pilardeau, P., and Boudia, D. (1984). Relationship between the intra-erythrocyte sodium composition and the membrane lipoprotein composition among different mammal species. *Comp. Biochem. Physiol. [A]* **77**, 315–317.
- Gaunt, S. D., Baker, D. C., and Green, R. A. (1981). Clinicopathologic evaluation of N-acetylcysteine therapy in acetaminophen toxicosis in the cat. *Am. J. Vet. Res.* **42**, 1982–1984.

- Gedde, M. M., Davis, D. K., and Huestis, W. H. (1997). Cytoplasmic pH and human erythrocyte shape. *Biophys. J.* **72**, 1234–1246.
- Geminard, C., De, G. A., and Vidal, M. (2002). Reticulocyte maturation: mitoptosis and exosome release. *Biocell* **26**, 205–215.
- Geor, R. J., Lund, E. M., and Weiss, D. J. (1993). Echinocytosis in horses: 54 cases (1990). *J. Am. Vet. Med. Assoc.* **202**, 976–980.
- George, L. W., Divers, T. J., Mahaffey, E. A., and Suarez, J. H. (1982). Heinz body anemia and methemoglobinemia in ponies given red maple (*Acer rubrum* L.) leaves. *Vet. Pathol.* **19**, 521–533.
- Giger, U. (2000). Erythrocyte phosphofructokinase and pyruvate kinase deficiencies. In “Schalm’s Veterinary Hematology” (B. F. Feldman, J. G. Zinkl, and N. C. Jain, Eds.), pp. 1020–1025. Lippincott Williams & Wilkins, Philadelphia.
- Giger, U. (2005). “Section of Medical Genetics.” Department of Clinical Studies, University of Pennsylvania. Available at: <http://w3.vet.upenn.edu/research/centers/penngen>.
- Giger, U., and Akol, K. G. (1990). Acute hemolytic transfusion reaction in an Abyssinian cat with blood group type B. *J. Vet. Intern. Med.* **4**, 315–316.
- Giger, U., Amador, A., Meyers-Wallen, V., and Patterson, D. F. (1988a). Stomatocytosis in miniature schnauzers. *Proc. ACVIM Forum* **754**.
- Giger, U., Argov, Z., Schnall, M., Bank, W. J., and Chance, B. (1988b). Metabolic myopathy in canine muscle-type phosphofructokinase deficiency. *Muscle Nerve* **11**, 1260–1265.
- Giger, U., and Bücheler, J. (1991). Transfusion of type-A and type-B blood to cats. *J. Am. Vet. Med. Assoc.* **198**, 411–418.
- Giger, U., and Harvey, J. W. (1987). Hemolysis caused by phosphofructokinase deficiency in English springer spaniels: seven cases (1983–1986). *J. Am. Vet. Med. Assoc.* **191**, 453–459.
- Giger, U., Harvey, J. W., Yamaguchi, R. A., McNulty, P. K., Chiapella, A., and Beutler, E. (1985). Inherited phosphofructokinase deficiency in dogs with hyperventilation-induced hemolysis: increased *in vitro* and *in vivo* alkaline fragility of erythrocytes. *Blood* **65**, 345–351.
- Giger, U., Mason, G. D., and Wang, P. (1991). Inherited erythrocyte pyruvate kinase deficiency in a beagle dog. *Vet. Clin. Pathol.* **20**, 83–86.
- Giger, U., and Noble, N. A. (1991). Determination of erythrocyte pyruvate kinase deficiency in basenjis with chronic hemolytic anemia. *J. Am. Vet. Med. Assoc.* **198**, 1755–1761.
- Giger, U., Rajpurohit, Y., Wang, P., Ford, S., Kohn, B., Niggemeier, A., Patterson, D. F., Beutler, E., and Henthorn, P. S. (1997). Molecular basis of erythrocyte pyruvate kinase (R-PK) deficiency in cats (abstract). *Blood* **90**(suppl 1), 5b.
- Giger, U., Smith, B. F., and Rajpurohit, Y. (1995). PCR-based screening test for phosphofructokinase (PFK) deficiency: a common inherited disease in English springer spaniels. *Proc. ACVIM Forum* **1002**.
- Giger, U., Smith, B. F., Woods, C. B., Patterson, D. F., and Stedman, H. (1992). Inherited phosphofructokinase deficiency in an American cocker spaniel. *J. Am. Vet. Med. Assoc.* **201**, 1569–1571.
- Giger, U., Wang, P., and Boyden, M. (1999). Familial methemoglobin reductase deficiency in domestic shorthair cats [abstract]. *Feline Practice Supplement* **31**, 14.
- Gillis, G. H., and Anastasiadis, P. A. (1985). Properties of avian, bovine and porcine erythrocyte membranes. *Comp. Biochem. Physiol. [B]* **81B**, 131–135.
- Giordano, A., Salvadori, M., Perialisi, C., and Paltrinieri, S. (2004). Usefulness of 2,3 diphosphoglycerate (2,3 DPG) measurement in the diagnosis of hypoxic conditions in racing horses (abstract). *Vet. Clin. Pathol.* **33**, 259.
- Gladwin, M. T., Crawford, J. H., and Patel, R. P. (2004). The biochemistry of nitric oxide, nitrite, and hemoglobin: role in blood flow regulation. *Free Radic. Biol. Med.* **36**, 707–717.
- Gordeuk, V. R., Stockton, D. W., and Prchal, J. T. (2005). Congenital polycythemia/erythrocytoses. *Haematologica* **90**, 109–116.
- Goth, L. (2001). A new type of inherited catalase deficiencies: its characterization and comparison to the Japanese and Swiss type of acatalasemia. *Blood Cells Mol. Dis.* **27**, 512–517.
- Goto, I., Agar, N. S., and Maede, Y. (1992). The relationship between reduced glutathione level and glutathione S-transferase activity in sheep erythrocytes. *Jpn. J. Vet. Res.* **40**, 99–104.
- Goto, I., Agar, N. S., and Maede, Y. (1993). Relation between reduced glutathione content and Heinz body formation in sheep erythrocytes. *Am. J. Vet. Res.* **54**, 622–626.
- Gov, N. S., and Safran, S. A. (2005). Red blood cell membrane fluctuations and shape controlled by ATP-induced cytoskeletal defects. *Biophys. J.* **88**, 1859–1874.
- Green, M. J., and Hill, H. A. (1984). “Methods in Enzymology” (L. Packer, Ed.), pp. 3–22. Academic Press, New York.
- Greenhalgh, J. F. D., Sharman, G. A. M., and Aitken, J. N. (1969). Kale anaemia. I. The toxicity to various species of animal of three types of kale. *Res. Vet. Sci.* **10**, 64–72.
- Griffith, W. P., and Kaltashov, I. A. (2003). Highly asymmetric interactions between globin chains during hemoglobin assembly revealed by electrospray ionization mass spectrometry. *Biochemistry* **42**, 10024–10033.
- Gruber, M., Hu, C. J., Johnson, R. S., Brown, E. J., Keith, B., and Simon, M. C. (2007). Acute postnatal ablation of Hif-2{alpha} results in anemia. *Proc. Natl. Acad. Sci. USA* **104**, 2301–2306.
- Gruber, W., and Deuticke, B. (1973). Comparative aspects of phosphate transfer across mammalian erythrocyte membranes. *J. Membr. Biol.* **13**, 19–36.
- Guerra-Shinohara, E. M., and Barretto, O. C. (1999). The erythrocyte cytoskeleton protein 4.2 is not demonstrable in several mammalian species. *Braz. J. Med. Biol. Res.* **32**, 683–687.
- Gumucio, D. L., Shelton, D. A., Zhu, W., Millinoff, D., Gray, T., Bock, J. H., Slightom, J. L., and Goodman, M. (1996). Evolutionary strategies for the elucidation of cis and trans factors that regulate the developmental switching programs of the beta-like globin genes. *Mol. Phylogenet. Evol.* **5**, 18–32.
- Gupta, J. D., Peterson, V. J., and Harley, J. D. (1974). Erythrocytic ouabain-sensitive and ouabain-insensitive adenosine triphosphatase in various mammalian species. *Comp. Biochem. Physiol. [A]* **47A**, 1123–1126.
- Gustin, P., Detry, B., Cao, M. L., Chenut, F., Robert, A., Ansay, M., Frans, A., and Clerbaux, T. (1994). Chloride and inorganic phosphate modulate binding of oxygen to bovine red blood cells. *J. Appl. Physiol.* **77**, 202–208.
- Haas, M. (1989). Regulated transport. The response of ion transport pathways to physiological stimuli. In “Red Blood Cell Membranes” (P. Agre and J. C. Parker, Eds.), pp. 663–690. Marcel Dekker, New York.
- Hackett, T. B., Wingfield, W. E., Mazzaferro, E. M., and Benedetti, J. S. (2002). Clinical findings associated with prairie rattlesnake bites in dogs: 100 cases (1989–1998). *J. Am. Vet. Med. Assoc.* **220**, 1675–1680.
- Haglin, L., Essen-Gustavsson, B., and Lindholm, A. (1994). Hypophosphatemia induced by dietary aluminium hydroxide supplementation in growing pigs: effects on erythrocytes, myocardium, skeletal muscle and liver. *Acta Vet. Scand.* **35**, 263–271.
- Hale, A. S. (1995). Canine blood groups and their importance in veterinary transfusion medicine. *Vet. Clin. North Am. Small Anim. Pract.* **25**, 1323–1332.
- Halvorsen, K., and Halvorsen, S. (1974). The regulation of erythropoiesis in the suckling rabbit. *Pediatr. Res.* **8**, 176–183.

- Ham, T. H., Grauel, J. A., Dunn, R. F., Murphy, J. R., White, J. G., and Kellermeyer, R. W. (1973). Physical properties of red cells as related to effects *in vivo*. IV. Oxidant drugs producing abnormal intracellular concentration of hemoglobin (eccentrocytes) with rigid-red-cell hemolytic syndrome. *J. Lab. Clin. Med.* **82**, 898–910.
- Hamasaki, N., Asakura, T., and Minakami, S. (1970). Effect of oxygen tension on glycolysis in human erythrocytes. *J. Biochem.* **68**, 157–161.
- Hammond, E., Deiss, A., Carnes, W. H., and Cartwright, G. E. (1969). Ultrastructural characteristics of siderocytes in swine. *Lab. Invest.* **21**, 292–297.
- Hammond, G. M., Loewen, M. E., and Blakley, B. R. (2004). Diagnosis and treatment of zinc poisoning in a dog. *Vet. Hum. Toxicol.* **46**, 272–275.
- Han, T. H., Pelling, A., Jeon, T. J., Gimzewski, J. K., and Liao, J. C. (2005). Erythrocyte nitric oxide transport reduced by a submembrane cytoskeletal barrier. *Biochim. Biophys. Acta* **1723**, 135–142.
- Hargreaves, B. J., Kronfeld, D. S., Waldron, J. N., Lopes, M. A., Gay, L. S., Saker, K. E., Cooper, W. L., Sklan, D. J., and Harris, P. A. (2002). Antioxidant status and muscle cell leakage during endurance exercise. *Equine Vet. J. Suppl.*, 116–121.
- Harkness, D., Osta, S., Roth, S., and Grayson, V. (1970). Some biochemical studies on the erythrocyte of the domestic goat, *Capra hircus*. *Int. J. Biochem.*, 575–581.
- Harkness, D. R., Ponce, J., and Grayson, V. (1969). A comparative study on the phosphoglyceric acid cycle in mammalian erythrocytes. *Comp. Biochem. Physiol. B* **28**, 129–138.
- Harris, R. L., Cottam, G. L., Johnston, J. M., and Baxter, C. R. (1981). The pathogenesis of abnormal erythrocyte morphology in burns. *J. Trauma* **21**, 13–21.
- Harvey, J. W. (1995). Methemoglobinemia and Heinz-body hemolytic anemia. In “Kirk’s Current Veterinary Therapy XII. Small Animal Practice” (J. D. Bonagura, Ed.), pp. 443–446. Saunders, Philadelphia.
- Harvey, J. W. (1996). Congenital erythrocyte enzyme deficiencies. *Veterinary Clinics of North America, Small Animal Practice* **26**, 1003–1011.
- Harvey, J. W. (2000). Hereditary methemoglobinemia. In “Schalm’s Veterinary Hematology” (B. F. Feldman, J. G. Zinkl, and N. C. Jain, Eds.), pp. 1008–1011. Lippincott Williams & Wilkins, Philadelphia.
- Harvey, J. W. (2001). “Atlas of Veterinary Hematology. Blood and Bone Marrow of Domestic Animals.” Saunders, Philadelphia.
- Harvey, J. W. (2006). Pathogenesis, laboratory diagnosis, and clinical implications of erythrocyte enzyme deficiencies in dogs, cats, and horses. *Vet. Clin. Pathol.* **35**, 144–156.
- Harvey, J. W., Asquith, R. L., Sussman, W. A., and Kivipelto, J. (1987). Serum ferritin, serum iron, and erythrocyte values in foals. *Am. J. Vet. Res.* **48**, 1348–1352.
- Harvey, J. W., and Beutler, E. (1982). Binding of heme by glutathione S-transferase: a possible role of the erythrocyte enzyme. *Blood* **60**, 1227–1230.
- Harvey, J. W., Calderwood Mays, M. B., Gropp, K. E., and Denaro, F. J. (1990a). Polysaccharide storage myopathy in canine phosphofructokinase deficiency (type VII glycogen storage disease). *Vet. Pathol.* **27**, 1–8.
- Harvey, J. W., Clapp, W. L., Yao, Y., and Efremov, G. D. (2007). Microcytic hypochromic erythrocytes containing siderotic inclusions, Heinz bodies, and hemoglobin crystals in a dog (abstract). *Vet. Clin. Pathol.* **36**, 313–314.
- Harvey, J. W., Dahl, M., and High, M. E. (1994). Methemoglobin reductase deficiency in a cat. *J. Am. Vet. Med. Assoc.* **205**, 1290–1291.
- Harvey, J. W., French, T. W., and Meyer, D. J. (1982). Chronic iron deficiency anemia in dogs. *J. Am. Anim. Hosp. Assoc.* **18**, 946–960.
- Harvey, J. W., French, T. W., and Senior, D. F. (1986). Hematologic abnormalities associated with chronic acetaminophen administration in a dog. *J. Am. Vet. Med. Assoc.* **189**, 1334–1335.
- Harvey, J. W., and Giger, U. (1991). Muscle-type phosphofructokinase deficiency in English springer spaniel dogs. *Comp. Pathol. Bull.* **23**(4), 3–4.
- Harvey, J. W., Gropp, K. E., and Bellah, J. R. (1992a). Biochemical findings in phosphofructokinase-deficient canine skeletal muscle. In “State of Art in Animal Clinical Biochemistry” (A. Ubaldi, Ed.), p. 79. Boehringer Mannheim, Parma.
- Harvey, J. W., and Kaneko, J. J. (1975a). Erythrocyte enzyme activities and glutathione levels of the horse, cat, dog and man. *Comp. Biochem. Physiol. [B]* **52B**, 507–510.
- Harvey, J. W., and Kaneko, J. J. (1975b). Mammalian erythrocyte glutathione reductase: kinetic constants and saturation with cofactor. *Am. J. Vet. Res.* **36**, 1511–1513.
- Harvey, J. W., and Kaneko, J. J. (1976a). Glucose metabolism of mammalian erythrocytes. *J. Cell Physiol.* **89**, 219–224.
- Harvey, J. W., and Kaneko, J. J. (1976b). Oxidation of human and animal haemoglobins with ascorbate, acetylphenylhydrazine, nitrite and hydrogen peroxide. *Br. J. Haematol.* **32**, 199–209.
- Harvey, J. W., and Kaneko, J. J. (1977). Mammalian erythrocyte metabolism and oxidant drugs. *Toxicol. Appl. Pharmacol.* **42**, 253–261.
- Harvey, J. W., Kaneko, J. J., and Hudson, E. B. (1977). Erythrocyte pyruvate kinase deficiency in a beagle dog. *Vet. Clin. Pathol.* **6**, 13–17.
- Harvey, J. W., and Keitt, A. S. (1983). Studies of the efficacy and potential hazards of methylene blue therapy in aniline-induced methaemoglobinemia. *Br. J. Haematol.* **54**, 29–41.
- Harvey, J. W., King, R. R., Berry, C. R., and Blue, J. T. (1991). Methaemoglobin reductase deficiency in dogs. *Comp. Haematol. Int.* **1**, 155–159.
- Harvey, J. W., and Kornick, H. P. (1976). Phenazopyridine toxicosis in the cat. *J. Am. Vet. Med. Assoc.* **169**, 327–331.
- Harvey, J. W., Ling, G. V., and Kaneko, J. J. (1974). Methemoglobin reductase deficiency in a dog. *J. Am. Vet. Med. Assoc.* **164**, 1030–1033.
- Harvey, J. W., Pate, M. G., Mhaskar, Y., and Dunaway, G. A. (1992b). Characterization of phosphofructokinase-deficient canine erythrocytes. *J. Inher. Metab. Dis.* **15**, 747–759.
- Harvey, J. W., Peteya, D. J., and Kociba, G. J. (1990b). Utilization of an enzyme heat stability test and erythrocyte glycolytic intermediate assays in the diagnosis of canine pyruvate kinase deficiency. *Vet. Clin. Pathol.* **19**, 55–58.
- Harvey, J. W., and Rackear, D. (1985). Experimental onion-induced hemolytic anemia in dogs. *Vet. Pathol.* **22**, 387–392.
- Harvey, J. W., and Reddy, G. R. (1989). Postnatal hematologic development in phosphofructokinase-deficient dogs. *Blood* **74**, 2556–2561.
- Harvey, J. W., Sameck, J. H., and Burgard, F. J. (1979). Benzocaine-induced methemoglobinemia in dogs. *J. Am. Vet. Med. Assoc.* **175**, 1171–1175.
- Harvey, J. W., and Smith, J. E. (1994). Haematology and clinical chemistry of English springer spaniel dogs with phosphofructokinase deficiency. *Comp. Haematol. Int.* **4**, 70–74.
- Harvey, J. W., Stockham, S. L., Scott, M. A., Johnson, P. J., Donald, J. J., and Chandler, C. J. (2003). Methemoglobinemia and eccentrocytosis in equine erythrocyte flavin adenine dinucleotide deficiency. *Vet. Pathol.* **40**, 632–642.
- Harvey, J. W., Sussman, W. A., and Pate, M. G. (1988). Effect of 2,3-diphosphoglycerate concentration on the alkaline fragility of

- phosphofructokinase-deficient canine erythrocytes. *Comp. Biochem. Physiol. [B]* **89B**, 105–107.
- Harvey, J. W., Wolfsheimer, K. J., Simpson, C. F., and French, T. W. (1985). Pathologic sideroblasts and siderocytes associated with chloramphenicol therapy in a dog. *Vet. Clin. Pathol.* **14**(1), 36–42.
- Haskins, S. C., and Rezende, M. L. (2006). The caprine oxyhemoglobin dissociation curve. *Res. Vet. Sci.* **80**, 103–108.
- Hayes, K., Harvey, J. W., Giger, U., and D'Agorne, S. (2007). Hemolysis, myopathy, and cardiac disease associated with hereditary phosphofructokinase deficiency in two whippets. *Submitted for publication*.
- Hebbel, R. P., Berger, E. M., and Eaton, J. W. (1980). Effect of increased maternal hemoglobin oxygen affinity on fetal growth in the rat. *Blood* **55**, 969–974.
- Hebbel, R. P., and Eaton, J. W. (1989). Pathobiology of heme interaction with the erythrocyte membrane. *Semin. Hematol.* **26**, 136–149.
- Heiene, R., Vulliet, P. R., Williams, R. L., and Cowgill, L. D. (2001). Use of capillary electrophoresis to quantitate carbamylated hemoglobin concentrations in dogs with renal failure. *Am. J. Vet. Res.* **62**, 1302–1306.
- Henquell, L., LaCelle, P. L., and Honig, C. R. (1976). Capillary diameter in rat heart *in situ*: relation to erythrocyte deformity, O<sub>2</sub> transport, and transmural O<sub>2</sub> gradients. *Microvasc. Res.* **12**, 259–274.
- Hickman, M. A., Rogers, Q. R., and Morris, J. G. (1990). Effect of diet on Heinz body formation in kittens. *Am. J. Vet. Res.* **51**, 475–478.
- Higasa, K., Manabe, J., Yubisui, T., Sumimoto, H., Pung-amritt, P., Tanphaichitr, V. S., and Fukumaki, Y. (1998). Molecular basis of hereditary methaemoglobinaemia, types I and II: two novel mutations in the NADH-cytochrome b<sub>5</sub> reductase gene. *Br. J. Haematol.* **103**, 922–930.
- Higgins, P. J., Garuck, R. L., and Bunn, H. F. (1982). Glycosylated hemoglobin in human and animal red cells. Role of glucose permeability. *Diabetes* **31**, 743–748.
- Hinds, T. R., Hammond, W. P., Maggio-Price, L., Dodson, R. A., and Vincenzi, F. F. (1989). The activity of the red blood cell Ca pump is decreased in hemolytic anemia of the beagle dog. *Blood Cells* **15**, 407–420.
- Hinds, T. R., and Vincenzi, F. F. (1986). Evidence for a calmodulin-activated Ca<sup>2+</sup> pump ATPase in dog erythrocytes. *Proc. Soc. Exp. Biol. Med.* **181**, 542–549.
- Hirose, J., Kano, H., Kidani, Y., Iwamoto, H., and Hiromi, K. (1992). Zinc deficient bovine erythrocyte superoxide dismutase has low specific activity. *Chem. Pharm. Bull. (Tokyo)* **40**, 506–508.
- Hjelle, J. J., and Grauer, G. F. (1986). Acetaminophen-induced toxicosis in dogs and cats. *J. Am. Vet. Med. Assoc.* **188**, 742–746.
- Hladky, S. B., and Rink, T. J. (1977). pH equilibrium across the red cell membrane. In "Membrane Transport in Red Cells" (V. L. Lew and J. C. Ellory, Eds.), pp. 115–135. Academic Press, New York.
- Ho, Y. S., Xiong, Y., Ma, W., Spector, A., and Ho, D. S. (2004). Mice lacking catalase develop normally but show differential sensitivity to oxidant tissue injury. *J. Biol. Chem.* **279**, 32804–32812.
- Hochstein, P., Kumar, K. S., and Forman, S. J. (1978). Mechanisms of copper toxicity in red cells. *Progr. Clin. Biol. Res.* **21**, 669–681.
- Holland, C. T., Canfield, P. J., Watson, A. D. J., and Allan, G. S. (1991). Dyserythropoiesis, polymyopathy, and cardiac disease in three related English springer spaniels. *J. Vet. Intern. Med.* **5**, 151–159.
- Holman, H. H., and Drew, S. M. (1964). The blood picture of the goat. II. Changes in erythrocyte shape, size and number associated with age. *Res. Vet. Sci.* **5**, 274–285.
- Holman, H. H., and Drew, S. M. (1966). Effect of an injection of iron dextran complex on blood constituents and body weight of young kids. *Vet. Rec.* **78**, 772–776.
- Holter, P. H., Framstad, T., Aulie, A., Refsum, H. E., and Sjaastad, O. V. (1991). Effect of iron treatment on erythrocyte parameters in postnatal anemia of the pig. *Pediatr. Hematol. Oncol.* **8**, 1–11.
- Houston, D. M., and Myers, S. L. (1993). A review of Heinz-body anemia in the dog induced by toxins. *Vet. Hum. Toxicol.* **35**, 158–161.
- Houwen, B. (1992). Reticulocyte maturation. *Blood Cells* **18**, 167–186.
- Hrinczenko, B. W., Alayash, A. I., Wink, D. A., Gladwin, M. T., Rodgers, G. P., and Schechter, A. N. (2000). Effect of nitric oxide and nitric oxide donors on red blood cell oxygen transport. *Br. J. Haematol.* **110**, 412–419.
- Hsia, C. C. W. (1998). Respiration function of hemoglobin. *N. Engl. J. Med.* **338**, 239–247.
- Hubler, M., Kaelin, S., Hagen, A., Fairburn, A., Canfield, P., and Ruesch, P. (1987). Feline neonatal isoerythrolysis in two litters. *J. Small Anim. Pract.* **28**, 833–838.
- Huebers, H., Csiba, E., Huebers, E., and Finch, C. A. (1985). Molecular advantage of diferric transferrin in delivering iron to reticulocytes: a comparative study. *Proc. Natl. Acad. Sci. USA* **179**, 222–226.
- Huisman, T. H. J., and Kitchens, J. (1968). Oxygen equilibria studies of the hemoglobins from normal and anemic sheep and goats. *Am. J. Physiol.* **215**, 140–146.
- Huisman, T. H. J., Lewis, J. P., Blunt, M. H., Adams, H. R., Miller, A., Dozy, A. M., and Boyd, E. M. (1969). Hemoglobin C in newborn sheep and goats: a possible explanation for its function and biosynthesis. *Pediatr. Res.* **3**, 189–198.
- Hultquist, D. E., Xu, F., Quandt, K. S., Schlafer, M., Mack, C. P., Till, G. O., Seekamp, A., Betz, A. L., and Ennis, S. R. (1993). Evidence that NADPH-dependent methemoglobin reductase and administered riboflavin protect tissues from oxidative injury. *Am. J. Hematol.* **42**, 13–18.
- Iampietro, P. F., Burr, M. J., Fiorica, V., McKenzie, J. M., and Higgins, E. A. (1967). pH-dependent lysis of canine erythrocytes. *J. Appl. Physiol.* **23**, 505–510.
- Ibrahim, E. D., McLellan, S. A., and Walsh, T. S. (2005). Red blood cell 2,3-diphosphoglycerate concentration and *in vivo* P50 during early critical illness. *Crit. Care Med.* **33**, 2247–2252.
- Inaba, M. (2000). Red blood cell membrane defects. In "Schalm's Veterinary Hematology" (B. F. Feldman, J. G. Zinkl, and N. C. Jain, Eds.), pp. 1012–1019. Lippincott Williams & Wilkins, Philadelphia.
- Inaba, M., and Maede, Y. (1984). Increase of Na<sup>+</sup> gradient-dependent L-glutamate and L-aspartate transport in high K<sup>+</sup> dog erythrocytes associated with high activity of (Na<sup>+</sup>, K<sup>+</sup>)-ATPase. *J. Biol. Chem.* **259**, 312–317.
- Inaba, M., and Maede, Y. (1986). Na,K-ATPase in dog red cells. *J. Biol. Chem.* **261**, 16099–16105.
- Inaba, M., Yawata, A., Koshino, I., Sato, K., Takeuchi, M., Takakuwa, Y., Manno, S., Yawata, Y., Kanzaki, A., Sakai, J., Ban, A., Ono, K., and Maede, Y. (1996). Defective anion transport and marked spherocytosis with membrane instability caused by hereditary total deficiency of red cell band 3 in cattle due to a nonsense mutation. *J. Clin. Invest.* **97**, 1804–1817.
- Isaacs, R. E., and Harkness, D. R. (1983). Erythrocyte organic phosphates and hemoglobin function in domestic mammals. In "Red Blood Cells of Domestic Mammals" (N. S. Agar and P. G. Board, Eds.), pp. 315–337. Elsevier, Amsterdam.
- Israel, Y., MacDonald, A., Bernstein, J., and Rosenmann, E. (1972). Changes from high potassium (HK) to low potassium (LK) in bovine red cells. *J. Gen. Physiol.* **59**, 270–284.
- Jacob, H. S., Yawata, Y., Craddock, P., Hebbel, R., Howe, R., and Silvis, S. (1973). Hyperalimentation hypophosphatemia: hematologic-neurologic

- dysfunction due to ATP depletion. *Trans. Assoc. Am. Physicians.* **86**, 143–153.
- Jacobasch, G., Minakami, S., and Rapoport, S. M. (1974). Glycolysis of the erythrocyte. In “Cellular and Molecular Biology of Erythrocytes” (H. Yoshikawa and S. M. Rapoport, Eds.), pp. 55–92. University Park Press, Baltimore.
- Jagger, J. E., Bateman, R. M., Ellsworth, M. L., and Ellis, C. G. (2001). Role of erythrocyte in regulating local O<sub>2</sub> delivery mediated by hemoglobin oxygenation. *Am. J. Physiol. Heart Circ. Physiol.* **280**, H2833–H2839.
- Jain, N. C. (1986). “Schalm’s Veterinary Hematology.” Lea & Febiger, Philadelphia.
- Jain, N. C., and Kono, C. S. (1977). Fusiform erythrocytes in angora goats resembling sickle cells: influence of temperature, pH, and oxygenation on cell shape. *Am. J. Vet. Res.* **38**, 983–990.
- Jain, N. C., Kono, C. S., Myers, A., and Bottomly, K. (1980). Fusiform erythrocytes resembling sickle cells in angora goats: observations on osmotic and mechanical fragilities and reversal of shape during anaemia. *Res. Vet. Sci.* **28**, 25–35.
- Jandl, J. H. (1987). “Blood: Textbook of Hematology.” Little Brown, Boston.
- Jarolim, P., Lahav, M., Liu, S.-C., and Palek, J. (1990). Effect of hemoglobin oxidation products on the stability of red cell membrane skeletons and the associations of skeletal proteins: correlation with a release of hemin. *Blood* **76**, 2125–2131.
- Jarvis, S. M., and Young, J. D. (1982). Nucleoside translocation in sheep reticulocytes and fetal erythrocytes: a proposed model for the nucleoside transporter. *J. Physiol. (Lond.)* **324**, 47–66.
- Jelkmann, W. (2007). Erythropoietin after a century of research: younger than ever. *Eur. J. Haematol.* **78**, 183–205.
- Jensen, F. B. (2004). Red blood cell pH, the Bohr effect, and other oxygenation-linked phenomena in blood O<sub>2</sub> and CO<sub>2</sub> transport. *Acta Physiol. Scand.* **182**, 215–227.
- Jensen, F. B. (2005). Nitrite transport into pig erythrocytes and its potential biological role. *Acta Physiol Scand.* **184**, 243–251.
- Jeong, J. R., Yamasaki, M., Komatsu, T., Inaba, M., Yamato, O., and Maeda, Y. (2005). Identification of heat shock protein 70 in canine reticulocytes and mature erythrocytes. *Jpn. J. Vet. Res.* **53**, 37–46.
- Jiang, W., Ding, Y., Su, Y., Jiang, M., Hu, X., and Zhang, Z. (2006). Interaction of glucose transporter 1 with anion exchanger 1 *in vitro*. *Biochem. Biophys. Res. Commun.* **339**, 1255–1261.
- Johnson, E. H., Nam, D., and Al-Busaigy, R. (2002). Observations on haemoglobin types in three breeds of Omani goats. *Vet. Res. Commun.* **26**, 353–359.
- Johnson, R. M., Goyette, G., Jr., Ravindranath, Y., and Ho, Y. S. (2000). Red cells from glutathione peroxidase-1-deficient mice have nearly normal defenses against exogenous peroxides. *Blood* **96**, 1985–1988.
- Johnson, R. M., Goyette, G., Jr., Ravindranath, Y., and Ho, Y. S. (2005). Hemoglobin autooxidation and regulation of endogenous H<sub>2</sub>O<sub>2</sub> levels in erythrocytes. *Free Radic. Biol. Med.* **39**, 1407–1417.
- Johnstone, R. M., Mathew, A., Setchenska, M. S., Grdisa, M., and White, M. K. (1998). Loss of glucose transport in developing avian red cells. *Eur. J. Cell Biol.* **75**, 66–77.
- Jubb, T. F., Jerrett, I. V., Browning, J. W., and Thomas, K. W. (1990). Haemoglobinuria and hypophosphataemia in postparturient dairy cows without dietary deficiency of phosphorus. *Aust. Vet. J.* **67**, 86–89.
- Kaneko, J. J. (1980). Erythrocyte metabolism. In “Clinical Biochemistry of Domestic Animals” (J. J. Kaneko, Ed.), pp. 119–174. Academic Press, New York.
- Kaushansky, K. (2006a). Hematopoietic stem cells, progenitors, and cytokines. In “Williams Hematology” (M. A. Lichtman, E. Beutler, T. J. Kipps, U. Seligsohn, K. Kaushansky, and J. T. Prchal, Eds.), pp. 201–220. McGraw-Hill, New York.
- Kaushansky, K. (2006b). Lineage-specific hematopoietic growth factors. *N. Engl. J. Med.* **354**, 2034–2045.
- Kay, M. (2005). Immunoregulation of cellular life span. *Ann. NY Acad. Sci.* **1057**, 85–111.
- Keppeler, D., Leier, I., Jedlitschky, G., and König, J. (1998). ATP-dependent transport of glutathione S-conjugates by the multidrug resistance protein MRP1 and its apical isoform MRP2. *Chem. Biol. Interact.* **111–112**, 153–161.
- Kerr, L. A., and McGavin, H. D. (1991). Chronic copper poisoning in sheep grazing pastures fertilized with swine manure. *J. Am. Vet. Med. Assoc.* **198**, 99–101.
- Kiefer, C. R., and Snyder, L. M. (2000). Oxidation and erythrocyte senescence. *Curr. Opin. Hematol.* **7**, 113–116.
- Kim, H. D. (1983). Postnatal changes in energy metabolism of mammalian red blood cells. In “Red Blood Cells of Domestic Mammals” (N. S. Agar and P. G. Board, Eds.), pp. 339–355. Elsevier, Amsterdam.
- Kim, H. D., and Duhm, J. (1974). Postnatal decrease in the oxygen affinity of pig blood induced by red cell 2,3-DPG. *Am. J. Physiol.* **226**, 1001–1006.
- Kim, H. D., and Luthra, M. G. (1977). Pig reticulocytes. III. Glucose permeability in naturally occurring reticulocytes and red cells from newborn piglets. *J. Gen. Physiol.* **70**, 171–185.
- Kim, H. D., and McManus, T. J. (1971). Studies on the energy metabolism of pig red cells. I. The limiting role of membrane permeability in glycolysis. *Biochim. Biophys. Acta* **230**, 1–11.
- Kim, H. D., Theg, B. E., and Lauf, P. K. (1980). LK sheep reticulocytosis: effect of anti-L on K influx and *in vitro* maturation. *J. Gen. Physiol.* **76**, 109–121.
- King, L. G., Giger, U., Diserens, D., and Nagode, L. A. (1992). Anemia of chronic renal failure in dogs. *J. Vet. Intern. Med.* **6**, 264–270.
- King, M. E., and Mifsud, C. V. (1981). Postnatal changes in erythrocyte 2,3-diphosphoglycerate in sheep and cattle. *Res. Vet. Sci.* **31**, 37–39.
- Kingsley, P. D., Malik, J., Fantauzzo, K. A., and Palis, J. (2004). Yolk sac-derived primitive erythroblasts enucleate during mammalian embryogenesis. *Blood* **104**, 19–25.
- Kirk, J. H., and Bulgin, M. S. (1979). Effects of feeding cull domestic onions (*Allium cepa*) to sheep. *Am. J. Vet. Res.* **40**, 397–399.
- Kirk, R. G., Andrews, S. B., and Lee, P. (1983). The correlation of composition and morphology during the high to low potassium transition in single erythropoietic cells. *J. Membr. Biol.* **76**, 281–286.
- Kirkman, H. N., and Gaetani, G. F. (2007). Mammalian catalase: a venerable enzyme with new mysteries. *Trends Biochem. Sci.* **32**, 44–50.
- Kirkman, H. N., Gaetani, G. F., and Clemons, E. H. (1986). NADP-binding proteins causing reduced availability and sigmoid release of NADP<sup>+</sup> in human erythrocytes. *J. Biol. Chem.* **261**, 4039–4045.
- Kirkman, H. N., Galiano, S., and Gaetani, G. F. (1987). The function of catalase-bound NADPH. *J. Biol. Chem.* **262**, 660–666.
- Kitchen, H. (1974). Animal hemoglobin heterogeneity. *Ann. NY Acad. Sci.* **241**, 12–24.
- Kitchen, H., and Brett, I. (1974). Embryonic and fetal hemoglobin in animals. *Ann. NY Acad. Sci.* **241**, 653–671.
- Klatt, P., and Lamas, S. (2000). Regulation of protein function by S-glutathiolation in response to oxidative and nitrosative stress. *Eur. J. Biochem.* **267**, 4928–4944.
- Kleiber, M. (1961). “The Fire of Life.” Wiley, New York.



- Knight, A. P., Lassen, D., McBride, T., Marsh, D., Kimberling, C., Delgado, M. G., and Gould, D. (2000). Adaptation of pregnant ewes to an exclusive onion diet. *Vet. Hum. Toxicol.* **42**, 1–4.
- Kobayashi, K. (1981). Onion poisoning in the cat. *Feline Pract.* **11**, 22–27.
- Kobylka, D., Khettry, A., Shin, B. C., and Carraway, K. L. (1972). Proteins and glycoproteins of the erythrocyte membrane. *Arch. Biochem. Biophys.* **148**, 475–487.
- Kohn, B., Goldschmidt, M. H., Hohenhaus, A. E., and Giger, U. (2000). Anemia, splenomegaly, and increased osmotic fragility of erythrocytes in Abyssinian and Somali cats. *J. Am. Vet. Med. Assoc.* **217**, 1483–1491.
- Kohn, B., Henthorn, P. S., Rajpurohit, Y., Reilly, M. P., Asakura, T., and Giger, U. (1999). Feline adult  $\beta$ -globin polymorphism reflected in restriction fragment length patterns. *J. Hered.* **90**, 177–181.
- Kohn, B., Reilly, M. P., Asakura, T., and Giger, U. (1998). Polymorphism of feline  $\beta$ -globins studied by reversed-phase high-performance liquid chromatography. *Am. J. Vet. Res.* **59**, 830–835.
- Kosower, N. S. (1993). Altered properties of erythrocytes in the aged. *Am. J. Hematol.* **42**, 241–247.
- Koury, M. J., and Ponka, P. (2004). New insights into erythropoiesis: the roles of folate, vitamin B12, and iron. *Annu. Rev. Nutr.* **24**, 105–131.
- Krake, A. C., Arendt, T. D., Teachout, D. J., Raffae, M. R., Christopher, M. M., Stowe, C. M., and Perman, V. (1985). Cetacaine-induced methemoglobinemia in domestic cats. *J. Am. Anim. Hosp. Assoc.* **21**, 527–534.
- Krishnamurthy, P. C., Du, G., Fukuda, Y., Sun, D., Sampath, J., Mercer, K. E., Wang, J., Sosa-Pineda, B., Murti, K. G., and Schuetz, J. D. (2006). Identification of a mammalian mitochondrial porphyrin transporter. *Nature* **443**, 586–589.
- Kruckeberg, W. C., and Chilson, O. P. (1973). Red blood cell AMP-deaminase: levels of activity in hemolysates from twenty different vertebrate species. *Comp. Biochem. Physiol. [B]* **46**, 653–660.
- Kruse, H. D., Orent, E. R., and McCollum, E. V. (1933). Studies on magnesium deficiency in animals. III. Chemical changes in the blood following magnesium deprivation. *J. Biol. Chem.* **100**, 603–643.
- Kuchel, P. W., and Benga, G. (2005). Why does the mammalian red blood cell have aquaporins? *Biosystems* **82**, 189–196.
- Kucia, M., Reza, R., Jala, V. R., Dawn, B., Ratajczak, J., and Ratajczak, M. Z. (2005). Bone marrow as a home of heterogeneous populations of nonhematopoietic stem cells. *Leukemia* **19**, 1118–1127.
- Kumar, S., and Bandyopadhyay, U. (2005). Free heme toxicity and its detoxification systems in human. *Toxicol. Lett.* **157**, 175–188.
- Kurata, M., Suzuki, M., and Agar, N. S. (1993). Antioxidant systems and erythrocyte life-span in mammals. *Comp. Biochem. Physiol. [B]* **106B**, 477–487.
- Kwong, F. Y., Baldwin, S. A., Scudder, P. R., Jarvis, S. M., Choy, M. Y., and Young, J. D. (1986). Erythrocyte nucleoside and sugar transport. Endo-beta-galactosidase and endoglycosidase-F digestion of partially purified human and pig transporter proteins. *Biochem. J.* **240**, 349–356.
- Laber, J., Perman, V., and Stevens, J. B. (1974). Polychromasia or reticulocytes: an assessment of the dog. *J. Am. Anim. Hosp. Assoc.* **10**, 399–406.
- Lagutchik, M. S., Mundie, T. G., and Martin, D. G. (1992). Methemoglobinemia induced by a benzocaine-based topically administered anesthetic in eight sheep. *J. Am. Vet. Med. Assoc.* **201**, 1407–1410.
- Lahey, M. E., Gubler, C. J., Chase, M. S., Cartwright, G. E., and Wintrobe, M. M. (1952). Studies on copper metabolism. II. Hematologic manifestations of copper deficiency in swine. *Blood* **7**, 1053–1074.
- Lalanne, M., and Willemot, J. (1980). Adenine and hypoxanthine salvage in erythrocytes of eight mammalian species. *Comp. Biochem. Physiol. [B]* **66**, 367–372.
- Landaw, S. A. (1988). Factors that accelerate or retard red blood cell senescence. *Blood Cells* **14**, 47–59.
- Lang, F., Lang, K. S., Lang, P. A., Huber, S. M., and Wieder, T. (2006). Mechanisms and significance of eryptosis. *Antioxid. Redox. Signal.* **8**, 1183–1192.
- Laris, P. G. (1958). Permeability and utilization of glucose in mammalian erythrocytes. *J. Cell. Comp. Physiol.* **51**, 273–306.
- Leberbauer, C., Boulme, F., Unfried, G., Huber, J., Beug, H., and Mullner, E. W. (2005). Different steroids co-regulate long-term expansion versus terminal differentiation in primary human erythroid progenitors. *Blood* **105**, 85–94.
- Lee, C. K., Odell, G. V., Eliot, F. P., Anderson, I. L., and Jones, E. W. (1971). Postnatal loss of bovine fetal hemoglobin. *Am. J. Vet. Res.* **32**, 1039–1044.
- Lee, G. R., Cartwright, G. E., and Wintrobe, M. M. (1968a). Heme biosynthesis in copper deficient swine. *Proc. Soc. Exp. Biol. Med.* **127**, 977–981.
- Lee, G. R., Nacht, S., Lukens, J. N., and Cartwright, G. E. (1968b). Iron metabolism in copper-deficient swine. *J. Clin. Invest.* **47**, 2058–2069.
- Lee, K. W., Yamato, O., Tajima, M., Kuraoka, M., Omae, S., and Maede, Y. (2000). Hematologic changes associated with the appearance of eccentrocytes after intragastric administration of garlic extract to dogs. *Am. J. Vet. Res.* **61**, 1446–1450.
- Lee, P., Brown, M. E., and Hutzler, P. T. (1976). Blood volume changes and production and destruction of erythrocytes in newborn dogs. *Am. J. Vet. Res.* **37**, 561–565.
- Lee, T. H., Kim, S. U., Yu, S. L., Kim, S. H., Park, D. S., Moon, H. B., Dho, S. H., Kwon, K. S., Kwon, H. J., Han, Y. H., Jeong, S., Kang, S. W., Shin, H. S., Lee, K. K., Rhee, S. G., and Yu, D. Y. (2003). Peroxiredoxin II is essential for sustaining life span of erythrocytes in mice. *Blood* **101**, 5033–5038.
- Lelanne, M., and Willemot, J. (1980). Adenine and hypoxanthine salvage in erythrocytes of eight mammalian species. *Comp. Biochem. Physiol. [B]* **66B**, 367–372.
- Lenard, J. G. (1974). A note on the shape of the erythrocyte. *Bulletin of Mathematical Biology* **36**, 55–58.
- Leng, R. A., and Annison, E. F. (1962). Metabolic activities of sheep erythrocytes. I. Glycolytic activities. *Aust. J. Agric. Res.* **13**, 31–43.
- León-Velarde, F., De Muizon, C., Palacios, J. A., Clark, D., and Monge, C. C. (1996). Hemoglobin affinity and structure in high-altitude and sea-level carnivores from Peru. *Comp. Biochem. Physiology. A: Comp. Physiol.* **113A**, 407–411.
- Letchworth, G. J., Bentinck-Smith, J., Bolton, G. R., Wootton, J. F., and Family, L. (1977). Cyanosis and methemoglobinemia in two dogs due to NADH methemoglobin reductase deficiency. *J. Am. Anim. Hosp. Assoc.* **13**, 75–79.
- Lewis, H. B., and Rebar, A. H. (1979). “Bone Marrow Evaluation in Veterinary Practice.” Ralston Purina, St. Louis, MO.
- Liard, J. F., and Kunert, M. P. (1993). Hemodynamic changes induced by low blood oxygen affinity in dogs. *Am. J. Physiol. Regul. Integr. Comp. Physiol.* **264**, R396–R401.
- Lichtman, M. A., and Santillo, P. (1986). Red cell egress from the marrow. *Blood Cells* **12**, 11–19.
- Lill, R., Dutkiewicz, R., Elsasser, H. P., Hausmann, A., Netz, D. J., Pierik, A. J., Stehling, O., Urzica, E., and Muhlenhoff, U. (2006). Mechanisms of iron-sulfur protein maturation in mitochondria,

- cytosol and nucleus of eukaryotes. *Biochim. Biophys. Acta* **1763**, 652–667.
- Lillig, C. H., and Holmgren, A. (2007). Thioredoxin and related molecules: from biology to health and disease. *Antioxid. Redox. Signal.* **9**, 25–47.
- Lincoln, S. D., Howell, M. E., Combs, J. J., and Hinman, D. D. (1992). Hematologic effects and feeding performance in cattle fed cull domestic onions (*Allium cepa*). *J. Am. Vet. Med. Assoc.* **200**, 1090–1094.
- Liu, S.-C., and Derick, L. H. (1992). Molecular anatomy of the red blood cell membrane skeleton: structure-function relationships. *Semin. Hematol.* **29**, 231–243.
- Liu, X., and Spolarics, Z. (2003). Methemoglobin is a potent activator of endothelial cells by stimulating IL-6 and IL-8 production and E-selectin membrane expression. *Am. J. Physiol. Cell Physiol.* **285**, C1036–C1046.
- Low, F. M., Hampton, M. B., Peskin, A. V., and Winterbourn, C. C. (2007). Peroxiredoxin 2 functions as a noncatalytic scavenger of low-level hydrogen peroxide in the erythrocyte. *Blood* **109**, 2611–2617.
- Low, P. S. (1989). Interaction of native and denatured hemoglobins with band 3. Consequences for erythrocyte structure and function. In "Red Blood Cell Membranes" (P. Agre and J. C. Parker, Eds.), pp. 237–260. Marcel Dekker, New York.
- Low, P. S. (1991). Role of hemoglobin denaturation and band 3 clustering in initiating red cell removal. *Adv. Exp. Med. Biol.* **307**, 173–183.
- Lund, J. E., and Brown, P. K. (1997). Hypersegmented megakaryocytes and megakaryocytes with multiple separate nuclei in dogs treated with PNU-100592, an oxazolidinone antibiotic. *Toxicol. Pathol.* **25**, 339–343.
- Luther, D. G., Cox, H. U., and Nelson, W. O. (1985). Screening for neonatal isohemolytic anemia in calves. *Am. J. Vet. Res.* **46**, 1078–1079.
- Luttgen, P. J., Whitney, M. S., Wolf, A. M., and Scruggs, D. W. (1990). Heinz body hemolytic anemia associated with high plasma zinc concentration in a dog. *J. Am. Vet. Med. Assoc.* **197**, 1347–1350.
- Lutz, H., Castelli, I., Ehrensperger, F., Pospischil, A., Roskopf, M., Siegl, G., Grob, M., and Martinod, S. (1995). Panleukopenia-like syndrome of FeLV caused by co-infection with FeLV and feline panleukopenia virus. *Vet. Immunol. Immunopathol.* **46**, 21–33.
- Lutz, H. U., Stammler, P., Kock, D., and Taylor, R. P. (1991). Opsonic potential of C3b-anti-band 3 complexes when generated on senescent and oxidatively stressed red cells or in fluid phase. *Adv. Exp. Med. Biol.* **307**, 367–376.
- Lykkesfeldt, J. (2002). Increased oxidative damage in vitamin C deficiency is accompanied by induction of ascorbic acid recycling capacity in young but not mature guinea pigs. *Free Radic. Res.* **36**, 567–574.
- Ma, Y., Freitag, P., Zhou, J., Brune, B., Frede, S., and Fandrey, J. (2004). Thyroid hormone induces erythropoietin gene expression through augmented accumulation of hypoxia-inducible factor-1. *Am. J. Physiol. Regul. Integr. Comp. Physiol.* **287**, R600–R607.
- MacLeay, J. M. (2001). Neonatal isoerythrolysis involving the Qc and Db antigens in a foal. *J. Am. Vet. Med. Assoc.* **219**, 50, 79–81.
- MacWilliams, P. S., Searcy, G. P., and Bellamy, J. E. C. (1982). Bovine postparturient hemoglobinuria: a review of the literature. *Can. Vet. J.* **23**, 309–312.
- Maede, Y., Amano, Y., Nishida, A., Murase, T., Sasaki, A., and Inaba, M. (1991). Hereditary high-potassium erythrocytes with high Na, K-ATPase activity in Japanese shiba dogs. *Res. Vet. Sci.* **50**, 123–125.
- Maede, Y., Hoshino, T., Inaba, M., and Namioka, S. (1987). Methionine toxicosis in cats. *Am. J. Vet. Res.* **48**, 289–292.
- Maede, Y., and Inaba, M. (1985). (Na,K)-ATPase and ouabain binding in reticulocytes from dogs with high K and low K erythrocytes and their changes in maturation. *J. Biol. Chem.* **260**, 3337–3343.
- Maede, Y., and Inaba, M. (1987). Energy metabolism in canine erythrocytes associated with inherited high Na<sup>+</sup>- and K<sup>+</sup>-stimulated adenosine triphosphatase activity. *Am. J. Vet. Res.* **48**, 114–118.
- Maede, Y., Inaba, M., and Taniguchi, N. (1983). Increase of Na-K-ATPase activity, glutamate, and aspartate uptake in dog erythrocytes associated with hereditary high accumulation of GSH, glutamate, glutamine, and aspartate. *Blood* **61**, 493–499.
- Maede, Y., Kasai, N., and Taniguchi, N. (1982). Hereditary high concentration of glutathione in canine erythrocytes associated with high accumulation of glutamate, glutamine, and aspartate. *Blood* **59**, 883–889.
- Maede, Y., Kuwabara, M., Sasaki, A., Inaba, M., and Hiraoka, W. (1989). Elevated glutathione accelerates oxidative damage to erythrocytes produced by aromatic disulfide. *Blood* **73**, 312–317.
- Maggio-Price, L., Emerson, C. L., Hinds, T. R., Vincenzi, F. F., and Hammond, W. R. (1988). Hereditary nonspherocytic hemolytic anemia in beagles. *Am. J. Vet. Res.* **49**, 1020–1025.
- Magnani, M., Piatti, E., Dacha, M., and Fornaini, G. (1980). Comparative studies of glucose metabolism on mammals' red cells. *Comp. Biochem. Physiol. [B]* **67B**, 139–142.
- Magnani, M., Stocchi, V., Serafini, N., Piatti, E., Dacha, M., and Fornaini, G. (1983). Pig red blood cell hexokinase: regulatory characteristics and possible physiological role. *Arch. Biochem. Biophys.* **226**, 377–387.
- Maher, A. D., and Kuchel, P. W. (2003). The Gardos channel: a review of the Ca<sup>2+</sup>-activated K<sup>+</sup> channel in human erythrocytes. *Int. J. Biochem. Cell Biol.* **35**, 1182–1197.
- Mairbäurl, H. (1994). Red blood cell function in hypoxia at altitude and exercise. *Int. J. Sports Med.* **15**, 51–63.
- Mairbäurl, H., and Herth, C. (1996). Na(+)-K(+)-2Cl<sup>-</sup> cotransport, Na<sup>+</sup>/H<sup>+</sup> exchange, and cell volume in ferret erythrocytes. *Am. J. Physiol.* **271**, C1603–C1611.
- Malik, R., Griffin, D. L., White, J. D., Rozmanec, M., Tisdall, P. L., Foster, S. F., Bell, K., and Nicholas, F. W. (2005). The prevalence of feline A/B blood types in the Sydney region. *Aust. Vet. J.* **83**, 38–44.
- Mandal, D., Mazumder, A., Das, P., Kundu, M., and Basu, J. (2005). Fas-, caspase 8-, and caspase 3-dependent signaling regulates the activity of the aminophospholipid translocase and phosphatidylserine externalization in human erythrocytes. *J. Biol. Chem.* **280**, 39460–39467.
- Mansfield, C. S., and Clark, P. (2005). Pyruvate kinase deficiency in a Somali cat in Australia. *Aust. Vet. J.* **83**, 483–485.
- Mansouri, A., and Lurie, A. A. (1993). Methemoglobinemia. *Am. J. Hematol.* **42**, 7–12.
- Maral, J., Puget, K., and Michelson, A. M. (1977). Comparative study of superoxide dismutase, catalase and glutathione peroxidase levels in erythrocytes of different animals. *Biochem. Biophys. Res. Commun.* **77**, 1525–1535.
- Marin, M. S., Fernandez, A., Sanchez-Yagüe, J., Cabezas, J. A., and Llanillo, M. (1990). Changes in the phospholipid and fatty acid composition in normal erythrocytes from sheep of different ages. Aminophospholipid organization in the membrane bilayer. *Biochimica* **72**, 745–750.
- Marks, S. L., Mannella, C., and Schaer, M. (1990). Coral snake envenomation in the dog: report of four cases and review of the literature. *J. Am. Anim. Hosp. Assoc.* **26**, 629–634.
- Maronpot, R. R. (1972). Erythrocyte glucose-6-phosphate dehydrogenase and glutathione deficiency in sheep. *Can. J. Comp. Med. Vet. Sci.* **36**, 55–60.
- Marta, M., Patamia, M., Colella, A., Sacchi, S., Pomponi, M., Kovacs, K. M., Lydersen, C., and Giardina, B. (1998). Anionic binding site and 2,3-DPG effect in bovine hemoglobin. *Biochemistry* **37**, 14024–14029.

- Martinovich, D., and Woodhouse, D. A. (1971). Postparturient haemoglobinuria in cattle: a Heinz body haemolytic anaemia. *N. Z. Vet. J.* **19**, 259–263.
- Mason, R. P. (1982). In “Free Radicals in Biology” (W. A. Pryor, Ed.), pp. 183–218. Academic Press, New York.
- Matthews, N. S., Brown, R. M., Barling, K. S., Lovering, S. L., and Herrig, B. W. (2004). Repetitive propofol administration in dogs and cats. *J. Am. Anim Hosp. Assoc.* **40**, 255–260.
- Mauk, A. G., and Taketa, F. (1972). Effects of organic phosphates on oxygen equilibria and kinetics of -SH reaction in feline hemoglobins. *Arch. Biochem. Biophys.* **150**, 376–381.
- Mawatari, S., and Murakami, K. (2004). Different types of glutathionylation of hemoglobin can exist in intact erythrocytes. *Arch. Biochem. Biophys.* **421**, 108–114.
- May, J. M. (1998). Ascorbate function and metabolism in the human erythrocyte. *Front Biosci.* **3**, 1–10.
- May, J. M., Qu, Z. C., Xia, L., and Cobb, C. E. (2000). Nitrite uptake and metabolism and oxidant stress in human erythrocytes. *Am. J. Physiol. Cell Physiol.* **279**, C1946–C1954.
- McClure, J. J., Koch, C., and Traub-Dargatz, J. (1994). Characterization of a red blood cell antigen in donkeys and mules associated with neonatal isoerythrolysis. *Anim. Genet.* **25**, 119–120.
- McCord, J. M., and Fridovich, I. (1969). Superoxide dismutase. *J. Biol. Chem.* **244**, 6049–6055.
- McCully, K., Chance, B., and Giger, U. (1999). *In vivo* determination of altered hemoglobin saturation in dogs with M-type phosphofructokinase deficiency. *Muscle Nerve* **22**, 621–627.
- McGillivray, S. R., Searcy, G. P., and Hirsch, V. M. (1985). Serum iron, total iron binding capacity, plasma copper and hemoglobin types in anemic and poikilocytic calves. *Can. J. Comp. Med.* **49**, 286–290.
- McKibbin, J. M., Schaefer, A. E., Frost, D. V., and Elvehjem, C. A. (1942). Studies on anemia in dogs due to pyridoxine deficiency. *J. Biol. Chem.* **142**, 77–84.
- McManus, T. J. (1967). Comparative biology of red cells. *Fed. Proc.* **26**, 1821–1826.
- McSherry, B. J., Roe, C. K., and Milne, F. J. (1966). The hematology of phenothiazine poisoning in horses. *Can. Vet. J.* **7**, 3–12.
- Meberg, A. (1980). Plasma erythropoietin levels in fetal and newborn rats: response to hypoxia. *Exp. Hematol.* **8**, 615–619.
- Meberg, A., Haga, P., and Johansen, M. (1980). Plasma erythropoietin levels in mice during the growth period. *Br. J. Haematol.* **45**, 569–574.
- Medeiros, L. O., Nurmberger, R., Jr., and Medeiros, L. F. (1984). The special behavior of equine erythrocytes connected with the methemoglobin regulation. *Comp. Biochem. Physiol. [B]* **78**, 869–871.
- Melzer, K. J., Wardrop, K. J., Hale, A. S., and Wong, V. M. (2003). A hemolytic transfusion reaction due to DEA 4 alloantibodies in a dog. *J. Vet. Intern. Med.* **17**, 931–933.
- Mendiratta, S., Qu, Z. C., and May, J. M. (1998). Enzyme-dependent ascorbate recycling in human erythrocytes: role of thioredoxin reductase. *Free Radic. Biol. Med.* **25**, 221–228.
- Meyer, D. J., and Harvey, J. W. (2004). “Veterinary Laboratory Medicine. Interpretation and Diagnosis.” Saunders, Philadelphia.
- Mgongo, F. O. K., Gomba, S., and Ogaa, J. S. (1981). Thyroid status in cobalt and vitamin B<sub>12</sub> deficiency in goats. *Vet. Rec.* **109**, 51–53.
- Mhaskar, Y., Giger, U., and Dunaway, G. A. (1991). Presence of a truncated M-type subunit and altered kinetic properties of 6-phosphofructo-1-kinase isozymes in the brain of a dog affected by glycogen storage disease type VII. *Enzyme* **45**, 137–144.
- Mhaskar, Y., Harvey, J. W., and Dunaway, G. A. (1992). Developmental changes of 6-phosphofructo-1-kinase subunit levels in erythrocytes from normal dogs and dogs affected by glycogen storage disease type VII. *Comp. Biochem. Physiol. [B]* **101B**, 303–307.
- Minakami, S., and Yoshikawa, H. (1966). Studies on erythrocyte glycolysis II. Free energy changes and rate limiting steps in erythrocyte glycolysis. *J. Biochem.* **59**, 139–144.
- Minneci, P. C., Deans, K. J., Zhi, H., Yuen, P. S., Star, R. A., Banks, S. M., Schechter, A. N., Natanson, C., Gladwin, M. T., and Solomon, S. B. (2005). Hemolysis-associated endothelial dysfunction mediated by accelerated NO inactivation by decompartmentalized oxyhemoglobin. *J. Clin. Invest* **115**, 3409–3417.
- Miseta, A., Bogner, P., Berenyi, E., Kellermayer, M., Galambos, C., Wheatley, D. N., and Cameron, I. L. (1993). Relationship between cellular ATP, potassium, sodium and magnesium concentrations in mammalian and avian erythrocytes. *Biochim. Biophys. Acta* **1175**, 133–139.
- Miyagawa, S., Kobayashi, M., Konishi, N., Sato, T., and Ueda, K. (2000). Insulin and insulin-like growth factor I support the proliferation of erythroid progenitor cells in bone marrow through the sharing of receptors. *Br. J. Haematol.* **109**, 555–562.
- Mohandas, N., and Chasis, J. A. (1993). Red blood cell deformability, membrane material properties and shape: regulation by transmembrane, skeletal and cytosolic proteins and lipids. *Semin. Hematol.* **30**, 171–192.
- Mollerberg, L., Ekman, L., and Jacobsson, S. O. (1975). Ferrokinetic studies in normal and iron deficiency anemic calves. *Acta Vet. Scand.* **16**, 205–217.
- Mooney, N. A., and Young, J. D. (1978). Nucleoside and glucose transport in erythrocytes from new-born lambs. *J. Physiol. (Lond.)* **284**, 229–239.
- Morita, T., Saeki, H., Imai, S., and Ishii, T. (1996). Erythrocyte oxidation in artificial Babesia gibsoni infection. *Vet. Parasitol.* **63**, 1–7.
- Morley, A., and Stohlman, F. (1969). Erythropoiesis in the dog: the periodic nature of the steady state. *Science* **165**, 1025–1056.
- Morris, J. G. (1977). The essentiality of biotin and vitamin B<sub>12</sub> for the cat. In “Kal Kan Symposium for the Treatment of Dog and Cat Diseases,” pp. 15–18, Ohio State University, Columbus, OH.
- Morris, J. G., Cripe, W. S., Chapman, H. L., Walker, D. F., Armstrong, J. B., Alexander, J. D., Jr., Miranda, R., Sanchez, A., Jr., Sanchez, B., Blair-West, J. R., and Denton, D. A. (1984). Selenium deficiency in cattle associated with Heinz bodies and anemia. *Science* **223**, 491–493.
- Mueggler, P. A., and Black, J. A. (1982). Postnatal regulation of canine oxygen delivery: control of erythrocyte 2,3-DPG levels. *Am. J. Physiol.* **242**, H500–H506.
- Mueggler, P. A., Black, J. A., Carpenter, S., Koler, R. D., and Metcalfe, J. (1981). Postnatal regulation of oxygen delivery: control of erythropoiesis following birth in dogs. *Resp. Physiol.* **43**, 189–196.
- Mueggler, P. A., Jones, G., Peterson, J. S., Bissonnette, J. M., Koler, R. D., Metcalfe, J., Jones, R. T., and Black, J. A. (1980). Postnatal regulation of canine oxygen delivery: erythrocyte components affecting Hb function. *Am. J. Physiol.* **238**, H73–H79.
- Mueggler, P. A., Peterson, J. S., Koler, R. D., Metcalfe, J., and Black, J. A. (1979). Postnatal regulation of oxygen delivery: hematologic parameters of postnatal dogs. *Am. J. Physiol.* **237**, H71–H75.
- Muller-Soyano, A., Platt, O., and Glader, B. E. (1986). Pyruvate kinase deficiency in dog and human erythrocytes: effects of energy depletion on cation composition and cellular hydration. *Am. J. Hematol.* **23**, 217–221.
- Mulquiney, P. J., Bubb, W. A., and Kuchel, P. W. (1999). Model of 2,3-bisphosphoglycerate metabolism in the human erythrocyte based on detailed enzyme kinetic equations: *in vivo* kinetic characterization of

- 2,3-bisphosphoglycerate synthase/phosphatase using  $^{13}\text{C}$  and  $^{31}\text{P}$  NMR. *Biochem. J.* **342**(Pt 3), 567–580.
- Munday, R., Munday, J. S., and Munday, C. M. (2003). Comparative effects of mono-, di-, tri-, and tetrasulfides derived from plants of the *Allium* family: redox cycling *in vitro* and hemolytic activity and Phase 2 enzyme induction *in vivo*. *Free Radic. Biol. Med.* **34**, 1200–1211.
- Myers, S., Wiks, K., and Giger, U. (1996). Macrocytic anemia caused by naturally occurring folate-deficiency in the cat (abstract). *Vet. Clin. Pathol.* **25**, 30.
- Nagababu, E., Chrest, F. J., and Rifkind, J. M. (2003). Hydrogen-peroxide-induced heme degradation in red blood cells: the protective roles of catalase and glutathione peroxidase. *Biochim. Biophys. Acta* **1620**, 211–217.
- Nakamura, K., Watanabe, M., Ikeda, T., Sasaki, Y., and Matsunuma, N. (1999). Tissue and organ expression of catalase in acatalasemic beagle dogs. *Exp. Anim.* **48**, 229–234.
- Nakamura, K., Watanabe, M., Sawai-Tanimoto, S., and Ikeda, T. (1998). A low catalase activity in dog erythrocytes is due to a very low content of catalase protein despite having a normal specific activity. *Int. J. Biochem. Cell Biol.* **30**, 823–831.
- Nakao, M. (1974). ATP-requiring phenomena in red-cell membranes. In “Cellular and Molecular Biology of Erythrocytes” (H. Yoshikawa and S. M. Rapoport, Eds.), pp. 35–54. University Park Press, Baltimore.
- Nakashima, M., Noda, H., Hasegawa, M., and Ikai, A. (1985). The oxygen affinity of mammalian hemoglobins in the absence of 2,3-diphosphoglycerate in relation to body weight. *Comp. Biochem. Physiol. [A]* **82**, 583–589.
- Neer, T. M. (1998). Canine monocytic and granulocytic ehrlichiosis. In “Infectious Diseases of the Dog and Cat” (C. E. Greene, Ed.), pp. 139–147. Saunders, Philadelphia.
- Nelson, G. J. (1967). Lipid composition of erythrocytes in various mammalian species. *Biochim. Biophys. Acta* **144**, 221–232.
- Nikinmaa, M. (2001). Haemoglobin function in vertebrates: evolutionary changes in cellular regulation in hypoxia. *Respir. Physiol.* **128**, 317–329.
- Noble, N. A., Jansen, C. A., Nathanielsz, P. W., and Tanaka, K. R. (1983). Mechanism of red cell 2,3-diphosphoglycerate increase in neonatal lambs. *Blood* **61**, 920–924.
- Noble, N. A., Xu, Q.-P., and Hoge, L. L. (1990). Reticulocytes II: reexamination of the *in vivo* survival of stress reticulocytes. *Blood* **75**, 1877–1882.
- Nonneman, D., Stockham, S. L., Shibuya, H., Messer, N. T., and Johnson, G. S. (1993). A missense mutation in the glucose-6-phosphate dehydrogenase gene associated with hemolytic anemia in an American saddlebred horse (abstract). *Blood* **82**(suppl 1), 466a.
- Norman, T. E., Chaffin, M. K., Johnson, M. C., Spangler, E. A., Weeks, B. R., and Knight, R. (2005). Intravascular hemolysis associated with severe cutaneous burn injuries in five horses. *J. Am. Vet. Med. Assoc.* **226**, 2039–2043. 2002.
- Nouri-Sorkhabi, M. H., Agar, N. S., Sullivan, D. R., Gallagher, C., and Kuchel, P. W. (1996). Phospholipid composition of erythrocyte membranes and plasma of mammalian blood including Australian marsupials; quantitative  $^{31}\text{P}$  NMR analysis using detergent. *Comp. Biochem. Physiol. B Biochem. Mol. Biol.* **113**, 221–227.
- Novak, D., Beveridge, M., and Verlander-Reed, J. (2002). Rat erythrocytes express the anionic amino acid transport protein EAAC1. *Blood Cells Mol. Dis.* **29**, 261–266.
- Novy, M. J., and Parer, T. J. (1969). Absence of high blood oxygen affinity in the fetal cat. *Respir. Physiol.* **6**, 144–150.
- Odartchenko, N., Cottier, H., and Bond, V. P. (1971). A study on ineffective erythropoiesis in the dog. *Cell Tissue Kinet.* **4**, 107–112.
- Ogawa, E., Kawakami, A., Yagi, T., Amaya, T., Fujise, H., and Takahashi, R. (1992). Oxidative damage to the membrane of canine erythrocytes with inherited high Na, K-ATPase activity. *J. Vet. Med. Sci.* **54**, 57–62.
- Ogawa, E., Kobayashi, K., Yoshiura, N., and Mukai, J. (1987). Bovine postparturient hemoglobinemia: hypophosphatemia and metabolic disorder in red blood cells. *Am. J. Vet. Res.* **48**, 1300–1303.
- Ogawa, E., Kobayashi, K., Yoshiura, N., and Mukai, J. (1989). Hemolytic anemia and red blood cell metabolic disorder attributable to low phosphorus intake in cows. *Am. J. Vet. Res.* **50**, 388–392.
- Ogawa, E., Komatsu, N., Suga, K., and Agar, N. S. (2002). The effect of potassium concentration on glycolysis in high and low potassium dog erythrocytes. *Comp. Clin. Path.* **11**, 92.
- Ogawa, E., Shinoki, T., Akahori, F., and Masaoka, T. (1986). Effect of onion ingestion on anti-oxidizing agents in dog erythrocytes. *Jpn. J. Vet. Sci.* **48**, 685–691.
- Ohashi, K., Yukioka, H., Hayashi, M., and Asada, A. (1998). Elevated methemoglobin in patients with sepsis. *Acta Anaesthesiol. Scand.* **42**, 713–716.
- Ohgami, R. S., Campagna, D. R., Greer, E. L., Antiochos, B., McDonald, A., Chen, J., Sharp, J. J., Fujiwara, Y., Barker, J. E., and Fleming, M. D. (2005). Identification of a ferrireductase required for efficient transferrin-dependent iron uptake in erythroid cells. *Nat. Genet.* **37**, 1264–1269.
- Oski, F. A., and Gottlieb, A. J. (1971). The interrelationships between red blood cell metabolites, hemoglobin, and the oxygen-equilibrium curve. *Prog. Hematol.* **7**, 33–67.
- Osuna, D. J., Armstrong, P. J., Duncan, D. E., and Breitschwerdt, E. B. (1990). Acute renal failure after methylene blue infusion in a dog. *J. Am. Anim. Hosp. Assoc.* **26**, 410–412.
- Otsuka, Y., Yamasaki, M., Yamato, O., and Maede, Y. (2001). Increased generation of superoxide in erythrocytes infected with *Babesia gibsoni*. *J. Vet. Med. Sci.* **63**, 1077–1081.
- Oxley, S. T., Porteous, R., Brindle, K. M., Boyd, J., and Campbell, I. D. (1984). A multinuclear NMR study of 2,3-bisphosphoglycerate metabolism in the human erythrocyte. *Biochim. Biophys. Acta* **805**, 19–24.
- Palek, J., and Sahr, K. E. (1992). Mutations of the red cell membrane proteins: from clinical evaluation to detection of the underlying genetic defect. *Blood* **80**, 308–330.
- Paltrinieri, S., Comazzi, S., and Agnes, F. (2000). Haematological parameters and altered erythrocyte metabolism in anaemic dogs. *J. Comp. Pathol.* **122**, 25–34.
- Paltrinieri, S., Comazzi, S., Cecilian, F., Prohaska, R., and Bonfanti, U. (2007). Stomatocytosis of standard schnauzers is not associated with stomatin deficiency. *Vet. J.* **173**, 202–205.
- Paniker, N. V., and Iyer, G. Y. (1965). Erythrocyte catalase and detoxication of hydrogen peroxide. *Can. J. Biochem.* **43**, 1029–1039.
- Papov, V. V., Gravina, S. A., Mielay, J. J., and Biemann, K. (1994). The primary structure and properties of thioltransferase (glutaredoxin) from human red blood cells. *Protein Sci.* **3**, 428–434.
- Parker, J. C. (1977). Solute and water movement in dog and cat red blood cells. In “Membrane Transport in Red Cells” (J. C. Ellory and V. L. Lew, Eds.), pp. 427–465. Academic Press, New York.
- Parker, J. C. (1992). Volume-activated cation transport in dog red cells: detection and transduction of the volume stimulus. *Comp. Biochem. Physiol. [A]* **102A**, 615–618.
- Patel, V. P., Ciechanover, A., Platt, O., and Lodish, H. F. (1985). Mammalian reticulocytes lose adhesion to fibronectin during maturation to erythrocytes. *Proc. Natl. Acad. Sci. USA* **82**, 440–444.

- Pearson, W., Boermans, H. J., Bettger, W. J., McBride, B. W., and Lindinger, M. I. (2005). Association of maximum voluntary dietary intake of freeze-dried garlic with Heinz body anemia in horses. *Am. J. Vet. Res.* **66**, 457–465.
- Pekow, C. A., Hinds, T. R., Maggio-Price, L., Hammond, W. P., and Vincenzi, F. F. (1992). Osmotic stress in red blood cells from beagles with hemolytic anemia. *Am. J. Vet. Res.* **53**, 1457–1461.
- Penedo, M. C. T. (2000). Red blood cell antigens and blood groups in the cow, pig, sheep, goat, and llama. In “Schalm’s Veterinary Hematology” (B. F. Feldman, J. G. Zinkl, and N. C. Jain, Eds.), pp. 778–782. Lippincott Williams & Wilkins, Philadelphia.
- Perkins, P. C., Grindem, C. B., and Cullins, L. D. (1995). Flow cytometric analysis of punctate and aggregate reticulocyte responses in phlebotomized cats. *Am. J. Vet. Res.* **56**, 1564–1569.
- Perman, V., and Schall, W. D. (1983). Diseases of the red cells. In “Textbook of Veterinary Internal Medicine: Diseases of the Dog and Cat” (S. J. Ettinger, Ed.), pp. 1938–2000. Saunders, Philadelphia.
- Pickrell, J. A., Schluter, S. J., Belasich, J. J., Stewart, E. V., Meyer, J., Hobbs, C. H., and Jones, R. K. (1974). Relationship of age of normal dogs to blood serum constituents and reliability of measured single values. *Am. J. Vet. Res.* **35**, 897–903.
- Pieragostini, E., Petazzi, F., and Di, L. A. (2003). The relationship between the presence of extra alpha-globin genes and blood cell traits in Altamurana sheep. *Genet. Sel. Evol.* **35**(suppl 1), S121–S133.
- Pieragostini, E., Rullo, R., Scaloni, A., Bramante, G., and Di, L. A. (2005). The alpha chains of goat hemoglobins: old and new variants in native Apulian breeds. *Comp. Biochem. Physiol. B Biochem. Mol. Biol.* **142**, 18–27.
- Pierce, K. R., Joyce, J. R., England, R. B., and Jones, L. P. (1972). Acute hemolytic anemia caused by wild onion poisoning in horses. *J. Am. Vet. Med. Assoc.* **160**, 323–327.
- Piercy, R. J., Swardson, C. J., and Hinchcliff, K. W. (1998). Erythroid hypoplasia and anemia following administration of recombinant human erythropoietin to two horses. *J. Am. Vet. Med. Assoc.* **212**, 244–247.
- Pillai, S. R., Steiss, J. E., Traber, M. G., Kayden, H. J., and Wright, J. C. (1992). Comparison of four erythrocyte fragility tests as indicators of vitamin E status in adult dogs. *J. Comp. Pathol.* **107**, 399–410.
- Pinkerton, P. H., Fletch, S. M., Brueckner, P. J., and Miller, D. R. (1974). Hereditary stomatocytosis with hemolytic anemia in the dog. *Blood* **44**, 557–567.
- Piomelli, S., and Seaman, C. (1993). Mechanism of red blood cell aging: relationship of cell density and cell age. *Am. J. Hematol.* **42**, 46–52.
- Pirastu, M., Manca, L., and Masala, B. (2003). Characterization of four novel variants of goat beta(A)-globin gene. *Biochem. Genet.* **41**, 209–217.
- Ploemen, J. H., Wormhoudt, L. W., van Ommen, B., Commandeur, J. N., Vermeulen, N. P., and van Bladeren, P. J. (1995). Polymorphism in the glutathione conjugation activity of human erythrocytes towards ethylene dibromide and 1,2-epoxy-3-(p-nitrophenoxy)-propane. *Biochim. Biophys. Acta* **1243**, 469–476.
- Ponka, P., Beaumont, C., and Richardson, D. R. (1998). Function and regulation of transferrin and ferritin. *Semin. Hematol.* **35**, 35–54.
- Pons, G., Berrocal, F., Tauler, A., and Carreras, J. (1985). Metabolism of glycerate-2,3-P2–VII: enzymes involved in the metabolism of glycerate-2,3-P2 in cat tissues. *Comp. Biochem. Physiol. [B]* **80**, 551–556.
- Porra, R. J., and Jones, O. T. G. (1963). Studies on ferrochelatase. I. Assay and properties of ferrochelatase from a pig-liver mitochondrial extract. *Biochem. J.* **87**, 181–185.
- Porter, D. L., and Goldberg, M. A. (1993). Regulation of erythropoietin production. *Exp. Hematol.* **21**, 399–404.
- Potgieter, L. N., Jones, J. B., Patton, C. S., and Webb Martin, T. A. (1981). Experimental parvovirus infection in dogs. *Can. J. Comp. Med.* **45**, 212–216.
- Prasse, K. W., Crouser, D., Beutler, E., Walker, M., and Schall, W. D. (1975). Pyruvate kinase deficiency anemia with terminal myelofibrosis and osteosclerosis in a beagle. *J. Am. Vet. Med. Assoc.* **166**, 1170–1175.
- Prchal, J. T. (2006). Production of erythrocytes. In “Williams Hematology” (M. A. Lichtman, E. Beutler, T. J. Kipps, U. Seligsohn, K. Kaushansky, and J. T. Prchal, Eds.), pp. 393–403. McGraw-Hill, New York.
- Prins, H. K., and Loos, J. A. (1969). Glutathione. In “Biochemical Methods in Red Cell Genetics” (J. J. Yunis, Ed.), pp. 1–49. Academic Press, New York.
- Pryor, W. A., Houk, K. N., Foote, C. S., Fukuto, J. M., Ignarro, L. J., Squadrito, G. L., and Davies, K. J. (2006). Free radical biology and medicine: it’s a gas, man! *Am. J. Physiol. Regul. Integr. Comp. Physiol.* **291**, R491–R511.
- Quigley, J. G., Yang, Z., Worthington, M. T., Phillips, J. D., Sabo, K. M., Sabath, D. E., Berg, C. L., Sassa, S., Wood, B. L., and Abkowitz, J. L. (2004). Identification of a human heme exporter that is essential for erythropoiesis. *Cell* **118**, 757–766.
- Rando, A., and Masina, P. (1985). Restriction site polymorphisms in the pig beta-globin gene cluster. *Anim. Blood Groups Biochem. Genet.* **16**, 35–40.
- Randolph, J. F., Center, S. A., Kallfelz, F. A., Blue, J. T., Dodds, W. J., Harvey, J. W., Paglia, D. E., Walsh, K. M., and Shelly, S. M. (1986). Familial nonspherocytic hemolytic anemia in poodles. *Am. J. Vet. Res.* **47**, 687–695.
- Rapoport, S. (1968). The regulation of glycolysis in mammalian erythrocytes. *Essays. Biochem.* **4**, 69–103.
- Rapoport, S. M. (1986). “The Reticulocyte.” CRC Press, Boca Raton, FL.
- Rapoport, T. A., Heinrich, R., and Rapoport, S. M. (1976). The regulatory principles of glycolysis in erythrocytes *in vivo* and *in vitro*. *Biochem. J.* **154**, 449–469.
- Reagan, W. J., Carter, C., and Turek, J. (1994). Eccentrocytosis in equine red maple leaf toxicosis. *Vet. Clin. Pathol.* **23**, 123–127.
- Reece, W. O., Self, H. L., and Hotchkiss, D. K. (1984). Injection of iron in newborn beef calves: erythrocyte variables and weight gains with newborn-dam correlations. *Am. J. Vet. Res.* **45**, 2119–2121.
- Reed, C. F. (1968). Phospholipid exchange between plasma and erythrocytes in man and dog. *J. Clin. Invest.* **47**, 749–759.
- Reimann, B., Klatt, D., Tsamaloukas, A. G., and Marezki, D. (1981). Membrane phosphorylation in intact human erythrocytes. *Acta Biol. Med. German* **40**, 487–493.
- Reinhart, W. H., Sung, L. A., and Chien, S. (1986). Quantitative relationship between Heinz body formation and red blood cell deformability. *Blood* **68**, 1383–1676.
- Rendell, M., Stephen, P. M., Paulsen, R., Valentine, J. L., Rasbold, K., Hestorff, T., Eastberg, S., and Shint, D. C. (1985). An interspecies comparison of normal levels of glycosylated hemoglobin and glycosylated albumin. *Comp. Biochem. Physiol. [B]* **81B**, 819–822.
- Rettig, M. P., Low, P. S., Gimm, J. A., Mohandas, N., Wang, J. Z., and Christian, J. A. (1999). Evaluation of biochemical changes during *in vivo* erythrocyte senescence in the dog. *Blood* **93**, 376–384.
- Riedel, N., Hoover, E. A., Gasper, P. W., Nicolson, M. O., and Mullins, J. I. (1986). Molecular analysis and pathogenesis of the feline aplastic anemia retrovirus, feline leukemia virus C-Sarma. *J. Virol.* **60**, 242–250.

- Rifkind, J. M., Nagababu, E., and Ramasamy, S. (2006). Nitric oxide redox reactions and red cell biology. *Antioxid. Redox. Signal* **8**, 1193–1203.
- Riggs, A. (1960). The nature and significance of the Bohr effect in mammalian hemoglobins. *J. Gen. Physiol.* **43**, 737–752.
- Rives, S., Pahl, H. L., Florensa, L., Bellosillo, B., Neusuess, A., Estella, J., Debatin, K. M., Kohne, E., Schwarz, K., and Cario, H. (2007). Molecular genetic analyses in familial and sporadic congenital primary erythrocytosis. *Haematologica* **92**, 674–677.
- Rivkin, S. E., and Simon, E. R. (1965). Comparative carbohydrate catabolism and methemoglobin reduction in pig and human erythrocytes. *J. Cell Physiol.* **66**, 49–56.
- Robertson, J. E., Christopher, M. M., and Rogers, Q. R. (1998). Heinz body formation in cats fed baby food containing onion powder. *J. Am. Vet. Med. Assoc.* **212**, 1260–1266.
- Robin, H., and Harley, J. D. (1966). Factors influencing response of mammalian species to the methaemoglobin reduction test. *Aust. J. Exp. Biol. Med. Sci.* **44**, 519–526.
- Robin, H., and Harley, J. D. (1967). Regulation of methaemoglobinaemia in horse and human erythrocytes. *Aust. J. Exp. Biol. Med. Sci.* **45**, 77–88.
- Robinson, W. F., Wilcox, G. E., and Fowler, R. L. P. (1980). Canine parvoviral disease: experimental reproduction of the enteric form with a parvovirus isolated from a case of myocarditis. *Vet. Pathol.* **17**, 589–599.
- Rojas, A. M., and Deves, R. (1999). Mammalian amino acid transport system y+ revisited: specificity and cation dependence of the interaction with neutral amino acids. *J. Membr. Biol.* **168**, 199–208.
- Rojko, J. L., and Olsen, R. G. (1984). The immunobiology of the feline leukemia virus. *Vet. Immunol. Immunopathol.* **6**, 107–165.
- Rose, R. J., Rossdale, P. D., and Leadon, D. P. (1982). Blood gas and acid-base status in spontaneously delivered, term-induced and induced premature foals. *J. Reprod. Fert. Suppl.* **32**, 521–528.
- Rossdale, P. D., and Ricketts, S. W. (1980). "Equine Stud Farm Medicine." Lea & Febiger, Philadelphia.
- Rossi, R., Milzani, A., le-Donne, I., Giustarini, D., Lusini, L., Colombo, R., and Di, S. P. (2002). Blood glutathione disulfide: *in vivo* factor or *in vitro* artifact? *Clin. Chem.* **48**, 742–753.
- Rotruck, J. T., Pope, A. L., Ganther, H. E., and Hoekstra, W. G. (1972). Prevention of oxidative damage to rat erythrocytes by dietary selenium. *J. Nutr.* **102**, 689–696.
- Rudolph, W. G., and Kaneko, J. J. (1971). Kinetics of erythroid bone marrow cells of normal and porphyric calves *in vitro*. *Acta Haematol.* **45**, 330–335.
- Rybicki, A. C., Schwartz, R. S., Hustedt, E. J., and Cobb, C. E. (1996). Increased rotational mobility and extractability of band 3 from protein 4.2-deficient erythrocyte membranes: evidence of a role for protein 4.2 in strengthening the band 3-cytoskeleton linkage. *Blood* **88**, 2745–2753.
- Saltman, P. (1989). Oxidative stress: a radical view. *Semin. Hematol.* **26**, 249–256.
- Sambrano, G. R., Parthasarathy, S., and Steinberg, D. (1994). Recognition of oxidatively damaged erythrocytes by a macrophage receptor with specificity for oxidized low density lipoprotein. *Proc. Natl. Acad. Sci. USA* **91**, 3265–3269.
- Sandberg, A. A., Lee, G. R., Cartwright, G. E., and Wintrobe, M. M. (1955). Purine nucleoside phosphorylase activity of blood. I. Erythrocytes. *J. Clin. Invest.* **34**, 1823–1829.
- Sankari, S., and Atroshi, F. (1983). Effect of dietary selenium on erythrocyte glutathione peroxidase and blood selenium in two types of Finnsheep genetically selected for high and low glutathione peroxidase activity. *Zentralbl. Veterinarmed. A.* **30**, 452–458.
- Sasaki, R., Ikura, K., Narita, H., and Chiba, H. (1977). Multifunctionality of the enzyme in 2,3-bisphosphoglycerate metabolism of pig erythrocytes. *Acta Biol. Med. German.* **36**, 669–680.
- Sass, M. D., Caruso, C. J., and Axelrod, D. R. (1969). Mechanism of the TPNH-linked reduction of methemoglobin by methylene blue. *Clin. Chim. Acta* **24**, 77–85.
- Sato, K., Inaba, M., and Maede, Y. (1994). Characterization of Na<sup>+</sup>-dependent L-glutamate transport in canine erythrocytes. *Biochim. Biophys. Acta Bio-Membr.* **1195**, 211–217.
- Sato, T., and Mizuno, M. (1982). Poikilocytosis of newborn calves. *Nippon. Juigaku. Zasshi.* **44**, 801–805.
- Sawada, K., Krantz, S. B., Dai, C. H., Koury, S. T., Horn, S. T., Glick, A. D., and Civin, C. I. (1990). Purification of human blood burst-forming units-erythroid and demonstration of the evolution of erythropoietin receptors. *J. Cell Physiol.* **142**, 219–230.
- Schaer, M., Harvey, J. W., Calderwood Mays, M. B., and Giger, U. (1992). Pyruvate kinase deficiency causing hemolytic anemia with secondary hemochromatosis in a Cairn terrier dog. *J. Am. Anim. Hosp. Assoc.* **28**, 233–239.
- Schechter, R. D., Schalm, O. W., and Kaneko, J. J. (1973). Heinz body hemolytic anemia associated with the use of urinary antiseptics containing methylene blue in the cat. *J. Am. Vet. Med. Assoc.* **162**, 37–44.
- Schmidt, W., Boning, D., and Braumann, K. M. (1987). Red cell age effects on metabolism and oxygen affinity in humans. *Respir. Physiol.* **68**, 215–225.
- Schmidt-Neilsen, K., and Larimer, J. L. (1958). Oxygen dissociation curves of mammalian blood in relation to body size. *Am. J. Physiol.* **195**, 424–428.
- Schrier, S. L. (1985). Red cell membrane biology: introduction. *Clin. Haematol.* **14**, 1–12.
- Schulman, H. M., Martinez-Medellin, J., and Sidloi, R. (1974). The oxidation state of newly synthesized hemoglobin. *Biochem. Biophys. Res. Commun.* **56**, 220–226.
- Schumacker, P. T., Suggett, A. J., Wagner, P. D., and West, J. B. (1985). Role of hemoglobin P50 in O<sub>2</sub> transport during normoxic and hypoxic exercise in the dog. *J. Appl. Physiol.* **59**, 749–757.
- Schwartz, E., and Gill, F. M. (1983). Hematology of the newborn. In "Hematology" (W. J. Williams, E. Beutler, A. J. Erslev, and M. A. Lichtman, Eds.), pp. 37–47. McGraw-Hill, New York.
- Scott, A. F., Bunn, H. F., and Brush, A. H. (1977). The phylogenetic distribution of red cell 2,3-diphosphoglycerate and its interaction with mammalian hemoglobins. *J. Exp. Zool.* **201**, 269–288.
- Scott, M. D., Wagner, T. C., and Chiu, D. T. Y. (1993). Decreased catalase activity is the underlying mechanism of oxidant susceptibility in glucose-6-phosphate dehydrogenase-deficient erythrocytes. *Biochim. Biophys. Acta Mol. Basis Dis.* **1181**, 163–168.
- Searcy, G. P., Miller, D. R., and Tasker, J. B. (1971). Congenital hemolytic anemia in the basenji dog due to erythrocyte pyruvate kinase deficiency. *Can. J. Comp. Med.* **35**, 67–70.
- Searcy, G. P., Tasker, J. B., and Miller, D. R. (1979). Animal model: pyruvate kinase deficiency in dogs. *Am. J. Physiol.* **94**, 689–692.
- Segel, G. B., and Palis, J. (2006). Hematology of the newborn. In "Williams Hematology" (M. A. Lichtman, E. Beutler, T. J. Kipps, U. Seligsohn, K. Kaushansky, and J. T. Prchal, Eds.), pp. 81–99. McGraw-Hill, New York.
- Seppi, C., Castellana, M. A., Minetti, G., Piccinini, G., Balduini, C., and Brovelli, A. (1991). Evidence for membrane protein oxidation during *in vivo* aging of human erythrocytes. *Mech. Aging Dev.* **57**, 247–258.

- Shadduck, R. K. (1995). Aplastic anemia. In "Williams Hematology" (E. Beutler, M. A. Lichtman, B. S. Coller, and T. J. Kipps, Eds.), pp. 238–251. McGraw-Hill, New York.
- Shamberger, R. J. (1986). Hyperalimentation hypophosphatemia. *Clin. Physiol. Biochem.* **4**, 42–49.
- Sheftel, A. D., Zhang, A. S., Brown, C., Shirihai, O. S., and Ponka, P. (2007). Direct interorganellar transfer of iron from endosome to mitochondrion. *Blood* **110**, 125–132.
- Shimizu, T., Kono, N., Kiyokawa, H., Yamada, Y., Hara, N., Mineo, I., Kawachi, M., Nakajima, H., Wang, Y. L., and Tarui, S. (1988). Erythrocyte glycolysis and its marked alteration by muscular exercise in type VII glycogenosis. *Blood* **71**, 1130–1134.
- Shiono, H., Yagi, Y., Chikayama, Y., Miyazaki, S., and Nakamura, I. (2003). The influence of oxidative bursts of phagocytes on red blood cell oxidation in anemic cattle infected with *Theileria sergenti*. *Free Radic. Res.* **37**, 1181–1189.
- Shull, R. M., Bunch, S. E., Maribei, J., and Spaulding, G. L. (1978). Spur cell anemia in a dog. *J. Am. Vet. Med. Assoc.* **173**, 978–982.
- Shviro, Y., and Shaklai, N. (1987). Glutathione as a scavenger of free hemin. A mechanism of preventing red cell membrane damage. *Biochem. Pharmacol.* **36**, 3801–3807.
- Siems, W. G., Sommerburg, O., and Grune, T. (2000). Erythrocyte free radical and energy metabolism. *Clin. Nephrol.* **53**, S9–S17.
- Siimes, M. A., Refino, C., and Dallman, P. R. (1980). Physiological anemia of early development in the rat: characterization of the iron responsive component. *Am. J. Clin. Nutr.* **33**, 2601–2608.
- Simpson, C. F., and Anderson, B. (1980). Heinz body anemia in cattle grazing rye pastures. *Florida Vet. J.* **9**, 26–27.
- Simpson, C. F., and Kling, J. M. (1967). The mechanism of denucleation in circulating erythroblasts. *J. Cell Biol.* **35**, 237–245.
- Simpson, C. F., and Kling, J. M. (1968). The mechanism of mitochondrial extrusion from phenylhydrazine-induced reticulocytes in the circulating blood. *J. Cell Biol.* **36**, 103–109.
- Singel, D. J., and Stamler, J. S. (2005). Chemical physiology of blood flow regulation by red blood cells: the role of nitric oxide and S-nitrosohemoglobin. *Annu. Rev. Physiol.* **67**, 99–145.
- Skelly, B. J., Wallace, M., Rajpurohit, Y. R., Wang, P., and Giger, U. (1999). Identification of a 6 base pair insertion in West Highland white terriers with erythrocyte pyruvate kinase deficiency. *Am. J. Vet. Res.* **60**, 1169–1172.
- Skibild, E., Dahlgaard, K., Rajpurohit, Y., Smith, B. F., and Giger, U. (2001). Haemolytic anaemia and exercise intolerance due to phosphofructokinase deficiency in related springer spaniels. *J. Small Anim. Pract.* **42**, 298–300.
- Slappendel, R. J. (1998). Hereditary spherocytosis associated with spectrin deficiency in golden retrievers (abstract). *Eur. Soc. Vet. Intern. Med.* 131.
- Slappendel, R. J., Renooij, W., and De Bruijne, J. J. (1994). Normal cations and abnormal membrane lipids in the red blood cells of dogs with familial stomatocytosis-hypertrophic gastritis. *Blood* **84**, 904–909.
- Slappendel, R. J., Van der Gaag, I., Van Nes, J. J., Van den Ingh, T. S. G. A. M., and Happé, R. P. (1991). Familial stomatocytosis-hypertrophic gastritis (FSHG), a newly recognized disease in the dog (Drentse patrijshond). *Vet. Q.* **13**, 30–40.
- Slappendel, R. J., van Zwieten, R., Van Leeuwen, M., and Schneijdenberg, C. T. (2005). Hereditary spectrin deficiency in golden retriever dogs. *J. Vet. Intern. Med.* **19**, 187–192.
- Smith, A. R., Shenvi, S. V., Widlansky, M., Suh, J. H., and Hagen, T. M. (2004). Lipoic acid as a potential therapy for chronic diseases associated with oxidative stress. *Curr. Med. Chem.* **11**, 1135–1146.
- Smith, B. F., Stedman, H., Rajpurohit, Y., Henthorn, P. S., Wolfe, J. H., Patterson, D. F., and Giger, U. (1996). Molecular basis of canine muscle type phosphofructokinase deficiency. *J. Biol. Chem.* **271**, 20070–20074.
- Smith, J. E. (1968). Low erythrocyte glucose-6-phosphate dehydrogenase activity and primaquine insensitivity in sheep. *J. Lab. Clin. Med.* **71**, 826–833.
- Smith, J. E. (1974). Relationship of in vivo erythrocyte glutathione flux to the oxidized glutathione transport system. *J. Lab. Clin. Med.* **83**, 444–450.
- Smith, J. E. (1987). Erythrocyte membrane: structure, function, and pathophysiology. *Vet. Pathol.* **24**, 471–476.
- Smith, J. E. (1991). Erythrocytes. *Adv. Vet. Sci. Comp. Med.* **36**, 9–55.
- Smith, J. E. (1997). Iron metabolism and its disorders. In "Clinical Biochemistry of Domestic Animals" (J. J. Kaneko, J. W. Harvey, and M. L. Bruss, Eds.), pp. 223–238. Academic Press, San Diego, CA.
- Smith, J. E., and Agar, N. S. (1976). Studies on erythrocyte metabolism following acute blood loss in the horse. *Equine Vet. J.* **8**, 34–37.
- Smith, J. E., and Anwer, M. S. (1971). Studies on glucose-6-phosphate dehydrogenase: variability in ATP inhibition. *Experientia* **27**, 835–836.
- Smith, J. E., Cipriano, J. E., DeBowes, R., and Moore, K. (1986). Iron deficiency and pseudo-iron deficiency in hospitalized horses. *J. Am. Vet. Med. Assoc.* **188**, 285–287.
- Smith, J. E., Kiefer, S., and Lee, M. (1972a). Glutathione reduction and other enzyme activities in equine erythrocytes. *Comp. Biochem. Physiol. [B]*, **43B**, 413–417.
- Smith, J. E., Lee, M. S., and Mia, A. S. (1973). Decreased gamma-glutamylcysteine synthetase: the probable cause of glutathione deficiency in sheep erythrocytes. *J. Lab. Clin. Med.* **82**, 713–718.
- Smith, J. E., McCants, M., Parks, P., and Jones, E. W. (1972b). Influence of erythrocyte age on enzyme activity in the bovine. *Comp. Biochem. Physiol. [B]* **41B**, 551–558.
- Smith, J. E., Mohandas, N., and Shohet, S. B. (1979). Variability in erythrocyte deformability among various mammals. *Am. J. Physiol.* **236**, H725–H730.
- Smith, J. E., Moore, K., Arens, M., Rinderknecht, G. A., and Ledet, A. (1983a). Hereditary elliptocytosis with protein band 4.1 deficiency in the dog. *Blood* **61**, 373–377.
- Smith, J. E., Moore, K., Boyington, D., and Potter, K. A. (1983b). Glutathione metabolism in canine hereditary stomatocytosis with mild erythrocyte glutathione deficiency. *J. Lab. Clin. Med.* **101**, 611–616.
- Smith, J. E., Ryer, K., and Wallace, L. (1976). Glucose-6-phosphate dehydrogenase deficiency in a dog. *Enzyme* **21**, 379–382.
- Smith, R. H. (1980). Kale poisoning: the brassica anaemia factor. *Vet. Rec.* **107**, 12–15.
- Snow, D. H., Billeter, R., Mascarello, F., Carpena, E., Rowleron, A., and Jenny, E. (1982). No classical type IIB fibers in dog skeletal muscle. *Histochem.* **75**, 53–65.
- Snow, D. H., and Martin, V. (1990). Effects of exercise and adrenaline on equine erythrocyte ATP content. *Res. Vet. Sci.* **49**, 77–81.
- Snow, N. S. (1962). Some observations on the reactive sulphhydryl groups of haemoglobin. *Biochem. J.* **84**, 360–364.
- Snyder, L. M., Reddy, W. J., and Kurjan, L. (1970). Mechanism of action of thyroid hormones on erythrocyte 2,3-diphosphoglyceric acid synthesis. *J. Clin. Invest.* **49**, 1993–1998.
- Sobin, S. S., and Tremer, H. M. (1972). Diameter of myocardial capillaries. *Microvasc. Res.* **4**, 330–331.
- Sobrinho, F., Rider, M. H., Gualberto, A., and Hue, L. (1987). Fructose 2,6-bisphosphate in rat erythrocytes. Inhibition of fructose 2,6-bisphosphate

- synthesis and measurement by glycerate 2,3-bisphosphate. *Biochem. J.* **244**, 235–238.
- Sohmiya, M., and Kato, Y. (2005). Human growth hormone and insulin-like growth factor-I inhibit erythropoietin secretion from the kidneys of adult rats. *J. Endocrinol.* **184**, 199–207.
- Soli, N. E., and Frosli, A. (1977). Chronic copper poisoning in sheep. I. The relationship of methaemoglobinemia to Heinz body formation and haemolysis during the terminal crisis. *Acta Pharmacol. Toxicol. Copenh.* **40**, 169–177.
- Solomon, A. K., Chasan, B., Dix, J. A., Lukacovic, M. F., Toon, M. R., and Verkman, A. S. (1983). The aqueous pore in the red cell membrane: band 3 as a channel for anions, cations, nonelectrolytes, and water. *Ann. NY Acad. Sci.* **414**, 97–124.
- Soni, S., Bala, S., Gwynn, B., Sahr, K. E., Peters, L. L., and Hanspal, M. (2006). Absence of erythroblast macrophage protein (Emp) leads to failure of erythroblast nuclear extrusion. *J. Biol. Chem.* **281**, 20181–20189.
- Spickett, C. M., Smith, W. E., Reglinski, J., Wilson, R., and Walker, J. J. (1998). Oxidation of erythrocyte glutathione by monocytes stimulated with interleukin-6: analysis by 1H spin echo NMR. *Clin. Chim. Acta* **270**, 115–124.
- Sprague, R., Bowles, E., Stumpf, M., Ricketts, G., Freidman, A., Hou, W. H., Stephenson, A., and Lonigro, A. (2005). Rabbit erythrocytes possess adenylyl cyclase type II that is activated by the heterotrimeric G proteins Gs and Gi. *Pharmacol. Rep.* **57(Suppl)**, 222–228.
- Srivastava, A. S., Kaushal, S., Mishra, R., Lane, T. A., and Carrier, E. (2006). Dexamethasone facilitates erythropoiesis in murine embryonic stem cells differentiating into hematopoietic cells *in vitro*. *Biochem. Biophys. Res. Commun.* **346**, 508–516.
- Srivastava, S. K., and Beutler, E. (1969). The transport of oxidized glutathione from the erythrocytes of various species in the presence of chromate. *Biochem. J.* **114**, 833–837.
- Srivastava, S. K., and Beutler, E. (1972). The effect of normal red cell constituents on the activities of red cell enzymes. *Arch. Biochem. Biophys.* **148**, 249–255.
- Stadtman, E. R. (1992). Protein oxidation and aging. *Science* **257**, 1220–1224.
- Stagsted, J., and Young, J. F. (2002). Large differences in erythrocyte stability between species reflect different antioxidative defense mechanisms. *Free Radic. Res.* **36**, 779–789.
- Standerfer, R. J., Templeton, J. W., and Black, J. A. (1974). Anomalous pyruvate kinase deficiency in the basenji dog. *Am. J. Vet. Res.* **35**, 1541–1543.
- Steffen, D. J., Elliott, G. S., Leipold, H. W., and Smith, J. E. (1992). Congenital dyserythropoiesis and progressive alopecia in Polled Hereford calves: hematologic, biochemical, bone marrow cytologic, electrophoretic, and flow cytometric findings. *J. Vet. Diagn. Invest.* **4**, 31–37.
- Stevenson, V. L., and Hardie, R. J. (2001). Acanthocytosis and neurological disorders. *J. Neurol.* **248**, 87–94.
- Stockham, S. L., Harvey, J. W., and Kinden, D. A. (1994). Equine glucose-6-phosphate dehydrogenase deficiency. *Vet. Pathol.* **31**, 518–527.
- Stokol, T., and Blue, J. T. (1999). Pure red cell aplasia in cats: 9 cases (1989–1997). *J. Am. Vet. Med. Assoc.* **214**, 75–79.
- Stokol, T., Blue, J. T., and French, T. W. (2000). Idiopathic pure red cell aplasia and nonregenerative immune-mediated anemia in dogs: 43 cases (1988–1999). *J. Am. Vet. Med. Assoc.* **216**, 1429–1436.
- Stokstad, E. L. R. (1968). Experimental anemias in animals resulting from folic acid and vitamin B<sub>12</sub> deficiencies. *Vitamins Hormones* **26**, 443–463.
- Stopka, T., Zivny, J. H., Stopkova, P., Prchal, J. F., and Prchal, J. T. (1998). Human hematopoietic progenitors express erythropoietin. *Blood* **91**, 3766–3772.
- Stormont, C. J. (1982). Blood groups in animals. *J. Am. Vet. Med. Assoc.* **181**, 1120–1124.
- Studzinski, T., Czarniecki, A., and Gluszek, A. (1982). Thyroxine effect on 2,3-diphosphoglycerate (2,3-DPG) level in sheep erythrocytes. *Acta Physiol. Pol.* **33**, 129–137.
- Studzinski, T., Gluszek, A., and Owczarski, K. (1978). Effect of anaemia on the 2,3-diphosphoglycerate content of equine erythrocytes. *Acta Physiol. Pol.* **29**, 335–341.
- Su, D., May, J. M., Koury, M. J., and Asard, H. (2006). Human erythrocyte membranes contain a cytochrome b561 that may be involved in extracellular ascorbate recycling. *J. Biol. Chem.* **281**, 39852–39859.
- Sullivan, P. S., Evans, H. L., and McDonald, T. P. (1994). Platelet concentration and hemoglobin function in greyhounds. *J. Am. Vet. Med. Assoc.* **205**, 838–841.
- Suter, S. E., Gouthro, T. A., McSweeney, P. A., Nash, R. A., Haskins, M. E., Felsburg, P. J., and Henthorn, P. S. (2004). Isolation and characterization of pediatric canine bone marrow CD34+ cells. *Vet. Immunol. Immunopathol.* **101**, 31–47.
- Suttle, N. F., Jones, D. G., Woolliams, C., and Woolliams, J. A. (1987). Heinz body anaemia in lambs with deficiencies of copper and selenium. *Br. J. Nutr.* **58**, 539–548.
- Suwalsky, M., Hernandez, P., Villena, F., and Sotomayor, C. P. (1999). The anticancer drug chlorambucil interacts with the human erythrocyte membrane and model phospholipid bilayers. *Z. Naturforsch. [C]* **54**, 1089–1095.
- Suwalsky, M., Hernandez, P., Villena, F., and Sotomayor, C. P. (2000). The anticancer drug cisplatin interacts with the human erythrocyte membrane. *Z. Naturforsch. [C]* **55**, 461–466.
- Suzuki, T., and Agar, N. S. (1983). Glutathione peroxidase, superoxide dismutase and catalase in the red blood cells of GSH-normal and GSH-deficient sheep. *Experientia* **39**, 103–104.
- Suzuki, T., Agar, N. S., and Suzuki, M. (1984). Red cell metabolism: a comparative study of some mammalian species. *Comp. Biochem. Physiol. [B]* **79**, 515–520.
- Takano, N., Hayashi, E., and Matsue, K. (1976). Effect of oxygen saturation on H<sup>+</sup> and Cl<sup>-</sup> distribution across the red cell membrane in human and ruminant blood. *Pflugers Arch.* **366**, 285–288.
- Taketa, F., and Antholine, W. E. (1982). The oxidation of cat, human, and the cat-human hybrid hemoglobins alpha 2 human beta 2 cat and alpha 2 cat beta 2 human by copper (II). *J. Inorg. Biochem.* **17**, 109–120.
- Taketa, F., Attermeier, M. H., and Mauk, A. G. (1972). Acetylated hemoglobins in feline blood. *J. Biol. Chem.* **247**, 33–35.
- Taketani, S., Adachi, Y., Kohno, H., Ikehara, S., Tokunaga, R., and Ishii, T. (1998). Molecular characterization of a newly identified heme-binding protein induced during differentiation of urine erythroleukemia cells. *J. Biol. Chem.* **273**, 31388–31394.
- Taylor, W. J. (1983). Sickled red cells in the cervidae. *Adv. Vet. Sci. Comp. Med.* **27**, 77–98.
- Teisseire, B. P., Ropars, C., Vallez, M. O., Herigault, R. A., and Nicolau, C. (1985). Physiological effects of high-P50 erythrocyte transfusion on piglets. *J. Appl. Physiol.* **58**, 1810–1817.
- Telen, M. J. (2000). Red blood cell surface adhesion molecules: their possible roles in normal human physiology and disease. *Semin. Hematol.* **37**, 130–142.
- Tennant, B., Asbury, A. C., Laben, R. C., Richards, W. P. C., Kaneko, J. J., and Cupps, P. T. (1967). Familial polycythemia in cattle. *J. Am. Vet. Med. Assoc.* **150**, 1493–1509.



- Tennant, B., Dill, S. G., Glickman, L. T., Mirro, E. J., King, J. M., Polak, D. M., Smith, M. C., and Kradel, D. C. (1981). Acute hemolytic anemia, methemoglobinemia, and Heinz body formation associated with ingestion of red maple leaves by horses. *J. Am. Vet. Med. Assoc.* **179**, 143–150.
- Tennant, B., Harrold, D., Reina-Guerra, M., and Laben, R. C. (1969). Arterial pH, PO<sub>2</sub>, and PCO<sub>2</sub> of calves with familial bovine polycythemia. *Cornell Vet.* **59**, 594–604.
- Terpstra, V., and van Berkel, T. J. C. (2000). Scavenger receptors on liver Kupffer cells mediate the *in vivo* uptake of oxidatively damaged red cells in mice. *Blood* **95**, 2157–2163.
- Thenen, S. W., and Rasmussen, S. D. (1978). Megaloblastic erythropoiesis and tissue depletion of folic acid in the cat. *Am. J. Vet. Res.* **39**, 1205–1207.
- Thomas, J. P., Maiorino, M., Ursini, F., and Girotti, A. W. (1990). Protective action of phospholipid hydroperoxide glutathione peroxidase against membrane-damaging lipid peroxidation. *In situ* reduction of phospholipid and cholesterol hydroperoxides. *J. Biol. Chem.* **265**, 454–461.
- Thompson, R. H., McMurray, C. H., and Blanchflower, W. J. (1976). The levels of selenium and glutathione peroxidase activity in sheep, cows and pigs. *Res. Vet. Sci.* **20**, 229–231.
- Tiedemann, K. (1977). On the yolk sac of the cat. II. Erythropoietic phases, ultrastructure of aging primitive erythroblasts, and blood vessels. *Cell Tissue Res.* **183**, 71–89.
- Titov, V. Y., and Petrenko, Y. M. (2005). Proposed mechanism of nitrite-induced methemoglobinemia. *Biochemistry (Mosc.)* **70**, 473–483.
- Tizard, I. R. (2000). “Veterinary Immunology: An Introduction.” Saunders, Philadelphia.
- Torti, F. M., and Torti, S. V. (2002). Regulation of ferritin genes and protein. *Blood* **99**, 3505–3516.
- Tosteson, D. C., and Hoffman, J. F. (1960). Regulation of cell volume by active cation transport in high and low potassium sheep red cells. *J. Gen. Physiol.* **44**, 169–194.
- Travis, S. F., Wagerle, L. C., De Alvarado, C. M., Rose, G., and Delivoria-Papadopoulos, M. (1985). Sequential changes in red cell glycolytic enzymes and intermediates and possible control mechanisms in the first two months of postnatal life in lambs. *Pediatr. Res.* **19**, 272–277.
- Tsuji-Takayama, K., Otani, T., Inoue, T., Nakamura, S., Motoda, R., Kibata, M., and Orita, K. (2006). Erythropoietin induces sustained phosphorylation of STAT5 in primitive but not definitive erythrocytes generated from mouse embryonic stem cells. *Exp. Hematol.* **34**, 1323–1332.
- Tucker, E. M. (1974). A shortened life span of sheep red cells with a glutathione deficiency. *Res. Vet. Sci.* **16**, 19–22.
- Tucker, E. M., and Ellory, J. C. (1971). The cation composition of the red cells of sheep with an inherited deficiency of reduced glutathione. *Res. Vet. Sci.* **12**, 600–602.
- Tucker, E. M., and Kilgour, L. (1970). An inherited glutathione deficiency and a concomitant reduction in potassium concentration in sheep red cells. *Experientia* **26**, 203–204.
- Tucker, E. M., and Young, J. D. (1980). Biochemical changes during reticulocyte maturation in culture. *Biochem. J.* **192**, 33–39.
- Tucker, E. M., Young, J. D., and Crowley, C. (1981). Red cell glutathione deficiency: clinical and biochemical investigations using sheep as an experimental model system. *Br. J. Haematol.* **48**, 403–415.
- Tunncliffe, G. (1994). Amino acid transport by human erythrocyte membranes. *Comp. Biochem. Physiol. [A]* **108A**, 471–478.
- Tunon, M. J., Gonzalez, P., and Vallejo, M. (1987). Erythrocyte potassium polymorphism in 14 Spanish goat breeds. *Anim. Genet.* **18**, 371–375.
- Tvedten, H., and Rowe, A. (2007). Hemoglobinuria due to phosphofructokinase deficiency as a new mutation in wachtelhounds. American Society for Veterinary Clinical Pathology Case Review. Savannah, GA.
- Twoeddale, P. M. (1973). DPG and the oxygen affinity of maternal and foetal pig blood and haemoglobins. *Resp. Physiol.* **19**, 12–18.
- Ulibarrena, C., Vecino, A., and Cesar, J. M. (1994). Red cell lipid abnormalities in acquired acanthocytosis are extended to platelets. *Br. J. Haematol.* **87**, 614–616.
- Umbreit, J. (2007). Methemoglobin: it's not just blue: a concise review. *Am. J. Hematol.* **82**, 134–144.
- Underwood, E. J. (1977). “Trace Elements in Human and Animal Nutrition.” Academic Press, New York.
- Vacha, J. (1983). Red cell life span. In “Red Blood Cells of Domestic Mammals” (N. S. Agar and P. G. Board, Eds.), pp. 67–132. Elsevier, Amsterdam.
- Vaden, S. L., Wood, P. A., Ledley, F. D., Cornwell, P. E., Miller, R. T., and Page, R. (1992). Cobalamin deficiency associated with methylmalonic acidemia in a cat. *J. Am. Vet. Med. Assoc.* **200**, 1101–1103.
- Val, A. L. (2000). Organic phosphates in the red blood cells of fish. *Comp. Biochem. Physiol. A* **125**, 417–435.
- Valko, M., Leibfritz, D., Moncol, J., Cronin, M. T., Mazur, M., and Telser, J. (2007). Free radicals and antioxidants in normal physiological functions and human disease. *Int. J. Biochem. Cell Biol.* **39**, 44–84.
- Van Belle, H. (1969). Uptake and deamination of adenosine by blood. Species differences, effect of pH, ions, temperature and metabolic inhibitors. *Biochim. Biophys. Acta* **192**, 124–132.
- Van Dyke, D., Johns, L. E., and Tennant, B. (1968). Erythropoietin enhancing factor in serum of a calf with primary familial polycythemia. *Nature* **217**, 1027–1028.
- Verhoeff, J., Hajer, R., and Van den Ingh, T. S. (1985). Onion poisoning of young cattle. *Vet. Rec.* **117**, 497–498.
- Vestri, R., Giordano, P. C., and Bernini, L. F. (1983). Different quantitative expression of the hemoglobin alpha-chain genes in sheep. *Biochem. Genet.* **21**, 1089–1099.
- Vestri, R., Pieragostini, E., and Ristaldi, M. S. (1994). Expression gradient in sheep alpha alpha and alpha alpha alpha globin gene haplotypes: mRNA levels. *Blood* **83**, 2317–2322.
- Vincent, S. H. (1989). Oxidative effects of heme and porphyrins on proteins and lipids. *Semin. Hematol.* **26**, 105–113.
- Vodela, J. K., and Dalvi, R. R. (1997). Erythrocyte glutathione-S-transferase activity in animal species. *Vet. Hum. Toxicol.* **39**, 9–11.
- Vogt, C., Pentz, S., and Rich, I. N. (1989). The role of the macrophage in normal hematopoiesis: III. *In vitro* and *in vivo* erythropoietin gene expression in macrophages detected by *in situ* hybridization. *Exp. Hematol.* **17**, 391–397.
- Vora, S., Giger, U., Turchen, S., and Harvey, J. W. (1985). Characterization of the enzymatic lesion in inherited phosphofructokinase deficiency in the dog: an animal analogue of human glycogen storage disease type VII. *Proc. Natl. Acad. Sci. USA* **82**, 8109–8113.
- Waddell, W. J. (1956). Lysis of dog erythrocytes in mildly alkaline isotonic media. *Am. J. Physiol.* **186**, 339–342.
- Waddell, W. J., and Bates, R. G. (1969). Intracellular pH. *Physiol. Rev.* **49**, 285–329.
- Wagener, F. A., Eggert, A., Boerman, O. C., Oyen, W. J., Verhofstad, A., Abraham, N. G., Adema, G., van Kooyk, Y., de Witte, T., and Figdor, C. G. (2001). Heme is a potent inducer of inflammation in mice and is counteracted by heme oxygenase. *Blood* **98**, 1802–1811.
- Wallace, W. J., Maxwell, J. C., and Caughey, W. S. (1974). The mechanisms of hemoglobin autoxidation evidence for proton-assisted nucleophilic displacement of superoxide by anions. *Biochem. Biophys. Res. Commun.* **57**, 1104–1110.
- Walton, R. M., Brown, D. E., Hamar, D. W., Meador, V. P., Horn, J. W., and Thrall, M. A. (1997). Mechanisms of echinocytosis induced by *Crotalus atrox* venom. *Vet. Pathol.* **34**, 442–449.

- Wang, F., Wang, T., Lai, J., Li, M., and Zou, C. (2006). Vitamin E inhibits hemolysis induced by hemin as a membrane stabilizer. *Biochem. Pharmacol.* **71**, 799–805.
- Wang, X. L., Gallagher, C. H., McClure, T. J., Reeve, V. E., and Canfield, P. J. (1985). Bovine post-parturient haemoglobinuria: effect of inorganic phosphate on red cell metabolism. *Res. Vet. Sci.* **39**, 333–339.
- Watson, A. D. (1977). Chloramphenicol toxicity in dogs. *Res. Vet. Sci.* **23**, 66–69.
- Watson, A. D., and Middleton, D. J. (1978). Chloramphenicol toxicosis in cats. *Am. J. Vet. Res.* **39**, 1199–1203.
- Watts, R. P., and Kim, H. D. (1984). Comparison of 2,3-diphosphoglycerate metabolism between fetal and postnatal pig red cells. *Biol. Neonate* **45**, 280–288.
- Waugh, R. E. (1991). Reticulocyte rigidity and passage through endothelial-like pores. *Blood* **78**, 3037–3042.
- Waugh, R. E., Mantalaris, A., Bauserman, R. G., Hwang, W. C., and Wu, J. H. (2001). Membrane instability in late-stage erythropoiesis. *Blood* **97**, 1869–1875.
- Weatherall, D. J. (2006). Disorders of globin synthesis: the thalassemias. In “Williams Hematology” (M. A. Lichtman, E. Beutler, T. J. Kipps, U. Seligsohn, K. Kaushansky, and J. T. Prchal, Eds.), pp. 633–666. McGraw-Hill, New York.
- Weber, R. E., Voelter, W., Fago, A., Echner, H., Campanella, E., and Low, P. S. (2004). Modulation of red cell glycolysis: interactions between vertebrate hemoglobins and cytoplasmic domains of band 3 red cell membrane proteins. *Am. J. Physiol. Regul. Integr. Comp. Physiol.* **287**, R454–R464.
- Weiden, P. L., Hackman, R. C., Deeg, J., Graham, C., Thomas, E. D., and Strob, R. (1981). Long-term survival and reversal of iron overload after marrow transplantation in dogs with congenital hemolytic anemia. *Blood* **57**, 66–70.
- Weinstein, N. M., Blais, M. C., Harris, K., Oakley, D. A., Aronson, L. R., and Giger, U. (2007). A newly recognized blood group in domestic shorthair cats: the Mik red cell antigen. *J. Vet. Intern. Med.* **21**, 287–292.
- Weiser, G., and O’Grady, M. (1983). Erythrocyte volume distribution analysis and hematologic changes in dogs with iron deficiency anemia. *Vet. Pathol.* **20**, 230–241.
- Weiser, M. G., and Kociba, G. J. (1982). Persistent macrocytosis assessed by erythrocyte subpopulation analysis following erythrocyte regeneration in cats. *Blood* **60**, 295–303.
- Weiser, M. G., and Kociba, G. J. (1983a). Erythrocyte macrocytosis in feline leukemia virus associated anemia. *Vet. Pathol.* **20**, 687–697.
- Weiser, M. G., and Kociba, G. J. (1983b). Sequential changes in erythrocyte volume distribution and microcytosis associated with iron deficiency in kittens. *Vet. Pathol.* **20**, 1–12.
- Weiss, D. J. (1986). Antibody-mediated suppression of erythropoiesis in dogs with red blood cell aplasia. *Am. J. Vet. Res.* **47**, 2646–2648.
- Weiss, D. J. (2005). Sideroblastic anemia in 7 dogs (1996–2002). *J. Vet. Intern. Med.* **19**, 325–328.
- Weiss, D. J. (2006). Aplastic anemia in cats: clinicopathological features and associated disease conditions 1996–2004. *J. Feline Med. Surg.* **8**, 203–206.
- Weiss, D. J., Aird, B., and Murtaugh, M. P. (1992a). Neutrophil-induced immunoglobulin binding to erythrocytes involves proteolytic and oxidative injury. *J. Leuk. Biol.* **51**, 19–23.
- Weiss, D. J., and Christopher, M. M. (1985). Idiopathic aplastic anemia in a dog. *Vet. Clin. Pathol.* **14**(2), 23–25.
- Weiss, D. J., Geor, R., Smith, C. M., II, and McClay, C. B. (1992b). Furosemide-induced electrolyte depletion associated with echinocytosis in horses. *Am. J. Vet. Res.* **53**, 1769–1772.
- Weiss, D. J., and Geor, R. J. (1993). Clinical and rheological implications of echinocytosis in the horse: a review. *Comp. Haematol. Int.* **3**, 185–189.
- Weiss, D. J., and Klausner, J. S. (1988). Neutrophil-induced erythrocyte injury: a potential cause of erythrocyte destruction in the anemia associated with inflammatory disease. *Vet. Pathol.* **25**, 450–455.
- Weiss, D. J., Kristensen, A., and Papenfuss, N. (1993). Qualitative evaluation of irregularly spiculated red blood cells in the dog. *Vet. Clin. Pathol.* **22**, 117–121.
- Weiss, D. J., and Lulich, J. (1999). Myelodysplastic syndrome with sideroblastic differentiation in a dog. *Vet. Clin. Pathol.* **28**, 59–63.
- Weiss, G., and Goodnough, L. T. (2005). Anemia of chronic disease. *N. Engl. J. Med.* **352**, 1011–1023.
- Weiss, L. (1984). “The Blood Cells and Hematopoietic Tissues.” Elsevier, New York.
- Weiss, M. J., Zhou, S., Feng, L., Gell, D. A., Mackay, J. P., Shi, Y., and Gow, A. J. (2005). Role of alpha hemoglobin-stabilizing protein in normal erythropoiesis and {beta}-thalassemia. *Ann. NY Acad. Sci.* **1054**, 103–117.
- Weitzman, S. A., and Gordon, L. I. (1990). Inflammation and cancer: role of phagocyte-generated oxidants in carcinogenesis. *Blood* **76**, 655–663.
- Wen, D., Boissel, J. P. R., Tracy, T. E., Gruninger, R. H., Mulcahy, L. S., Czelusniak, J., Goodman, M., and Bunn, H. F. (1993). Erythropoietin structure-function relationships: high degree of sequence homology among mammals. *Blood* **82**, 1507–1516.
- Wessels, J. M., and Veerkamp, J. H. (1973). Some aspects of the osmotic lysis of erythrocytes. 3. Comparison of glycerol permeability and lipid composition of red blood cell membranes from eight mammalian species. *Biochim. Biophys. Acta* **291**, 190–196.
- Wessling-Resnick, M. (2006). Iron imports. III. Transfer of iron from the mucosa into circulation. *Am. J. Physiol. Gastrointest. Liver Physiol.* **290**, G1–G6.
- West, J. B. (1985). “Best and Taylor’s Physiologic Basis of Medical Practice” (J. B. West, Ed.), pp. 516–532, 546–570. Williams & Wilkins, Baltimore.
- Whitfield, C. F., Mylin, L. M., and Goodman, S. R. (1983). Species-dependent variations in erythrocyte membrane skeletal proteins. *Blood* **61**, 500–506.
- Whitney, K. M., Goodman, S. A., Bailey, E. M., and Lothrop, C. D., Jr. (1994). The molecular basis of canine pyruvate kinase deficiency. *Exp. Hematol.* **22**, 866–874.
- Whitney, K. M., and Lothrop, C. D., Jr. (1995). Genetic test for pyruvate kinase deficiency of basenjis. *J. Am. Vet. Med. Assoc.* **207**, 918–921.
- Widdas, W. F. (1955). Hexose permeability of foetal erythrocytes. *J. Pathol.* **127**, 318–327.
- Wilhelmsen, C. L. (1979). An immunohematological study of chronic copper toxicity in sheep. *Cornell Vet.* **69**, 225–232.
- Wilkie, D. A., and Kirby, R. (1988). Methemoglobinemia associated with dermal application of benzocaine cream in a cat. *J. Am. Vet. Med. Assoc.* **192**, 85–86.
- Willard, M. D., Zerbe, C. A., Schall, W. D., Johnson, C., Crow, S. E., and Jones, R. (1987). Severe hypophosphatemia associated with diabetes mellitus in six dogs and one cat. *J. Am. Vet. Med. Assoc.* **190**, 1007–1010.
- Williams, D. M., Loukopoulos, D., Lee, G. R., and Cartwright, G. E. (1976). Role of copper in mitochondrial iron metabolism. *Blood* **48**, 77–85.

- Williams, D. M., Lynch, R. E., Lee, G. R., and Cartwright, G. E. (1975). Superoxide dismutase activity in copper-deficient swine. *Proc. Soc. Exp. Biol. Med.* **149**, 534–536.
- Winslow, R. M., Swenberg, M.-L., Benson, J., Perrella, M., and Benazzi, L. (1989). Gas exchange properties of goat hemoglobins A and C. *J. Biol. Chem.* **264**, 4812–4817.
- Wood, W. G., Bunch, C., Kelly, S., Gunn, Y., and Breckon, G. (1985). Control of haemoglobin switching by a developmental clock? *Nature* **313**, 320–323.
- Woods, P. R., Campbell, G., and Cowell, R. L. (1997). Nonregenerative anaemia associated with administration of recombinant human erythropoietin to a thoroughbred racehorse. *Equine Vet. J.* **29**, 326–328.
- Wu, H., Riha, G. M., Yang, H., Li, M., Yao, Q., and Chen, C. (2005). Differentiation and proliferation of endothelial progenitor cells from canine peripheral blood mononuclear cells. *J. Surg. Res.* **126**, 193–198.
- Xu, D. P., Washburn, M. P., Sun, G. P., and Wells, W. W. (1996). Purification and characterization of a glutathione dependent dehydroascorbate reductase from human erythrocytes. *Biochem. Biophys. Res. Commun.* **221**, 117–121.
- Xu, F., Quandt, K. S., and Hultquist, D. E. (1992). Characterization of NADPH-dependent methemoglobin reductase as a heme-binding protein present in erythrocytes and liver. *Proc. Natl. Acad. Sci. USA* **89**, 2130–2134.
- Xu, Z.-C., Dunham, P. B., Dyer, B., and Blostein, R. (1994). Decline in number of Na-K pumps on low-K<sup>+</sup> sheep reticulocytes during maturation is modulated by L<sub>p</sub> antigen. *Am. J. Physiol. Cell Physiol.* **266**, C1173–C1181.
- Yamakawa, T. (1983). Glycolipids of the red blood cells. In “Red Blood Cells of Domestic Mammals” (N. S. Agar and P. G. Board, Eds.), pp. 37–53. Elsevier, Amsterdam.
- Yamasaki, M., Takada, A., Yamato, O., and Maede, Y. (2005). Inhibition of Na,K-ATPase activity reduces Babesia gibsoni infection of canine erythrocytes with inherited high K, low Na concentrations. *J. Parasitol.* **91**, 1287–1292.
- Yamato, O., Kasai, E., Katsura, T., Takahashi, S., Shiota, T., Tajima, M., Yamasaki, M., and Maede, Y. (2005). Heinz body hemolytic anemia With eccentrocytosis from ingestion of Chinese chive (*Allium tuberosum*) and garlic (*Allium sativum*) in a dog. *J. Am. Anim Hosp. Assoc.* **41**, 68–73.
- Yamato, O., Lee, K. W., Chang, H. S., Tajima, M., and Maede, Y. (1999). Relation between erythrocyte reduced glutathione and glutamate concentrations in Korean Jindo dogs with erythrocytes possessing hereditary high activity of Na-K-ATPase and a high concentration of potassium. *J. Vet. Med. Sci.* **61**, 1179–1182.
- Yamato, O., and Maede, Y. (1992). Susceptibility to onion-induced hemolysis in dogs with hereditary high erythrocyte reduced glutathione and potassium concentrations. *Am. J. Vet. Res.* **53**, 134–137.
- Yawata, Y., Hebbel, R. P., Silvis, S., Howe, R., and Jacob, H. (1974). Blood cell abnormalities complicating the hypophosphatemia of hyperalimantation: erythrocyte and platelet ATP deficiency associated with hemolytic anemia in hyperalimanted dogs. *J. Lab. Clin. Med.* **84**, 643–653.
- Yawata, Y., Sugihara, T., Mori, M., Nakashima, S., and Nozawa, Y. (1984). Lipid analyses and fluidity studies by electron spin resonance of red cell membranes in hereditary high red cell membrane phosphatidylcholine hemolytic anemia. *Blood* **64**, 1129–1134.
- Yin, T., and Li, L. (2006). The stem cell niches in bone. *J. Clin. Invest* **116**, 1195–1201.
- Yoshida, A. (1973). Hemolytic anemia and G6PD deficiency. *Science* **179**, 532–537.
- Yoshida, H., Kawane, K., Koike, M., Mori, Y., Uchiyama, Y., and Nagata, S. (2005). Phosphatidylserine-dependent engulfment by macrophages of nuclei from erythroid precursor cells. *Nature* **437**, 754–758.
- Young, J. D. (1983). Erythrocyte amino acid and nucleoside transport. In “Red Blood Cells of Domestic Mammals” (N. S. Agar and P. G. Board, Eds.), pp. 271–290. Elsevier, Amsterdam.
- Young, J. D., Ellory, J. C., and Tucker, E. M. (1975). Amino acid transport defect in glutathione-deficient sheep erythrocytes. *Nature* **254**, 156–157.
- Young, J. D., Paterson, A. R., and Henderson, J. F. (1985). Nucleoside transport and metabolism in erythrocytes from the Yucatan miniature pig. Evidence that inosine functions as an *in vivo* energy substrate. *Biochim. Biophys. Acta* **842**, 214–224.
- Young, N. S. (2002). Acquired aplastic anemia. *Ann. Intern. Med.* **136**, 534–546.
- Young, N. S., Calado, R. T., and Scheinberg, P. (2006). Current concepts in the pathophysiology and treatment of aplastic anemia. *Blood* **108**, 2509–2519.
- Yu, M., Li, Q., and Stamatoyannopoulos, G. (2005). Investigations of the induction of the goat beta(C) globin gene by erythropoietin: studies in transgenic mice. *Blood Cells Mol. Dis.* **35**, 332–338.
- Yubisui, T., Takeshita, M., and Yoneyama, Y. (1980). Reduction of methemoglobin through flavin at the physiologic concentration by NADPH-flavin reductase of human erythrocytes. *J. Biochem.* **87**, 1715–1720.
- Zachara, B., Zakrzewska, I., Maziarz, Z., Gaszynski, W., and Wachowicz, N. (1981). Concentration of 2,3-diphosphoglycerate and adenosine triphosphate in erythrocytes following acute blood loss in beagles. *Haematol.* **14**, 285–291.
- Zaks, K. L., Tan, E. O., and Thrall, M. A. (2005). Heinz body anemia in a dog that had been sprayed with skunk musk. *J. Am. Vet. Med. Assoc.* **226**, 1516–1518.
- Zauch, J. A., Yu, C., Lothrop, C. D. J., Nash, R. A., Sale, G., Georges, G., Kiem, H. P., Niemeyer, G. P., Dufresne, M., Cao, Q., and Storb, R. (2001). Severe canine hereditary hemolytic anemia treated by nonmyeloablative marrow transplantation. *Biol. Blood Marrow Transplant.* **7**, 14–24.
- Zeidler, R. B., and Kim, H. D. (1982). Pig reticulocytes. IV. *In vitro* maturation of naturally occurring reticulocytes with permeability loss to glucose. *J. Cell Physiol.* **112**, 360–366.
- Zeidler, R. B., Metzler, M. H., Moran, J. B., and Kim, H. D. (1985). The liver is an organ site for the release of inosine metabolized by non-glycolytic pig red cells. *Biochim. Biophys. Acta* **838**, 321–328.
- Zerez, C. R., Lee, S. J., and Tanaka, K. R. (1987). Spectrophotometric determination of oxidized and reduced pyridine nucleotides in erythrocytes using a single extraction procedure. *Anal. Biochem.* **164**, 367–373.
- Zermati, Y., Fichelson, S., Valensi, F., Freyssinier, J. M., Rouyer-Fessard, P., Cramer, E., Guichard, J., Varet, B., and Hermine, O. (2000). Transforming growth factor inhibits erythropoiesis by blocking proliferation and accelerating differentiation of erythroid progenitors. *Exp. Hematol.* **28**, 885–894.
- Zhang, Y., Kobayashi, K., Sasagawa, K., Imai, K., and Kobayashi, M. (2003). Significance of affinity and cooperativity in oxygen binding to hemoglobin of horse fetal and maternal blood. *Zool. Sci.* **20**, 1087–1093.

- Zimran, A., Forman, L., Suzuki, T., Dale, G. L., and Beutler, E. (1990). *In vivo* aging of red cell enzymes: study of biotinylated red blood cells in rabbits. *Am. J. Hematol.* **33**, 249–254.
- Zinkl, J., and Kaneko, J. J. (1973a). Erythrocyte 2,3-diphosphoglycerate in normal and porphyric fetal, neonatal and adult cattle. *Comp. Biochem. Physiol. [A]* **45**, 699–704.
- Zinkl, J., and Kaneko, J. J. (1973b). Erythrocytic enzymes and glycolytic intermediates in the normal bovine and in bovine erythropoietic porphyria. *Comp. Biochem. Physiol. [A]* **45A**, 463–476.
- Zwaal, R. F., Comfurius, P., and Bevers, E. M. (1993). Mechanism and function of changes in membrane-phospholipid asymmetry in platelets and erythrocytes. *Biochem. Soc. Trans.* **21**, 248–253.

# Porphyryns and the Porphyrias

J. Jerry Kaneko

*Department of Pathology, Microbiology, and Immunology*

*School of Veterinary Medicine*

*University of California, Davis*

*Davis, California*

---

## I. INTRODUCTION

### II. PORPHYRINS

- A. Structure of the Porphyrins
- B. Synthesis of Porphyrins and Heme

### III. METHODOLOGY

- A. Urinary Porphyrins
- B. Fecal Porphyrins
- C. Blood Porphyrins
- D. Porphobilinogen

### IV. PORPHYRIAS

- A. Classification
- B. Erythropoietic Porphyrias
- C. Hepatic Porphyrias
- D. Porphyrinurias (Acquired Toxic Porphyrias)

## REFERENCES

---

## I. INTRODUCTION

The metal-porphyrin complexes are found widespread in nature as constituents of compounds of fundamental importance in the metabolic processes of life. The photosynthetic pigment of plants, chlorophyll, is a magnesium porphyrin. The iron-porphyrin complexes of animals are found as prosthetic groups of proteins, including the hemoglobins, myoglobins, and the heme enzymes peroxidase, catalase, and the cytochromes. The porphyrins also exist in nature in their free state or as zinc complexes, and it is this group that is associated with the porphyrias and the porphyrinurias.

Present knowledge of the porphyrins has its basis in the classic studies of the German physician and chemist Hans Fischer, whose work on the porphyrins dates back to 1915.

The development of elegant methods of detection and identification of porphyrins and sophisticated enzymological techniques have resulted in the present clear understanding of the mechanisms of porphyrin biosynthesis and the biochemical and molecular bases for the disorders of porphyrin metabolism.

## II. PORPHYRINS

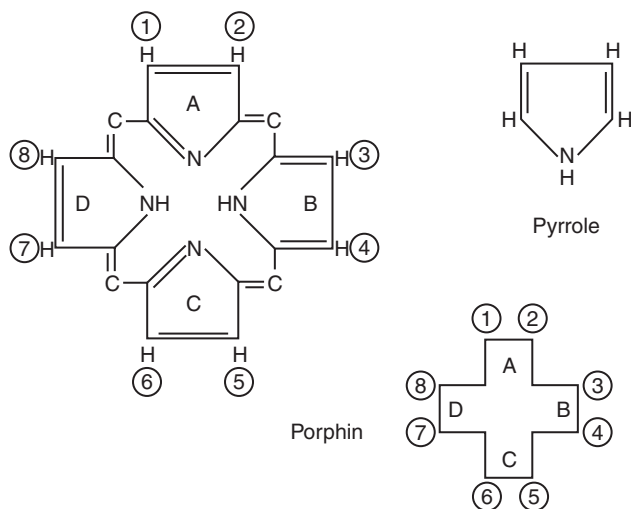
### A. Structure of the Porphyrins

The parent nucleus of the porphyrins is a cyclic tetrapyrrole, which consists of four pyrrole nuclei with their  $\alpha$  (adjacent to the  $\beta$ ) carbon atoms linked together by methylene ( $-C=$ ) bridges. This compound is called porphin and is shown in Figure 8-1. The various synthetic and naturally occurring porphyrins are derivatives of porphin, distinguished from each other by the type and position of the radicals substituted for the hydrogen atoms at positions 1 through 8. For convenience in discussing the substitutions, the simplified representation of the porphin nucleus as shown in Figure 8-1 is used.

The classification of the porphyrins is based on the synthetic porphyrin, etioporphyrin (ETIO), in which two different radicals are substituted at positions 1 through 8. The substituted radicals are four methyl (M) and four ethyl (E) groups. The number of structural isomers possible with these eight substituted radicals is four, as shown at the top of Figure 8-2. The naturally occurring porphyrins are only those in which the positioning of their substituted radicals correspond to isomer I or III of etioporphyrin, ETIO I and ETIO III. This observation led Fischer to speak of a "dualism" of porphyrins in nature, which is in essential agreement with present knowledge of the biosynthesis of the

porphyrin isomers as proceeding along parallel and independent paths.

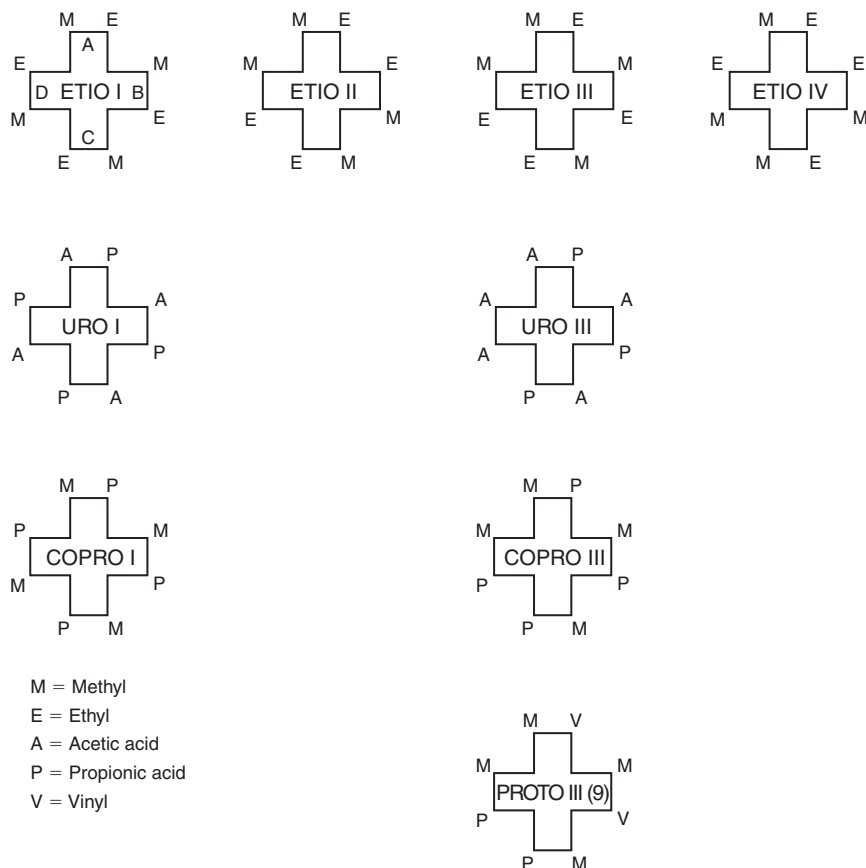
The uroporphyrins also contain two different radicals, acetic (A) and propionic (P) acids, and four each of these are arranged to correspond to either isomer ETIO I or ETIO III (Figure 8-2). In this case, A corresponds to M and P



**FIGURE 8-1** The precursor pyrrole and the parent porphin nucleus of porphyrins. Sites of isomeric substitutions are given as circled numbers and the pyrrole rings as letters. A schematic representation is also given.

corresponds to E. Therefore, these are designated uroporphyrin I (URO I) or uroporphyrin III (URO III). Similarly, the coproporphyrins contain four M and four P groups and are designated coproporphyrin I (COPRO I) and coproporphyrin III (COPRO III). The protoporphyrin of heme (iron-protoporphyrin, the prosthetic group of hemoglobin) corresponds to the series III isomer. In this case, however, three different radicals instead of two are substituted. These consist of four M, two P, and two vinyl (V) radicals. With three different radicals, 15 isomers are possible, but the protoporphyrin of heme is the only naturally occurring isomer known. This isomer was designated protoporphyrin IX because it was the ninth in the series of protoporphyrin isomers synthesized by Fischer. The arrangement of the methyl groups of this isomer as shown in Figure 8-2 corresponds to that of a type III etioporphyrin isomer and more properly should be called protoporphyrin III. However, by convention, the name protoporphyrin IX (PROTO IX) is the designation for this porphyrin.

An interesting isomer with only one vinyl group located on the A ring occurs and is known as harderoporphyrinogen, which is thought to be an intermediate in the synthesis of protoporphyrinogen III. Other naturally occurring or chemically synthesized porphyrins are derivatives of PROTO IX. If the two vinyl groups are hydrogenated to ethyl groups, the product is mesoporphyrin IX. If the



**FIGURE 8-2** The isomeric porphyrins. The nomenclature of the porphyrins URO, COPRO, and PROTO is based on the isomeric structure of the etioporphyrins. Note that there are only the type I and type III isomers.

two vinyl groups are converted to hydroxy-ethyl groups, the product is hematoporphyrin IX. If the two vinyl groups are replaced by hydrogen atoms, the product is deuteroporphyrin IX. Protoporphyrin and deuteroporphyrin normally occur in feces but are primarily products of intestinal bacterial degradation.

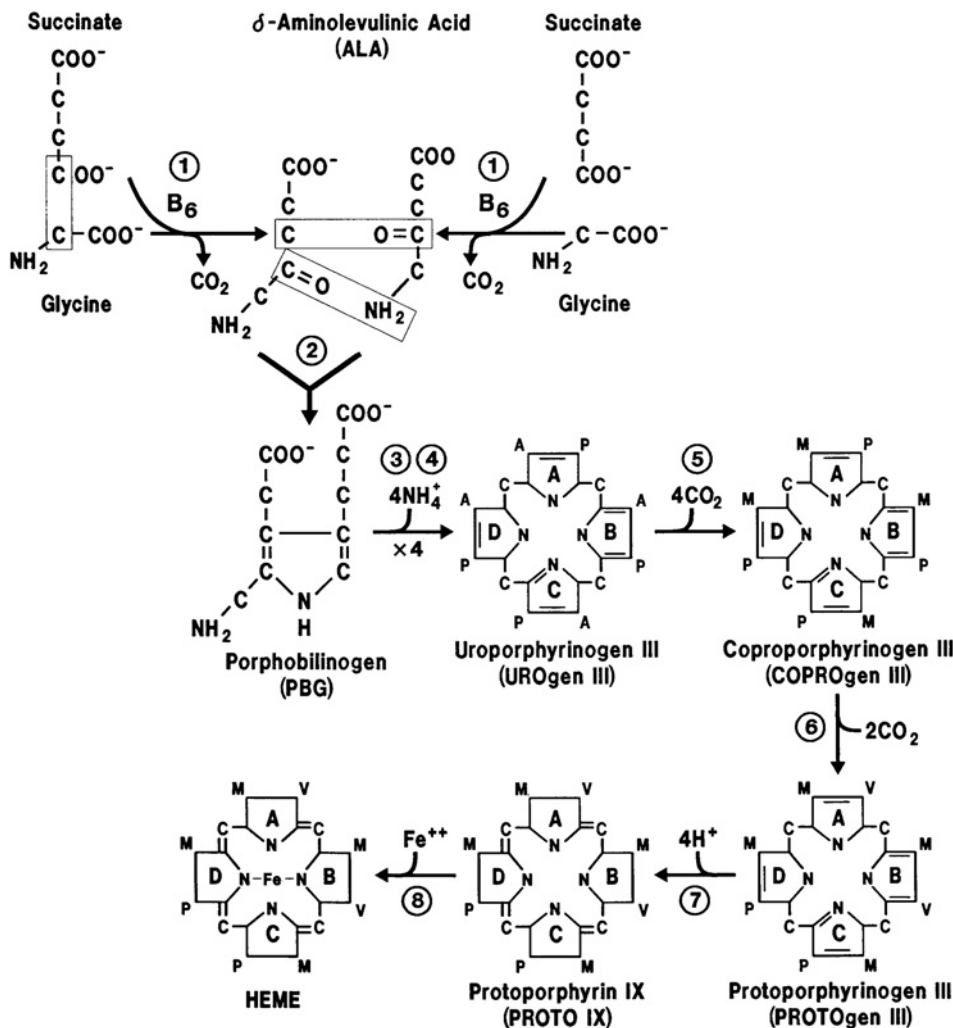
### B. Synthesis of Porphyrins and Heme

The initial steps in the pathway for porphyrin and heme biosynthesis begins with the incorporation of the methyl carbon (C-2) and nitrogen atom of glycine into the porphyrin ring and ultimately into the heme of hemoglobin. Porphyrin metabolism and the porphyrias have been periodically reviewed (Elder and Sheppard, 1982; Hindmarsh, 1986; Sassa, 2006; Sassa and Kappas, 2000).

The methyl carbons (C-2) of glycine supply 8 of the 34 carbons of protoporphyrin: one for each of the four methylene bridges and one for each of the pyrrole rings (Fig. 8-3).

The carboxyl carbon atom of glycine is given off as CO<sub>2</sub> and is not incorporated into the protoporphyrin molecule (Fig. 8-3). The direct incorporation of the nitrogen or the methyl carbon glycine into the heme of hemoglobin has been the basis for a useful technique to label the erythrocyte and to measure its survival time. After administering <sup>15</sup>N-glycine, the concentration of <sup>15</sup>N in heme rises rapidly, remains constant for a time, and then falls. Mathematical analysis of the curve indicates a survival time of 120 days for the human erythrocyte. On a similar basis, methyl carbon labeled glycine has been used to determine the life span of the erythrocytes of a number of domestic animals (Table 8-1).

The remaining carbons of protoporphyrin are supplied by the tricarboxylic acid (TCA) cycle intermediate, succinyl-CoA. An outline of the pathway of heme and porphyrin synthesis is given in Figure 8-4, which depicts the compartmentalization of their pathways between the mitochondria and cytosol. The nomenclature of the enzymes of porphyrin synthesis varies among authors, so a guide to the nomenclature of the enzymes is provided in Table 8-2.



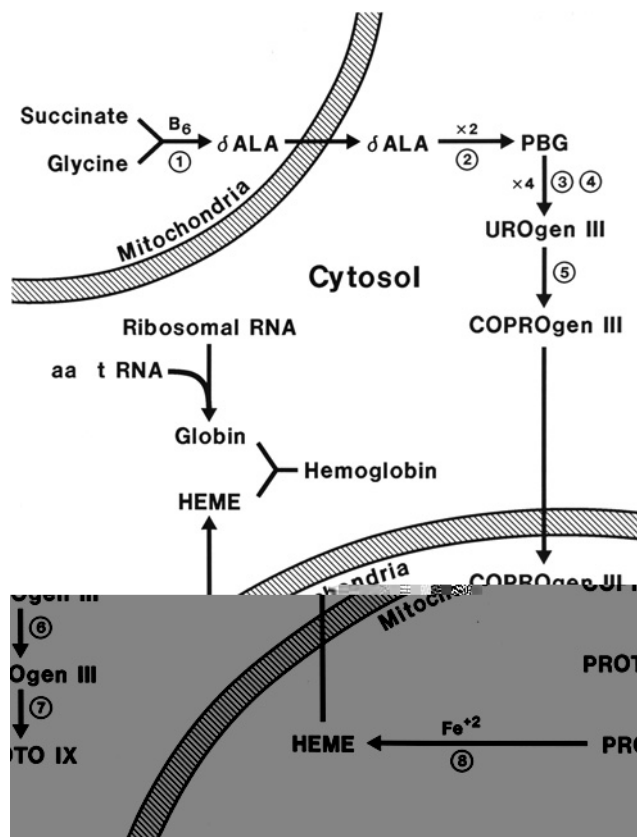
**FIGURE 8-3** The synthetic pathway for protoporphyrin and heme. Note that two enzymes are required to catalyze the formation of UROgenIII. The circled numbers correspond to the enzymes listed in Table 8-2.

**TABLE 8-1** Erythrocyte Life Span of Animals Determined by the Cohort Labeling of Heme

Animal	Label	Life Span (Days)	Reference
Antelope	<sup>14</sup> C	80	Cornelius <i>et al.</i> (1959)
Cat	<sup>15</sup> N	77	Valentine <i>et al.</i> (1951)
"	<sup>14</sup> C	66–79	Kaneko <i>et al.</i> (1966)
"	<sup>59</sup> Fe	68	Brown and Eadie (1953)
"	"	36–66	Liddle <i>et al.</i> (1984)
Chicken	<sup>14</sup> C	20	Altland and Brace (1956)
Cow	<sup>14</sup> C	135–162	Kaneko (1963)
Deer (Mule)	"	95	Cornelius <i>et al.</i> (1959)
Dog	"	86–106	Cline and Berlin (1963)
"	<sup>59</sup> Fe	95–109	Finch <i>et al.</i> (1949)
Duck	<sup>14</sup> C	39	Altland and Brace (1956)
Goat	"	125	Kaneko and Cornelius (1962)
Tahr Goat	"	160–165	" " " "
Guanaco	"	225	Cornelius and Kaneko (1962)
Guinea Pig	<sup>59</sup> Fe	83	Everett and Yoffey (1959)
Horse	<sup>14</sup> C	140–150	Cornelius <i>et al.</i> (1960)
Human	"	120	Berlin <i>et al.</i> (1957)
"	<sup>15</sup> N	127	Shemin and Rittenberg (1946b)
Mouse	<sup>59</sup> Fe	20–30	Burwell <i>et al.</i> (1953)
Pig	"	63	Jensen <i>et al.</i> (1956)
"	<sup>14</sup> C	62	Bush <i>et al.</i> (1955)
Rabbit	<sup>15</sup> N	65–70	Neuberger and Niven (1951)
"	<sup>59</sup> Fe	57	Gower and Davidson (1963)
"	<sup>14</sup> C	50	" " " "
Rat	"	64	Berlin and Lotz (1951)
"	"	68	Berlin <i>et al.</i> (1951)
"	<sup>59</sup> Fe	45–50	Burwell <i>et al.</i> (1953)
Sheep	"	70–153	Tucker (1963)
"	<sup>14</sup> C	64–118	Kaneko <i>et al.</i> (1961)
Bighorn	"	147	" " " "
Karakul	"	130	" " " "
Aoudad	"	60 and 170	Cornelius <i>et al.</i> (1959)

### 1. $\delta$ -Amino Levulinic Acid

The initial step in the pathway of  $\delta$ -aminolevulinic acid (ALA) synthesis occurs in the mitochondria and involves the enzymatic condensation of glycine with succinyl-CoA to form ALA. This reaction requires vitamin B<sub>6</sub> as pyridoxal phosphate, and it is the pyridoxal-phosphate-glycine



**FIGURE 8-4** The synthetic pathway for protoporphyrin and heme. Note the partitioning of the heme synthetic pathway between the mitochondria and the cytosol. The circled numbers correspond to the enzymes listed in Table 8-2.

complex that condenses with succinyl-CoA (Gibson *et al.*, 1958, Kikuchi *et al.*, 1958). The requirement for pyridoxine explains the pyridoxine responsive anemia of pyridoxine deficiency because in the absence of pyridoxine, the condensation cannot occur. The condensing reaction is catalyzed by the enzyme ALA synthase (ALA-Syn). ALA-Syn is the rate-controlling enzyme for heme synthesis (Granick, 1966). ALA-Syn is induced by heme and is also suppressed by negative feedback inhibition by heme. Thus, the end product, heme, controls its own synthesis (Granick and Levere, 1964). The ALA is next transferred into the cytosol (Sano and Granick, 1961).

### 2. Porphobilinogen

Two moles of ALA are next condensed to form the precursor pyrrole, porphobilinogen (PBG) in the cytosol (Cookson and Rimington, 1953). The enzyme ALA-dehydrase (ALA-D), an enzyme that is strongly inhibited by lead, catalyzes this reaction. The activity of this enzyme has been assayed in lead poisoning, and a reduced activity is generally regarded as presumptive evidence of exposure to lead.



**TABLE 8-2** Nomenclature for Enzymes of Porphyrin and Heme Synthesis and Their Synonyms

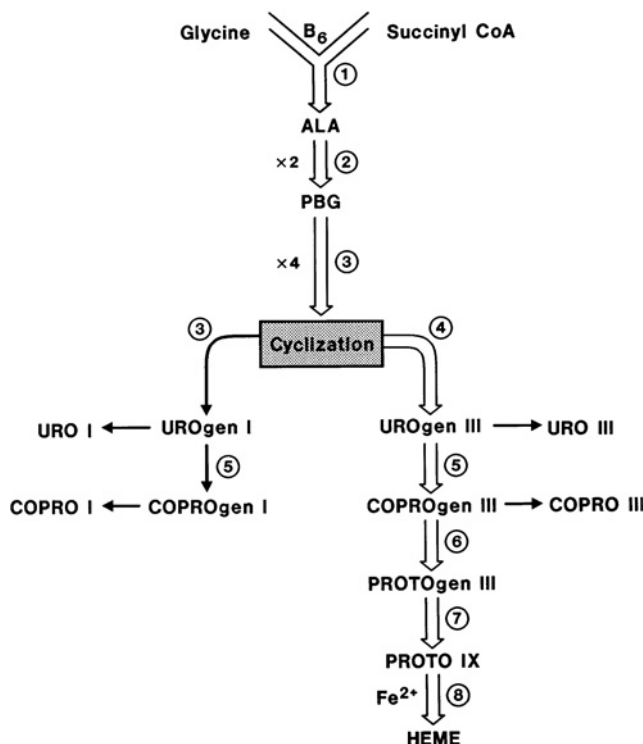
Abbreviations	Nomenclature
1. ALA-Syn	delta-aminolevulinate synthase (synthetase)
2. ALA-D	delta-aminolevulinate dehydrase (dehydratase); porphobilinogen synthase
3. PBG-D	porphobilinogen deaminase, uroporphyrinogen I synthase (synthetase), hydroxymethylbilane synthase
4. UROgenIII-Cosyn	uroporphyrinogen III cosynthase (cosynthetase)
5. UROgen-D	uroporphyrinogen decarboxylase
6. COPROgenIII-Ox	coproporphyrinogen III oxidase
7. PROTOgen-Ox	protoporphyrinogen oxidase
8. FER-Ch	ferrochelatase; heme synthase (synthetase)

### 3. Uroporphyrinogen

Next, two enzymes, porphobilinogen deaminase (PBG-D) (formerly called uroporphyrinogen I synthase [UROgenI-Syn]) and uroporphyrinogen III cosynthase (UROgenIII-Cosyn) act together to condense four moles of PBG into the cyclic tetrapyrrole, uroporphyrinogen III (UROgenIII). PBG-D initially catalyzes the formation of a symmetrical linear tetrapyrrole. UROgenIII-Cosyn then flips the D ring and closes the pyrroles into an asymmetrical porphyrin ring of the type III configuration. In the absence of the UROgenIII-Cosyn, the symmetrical linear tetrapyrrole spontaneously closes into a symmetrical porphyrin ring of the type I configuration. Normally, there is a great excess of UROgenIII-Cosyn, so UROgenIII is synthesized. Both enzymes have been isolated from the spleens of anemic mice and *in vitro*, in the presence of both enzymes, UROgenIII was produced (Levin and Coleman, 1967).

### 4. Coproporphyrinogen

The eight carboxyl UROgens I or III are next progressively decarboxylated into the four carboxyl coproporphyrinogens (COPROgen) I or III with the decarboxylations catalyzed by the enzyme uroporphyrinogen decarboxylase (UROgen-D). UROgen-D is nonspecific so it catalyzes the decarboxylation of either UROgenI or UROgenIII. The COPROgens now move back into the mitochondria (Fig. 8-4).



**FIGURE 8-5** Alternate pathways for porphyrin synthesis. Normally, enzymes 3 and 4 function together in a coordinated manner to form heme. In the absence of enzyme 4, the alternate and terminal pathway to form the I isomers is taken. The circled numbers correspond to the enzymes listed in Table 8-2.

### 5. Protoporphyrinogen

Within the mitochondria, coproporphyrinogen III oxidase (COPROgenIII-Ox) catalyzes the decarboxylation of the two propionic acid groups on the A and B pyrrole rings of COPROgenIII to vinyl groups and the resulting product is protoporphyrinogen III (PROTOgenIII). COPROgenIII-Ox is highly specific for COPROgenIII, and this explains the presence of only type III porphyrin isomers in nature. This also means that COPROgenI is a terminal intermediate that is oxidized to coproporphyrin I, the end product of this path (Fig. 8-5). COPROgenIII, when in excess, is also oxidized to coproporphyrin III. Similarly, the UROgens I and III can be oxidized to their end products, the uroporphyrins I and III. Figure 8-5 illustrates that each of the -gen forms can be oxidized into their free forms, which are the forms usually found in the circulatory system. These free porphyrins and protoporphyrins are photoreactive and are the causative agents of the photosensitivity in the porphyrias.

### 6. Protoporphyrin

PROTOgenIII, the 2-carboxyl porphyrinogen, is next oxidized at the carbon bridges to form the methene bridges connecting the pyrroles and is catalyzed by protoporphyrinogen III oxidase (PROTOgenIII-Ox). The resulting product is protoporphyrin IX (PROTO IX).

## 7. Heme

Within the mitochondria, ferrous iron ( $\text{Fe}^{+2}$ ) is chelated with PROTO IX to form heme and is catalyzed by the enzyme ferrochelatase (FER-Ch). Iron can also be incorporated with relative ease by a nonenzymic method, but the enzymic iron incorporation is more than 10 times that of the nonenzymic route (Labbe and Hubbard, 1961). Conditions that help to maintain iron in its ferrous form including the presence of reducing agents (ascorbic acid, cysteine, glutathione) enhance both enzymic and nonenzymic iron incorporation. Because iron is incorporated into heme as an integral part of the molecule, labeled iron can also be used as a cohort label to determine the life span of the erythrocyte (Table 8-1).

## 8. Hemoglobin

Heme next moves into the cytosol where it is linked to the heme pocket of globin in a precise and stable position that permits binding of oxygen to the heme. Hemoglobin consists of four moles of this heme-globin moiety linked together as a globular tetramer. It is this globular tetrameric form of the hemoglobin molecule that permits the cooperative interaction of oxygen binding, which gives the familiar sigmoid oxygen-hemoglobin saturation curve.

## 9. Summary

In summary, the synthesis of porphyrins, heme, and globin can only occur in those respiring cells with full complements of mitochondrial and cytosolic enzymes. The TCA cycle is an aerobic cycle, and therefore a lack of oxygen would preclude synthesis of succinyl-CoA and hence of heme. PROTO IX formation and the chelation of iron to form heme are also oxygen-requiring systems. Therefore, the reticulocyte with its residual complement of enzymes can synthesize hemoglobin, but the mature erythrocyte, which is devoid of mitochondrial enzymes, cannot.

## III. METHODOLOGY

The principal method now employed for the detection of porphyrins in biological materials in the clinical laboratory is based on the characteristic red fluorescence observed when acidic solutions of the porphyrins are exposed to ultraviolet light. The color of the fluorescence cannot be used to distinguish between the uroporphyrins and the coproporphyrins, and, therefore, these must be separated before examination for fluorescence. The separation procedures are based on the solubility differences of the porphyrins in various organic solvents. In general, the following solubility properties are used in the separation of the uroporphyrins from the coproporphyrins:

1. The coproporphyrins are soluble in diethyl ether, whereas the uroporphyrins are not, and therefore uroporphyrins remain in the aqueous phase.

2. Both uroporphyrin and coproporphyrin are soluble in strong acid, 1.5N HCl. Coproporphyrins are therefore extracted from the organic phase with 1.5N HCl. The uroporphyrins in the aqueous phase are absorbed with aluminum trioxide and subsequently eluted with 1.5N HCl.

The acidic solutions of the porphyrins are then observed visually for fluorescence or examined in a sensitive fluorometer. The most suitable condition for the excitation of fluorescence is the use of ultraviolet light in the near visible range using aqueous solutions of the porphyrins at pH 1–2. Further means of identification include spectrophotometric examination, melting points of their methyl esters, and high-performance liquid chromatography (HPLC). The quantitative methods employing HPLC with fluorometric detection have been described in detail by Hindmarsh *et al.* (1999). The HPLC method now appears to be the most accurate method for urine and fecal porphyrins (Zuijderhoudt *et al.*, 2000, 2002). The following screening procedures are guides for further laboratory examinations.

### A. Urinary Porphyrins

The urine for porphyrin examination must be alkalinized because porphyrins readily precipitate in acid urine. Addition of 0.5g of sodium bicarbonate to the collecting bottle for each 100ml of urine will keep the urine alkaline. The alkalinized urine can be stored at 4°C for 2 to 3 days before analysis. All contact of the urine with metal must be avoided and unfiltered urine is used. The following is a simplified screening procedure:

1. Place 5ml urine in a 250-ml separatory funnel and add 5ml acetate buffer (four parts glacial acetic acid: 1 part saturated sodium acetate) and adjust pH to 4.6 to 5.0.

2. Add 15ml cold water.

3. Extract the mixture with two 50ml aliquots of diethyl ether (or until the ether phases show no fluorescence under ultraviolet [UV] light) and pool the aliquots. The coproporphyrins will enter the ether phase.

4. Most of the porphyrins in urine are in the form of their nonfluorescent precursors. Storage of the urine for 24h in a refrigerator will enhance their conversion to the fluorescent pigments. If fresh urine is used, the ether phase is gently shaken with 5ml of fresh 0.005% iodine solution (dilute 0.5ml of a stock 1% iodine in ethanol solution to 100ml with water) to convert the precursors to the porphyrins.

5. Extract the pooled ether phases with 20ml 5% HCl (1.5N) and examine for fluorescence under UV light. Fluorescence indicates the presence of coproporphyrins.

6. Uroporphyrins are insoluble in ether. Therefore, fluorescence in the aqueous urinary phase indicates the presence of uroporphyrins.

## B. Fecal Porphyrins

The screening test as described for urine can also be used with fecal samples after prior extraction with strong acid. First, 5g of a fecal sample is emulsified with 10ml 95% ethanol. Then 25ml of concentrated HCl and 25ml water are added to the emulsion, and the mixture is kept overnight at room temperature. The mixture is next diluted to 200ml with water, filtered, and the filtrate examined for porphyrins as described for urine.

## C. Blood Porphyrins

Almost all porphyrins in blood are present in the erythrocytes, and only trace amounts are in plasma. Therefore, it is important to use whole blood in the test and to understand that the test is a measure of the porphyrin content of the erythrocytes. Mix 2ml heparinized whole blood and 6ml ethyl acetate:glacial acetic acid (4:1) in a glass centrifuge tube. Stir thoroughly, centrifuge, and pour off the supernate into a second centrifuge tube. Add 1ml 3N HCl, vortex, and allow the phases to separate. Fluorescence under UV light in the aqueous layer indicates the presence of porphyrins in the erythrocytes. Normally, there will only be a trace of fluorescence so that more than a trace indicates an abnormal concentration.

## D. Porphobilinogen

The Watson and Schwartz test for porphobilinogen is reliable for screening (Watson and Schwartz, 1941). For this test, 3ml fresh urine is mixed with 3ml Ehrlich's aldehyde reagent (0.7g p-dimethylaminobenzaldehyde, 150ml concentrated HCl, and 100ml water), the reagent that is used for the urine urobilinogen test. Next, 5ml chloroform are added, shaken vigorously in a separatory flask, and allowed to separate. The porphobilinogen aldehyde formed in the test is insoluble in chloroform and will remain in the lower aqueous phase. If the pink color is due to urobilinogen, it will be extracted into the chloroform phase. Porphobilinogen is found characteristically in the urine of patients with hepatic forms of porphyria, forms that have not been reported in animals.

# IV. PORPHYRIAS

## A. Classification

By convention, the term *porphyria* is used to define those disease states that have a hereditary basis and increased

urinary or fecal excretion of uroporphyrins and coproporphyrins. Depending on the fundamental biochemical defect, the porphyrias can be broadly classified on the basis of their tissue of origin, the erythropoietic system, or the liver. The term *porphyrinuria* is used to define those acquired conditions in which the principal, if not the sole, porphyrins being excreted are the coproporphyrins. Excess coproporphyrin excretion is observed in a wide variety of conditions including infections, hemolytic anemias, liver disease, and lead poisoning. The screening test for coproporphyrinuria has been especially useful for detecting exposure to lead.

Many systems for classifying porphyrias have been devised, and most are based on the defect in the tissue of origin, the erythropoietic system, or the liver. There is general agreement on the classification of the erythropoietic forms, but there is still some uncertainty as to the classification of the hepatic forms. These have been classified on the basis of their clinical manifestations, heredity, porphyrins excreted, and their enzymatic defects (Elder and Sheppard, 1982; Hindmarsh, 1986; Sassa, 2006; Sassa and Kappas, 2000). Each of the enzymatic defects has now been described on a molecular level in humans, and they have been summarized by Sassa and Kappas (2000). The genes have been cloned, and it is now known that there is a great deal of genetic heterogeneity, which presumably accounts for the wide variety of disease manifestations in each of the porphyrias. A useful system of classification is given in Table 8-3.

Methods are also available for the experimental production of the two major types of porphyria. In lead or

**TABLE 8-3** Classification of the Porphyrrias<sup>a</sup>

Porphyria Type	Inheritance	Enzyme Deficiency
I. Erythropoietic porphyrias		
A. Congenital erythropoietic porphyria	AR	UROgenIII-Cosyn
B. Erythropoietic protoporphyria	AD	FER-Ch
II. Hepatic porphyrias		
A. ALA-D deficiency porphyria	AR	ALA-D
B. Acute intermittent porphyria	AD	PBG-D
C. Porphyria cutanea tarda	AD	UROgen-D
D. Hepatoerythropoietic porphyria	AR	UROgen-D
E. Harderoporphyria	AR	COPROgenIII-Ox
F. Hereditary coproporphyria	AD	COPROgenIII-Ox
G. Variegata porphyria	AD	PROTOgen-Ox

<sup>a</sup>Inheritance: A = autosomal; R = recessive; D = dominant; see Table 8-2 for enzyme abbreviations.

phenylhydrazine poisoning, a type of porphyrinuria has been observed that has some of the characteristics of erythropoietic porphyria of humans and cattle (Schwartz *et al.*, 1952). A hepatic form can be produced with sedormid (allylisopropylacetylcarbamide) (Schmid and Schwartz, 1952), dihydrocollidine (Granick and Urata, 1963), or hexachlorobenzene.

## B. Erythropoietic Porphyrrias

### 1. Bovine Congenital Erythropoietic Porphyrria

#### a. Introduction

One of the characteristic findings in bovine congenital erythropoietic porphyria (CEP) is a reddish brown discoloration of the teeth and bones. Discolorations of this type have been observed in cattle at slaughter since the turn of the century, and these cattle are presumed to have had the disease. The first living cases were encountered in South Africa in a herd of grade Shorthorn cattle. Since then, CEP has been reported in cattle in Denmark (Jorgensen and With, 1955), the United Kingdom (Amoroso *et al.*, 1957), the United States (Rhode and Cornelius, 1958), and Jamaica (Nestal, 1958). The disease has been seen primarily in Holsteins with a few cases in Shorthorns and Jamaican cattle.

The simple Mendelian autosomal recessive heredity of the disease was established by the study of the genealogy of the affected cattle and by breeding experiments. The affected homozygotes are characterized by discoloration of the teeth and urine, photosensitivity of the light areas of the skin, and generalized lack of condition and weakness. The condition is present at birth, and severely affected calves must be protected from sunlight if a state of health is to be maintained.

The predominant symptoms of teeth and urine discoloration and the photosensitization of the severely affected

animal are readily apparent, and a tentative diagnosis can be confirmed by the orange-red fluorescence of the teeth and urine when examined with near ultraviolet light or a Woods lamp. The symptomatology of affected animals, however, may vary from minimal to severe and with age and season. The discoloration of the teeth may vary in the same breed, being more pronounced in the young and less apparent in the older animals. Porphyrin deposits are heavily concentrated in the dentine so the occlusal surfaces should also be examined. If porphyrins are present, the discoloration and the fluorescence of the dentine will be readily detected.

The degree of photosensitization will vary with the amount of porphyrin deposition in the dermis, coat color, density of the coat, and extent of exposure to sunlight. The photosensitization may be so slight as to escape detection. At times, loss of condition may be the only outward symptom for which the veterinarian is called. Marked variations in the urinary excretion of the porphyrins also occur. These may range from minimal to thousands of micrograms in the same animal so that the urine color may vary widely. The variations observed in this disease indicate the dynamic state of flux of porphyrin metabolism in the living animal, and the porphyrin deposits constitute a part of this dynamic state.

#### b. Distribution of Porphyrins

Some normal values for the porphyrins in animals are given in Table 8-4. These values are to be considered as best approximations obtained from a relatively few animals. The figures, however, indicate the very low concentrations of the free porphyrins normally found in the body. Thus, the finding of porphyrins in greater than trace amounts is always significant. Porphyrin concentrations in porphyric cows and calves are given in Table 8-5 (Kaneko and Mills, 1970).

**TABLE 8-4** Reference Values for Porphyrin Concentrations<sup>a</sup>

Species	Urine (kg/dl)		Feces (kg/g)		RBC (kg/dl cells)		Plasma (kg/dl)		Bone Marrow (kg/dl cells)		
	URO <sup>b</sup>	COPRO	COPRO	PROTO	COPRO	PROTO	COPRO	PROTO	URO	COPRO	PROTO
Cow	1.09 ± 0.92	4.06 ± 1.96	3.12 ± 0.96	0.75 ± 0.30	Trace	Trace	Trace	Trace	1	5	100
	0.80 ± 1.60	2.05 ± 6.15	1.11 ± 4.28	0.15 ± 1.25							
Pig		104 <sup>c</sup>				118					
Rabbit	25 <sup>c</sup>	41	25 <sup>c</sup>		2.6	83.3			Trace	4.5	87.5
Dog	50 <sup>c</sup>			50 <sup>c</sup>		35.0					

<sup>a</sup>References: Cow; Jorgensen (1961); Watson *et al.* (1959); Kaneko and Mills (1970). Pig; Cartwright and Wintrobe (1948). Rabbit; Schmid *et al.* (1952). Dog; Schwartz *et al.* (1960).

<sup>b</sup>Abbreviations: URO uroporphyrin; COPRO, coproporphyrin; PROTO, protoporphyrin.

<sup>c</sup>Micrograms per day.

**i. Urine** It is known that porphyrin excretion varies over wide limits. Jorgensen (1961) in 52 cases found values for urinary uroporphyrins between 6.3 to 3900 $\mu\text{g}/\text{dl}$  (0.076 to 46.96 $\mu\text{mol}/\text{l}$ ) and coproporphyrins between 2.1 and 8300 $\mu\text{g}/\text{dl}$  (0.032 to 126.74 $\mu\text{mol}/\text{l}$ ). At concentrations of 100 $\mu\text{g}/\text{dl}$  (1.53 $\mu\text{mol}/\text{l}$ ) or more, a reddish discoloration is discernible in the urine. At 1000 $\mu\text{g}/\text{dl}$  (15.27 $\mu\text{mol}/\text{l}$ ) or more, an intense red fluorescence of the urine is readily observed when examined in the dark with Woods light. The principal porphyrins excreted are URO I and COPRO I and only a small fraction is of the type III isomers. The percentage of each appearing in the urine is also variable. There is usually a greater excretion of URO I than COPRO I, but Jorgensen (1961) observed a greater excretion of COPRO I than URO I.

Porphobilinogen is not usually found in bovine CEP urine, and earlier reports of its presence (Jorgensen and With, 1955) have not been confirmed (Jorgensen, 1961). Normally colored, nonfluorescent urine of a CEP cow has consistently given a definite pink Ehrlich reaction, but unlike porphobilinogen aldehyde, the pigment is soluble in chloroform. The nature of the pigment is unknown. Upon heating on a steam bath for an hour or standing at room temperature for several days, a red fluorescence is apparent on exposure to UV light. Quantitative porphyrin determinations of this urine yielded values of 135 $\mu\text{g}/\text{dl}$  (1.63 $\mu\text{mol}/\text{l}$ ) and 87 $\mu\text{g}/\text{dl}$  (1.33 $\mu\text{mol}/\text{l}$ ) for uroporphyrin and coproporphyrin,

respectively. Watson *et al.* (1959) also described a similar experience with bovine CEP urine.

**ii. Bile and Feces** Bovine fecal porphyrins may be derived from two sources: the bile and from chlorophyll of the food. The porphyrins derived from chlorophyll are excluded by the usual analytical method. Essentially, the only porphyrin found in the bile and feces of CEP cattle is COPRO I, and its concentration varies over wide limits (Tables 8-4 and 8-5). Fecal coproporphyrin varied between 1.9 and 11,800 $\mu\text{g}/\text{g}$  (0.003 to 18.0 $\mu\text{mol}/\text{g}$ ) and biliary coproporphyrin between 320 and 13,600 $\mu\text{g}/\text{dl}$  (4.88–207.67 $\mu\text{mol}/\text{l}$ ) (Jorgensen, 1961). Only small amounts of COPRO III have been observed in feces. Watson *et al.* (1959) also observed this preponderance of COPRO I in feces and also reported the presence of small amounts of URO I.

**iii. Plasma and Erythrocytes** Only traces of free porphyrins are normally present in the plasma and in the erythrocytes. In bovine CEP plasma, Watson *et al.* (1959) observed variable amounts of porphyrins that were in general equally URO I (1 to 27 $\mu\text{g}/\text{dl}$ ; 0.012–0.33 $\mu\text{mol}/\text{l}$ ) and COPRO I (4.2 to 25 $\mu\text{g}/\text{dl}$ ; 0.064 to 0.38 $\mu\text{mol}/\text{l}$ ). A striking difference as compared to the human disease was the high level of free protoporphyrin in the erythrocytes of the CEP cow. The significance of this high level of protoporphyrin was unclear but was most likely related to the severe hemolytic

**TABLE 8-5** Porphyrins in Blood and Excreta of Normal, Porphyrin, and Porphyria Carrier Cattle<sup>a</sup>

Animals <sup>c</sup>	Erythrocytes		Plasma		Urine		Feces	
	COPRO <sup>b</sup>	PROTO	COPRO	PROTO	COPRO	URO	COPRO	PROTO
Normal Mature Cows (N = 10)	Trace	Trace	Trace	Trace	2.05–6.15 (4.06)	0.80–1.60 (1.09)	111–428 (312 ± 96)	15–125 (75 ± 30)
Mature Porphyric Cows								
1184	3.0	61	15.3	1.8	410	378	5670	46
652 (N = 3)	3.4	64	4.5	1.6	313	336	1900	12
2026 (N = 2)	3.1	457	8.9	1.5	498	487	2090	62
718	89.7	36		1450	1280			
Mature Porphyria Carrier Cows								
1140	Trace	Trace	Trace	Trace	Trace	Trace	292	88
1141	Trace	Trace	Trace	Trace	Trace	Trace	273	92
Porphyric Calves, 2 to 6 Months Old								
1857 (N = 3)	2.9	109	1.5	Trace	13	70	796	144
1801 (N = 3)	7.8	104	38.4	2.6	1430	1144	12	72
1959	18.6	288	Trace	Trace	480	265	22	99
Porphyria Carrier Calf, 5 Months Old								
1802	Trace	Trace	Trace	Trace	Trace	Trace	495	40

<sup>a</sup> Values are means given in micrograms per deciliter or micrograms per 100 g; values in parentheses are means plus or minus a single standard deviation (Kaneko and Mills, 1970).

<sup>b</sup> Abbreviations: COPRO, coproporphyrins; PROTO, protoporphyrins; URO, uroporphyrins.

<sup>c</sup> N denotes number of animals or number of determinations per animal.

**TABLE 8-6** Tissue Porphyrins in Bovine Congenital Erythropoietic Porphyria<sup>a</sup>

Tissue	Uroporphyrins	Coproporphyrins	Protoporphyrins	Total
Bone marrow	Tr – 162	Tr – 1890	Tr – 394	Tr – 2,396
Bones	6,000	Tr	Tr	6,000
Teeth	18,550	Tr	Tr	18,550
Spleen	0–10	Tr – 342	Tr – 60	7–400
Liver	0–Tr	16–340	42–65	66–403
Lung	0–79	0–37	Tr – 20	20–130
Kidney	0	Tr – 117	5–16	5–133
Lymph node	0	0–40	1–7	1–49
Intestine	0	Tr – 65	7–77	18–104
Stomach	0	Tr – 58	12–82	12–111
Bile	0–690	112–12,205	0–856	112–13,750
Adrenal	0–6	Tr – 202	19–170	19–378
Ovary	0	65	1	66
Testes	0	0	9–14	9–14
Skin	0	0	0	0
Muscle	0	10	30	40
Brain/spinal cord	0	23	57	80

<sup>a</sup> Given in micrograms per 100 g of tissue.

anemia in the CEP cow. Excess PROTO IX is commonly found in iron deficiency, hemolytic anemia, and in lead poisoning. In iron deficiency, PROTO IX accumulates because of failure to form hemoglobin, but in CEP, serum iron is normal or elevated (Kaneko, 1963; Kaneko and Mattheeuws, 1966; Watson *et al.*, 1959). Similarly, PROTO IX accumulates in lead poisoning because of inhibition of ferrochelatase and a subsequent inability to insert iron into hemoglobin.

**iv. Tissue** The range of concentrations of porphyrins in the tissues of CEP cattle is given in Table 8-6. The deposition of porphyrins throughout the bones and soft tissues is readily apparent at postmortem of severe cases by the generalized discoloration. A reddish brown discoloration is most apparent in the teeth, bones, and bone marrow. Greatest discoloration of soft tissues occurs in the lungs and spleen in which characteristic fluorescence may be observed with UV light. The high concentration of porphyrins in the spleen is consistent with the hemolytic type of anemias in CEP. Discoloration of skin, muscle, heart, liver, and kidney is also observed but only a part is due to porphyrins. The discoloration is likely due to other porphyrin derivatives and to hemoglobin staining.

### c. Hematology

The hematological picture of the majority of reported cases is one of a responsive hemolytic anemia. In general, the degree of response is correlated with the severity of the hemolytic anemia. The anemia in mild cases of bovine CEP is normocytic and in the more severe cases is macrocytic, a reflection of the severity of the hemolysis and the acuteness of the response. In the severe cases of bovine CEP, there is reticulocytosis, polychromasia, anisocytosis, basophilic stippling, and an increase in nucleated erythrocytes. A consistent monocytosis has been observed (Kaneko, 1963; Rhode and Cornelius, 1958), but this remains unexplained. There is a markedly decreased M:E ratio in the presence of the anemia, indicating a marked bone marrow hyperplasia. Bone marrow is also a principal site of porphyrin deposition, and Watson *et al.* (1959) found high concentrations of uroporphyrins in the bone marrow of a CEP cow.

The presence of porphyrins in the nucleated erythrocytes is clearly evident by examination of unfixed and unstained bone marrow smears with a fluorescent microscope. These fluorescent cells have been called fluorocytes. This phenomenon was originally observed by Schmid *et al.* (1955) in the bone marrow of a human patient and helped

to localize the metabolic lesion in the erythropoietic tissue. They also reported that the fluorescence was seen only in morphologically abnormal nucleated erythrocytes that contained abnormal nuclear inclusions. Similar nuclear abnormalities were observed in bovine CEP bone marrow (Watson *et al.*, 1959). Schmid *et al.* (1955) concluded that there were two populations of erythrocytes, one normal and one containing free porphyrins.

The presence of two populations of erythrocytes was reported in humans, but this was attributed to the intermittent hemolytic crises that occurred (Gray *et al.*, 1950). Runge and Watson (1969), who were studying fluorescing bovine CEP bone marrow cells after bleeding, also concluded that there was only a single population of erythrocytes in bovine CEP.

The hematology of newborn CEP calves also has striking differences from that of older CEP calves and cows (Kaneko and Mills, 1970). There is an intense erythrogenic response in the neonatal CEP calf, which persists for the first 3 weeks of life. Nucleated erythrocyte counts during the first 24 h of life ranged from 5000 to 63,500/ $\mu$ l. Reticulocyte counts were lower than expected (6.4%) and increased to a peak of only 12.5% at 4 days of age. The persistent reticulocytosis is thought to be due to a delay in maturation of the reticulocytes (Rudolph and Kaneko, 1971; Smith and Kaneko, 1966). This delay in maturation of the reticulocyte, which is proportional to the degree of anemia, is now a well-established phenomenon during the reticulocyte response to a blood loss or hemolytic anemia. In essence, this delay represents the increase in survival time of the reticulocyte beyond its normal 1-day survival time. This increased survival time is the now commonly used maturation correction factor (MCF) for estimating the reticulocyte production index (RPI) when evaluating the response to an anemia.

#### d. Mechanism of the Anemia

A responsive hemolytic anemia is a well-established occurrence in CEP. Erythrocyte porphyrins are high in CEP, and if these erythrocytes with high porphyrin concentrations were more susceptible to destruction, a shortening of their life span would be expected. Erythrocyte life span is shortened in bovine (Kaneko, 1963) and in human CEP (Gray *et al.*, 1950). There is general agreement that this shortening of life span is associated with the hemolytic process, but the mechanism of the hemolysis remains obscure. It has been shown that erythrocyte survival in bovine CEP is inversely correlated with erythrocyte coproporphyrin concentration (Kaneko *et al.*, 1971). The shortest erythrocyte survival time of 27 days (normal = 150 days) was associated with the highest erythrocyte coproporphyrin concentration. The porphyrins through their lipid solubility are presumed to damage the erythrocyte membrane

leading to the hemolysis. *In vivo*  $^{59}\text{Fe}$  metabolic studies were completely compatible with a hemolytic type of anemia, and ineffective erythropoiesis (i.e., bone marrow hemolysis) was also demonstrated (Kaneko, 1963; Kaneko and Mattheeuws, 1966). Plasma iron turnover and transfer rates, erythrocyte iron uptake, and organ uptakes were increased as expected in a hemolytic process.

The mechanism of cell damage has also been studied in reticulocytes and in nucleated erythrocytes. A biochemical defect in the bovine CEP reticulocyte *in vitro* was expressed as an increase in porphyrin synthesis, a marked decrease in heme synthesis and a delay in the maturation time of the reticulocyte (Smith and Kaneko, 1966). The  $T_{1/2}$  for the maturation of the reticulocyte was 50 h compared to a normal of 3 to 10 h. This delay in reticulocyte maturation is thought to be the direct result of the defect in heme synthesis, because the rate of heme synthesis controls the rate of maturation of the reticulocyte (Schulman, 1968). This means that there is an increase in the reticulocyte survival time inversely proportional to the degree of anemia.

A similar delay in the maturation of the metarubricyte to the reticulocyte was observed in the bone marrow cells of CEP cows (Rudolph and Kaneko, 1971), but there was no effect on the earlier stages of nucleated erythrocytes. Therefore, the more mature erythrocytic cells are the cells most affected by the high porphyrin content. This is not surprising because heme and hemoglobin synthesis are most active in the later stages of erythrocytic cell development. Ultimately, the accumulation of porphyrins in these cells, whether in bone marrow or in blood, induces hemolysis. Upon exposure of surface capillaries to sunlight, photohemolysis of the type observed in erythropoietic protoporphyria (Harber *et al.*, 1964) would further aggravate the hemolysis.

This hemolytic mechanism might also explain the striking erythrogenic response seen in the neonatal porphyric calf. Because most of the porphyrins are within the fetal erythrocytes and these would not normally cross the placenta, the porphyrin containing erythrocytes would accumulate in the fetus and a profound hemolysis would occur *in utero*. This hemolysis in turn would induce a marked erythrogenic response in the fetus, and this is observed at birth. At birth, porphyrins are high, but they fall to their steady state level in about 3 weeks in CEP calves. This is comparable to the rate of clearance of  $^{14}\text{C}$ -porphyrin into urine, which fell to 0.1% of the initial concentration in 3 weeks. Furthermore, 3 weeks is also the time at which the erythrogenic response is stabilized at a steady state level in the neonatal calf (Kaneko and Mills, 1970).

In summary, as a result of the heme synthetic defect in erythropoietic porphyria, there is excess porphyrin accumulation in the mature and developing erythrocytes, which induces their hemolysis in the circulation or in the bone marrow. There is a corresponding shortening of erythrocyte

life span. In addition, the decrease in heme synthesis induces an increase in the survival time of the reticulocyte by inhibiting the maturation of the developing erythrocytes, which further aggravates the anemia. This biochemical defect in heme synthesis is morphologically expressed in the fluorocytes and in the evidence of erythrocytic response in the blood and bone marrow, the degree of which is directly related to the severity of the enzymatic defect of the porphyria.

#### e. Detection of the Carrier State

Bovine CEP is inherited as an autosomal recessive trait. Previously, carrier animals were detectable only by the occurrence of the disease in their progeny. Levin (1968a) developed an assay for UROgenIII-Cosyn and found that its activity was considerably less in CEP cattle than in normals (Levin, 1968b). Heterozygous cattle, which are the clinically unaffected carriers of the porphyria gene, had UROgenIII-Cosyn activities intermediate between porphyrics and normals (Romeo *et al.*, 1970). Similarly low UROgenIII-Cosyn activity is found in human CEP, but carriers are less readily detectable in humans than in cattle (Romeo and Levin, 1969). These findings are also in keeping with the concept that the genetic defect in CEP is a deficiency of UROgenIII-Cosyn. Romeo (1977) has reviewed the genetic aspects of all forms of hereditary porphyrias and determined that the evidence is conclusive for a UROgenIII-Cosyn deficiency in CEP.

#### f. Metabolic Basis of Bovine Congenital Erythropoietic Porphyria

The mechanisms for heme biosynthesis and the biochemical nature of the porphyrins in the tissues and excreta provide an explanation for the metabolic defect in CEP. Certain features of the biosynthetic mechanism are particularly important in an explanation of the clinical and metabolic manifestations of CEP, which has its ultimate pathogenesis in a hereditary deficiency of UROgenIII-Cosyn. These may be summarized as follows:

1. There is a compartmentation of the enzymes of heme biosynthesis between the mitochondria and the cytosol.
2. Mitochondrial systems are involved in the synthesis of ALA, PROTO IX, and heme.
3. Cytosolic systems catalyze the formation of PBG, UROgenIII or I, and COPROgenIII or I.
4. Mitochondria are present only in the immature nucleated erythropoietic cells and in the reticulocytes. Mitochondria are not present in the mature erythrocyte. The most active heme and hemoglobin synthesis occurs in the metarubricyte and secondly in the reticulocyte.
5. There is no heme or hemoglobin synthesis in the mature erythrocyte.

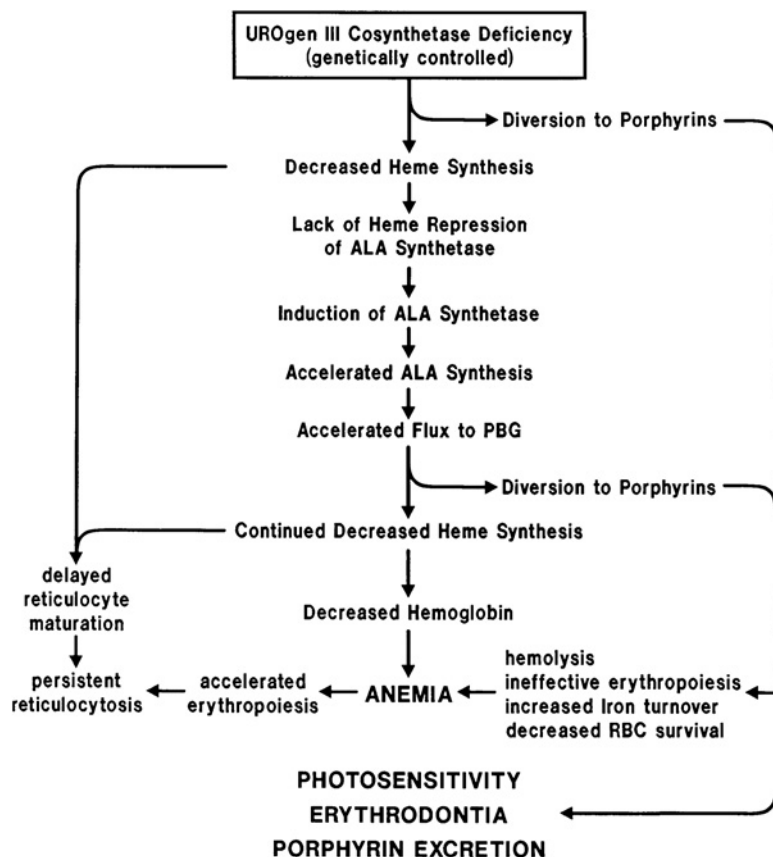
The enzymatic deficiency in CEP is localized in the erythropoietic tissue within the developing erythropoietic cells, which are the mitochondria-containing cells. Normally, the combined action of UROgenI-Syn and UROgenIII-Cosyn catalyzes the formation of the normal type III porphyrin isomer, UROgenIII leading to the formation of heme. In the absence of UROgenIII-Cosyn, the type I isomer, UROgenI, and then COPROgenI are formed. Thus, the relative activities of these enzymes govern the extent as to which of these pathways is traversed. The type I isomers that are formed in the deficiency state cannot be converted into PROTOgenI and thus into a type I heme. This is because there is no coproporphyrinogen I oxidase and the COPROgenIII-Ox is highly specific only for the type III isomer. The type UROgenI and COPROgenI isomers are oxidized to their corresponding uroporphyrins and coproporphyrins. These oxidized free porphyrins accumulate in the erythropoietic tissues, developing erythrocytic cells, and in the mature erythrocytes where they induce the hemolysis characteristic of CEP. In addition, the porphyrins are released into the circulation and are widely distributed throughout the body in all body fluids and are readily excreted in the feces and urine. They are deposited in all tissues, most notably in the teeth, bones, and skin. When exposed to ultraviolet light, the porphyrins in the skin are excited by absorption of the ultraviolet light energy into an unstable higher-level energy state. The excitation energy is then emitted when the excited molecule returns to its ground state. The energy can be emitted as fluorescence or transferred to molecular oxygen to form singlet oxygen. Singlet oxygen is a powerful oxidant for many forms of biologically important compounds including the peroxidation of membrane lipids, membrane and cellular proteins, cell enzymes, and cell organelles. Peroxidation appears to be the primary event in the photosensitivity and photodermatitis seen in the porphyrias (Poh-Fitzpatrick, 1982).

Total deficiency of UROgenIII-Cosyn is obviously incompatible with life so that surviving cases of CEP have only a partial deficiency of UROgenIII-Cosyn. Also, there is a wide variation in the severity of the disease commensurate with the degree of the enzyme deficiency as well as with the conditions of husbandry. The severity of the disease, however, is constant in each bovine if it is kept under standard controlled conditions. The metabolic basis for bovine CEP is summarized in Figure 8-4, in which the central theme is the genetically controlled UROgenIII-Cosyn deficiency with the resultant type I porphyrin accumulation and a failure of heme synthesis.

#### 2. Bovine Erythropoietic Protoporphyrin

This disorder of porphyrin metabolism occurs in humans and in cattle. Erythropoietic protoporphyria (EPP) was first reported by Magnus *et al.* (1961), and is now well





**FIGURE 8-6** Metabolic basis of bovine congenital erythropoietic porphyria. The fundamental defect is a deficiency of UROgenIII-Cosyn leading to the accumulation of type I uroporphyrins and coproporphyrins. These type I porphyrins account for the clinical, hematological, and biochemical features of this disease.

recognized in humans (Harber *et al.*, 1964; Redeker *et al.*, 1963). It is inherited as a dominant autosomal trait (Romeo, 1977). Patients do not have the major signs of CEP such as anemia, porphyrinuria, or discolored teeth. Photosensitivity of the skin is the only significant clinical manifestation of the disease, and this is associated with a high plasma protoporphyrin concentration. In the laboratory, the most striking findings are the high concentrations of PROTO IX in the erythrocytes and feces.

In cattle, EPP is inherited as an autosomal recessive trait in contrast to humans and may be sex linked because to date it has only been seen in females. The photosensitivity also seems to diminish in adult life. Affected cattle also do not have anemia, porphyrinuria, or discoloration of the teeth. Erythrocyte and fecal protoporphyrins are very high in comparison to normal cows (Ruth *et al.*, 1977).

The fundamental enzymatic defect in bovine EPP is a deficiency of ferrochelatase (FER-Ch) (Ruth *et al.*, 1977), which results in the accumulation of PROTO IX. Low FER-Ch was found in all tissues of EPP calves so that the defect is a total body defect.

### 3. Porphyrin of Swine

Porphyria in swine was first recognized in New Zealand by Clare and Stephens (1944) and later in Denmark

(Jorgensen and With, 1955). Porphyria in swine is inherited as a simple autosomal dominant trait. Except for the very severe cases, there appears to be little or no effect on the general health of the pig. Photosensitivity is not seen even in the white pigs. The predominant feature in the affected pig is a characteristic reddish discoloration of the teeth, which fluoresces on exposure to ultraviolet light. Porphyrin deposition in the teeth of the newborn pig is virtually pathognomonic of porphyria in swine. Occasionally, darkly discolored teeth may not fluoresce, but porphyrins may be extracted from these teeth with 0.5N HCl (With, 1955). Similar, though less apparent, deposition occurs in the bones. The porphyrins are principally URO I and have been found in concentrations of up to 200 $\mu\text{g/g}$  of teeth or bones. The liver, spleen, lungs, kidneys, bones, and teeth are also discolored by another dark pigment, the nature of which is unknown.

The urine of the affected pig is discolored only in the more severely affected pig. The 24-h urinary excretion of uroporphyrins ranged between 100 and 10,000 $\mu\text{g}$  and for coproporphyrin, only 50 $\mu\text{g}$ . These were both the type I isomers. PBG is absent in the urine. Close similarities in this pattern of porphyrin excretion to that found in bovine CEP are apparent, but the localization of the defect in the erythropoietic tissue has not been established. This disease has not been observed in pigs since the original occurrences.

#### 4. *Porphyria of Cats*

Porphyria in cats was first reported in a male kitten (Tobias, 1964). One of its three littermates and kittens from a previous litter were also reported to have had the same unusually discolored teeth. The kitten's teeth were brown and fluoresced red under ultraviolet light. Its urine was amber colored and was qualitatively positive for uroporphyrin, coproporphyrin, and porphobilinogen. There was no evidence of anemia or photosensitization. These cats had been kept indoors all their lives. One of these cats was the propositus for a porphyric cat colony (Glenn *et al.*, 1968). The inheritance of the porphyria in these cats is a simple autosomal dominant trait analogous to that seen in swine.

Detailed studies of the porphyria in a family of Siamese cats has been reported (Giddens *et al.*, 1975) in which excessive accumulation of URO I, COPRO I, and PROTO IX were observed in erythrocytes, urine, feces, and tissues. These cats had photosensitivity, severe anemia, and severe renal disease. The researchers concluded that the principal defect in these cats was a deficiency of UROgenIII-Cosyn similar to CEP of humans and cows.

#### 5. *Normal Porphyrrias*

All fox squirrels (*Sciurus niger*) have red bones caused by the accumulation of URO I and COPRO I (Flyger and Levin, 1977). The fox squirrel porphyria resembles the CEP of humans, cows, and cats by having a deficiency of UROgenIII-Cosyn, type I porphyrins in their urine and feces, and discolored bones, teeth, and tissues, which fluoresce on exposure to ultraviolet light. There is increased erythropoiesis but no apparent hemolytic anemia, no photosensitivity, or any other clinically deleterious effects. These relatively benign effects are most likely due to their thick hair coats and nocturnal living habits. It is interesting that an enzyme deficiency with serious health effects in other animals should have evolved as a "normal" characteristic in the fox squirrel. This is understandable when one appreciates that CEP cattle always kept indoors and protected from sunlight tend to thrive and reproduce normally.

The UROgenIII-Cosyn deficiency is found only in the fox squirrel and not in the closely related gray squirrel (*Sciurus carolinensis*). Urine porphyrin excretion in the fox squirrel is 10-fold greater than in the gray squirrel and is markedly increased when erythropoiesis is stimulated by bleeding. The UROgenIII-Cosyn of fox squirrel erythrocytes is very heat sensitive, and this may indicate that its CEP is due to an increased lability of the enzyme.

In the feathers of certain brightly colored birds (e.g., Touracos and in certain lower animals and microorganisms), porphyrins accumulate but these appear to be normal phenomena.

### C. *Hepatic Porphyrrias*

This group of diseases is seen only in humans as naturally occurring diseases. They constitute the most common group of porphyrias seen in humans. The salient features of this group of porphyrias are also summarized in Table 8.2. As the name of this group implies, the predominant site of the metabolic defect is localized in the liver, and the group is further subdivided on the bases of their principal clinical manifestations. Specific enzyme deficiencies have been identified for all forms of hereditary porphyria (Table 8.2). As mentioned earlier, their genetic heterogeneity accounts for the wide variety of symptoms.

#### 1. *δ-Amino-Levulinic Acid Dehydratase Porphyria*

This rare hepatic form of porphyria has a marked deficiency of the enzyme  $\delta$ -amino-levulinic acid dehydratase (ALA-D) in the homozygous state (Brandt and Doss, 1981; Doss *et al.*, 1979) and is referred to as ALA-D porphyria (ADP). It is characterized by neurological symptoms without skin photosensitivity. It is inherited as an autosomal recessive trait. A similar though less marked ALA-D deficiency that was without symptoms was reported (Bird *et al.*, 1979), and this is thought to be the heterozygous state of the deficiency.

#### 2. *Acute Intermittent Porphyria*

Acute intermittent porphyria (AIP) is a common form in humans characterized by acute abdominal pain and neurological symptoms. Photosensitivity is not a feature of this form. Most patients are not clinically affected unless some form of aggravating factor is present. The attacks are precipitated by a large number of causative factors, the principal ones being barbiturates, sulfonamides, estrogens, and alcohol. The disease occurs more commonly in the adult female than in the male. The principal urinary finding is the excretion of large amounts of ALA and PBG. This is in keeping with the hereditary deficiency of UROgenI-Syn (PBG-D) in this disease (Strand *et al.*, 1970). AIP is the major autosomal dominant form of hepatic porphyria.

#### 3. *Porphyria Cutanea Tarda*

Porphyria cutanea tarda (PCT) is caused by a deficiency of UROgen-D and presents as both a sporadic form and a familial form. The sporadic form is the acquired form of PCT and is the most common of all forms of human porphyria. The familial form is inherited as an autosomal dominant. As the name implies, the characteristic clinical signs of PCT are the photosensitive lesions of the skin. The disease occurs in mid to late adult life and common precipitating causes of this disease are alcohol and

estrogens. The disease can be successfully treated by the avoidance of alcohol and estrogens. There is a decrease in hepatic UROgen-D in both forms, but the enzyme deficiency is found in extrahepatic tissues only in the familial form (Pimstone, 1982). In the sporadic form, erythrocyte UROgen-D activity is normal, whereas in the familial form, erythrocyte UROgen-D is less than 50% of normal (McManus *et al.*, 1988). The erythrocyte UROgen-D assay is difficult and not readily available, therefore indirect means of distinguishing the sporadic form from the familial are used. One of the most simple, indirect methods has been to assay the plasma  $\gamma$ -glutamyltransferase activity (GGT). Sporadic PCT has a significant increase in GGT, whereas the familial form has normal GGT activity (Badcock *et al.*, 1993). Furthermore, the ratio of fecal COPRO III:COPRO I when combined with the plasma GGT was found to give an even more accurate differentiation of the sporadic form from the familial form (Badcock *et al.*, 1995).

#### 4. Hepatoerythropoietic Porphyrria

Hepatoerythropoietic porphyria (HEP) is a form that clinically resembles congenital erythropoietic porphyria (CEP), but there is a severe deficiency of UROgen-D as in PCT. It is thought to be the homozygous form of familial PCT. HEP is characterized by a severe photosensitivity, but there is no liver involvement.

#### 5. Harderoporphyria

This is a rare form of porphyria in which the propionate group on the A ring only is converted to a vinyl group. The normal next step of B ring conversion is somehow disrupted. There is a deficiency of COPROgenIII-Ox, but the mechanism explaining why the groups on both rings are not oxidized is unknown.

#### 6. Hereditary Coproporphyrria

Hereditary coproporphyrria (HCP) is clinically similar to PCT with a mild cutaneous photosensitivity, and it may also have neurological symptoms as in AIP. Like AIP, HCP is commonly precipitated by drugs and alcohol. As in harderoporphyria, COPROgenIII-Ox is the deficient enzyme.

#### 7. Variegate Porphyrria

The symptoms of variegate porphyria (VP) are generally more variable than the other forms but in most cases, acute abdominal pain and photosensitivity are seen. VP is most common among the South African white population. VP is inherited as an autosomal dominant. There is a deficiency of PROTOgenIII-Ox, which can be observed in

cultured fibroblasts and in leukocytes of VP patients. Hift *et al.* (2004) found plasma fluorescence scanning to be a more sensitive and specific test for VP than fecal porphyrin analysis.

### D. Porphyrinurias (Acquired Toxic Porphyrrias)

#### 1. Chemical Porphyrinurias

The two major forms of the porphyrinurias are those due to organic chemical intoxication and to heavy metal poisonings, mainly lead. Experimentally, hexachlorobenzene (HCB) (Elder *et al.*, 1976), 2,3,7,8-tetrachlorodibenzo-p-dioxin (TCDD) (Elder and Sheppard, 1982), allylisopropylacetylcarbamide (Sedormid) (Schmid and Schwartz, 1952), or dihydrocollidine (DHC) (Granick and Urata, 1963) has been used to produce the hepatic forms of porphyria.

#### 2. Lead Poisoning

Lead poisoning occurs in all domestic animals and is a significant clinical problem, particularly in the dog. In the dog as in other animals, the principal clinical features are related to the gastrointestinal and the nervous systems. Anemia is usually seen only in the long-standing chronic lead toxicities. The anemia has certain features that suggest lead poisoning but are not diagnostic. The anemia is a mild to moderate normocytic normochromic anemia with basophilic stippling and nucleated erythrocytes (NRBC) out of proportion to the degree of anemia. Zook *et al.* (1970) considered that >15 stippled cells per 10,000 erythrocytes is suggestive of and that >40 stippled cells per 10,000 erythrocytes is diagnostic of lead poisoning in the dog. Stippling is thought to be accumulated ribosomal RNA aggregates that have not been normally degraded to their nucleotides and subsequently dephosphorylated by pyrimidine-5' nucleotidase (P5NT). Lead has been shown to decrease the activity of the dephosphorylating enzyme, P5NT in humans (Valentine *et al.*, 1976) and in calves (George and Duncan, 1982).

Lead is known to have widespread toxic effects on sulfhydryl-, carboxyl-, and imidazole-containing proteins that would include enzymes, cell proteins, globins, and membrane proteins (Fell, 1984). However, only a few are altered specifically and significantly to be of diagnostic value. Globin synthesis and therefore hemoglobin synthesis is disrupted, and this is the major mechanism of the anemia of lead poisoning. The anemia, however, occurs late in chronic lead poisoning, and its nonspecific nature makes it of less diagnostic importance than is usually attributed to it.

A major focus is on the enzyme systems of heme synthesis because several of the enzymes are very sensitive in early exposure to small quantities of lead. The most sensitive are ALA-D and FER-Ch, and these enzymes and their accumulated substrates are widely used as screening tests

for lead exposure. Erythrocyte ALA-D is strongly inhibited by lead, and as a result, ALA rises in plasma and is excreted in the urine. Measurement of ALA is difficult, and the results lack sensitivity for low-level lead exposure; therefore, instead of its substrate ALA, erythrocyte ALA-D is more commonly assayed. Farant and Wigfield (1982), using the ratio of ALA-D activities assayed at two different pH's, demonstrated ALA-D inhibition at blood lead concentrations of 10 to 15  $\mu\text{g}/\text{dl}$  (0.50 to 0.70  $\mu\text{mol}/\text{l}$ ). They found this to be a highly sensitive and reliable index of the blood lead concentration.

Coproporphyrin also rises in plasma and is excreted in urine, and like ALA, it is also difficult to measure and lacks sensitivity. Hence, this method is not used as an index of lead poisoning.

FER-Ch is the second major enzyme that is strongly inhibited by lead, and as a result, PROTO IX accumulates in the erythrocytes. This PROTO IX is a zinc complexed PROTO IX instead of the "free" PROTO IX. Piomelli *et al.* (1982) found that erythrocyte zinc PROTO IX increased when blood lead concentrations were at 15 to 18  $\mu\text{g}/\text{dl}$  (0.75 to 0.85  $\mu\text{mol}/\text{l}$ ).

It is not quite as sensitive an index of blood lead concentration as ALA-D but is well below the diagnostic criteria for lead poisoning. George and Duncan (1981) found marked elevations in erythrocyte PROTO IX in experimental lead poisoning in calves. Modern fluorimeters specifically designed to measure porphyrins have greatly simplified the assay. For these reasons, the current test of choice to monitor lead exposure is the blood zinc PROTO IX concentration.

The final diagnosis of lead poisoning ultimately rests on the measurement of blood lead concentration, and this is best done using flame atomic absorption spectrophotometry. In children, a blood lead concentration of <30  $\mu\text{g}/\text{dl}$  (1.45  $\mu\text{mol}/\text{l}$ ) is currently regarded as normal, but it has been shown that zinc PROTO IX rises at blood lead levels of half that amount (Piomelli *et al.*, 1982). It is clear that the heme synthetic pathway is affected at blood lead concentrations well below that considered normal. Zook *et al.* (1970) reported a normal range for blood lead in the dog of 10 to 50  $\mu\text{g}/\text{dl}$  (0.48 to 2.41  $\mu\text{mol}/\text{l}$ ) and considered a blood lead concentration of >60  $\mu\text{g}/\text{dl}$  (2.90  $\mu\text{mol}/\text{l}$ ) diagnostic of lead poisoning. In the domestic rabbit, the blood lead concentration is reported to be 2 to 27  $\mu\text{g}/\text{dl}$  (0.10 to 1.30  $\mu\text{mol}/\text{l}$ ) (Gerken and Swartout, 1986). Therefore, lead concentrations of >30  $\mu\text{g}/\text{dl}$  (1.45  $\mu\text{mol}/\text{l}$ ) are considered diagnostic of lead poisoning in the dog and in all animals.

## REFERENCES

- Altland, P. D., and Brace, K. C. (1956). Life span of duck and chicken erythrocytes as determined with C14. *Proc. Soc. Exp. Biol. Med.* **92**, 615–617.
- Amoroso, E. C., Loosmore, R. M., Rimington, C., and Tooth, B. E. (1957). Congenital porphyria in bovines: first living cases in Britain. *Nature (London)* **180**, 230–231.
- Badcock, N. R., O'Reilly, D. A., Zoanetti, G. D., Robertson, E. F., and Parker, C. J. (1993). Childhood porphyrias: implications and treatments. *Clin. Chem.* **39**, 1334–1340.
- Badcock, N. R., Szep, D. A., Zoanetti, G. D., and Lewis, B. D. (1995). Fecal coproporphyrin isomers in sporadic and familial porphyria cutanea tarda. *Clin. Chem.* **41**, 1315–1317.
- Berlin, N. I., Beechmans, M., Elmlinger, P. J., and Lawrence, J. H. (1957). A comparative study of the Ashby differential agglutination: carbon 14 and iron 59 methods for the determination of red cell life span. *J. Lab. Clin. Med.* **50**, 558–569.
- Berlin, N. I., and Lotz, C. I. (1951). Life span of the red blood cell of the rat following acute hemorrhage. *Proc. Soc. Exp. Biol. Med.* **78**, 788–790.
- Berlin, N. I., Meyer, L. M., and Lazarus, M. (1951). Life span of the rat red blood cell as determined by glycine-2-C14. *Am. J. Physiol.* **165**, 465–467.
- Bird, T. D., Hamernyik, P., Butter, J. Y., and Labbe, R. F. (1979). Inherited deficiency of delta-aminolevulinic acid dehydratase. *Am. J. Hum. Gen.* **31**, 662–668.
- Brandt, A., and Doss, M. (1981). Hereditary porphobilinogen synthase deficiency in human associated with acute hepatic porphyria. *Hum. Genet.* **58**, 194–197.
- Brown, I. W. J., and Eadie, G. S. (1953). An analytical study of in vivo survival of limited populations of animal red blood cells tagged with radio-iron. *J. Gen. Physiol.* **36**, 327–343.
- Burwell, E. L., Brickley, B. A., and Finch, C. A. (1953). Erythrocyte life span in animals: comparison of two in vivo methods employing radioiron. *Am. J. Physiol.* **172**, 18–24.
- Bush, J. A., Berlin, N. I., Jensen, W. N., Brill, A. B., Cartwright, G. E., and Wintrobe, M. M. (1955). Erythrocyte life span in growing swine as determined by glycine-2-C14. *J. Exp. Med.* **101**, 451–459.
- Cartwright, G. E., and Wintrobe, M. M. (1948). Studies on free erythrocyte protoporphyrin, plasma copper, and plasma iron in normal and pyridoxine deficient swine. *J. Biol. Chem.* **172**, 557–565.
- Clare, H. T., and Stephens, E. H. (1944). Congenital porphyria in pigs. *Nature (London)* **153**, 252–253.
- Cline, H. T., and Berlin, N. I. (1963). Erythropoiesis and red cell survival in the hypothyroid dog. *Am. J. Physiol.* **204**, 415–418.
- Cookson, G. H., and Rimington, C. (1953). Porphobilinogen; chemical constitution. *Nature (London)* **171**, 875–876.
- Cornelius, C. E., and Kaneko, J. J. (1962). Erythrocyte life span in the guanaco. *Science* **137**, 673–674.
- Cornelius, C. E., Kaneko, J. J., and Benson, D. C. (1959). Erythrocyte survival studies in the mule deer, aoudad sheep, and springbok antelope using glycine-2-C14. *Am. J. Vet. Res.* **20**, 917–920.
- Cornelius, C. E., Kaneko, J. J., Benson, D. C., and Wheat, J. D. (1960). Erythrocyte survival studies in the horse using glycine-2-C14. *Am. J. Vet. Res.* **21**, 1123–1124.
- Doss, M., von Tiepermann, R., Schneider, J., and Schmid, H. (1979). New type of hepatic porphyria with porphobilinogen synthase defect and intermittent acute clinical manifestation. *Klin. Wochenschr.* **57**, 1123–1127.
- Elder, G. H., Evans, J. O., and Matlin, S. A. (1976). The effect of the porphyrinogenic compound, hexachlorobenzene, on the activity of uroporphyrinogen decarboxylase in the rat. *Clin. Sci. Mol. Med.* **51**, 71–80.
- Elder, G. H., and Sheppard, D. M. (1982). Immunoreactive uroporphyrinogen decarboxylase is unchanged in porphyria caused by TCDD

- and hexachlorobenzene. *Biochem. Biophys. Res. Commun.* **109**, 113–120.
- Everett, N. B., and Yoffey, J. M. (1959). Life of guinea pig circulating erythrocyte and its relation to erythrocyte population of bone marrow. *Proc. Soc. Exp. Biol. Med.* **101**, 318–319.
- Farant, J. P., and Wigfield, D. C. (1982). Biomonitoring lead exposure with delta-aminolevulinic acid dehydratase (ALA-D) activity ratios. *Int. Arch. Occup. Environ. Health.* **51**, 15–24.
- Fell, G. S. (1984). Lead toxicity: problems of definition and laboratory evaluation. *Ann. Clin. Biochem.* **21**, 453–460.
- Finch, C. A., Wolff, J. A., Rath, C. E., and Fluharty, R. G. (1949). Iron metabolism: erythrocyte iron turnover. *J. Lab. Clin. Med.* **34**, 1480–1490.
- Flyger, V., and Levin, E. Y. (1977). Animal model: normal porphyria of fox squirrels (*Sciurus niger*). *Am. J. Pathol.* **87**, 269–272.
- George, J. W., and Duncan, J. R. (1981). Erythrocyte protoporphyrin in experimental chronic lead poisoning in calves. *Am. J. Vet. Res.* **42**, 1630–1637.
- George, J. W., and Duncan, J. R. (1982). Pyrimidine-specific 5' nucleotidase activity in bovine erythrocytes: effect of phlebotomy and lead poisoning. *Am. J. Vet. Res.* **43**, 17–20.
- Gerken, D. F., and Swartout, M. S. (1986). Blood lead concentrations in rabbits. *Am. J. Vet. Res.* **47**, 2674–2675.
- Gibson, K. D., Laver, W. G., and Neuberger, A. (1958). Initial stages in the biosynthesis of porphyrins. 2. The formation of delta-aminolevulinic acid from glycine and succinyl-coenzyme A by particles from chicken erythrocytes. *Biochem. J.* **70**, 71–81.
- Giddens, W. E., Jr, Labbe, R. F., Swango, L. J., and Padgett, G. A. (1975). Feline congenital erythropoietic porphyria associated with severe anemia and renal disease: clinical, morphologic, and biochemical studies. *Am. J. Pathol.* **80**, 367–386.
- Glenn, B. L., Glenn, H. G., and Omtvedt, I. T. (1968). Congenital porphyria in the domestic cat (*Felis catus*): preliminary investigation on inheritance pattern. *Am. J. Vet. Res.* **29**, 1653–1657.
- Gower, D. B., and Davidson, W. M. (1963). The mechanism of immune hemolysis. I. The relationship of age of destruction of red cells to their ages following the administration to rabbits of immune haemolysin. *Brit. J. Haematol.* **9**, 132–140.
- Granick, S., and Levere, R. D. (1964). Heme synthesis in erythroid cells. *Prog. Hematol.* **27**, 1–47.
- Granick, S. (1966). The induction in vitro of the synthesis of delta-aminolevulinic acid synthetase in chemical porphyria: a response to certain drugs, sex hormones, and foreign chemicals. *J. Biol. Chem.* **241**, 1359–1375.
- Granick, S., and Urata, G. (1963). Increase in activity of alpha-aminolevulinic acid synthetase in liver mitochondria induced by feeding of 3,5-dicarboxy-1,4-dihydrocollidine. *J. Biol. Chem.* **238**, 821–827.
- Gray, C. H., Muir, I. M. H., and Neuberger, A. (1950). Studies in congenital porphyria. 3. The incorporation of <sup>15</sup>N into the haem and glycine of haemoglobin. *Biochem. J.* **47**, 542–548.
- Harber, L. C., Fleischer, A. S., and Baer, R. L. (1964). Erythropoietic protoporphyria and photohemolysis. *J. Am. Med. Assoc.* **189**, 191–194.
- Hift, R. J., Davidson, B. P., Van der Hoof, C., Meissner, D. M., and Meissner, P. N. (2004). Plasma fluorescence scanning and fecal porphyrin analysis for the diagnosis of variegate porphyria: precise determination of sensitivity and specificity with detection of protoporphyrinogen oxidase mutations as a reference standard. *Clin. Chem.* **50**, 915–923.
- Hindmarsh, J. T. (1986). The porphyrias: recent advances. *Clin. Chem.* **32**, 1255–1263.
- Hindmarsh, J. T., Oliveras, L., and Greenway, D. C. (1999). Plasma porphyrins in the porphyrias. *Clin. Chem.* **45**, 1070–1076.
- Jensen, W. N., Bush, J. A., Ashenbrucker, H., Cartwright, G. E., and Wintrobe, M. M. (1956). The kinetics of iron metabolism in normal growing swine. *J. Exp. Med.* **103**, 145–159.
- Jorgensen, S. K. (1961). Studies in congenital porphyria in cattle in Denmark. II. Clinical features, morbid anatomy, and chemical pathology. *Brit. Vet. J.* **117**, 61–73.
- Jorgensen, S. K., and With, T. K. (1955). Congenital porphyria in swine and cattle in Denmark. *Nature (London)* **176**, 156–158.
- Kaneko, J. J. (1963). Erythrokinetics and iron metabolism in bovine porphyria erythropoietica. *Ann. NY Acad. Sci.* **104**, 689–700.
- Kaneko, J. J., and Cornelius, C. E. (1962). Erythrocyte survival studies in the Himalayan tahr and domestic goats. *Am. J. Vet. Res.* **23**, 913–915.
- Kaneko, J. J., Cornelius, C. E., and Heuschele, W. P. (1961). Erythrocyte survival studies in domestic and bighorn sheep, using glycine-2-C14. *Am. J. Vet. Res.* **22**, 683–685.
- Kaneko, J. J., Green, R. A., and Mia, A. S. (1966). Erythrocyte survival in the cat as determined by glycine-2-C14. *Proc. Soc. Exp. Biol. Med.* **123**, 783–784.
- Kaneko, J. J., and Mattheeuws, D. R. G. (1966). Iron metabolism in normal and porphyric calves. *Am. J. Vet. Res.* **27**, 923–929.
- Kaneko, J. J., and Mills, R. (1970). Hematological and biochemical observations in neonatal and porphyric and normal calves in early life. *Cornell Vet.* **60**, 52–60.
- Kaneko, J. J., Zinkl, J. G., and Keeton, K. S. (1971). Erythrocyte porphyrin and erythrocyte survival in bovine erythropoietic porphyria. *Am. J. Vet. Res.* **32**, 1981–1985.
- Kikuchi, G., Kumar, A., Talmage, P., and Shemin, D. (1958). The enzymatic synthesis of delta-aminolevulinic acid. *J. Biol. Chem.* **233**, 1214–1219.
- Labbe, R. F., and Hubbard, H. (1961). Metal specificity of the iron-protoporphyrin chelating enzyme from rat liver. *Biochim. Biophys. Acta* **52**, 130–135.
- Levin, E. Y. (1968a). Uroporphyrinogen 3 cosynthetase from mouse spleen. *Biochemistry* **7**, 3781–3788.
- Levin, E. Y. (1968b). Uroporphyrinogen 3 cosynthetase in bovine erythropoietic porphyria. *Science* **161**, 907–908.
- Levin, E. Y., and Coleman, D. L. (1967). Enzymatic conversion of porphobilinogen to uroporphyrinogen catalyzed by extracts of hematopoietic mouse spleen. *J. Biol. Chem.* **242**, 4247–4253.
- Liddle, C. G., Putnam, J. P., Berman, E., and Fisher, H. (1984). A comparison of chromium-51 and iron-59 for estimating erythrocyte survival in the cat. *Lab. Anim. Sci.* **34**, 365–370.
- Magnus, I. A., Jarrett, A., Pranker, T. A. J., and Rimington, C. (1961). Erythropoietic protoporphyria: a new porphyria syndrome with solar urticaria due to protoporphyrinaemia. *Lancet* **2**, 448–451.
- McManus, J., Blake, D., and Ratnaike, S. (1988). An assay of uroporphyrinogen decarboxylase in erythrocytes. *Clin. Chem.* **34**, 2355–2357.
- Nestel, B. L. (1958). Bovine congenital porphyria (pink tooth), with a note on five cases observed in Jamaica. *Cornell Vet.* **48**, 430–439.
- Neuberger, A., and Niven, J. S. F. (1951). Haemoglobin formation in rabbits. *J. Physiol.* **112**, 292–310.
- Pimstone, N. R. (1982). Porphyria cutanea tarda. *Sem. in Liver Dis.* **11**, 132–142.
- Piomelli, S., Seaman, C., Zullo, D., Curran, A., and Davidow, B. (1982). Threshold for lead damage to heme synthesis in urban children. *Proc. Natl. Acad. Sci. USA* **79**, 3335–3339.

- Poh-Fitzpatrick, M. B. (1982). Pathogenesis and treatment of photo-cutaneous manifestations of the porphyrias. *Sem. in Liver Dis.* **2**, 164–176.
- Redeker, A. G., Bronow, R. S., and Sterling, R. E. (1963). Erythropoietic protoporphyria. *S. Afr. J. Lab. Clin. Med.* **14**, 235–238.
- Rhode, E. A., and Cornelius, C. E. (1958). Congenital porphyria (pink tooth) in Holstein Fresian calves in California. *J. Am. Vet. Med. Assoc.* **132**, 112–116.
- Romeo, E. Y., and Levin, E. Y. (1969). Uroporphyrinogen 3 cosynthetase in human congenital erythropoietic porphyria. *Proc. Natl. Acad. Sci. USA* **63**, 856–863.
- Romeo, G. (1977). Enzymatic defects of hereditary porphyrias: an explanation of dominance at the molecular level. *Hum. Genet.* **39**, 261–276.
- Romeo, G., Glenn, B. C., and Levin, E. Y. (1970). Uroporphyrinogen 3 cosynthetase in asymptomatic carriers of congenital erythropoietic porphyria. *Biochem. Genet.* **4**, 719–726.
- Rudolph, W. G., and Kaneko, J. J. (1971). Kinetics of erythroid bone marrow cells of normal and porphyric calves in vitro. *Acta Haematol.* **45**, 330–335.
- Runge, W., and Watson, C. J. (1969). The effect of bleeding on the proportion of red fluorescing forms among the total normoblasts of bovine protoporphyric bone marrow. *Blood* **33**, 119–123.
- Ruth, G. R., Schwartz, S., and Stephenson, B. (1977). Bovine protoporphyria: the first nonhuman model of this hereditary photosensitizing disease. *Science* **198**, 199–201.
- Sano, S., and Granick, S. (1961). Mitochondrial coproporphyrinogen oxidase and protoporphyria formation. *J. Biol. Chem.* **236**, 1173–1180.
- Sassa, S. (2006). Modern diagnosis and management of the porphyrias. *Br. J. Haematol.* **135**, 281–292.
- Sassa, S., and Kappas, A. (2000). Molecular aspects of the inherited porphyrias. *J. Intern. Med.* **247**, 169–178.
- Schmid, R., and Schwartz, S. (1952). Experimental porphyria. III. Hepatic type produced by sedormid. *Proc. Soc. Exp. Biol. Med.* **81**, 685–689.
- Schmid, R., Hanson, B., and Schwartz, S. (1952). Experimental porphyria. I. Isolation of uroporphyrin I from bone marrow of lead poisoned rabbits. *Proc. Soc. Exp. Biol. Med.* **79**, 459–462.
- Schmid, R., Schwartz, S., and Sundberg, R. D. (1955). Erythropoietic (congenital) porphyria: a rare abnormality of the normoblasts. *Blood* **10**, 416–428.
- Schulman, H. M. (1968). Hemoglobin synthesis during rabbit reticulocyte maturation in vitro. *Biochim. Biophys. Acta* **155**, 253–261.
- Schwartz, S., Berg, M. H., Bossenmaier, I., and Dinsmore, H. (1960). Determination of porphyrins in biological materials. *Methods Biochem. Anal.* **8**, 221–293.
- Schwartz, S., Keprios, M., and Schmid, R. (1952). Experimental porphyria. II. Type produced by lead, phenylhydrazine and light. *Proc. Soc. Exp. Biol. Med.* **79**, 463–468.
- Shemin, D., and Rittenberg, D. (1946b). The life span of the human red blood cell. *J. Biol. Chem.* **166**, 536–627.
- Smith, J. E., and Kaneko, J. J. (1966). Rate of heme and porphyrin synthesis by bovine porphyric reticulocytes in vitro. *Am. J. Vet. Res.* **27**, 931–940.
- Strand, L. J., Felsher, B. F., Redeker, A. G., and Marver, H. S. (1970). Heme synthesis in intermittent acute porphyria: decreased hepatic conversion of porphobilinogen to porphyrins and increased delta-aminolevulinic acid synthetase activity. *Proc. Natl. Acad. Sci. USA* **67**, 1315–1320.
- Tobias, G. (1964). Congenital porphyria in a cat. *J. Am. Vet. Med. Assoc.* **145**, 462–463.
- Tucker, E. M. (1966). The life span and other physiological properties of sheep red cells containing type A, B, or C(N) haemoglobin. *Res. Vet. Sci.* **7**, 368–378.
- Valentine, W. N., Paglia, S., Fink, K., and Madokoro, G. (1976). Lead poisoning: association with hemolytic anemia, basophilic stippling, erythrocyte pyrimidine 5'-nucleotidase deficiency, and intraerythrocytic accumulation of pyrimidines. *J. Clin. Invest.* **58**, 926–932.
- Valentine, W. N., Pearce, M. L., Riley, R. F., Richter, E., and Lawrence, J. S. (1951). Heme synthesis and erythrocyte life span in the cat. *Proc. Soc. Exp. Biol. Med.* **77**, 244–245.
- Watson, C. J., Perman, V., Spurell, F. A., Hoyt, H. H., and Schwartz, S. (1959). Some studies of the comparative biology of human and bovine erythropoietic porphyria. *AMA Arch. Intern. Med.* **103**, 436–444.
- Watson, C. J., and Schwartz, S. (1941). A simple test for urinary porphobilinogen. *Proc. Soc. Exp. Biol. Med.* **47**, 393–394.
- Zook, B. C., McConnell, G., and Gilmore, C. E. (1970). Basophilic stippling of erythrocytes in dogs with special reference to lead poisoning. *J. Am. Vet. Med. Assoc.* **157**, 2092–2099.
- Zuijderhoudt, F. M., Kamphuis, J. S., Kluitenberg, W. E., and Dorresteyn-Bok, J. (2002). Precision and accuracy of a HPLC method for measurement of fecal porphyrin concentrations. *Clin. Chem. Lab. Med.* **40**, 1036–1039.
- Zuijderhoudt, F. M., Koehorst, S. G., Kluitenberg, W. E., and Dorresteyn-Bok, J. (2000). On accuracy and precision of a HPLC method for measurement of urine porphyrin concentrations. *Clin. Chem. Lab. Med.* **38**, 227–230.

# Iron Metabolism and Its Disorders

John W. Harvey

*Department of Physiological Sciences*

*College of Veterinary Medicine*

*University of Florida*

*Gainesville, Florida*

- 
- I. INTRODUCTION**
  - II. IRON DISTRIBUTION**
    - A. Hemoglobin
    - B. Storage Iron
    - C. Myoglobin
    - D. Tissue Iron
    - E. Plasma Iron
  - III. IRON ABSORPTION**
  - IV. PLASMA IRON TRANSPORT**
  - V. REGULATION OF IRON METABOLISM**
    - A. Intracellular Regulation of Iron Metabolism
    - B. Systematic Regulation of Iron Metabolism
  - VI. IRON METABOLISM IN CELLS**
    - A. Iron Metabolism in Erythroid Cells
    - B. Iron Metabolism in Macrophages
    - C. Iron Metabolism in Hepatocytes
  - VII. TESTS FOR EVALUATING IRON METABOLISM**
    - A. Hematology
    - B. Serum Iron
    - C. Serum Total Iron-Binding Capacity
    - D. Serum Ferritin
    - E. Bone Marrow Iron
    - F. Erythrocyte Zinc Protoporphyrin
    - G. Tissue Nonheme Iron
    - H. Ferrokinetics
  - VIII. DISORDERS OF IRON METABOLISM**
    - A. Iron Deficiency
    - B. Anemia of Inflammatory Disease
    - C. Portosystemic Shunts
    - D. Copper Deficiency
    - E. Iron Overload
    - F. Siderotic Inclusions in Erythroid Cells

## REFERENCES

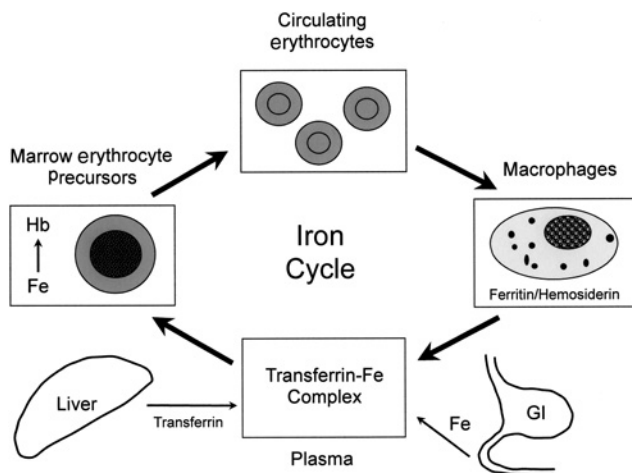
---

### I. INTRODUCTION

Iron is an essential nutrient required in a wide variety of metabolic processes. In solution, iron exists in two oxidation

states, ferrous ( $\text{Fe}^{+2}$ ) and ferric ( $\text{Fe}^{+3}$ ), which can donate or accept electrons, respectively. Iron is typically in the  $\text{Fe}^{+2}$  state for transport across membranes and in the  $\text{Fe}^{+3}$  state when bound to transport and storage proteins. Iron may be in either oxidation state when present in heme and iron-sulfur (Fe-S) cluster-containing proteins. The ability of iron to vary in oxidation state and redox potential, depending on the ligands it forms, enables iron to serve multiple functions. Iron-containing proteins are critical for oxygen transport and storage, respiration, DNA synthesis, citric acid cycle function, and various enzymatic reactions. Unfortunately, the same physical characteristics that allow iron to function as a cofactor in controlled redox biochemistry also makes iron potentially toxic to cells, because of its ability to catalyze the formation of reactive oxygen species. The binding of iron to coordinating ligands, such as O, N, and S, in proteins and the tight regulation of iron uptake, transport, and storage tends to shield iron from reactions with molecular oxygen that generate free radicals and injure tissues (Ryan and Aust, 1992).

Iron is absorbed from the diet in the small intestine and transferred to plasma, where it is bound to transferrin for transport to cells within the body. Once inside the body, iron cycles in a nearly closed system (Fig. 9-1) because little iron is lost in domestic animals unless hemorrhage occurs (Finch *et al.*, 1978). About 75% of the iron present in plasma will be transported to the bone marrow for incorporation into hemoglobin in developing erythroid cells (Smith, 1997). The remaining plasma iron is taken up by nonerythroid tissues, primarily the liver (Koury and Ponka, 2004). Erythrocytes containing hemoglobin normally circulate for several months before being phagocytized by macrophages when senescent. After phagocytosis, erythrocytes are lysed, hemoglobin is degraded, and iron is released. Most iron from degraded hemoglobin is quickly released back into plasma, but a small amount may be stored as ferritin or hemosiderin within macrophages, which is released more slowly into plasma. The vast majority of iron entering plasma each day comes from macrophage release.



**FIGURE 9-1** Iron cycle. Iron (Fe) is highly conserved in the body. Iron in plasma is bound to transferrin, a transport protein that is synthesized in the liver. Iron is transported to all tissues, but most iron is utilized to synthesize hemoglobin in developing erythroid cells. Aged blood erythrocytes are phagocytized by macrophages, and hemoglobin is degraded. Released iron is either returned to plasma or stored in macrophages as ferritin and hemosiderin. Nearly all of the iron in plasma under normal conditions comes from the release of iron by macrophages that have phagocytized and degraded erythrocytes (large arrow). Only about 3% of the iron in plasma results from gastrointestinal (GI) enterocyte absorption in normal individuals (small arrow).

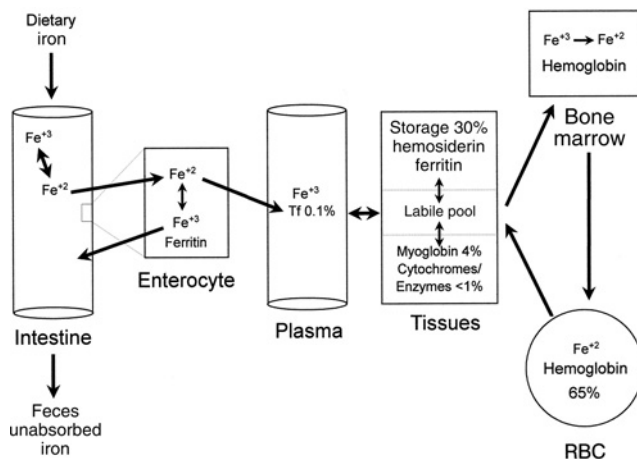
Iron absorption from the small intestine compensates for the small amount of iron lost each day, largely from skin exfoliation and cell desquamation in urine, bile, sweat, and feces (Beutler, 2006b; Underwood, 1977).

## II. IRON DISTRIBUTION

The relative distribution in the body is shown in Figure 9-2. Normally about 60% to 70% of total body iron is present in hemoglobin. About 20% to 30% is stored as ferritin and hemosiderin (primarily within macrophages and hepatocytes), 3% to 7% is present in myoglobin (with the higher values occurring in myoglobin-rich species such as dogs, horses, and cattle), 1% is present in enzymes, and less than 0.1% is bound to transferrin in plasma (Ponka *et al.*, 1998).

### A. Hemoglobin

Hemoglobin accounts for more than 90% of the protein within erythrocytes (Quigley *et al.*, 2004). It contains 0.34% iron by weight; consequently, each milliliter of packed erythrocytes contains 1.1mg of iron. Hemoglobin plays vital roles in oxygen transport, carbon dioxide transport, and buffering of hydrogen ions (see Chapter 7 for details). It is a tetrameric protein consisting of four polypeptide globin chains, each of which contains a heme prosthetic group. Heme is a planar molecule composed of the tetrapyrrole protoporphyrin IX, containing a central iron ion. A hemoglobin tetramer



**FIGURE 9-2** Overview of iron metabolism. Ferric iron ( $\text{Fe}^{+3}$ ) ions present in the diet are reduced to ferrous iron ( $\text{Fe}^{+2}$ ) ions and absorbed by duodenal enterocytes. Once inside enterocytes,  $\text{Fe}^{+2}$  may be oxidized and stored as ferritin or exported to plasma where it is oxidized and bound to transferrin (Tf) for transport to the tissues. Iron stored as ferritin is returned to the small intestine lumen when enterocytes are sloughed at the tip of the villus. Iron is incorporated into many proteins in all tissues, but most iron is utilized to synthesize hemoglobin in developing erythroid cells, where  $\text{Fe}^{+3}$  must be reduced to  $\text{Fe}^{+2}$  during heme synthesis. Aged blood erythrocytes are phagocytized by macrophages. Hemoglobin is degraded and iron is either returned to plasma or stored in macrophages as ferritin and hemosiderin. Modification of Kaneko, 1964, with permission.

is capable of binding four molecules of oxygen when fully saturated. To bind oxygen, iron ions within heme molecules must be in the  $\text{Fe}^{+2}$  state. Methemoglobin is formed when iron is oxidized to the  $\text{Fe}^{+3}$  state. Fortunately, the oxidation of  $\text{Fe}^{+2}$  ions to  $\text{Fe}^{+3}$  ions is minimized by the location of heme groups within hydrophobic pockets of globin chains, and methemoglobin that forms can be reduced enzymatically within erythrocytes.

### B. Storage Iron

Ferritin is a ubiquitous iron storage protein that is detected in almost all animal and plant tissues, as well as in bacteria and fungi. The binding of iron in ferritin minimizes its potential to catalyze the formation of damaging free radicals (Arosio and Levi, 2002). Each mammalian ferritin molecule is composed of a protein shell of 24 apoferitin H or L monomeric subunits surrounding a central cavity that can accommodate as many as 4000 iron atoms in a ferric hydroxide core. The inner surface of the protein shell has catalytic sites (associated with H subunits) that promote the oxidation of  $\text{Fe}^{+2}$  ions to  $\text{Fe}^{+3}$  ions (Arosio and Levi, 2002). The L subunit lacks ferroxidase activity, but it is more efficient than the H subunit in the enucleation and mineralization of iron in the ferritin core (Levi *et al.*, 1994). Subunit composition varies between cell types, with the H subunit predominating in erythrocytes and muscle, and the L subunit predominating in liver, spleen, and



plasma of humans (Beutler, 2006b). Dog and horse ferritin H and L subunit cDNA clones have been prepared and sequenced from various tissues. The amino acid residues involved in the ferroxidase center and in iron nucleation were conserved in H and L subunits of canine and equine ferritins, respectively (Orino *et al.*, 2005).

Although iron is generally stored in cells as ferritin, iron overloaded cells (macrophages in normal animals) contain another storage form of iron called hemosiderin, which represents partially degraded ferritin that forms after uptake by lysosomes (Anderson and Frazer, 2005; Ponka *et al.*, 1998). Surprisingly little is known about how ferritin releases its iron in cells. It is possible that intracellular iron release requires catabolism in lysosomes (Ponka *et al.*, 1998).

Free cytoplasmic ferritin molecules are water soluble and visible by electron microscopy, but they are not visible by light microscopy unless present in large aggregates. Hemosiderin is insoluble and visible by light microscopy. Hemosiderin appears gray to black in aspirate smears stained with routine bloodstains, golden-brown in H & E-stained tissue sections, and blue when stained with Prussian blue stain. There is a fairly good correlation between Prussian blue staining of tissues and the measurement of storage iron chemically, but staining is less sensitive in detecting storage iron (Blum and Zuber, 1975; Franken *et al.*, 1981). Storage iron can be present as ferritin that is not identified by Prussian blue staining (Blum and Zuber, 1975).

Major sites of iron storage include the liver, spleen, and bone marrow. The amount stored in a given tissue may vary by species. The liver appears to be the major site of iron storage in humans, but the spleen is reported to be more important in horses and cattle (Blum and Zuber, 1975; Franken *et al.*, 1981; Kolb, 1963). The relative contributions of ferritin and hemosiderin to the storage iron pool vary with species, organ, and amount of iron stored. In normal adults, ferritin concentration generally equals or exceeds hemosiderin concentration in the liver, but hemosiderin concentration typically exceeds ferritin concentration in the spleen. When iron stores are high, hemosiderin tends to accumulate more than ferritin, and when iron stores are low, ferritin tends to be higher than hemosiderin (Kolb, 1963; Underwood, 1977). Total body iron stores vary at birth between species, with considerable iron stores in humans, dogs, cattle, goats, horses, and rabbits; intermediate iron stores in cats and rodents; and minimal iron stores in pigs (Keen *et al.*, 1981; Kolb, 1963; Underwood, 1977). Iron stores decrease in nursing animals when demands for growth exceed iron absorption from milk (Blum and Zuber, 1975; Harvey *et al.*, 1987a; Keen *et al.*, 1981; Kolb, 1963).

### C. Myoglobin

Myoglobin is an oxygen-binding protein located primarily in muscles. It contains one heme group per molecule

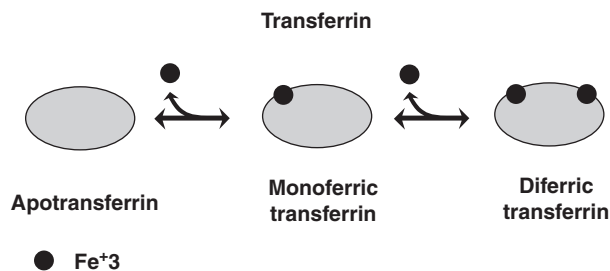
and has a structure similar to that of hemoglobin monomers. Myoglobin serves as a local oxygen reservoir that can temporarily provide oxygen when blood oxygen delivery is insufficient during periods of intense muscular activity. Iron within the heme group must be in the  $\text{Fe}^{+2}$  state to bind oxygen. If iron is oxidized to the  $\text{Fe}^{+3}$  state, metmyoglobin is formed. The total amount of myoglobin in an animal depends on body weight, degree of muscle development, and the myoglobin concentration in muscle, which varies between muscle types (red muscle is rich in myoglobin and white muscle is myoglobin poor). The myoglobin concentration in muscle varies with species. For example, the myoglobin concentration in muscles of racehorses is about 6 times that of human muscles (Kolb, 1963). Because much of the iron in muscle is in myoglobin, the percentage of total body iron present in muscle is higher in horses than in humans.

### D. Tissue Iron

In addition to the need for iron in hemoglobin and myoglobin, iron is vital in various metabolic processes. Nearly half of the enzymes in the citric acid cycle either contain iron or need it as a cofactor. Heme-containing proteins include catalase, peroxidase, and cytochromes. Cytochromes a, b, and c are required for oxidative phosphorylation in mitochondria. Other cytochromes, such as cytochrome P450 located in the endoplasmic reticulum, function in oxidative degradation of endogenous compounds and drugs. Nonheme iron, in Fe-S compounds and metalloflavoproteins, is required for enzymes including succinate dehydrogenase, cytochrome c reductase, nicotinamide adenine dinucleotide dehydrogenase, xanthine oxidase, and aconitase (Smith, 1997).

### E. Plasma Iron

Nearly all of the iron present in plasma in healthy animals is bound to apotransferrin, a 72 to 83 kDa glycoprotein (containing 2 to 4 sialic acid residues/molecule) to form transferrin (Welch, 1990). Apotransferrin is a bilobar protein with two binding sites for  $\text{Fe}^{+3}$  that is synthesized by the liver. It is believed to have evolved from duplication of a primordial gene coding for a protein with one iron-binding site. The concomitant binding of a bicarbonate anion is required for each  $\text{Fe}^{+3}$  molecule bound to apotransferrin (Ponka *et al.*, 1998). Normally 25% to 50% of the plasma apotransferrin binding sites are saturated with iron. When one or two  $\text{Fe}^{+3}$  ions are bound, the protein is referred to as monoferric or diferric transferrin, respectively. There is a random distribution of iron on binding sites (Fig. 9-3), with apotransferrin predominant at low plasma iron concentrations and diferric transferrin predominant at high plasma iron concentrations (Huebers *et al.*, 1984). Monoferric transferrin is predominant at 50% saturation of transferrin



**FIGURE 9-3** Apotransferrin is a bilobar protein with two binding sites for  $\text{Fe}^{+3}$  ions. When one or two  $\text{Fe}^{+3}$  ions are bound, the protein is referred to as monoferric or diferric transferrin, respectively. There is a random distribution of iron on binding sites, with apotransferrin predominant at low plasma iron concentrations and diferric transferrin predominant at high plasma iron concentrations. Monoferric transferrin is predominant at 50% saturation of transferrin with iron, with lesser amounts of apotransferrin and diferric transferrin present.

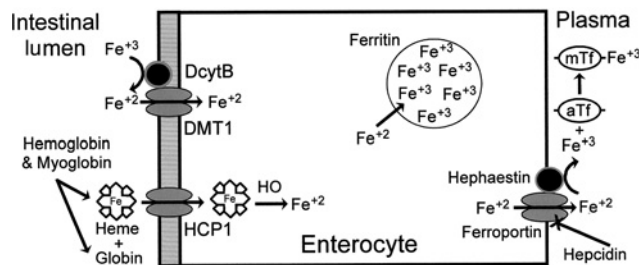
with iron, with lesser amounts of monoferric and diferric iron present. Transferrin is primarily responsible for iron transport throughout the body.

Ferritin is another iron-binding protein that can be measured in plasma. Although ferritin is released in small amounts from the liver and macrophages and can be taken up by cells (especially hepatocytes), it is of little or no importance in iron transport under normal conditions. Ferritin is normally present in very low concentrations in plasma and has low iron content; consequently, it contributes little to the plasma iron pool (Ponka *et al.*, 1998).

Nontransferrin bound iron (NTBI) has been measured in people with severe iron overload, when transferrin is fully saturated, and in mice with hereditary hypotransferrinemia. The nature of NTBI is unclear, but it may be complexed with low-molecular-weight molecules such as citrate, sugars, and amino acids or nonspecifically bound to albumin and other plasma proteins. NTBI has the potential to promote the formation of oxygen-free radicals and cause tissue injury (Ponka *et al.*, 1998).

### III. IRON ABSORPTION

Iron is not actively excreted from the body and minimal iron loss normally occurs, except in menstruating primates and egg-laying birds (Finch *et al.*, 1978; Kolb, 1963); consequently, the amount within the body must be controlled at the point of absorption. Iron absorption from the diet depends on age, species of the animal, iron stores, changes in rate of erythropoiesis, hypoxia, inflammation, and pregnancy, as well as the amount and chemical form of iron ingested (Frazer and Anderson, 2005; Mackenzie and Garrick, 2005; Stewart *et al.*, 1953). A low percentage (0.2% to 4.5%) of dietary iron is generally absorbed in normal adult animals (Finch *et al.*, 1978; Nathanson *et al.*, 1985). Iron absorption occurs through mature villus enterocytes of the duodenum and proximal jejunum. Absorption



**FIGURE 9-4** Mechanisms of iron absorption. Ferrous iron ( $\text{Fe}^{+2}$ ) ions are transported into enterocytes in the duodenum by the divalent metal transporter-1 (DMT1) after reduction of ferric iron ( $\text{Fe}^{+3}$ ) ions using a duodenal cytochrome b (DcytB). Heme is transported into enterocytes using heme carrier protein-1 (HCP1). Once inside, inorganic iron is released from heme by the action of the heme oxygenase (HO) reaction.  $\text{Fe}^{+2}$  ions are exported from enterocytes using ferroportin, oxidized to  $\text{Fe}^{+3}$  using hephaestin, and bound by apotransferrin (aTf) to form monoferric transferrin (mTf) and diferric transferrin (not shown). Hepcidin in plasma inhibits iron export to plasma by interacting directly with ferroportin, leading to ferroportin's internalization and lysosomal degradation.  $\text{Fe}^{+2}$  not transported to plasma is stored as ferritin following oxidation to  $\text{Fe}^{+3}$ . Iron stored as ferritin is returned to the small intestine lumen when enterocytes are sloughed at the tip of the villus.

includes iron uptake at the apical membrane of the enterocyte, translocation within the cytoplasm, and transfer to plasma at the basolateral membrane of the enterocyte. Iron can be taken in by enterocytes as free ions or as heme by different pathways (Fig. 9-4). The relative importance of these pathways varies depending on animal species and diet (Steele *et al.*, 2005).

Compounds in the diet such as phytates, tannins, and phosphates bind iron in insoluble complexes that cannot be absorbed. Most nonheme iron in the diet is in the  $\text{Fe}^{+3}$  state. Dietary  $\text{Fe}^{+3}$  is solubilized from food by hydrochloric acid in the stomach and binds to mucins and various small molecules, which keep the iron soluble and available for absorption in the more alkaline environment of the small intestine (Mackenzie and Garrick, 2005). Unbound  $\text{Fe}^{+3}$  is prone to hydrolysis, forming essentially insoluble ferric hydroxide and oxohydroxide polymers (Ponka *et al.*, 1998). The most important pathway for nonheme iron uptake utilizes the divalent metal transporter-1 (DMT1). A proton-coupled process facilitates this uptake. Although DMT1 has the highest affinity for iron, it can also transport manganese and potentially other divalent metal ions.  $\text{Fe}^{+3}$  ions must be reduced to  $\text{Fe}^{+2}$  ions before they can be transported into the enterocyte via the DMT1. Ascorbic acid in the diet or from gastric or biliary secretions promotes the reduction of  $\text{Fe}^{+3}$  ions. Although some  $\text{Fe}^{+3}$  ion reduction may occur by direct interaction with ascorbic acid, most reduction appears to rely on the presence of one or more brush border ferrireductase enzymes. A duodenal cytochrome b (DcytB) is believed to be important in this regard, but other intestinal ferrireductases may also exist (Mackenzie and Garrick, 2005).

Although the dominant role of DMT1 is acknowledged, debate continues as to whether important alternative

pathways of nonheme iron uptake exist. The role of the protein mobilferrin needs further evaluation. It might be part of a separate uptake pathway for  $\text{Fe}^{+3}$  ions, or it might interact with DMT1 in  $\text{Fe}^{+2}$  ion uptake (Conrad *et al.*, 2000; Mackenzie and Garrick, 2005). Although humans absorb  $\text{Fe}^{+2}$  salts more readily from the intestine than the  $\text{Fe}^{+3}$  salts, dogs are reported to absorb both valence forms equally well (Moore *et al.*, 1944). The reason for this difference is not known, but it could be related to a greater ability to reduce  $\text{Fe}^{+3}$  in the dog intestine, the presence of an important pathway for  $\text{Fe}^{+3}$  absorption in the dog intestine, or a greater ability to prevent the formation of insoluble  $\text{Fe}^{+3}$  complexes in the gastrointestinal tract of dogs.

Heme is released from dietary myoglobin and hemoglobin by the action of digestive enzymes. Dietary heme iron is generally more bioavailable than is nonheme iron and is an important nutritional source of iron in carnivores and omnivores. Heme enters duodenal enterocytes as an intact metalloporphyrin using a membrane protein named heme carrier protein 1 (HCP1) that has homology to bacterial metal-tetracycline transporters (Shayeghi *et al.*, 2005). The expression of HCP1 is regulated pre- and posttranslationally in hypoxic and iron-deficient mice, respectively (Latunde-Dada *et al.*, 2006b). Once inside the enterocyte, inorganic iron is apparently released from heme by the action of the heme oxygenase reaction, and this heme-splitting reaction appears to be the rate-limiting step in the absorption of iron contained within hemoglobin and myoglobin (Wheby and Spyster, 1981).

The intracellular transport of iron within the enterocyte is poorly understood. Iron ions in this labile iron pool (LIP) are presumably bound to chaperone molecules to keep them soluble. The nature of these chaperone molecules is yet to be defined. Iron ions can catalyze oxidative reactions that would injure the cell. The enterocyte protects itself against the toxic effects of excess iron by increasing apoferritin synthesis and incorporating the excess iron into ferritin. Consequently, iron uptake into enterocytes in excess of that needed for metabolic purposes or transferred to plasma is stored as ferritin. Iron stored as ferritin is returned to the small intestine when enterocytes are sloughed at the tip of the villus after 1 to 2 days (Steele *et al.*, 2005).

The transfer of iron atoms from enterocytes to transferrin in plasma is mediated by ferroportin (also known as Ireg1), an iron transport protein located on the basolateral surface of mature enterocytes. In addition to ferroportin, the efflux of iron from enterocytes requires a copper-containing protein called hephaestin that is also located on the basolateral membranes of mature enterocytes. Hephaestin is a membrane-bound ferroxidase that has significant homology to the plasma protein ceruloplasmin. Hephaestin's function may relate to its ability to oxidize  $\text{Fe}^{+2}$  ions to  $\text{Fe}^{+3}$  ions for binding to transferrin in plasma (Steele *et al.*, 2005). Sex-linked anemia (sla) mice have a block in mucosal iron transfer to plasma, with resultant microcytic hypochromic

anemia because these animals have an inherited hephaestin defect (Wessling-Resnick, 2006).

Components of brush border iron uptake, including DMT1 and DcytB, are strongly influenced by the iron concentration within enterocytes, with increased components expressed when intracellular iron content is low and decreased components expressed when iron content is high (Frazer and Anderson, 2005). These locally responsive changes in brush border transport components help buffer the body against the absorption of excessive iron, but it is the control of the basolateral transport of iron from enterocytes to plasma that represents the primary site at which iron absorption is controlled (Steele *et al.*, 2005). Hepcidin, a peptide produced by hepatocytes and secreted into plasma, inhibits iron transfer from enterocytes to plasma by interacting directly with ferroportin, leading to the internalization and lysosomal degradation of this iron export protein. Hepcidin production is increased in disorders such as iron overload and inflammation that result in decreased intestinal iron absorption. Hepcidin production is decreased in iron deficiency and disorders with increased erythropoiesis that result in increased iron absorption by enterocytes. Hephaestin expression is minimally affected by iron status (Vokurka *et al.*, 2006).

#### IV. PLASMA IRON TRANSPORT

At physiological pH and oxygen tension,  $\text{Fe}^{+2}$  in solution is readily oxidized to  $\text{Fe}^{+3}$ , which is prone to hydrolysis and precipitation. In addition, unless appropriately chelated, iron in plasma can promote harmful oxygen radical formation and peroxidative tissue damage because of its catalytic action in one-electron redox reactions (Ponka *et al.*, 1998). Fortunately, most iron in plasma is bound to the protein apotransferrin to form transferrin. The binding of iron to apotransferrin keeps iron molecules soluble and prevents iron catalyzed oxidative reactions. In addition, the vast majority of iron is transported to cells within the body following binding to apotransferrin in plasma (Ponka *et al.*, 1998). At normal iron saturation levels, apotransferrin is most abundant in plasma, followed by monoferric transferrin and diferric transferrin (Ponka *et al.*, 1998). Although diferric transferrin is normally much lower in concentration (about 10% of total transferrin) than monoferric transferrin, it accounts for most of the iron delivery to cells because diferric transferrin binds with 8- to 10-fold higher affinity to transferrin receptor-1 (TfR1) receptors on cells than does monoferric transferrin (Anderson and Frazer, 2005; Huebers *et al.*, 1985). Apotransferrin has very low affinity for TfR1 receptors on cells (Ponka *et al.*, 1998).

Iron turns over in 3 h or less in plasma (Smith, 1997). Nearly all of the iron in plasma under normal conditions comes from the release of iron by macrophages that have phagocytized and degraded erythrocytes (Fig. 9-1).

In contrast, only about 3% of the iron in plasma results from enterocyte absorption in normal individuals (Ponka *et al.*, 1998).

## V. REGULATION OF IRON METABOLISM

### A. Intracellular Regulation of Iron Metabolism

#### 1. Cytoplasmic Iron Regulation

The synthesis of a number of proteins important in iron metabolism, including apotransferrin, TfR1, apoferritin, DMT1, DcytB, ferroportin, iron responsive protein-1 (IRP1), and erythroid-specific 5-aminolevulinic acid synthase (eALAS or ALAS2), is regulated posttranscriptionally depending on intracellular iron content (Beutler, 2006b; Koury and Ponka, 2004; Latunde-Dada *et al.*, 2006a). The mRNA for each protein contains one or more iron responsive elements (IREs), each consisting of a stem-loop structure. The IREs located at the 5' end of mRNAs regulate translation, and IREs located at the 3' end regulate mRNA stability. IRP1 contains an Fe-S (4Fe-4S) cluster and exhibits aconitase activity when cells are iron replete, but it lacks the Fe-S cluster and aconitase activity when cytoplasmic iron is scarce. IRP1 binds tightly to IREs when cytoplasmic iron content is low. IRP2 is closely related to IRP1, but it lacks aconitase activity. The regulation of IRP2 is mediated by proteosomal degradation when cellular iron is adequate, through binding to iron and possibly heme (Wingert *et al.*, 2005). The binding of IRPs to IREs at the 5' end of mRNAs (including apoferritin and eALAS) inhibits translation and protein synthesis from these mRNAs, but the binding of IRPs to IREs at the 3' end of mRNAs (including TfR1 and intestinal DMT1) promotes mRNA stability, thereby enhancing protein synthesis from these mRNAs. When cytoplasmic iron content is high, IRPs are displaced from IREs, resulting in opposite effects on protein synthesis (Starzynski *et al.*, 2004). Because of these controlling factors, TfR1 synthesis is higher and apoferritin synthesis is lower when cytoplasmic iron content is low, and TfR1 synthesis is lower and apoferritin synthesis is higher when cytoplasmic iron content is high (Napier *et al.*, 2005).

#### 2. Mitochondrial Iron Regulation

Mitochondria are clearly central in the intracellular metabolism of iron; however, much remains to be discovered about their iron metabolism. The first enzyme reaction in heme synthesis (ALAS) and the final three enzyme reactions (including the insertion of Fe<sup>+2</sup> into protoporphyrin IX by ferrochelatase to form heme) occur within mitochondria (see Chapter 8 for details), and proteins involved in Fe-S cluster synthesis are located within mitochondria. Fe-S cluster synthesis has been studied in microbes, but

this pathway has not been well characterized in mammals. An inherited defect in a small protein called frataxin causes Friedreich ataxia in humans (Napier *et al.*, 2005). This disorder results in spino/cerebellar ataxia, cardiomyopathy, and diabetes associated with mitochondrial iron overload in nerve and cardiac tissue, but not in erythroid cells. Frataxin participates in the synthesis of Fe-S clusters, possibly as a mitochondrial iron chaperone that shields this metal from reactive oxygen species and renders it bioavailable as Fe<sup>+2</sup> (Napier *et al.*, 2005). Heme and Fe-S clusters synthesized within mitochondria are used locally and exported from mitochondria for insertion into cytoplasmic and nuclear enzymes. With the exception of a limited number of enzymes, such as ribonucleotide reductase, that have mono- or di-iron-binding sites, iron in heme and Fe-S clusters accounts for most of the enzyme iron. Consequently, almost all of the iron within cells must transit through mitochondria to be functionally active (Arosio and Levi, 2002).

Mitoferrin, a member of the vertebrate mitochondrial solute carrier family (SLC25), appears to be essential for the uptake of iron into mitochondria (Shaw *et al.*, 2006). The transporter needed to export heme from mitochondria to the cytoplasm is unknown; however, an inner mitochondrial membrane ATP-binding cassette protein B7 (ABCB7) appears to be required as an exporter for Fe-S clusters (Napier *et al.*, 2005). Studies in a zebra fish shiraz model indicate that heme synthesis in erythroid cells is dependent on the production of Fe-S clusters (Wingert *et al.*, 2005). Deficient Fe-S cluster formation (resulting from glutaredoxin 5 deficiency) and the resultant deficiency of Fe-S clusters in the cytoplasm of developing erythroid cells result in IRP1 binding to IREs of eALAS and the inhibition of eALAS translation. A deficiency in eALAS activity in zebra fish erythroid cells results in deficient heme synthesis and the formation of hypochromic erythrocytes (Wingert *et al.*, 2005). A human with mitochondrial glutaredoxin 5 deficiency has recently been described with sideroblast-like microcytic anemia and iron overload (Camaschella *et al.*, 2007).

Mitochondria can store excess iron using mitochondrial ferritin (m-ferritin). Unlike cytoplasmic apoferritin, mitochondrial apoferritin lacks an IRE and may be transcriptionally regulated by iron. M-ferritin forms homopolymeric shells that have more homology with cytoplasmic H-ferritin chains than L-ferritin chains (Napier *et al.*, 2005). M-ferritin concentration is very low in most cells, including erythroid cells, but it is markedly increased in disorders with mitochondrial iron overload, presumably limiting the oxidative damage generated by the excess iron. M-ferritin appears to be degraded to hemosiderin-like material within mitochondria, but the mechanism is unknown (Napier *et al.*, 2005).

### B. Systemic Regulation of Iron Metabolism

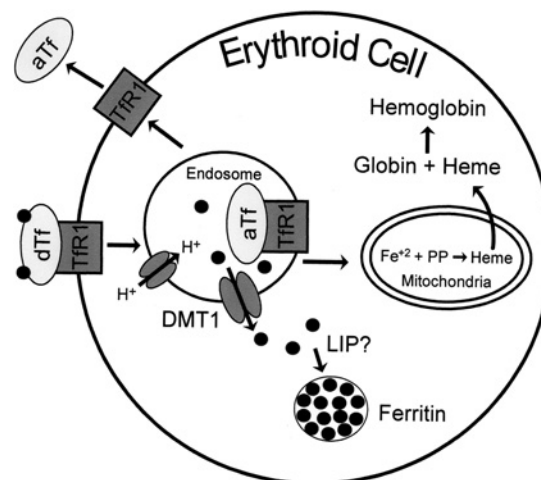
Hepcidin, a small antimicrobial peptide secreted by hepatocytes into the circulation, is an important regulator

of iron absorption in the small intestine, as well as iron transport across the placenta, and iron release from macrophages and hepatocytes. Hepcidin inhibits iron export from cells by interacting directly with ferroportin, leading to the internalization and lysosomal degradation of this iron export protein (Nemeth *et al.*, 2004b). Hepcidin production is decreased in iron deficiency and disorders resulting in increased erythropoiesis, which has increased demand for iron (Pak *et al.*, 2006). Decreased plasma hepcidin results in abundant ferroportin transporters on the basolateral surface of enterocytes and increased iron absorption and release to plasma. Ferroportin transporters are also abundant on the surface of macrophages and hepatocytes, promoting the export of iron from the storage pool to plasma (Ganz and Nemeth, 2006; Vokurka *et al.*, 2006). Conversely, hepcidin production is increased and ferroportin transporter expression on cell surfaces is decreased in disorders such as iron overload and inflammation. As a consequence, increased plasma hepcidin results in decreased iron absorption from the intestine and decreased iron release to plasma from macrophages and hepatocytes (Steele *et al.*, 2005). Hepcidin production is modulated by body iron requirements, which are largely influenced by the magnitude of erythropoiesis present (Pak *et al.*, 2006; Wilkins *et al.*, 2006). However, hepcidin production is also increased during inflammation by a pathway not dependent on body iron requirements (Steele *et al.*, 2005). Possible mechanisms involved in the control of hepcidin production are discussed in the section on liver iron metabolism.

## VI. IRON METABOLISM IN CELLS

### A. Iron Metabolism in Erythroid Cells

Although all cells require iron, erythroid precursors have iron requirements that far exceed the iron requirements of any other cell type because of the need for hemoglobin synthesis. Erythrocytes contain approximately 45,000-fold more heme iron (largely in hemoglobin) than nonheme iron, and the delivery of iron to erythrocytes is stringently dependent on transferrin as the source of iron (Koury and Ponka, 2004). Diferric transferrin molecules bind to TfR1 on the surface of cells, and these transferrin-TfR1 complexes localize to clathrin-coated pits, which invaginate to initiate endocytosis (Beutler, 2006b). Clathrin is a structural protein that enables endocytosis through the formation of concave lattices with the plasma membrane. After the transferrin-TfR1 complexes are internalized as endosomes, a proton pump decreases the pH in the endosome, resulting in conformational changes in the proteins and subsequent release of  $\text{Fe}^{+3}$  ions from transferrin (Fig. 9-5). Iron is exported from the endosome using DMT1, following reduction with Steap3, an NADPH-dependent ferrireductase (Ohgami *et al.*, 2005). The resultant apotransferrin-TfR1 complex is recycled to the cell membrane, where apotransferrin is released from the



**FIGURE 9-5** Iron metabolism in erythroid cells. Diferric transferrin (dTf) binds to transferrin receptor-1 (TfR1) on the surface of developing erythroid cells. The dTf-TfR1 complexes are internalized within an endosome and a proton pump decreases the pH in the endosome, resulting in release of iron ions (dark spheres). Iron is exported from the endosome using the divalent metal transporter-1 (DMT1). The resultant apotransferrin (aTf)-TfR1 complex is recycled to the cell membrane, where aTf is released from the cell, and the TfR1 is available for binding additional dTf. A direct interorganelle transfer of iron occurs between endosomes and mitochondria for insertion into protoporphyrin IX (PP) to form heme and for synthesis of iron-sulfur clusters (not shown). Some iron presumably exists in a cytoplasmic labile iron pool (LIP), with excess iron stored as ferritin.

cell, and the TfR1 is again available for binding additional iron-containing transferrin molecules. Erythroid precursor cells in the bone marrow and reticulocytes that synthesize hemoglobin have TfR1 on their surfaces for iron uptake, but reticulocytes lose their TfR1 as they develop into mature erythrocytes (Ponka *et al.*, 1998).

A direct interorganelle transfer of iron occurs between endosomes and mitochondria where iron is used for heme and iron-sulfur cluster synthesis (Sheftel *et al.*, 2007). Some iron is presumably released from endosomes into a cytoplasmic labile iron pool (LIP), with excess cytoplasmic iron stored as ferritin. Various chaperone molecules have been proposed, but the nature of the iron in the LIP remains enigmatic (Beutler, 2006b). Iron stored as ferritin in the cytoplasm is not available for hemoglobin synthesis in erythroid cells (Ponka *et al.*, 1998).

TfR1, apoferritin, and eALAS synthesis are regulated by the amount of intracellular iron present. An increase in the LIP stimulates apoferritin synthesis and inhibits TfR1 expression to minimize the potential of iron toxicity to the cell. A decrease in the LIP results in decreased apoferritin synthesis and increased TfR1 expression on cell surfaces to maximize iron uptake and use for heme synthesis (Beutler, 2006b). Erythrocytes coordinate protoporphyrin IX formation with the availability of iron by increasing the synthesis

of eALAS (rate limiting enzyme in porphyrin synthesis) when the LIP is high, and decreasing eALAS synthesis when the LIP is low.

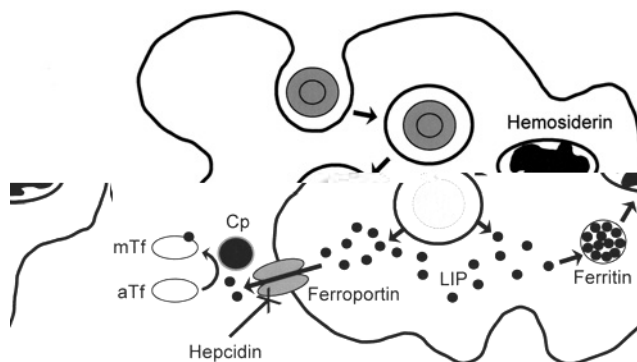
Even though three different pathways are required for hemoglobin synthesis in erythrocyte precursors and reticulocytes, virtually no intermediates (iron, globin chains, or heme) accumulate in the cytoplasm of these cells. Several positive and negative feedback mechanisms account for the balanced production of these hemoglobin components. As already discussed, an increase in the LIP limits the uptake of additional iron by decreasing TfR1 synthesis. The availability of iron also limits, and thereby controls, heme synthesis. Free “uncommitted” heme inhibits iron uptake by erythroid cells and consequently heme synthesis. In addition, free heme is essential for the synthesis of globin chains at both the transcriptional and translational levels (Koury and Ponka, 2004). Consequently, globin synthesis does not occur in the absence of heme.

A heme exporter termed FLVCR is up-regulated on colony-forming units-erythroid (CFU-E) progenitor cells. It may provide a safety mechanism to prevent the accumulation of toxic amounts of cytoplasmic heme before globin synthesis is initiated. FLVCR is the cell surface receptor for feline leukemia virus, subgroup C (FeLV-C). Cats with FeLV-C infections develop erythroid aplasia because of a block at the CFU-E stage of erythroid development. It appears that the binding of FeLV-C to receptors on CFU-E progenitor cells inhibits heme export and results in apoptosis of these cells (Quigley *et al.*, 2004).

In addition to the entry of iron into mitochondria for incorporation into protoporphyrin IX to form heme, iron is critical for Fe-S cluster biogenesis within mitochondria. Fe-S clusters are important prosthetic groups for numerous proteins involved in electron transfer, metabolic, and regulatory processes. Although Fe-S clusters are formed within mitochondria, Fe-S proteins are located in the nucleus and cytoplasm of cells, as well as in mitochondria (Lill *et al.*, 2006). Recent studies in zebra fish provide evidence for a regulatory link between Fe-S cluster formation and heme synthesis. In the absence of Fe-S clusters, IRP1 binds to eALAS mRNA, which inhibits eALAS synthesis and heme production (Wingert *et al.*, 2005).

## B. Iron Metabolism in Macrophages

In contrast to erythroid cells, virtually no iron enters macrophages via plasma transferrin. Rather, nearly all iron enters macrophages by the phagocytosis of aged or prematurely damaged erythrocytes (Fig. 9-6) (Ponka and Richardson, 1997). Following phagocytosis, erythrocytes are lysed, and hemoglobin is degraded to heme and globin. The microsomal heme oxygenase reaction within macrophages degrades heme and releases iron. Most of the iron from degraded heme is quickly exported (half-life 34 min in dogs) from the macrophage and bound to plasma transferrin for transport



**FIGURE 9-6** Iron metabolism in macrophages. Nearly all iron enters macrophages by the phagocytosis of aged or prematurely damaged erythrocytes. Following phagocytosis, erythrocytes are lysed, and hemoglobin is degraded to heme and globin. The microsomal heme oxygenase reaction within macrophages degrades heme and releases iron to the labile iron pool (LIP). Most of the released iron is exported from the macrophage by ferroportin as ferrous iron, oxidized to ferric iron by ceruloplasmin (Cp) in plasma, and bound to apotransferrin (aTf) to form monoferric transferrin (mTf) or diferric transferrin (not shown). Hepcidin in plasma inhibits iron export by interacting directly with ferroportin, leading to ferroportin’s internalization and lysosomal degradation. Iron not rapidly released to plasma is stored within macrophages as ferritin, which may be degraded to hemosiderin within lysosomes.

to other cells (especially erythrocyte precursors in the bone marrow). The export of iron from macrophages is mediated by ferroportin and controlled by hepcidin as has been discussed for enterocytes (Verga Falzacappa and Muckenthaler, 2005). In contrast to enterocytes that utilize membrane-bound hephaestin, macrophages utilize the copper-containing plasma protein ceruloplasmin to oxidize  $\text{Fe}^{+2}$  ions to  $\text{Fe}^{+3}$  ions for binding to transferrin in plasma (Nemeth *et al.*, 2004b). Iron not rapidly released to plasma is stored within macrophages as ferritin and hemosiderin. Iron that is stored within macrophages is released to plasma more slowly, with a half-life of 7 days in dogs (Fillet *et al.*, 1974). The mononuclear phagocyte system accounts for much of the total body iron stores. Iron in the storage pool turns over slowly unless there is an increased need for iron for hemoglobin synthesis (Beutler, 2006b). In addition to iron export by ferroportin, a small amount of iron is apparently released as ferritin. It is not clear whether this is secreted or simply represents a “leak” from damaged cells (Ponka *et al.*, 1998).

Macrophages can take up iron present in hemoglobin-haptoglobin complexes and heme-hemopexin complexes in plasma. Haptoglobin-hemoglobin complexes form following intravascular hemolysis when released hemoglobin binds with high affinity to the plasma glycoprotein haptoglobin. Heme-hemopexin complexes can also form secondary to intravascular hemolysis when hemoglobin heme is released, but additional heme-containing proteins (such as myoglobin) release heme that binds to the plasma protein hemopexin. The hemoglobin-haptoglobin complex undergoes endocytosis after binding to the hemoglobin scavenger receptor CD163. Expression of this receptor is

induced by interleukin-6 (IL-6), IL-10, and glucocorticoids (Graversen *et al.*, 2002). The heme-hemopexin complexes undergo endocytosis after binding to CD91, also called the low-density lipoprotein receptor-related protein (LRP) or  $\alpha_2$ -macroglobulin receptor. Once inside the cell, the complexes are transported to lysosomes for degradation, and receptors are recycled to the cell surface (Hvidberg *et al.*, 2005).

### C. Iron Metabolism in Hepatocytes

The liver is essential for normal iron homeostasis in the body. It regulates iron movement into and around the body through hepcidin synthesis, accounts for about 40% of the body iron stores, and is the site of synthesis of apotransferrin, ceruloplasmin, haptoglobin, and hemopexin plasma proteins (Anderson and Frazer, 2005).

Hepatocytes synthesize hepcidin in an endocrine manner to regulate iron metabolism in the body. Hepcidin is a small cationic peptide (25 amino acids in humans) that forms from a larger prohepcidin peptide (84 amino acids) (Park *et al.*, 2001). Hepcidin has been cloned, expressed, and sequenced in several species, including dogs (Fry *et al.*, 2004; Verga Falzacappa and Muckenthaler, 2005). Because of its small size, hepcidin is rapidly cleared by the kidney and is measurable in urine. Using immunohistochemistry techniques, prohepcidin is localized to organelles of the secretory pathway, particularly the Golgi apparatus, of hepatocytes suggesting that molecules may accumulate before receiving a signal for secretion (Wallace *et al.*, 2005). Prohepcidin circulates in plasma, but its plasma concentration does not correlate well with urinary hepcidin concentrations or other iron parameters (Kemna *et al.*, 2005). The site, nature, and potential regulation of the conversion of prohepcidin to hepcidin remain to be identified.

A number of systemic stimuli, including body iron stores, anemia, hypoxia, degree of erythropoiesis, and inflammation have been reported to modulate hepcidin levels; however, the pathways involved in hepcidin production remain to be elucidated (Anderson and Frazer, 2005; Steele *et al.*, 2005). Anemia, hypoxia, and erythropoietin themselves do not seem to be of primary importance (Pak *et al.*, 2006; Vokurka *et al.*, 2006). Hepcidin production is modulated by body iron requirements, which are largely influenced by the magnitude of erythropoiesis present (Wilkins *et al.*, 2006). A signal arising from erythropoietic activity in bone marrow is proposed to regulate hepcidin production, but its nature is unknown at the time of this manuscript preparation (Pak *et al.*, 2006). The content of diferric transferrin in plasma may be a key indicator of body iron requirement (Wilkins *et al.*, 2006). Many questions remain concerning how hepcidin expression is modulated in response to body iron requirements; however, three molecules (hemochromatosis [HFE] protein, Tfr2,

and hemojuvelin) have been identified that are involved in the regulation of this pathway(s). Defects in each of these molecules in humans or mice have resulted in inappropriately low hepcidin levels and increased iron absorption leading to hemochromatosis. It is hypothesized that hepcidin is regulated by HFE and Tfr2 on hepatocyte surfaces in response to plasma transferrin saturation. Tfr2 has a 25-fold lower affinity for diferric transferrin than does Tfr1 and would presumably become active when diferric transferrin concentrations are high (Anderson and Frazer, 2005). The pathway involving plasma diferric transferrin concentration may not be the only way hepcidin production is regulated. Hemojuvelin may modulate this pathway or affect hepcidin synthesis independently (Steele *et al.*, 2005). Studies indicate that hepcidin synthesis is stimulated by certain bone morphogenetic proteins (BMPs) that bind to hemojuvelin, regulating hepcidin expression through a BMP signal transduction pathway (Truksa *et al.*, 2006). In addition, hepcidin expression increases in response to inflammation, and this increase precedes any alteration in transferrin saturation (Steele *et al.*, 2005).

Most of the iron stored within the liver is found in hepatocytes stored as ferritin. Hepatocytes secrete a glycosylated form of ferritin into plasma (Ghosh *et al.*, 2004). Ferritin in human plasma is primarily composed of L subunits, but H subunits predominate in ferritin in dog plasma (Watanabe *et al.*, 2000). Plasma ferritin concentrations generally correlate with body iron stores; however, ferritin is an acute phase protein that increases in plasma during inflammation (Torti and Torti, 2002).

Hepatocyte membranes contain ferritin receptors. However, serum ferritin is present in low concentrations and contains little iron, so it is unlikely that hepatocytes take up significant amounts of iron from plasma by this mechanism under normal conditions (Anderson and Frazer, 2005; Ponka *et al.*, 1998). Like other cells, hepatocytes utilize Tfr1 to transport iron into the cells. NTBI is thought to be chelated by small organic acids, such as citrate, but some may be bound loosely to proteins such as albumin (Anderson and Frazer, 2005). The liver rapidly clears NTBI. In experimental studies using mice, the half-time of clearance of NTBI in plasma was 30sec, compared to a half-time clearance for transferrin-bound iron of 50min (Craven *et al.*, 1987). Like macrophages and enterocytes, hepatocytes utilize ferroportin to export iron to plasma. Ferroportin expression is lower in hepatocytes than in enterocytes and macrophages, which may help explain why these cells preferentially accumulate iron in most iron-overload conditions (Rivera *et al.*, 2005).

As discussed earlier, transferrin (apotransferrin with bound  $\text{Fe}^{+3}$  ions) is critical for normal iron transport to cells. Liver synthesis and release of apotransferrin to plasma is increased in most species in response to iron deficiency (but not generally in dogs) and decreased in response to inflammation (negative acute phase protein). Transferrin deficient

mice have iron deficiency anemia, but iron accumulates in the liver, presumably because of the ability of hepatocytes to take up NTBI (Verga Falzacappa and Muckenthaler, 2005).

Ceruloplasmin is a glycoprotein with a molecular weight of 100 to 155 kDa depending on species. It migrates in the  $\alpha_2$ -region in humans but in the  $\alpha_1$ -region in horses on protein electrophoresis (Okumura *et al.*, 1991). During biosynthesis, six atoms of copper are incorporated into ceruloplasmin late in the secretory pathway (Hellman and Gitlin, 2002). It contains most of the copper in the circulation in all species studied, except for the dog in which ceruloplasmin accounts for only about 40% of the plasma copper content (Montaser *et al.*, 1992). It plays no role in copper transport or delivery to tissues (Hellman and Gitlin, 2002). Ceruloplasmin has ferroxidase enzyme activity that facilitates the oxidation of  $\text{Fe}^{+2}$  to  $\text{Fe}^{+3}$ , a process involved in iron mobilization from liver and other tissue, but not from enterocytes (Osaki *et al.*, 1971; Wessling-Resnick, 2006). It also appears to function as an antioxidant in plasma. Ceruloplasmin is a mild to moderate acute phase protein that increases in concentration in association with inflammation (Ceron *et al.*, 2005; Smith and Cipriano, 1987). Its synthesis may also be enhanced by iron deficiency, estrogen, and progesterone. In contrast to iron, hepatocytes can excrete copper in the bile by a process that is dependent on the intracellular concentration of copper (Hellman and Gitlin, 2002).

Haptoglobin is a glycoprotein of approximately 80 kDa molecular weight that contains approximately 20% carbohydrate. As an acute phase protein, the liver secretes increased amounts of haptoglobin into the circulation in response to inflammation (see Chapter 5). Plasma haptoglobin concentration may also increase following glucocorticoid administration in dogs and cattle (Harvey and West, 1987; Higuchi *et al.*, 1994; Yoshino *et al.*, 1993). Haptoglobin exists in dimer and polymer forms and is a major component of the  $\alpha_2$ -protein band identified by electrophoresis in most species. Lysis of erythrocytes in the circulation (intravascular hemolysis) releases free hemoglobin into plasma, and hemoglobin tetramers spontaneously dissociate into  $\alpha$ - $\beta$  dimers that are bound by haptoglobin. Each haptoglobin monomer can irreversibly bind a hemoglobin  $\alpha$ - $\beta$  dimer, preventing some hemoglobin loss (and therefore iron loss) in the urine following intravascular hemolysis. Macrophages remove hemoglobin-haptoglobin complexes from plasma, degrade the protein complex, and subsequently recycle the released iron. Haptoglobin also assists in the protection against bacterial infections by binding to free hemoglobin in infected tissues, limiting iron availability for bacterial growth. In addition, haptoglobin functions as an antioxidant because free hemoglobin promotes oxidative injury, which is inhibited by binding to haptoglobin (Melamed-Frank *et al.*, 2001).

Hepatocytes synthesize hemopexin, a 60-kDa acute phase plasma protein with a remarkably high binding affinity for heme. Free heme may be released in toxic amounts

when intravascular hemolysis, rhabdomyolysis, or internal hemorrhage occur. Heme binds to cell membranes and other lipophilic structures, such as low-density lipoproteins, and promotes oxidative injury and inflammatory reactions. Binding of heme to hemopexin dampens these toxic effects. Like macrophages, hepatocytes can endocytose heme-hemopexin complexes following binding to CD91 on their surfaces. Once inside the cell, the complexes are transported to lysosomes for degradation and release of iron, and receptors are recycled to the cell surface (Hvidberg *et al.*, 2005).

## VII. TESTS FOR EVALUATING IRON METABOLISM

### A. Hematology

When the hemoglobin concentration reaches a certain level in developing erythroid cells, it appears to signal the cessation of cell division. Abnormalities in heme or globin synthesis result in deficient hemoglobin synthesis and a delay in the signal for cell division to cease. When this happens, one or more extra cell divisions occur during erythroid cell development, resulting in the formation of microcytic erythrocytes (Stohlman *et al.*, 1963). A deficiency in hemoglobin synthesis can also result in the formation of hypochromic erythrocytes with decreased hemoglobin concentration. Iron is essential for heme synthesis; consequently, iron deficiency results in deficient heme synthesis and the formation of microcytic, hypochromic erythrocytes. In addition to true iron deficiency, disorders that result in functional iron deficiency or defective iron incorporation into heme in mitochondria may result in the formation of microcytic, and possibly hypochromic, erythrocytes. These disorders include the anemia of inflammatory disease, copper deficiency, myelodysplastic disorders, drug or chemical toxicities, and possibly portosystemic shunts (Harvey, 2000).

The mean cell volume (MCV) represents the average volume of a single erythrocyte in femtoliters ( $\text{fl} = 10^{-15}\text{l}$ ). The MCV is determined most accurately with appropriately calibrated electronic cell counters that determine the size of individual cells and compute the MCV. The MCV varies greatly depending on species and, in some cases, depending on a breed within a species. Some dogs from Japanese breeds (Akita and Shiba) normally have MCV values below the reference intervals established for other breeds of dogs (Gookin *et al.*, 1998), but these dogs are not anemic. The MCV is a fairly insensitive indicator of the formation of microcytes because a relatively high percentage of microcytes must generally be present in blood for the MCV to decrease below the reference interval.

The mean cell hemoglobin concentration (MCHC) represents the average hemoglobin concentration within erythrocytes. It is calculated by dividing the



hemoglobin value (in g/dl) by the hematocrit (as a percentage) and multiplying by 100. The MCHC is expressed as g/dl of erythrocytes. It may be normal in iron deficiency anemia when MCV values are only slightly decreased, but the MCHC is typically low when the MCV is moderately to markedly decreased.

The mean cell hemoglobin (MCH) represents the average amount of hemoglobin in a single erythrocyte. It is calculated by dividing the Hb value (in g/dl) by the RBC count (in millions per  $\mu\text{l}$ ) and multiplying by 10. The MCH generally provides little added information beyond that obtained from the MCV and MCHC because the MCH depends on both the size and hemoglobin concentration of erythrocytes. It usually correlates directly with the MCV, except in animals with macrocytic hypochromic erythrocytes. Exceptionally low MCH values strongly suggest true iron deficiency is present.

Although quite useful when abnormal, MCV and MCHC values are relatively insensitive in identifying the presence of erythrocytes with abnormal volumes or hemoglobin concentrations. Many microcytic or macrocytic erythrocytes are required to move the MCV below or above the reference interval, respectively, and many hypochromic erythrocytes are needed to move the MCHC below the reference interval. In addition to counting cells, electronic cell counters can determine and plot the volume of individual erythrocytes, and examination of these erythrocyte volume histograms can reveal the presence of increased numbers of microcytes or macrocytes even when the MCV is within the reference interval (Weiser and Kociba, 1983). Some electronic cell counters such as the Advia 120 (Siemens Medical Solutions Diagnostics, Tarrytown, NY) can also determine the hemoglobin concentration of individual erythrocytes from the deflection of light that occurs when a laser beam strikes individual cells. Inspection of hemoglobin concentration histograms can reveal the presence of increased numbers of hypochromic erythrocytes, even when MCHC has not decreased below the reference interval. Individual erythrocytes can be further characterized by creating a cytogram in which the erythrocyte volumes

of individual cells are plotted against their respective hemoglobin concentrations. In addition, the percentages of microcytes, macrocytes, hypochromic erythrocytes, hyperchromic erythrocytes, erythrocytes with low hemoglobin content, and erythrocytes with high hemoglobin content can be determined, and these same parameters can also be determined for reticulocytes in a blood sample. Because reticulocytes are recently formed immature erythrocytes, reticulocyte parameters may best reflect the current state of iron sufficiency in an animal. Alterations in several reticulocyte indices—including reticulocyte MCV ( $\text{MCV}_{\text{retic}}$ ), reticulocyte hemoglobin content ( $\text{CH}_{\text{retic}}$ ), percentage of hypochromic reticulocytes ( $\% \text{Hypo}_{\text{retic}}$ ), percentage of reticulocytes with low hemoglobin content ( $\% \text{Low CH}_{\text{retic}}$ ), percentage of reticulocytes with high hemoglobin content ( $\% \text{High CH}_{\text{retic}}$ ), and percentage of macrocytic reticulocytes ( $\% \text{Macro}_{\text{retic}}$ )—appear to be of value in the diagnosis of iron deficiency in dogs (Fry and Kirk, 2006; Steinberg and Olver, 2005).

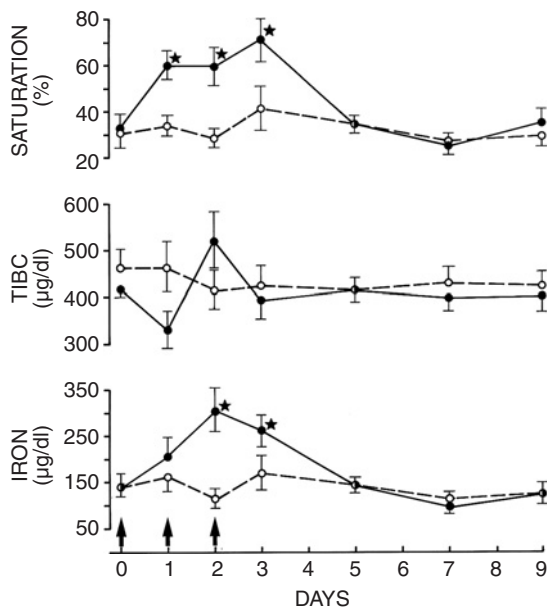
## B. Serum Iron

Serum iron can be measured to assess the transport compartment of iron (Table 9-1). Serum iron concentration is increased in animals with hemolytic anemia and dyserythropoiesis, in which iron transfer from macrophages to plasma is increased (Harvey and Smith, 1994; Smith, 1992; Steffen *et al.*, 1992; Stewart *et al.*, 1953; Watanabe *et al.*, 1998; Weiss and Lulich, 1999); in hypoplastic or aplastic anemia, in which iron transfer from plasma is decreased (Lange *et al.*, 1976; Smith, 1992; Stokol and Blue, 1999; Stokol *et al.*, 2000); in iron overload (Arnbjerg, 1981; House *et al.*, 1994; Lavoie and Teuscher, 1993; Paglia *et al.*, 2001; Sprague *et al.*, 2003); in pigs with experimental pyridoxine deficiency (Deiss *et al.*, 1966); in dogs and horses following the administration of glucocorticoid steroids (Fig. 9-7) (Adamama-Moraitou *et al.*, 2005; Harvey *et al.*, 1987b; Smith *et al.*, 1986b); and in dogs with chronic hepatopathy (Soubasis *et al.*, 2006). Serum iron concentrations are high at birth in foals, with most of the transferrin saturated with iron (Fig. 9-8), but serum iron

**TABLE 9-1** Serum Iron Analyte Reference Intervals in Domestic Animals<sup>a</sup>

Species	Iron ( $\mu\text{mol/l}$ )	TIBC ( $\mu\text{mol/l}$ )	Ferritin ( $\mu\text{g/l}$ )	Reference(s)
Dog	5.9–26.3	50.5–69.1	80–800	Weeks <i>et al.</i> (1988)
Cat	5.9–24.2	30.3–58.2	32–123	Andrews <i>et al.</i> (1994)
Horse	9.0–35.4	41.3–81.4	43–261	Smith <i>et al.</i> (1986a)
Cattle	7.0–27.7	33.3–48.3	33–55	Kolb (1963), Smith (1997)
Pig	9.8–33.5	43.1–70.3	20–125	Kolb (1963), Smith <i>et al.</i> (1984a)

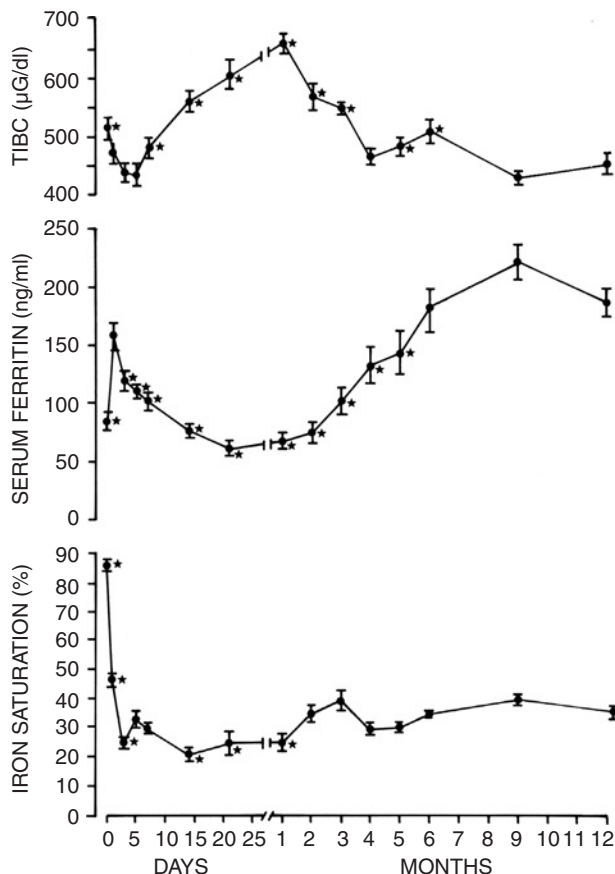
<sup>a</sup>Iron and total iron-binding capacity (TIBC) values can be converted from SI units to conventional units ( $\mu\text{g/dl}$ ) by multiplying by 5.59.



**FIGURE 9-7** Effect of oral prednisone (2mg/kg bid) administration for 3 consecutive days (arrows) on serum iron parameters in dogs (closed circles with solid lines) compared to control dogs without prednisone (open circles with dashed lines). Values are mean  $\pm$  standard error with stars indicating significant differences between groups ( $p < 0.05$ ). TIBC = total iron-binding capacity. Saturation refers to the percentage saturation of transferrin with iron. From Harvey *et al.* (1987b), with permission.

decreases to adult values by 3 days of age (Harvey *et al.*, 1987a). Although serum iron values in calves and piglets are not as high as values in foals at birth, a rapid decrease in serum iron also occurs in these species within a few days after birth (Kolb, 1963). Serum iron increases markedly in chickens associated with increased estrogen secretion and the onset of egg laying (Kolb, 1963). Serum iron values may be spuriously increased if laboratory tubes or pipettes used to handle serum are contaminated with iron. The use of disposable plastic pipettes and tubes minimizes this possibility. Iron concentrations may be spuriously increased in plasma samples if kits designed for serum iron determinations are used to measure iron in plasma.

Serum iron concentration is generally low in both iron deficiency (Furugouri, 1972; Halvorsen and Halvorsen, 1973; Harvey *et al.*, 1982; Harvey *et al.*, 1987a; Kolb, 1963; Mollerberg *et al.*, 1975; Weiser and Kociba, 1983) and with inflammation (Borges *et al.*, 2007; Feldman *et al.*, 1981b; Kolb, 1963; Neumann, 2003; Smith and Cipriano, 1987; van Miert *et al.*, 1986; van Miert *et al.*, 1990). It may also be decreased when demands for erythropoiesis exceed the iron flow from the diet and storage pools, such as might occur with erythropoietin administration (Brugnara *et al.*, 1993; Cowgill *et al.*, 1998; Pak *et al.*, 2006). Serum iron concentration is decreased following glucocorticoid administration to cattle and goats (Maddux *et al.*, 1988; van Miert *et al.*, 1986; Weeks *et al.*, 1989a).



**FIGURE 9-8** Serum total iron-binding capacity (TIBC), ferritin concentration, and percentage saturation of transferrin with iron (mean  $\pm$  standard error) from 21 healthy foals during the first year of life. The day 0 sample was taken before foals were allowed to nurse. The sharp increase in serum ferritin when 1 day old resulted from the consumption of colostrum with high ferritin concentration compared to that in blood. Values marked with a star were significantly different from 77 healthy adult horses. From Harvey *et al.* (1987a), with permission.

### C. Serum Total Iron-Binding Capacity

The total iron-binding capacity (TIBC) of serum is a measure of total serum transferrin (apotransferrin, monotransferrin, diferric transferrin) concentration because insignificant amounts of plasma iron are bound to other proteins. TIBC is calculated by measuring serum iron and serum unsaturated iron-binding capacity and summing these values. The percentage saturation of transferrin with iron is calculated by dividing the serum iron concentration by the TIBC and multiplying by 100. Serum TIBC is low-normal or decreased in association with inflammatory disorders (Feldman *et al.*, 1981b; Ottenjann *et al.*, 2006; Smith and Cipriano, 1987) and increased in iron-deficient humans, rabbits, pigs, horses, and cattle (Furugouri, 1972; Halvorsen and Halvorsen, 1973; Harvey *et al.*, 1987a; Miltenburg *et al.*, 1992b; Mollerberg *et al.*, 1975). A slight increase in serum TIBC was reported in an experimental study of diet-induced iron deficiency anemia in young

growing dogs (Fry and Kirk, 2006), but serum TIBC is generally normal in dogs with naturally occurring iron deficiency anemia (Harvey *et al.*, 1982; Weiser and O'Grady, 1983). TIBC may be increased in some animals with iron overload (House *et al.*, 1994; Sprague *et al.*, 2003) and in dogs with chronic hepatitis (Soubasis *et al.*, 2006).

#### D. Serum Ferritin

Serum ferritin concentration correlates with tissue iron stores in humans and domestic animals (Andrews *et al.*, 1994; Smith *et al.*, 1984a; Smith *et al.*, 1984b; Weeks *et al.*, 1989b). Increased serum ferritin occurs in animals with increased storage iron as reported in dogs with chronic hemolytic anemia (e.g., pyruvate kinase and phosphofructokinase deficiency) (Harvey and Smith, 1994), malignant histiocytosis (Newlands *et al.*, 1994), and hemochromatosis secondary to repeated blood transfusion (Sprague *et al.*, 2003). Serum ferritin is also increased in cattle with increased iron stores secondary to *Theileria sergenti*-induced hemolytic anemia (Watanabe *et al.*, 1998). Serum ferritin is transiently increased in horses after moderate to severe exercise (Hyypya *et al.*, 2002) and in foals following consumption of colostrum, which contains high ferritin concentrations compared to milk (Harvey *et al.*, 1987a). Serum ferritin is decreased in animals with iron deficiency (Harvey *et al.*, 1987a; Smith *et al.*, 1986a; Weeks *et al.*, 1990).

Serum ferritin is an acute phase protein; consequently, increased values are expected in inflammatory conditions, in addition to conditions with increased iron stores (Ottenjann *et al.*, 2006; Smith *et al.*, 1986a; Smith and Cipriano, 1987). The proinflammatory cytokine tumor necrosis factor- $\alpha$  (TNF $\alpha$ ) stimulated sustained ferritin secretion in cultured human hepatocytes (Torti and Torti, 2002). Serum iron concentration may be decreased in both iron deficiency and in inflammatory conditions (Andrews and Smith, 2000). Consequently, serum ferritin concentration can help differentiate true iron deficiency (serum ferritin is low) from the anemia of inflammatory disease (serum ferritin is normal or high). It should be remembered that true iron deficiency could be missed if concomitant inflammation was present and resulted in increased ferritin secretion into blood. Commercial assay kits are not available for serum ferritin assays in animals, but ferritin assays may be performed for several species at Kansas State University.

#### E. Bone Marrow Iron

Prussian blue stain is used to evaluate bone marrow hemosiderin stores. Smears may be sent to a commercial laboratory for this stain, or a stain kit can be purchased and applied in-house (Harleco Ferric Iron Histochemical Reaction Set, #6498693, EM Diagnostic Systems, Gibbstown, New Jersey). When this stain is applied, iron-positive material

stains blue, in contrast to the dark pink color of the cells and background. A good-quality marrow aspirate smear with at least nine particles has been recommended to adequately assess marrow hemosiderin stores in macrophages using the Prussian blue stain (Hughes *et al.*, 2004). Determination of stainable iron in bone marrow is used as a measure of total body iron stores (Blum and Zuber, 1975; Franken *et al.*, 1981). A lack of stainable iron is consistent with iron deficiency; however, negative iron staining is not necessarily predictive of iron deficiency (Ganti *et al.*, 2003). Cats normally lack stainable iron in the marrow (Harvey, 1981). In addition, some cattle (especially younger animals) lack stainable iron in the marrow even though marrow iron can be demonstrated by chemical assay (Blum and Zuber, 1975). Cattle that lack stainable iron generally have lower marrow iron concentrations when measured chemically than cattle with a positive iron stain. Similarly, recently weaned dogs have little or no stainable iron in marrow, presumably reflecting low iron stores at the end of the nursing period (Fry and Kirk, 2006). Stainable iron in the marrow tends to increase with advancing age in humans, horses, and cattle (Blum and Zuber, 1975; Franken *et al.*, 1981). Stainable iron in bone marrow is generally increased in animals with hemolytic anemia and dyserythropoiesis, in which phagocytosis of erythroid cells is increased (Canfield *et al.*, 1987; Holland *et al.*, 1991; Steffen *et al.*, 1992; Weiss and Lulich, 1999), and in animals with anemia resulting from decreased erythrocyte production, including the anemia of inflammatory disease (Feldman *et al.*, 1981b).

Some nucleated erythrocytes in Prussian blue-stained smears from normal animals may contain one to three small, blue granules in their cytoplasm (Deiss *et al.*, 1966; Feldman *et al.*, 1981a). When heme synthesis is impaired (other than by iron deficiency), mitochondria accumulate excess amorphous iron aggregates, and increased siderotic granules are present that may form a ring around the nucleus (generally called a ringed sideroblast in human hematology) (Bottomley, 2004). Read Section VIII.F in this chapter for more information.

#### F. Erythrocyte Zinc Protoporphyrin

Heme is formed inside mitochondria when an Fe<sup>+2</sup> ion is inserted into protoporphyrin IX in a reaction catalyzed by ferrochelatase. The ferrochelatase enzyme also catalyzes zinc chelation with protoporphyrin IX to form zinc protoporphyrin (ZnPP) in trace amounts in normal animals. When iron is deficient or iron utilization is impaired, zinc becomes a prominent substrate for ferrochelatase, leading to increased ZnPP formation and accumulation in erythroid cells (Labbe *et al.*, 1999). ZnPP is a stable chelate that remains in erythrocytes throughout their life spans. It can be extracted from erythrocytes and measured using fluorometry or spectrophotometry. Unfortunately, ZnPP was unknowingly converted to free protoporphyrin during analysis for many years; consequently,

investigators using these methods reported ZnPP as free protoporphyrin (Labbe *et al.*, 1999). Fortunately, ZnPP can now be measured without extraction in washed erythrocytes using a hematofluorometer. This dedicated instrument measures the ratio of ZnPP fluorescence to heme (hemoglobin) absorption (Labbe *et al.*, 1999). In addition, a new fluorescent method for the direct and simultaneous measurement of ZnPP, free protoporphyrin IX, and fluorescent heme degradation product has been described using human and mouse hemolysates (Chen and Hirsch, 2006).

Increased ZnPP concentrations in circulating erythrocytes indicates that Fe<sup>+2</sup> availability was insufficient in the mitochondria of their precursors (nucleated erythroid cells and reticulocytes) and limited heme synthesis in these precursor cells. Because high ZnPP concentration is only present in erythrocytes formed during periods of limited iron availability and erythrocytes have long life spans in the circulation, conditions of limited iron availability need to persist for weeks before whole blood erythrocyte ZnPP concentrations are clearly above reference intervals (Martin *et al.*, 2004). Erythrocyte ZnPP concentration is high in true iron deficiency and in inflammatory disorders in which iron delivery to erythroid cells is limited (Feldman *et al.*, 1981a; Labbe *et al.*, 1999; Weeks *et al.*, 1990).

ZnPP concentration is also increased in association with lead toxicity (Hawke *et al.*, 1992; Kowalczyk *et al.*, 1981; Martin *et al.*, 2004). Lead inhibits the ferrochelatase enzyme to some degree. This inhibition should result in increased free protoporphyrin, rather than the increase in ZnPP that predominates in lead toxicity in humans (Lamola and Yamane, 1974) and the 2:1 increase in ZnPP versus free protoporphyrin that occurs in cattle with lead toxicity (George and Duncan, 1981). Consequently, it appears that lead impairs iron utilization in an additional way (Labbe *et al.*, 1999). Erythrocyte ZnPP may also increase when iron is being delivered to developing erythroid cells in the marrow at a rate insufficient to meet the demands of conditions with accelerated erythropoiesis.

### G. Tissue Nonheme Iron

Iron stores (ferritin and hemosiderin) can be determined directly by measuring nonheme iron concentrations in various organs. Although it may be desirable to measure total body nonheme iron stores, this is impossible in clinical patients and impractical in most research animals. Consequently, nonheme iron concentration is generally only determined in the liver and spleen because these organs contain large quantities of stored iron and are easily biopsied.

Total tissue iron includes heme-containing proteins, including hemoglobin, myoglobin, and certain enzymes, in addition to iron stored as ferritin and hemosiderin. Heme resists acid hydrolysis; consequently, nonheme iron can be separated from heme iron by extraction in acid and determined colorimetrically or coulometrically (Smith, 1997).

Nonheme iron stores are decreased in iron deficiency and increased in iron overload disorders (see Section VII.D). Nonheme stores are also increased in animals with hemolytic anemia and in animals with anemia resulting from decreased erythrocyte production. These conditions are not necessarily associated with an increase in total body iron, but rather with a shift of heme iron normally present in hemoglobin in circulating erythrocytes to nonheme iron stored as ferritin and hemosiderin within macrophages.

### H. Ferrokinetics

Ferrokinetics refers to measurements that are made following the intravenous injection of transferrin labeled with radioactive iron or the absorption of radioactive iron from the diet. Ferrokinetics studies of intravenously administered radioactive iron provide information concerning plasma iron turnover and iron incorporation in hemoglobin in circulating erythrocytes. Radioactive iron is cleared from plasma with half-time of about 60 to 90min (Nathanson *et al.*, 1985; Smith, 1997), and from 60% to 95% of the iron present in plasma is transported to the bone marrow for incorporation into hemoglobin in developing erythroid cells in animals (Fillet *et al.*, 1974; Gillis and Mitchell, 1974; Kaneko, 1964; Kaneko and Mattheeuws, 1966; Smith, 1997). Plasma iron transfer rates, plasma iron turnover rates, and marrow transit times may also be calculated (Smith, 1997). Ferrokinetic studies of experimental iron deficiency in dogs revealed that iron absorption was increased, plasma iron clearance was shortened, and iron retention in the body was increased compared to normal dogs (Nathanson *et al.*, 1985). Ferrokinetic studies provide useful pathophysiological information, but they are not practical for use in diagnostic veterinary medicine. The reader is referred to the fifth edition of this text for more detailed ferrokinetic information (Smith, 1997).

## VIII. DISORDERS OF IRON METABOLISM

### A. Iron Deficiency

Iron deficiency may be classified in three stages: storage iron deficiency, iron-deficient erythropoiesis, and iron deficiency anemia (Table 9-2). Iron deficiency in domestic animals is generally not recognized until microcytic anemia is present. Iron deficiency results from insufficient iron absorption in the intestine (rare except in nursing animals) or from hemorrhage and associated iron loss from the body.

#### 1. Clinical Signs

Clinical signs associated with iron deficiency anemia include pale mucous membranes, lethargy, weakness, and weight loss or retarded growth. These signs result not only from decreased hemoglobin synthesis, but from deficiencies

**Table 9-2** Iron Analytes in Various Stages of Iron Deficiency

Analyte	Iron Deficiency	Iron-Deficient Erythropoiesis	Iron Deficiency Anemia
Bone marrow iron	Low	Low	Low
Serum ferritin	Low	Low	Low
Serum iron	Normal	Low	Low
Zinc protoporphyrin	Normal	High	High
Transferrin saturation	Normal	Low	Low
Blood hemoglobin	Normal	Normal	Low
Erythrocyte size	Normal	Normal	Low

From Hastka et al. (1994).

in other iron-containing proteins including myoglobin, cytochromes, citric acid cycle enzymes, and other heme and nonheme iron-containing enzymes (Kolb, 1963; Smith, 1997). Additional signs that may be present include diarrhea, dermatitis, hematuria, hematochezia, and melena, depending on the cause of the iron deficiency anemia and the presence of other concomitant disorders. Iron-deficient animals are more susceptible to infections because of lowered immunity (Kolb, 1963). Asymptomatic dogs are commonly recognized serendipitously when complete blood counts are done as a routine screen before surgery and microcytic anemia is found.

## 2. Clinical Findings

With the exception of young growing animals, iron deficiency in domestic animals usually results from blood loss. Chronic iron deficiency anemia is common in adult dogs and ruminants in areas where bloodsucking parasite infestations are severe (Harvey *et al.*, 1982; Weiser and O'Grady, 1983). Chronic hemorrhage resulting in iron deficiency may also occur with intestinal neoplasms, transitional cell carcinomas, gastrointestinal ulcers, thrombocytopenia, inherited hemostatic disorders, hemorrhagic colitis, and menorrhagia (primates only). Excessive removal of blood from a blood donor animal can result in an iron-deficient state. Iron deficiency anemia appears to be rare in adult cats and horses (French *et al.*, 1987; Fulton *et al.*, 1988; Smith *et al.*, 1986a).

Milk contains relatively low concentrations of iron (Anderson, 1992; Kolb, 1963); consequently, nursing

animals can easily deplete body iron stores as they grow (Kolb, 1963; Smith, 1997). Piglets reared in modern facilities without access to soil are especially susceptible to the development of dietary iron deficiency anemia because they have lower iron stores at birth than other domestic animals studied, and they exhibit remarkably rapid growth while nursing (Kolb, 1963; Underwood, 1977). Iron deficiency can be prevented in piglets by allowing them to eat earth while rooting in open fields or by adding pieces of sod to their pens; however, iron deficiency is generally prevented by intramuscular iron dextran injections when pigs are raised in confinement (Kolb, 1963; Underwood, 1977). The concomitant occurrence of bloodsucking parasite infestations can result in especially severe iron deficiency anemia in nursing animals. Once the consumption of solid food begins, dietary iron deficiency in growing animals usually resolves (Kolb, 1963). At least 80mg available iron per kilogram diet is required to avoid iron-limited erythropoiesis in puppies, kittens, and piglets (Chausow and Czarnecki-Maulden, 1987; Kolb, 1963). Iron deficiency anemia is an unavoidable consequence of feeding practices designed to produce pale meat in veal calves (Miltenburg *et al.*, 1992a).

## 3. Laboratory Findings

Anemia in iron-deficient animals generally results from a combination of hemorrhage and impaired (iron-limited) erythrocyte production. However, iron-deficient erythrocytes also exhibit decreased life spans, with evidence of enhanced eryptosis characterized by cell shrinkage, membrane blebbing, and surface exposure of phosphatidylserine (Kempe *et al.*, 2006). The hematocrit decreases before the MCV and MCHC decrease, especially when iron deficiency is caused by bleeding. The MCV is generally normal in acute iron deficiency. If the iron-deficient state persists for weeks to months, the number of microcytic cells produced can constitute a sufficient enough portion of the erythrocyte population to reduce the MCV below the normal reference intervals. Iron deficiency anemia is defined as iron deficiency that results in microcytic anemia. Because erythrocyte indices are generally normal during early iron deficiency, most cases of iron deficiency go undiagnosed at this stage. Microcytic erythrocytes are produced in response to iron deficiency in nursing kittens and pups, but low MCV values may not develop postnatally because the MCV is above adult values at birth in these species and some fetal macrocytes may persist during the iron-deficient nursing period. The review of erythrocyte volume histograms can reveal the presence of microcytes in iron-deficient pups and kittens that have normal MCV values (Weiser and Kociba, 1983). New hematology instruments have the ability to calculate the percentage of microcytes present.

The mean cell hemoglobin concentration (MCHC) within iron-deficient erythrocytes may be low because iron

is needed for normal hemoglobin synthesis. A decrease in MCV generally precedes a decrease in MCHC in iron-deficient animals (Harvey, 2000). A low MCHC is often present in severely affected dogs and ruminants, but it is rarely present in iron-deficient horses or adult cats. The red cell distribution width (RDW) is often increased because of the presence of increased numbers of microcytes together with normocytic cells.

Because reticulocytes are recently formed immature erythrocytes, reticulocyte parameters may better reflect the current state of iron sufficiency in an animal. A retrospective study of dogs with natural disease found that low  $MCV_{retic}$  and low,  $CH_{retic}$  were indicators of iron deficiency (Steinberg and Olver, 2005). In addition to these parameters, a prospective study of diet-induced iron deficiency in post-weaning dogs found that increased %  $Hypo_{retic}$ , increased % Low  $CH_{retic}$ , decreased % High  $CH_{retic}$ , and decreased %  $Macro_{retic}$  were indicators of iron deficiency (Fry and Kirk, 2006). Of these various reticulocyte parameters, the  $CH_{retic}$  appears to be the most widely used in the diagnosis of iron deficiency in humans (Brugnara *et al.*, 2006).

Erythrocytes from dogs and ruminants with iron deficiency anemia often appear hypochromic on stained blood smears (Harvey, 2001). In these species in which erythrocytes appear as discocytes, hypochromic erythrocytes have a narrow rim of lightly stained hemoglobin and greater than normal area of central pallor. This hypochromasia results from both decreased hemoglobin concentration within cells and from the fact that the cells are thin (leptocytes). Because these microcytic leptocytes have increased diameter-to-volume ratios, they may not appear as small cells when viewed in stained blood films. Erythrocytes from members of the family Camelidae are elliptical and not biconcave. Microcytic erythrocytes from iron-deficient llamas exhibit irregular or eccentric areas of hypochromasia within the cells (Morin *et al.*, 1993).

Poikilocytosis (keratocytes and schistocytes) is often present, being most pronounced in association with severe microcytosis (Harvey, 2001). Poikilocytosis is common in young calves. In some cases it may result from iron deficiency, but abnormalities in protein 4.2 in the membrane and hemoglobin composition have also been suggested as causative factors (Okabe *et al.*, 1996). Folded cells and dacryocytes are common erythrocyte shape abnormalities in iron-deficient llamas (Morin *et al.*, 1993).

Not only is there apparently a low incidence of this disorder in horses and adult cats, but some cases may not be recognized because hypochromasia is usually not apparent when stained blood films from iron-deficient horses and adult cats are examined. Additionally, some electronic cell counters may not count the microcytic cells present, resulting in a spuriously increased MCV. Electronic cell counters with erythrocyte histogram displays provide visual evidence that a threshold failure has occurred (Weiser and Kociba, 1983).

Increased production and release of reticulocytes from bone marrow typically occur in response to hemorrhage in species other than the horse. Consequently, absolute reticulocytosis is often present in the early stage of iron deficiency secondary to hemorrhage, at least in the dog (Harvey *et al.*, 1982). As iron depletion becomes more severe, there is insufficient iron for reticulocyte production, and the absolute reticulocyte count no longer increases. Thrombocytosis is often present in animals with iron deficiency anemia. This platelet increase may in part be related to a stimulation of megakaryopoiesis by high erythropoietin concentration in plasma (Loo and Beguin, 1999), but the mechanism has not been clearly defined (Kadikoylu *et al.*, 2006). Plasma protein concentrations may decrease if substantial recent or ongoing hemorrhage is present.

Serum iron concentration is usually low in animals with iron deficiency anemia (Furugouri, 1972; Halvorsen and Halvorsen, 1973; Harvey *et al.*, 1982; Harvey *et al.*, 1987a; Mollerberg *et al.*, 1975; Weiser and Kociba, 1983), but it can also be low in association with inflammatory disorders (Feldman *et al.*, 1981b; Kolb, 1963; Neumann, 2003; Smith and Cipriano, 1987; van Miert *et al.*, 1990). Serum iron is also affected by other factors such as endogenous cortisol concentration, administration of glucocorticoids (Harvey *et al.*, 1987b), and consumption of meat (Brugnara, 2003).

TIBC is usually normal in dogs and cats, but it is increased in humans, rabbits, pigs, horses, and cattle (Furugouri, 1972; Halvorsen and Halvorsen, 1973; Harvey *et al.*, 1982; Harvey *et al.*, 1987a; Mollerberg *et al.*, 1975; Weiser and Kociba, 1983). However, transferrin is a negative acute phase protein (Ceron *et al.*, 2005), and the concomitant presence of inflammation with iron deficiency might lower serum TIBC concentration in animals that could otherwise have high values.

Serum ferritin concentration correlates directly with body iron stores in dogs, cats, horses, and pigs (Andrews *et al.*, 1994; Smith *et al.*, 1984a; Smith *et al.*, 1984b; Weeks *et al.*, 1989b). Consequently, serum ferritin is low in iron deficiency (Fry and Kirk, 2006). A problem with serum ferritin is that it is an acute phase protein and it can increase secondarily to inflammation or liver disease (Ottenjann *et al.*, 2006; Smith and Cipriano, 1987), resulting in an overestimation of total body iron content that might mask the presence of concomitant iron deficiency (Coenen *et al.*, 1991). Suspected iron deficiency can be confirmed by finding minimal or absent stainable iron in the bone marrow of most species. However, stainable iron is not present in the bone marrow of normal cats (Harvey, 1981); consequently, a lack of stainable iron does not indicate iron deficiency in this species. Although cat bone marrow normally lacks stainable iron (hemosiderin), it presumably still has ferritin stores not identified using Prussian blue staining (Blum and Zuber, 1975; Navone *et al.*, 1988).

Serum soluble TfR levels and erythrocyte ZnPP concentrations have been used in the diagnosis of iron deficiency

in humans (Metzgeroth *et al.*, 2005). Soluble TfR levels are increased in iron deficiency and other disorders with increased erythropoiesis, but not in the anemia of inflammatory disease (Ferguson *et al.*, 1992). This assay is not available for domestic animals at this time. Erythrocyte ZnPP is increased when iron delivery to mitochondria is limited (iron deficiency and anemia of inflammatory disease), but not influenced by the erythropoietic activity (Metzgeroth *et al.*, 2005).

## B. Anemia of Inflammatory Disease

A mild to moderate nonregenerative anemia often accompanies chronic inflammatory disease. It has been called the anemia of inflammatory disease or the anemia of chronic disease. The anemia of inflammatory disease has also been associated with neoplastic conditions, but this could not be confirmed in dogs with lymphoma (Lucroy *et al.*, 1998). Clinical signs and physical findings vary depending on the nature of the disorder, but weight loss and fever are often present. The anemia is generally normocytic, but it may be slightly microcytic in long-standing cases (Harvey, 2000; Ottenjann *et al.*, 2006). The cause of the anemia is multifactorial. Abnormalities that contribute to the anemia include the production of inflammatory mediators that directly or indirectly inhibit erythropoiesis, blunt the erythropoietin response to the anemia, decrease serum iron, and shorten erythrocyte life spans (Theurl *et al.*, 2006; Weiss and Goodnough, 2005).

The proliferation of erythroid progenitor cells (burst-forming unit-erythroid [BFU-E] and CFU-E) is inhibited in the presence of TNF $\alpha$ , IL-1, and the interferon- $\alpha$ , - $\beta$ , and - $\gamma$ . Of these molecules, interferon- $\gamma$  appears to be the most potent inhibitor. The underlying mechanism responsible for this inhibition may involve cytokine-mediated apoptosis, which may be related to down-regulation of erythropoietin receptors on progenitor cells and reduced expression of hematopoietic growth factors. Cytokines may also stimulate macrophages in the marrow to form nitrogen and oxygen-free radicals that could be toxic to neighboring progenitor cells (Weiss and Goodnough, 2005). Erythrocyte proliferation is further reduced because cytokines such as IL-1 and TNF $\alpha$  inhibit erythropoietin expression by the kidney. As a result, the erythropoietin response to the anemia of inflammatory disease is inadequate for the degree of anemia present (Ottenjann *et al.*, 2006; Weiss *et al.*, 1983; Weiss and Goodnough, 2005).

Erythropoiesis is also limited in the anemia of inflammatory disease because serum iron concentration is generally low (Feldman *et al.*, 1981a; Neumann, 2003; Smith and Cipriano, 1987; Verheijden *et al.*, 1982; Weiss *et al.*, 1983), although hypoferrremia was reported in a minority of cats with naturally occurring inflammation (Ottenjann *et al.*, 2006). Altered iron metabolism associated with

inflammatory and neoplastic disorders is attributable to increased hepcidin production. Hepcidin expression is induced by IL-6 and possibly IL-1 (Lee *et al.*, 2005; Nemeth *et al.*, 2004a). Increased hepcidin expression occurs within hours following an inflammatory insult. Hepcidin interacts directly with ferroportin, leading to the internalization and lysosomal degradation of this iron export protein. Decreased ferroportin expression results in decreased iron absorption and decreased iron release from macrophages and hepatocytes (Verga Falzacappa and Muckenthaler, 2005). Continued utilization of transferrin-bound iron, with decreased entry of iron into plasma, results in hypoferrremia (Steele *et al.*, 2005). Injection of recombinant human hepcidin resulted in hypoferrremia within 1 h in mice. This decrease occurs rapidly because the plasma iron pool is small compared to the iron flux needed for erythropoiesis (Rivera *et al.*, 2005). This hypoferrremia is part of an iron-withholding defense system, which deprives microbial invaders and neoplastic cells of iron essential for their growth (Kontoghiorghes and Weinberg, 1995). Hepcidin itself has antimicrobial properties, but the clinical importance of this function is unclear (Park *et al.*, 2001; Verga Falzacappa and Muckenthaler, 2005).

Although reduced erythropoiesis primarily accounts for the anemia associated with inflammatory diseases, shortened erythrocyte life spans also contribute to the development of anemia in these disorders (Weiss and Krehbiel, 1983). Inflammatory reactions generate free radicals that can damage erythrocyte membranes, resulting in premature erythrophagocytosis (Weiss *et al.*, 1992; Weiss and Klausner, 1988; Weiss and Goodnough, 2005).

The hematocrit is generally only slightly decreased in association with inflammation in most animals but is more likely to be moderately decreased (or rarely markedly decreased) in cats, in which anemia develops more rapidly than in dogs (Mahaffey and Smith, 1978; Ottenjann *et al.*, 2006; Weiss *et al.*, 1983). The MCV is usually at the low end of the reference interval but may occasionally be slightly below the reference interval (Harvey, 2000; Ottenjann *et al.*, 2006). The MCHC and RDW are generally normal. The erythrocyte morphology is usually normal, except for increased rouleaux formation at times in dogs. Reticulocyte counts in blood are not increased in response to the anemia because of the impaired erythropoiesis present (Feldman *et al.*, 1981a; Ottenjann *et al.*, 2006; Weiss *et al.*, 1983).

Serum iron is generally decreased (Feldman *et al.*, 1981b; Weiss *et al.*, 1983) because inflammation results in increased hepcidin secretion into plasma by hepatocytes. TIBC in serum is a measure of total transferrin (apotransferrin, monoferric transferrin, and diferric transferrin) concentration. Transferrin is a negative acute phase protein and tends to decrease during inflammation. Consequently, TIBC may be decreased in association with the anemia of inflammatory disease (Feldman *et al.*, 1981a; Ottenjann *et al.*, 2006; Smith and Cipriano, 1987). An exception to

**TABLE 9-3** Laboratory Findings in Chronic Iron Deficiency Anemia versus the Anemia of Inflammatory Disease

Parameter	Iron Deficiency Anemia	Anemia of Inflammatory Disease
Hematocrit	Slight to marked decrease	Slight to moderate decrease
Mean cell volume	Slight to marked decrease	Normal to slight decrease
Serum iron	Slight to marked decrease	Slight to moderate decrease
Serum TIBC	Normal to increased	Normal to decreased
Serum ferritin	Decreased	Normal to increased
Marrow hemosiderin	Decreased or absent	Normal to increased

Abbreviation: TIBC, total iron-binding capacity.

this pattern appears to be chronic hepatitis, in which serum iron and TIBC may be increased rather than decreased (Soubasis *et al.*, 2006). Serum ferritin, bone marrow stainable iron, and liver nonheme iron are increased with inflammation (Feldman *et al.*, 1981a, 1981c). Serum ferritin may be increased both as a result of increased iron stores and because it is an acute phase protein (Ottenjann *et al.*, 2006; Smith and Cipriano, 1987). Hematological aspects of the anemia of inflammatory disease are compared to iron deficiency in Table 9-3.

### C. Portosystemic Shunts

Vascular connections between the portal and systemic circulation that preferentially divert portal blood around the liver are called portosystemic shunts (PSS). They may be congenital or develop secondary to portal hypertension associated with chronic primary hepatobiliary disease (Center and Magne, 1990).

Microcytosis occurs in approximately two-thirds of the dogs with PSS. The cause of the microcytosis is not completely understood, but it is associated with abnormal iron metabolism. The MCV is seldom more than 7fl below the reference interval and the hematocrit is within or slightly below the reference interval. The MCHC is slightly decreased and the RDW is slightly increased in a majority of cases. Codocytes are commonly observed in dogs. The MCV is slightly decreased in about one-third of the cats with PSS. Poikilocytosis (keratocytes and elliptocytes) is common, but anemia is not usually present (Center and Magne, 1990; Levy *et al.*, 1995).

About half of the dogs with PSS exhibit hypoferrremia with normal or slightly decreased serum TIBC. Serum ferritin and stainable iron (hemosiderin) in the liver and bone marrow are normal or high (Bunch *et al.*, 1995; Doberneck *et al.*, 1963; Laflamme *et al.*, 1994; Meyer and Harvey, 1994; Simpson *et al.*, 1997). Erythrocyte protoporphyrin and serum ceruloplasmin concentrations are normal (Bunch *et al.*, 1995). Although the animals are not truly iron deficient, the low serum iron appears to be related to the development of microcytosis (Simpson *et al.*, 1997).

### D. Copper Deficiency

Copper deficiency generally results in anemia in mammals (Auclair *et al.*, 2006; Brewer, 1987; Lahey *et al.*, 1952), although anemia was not a feature of experimental copper deficiency in the cat (Doong *et al.*, 1983). The anemia is generally microcytic hypochromic; however, normocytic anemia has been reported in experimental studies in dogs, and normocytic or macrocytic anemias have been reported in cattle and adult sheep (Brewer, 1987).

Copper deficiency results in impaired iron metabolism (Lee *et al.*, 1968b). In experimental studies in pigs, serum iron concentration is low in early copper deficiency when iron stores are normal (Lahey *et al.*, 1952; Lee *et al.*, 1968b). Functional iron deficiency occurs because copper-containing proteins hephaestin and ceruloplasmin are required for normal iron transport (Lee *et al.*, 1968a; Wessling-Resnick, 2006). Decreased hephaestin levels in intestinal enterocytes of copper-deficient animals result in decreased iron release from enterocytes into plasma because hephaestin facilitates iron export by ferroportin (Reeves *et al.*, 2005; Wessling-Resnick, 2006). Copper deficiency in pigs results in a marked decrease in circulating ceruloplasmin and decreased release of iron from tissue stores. Administration of ceruloplasmin to these copper-deficient pigs results in a prompt release of iron into the circulation bound to transferrin (Lee *et al.*, 1968b; Roeser *et al.*, 1970). Iron is diminished in the liver of copper-deficient pigs but accumulates in the liver of copper-deficient rats and mice, suggesting that intestinal iron absorption may not be as compromised in copper-deficient rodents (Auclair *et al.*, 2006; Wessling-Resnick, 2006). Humans with hereditary aceruloplasminemia have iron accumulation in liver and other tissues. Clinical signs include diabetes, dementia, and retinal degeneration, but not liver disease (Hellman and Gitlin, 2002).

If experimental copper deficiency is prolonged in pigs, hyperferrremia occurs and nucleated erythroid cells with cytoplasmic siderotic (iron-positive) inclusions increase in bone marrow (Lee *et al.*, 1968a). Reticulocyte mitochondria from copper-deficient pigs are unable to synthesize heme at the normal rate using Fe<sup>+3</sup> (Williams *et al.*, 1976). A deficiency in copper-containing cytochrome oxidase within mitochondria may slow the reduction of Fe<sup>+3</sup> to Fe<sup>+2</sup> within mitochondria. That would limit heme synthesis, which



requires iron in the  $\text{Fe}^{+2}$  state (Porra and Jones, 1963). Siderotic inclusions have also been reported in erythroid cells in copper deficiency in humans (Gregg *et al.*, 2002).

Zinc toxicity results in copper deficiency (presumably secondary to impaired copper absorption), hypoferrremia, and microcytic anemia in humans (Beutler, 2006a; Fosmire, 1990; Gyorffy and Chan, 1992), and zinc toxicity, from the use of galvanized feeding bins, resulted in copper deficiency and anemia in pigs (Pritchard *et al.*, 1985).

### E. Iron Overload

Iron accumulates in hepatocytes when transferrin saturation is high. In addition to transferrin-bound iron, the liver can readily take up NTBI from plasma and iron contained within heme that is bound to the plasma protein hemopexin. Ferroportin expression is lower in hepatocytes than in enterocytes and macrophages, which may help explain why hepatocytes preferentially accumulate iron in most iron overload conditions; however, considerable amounts of iron are stored in macrophages with transfusional iron overload (Anderson and Frazer, 2005; Rivera *et al.*, 2005). The increased uptake of iron by hepatocytes results in increased synthesis of apoferritin and formation of ferritin in cytoplasm and formation of hemosiderin in lysosomes. Although binding of iron molecules in these storage proteins minimizes the amount of “free” iron available to catalyze the formation of reactive oxygen species, oxidation of polyunsaturated phospholipids within organelles and cellular membranes and oxidative damage to proteins and DNA may still occur in conditions resulting in excess intracellular iron accumulation (Ramm and Ruddell, 2005; Rothman *et al.*, 1992; Ryan and Aust, 1992). Hepatic stellate cells become activated into highly proliferative myofibroblast-like cells during conditions with excessive iron accumulation. This activation results in increased fibrogenesis and subsequently cirrhosis within the liver in conditions with chronic iron accumulation (Ramm and Ruddell, 2005). Other sites that may accumulate iron, depending on the cause of iron overload, include pancreas, heart, kidneys, and endocrine organs (House *et al.*, 1994; Lowenstine and Munson, 1999).

Serum iron and serum ferritin concentrations are increased in animals with iron overload, but both can be increased in other conditions (see serum iron section). Consequently, a liver biopsy is needed to definitively diagnose iron overload (Lowenstine and Munson, 1999). Excessive accumulation of iron within hepatocytes can be identified by the staining of hepatocytes using an iron stain (Perl’s Prussian blue) and quantified using flame atomic absorption (Sprague *et al.*, 2003).

#### 1. Acute Iron Toxicity

NTBI in plasma may play a significant role in the pathogenesis of tissue injury in severely iron-overloaded

individuals, especially in individuals with acute iron toxicity (Koury and Ponka, 2004). The amount of iron taken up by hepatocytes and other cells in acute iron toxicity far exceeds the ability of these cells to increase apoferritin synthesis as a protective response. Most fatal cases of acute iron toxicity in animals have resulted from the parenteral administration of large doses of iron, and animals with hypovitaminosis E appear to be especially susceptible (Arnbjerg, 1981). Acute iron toxicity from parenteral iron administration in calves and goats resulted in clinical findings including central nervous system signs, vocalization, respiratory distress, icterus, and death. Pulmonary edema, hemorrhages on serosal surfaces, and hepatic necrosis were documented at necropsy (Ruhr *et al.*, 1983). The oral consumption of large amounts of iron can also result in central nervous system signs, hemorrhage, icterus, and pulmonary edema, but clinical findings can also include vomiting, bloody diarrhea, and subsequently, dehydration, metabolic acidosis, and hypovolemic shock. Histological findings associated with oral iron toxicity include small intestine ulceration, hemorrhage, and necrosis; pulmonary edema and hemorrhage; and degenerative changes in kidneys and liver (Arnbjerg, 1981). Newborn foals exhibited hepatotoxicity following the oral administration of a digestive paste containing ferrous fumarate iron at a concentration much lower than is required for acute iron toxicity in adult animals of various species (Mullaney and Brown, 1988). This liver injury may have resulted from increased NTBI uptake by the liver because serum transferrin is highly saturated at birth in foals (Harvey *et al.*, 1987a). In addition, iron absorption may be higher in neonatal foals as reported in neonatal piglets and rats (Mullaney and Brown, 1988). Cirrhosis is not a feature of acute iron toxicity except in animals that survive long enough for fibrosis to develop (Mullaney and Brown, 1988).

#### 2. Hemochromatosis

The term *hemochromatosis* refers to the accumulation of iron in parenchymal cells, resulting in organ injury and dysfunction. Accumulation of iron within cells (typically macrophages), without evidence of organ dysfunction, is termed *hemosiderosis*. Localized iron overload occurs in macrophages in areas where hemorrhage has occurred. Systemic iron deposition may occur in a variety of organs, but it is especially prominent in hepatocytes (Lowenstine and Munson, 1999). The accumulation of large amounts of iron in hepatocytes results in hepatocellular injury, increased fibrogenesis, and liver failure in severe cases. Hemochromatosis is classified as primary, secondary, or idiopathic. Primary hemochromatosis refers to inherited disorders of iron metabolism resulting in hemochromatosis. Secondary hemochromatosis refers to disorders in which iron accumulation occurs secondary to other disorders, including excessive dietary iron, unnecessary parenteral

iron supplementation, chronic hemolytic anemia, repeated blood transfusions, ineffective erythropoiesis, and possibly primary liver disease (Lowenstine and Munson, 1999). The etiology of idiopathic hemochromatosis by definition cannot be determined.

### 3. H<sub>2</sub>O<sub>2</sub> A<sub>2</sub>

Intestinal iron absorption is increased in animals and humans with hemolytic anemia and compensatory increased erythropoiesis (Latunde-Dada *et al.*, 2006a). Hepcidin synthesis is down-regulated and DMT1, DcytB, and ferroportin are up-regulated during hemolysis in rats induced by phenylhydrazine (Latunde-Dada *et al.*, 2006a).

This increased iron absorption, even with high hepatic iron stores, documents the importance of erythroid drive over iron storage in the regulation of iron absorption (Latunde-Dada *et al.*, 2006a). Hemosiderin is typically increased in macrophages in animals with hemolytic anemia because of increased phagocytosis of erythrocytes. However, increased iron absorption associated with persistent regenerative anemia can also result in iron accumulation within hepatocytes.

Hemosiderosis, hemochromatosis, and fibrosis develop in the liver of erythrocyte pyruvate kinase-deficient dogs secondary to progressive iron overload (Searcy *et al.*, 1979; Weiden *et al.*, 1981; Zaucha *et al.*, 2001). Dogs with inherited pyruvate kinase deficiency also exhibit the progressive development of myelofibrosis and osteosclerosis, and it is proposed that the marrow fibrosis, like the cirrhosis, occurs in response to damage caused by iron overload (Zaucha *et al.*, 2001). Pyruvate kinase-deficient dogs generally die between 1 and 5 years of age because of bone marrow failure or liver failure (Harvey, 2006).

### 4. R<sub>2</sub>H<sub>2</sub> B<sub>2</sub> r F<sub>2</sub> , , , , r P<sub>2</sub>H<sub>2</sub> B<sub>2</sub> r F<sub>2</sub> Ar , , r

Long-term repeated blood transfusions commonly result in iron overload in human patients, but animals are rarely given sufficient transfusions for this to be a risk in veterinary medicine. Hemochromatosis, with subsequent liver failure, occurred in a dog given whole blood transfusions every 6 to 8 weeks for 3 years as treatment for pure red cell aplasia (Sprague *et al.*, 2003). Histological evaluation of the liver revealed hepatocellular degeneration, bridging portal fibrosis, lobular atrophy, biliary hyperplasia, and large amounts of hemosiderin in hepatocytes and mononuclear phagocytes. The repeated administration of large doses of parenteral iron to dogs in experimental studies over several years resulted in hepatic iron overload and cirrhosis (Lisboa, 1971).

### 5. D<sub>2</sub>H<sub>2</sub> r F<sub>2</sub> O<sub>2</sub> B<sub>2</sub> r

Some species of wild animals develop iron overload, and sometimes hemochromatosis, when housed in captivity.

These animals include black rhinoceroses, lemurs, and birds (most notably mynahs and toucans) (Lowenstine and Munson, 1999; Paglia *et al.*, 2001). Dietary iron overload may occur from increased amounts of iron in the diet or from an alteration in the diet that results in increased absorption of iron. Compounds including tannins and phytates in natural diets may chelate much of the dietary iron into insoluble complexes. When diets fed in captivity contain less of these inhibitory compounds, iron may be absorbed in excess of what is needed for hemoglobin synthesis and other metabolic functions. For example, black rhinoceroses are browsers in the wild with a diet rich in woody plants, but they are fed manufactured pellets and domestic forages in captivity that contain more bioavailable iron (Paglia *et al.*, 2001). Kinetic studies comparing Fe<sup>+2</sup> absorption by enterocytes from mynahs and chickens revealed a three-fold higher V<sub>max</sub> for mynahs, even though liver iron content was at least 10-fold higher in mynahs than chickens (Mete *et al.*, 2003). This results from an overexpression of intestinal iron transporters DMT1 and ferroportin (Mete *et al.*, 2005). Although mynahs can down-regulate iron uptake to some extent (Mete *et al.*, 2001), this evolutionary adaptation to their natural diet results in excessive iron absorption when they are fed a different diet in captivity.

### 6. H<sub>2</sub>H<sub>2</sub> r F<sub>2</sub> H<sub>2</sub> B<sub>2</sub> r , ,

Most types of hereditary hemochromatosis in humans are characterized by primary or secondary hepcidin deficiency. Primary hepcidin deficiency results from a mutation in the hepcidin gene. Secondary hepcidin deficiency occurs when there are mutations in the HFE gene, Tfr2 gene, or hemojuvelin gene (Verga Falzacappa and Muckenthaler, 2005). Murine models of each of these defects have been created and each results in iron overload (Vaulont *et al.*, 2005). The mechanisms by which the protein products of these genes control hepcidin synthesis remain to be defined. Iron also accumulates in humans with various mutations in ferroportin that result in resistance to down-regulation by hepcidin. Most patients have iron accumulation predominantly in hepatocytes, but some have iron accumulation predominantly in macrophages (Fleming *et al.*, 2005; Wessling-Resnick, 2006).

Hemochromatosis has been described in related Salers cattle, and it is presumed to be inherited (House *et al.*, 1994; O'Toole *et al.*, 2001). Affected animals were young (about 2 years old or less) with a history of poor growth, weight loss, and poor hair coat. They had iron accumulations in liver, spleen, lymph nodes, kidney, brain, thyroid, and other glandular organs. Histopathology of the liver revealed marked accumulations of stainable-iron in hepatocytes, Kupffer cells, and arteriolar walls, with bridging periportal fibrosis. Affected cattle also have markedly increased iron content in bone, periosteal dysplasia, and osteopenia resulting in pathological fractures and tooth loss

(Norrdin *et al.*, 2004). The cause of this disorder in cattle is unknown, but the findings that BMPs can stimulate hepcidin expression (Truksa *et al.*, 2006), and that deficient BMP activity can result in osteopenia (Rosen, 2006), suggest that a BMP defect or a BMP signal transduction pathway defect should be investigated.

## 7. Iron, Hemoglobin, and Iron

Idiopathic hemochromatosis with hepatic cirrhosis and biliary hyperplasia has been described in three full-sized horses (14 years to 16 years old) and an 11-year-old racing pony (Lavoie and Teuscher, 1993; Pearson *et al.*, 1994). Hepatocytes and Kupffer cells contained markedly increased stainable iron in all horses, and iron accumulations were noted outside the liver in tissues including the epithelium of large bile ducts, follicular epithelium of the thyroid gland, cortical tubules of the kidneys, and in the neurohypophysis in the pony (Lavoie and Teuscher, 1993). Iron can accumulate in the liver of animals with chronic liver disease; consequently, one might speculate that the full-sized horses had primary liver disease with secondary iron accumulation (Pearson *et al.*, 1994; Schultheiss *et al.*, 2002). However, iron accumulation secondary to chronic liver disease is reported to occur in Kupffer cells and macrophages, but not hepatocytes (Schultheiss *et al.*, 2002). The widespread iron deposition in the pony is similar to that seen in people with hereditary hemochromatosis.

## F. Siderotic Inclusions in Erythroid Cells

Anucleated erythrocytes containing siderotic inclusions are called siderocytes. Nucleated siderocytes have been called sideroblasts in human hematology, in which terminology used for erythrocyte precursors is generally different from that conventionally used in veterinary hematology (Bottomley, 2004). Siderotic inclusions in erythroid cells may consist of cytoplasmic ferritin aggregates or iron-loaded mitochondria. Ferritin aggregates can occur normally in nucleated erythroid cells, but the presence of iron-loaded mitochondria is a pathological finding (Cartwright and Deiss, 1975). Electron microscopy is used to definitively identify the nature of siderotic inclusions (Fresco, 1981; Hammond *et al.*, 1969); however, the location of iron-positive inclusions in a ring around the nucleus of a nucleated siderocyte (termed ringed sideroblast in human hematology) strongly suggests the presence of iron-loaded mitochondria (Bottomley, 2004).

Except for iron deficiency, disorders in heme synthesis have the potential to cause excess iron accumulation in mitochondria (Beutler, 1995; Fairbanks and Beutler, 1995). Chronic copper deficiency, as a cause for the formation of siderotic inclusions, was discussed previously. Pyridoxine, vitamin B<sub>6</sub>, is required for the first step in heme synthesis, and erythroid cells with iron-loaded mitochondria have been documented in pigs fed a pyridoxine-deficient diet

(Hammond *et al.*, 1969). Drugs or chemicals reported to cause siderocytes or nucleated siderocytes in dogs include chloramphenicol (Harvey *et al.*, 1985), lead, hydroxyzine, zinc (Harvey, 2001), and an oxazolidinone antibiotic (Lund and Brown, 1997).

Siderotic inclusions in erythroid cells have been recognized in some dogs and cats with myeloproliferative disorders (Blue *et al.*, 1988; Weiss and Lulich, 1999). Acquired dyserythropoiesis with siderocytes have been reported in dogs in which specific etiologies could not be determined, although some of these animals had inflammatory disorders (Canfield *et al.*, 1987; Weiss, 2005). Persistent siderotic inclusions have been recognized in microcytic hypochromic erythrocytes from an English bulldog. Erythrocytes also contained Heinz bodies and rare hemoglobin crystals (Harvey *et al.*, 2007). A congenital defect resulting in mitochondrial iron overload and secondary oxidant injury was suspected but not identified.

Congenital anemias with ringed nucleated siderocytes have been reported in humans but not in domestic animals (Bottomley, 2004, 2006). Inherited causes recognized in humans include defective eALAS, adenosine triphosphate-binding cassette 7 (ABC7) transporter, glutaredoxin 5, thiamine transporter, pseudouridine synthase I, and respiratory chain components (Bottomley, 2006; Camaschella *et al.*, 2007). Siderotic inclusions occur in erythroid cells of mice genetically altered to produce eALAS deficiency (Nakajima *et al.*, 2006) and mitochondrial superoxide dismutase 2 deficiency (Friedman *et al.*, 2004).

## REFERENCES

- Adamama-Moraitou, K. K., Saridomichelakis, M. N., Polizopoulou, Z., Kritsepi, M., Tsompanakou, A., and Koutinas, A. F. (2005). Short-term exogenous glucocorticosteroidal effect on iron and copper status in canine leishmaniasis (*Leishmania infantum*). *Can. J. Vet. Res.* **69**, 287–292.
- Anderson, G. J., and Frazer, D. M. (2005). Hepatic iron metabolism. *Semin. Liver Dis.* **25**, 420–432.
- Anderson, R. R. (1992). Comparison of trace elements in milk of four species. *J. Dairy Sci.* **75**, 3050–3055.
- Andrews, G. A., Chavey, P. S., and Smith, J. E. (1994). Enzyme-linked immunosorbent assay to measure serum ferritin and the relationship between serum ferritin and nonheme iron stores in cats. *Vet. Pathol.* **31**, 674–678.
- Andrews, G. A., and Smith, J. E. (2000). Iron metabolism. In “Schalm’s Veterinary Hematology” (B. F. Feldman, J. G. Zinkl, and N. C. Jain, Eds.), pp. 129–139. Lippincott Williams and Wilkins, Philadelphia.
- Arnbjerg, J. (1981). Poisoning in animals due to oral application of iron: with description of a case in a horse. *Nord. Vet. Med.* **33**, 71–76.
- Arosio, P., and Levi, S. (2002). Ferritin, iron homeostasis, and oxidative damage. *Free Radic. Biol. Med.* **33**, 457–463.
- Auclair, S., Feillet-Coudray, C., Coudray, C., Schneider, S., Muckenthaler, M. U., and Mazur, A. (2006). Mild copper deficiency alters gene expression of proteins involved in iron metabolism. *Blood Cells Mol. Dis.* **36**, 15–20.

- Beutler, E. (1995). Hereditary and acquired sideroblastic anemias. In "Williams Hematology" (E. Beutler, M. A. Lichtman, B. S. Coller, and T. J. Kipps, Eds.), pp. 747–750. McGraw-Hill, New York.
- Beutler, E. (2006a). Anemia resulting from other nutritional deficiencies. In "Williams Hematology" (M. A. Lichtman, E. Beutler, T. J. Kipps, U. Seligsohn, K. Kaushansky, and J. T. Prchal, Eds.), pp. 555–559. McGraw-Hill, New York.
- Beutler, E. (2006b). Disorders of iron metabolism. In "Williams Hematology" (M. A. Lichtman, E. Beutler, T. J. Kipps, U. Seligsohn, K. Kaushansky, and J. T. Prchal, Eds.), pp. 511–553. McGraw-Hill, New York.
- Blue, J. T., French, T. W., and Kranz, J. S. (1988). Non-lymphoid hematopoietic neoplasia in cats: a retrospective study of 60 cases. *Cornell Vet.* **78**, 21–42.
- Blum, J. W., and Zuber, U. (1975). Iron stores of liver, spleen and bone marrow, and serum iron concentrations in female dairy cattle in relationship to age. *Res. Vet. Sci.* **18**, 294–298.
- Borges, A. S., Divers, T. J., Stokol, T., and Mohammed, O. H. (2007). Serum iron and plasma fibrinogen concentrations as indicators of systemic inflammatory diseases in horses. *J. Vet. Intern. Med.* **21**, 489–494.
- Bottomley, S. S. (2004). Sideroblastic anemias. In "Wintrobe's Clinical Hematology" (J. P. Greer, J. Foerster, J. N. Lukens, G. M. Rogers, and F. Paraskevas, Eds.), pp. 1011–1033. Lippincott Williams and Wilkin, Philadelphia.
- Bottomley, S. S. (2006). Congenital sideroblastic anemias. *Curr. Hematol. Rep.* **5**, 41–49.
- Brewer, N. R. (1987). Comparative metabolism of copper. *J. Am. Vet. Med. Assoc.* **190**, 654–658.
- Brugnara, C. (2003). Iron deficiency and erythropoiesis: new diagnostic approaches. *Clin. Chem.* **49**, 1573–1578.
- Brugnara, C., Chambers, L. A., Malynn, E., Goldberg, M. A., and Kruskall, M. S. (1993). Red blood cell regeneration induced by subcutaneous recombinant erythropoietin: iron-deficient erythropoiesis in iron-replete subjects. *Blood* **81**, 956–964.
- Brugnara, C., Schiller, B., and Moran, J. (2006). Reticulocyte hemoglobin equivalent (Ret He) and assessment of iron-deficient states. *Clin. Lab. Haematol.* **28**, 303–308.
- Bunch, S. E., Jordan, H. L., Sellon, R. K., Cullen, J. M., and Smith, J. E. (1995). Characterization of iron status in young dogs with portosystemic shunt. *Am. J. Vet. Res.* **56**, 853–858.
- Camaschella, C., Campanella, A., De, F. L., Boschetto, L., Merlini, R., Silvestri, L., Levi, S., and Iolascon, A. (2007). *Blood* **110**, 1353–1358.
- Canfield, P. J., Watson, A. D. J., and Ratcliffe, R. C. C. (1987). Dyserythropoiesis, sideroblasts/siderocytes and hemoglobin crystallization in a dog. *Vet. Clin. Pathol.* **16**(1), 21–28.
- Cartwright, G. E., and Deiss, A. (1975). Sideroblasts, siderocytes, and sideroblastic anemia. *N. Engl. J. Med.* **292**, 185–193.
- Center, S. A., and Magne, M. L. (1990). Historical, physical examination, and clinicopathologic features of portosystemic vascular anomalies in the dog and cat. *Sem. Vet. Med. Surg. Small Anim.* **5**, 83–93.
- Ceron, J. J., Eckersall, P. D., and Martynez-Subiela, S. (2005). Acute phase proteins in dogs and cats: current knowledge and future perspectives. *Vet. Clin. Pathol.* **34**, 85–99.
- Chausow, D. G., and Czarniecki-Maulden, G. L. (1987). Estimation of the dietary iron requirement for the weanling puppy and kitten. *J. Nutr.* **117**, 928–932.
- Chen, Q., and Hirsch, R. E. (2006). A direct and simultaneous detection of zinc protoporphyrin IX, free protoporphyrin IX, and fluorescent heme degradation product in red blood cell hemolysates. *Free Radic. Res.* **40**, 285–294.
- Coenen, J. L. L. M., Van Dieijen-Visser, M. P., Van Pelt, J., Van Deursen, C. T. B. M., Fickers, M. M. F., Van Wersch, J. W. J., and Brombacher, P. J. (1991). Measurements of serum ferritin used to predict concentrations of iron in bone marrow in anemia of chronic disease. *Clin. Chem.* **37**, 560–563.
- Conrad, M. E., Umbreit, J. N., Moore, E. G., Hainsworth, L. N., Porubcin, M., Simovich, M. J., Nakada, M. T., Dolan, K., and Garrick, M. D. (2000). Separate pathways for cellular uptake of ferric and ferrous iron. *Am. J. Physiol. Gastrointest. Liver Physiol.* **279**, G767–G774.
- Cowgill, L. D., James, K. M., Levy, J. K., Browne, J. K., Miller, A., Lobingier, R. T., and Egrie, J. C. (1998). Use of recombinant human erythropoietin for management of anemia in dogs and cats with renal failure. *J. Am. Vet. Med. Assoc.* **212**, 521–528.
- Craven, C. M., Alexander, J., Eldridge, M., Kushner, J. P., Bernstein, S., and Kaplan, J. (1987). Tissue distribution and clearance kinetics of non-transferrin-bound iron in the hypotransferrinemic mouse: a rodent model for hemochromatosis. *Proc. Natl. Acad. Sci. USA* **84**, 3457–3461.
- Deiss, A., Kurth, D., Cartwright, G. E., and Wintrobe, M. M. (1966). Experimental production of siderocytes. *J. Clin. Invest.* **45**, 353–364.
- Doberneck, R. C., Kline, D. G., Morse, A. S., and Berman, A. (1963). Relationship of hemosiderosis to portocaval shunting. *Surgery* **54**, 912–921.
- Doong, G., Keen, C. L., Rogers, Q. R., Morris, J. G., and Rucker, R. B. (1983). Selected features of copper metabolism in the cat. *J. Nutr.* **113**, 1963–1971.
- Fairbanks, V. F., and Beutler, E. (1995). Iron deficiency. In "Williams Hematology" (E. Beutler, M. A. Lichtman, B. S. Coller, and T. J. Kipps, Eds.), pp. 490–511. McGraw-Hill, New York.
- Feldman, B. F., Kaneko, J. J., and Farver, T. B. (1981a). Anemia of inflammatory disease in the dog: clinical characterization. *Am. J. Vet. Res.* **42**, 1109–1113.
- Feldman, B. F., Kaneko, J. J., and Farver, T. B. (1981b). Anemia of inflammatory disease in the dog: ferrokinetics of adjuvant-induced anemia. *Am. J. Vet. Res.* **42**, 583–585.
- Feldman, B. F., Keen, C. L., Kaneko, J. J., and Farver, T. B. (1981c). Anemia of inflammatory disease in the dog: measurement of hepatic superoxide dismutase, hepatic nonheme iron, copper, zinc, and ceruloplasmin and serum iron, copper, and zinc. *Am. J. Vet. Res.* **42**, 1114–1117.
- Ferguson, B. J., Skikne, B. S., Simpson, K. M., Baynes, R. D., and Cook, J. D. (1992). Serum transferrin receptor distinguishes the anemia of chronic disease from iron deficiency anemia. *J. Lab. Clin. Med.* **119**, 385–390.
- Fillet, G., Cook, J. D., and Finch, C. A. (1974). Storage iron kinetics. VII. A biologic model for reticuloendothelial iron transport. *J. Clin. Invest.* **53**, 1527–1533.
- Finch, C. A., Ragan, H. A., Dyer, I. A., and Cook, J. D. (1978). Body iron loss in animals. *Proc. Soc. Exp. Biol. Med.* **159**, 335–338.
- Fleming, R. E., Britton, R. S., Waheed, A., Sly, W. S., and Bacon, B. R. (2005). Pathophysiology of hereditary hemochromatosis. *Semin. Liver Dis.* **25**, 411–419.
- Fosmire, G. J. (1990). Zinc toxicity. *Am. J. Clin. Nutr.* **51**, 225–227.
- Franken, P., Wensing, T., and Schotman, A. J. (1981). The concentration of iron in the liver, spleen and plasma, and the amount of iron in bone marrow of horses. *Zentralbl. Veterinarmed. A* **28**, 381–389.
- Frazer, D. M., and Anderson, G. J. (2005). Iron imports. I. Intestinal iron absorption and its regulation. *Am. J. Physiol. Gastrointest. Liver Physiol.* **289**, G631–G635.
- French, T. W., Fox, L. E., Randolph, J. F., and Dodds, W. J. (1987). A bleeding disorder (von Willebrand's disease) in a Himalayan cat. *J. Am. Vet. Med. Assoc.* **190**, 437–439.

- Fresco, R. (1981). Electron microscopy in the diagnosis of the bone marrow disorders of the erythroid series. *Semin. Hematol.* **18**, 279–292.
- Friedman, J. S., Lopez, M. F., Fleming, M. D., Rivera, A., Martin, F. M., Welsh, M. L., Boyd, A., Doctrow, S. R., and Burakoff, S. J. (2004). SOD2-deficiency anemia: protein oxidation and altered protein expression reveal targets of damage, stress response, and antioxidant responsiveness. *Blood* **104**, 2565–2573.
- Fry, M. M., and Kirk, C. A. (2006). Reticulocyte indices in a canine model of nutritional iron deficiency. *Vet. Clin. Pathol.* **35**, 172–181.
- Fry, M. M., Liggett, J. L., and Baek, S. J. (2004). Molecular cloning and expression of canine hepcidin. *Vet. Clin. Pathol.* **33**, 223–227.
- Fulton, R., Weiser, M. G., Freshman, J. L., Gasper, P. W., and Fettman, M. J. (1988). Electronic and morphologic characterization of erythrocytes of an adult cat with iron deficiency anemia. *Vet. Pathol.* **25**, 521–523.
- Furugouri, K. (1972). Plasma iron and total iron-binding capacity in piglets in anemia and iron administration. *J. Anim. Sci.* **34**, 421–426.
- Ganti, A. K., Moazzam, N., Laroia, S., Tendulkar, K., Potti, A., and Mehdi, S. A. (2003). Predictive value of absent bone marrow iron stores in the clinical diagnosis of iron deficiency anemia. *In Vivo* **17**, 389–392.
- Ganz, T., and Nemeth, E. (2006). Iron imports. IV. Hepcidin and regulation of body iron metabolism. *Am. J. Physiol. Gastrointest. Liver Physiol.* **290**, G199–G203.
- George, J. W., and Duncan, J. R. (1981). Erythrocyte protoporphyrin in experimental chronic lead poisoning in calves. *Am. J. Vet. Res.* **42**, 1630–1637.
- Ghosh, S., Hevi, S., and Chuck, S. L. (2004). Regulated secretion of glycosylated human ferritin from hepatocytes. *Blood* **103**, 2369–2376.
- Gillis, D. B., and Mitchell, R. A. (1974). Erythrokinetics in normal cats. *Am. J. Vet. Res.* **35**, 31–33.
- Gookin, J. L., Bunch, S. E., Rush, L. J., and Grindem, C. B. (1998). Evaluation of microcytosis in 18 Shibas. *J. Am. Vet. Med. Assoc.* **212**, 1258–1259.
- Graversen, J. H., Madsen, M., and Moestrup, S. K. (2002). CD163: a signal receptor scavenging haptoglobin-hemoglobin complexes from plasma. *Int. J. Biochem. Cell. Biol.* **34**, 309–314.
- Gregg, X. T., Reddy, V., and Prchal, J. T. (2002). Copper deficiency masquerading as myelodysplastic syndrome. *Blood* **100**, 1493–1495.
- Gyorffy, E. J., and Chan, H. (1992). Copper deficiency and microcytic anemia resulting from prolonged ingestion of over-the-counter zinc. *Am. J. Gastroenterol.* **87**, 1054–1055.
- Halvorsen, K., and Halvorsen, S. (1973). The “early anaemia”; its relation to postnatal growth rate, milk feeding, and iron availability. Experimental study in rabbits. *Arch. Dis. Child.* **48**, 842–849.
- Hammond, E., Deiss, A., Carnes, W. H., and Cartwright, G. E. (1969). Ultrastructural characteristics of siderocytes in swine. *Lab. Invest.* **21**, 292–297.
- Harvey, J. W. (1981). Myeloproliferative disorders in dogs and cats. *Veterinary Clinics of North America, Small Animal Practice* **11**, 349–381.
- Harvey, J. W. (2000). Microcytic anemias. In “Schalm’s Veterinary Hematology” (B. F. Feldman, J. G. Zinkl, and N. C. Jain, Eds.), pp. 200–204. Lippincott Williams and Wilkins, Philadelphia.
- Harvey, J. W. (2001). “Atlas of Veterinary Hematology. Blood and Bone Marrow of Domestic Animals.” Saunders, Philadelphia.
- Harvey, J. W. (2006). Pathogenesis, laboratory diagnosis, and clinical implications of erythrocyte enzyme deficiencies in dogs, cats, and horses. *Vet. Clin. Pathol.* **35**, 144–156.
- Harvey, J. W., Asquith, R. L., Sussman, W. A., and Kivipelto, J. (1987a). Serum ferritin, serum iron, and erythrocyte values in foals. *Am. J. Vet. Res.* **48**, 1348–1352.
- Harvey, J. W., Clapp, W. L., Yao, Y., and Efremov, G. D. (2007). Microcytic hypochromic erythrocytes containing siderotic inclusions, Heinz bodies, and hemoglobin crystals in a dog (abstract). *Vet. Clin. Pathol.* **36**, 313–314.
- Harvey, J. W., French, T. W., and Meyer, D. J. (1982). Chronic iron deficiency anemia in dogs. *J. Am. Anim. Hosp. Assoc.* **18**, 946–960.
- Harvey, J. W., Levin, D., and Chen, C. L. (1987b). Potential effects of glucocorticoids on serum iron concentrations in dogs. *Vet. Clin. Pathol.* **16**, 46–50.
- Harvey, J. W., and Smith, J. E. (1994). Haematology and clinical chemistry of English springer spaniel dogs with phosphofructokinase deficiency. *Comp. Haematol. Int.* **4**, 70–74.
- Harvey, J. W., and West, C. L. (1987). Prednisone-induced increases in serum alpha-2-globulin and haptoglobin concentrations in dogs. *Vet. Pathol.* **24**, 90–92.
- Harvey, J. W., Wolfsheimer, K. J., Simpson, C. F., and French, T. W. (1985). Pathologic sideroblasts and siderocytes associated with chloramphenicol therapy in a dog. *Vet. Clin. Pathol.* **14**(1), 36–42.
- Hastka, J., Lasserre, J.-J., Schwarzbeck, A., and Hehlmann, R. (1994). Central role of zinc protoporphyrin in staging iron deficiency. *Clin. Chem.* **40**, 768–773.
- Hawke, C. G., Maddison, J. E., Poulos, V., and Watson, A. D. J. (1992). Erythrocyte protoporphyrin concentrations in clinically normal cats and cats with lead toxicity. *Res. Vet. Sci.* **53**, 260–263.
- Hellman, N. E., and Gitlin, J. D. (2002). Ceruloplasmin metabolism and function. *Annu. Rev. Nutr.* **22**, 439–458.
- Higuchi, H., Katoh, N., Miyamoto, T., Uchida, E., Yuasa, A., and Takahashi, K. (1994). Dexamethasone-induced haptoglobin release by calf liver parenchymal cells. *Am. J. Vet. Res.* **55**, 1080–1085.
- Holland, C. T., Canfield, P. J., Watson, A. D. J., and Allan, G. S. (1991). Dyserythropoiesis, polymyopathy, and cardiac disease in three related English springer spaniels. *J. Vet. Intern. Med.* **5**, 151–159.
- House, J. K., Smith, B. P., Lane, V. M., Anderson, B. C., Graham, T. W., and Pino, M. V. (1994). Hemochromatosis in Salers cattle. *J. Vet. Intern. Med.* **8**, 105–111.
- Huebers, H., Csiba, E., Huebers, E., and Finch, C. A. (1985). Molecular advantage of diferric transferrin in delivering iron to reticulocytes: a comparative study. *Proc. Natl. Acad. Sci. USA* **179**, 222–226.
- Huebers, H. A., Josephson, B., Huebers, E., Csiba, E., and Finch, C. A. (1984). Occupancy of the iron binding sites of human transferrin. *Proc. Natl. Acad. Sci. USA* **81**, 4326–4330.
- Hughes, D. A., Stuart-Smith, S. E., and Bain, B. J. (2004). How should stainable iron in bone marrow films be assessed? *J. Clin. Pathol.* **57**, 1038–1040.
- Hvidberg, V., Maniecki, M. B., Jacobsen, C., Hojrup, P., Moller, H. J., and Moestrup, S. K. (2005). Identification of the receptor scavenging hemopexin-heme complexes. *Blood* **106**, 2572–2579.
- Hyypä, S., Hoyhtya, M., Nevalainen, M., and Poso, A. R. (2002). Effect of exercise on plasma ferritin concentrations: implications for the measurement of iron status. *Equine Vet. J. Suppl.* **34**, 186–190.
- Kadikoylu, G., Yavasoglu, I., Bolaman, Z., and Senturk, T. (2006). Platelet parameters in women with iron deficiency anemia. *J. Natl. Med. Assoc.* **98**, 398–402.
- Kaneko, J. J. (1964). Iron metabolism in canine anemia. *Gaines Vet. Symp.* **13**, 2–5.
- Kaneko, J. J., and Mattheeuws, D. R. (1966). Iron metabolism in normal and porphyric calves. *Am. J. Vet. Res.* **27**, 923–929.
- Keen, C. L., Lonnerdal, B., and Fisher, G. L. (1981). Age-related variations in hepatic iron, copper, zinc, and selenium concentrations in beagles. *Am. J. Vet. Res.* **42**, 1884–1887.

- Kemna, E., Pickkers, P., Nemeth, E., van der Hoeven, H., and Swinkels, D. (2005). Time-course analysis of hepcidin, serum iron, and plasma cytokine levels in humans injected with LPS. *Blood* **106**, 1864–1866.
- Kempe, D. S., Lang, P. A., Duranton, C., Akel, A., Lang, K. S., Huber, S. M., Wieder, T., and Lang, F. (2006). Enhanced programmed cell death of iron-deficient erythrocytes. *FASEB J.* **20**, 368–370.
- Kolb, E. (1963). The metabolism of iron in farm animals under normal and pathologic conditions. *Adv. Vet. Sci. Comp. Med.* **19**, 49–114.
- Kontoghiorghes, G. J., and Weinberg, E. D. (1995). Iron: mammalian defense systems, mechanisms of disease, and chelation therapy approaches. *Blood Rev.* **9**, 33–45.
- Koury, M. J., and Ponka, P. (2004). New insights into erythropoiesis: the roles of folate, vitamin B12, and iron. *Annu. Rev. Nutr.* **24**, 105–131.
- Kowalczyk, D. F., Naylor, J. M., and Gunson, D. (1981). The value of zinc protoporphyrin in equine lead poisoning: a case report. *Vet. Hum. Toxicol.* **23**, 12–15.
- Labbe, R. F., Vreman, H. J., and Stevenson, D. K. (1999). Zinc protoporphyrin: a metabolite with a mission. *Clin. Chem.* **45**, 2060–2072.
- Laflamme, D. P., Mahaffey, E. A., Allen, S. W., Twedt, D. C., Prasse, K. W., and Huber, T. L. (1994). Microcytosis and iron status in dogs with surgically induced portosystemic shunts. *J. Vet. Intern. Med.* **8**, 212–216.
- Lahey, M. E., Gubler, C. J., Chase, M. S., Cartwright, G. E., and Wintrobe, M. M. (1952). Studies on copper metabolism. II. Hematologic manifestations of copper deficiency in swine. *Blood* **7**, 1053–1074.
- Lamola, A. A., and Yamane, T. (1974). Zinc protoporphyrin in the erythrocytes of patients with lead intoxication and iron deficiency anemia. *Science* **186**, 936–938.
- Lange, R. D., Jones, J. B., Chambers, C., Quirin, Y., and Sparks, J. C. (1976). Erythropoiesis and erythrocytic survival in dogs with cyclic hematoipoiesis. *Am. J. Vet. Res.* **37**, 331–334.
- Latunde-Dada, G. O., McKie, A. T., and Simpson, R. J. (2006a). Animal models with enhanced erythropoiesis and iron absorption. *Biochim. Biophys. Acta.* **1762**, 414–423.
- Latunde-Dada, G. O., Simpson, R. J., and McKie, A. T. (2006b). Recent advances in mammalian haem transport. *Trends Biochem. Sci.* **31**, 182–188.
- Lavoie, J. P., and Teuscher, E. (1993). Massive iron overload and liver fibrosis resembling haemochromatosis in a racing pony. *Equine Vet. J.* **25**, 552–554.
- Lee, G. R., Cartwright, G. E., and Wintrobe, M. M. (1968a). Heme biosynthesis in copper deficient swine. *Proc. Soc. Exp. Biol. Med.* **127**, 977–981.
- Lee, G. R., Nacht, S., Lukens, J. N., and Cartwright, G. E. (1968b). Iron metabolism in copper-deficient swine. *J. Clin. Invest.* **47**, 2058–2069.
- Lee, P., Peng, H., Gelbart, T., Wang, L., and Beutler, E. (2005). Regulation of hepcidin transcription by interleukin-1 and interleukin-6. *Proc. Natl. Acad. Sci. USA* **102**, 1906–1910.
- Levi, S., Santambrogio, P., Cozzi, A., Rovida, E., Corsi, B., Tamborini, E., Spada, S., Albertini, A., and Arosio, P. (1994). The role of the L-chain in ferritin iron incorporation. Studies of homo and heteropolymers. *J. Mol. Biol.* **238**, 649–654.
- Levy, J. K., Bunch, S. E., and Komtebedde, J. (1995). Feline portosystemic vascular shunts. In “Kirk’s Current Veterinary Therapy XII. Small Animal Practice” (J. D. Bondagura, Ed.), pp. 743–749. Saunders, Philadelphia.
- Lill, R., Dutkiewicz, R., Elsasser, H. P., Hausmann, A., Netz, D. J., Pierik, A. J., Stehling, O., Urzica, E., and Muhlenhoff, U. (2006). Mechanisms of iron-sulfur protein maturation in mitochondria, cytosol and nucleus of eukaryotes. *Biochim. Biophys. Acta* **1763**, 652–667.
- Lisboa, P. E. (1971). Experimental hepatic cirrhosis in dogs caused by chronic massive iron overload. *Gut* **12**, 363–368.
- Loo, M., and Beguin, Y. (1999). The effect of recombinant human erythropoietin on platelet counts is strongly modulated by the adequacy of iron supply. *Blood* **93**, 3286–3293.
- Lowenstine, L. J., and Munson, L. (1999). Iron overload in the animal kingdom. In “Zoo and Wild Animal Medicine: Current Therapy 4” (M. E. Fowler and R. E. Miller, Eds.), pp. 260–268. Saunders, Philadelphia.
- Lucroy, M. D., Christopher, M. M., Kraegel, S. A., Simonson, E. R., and Madewell, B. R. (1998). Anaemia associated with canine lymphoma. *Comp. Haematol. Int.* **8**, 1–6.
- Lund, J. E., and Brown, P. K. (1997). Hypersegmented megakaryocytes and megakaryocytes with multiple separate nuclei in dogs treated with PNU-100592, an oxazolidinone antibiotic. *Toxicol. Pathol.* **25**, 339–343.
- Mackenzie, B., and Garrick, M. D. (2005). Iron imports. II. Iron uptake at the apical membrane in the intestine. *Am. J. Physiol. Gastrointest. Liver Physiol.* **289**, G981–G986.
- Maddux, J. M., Moore, W. E., Keeton, K. S., and Shull, R. M. (1988). Dexamethasone-induced serum biochemical changes in goats. *Am. J. Vet. Res.* **49**, 1937–1940.
- Mahaffey, E. A., and Smith, J. E. (1978). Depression anemia in cats. *Feline Pract.* **8**, 19–22.
- Martin, C. J., Wertz, C. L., III, and Ducatman, A. M. (2004). The interpretation of zinc protoporphyrin changes in lead intoxication: a case report and review of the literature. *Occup. Med. (Lond)* **54**, 587–591.
- Melamed-Frank, M., Lache, O., Enav, B. I., Szafranek, T., Levy, N. S., Ricklis, R. M., and Levy, A. P. (2001). Structure-function analysis of the antioxidant properties of haptoglobin. *Blood* **98**, 3693–3698.
- Mete, A., Dorresteijn, G. M., Marx, J. J. M., Lemmens, A. G., and Beynen, A. C. (2001). A comparative study of iron retention in mynahs, doves, and rats. *Avian Pathol.* **30**, 479–486.
- Mete, A., Hendriks, H. G., Klaren, P. H., Dorresteijn, G. M., Van Dijk, J. E., and Marx, J. J. (2003). Iron metabolism in mynah birds (*Gracula religiosa*) resembles human hereditary haemochromatosis. *Avian Pathol.* **32**, 625–632.
- Mete, A., Jalving, R., van Oost, B. A., Van Dijk, J. E., and Marx, J. J. (2005). Intestinal over-expression of iron transporters induces iron overload in birds in captivity. *Blood Cells Mol. Dis.* **34**, 151–156.
- Metzgeroth, G., Adelberger, V., Dorn-Beineke, A., Kuhn, C., Schatz, M., Maywald, O., Bertsch, T., Wissner, H., Hehlmann, R., and Hastka, J. (2005). Soluble transferrin receptor and zinc protoporphyrin: competitors or efficient partners? *Eur. J. Haematol.* **75**, 309–317.
- Meyer, D. J., and Harvey, J. W. (1994). Hematologic changes associated with serum and hepatic iron alterations in dogs with congenital portosystemic vascular abnormalities. *J. Vet. Intern. Med.* **8**, 55–56.
- Miltenburg, G. A., Wensing, T., Smulders, F. J., and Breukink, H. J. (1992a). Relationship between blood hemoglobin, plasma and tissue iron, muscle heme pigment, and carcass color of veal. *J. Anim. Sci.* **70**, 2766–2772.
- Miltenburg, G. A., Wensing, T., van de Broek, J., Mevius, D. J., and Breukink, H. J. (1992b). Effects of different iron contents in the milk replacer on the development of iron deficiency anaemia in veal calves. *Vet. Q.* **14**, 18–21.
- Mollerberg, L., Ekman, L., and Jacobsson, S. O. (1975). Ferrokinetic studies in normal and iron deficiency anemic calves. *Acta Vet. Scand.* **16**, 205–217.
- Montaser, A., Tetreault, C., and Linder, M. (1992). Comparison of copper binding components in dog serum with those in other species. *Proc. Soc. Exp. Biol. Med.* **200**, 321–329.

- Moore, C. V., Dubach, R., Minnich, V., and Roberts, H. K. (1944). Absorption of ferrous and ferric radioactive iron by human subjects and by dogs. *J. Clin. Invest.* **23**, 755–767.
- Morin, D. E., Garry, F. B., and Weiser, M. G. (1993). Hematologic responses in llamas with experimentally-induced iron deficiency anemia. *Vet. Clin. Pathol.* **22**, 81–85.
- Mullaney, T. P., and Brown, C. M. (1988). Iron toxicity in neonatal foals. *Equine Vet. J.* **20**, 119–124.
- Nakajima, O., Okano, S., Harada, H., Kusaka, T., Gao, X., Hosoya, T., Suzuki, N., Takahashi, S., and Yamamoto, M. (2006). Transgenic rescue of erythroid 5-aminolevulinic synthase-deficient mice results in the formation of ring sideroblasts and siderocytes. *Genes Cells* **11**, 685–700.
- Napier, I., Ponka, P., and Richardson, D. R. (2005). Iron trafficking in the mitochondrion: novel pathways revealed by disease. *Blood* **105**, 1867–1874.
- Nathanson, M. H., Muir, A., and McLaren, G. D. (1985). Iron absorption in normal and iron-deficient beagle dogs: mucosal iron kinetics. *Am. J. Physiol.* **249**, G439–G448.
- Navone, R., Azzoni, L., and Valente, G. (1988). Immunohistochemical assessment of ferritin in bone marrow trephine biopsies: correlation with marrow hemosiderin. *Acta Haematol. (Basel)* **80**, 194–198.
- Nemeth, E., Rivera, S., Gabayan, V., Keller, C., Taudorf, S., Pedersen, B. K., and Ganz, T. (2004a). IL-6 mediates hypoferrremia of inflammation by inducing the synthesis of the iron regulatory hormone hepcidin. *J. Clin. Invest.* **113**, 1271–1276.
- Nemeth, E., Tuttle, M. S., Powelson, J., Vaughn, M. B., Donovan, A., Ward, D. M., Ganz, T., and Kaplan, J. (2004b). Hepcidin regulates cellular iron efflux by binding to ferroportin and inducing its internalization. *Science* **306**, 2090–2093.
- Neumann, S. (2003). Serum iron level as an indicator for inflammation in dogs and cats. *Comp. Clin. Path.* **12**, 90–94.
- Newlands, C. E., Houston, D. M., and Vasconcelos, D. Y. (1994). Hyperferritinemia associated with malignant histiocytosis in a dog. *J. Am. Vet. Med. Assoc.* **205**, 849–851.
- Norrdin, R. W., Hoopes, K. J., and O'Toole, D. (2004). Skeletal changes in hemochromatosis of Salers cattle. *Vet. Pathol.* **41**, 612–623.
- O'Toole, D., Kelly, E. J., McAllister, M. M., Layton, A. W., Norrdin, R. W., Russell, W. C., Saeb-Parsy, K., and Walker, A. P. (2001). Hepatic failure and hemochromatosis of Salers and Salers-cross cattle. *Vet. Pathol.* **38**, 372–389.
- Ohgami, R. S., Campagna, D. R., Greer, E. L., Antiochos, B., McDonald, A., Chen, J., Sharp, J. J., Fujiwara, Y., Barker, J. E., and Fleming, M. D. (2005). Identification of a ferrireductase required for efficient transferrin-dependent iron uptake in erythroid cells. *Nat. Genet.* **37**, 1264–1269.
- Okabe, J., Tajima, S., Yamato, O., Inaba, M., Hagiwara, S., and Maede, Y. (1996). Hemoglobin types, erythrocyte membrane skeleton and plasma iron concentration in calves with poikilocytosis. *J. Vet. Med. Sci.* **58**, 629–634.
- Okumura, M., Fujinaga, T., Yamashita, K., Tsunoda, N., and Mizuno, S. (1991). Isolation, characterization, and quantitative analysis of ceruloplasmin from horses. *Am. J. Vet. Res.* **52**, 1979–1985.
- Orino, K., Miura, T., Muto, S., and Watanabe, K. (2005). Sequence analysis of canine and equine ferritin H and L subunit cDNAs. *DNA Seq.* **16**, 58–64.
- Osaki, S., Johnson, D. A., and Frieden, E. (1971). The mobilization of iron from the perfused mammalian liver by a serum copper enzyme, I. *J. Biol. Chem.* **246**, 3018–3023.
- Ottjenann, M., Weingart, C., Arndt, G., and Kohn, B. (2006). Characterization of the anemia of inflammatory disease in cats with abscesses, pyothorax, or fat necrosis. *J. Vet. Intern. Med.* **20**, 1143–1150.
- Paglia, D. E., Kenny, D. E., Dierenfeld, E. S., and Tsu, I. H. (2001). Role of excessive maternal iron in the pathogenesis of congenital leukoencephalomalacia in captive black rhinoceroses (*Diceros bicornis*). *Am. J. Vet. Res.* **62**, 343–349.
- Pak, M., Lopez, M. A., Gabayan, V., Ganz, T., and Rivera, S. (2006). Suppression of hepcidin during anemia requires erythropoietic activity. *Blood* **108**, 3730–3735.
- Park, C. H., Valore, E. V., Waring, A. J., and Ganz, T. (2001). Hepcidin, a urinary antimicrobial peptide synthesized in the liver. *J. Biol. Chem.* **276**, 7806–7810.
- Pearson, E. G., Hedstrom, O. R., and Poppenga, R. H. (1994). Hepatic cirrhosis and hemochromatosis in three horses. *J. Am. Vet. Med. Assoc.* **204**, 1053–1056.
- Ponka, P., Beaumont, C., and Richardson, D. R. (1998). Function and regulation of transferrin and ferritin. *Semin. Hematol.* **35**, 35–54.
- Ponka, P., and Richardson, D. R. (1997). Can ferritin provide iron for hemoglobin synthesis? *Blood* **89**, 2611–2612.
- Porra, R. J., and Jones, O. T. G. (1963). Studies on ferrochelatase. I. Assay and properties of ferrochelatase from a pig-liver mitochondrial extract. *Biochem. J.* **87**, 181–185.
- Pritchard, G. C., Lewis, G., Wells, G. A., and Stopforth, A. (1985). Zinc toxicity, copper deficiency and anaemia in swill-fed pigs. *Vet. Rec.* **117**, 545–548.
- Quigley, J. G., Yang, Z., Worthington, M. T., Phillips, J. D., Sabo, K. M., Sabath, D. E., Berg, C. L., Sassa, S., Wood, B. L., and Abkowitz, J. L. (2004). Identification of a human heme exporter that is essential for erythropoiesis. *Cell* **118**, 757–766.
- Ramm, G. A., and Ruddell, R. G. (2005). Hepatotoxicity of iron overload: mechanisms of iron-induced hepatic fibrogenesis. *Semin. Liver Dis.* **25**, 433–449.
- Reeves, P. G., Demars, L. C., Johnson, W. T., and Lukaski, H. C. (2005). Dietary copper deficiency reduces iron absorption and duodenal enterocyte hephaestin protein in male and female rats. *J. Nutr.* **135**, 92–98.
- Rivera, S., Nemeth, E., Gabayan, V., Lopez, M. A., Farshidi, D., and Ganz, T. (2005). Synthetic hepcidin causes rapid dose-dependent hypoferrremia and is concentrated in ferroportin-containing organs. *Blood* **106**, 2196–2199.
- Roeser, H. P., Lee, G. R., Nacht, S., and Cartwright, G. E. (1970). The role of ceruloplasmin in iron metabolism. *J. Clin. Invest.* **49**, 2408–2417.
- Rosen, V. (2006). BMP and BMP inhibitors in bone. *Ann. NY Acad. Sci.* **1068**, 19–25.
- Rothman, R. J., Serroni, A., and Farber, J. L. (1992). Cellular pool of transient ferric iron, chelatable by deferoxamine and distinct from ferritin, that is involved in oxidative cell injury. *Mol. Pharmacol.* **42**, 703–710.
- Ruhr, L. P., Nicholson, S. S., Confer, A. W., and Blakewood, B. W. (1983). Acute intoxication from a hematitic in calves. *J. Am. Vet. Med. Assoc.* **182**, 616–618.
- Ryan, T. P., and Aust, S. D. (1992). The role of iron in oxygen-mediated toxicities. *Crit. Rev. Toxicol.* **22**, 119–141.
- Schultheiss, P. C., Bedwell, C. L., Hamar, D. W., and Fettman, M. J. (2002). Canine liver iron, copper, and zinc concentrations and association with histologic lesions. *J. Vet. Diagn. Invest.* **14**, 396–402.
- Searcy, G. P., Tasker, J. B., and Miller, D. R. (1979). Animal model: pyruvate kinase deficiency in dogs. *Am. J. Physiol.* **94**, 689–692.
- Shaw, G. C., Cope, J. J., Li, L., Corson, K., Hersey, C., Ackermann, G. E., Gwynn, B., Lambert, A. J., Wingert, R. A., Traver, D., Trede, N. S.,

- Barut, B. A., Zhou, Y., Minet, E., Donovan, A., Brownlie, A., Balzan, R., Weiss, M. J., Peters, L. L., Kaplan, J., Zon, L. I., and Paw, B. H. (2006). Mitoferrin is essential for erythroid iron assimilation. *Nature* **440**, 96–100.
- Shayeghi, M., Latunde-Dada, G. O., Oakhill, J. S., Laftah, A. H., Takeuchi, K., Halliday, N., Khan, Y., Warley, A., McCann, F. E., Hider, R. C., Frazer, D. M., Anderson, G. J., Vulpe, C. D., Simpson, R. J., and McKie, A. T. (2005). Identification of an intestinal heme transporter. *Cell* **122**, 789–801.
- Sheftel, A. D., Zhang, A. S., Brown, C., Shirihai, O. S., and Ponka, P. (2007). Direct interorganellar transfer of iron from endosome to mitochondrion. *Blood* **110**, 125–132.
- Simpson, K. W., Meyer, D. J., Boswood, A., White, R. N., and Maskell, I. E. (1997). Iron status and erythrocyte volume in dogs with congenital portosystemic vascular anomalies. *J. Vet. Intern. Med.* **11**, 14–19.
- Smith, J. E. (1992). Iron metabolism in dogs and cats. *Comp. Cont. Ed. Pract. Vet.* **14**, 39–43.
- Smith, J. E. (1997). Iron metabolism and its disorders. In “Clinical Biochemistry of Domestic Animals” (J. J. Kaneko, J. W. Harvey, and M. L. Bruss, Eds.), pp. 223–238. Academic Press, San Diego, CA.
- Smith, J. E., and Cipriano, J. E. (1987). Inflammation-induced changes in serum iron analytes and ceruloplasmin of Shetland ponies. *Vet. Pathol.* **24**, 354–356.
- Smith, J. E., Cipriano, J. E., DeBowes, R., and Moore, K. (1986a). Iron deficiency and pseudo-iron deficiency in hospitalized horses. *J. Am. Vet. Med. Assoc.* **188**, 285–287.
- Smith, J. E., DeBowes, R. M., and Cipriano, J. E. (1986b). Exogenous corticosteroids increase serum iron concentrations in mature horses and ponies. *J. Am. Vet. Med. Assoc.* **188**, 1296–1298.
- Smith, J. E., Moore, K., Boyington, D., Pollmann, D. S., and Schoneweis, D. (1984a). Serum ferritin and total iron-binding capacity to estimate iron storage in pigs. *Vet. Pathol.* **21**, 597–600.
- Smith, J. E., Moore, K., Cipriano, J. E., and Morris, P. G. (1984b). Serum ferritin as a measure of stored iron in horses. *J. Nutr.* **114**, 677–681.
- Soubasis, N., Rallis, T. S., Vlemmas, J., Adamama-Moraitou, K. K., Roubies, N., Prassinou, N. N., and Brellou, G. (2006). *J. Gastroenterol. Hepatol.* **21**, 599–604.
- Sprague, W. S., Hackett, T. B., Johnson, J. S., and Swardson-Olver, C. J. (2003). Hemochromatosis secondary to repeated blood transfusions in a dog. *Vet. Pathol.* **40**, 334–337.
- Starzynski, R. R., Gralak, M. A., Smuda, E., and Lipinski, P. (2004). A characterization of the activities of iron regulatory protein 1 in various farm animal species. *Cell. Mol. Biol. Lett.* **9**, 651–664.
- Steele, T. M., Frazer, D. M., and Anderson, G. J. (2005). Systemic regulation of intestinal iron absorption. *IUBMB Life* **57**, 499–503.
- Steffen, D. J., Elliott, G. S., Leipold, H. W., and Smith, J. E. (1992). Congenital dyserythropoiesis and progressive alopecia in Polled Hereford calves: hematologic, biochemical, bone marrow cytologic, electrophoretic, and flow cytometric findings. *J. Vet. Diagn. Invest.* **4**, 31–37.
- Steinberg, J. D., and Olver, C. S. (2005). Hematologic and biochemical abnormalities indicating iron deficiency are associated with decreased reticulocyte hemoglobin content (CHr) and reticulocyte volume (rMCV) in dogs. *Vet. Clin. Pathol.* **34**, 23–27.
- Stewart, W. B., Vassar, P. S., and Stone, R. S. (1953). Iron absorption in dogs during anemia due to acetylphenylhydrazine. *J. Clin. Invest.* **32**, 1225–1228.
- Stohlman, F., Howard, A., and Beland, A. (1963). Humoral regulation of erythropoiesis. XII. Effect of erythropoietin and iron on cell size in iron deficiency anemia. *Proc. Soc. Exp. Biol. Med.* **113**, 986–988.
- Stokol, T., and Blue, J. T. (1999). Pure red cell aplasia in cats: 9 cases (1989–1997). *J. Am. Vet. Med. Assoc.* **214**, 75–79.
- Stokol, T., Blue, J. T., and French, T. W. (2000). Idiopathic pure red cell aplasia and nonregenerative immune-mediated anemia in dogs: 43 cases (1988–1999). *J. Am. Vet. Med. Assoc.* **216**, 1429–1436.
- Theurl, I., Mattle, V., Seifert, M., Mariani, M., Marth, C., and Weiss, G. (2006). Dysregulated monocyte iron homeostasis and erythropoietin formation in patients with anemia of chronic disease. *Blood* **107**, 4142–4148.
- Torti, F. M., and Torti, S. V. (2002). Regulation of ferritin genes and protein. *Blood* **99**, 3505–3516.
- Truksa, J., Peng, H., Lee, P., and Beutler, E. (2006). Bone morphogenetic proteins 2, 4, and 9 stimulate murine hepcidin 1 expression independently of Hfe, transferrin receptor 2 (Tfr2), and IL-6. *Proc. Natl. Acad. Sci. USA* **103**, 10289–10293.
- Underwood, E. J. (1977). “Trace Elements in Human and Animal Nutrition.” Academic Press, New York.
- van Miert, A. S., van Duin, C. T., and Wensing, T. (1986). The effects of ACTH, prednisolone and Escherichia coli endotoxin on some clinical haematological and blood biochemical parameters in dwarf goats. *Vet. Q.* **8**, 195–203.
- van Miert, A. S., van Duin, C. T., and Wensing, T. (1990). Fever and changes in plasma zinc and iron concentrations in the goat: the effects of interferon inducers and recombinant IFN-alpha 2a. *J. Comp. Pathol.* **103**, 289–300.
- Vaulont, S., Lou, D. Q., Viatte, L., and Kahn, A. (2005). Of mice and men: the iron age. *J. Clin. Invest.* **115**, 2079–2082.
- Verga Falzacappa, M. V., and Muckenthaler, M. U. (2005). Hepcidin: iron-hormone and anti-microbial peptide. *Gene* **364**, 37–44.
- Verheijden, J. H., van Miert, A. S., Schotman, A. J., and van Duin, C. T. (1982). Plasma zinc and iron concentrations as measurements for evaluating the influence of endotoxin-neutralizing agents in Escherichia coli endotoxin-induced mastitis. *Am. J. Vet. Res.* **43**, 724–728.
- Vokurka, M., Krijt, J., Sulc, K., and Necas, E. (2006). Hepcidin mRNA levels in mouse liver respond to inhibition of erythropoiesis. *Physiol. Res.* **55**, 667–674.
- Wallace, D. F., Summerville, L., Lusby, P. E., and Subramaniam, V. N. (2005). Prohepcidin localises to the Golgi compartment and secretory pathway in hepatocytes. *J. Hepatol.* **43**, 720–728.
- Watanabe, K., Hayashi, K., Miyamoto, T., Tanaka, M., Okano, S., and Yamamoto, S. (2000). Characterization of ferritin and ferritin-binding proteins in canine serum. *Biometals* **13**, 57–63.
- Watanabe, K., Ozawa, M., Ochiai, H., Kamohara, H., Iijima, N., Negita, H., Orino, K., and Yamamoto, S. (1998). Changes in iron and ferritin in anemic calves infected with Theileria sergenti. *J. Vet. Med. Sci.* **60**, 943–947.
- Weeks, B. R., Smith, J. E., DeBowes, R. M., and Smith, J. M. (1989a). Decreased serum iron and zinc concentrations in cattle receiving intravenous dexamethasone. *Vet. Pathol.* **26**, 345–346.
- Weeks, B. R., Smith, J. E., and Northrop, J. K. (1989b). Relationship of serum ferritin and iron concentrations and serum total iron-binding capacity to nonheme iron stores in dogs. *Am. J. Vet. Res.* **50**, 198–200.
- Weeks, B. R., Smith, J. E., and Phillips, R. M. (1988). Enzyme-linked immunosorbent assay for canine serum ferritin, using monoclonal anti-canine ferritin immunoglobulin G. *Am. J. Vet. Res.* **49**, 1193–1196.
- Weeks, B. R., Smith, J. E., and Stadler, C. K. (1990). Effect of dietary iron content on hematologic and other measures of iron adequacy in dogs. *J. Am. Vet. Med. Assoc.* **196**, 749–753.



- Weiden, P. L., Hackman, R. C., Deeg, J., Graham, C., Thomas, E. D., and Strob, R. (1981). Long-term survival and reversal of iron overload after marrow transplantation in dogs with congenital hemolytic anemia. *Blood* **57**, 66–70.
- Weiser, G., and O'Grady, M. (1983). Erythrocyte volume distribution analysis and hematologic changes in dogs with iron deficiency anemia. *Vet. Pathol.* **20**, 230–241.
- Weiser, M. G., and Kociba, G. J. (1983). Sequential changes in erythrocyte volume distribution and microcytosis associated with iron deficiency in kittens. *Vet. Pathol.* **20**, 1–12.
- Weiss, D. J. (2005). Sideroblastic anemia in 7 dogs (1996–2002). *J. Vet. Intern. Med.* **19**, 325–328.
- Weiss, D. J., Aird, B., and Murtaugh, M. P. (1992). Neutrophil-induced immunoglobulin binding to erythrocytes involves proteolytic and oxidative injury. *J. Leuk. Biol.* **51**, 19–23.
- Weiss, D. J., and Klausner, J. S. (1988). Neutrophil-induced erythrocyte injury: a potential cause of erythrocyte destruction in the anemia associated with inflammatory disease. *Vet. Pathol.* **25**, 450–455.
- Weiss, D. J., and Krehbiel, J. D. (1983). Studies of the pathogenesis of anemia of inflammation: erythrocyte survival. *Am. J. Vet. Res.* **44**, 1830–1831.
- Weiss, D. J., Krehbiel, J. D., and Lund, J. E. (1983). Studies of the pathogenesis of anemia of inflammation: mechanisms of impaired erythropoiesis. *Am. J. Vet. Res.* **44**, 1832–1835.
- Weiss, D. J., and Lulich, J. (1999). Myelodysplastic syndrome with sideroblastic differentiation in a dog. *Vet. Clin. Pathol.* **28**, 59–63.
- Weiss, G., and Goodnough, L. T. (2005). Anemia of chronic disease. *N. Engl. J. Med.* **352**, 1011–1023.
- Welch, S. (1990). A comparison of the structure and properties of serum transferrin from 17 animal species. *Comp. Biochem. Physiol. B* **97**, 417–427.
- Wessling-Resnick, M. (2006). Iron imports. III. Transfer of iron from the mucosa into circulation. *Am. J. Physiol. Gastrointest. Liver Physiol.* **290**, G1–G6.
- Wheby, M. S., and Spyker, D. A. (1981). Hemoglobin iron absorption kinetics in the iron-deficient dog. *Am. J. Clin. Nutr.* **34**, 1686–1693.
- Wilkins, S. J., Frazer, D. M., Millard, K. N., McLaren, G. D., and Anderson, G. J. (2006). Iron metabolism in the hemoglobin-deficit mouse: correlation of diferric transferrin with hepcidin expression. *Blood* **107**, 1659–1664.
- Williams, D. M., Loukopoulos, D., Lee, G. R., and Cartwright, G. E. (1976). Role of copper in mitochondrial iron metabolism. *Blood* **48**, 77–85.
- Wingert, R. A., Galloway, J. L., Barut, B., Foott, H., Fraenkel, P., Axe, J. L., Weber, G. J., Dooley, K., Davidson, A. J., Schmid, B., Paw, B. H., Shaw, G. C., Kingsley, P., Palis, J., Schubert, H., Chen, O., Kaplan, J., and Zon, L. I. (2005). Deficiency of glutaredoxin 5 reveals Fe-S clusters are required for vertebrate haem synthesis. *Nature* **436**, 1035–1039.
- Yoshino, K., Katoh, N., Takahashi, K., and Yuasa, A. (1993). Possible involvement of protein kinase C with induction of haptoglobin in cows by treatment with dexamethasone and by starvation. *Am. J. Vet. Res.* **54**, 689–694.
- Zaucha, J. A., Yu, C., Lothrop, C. D. J., Nash, R. A., Sale, G., Georges, G., Kiem, H. P., Niemeyer, G. P., Dufresne, M., Cao, Q., and Storb, R. (2001). Severe canine hereditary hemolytic anemia treated by nonmyeloablative marrow transplantation. *Biol. Blood Marrow Transplant.* **7**, 14–24.

# Hemostasis

Patricia Gentry

Department of Biomedical Sciences  
Ontario Veterinary College  
University of Guelph  
Guelph, Ontario, Canada

Hilary Burgess

Department of Pathobiology  
Ontario Veterinary College  
University of Guelph  
Guelph, Ontario, Canada

Darren Wood

Department of Pathobiology  
Ontario Veterinary College  
University of Guelph  
Guelph, Ontario, Canada

---

## I. INTRODUCTION

### II. MECHANISMS OF HEMOSTASIS

- A. Role of Vascular Endothelium
- B. Platelets
- C. Coagulation Proteins, Complexes, and Thrombin Activation
- D. Fibrinolysis

### III. LABORATORY ASSESSMENT OF HEMOSTASIS

- A. Quality Control and Reagent Variation
- B. Routine Testing of Hemostasis
- C. Additional Assays

### IV. DISORDERS OF HEMOSTASIS

- A. Hereditary Disorders
- B. Acquired Disorders

### V. BEYOND HEMOSTASIS: INTERACTIONS WITH INFLAMMATION

#### REFERENCES

---

## I. INTRODUCTION

The maintenance of blood fluidity occurs through the process of finely balancing hemorrhage and clotting. Hemostasis, which is the process of arresting the escape of blood from the vascular system, is integral to survival in animals, is regulated by a series of orchestrated events, and is dependent on the vessels through which blood flows, as well as numerous proteins (coagulation factors, inhibitors, and fibrinolytic proteins) and cells (platelets, endothelial cells, and monocytes predominantly). Other systems in the body are also closely related to blood clotting and influenced by the activation of hemostasis such as the innate immune system (complement and phagocytes) and the inflammatory response (the kinin system and the cells important for hemostasis). The stepwise process that takes place to minimize blood loss and repair the injury includes

(1) initial vasospasm, (2) platelet activation and plug formation, (3) assembly and activation of the coagulation cascade factors, (4) fibrin clot formation at the site of injury, and (5) dissolution of the clot and vascular repair. Each of these processes is described in more detail in the discussion that follows.

Numerous reviews are available that describe the hemostatic process in detail (Crawley *et al.*, 2007; Hoffman and Monroe, 2007; Hopper and Bateman, 2005; Sere and Hackeng, 2003). The goals of this chapter are to review the comparative biochemistry of hemostasis and to describe how the dramatic variations in blood clotting in different species impact laboratory testing, response to therapeutic agents, downstream effects on other body systems, and the array of diseases that can occur.

## II. MECHANISMS OF HEMOSTASIS

### A. Role of Vascular Endothelium

Endothelial cells that line the lumen of blood vessels are the principal components of the vessel wall that contribute to maintenance of the fluid state of blood during health and the formation of clots during vascular compromise. Besides serving as a direct barrier between blood and tissue, these cells are actively involved in the regulation of hemostasis, inflammation, host defense, and numerous metabolic reactions. The phenotype of endothelial cells varies throughout the body, so the importance of these functions in different parts of the vascular system also varies. The endothelium exhibits plasticity with respect to hemostasis in that it is the balance of pro- and antithrombotic mediators that determine whether normal blood flow, hemorrhage, or clot formation occurs (Table 10-1). Unregulated or widespread activation of endothelial cells can have drastic consequences, as observed with disseminated intravascular coagulation (DIC).

**TABLE 10-1** Antithrombotic and Prothrombotic Properties of Endothelium

Antithrombotic Properties	Prothrombotic Properties
Prostacyclin (PGI <sub>2</sub> )	Tissue factor release/expression
Nitric oxide	von Willebrand factor
Thrombomodulin	Plasminogen activator inhibitor-1 (PAI-1)
Tissue factor pathway inhibitor (TFPI)	Factor V
Heparan sulfate	Platelet activating factor
Tissue plasminogen activator	P-selectin expression

During homeostasis, endothelial cells promote an anticoagulant and anti-inflammatory state. This is facilitated by several factors including the production of prostacyclin (PGI<sub>2</sub>), adenosine, and nitric oxide, which act together to inhibit the association of platelets with the endothelium and with other platelets (Becker *et al.*, 2000). The expression of thrombomodulin on the luminal surface binds any thrombin that may be formed and activates protein C to down-regulate the effects of any factor V (FV) and factor VIII (FVIII) that may be activated (see Section II.C.5.c). Tissue factor pathway inhibitor (TFPI) is synthesized by endothelial cells and is important for preventing co-localization of tissue factor with activated FVII (FVIIa), which would stimulate downstream production of thrombin and subsequently fibrin (see Section II.C.5.a). Tissue plasminogen activator (tPA) from endothelial cells activates plasmin, which results in lysis of any fibrin that is formed (see Section II.D.3). Proteoglycans such as heparin, heparan sulfate, and dermatan sulfate inhibit clotting factors and platelet aggregation. Finally, there is a relative lack of expression of adhesion molecules (e.g., P selectin) that would facilitate tethering of platelets to the endothelial surface (Becker *et al.*, 2000).

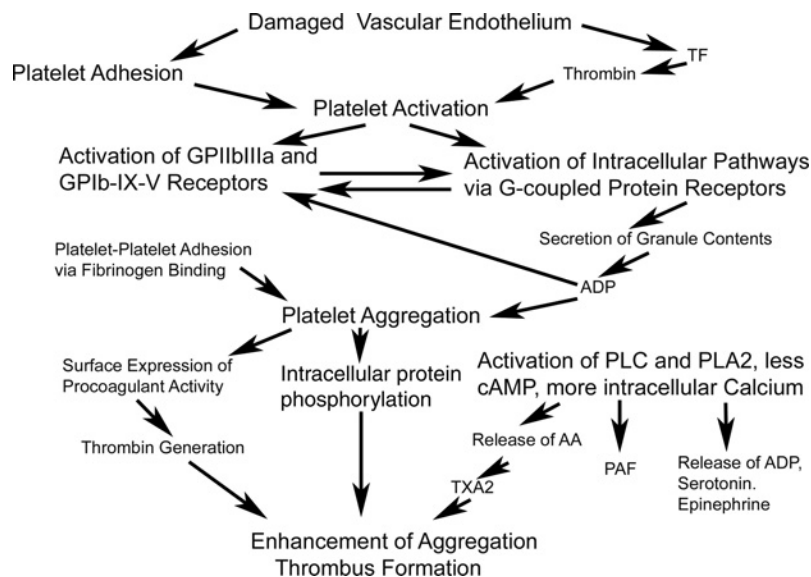
The initial reaction to vessel injury is vasoconstriction. This is a transient effect that minimizes blood flow to the affected area and is mediated by an autonomic neurogenic reflex and vasoactive mediators including endothelin. Within minutes of vascular injury or activation, the anticoagulant effect can change to a procoagulant milieu with resultant clot formation. Several factors contribute to this alteration. The expression of TF on the endothelial cell luminal surface is usually limited, but if expression is enhanced, activation of the clotting mechanism can occur. At the same time, expression of thrombomodulin and heparan sulfate can be lost, removing an important inhibitor to fibrin clot formation. Release of von Willebrand factor

(vWF) from endothelial Weibel-Palade bodies facilitates the binding of platelets to subendothelial collagen. This contributes to platelet activation and release of granule contents, facilitating platelet aggregation and plug formation (see Section II.B.3.a). Plasminogen activator inhibitor-1 is released, negating the activation of plasmin and thereby minimizing fibrinolysis (see Section II.D.4.a). Thromboxane A<sub>2</sub> and platelet activating factor (PAF) are released, which encourage further platelet aggregation and activation. Endothelial cells also contain FV, which, when available, greatly amplifies thrombin formation. Additionally, there is locally enhanced expression of adhesion molecules such as P-selectin, which promote tethering of platelets to the endothelial surface. If the endothelial cell becomes apoptotic, the exposure of phosphatidylserine (PS) on the outer cell membrane leaflet can support the direct formation of thrombin because it can act as the phospholipid source for the prothrombinase complex (Becker *et al.*, 2000).

Besides traumatic injury, endothelial dysfunction can occur in various disease states, which may have clinical consequences on a proper functioning hemostatic system. Examples include systemic inflammatory mediators such as tumor necrosis factor (TNF) and interleukin-1 (IL-1), various systemic viral infections, Gram-negative bacteria, rickettsial agents, and in people, cholesterol and oxidative lipoproteins as observed in atherogenesis (see Cullen *et al.*, 2005 for a thorough review on atherosclerosis). The outcome of endothelial dysfunction observed in these disease states includes local or disseminated formation of thrombi, vascular permeability causing accumulation of extravascular fluid, and petechiae or hemorrhage.

## B. Platelets

Platelet plug formation involves a complex, interrelated sequence of events that overcome local resistance to platelet activation long enough to permit the cessation of bleeding. It is not possible to describe the biochemical events involved in platelet function, activation, and aggregation in a strictly temporal sequence because of the numerous positive feedback reactions, multiple agonists, and complementary intracellular pathways that function in a cooperative, coordinated fashion (Fig. 10-1). For simplicity, the process that results from activation, and leads to platelet plug formation, can be divided into three major events. The initiating response is the tethering of platelets to ligands exposed in the perturbed extracellular matrix (ECM) and subsequent formation of a platelet monolayer around the site of damage. The platelet plug grows when additional activated platelets accumulate on top of this monolayer in a complex series of reactions involving “outside-in” and “inside out” signaling (see Section II.B.2). These events involve platelet shape change, the release of granule contents, and the formation of platelet-platelet aggregates that initiate contact-dependent signaling



**FIGURE 10-1** Simplified sequence of platelet activation and aggregation. Abbreviations: AA, arachidonic acid; ADP, adenosine diphosphate; PAF, platelet activating factor; TF, tissue factor; TXA<sub>2</sub>, thromboxane A<sub>2</sub>.

and the recruitment of additional intracellular signals. The various reactions are controlled by an integrated network of biochemical pathways (Levy-Toledano, 1999). Results of *in vitro* studies, involving the exposure of platelets from various mammalian species to a single agonist, indicate that there are species differences in the relative importance of various membrane receptors and signaling pathways (Gentry, 1992, 2000b). However, it is difficult to extrapolate the results of *in vitro* studies to the physiological setting. Under *in vivo* conditions, circulating platelets are exposed to multiple agonists and, once platelets are activated, the phenomenon of “crosstalk” between the various extracellular and intracellular signaling pathways occurs (Fig. 10-1). Although most of the current knowledge regarding platelet biochemistry has come from human and murine studies, it is likely that there are more similarities than differences in biochemical mechanisms among species. In addition to a full complement of biochemical pathways, an adequate number of circulating platelets with structural integrity are required for platelets to fulfill their central role in hemostasis.

### 1. Platelet Production

Platelet formation is the culminating event of megakaryopoiesis. In bone marrow, long, cylindrical processes of megakaryocyte cytoplasm are pinched off, to form proplatelets, and released into the circulation (Nagata *et al.*, 2003). These fusiform, or elongated, platelets undergo morphogenesis into mature platelets through additional fragmentation processes involving the fusion of cytoplasmic vesicles with the plasma membrane (Benke, 1993). Fusiform platelets constitute about 15% of the platelet population in the rat and guinea pig, and elongated platelets, up to 20 $\mu$  long, can occur in horses (Tablin, 2000). The mature mammalian platelet is small, 5 to 7 $\mu$  long and

frequently less than 3 $\mu$  wide (Tablin, 2000). Early clinical studies indicated that among the physiological roles of interleukins, including IL-1, IL-3, IL-6, and IL-11, was their ability to stimulate platelet production. More recent studies have confirmed that thrombopoietin (TPO) is the primary biochemical regulator of steady state megakaryopoiesis and platelet production (Kuter and Begley, 2002). TPO, also known as c-Mpl ligand, is a lineage-specific cytokine that is constitutively synthesized in the liver. It is removed from the circulation by binding to the c-Mpl receptor on platelets and bone marrow megakaryocytes (Kaushansky, 2002). The TPO molecule consists of 331 amino acids organized in two domains, a receptor-binding domain that shows some homology to erythropoietin and a highly glycosylated carboxy-terminal portion that stabilizes the TPO protein. Although TPO increases the size, ploidy, and number of megakaryocytes, and also stimulates the expression of platelet-specific markers, it does not appear to increase the rate of platelet shedding from late-stage megakaryocytes (Choi *et al.*, 1996). Circulating TPO levels appear to be directly influenced by platelet mass because TPO levels rise and remain elevated during persistent thrombocytopenia. It is likely that TPO-independent mechanisms are also involved in platelet production because TPO<sup>-/-</sup> mice are healthy and show no signs of spontaneous hemorrhage, despite being thrombocytopenic (Alexander *et al.*, 1996).

The normal circulating life span of mammalian platelets is in the range of 3 to 10 days. The mechanisms involved in the clearance of senescent platelets from the circulation are not yet known, but evidence is emerging that platelet aging is associated with the universal cellular phenomenon of loss of membrane asymmetry. For example, the proportion of canine platelets with PS exposed on the plasma membrane increases with age and is accompanied by

**TABLE 10-2** Major Platelet Ligands, Integrin/Receptors, and Their Physiological Effects

Integrin/Receptor	Major Ligand	Effect
$\alpha_2\beta_1$	Collagen	Platelet adhesion to ECM ↑ effectiveness GPVI receptor
GPVI	Collagen	Platelet adhesion to ECM Activation of PLC <sub>2</sub>
GP1b-IX-V	vWF	Up-regulation of $\alpha_2\beta_1$ receptor ↑ intracellular calcium Up-regulation of GPIIb-IIIa receptors
GPIIb-IIIa	Fibrinogen	Calcium mobilization Protein kinase activation Cytoskeleton rearrangement Platelet aggregation
PAR-1 PAR-4	Thrombin	Activation of G <sub>q</sub> receptor → PLC <sub>β2</sub> activation Activation of G <sub>i</sub> receptor → ↓ adenylyl cyclase activity
P2Y <sub>1</sub>	ADP	Activation of G <sub>q</sub> receptor → PLC <sub>β2</sub> activation Activation of MLCK → cytoskeleton rearrangement
P2Y <sub>12</sub>	ADP	Activation of G <sub>iα</sub> receptor → inhibition of adenylyl cyclase
P2X <sub>1</sub>	ADP	↑ intracellular calcium
PAFR	PAF	Activation of PLA <sub>2</sub> ↓ adenylyl cyclase activity

Abbreviations: ADP, adenosine diphosphate; ECM, extracellular matrix; MLCK, myosin light chain kinase; PAF, platelet activating factor; PAR, protease activated receptor; PLC, phospholipase C; vWF, von Willebrand factor.

mitochondrial changes consistent with apoptosis (Pereira *et al.*, 2002).

## 2. Platelet Structure

Mammalian platelets circulate as discoid, anucleate subcellular particles that contain several types of organelles including  $\alpha$ -granules, dense granules, mitochondria, and lysosomes (Triplett, 2000). The majority of mammalian platelets exhibit an extensive canalicular system that is continuous with the plasma membrane, also known as the open-canalicular system (OCS). The OCS not only plays an essential role in platelet adhesion and aggregation but it also facilitates the two-way exchange of biological compounds between the platelet interior and the surrounding plasma (Escolar and White, 1991). In platelets of domestic cattle, horses, and Asian elephants, there is no evidence for the presence of an OCS. Despite this major ultrastructural difference, the biochemical mechanisms involved in platelet aggregation in these species are generally similar to those of other mammalian species (Bondy and Gentry, 1988; Cheryk *et al.*, 1997; Gentry *et al.*, 1989; Segura *et al.*, 2006). The biochemical mechanisms required for normal platelet function are tightly regulated. Multiple positive feedback reactions facilitate rapid adhesion and aggregation at sites of vascular injury, whereas negative feedback responses modulate the continuation of platelet

activation and thus regulate the extent of thrombus formation once wound healing has been initiated.

Several types of membrane proteins and phospholipids are essential for platelet adhesion and aggregation (Tables 10-2 and 10-3). Integrins are heterodimeric ( $\alpha\beta$ ) type 1 transmembrane receptors in which each subunit typically contains a large extracellular domain and a short cytoplasmic tail composed of 20 to 60 amino acids. Integrins, like the membrane G-protein coupled receptors (GPCR), can be viewed as “two-faced” receptors. In the case of integrins, the face oriented to the platelet exterior interacts with ligands on the ECM, and the face internally oriented interacts with platelet cytoplasmic proteins. Ligand binding to either face can trigger information transfer across the plasma membrane to initiate biochemical responses at the other face. This type of cross-membrane signaling is referred to as “outside-in” and “inside-out” signaling depending on the direction of information transfer (Barkalow *et al.*, 2003; Shattil and Newman, 2004). Current knowledge of integrin biochemistry has come primarily from the investigation of human and murine platelets and the impaired aggregation responses in “knockout” mice. The major integrins involved in platelet adhesion and the stabilization of the primary hemostatic plug are the glycoproteins GPIIb-IIIa (also termed  $\alpha_{IIb}\beta_3$ ),  $\alpha_2\beta_1$ , the glycoprotein complex GP1b-V-IX, and GPVI, which is a member of the Ig receptor superfamily (Boudreaux, 1996; Gibbins,

**TABLE 10-3** Intracellular Activation Signaling Pathways

Effector	Major Actions
Tyrosine and serine/threonine kinases (e.g., Src, Syk, Erk, PKC)	Enzyme activation including PLC, PLA <sub>2</sub> , MLCK
↑ intracellular calcium	Calmodulin mediated activation of MLCK Activation of PLC, PLA <sub>2</sub> , PKC Activation of phosphodiesterase → ↓ cAMP
PLC <sub>α</sub> , PLC <sub>β</sub>	Hydrolysis of PI to IP <sub>3</sub> and DAG
IP <sub>3</sub>	Activation of calcium-dependent ATPase → release of calcium from dense granules
DAG	Activation of PKC → integrin conformation changes → ↑ affinity of GPIIb-IIIa for fibrinogen
PLA <sub>2</sub>	Hydrolysis of PC → release of AA and lyso-PAF

Abbreviations: AA, arachidonic acid; DAG, diacyl glycerol; IP<sub>3</sub>, inositol 3-phosphate; MLCK, myosin light chain kinase; PAF, platelet activating factor; PI, phosphoinositol; PKC, protein kinase C; PLA<sub>2</sub>, phospholipase A<sub>2</sub>; PLC, phospholipase C.

2004; Shattil and Newman, 2004). Other examples of integrins involved in cross-membrane signaling are the ephrins that activate specific Eph kinases to ephrins, enhancing platelet adhesion through phosphatidylinositol 3 (PI3) kinase and protein kinase C (PKC) mediated mechanisms (see Table 10-3) (Prevost *et al.*, 2004). CD40, a phosphorylated transmembrane glycoprotein, a member of the TNF receptor superfamily, is constitutively expressed in platelets, but it is only functional following platelet activation by other agonists. It has been shown that CD40 participates in the release of P selectin (CD62P) and other  $\alpha$ -granule constituents, following agonist stimulation of human platelets (Inwald *et al.*, 2003).

Several members of the GPCR superfamily have been identified as integral components of platelet membranes (Coughlin, 2005b). Platelet agonists bind to the surface-accessible N-terminal domain of these proteins causing information to be transmitted through a seven-transmembrane domain. This induces a conformational change in the intracellular C-terminal domain which, in turn, activates GPCR proteins associated with the intracellular surface of the receptor (Hamm, 2001). GPCR proteins are heterotrimeric, being composed of single  $\alpha$ ,  $\beta$ , and  $\gamma$  subunits, and are classified into families according to the structure of their  $\alpha$  subunit. Members of four families have been identified in human platelets. Activation of G<sub>s</sub> and G<sub>i</sub> proteins induces an increase and decrease in intracellular cAMP levels,

respectively, activation of G<sub>q</sub> stimulates the  $\beta$  isoforms of phospholipase C (PLC, see Section II.B.3.c), and activation of the G<sub>12</sub> contributes to the regulation of the platelet actin cytoskeleton through protein phosphorylation (Brass, 2003). Whether a similar array of G protein receptors is expressed on other types of mammalian platelets has yet to be determined. However, based on studies with murine platelets, it is evident that the abundance of G protein types is necessary to support the similarity of platelet responses to multiple dissimilar agonists (Yang *et al.*, 2002).

The most important group of platelet membrane lipids involved in hemostasis are the *phospholipids* (phosphoglycerides), which constitute 63% and 57% of the total lipid content of pig and human platelets, respectively (Gentry and Nyarko, 2000). The major phospholipids involved in platelet function are phosphatidylserine (PS), phosphatidyl ethanolamine (PE), phosphatidylcholine (PC), sphingosine (SP), and phosphatidyl inositol (PI). PI is the parent molecule for the downstream, or secondary messenger, signal transducers inositol triphosphate (IP<sub>3</sub>) and 1,2 diacylglycerol (DAG) (Table 10-3), whereas PC is hydrolyzed to arachidonic acid (AA) in activated platelets (Nozawa *et al.*, 1991). In all species, AA serves as the precursor of thromboxane A<sub>2</sub> (TXA<sub>2</sub>) and prostaglandins, such as prostacyclin (PGI<sub>2</sub>), and serves as an autocrine agonist in some species (Gentry and Nyarko, 2000). In unstimulated platelets the negatively charged PS and PE are found predominantly on the intracellular side of the plasma membrane, whereas the neutral phospholipids, PC and SP, are localized to the outer leaflet. In response to the elevated intracellular calcium levels that occur following platelet activation, PS and PE are translocated to the outer leaflet of the membrane. Here they congregate to form the lipid platform that is essential for the localized platelet membrane binding and proteolytic activity of two key enzyme complexes in thrombin formation, namely the factor VIIIa-IXa-Ca-PS (tenase) complex and the factor Va-IXa-Ca-PS (prothrombinase) complex (see Section II.C.3).

Platelets contain three types of organelles, also known as granules, in which they transport various specific hemostatic and wound healing compounds around the body (Tablin, 2000). Dense granules contain small nonprotein molecules such as ADP, ATP, serotonin, Ca<sup>2+</sup>, and Mg<sup>2+</sup>. The release of ADP and serotonin, from the first layer of activated platelets that adhere to a site of vascular damage, is important in the recruitment of additional platelets and the development of the platelet plug (Fig. 10-1)  $\alpha$ -granules, the largest granule population, contain a variety of proteins such as albumin, fibronectin, thrombospondin, and the hemostatic proteins, fibrinogen, and FV (Polasek, 2004). They also contain platelet-specific proteins, including  $\beta$ -thromboglobulin and platelet factor 4, platelet derived growth factor (PDGF), epidermal growth factor (EGF), transforming growth factor  $\beta$  (TGF $\beta$ ), and endothelial cell growth factor (ECGF) (Rendu and Brohard-Bohn, 2001).

The proteins stored in the  $\alpha$ -granules are either synthesized by megakaryocytes or are endocytosed by platelets as they circulate around the body (Reed, 2004). Like other endocytotic cell types, platelets contain lysosomes that release hydrolases. It has been suggested that these hydrolases assist in the elimination of circulating platelet aggregates to prevent inappropriate thrombus formation (Rendu and Brohard-Bohn, 2001). Mitochondria and cytoplasmic glycogen stores provide the energy to support the granule exocytotic secretory process in activated platelets (Flaumenhaft, 2003). This exocytosis process involves contraction of the actin-myosin cytoskeleton and the apposition and fusion of each granule membrane with the platelet plasma membrane (Escolar and White, 1991; Reed, 2004; Rendu and Brohard-Bohn, 2001). In addition to the extrusion of granule contents, the alteration in platelet morphology results in the exposure of both GPIIb-IIIa integrin complexes and membrane markers, such as CD62 and CD63, on the surface of the activated platelets (Polasek, 2004). CD62, also referred to as P-selectin, has been used as a marker of activated canine platelets (Moritz *et al.*, 2003a, 2003b).

### 3. Platelet Activation

#### a. Immobilized Agonists

When the ECM is damaged, various macromolecules interact with platelets as they roll along the exposed subendothelial surface collagen. Of these, collagen-bound vWF is considered to be the most important for the initial tethering and adhesion of platelets to areas of vascular damage (Nieswandt and Watson, 2003). This occurs through the interaction of collagen-bound vWF with the GPIb-IX-V integrin complex. However, at the medium and high shear rates found in arteries and arterioles, this reaction is reversible and must be followed by the more stable binding of collagen to its specific platelet receptors  $\alpha_2\beta_1$  and GPVI (Table 10-2). The initial interaction between platelets and the ECM through vWF-GPIb-IX-V binding is important because it induces activation of intracellular tyrosine kinases, causing increased affinity of  $\alpha_2\beta_1$  for collagen binding as well as an increase in the affinity of GPIIb-IIIa for a variety of ligands including fibrinogen, vWF, fibronectin, vitronectin, and thrombospondin (Calvete, 2004). The two collagen receptors,  $\alpha_2\beta_1$  and GPVI, are thought to have complementary functions in platelet adhesion (Andrews and Berndt, 2004). In human platelets,  $\alpha_2\beta_1$  binds collagen in an  $Mg^{2+}$ -dependent manner, tethering platelets to the ECM before platelet activation. At the same time, collagen- $\alpha_2\beta_1$  binding facilitates the interaction between collagen and GPVI in a nontyrosine kinase-dependent reaction. GPVI is currently considered to be the major collagen receptor because it initiates shape change, activation, and secretion reactions following platelet adhesion (Nieswandt and Watson, 2003). In mouse platelets,

it appears that GPVI provides the primary collagen signal that activates and recruits  $\alpha_2\beta_1$  integrins to the surface of the platelet so that collagen signaling is amplified (Chen and Kahn, 2003). One of the important intracellular pathways activated as a result of collagen binding to GPVI is the PLC pathway, specifically the activation of the PLC $\gamma_2$  isomer (Savage *et al.*, 2001).

As platelets adhere to collagen and receptor activation occurs, they lose their resting discoid shape and extend pseudopods as they spread over the endothelial surface (Escolar and White, 1991; Gentry, 2000b). This increases the surface area of the platelets, which, coupled with the clustering of integrin molecules on platelet membranes and the increase in integrin affinity, results in the formation of irreversible platelet-endothelial binding via vWF and the GPIb-IX-V receptors and platelet-platelet interactions via vWF and fibrinogen binding to GPIIb-IIIa receptors (Boudreaux, 1996; Savage *et al.*, 2001). The GPIb-IX-V receptor is a sialoglycoprotein-rich complex that contributes to the net negative charge on the platelet surface. GPIb consists of two disulfide-linked subunits, GPIb $_{\alpha}$  and GPIb $_{\beta}$ , that are associated with GPIX in a 1:1 complex (Lopez and Dong, 1997). In mouse platelets, the activation function of vWF binding to GPIb-IX-V is, like collagen binding to the GPVI receptor, dependent on tyrosine phosphorylation (Shattil and Newman, 2004). This phosphorylation activity is dependent on the FcR, a molecule that associates noncovalently with GPVI and GPIb-IX-V. FcR $\gamma$  is a component of the multisubunit high-affinity receptor for immunoglobulin (IgE), and its tyrosine-phosphorylated active motif helps to recruit tyrosine kinases to the glycoprotein receptors. The binding site for vWF on the receptor complex is localized to a site on the GPIb $_{\beta}$  chain, which can also serve as a thrombin receptor. The outside-in signaling events that ensue from vWF-GPIb $_{\beta}$  binding include activation of protein kinase C (PKC), protein kinase G (PKG) and phosphoinositol 3 kinase (PI3K), elevation of intracellular Ca $^{2+}$ , and rearrangement of the cytoskeleton (Gibbins, 2004). These reactions complete the irreversible adhesion of the activated platelet monolayer to the damaged endothelium. As part of the defense mechanism against inappropriate platelet adhesion and aggregation, GPIb-IX-V receptors only bind vWF immobilized on collagen and not soluble vWF, except under conditions of high shear flow rates (Lopez and Dong, 1997).

The continued growth of the platelet plug requires platelet-platelet adhesion that is accomplished through a process described as “contact-dependent” signaling and involves the expression and activation of GPIIb-IIIa receptors (Shattil and Newman, 2004). GPIIb-IIIa is the most abundant integrin on the platelet surface and is not only necessary for platelet-platelet aggregation but also for platelet secretion, the development of procoagulant activity, and clot retraction. This integrin is typical of type 1 membrane receptors in that it contains a relatively large

globular external domain, formed by the association of the N-terminal ends of both the  $\alpha$  and  $\beta$  subunits, a single pass transmembrane domain and short C-terminal cytoplasmic tails composed of 20 to 60 amino acids (Hynes, 2002). The ligand binding sites contained in the external domain are converted to a high-affinity state through several inside-out signaling mechanisms. Among these signals are the interaction of the  $\alpha$  and  $\beta$  subunit cytoplasmic tails with cytoskeleton proteins, actin and talin, inducing the formation of larger actin-based signaling complexes that are essential for granule migration and the fusion of granule and plasma membranes that precede the secretion of granule contents (Williams *et al.*, 1995). Fibrinogen is the primary hemostatic ligand for GPIIb-IIIa, and fibrinogen bridges between platelets are the backbone of stable platelet aggregates. Other plasma proteins, including vWF, fibronectin, vitronectin, and thrombospondin, that have an RGD sequence similar to that present in fibrinogen can also bind to the  $\alpha$  subunit of the GPIIb-IIIa. Fibrinogen has two RGD sequences per monomer, but it can also bind to GPIIb-IIIa through a recognition site involving residues 400 to 411 on its  $\gamma$  chain (Calvete, 2004; Williams *et al.*, 1995). Occupancy of GPIIb-IIIa binding sites with fibrinogen up-regulates this integrin by inducing microclustering, as well as initiating downstream signaling through activation of Src and Syk protein kinases (Tables 10-2 and 10-3) (Shattil and Newman, 2004).

It is now recognized that GPIIb-IIIa plays a continuing role in platelet function after a thrombus has formed through its role in clot retraction (Osdoit and Rosa, 2001). It has been postulated that one of the reasons platelet-rich clots are more resistant to thrombolysis than platelet-poor clots is related to the lower affinity of tissue plasminogen activator (tPA) for the retracted fibrin fibers of a platelet-rich clot compared to the less retracted fibrin fibers of a platelet-poor clot (Collet *et al.*, 2002) (see Section II.D.2.b). Although the biochemical mechanisms involved in clot retraction are poorly understood, studies with mouse platelets have shown that after the initial wave of tyrosine phosphorylation initiated by activation of the  $\beta_3$  cytoplasmic tail of the GPIIb-IIIa receptor, a sustained GPIIb-IIIa-dependent tyrosine dephosphorylation of several polypeptides occurs (Osdoit and Rosa, 2001). This dephosphorylation response causes actin-dependent changes in the cytoskeleton that result in shrinkage in the size of the platelet-fibrin mass.

#### b. Soluble Agonists

In addition to immobilized collagen and vWF on the surface of damaged ECM, there are several soluble mediators that act as potent platelet agonists in the aggregation of mammalian platelets (Gentry, 2000b). The local accumulation of thrombin, generated from TF expression on the surface of damaged endothelial cells (see Section II.C.2), and ADP, released from  $\alpha$ -granule stores in activated platelets,

is essential for the growth of the primary hemostatic plug on top of the initial monolayer of collagen-bound platelets. Thrombin and ADP, and in some species TXA<sub>2</sub>, induce similar platelet-platelet aggregation formation through activation of the  $\alpha_{IIb}\beta_3$  receptors (Brass, 2003).

The major pathways of thrombin-induced activation result from hydrolysis of specific thrombin substrates, protease-activated receptors-1 and -4 (PAR-1, PAR-4), that are members of the G-protein coupled seven transmembrane domain receptor family (Major *et al.*, 2003). To activate these receptors, thrombin cleaves the N-terminus, exposing a new N-terminus that serves as a “tethered-ligand” and binds to the extracellular-2 domain of the cleaved receptor (Dugina *et al.*, 2002). A highly effective local concentration of this ligand is present, as it is not free to diffuse away from the platelet surface (Brass, 2003). Activation of PAR-1 and PAR-4 causes a downstream activation of G<sub>q</sub>, G<sub>12</sub>, and G<sub>i</sub> that, in turn, leads to the activation of the  $\beta$  isomer of PLC, PI3-kinase, and the inhibition of adenylyl cyclase, respectively (Table 10-2) (Grand *et al.*, 1996). Studies on PAR receptors to date have focused on human and murine platelets, and results have revealed distinct differences in PAR receptor expression. In human platelets, activation of PAR-4 requires 10- to 100-fold higher concentrations of thrombin than PAR-1. Hence, PAR-1 is considered to be the more important thrombin receptor (Kahn *et al.*, 1998). This difference in receptor sensitivity may be related to the hirudin-like sequences in PAR-1, but not PAR-4, that facilitate receptor cleavage by thrombin. In contrast, PAR-4 is the primary thrombin receptor in mouse platelets (Ishihara *et al.*, 1997). In this species the cleavage of PAR-4 is facilitated by PAR-3 receptors. PAR-3 is the only member of the PAR family that does not possess an activating peptide, and, hence, it cannot directly activate platelets. PAR-2, the fourth member of the PAR family to be identified, is not activated by thrombin but by other serine proteases such as trypsin, TF, and FXa (Camerer *et al.*, 2000). The PAR-2 receptor has not been found on platelets but is present in a number of other cell types, including endothelial cells. The potency of thrombin as an agonist may also be related to its ability to interact not only with PARs but also non-PARs, particularly the GPIb $\alpha$  component of the GPIb-IX-V complex (Soslau *et al.*, 2001). It has been suggested that, in human platelets, binding of thrombin to GPIb $\alpha$  may facilitate PAR-1 cleavage in a manner analogous to the role of PAR-3 in mouse platelets (DeCandia *et al.*, 2001).

ADP was the first low-molecular-weight platelet-aggregating agent to be discovered and, like thrombin, is recognized as a universal agonist. It is stored in dense granules, in near molar amounts, and can be released not only from this source but also from damaged endothelial cells and red blood cells at sites of vascular damage (Gachet, 2001). ADP induces a broad range of biochemical changes in platelets. By itself, it is a relatively weak agonist, but it



exhibits synergy with the stronger agonists, such as collagen and thrombin, which induce its secretion from dense granules (Mills, 1996). Further, low concentrations of ADP potentiate and amplify the effects of other weak agonists such as serotonin, epinephrine, and TXA<sub>2</sub> (Dangelmaier *et al.*, 2001). So far, three platelet ADP receptors have been identified: P2Y<sub>1</sub>, P2Y<sub>12</sub>, and P2X<sub>1</sub> (Table 10-2) (Gachet, 2001). The central role of ADP in platelet function may be due, at least in part, to its ability to directly cause an elevation in intracellular calcium levels while simultaneously stimulating two biochemical pathways, one of which is mediated through G<sub>q</sub>/PLC-mediated reactions (Table 10-3) and the other through G<sub>i2</sub>-mediated inhibition of adenylyl cyclase. Co-activation of both G<sub>q</sub> and G<sub>i2</sub> pathways, through P2Y<sub>1</sub> and P2Y<sub>12</sub>, respectively, are essential for normal ADP-induced aggregation (Gachet, 2001). P2Y<sub>1</sub> and P2Y<sub>12</sub> are GPCRs that exhibit the usual seven hydrophobic domains and are sometimes referred to as “metabotropic.” In addition to activating the PLC<sub>β</sub> isomer of PLC, the P2Y<sub>1</sub> receptor induces phosphorylation of myosin light chain kinase (MLCK), which permits reversible incorporation of proteins, such as actin and talin, into the cytoskeleton to promote shape change (Savage *et al.*, 2001). This cytoskeletal reorganization is accompanied by an increase in the levels of the regulatory subunit of P13 kinase analogous to that observed following activation of platelets by thrombin (Rittenhouse, 1996). When ADP interacts with the P2Y<sub>12</sub> receptor it causes the heterodimeric G<sub>i</sub> protein to disassociate into its α<sub>i2</sub> and β<sub>γ</sub> subunits, which in turn causes the inhibition of adenylyl cyclase and a reduction in intracellular cAMP levels. These biochemical reactions slow the rate of calcium removal from the cytosol, which helps sustain the aggregation response. ADP also facilitates the development of stable platelet-platelet aggregates because activation of both the P2Y<sub>1</sub> and P2Y<sub>12</sub> receptors enhances the number and clustering of binding sites for fibrinogen on α<sub>Ib</sub>β<sub>3</sub> receptors (Gachet, 2001). The P2X<sub>1</sub> receptor resembles a ligand-gated ion channel protein, exhibits two hydrophobic domains, and is referred to as “ionotropic” (Gachet, 2001; Mills, 1996). ADP interacts with its receptors as the anion ADP<sup>3-</sup>, indicating that positively charged groups on the receptors are involved in ligand binding. The major advances in knowledge of ADP receptors have come from studies with human and mouse platelets. It appears that at least the P2Y<sub>1</sub> and P2Y<sub>12</sub> receptors may be ubiquitous, although the relative number and sensitivity of receptors may differ (Coomber *et al.*, 2006). For example, compared to human platelets, the P2Y<sub>12</sub> receptor may have a more important role in equine platelets than the P2Y<sub>1</sub> receptor (Mateos-Trigos *et al.*, 2002).

Platelet-activating factor (PAF) is also a potent soluble inducer of platelet aggregation but, unlike the universal agonists thrombin and ADP, not all mammalian platelets exhibit specific PAF receptors. Like human platelets, cow, sheep, horse, pig, dog, cat, elephant, guinea pig, and rabbit

platelets respond to PAF at concentrations between 10<sup>-10</sup> and 10<sup>-7</sup>M (Kulikov and Muzya, 1998). Platelets from mice, rabbits, and hamsters are unresponsive to PAF. PAF is a proinflammatory lipid mediator with a unique 1-O-alkyl-glycerophospholipid backbone that exhibits multiple biological properties, including activation of platelets, neutrophils, monocytes, and macrophages (Chao and Olson, 1993; Prescott *et al.*, 2000). In PAF activated endothelial cells and platelets, cytoplasmic PLA<sub>2</sub> simultaneously releases AA and lyso-PAF that is converted to additional PAF molecules by acetyl CoA lyso-PAF transferase (Chao and Olson, 1993; Honda *et al.*, 2002). In endothelial cells, PAF is translocated from its site of synthesis in the endoplasmic reticulum to the plasma membrane where the polar head of the molecule is inserted into the outer leaflet and serves as a juxtacrine ligand (Honda *et al.*, 2002). In contrast, PAF formed in platelets, from lyso-PAF, is released into the circulation. PAF is degraded in the plasma by removal of an acetyl group at the sn-2 position, regenerating lyso-PAF and acetate. This reaction is catalyzed by a PAF acetylhydrolase that circulates in association with low-density and high-density lipoproteins (Prescott *et al.*, 2000). The PAF receptor (PAFR) possesses the typical structure of the GPCRs. Therefore, PAF can induce intracellular protein phosphorylation in activated platelets indirectly through DAG stimulated protein kinase C activation, as well as through activation of tyrosine kinases (Table 10-2).

It is well established that platelets from various species exhibit different sensitivities when exposed *in vitro* to a single dose of a weak agonist such as serotonin, epinephrine, or arachidonic acid (Dodds, 1978; Meyers and Wardrop, 1991; Pelagalli *et al.*, 2002). Serotonin causes only a weak aggregation response in human, rabbit, cat, cow, sheep, and horse platelets, whereas canine platelets are unresponsive (Bailey *et al.*, 2000; Mischke and Schulze, 2004; Ogawa *et al.*, 1998). As in mammalian platelets, serotonin is present in thrombocytes of birds and reptiles (Maurer-Spurej, 2005). In these species serotonin acts as a vasoconstrictor and plays a role in endothermic body temperature regulation through its ability to regulate skin blood flow. It has been postulated that serotonin released from activated platelets may also have a role in mammalian thermoregulation (Maurer-Spurej, 2005). Canine and equine platelets are relatively unresponsive to epinephrine alone (Mischke and Schulze, 2004; Segura *et al.*, 2005). The ability of epinephrine to act synergistically with collagen is used to advantage for the assessment of platelet function in whole blood with the PFA analyzer (see Section III.B.2.c). However, the response of both canine and equine platelets is lower when collagen-epinephrine is used as the agonist compared to collagen-ADP (Mischke and Schulze, 2004; Segura *et al.*, 2005).

### c. Intracellular Signaling Mechanisms

The ligand binding of integrins and agonist binding to G-protein coupled receptors initiate intracellular signaling

through multiple, interrelated pathways. The major signal transduction systems are summarized in Table 10-3. These biochemical pathways appear to be universal in platelets from all species, although they have been primarily investigated in human platelets. The limited information available for nonhuman platelets indicates that variations occur in the relative predominance of the individual enzymatic pathways (Gentry, 1992, 2000b). Protein phosphorylation by tyrosine and serine/threonine kinases is known to be critical for the modulation of the biological functions of platelets. Enzyme systems that have been identified include the nonreceptor tyrosine kinases, Src and Syk, that activate the cytoplasmic tail of the GPIIb-IIIa integrin  $\beta_3$  chain inducing an increase in the affinity of the  $\alpha_{IIb}$  chain for fibrinogen (Marshall *et al.*, 2004). The fibrinogen binding reaction is also enhanced by protein kinase C (PKC), following its activation through a diacylglycerol (DAG)-dependent mechanism (Buensuceso *et al.*, 2005).  $\alpha_2\beta_1$  activation of collagen-adherent platelets also stimulates phosphorylation of proteins such as Src, Syk, and the PLC $\gamma_2$  isomer of PLC, all of which are components in the GPVI-FcR $\gamma$ -chain cascade (Inoue *et al.*, 2003). Activation of platelets by collagen-GPVI interaction induces PKC-Ca<sup>2+</sup>-mediated activation of the MLCK that, in turn, induces the cytoskeletal changes necessary for granule secretion. The phosphorylation of the myosin light chain can also occur through a Ca<sup>2+</sup>/calmodulin mechanism that is mediated by an extracellular signal regulated kinase (Erk2) (Toth-Zsomboki *et al.*, 2003).

The elevation of free cytosolic calcium, following receptor-mediated influx of extracellular calcium and secondary release of calcium from the dense tubular system, is one of the critical biochemical events in platelet activation in all species (Gentry, 2000b; Heemskerk and Sage, 1994). In addition to mediating the activation of PKC, calcium is directly involved in the regulation of phospholipid metabolism through activation of the calcium-dependent enzymes phospholipase C (PLC) and phospholipase A2 (PLA2). A further response to increased intracellular calcium is the lowering of intracellular cyclic adenosine monophosphate (cAMP) levels through activation of cAMP phosphodiesterase. The reduced cAMP levels exert a positive feedback response to further increase intracellular calcium levels, which, in turn, further enhance platelet reactivity and aggregation (Table 10-3).

PLC is one of the secondary messenger systems that is universally activated by platelet agonists. It catalyses the cleavage of membrane bound phosphatidyl 4,5 bisphosphate (PIP2), one of the phosphorylated derivatives of PI, to lipophilic membrane bound DAG and hydrophilic IP3 that is released into the cytoplasm (Kroll and Schafer, 1989; Nozawa *et al.*, 1991). DAG and IP3 act synergistically as signal transducers to promote all aspects of the basic platelet response, including shape change, increase in integrin and receptor affinity, and secretion of granule contents (Table 10-3). As noted previously, DAG-activated kinases, such

as PKC, cause protein phosphorylation to mediate cellular changes such as increased affinity of GPIIb-IIIa integrins and a rise in intracellular calcium. IP3 is also instrumental in elevating calcium levels through the activation of a calcium transporting adenosine triphosphate (ATPase) system that mobilizes calcium from the dense tubular system. The continued functioning of the IP3-DAG system depends on the continued agonist-receptor-mediated activation of PLC, as both IP3 and DAG are rapidly converted to inositol and phosphatidic acid (PA), respectively. Both inositol and PA can be utilized for the resynthesis of PI and therefore are recycled within the platelet (Nozawa *et al.*, 1991).

In platelets from most species of domestic animals, collagen and thrombin are more potent activators of the phospholipase A2 (PLA2)-mediated secondary messenger system than are ADP or PAF (Gentry and Nyarko, 2000). PLA2 is an acyl hydrolase that cleaves the sn-2 acyl bond of the platelet membrane phospholipids, PC and PE, to release AA and lysophospholipids (Puri, 1998). AA is the major free fatty acid present in both platelet membranes and granules. Following its release into the cytoplasm, it is rapidly metabolized by the cyclooxygenase and lipoxygenase enzyme systems into labile products that function as both intracellular and extracellular messengers (Gentry and Nyarko, 2000). Unlike many nucleated cells, including endothelial cells that contain two forms of cyclooxygenase (COX), only the constitutively expressed form, COX-1, is found in platelets. In platelets, COX-1 first oxidizes and cyclizes AA to form prostaglandin PGG2, which it subsequently hydrolyzes to prostaglandin PGH2. These cyclic endoperoxides are rapidly metabolized to TXA2 by thromboxane synthetase; prostacyclin (PGI2) by PGI synthetase; or are converted to the eicosanoids, PGD2, PGE2, or PGF2 by isomerase enzymes that have yet to be fully characterized in platelets. In most mammalian platelets, TXA2 is the major metabolite, and in human platelets, it exerts a positive feedback effect on platelet aggregation through its receptor. Variable responses to TXA2 have been found in canine platelets, and bovine platelets do not respond to this agonist (Gentry, 1992, 2000b). It is possible that the variable response of mammalian platelets to the agonist effect of TXA2 is related to different receptor populations in different species. Because of the labile nature of TXA2, its stable metabolite, TXB2, is used to evaluate the extent of AA metabolism in activated platelets. Comparable to the difference in aggregation response to TXA2, the level of TXB2 released from thrombin-stimulated human, horse, and cat platelets is 10-fold greater than the amount released after similar activation of cow, pig, sheep, and mink platelets (Gentry and Nyarko, 2000).

#### d. Negative Regulation of Aggregation

To balance the ability of platelets to be rapidly activated when needed, a number of regulatory mechanisms exist

**TABLE 10-4** Inhibitory Intracellular Signaling Mechanisms

Effector	Major Actions
PGI <sub>2</sub>	↑ adenylyl cyclase activity → ↑ cAMP Inhibition of PI hydrolysis → ↓ IP <sub>3</sub> and ↓ DAG
cAMP	↓ free cytosolic calcium Inhibition of PI hydrolysis Suppression of adhesion and aggregation responses
NO/cGMP/cGKI	Inhibition of ADP2Y <sub>12</sub> receptor activation Inhibition of GPIIb-IIIa receptor activity
PECAM-1	Inhibition of collagen stimulated calcium mobilization, granule secretion, and aggregation

Abbreviations: DAG, diacyl glycerol; GKI, GMP-dependent protein kinase; IP<sub>3</sub>, inositol 3-phosphate; NO, nitric oxide; PECAM, platelet endothelial cell adhesion molecule; PGI<sub>2</sub>, prostacyclin; PI, phosphoinositol.

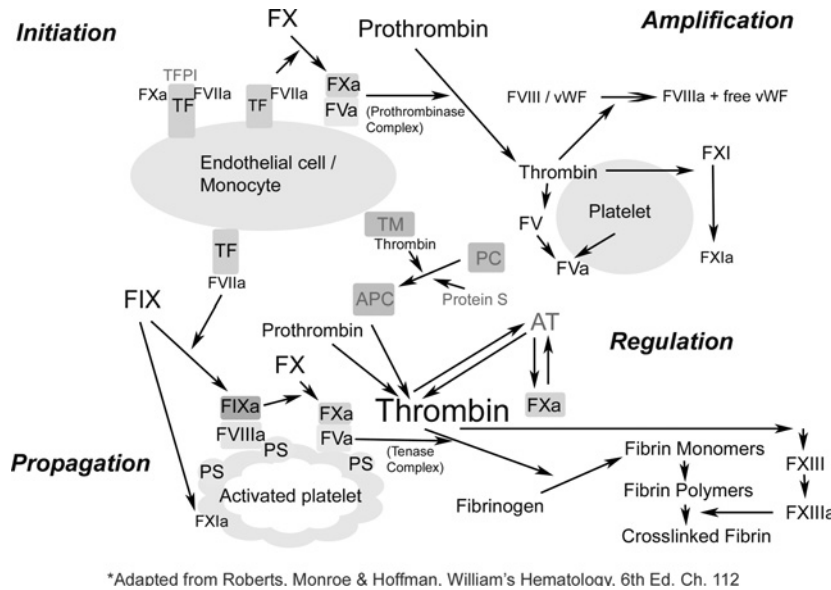
that prevent unwarranted platelet activation and limit the extent of aggregation. Most of the important physiological platelet inhibitors are endothelial-derived factors and their mediators (Table 10-4). The PGI<sub>2</sub>/cAMP and nitric oxide (NO)/cGMP inhibitory pathways have multiple synergistic interactions with respect to cyclic nucleotide generation/degradation and protein phosphorylation in platelets (Schwarz *et al.*, 2001).

Eicosanoids, such as PGI<sub>2</sub> and TXA<sub>2</sub>, are autocooids that only influence the activity of cells in the proximity of the producing cell. Both compounds are metabolites of AA, and whereas TXA<sub>2</sub> is the major product in platelets, PGI<sub>2</sub> is the major end product in endothelial cells after stimulation by agonists such as thrombin, ADP, and inflammatory mediators. PGI<sub>2</sub> acts as a potent platelet inhibitor, whereas enhancement of aggregation occurs in response to TXA<sub>2</sub> (deGroot and Sixma, 1996). To a great extent, platelet function is regulated by the intracellular concentration of cAMP. In platelets, as in other cells, cAMP formation is regulated bimodally by GPCRs that stimulate or inhibit adenylyl cyclase (Tables 10-2 and 10-3). PGI<sub>2</sub> suppresses intracellular signaling in activated platelets by stimulating adenylyl cyclase formation via G<sub>s</sub>-coupled IP receptors (Moncada and Vane, 1976). This results in the activation of a cAMP-dependent protein kinase (PKA) that stimulates the phosphorylation of a low-molecular-weight GTP-binding protein, rap 1B, which subsequently dissociates from the platelet membrane and inhibits PLC membrane binding. The net effect of this response is to suppress PI hydrolysis and reduce intracellular levels of IP<sub>3</sub> and DAG (Table 10-4). In addition to these effects on phospholipid metabolism, elevated cAMP levels reduce platelet reactivity through a number of mechanisms. These include a

reduction in GPIIb-IIIa expression and a reduction in the magnitude and duration of elevated cytosolic-free calcium after platelet activation (Gentry, 2000b).

Human platelets generate cGMP through the soluble NO-activated guanylyl cyclase enzyme and degrade it through the phosphodiesterase (PDE 2 and 5) (Feil *et al.*, 2003). The inhibitor effects of cGMP on platelet adhesion/activation are mediated through a cGMP-dependent protein kinase, cGKI (Table 10-4). The isomer present in platelets is cGKI<sub>β</sub>, a homodimer consisting of two 75-kDa subunits. Each subunit is composed of an N-terminal domain that suppresses kinase activity in the absence of cGMP, a regulatory domain that contains two nonidentical cGMP-binding sites, and a kinase domain that catalyzes the transfer of the γ phosphate of ATP to the hydroxyl group of a serine/threonine side chain of the target protein (Feil *et al.*, 2003). One of the ways in which cGKI contributes to a negative feedback response is through the inhibition of the G<sub>q</sub>/G<sub>i</sub>-coupled receptor responses, particularly in response to activation of the ADP-P2Y<sub>12</sub> receptor (Atkas *et al.*, 2002). Another negative feedback response is initiated by cGKI-mediated phosphorylation of platelet proteins, such as vasodilator-stimulated phosphoprotein (VASP), and is correlated with inhibition of the GPIIb-IIIa-fibrinogen receptor (Feil *et al.*, 2003). Studies with cGKI-deficient mice have shown that platelet cGKI, but not endothelial or smooth muscle cGKI, plays an important role in the prevention of platelet adhesion and aggregation in the microcirculation after ischemia (Massberg *et al.*, 1999).

Platelet endothelial cell adhesion molecule (PECAM-1), also known as CD31, is a 130-kDa type 1 transmembrane glycoprotein whose function is regulated by phosphorylation of serine residues in the cytoplasmic domain (Newman and Newman, 2003). Based on cDNA sequencing, there appears to be considerable homology in PECAM-1 across species. Phosphorylated PECAM-1 serine residues have been detected in resting platelets, and their level of phosphorylation increases two- to three-fold in collagen and thrombin-activated platelets. PKC is thought to play a primary role in this phosphorylation process, although Src kinases may also be involved (Edmead *et al.*, 1999). The presence of two distinct immunoreceptor tyrosine-based inhibitory motifs (ITIMs) in the cytoplasmic domain characterize PECAM-1 as belonging to the Ig-ITIM family of inhibitory receptors (Newman, 1999). ITIM-containing inhibitory receptors are thought to function primarily by counteracting signal transduction pathways initiated by receptors via their immunoreceptor tyrosine-based activation motifs, such as the FcR<sub>γ</sub> chain that is associated with the GPVI collagen receptor (Ravetch and Lanier, 2000). PECAM-1 is capable of inhibiting calcium mobilization, granule secretion, and aggregation following collagen activation of the GPVI/FcR<sub>γ</sub> chain complexes (Table 10-4) (Newman and Newman, 2003). It is important to note, however, that PECAM-1 inhibitory signaling can be overcome



**FIGURE 10-2** Major components of pro- and anticoagulant systems. Black lines represent activation reactions, and red lines represent inhibitory reactions. Abbreviations: APC, activated protein C; AT, antithrombin; PC, protein C; PS, phosphatidylserine; TF, tissue factor; TFPI, tissue factor pathway inhibitor; TM, thrombomodulin; vWF, von Willebrand factor.

by strong stimulation of GPIIb/IIIa receptors, and that PECAM-1 does not inhibit GPCR signaling (Patil *et al.*, 2001). Consequently, when endothelial damage is severe enough to expose high concentrations of collagen and to locally generate thrombin, PECAM-1 will not be an effective inhibitor of thrombus formation.

### C. Coagulation Proteins, Complexes, and Thrombin Activation

#### 1. Overview

Bleeding from a vessel may be transiently arrested by vasospasm and platelet plug formation, but the formation of a thrombus eventually occurs and provides a permanent clot while repair occurs. The soluble plasma coagulation proteins are required for formation of the thrombus. Most of these proteins are made in the liver, but other cells, including endothelial cells and platelets, are important sources of additional coagulation factors. Most coagulation proteins circulate in plasma as inactive zymogens, but when provided with the appropriate catalyst, they become activated in a cascade-like manner to ultimately produce thrombin and then fibrin (Fig. 10-2). Along with a phospholipid surface provided by activated platelets and calcium as a cofactor, this series of enzymatic reactions result in cross-linked fibrin deposition within the platelet plug. Most coagulation proteins have a Roman numeral designation, which is followed with an “a” when referring to the activated form (e.g., FVII is the inactive zymogen, whereas FVIIa is the activated protein). All coagulation proteins additionally may be referred to by a common or alternate name (Table 10-5). Specific details of the characteristics of individual factors can be found elsewhere (Dodds, 1997), but details

**TABLE 10-5** Coagulation Factors

Traditional Designation	Alternate Name(s)
Factor I	Fibrinogen
Factor II	Prothrombin
Factor III	Tissue factor
Factor V	Proaccelerin, accelerator globulin
Factor VII	Proconvertin
Factor VIII	Antihemophilic factor
Factor IX	Christmas factor
Factor X	Stuart factor
Factor XI	Plasma thromboplastin antecedent
Factor XII	Hageman factor
Factor XIII	Fibrin stabilizing factor
Prekallikrein	Fletcher factor

on groups of proteins and how they contribute to blood clot formation are provided in Section II.C.2.

#### 2. Complexes of the Procoagulant System

##### a. Tissue Factor-FVIIa Complex

Currently, a single pathway, the tissue factor (TF) pathway, formerly known as the extrinsic pathway, is considered to be predominant in the initiation of thrombin formation (see Fig. 10-2). TF is a lipid-dependent transmembrane glycoprotein

that is present in unactivated endothelial cells and monocytes, as well as free in plasma (Monroe and Key, 2007). TF is recognized to contribute to many biological processes in addition to coagulation, which include thrombus propagation, migration and proliferation of vascular smooth muscle cells, development of embryonic blood vessels, tumor neovascularization and metastasis, and induction of the proinflammatory response (Monroe and Key, 2007). Following cellular activation by vascular trauma or an inflammatory stimulus, TF becomes exposed on the plasma membrane where it interacts with circulating FVII, or its activated form, FVIIa, to form the enzymatically reactive TF-FVIIa complex (Gentry, 2004). About 99% of FVII circulates in the inactive zymogen form (Monroe and Key, 2007). Cell-associated TF binds to either FVII or FVIIa in order to either promote FVII activation or enhance catalysis, respectively. TF and FVII/FVIIa bind together over a large area at multiple sites in a  $\text{Ca}^{2+}$ -dependent manner to form the binary complex. The stabilization of the structure of FVIIa is crucial for its procoagulant activity. Unique from tenase and prothrombinase complex formation, TF-FVIIa complex formation is less dependent on a phospholipid surface for expression of its procoagulant activity (Monroe and Key, 2007). This complex functions primarily to convert FX to its activated form, FXa, but it also activates circulating FIX to FIXa. It is this FXa formation that results in initial production of thrombin (see Section II.C.3).

#### b. Tenase Complex

Factor IX in plasma is proteolytically activated to the serine protease factor IXa by the TF-VIIa complex (see Section II.C.2.a) (see Fig. 10-2). FVIII normally circulates in a complex with von Willebrand factor (vWF), which effectively extends the plasma half-life of FVIII because it is protected from proteolytic degradation in the complex form (Gentry, 2004). Initial thrombin formation not only results in dissociation of FVIII from vWF, but it also converts it to a more potent cofactor, FVIIIa. Factor IXa and factor VIIIa then assemble on phosphatidyl-L-serine-containing phospholipid membranes in the presence of  $\text{Ca}^{2+}$  to form an enzymatic complex known as the tenase complex (Blostein *et al.*, 2003). The tenase complex converts factor X to factor Xa, the enzyme that converts prothrombin to thrombin leading to the conversion of fibrinogen to fibrin and the formation of a fibrin clot. This tenase complex cleaves FX at the same reactive site as that cleaved by the TF-FVIIa complex and hence produces the same FXa product. Factor X activation by the tenase complex is the rate-limiting step for thrombin generation during tissue factor-dependent coagulation (Blostein *et al.*, 2003).

#### c. Prothrombinase Complex

The generation of thrombin requires the formation of the prothrombinase complex, which consists of FXa, phospholipid, calcium, and a protein cofactor, FV (Gentry, 2004)

(see Fig. 10-2). The complex catalyzes two cleavages in prothrombin, at Arg320 (to produce meizothrombin) and at Arg271, leading to the formation of thrombin (Autin *et al.*, 2006). The first few molecules of thrombin generated by this prothrombinase complex initiate several positive-feedback reactions that sustain its own formation and facilitate the rapid growth of the blood clot or thrombus around the area of vascular damage. For example, thrombin can convert FXI to its proteolytically active form, FXIa, which, in turn, converts FIX to FIXa. The thrombin-induced conversion of FV to FVa, along with the increased availability of FXa, greatly enhances the rate and extent of thrombin formation by the prothrombinase complex. This is a crucial reaction for normal blood coagulation. FXa alone can slowly activate PT, but the rate of thrombin formation is enhanced several orders of magnitude by the presence of FVa in the PTase complex (Autin *et al.*, 2006). Another positive feedback response is the increased availability of phospholipids on the surface on thrombin-activated platelets that accumulate at sites of vascular damage (Gentry, 2004).

### 3. Mechanisms of Thrombin Formation

Minimal activation of coagulation proteins is needed to initiate further propagation and amplification of the cascade of reactions that ultimately leads to the formation of thrombin, which then converts fibrinogen to fibrin and forms the stable clot at a site of vascular injury (see Fig. 10-2). Each complex that participates in thrombin generation is simply composed of a serine protease interacting with a cofactor or receptor on an activated cell membrane surface (Mann, 2003). Coagulation is dependent on vitamin K because adequate concentration of this vitamin is required for activation of procoagulants, FVII, FIX, FX, prothrombin, and for anticoagulants, protein C, and protein S. The clinical consequences of antagonism or deficiency of vitamin K demonstrate how important it is to proper hemostasis (see Sections IV.B.5).

The release of tissue thromboplastin or TF from damaged cells or its enhanced expression on cell membranes initiates *in vivo* coagulation. This occurs when TF binds with and activates FVII to FVIIa (see Section II.C.2.a). The TF-FVIIa complex then has the ability to activate subsequent zymogens FIX and FX in the presence of calcium ions and a negatively charged phospholipid surface provided by activated platelets (see Section II.B.2), resulting in the formation of their respective activated forms, FIXa and FXa. The latter is the more efficient substrate in the early phase of thrombin generation. Once some Xa has been formed, it actually facilitates further activation of FIX (Lawson and Mann, 1991). The TF-FVIIa activation process has historically been referred to as the extrinsic coagulation pathway and is currently often referred to

as the tissue factor pathway. There appears to be a small proportion (1% to 2%) of constitutively activated FVII in plasma (Mann *et al.*, 2003). However, it does not exhibit proteolytic activity unless bound to TF. Once the TF-FVIIa complex forms, the rate of FXa formation increased four-fold (Mann *et al.*, 2003). During the initiation stage, any membrane-bound Xa produced is able to begin converting a small amount of prothrombin to thrombin. This small amount of thrombin is crucial for further propagation of the coagulation cascade, as it activates platelets and converts FV to FVa and FVIII to FVIIIa (Brummel *et al.*, 2002).

The ability of the TF-FVIIa complex to continue the generation of FIXa is compromised by the presence in the circulation of tissue factor pathway inhibitor (TFPI) (see Section II.C.5.a). Alternative activation pathways exist for the activation of FIX so that the tenase complex can be formed at a sufficient rate and adequate level to sustain thrombin formation until a clot has formed and wound healing is initiated. In a direct positive feedback reaction, thrombin can convert FIX to the same enzymatically active form of FIXa as produced by the TF-FVIIa complex (Minnema *et al.*, 1999). In an indirect feedback pathway, thrombin can activate FXI to a proteolytically active enzyme (FXIa), which can, in turn, convert FIX to FIXa (Gailani, 2000; Gailani and Broze, 1991). FXI is one of the proteins involved in the coagulation pathway historically known as the intrinsic pathway that is now referred to as the contact activation system. The other components of this system are FXII, prekallikrein (PK), and high-molecular-weight kininogen (HK) (Table 10-5). This pathway is initiated when the zymogen FXII comes into contact with a negatively charged surface (e.g., damaged endothelium or an endotoxin contact) and undergoes a conformational change to become an active serine protease (FXIIa). FXIIa then propagates coagulation by activating the next protein in this system, FXI, in a reaction that is accelerated by the presence of PK and HK (Wachtfogel *et al.*, 1993). In plasma, HK circulates as biomolecular complexes with FXI and PK, respectively. The initial molecules of FXIIa generated on damaged endothelium convert HK to HKa. HKa has a high surface binding affinity and thus brings large amounts of FXI and PK to the charged surface in close proximity to the already adherent FXIIa. The spatial configuration of these complexes permits FXIIa to rapidly convert FXI to FXIa and convert PK to kallikrein. It is now generally accepted that activation of the contact activation system is not the predominant *in vivo* mechanism of thrombin generation (Gentry, 2004; Rojkaer and Schmaier, 1999). However, it may serve as a link between fibrin formation, fibrinolysis, and inflammation because kallikrein can function as a weak activator of the fibrinolytic system (see Section II.E) and as stimulator of both chemotaxis and degranulation in neutrophils attracted to a site of endothelial damage (Jiminez and Fernandez, 2000).

After the coagulation cascade is initiated, further amplification ensures that sufficient thrombin is produced to cleave fibrinogen and form insoluble fibrin. Once FIXa is formed, it complexes with calcium ions (Ca) and platelet PSs and FVIIIa to form the FIXa-FVIIIa-Ca-PS (tenase or Xase) complex, a potent stimulator of further FX activation. Large amounts of FXa are created by the tenase complex, which is approximately 50-fold more efficient than the TF-FVIIa complex at performing the same process (Ahmed *et al.*, 1992). Once formed, FXa converts prothrombin (factor II) to thrombin (FIIa). This reaction is additionally dependent on the formation of the prothrombinase complex, composed of FVa, FXa, platelet phospholipid surface, and calcium ions (FXa-FVa-Ca-PS) and is 300,000-fold more potent than Xa at catalyzing prothrombin conversion (Mann *et al.*, 2003).

Thrombin (FIIa) converts fibrinogen to fibrin and additionally activates factor XIII, which is important for cross-linking and stabilizing the fibrin clot (see Section II.C.4).

#### 4. Fibrin Clot Formation

Ultimately, repair of a vascular lesion requires development of a more permanent clot than a platelet plug can provide. A stable fibrin clot is the end point of the conversion of fibrinogen to fibrin and involves three phases: proteolysis, polymerization, and stabilization. Proteolysis occurs when thrombin cleaves fibrinogen to form fibrin monomers and the secondary by-product fragments fibrinopeptides A and B (FPA and FPB). These fibrinopeptide molecules are cleaved from the N-terminal regions of the A $\alpha$  and B $\beta$  chains (Sidelmann *et al.*, 2000). It is proposed that removal of FPA permits end-to-end polymerization, whereas removal of FPB promotes side-to-side polymerization (Mosesson, 1992). The cleaved fibrinogen molecules can then form complexes with other fibrinogen and fibrin molecules to form what is referred to as soluble fibrin or fibrin monomers (Sidelmann *et al.*, 2000). Fibrin monomers then polymerize at their ends via hydrogen bonding, and the polymers are then stabilized covalently via peptide bond formation under the influence of the transglutaminase FXIIIa (which is activated by thrombin) to form cross-linked fibrin strands.

Thrombin cleaves a peptide from each of two alpha chains on FXIII, which results in the formation of an inactive intermediate. In the presence of Ca, this intermediate dissociates and produces the activated protein. FXIIIa then induces adjacent  $\gamma$ -chains to quickly cross-link to form  $\gamma$ -dimers, whereas  $\alpha$ -chain cross-linking occurs more slowly. Even native fibrinogen can be cross-linked by FXIIIa, following the same pattern of initial  $\gamma$ -chain dimerization followed by A $\alpha$ -chains to form high-molecular-weight polymers.

The cross-linking that occurs between fibrin polymers makes the fibrin “gel” more resistant to lysis by fibrinolytic

**TABLE 10-6** Major Inhibitors of Coagulation and Fibrinolysis

Inhibitor	Target Enzymes	Cofactor(s)
TFPI	Factor Xa Tissue factor/factor VIIa	Calcium
Antithrombin	Thrombin, factor Xa Factors IXa, XIa, XIIa	Heparin/heparan sulfate
Heparin cofactor II	Thrombin	Heparin/heparan sulfate
$\alpha_1$ -Antitrypsin/ $\alpha_1$ -protease inhibitor	Thrombin, factors Xa, XIa Activated protein C, plasmin	—
$\alpha_2$ -Macroglobulin	Factor Xa, thrombin Activated protein C, plasmin	—
C1 inhibitor	Factors XIa, XIIa, kallikrein	—
Protein C inhibitor	Thrombin, factors Xa, XIa Activated protein C tPA, uPA	Thrombomodulin Heparin/heparan sulfate
Activated protein C	Factor VIIIa, factor Va TAFI, PAI-1	Protein S, thrombomodulin, EPCR
TAFI	tPA	Fibrin
PAI-1	tPA, uPA	—
$\alpha_2$ -Antiplasmin	Plasmin	Fibrin

Abbreviations: EPCR, endothelial cell protein C receptor; PAI-1, plasminogen activator inhibitor -1; TAFI, thrombin activatable fibrinolysis inhibitor; tPA, tissue-type plasminogen activator; u-PA, urokinase-type plasminogen activator.

proteins such as plasmin. One way this occurs is by FXIIIa-mediated incorporation of plasmin inhibitor into the developing fibrin meshwork (see Section II.D.3). Plasmin inhibitor becomes bound to  $\alpha$ -chains of both fibrinogen and fibrin and prevents the absorption of plasminogen to fibrin. FXIIIa can also cross-link other plasma proteins to fibrin strands (see Section II.C.4) (Sidelmann *et al.*, 2000). Once the lesion has been repaired, which may also be partly mediated by FXIIIa (Barry and Mosher, 1988), a process called fibrinolysis dissolves the fibrin clot (see Section II.D).

### 5. Inhibitors of Coagulation

Several biochemical mechanisms exist that function to keep the formation of a blood clot localized to a site of vascular injury, to prevent the excessive growth of the clot, and to prevent thrombin generation and fibrin formation from becoming generalized to nondamaged areas of the vascular system. The target enzymes and cofactors for these and other circulating inhibitors are summarized in Table 10-6.

#### a. Tissue Factor Pathway Inhibitor (TFPI)

TFPI is the principal endogenous inhibitor of the tissue factor pathway. TFPI is a Kunitz-type serine protease

inhibitor that has a double inhibitory effect: it inhibits both FXa and the TF/FVIIa complex (Golino *et al.*, 2002; Lindahl, 1997). Between 75% and 90% of the total body TFPI is located in endothelial cells; the remaining 10% to 25% circulates bound to plasma lipoproteins with only trace amounts being detectable free in plasma or in platelet cytosol. Because of its association with lipoproteins, TFPI was formerly known as lipoprotein-associated coagulation inhibitor (LACI). TFPI is a single-chain 32-kDa glycoprotein that has a highly negatively charged N-terminus connected to three tandem domains that show homology to Kunitz-type protease inhibitors and a highly positively charged C-terminal region (Broze, 1992). Multiple forms of TFPI have been identified in human plasma with 36- and 43-kDa forms predominating. This size variation appears to be due to the formation of disulfide bonds and glycosylation of the TFPI molecule (Broze, 1992; Lindahl, 1997). A 34-kDa form of TFPI circulates in association with plasma LDL, and a 40-kDa form associates with HDL. TFPI is not uniformly dispersed in the vasculature. It is constitutively expressed by endothelial cells of the microvasculature but not by endothelial cells of larger vessels (Doshi and Mamur, 2002). A localized increase of TFPI can occur at the site of a clot because thrombin is able to induce the release of TFPI from activated platelets (Novotny *et al.*, 1988). TFPI is stored on

the extracellular matrix of endothelial cells bound to GAGs such as heparan sulfate (Abildgaard, 1992). Consequently, infusion of heparin can displace this surface-bound TFPI to induce a two- to four-fold increase in circulating TFPI levels (Golino *et al.*, 2002; Novotny *et al.*, 1991). The liver effectively clears circulating TFPI by receptor-mediated endocytosis resulting in a half-life for TFPI of less than 70 min (Lindhal, 1997). The inhibitory activity of TFPI depends on the activation of the TF pathway and the formation of FXa. TFPI binds to FXa at, or near, its serine active site in a reversible calcium-independent reaction to form a 1:1 complex (Broze, 1992). This complex is formed most efficiently when FXa is incorporated into the prothrombinase complex (see Section II.C.3). The ability of TFPI to inhibit the activity of the TF/FVIIa complex depends on the TFPI/FXa complex forming an irreversible, calcium-dependent quaternary complex consisting of TFPI-FXa-TF-FVIIa (Lindahl, 1997). Hence, TFPI is not only able to inhibit FXa activity, but it is also able to suppress the generation of additional FXa by blocking the TF/FVIIa-catalyzed conversion of FX to FXa. TFPI is able to exert this bimodal inhibitory effect because the inhibition of FXa depends on the first Kunitz-type domain and an intact C-terminal region, whereas the second Kunitz-type domain of TFPI molecule is responsible for the binding of the TFPI/FXa complex to the TF/FVIIa complex (Lindahl, 1997). Because TFPI does not interfere with FXa activation by the tenase complex (FIXa-FVIIIa-Ca-PL, see Section II.C.3), it does not completely block thrombin formation. The importance of TFPI in regulating thrombin generation and fibrin formation has been demonstrated in animal models depleted of TFPI. These animals are sensitized to TF and readily develop DIC (see Section IV.B.4) in response to endotoxin, which causes the release of TF from endothelial cells (Huang *et al.*, 1997; Sandset *et al.*, 1991). Hence, one of the factors involved in DIC is an imbalance between the levels of TF and TFPI.

#### b. Serine Protease Inhibitors (Serpins)

Antithrombin (AT, also known as antithrombin III, ATIII) is the principal member of the superfamily of serine protease inhibitors, or serpins, that inhibit the action of several serine proteases of the hemostatic system (Pike *et al.*, 2005). Serpins have a common mechanism of action that involves trapping and irreversibly inactivating the proteases through the formation of a covalent bond followed by the removal of the serpin-enzyme complex from the circulation by the action of receptors, which specifically recognize the inhibited conformation of the serpin (Gettins, 2002). One of the functions of serpins is to neutralize any of the procoagulant enzymes that escape from the vicinity of a blood clot and thus prevent inappropriate thrombus formation.

AT is a 58-kDa single-chain glycoprotein synthesized in the liver and endothelial cells. Structural similarities exist in the AT molecule across many species (Frost *et al.*, 2002; Johnstone, 2000). Although AT can inhibit several serine

protease of the coagulation system including thrombin, FIXa, FXa, FXIa, and FXIIa, the principal targets are considered to be thrombin and FXa (Pike *et al.*, 2005). The AT molecule has two functional sites: the reactive site for serpins and a binding site for glycosaminoglycans (GAGs), such as heparin and heparan sulfate. GAGs serve as potent cofactors that enhance the rate of thrombin inhibition from one that is nonphysiological to a physiologically relevant level. In its unactivated, or native state, the AT molecule contains a reactive center loop that is partially inserted into its A $\beta$ -sheet. When thrombin comes in contact with AT, it cleaves a specific bond in the reactive center loop causing it to become fully inserted into the A $\beta$ -sheet and at the same time translocating thrombin from the top of the AT molecule to the bottom (Munoz and Linhardt, 2004). In this way, a 1:1 stoichiometric complex is formed through covalent bonding between the active site serine of thrombin and the reactive site arginine of AT. The interaction between GAGs, like heparin, and AT involves several steps. First, a low-affinity interaction occurs forming ion pairs between a cluster of positively charged amino acids, such as arginine and lysine, in the D-helix of the AT molecule and specific spatially defined negatively charged sulfo- and carboxyl groups in the heparin pentasaccharide sequence (Huntington *et al.*, 1996). This binding induces a conformation change in AT that results in both stronger heparin binding and the expulsion of the reactive center loop of AT from the A $\beta$ -sheet (Munoz and Linhardt, 2004). In effect, heparin facilitates the diffusion of thrombin and AT toward each other through the formation of a tertiary complex between heparin and AT. For example, in the presence of heparin the inhibition of thrombin by AT is accelerated 1000-fold from 4.4 min to 0.27 sec and the rate of inhibition of FXa by AT is accelerated 10,000-fold (Olson and Shore, 1982; Pike *et al.*, 2005). The formation of the FXa-AT-heparin complex requires the presence of calcium ions to overcome the negative effects of the Gla-domains in FXa (Rezaie, 1998). Because clot-bound thrombin and FXa are protected from inactivation by AT, the physiological role of AT is not to cause the cessation of clotting but rather to localize the clot and prevent it from spreading too far beyond the site of damage (Weitz *et al.*, 1990). It also functions to prevent thrombin formation from occurring on undamaged endothelium. Heparan sulfate is an extracellular component of the extracellular matrix of all animal cells, whereas heparin is localized to the granules of mast cells and is only released locally in an allergic reaction. In the vasculature, only heparan sulfate in the outer monolayer of endothelial cells possesses the AT binding sites that can accelerate the inhibitory action of AT, whereas the heparan sulfate contained in the underlying layer of smooth muscle cells lacks AT binding sites (Munoz and Linhardt, 2004). Thus, when thrombin comes in contact with AT-heparan sulfate complex on the "healthy" intact vascular wall, the T-AT complex irreversibly inactivates it.



However, when the vessel wall is damaged, thrombin is so inefficiently inhibited by AT, the conversion of fibrinogen to fibrin and hence clot formation can proceed (Pike *et al.*, 2005).

Heparin cofactor II (HCII) is a specific thrombin inhibitor that has a similar mechanism of action as AT, but it is dissimilar both antigenically and in its cofactor requirements (Johnstone, 2000). HCII appears to be synthesized exclusively by the liver as a 65.6-kDa glycoprotein with a unique amino-terminal extension that contains two tandem repeats rich in acidic amino acids with two sulfated tyrosines (Inhorn and Tollefsen, 1986). These repeats are homologous to the carboxyl-terminal sequence of hirudin, the specific thrombin inhibitor from the medicinal leech. Although heparin, heparan sulfate, and dermatan sulfate are all physiological activators of HCII, many different polyanions, including polyphosphates, polysulfates, and polycarboxylates, are also able to accelerate HCII inhibition of thrombin up to 1000-fold (Tollefsen, 2004). Although the physiological function of HCII has not been fully elucidated, it has been suggested that it may function as a thrombin-inhibitor reserve when AT levels become subnormal such as occurs in DIC (see Section IV.B.4; Tran and Duckert, 1984). Experimental animal studies and human clinical studies indicate that HCII may have a protective antithrombotic effect following arterial oxidative damage (Tollefsen, 2004).

As summarized in Table 10-6, a number of other serpins participate in modulating hemostasis (Silverman *et al.*, 2001). The broad spectrum protease inhibitor known both as  $\alpha_1$ -antitrypsin and  $\alpha_1$ -protease inhibitor ( $\alpha_1$ -PI) can inhibit thrombin, FXa and FXIa, APC, and plasmin, although its main physiological function is as a circulating antitrypsin inhibitor. However,  $\alpha_1$ -PI appears to be a more effective inhibitor of FXIa than AT (Scott *et al.*, 1982). It circulates as a 50-kDa glycoprotein and contains the characteristic reactive site loop of a serpin (Long *et al.*, 1984).

$\alpha_2$ -Macroglobulin circulates as a large 650-kDa glycoprotein composed of four identical subunits. This protein can bind one or two molecules of a protease depending on its size. Small proteases such as trypsin maximally form 2:1 complexes with  $\alpha_2$ -M, whereas larger proteases such as plasmin form 1:1 complexes. It has been suggested that  $\alpha_2$ -M is one of the major physiological inhibitors of FXa *in vivo* (Fuchs and Pizzo, 1983).  $\alpha_2$ -M-protease complexes are rapidly removed from the circulation by the liver through interaction with the lipoprotein receptor-related protein that serves as a large multifunctional endocytosis receptor (Narita *et al.*, 1998). This receptor protein is also responsible for the removal of other proteases such as tissue-type plasminogen activator and thrombin activatable fibrinolysis inhibitor (TAFI) (Orth *et al.*, 1992; Warshawsky *et al.*, 1994).

C1 inhibitor is a 104-kDa single-chain glycoprotein that exhibits structural homology with other members of

the serpin superfamily. It appears to be the main circulating inhibitor of FXIa, although it can also suppress the activity of FXIIa and kallikrein but not FXa or plasmin (Harpel *et al.*, 1985; Pixley *et al.*, 1985). As its name suggests, the main physiological role of C1 inhibitor is to modulate the complement system.

Protein C inhibitor (PCI), also known as plasminogen activator inhibitor-3, inactivates the proteolytic activity of numerous serine proteases including thrombin, FXa, FXIa, APC, tissue-type plasminogen (tPA) activator, and urokinase-type plasminogen activator (uPA) (Meijers *et al.*, 2002). The mature PCI protein is 57 kDa and is found in several body fluids as well as plasma (Pike *et al.*, 2005). Like HCII, several GAGs and polyanions can enhance the activity of PCI. In the presence of heparin, a ternary complex is formed between PCI and the active protease through a GAG binding region localized on the H-helix region of PCI (Pratt and Church, 1992). However, even in the presence of heparin, the inhibitory effects of PCI for thrombin and FXa are still modest compared to those of AT and HCII (Pike *et al.*, 2005). Although PCI can inhibit APC in the presence of heparin and calcium ions, the more physiologically relevant role of PCI in modulating the protein C anticoagulant system is the result of its ability to inhibit the activity of the thrombin-thrombomodulin (T-TM) complex (Yang *et al.*, 2003). As described later, this complex is key to the conversion of the inactive zymogen protein C to its active form.

### c. Protein C Anticoagulant System

The protein C anticoagulant system regulates thrombin formation by modulating the activity of the cofactors FVIIIa and FVa (Dahlback, 1995). This inhibitory system is composed of several components: protein C (PC), thrombomodulin (TM), endothelial cell protein C receptor (EPCR), and protein S (Table 10-6). Protein C, the key component, is a vitamin K-dependent, 62-kDa glycoprotein that is synthesized by the liver and circulates as a biologically inactive molecule consisting of a 40-kDa heavy chain and a 20-kDa light chain joined by a disulfide bond (Stenflo and Fernlund, 1982). As occurs with other vitamin K-dependent proteins, PC lacks biological activity unless it has undergone vitamin K-dependent posttranslational carboxylation of glutamine residues in the N-terminal region of the molecule. Thrombin cleavage of this N-terminal region converts PC to its proteolytic active form, APC (Esmon, 2003). For thrombin to activate PC at a physiologically relevant rate, it requires the presence of the cofactor thrombomodulin (TM) so that T-TM complexes can form. TM is a 58.7-kDa transmembrane glycoprotein that is present on vascular endothelial cells with the highest concentrations being present in microvascular beds (Esmon, 2003). In the presence of TM, the rate of PC activation is increased by more than 1000-fold (Van de Wouwer *et al.*, 2004). The TM molecule is organized into five distinct domains.

A short cytoplasmic tail at the C-terminus is followed by a membrane-spanning region that contains serine/threonine-rich domains that serve as glycosylation sites, which support its attachment to chondroitin sulfate (CS) in the extracellular matrix. The membrane-spanning domain is followed by a domain that consists of six epidermal growth factor (EGF)-like repeats, which determine the biological activity of TM. The N-terminal region of TM includes two amino acid sequences that play no role in its hemostatic function. Rather, the anticoagulant activity of TM is conferred by EGF domains 4, 5, and 6, which are also the areas that are involved in the ability of TM to enhance thrombin inhibition by PCI (Tsiang *et al.*, 1992). The EGF5 and EGF6 domains have been identified as thrombin binding sites (Van de Wouwer *et al.*, 2004). For APC to act efficiently as an anticoagulant, the presence of the cofactor, protein S, at the endothelial cell surface is also required. Protein S is a single-chain polypeptide that is synthesized by hepatocytes, endothelial cells, and megakaryocytes in forms that vary in size from 69 to 84 kDa (Johnstone, 2000). In plasma, the majority of protein S circulates bound to the complement regulatory protein C4b-binding protein and only about 30% is in the free, more biologically active form (Dahlback, 1995). Unlike the other vitamin K-dependent hemostatic proteins, protein S is not a zymogen and functions solely as a cofactor to promote the formation of the inhibitory complex that consists of APC-protein S-calcium on the negatively charged phospholipids (PL) that are exposed on damaged endothelium and activated platelets (Walker, 1984). These PLs are also those that are involved in the formation of the tenase complex and the prothrombinase complex (see Section II.C.3). Hence, protein S effectively acts as a mediator to increase the number of APC molecules bound to the PL, to bring them in closer contact with FVIIIa and FVa, and thus to accelerate the rate at which APC can cleave these proteins to produce their inactive forms, FVIIIai and FVai (Dahlback, 2000). The reduction in FVIIIa and FVa cofactor activity effectively reduces the rate of thrombin formation. APC can only inhibit FVIII when it is a component of the tenase complex because it is protected from proteolysis as FVIII circulates in plasma bound to vWF (see Section II.C.2). In contrast, circulating FV, like FVa, can bind to membrane PLs where it can be cleaved to generate an anticoagulant form of FV that functions in synergy with protein S as an APC cofactor in the inactivation of FVIIIa (Dahlback, 2000). In this way, FV can, like thrombin, function as both a procoagulant and an anticoagulant cofactor in hemostasis. It is now recognized that TM is not the only cofactor expressed on endothelial cells that can function as a cofactor for thrombin-induced PC activation. EPCR is constitutively expressed in endothelial cells, particularly in large blood vessels, and is structurally similar to the major histocompatibility class I/CDI family of molecules that are involved in immunity and inflammation (Di Cera, 2003; Esmon, 2003; Van de Wouwer *et al.*, 2004). Not only does EPCR accelerate thrombin-mediated

activation of PC, but it also concentrates APC near the surface of the vessel wall (Stearns-Kurosawa *et al.*, 1996). When APC is generated, it remains bound to EPCR for only a short time before it becomes associated with protein S on the surface of activated platelets or damaged endothelium (Van de Wouwer *et al.*, 2004). After APC has caused the inhibition of FVIIIa and FVa, it is itself inactivated by several serpins including,  $\alpha_1$ -protease inhibitor,  $\alpha_2$ -M, and protein C inhibitor (Table 10-6). The APC pathway can also be down-regulated by inflammatory cytokines such as IL-1 $\beta$  and TNF $\alpha$ , which reduce the expression of both TM and EPCR (Esmon, 2003). It would appear that TM can exert multifunctions in the regulation of hemostasis. For example, when TM is bound to CS on the extracellular matrix, not only is the PC cofactor activity of TM enhanced but the rate of neutralization of thrombin by both heparin-AT and by PCI is accelerated (Koyama *et al.*, 1991). TM also exhibits antifibrinolytic activity through the ability of both EGF domains 3 through 6 of the thrombin-TM complex to activate TAFI (see Section II.D.3) (Nesheim, 2003).

## D. Fibrinolysis

### 1. Overview

It is essential that the coagulation pathways are counterbalanced by a functional fibrinolytic cascade so that blood fluidity can be maintained in the vascular system (Welles, 1996). Like the coagulation pathway, the fibrinolytic system is normally latent but can be fully activated within a minute or two after stimulation (Nesheim, 2003). The major enzymatic component of this fibrin degradation system is plasmin, which, like thrombin, is a serine protease but with broader substrate specificity (Lijnen, 2002). In addition to cleaving specific sites on polymerized fibrin, under some pathophysiological conditions plasmin can also degrade fibrinogen, FV, and FVIII and activate metalloproteinases (Darien, 2000b). The fibrinolytic system shares several biochemical characteristics with the coagulation system. These include an initiation phase that involves the liberation of tissue-type plasminogen activator (tPA) from damaged endothelium; the conversion of the circulating zymogen, plasminogen, to the active protease, plasmin; and positive feedback reactions that increase the concentration of plasmin in the area of a clot (Fig. 10-3). The system is down-regulated by both protease inhibitors, such as plasminogen activator inhibitor type 1 (PAI-1) and antiplasmin (AP), and by a reaction mediated by the thrombin-TM complex (Table 10.6) (Coughlin, 2005a; Nesheim, 2003). The ability of fibrin to act as an effective cofactor for enhanced plasmin activity is an important factor in localizing the physiological activity of this protease to the site of a fibrin clot (Medved and Nieuwenhuzen, 2003). Nonphysiological activators of fibrinolysis, such as streptokinase, have only proved to be effective in dissolving fibrin clots in human plasma.

## 2. Components of the Fibrinolytic System

### a. Plasminogen

Plasminogen is secreted by the liver as a single-chain 92-kDa glycoprotein with glutamine as the N-terminal amino acid (Glu-plasminogen). It is composed of five kringle-like domains containing “lysine-binding sites” and a C-terminal domain homologous to other trypsin-like proteases (Ponting *et al.*, 1992). The kringle domains mediate the interaction of plasminogen, and its active form plasmin, with substrates, inhibitors, and cell membranes. Consequently the kringle domains are important in both regulation of plasminogen activation and the localization of the proteolytic activity of plasmin to the appropriate physiological site (Wu *et al.*, 1990). Plasminogen can be cleaved by plasmin at several sites resulting in lysine as the N-terminal amino acid (Lys-plasminogen) and the release of an 8-kDa N-terminal polypeptide. Lys-plasminogen, in the absence of fibrin, is converted to plasmin at a faster rate than Glu-plasminogen. The cleavage of an Arg-Val peptide bond in single-chain plasminogen converts it to plasmin, which now consists of two polypeptide chains linked by a disulfide bond (Dobrovolsky and Titaeva, 2002). The N-terminal heavy A chain contains the kringle domains that convey substrate specificity to plasmin, whereas the C-terminal light B chain contains the catalytic site.

### b. Plasminogen Activators

tPA is synthesized and secreted by endothelial cells as a 70-kDa single-chain active enzyme. It is the only protease of the hemostatic system secreted in an active form (Dobrovolsky and Titaeva, 2002). The molecule is composed of five domains: the N-terminal domain, which is homologous to the finger-like domains of fibronectin, is

followed by a region homologous to the epidermal growth factor (EGF) domain, two kringle-like domains similar to those of plasminogen, and a C-terminal domain homologous to other trypsin-like proteases (van Zonneveld *et al.*, 1986). The finger-like kringle domains possess two distinct fibrin-binding sites. Plasmin, kallikrein, and FXa can all cleave tPA to form a two-chain form of the molecule that, in the presence of fibrin, activates plasminogen at the same rate as single-chain tPA (Dobrovolsky and Titaeva, 2002). Stimuli such as exercise, venous occlusion, and intravenous injection of vasoactive drugs can increase the release of tPA from endothelial cells, whereas inflammatory mediators such as tissue necrosis factor  $\alpha$  (TNF $\alpha$ ) and interleukin-1 (IL-1) cause a decrease in free plasma tPA levels. Recombinant tPA is currently being used to induce thrombolysis in human patients with myocardial infarctions and other thromboembolic problems (Dobrovolsky and Titaeva, 2002).

A trypsin-like protease capable of activating plasminogen was originally isolated from human urine and named urokinase. It is now known that many cell types can synthesize and secrete a single-chain 54-kDa glycoprotein, which was initially referred to as prourokinase. Current nomenclature designate these proteins as two forms: single-chain urokinase-type plasminogen activator (scuPA) and two-chain urokinase-type plasminogen activator (tcuPA). The scuPA molecule is composed of three domains. The N-terminal domain is homologous to the EGF domain, the middle protein is homologous to the kringle domain of plasminogen, and the C-terminal domain is homologous to trypsin-like proteases (Dobrovolsky and Titaeva, 2002). Both plasmin and kallikrein can cleave a Lys-Lys peptide bond in uPA to form fully functional tcuPA. Thrombin cleaves an Arg-Phe bond to produce a variant tcuPA molecule that appears incapable of directly activating plasminogen until after it has been further hydrolyzed by plasmin cleavage of a Lys-Ile bond (Dobrovolsky and Titaeva, 2002). Although initially considered to be a major component of the plasma fibrinolytic system, it is now recognized that a more important physiological function of uPA may be its ability to activate metalloproteinases that degrade cellular matrix components inducing pericellular proteolysis (Lijnen, 2002). uPA mediates this effect through its ability to bind to specific cellular receptors (uPARs), which bring uPA into close contact with cell-bound plasminogen and thus promote plasmin generation on the cell surface. Thus, uPAR plays an important role in cell migration and the tissue remodeling processes that are required following vascular damage and thrombus formation.

## 3. Mechanism of Fibrinolysis

Fibrinolysis, like coagulation, is organized on a surface that facilitates the assembly and

components of the system in close proximity to each other. The formation of a fibrin clot is not only the physiological trigger for the activation of the fibrinolytic system, but it also accelerates the rate of tPA induced conversion of plasminogen to plasmin up to three orders of magnitude (Collen, 1999). Fibrin essentially acts as a cofactor in plasmin activation through a two-step process (Medved and Nieuwenhuizen, 2003). As fibrinogen undergoes polymerization to fibrin, cryptic tPA and Glu-plasminogen binding sites are exposed on its D-domains that facilitate the formation of tertiary complexes between the three molecules. The Glu-plasmin generated on the fibrin surface begins to cleave specific arginine and lysine residues in the  $\alpha$ ,  $\beta$ , and  $\gamma$  chains to form a modified fibrin polymer that has additional exposed C-terminal lysine residues that promote increased binding of tPA and plasminogen. Thus, this modified form of the fibrin gel is three-fold more potent as a cofactor for fibrinolysis than the unmodified form. Not only does the modified fibrin increase the concentration of tPA and plasminogen on the fibrin surface, but it also enhances the plasmin-induced conversion of Glu-plasminogen to Lys-plasminogen (Nesheim, 2003). This serves as a positive feedback response, because Lys-plasminogen is approximately 20-fold better than Glu-plasminogen as a substrate for tPA catalysis. Plasmin sequentially digests fibrin with the formation of degradation products designated as X-, Y-, D-, and E-fragments (Dobrovolsky and Titaeva, 2002). The sites most sensitive to proteolysis are specific Lys/Arg residues on the  $\alpha$ - and  $\beta$ -chains. The cleavages result in a set of X-fragments with molecular masses ranging from 330 to 240 kDa. Degradation of insoluble fibrin clots to the soluble Y-, D-, and E-fragments occurs after at least one D-fragment has been cleaved. The presence of fibrin fragments in the circulation is used diagnostically as evidence of inappropriate fibrinolysis (see Sections III.B.4.a and b).

#### 4. Inhibitors of Fibrinolysis

The major inhibitor components of fibrinolysis are shown in Table 10-6.

##### a. Plasminogen Activator Inhibitor Type-1 (PAI-1)

PAI-1 is the major endogenous inhibitor of fibrinolysis, or thrombolysis, as it is effective in blocking the conversion of plasminogen to plasmin by either tPA or uPA (Kruithof, 1998). PAI-1 is a 52-kDa-glycoprotein synthesized and secreted by endothelial cells in its active form. In plasma, PAI-1 is present in two forms: an active form in which the reactive site is exposed on the surface of the molecule and a latent form in which the reactive site is concealed within the protein globule (Dobrovolsky and Titaeva, 2002). The change of active PAI-1 to its latent form occurs spontaneously in plasma. Although the physiological mechanisms that induce the reverse transformation are not fully understood,

it appears that latent PAI-1 can be reactivated by phospholipid vesicles containing PS or phosphatidylinositol (PI). This indicates that at sites of vascular injury, activated platelets may be able to activate latent PAI-1 (see Section II.B.2.a). Hence, the local concentration of active PAI-1 can be significantly increased at sites of thrombus formation as approximately 90% of PAI-1 circulates as one of the constituents of platelet  $\alpha$ -granules. Thus, PAI-1, along with the action of thrombin activatable fibrinolysis inhibitor (TAFI, see Section II.D.4.c), is a contributing factor in the stabilization of the fibrin matrix. It has been shown in people that circulating PAI-1 levels vary more than any other component of the fibrinolytic system. This is likely due to the ability of a wide variety of substances to stimulate PAI-1 production. These include insulin,  $\text{TNF}\alpha$ , IL-1, transforming growth factor  $\beta$  (TGF $\beta$ ), and thrombin (Tsikouris *et al.*, 2002). Endotoxin and  $\text{TNF}\alpha$  have been shown to stimulate PAI-1 production in the liver, kidney, lung, and adrenals of mice. At least in human and murine plasma, PAI-1 exhibits the characteristics of an acute phase protein. In various disease states, a companion serine proteinase inhibitor of tPA known as plasminogen activator inhibitor type-2 (PAI-2) can appear in the circulation (Dobrovolsky and Titaeva, 2002). PAI-2 is synthesized by placenta, monocytes, and macrophages and is an effective inhibitor of t-PA.

##### b. Antiplasmin (AP)

Antiplasmin (AP, also referred to  $\alpha_2$ -antiplasmin,  $\alpha_2\text{AP}$ ) is the principal inhibitor of plasmin in the circulation. The liver secretes it as a single-chain 70-kDa protein. AP possesses the conserved core structure of the serpin family of proteins, and its amino acid sequence is highly conserved across species (Coughlin, 2005a). Human AP is 80% identical with the bovine protein and 74% identical with murine AP. In people, 30% of AP circulates in the form of Met-AP and 30% as Asn-AP. The latter is a truncated form that has lost a 12-amino acid sequence from the N-terminal end of the protein. Both Met-AP and Asn-AP inhibit plasmin at similar rates, but Asn-AP has a higher affinity for fibrin than Met-AP (Dobrovolsky and Titaeva, 2002). The N-terminal portion of AP is cross-linked to fibrin by a transglutaminase reaction catalyzed by FXIIIa. The amount of AP cross-linked to fibrin is a more important determinant of the rate of clot lysis than is the amount of free plasmin in the circulation (Coughlin, 2005a).

##### c. Thrombin Activatable Fibrinolytic Inhibitor (TAFI)

The function of TAFI is to down-regulate the onset of fibrinolysis once the fibrin clot has successfully stopped blood loss. TAFI is a single-chain, 46-kDa plasma protein that is classified as a zinc-containing metalloproteinase (Bajzar, 2000). It can be cleaved by thrombin, plasmin, and trypsin to yield an activation peptide and an enzyme, TAFIa, that exhibits carboxypeptidase activity. Thrombin, by itself,

is a relatively poor activator of TAFI, but in the presence of TM its catalytic efficiency is increased over 1000-fold (Nesheim, 2003). This enhancement of TAFI activation is dependent on the formation of a ternary complex between thrombin-TAFI and the EGF 3 through EGF 6 domains of the TM molecule. Like the thrombin-TM-mediated activation of PC, the activation of TAFI is calcium dependent (Bajzar *et al.*, 1995). Plasmin is also a physiological activator of TAFI with a catalytic efficiency eight times that of thrombin. However, the ability of plasmin to activate TAFI is reduced to only one-tenth that of thrombin-TM in the presence of glycosaminoglycans, such as those found in the extracellular matrix (Mao *et al.*, 1999).

### 5. Regulation of Plasminogen Activation and Plasmin Activity

Although it is important that fibrinolysis occurs after wound healing has been initiated, it is equally important that the degradation of the clot not occur prematurely. This is achieved because, in the initial stages of thrombus formation, the thrombin-induced release of tPA from endothelial cells is effectively opposed by the localized activation of TAFI. Through its affinity for and its ability to modify partially degraded fibrin, TAFIa functions to block the ability of tPA to activate plasminogen (Fig. 10-3). Following partial degradation by plasmin, the newly exposed lysine residues of fibrin bind both tPA and plasmin with high affinity promoting fibrinolysis (see Section II.D.3). TAFIa catalyzes the release of both arginine and lysine residues from the partially degraded fibrin thus reducing both tPA and Glu-plasminogen binding, which has the effect of reducing plasmin formation. The reduced binding of Glu-plasminogen to TAFIa modified fibrin has been correlated with an increase in clot lysis time (Sakharov *et al.*, 1997). Both TAFI and TAFIa are cross-linked to fibrin by FXIIIa, which localizes these molecules to the fibrin clot. TAFIa is an unstable molecule, which decays rapidly at 37°C such that its half-life is approximately 8 min (Nesheim, 2003). To date no physiological inhibitor of TAFI has been identified (Bajzar, 2000).

PAI-1 is the major inhibitor of both tPA and uPA (Tsikouris *et al.*, 2002). It inhibits plasminogen activation by first forming a reversible complex with tPA that then cleaves PAI-1 at its reactive site to release the C-terminal peptide of the inhibitor. Further proteolytic activity of tPA is blocked because the carboxyl group of one of the cleaved PAI-1 arginine residues remains covalently bound to a serine residue at the reactive center of tPA (Dobrovolsky and Titaeva, 2002). Because of the relatively high levels of PAI-1 in the circulation, most of the tPA released by endothelial cells is inactivated before it can interact with plasminogen. Hence, in the absence of fibrin plasminogen is only slowly converted to plasmin. Once tPA becomes bound to fibrin, it

is protected from the inhibitory effects of PAI-1 and plasmin formation can proceed rapidly.

Antiplasmin is the major physiological inhibitor of plasmin irrespective of whether the plasmin is bound to fibrin or is free in the circulation. In plasma, the reaction between AP and plasmin is rapid and the formation of a stable 1:1 bimolecular complex between the two molecules results in the irreversible inactivation of plasmin (Darien, 2000b). Because AP is partially degraded by plasmin, other circulating protease inhibitors (Table 10-6) can act as plasmin inhibitors, particularly when the capacity of AP is exceeded by high concentrations of free plasmin. These reactions are important in preventing systemic lytic states from developing such as occurs in certain disease states (see Section IV.B.4). When fibrin is formed, it binds plasminogen and AP in equimolar amounts. AP is bound via its N-terminal portion, which leaves the C-terminal portion free to bind to one of the kringle domains of the plasmin molecules that form in response to tPA activity (Coughlin, 2005a). This modulates plasmin such that the proteolytic cleavages do not initially destroy the fibrin network but rather open new affinity binding sites for additional tPA and plasminogen. As this first phase of fibrinolysis proceeds, more plasmin is generated on the partially degraded fibrin, which can induce the second phase that produces final degradation of the fibrin meshwork. The existence of the two sequential phases of fibrin degradation may be one of the mechanisms that provide temporary stability of fibrin clots at sites of vascular damage (Dobrovolsky and Titaeva, 2002).

## III. LABORATORY ASSESSMENT OF HEMOSTASIS

### A. Quality Control and Reagent Variation

The common laboratory assays available to assess the integrity of the hemostatic system can be divided into those assessing primary hemostasis (platelet quantity and function) and those assessing secondary hemostasis (clotting factor activity and fibrin formation and dissolution).

Proper collection of plasma that is free from clots and activated platelets is very important for all hemostasis testing. To obtain the best sample, minimal pressure should be placed on the vein and a single clean venipuncture performed, to avoid release of excessive TF, which would activate the clotting mechanism, consume coagulation factors, and therefore artifactually prolong the clotting times. The stopper should be removed from the Vacutainer and blood slowly expelled from the syringe into the tube because excessive vacuum turbulence may activate platelets. Ideally, the first few drops of blood collected should be discarded because they most likely would contain some TF. The blood should be gently mixed with the citrate, to ensure anticoagulation, but not too aggressively mixed so as to activate hemostasis.

There is controversy whether a citrated plasma sample obtained directly from a peripheral catheter is suitable for hemostatic testing. Advocates of this technique argue that the ability to get the sample from a previously placed access port minimizes patient discomfort, allows for more accurate volume extraction, and ensures no contamination with tissue factor. If this approach is used, the catheter should be flushed with saline, and then blood volume equal to six times the catheter dead space should be removed and discarded before collecting the sample for analysis (Arkin *et al.*, 1998). A study by Mills *et al.* (1995) documented that this procedure did not result in significant differences compared with direct venipuncture in healthy dogs.

Several reports have compared the effect on various hemostatic parameters with respect to the concentration of citrate used and the volume of blood to citrate obtained. Historically, 3.8% sodium citrate tubes only were available, but recently 3.2% sodium citrate tubes have become the standard in Europe and are now available in the United States and elsewhere (Morales *et al.*, 2007). One study determined that for some coagulation assays there can be significant differences between the two types of tubes (Stokol *et al.*, 2000a), whereas another more recent study (Morales *et al.*, 2007) suggests that there is no difference in any common coagulation assay between the two concentrations. It is recommended that each laboratory specify the citrate concentration preferred and develop reference intervals based on results from samples collected in the defined manner.

The time a sample is stored before assessment may also have an impact on the test result. Most often samples are analyzed relatively quickly (i.e., within a few hours or at least the same day), but there may be an occasion when a sample cannot be assessed until the following day or two, or, depending on the assay, samples may be stored until sufficient numbers are collected and then run as a batch. Although longer than generally considered acceptable, a recent paper (Furlanello *et al.*, 2006) found that samples could be kept at room temperature for up to 48 h without any significant change from immediate analysis, whereas storage at either room temperature or refrigeration was not recommended beyond 48 to 72 h. The typical recommendation is to perform assays within 4 h of sampling, after centrifuging and removal of plasma or to freeze the sample until analysis can be performed. Plasma samples can be safely stored at  $-70^{\circ}\text{C}$  for up to 6 months with minimal change in results except for the aPTT (Bateman *et al.*, 1999a; Iazbik *et al.*, 2001).

## B. Testing of Hemostasis

### 1. Assessment of Platelet Quantity

#### a. Platelet Concentration and Volume

Platelets can be enumerated from either an EDTA or sodium citrate-anticoagulated blood sample. Heparinized

blood is not suitable as marked platelet clumping often occurs. Assessment is best performed within 4 to 5 h, but the count may remain relatively stable for up to 24 to 48 h if the sample is refrigerated (Stockham and Scott, 2002).

Manual or automated methods can be used for platelet quantity assessment. Manual methods include estimation of platelet quantity from a stained blood smear and hemacytometer chamber counting. Most automated hematology analyzers using impedance or light scattering technology can also enumerate platelets.

Platelet clumping must be avoided for any platelet quantification method, or underestimation of the platelet count will occur. This can happen in any species with traumatic sampling and tends to occur most frequently in cats and cattle. Therefore, it is critical that a peripheral blood smear be examined for the presence of clumps; this also provides an opportunity to ensure appropriate cell morphology and to perform an estimate of platelet numbers as a cross-check of an automated determination.

The mean platelet volume (MPV) is frequently determined by automated analyzers and reflects the average volume of all cells that are enumerated as platelets. For an accurate determination, platelet clumping needs to be avoided, and the cells should be unactivated and circular in shape without pseudopod formation. Variables such as time to analysis, storage temperature, and anticoagulant used can all impact MPV assessment. Generally, there tends to be an inverse relationship between platelet concentration and MPV; the value is higher when platelet concentration is low, and it is lower when numerous platelets are present. This has been documented in healthy cats (Weiser and Kociba, 1984.) An increase in MPV is a favorable finding in an animal with thrombocytopenia, as it is usually a reflection of active thrombopoiesis. Excessively large platelets are often observed in Cavalier King Charles spaniels, but the corresponding platelet concentration also tends to be lower, making overall platelet mass similar to other breeds (Smedile *et al.*, 1997).

#### b. Clot Retraction

Retraction of a blood clot depends on platelets, so defects in platelet quantity or quality will prolong the time required for whole blood to clot in a tube. Measurements of clot retraction are available, but this test is limited by subjectivity and is not often performed.

#### c. Buccal Mucosal Bleeding Time

Although typically assessed as an indicator of platelet function, a sufficient quantity of platelets also needs to be present to form a platelet plug in a standardized mucosal incision. Once thrombocytopenia is present, the BMBT may be prolonged simply from lack of platelets. See Section III.B.2.a for further details.

## 2. Assessment of Platelet Quality

### a. Buccal Mucosal Bleeding Time

The BMBT is an *in vivo* test of platelet function, which also depends on adequate platelet concentration and properly functioning endothelium. The incision is small enough that secondary hemostasis is not required to stop blood flow; formation of a platelet plug alone will stop the bleeding. A standardized incision using a commercially available device is made on the buccal mucosa of the lip and the time to clotting recorded in seconds or minutes. Time to clotting can vary substantially within and between observers, making this a less than ideal test, but most healthy dogs clot in less than 4 min (Sato *et al.*, 2000). It is, however, useful as a quick and inexpensive screening test for congenital or acquired thrombopathia, which can be followed up by more specific testing if the result is prolonged. Skin and toenail bleeding time tests have also been described but are even less standardized than the BMBT and are not recommended.

### b. Platelet Aggregometry

The propensity of platelets to bind to each other in the presence of certain agonistic substances can be exploited as a method to determine appropriate platelet function. Platelet aggregometers trace the optical density of a standardized platelet preparation after the addition of an aggregating substance such as ADP, epinephrine, or collagen. There are marked species differences with respect to concentration and type of agonist required to promote aggregation. Platelet aggregation is technically demanding, time consuming, and therefore generally limited to specialized or research laboratories.

### c. PFA-100

The Platelet Function Analyzer-100 (Bayer) has revolutionized assessment of platelet function in human medicine. The ability to quickly assess aperture closure time in a whole blood sample in a clinical setting has eliminated all the limitations of time-consuming and technically demanding platelet aggregometry. The PFA-100 simulates high shear flow blood vessel conditions and, with the addition of either epinephrine or ADP as an agonist on a collagen membrane, determines how quickly a platelet plug can close an aperture and arrest blood flow.

The method has been evaluated for use in the dog (Couto *et al.*, 2007), and the collagen/ADP cartridge has been found to be useful to screen for platelet dysfunction in von Willebrand disease (Mischke and Keidel, 2003), NSAID administration (Gaal *et al.*, 2007; Neilsen *et al.*, 2007), and during endotoxemia (Yilmaz *et al.*, 2005).

There are single reports evaluating the instrument for horses where it was determined it was sensitive enough to detect decreased platelet function related to ASA administration (Segura *et al.*, 2005) and in a pig model of severe hemorrhagic shock (Arnaud *et al.*, 2006).

## 3. Screening Tests of Hemostasis

### a. OSPT

The one-stage prothrombin time (OSPT) assesses the plasma activity of prothrombin, FV, FVII, and FX after addition of calcium and activator known as tissue thromboplastin. The test therefore gives information about the tissue factor (extrinsic) pathway and the common pathway. Different sources of thromboplastin will result in different clotting times, and although the use of homologous tissue is ideal, human source reagents can be used effectively (Hall, 1970; Mischke and Nolte, 1997; Mischke *et al.*, 2003). Clotting times tend to be rapid in domestic animals, often less than 10sec, which reduces the sensitivity of the assay for detecting minor abnormalities. Dilution of reagents has been advocated as a way to extend clotting times to 10 to 15sec.

As a screening test, the OSPT is not sensitive to minor coagulation abnormalities, and it generally takes loss of >70% activity of one or more factors to prolong the clotting time. Modification of the test to assess individual factor activity can be achieved using specific factor deficient plasma, and several assays have been shown to have similar ability to detect factor deficiencies (Mischke, 2002). The effects of common interferences (lipid, hemoglobin, bilirubin) on the PT assay have been studied (Moreno and Ginel, 1999). These authors found that bilirubin caused a statistically significant prolongation of the OSPT but that clinical significance associated with this prolongation was unlikely. Point-of-care analyzers are now available that can quickly perform the OSPT at the animal's cage side and have been evaluated in dogs (Tseng *et al.*, 2001).

The International Normalized Ratio (INR) is frequently used in place of the OSPT in human medicine for monitoring people on warfarin anticoagulant therapy because different thromboplastins have variable sensitivities to warfarin-induced changes in factor activity (Stockham and Scott, 2002). The International Sensitivity Index (ISI), which is specific for an individual reagent, is incorporated into the INR calculation and is meant to correct for reagent variation. ISI values are not widely available for domestic animal species, so the INR is not frequently used in veterinary medicine.

### b. aPTT

The activated partial thromboplastin time (aPTT) assay detects fibrin clot formation after addition of an activating agent, partial thromboplastin (phospholipids that lack TF), and recalcification of plasma. It assesses the activity of prothrombin, FV, FVIII, FIX, FX, FXI, and FXII, therefore providing information about the integrity of the contact activation (intrinsic) and common pathways (see Section II.C.3). Activating agents include substances such as kaolin and ellagic acid, and clotting times can vary between species

and depending on the specific activators used. Pooled plasma from a similar species is required as a control to avoid interpretive errors. There can be significant variations in the assay method and reagents used, so it is crucial that each laboratory define its own species-specific reference interval (Evans and Flynn, 1992; Johnstone, 1984). Similar to the OSPT, the test is relatively insensitive, requiring loss of activity of 70% of at least one factor before prolongation of the clotting time. Common interferences (lipid, hemoglobin, bilirubin) may interfere with an optical method and provide an erroneous result. Hemoconcentration was demonstrated to prolong aPTT in one study, emphasizing the importance of the blood-anticoagulant ratio for accurate testing (O'Brien *et al.*, 1995).

The aPTT can additionally be used to monitor cats and dogs receiving heparin therapy (Greene and Meriwether, 1982; Mischke, 2003). The assay can be modified to detect specific factor deficiencies (Deniz *et al.*, 1995; Mischke, 2000).

#### c. ACT

The activated clotting time (ACT) is similar to the aPTT in that it provides information about the same portions of the clotting mechanism (intrinsic or common pathways), but it is a less sensitive test. It is a point-of-care test performed on whole blood, where a compound in the tube, typically siliceous earth, activates the contact (intrinsic) pathway (Stockham and Scott, 2002). It depends on endogenous platelets in the sample as the phospholipid source for clotting. Because of this, although not well documented, severe thrombocytopenia may result in a prolonged ACT. It is used primarily as a screening test for coagulopathies, but it requires loss of greater than 95% loss of activity of one or more factors before it is prolonged, so disease is often advanced by the time the ACT is abnormal. The ACT is the time in seconds to first visible clot formation while gently inverting the tube after initial incubation for 60sec at 37°C either in a heating block or in a human axilla. The ACT is used in humans and sometimes in animal patients to monitor therapeutic heparinization.

Reference values have been published for cats (Bay *et al.*, 2000), but each facility should follow a standard protocol and ideally define its own reference interval. Automated ACT methods are available on some point-of-care instruments that offer OSPT and aPTT, but they are not exactly the same as the tube ACT (phospholipid is added) and provide no advantage over an automated aPTT (Tseng *et al.*, 2001).

#### d. TCT

The thrombin clotting time (or simply thrombin time) assesses the ability of thrombin to convert fibrinogen to fibrin, so it is abnormal when there are quantitative or qualitative abnormalities in fibrinogen. Variations of the test are available, so a reference interval specific for the

laboratory and species should be developed (Mischke and Jacobs, 2001). The Clauss method is specifically used to derive a concentration of fibrinogen in a plasma sample (see Section III.B.5.b).

### 4. Assessment of Fibrinolysis

#### a. FDPs

Fibrin-fibrinogen degradation product (FDP) assays measure the breakdown split products of either fibrinogen or fibrin, and increased values indicate enhanced fibrinogenolysis or fibrinolysis. Elevated FDPs are used to help confirm the presence of DIC (see Section IV.B.4). Several human assays are available, including both serum and plasma-based assays, but the plasma latex agglutination test appears more sensitive for detecting DIC in dogs (Boisvert *et al.*, 2001; Stokol *et al.*, 1999). FDP assays have also been used in cats and horses.

#### b. D-Dimer

D-dimers and x-oligomers are small fragments created when fibrinolysis occurs. They are products of fibrin degradation, not fibrinogen degradation, so are more specific for enhanced fibrinolysis. There are currently no available animal-specific assays, but there appears to be sufficient cross-reactivity between human and canine proteins as some human-based semiquantitative immunological latex agglutination methods have been used in canine patients (Griffin *et al.*, 2003; Nelson and Andreasen, 2003; Stokol, 2003; Stokol *et al.*, 2000b). D-dimers have been assessed in horses, predominantly in an attempt to document DIC related to colic (Dallap *et al.*, 2003; Heidmann *et al.*, 2005; Monreal, 2003; Sandholm *et al.*, 1995).

### 5. Assessment of Specific Hemostasis Proteins

#### a. Prothrombin, FV, FVII, FVIII, FIX, FX, FXI, FXII

Specific factor activity is traditionally assessed using coagulometric methods. Depending on the factor, modifications of the OPST (for extrinsic or common pathway factors) or the APTT (for intrinsic factors) are used where the activity of the factor in patient plasma is measured in a sample mixed with plasma known to be deficient in the factor. If the patient sample is deficient in the factor in question, the OSPT or APTT, as appropriate, does not correct (Stockham and Scott, 2002). The activity of the factor in the patient's plasma is derived from a standard curve created from serial dilutions of pooled homologous plasma from clinically healthy animals that has been added to the factor-deficient plasma. Factor-deficient plasmas for domestic animal species are not generally available, so methods must be validated using human reagents.

Chromogenic methods are now available and used quite extensively in human medicine. However, the expense, the



necessity to use a 96-well plate, and the limited shelf life of reagents once the kit is opened limit extensive use of this methodology for veterinary medicine unless samples can be batched.

#### b. Fibrinogen

For the heat precipitation method, EDTA-anticoagulated blood is centrifuged in a microhematocrit tube and heated for 3 to 9 min at 56°C, and then the amount of precipitate formed is quantified as a measure of fibrinogen. This method is useful only as a crude estimate of an increased concentration of fibrinogen and is no longer routinely used.

Derivation of fibrinogen concentration from the Clausu thrombin clotting time (Stockham and Scott, 2002) is more often performed at veterinary labs, because routine fibrin-based clotting assays are usually offered. Fibrinogen concentration is inversely proportional to the time it takes for thrombin to form fibrin from fibrinogen, so it depends on the amount of fibrinogen present when excessive thrombin is used to negate the effects of any inhibitors such as heparin or fibrin degradation products (Stockham and Scott, 2002). The time to clot formation is recorded in seconds and then converted to mg/dl or g/l based on a standard curve. A fibrinogen antigen assay is available but is not a functional test. Therefore, if the antigen assay is not decreased but the TCT is abnormal, dysfibrinogenemia is likely.

#### c. von Willebrand Factor

Assessment of von Willebrand factor (vWF) protein is most commonly determined by detecting antigen concentration in plasma, but additional tests are available if more detailed information is needed to manage the animal. See Section IV.A.1.b for more details.

#### d. Antithrombin

As an indicator of anticoagulant status, there are both functional and antigenic assays for the detection of antithrombin (AT) in plasma. Functional assays can be either thrombin or FXa based, where the more AT there is, the less activity of either of these enzymes there will be. A standard curve from homologous pooled plasma must be prepared to determine the test plasma activity. Both manual and automated methods are available. The activity of AT is stable, and in one study values remained relatively unchanged after 6 months of storage of plasma at -70°C and after 6 weeks of storage of whole blood at 4°C (Green, 1988). The same study suggested that FXa-based assays may be more appropriate because heparin cofactor II activity may be measured in some thrombin-based assays and falsely elevate the AT measurement. Hemoglobin in the sample may interfere with the ability to accurately determine plasma AT activity in some chromogenic assays (van der Merwe and Reyers, 2007).

### C. Additional Assays

Several additional assays of activation of coagulation and fibrinolysis have been examined on a limited basis in veterinary medicine (Roncales and Sancho, 2000). Most of these tests are used widely in human medicine but need more thorough evaluation and standardization before being offered as routine tests for domestic animals. Some of the proteins or complexes tested include activated clotting factors such as FVIIa and FVIIa, activation peptides such as fibrinopeptides A and B, and indicators of fibrinolysis such as plasmin-antiplasmin complexes and PAI-1. Thrombin-antithrombin complexes (TAT) have been measured as an indicator of coagulation activation in dogs with malignant neoplasia (Maruyama *et al.*, 2005) and horses with colic (Topper and Prasse, 1996).

The Russell viper venom time (RVVT) test is an additional assay used occasionally to provide information about common pathway abnormalities (Stockham and Scott, 2002). The time to clot formation depends on activation of FX by the venom of a Russell's viper. This test is not routinely used.

Proteins induced by vitamin K antagonism or absence (PIVKA) are inactive vitamin K-dependent clotting factors produced by hepatocytes when this important cofactor is unavailable (see Section IV.B.5). The Thrombotest PT is a modification of the prothrombin time that is sensitive, but not entirely specific, to the presence of these abnormal proteins (Center *et al.*, 2000).

Thromboelastography (TEG) provides a global assessment of hemostasis and specifically provides general information about the rate of fibrin polymerization and overall clot strength. Analysis of the TEG tracing can give a summary of platelet function, coagulation proteins, and fibrinolysis (Luddington, 2005). TEG has traditionally been used in human medicine to facilitate blood product use decisions in patients undergoing liver transplant or cardiac surgery. Its use has been minimally evaluated in veterinary medicine (Donahue and Otto, 2005). One study used TEG to document hypercoagulability in dogs with parvoviral enteritis (Otto *et al.*, 2000). Routine use of TEG suffers from lack of standardization, although a group recently developed TEG values for clinically healthy dogs (Wiinberg *et al.*, 2005).

## IV. DISORDERS OF HEMOSTASIS

### A. Hereditary Disorders

#### 1. von Willebrand Disease

Although von Willebrand disease (vWD) is the most common inherited bleeding disorder in both humans and dogs, it has also been reported in swine and cats (Denis and Wagner, 1999; Thomas, 1996). Human vWD was described initially

**TABLE 10-7** Recognized Types of Canine von Willebrand Disease and Their Features

	Type I	Type II	Type III
vWF Concentration <sup>a</sup>	Decreased	Decreased	Undetectable
vWF Structure <sup>a</sup>	Normal	Decrease in large multimers	Undetectable
Breed Predilection <sup>a</sup>	Doberman pinschers Airedales Dachshunds German shepherds Shetland sheepdogs Several other breeds	German shorthaired and wirehaired pointers only	Chesapeake Bay retriever Dutch kooiker Scottish terrier Shetland sheepdog
Inheritance Pattern	Autosomal dominant	Appears autosomal recessive	Autosomal recessive
Hemorrhage	Variable	Severe	Severe

<sup>a</sup> See Brooks, 1992.

in the 1920s by Erik von Willebrand, and since then it has been classified into three distinct variants (Ewenstein, 1997). Two are quantitative deficiencies (types I and III), with a decrease in circulating vWF, and one is a qualitative defect (type II) (Ewenstein, 1997). Human type II vWD is further divided into four subtypes (A, B, M, and N) (Ewenstein, 1997). The first incidence of vWD in dogs was reported in 1970 in a family of German shepherd dogs (Denis and Wagner, 1999). Since then, as in humans, three types of vWD have been identified and are summarized in Table 10-7. Whereas types I and III vWD share phenotypic characteristics with the respective human types, the qualitative defect (type II) is characterized by a decrease in high-molecular-weight vWF multimers without further subclassification. Although modes of inheritance have been identified, the actual genetic defect is unknown for many of the affected breeds (Denis and Wagner, 1999).

Inheritance of type I vWD is autosomal dominant with incomplete penetrance. A dominant trait requires only one copy of the gene to produce abnormalities. Therefore, clinical signs can be identical for homozygotes and heterozygotes (Brooks, 2000). Hemorrhage in type I vWD can vary from mild to severe, and even dogs with comparable concentrations of vWF can show a range of clinical signs (Brooks, 2000). Manifestations of type I vWD are due to a proportional decrease in all multimer sizes (Brooks, 1999). It has been reported that in Doberman pinschers there is a decrease in vWF mRNA as well as a reduced release of vWF from endothelial cells, suggesting that the disease is a result of defective expression of the gene (Denis and Wagner, 1999). However, immunofluorescent studies have shown that there is no detectable difference in the localization of vWF:Ag or the fluorescence intensity in endothelial cells from control dogs and type I vWD-positive Doberman pinschers (Meyers *et al.*, 1990b). As of 1981, the reported prevalence of vWD in Dobermans in North America was

63% (Dodds *et al.*, 1981). Although the Doberman pinscher is the most well-known breed associated with type I vWD, the condition is also commonly found in a variety of other breeds including Airedale terriers, dachshunds, Pembroke Welsh Corgis, and German shepherd dogs.

Type II disease is rare in dogs and has been reported only in German shorthaired and wirehaired pointers (Brooks, 2000). Disease manifestation is due to lack of high-molecular-weight multimers of vWF and tends to produce recurrent severe hemorrhage. Generally, one or more episodes of bleeding occur by the time the animal is 1 year old (Brooks, 2000). In one study, a particular family line of German shorthaired pointers, in which some members were positive for type II vWD, was examined and it was found that none of the affected dogs had a vWF:Ag concentration higher than 68% (Kramer *et al.*, 2004). Persistent spontaneous bleeding episodes in this family of dogs was confined to homozygotes, dogs with vWF:Ag concentrations of less than 10%, or both (Kramer *et al.*, 2004). The pattern of inheritance in this family line appeared consistent with an autosomal recessive trait. This study was successful in identifying a consistent single nucleotide defect within the sequence for the vWF A2 domain of the affected dogs and an identical defect in German wirehaired pointers (Kramer *et al.*, 2004).

Similar to type I disease, the type III phenotype is dependant on the level of vWF:Ag present. This manifestation of vWD is autosomal recessive. Homozygotes have no measurable circulating factor and are clinically affected, whereas heterozygotes exhibit low levels of vWF and clinically appear normal (Brooks, 2000). FVIII activity tends to vary between 15% to 50% in type III patients (Denis and Wagner, 1999).

#### a. Hemorrhagic Tendencies

In type I vWD, it is not uncommon for animals to present without a bleeding history, in contrast to type II and III

disease where bleeding generally occurs during the first year of life. The ability of vWF to mediate platelet adherence and aggregation is a key component in primary hemostasis (see Section II.B.3.a). In the absence, or dysfunction, of vWF in high-flow conditions, the inability of platelets to successfully bind collagen and form aggregates can resemble a primary platelet disorder. As such, thrombocytopenias, thrombocytopathias, and vWD can present in a similar fashion; however, petechiae can be a distinguishing feature. In contrast to platelet disorders, petechiae are not a feature of vWD, and to the authors' knowledge, the reason for this has not been explained in the literature. When the interaction between vWF and platelets is examined, the importance of hemorrheology quickly becomes evident. The role of vWF is most important in platelet adherence in high blood flow environments. As mentioned previously (see Section II.B.3.a), the platelets are able to bind collagen through the GP VI and GP Ia-IIa receptors independent of vWF in areas of low blood flow. Capillaries are sites of low blood flow, and therefore, during normal wear and tear, platelets are able to occlude small vessel defects without assistance from vWF. Therefore, a decreased concentration or function of vWF would not be reflected as a defect in this process. However, a decrease in platelet number or function would prevent occlusion of these vessel defects and result in petechiae.

Bleeding in vWD-positive dogs generally involves hemorrhage from mucosal surfaces and excessive hemorrhage after surgery or trauma (Thomas, 1996). Epistaxis, hematuria, gastrointestinal hemorrhage, prolonged estral bleeding, and gingival bleeding at tooth eruption are some of the more commonly reported occurrences (Brooks, 2000). In some dogs, rebleeding from incised tissues has been observed as long as 24 h after a surgical procedure (Brooks, 1992). In general, animals that tend to be more likely to hemorrhage have vWF concentrations below 20%; however, the concentration of vWF:Ag does not accurately predict the risk of hemorrhage (Brooks, 2000; Thomas, 1996). Multiple factors, beyond the concentration of vWF, can influence an animal's likelihood to bleed. The type of tissue affected can contribute to the level of hemorrhage. For example, the oronasal cavity and urinary tract are areas that are high in fibrinolysins and therefore tend to produce a more severe bleed (Brooks, 2000). Concurrent platelet dysfunction can also increase the likelihood that a vWD patient will experience hemorrhage. Therefore, in conditions that can influence platelet function (e.g., uremia, hypoproteinemia, anemia, and liver disease), an increased possibility of hemorrhage should be considered (Brooks, 2000).

#### b. Diagnosis

Determination of both vWF concentration and function is important in the diagnosis of vWD, as no single test is comprehensive enough to detect all of the variants (Favaloro *et al.*, 1999; Paczuski, 2002). The current gold standard is the vWF antigen concentration (vWF:Ag)

test. Reported ranges include normal (>70%), abnormal (<50%), and indeterminate values that comprise the difference (Thomas, 1996). This test can identify some of the dogs with types I and III vWD, but it can leave some diagnoses indeterminate. In addition, this test is not effective for identifying type II disease as this is a qualitative rather than a quantitative deficiency. Type I disease can also be problematic to diagnose because of extragenic influences that can temporarily increase vWF into the normal range, as discussed later in the chapter (Ewenstein, 1997).

In 1986 the use of a collagen binding assay (CBA) as an alternate to ristocetin-induced platelet aggregation assays (vWF:RCof) was proposed (Paczuski, 2002). This assay measures the quantity of vWF bound to immobilized collagen in a procedure similar to that of an ELISA (Paczuski, 2002). The coefficient of variation for this test has been reported as low as 4.4% (Callan *et al.*, 2005). When compared to the vWF:RCof, the CBA was superior in its detection of type II vWD and had decreased assay variability (interassay and interlaboratory) (Favaloro, 2000). Collagen has been shown to bind vWF with a preference for the high-molecular-weight forms, and therefore the CBA can be used to assess the relative proportion of large vWF multimers (Brown and Bosak, 1986; Duggan *et al.*, 1987). In vWD patients the collagen binding activity is significantly decreased compared to control patients (Paczuski, 2002). In types I and III vWD, the decrease in function of vWF parallels the level of vWF:Ag present; in type II vWD, there is a disproportionate decrease in activity (Denis and Wagner, 1999). Collagen binding assays, in conjunction with the antigen assay, can therefore be used to assess the quantity of vWF as well as its function (Paczuski, 2002). This makes these assays valuable not only as screening tests for vWD but also to distinguish between types I and II (Paczuski, 2002). The ratio of vWF:Ag to vWF:CBA in normal patients and type I vWD is generally less than or equal to 1 (Favaloro *et al.*, 1991). In type II vWD, this ratio has been reported to range from 2 to 8 (Brown and Bosak, 1986; Favaloro *et al.*, 1991). Although the CBA is currently utilized extensively in human diagnostics, it is only recently becoming available for the diagnosis of canine vWD.

#### c. Extragenic Influences on vWF Concentration

The value of a single sample in an animal with an indeterminate vWF:Ag ELISA result is limited by daily and weekly variation in vWF:Ag concentration (Kramer *et al.*, 2004). In humans there is question as to whether other traits may influence the phenotypic expression in type I disease. For instance, individuals with blood type O have levels of vWF 20% to 30% lower than individuals with other blood types (Ewenstein, 1997). Several other factors have also been found to increase the plasma concentration of vWF, including azotemia, liver disease, strenuous exercise, endotoxemia, parturition, and increased plasma vasopressin (Thomas, 1996). In dogs, significant increases in the vWF concentration occur during the last one-third

of gestation; however, values return to normal by 7 to 14 days postpartum (Moser *et al.*, 1998). This change is more notable in normal dogs but does also occur in type I vWD patients (Moser *et al.*, 1998). It has been suggested that this may be a result of rapidly dividing endothelial cells in a highly vascular placenta (Moser *et al.*, 1998). In contrast, there is no significant change in vWF concentration during the estrus cycle (Moser *et al.*, 1998). Age can also have an effect on the vWF concentration, with younger puppies generally having lower concentrations that gradually approach mean adult values by 11 weeks of age (Mansell and Parry, 1992).

In humans, patient response to desmopressin has a positive correlation with the level of platelet vWF (Ewenstein, 1997). Vasopressin stimulates V2 vasopressin receptors, resulting in the release of intracellular stores of vWF (Brooks, 2000). A study involving normal dogs and Doberman pinschers with vWD was conducted in order to assess the effect of exercise, DDAVP, and epinephrine on vWF concentration and FVIII activity (Meyers *et al.*, 1990a). The vWF-deficient dogs were unable to sustain intense exercise for longer than 30min, whereas the normal dogs were able to complete a 10km run in 40min. An increase in FVIII activity was noted in the normal dogs that was related to the intensity of exercise and increased blood lactate concentrations, although the basis for the increase was not clear. vWF increased in these dogs to a greater extent than FVIII. There was no significant change in FVIII or vWF concentration in the vWD-positive dogs. Although their level of exercise was less than that of the normal dogs, the equivalent exercise was sufficient to cause an increase in vWF:Ag concentration of 30% in the normal dogs. The increase in vWF:Ag and FVIII concentrations after infusion of DDAVP in normal dogs is less than observed in humans, and some dogs react poorly to this therapy (Meyers *et al.*, 1990a). In the Meyers *et al.* study, the vWF:Ag concentration increased in normal dogs after treatment with DDAVP. Although the increase noted in the vWF-deficient dogs was less than 0.1 U/ml, bleeding time decreased in three of six of these dogs. This finding suggested that DDAVP may induce the release of the high-molecular-weight (and therefore more active) forms of vWF; however, Callan *et al.* (2005) confirmed through multimer analysis that DDAVP produces an increase in all multimer sizes. Finally, whereas the vWF:Ag concentration increased 30min after administration of epinephrine in the normal dogs, there was no change in FVIII activity, nor were there changes in either factor in the vWF-deficient dogs. Breed variations have also been noted, for example Airedale terriers tend to have decreased concentrations of vWF compared to control dogs, yet a history of bleeding is rare (Thomas, 1996).

## 2. Platelet Number

Typical clinical signs of thrombocytopenia include petechiae and ecchymoses, bleeding from mucosal surfaces, and cutaneous bruising. As mentioned (see Section IV.A.1.a),

with the exception of petechiae, these signs are similar to those noted in patients with vWD.

Greyhounds and Cavalier King Charles spaniels (CKCS) have been shown to have lower platelet numbers when compared to other breeds, without apparent consequence (Cowan *et al.*, 2004; Sullivan *et al.*, 1994). In addition to decreased platelet numbers, in 51% of the CKCS studied, 33% exhibited macrothrombocytes (Cowan *et al.*, 2004). In fact, the platelet counts in those dogs with macrothrombocytes were significantly lower than in CKCS dogs with normal-sized platelets (Cowan *et al.*, 2004). The apparent connection between platelet size and number in these dogs is not surprising based on the association between platelet mass and TPO concentration (see Section II.B.1). Although, as mentioned, this platelet anomaly is benign, there is a decreased platelet aggregation response to ADP in CKCS (Cowan *et al.*, 2004).

## 3. Platelet Function

As noted previously (see Section II.B.2), the GPIIb-IIIa integrin is essential for platelet aggregation. A deficiency of this integrin results in thrombasthenic thrombopathia, also known as Glanzmann's thrombasthenia. This deficiency has been identified in humans, dogs (otterhounds and Great Pyrenees), and horses. Clinical signs of bleeding in affected canine patients are generally recognized before 1 year of age and include mucosal hemorrhage, melena, hematuria, cutaneous ecchymoses, and excessive surgical bleeding (Boudreaux and Catalfamo, 2001). In platelet aggregation studies, affected platelets will undergo shape change but fail to aggregate normally. Abnormal *in vitro* clot retraction is also typical of this disease and has been used as a screening tool; however, this test is not reliable for identification of carrier animals (Boudreaux and Catalfamo, 2001). Documentation of decreased or absent membrane GPIIb-IIIa through flow cytometry or electrophoretic studies provides a definitive diagnosis. Thus far, two genetic defects have been identified in Great Pyrenees dogs, and a single defect in otterhounds (Boudreaux and Catalfamo, 2001; Lipscomb *et al.*, 2000). Similar to the dog, equine cases also present with mucosal bleeding, and they have markedly impaired platelet aggregation and markedly decreased clot retraction (Livesey *et al.*, 2005). A single genetic defect has been identified in the horse and was consistent between two affected horses of different breeds (Christopherson *et al.*, 2006).

Platelet storage pool defects, specifically a deficiency of dense granules and their contents, result in thrombopathia in Chediak-Higashi syndrome (CHS). In both cattle and humans affected with this disease, compared to unaffected individuals, platelet aggregation was decreased in response to collagen; concentrations of serotonin, ATP, and ADP were decreased; and the ratio of ATP:ADP was abnormally increased (Bell *et al.*, 1976). Similarly, in CHS cats, platelet aggregation required considerably higher

concentrations of serotonin, ADP, or collagen; platelet ATP, ADP, and serotonin content was decreased; and secretion of  $\text{Ca}^{2+}$  and  $\text{Mg}^{2+}$  by activated platelets was markedly decreased (Meyers *et al.*, 1981). More recent studies have demonstrated that, in addition to the dense granule deficiency, the collagen-induced increase in cytosolic  $\text{Ca}^{2+}$ , through the PLC $\gamma$  pathway (see Sections II.B.3.a and c), is depressed in the platelets of Japanese black cattle affected with CHS (Shiraishi *et al.*, 2002a, 2002b). These results suggest an additional mechanism for the decreased platelet function in CHS. A dense granule storage defect, similar to that in CHS, has been described in three families of American cocker spaniel dogs with moderate to severe bleeding (Callan *et al.*, 1995). Although these dogs had a decrease in ADP content and an increased ATP:ADP ratio, in contrast to CHS, the number and morphology of dense granules on ultrastructural studies and concentrations of serotonin appeared normal (Callan *et al.*, 1995). The defect identified in these dogs appears to be an isolated abnormality in the  $\delta$ -granule adenine nucleotide storage (Callan *et al.*, 1995).

Platelet dysfunction in basset hounds has been attributed to defective intracellular signaling. Ultrastructural appearance, surface molecules, and granule constituents appear normal in these dogs; however, secretion of dense granules, expression of fibrinogen binding sites on GPIIb-IIIa, and platelet aggregation are impaired in response to several platelet agonists (Catalfamo *et al.*, 1986). An elevation of basal cAMP levels has been detected in these platelets and is thought to result from a defect in cAMP metabolism (Boudreaux *et al.*, 1986; Catalfamo and Dodds, 2000). As previously mentioned, elevated cAMP levels reduce platelet reactivity through a number of mechanisms (see Section II.B.3.d, and Table 10-3) and thus would be detrimental during hemostatic challenge. The thrombopathia of Simmental cattle has also been attributed to defective intracellular signal pathways. Whole blood from these cattle exhibit normal clot retraction, but aggregation in response to ADP and collagen is markedly impaired (Searcy *et al.*, 1990). Similar to basset hounds, these cattle express normal levels of GPIIb-IIIa on the platelet surface; however, in contrast, dense granule secretion is unimpaired (Searcy *et al.*, 1990). The cytoskeletal assembly in response to ADP was shown to be incomplete, and this is thought to result in delayed activation of GPIIb-IIIa and therefore delayed fibrinogen binding (Frojmovic *et al.*, 1996; Searcy *et al.*, 1994).

#### 4. Coagulation Factor Disorders

##### a. Fibrinogen Deficiency

As previously discussed, fibrinogen not only takes part in primary hemostasis but is imperative for final clot formation in secondary hemostasis (see Section II.C.4). Fibrinogen is primarily synthesized in hepatocytes through production and assembly of three polypeptide chains ( $A\alpha$ ,  $B\beta$ , and  $\gamma$ ), which subsequently dimerize to form hexameric fibrinogen

(Asselta *et al.*, 2006). Each of the fibrinogen chains is encoded by separate genes, and all are required for successful assembly and secretion (Roy *et al.*, 1991). Numerous genetic defects have been identified in humans, with variable influence on production, secretion, and function of the molecule. Hereditary fibrinogen deficiencies are generally categorized into quantitative (afibrinogenemia and hypofibrinogenemia) and qualitative disorders (dysfibrinogenemia) (Asselta *et al.*, 2006). In humans, the quantitative deficiencies are generally inherited as autosomal recessive disorders, whereas the qualitative deficiencies are generally autosomal dominant (Asselta *et al.*, 2006). Bleeding tendencies are variable; however, umbilical cord bleeding, hemorrhages from mucosal surfaces, hemarthroses, and hematomas are some of the more frequently encountered symptoms (Lak *et al.*, 1999). Hemarthrosis and hematomas tend to be less frequent and severe than in the hemophilias (Lak *et al.*, 1999). In afibrinogenemic and hypofibrinogenemic patients, the majority of bleeding episodes occurs as a result of trauma or surgery (71% and 80%, respectively), with the remainder comprising spontaneous episodes (Acharya *et al.*, 2004). Thrombin time is prolonged in fibrinogen defects; however, partial thromboplastin time and prothrombin time are also prolonged because of their dependency on a fibrin clot end point (see Section III.B.3.d). Further investigation should include quantification of fibrinogen, an absence indicating afibrinogenemia, and decreased levels in hypofibrinogenemia. Although fibrinogen concentration is generally within reference intervals for dysfibrinogenemias, some present with low fibrinogen concentrations (Hayes, 2002). It is important to measure activity in conjunction with concentration in order to reveal functional deficiencies. Typically a 1:1 ratio of functional to quantitative levels are present; however, in dysfibrinogenemia the ratio is more typically 1:2, with disproportionately low function compared to concentration (Hayes, 2002).

Although significant progress has been made in the characterization of human fibrinogen deficiencies, this disorder is still exceedingly rare and poorly characterized in animals. Fibrinogen defects have historically been identified in goats and various breeds of dog (Dodds, 2000). More recent reports include a Border Leicester lamb with disproportionately low fibrinogen function when compared to concentration (Fecteau *et al.*, 1997). However, in this report, diagnostic limitations prevented definitive distinction between dysfibrinogenemia and afibrinogenemia. Clinical signs were consistent with those reported in humans, including umbilical bleeding and a hematoma. A case of congenital afibrinogenemia was confirmed, through extensive testing, in a Bichon Frise. This patient experienced excessive bleeding at sites of venipuncture, a hematoma, and uncontrolled hemorrhage following ovariohysterectomy (Wilkerson *et al.*, 2005).

Acquired deficiencies of fibrinogen are generally associated with consumptive coagulopathies, but they can also result from decreased production in liver failure.

#### b. Vitamin K-Dependent Factor Deficiencies (Prothrombin, FVII, FIX, FX, Protein C, Protein S)

The presence of vitamin K is essential to the function of several procoagulant and anticoagulant proteins, including prothrombin, FVII, FIX, FX, protein C, and protein S. These vitamin K-dependent factors rely on posttranslational carboxylation to allow binding of calcium and subsequent binding to negatively charged phospholipid membranes (Dowd *et al.*, 1995a). Before participation in the carboxylation of the vitamin K-dependent proteins, conversion of vitamin K<sub>1</sub> to its biologically active form, vitamin K hydroquinone (vitamin K<sub>1</sub>H<sub>2</sub>), through an NADH-dependent reductase is necessary (Dowd *et al.*, 1995b). The oxidation of vitamin K<sub>1</sub>H<sub>2</sub> to vitamin K<sub>1</sub> 2,3 epoxide occurs simultaneously with, and provides energy for, carboxylation of the glutamic acid residue through  $\gamma$ -glutamyl carboxylase (Dowd *et al.*, 1995b). The resultant vitamin K<sub>1</sub> 2,3 epoxide is then reduced to vitamin K<sub>1</sub> through vitamin K epoxide reductase, completing the cycle.

Inherited defects in the vitamin K cycle have been identified in Devon Rex cats and Rambouillet sheep. Initial reports in related Devon Rex cats observed multiple factor deficiencies that resembled anticoagulant toxicity and were responsive to vitamin K therapy (Maddison *et al.*, 1990). These cats presented with hematomas, intrathoracic hemorrhage, and hemorrhage in the bladder, sublumbar area, and perineum (Maddison *et al.*, 1990). The specific mechanism for the disorder was not identified in that report. A later case report on two littermates was able to identify a decreased affinity of the  $\gamma$ -glutamyl carboxylase for vitamin K (Soule *et al.*, 1992). Investigation into a flock of Rambouillet sheep experiencing increased lamb mortality because of ineffective hematopoiesis also identified a defect in  $\gamma$ -glutamyl carboxylase, specifically a single nucleotide polymorphism resulting in truncation of the enzyme (Johnson *et al.*, 2006a, 2006b). The affected lambs continually bled from the umbilicus and experienced subcutaneous and body cavity hemorrhage, resulting in death (Johnson *et al.*, 2006b). Breeding data from the flock indicated an autosomal recessive trait (Johnson *et al.*, 2006b). Unlike the defect in the Devon Rex cats, vitamin K therapy was not effective in these lambs (Johnson *et al.*, 2006b). To the authors' knowledge, there has been a single case report of naturally occurring protein C deficiency in animals. A 2-year-old Thoroughbred colt was diagnosed with a functional deficiency in protein C resulting in recurrent venous thrombosis (Edens *et al.*, 1993). Although a specific genetic defect was not identified, it was suggested that this deficiency was a result of either a primary inherited abnormality in protein C or an abnormal posttranslational  $\gamma$ -carboxylation (Edens *et al.*, 1993).

#### c. Factor VII Deficiency

FVII deficiency is well described in beagles but has also been documented in Alaskan malamutes and a mixed-breed

dog (Macpherson *et al.*, 1999; Mills *et al.*, 1997). Presenting hemorrhagic signs in nonbeagle dogs have included mucosal hemorrhage, subcutaneous bruising, and excessive surgical hemorrhage. Although clinical manifestations are occasionally reported in beagles, the coagulation deficiency is often an incidental finding in beagle colonies when routine coagulation screens are performed before experimental studies (Spurling *et al.*, 1972, 1974). Routine OSPT is prolonged and FVII coagulant activity decreased in affected dogs; however these are not reliable methods to detect carrier status (Callan *et al.*, 2006). In contrast, both homozygous and heterozygous beagles appear to have impaired clotting profiles in rotational thromboelastography when compared to normal canine plasma (Callan *et al.*, 2006). A missense mutation has been identified in beagles and is consistent within the breed (Callan *et al.*, 2006).

#### d. Factor VIII Deficiency (Hemophilia A)

Hemophilia A is one of the most common inherited coagulopathies in dogs, having been identified in many breeds, and it has also been reported in cats, cattle, horses, and an alpaca (Cotter *et al.*, 1978; Healy *et al.*, 1984; Henninger, 1988; Miesner and Anderson, 2006). Reported hemorrhagic signs have included umbilical hemorrhage, gingival bleeding at teething, hematomas, hemarthrosis, intraspinal hemorrhage, excessive surgical bleeding, and delayed rebleeding postsurgery (Fogh, 1988; Miesner and Anderson, 2006; Thompson and Kreeger, 1999). Mildly affected animals (FVIII activity of 5% or higher) do not tend to bleed spontaneously and are generally able to maintain adequate hemostasis, whereas moderately affected animals (FVIII activity of 2% to 5%) are more likely to experience severe sequelae to minor trauma, and severely affected animals (FVIII activity less than 2%) may bleed spontaneously (Mansell, 2000). The buccal mucosal bleeding time (see Sections III.B.1.a and b) is within reference intervals for FVIII-deficient dogs; however, cuticle bleeding time is prolonged (Brooks and Catalfamo, 1993; VanderVelden and Giles, 1988). Evaluation of biopsies from experimentally injured cuticles, using light and electron microscopy, have shown significant differences in the platelet component of the platelet plug as well as gross abnormalities in fibrinous transformation in FVIII-deficient dogs compared to normal dogs (Fogh and Fogh, 1988; VanderVelden and Giles, 1988). The platelet plugs were larger, often fragmented, and frequently did not appear to be associated with the vessel. Platelets within the plug appeared quiescent (remained granular and lack of OCS dilatation), and minimal fibrinous transformation of the plug occurred (VanderVelden and Giles, 1988). The changes noted in FVIII-deficient animals cannot be extrapolated to other secondary hemostatic deficiencies. Under the same conditions, the sequential events that occurred during clot formation in normal dogs were also observed in FVIII-deficient dogs; however, a time delay was apparent (VanderVelden and Giles, 1988). The rebleeding phenomenon described in hemophiliacs can be explained by

the role of TAFI (see Section II.C.4.c) in fibrinolysis inhibition. Although a small amount of thrombin formation is sufficient to stabilize the initial platelet plug, the secondary burst of thrombin that occurs in the propagation phase of coagulation is required for the activation of TAFI (Mosnier *et al.*, 2001). In hemophilia A, this secondary burst of thrombin formation is inadequate, resulting in deficient TAFI and fibrinolysis of the initial clot (Monroe and Hoffman, 2006; Mosnier *et al.*, 2001). Hemophilia A is an X-linked recessive trait, and therefore males are most commonly affected. Laboratory findings in homozygotes generally include prolonged aPTT, OSPT within reference intervals, and decreased FVIII activity. There is a poor correlation between the degree of prolongation of the aPTT and the activity of FVIII in plasma (Mansell, 2000). Heterozygotes are asymptomatic, and typical laboratory testing does not reliably discriminate between normal and carrier animals. Recently, a marker allele associated with the hemophilia A phenotype has been identified in a golden retriever family and was able to define carrier status (Brooks *et al.*, 2005).

#### e. Factor IX Deficiency (Hemophilia B)

Based on clinical signs, hemophilia B is indistinguishable from hemophilia A. Generally, it is considered that clinical signs are more severe in young and large-breed dogs (Nakata *et al.*, 2006). As with FVIII deficiency, this disorder is an X-linked recessive trait and has been reported in both dogs and cats. Laboratory testing reveals a prolonged aPTT, a normal OSPT, and a decrease in plasma FIX activity. In contrast to the variability seen in hemophilia A, FIX activity is generally low (<5%) in homozygotes (Mansell, 2000). In addition, mild decreases in FIX activity appear more consistent in heterozygotes of hemophilia B, and therefore factor activity screening is more reliable in their identification (Mansell, 2000). A variety of genetic mutations have been identified in dogs, and recently two distinct nucleotide changes were identified in two cats (Evans *et al.*, 1989; Goree *et al.*, 2005; Gu *et al.*, 1999).

#### f. Factor X Deficiency

Canine FX deficiency was first reported in a breeding colony of cocker spaniels in 1973 (Dodds, 1973). This colony was experiencing increased morbidity and mortality in newborn puppies, within 7 to 10 days of birth, from obvious hemorrhagic complications (Dodds, 1973). Dogs with factor activities between 18% and 68% experienced moderate to severe hemorrhagic signs, and the trait appeared to be lethal in many of these dogs (Dodds, 1973). FX deficiency has also been identified in a Jack Russell terrier and domestic shorthair cat (Cook *et al.*, 1993; Gookin *et al.*, 1997). In humans, this deficiency is inherited as an autosomal recessive trait; however, in the initial canine report an autosomal dominant inheritance, with incomplete penetrance, was suspected (Dodds, 1973). aPTT, OSPT, and

Russell viper venom time (RVVT) are all prolonged in affected animals, factor X activity is decreased, and thrombin time is within reference intervals.

Acquired FX deficiency resulting from *Hymenoxys odorata* (bitterweed) has been demonstrated experimentally in sheep (Steel *et al.*, 1976). This annual weed produces illness and death, as early as 24h postingestion, in sheep and occasionally cattle. Experimentally exposed sheep had prolongation of both the OSPT and aPTT within 3 days (Steel *et al.*, 1976). Plasma FX activity was decreased; however, all other specific factors remained within reference intervals (Steel *et al.*, 1976).

#### g. Factor XI Deficiency

Congenital FXI deficiency is uncommon in animals; however, it has been identified in dogs, cattle, and more recently in a cat (Dodds and Kull, 1971; Gentry *et al.*, 1975; Troxel *et al.*, 2002). Hemorrhagic signs associated with this deficiency tend to be mild; however, they can be substantial after challenge with surgery or severe trauma (Gentry, 2000a). FXI deficiency is transmitted as an autosomal recessive trait, and although the degree of reduced factor activity varies between species, in general homozygotes have less than 11% FXI activity and heterozygotes vary from 23% to 48% (Gentry, 2000a; Gentry and Ross, 1994; Knowler *et al.*, 1994). Prolongation of the aPTT, an OSPT within reference intervals, and a decreased plasma FXI activity are typical of homozygous animals. The aPTT has been proven inadequate to identify heterozygotes, and identification based on FXI activity has proven difficult because of an overlap in the range of activities between carrier and normal animals (Gentry and Ross, 1986; Kunieda *et al.*, 2005). Two distinct genetic mutations, both insertions, have been identified in the Holstein and Japanese black cattle, thus providing a more accurate diagnostic approach to the heterozygote in this species (Kunieda *et al.*, 2005; Marron *et al.*, 2004).

To the authors' knowledge, there has been a single report of acquired FXI deficiency. A 5-year-old neutered male cat without a previous history of hemorrhage was presented with epistaxis. FXI activity was markedly decreased (<5%), and mixing studies indicated the presence of an inhibitor (Feldman *et al.*, 1983). A systemic lupus erythematosus (SLE) inhibitor was suspected on subsequent detection of erythrocyte autoagglutination (Feldman *et al.*, 1983). Marked intraperitoneal hemorrhage resulted in the death of this patient.

#### h. Contact Factor Deficiencies

Of the contact factors, FXII (Hageman factor) deficiency is the most common. This deficiency is generally associated with cats, and an autosomal recessive mode of transmission has been identified in this species (Kier *et al.*, 1980). Homozygotes for FXII deficiency have a factor activity of

less than 2%, whereas heterozygotes average approximately 50% (Kier *et al.*, 1980). Laboratory evidence for this deficiency includes a prolonged aPTT and decreased plasma FXII activity. Cats are often identified incidentally during routine coagulation screening and do not exhibit hemorrhagic signs. An absence of FXII has been demonstrated as a normal phenomenon in several species, including some marine mammals, birds, and reptiles (Robinson *et al.*, 1969). This finding suggests that FXII is not integral to the coagulation system, and similarly may explain the absence of hemorrhage in deficient cats. FXII deficiency in combination with other factor deficiencies has been reported in both dogs and cats (Dillon and Boudreaux, 1988; Littlewood and Evans, 1990; Otto *et al.*, 1991; Randolph *et al.*, 1986).

Prekallikrein deficiency is rare; however, it has been reported in the dog and in miniature and Belgian horses (Chinn *et al.*, 1986; Geor *et al.*, 1990; Otto *et al.*, 1991; Turrentine *et al.*, 1986). Excessive hemorrhage after castration occurred in the proband Belgian horse, but in other animals hemorrhagic signs were not present without concurrent underlying disease or combination factor deficiencies. Laboratory tests reveal a prolonged aPTT, and decreased prekallikrein activity in this deficiency. In the equine families examined, an autosomal recessive mode of inheritance was suggested (Geor *et al.*, 1990; Turrentine *et al.*, 1986). In general, homozygotes exhibited markedly decreased prekallikrein activities, and heterozygotes exhibited mild to moderate decreases (Geor *et al.*, 1990; Turrentine *et al.*, 1986). Additional reports of contact factor pathway deficiencies have included a horse and German shorthaired pointer; however, definitive identification of the specific factor deficiency was not possible (Ainsworth *et al.*, 1985; Lisciandro *et al.*, 2000). Bleeding diathesis was not present in either case, despite challenge with ovariectomy in the German shorthaired pointer.

## B. Acquired Disorders

### 1. Thrombocytopenia

Clinically relevant thrombocytopenias are generally acquired; however, there are numerous etiologies, and detailed discussion of each extends beyond the scope of this chapter. Refer to Russell and Grindem (2000), Scott (2000), Zimmerman (2000) and for more details. In general, the pathogenesis of acquired thrombocytopenias can be grouped into three categories: (1) decreased production, (2) increased consumption or destruction, and (3) sequestration. Decreased production can result from infectious agents (e.g., *Ehrlichia* spp., bovine viral diarrhea virus, feline leukemia virus, equine infectious anemia virus), toxins, or drugs that suppress bone marrow (such as chemotherapeutic agents, estrogen, and NSAIDs); myelophthisis; or immune-mediated mechanisms that target megakaryocytes. Increased destruction of platelets is frequently associated with consumptive

coagulopathies (see Section IV.B.4) and immune-mediated mechanisms. Immune-mediated thrombocytopenias can be idiopathic (primary) or associated with systemic immune disease, drug therapy, neoplasia, or infectious agents (secondary). Finally, abnormal distribution or sequestration (e.g., enlarged spleen) can result in decreased platelet numbers; however, this tends not to be responsible for the more dramatic cases of thrombocytopenia.

### 2. Platelet Dysfunction

As with acquired thrombocytopenias, acquired platelet function disorders are numerous, and detailed discussion is beyond the scope of this chapter (see Boudreaux [2000], for more details). Briefly, uremia, increased FDPs (DIC or liver failure), neoplasia, and hyperproteinemia or paraproteinemia can impair adhesion of platelets. Several therapeutic agents can also impede platelet function through various mechanisms, including inhibition of the cyclooxygenase enzyme (nonsteroidal anti-inflammatories), inhibition of calcium influx across the platelet membrane (calcium channel blockers), and inhibition of agonist receptors ( $\beta$ -lactam antibiotics) (Boudreaux, 2000).

### 3. Liver Disease

The majority of coagulation proteins is synthesized in the liver, and therefore, as seen with other products of the liver, decreased synthesis occurs with severe decreases in functional hepatic mass. Refer to recent reviews on hemostatic abnormalities of liver disease in humans for a detailed discussion (Lisman *et al.*, 2002; Senzolo *et al.*, 2006). Briefly, the effect of liver disease is complex, as it is involved in both procoagulant and anticoagulant systems. Therefore, dysfunction can result in either hemorrhagic or thrombotic complications (Senzolo *et al.*, 2006). Dysfunction can include decreased production of coagulation proteins or production of abnormal proteins with altered function (Lisman *et al.*, 2002). Studies comparing acute (toxicity induced) liver failure and chronic cirrhosis have suggested different mechanisms for coagulation factor deficiencies. In acute failure, prothrombin, FV, FVII, and FX were significantly reduced and proposed to result from a concurrent increase in IL-6 and TNF- $\alpha$  that resulted in increased TF expression (Kerr *et al.*, 2003). Although TF activates the thrombin-generating pathways (see Section II.C.3), because of a simultaneous increase in thrombin-anti-thrombin (TAT) complexes the activity of thrombin is suppressed, effectively reducing the subsequent consumption of FVIII, FIX, and FXI (Kerr *et al.*, 2003). In fact, FVIII levels were markedly elevated in acute liver failure, which can assist in the differentiation of acute hepatic failure from DIC, where FVIII levels would be decreased (Kerr *et al.*, 2003; Senzolo *et al.*, 2006). In contrast, prothrombin, FV, FVII, FIX, and FX were found to decrease in similar



proportions as a result of chronic liver failure (i.e. cirrhosis), suggesting decreased production (Kerr *et al.*, 2003). FXI was more notably decreased than the other factors in chronic liver failure, and FVIII was increased in relation to the other factors but not in relation to normal patients (Kerr *et al.*, 2003). The concurrent decreased production of anticoagulant factors may allow the liver to maintain its balance between procoagulant and anticoagulant systems, under stable conditions (Senzolo *et al.*, 2006).

In some studies of coagulation testing in canine liver disease, up to 93% of subjects exhibit at least one coagulation test abnormality (Badylak *et al.*, 1983). Reports of the relative frequency of these abnormalities vary, with some suggesting a higher frequency of prolonged aPTT (Badylak *et al.*, 1983) and others reporting a higher frequency of prolonged OSPT (Badylak and Van Vleet, 1981; Toulza *et al.*, 2006). In general, these routine coagulation tests lack specificity for any given hepatic disease (Badylak and Van Vleet, 1981). Evaluation of specific factor changes in hepatic disease has demonstrated trends that may provide more specificity (Badylak *et al.*, 1983). For instance, similar to humans, decreased FIX, FX, and FXI activities have been demonstrated in canine cirrhosis (Badylak *et al.*, 1983). Coagulation factor trends have also been identified in canine congenital portosystemic shunts (CPS). Presurgically there is a decrease in prothrombin, FV, FVII, and FX, with a concurrent increase in FVIII, and in the immediate postsurgical period, fibrinogen and FVIII, FIX, and FXI also decrease (Kummeling *et al.*, 2006). In the canine studies, hemorrhagic complications were not observed; however, more intensive monitoring of potential bleeding sites in postoperative CPS patients has been recommended (Kummeling *et al.*, 2006). In feline studies of naturally occurring hepatic disease, the frequency of abnormal coagulation tests varied from 60% to 82% (Center *et al.*, 2000; Lisciandro *et al.*, 1998). Abnormal PIVKA and OSPT results were the most frequent coagulation test abnormalities reported in each study, respectively, and vitamin K deficiency appeared to be the most common underlying pathogenesis of the abnormal coagulation tests (Center *et al.*, 2000; Lisciandro *et al.*, 1998). In the Center *et al.* study (2000), only 14% of the cats with liver disease (representing 23% of those with coagulation test abnormalities) demonstrated bleeding tendencies. All of the hemorrhagic signs were associated with clinical procedures (such as catheterization or venipuncture) rather than spontaneous episodes (Center *et al.*, 2000). In the Lisciandro *et al.* study (1998), only 1 of 22 cats was reported to exhibit clinically relevant (and fatal) hemorrhage after a liver biopsy. This particular patient had coagulation abnormalities consistent with vitamin K deficiency (Lisciandro *et al.*, 1998).

Various guidelines exist for prediction of bleeding based on diagnostic test results in human medicine and are discussed in Senzolo *et al.* (2006). At this time, formal guidelines have not been developed for domestic animals,

**TABLE 10-8** Diseases and Disorders That Predispose to the Development of Disseminated Intravascular Coagulation

Condition	Etiology
Infectious disease/sepsis	Bacteria, protozoa, fungi, viruses
Neoplasia	Solid tumors, lympho- and myeloproliferative disease
Trauma	Tissue damage, burns, fat embolism
Organ damage/failure	Severe pancreatitis, liver failure
Toxic/Immunologic	Envenomation, transfusion reactions, immune-mediated disease

and routine coagulation tests do not appear to consistently predict the risk of hemorrhage.

#### 4. Disseminated Intravascular Coagulation

Disseminated intravascular coagulation (DIC) is a potentially life-threatening hemostatic complication of many serious clinical diseases and disorders (Levi, 2004). (See Table 10-8 for common precipitating causes in animals.) It is characterized by systemic activation of the clotting mechanism that leads to widespread deposition of fibrin in the vascular tree, to the point of potentially compromising blood flow to tissues and causing ischemic damage and even organ failure. Concurrently, platelet and clotting factor supply becomes depleted as a result of widespread thrombus formation, and subsequent hemorrhage may occur. Although it may seem paradoxical and complicates management, a patient with DIC can be presented with clinical signs of both thrombosis and bleeding simultaneously.

The pathogenesis of DIC varies with the underlying primary disease process, and much of the understanding of how the process develops comes from human and animal sepsis models. It appears that either a systemic inflammatory response or release of procoagulant materials into the vascular space can activate coagulation on a widespread basis (Levi, 2004). The simultaneous development of increased thrombin generation, suppressed anticoagulant mechanisms, impaired fibrinolysis, and activation of the inflammatory response provide all the factors necessary for the syndrome to occur (Franchini *et al.*, 2006).

Cell membrane components of organisms (such as endotoxin and lipopolysaccharide) or bacterial exotoxins cause a generalized inflammatory response resulting in elaboration of proinflammatory cytokines that can activate endothelial cells directly (Slofstra, 2003). Excessive generation of

thrombin during endotoxemia appears to occur from activation of the TF pathway via FVIIa. Inhibition of this pathway resulted in complete absence of thrombin generation in experimental primate studies (Biemond *et al.*, 1995; Pixley *et al.*, 1993), and administration of TFPI completely abrogates this response (DeJonge *et al.*, 2000). The source of TF may be from activated monocytes, other leukocytes, or altered endothelium (Levi, 2004). The role of neutrophils in the pathogenesis of DIC has been examined, and it appears they may interact with platelets and stimulate TF production and fibrin formation (Goel and Diamond, 2001). Neutrophil elastase also has the potential to degrade fibrinolytic proteases (Moir *et al.*, 2002), thereby minimizing clot dissolution.

Additionally, the natural anticoagulant pathways may become inhibited, which would further amplify thrombin generation. AT activity can be markedly reduced because of consumption from enhanced thrombin generation, degradation by elastase released by neutrophils, and possibly decreased synthesis if liver synthetic function is impaired (Levi, 2005). The protein C system can similarly become exhausted by enhanced consumption, impaired hepatic synthesis, and down-regulation of TM expression on endothelial cells as part of the change from an antithrombotic to a prothrombotic milieu (Faust *et al.*, 2001) (see Section II.A).

Fibrinolysis is impaired due to rapidly increased levels of PAI-1, which suppresses plasminogen activation, and therefore subsequently any clots that develop are not as efficiently degraded. Many of the hemostatic abnormalities that occur during DIC can be attributed to up-regulation of proinflammatory cytokines such as tumor necrosis factor alpha (TNF-alpha) and interleukin-1 (IL-1), which then promote a procoagulatory endothelial phenotype. It is also known that parts of the coagulation cascade, once activated, can also stimulate further activation of inflammation as well. For example, thrombin, via PARs on cell membranes, activates additional inflammatory mediators. So it is indeed a bidirectional process once either inflammation or coagulation is stimulated. Additionally, suppression of the protein C pathway may result in a proinflammatory state because it has anti-inflammatory properties (Yuksel *et al.*, 2002). It must be emphasized that different disease states can result in DIC by a different mechanism. For example, some neoplastic cells may directly express TF or other procoagulant molecules (Rickles and Falanga, 2001), whereas DIC secondary to trauma or burns is related to systemic release of fat and phospholipids (Gando, 2001).

The diagnosis of DIC is based on clinical signs of the primary disease, as well as those associated with both hemorrhage and thrombosis, in conjunction with abnormal laboratory tests. Overt hemorrhage is often more prominent in animals with DIC, which may reflect the stage the syndrome is detected, or it may be that thrombosis is not detected readily antemortem. Because there is no single test that confirms the present of DIC, most often the diagnosis is made on a series of tests in an animal with an appropriate clinical

context in which DIC can develop. Molecular markers of activation of coagulation or fibrin formation such as prothrombin fragment F1 + 2 and soluble fibrin concentration may be the most sensitive indicators of the presence of DIC, but they are poorly specific and not widely available (Levi, 2004).

The common laboratory test abnormalities include thrombocytopenia; presence of schistocytes on a blood smear; prolonged OSPT and aPTT; increased levels of indicators of fibrinolysis (FDPs, d-dimers); and decreased fibrinogen, AT, protein C, and coagulation factors. Some of these tests are more commonly altered than others, and serial measurements may sometimes be more helpful than a single sample. Fibrinogen concentration can sometimes actually be within the reference interval or even elevated as it is also an acute phase reactant in some species. Furthermore, although elevated products of fibrinolysis do occur during DIC, they can be increased in other disease states as well, which limits their specificity. The International Society on Thrombosis and Haemostasis (ISTH) has developed a scoring system to facilitate establishing the presence of DIC in human patients using a combination of results of different tests in a patient with a disease that can predispose to the condition and has a reported sensitivity and specificity of >90% (Bakhtiari *et al.*, 2004).

DIC has been documented in many species of domestic animals (Bateman *et al.*, 1999b; Dolente *et al.*, 2002; Irmak and Turgut, 2005) but is most commonly reported in dogs. The most common precipitating diseases are listed in Table 10-8.

### 5. Vitamin K Antagonism or Deficiency

Anticoagulant rodenticides are the most common cause of acquired vitamin K-dependent factor deficiencies. Their action is through inhibition of the vitamin K epoxide reductase enzyme, preventing recycling of vitamin K and resulting in depletion of vitamin K<sub>1</sub>H<sub>2</sub> (Murphy, 2002). The development of resistance, by rodents, to the first generation anticoagulant rodenticides (e.g., warfarin) necessitated the development of second-generation compounds (e.g., brodifacoum, bromadiolone) with more potent and persistent action (Boermans *et al.*, 1991; Park and Leck, 1982). In experimental exposure to anticoagulant rodenticides, initial clinical signs generally include anorexia and somnolence, whereas clinical reports generally identify dyspnea, lethargy, and coughing/hemoptysis as the most frequent initial presenting complaints (Boermans *et al.*, 1991; Forbes *et al.*, 1973; Sheafor and Couto, 1999). Additional clinical signs can often include epistaxis, melena, lameness, spontaneous subcutaneous hematoma formation, hematuria, collapse, abdominal distension, and sudden death (DuVall *et al.*, 1989; Sheafor and Couto, 1999). Case reports of rodenticide toxicity in neonates provide circumstantial evidence that rodenticides can cross the placenta and therefore should be

a consideration in neonatal hemorrhagic disorders (Munday and Thompson, 2003).

Although anticoagulant toxicity is most common in canine patients, accidental exposure can also occur in cats, horses, and ruminants. Ruminants have historically been thought more resistant to these rodenticides because of rumenal degradation of the compounds (Berny *et al.*, 2006). It has recently been shown that there is no significant breakdown of the rodenticides in the rumen, and oral bioavailability of these compounds is excellent (79% for warfarin, 88% for bromadiolone) (Berny *et al.*, 2006). Further, prolongation of the OSPT was observed for both compounds; however, no clinical signs of toxicosis were evident (Berny *et al.*, 2006). A prolonged OSPT is generally the initial laboratory change in rodenticide toxicity because of the relatively short half-life of FVII (4 to 6 h). With subsequent decreases in FIX, FX, and prothrombin, a prolonged aPTT develops. Interestingly, experimental brodifacoum toxicity in the horse resulted in prolongation of the aPTT before the OSPT was affected (Boermans *et al.*, 1991). As a result of this observation, it was proposed that clearance of vitamin K-dependent factors in the horse may differ from that in the dog and human (Boermans *et al.*, 1991). The onset of laboratory changes and clinical signs varies with the amount and type of anticoagulant rodenticide consumed. In addition to changes in routine coagulation tests (OSPT and aPTT), the accumulation of the nonfunctional forms of the vitamin K-dependent coagulation proteins (PIVKA) can be detected by a commercial Thrombotest assay (see Section III.C).

In addition to anticoagulant rodenticides, ingestion of moldy sweet clover (dicumarol) can result in vitamin K-dependent coagulation factor deficiencies, acting through the same mechanism. However, clinical signs generally only develop after weeks of exposure (Berny *et al.*, 2006). Ingestion of sulfaquinoxaline, a poultry coccidiostat, has also been reported to result in vitamin K-dependent factor deficiencies in dogs through inhibition of vitamin K epoxide reductase (Neer and Savant, 1992; Preusch *et al.*, 1989).

## 6. Thrombosis

Pathological thrombus formation can occur in any vascular structure and, depending on the extent of obstruction and the tissue affected, can elicit a wide range and severity of clinical signs. Acute dyspnea and hemoptysis is observed with pulmonary thromboemboli, hematuria, and abdominal pain with renal thrombosis and pain and paresis or paralysis in with distal aortic thromboembolism in cats with cardiac disease.

Although not frequently easily detected clinically, predisposition to thrombosis can occur with many diseases in various domestic species. Most often, thrombosis is associated with an underlying disease process that causes a disturbance of hemostatic processes, particularly those that promote a hypercoagulable state. However, additional

abnormalities including inappropriate platelet and endothelium activation may exist concurrently to exacerbate the situation (Darien, 2000a).

An example of a disease associated with a high risk for thromboembolic complications in dogs is immune-mediated hemolytic anemia (IMHA). Up to 50% of patients with this disease develop thrombi, often in the pulmonary system (Balch and Mackin, 2007). These dogs are frequently in a hypercoagulable state as a result of inflammatory cytokine activation of endothelial cells from red blood cell necrosis and hypoxia, vascular stasis from catheterization and immobility, and enhanced platelet activation (Weiss and Brazzell, 2006).

Other diseases associated with pathological thrombus development include endotoxemia, heartworm disease, hemangiosarcoma, hyperadrenocorticism, and various cardiac diseases (Darien, 2000a).

## V. BEYOND HEMOSTASIS: INTERACTIONS WITH INFLAMMATION

It has become quite well documented that there is a continuum between the inflammatory response and the hemostatic system and that activation of one system up-regulates the other. Numerous recent reviews summarize this active research area (Esmon, 2005; Franchini *et al.*, 2007; Gear and Camerini, 2003; Levi and van der Poll, 2005; Vincent, 2003; Zarbock *et al.*, 2007).

Inflammatory mediators can increase platelet production, activate platelets, diminish endogenous anticoagulant activity, initiate and contribute to propagation of the coagulation cascade, increase fibrinogen concentration, and inhibit fibrinolysis (Esmon, 2005). Inversely, activation of the hemostatic mechanism can cause the release of inflammatory mediators from activated platelets and endothelial cells (Table 10-9). Traditional figurative depictions of either system rarely include elements of the other. More recently, however, appreciation for interactions between the two systems has become apparent. There are even some structural similarities between proteins in the two systems, which supports the theory of a parallel evolution (Esmon, 2005). Examples include protein S with C4 binding protein, endothelial cell protein C receptor with MHC class 1, and TM's similarity with lectins.

The release or enhanced expression of TF during inflammation is central to the widespread activation of coagulation observed during a systemic inflammatory response. It has been proposed that phospholipid-rich microparticles derived from leukocytes (especially monocytes) or endothelial cells express TF, and this facilitates further development of the thrombus via P-selectin-glycoprotein ligand-1 and P-selectin binding, which brings platelets and leukocytes into close approximation (Day *et al.*, 2005). The role of TF in inflammation is further corroborated by

**TABLE 10-9** Effects of Inflammation on Coagulation and Vice Versa

Inflammation—Coagulation	Coagulation—Inflammation
Increased fibrinogen—substrate for fibrin formation	Platelet granule release—CD40 ligand, which increases IL-6 and IL-8
Tissue factor expression on monocytes—procoagulant surface	Tissue factor—activates PARs, which facilitates leukocyte adhesion and activation
Increased C reactive protein—promotes PAI-1 and TF formation	Fibrin formation—increased TNF- $\alpha$ , IL- $\beta$ , binding of neutrophils
Complement activation—increased procoagulant surface	Antithrombin—decreased expression of CD11b/CD18 on leukocytes
Interleukin-6—increased platelet production with increased reactivity	Antithrombin—inhibits chemokine-induced neutrophil migration
Histamine, TNF- $\alpha$ , IL-8, IL-6—release of high-molecular-weight vWF multimers	TAFI—inhibits bradykinin and C5a
Various inflammatory mediators—consume/inactivate antithrombin and heparin-like molecules	Thrombomodulin—inhibits leukocyte migration
Endotoxin, IL-1 $\beta$ , TNF- $\alpha$ , elastase—down-regulation of thrombomodulin and EPCR	Activated protein C—inhibits NF- $\kappa$ B in monocytes, decreased TF expression

Abbreviations: EPCR, endothelial cell protein C receptor; PAR, protease activated receptor; TAFI, thrombin activatable fibrinolytic inhibitor; TF, tissue factor.

the fact that inhibition of TF–FVIIa reduces inflammation in animal models of endotoxemia and in patients with sepsis (Monroe and Key, 2007)

As can be observed by looking at the mechanisms listed in Table 10-9, if the natural anticoagulant mechanisms do not occur, promotion of inflammation takes place. Therefore, in addition to traditional anti-inflammatory therapy, treatment with anticoagulants may also reduce inflammation. Of antithrombin, TFPI, and APC, only the latter actually reduced 28-day mortality in septic patients (Bernard *et al.*, 2001).

## REFERENCES

- Abilgaard, U. (1992). Tissue factor pathway inhibitor and heparin. *Adv. Exp. Med. Biol.* **313**, 199–204.
- Acharya, S. S., Coughlin, A., and Dimichele, D. M. (2004). North American Rare Bleeding Disorder Study Group. Rare bleeding disorder registry: deficiencies of II, V, VII, X, XIII, fibrinogen and dysfibrinogenemias. *J. Thromb. Haemost.* **2**, 248–256.
- Ahmed, S. S., Rawala-Sheikh, R., and Walsh, P. N. (1992). Components and assembly of the factor X activating complex. *Semin. Thromb. Hemost.* **18**, 311–323.
- Ainsworth, D. M., Dodds, W. J., and Brown, C. M. (1985). Deficiency of the contact phase of intrinsic coagulation in a horse. *J. Am. Vet. Med. Assoc.* **187**, 71–72.
- Alexander, W. S., Roberts, A. W., Nicola, N. A., Li, R., and Metcalf, D. (1996). Deficiencies in progenitor cells of multiple hematopoietic lineages and defective megakaryocytopoiesis in mice lacking the thrombopoietic receptor c-Mpl. *Blood* **87**, 2162–2170.
- Andrews, R. K., and Berndt, M. C. (2004). Platelet physiology and thrombosis. *Thromb. Res.* **114**, 4447–4453.
- Arkin, C. F., Bowie, E. J. W., Carroll, J. J., Day, H. J., Joist, J. H., Lenahan, J. G., Marlar, R. A., and Triplett, D. A. (1998). Collection, transport and processing of blood samples for coagulation testing and general performance of coagulation assays: approved guideline. *N. C. C. L. S.* **18**, 1–24.
- Arnaud, F., Handrigan, M., Hammett, M., Philbin, N., Rice, J., Dong, F., Pearce, L. B., McCarron, R., and Freilich, D. (2006). Coagulation patterns following haemoglobin-based oxygen carrier resuscitation in severe uncontrolled haemorrhagic shock in swine. *Transfus. Med.* **16**, 290–302.
- Asselta, R., Duga, S., and Tenchini, M. L. (2006). The molecular basis of quantitative fibrinogen disorders. *J. Thromb. Haemost.* **4**, 2115–2129.
- Atkas, B., Honig-Liedl, P., Walter, U., and Geiger, J. (2002). Inhibition of platelet P2Y<sub>12</sub> and  $\alpha$ 2A receptor signaling by cGMP-dependent protein kinase. *Biochem. Pharmacol.* **64**, 433–439.
- Autin, L., Steen, M., Dahlback, B., and Villoutreix, B. O. (2006). Proposed structural models of the prothrombinase (FXa–FVa) complex. *Proteins* **63**, 440–450.
- Badylak, S. F., Dodds, W. J., and Van Vleet, J. F. (1983). Plasma coagulation factor abnormalities in dogs with naturally occurring hepatic disease. *Am. J. Vet. Res.* **44**, 2336–2340.
- Badylak, S. F., and Van Vleet, J. F. (1981). Alterations of prothrombin time and activated partial thromboplastin time in dogs with hepatic disease. *Am. J. Vet. Res.* **42**, 2053–2056.
- Bailey, S. R., Andrews, M. J., Elliott, J., and Cunningham, F. (2000). Actions and interactions of ADP, 5-HT, histamine and PAF on equine platelets. *Res. Vet. Sci.* **68**, 175–180.
- Balch, A., and Mackin, A. (2007). Canine immune-mediated hemolytic anemia: treatment and prognosis. *Compendium* **29**, 230–239.
- Bajzar, L. (2000). Thrombin activatable fibrinolysis inhibitor and an anti-fibrinolytic pathway. *Thromb. Vasc. Biol.* **20**, 2511–2518.
- Bajzar, L., Manuel, R., and Nesheim, M. (1995). Purification and characterization of TAFI, a thrombin-activatable fibrinolysis inhibitor. *J. Biol. Chem.* **270**, 14477–14484.

- Bakhtiari, K., Meijers, J. C., de Jonge, E., and Levi, M. (2004). Prospective validation of the International Society of Thrombosis and Haemostasis scoring system for disseminated intravascular coagulation. *Crit. Care Med.* **32**, 2416–2421.
- Barkalow, K. L., Falet, H., Italiano, J. E., van Vugt, A., Carpenter, C. L., Schreiber, A. D., and Hartwig, J. H. (2003). Role of phosphoinositide 3-kinase in Fc $\gamma$ RIIA-induced platelet shape change. *Am. J. Physiol. Cell Physiol.* **285**, C797–C805.
- Barry, E. L. R., and Mosher, F. D. (1988). Factor XIII cross-linking of fibronectin at cellular matrix assembly sites. *J. Biol. Chem.* **263**, 10464–10469.
- Bateman, S. W., Mathews, K. A., Abrams-Ogg, A. C., Lumsden, J. H., and Johnstone, I. B. (1999a). Evaluation of the effect of storage at  $-70$  degrees C for six months on hemostatic function testing in dogs. *Can. J. Vet. Res.* **63**, 216–220.
- Bateman, S. W., Mathews, K. A., Abrams-Ogg, A. C., Lumsden, J. H., Johnstone, I. B., Hillers, T. K., and Foster, R. A. (1999b). Diagnosis of disseminated intravascular coagulation in dogs admitted to an intensive care unit. *J. Am. Vet. Med. Assoc.* **215**, 798–804.
- Bay, J. D., Scott, M. A., and Hans, J. E. (2000). Reference values for activated coagulation time in cats. *Am. J. Vet. Res.* **61**, 750–753.
- Becker, B. F., Heindl, B., Kupatt, C., and Zahler, S. (2000). Endothelial function and hemostasis. *Z. Kardiol.* **89**, 160–167.
- Bell, T. G., Meyers, K. M., Prieur, D. J., Fauci, A. S., Wolff, S. M., and Padgett, G. A. (1976). Decreased nucleotide and serotonin storage associated with defective function in Chediak-Higashi syndrome cattle and human platelets. *Blood* **48**, 175–184.
- Benke, O. (1993). The formation of fusiform proplatelets and their transformation to discoid platelets. *Platelets* **4**, 262–267.
- Bernard, G. R., Vincent, J. L., Laterre, P. F., LaRosa, S. P., Dhainaut, J. F., Lopez-Rodriguez, A., Steingrub, J. S., Garber, G. E., Helterbrand, J. T., Ely, E. W., and Fisher, C. J. (2001). Efficacy and safety of recombinant human activated protein C for severe sepsis. *New Engl. J. Med.* **344**, 699–709.
- Berny, P. J., de Oliveira, L. A., Videmann, B., and Rossi, S. (2006). Assessment of rumenal degradation, oral bioavailability, and toxic effects of anticoagulant rodenticides in sheep. *Am. J. Vet. Res.* **67**, 363–371.
- Biemond, B. J., Levi, M., ten Cate, H., Soule, H. R., Morris, L. D., Foste, D. L., Bogowitz, C. A., van der Poll, T., Buller, H. R., and ten Cate, J. W. (1995). Complete inhibition of endotoxin-induced coagulation activation in chimpanzees with a monoclonal Fab fragment against factor VII/VIIa. *Thromb. Haemost.* **73**, 223–230.
- Blostein, M. D., Furie, B. C., Rajotte, I., and Furie, B. (2003). The Gla domain of factor IXa binds to factor VIIIa in the tenase complex. *J. Biol. Chem.* **278**, 31297–31302.
- Boermans, H. J., Johnstone, I., Black, W. D., and Murphy, M. (1991). Clinical signs, laboratory changes and toxicokinetics of brodifacoum in the horse. *Can. J. Vet. Res.* **55**, 21–27.
- Boisvert, A. M., Swenson, C. L., and Haines, C. J. (2001). Serum and plasma latex agglutination tests for detection of fibrin(ogen) degradation products in clinically ill dogs. *Vet. Clin. Pathol.* **30**, 133–136.
- Bondy, G. S., and Gentry, P. A. (1988). Comparison of the inhibitory effect of T-2 toxin on bovine platelet function with that of other known platelet inhibitors. *Toxicol. In Vitro*, **2**, 241–245.
- Boudreaux, M. K. (1996). Platelets and coagulation. *Vet. Clin. North Am. Small Anim. Pract.* **26**, 1065–1087.
- Boudreaux, M. K. (2000). Acquired platelet dysfunction. In “Schalm’s Veterinary Hematology” (B. F. Feldman, J. G. Zinkl, and N. C. Jain, Eds.), 5th ed., pp. 496–500. Lippincott Williams and Wilkins, Philadelphia.
- Boudreaux, M. K., and Catalfamo, J. L. (2001). Molecular and genetic basis for thrombasthenic thrombopathia in otterhounds. *Am. J. Vet. Res.* **62**, 1797–1804.
- Boudreaux, M. K., Dodds, W. J., Slauson, D. O., and Catalfamo, J. L. (1986). Impaired cAMP metabolism associated with abnormal function of thrombopathic canine platelets. *Biochem. Biophys. Res. Commun.* **140**, 595–601.
- Brass, L. F. (2003). Thrombin and platelet activation. *Chest* **124**, 18S–25S.
- Brooks, M. (1992). Management of canine von Willebrand’s disease. *Probl. Vet. Med.* **4**, 636–646.
- Brooks, M. (1999). A review of canine inherited bleeding disorders: biochemical and molecular strategies for disease characterization and carrier detection. *J. Hered.* **90**, 112–118.
- Brooks, M. (2000). von Willebrand disease. In “Schalm’s Veterinary Hematology” (B. F. Feldman, J. G. Zinkl, and N. C. Jain, Eds.), 5th ed., pp. 509–515. Lippincott Williams and Wilkins, Philadelphia.
- Brooks, M., and Catalfamo, J. L. (1993). Buccal mucosa bleeding time is prolonged in canine models of primary hemostatic disorders. *Thromb. Haemost.* **70**, 777–780.
- Brooks, M. B., Barnas, J. L., Fremont, J., and Ray, J. (2005). Cosegregation of a factor VIII microsatellite marker with mild hemophilia A in golden retriever dogs. *J. Vet. Intern. Med.* **19**, 205–210.
- Brown, J. E., and Bosak, J. O. (1986). An ELISA test for the binding of von Willebrand antigen to collagen. *Thromb. Res.* **43**, 303–311.
- Broze, G. J. (1992). The role of tissue factor pathway inhibitor in a revised coagulation cascade. *Semin. Hematol.* **29**, 159–169.
- Brummel, K. E., Paradis, S. G., Butenas, S., and Mann, K. G. (2002). Thrombin functions during tissue factor-induced blood coagulation. *Blood* **100**, 148–152.
- Buensuceso, C. S., Obergfell, A., Soriani, A., Eto, K., Kiosses, W. B., Arias-Salgado, E. G., Kawakami, T., and Shattil, S. J. (2005). Regulation of outside-in signaling in platelets by integrin-associated protein kinase C $\beta$ . *J. Biol. Chem.* **280**, 644–653.
- Callan, M. B., Aljamali, M. N., Margaritis, P., Griot-Wenk, M. E., Pollak, E. S., Werner, P., Giger, U., and High, K. A. (2006). A novel missense mutation responsible for factor VII deficiency in research beagles. *J. Thromb. Haemost.* **4**, 2616–2622.
- Callan, M. B., Bennett, J. S., Phillips, D. K., Haskins, M. E., Hayden, J. E., Anderson, J. G., and Giger, U. (1995). Inherited platelet delta-storage pool disease in dogs causing severe bleeding: an animal model for a specific ADP deficiency. *Thromb. Haemost.* **74**, 949–953.
- Callan, M. B., Giger, U., and Catalfamo, J. L. (2005). Effect of desmopressin on von Willebrand factor multimers in Doberman pinschers with type 1 von Willebrand disease. *Am. J. Vet. Res.* **66**, 861–867.
- Calvete, J. J. (2004). Structures of integrin domains and concerted conformational changes in the bidirectional signaling mechanism of  $\alpha_{IIb}\beta_3$ . *Exp. Biol. Med.* **229**, 732–744.
- Camerer, E., Huang, W., and Coughlin, S. R. (2000). Tissue factor- and factor X-dependent activation of protease-activated receptor 2 by factor VIIa. *Proc. Natl. Acad. Sci. USA*, **97**, 5255–5260.
- Catalfamo, J. L., and Dodds, W. J. (2000). Thrombopathias. In “Schalm’s Veterinary Hematology” (B. F. Feldman, J. G. Zinkl, and N. C. Jain, Eds.), 5th ed., pp. 1042–1050. Lippincott Williams and Wilkins, Philadelphia.
- Catalfamo, J. L., Raymond, S. L., White, J. G., and Dodds, W. J. (1986). Defective platelet-fibrinogen interaction in hereditary canine thrombopathia. *Blood* **67**, 1568–1577.
- Center, S. A., Warner, K., Corbett, J., Randolph, J. F., and Erb, H. (2000). Proteins invoked by vitamin K absence and clotting times in clinically ill cats. *J. Vet. Intern. Med.* **14**, 292–297.

- Chao, W., and Olson, M. S. (1993). Platelet-activating factor: receptors and signal transduction. *Biochem.* **292**, 617–629.
- Chen, H., and Kahn, M. L. (2003). Reciprocal signaling by integrin and nonintegrin receptors during collagen activation of platelets. *Mol. Cell. Biol.* **23**, 4764–4777.
- Cheryk, L. A., Gentry, P. A., and Tablin, F. (1997). Morphological characteristics of bovine platelets activated with platelet activating factor or thrombin. *Comp. Haematol. Int.* **1**, 88–94.
- Chinn, D. R., Dodds, W. J., and Seicer, B. A. (1986). Prekallikrein deficiency in a dog. *J. Am. Vet. Med. Assoc.* **188**, 69–71.
- Choi, E. S., Hokom, M. M., Chen, J. L., Skrine, J., Faust, J., Nichol, J., and Hunt, P. (1996). The role of megakaryocyte growth and development factor in terminal stages of thrombopoiesis. *Br. J. Haematol.* **95**, 227–233.
- Christopherson, P., Insalaco, T., van Santen, V. L., Livesey, L., Bourne, C., and Boudreaux, M. K. (2006). Characterization of the cDNA encoding  $\alpha_{IIb}$  and  $\beta_3$  in normal horses and two horses with Glanzmann thrombasthenia. *Vet. Pathol.* **43**, 78–82.
- Collen, D. (1999). The plasminogen (fibrinolytic) system. *Thromb. Haemost.* **82**, 259–270.
- Collet, J. P., Montalescot, G., Lesty, C., and Weisel, J. W. (2002). A structural and dynamic investigation of the facilitating effect of glycoprotein IIb/IIIa inhibitors in dissolving platelet-rich clots. *Circ. Res.* **90**, 428–434.
- Cook, A. K., Werner, L. L., O'Neil, S., Brooks, M., and Feldman, B. F. (1993). Factor X deficiency in a Jack Russell terrier. *Vet. Clin. Pathol.* **22**, 68–71.
- Coomber, B. L., Mitchell, G. B., Starr, A. E., Minhas, K., Tamblyn, A., Shewan, P. E., and Gentry, P. A. (2006). Clopidogrel induced suppression of bovine platelet activation *in vitro* and a preliminary study of its effect on development of *Mannheimia haemolytica* induced pneumonia. *Vet. J.* **171**, 126–134.
- Cotter, S. M., Brenner, R. M., and Dodds, W. J. (1978). Hemophilia A in three unrelated cats. *J. Am. Vet. Med. Assoc.* **172**, 166–168.
- Coughlin, P. B. (2005a). Antiplasmin. The forgotten serpin. *FEBS J.* **272**, 4852–4857.
- Coughlin, S. R. (2005b). Protease-activated receptors in hemostasis, thrombosis and vascular biology. *J. Thromb. Haemost.* **3**, 1800–1814.
- Couto, C. G., Lara, A., Iazbik, M. C., and Brooks, M. B. (2006). Evaluation of platelet aggregation using a point-of-care instrument in retired racing greyhounds. *J. Vet. Intern. Med.* **20**, 365–370.
- Cowan, S. M., Bartges, J. W., Gompf, R. E., Hayes, J. R., Moyers, T. D., Snider, C. C., Gerard, D. A., Craft, R. M., Muenchen, R. A., and Carroll, R. C. (2004). Giant platelet disorder in the Cavalier King Charles spaniel. *Exp. Hematol.* **32**, 344–350.
- Crawley, J. T., Zanardelli, S., Chion, C. K., and Lane, D. A. (2007). The central role of thrombin in hemostasis. *J. Thromb. Haemost.* **5(suppl 1)**, 95–101.
- Cullen, P., Rauterberg, J., and Lorkowski, S. (2005). The pathogenesis of atherosclerosis. *Handb. Exp. Pharmacol.* **170**, 3–70.
- Dahlback, B. (1995). The protein C anticoagulant system: inherited defects as basis for venous thrombosis. *Thromb. Res.* **77**, 1–43.
- Dahlback, B. (2000). Blood coagulation. *Lancet* **355**, 1627–1632.
- Dallap, B. L., Dolente, B., and Boston, R. (2003). Coagulation profiles in 27 horses with large colon volvulus. *J. Vet. Emerg. Crit. Care*, **13**, 215–225.
- Dangelmaier, C., Jin, J., Smith, J. B., and Kunapuli, S. P. (2001). Potentiation of thromboxane A<sub>2</sub>-induced platelet secretion by Gi signaling through the phosphoinositide-3 kinase pathway. *Thromb. Haemost.* **85**, 341–348.
- Darien, B. J. (2000a). Acquired coagulopathy V: Thrombosis. In “Schalm’s Veterinary Hematology” (B. F. Feldman, J. G. Zinkl, and N. C. Jain, Eds.), 5th ed., pp. 574–580. Lippincott Williams and Wilkins, Philadelphia.
- Darien, B. J. (2000b). Fibrinolytic system. In “Schalm’s Veterinary Hematology” (B. F. Feldman, J. G. Zinkl, and N. C. Jain, Eds.), 5th ed., pp. 544–548. Lippincott Williams and Wilkins, Philadelphia.
- Day, S. M., Reeve, J. L., Pedersen, B., Farris, D. M., Meyers, D. D., Im, M., Wakefield, T. W., Mackman, N., and Fay, W. P. (2005). Macrovascular thrombosis is driven by tissue factor derived primarily from the blood vessel wall. *Blood* **105**, 192–198.
- DeCandia, E., Hall, S. W., and Rutella, S. (2001). Binding of thrombin to glycoprotein Ib accelerates the hydrolysis of Par-1 on intact platelets. *J. Biol. Chem.* **276**, 4692–4698.
- deGroot, P. G., and Sixma, J. J. (1996). Regulation of platelet-rich thrombus formation by the endothelium. In “Vascular Control of Hemostasis” (V. M. vanHinsbergh, Ed.), pp. 127–146. Harwood Academic Publishers, Amsterdam.
- de Jonge, E., Dekkers, P. E., Creasey, A. A., Hack, C. E., Paulson, S. K., Karim, A., Kesecioglu, J., Levi, M., van Deventer, S. J., and van Der Poll, T. (2000). Tissue factor pathway inhibitor dose-dependently inhibits coagulation activation without influencing the fibrinolytic and cytokine response during human endotoxemia. *Blood* **95**, 1124–1129.
- Denis, C. V., and Wagner, D. D. (1999). Insights from von Willebrand disease animal models. *Cell. Mol. Life Sci.* **56**, 977–990.
- Deniz, A., Mischke, R., and Nolte, I. (1995). Applicability of activated partial thromboplastin time (APTT) as a screening test of milk to medium deficiencies of coagulation factors in cats. *Dtsch. Tierarztl. Wochenschr.* **102**, 206–208.
- Di Cera, E. (2003). Thrombin interactions. *Chest* **124**, 11S–17S.
- Dillon, A. R., and Boudreaux, M. K. (1988). Combined factor IX and XII deficiencies in a family of cats. *J. Am. Vet. Med. Assoc.* **193**, 833–834.
- Dobrovolsky, A. B., and Titaeva, E. V. (2002). The fibrinolysis system: regulation of activity and physiological function of its main components. *Biochemistry (Moscow)* **67**, 99–108.
- Dodds, W. J. (1973). Canine factor X (Stuart-Prower factor) deficiency. *J. Lab. Clin. Med.* **82**, 560–566.
- Dodds, W. J. (1978). Platelet function in animals: species specificities. In “Platelets: A Multidisciplinary Approach” (G. deGaetano and S. Garattini, Eds.), pp. 45–59. Raven Press, New York.
- Dodds, W. J. (1997). Hemostasis. In “Clinical Biochemistry of Domestic Animals” (J. J. Kaneko, J. W. Harvey, and M. L. Bruss, Eds.), 5th ed., pp. 241–283. Academic Press, San Diego, CA.
- Dodds, W. J. (2000). Other hereditary coagulopathies. In “Schalm’s Veterinary Hematology” (B. F. Feldman, J. G. Zinkl, and N. C. Jain, Eds.), 5th ed., pp. 1030–1036. Lippincott Williams and Wilkins, Philadelphia.
- Dodds, W. J., and Kull, J. E. (1971). Canine factor XI (plasma thromboplastin antecedent) deficiency. *J. Lab. Clin. Med.* **78**, 746–752.
- Dodds, W. J., Moynihan, A. C., Fisher, T. M., and Trauner, D. B. (1981). The frequencies of inherited blood and eye diseases as determined by genetic screening programs. *J. Am. Anim. Hosp. Assoc.* **17**, 697–704.
- Dolente, B. A., Wilkins, P. A., and Boston, R. C. (2002). Clinicopathologic evidence of disseminated intravascular coagulation in horses with acute colitis. *J. Am. Vet. Med. Assoc.* **220**, 1034–1038.
- Donahue, S. M., and Otto, C. M. (2005). Thromboelastography: a tool for measuring hypercoagulability, hypocoagulability, and fibrinolysis. *J. Vet. Emerg. Crit. Care*. **15**, 9–16.
- Doshi, S., and Marmur, J. D. (2002). Evolving role of tissue factor and its pathway inhibitor. *Crit. Care Med.* **30**, S241–S250.

- Dowd, P., Ham, S. W., Naganathan, S., and Hershline, R. (1995a). The mechanism of action of vitamin K. *Ann. Rev. in Nut.* **15**, 419–440.
- Dowd, P., Hershline, R., Ham, S. W., and Naganathan, S. (1995b). Vitamin K and energy transduction: a base strength amplification mechanism. *Science* **269**, 1684–1691.
- Duggan, M. J., Dimichele, D. M., Christian, M. J., Fink, L. M., and Hathaway, W. E. (1987). Collagen-binding of von Willebrand's factor antigen in the classification of von Willebrand's disease. *Am. J. Clin. Pathol.* **88**, 97–102.
- Dugina, T. N., Kiseleva, E. V., Chistove, I. V., Umarova, B. A., and Strukova, S. M. (2002). Receptors of the PAR family as a link between blood, coagulation and inflammation. *Biochem.* **67**, 65–74.
- DuVall, M. D., Murphy, M. J., Ray, A. C., and Reagor, J. C. (1989). Case studies on second-generation anticoagulant rodenticide toxicities in nontarget species. *J. Vet. Diagn. Invest.* **1**, 66–68.
- Edens, L. M., Morris, D. D., Prasse, K. W., and Anver, M. R. (1993). Hypercoagulable state associated with a deficiency of protein C in a thoroughbred colt. *J. Vet. Intern. Med.* **7**, 190–193.
- Edmead, C. E., Crosby, D. A., Southcott, M., and Poole, A. W. (1999). Thrombin-induced association of SHP-2 with multiple tyrosine-phosphorylated proteins in human platelets. *FEBS Lett.* **459**, 27–32.
- Escobar, G., and White, J. G. (1991). The platelet open canalicular system: a final common pathway. *Blood Cells* **17**, 467–485.
- Esmon, C. T. (2003). The protein C pathway. *Chest* **124**, 26S–32S.
- Esmon, C. T. (2005). The interactions between inflammation and coagulation. *Br. J. Haematol.* **131**, 417–430.
- Evans, G. O., and Flynn, R. M. (1992). Activated partial thromboplastin time measurements in citrated canine plasma. *J. Comp. Pathol.* **106**, 79–82.
- Evans, J. P., Brinkhous, K. M., Brayer, G. D., Reisner, H. M., and High, K. A. (1989). Canine hemophilia B resulting from a point mutation with unusual consequences. *Proc. Natl. Acad. Sci. USA*, **86**, 10095–10099.
- Ewenstein, B. (1997). Von Willebrand's disease. *Annu. Rev. Med.* **48**, 525–542.
- Faust, S. N., Levin, M., Harrison, O. B., Goldin, R. D., Lockhart, M. S., Kondaveeti, S., Laszik, Z., Esmon, C. T., and Heyderman, R. S. (2001). Dysfunction of endothelial protein C activation in severe meningococcal sepsis. *N. Engl. J. Med.* **345**, 408–416.
- Favaloro, E. J. (2000). Detection of von Willebrand disorder and identification of qualitative von Willebrand factor defects: direct comparison of commercial ELISA-based von Willebrand factor activity options. *Am. J. Clin. Pathol.* **114**, 608–618.
- Favaloro, E. J., Facey, D., and Henniker, A. (1999). Use of a novel platelet function analyzer (PFA-100) with a high sensitivity to disturbances in von Willebrand factor to screen for von Willebrand's disease and other disorders. *Am. J. Hematol.* **62**, 165–174.
- Favaloro, E. J., Grispo, L., and Koutts, J. (1991). Development of a simple collagen based ELISA assay aids in the diagnosis of, and permits sensitive discrimination between type I and type II, von Willebrand's disease. *Blood Coagul. Fibrinolysis* **2**, 285–291.
- Fecteau, G., Zinkl, J. G., Smith, B. P., O'Neil, S., Smith, S., and Klopfer, S. (1997). Dysfibrinogenemia or afibrinogenemia in a Border Leicester lamb. *Can. Vet. J.* **38**, 443–444.
- Feil, R., Lohmann, S. M., deJonge, H., Walter, U., and Hofmann, F. (2003). Cyclic GMP-dependent protein kinases and the cardiovascular system. *Circ. Res.* **93**, 907–916.
- Feldman, B. F., Soares, M. A., Kitchell, B. E., Brown, C. C., and O'Neill, S. (1983). Hemorrhage in a cat caused by inhibition of factor XI (plasma thromboplastin antecedent). *J. Am. Vet. Med. Assoc.* **182**, 589–591.
- Flaumenhaft, R. (2003). Molecular basis of platelet granule secretion. *Arterioscler. Thromb. Vasc. Biol.* **23**, 1152–1160.
- Fogh, J. M. (1988). A study of hemophilia in German shepherd dogs in Denmark. *Vet. Clin. North Am. Small Anim. Pract.* **18**, 245–254.
- Fogh, J. M., and Fogh, I. T. (1988). Inherited coagulation disorders. *Vet. Clin. North Am. Small Anim. Pract.* **18**, 231–243.
- Forbes, C. D., Thomson, C., Prentice, C. R. M., and McNicol, G. P. (1973). Experimental warfarin poisoning in the dog. *J. Comp. Pathol.* **83**, 173–180.
- Franchini, M., Lippi, G., and Manzato, F. (2006). Recent acquisitions in the pathophysiology, diagnosis and treatment of disseminated intravascular coagulation. *Thrombosis J.* **4**, 4.
- Franchini, M., Veneri, D., and Lippi, G. (2007). Inflammation and hemostasis: a bidirectional interaction. *Clin. Lab.* **53**, 63–67.
- Frojmovic, M. M., Wong, T., and Searcy, G. P. (1996). Platelets from bleeding Simmental cattle have a long delay in both ADP-activated expression of GpIIB-IIIa receptors and fibrinogen-dependent platelet aggregation. *Thromb. Haemost.* **76**, 1047–1052.
- Frost, C. L., Naude, R. J., and Muramoto, K. (2002). Ostrich antithrombin III: kinetics and mechanism of inhibition of ostrich thrombin. *Int. J. Biochem. Cell Biol.* **34**, 1164–1171.
- Fuchs, H. E., and Pizzo, S. V. (1983). The regulation of factor Xa *in vitro* in human and mouse plasma and *in vivo* in mouse. The role of the endothelium and the plasma proteinase inhibitors. *J. Clin. Invest.* **72**, 2041–2049.
- Furlanello, T., Caldin, M., Stocco, A., Tudone, E., Tranquillo, V., Lubas, G., and Solano-Gallego, L. (2006). Stability of stored canine plasma for hemostasis testing. *Vet. Clin. Pathol.* **35**, 204–207.
- Gaal, T., Halmay, D., Kocsis, R., and Abonyi-Toth, Z. (2007). Evaluation of the effect of ketoprofen and carprofen on platelet function in dogs studied by PFA-100 point-of-care analyser. *Acta Vet. Hung.* **55**, 287–294.
- Gachet, C. (2001). ADP receptors of platelets and their inhibition. *Thromb. Haemost.* **86**, 222–232.
- Gailani, D. (2000). Activation of factor IX by factor IXa. *Trends Cardiovasc. Med.* **10**, 198–204.
- Gailani, D., and Broze, G. J. (1991). Factor XI activation in a revised model of blood coagulation. *Science* **253**, 909–912.
- Gando, S. (2001). Disseminated intravascular coagulation in trauma patients. *Semin. Thromb. Haemost.* **27**, 585–592.
- Gear, A. R., and Camerini, D. (2003). Platelet chemokines and chemokine receptors: linking hemostasis, inflammation, and host defense. *Microcirculation* **10**, 335–350.
- Gentry, P. A. (1992). The mammalian blood platelets: its role in haemostasis, inflammation and tissue repair. *J. Comp. Pathol.* **107**, 243–270.
- Gentry, P. A. (2000a). Factor XI deficiency. In "Schalm's Veterinary Hematology" (B. F. Feldman, J. G. Zinkl, and N. C. Jain, Eds.), 5th ed., pp. 1037–1041. Lippincott Williams and Wilkins, Philadelphia.
- Gentry, P. A. (2000b). Platelet biology. In "Schalm's Veterinary Hematology" (B. F. Feldman, J. G. Zinkl, and N. C. Jain, Eds.), 5th ed., pp. 459–466. Lippincott Williams and Wilkins, Philadelphia.
- Gentry, P. A. (2004). Comparative aspects of blood coagulation. *Vet. J.* **168**, 238–251.
- Gentry, P. A., Crane, S., and Lotz, F. (1975). Factor XI (plasma thromboplastin antecedent) deficiency in cattle. *Can. Vet. J.* **16**, 160–162.
- Gentry, P. A., Niemuller, C., Ross, M. L., and Liptrap, R. M. (1989). Platelet aggregation in the Asian elephant is not dependent on thromboxane B<sub>2</sub> production. *Comp. Biochem. Physiol.* **94A**, 47–51.
- Gentry, P. A., and Nyarko, K. (2000). Platelet lipids and prostaglandins. In "Schalm's Veterinary Hematology" (B. F. Feldman, J. G. Zinkl, and

- N. C. Jain, Eds.), 5th ed., pp. 453–458. Lippincott Williams and Wilkins, Philadelphia.
- Gentry, P. A., and Ross, M. L. (1986). Failure of routine coagulation screening tests to detect heterozygous state of bovine factor XI deficiency. *Vet. Clin. Pathol.* **15**, 12–16.
- Gentry, P. A., and Ross, M. L. (1994). Coagulation factor XI deficiency in Holstein cattle: expression and distribution of factor XI activity. *Can. J. Vet. Res.* **58**, 242–247.
- Geor, R. J., Jackson, M. L., Lewis, K. D., and Fretz, P. B. (1990). Prekallikrein deficiency in a family of Belgian horses. *J. Am. Vet. Med. Assoc.* **197**, 741–745.
- Gettins, P. G. (2002). Serpin structure, mechanism, and function. *Chem. Rev.* **102**, 4751–4804.
- Gibbins, J. M. (2004). Platelet adhesion signaling and the regulation of thrombus formation. *J. Cell Sci.* **117**, 3415–3425.
- Goel, M. S., and Diamond, S. L. (2001). Neutrophil enhancement of fibrin deposition under flow through platelet-dependent and -independent mechanisms. *Arterioscler. Thromb. Vasc. Biol.* **21**, 2093–2098.
- Golino, P., Ragni, M., Cimmino, G., and Forte, L. (2002). Role of tissue factor pathway inhibitor in the regulation of tissue factor-dependent blood coagulation. *Cardiovasc. Drug Rev.* **20**, 67–80.
- Gookin, J. L., Brooks, M., Catalfamo, J. L., Bunch, S. E., and Munana, K. R. (1997). Factor X deficiency in a cat. *J. Am. Vet. Med. Assoc.* **211**, 576–578.
- Goree, M., Catalfamo, J. L., Aber, S., and Boudreaux, M. K. (2005). Characterization of the mutations causing hemophilia B in 2 domestic cats. *J. Vet. Intern. Med.* **19**, 200–204.
- Grand, R. J. A., Turnell, A. S., and Brabham, P. W. (1996). Cellular consequences of the thrombin-receptor activation. *Biochem.* **313**, 353–358.
- Green, R. A. (1988). Pathophysiology of antithrombin III deficiency. *Vet. Clin. North Am. Small Anim. Pract.* **18**, 95–104.
- Greene, C. E., and Meriwether, E. (1982). Activated partial thromboplastin time and activated coagulation time in monitoring heparinized cats. *Am. J. Vet. Res.* **43**, 1473–1477.
- Griffin, A., Callan, M. B., Shofer, F. S., and Giger, U. (2003). Evaluation of a canine D-dimer point-of-care test kit for use in samples obtained from dogs with disseminated intravascular coagulation, thromboembolic disease, and hemorrhage. *Am. J. Vet. Res.* **64**, 1562–1569.
- Gu, W., Brooks, M., Catalfamo, J. L., Ray, J., and Ray, K. (1999). Two distinct mutations cause severe hemophilia B in two unrelated canine pedigrees. *Thromb. Haemost.* **82**, 1270–1275.
- Hall, D. E. (1970). Sensitivity of different thromboplastin reagents to Factor VII deficiency in the blood of beagle dogs. *Lab. Animals*, **4**, 55–59.
- Hamm, H. E. (2001). How activated receptors couple to G proteins. *Proc. Natl. Acad. Sci. USA*, **91**, 4819–4821.
- Harpel, P. C., Lewin, M. F., and Kaplan, A. P. (1985). Distribution of plasma kallikrein between C1 inactivator and  $\alpha_2$ -macroglobulin in plasma utilizing a new assay for  $\alpha_2$ -macroglobulin-kallikrein complexes. *J. Biol. Chem.* **260**, 4257–4263.
- Hayes, T. (2002). Dysfibrinogenemia and thrombosis. *Arch. Pathol. Lab. Med.* **126**, 1387–1390.
- Healy, P. J., Sewell, C. A., Exner, T., Morton, A. G., and Adams, B. S. (1984). Haemophilia in Hereford cattle: factor VIII deficiency. *Australian Vet. J.* **61**, 132–133.
- Heemskerk, J. W. M., and Sage, S. O. (1994). Calcium signaling in platelets and other cells. *Platelets* **5**, 295–316.
- Heidmann, P., Tornquist, S. J., Qu, A., and Cebra, C. K. (2005). Laboratory measures of hemostasis and fibrinolysis after intravenous administration of epsilon-aminocaproic acid in clinically normal horses and ponies. *Am. J. Vet. Res.* **66**, 313–318.
- Henninger, R. W. (1988). Hemophilia A in two related quarter horses. *J. Am. Vet. Med. Assoc.* **193**, 91–94.
- Hoffman, M., and Monroe, D. M. (2007). Coagulation 2006: a modern view of hemostasis. *Hematol. Oncol. Clin. North Am.* **21**, 1–11.
- Honda, Z., Ishii, S., and Shimizu, T. (2002). Platelet-activating factor receptor. *J. Biochem.* **131**, 773–779.
- Hopper, K., and Bateman, S. (2005). An updated view of hemostasis: mechanisms of hemostatic dysfunction associated with sepsis. *J. Vet. Emerg. Crit. Care* **15**, 83–91.
- Huang, Z. F., Higuchi, D., Lasky, N., and Broze Jr. G. J. (1997). Tissue factor pathway inhibitor gene disruption produces intrauterine lethality in mice. *Blood* **90**, 944–951.
- Huntington, J. A., Olson, S. T., Fan, B., and Gettins, P. G. (1996). Mechanism of heparin activation of antithrombin: evidence for reactive center loop preinsertion with expulsion of heparin binding. *Biochemistry* **35**, 8495–8503.
- Hynes, R. (2002). Integrins: bidirectional, allosteric signaling machines. *Cell* **110**, 673–687.
- Iazbik, C., Couto, C. G., Gray, T. L., and Kociba, G. (2001). Effect of storage conditions on hemostatic parameters of canine plasma obtained for transfusion. *Am. J. Vet. Res.* **62**, 734–735.
- Inhorn, R. C., and Tollefsen, D. M. (1986). Isolation and characterization of a partial cDNA clone for heparin cofactor II. *Biochem. Biophys. Res. Commun.* **266**, 8129–8135.
- Inoue, O., Suzuki-Inoue, K., Dean, W. L., Frampton, J., and Watson, S. P. (2003). Integrin  $\alpha_2\beta_1$  mediates outside-in regulation of platelet spreading on collagen through activation of Src kinases and PLC $\gamma$ 2. *J. Cell Biol.* **160**, 769–780.
- Inwald, D. P., McDowell, A., Peters, M. J., Callard, R. E., and Klein, N. J. (2003). CD40 is constitutively expressed on platelets and provides a novel mechanism for platelet activation. *Circ. Res.* **92**, 1041–1048.
- Irmak, K., and Turgut, K. (2005). Disseminated intravascular coagulation in cattle with abomasal displacement. *Vet. Res. Commun.* **29**, 61–68.
- Ishihara, H., Connolly, A. J., Zeng, D., Kahn, M. L., Zheng, Y. W., Timmons, C., Tram, T., and Coughlin, S. R. (1997). Protease-activated receptor 3 is a second thrombin receptor in humans. *Nature* **386**, 502–506.
- Jimenez, C., and Fernandez, F. (2000). Inflammation, kinins, and complement system interactions with hemostasis. In “Schalm’s Veterinary Hematology” (B. F. Feldman, J. G. Zinkl, and N. C. Jain, Eds.), 5th ed., pp. 549–551. Lippincott Williams and Wilkins, Philadelphia.
- Johnson, J. S., Laegreid, W. S., Basaraba, R. J., and Baker, D. C. (2006a). Truncated gamma-glutamyl carboxylase in Rambouillet sheep. *Vet. Pathol.* **43**, 430–437.
- Johnson, J. S., Soute, B. A., Olver, C. S., and Baker, D. C. (2006b). Defective  $\gamma$ -glutamyl carboxylase activity and bleeding in Rambouillet sheep. *Vet. Pathol.* **43**, 726–732.
- Johnstone, I. B. (1984). The activated partial thromboplastin time of diluted plasma: variability due to the method of fibrin detection. *Can. J. Comp. Med.* **48**, 198–201.
- Johnstone, I. B. (2000). Coagulation inhibitors. In “Schalm’s Veterinary Hematology” (B. F. Feldman, J. G. Zinkl, and N. C. Jain, Eds.), pp. 538–543. Lippincott Williams and Wilkins, Baltimore.
- Kahn, M. L., Zheng, Y. W., Huang, W., Bigornia, V., Zeng, D., Moff, S., Farese, R. V., Tam, C., and Coughlin, S. R. (1998). A dual thrombin receptor system for platelet activation. *Nature* **394**, 690–694.
- Kaushansky, K. (2002). Thrombopoietin: from theory to reality. *Intl. J. Hematol.* **76(suppl 1)**, 343–345.
- Kerr, R., Newsome, P., Germain, L., Thompson, E., Dawson, P., Stirling, D., and Ludlam, C. A. (2003). Effects of acute liver injury on blood coagulation. *J. Thromb. Haemost.* **1**, 754–759.



- Kier, A. B., Bresnahan, J. F., White, F. J., and Wagner, J. E. (1980). The inheritance pattern of factor XII (Hageman) deficiency in domestic cats. *Can. J. Comp. Med.* **44**, 309–314.
- Knowler, C., Giger, U., Dodds, W. J., and Brooks, M. (1994). Factor XI deficiency in Kerry Blue terriers. *J. Am. Vet. Med. Assoc.* **205**, 1557–1561.
- Koyama, T., Parkinson, J. F., Sie, P., Bang, N. U., Muller, B. G., and Preissner, K. T. (1991). Different glycoforms of human thrombomodulin—their glycosaminoglycan-dependent modulatory effects on thrombin inactivation by heparin cofactor II and antithrombin III. *Eur. J. Biochem.* **198**, 563–570.
- Kramer, J. W., Venta, P. J., Klein, S. R., Cao, Y., Schall, W. D., and Yuzbasiyan-Gurkan, V. (2004). A von Willebrand's factor genomic nucleotide variant and polymerase chain reaction diagnostic test associated with inheritable type-2 von Willebrand's disease in a line of German shorthaired pointer dogs. *Vet. Pathol.* **41**, 221–228.
- Kroll, M. H., and Schafer, A. I. (1989). Biochemical mechanisms of platelet activation. *Blood* **74**, 1181–1195.
- Kruihof, E. K. O. (1998). Plasminogen activators inhibitors—a review. *Enzyme* **40**, 113–121.
- Kulikov, V. I., and Muzya, G. I. (1998). The bioregulatory role of platelet-activating factor in intracellular processes and cell-cell interactions. *Biochem.* **63**, 47–54.
- Kummeling, A., Teske, E., Rothuizen, J., and Van Sluijs, F. J. (2006). Coagulation profiles in dogs with congenital portosystemic shunts before and after surgical attenuation. *J. Vet. Intern. Med.* **20**, 1319–1326.
- Kunieda, M., Tsuji, T., Abbasi, A. R., Khalaj, M., Ikeda, M., Miyadera, K., Ogawa, H., and Kunieda, T. (2005). An insertion mutation of the bovine F11 gene is responsible for factor XI deficiency in Japanese black cattle. *Mamm. Genome* **16**, 383–389.
- Kuter, D. J., and Begley, C. G. (2002). Recombinant human thrombopoietin: basic biology and evaluation of clinical studies. *Blood* **100**, 3457–3469.
- Lak, M., Keihani, M., Elahi, F., Peyvandi, F., and Mannucci, P. M. (1999). Bleeding and thrombosis in 55 patients with inherited afibrinogenemia. *Br. J. Haematol.* **107**, 204–206.
- Lawson, J. H., and Mann, K. G. (1991). Cooperative activation of human factor IX by the human extrinsic pathway of blood coagulation. *J. Biol. Chem.* **266**, 11317–11327.
- Levi, M. (2004). Current understanding of disseminated intravascular coagulation. *Brit. J. Haematol.* **124**, 567–576.
- Levi, M. (2005). Disseminated intravascular coagulation: what's new? *Crit. Care Clin.* **21**, 449–467.
- Levi, M., and van der Poll, T. (2005). Two-way interactions between inflammation and coagulation. *Trends Cardiovasc. Med.* **15**, 254–259.
- Levy-Toledano, S. (1999). Platelet signal transduction pathways: could we organize them into a “hierarchy”? *Haemostasis* **29**, 4–15.
- Lijnen, H. R. (2002). Matrix metalloproteinases and cellular fibrinolytic activity. *Biochemistry (Moscow)* **67**, 92–98.
- Lindahl, A. K. (1997). Tissue factor pathway inhibitor: from unknown coagulation inhibitor to major antithrombotic principle. *Cardiovasc. Res.* **33**, 286–291.
- Lipscomb, D. L., Bourne, C., and Boudreaux, M. K. (2000). Two genetic defects in  $\alpha_{IIb}$  are associated with type I Glanzmann's thrombasthenia in a Great Pyrenees dog: a 14-base insertion in Exon 13 and a splicing defect of intron 13. *Vet. Pathol.* **37**, 581–588.
- Lisciandro, G. R., Brooks, M., and Catalfamo, J. L. (2000). Contact factor deficiency in a German shorthaired pointer without clinical evidence of coagulopathy. *J. Vet. Intern. Med.* **14**, 308–310.
- Lisciandro, S. C., Hohenhaus, A., and Brooks, M. (1998). Coagulation abnormalities in 22 cats with naturally occurring liver disease. *J. Vet. Intern. Med.* **12**, 71–75.
- Lisman, T., Leebeek, F., and deGroot, P. G. (2002). Haemostatic abnormalities in patients with liver disease. *J. Hepatol.* **37**, 280–287.
- Littlewood, J. D., and Evans, R. J. (1990). A combined deficiency of factor VIII and contact activation defect in a family of cats. *Br. Vet. J.* **146**, 30–35.
- Livesey, L., Christopherson, P., Hammond, A., Perkins, J., Toivio-Kinnucan, M., Insalaco, T., and Boudreaux, M. K. (2005). Platelet dysfunction (Glanzmann's thrombasthenia) in horses. *J. Vet. Intern. Med.* **19**, 917–919.
- Long, G. L., Chandra, T., Woo, S. L. C., Daview, E. W., and Kurachi, K. (1984). Complete sequence of the cDNA for human  $\alpha_1$ -antitrypsin and the gene for the S variant. *Biochemistry* **23**, 4828–4837.
- Lopez, J. A., and Dong, J. F. (1997). Structure and function of the glycoprotein Ib-IX-V complex. *Curr. Opin. Hematol.* **4**, 323–329.
- Luddington, R. J. (2005). Thrombelastography/thromboelastometry. *Clin. Lab. Haematol.* **27**, 81–90.
- Macpherson, R., Scherer, J., Ross, M. L., and Gentry, P. A. (1999). Factor VII deficiency in a mixed breed dog. *Can. Vet. J.* **40**, 503–505.
- Maddison, J. E., Watson, A. D. J., Eade, I. G., and Exner, T. (1990). Vitamin K-dependent multifactor coagulopathy in Devon Rex cats. *J. Am. Vet. Med. Assoc.* **197**, 1495–1497.
- Major, C. D., Santulli, R. J., Derian, C. K., and Andrade-Gordon, P. (2003). Extracellular mediators in atherosclerosis and thrombosis. *Arterioscler. Thromb. Vasc. Biol.* **23**, 931–939.
- Mann, K. G. (2003). Thrombin formation. *Chest* **124**, 4S–10S.
- Mann, K. G., Butenas, S., and Brummel, K. (2003). The dynamics of thrombin formation. *Arterioscler. Thromb. Vasc. Biol.* **23**, 17–25.
- Mansell, P. (2000). Hemophilia A and B. In “Schalm's Veterinary Hematology” (B. F. Feldman, J. G. Zinkl and N. C. Jain, Eds.), 5th ed., pp. 1026–1029. Lippincott Williams and Wilkins, Philadelphia.
- Mansell, P. D., and Parry, B. W. (1992). Changes in factor VIII activity and von Willebrand factor antigen concentration with age in dogs. *Br. Vet. J.* **148**, 329–337.
- Mao, S. S., Cooper, C. M., Wood, T., Shafer, J. A., and Gardell, S. J. (1999). Characterization of plasmin-mediated activation of plasma carboxypeptidase B. *J. Biol. Chem.* **274**, 35046–35052.
- Marron, B. M., Robinson, J. L., Gentry, P. A., and Beaver, J. E. (2004). Identification of a mutation associated with factor XI deficiency in Holstein cattle. *Animal Genetics* **35**, 454–456.
- Marshall, S. J., Senis, Y. A., Auger, J. M., Feil, R., Hofmann, F., Salmon, G., Peterson, J. T., Burslem, F., and Watson, S. P. (2004). GPIb-dependent platelet activation is dependent on Src kinases but not MAP kinase or cGMP-dependent kinase. *Blood* **103**, 2601–2609.
- Maruyama, H., Watari, T., Miura, T., Sakai, M., Takahashi, T., Koie, H., Yamaya, Y., Asano, K., Edamura, K., Sato, T., Tanaka, S., Hasegawa, A., and Tokuriki, M. (2005). Plasma thrombin-antithrombin complex concentrations in dogs with malignant tumours. *Vet. Rec.* **156**, 839–840.
- Massberg, S., Sausbier, M., Klatt, P., Bauer, M., Pfeifer, A., Siess, W., Fassler, R., Ruth, P., Krombach, F., and Hoffman, F. (1999). Increased adhesion and aggregation of platelets lacking cyclic guanosine 3',5'-monophosphate kinase I. *J. Exp. Med.* **189**, 1255–1264.
- Mateos-Trigos, G., Evans, R. J., and Heath, M. F. (2002). Effects of a P2Y<sub>12</sub> receptor antagonist on the response of equine platelets to ADP. Comparison with human platelets. *Res. Vet. Sci.* **73**, 171–175.
- Maurer-Spurej, E. (2005). Circulating serotonin in vertebrates. *Cell. Mol. Life Sci.* **62**, 1881–1889.

- Medved, L., and Niewenhuizen, W. (2003). Molecular mechanisms of initiation of fibrinolysis by fibrin. *Thromb. Haemost.* **89**, 409–419.
- Meijers, J. C., Marquart, J. A., Bertina, R. M., Bouma, B. N., and Rosendaal, F. R. (2002). Protein C inhibitor (plasminogen activator inhibitor-3) and the risk of venous thrombosis. *Br. J. Haematol.* **118**, 604–609.
- Meyers, K., and Wardrop, K. J. (1991). Platelets and coagulation. *Adv. Vet. Sci. Comp. Med.* **36**, 87–150.
- Meyers, K. M., Seachord, C. L., Holmsen, H., and Prieur, D. J. (1981). Evaluation of the platelet storage pool deficiency in the feline counterpart of the Chediak-Higashi syndrome. *Am. J. Hematol.* **11**, 241–253.
- Meyers, K. M., Wardrop, K. J., Dodds, W. J., and Brassard, J. (1990a). Effect of exercise, DDAVP, and epinephrine on the Factor VIII:C/von Willebrand factor complex in normal dogs and von Willebrand factor deficient Doberman pinscher dogs. *Thromb. Res.* **57**, 97–108.
- Meyers, K. M., Wardrop, K. J., Helmick, C., and White, F. (1990b). von Willebrand factor is present in the vascular endothelium from normal dogs and from Doberman pinscher dogs with a plasma von Willebrand factor deficiency. *Thromb. Res.* **57**, 109–116.
- Miesner, M. D., and Anderson, D. E. (2006). Factor VIII deficiency in a newborn alpaca. *J. Vet. Intern. Med.* **20**, 1248–1250.
- Mills, D. C. B. (1996). ADP receptors on platelets. *Thromb. Haemost.* **76**, 835–856.
- Mills, D. L., Hawkins, E., Jager, M., and Boyle, C. R. (1995). Comparison of coagulation test results for blood samples obtained by means of direct venipuncture and through a jugular vein catheter in clinically normal dogs. *J. Am. Vet. Med. Assoc.* **207**, 1311–1314.
- Mills, J. N., Labuc, R. H., and Lawley, M. J. (1997). Factor VII deficiency in an Alaskan malamute. *Aust. Vet. J.* **75**, 320–324.
- Minnema, M. C., ten Cate, H., and Hack, E. (1999). The role of factor XI in coagulation: a matter of revision. *Sem. Thromb. Hemost.* **25**, 419–428.
- Mischke, R. (2000). Activated partial thromboplastin time as a screening test of minor or moderate coagulation factor deficiencies for canine plasma: sensitivity of different commercial reagents. *J. Vet. Diagn. Invest.* **12**, 433–437.
- Mischke, R. (2002). Commercial variants of the prothrombin time test as a screening test of acquired coagulation factor II, VII, and X deficiencies in dogs. *Res. Vet. Sci.* **73**, 165–170.
- Mischke, R. (2003). Heparin *in vitro* sensitivity of the activated partial thromboplastin time in canine plasma depends on reagent. *J. Vet. Diagn. Invest.* **15**, 588–591.
- Mischke, R., Diedrich, M., and Nolte, I. (2003). Sensitivity of different prothrombin time assays to factor VII deficiency in canine plasma. *Vet. J.* **166**, 79–85.
- Mischke, R., and Jacobs, C. (2001). The monitoring of heparin administration by screening tests in experimental dogs. *Res. Vet. Sci.* **70**, 101–108.
- Mischke, R., and Keidel, A. (2003). Influence of platelet count, acetylsalicylic acid, von Willebrand's disease, coagulopathies, and haematocrit on results obtained using a platelet function analyser in dogs. *Vet. J.* **165**, 43–52.
- Mischke, R., and Nolte, I. (1997). Optimization of prothrombin time measurements in canine plasma. *Am. J. Vet. Res.* **58**, 236–241.
- Mischke, R., and Schulze, U. (2004). Studies on platelet aggregation using the Born method in normal and uraemic dogs. *Vet. J.* **168**, 270–275.
- Moir, E., Robbie, L. A., Bennett, B., and Booth, N. A. (2002). Polymorphonuclear leucocytes have two opposing roles in fibrinolysis. *Thromb. Haemost.* **87**, 1006–1010.
- Moncada, S., and Vane, J. R. (1976). Arachidonic acid metabolites and the interaction between platelets and blood vessel walls. *New Engl. J. Med.* **300**, 1141–1146.
- Monreal, L. (2003). D-dimer as a new test for the diagnosis of DIC and thromboembolic diseases. *J. Vet. Intern. Med.* **17**, 757–759.
- Monroe, D. M., and Hoffman, M. (2006). What does it take to make the perfect clot? *Arterioscler. Thromb. Vasc. Biol.* **26**, 41–48.
- Monroe, D. M., and Key, N. S. (2007). The tissue factor-FVIIa complex: complex: procoagulant activity, regulation, and multitasking. *J. Thromb. Haemost.* **5**, 1097–1105.
- Morales, F., Couto, C. G., and Iazbik, M. C. (2007). Effects of 2 concentrations of sodium citrate on coagulation test results, von Willebrand factor concentration, and platelet function in dogs. *J. Vet. Intern. Med.* **21**, 472–475.
- Moreno, P., and Ginel, P. J. (1999). Effects of haemolysis, lipaemia and bilirubinaemia on prothrombin time, activated partial thromboplastin time and thrombin time in plasma samples from healthy dogs. *Res. Vet. Sci.* **67**, 273–276.
- Moritz, A., Walcheck, B. K., Deye, J., and Weiss, D. J. (2003a). Effects of short-term racing activity on platelet and neutrophil activation in dogs. *Am. J. Vet. Res.* **64**, 855–859.
- Moritz, A., Walcheck, B. K., and Weiss, D. J. (2003b). Flow cytometric detection of activated platelets in the dog. *Vet. Clin. Pathol.* **32**, 6–12.
- Moser, J., Meyers, K. M., Russon, R. H., and Reeves, J. J. (1998). Plasma von Willebrand factor changes during various reproductive cycle stages in mixed-breed dogs with normal von Willebrand factor and in Doberman Pinschers with type-I von Willebrand's disease. *Am. J. Vet. Res.* **59**, 111–118.
- Mosesson, M. W. (1992). The roles of fibrinogen and fibrin in hemostasis and thrombosis. *Semin. Hematol.* **29**, 177–188.
- Mosnier, L. O., Lisman, T., van den Berg, H. M., Nieuwenhuis, H. K., Meijers, J. C. M., and Bouma, B. N. (2001). The defective down regulation of fibrinolysis in haemophilia A can be restored by increasing the TAFI plasma concentration. *Thromb. Haemost.* **86**, 1035–1039.
- Munday, J. S., and Thompson, L. J. (2003). Brodifacoum toxicosis in two neonatal puppies. *Vet. Pathol.* **40**, 216–219.
- Munoz, E. M., and Linhardt, R. J. (2004). Heparin-binding domains in vascular biology. *Arterioscler. Thromb. Vasc. Biol.* **24**, 1549–1557.
- Murphy, M. J. (2002). Rodenticides. *Vet. Clin. North Am. Small Anim. Pract.* **32**, 469–484.
- Nagata, Y., Yoshikawa, J., Hashimoto, A., Yamamoto, M., Payne, A. H., and Todokoro, K. (2003). Proplatelet formation of megakaryocytes is triggered by autocrine-synthesized estradiol. *Genes Dev.* **17**, 2864–2869.
- Nakata, M., Sakai, M., and Sakai, T. (2006). Hemophilia B in a crossbred Maltese dog. *J. Vet. Med. Sci.* **68**, 1223–1224.
- Narita, M., Rudolph, A. E., Miletich, J. P., and Schwartz, A. L. (1998). The low-density lipoprotein receptor-related protein (LPR) mediates clearance of coagulation factor Xa *in vivo*. *Blood* **91**, 555–560.
- Neer, T. M., and Savant, R. L. (1992). Hypoprothrombinemia secondary to administration of sulfaquinoxaline to dogs in a kennel setting. *J. Am. Vet. Med. Assoc.* **200**, 1344–1345.
- Nelson, O. L., and Andreasen, C. (2003). The utility of plasma D-dimer to identify thromboembolic disease in dogs. *J. Vet. Intern. Med.* **17**, 830–834.
- Nesheim, M. (2003). Thrombin and fibrinolysis. *Chest* **124**, 33S–39S.
- Newman, P. J. (1999). Switched at birth: a new family for PECAM-1. *J. Clin. Invest.* **103**, 5–9.
- Newman, P. J., and Newman, D. K. (2003). Signal transduction pathways mediated by PECAM-1. *Arterioscler. Thromb. Vasc. Biol.* **23**, 953–964.

- Nielsen, L. A., Zois, N. E., Pedersen, H. D., Olsen, L. H., and Tarnow, I. (2007). Platelet function in dogs: breed differences and effect of acetylsalicylic acid administration. *Vet. Clin. Pathol.* **36**, 267–273.
- Nieswandt, B., and Watson, S. P. (2003). Platelet-collagen interaction: is GPVI the central receptor? *Blood* **102**, 449–461.
- Novotny, W. F., Brown, S. G., Miletich, J. P., Rader, D. J., and Broze, G. J. (1991). Plasma antigen levels of the lipoprotein-associated coagulation inhibitor in patient samples. *Blood* **78**, 387–393.
- Novotny, W. F., Girard, T. J., Miletich, J. P., and Broze, G. J. (1988). Platelets secrete a coagulation inhibitor functionally and antigenically similar to the lipoprotein-associated coagulation inhibitor from human plasma. *Blood* **72**, 2020–2025.
- Nozawa, Y., Nakashima, S., and Nagata, K. (1991). Phospholipid-mediated signaling in receptor activation of human platelets. *Biochimica et Biophysica Acta* **1082**, 219–238.
- O'Brien, S. R., Sellers, T. S., and Meyer, D. J. (1995). Artifactual prolongation of the activated partial thromboplastin time associated with hemoconcentration in dogs. *J. Vet. Intern. Med.* **9**, 169–170.
- Ogawa, T., Sugidachi, A., Asai, F., and Koike, H. (1998). Involvement of platelet-derived 5-hydroxytryptamine in thromboxane A<sub>2</sub>-induced aggregation in cat platelets. *Blood Coagul. Fibrinolysis* **9**, 233–240.
- Olson, S. T., and Shore, J. D. (1982). Demonstration of a two-step reaction mechanism for inhibition of alpha-thrombin by antithrombin III and identification of the step affected by heparin. *J. Biol. Chem.* **257**, 14891–14895.
- Orth, K., Madison, E. L., Genting, M.-J., Sambrook, J. F., and Herz, J. (1992). Complexes of tissue-type plasminogen activator and its serpin inhibitor plasminogen-activator inhibitor type 1 are internalized by means of the low density lipoprotein receptor-related protein/ $\alpha_2$ -macroglobulin receptor. *Proc. Natl. Acad. Sci. USA* **89**, 7422–7426.
- Osdoit, S., and Rosa, J. P. (2001). Fibrin clot retraction by human platelets correlates with  $\alpha_{IIb}\beta_3$  integrin-dependent protein tyrosine dephosphorylation. *J. Biol. Chem.* **276**, 6703–6710.
- Otto, C. M., Dodds, W. J., and Greene, C. E. (1991). Factor XII and partial prekallikrein deficiencies in a dog with recurrent gastrointestinal hemorrhage. *J. Am. Vet. Med. Assoc.* **198**, 129–131.
- Otto, C. M., Rieser, T. M., Brooks, M. B., and Russell, M. W. (2000). Evidence of hypercoagulability in dogs with parvoviral enteritis. *J. Am. Vet. Med. Assoc.* **217**, 1500–1504.
- Paczuski, R. (2002). Determination of von Willebrand factor activity with collagen-binding assay and diagnosis of von Willebrand disease: effect of collagen source and coating conditions. *J. Lab. Clin. Med.* **140**, 250–254.
- Park, B. K., and Leck, J. B. (1982). A comparison of vitamin K antagonism by warfarin, difenacoum and brodifacoum in the rabbit. *Biochem. Pharmacol.* **31**, 3635–3639.
- Patil, S., Newman, D. K., and Newman, P. J. (2001). Platelet endothelial cell adhesion molecule-1 serves as an inhibitory receptor that modulates platelet responses to collagen. *Blood* **97**, 1727–1732.
- Pelagalli, A., Lombardi, P., d'Angelo, D., Della Morte, R., Avallone, L., and Staiano, N. (2002). Species variability in platelet aggregation response to different agonists. *J. Comp. Pathol.* **127**, 126–132.
- Pereira, J., Soto, M., Palomo, I., Ocqueteau, M., Coetzee, L. M., Astudillo, S., Aranda, E., and Mezzano, D. (2002). Platelet aging *in vivo* is associated with activation of apoptotic pathways: studies in a model of suppressed thrombopoiesis in dogs. *Thromb. Haemost.* **87**, 905–909.
- Pike, R. N., Buckle, A. M., le Bonniec, B. F., and Church, F. D. (2005). Control of the coagulation system by serpins. *FEBS J.* **272**, 4842–4851.
- Pixley, R. A., De La Cadena, R., Page, J. D., Kaufman, N., Wyshock, E. G., Chang, A., Taylor, F. B., Jr, and Colman, R. W. (1993). The contact system contributes to hypotension but not disseminated intravascular coagulation in lethal bacteremia *in vivo* use of monoclonal anti-factor XII antibody to block contact activation in baboons. *J. Clin. Invest.* **91**, 61–68.
- Pixley, R. A., Schapira, M., and Colman, R. W. (1985). The regulation of human factor XII by plasma proteinase inhibitors. *J. Biol. Chem.* **260**, 1723–1729.
- Polasek, J. (2004). Procoagulation potential of platelet alpha granules. *Platelets* **15**, 403–407.
- Ponting, C. P., Marshal, J. M., and Cederholm-Williams, S. A. (1992). Plasminogen: a structural review. *Blood Coagul. Fibrinolysis* **3**, 605–614.
- Pratt, C. W., and Church, F. C. (1992). Heparin binding to protein C inhibitor. *J. Biol. Chem.* **267**, 8789–8794.
- Prescott, S. M., Zimmerman, G. A., Stafforini, D. M., and McIntyre, T. M. (2000). Platelet-activating factor and related lipid mediators. *Ann. Rev. Biochem.* **69**, 419–445.
- Preusch, P. C., Hazelett, S. E., and Lemasters, K. K. (1989). Sulfaquinoxaline inhibition of vitamin K epoxide and quinone reductase. *Arch. Biochem. Biophys.* **269**, 18–24.
- Prevost, N., Woulfe, D. S., Tognolini, M., Tanaka, T., Jian, W., Fortna, R. R., Jiang, H., and Brass, L. F. (2004). Signaling by ephrin B1 and Eph kinases in platelets promotes Rap1 activation, platelet adhesion, and aggregation via effector pathways that do not require phosphorylation of ephrin B1. *Blood* **103**, 1348–1355.
- Puri, R. N. (1998). Phospholipase A<sub>2</sub>: its role in ADP- and thrombin-induced platelet activation mechanisms. *Int. J. Biochem. Cell Biol.* **30**, 1107–1122.
- Randolph, J. F., Center, S. A., and Dodds, W. J. (1986). Factor XII deficiency and von Willebrand's disease in a family of miniature poodle dogs. *The Cornell Veterinarian* **76**, 3–10.
- Ravetch, J. V., and Lanier, L. L. (2000). Immune inhibitory receptors. *Science* **290**, 84–89.
- Reed, G. L. (2004). Platelet secretory mechanisms. *Semin. Thromb. Hemost.* **30**, 441–450.
- Rendu, F., and Brohard-Bohn, B. (2001). The platelet release reaction: granules' constituents, secretion and functions. *Platelets* **12**, 261–273.
- Rezaie, A. R. (1998). Calcium enhances heparin catalysis of the anti-thrombin-factor Xa reaction by a template mechanism: evidence that calcium alleviates Gla domain antagonism of heparin binding to Factor Xa. *J. Biol. Chem.* **273**, 16824–16827.
- Rickles, F. R., and Falanga, A. (2001). Molecular basis for the relationship between thrombosis and cancer. *Thromb. Res.* **102**, V215–V224.
- Rittenhouse, S. E. (1996). Phosphoinositide 3-kinase activation and platelet function. *Blood* **88**, 4401–4414.
- Robinson, A. J., Kropatkin, M., and Aggeler, P. M. (1969). Hageman factor (factor XII) deficiency in marine mammals. *Science* **166**, 1420–1422.
- Rojkjaer, R., and Schmaier, A. H. (1999). Activation of the plasma kallikrein/kinin system on endothelial cell membranes. *Immunopharmacol.* **43**, 109–114.
- Roncales, F. J., and Sancho, J. M. (2000). Coagulation activators. In "Schalm's Veterinary Hematology" (B. F. Feldman, J. G. Zinkl, and N. C. Jain, Eds.), 5th ed., pp. 532–537. Lippincott Williams and Wilkins, Philadelphia.
- Roy, S. N., Procyk, R., Kudryk, B. J., and Redman, C. M. (1991). Assembly and secretion of recombinant human fibrinogen. *J. Biol. Chem.* **266**, 4758–4763.

- Russell, K. E., and Grindem, C. B. (2000). Secondary thrombocytopenia. In "Schalm's Veterinary Hematology" (B. F. Feldman, J. G. Zinkl, and N. C. Jain, Eds.), 5th ed., pp. 487–495. Lippincott Williams and Wilkins, Philadelphia.
- Sakharov, D. V., Plow, E. F., and Rijken, D. C. (1997). On the mechanism of the antifibrinolytic activity of plasma carboxypeptidase B. *J. Biol. Chem.* **272**, 14477–14482.
- Sandholm, M., Vidovic, A., Puotunen-Reinert, A., Sankari, S., Nyholm, K., and Rita, H. (1995). D-dimer improves the prognostic value of combined clinical and laboratory data in equine gastrointestinal colic. *Acta Vet. Scand.* **36**, 255–272.
- Sandset, P. M., Warn-Cramer, B. J., Maki, S. L., and Rapaport, S. I. (1991). Immunodepletion of extrinsic pathway inhibitor sensitizes rabbits to endotoxin-induced intravascular coagulation and the generalized Shwartzman reaction. *Blood* **78**, 1496–1502.
- Sato, I., Anderson, G. A., and Parry, B. W. (2000). An interobserver and intraobserver study of buccal mucosal bleeding time in greyhounds. *Res. Vet. Sci.* **68**, 41–45.
- Savage, B., Cattaneo, M., and Ruggeri, Z. M. (2001). Mechanisms of platelet aggregation. *Curr. Opin. Hematol.* **8**, 270–276.
- Schwarz, U. R., Walter, U., and Eigenthaler, M. (2001). Taming platelets with cyclic nucleotides. *Biochem. Pharmacol.* **62**, 1153–1161.
- Scott, C. F., Schapira, M., James, H. L., Cohen, A. B., and Colman, R. W. (1982). Inactivation of factor XIa by plasma proteinase inhibitors. *J. Clin. Invest.* **69**, 844–852.
- Scott, M. A. (2000). Immune-mediated thrombocytopenia. In "Schalm's Veterinary Hematology" (B. F. Feldman, J. G. Zinkl, and N. C. Jain, Eds.), 5th ed., pp. 478–486. Lippincott Williams and Wilkins, Philadelphia.
- Searcy, G. P., Frojmovic, M. M., McNicol, A., Robertson, C., Wong, T., and Gerrard, J. M. (1994). Platelets from bleeding Simmental cattle mobilize calcium, phosphorylate myosin light chain and bind normal numbers of fibrinogen molecules but have abnormal cytoskeletal assembly and aggregation in response to ADP. *Thromb. Haemost.* **71**, 240–246.
- Searcy, G. P., Sheridan, D. S., and Dobson, K. A. (1990). Preliminary studies of a platelet function disorder in Simmental cattle. *Can. J. Vet. Res.* **54**, 394–396.
- Segura, D., Monreal, L., Espada, Y., Pastor, J., Mayos, I., and Homedes, J. (2005). Assessment of a platelet function analyser in horses: reference range and influence of a platelet aggregation inhibitor. *Vet. J.* **170**, 108–112.
- Segura, D., Monreal, L., Perez-Pujol, S., Pino, M., Ordinas, A., Bragues, R., White, J., and Escolar, G. (2006). Assessment of platelet function in horses: ultrastructure, flow cytometry, and perfusion techniques. *J. Vet. Intern. Med.* **20**, 581–588.
- Senzolo, M., Burra, P., Cholongitas, E., and Burroughs, A. K. (2006). New insights into the coagulopathy of liver disease and liver transplantation. *World J. Gastroenterol.* **12**, 7725–7736.
- Sere, K. M., and Hackeng, T. M. (2003). Basic mechanisms of hemostasis. *Semin. Vasc. Med.* **3**, 3–12.
- Shattil, S. J., and Newman, P. J. (2004). Integrins: dynamic scaffolds for adhesion and signaling in platelets. *Blood* **104**, 1606–1615.
- Sheafor, S. E., and Couto, C. G. (1999). Anticoagulant rodenticide toxicity in 21 dogs. *J. Am. Anim. Hosp. Assoc.* **35**, 38–46.
- Shiraishi, M., Kawashima, S., Moroi, M., Shin, Y., Morita, T., Horii, Y., Ikeda, M., and Ito, K. (2002a). A defect in collagen receptor-Ca<sup>2+</sup> signaling in platelets from cattle with Chediak-Higashi syndrome. *Thromb. Haemost.* **87**, 334–341.
- Shiraishi, M., Ogawa, H., Ikeda, M., Kawashima, S., and Ito, K. (2002b). Platelet dysfunction in Chediak-Higashi syndrome-affected cattle. *J. Vet. Med. Sci.* **64**, 751–760.
- Sidelmann, J. J., Gram, J., Jespersen, J., and Klufft, C. (2000). Fibrin clot formation and lysis: basic mechanisms. *Sem. Thromb. Hemost.* **26**, 605–618.
- Silverman, G. A., Bird, P. I., Carrell, R. W., Church, F. C., Goughlin, P. B., Gettins, P. G., Irving, J. A., Lomas, D. A., Luke, C. J., Moyer, R. W., Pemberton, P. A., Remold-O'Donnel, E., Salvesen, G. S., Travis, J., and Whisstock, J. C. (2001). The serpins are an expanding superfamily of structurally similar but functionally diverse proteins: evolution, mechanisms of inhibition, novel functions, and a revised nomenclature. *J. Biol. Chem.* **276**, 33292–33296.
- Slofstra, S. H., Spek, C. A., and ten Cate, H. (2003). Disseminated intravascular coagulation. *Hematol. J.* **4**, 295–302.
- Smedile, L. E., Houston, D. M., Taylor, S. M., Post, K., and Searcy, G. P. (1997). Idiopathic, asymptomatic thrombocytopenia in Cavalier King Charles spaniels: 11 cases. *J. Am. Anim. Hosp. Assoc.* **33**, 411–415.
- Soslau, G., Class, R., Morgan, D. A., Foster, C., Lord, S. T., Marchese, P., and Ruggeri, Z. M. (2001). Unique pathway of thrombin-induced platelet aggregation mediated by glycoprotein Ib. *J. Biol. Chem.* **276**, 21173–21183.
- Soute, B. A., Ulrich, M. M., Watson, A. D., Maddison, J. E., Ebberink, R. H., and Vermeer, C. (1992). Congenital deficiency of all vitamin K-dependent blood coagulation factors due to a defective vitamin-K dependent carboxylase in Devon Rex cats. *Thromb. Haemost.* **68**, 521–525.
- Spurling, N. W., Burton, L. K., Peacock, R., and Pilling, T. (1972). Hereditary factor-VII deficiency in the beagle. *Br. J. Haematol.* **23**, 59–67.
- Spurling, N. W., Peacock, R., and Pilling, T. (1974). The clinical aspects of canine factor-VII deficiency including some case histories. *J. Small Anim. Pract.* **15**, 229–239.
- Stearns-Kurosawa, D. J., Kurosawa, S., Mollica, J. S., Ferrell, G. L., and Esmon, C. T. (1996). The endothelial cell protein C receptor augments protein C activation by the thrombin-thrombomodulin complex. *Proc. Natl. Acad. Sci. USA*, **93**, 10212–10216.
- Steel, E. G., Witzel, D. A., and Blanks, A. (1976). Acquired coagulation factor X activity deficiency connected with *Hymenoxys odorata* DC (Compositae), bitterweed poisoning in sheep. *Am. J. Vet. Res.* **37**, 1383–1386.
- Stenflo, J., and Fernlund, P. (1982). Amino acid sequence of the heavy chain of bovine protein C. *J. Biol. Chem.* **257**, 12180–12190.
- Stockham, S. L., and Scott, M. A. (2002). Hemostasis. In "Fundamentals of Veterinary Clinical Pathology" (S. L. Stockham and M. A. Scott, Eds.), pp. 155–226. Iowa State Press, Ames.
- Stokol, T. (2003). Plasma D-dimer for the diagnosis of thromboembolic disorders in dogs. *Vet. Clin. North Am. Small Anim. Pract.* **33**, 1419–1435.
- Stokol, T., Brooks, M., Erb, H., and Mauldin, G. E. (1999). Evaluation of kits for the detection of fibrin(ogen) degradation products in dogs. *J. Vet. Intern. Med.* **13**, 478–484.
- Stokol, T., Brooks, M. B., and Erb, H. N. (2000a). Effect of citrate concentration on coagulation test results in dogs. *J. Am. Vet. Med. Assoc.* **217**, 1672–1677.
- Stokol, T., Brooks, M. B., Erb, H. N., and Mauldin, G. E. (2000b). D-dimer concentrations in healthy dogs and dogs with disseminated intravascular coagulation. *Am. J. Vet. Res.* **61**, 393–398.
- Sullivan, P. S., Evans, H. L., and McDonald, T. P. (1994). Platelet concentration and hemoglobin function in greyhounds. *J. Am. Vet. Med. Assoc.* **205**, 838–841.

- Tablin, F. (2000). Platelet structure and function. In "Schalm's Veterinary Hematology" (B. F. Feldman, J. G. Zinkl, and N. C. Jain, Eds.), 5th ed., pp. 448–452. Lippincott Williams and Wilkins, Philadelphia.
- Thomas, J. S. (1996). von Willebrand's disease in the dog and cat. *Vet. Clin. North Am. Small Anim. Pract.* **26**, 1089–1111.
- Thompson, M. S., and Kreeger, J. M. (1999). Acute paraplegia in a puppy with hemophilia A. *J. Am. Anim. Hosp. Assoc.* **35**, 36–37.
- Tollefsen, D. M. (2004). Does heparin cofactor II modulate atherosclerosis and restenosis? *Circulation* **109**, 2682–2684.
- Topper, M. J., and Prasse, K. W. (1996). Use of enzyme-linked immunosorbent assay to measure thrombin-antithrombin III complexes in horses with colic. *Am. J. Vet. Res.* **57**, 456–462.
- Toth-Zsamboki, E., Oury, C., Cornelissen, H., DeVos, R., Vermynen, J., and Hoylaerts, M. F. (2003). P2X<sub>1</sub>-mediated ERK2 activation amplifies the collagen-induced platelet secretion by enhancing myosin light chain kinase activation. *J. Biol. Chem.* **278**, 46661–46667.
- Toulza, O., Center, S. A., Brooks, M., Erb, H., Warner, K. L., and Deal, W. (2006). Evaluation of protein C activity for detection of hepatobiliary disease and portosystemic shunting in dogs. *J. Am. Vet. Med. Assoc.* **229**, 1761–1771.
- Tran Tri, H., and Duckert, F. (1984). Heparin cofactor II determination levels in normals and patients with hereditary antithrombin III deficiency and disseminated intravascular coagulation. *Thromb Haemost.* **52**, 112–116.
- Triplett, D. A. (2000). Coagulation and bleeding disorders: review and update. *Clin. Chem.* **46**, 1260–1269.
- Troxel, M. T., Brooks, M., and Esterline, M. L. (2002). Congenital factor XI deficiency in a domestic shorthair cat. *J. Am. Anim. Hosp. Assoc.* **38**, 553.
- Tseng, L. W., Hughes, D., and Giger, U. (2001). Evaluation of a point-of-care coagulation analyzer for measurement of prothrombin time, activated partial thromboplastin time, and activated clotting time in dogs. *Am. J. Vet. Res.* **62**, 1455–1460.
- Tsiang, M., Lentz, S. R., and Sadler, J. E. (1992). Functional domains of membrane-bound human thrombomodulin. EGF-like domains four to size and the serine/threonine-rich domain are required for cofactor activity. *J. Biol. Chem.* **267**, 6164–6170.
- Tsikouris, J. P., Suarez, J. A., and Meyerrose, G. E. (2002). Plasminogen activator inhibitor-1: physiologic role, regulation, and the influence of common pharmacologic agents. *J. Clin. Pharmacol.* **42**, 1187–1199.
- Turrentine, M. A., Sculley, P. W., Green, E. M., and Johnson, G. S. (1986). Prekallikrein deficiency in a family of miniature horses. *Am. J. Vet. Res.* **47**, 2464–2467.
- Van de Wouwer, M., Collen, D., and Conway, E. M. (2004). Thrombomodulin-protein C-EPCR system. Integrated to regulate coagulation and inflammation. *Arterioscler. Thromb. Vasc. Biol.* **24**, 1374–1383.
- van der Merwe, L., and Reyers, F. (2007). The effect of hemolysis on plasma antithrombin activity as determined by a chromogenic method. *Vet. Clin. Pathol.* **36**, 55–59.
- VanderVelden, P., and Giles, A. R. (1988). A detailed morphological evaluation of the evolution of the haemostatic plug in normal, factor VII and factor VIII deficient dogs. *Br. J. Haematol.* **70**, 345–355.
- van Zonneveld, A. J., Veerman, H., McDonald, M. E., van Mourik, J. A., and Pannekoek, H. (1986). Structure and function of human tissue-type plasminogen activator (t-PA). *J. Cell Biochem.* **32**, 169–178.
- Vincent, J. L. (2003). Infection/inflammation and hemostasis. *Curr. Hematol. Rep.* **2**, 407–410.
- Wachtfogel, Y. T., Dela, C. R., and Colman, R. W. (1993). Structural biology, cellular interactions and pathophysiology of the contact system. *Thromb. Res.* **72**, 1–21.
- Walker, F. J. (1984). Protein S and the regulation of activated protein C. *Sem. Thromb. Haemost.* **10**, 131–138.
- Warshawsky, I., Broze, G. J., and Schwartz, A. L. (1994). The low density lipoprotein receptor-related protein mediates the cellular degradation of tissue factor pathway inhibitor. *Proc. Natl. Acad. Sci. USA* **91**, 6664–6668.
- Weiser, M. G., and Kociba, G. J. (1984). Platelet concentration and platelet volume distribution in healthy cats. *Am. J. Vet. Res.* **45**, 518–522.
- Weiss, D. J., and Brazzell, J. L. (2006). Detection of activated platelets in dogs with primary immune-mediated hemolytic anemia. *J. Vet. Intern. Med.* **20**, 682–686.
- Weitz, J. I., Hudoba, M., Massel, D., Maraganore, J., and Hirsh, J. (1990). Clot-bound thrombin is protected from inhibition by heparin-antithrombin III but is susceptible to inactivation by antithrombin III-independent inhibitors. *J. Clin. Invest.* **86**, 385–391.
- Welles, E. G. (1996). Antithrombotic and fibrinolytic factors. A review. *Vet. Clin. North Am. Small Anim. Pract.* **26**, 1111–1127.
- Wiinberg, B., Jensen, A. L., Rojksjaer, R., Johansson, P., Kjelgaard-Hansen, M., and Kristensen, A. T. (2005). Validation of human recombinant tissue factor-activated thromboelastography on citrated whole blood from clinically healthy dogs. *Vet. Clin. Pathol.* **34**, 389–393.
- Wilkerson, M. J., Johnson, G. S., Stockham, S., and Riley, L. (2005). Afibrinogenemia and a circulating antibody against fibrinogen in a Bichon Frise dog. *Vet. Clin. Pathol.* **34**, 148–155.
- Williams, M. J., Du, X., Loftus, J. C., and Ginsberg, M. H. (1995). Platelet adhesion receptors. *Cell Biol.* **6**, 305–314.
- Wu, H. L., Chang, B. I., Wu, D. H., Chang, L. C., Gong, C. C., Lou, K. L., and Shi, G. Y. (1990). Interaction of plasminogen and fibrin in plasminogen activation. *J. Biol. Chem.* **265**, 19658–19664.
- Yang, J., Wu, J., Jiang, H., Mortensen, R., Austin, S., Manning, D. R., Woulfe, D., and Brass, L. F. (2002). Signaling through G<sub>i</sub> family members in platelets: redundancy and specificity in the regulation of adenylyl cyclase and other effectors. *J. Biol. Chem.* **277**, 46035–46042.
- Yang, L., Manithody, C., Walston, T. D., Cooper, S. T., and Rezaie, A. R. (2003). Thrombomodulin enhances the reactivity of thrombin with protein C inhibitor by providing both a binding site for the serpin and allosterically modulating the activity of thrombin. *J. Biol. Chem.* **278**, 37465–37470.
- Yilmaz, Z., Ilcol, Y. O., and Ulus, I. H. (2005). Investigation of diagnostic importance of platelet closure times measured by Platelet Function Analyzer-PFA 100 in dogs with endotoxemia. *Berl. Munch. Tierarztl. Wochenschr.* **118**, 341–348.
- Yuksel, M., Okajima, K., Uchiba, M., Horiuchi, S., and Okabe, H. (2002). Activated protein C inhibits lipopolysaccharide-induced tumor necrosis factor- $\alpha$  production by inhibiting activation of both nuclear factor- $\kappa$ B and activator protein-1 in human monocytes. *Thromb. Haemost.* **88**, 267–273.
- Zarbock, A., Polanowska-Grabowska, R. K., and Ley, K. (2007). Platelet-neutrophil-interactions: linking hemostasis and inflammation. *Blood Rev.* **21**, 99–111.
- Zimmerman, K. L. (2000). Drug-induced thrombocytopenias. In "Schalm's Veterinary Hematology" (B. F. Feldman, J. G. Zinkl, and N. C. Jain, Eds.), 5th ed., pp. 472–477. Lippincott Williams and Wilkins, Philadelphia.

# Neutrophil Function

Douglas J. Weiss

*Department of Veterinary Pathobiology  
College of Veterinary Medicine  
University of Minnesota  
St. Paul, Minnesota*

Bruce Walcheck

*Department of Veterinary and Biomedical Sciences  
College of Veterinary Medicine  
University of Minnesota  
St. Paul, Minnesota*

## I. INTRODUCTION

### II. NEUTROPHIL FUNCTIONS

- A. Adherence and Chemoattractants
- B. Phagocytosis
- C. Bactericidal Mechanisms
- D. Neutrophil-Mediated Amplification of Inflammation

### III. VIRULENCE FACTORS PREVENTING NEUTROPHIL-MEDIATED KILLING

### IV. ACQUIRED NEUTROPHIL FUNCTION DEFECTS

- A. Neutrophil Dysfunction in Periparturient Dairy Cattle
- B. Neutrophil Dysfunction in Neonatal Animals
- C. Neutrophil Dysfunction Associated with Viral Infection
- D. Effects of Nutrition on Neutrophil Function
- E. Effects of Stress on Neutrophil Function

### V. NEUTROPHIL-MEDIATED TISSUE INJURY

- A. Neutrophil-Mediated Injury at Sites of Inflammation
- B. Ischemia/Reperfusion Injury
- C. Neutrophil-Mediated Injury at Distant Sites
- D. Role of Neutrophils in Microvascular Thrombosis

## REFERENCES

## I. INTRODUCTION

Pluripotential hematopoietic stem cells in the bone marrow differentiating in response to specific growth factors give rise to committed progenitors and then neutrophils. These cells are characterized by their multilobed nuclei and abundant granules in the cytoplasm (polymorphonuclear neutrophilic granulocytes). Except in disease states, only functionally mature neutrophils are released into the blood from the bone marrow, and these cells contain much

of their effector molecules prepackaged in cytoplasmic granules or in the plasma membrane. Mature neutrophils do not multiply but instead are continuously replaced. Neutrophils circulate in the blood for only a few hours and survive in the tissue for only a few days; however, this can be extended by a day or two upon their exposure to various activating agents at sites of inflammation. In any case, neutrophils eventually succumb to programmed cell death by an intrinsic or extrinsic apoptotic pathway. Once neutrophils are recruited into the underlying tissue from the blood and encounter a microorganism, they phagocytize and kill the pathogen to eliminate the infection. This chapter provides an overview of the mechanisms of neutrophil adherence, chemotaxis, phagocytosis, and organism killing. It also discusses congenital and acquired defects in neutrophil function that predispose animals to infection. Finally, this chapter discusses neutrophil-mediated tissue injury.

## II. NEUTROPHIL FUNCTIONS

### A. Adherence and Chemoattractants

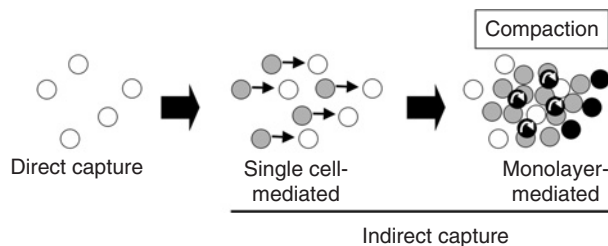
#### 1. Overview

The recruitment of neutrophils to sites of tissue injury and infection is a hallmark of the acute inflammatory response. Efficient neutrophil extravasation at sites of inflammation requires a coordinated cascade of adhesive and signaling events. Neutrophils leave the flowing blood stream by first tethering and then rolling on the inflamed endothelium lining the blood vessel lumen. In the systemic circulation, this occurs primarily as neutrophils enter the venule from the capillaries (postcapillary venules) and in the collecting venules (Atherton, 1972; Schmid-Schonbein *et al.*, 1980). With the appropriate chemoattractants, rolling neutrophils will arrest (stop rolling) becoming firmly adherent to the endothelial surface and then migrate across the endothelium.

Estimates from *in vitro* studies of leukocyte extravasation show the process to be rapid, with transmigration being completed in <2 minutes (Beesley *et al.*, 1978; Burns *et al.*, 1997). Neutrophil transendothelial migration can occur through distinct routes, either paracellular (between endothelial cells) or transcellular (through endothelial cells) (Feng *et al.*, 1998; Yang *et al.*, 2005). Some of the first observations of leukocyte interactions with the vascular wall come from Albrecht von Haller (1756), Rudolf Virchow (1871), and Rudolf Wagner (1839). Early mechanistic insights into leukocyte transmigration came from Julius Conheim (1877, 1889) and Elle Metchnikoff (1893), who attributed leukocyte emigration to activities primarily by endothelial cells or leukocytes, respectively. Research since the 1980s has greatly enhanced our understanding of the molecular basis for the regulation of leukocyte interactions with the vascular endothelium at sites of inflammation. The following is a general overview of the various physiological parameters, adhesion molecules, and chemoattractants that play a critical role in neutrophil capture/rolling, activation, and arrest/locomotion.

## 2. Physiological Factors Contributing to Neutrophil Adherence

Neutrophil accumulation predominantly occurs along the vascular endothelium of venules as a result of several physiological factors. Neutrophil capture by the endothelium is enhanced by red blood cells, those lined up behind neutrophils as they leave the capillaries as well as by red blood cells occupying the center of the bloodstream, which force neutrophils toward the venular endothelium (Nobis *et al.*, 1985; Schmid-Schonbein *et al.*, 1980). Endothelial cells lining postcapillary venules in secondary lymphoid organs of humans and mice (high endothelial cell venules) bulge into the luminal space, thus increasing their collision with lymphocytes (Von Andrian, 1996). Though endothelial cells lining venules in nonlymphoid tissues tend to be flat, attached neutrophils at sites of inflammation appear to provide temporary extensions into the blood vessel lumen, causing collisions and capture of free-flowing neutrophils. This process is referred to as indirect or secondary capture (tethering) and was observed as early as 1955 when Allison and colleagues reported that “leukocytes were frequently seen to stick to one another, indicating that the increased adhesiveness characteristic of the inflammatory response is not limited to the endothelium” (Allison *et al.*, 1955). Indeed, neutrophils individually and as a monolayer facilitate indirect capture, and this appears to accelerate and sustain their accumulation (Bargatze *et al.*, 1994; Eriksson *et al.*, 2001; Sperandio *et al.*, 2003; St. Hill *et al.*, 2003; Walcheck *et al.*, 1996). In addition, because leukocyte accumulation on activated endothelium at sites of inflammation shows spatial variability (Kunkel *et al.*,



**FIGURE 11-1** Indirect (2°) neutrophil capture increases their accumulation rate and density on the vascular endothelium. Direct neutrophil binding to the endothelium (e.g., via P-selectin) occurs randomly (open circles). Next, neutrophil-neutrophil interactions mediate two means of indirect capture. Individual attached neutrophils capture free-flowing neutrophils (gray circles) during initial neutrophil accumulation. In addition, a monolayer of attached neutrophils will capture free-flowing neutrophils, which roll across the neutrophil monolayer (black circles containing arrows) resulting in pavementing by the neutrophils and their compaction in discrete locations.

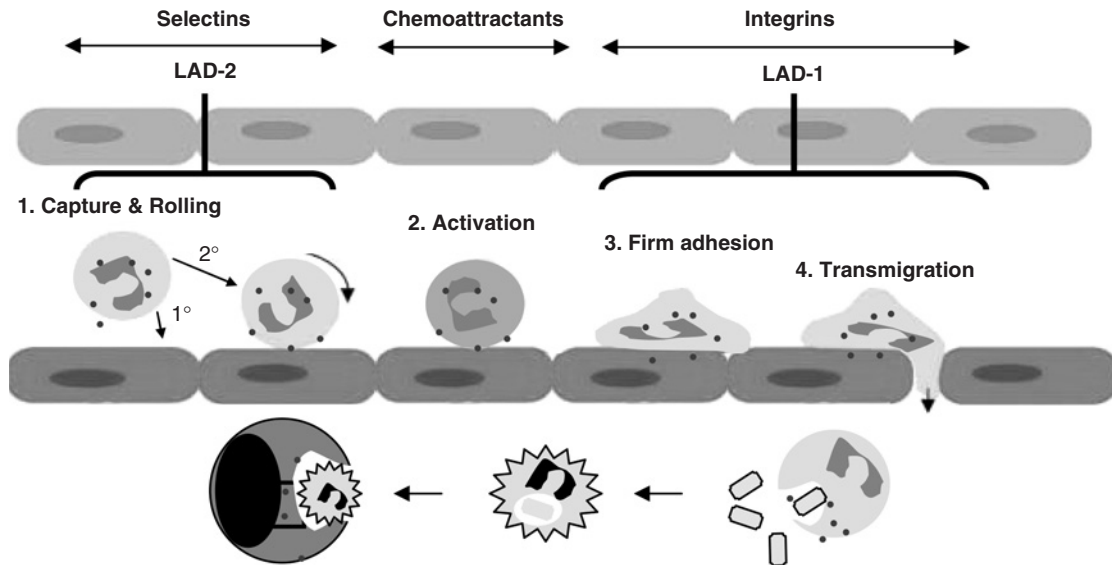
1998), indirect capture may be a mechanism for compacting (pavementing) leukocytes within discrete sites of activated endothelium, as illustrated in Figure 11-1.

Neutrophils from the flowing blood that adhere to the vascular endothelium incur forces (wall shear stresses) that are affected by several factors, including blood flow velocity, vessel diameter, red blood cell concentration, and plasma viscosity. Shear stresses on adhered neutrophils in venules *in vivo* range between  $\sim 1$  and  $35$  dynes/cm<sup>2</sup>, assuming a cell-free, plasma viscosity of 1.1 centipoise (Damiano *et al.*, 1996). In general, leukocyte adhesion and rolling are reduced with increasing wall shear stress (Damiano *et al.*, 1996). The wall shear stress is generally lower in venules than in arterioles of equal size. These forces are balanced by the interaction of adhesion molecules on the leukocyte with those on the endothelium, which is discussed in more detail later.

## 3. Selectins

Selectins mediate the initial interactions between neutrophils and the endothelium resulting in their attachment and rolling at velocities considerably below that of cells in the flowing blood. The nature of cell adhesion mediated by selectins differs from that mediated by most other classes of adhesion molecules. Rapid on and off bonding events between selectins and their ligands cause leukocytes attached to the endothelium to roll under blood flow conditions (Fig. 11-2). There are three known selectins, each with a highly specific pattern of cellular expression. Forgoing the listing of all of their earlier more descriptive names, they are known today by single letters designating the cell type by which they were first identified. L-selectin (CD62L) is expressed by leukocytes, E-selectin (CD62E) expression is limited to endothelial cells, and P-selectin (CD62P) is expressed by platelets as well as endothelial cells.





**FIGURE 11-2** Multistep process of neutrophil effector functions. Neutrophils in flowing blood initially accumulate along the vascular endothelium by direct ( $1^\circ$ ) or indirect ( $2^\circ$ ) capture. The tethered neutrophils then roll and upon chemoattractant recognition become activated. This leads to firm adhesion and transendothelial cell migration. Upon entering the underlying tissues, neutrophils phagocytize bacterial pathogens, which induces their programmed cell death (apoptosis). Eventually, the apoptotic neutrophils are recognized and engulfed by macrophages to down-regulate the inflammatory response. Additionally, this figure depicts the site of classical leukocyte adhesion deficiency (LAD-1), a deficiency of CD18, and LAD-2, a defect in the selectin-mediated adhesion.

The selectins are type I integral membrane proteins composed of distinct tandem protein domains. At the amino-terminus is a C-type ( $\text{Ca}^{+2}$ -dependent) lectin domain. Following this is a single epidermal growth factor (EGF)-like domain, followed by a series of short-consensus-repeat (SCR) domains. Next are a transmembrane domain and a short cytoplasmic region. The genes for the selectins are arranged in tandem on chromosome 1 for both mouse and human, indicating that they arose by gene-duplication (Watson *et al.*, 1990). Selectin ligands are carbohydrate in nature, and the lectin domain of the selectins is responsible for ligand specificity and recognition (Weis *et al.*, 1998).

E-selectin expression is induced on most cultured endothelium as well as most postcapillary endothelium *in vivo* by a number of inflammatory mediators (Bevilacqua *et al.*, 1989). Induction of E-selectin by cytokines occurs exclusively at the transcriptional level. E-selectin mRNA is first detectable approximately 2h after initial exposure of endothelial cells to cytokine. In cultured endothelium, E-selectin expression peaks in 4 to 8h, and subsequently declines even in the continued presence of the cytokine. *In vivo*, however, E-selectin can be chronically expressed at sites of inflammation, especially in the skin (Ley and Kansas, 2004).

P-selectin is expressed on both activated platelets and activated endothelium. Unlike E-selectin, P-selectin is expressed in the Weibel-Palade bodies of endothelial cells as well as the  $\alpha$ -granules of platelets (Bonfanti *et al.*, 1989;

McEver *et al.*, 1989). Exposure of either of these two cell types to various stimuli induces rapid (seconds to minutes) fusion of the P-selectin-containing granules with the outer membrane of the cell, exposing P-selectin at the cell surface. In the case of endothelial cells, histamine released from tissue mast cells in response to an inflammatory insult is one of the physiological inducers of rapid P-selectin expression. Interestingly, P-selectin-deficient mice have a defect in leukocyte rolling immediately following tissue exteriorization, as determined by intravital microscopy, and neutrophil recruitment into inflammatory lesions is delayed by about 2h (Mayadas *et al.*, 1993). In addition to its rapid surface expression, P-selectin is also transcriptionally induced (Weller *et al.*, 1992). Moreover, P-selectin can be chronically expressed at sites of long-standing inflammation, such as atherosclerotic vessels, rheumatoid arthritis, and psoriasis (Grober *et al.*, 1993; Johnson-Tidey *et al.*, 1994; Terajima *et al.*, 1998).

Neutrophils uniformly and constitutively express L-selectin. This selectin arguably plays the broadest and most significant role of the family members in neutrophil accumulation on the endothelium as it mediates both direct and indirect capture. In an assortment of inflammatory models, leukocyte accumulation along the microvasculature and recruitment into the tissue were greatly reduced ( $\sim 60\%$  to  $85\%$ ) upon blocking L-selectin function with antibodies or in L-selectin-deficient mice (Davenpeck *et al.*, 1997;



Jung *et al.*, 1998; Kanwar *et al.*, 1999; Ley *et al.*, 1993; Tedder *et al.*, 1995; Von Andrian *et al.*, 1991, 1992, 1993).

Consistent with L-selectin's broad role in neutrophil recruitment, it is tightly regulated. For instance, neutrophils down-regulate L-selectin expression by ectodomain proteolysis (shedding) in a very efficient and rapid manner upon their stimulation by cytokines and chemoattractants (Alexander *et al.*, 2000; Kishimoto *et al.*, 1989; Rizoli *et al.*, 1999; Walcheck *et al.*, 1996). Studies performed *in vitro* and *in vivo* indicate that L-selectin shedding affects leukocyte adhesiveness and recruitment (Hafezi-Moghadam and Ley, 1999; Venturi *et al.*, 2003, Walcheck *et al.*, 1996). In addition, homeostatic L-selectin shedding maintains high levels of soluble L-selectin in the serum (~1 to 3 µg/ml) (Kishimoto *et al.*, 1995; Palecanda *et al.*, 1992), which is functional and can diminish leukocyte-endothelium interactions. Soluble L-selectin may thus serve as an adhesion buffer to suppress neutrophil accumulation below a certain inflammatory threshold. Interestingly, a reduced level of serum L-selectin correlates with susceptibility to inflammatory disease (Donnelly *et al.*, 1994; Seidelin *et al.*, 2002). TNF- $\alpha$  converting enzyme (TACE or ADAM17) appears to be a key sheddase of L-selectin upon overt cell activation.

The selectin family of adhesion proteins is highly selective lectins that recognize specific glycan structures displayed in most cases on an appropriate protein backbone. The main glycoprotein ligand for P-selectin on neutrophils is a homodimeric sialomucin designated PSGL-1 (P-selectin glycoprotein ligand-1) (Moore *et al.*, 1995; Sako *et al.*, 1993). PSGL-1 also serves as the primary ligand for L-selectin during leukocyte-leukocyte facilitated indirect neutrophil accumulation along the endothelium (Walcheck *et al.*, 1996). Importantly, specific posttranslational modifications of PSGL-1 are required for L- and P-selectin recognition. PSGL-1 has a tyrosine sulfate motif at its amino-terminus, and mutational analyses have revealed that at least one of the three tyrosines in the motif must be sulfated for recognition (Pouyani and Seed, 1995; Sako *et al.*, 1995). In addition, a threonine residue just downstream from the tyrosine sulfate motif must be modified by sialylated, fucosylated oligosaccharides, such as a core 2 O-glycan terminated by sialyl Lewis X (sLe<sup>X</sup>) (Leppanen *et al.*, 1999, 2003). PSGL-1 has also been reported to function as a ligand for E-selectin (Asa *et al.*, 1995; Sako *et al.*, 1993). However, leukocytes derived from PSGL-1 knockout mice demonstrated no obvious defect in rolling on E-selectin (Yang *et al.*, 1999). Altogether, various studies suggest that PSGL-1 expression by neutrophils is not as critical for E-selectin binding as it is for L- and P-selectin. Indeed, other E-selectin ligands on neutrophils have been described, including E-selectin ligand-1 (ESL-1), glycolipids, and L-selectin (Alon *et al.*, 1995; Steegmaier *et al.*, 1995). In addition to recognizing its leukocyte ligand PSGL-1, L-selectin on neutrophils also mediates their

direct accumulation on the endothelium, yet these endothelial ligands remain poorly characterized.

#### 4. Chemoattractants

Chemoattractants are small soluble molecules that bind to receptors on leukocytes causing their stimulation, polarization, and locomotion, in part through the activation of the integrin adhesion molecules. Leukocyte locomotion toward higher concentrations of a chemoattractant is referred to as chemotaxis, and this can occur in a hierarchical manner. For instance, neutrophils become less sensitive to an initially encountered chemoattractant gradient, allowing them to then respond to a newly encountered chemoattractant (Foxman *et al.*, 1997, 1999). This process allows neutrophils to find their ultimate target through a complex stimulant environment. Different classes of chemoattractants include chemokines, lipid mediators, complement factors, and other peptides. The largest class of chemoattractants constitutes the chemokines, a superfamily of small, secreted proteins (8 to 10 kDa). The chemokines are structurally homologous and are subdivided into four subfamilies based on the position of conserved cysteine residues near the amino-terminus of the molecules (Rot and von Andrian, 2004). CXC chemokines ( $\alpha$ -chemokines) are characterized by the presence of two cysteine residues that are separated by one amino acid, CC chemokines ( $\beta$ -chemokines) have two cysteine residues that are adjacent, C chemokines have one cysteine residue near the amino-terminus, and the CXXXC subfamily is characterized by cysteines being separated by three amino acids. The CC and CXC chemokines represent the largest of the chemokine families and contain many members. The C and CXXXC subfamilies together consist of three members at this time. The CXC chemokines can be further subdivided based on the presence or absence of a glutamic acid-lysine-arginine (ELR) sequence preceding the CXC motif. This structural difference determines separate functional activities of chemokines in this subfamily. CXC chemokines that contain an ELR sequence (e.g., IL-8) are chemotactic for neutrophils, whereas non-ELR-containing CXC chemokines and CC chemokines appear not to be active on neutrophils (DeVries *et al.*, 1999). Chemokines induce leukocyte activation and locomotion by binding to specific G-protein-coupled cell surface receptors. Most chemokine receptors recognize more than one chemokine, and several chemokines can bind to more than one receptor. However, there is receptor-ligand specificity within chemokine subfamilies, with CXC chemokines binding exclusively to CXC receptors and CC chemokines binding to CC receptors (Rot and von Andrian, 2004).

#### 5. Integrins

Integrins mediate neutrophil firm adhesion and locomotion by interacting with ligands on cells and in the extracellular

matrix with a dependence on divalent cations (Fig. 11-2). Integrins are noncovalent heterodimers ( $\alpha$  and  $\beta$  subunits) of type I transmembrane glycoproteins, and are made up of various subfamilies that are organized around a particular subunit (Harris *et al.*, 2000). For instance, the  $\beta_2$  (CD18) subfamily is expressed on all cells of hematopoietic origin and plays a critical role in neutrophil transendothelial cell migration (Simon and Green, 2005) and other key effector activities, such as phagocytosis and apoptosis (Mayadas and Cullere, 2005). CD18 integrins are present in an inactive state on circulating leukocytes; however, upon cell stimulation with various stimuli (e.g., chemoattractants) and ligand interactions, they undergo rapid affinity and valency changes required for optimal integrin function (Carman and Springer, 2003). There are four known  $\alpha$  (CD11) subunits that can combine with the CD18 subunit to form unique receptors. The  $\alpha$  subunits are defined, in part, as CD11a, b, c, and d. The  $\alpha$  and  $\beta$  subunits are expressed from different genes and can be independently expressed on different cell types.

*CD11a/CD18* ( $\alpha_L\beta_2$  or lymphocyte function-associated antigen [LFA-1]) is the most broadly expressed leukocyte integrin. It is expressed on early hematopoietic progenitor cells and on all mature leukocytes. LFA-1 interacts with cell surface ligands known as intercellular adhesion molecules (ICAMs). ICAMs are type I transmembrane glycoproteins and belong to the immunoglobulin superfamily (Kishimoto and Rothlein, 1994). ICAM-1 is expressed on resting endothelium and is induced on many cell types by inflammatory cytokines. LFA-1 also binds to ICAM-2 or ICAM-3, which are mainly expressed on endothelial cells and leukocytes, respectively. ICAM-1 is a more active LFA-1 ligand than ICAM-2 or ICAM-3.

*CD11b/CD18* ( $\alpha_M\beta_2$  or Mac-1) is constitutively expressed by neutrophils, monocytes, and macrophages. Mac-1 is stored in endosome-like vesicles in neutrophils that are translocated to the surface following certain types of activation, allowing increased Mac-1 surface expression (Borregaard *et al.*, 1987). Mac-1, like LFA-1, is less active on resting cells than activated cells. Mac-1 also interacts with ICAM-1, but at a site distinct from LFA-1 (Diamond *et al.*, 1991). Both of these CD18 subfamily members function as the primary integrins that mediate arrest and transmigration at sites of inflammation. Mac-1 interacts with a wider variety of ligands compared to LFA-1, including fibronectin, fibrinogen, vitronectin, laminin, collagen, ICAM-2, albumin, myeloperoxidase, kininogen, elastase, heparin, and zymosan (Kishimoto and Rothlein, 1994; Simon and Green, 2005). Mac-1 also participates in a number of adhesion reactions where the nature of the ligand is not known, such as adhesion of neutrophils to plastic or glass surfaces and binding to a variety of denatured proteins, suggesting a scavenger receptor-like function. Of particular importance is that Mac-1, also referred to as complement receptor 3, binds to C3bi. This complement fragment bonds to surfaces when triggered by immunoglobulin or microbial surfaces, and particles

coated with C3bi (opsonization) are readily phagocytized by neutrophils (Mayadas and Cullere, 2005).

*CD11c/CD18* ( $\alpha_X\beta_2$  or P150,95) is highly homologous to Mac-1, but it is expressed at lower levels on neutrophils and not nearly as well studied. Like Mac-1, CD11c/CD18 binds to some of the same ligands, including C3bi as well as binding to many pathogens directly to promote their phagocytosis, fibrinogen, and a variety of denatured proteins (Kishimoto and Rothlein, 1994; Mayadas and Cullere, 2005).

*CD11d/CD18* ( $\alpha_D\beta_2$ ) is the most recently defined member of the leukocyte integrin family and is expressed on tissue macrophages, dendritic cells, and eosinophils and binds to ICAM-3 and vascular cell adhesion molecule-1 (VCAM-1) (Danilenko *et al.*, 1995; Grayson *et al.*, 1998; Van der Vieren *et al.*, 1995). The later binding interaction may contribute to recruitment of eosinophils to inflamed airways.

## 6. Leukocyte Adhesion Deficiency

Leukocyte adhesion deficiency (LAD) syndromes (LAD-1, LAD-1 variants, and LAD-2) result in immunodeficiency disorders caused by an impaired extravasation of neutrophils into sites of inflammation because of dysfunctional selectin- or integrin-mediated adhesion events (Fig. 11-2). The LAD syndromes are relatively uncommon; however, the clinical consequences are often severe and lethal and include recurrent or unresolved localized infections, systemic sepsis, and impaired wound surveillance and repair.

Classical leukocyte adhesion deficiency type I (LAD-1) is an autosomal recessive disorder arising from germline mutations in the gene encoding CD18 and thus affects all CD18 subfamilies. LAD-1 has been described in humans, Holstein cattle, and dogs (Anderson and Springer, 1987; Gu *et al.*, 2004; Nagahata, 2004). In humans, the CD18-integrin subunit is either not synthesized or unable to associate with the respective CD11 subunits, and the resulting LAD can be characterized as severe to moderate. Children with severe deficiency typically display less than 1% of normal levels of CD11/CD18, and children with moderate deficiency typically express 5% to 10% of normal levels of the integrin.

Bovine leukocyte adhesion deficiency (BLAD) has been extensively investigated (Nagahata, 2004; Shuster *et al.*, 1992). The molecular basis of BLAD is a single point mutation that results in an aspartic acid to glycine substitution at amino acid 128 of the CD18 polypeptide. Interestingly, expression of L-selectin on neutrophils from BLAD calves appears to be reduced as well. Neutrophil adhesion is markedly impaired and chemotactic responses are diminished. The hallmark clinical findings in BLAD include recurrent or chronic diarrhea, chronic pneumonia, ulcerative stomatitis, gingivitis, chronic dermatitis, stunted growth, and impaired wound healing. Persistent and severe neutrophilia is the most prominent hematological finding; however, neutrophil morphology is normal. Pathological lesions are primarily located in the lungs and intestinal tract. Neutrophils

are present within the lung lesions but not within intestinal ulcers or lesions in other tissues. Therefore, neutrophils can enter the lung by integrin-independent processes (Ackermann *et al.*, 1996).

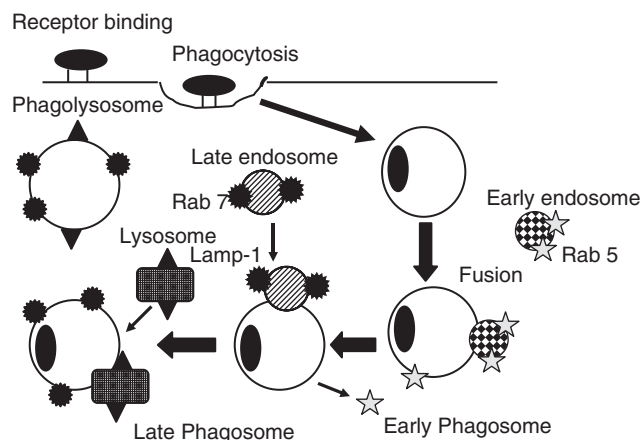
Canine leukocyte adhesion deficiency (CLAD) occurs in Irish setter and Irish setter-cross-bred dogs (Giger *et al.*, 1987; Gu *et al.*, 2004; Kijas *et al.*, 1999; Renshaw *et al.*, 1975). As with BLAD, the molecular basis of CLAD is due to a single point mutation; however, in the dog, a cysteine at amino acid 36 is substituted for a serine. This cysteine is a highly conserved residue in the extracellular domain of CD18, and the structural defect from the mutation results in the failure to express the CD11/CD18 complex on the leukocyte surface. Affected dogs develop severe bacterial infections shortly after birth and usually die or are euthanized.

More recently, variant forms of LAD-1 have been reported in humans in which CD18 integrins are expressed on the surface of leukocytes at normal levels but fail to support their adhesion (Wehrle-Haller and Imhof, 2003). In one case, LAD-1 was caused by a point mutation in the  $\beta_2$ -integrin, rendering it nonresponsive to inside-out activation of leukocytes (Hogg *et al.*, 1999). In other cases, the leukocyte adhesion deficiency was extended to various integrin families as well, including  $\beta_1$ -,  $\beta_2$ -, and  $\beta_3$ -integrin function. Interestingly, these latter cases result from a failure by intracellular factor(s) or signaling pathway(s) essential for integrin activation/clustering. Under physiological shear stress, these LAD-affected leukocytes are unable to generate firm adhesion and arrest.

Another human adhesion deficiency (LAD-2) was first described in 1992 in two children of Arab origin (Etzioni *et al.*, 1992). LAD-2 is a rare congenital disease resulting in mutations in a GDP-fucose transporter and a generalized fucosylation defect that affects  $\alpha 1,2$ -,  $\alpha 1,3$ -,  $\alpha 1,4$ -, and  $\alpha 1,6$ -linkages of fucose in glycoproteins and glycolipids (Wild *et al.*, 2002). Among other effects, LAD-2 neutrophils demonstrate strongly reduced sLe<sup>x</sup> expression, which diminishes their adhesivity with the selectin family members and their accumulation on endothelium (Fig. 11-2). Thus, this disorder disrupts leukocyte extravasation at an earlier stage than LAD-1.

## B. Phagocytosis

The process of phagocytosis has been extensively studied in macrophages but less well studied in neutrophils. Therefore, we will present a general overview of phagocytosis based on knowledge gained primarily from macrophages. Phagocytic cells ingest bacteria and other particulate material by receptor-mediated phagocytosis (Peyron *et al.*, 2001; Stossel, 1974). This process forms a vesicle around the organism and internalizes it (Fig. 11-3). After internalization, the vesicle containing the organism undergoes a stepwise process of maturation in which the vesicle fuses with early



**FIGURE 11-3** Receptor-mediated phagocytosis of organisms by leukocytes. After binding of organisms to cell membrane receptors, organisms are endocytosed into a phagosome. After fusion with early endosomes, the early phagosome is characterized by the presence of Rab5. Acidification of the phagosome occurs at this stage. Thereafter, fusion with late endosomes results in acquisition of Rab7 and shedding of Rab5. The late phagosome then fuses with lysosomes, forming the phagolysosome that is characterized by the presence of Rab7 and Lamp-1.

and late endosomes and lysosomes to create a phagolysosome. Within the phagolysosome, lysosomal enzymes and reactive oxygen radicals digest organisms. The process of phagolysosome fusion and organism killing is complex, and the details are still being investigated. Fusion of early endosomes coincides with initiation of vesicle acidification. This phase is marked by the presence of high levels of the GTP-binding protein Rab5 on the phagosome membrane. It is not clear whether Rab5 is brought to phagosome by the early endosome or is acquired from the cytoplasm (Via *et al.*, 1997). Fusion of the phagosome with late endosomes is marked by acquisition of Rab7 and loss of Rab5. Subsequent fusion of lysosomes to the late phagosome is characterized by acquisition of lysosome-associated membrane protein (LAMP)-1 and LAMP-2.

Neutrophils contain primary, secondary, and, in some species, tertiary granules in addition to lysosomes (Stossel, 1974). Primary granules contain oxygen-dependent killing mechanisms and a variety of cationic proteins and bactericidal/permeability-increasing (BPI) protein (Klebanoff and Clark, 1978). Secondary granules contain most of the lysozyme and lactoferrin. Secondary granules appear to fuse first followed by primary granules (Klebanoff and Clark, 1978).

Phagosome-to-endosome fusion is a highly controlled process. The fusion system is typically composed of specific receptor-mediated processes. An ATPase N-ethyl-maleimide-sensitive factor (NSF) and  $\alpha$  soluble NSF attachment protein ( $\alpha$ SNAP) interact with vesicle and target integral membrane SNAP receptors (v- and t-SNAREs) that serve as docking and fusion devices (Vieira *et al.*, 2002). v- and t-SNAREs form complexes spontaneously, and NSF and SNAP provide the energy necessary to separate

the v- and t-SNAREs. When separated, SNAREs from apposed membranes are paired resulting in fusion of the lipid bilayers. However, fusion occurs in a highly controlled manner being regulated primarily by an Src family of RAB GTPases (Peyron *et al.*, 2001).

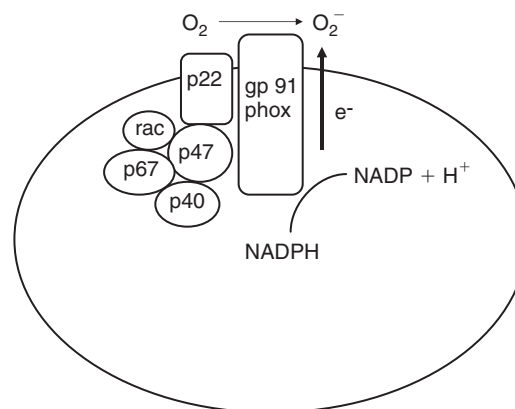
Phagolysosome fusion is a critical event in killing of pathogenic organisms. Defective phagolysosome fusion occurs in Chediak-Higashi syndrome. Chediak-Higashi syndrome has been described in several breeds of cattle, Persian cats, foxes, mink, and a killer whale (Ayers *et al.*, 1988; Colgan *et al.*, 1992). Humans and animals have partial oculocutaneous albinism, frequent infections, and mild bleeding diatheses. Neutrophils, monocytes, and melanocytes contain giant granules that result of abnormal fusion events that appear to be due to defects in lysosomal docking proteins. Granule membrane fusion is defective and discharge of granule contents into the phagosome is delayed (Mills and Noya, 1993).

### C. Bactericidal Mechanisms

The mature phagolysosome has multiple mechanisms to kill microorganisms. These have generally been divided into oxygen-dependent and oxygen-independent mechanisms (Klebanoff, 1975).

#### 1. Oxygen-Dependent Mechanisms

Oxygen-dependent mechanisms are located within primary granules (Babior, 1984; Babior *et al.*, 2002). These mechanisms are initiated by the process of phagocytosis or by perturbation of the cell membrane. A membrane-bound nicotinamide-adenine dinucleotide phosphate (NADPH) oxidase consists of five essential protein components; two of these are in the membrane and three are in the cytosol (Fig. 11-4). The membrane-associated component is a flavocytochrome  $b_{558}$  that consists of a heterodimer composed of 91 (gp91<sup>phox</sup>) and 22 (gp22<sup>phox</sup>) kDa proteins. Flavocytochrome  $b_{558}$  is distributed in the cell membrane and in the membrane of the granules and is incorporated into the wall of phagocytic vacuoles. The cytosolic components consist of a 40-kDa protein (p40-*phox*), a 47-kDa protein (p47-*phox*) and a 67-kDa component (p67-*phox*). When stimulated, the cytosolic components are translocated to the membrane. Both the assembly of the NADPH oxidase complex and the electron flow are dependent on the influence of three GTP-binding proteins; Rac1, Rac2, and Rap1A. The NADPH oxidase complex catalyzes the reduction of molecular oxygen to superoxide anion ( $\text{NADPH} + \text{O}_2 \rightarrow \text{NADP}^+ + \text{H}^+ + \text{O}_2^-$ ). The associated rapid consumption of oxygen has been termed the “respiratory burst.” Superoxide anions are rapidly dismutated to hydrogen peroxide ( $\text{H}_2\text{O}_2$ ). Superoxide anions also can be converted to hydroxyl radicals ( $\text{OH}^\cdot$ ) in the presence of catalytic metals such as iron according to the Haber-Weiss reaction ( $\text{Fe}^{2+} + \text{H}_2\text{O}_2 \rightarrow \text{Fe}^{3+} + \text{OH}^- + \text{OH}^\cdot + \text{O}_2$ ).



**FIGURE 11-4** The NADPH oxidase complex consists of a membrane-bound flavocytochrome  $b_{558}$  consisting of two subunits (22 and 91kDa) and three cytosolic molecules (p40, p47, and p67). The assembly of NADPH and electron flow are dependent on three GTP-binding proteins (Rac).

Myeloperoxidase catalyzes the conversion of  $\text{H}_2\text{O}_2$  and halide ions to hypohalous acids with hypochlorous acid being the primary acid produced. Finally  $\text{H}_2\text{O}_2$  interacts with hypohalous acids to produce singlet oxygen ( $^1\text{O}_2$ ). Singlet oxygen is a high-energy form of oxygen that can attack double bonds. These reactive oxygen intermediates interact with unsaturated lipids, carbon bonds, sulfhydryl and amino groups, nucleic acids, pyrimidine nucleotides, and enzymes within organisms. The extent to which these events contribute directly to disruption of organism function and organism killing is controversial (Segal, 2005; this subject is discussed in more detail in the next section). Myeloperoxidase is not essential for antimicrobial activity because humans with myeloperoxidase deficiency do not have severe bacterial infections. Additionally chicken heterophils lack myeloperoxidase.

Products of the respiratory burst are toxic to cells as well as to invading organisms. A variety of antioxidant systems exist to protect cells from the harmful effect of these oxidants (VanSteenhouse, 1987). These systems include cytosolic superoxide dismutase, glutathione peroxidase, glutathione reductase, and catalase, all of which convert oxygen radicals to water. Other compounds with oxygen radical scavenging potential including vitamin E, vitamin C, selenium, transferrin, and cysteine (VanSteenhouse, 1987). The glutathione needed for the reaction is maintained in the reduced state by reduced NADPH that is supplied by the hexose monophosphate pathway.

Several defects in the capacity of neutrophils to generate oxygen radicals have been described. These include chronic granulomatous disease, glutathione peroxidase deficiency, glucose-6-phosphatase deficiency, and myeloperoxidase deficiency (Malech and Nauseef, 1997).

Chronic granulomatous disease is caused by mutations in genes encoding components of NADPH oxidase. In excess of 40 specific mutations have been reported in human

patients (Cross *et al.*, 2000). Chronic granulomatous disease is characterized by recurrent severe, but usually not fatal, bacterial and fungal infections beginning in early childhood (Malech and Nauseef, 1997). Neutrophils have an inability to mount a respiratory burst because of an inability to activate the NADPH oxidase system. A neutrophil bactericidal dysfunction with decreased capacity to mount a respiratory burst has been described in eight closely related Doberman pinschers (Breitschwerdt *et al.*, 1987). However, the defect in oxygen radical generation was not as severe as in humans, and it is not clear if the defect is in NADPH or in another pathway such as myeloperoxidase deficiency.

Glutathione peroxidase deficiency is clinically similar to chronic granulomatous disease (Malech and Nauseef, 1997). The defects appear to result from a failure of the hexose monophosphate pump to generate NADPH. Impaired neutrophil bactericidal activity is also found in selenium-deficient cats and cattle and in copper-deficient cattle. Because selenium is required for glutathione metabolism, selenium deficiency probably causes a defect in the oxygen-dependent pathway of bacterial killing (Serfass and Ganther, 1975).

Myeloperoxidase deficiency has also been documented as the most common of the inherited neutrophil defects in humans (Malech and Nauseef, 1997). However, the condition produces few clinical signs. The number of individuals that develop severe infections is small. Although killing of bacterial organisms is delayed, killing is eventually complete. Myeloperoxidase deficiency has been described in cyclic hematopoiesis of gray collie dogs. Affected dogs have defective bactericidal activity. These dogs have an insertion of an adenine nucleotide in AP3B1 leading to a frame shift with premature termination (Horwitz *et al.*, 2004). This is equivalent to the mutation in Hermansky-Pudlak syndrome type II in humans but is unlike the ELA2 mutation seen in cyclic neutropenia in humans.

Abnormal neutrophil chemiluminescence responses have been described in a group of Weimaraner pups with recurrent fevers, diarrhea, pneumonia, pyoderma, lymphadenopathy, stomatitis, and osteomyelitis (Couto *et al.*, 1989). Decreased chemiluminescence in response to phorbol esters was the major neutrophil function alteration noted in these dogs. Defects in humoral or cellular immune responses were not detected.

## 2. Oxygen-Independent Mechanisms

Nonoxidative mechanisms may be more important in killing of microorganisms than previously suspected. Some investigators hypothesize that the major role of the NADPH oxidase system is to adjust phagosomal pH and to pump electrons into the phagocytic vacuole (Roos *et al.*, 2003; Segal, 2005). This movement of ions across the phagosome membrane produces conditions that are conducive to oxygen-independent organism killing. For example, the initiation of superoxide production is accompanied by phagosomal

alkalinization because of the proton-acceptor function of the superoxide anion. This pH change may be essential for activation of enzymes within the phagolysosome. Additionally, gp91<sup>phox</sup> of NADPH oxidase functions as a proton channel. This proton pump appears to play a critical role in shuttling hydrogen ion and several other ions across the cell and phagosomal membranes (Geiszt *et al.*, 2001). An influx of potassium appears to be important in liberating proteases such as elastase and cathepsins from their acidic proteoglycan matrix within granules. NADPH oxidase also is thought to induce depolarization that inhibits calcium influx into neutrophils.

Neutrophil-independent bacterial killing mechanisms are present within primary, secondary, and tertiary granules and lysosomes (Klebanoff and Clark, 1978). The primary granules contain a variety of cationic proteins including defensins, cathepsin G, azurocidin, and BPI protein. Primary granules also contain hydrolases including collagenase, elastase,  $\beta$ -glucuronidase, and lysozyme. The secondary granules contain much of the lysozyme, lactoferrin, adhesin, and chemotactic receptors, and gelatinase. A third type of granule has been identified in humans, cows, sheep, goats, horses, dogs, and rabbits (Bertram, 1985). In some species these granules contain gelatinase and some acid hydrolases. However, tertiary granules of bovine neutrophils appear to be distinct in that they contain a potent antimicrobial system (Gennaro *et al.*, 1983).

Defensins are a family of low-molecular-weight, antimicrobial peptides that have been isolated from neutrophils and heterophils of humans, rats, guinea pigs, and rabbits (Evans and Harmon, 1995). They contain six invariant cysteine residues and are arginine rich. The cysteine residues form disulfide bonds, and pairing of the first and sixth residues creates a cyclic structure. Similar peptides have been isolated from bovine and equine neutrophils and from chicken heterophils. These defensin-like peptides have a broad spectrum of antimicrobial activity being active against both Gram-positive and Gram-negative bacteria, as well as some fungi, enveloped viruses, protozoa, and cells.

Cathepsin G is rich in cysteine and has microbicidal activity against Gram-positive and Gram-negative bacteria as well as some fungal organisms. Cathepsin G inhibits bacterial respiration and energy-dependent transport systems, as well as protein, DNA, and RNA biosynthesis.

BPI is a large, lysine-rich protein that is highly active against *E. coli* and *Salmonella typhimurium* (Weiss *et al.*, 1978). However, it lacks antimicrobial activity against Gram-positive bacteria and fungi. BPI appears to bind to the outer membrane of susceptible Gram-negative bacteria and increases membrane permeability to hydrophobic molecules. BPI also activates enzymes that degrade envelope phospholipids and peptidoglycans. Neutrophils from neonatal children were reported to have three- to four-fold less BPI per neutrophil compared to adults. This correlated with a decreased antibacterial activity against *E. coli*

(Levy *et al.*, 1999). This selective deficiency of BPI may explain the increased incidence of Gram-negative sepsis among newborns.

Granulocytes also contain a variety of proteases and acid hydrolases, the most notable of which are cathepsin G, elastase, collagenase, lysozyme, acid phosphatase, aryl sulfatase, neuramidase, and nuclease. Elastase degrades bacterial cell wall proteins and potentiates the lytic activity of lysozyme and the microbicidal activity of cathepsin G. Lysozyme is a cationic protein that hydrolyzes bacterial cell walls by attacking the  $\beta$ 1-4 glycosidic linkage that joins N-acetyl muramic acid and N-acetyl glucosamine of peptidoglycan. Although a wide variety of bacteria are sensitive to the action of lysozyme, group A *Streptococcus*, *Staphylococcus*, and most Gram-negative organisms resist the action of lysozyme.

Lactoferrin has bacteriostatic activity that is associated with its capacity to sequester iron. However, lactoferrin also exerts a bactericidal effect independent of its bacteriostatic effects (Lehrer and Ganz, 1990).

Few deficiencies of oxygen-independent mechanisms have been described. A specific granule deficiency has been described in humans in which specific granules lack lactoferrin, vitamin B<sub>12</sub> binding protein, and defensins (Gallin, 1985). Affected individuals have recurrent severe bacterial infections. Neutrophils have small, elongated granules that appear late in maturation.

#### D. Neutrophil-Mediated Amplification of Inflammation

Neutrophils secrete a variety of proinflammatory mediators that amplify the inflammatory process. These include leukotrienes, prostaglandins, cytokines, and chemokines.

##### 1. Prostaglandins and Leukotrienes

Arachidonic acid and other C<sub>20</sub> polyunsaturated fatty acids containing four and five carbon-carbon double bonds are the immediate precursors of prostaglandins and leukotrienes. They are released from phospholipids by the action of phospholipase A, phospholipase C, and diacylglycerol lipase. Among the leukocytes, macrophages appear to be the major producers of prostaglandins, whereas neutrophils, monocytes, macrophages, eosinophils, and mast cells are major producers of leukotrienes (Lewis and Austen, 1984). Leukotriene (LTB) synthesis begins when 5-lipoxygenase catalyzes the production of 5-monohydroperoxy-eicosatetraenoic acid (5-HPETE) from arachidonic acid. 5-HPETE is converted to 5-hydroxyeicosatetraenoic acid (5-HETE). In addition, 5-lipoxygenase converts 5-HPETE to LTA<sub>4</sub>. Separate pathways synthesize LTB<sub>4</sub> and sulfidopeptide leukotrienes (LTC<sub>4</sub>, LTD<sub>4</sub>, LTE<sub>4</sub>). Neutrophils synthesize mostly LTB<sub>4</sub> (Lewis and Austen, 1984). LTB<sub>4</sub> has both

priming and direct activating effects on neutrophils. It is a potent chemotactic and chemokinetic agent for neutrophils, monocytes, and eosinophils. It also stimulates neutrophil aggregation, superoxide production, and integrin expression.

##### 2. Cytokines and Chemokines

Neutrophils secrete a broad spectrum of cytokines. Most of these are involved in the innate immune response, however, neutrophils also secrete cytokines that affect adaptive immunity (Petrofsky and Bermudez, 1999; Tacchini-Cottier *et al.*, 2000). Activated neutrophils release a variety of proinflammatory cytokines including tumor necrosis factor- $\alpha$  (TNF- $\alpha$ ), IL-1 $\beta$ , and IL-6. At sites of inflammation, release of these cytokines amplifies the inflammatory process. Neutrophils also produce interferon- $\gamma$  (IFN- $\gamma$ ), IL-12, and transforming growth factor- $\beta$  (TGF- $\beta$ ), known to affect adaptive immunity. Several studies indicate that neutrophils may modulate the adaptive immune response to infectious agents. For example, in a mouse model of leishmaniasis, depletion of neutrophils 6h before infection prevented the early Th2-type immune response suggesting a role of neutrophils in initiating this response (Tacchini-Cottier *et al.*, 2000).

Neutrophils also have cell surface receptors for many cytokines. These include TNF- $\alpha$ , IL-1, IL-4, IL-6, IL-8, IL-10, G-CSF, and GM-CSF (Lapinet *et al.*, 2000; Lavkan *et al.*, 1998; Skoutelis *et al.*, 2000). Although most of these cytokines activate neutrophils, IL-4 and IL-10 are potent inhibitors of neutrophil function (Lapinet *et al.*, 2000).

Neutrophils secrete both CC and CXC chemokines (Lapinet *et al.*, 2000). CC chemokines include macrophage inflammatory protein-1 $\alpha$  (MIP-1 $\alpha$ ) and MIP-1 $\beta$ . CXC chemokines include IL-8 and IFN- $\gamma$ -inducible protein-10. Therefore, neutrophils at a site of inflammation amplify the inflammatory response by attracting more inflammatory cells to the site.

### III. VIRULENCE FACTORS PREVENTING NEUTROPHIL-MEDIATED KILLING

Many pathogenic organisms have developed the capacity to evade killing by neutrophils and macrophages. Each pathogen has developed its own group of evasion tactics that provide a competitive advantage for survival and growth (Allen, 2003; Mayer-Scholl *et al.*, 2004).

*Staphylococcus aureus* is resistant to neutrophil phagocytosis. This is largely due to the capsule. A slime layer is composed of capsular polysaccharide. Like other Gram-positive bacteria, *S. aureus* is resistant to defensins, probably as a result of the composition of the cell wall.

*Anaplasma phagocytophilum* survives and replicates within neutrophils. The organism has the capacity to block



oxygen radical generation. Although the mechanism of this suppression is unknown, both the membrane-bound and cytoplasmic components of NADPH oxidase appear to be down-regulated in infected neutrophils.

*Yersinia enterocolitica* blocks phagocytosis by neutrophils and macrophages. Tight binding of the organism to cell membrane receptors of these cells causes a local decrease in extracellular calcium that results in uptake of TTSS and Yop proteins from the organism into the cytosol. Yop H is a tyrosine phosphatase that targets SH2 domains and prevents increases in intracellular calcium necessary for phagocytosis and degranulation. Mutant bacteria lacking Yop H are rapidly phagocytized and cleared by phagocytes.

*Salmonella* spp. have several virulence factors (Roos *et al.*, 2003). Spi-1 encodes proteins that are secreted into cells and modulate the actin cytoskeleton. This leads to uptake of the organism into a membrane-bound vacuole within the cell. Once in the target cell, the Spi-2 gene cluster promotes bacterial survival. These proteins interfere with formation of the NADPH oxidase complex thus reducing the generation of oxygen radicals.

*Shigella* invade the colonic mucosa and are engulfed by macrophages and epithelial cells. *Shigella* contain virulence factors IpaB and IpaC that enable them to escape from phagosomes of both macrophages and epithelial cells. However, elastase within neutrophils selectively degrades IpaB and IpaC, which prevents escape of the organism from the phagosome and facilitates organism killing.

Mycobacteria enhance their survival within phagocytes primarily by inhibiting fusion of late endosomes and lysosomes with the phagosome (Peyron *et al.*, 2001). As a result, phagosomes fail to obtain markers of maturation including Rab7, LAMP-1, and LAMP-2 (Fig. 11-3). This process has been most studied in macrophages. Mechanisms responsible for the arrest of phagosome maturation are complex and involve both host and organism factors. Coronin 1, also termed tryptophan-aspartate-containing coat protein (TACO), has been identified as being involved. Coronin 1 is a member of a family of proteins involved in actin-cytoskeletal remodeling and phagocytosis as well as other cell functions. In murine macrophages, coronin 1 is retained on the phagosomes of macrophages infected with live mycobacteria, whereas it rapidly dissociates from phagosomal membranes of dead mycobacteria (Tailleux *et al.*, 2003). Mycobacteria appear to be able to arrest phagosome maturation by depleting the phosphatidylinositol 3-phosphate (PI3P) content within the phagosomal membrane (Hmama *et al.*, 2004). PI3P is synthesized in early endosome and phagosome membranes and functions as a membrane-trafficking regulatory lipid essential for phagolysosome biosynthesis. This effect may be mediated by glycosylated phosphatidylinositol lipoarabinomannan derived from the cell wall of pathogenic mycobacterial organisms (Hmama *et al.*, 2004).

## IV. ACQUIRED NEUTROPHIL FUNCTION DEFECTS

### A. Neutrophil Dysfunction in Periparturient Dairy Cattle

Numerous studies have documented neutrophil dysfunction in periparturient dairy cattle. Significantly decreased random migration, iodination, and chemiluminescence of neutrophils were observed 1 week after parturition (Kehrli *et al.*, 1989). In another study, a decrease in neutrophils oxidative burst activity was observed 1 to 3 weeks after calving (Dosogne *et al.*, 1999). This was related to a pregnancy-associated glycoprotein in the blood.

The cause of periparturient neutrophil dysfunction is incompletely understood. Selenium concentrations in periparturient cattle may be a significant factor in predicting neutrophil function. Neutrophils from postparturient dairy cows with relatively high blood selenium concentrations had greater superoxide production and greater potential to kill bacteria when compared to cows with relatively low selenium concentrations (Cebra *et al.*, 2003). Excessive glucocorticoid production may also be involved in the neutrophil dysfunction. In a study in which microarrays and real-time RT-PCR techniques were used to study neutrophils from periparturient and glucocorticoid-treated cattle, similar functional alterations were observed (Burton *et al.*, 2005).

Altered neutrophil function and recruitment to the mammary gland have been incriminated as a factor in the increased incidence of mastitis during the periparturient period (Kehrli *et al.*, 1989; Paape *et al.*, 2003). In general, milk neutrophils are less effective than blood neutrophils in phagocytizing and killing bacteria (Paape *et al.*, 2003). This has been attributed to the lower energy reserve of milk neutrophils and phagocytosis of milk fat globules and casein. Lysosomes fuse with phagosomes containing milk-fat globules and casein thus reducing the number available to fuse with phagosomes containing bacteria. Milk has been reported to reduce the capacity of neutrophils to phagocytize bacteria three-fold. (Paape *et al.*, 1981). A negative correlation has been reported between the capacity of milk to support neutrophil phagocytosis and clinical mastitis (Paape *et al.*, 2003). In another field study of 70 lactating dairy cows, decreased milk neutrophil chemiluminescence activity was associated with susceptibility to mastitis caused by *S. aureus* (Piccinini *et al.*, 1999). This relationship indicates that neutrophil oxidative burst activity may play a major role in preventing mastitis. Additionally, postparturient cows have a reduced capacity to recruit neutrophils into the mammary gland during coliform mastitis (Shuster *et al.*, 1996).

Neutrophil recruitment appears to be a critical determinant of resistance to mastitis. Several studies have documented that increasing the milk somatic cell count is highly effective in preventing mastitis. In one field trial,

insertion of a polyethylene intramammary device into the gland cisterns increased the somatic cell count and resulted in a 75% reduction in clinical mastitis (Goodger *et al.*, 1993). Additionally, intramammary administration of soluble CD14 in coliform mastitis causes binding of endotoxin and results in recruitment of neutrophils.

Genetic markers have also been associated with susceptibility to bovine mastitis. Cows with allelic variation in CXCR2 (i.e., the IL-8 receptor) had increased susceptibility to mastitis (Rameaud and Pighetti, 2005). Cows with a CC or GC at CXCR2 + 777 had decreased neutrophil migration in response to IL-8 when compared to cows expressing the GG genotype. Additionally, decreased up-regulation of cell surface CD18 was observed on neutrophils after stimulation with IL-8. The results of these studies support a genetic predisposition to mastitis and further emphasize the importance of rapid mobilization of neutrophils into the mammary gland in prevention of infection.

## B. Neutrophil Dysfunction in Neonatal Animals

Neutrophil dysfunction appears to contribute to the susceptibility of newborn calves and foals to pneumonia, septicemia, enteritis, and endotoxemia. Reports on neutrophil function in calves tend to be inconsistent. This is in part due to variation in the age of the calves, the colostrum status, and the techniques used to evaluate neutrophil function. For example, both increased and decreased respiratory burst activity have been reported in neonatal calves when compared to adult cows (Dore *et al.*, 1991; Higuchi and Nigahata, 1998). Respiratory burst activity in neonates is dependent on the agonist used. Respiratory burst activity appears to be reduced when neonatal neutrophils are activated by heat-aggregated albumin or protein kinase C and enhanced when activated by opsonized zymosan. This suggests age-related alterations in cell membrane receptors or differences in intracellular signal transduction probably involving protein kinase C activity and tyrosine phosphorylation of cellular proteins (Higuchi and Nigahata, 1998). Other functional alterations in neonatal neutrophils when compared to adult neutrophils include decreased myeloperoxidase and increased alkaline phosphatase activities, decreased concanavalin A capping, decreased Fc receptor number, increased chemotaxis, increased aggregation, and increased shape change (Zwahlen *et al.*, 1992).

Reports of neutrophil dysfunction in foals are also somewhat inconsistent. When compared to adult horses, some reports indicate that foals have no difference in phagocytic activity, others report decreased phagocytosis when organisms are opsonized with autologous serum but not when opsonized with adult serum, whereas yet others state that phagocytosis of *Staphylococcus aureus* is decreased when opsonized with either autologous or adult serum (McTaggart *et al.*, 2001). Bacterial killing has been reported to be similar to that of

adult horses in several studies but was found to be reduced in other studies (Wichtel *et al.*, 1991). Other neutrophil function alterations reported in foals include increased random migration, decreased chemotaxis, decreased iodination, increased CD18 expression, and the presence of an unidentified serum factor that suppresses oxidative burst activity.

## C. Neutrophil Dysfunction Associated with Viral Infection

Viral infections have frequently been incriminated as predisposing food animals to bacterial infections. This effect may, in part, be mediated by virus-induced neutrophil dysfunction. The bovine viral diarrhea (BVD) virus is a classic example of a virus that induces neutrophil dysfunction (Brown *et al.*, 1991; Roth *et al.*, 1981). Neutrophils from cows experimentally infected with cytopathogenic or noncytopathogenic strains of BVD developed marked impairment of iodination capacity. Alternatively, other measures of oxygen radical generation were not altered. Cattle that were persistently infected with BVD had multiple alterations in neutrophil function including decreased random migration, decreased *Staphylococcus aureus* ingestion, decreased cytochrome C reduction, decreased iodination, decreased antibody-independent cell-mediated cytotoxicity, decreased cytoplasmic calcium flux, and decreased oxygen radical production.

Another virus incriminated as predisposing cattle to bacterial pneumonia is infectious bovine rhinotracheitis (IBR) virus (McGuire and Babiuk, 1983/1984). In an *in vivo* study, calves were exposed to an aerosol of IBR virus and then to an aerosol of *Mannheimia haemolytica* 5 days later. When compared to calves not exposed to IBR virus, IBR-exposed calves had delayed neutrophil migration into the lungs. Neutrophils from IBR-exposed calves also had decreased random migration and chemotactic responses. Further, alveolar macrophages had decreased capacity to produce chemotactic factors. The results of this study indicate that IBR infection may predispose cattle to secondary bacterial infections.

Neutrophil function has also been investigated in cats infected with feline leukemia virus (Kiehl *et al.*, 1987). Neutrophil chemotaxis was evaluated *in vitro* by use of a modified Boyden chamber apparatus. Cats that were viremic and clinically ill had lower chemotactic responses compared to subclinically infected cats. This did not appear to be a nonspecific effect in that cats that were sick from other causes did not have reduced chemotactic responses.

## D. Effects of Nutrition on Neutrophil Function

Selenium and vitamin E appear to be important nutrients in maintaining neutrophil function. As stated previously,



neutrophils from postparturient dairy cows with relatively high blood selenium concentrations had greater superoxide production and greater capacity to kill bacteria compared to cows with relatively low selenium concentrations (Cebra *et al.*, 2003). In another study, injection of selenium-vitamin E into cows was reported to increase the capacity of neutrophils to kill bacteria (Gyang *et al.*, 1984).

Copper deficiency may also adversely affect neutrophil function. Neutrophils from cattle made copper deficient by feeding diets low in copper and high in molybdenum or iron were reported to have decreased capacity to kill *Candida albicans* organisms (Boyne and Arthur, 1986).

### E. Effects of Stress on Neutrophil Function

The effects of environmental, transportation, and exercise stress on neutrophil function have been evaluated. The effect of 4 h of transportation was evaluated on four 4- to 6-month-old Holstein calves (Murata *et al.*, 1987). Total and differential leukocyte counts, lymphocyte blastogenesis, nitroblue tetrazolium (i.e., measures neutrophil superoxide production), and plasma cortisol concentration were measured before and after transportation. After transportation calves had a neutrophilia, enhanced NBT activity, suppressed lymphocyte blastogenesis, and increased plasma cortisol concentration. These data suggest that neutrophils became activated during transportation despite the potentially suppressive effects of cortisol on neutrophil function.

The effect of cold stress on neutrophil function has been evaluated in bovine neonates (Woodard *et al.*, 1980). Exposure of neonatal calves to temperatures of 1°C for 3 days had no effect on bactericidal activity of neutrophils.

The effects of exercise on equine neutrophil function have been evaluated (Raidal *et al.*, 2000). When previously untrained horses were subjected to moderately intense exercise, an increase in neutrophil oxidative burst activity and neutrophil phagocytosis was observed. However, high-intensity exercise was associated with transient impairment of these responses. After 17 weeks of exercise training, neutrophil oxidative burst activity and neutrophil phagocytosis were decreased when compared to neutrophil function test results at 0 and 10 weeks. These data suggest that high-intensity exercise training and long duration training have a general suppressive effect on equine neutrophil function.

## V. NEUTROPHIL-MEDIATED TISSUE INJURY

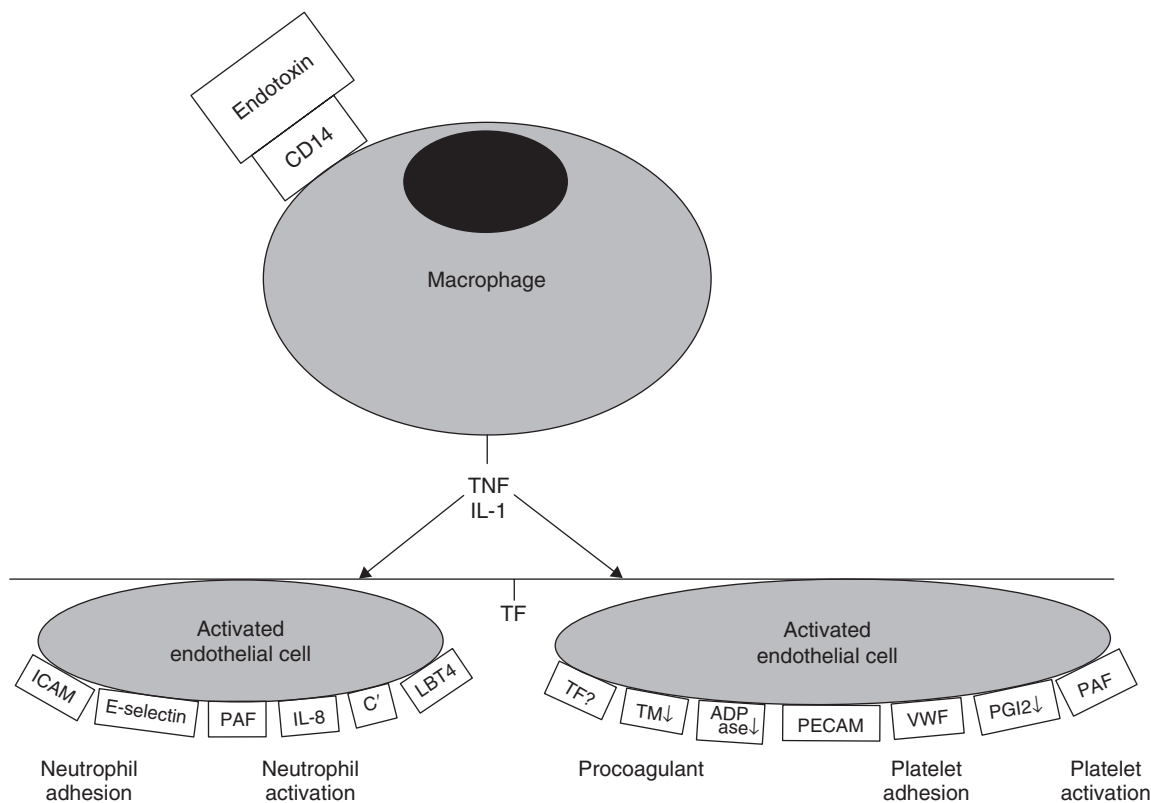
Under certain circumstances neutrophils cause injury to host tissues by the same mechanisms used to kill invading organisms (Lee and Downey, 2001; Lehr *et al.*, 2000; Lush and Kveitys, 2000). This injury can vary from local tissue injury at a site of inflammation to systemic activation of

neutrophils resulting in a systemic inflammatory response syndrome. Several experimental models of neutrophil-mediated tissue injury have been developed. These include neutrophil-mediated rat lung injury associated with thermal injury to skin, ischemia-reperfusion-induced injury to several organs, endotoxin-induced lung injury, and injury of isolated perfused organs. Localized tissue injury in which neutrophils have been incriminated include sites of inflammation and ischemia/reperfusion injury. Systemic disease states have variously been termed systemic inflammatory response syndrome, adult respiratory distress syndrome (ARDS), endotoxic shock, septic shock, and multiple organ dysfunction syndrome (MODS; Lee and Downey, 2001; Lehr *et al.*, 2000; Maier, 2000). The lungs are particularly sensitive to neutrophil-mediated injury both because of their extensive capillary network and a unique sensitivity of their capillary endothelium to neutrophil-mediated injury. However, other organs, including heart, liver, and kidneys, also can be damaged and undergo functional compromise.

### A. Neutrophil-Mediated Injury at Sites of Inflammation

The most studied localized neutrophil-mediated organ injury in veterinary medicine is lung injury associated with shipping fever in cattle. Invasion of the causative organism, *Mannheimia haemolytica*, results in rapid recruitment of neutrophils into the lungs within the first 2 h. These changes are characterized histopathologically by a fibrinopurulent pneumonia and ultrastructurally by endothelial disruption and alveolar epithelial swelling (Whiteley *et al.*, 1992). Lesions are characterized by severe endothelial and alveolar epithelial damage that occurs immediately beneath sites of neutrophil attachment. Alveolar and pulmonary intravascular macrophages appear to play a central role in attracting neutrophils into the lungs (Whiteley *et al.*, 1992). Activated macrophages secrete proinflammatory cytokines, including TNF- $\alpha$  and IL-1, that activate alveolar capillary endothelium, converting it from an antiadhesive and anticoagulant surface to a proadhesive (for leukocytes and platelets) and procoagulant surface (Fig. 11-5). Production of IL-8 and platelet-activating factor by alveolar capillary endothelial cells may be involved in activating neutrophils while they are attached to endothelium (McClenahan *et al.*, 2002). The resultant vascular injury and increased permeability cause flooding of alveoli with plasma and promote thrombotic events.

The role of neutrophils in the lung injury has been investigated by neutrophil depletion studies. Neutrophil depletion before experimental inoculation of *Mannheimia haemolytica* organisms into the lungs of calves markedly attenuates alveolar capillary endothelial injury in the first 6 to 8 h after inoculation of the organism.



**FIGURE 11-5** The activation of endothelial cells at a site of inflammation. At sites of inflammation, activated macrophages release proinflammatory mediators including tumor necrosis factor- $\alpha$  (TNF- $\alpha$ ) and interleukin-1 (IL-1). These cytokines activate endothelial cells, converting their surface from antiadhesive and anticoagulant to proadhesive and procoagulant. Activated endothelium express intercellular adhesion molecules (ICAM) and selectin molecules that promote neutrophil adhesion. Activated endothelium also express platelet-activating factor (PAF), interleukin-8 (IL-8), and leukotriene-B4 (LTB4) and may bind complement, all of which will activate neutrophils while attached to endothelium. Decreased expression of adenosine diphosphatase and thrombomodulin as well as increased expression of platelet-endothelial cell adhesion molecules (PECAM) and von Willebrand's factor promote platelet adhesion. Decreased production of prostaglandin I<sub>2</sub> (PGI<sub>2</sub>) and expression of PAF promotes platelet activation. Finally, tissue factor (TF), a potent activator of the extrinsic clotting pathway, may be expressed on activated endothelium.

## B. Ischemia/Reperfusion Injury

Prolonged ischemia results in numerous metabolic and ultrastructural changes within cells. Ischemia decreases cellular oxidative phosphorylation resulting in failure to resynthesize high-energy phosphate compounds such as adenosine 5'-triphosphate. Adenosine 5'-triphosphate catabolism during ischemia results in accumulation of hypoxanthine. Hypoxanthine is subsequently converted to oxygen radicals upon reperfusion of the tissue. Ischemia also promotes expression of leukocyte and platelet adhesion receptors on the cell surface; promotes expression of proinflammatory cytokines (e.g., IL-8) and bioactive agents (e.g., platelet-activating agents, endothelin, thromboxane A<sub>2</sub>); and suppresses certain gene products including nitric oxide, nitric oxide synthase, thrombomodulin, and prostacyclin.

Restoration of blood flow after a period of ischemia places tissues at risk of further cellular necrosis (Carden and Granger, 2000; Eltzschig and Collard, 2004). Reperfusion

injury is primarily directed at the endothelial cells lining the microvasculature and is manifest as accelerated production of a variety of bioactive agents and expression of adhesion molecules for neutrophils. Neutrophils appear to become activated while attached to endothelium-releasing oxygen radicals and granule contents directly onto the endothelial surface. In addition to production of superoxide by neutrophils, superoxide is generated from hypoxanthine within endothelial cells and is produced by mast cells and macrophages.

Neutrophils may also contribute to tissue hypoperfusion after blood flow is reestablished. Activated neutrophils are rigid and tend to lodge in capillaries, obstructing blood flow. Neutrophil-neutrophil aggregates and platelet-neutrophil aggregates also may contribute to capillary malperfusion by plugging capillaries resulting in prolonged maldistribution of blood flow. Platelet-neutrophil aggregates may also contribute to microthrombus formation.

The observation that blood flow to an ischemic organ is not fully restored after release of a vascular occlusion has been termed the no-reflow phenomenon. Experimental studies, using leukocyte depletion models, have demonstrated a central role of neutrophils in the no-reflow phenomenon.

### C. Neutrophil-Mediated Injury at Distant Sites

Neutrophils become activated within the circulation during a variety of physiological and pathological conditions in domestic animals. Circulating activated neutrophils have been documented during strenuous exercise, inflammatory disease, equine colic, and equine laminitis. At least in some circumstances, there is evidence to suggest that these activated neutrophils may contribute to the pathogenesis of the disease process.

#### 1. Exercise

Strenuous exercise has been associated with up-regulation of neutrophil surface-associated integrin receptors in dogs undergoing short duration sled-pulling activity (Moritz *et al.*, 2003). Additionally, decreased neutrophil granularity was observed postexercise. Because CD11b/CD18 integrin is stored in neutrophil granules and transported to the cell surface when neutrophils degranulate, the combination of increased cell surface integrin concentration and decreased granularity postrace is consistent with exercise-associated neutrophil degranulation.

#### 2. Inflammatory Disease

Neutrophils circulate in an activated state in a variety of inflammatory conditions. Dogs with naturally occurring septic and nonseptic inflammatory diseases had increased cell surface expression of CD11b (Weiss *et al.*, 2004). Neutrophils from dogs with septic inflammatory diseases and those with evidence of multiple organ dysfunction also had decreased neutrophil granularity and increased neutrophil size. However, neutrophil activation markers may not predict neutrophil function. In a study by Gosset *et al.* (1983/1984), neutrophils from dogs with severe inflammatory disease were reported to have a defect in bactericidal activity. Monocytes and lymphocytes from dogs with septic and nonseptic inflammation and multiple organ dysfunction had decreased expression of major histocompatibility factor class-II suggesting impaired immune responsiveness (Weiss *et al.*, 2004).

Leukocyte deformability, neutrophil CD11b expression, and neutrophil size were evaluated in calves experimentally inoculated intrabronchially with *Mannheimia haemolytica* organisms (McClenahan *et al.*, 1999). Infected calves had decreased leukocyte deformability and increased neutrophil size by 1h and increased CD11b expression by 6h after

organism inoculation. Decreased neutrophil deformability and increased size may contribute to sequestration of neutrophils in alveolar capillary beds during sepsis.

#### 3. Colic

The activation status of circulating neutrophils was evaluated in horses with naturally occurring colic (Weiss and Evanson, 2003). Activated neutrophils were not detected in healthy horses or horses with impaction or gas colic. Conversely, horses with inflammatory bowel disease consistently had increased neutrophil cell membrane CD11/CD18 expression, increased neutrophil size, and decreased neutrophil granularity consistent with circulating activated and degranulated neutrophils. These horses also had decreased leukocyte deformability indicating that neutrophils were rigid. Horses with strangulating colic had variable results. Among horses with strangulating colic, changes in leukocyte deformability, neutrophil size, and neutrophil granularity correlated directly with adverse outcome.

#### 4. Equine Laminitis

Neutrophils may become activated in the prodromal stages of equine laminitis. At various times during the first 12h after induction of black walnut-induced laminitis, horse neutrophils had increased oxygen radical production, and some horses had increased phagocytosis of bacteria (Black *et al.*, 2006). These changes were associated with neutropenia and were presumed to be due to a systemic inflammatory response resulting from absorption of inflammatory mediators from the intestine. These activated neutrophils have been incriminated in the pathogenesis of the laminar injury (Black *et al.*, 2006).

#### 5. Adult Respiratory Distress Syndrome and Multiple Organ Failure

Activated neutrophils are central to the pathogenesis of ARDS and MODS associated with sepsis and endotoxemia (Lehr *et al.*, 2000). As in ischemia/reperfusion injury, microvascular injury is a major site of injury in these conditions. The lungs are particularly sensitive to neutrophil-induced vascular injury. The process of lung involvement has been divided into four sequential stages: (1) sequestration of neutrophils in pulmonary capillaries, (2) adhesion, (3) activation, and (4) release of oxygen radicals and proteases (Lee and Downey, 2001). The process of neutrophil sequestration in the lungs differs from that of other tissues. In other tissues, neutrophil sequestration occurs predominately in post-capillary venules and is dependent on selectin and integrin adhesion molecules. Alternatively, neutrophil sequestration in the lungs occurs primarily in pulmonary capillaries and is largely independent of adhesion molecules. Sequestration

is thought to be due to the fact that activated neutrophils are rigid and tend to lodge in capillary beds.

Limited neutrophil activation while in contact with the endothelium is probably a normal process. This results from binding of neutrophil adhesion molecules to endothelial cells. Although not completely elucidated, these signaling pathways appear to involve the Src-family of tyrosine kinases, mitogen-activated protein kinases, and phosphatidylinositol 3-kinase (Lee and Downey, 2001). However, excessive activation of neutrophils while attached to endothelium can result in direct release of oxygen radicals and granule contents onto the endothelial surface. A variety of factors, including platelet-activating factor, IL-8, LTB<sub>4</sub>, and complement, have been incriminated as neutrophil activating agents. Platelet activating factor and IL-8 are produced by activated endothelial cells and expressed on the cell surface. Neutralization of platelet activating factor both *in vitro* and *in vivo* has been reported to attenuate bovine neutrophil-induced endothelial injury (McClenahan *et al.*, 2000, 2002). Multiple mediators are involved in neutrophil-mediated endothelial injury. Mediators implicated in various experimental models of ARDS include oxygen radicals, activated complement factors, nitric oxide, proteolytic enzymes, and metalloproteinases (Lee and Downey, 2001). Consequences of this endothelial injury include (1) massive leakage of plasma into alveoli, (2) vasodysregulation leading to maldistribution of blood flow, and (3) disturbances of oxygen transport and utilization. All of these lead to dyspnea and hypoxemia.

As in ischemia/reperfusion injury, capillary plugging by activated neutrophils appears to play a central role in ARDS and MODS. Activated neutrophils are stiff because of the assembly of F-actin filaments and tend to lodge in capillaries. Additionally activated neutrophils form neutrophil-neutrophil and neutrophil-platelet aggregates, which form microvascular plugs in larger vessels. This leads to microvascular thrombosis, tissue necrosis, and release of additional toxic substances.

#### D. Role of Neutrophils in Microvascular Thrombosis

Local and disseminated activation of coagulation frequently accompanies sepsis and endotoxemia (Weiss and Rashid, 1998). The mechanism responsible for this sepsis-induced procoagulant effect is complex. The role of neutrophils in microvascular thrombosis appears to be in their capacity to induce endothelial injury and to bind and activate platelets. Endothelial injury results in conversion of the endothelial cell surface from an anticoagulant surface to a procoagulant surface (Fig. 11-5). Destruction of endothelial cells activates the intrinsic clotting system through exposure of subendothelial collagen and activates the extrinsic coagulation system through contact with tissue factor.

Platelets also frequently become activated during sepsis and endotoxemia. Both activated neutrophils and activated endothelial cells express platelet activating factor that is a potent platelet agonist. When activated platelets degranulate, P-selectin is transported from alpha granules to the cell membrane. P-selectin interacts with PSGL-1 on the neutrophil surface forming platelet-neutrophil aggregates. Platelet-neutrophil aggregates are rigid and therefore lodge in capillary beds and initiate microvascular inflammatory and thrombotic events. Platelet-neutrophil aggregates have been detected in horses undergoing near-maximal treadmill exercise and in horses and ponies with carbohydrate overload-induced laminitis (Weiss *et al.*, 1998a, 1998b). The potential causative role of activated platelets/platelet-neutrophil aggregates in laminitis was inferred from *in vivo* studies in which ponies were treated with a competitive inhibitor of platelet aggregation before administration of carbohydrate overload. The platelet aggregation inhibitor prevented the formation of platelet-neutrophil aggregates and the prevented onset of lameness in all eight ponies tested (Weiss *et al.*, 1998a).

#### REFERENCES

- Ackermann, M. R., Kehrl, M. E., Jr., Laufer, J. A., and Nusz, L. T. (1996). Alimentary and respiratory tract lesions in eight medically fragile Holstein cattle with bovine leukocyte adhesion deficiency (BLAD). *Vet. Pathol.* **33**, 273.
- Allen, L. H. (2003). *Microbes Infects.* **5**, 1329.
- Alexander, S. R., Kishimoto, T. K., and Walcheck, B. (2000). Effects of selective protein kinase C inhibitors on the proteolytic down-regulation of L-selectin chemoattractant activated neutrophils. *J. Leukoc. Biol.* **67**, 415.
- Allison, F., Jr., Smith, M. R., and Wood, W. B., Jr. (1955). Studies on the pathogenesis of acute inflammation. *J. Exp. Med.* **102**, 655.
- Alon, R., Feizi, T., Yuen, C. T., Fuhlbrigge, R. C., and Springer, T. A. (1995). Glycolipid ligands for selectins support leukocyte tethering and rolling under physiologic flow conditions. *J. Immunol.* **154**, 5356.
- Anderson, D. C., and Springer, T. A. (1987). *Ann. Rev. Med.* **38**, 175.
- Asa, D., Raycroft, L., Ma, L., Aeed, P. A., Kaytes, P. S., Elhammer, A. P., and Geng, J. G. (1995). The P-selectin glycoprotein ligand functions as a common human leukocyte ligand for P- and E-selectin. *J. Biol. Chem.* **270**, 11662.
- Atherton, A. (1972). Quantitative investigations of the adhesiveness of circulating polymorphonuclear leukocytes to blood vessel walls. *J. Physiol.* **222**, 447.
- Ayers, J. R., Leipold, H. W., and Padgett, G. A. (1988). Lesions in Brangus cattle with Chediak-Higashi syndrome. *Vet. Pathol.* **25**, 432.
- Babior, B. M. (1984). Oxidants from phagocytes: agents of defense and destruction. *Blood* **64**, 959.
- Babior, B. M., Lambeth, J. D., and Nauseff, W. (2002). The neutrophil NADPH oxidase. *Arch. Biochem. Biophys.* **397**, 342.
- Bargatze, R. F., Kurk, S., Butcher, E. C., and Jutila, M. A. (1994). Neutrophils roll on adherent neutrophils bound to cytokine-induced endothelial cells via L-selectin on the rolling cells. *J. Exp. Med.* **180**, 1785.
- Beesley, J. E., Pearson, J. D., Carleton, J. S., Hutchings, A., and Gordon, J. L. (1978). Interactions of leukocytes with vascular cells in culture. *J. Cell Sci.* **33**, 85.

- Bertram, T. A. (1985). Neutrophilic leukocyte structure and function in domestic animals. *Adv. Vet. Sci. Comp. Med.* **30**, 91.
- Black, S. J., Lunn, D. P., Yin, C., Hwang, M., Lenz, S. D., and Belknap, J. K. (2006). Leukocyte emigration in the early stages of laminitis. *Vet. Immunol. Immunopathol.* **15**, 161.
- Bonfanti, R., Furie, B. C., Furie, B., and Wagner, D. D. (1989). PADGEM (GMP140) us a component of Weibel-Palade bodies of human endothelial cells. *Blood* **73**, 1109.
- Borregaard, N., Miller, L. S., and Springer, T. A. (1987). Chemoattractant-regulated mobilization of a novel intracellular compartment in human neutrophils. *Science* **237**, 1204.
- Boyne, R., and Arthur, J. R. (1986). Effects of molybdenum or iron induced copper deficiency on the viability and function of neutrophils from cattle. *Res. Vet. Sci.* **41**, 417.
- Breitschwerdt, E. B., Brown, T. T., Buysscher, E. V., Anderson, B. R., Thrall, D. E., Hager, E., Ananaba, G., Degen, M. A., and Ward, M. D. W. (1987). Rhinitis, pneumonia, and defective neutrophil function in the Doberman pinscher. *Am. J. Vet. Res.* **48**, 1054.
- Brown, G. B., Bolin, S. R., Frank, D. E., and Roth, J. A. (1991). Defective function of leukocytes from cattle persistently infected with bovine viral diarrha virus, and the influence of recombinant cytokines. *Am. J. Vet. Res.* **52**, 381.
- Burns, A. R., Walker, D. C., Brown, E. S., Thurmon, L. T., Bowden, R. A., Keese, C. R., Simon, S. L., Entman, M. L., and Smith, C. W. (1997). Neutrophil transendothelial migration is independent of tight junctions and occurs preferentially at tricellular corners. *J. Immunol.* **159**, 2893.
- Burton, J. L., Madsen, S. A., Chang, L., Weber, P. S. D., Buckham, K. R., van Dorp, R., Hickey, M., and Earley, B. (2005). Gene expression signatures in neutrophils exposed to glucocorticoids: a new paradigm to help explain "neutrophil dysfunction" in parturient dairy cows. *Vet. Immunol. Immunopathol.* **105**, 197.
- Carden, D. L., and Granger, D. N. (2000). Pathophysiology of ischemia-reperfusion injury. *J. Pathol.* **190**, 255.
- Carman, C. V., and Springer, T. A. (2003). Integrin avidity regulation: are changes in affinity and conformation underemphasized. *Curr. Opin. Cell Biol.* **15**, 547.
- Cebra, C. K., Heidel, J. R., Crisman, R. O., and Stang, B. V. (2003). The relationship between endogenous cortisol, blood micronutrients, and neutrophil function in postparturient Holstein cows. *J. Vet. Intern. Med.* **17**, 902.
- Cohnheim, J. (1877). "Vorlesung über allgemeine Pathologie." Hirschwald, Berlin.
- Cohnheim, J. (1889). "Lectures on general pathology: A handbook for the practitioners and students." The New Sydenham Society, London.
- Colgan, S. P., Gasper, P. W., Thrall, M. A., and Boone, T. C. (1992). Neutrophil function in normal and Chediak-Higashi syndrome cats following administration of recombinant canine granulocyte colony-stimulating factor. *Exp. Hematol.* **20**, 1229.
- Couto, C. G., Krakowka, S., Johnson, G., Ciekot, P., Hill, R., Lafrade, L., and Kociba, G. (1989). In vitro immunologic features of Weimaraner dogs with neutrophil abnormalities and recurrent infections. *Vet. Immunol. Immunopathol.* **23**, 103.
- Cross, A. R., Noack, D., Rae, J., Curnutte, J. T., and Heyworth, P. G. (2000). Hematologically important mutations: the autosomal recessive forms of chronic granulomatous disease (first update). *Blood Cells.* **26**, 561.
- Damiano, E., Westheider, R. J., Tozeren, A., and Ley, K. (1996). Variation in the velocity, deformation, and adhesion energy density of leukocytes rolling within venules. *Circ. Res.* **79**, 1122.
- Danilenko, D. M., Rossitto, P. V., Van der Vieren, M., Le Trong, H., McDonough, S. P., Affolter, V. K., and Moore, P. F. (1995). A novel canine leukointegrin, alpha d beta 2 is expressed by specific macrophage subpopulations in tissues and a minor CD8+ lymphocyte subpopulation in peripheral blood. *J. Immunol.* **155**, 35.
- Davenpeck, K. L., Steeber, D. A., Tedder, T. F., and Bochner, B. S. (1997). P- and L-selectin mediate distinct but overlapping functions in endotoxin-induced leukocyte-endothelial interactions in the rat mesenteric microcirculation. *J. Immunol.* **159**, 1977.
- DeVries, M. E., Ran, L., and Kelvin, D. J. (1999). On the edge: the physiologic and pathophysiological role of chemokines during inflammatory and immunological responses. *Semin. Immunol.* **11**, 95.
- Diamond, M. S., Staunton, D. E., Marlin, S. D., and Springer, T. A. (1991). Binding of the integrin Mac-1 (CD11b/CD18) to the third immunoglobulin-like domain of ICAM-1 (CD54) and its regulation by glycosylation. *Cell* **65**, 961.
- Donnelly, S. C., Haslett, C., Dransfield, I., Robertson, C. E., Carter, D. C., Ross, J. A., Grant, I. S., and Tedder, T. F. (1994). Role of selectins in development of adult respiratory distress syndrome. *Lancet* **344**, 215.
- Dore, M., Slauson, D. O., and Neilsen, N. R. (1991). Decreased respiratory burst activity in neonatal bovine neutrophils stimulated by protein kinase C agonists. *Am. J. Vet. Res.* **52**, 375.
- Dosogne, H., Burvenich, C., Freeman, A. E., Kehrl, M. E., Detilleux, J. C., Sulon, J., Beckers, J. F., and Hoeben, D. (1999). Pregnancy-associated glycoprotein and decreased polymorphonuclear leukocyte function in early post-partum dairy cows. *Vet. Immunol. Immunopathol.* **67**, 47.
- Eltzschia, H. K., and Collard, C. D. (2004). Vascular ischaemia and reperfusion injury. *Brit. Med. Bull.* **70**, 71.
- Eriksson, E. E., Xie, X., Werr, J., Thoren, P., and Lindbom, L. (2001). Importance of primary capture and L-selectin-dependent secondary capture in leukocyte accumulation in inflammation and atherosclerosis in vivo. *J. Exp. Med.* **194**, 205.
- Etzioni, A., Frydman, M., Pollack, S., Avidor, I., Phillips, M. L., Paulson, J. C., and Gershoni-Baruch, R. (1992). Recurrent severe infections caused by a novel leukocyte adhesion deficiency. *N. Engl. J. Med.* **327**, 1789.
- Evans, E. W., and Harmon, B. G. (1995). A review of antimicrobial peptides: defensins and related cationic peptides. *Vet. Clin. Pathol.* **24**, 109.
- Feng, D., Nagy, J. A., Pyne, K., Dvorak, H. F., and Dvorak, A. M. (1998). Neutrophils emigrate from venules by a transendothelial cell pathway in response to FMLP. *J. Exp. Med.* **187**, 903.
- Foxman, E. F., Campbell, J. J., and Butcher, E. C. (1997). Multistep navigation and the combinatorial control of leukocyte chemotaxis. *J. Cell Biol.* **139**, 1349.
- Foxman, E. F., Kunkel, E. J., and Butcher, E. C. (1999). Integrating conflicting chemotactic signals. The role of memory in leukocyte navigation. *J. Cell Biol.* **147**, 577.
- Gallin, J. I. (1985). Neutrophil specific granule deficiency. *Annu. Rev. Med.* **36**, 236.
- Geiszt, M., Kapus, A., and Ligeti, E. (2001). Chronic granulomatous disease: more than the lack of superoxide. *J. Leuko. Biol.* **69**, 191.
- Gennaro, R., Odzani, L., and Romeo, D. (1983). Potency of bactericidal proteins purified from the large granules of bovine neutrophils. *Infect. Immun.* **40**, 684.
- Giger, U., Boxer, L. A., Simpson, P. J., Lucchesi, B. R., and Todd, R. F. I. (1987). Deficiency of leukocyte surface glycoproteins Mo1, LFA-1, and Leu M5 in a dog with recurrent bacterial infections: an animal model. *Blood* **69**, 1622.

- Goodger, W. J., Farver, T., Galland, J., Jasper, D., and Pelletier, J. (1993). Effects of a high-density intramammary device on mammary glands, production, and reproductive performance in dairy cows. *J. Am. Vet. Med. Assoc.* **202**, 1966.
- Gosset, K. A., MacWilliams, P. S., Enright, F. M., and Clefhorn, B. (1983/1984). In vitro function of canine neutrophils during experimental inflammatory disease. *Vet. Immunol. Immunopathol.* **5**, 151.
- Grayson, M. H., Van der Vieren, M., Sterbinsky, S. A., Michael Gallatin, W., Hoffman, P. A., Staunton, D. E., and Bochner, B. S. (1998). Alpha d beta 2 integrin is expressed on human eosinophils and functions as an alternative ligand for vascular cell adhesion molecule 1 (VCAM-1). *J. Exp. Med.* **188**, 2187.
- Grober, J. S., Bowen, B. L., Ebling, H., Athey, B., Thompson, C. B., Fox, D. A., and Stoolman, L. M. (1993). Monocyte-endothelial adhesion in chronic rheumatoid arthritis. In situ detection of selectin and integrin-dependent interactions. *J. Clin. Invest.* **91**, 2609.
- Gu, Y., Bauer, C., Jr., Ackermann, M. R., Smith, C. W., Kehrl, M. E., Jr., Starost, M. F., and Hickstein, D. D. (2004). The genetic immunodeficiency disease, leukocyte adhesion deficiency, in humans, dogs, cattle, and mice. *T. Comp. Med.* **54**, 363.
- Gyang, E. O., Stevens, J. B., Olson, W. G., Tsitsamis, S. D., and Usenik, E. A. (1984). Effects of selenium-vitamin E injection on bovine polymorphonucleated leukocytes phagocytosis and killing of *Staphylococcus aureus*. *Am. J. Vet. Res.* **45**, 175.
- Hafezi-Moghadam, A., and Ley, K. (1999). Relevance of L-selectin shedding for leukocyte rolling in vivo. *J. Exp. Med.* **189**, 939.
- Harris, E. S., McIntyre, T. M., Prescott, S. M., and Zimmerman, G. A. (2000). The leukocyte integrins. *J. Biol. Chem.* **275**, 23409.
- Higuchi, H., and Nagahata, H. (1998). Comparison of superoxide production, protein kinase C and tyrosine kinase activities in neutrophils from neonatal calves and cows. *Res. Vet. Sci.* **65**, 139.
- Hogg, N., Stewart, M. P., Scarth, S. L., Newton, R., Shaw, J. M., Law, S. K., and Klein, N. (1999). A novel leukocyte adhesion deficiency caused by expressed but nonfunctional beta2 integrins Mac-1 and LFA-1. *J. Clin. Invest.* **103**, 97.
- Horwitz, M., Benson, K. F., Duan, Z., Li, F., and Person, R. E. (2004). Hereditary neutropenia: dogs explain human neutrophil elastase mutations. *Trends Mol. Med.* **10**, 163.
- Johnson-Tidey, R. R., McGregor, J. L., Taylor, P. R., and Poston, R. N. (1994). Increase in the adhesion molecule P-selectin endothelium overlying atherosclerotic plaques. Coexpression with intercellular adhesion molecule-1. *Am. J. Pathol.* **144**, 952.
- Jung, U., Ramos, C. L., Bullard, D. C., and Ley, K. (1998). Gene-targeted mice reveal importance of L-selectin-dependent rolling for neutrophil adhesion. *Am. J. Physiol.* **274**, H1785.
- Kanwar, S., Steeber, D. A., Tedder, T. F., Hickey, M. J., and Kubes, P. (1999). Overlapping roles for L-selectin and P-selectin in antigen-induced immune responses in the microvasculature. *J. Immunol.* **162**, 2709.
- Kehrl, M. E., Nonnecke, B. J., and Roth, J. A. (1989). Alterations in bovine lymphocyte function during the periparturient period. *Am. J. Vet. Res.* **50**, 207.
- Kiehl, A. R., Fettman, M. J., Quackenbush, S. L., and Hoover, E. A. (1987). Effects of feline leukemia virus infection on neutrophil chemotaxis in vitro. *Am. J. Vet. Res.* **48**, 76.
- Kijas, J. M., Bauer, T. R., Jr., Gafvert, S., Marklund, S., Trowald-Wigh, G., Johannisson, A., Hedhammar, A., Binns, M., Juneja, R. K., Hickstein, D. D., and Andersson, L. (1999). A missense mutation in the beta-2 integrin gene (ITGB2) causes canine leukocyte adhesion deficiency. *Genomics* **61**, 101.
- Kishimoto, T. K., Jutila, M. A., Berg, E. L., and Butcher, E. C. (1989). Neutrophil Mac-1 and Mel-14 adhesion proteins inversely regulated by chemotactic factors. *Science* **245**, 1238.
- Kishimoto, T. K., Kahn, J., Migaki, G., Mainolfi, E., Shirley, F., Ingraham, R., and Rothlein, R. (1995). Regulation of L-selectin expression by membrane proximal proteolysis. *Agents Actions Suppl.* **47**, 121.
- Kishimoto, T. K., and Rothlein, R. (1994). Integrins, ICAMs, and selectins: role and regulation of adhesion molecules in neutrophil recruitment to inflammatory sites. *Adv Pharmacol* **25**, 117.
- Klebanoff, S. J. (1975). Antimicrobial mechanisms in neutrophilic polymorphonuclear leukocytes. *Semin. Hematol.* **12**, 117.
- Klebanoff, S. J., and Clark, R. A. (1978). "The Neutrophil: Function and Clinical Disorders." New York, North-Holland.
- Kunkel, E. J., Chomas, J. E., and Ley, K. (1998). Role of primary and secondary capture for leukocyte accumulation in vivo. *Circ. Res.* **82**, 30.
- Lapinet, J. A., Scapini, P., Calzetti, F., Perez, O., and Cassella, M. A. (2000). Gene expression and production of tumor necrosis factor alpha, interleukin-1beta (IL-1beta), IL-8, macrophage inflammatory protein 1alpha (MIP-1alpha), MIP-1beta, and gamma interferon-inducible protein 10 by human neutrophils stimulated with group B meningococcal membrane vesicles. *Infect. Immun.* **68**, 6917.
- Lavkan, A. H., Astiz, M. E., and Rackow, E. C. (1998). Effects of proinflammatory cytokines and bacterial toxins on neutrophil rheologic properties. *Crit. Care Med.* **26**, 1677.
- Lee, W. L., and Downey, G. P. (2001). Neutrophil activation and acute lung injury. *Curr. Opin. Crit. Care* **7**, 1.
- Lehr, H., Bittinger, F., and Kirkpatrick, C. J. (2000). Microcirculatory dysfunction in sepsis: a pathogenetic basis for therapy. *J. Pathol.* **190**, 373.
- Lehrer, R. I., and Ganz, T. (1990). Antimicrobial polypeptides of human neutrophils. *Blood* **76**, 2169.
- Leppanen, A., Mehta, P., Ouyang, Y. B., Ju, T., Helin, J., Moore, K. L., van Die, I., Canfield, W. M., McEver, R. P., and Cummings, R. D. (1999). A novel glycosulfopeptide binds to P-selectin and inhibits leukocyte adhesion to P-selectin. *J. Biol. Chem.* **274**, 24838.
- Leppanen, A., Yago, T., Otto, V. I., McEver, R. P., and Cummings, R. D. (2003). Model glycosulfopeptides from P-selectin glycoprotein ligand-1 requires tyrosine sulfation and a core 2-branched O-glycan to bind to L-selectin. *J. Biol. Chem.* **278**, 391.
- Levy, O., Martin, S., Eichewald, E., Ganz, T., Valore, E., Carroll, S. F., Lee, K., Goldman, D., and Thorne, G. M. (1999). Impaired innate immunity in the newborn: newborn neutrophils are deficient in bactericidal/permeability-increasing protein. *Pediatrics*. **104**, 1327.
- Lewis, R. A., and Austen, K. F. (1984). The biologically active leukotrienes. Biosynthesis, metabolism, receptors, functions, and pharmacology. *J. Clin. Invest.* **73**, 889.
- Ley, K., and Kansas, G. S. (2004). Selectins in T-cell recruitment to non-lymphoid tissues and sites of inflammation. *Nat. Rev. Immunol.* **4**, 325.
- Ley, K., Tedder, T. F., and Kansas, G. S. (1993). L-selectin can mediate leukocyte rolling in untreated mesenteric venules in vivo independent of E- or P-selectin. *Blood* **82**, 1632.
- Lush, C. W., and Kviety, K. (2000). Microvascular dysfunction in sepsis. *Microcirc.* **7**, 83.
- Maier, R. V. (2000). Pathogenesis of multiple organ dysfunction syndrome-endotoxin, inflammatory cells, and their mediators: cytokines and reactive oxygen species. *Surg. Infect.* **1**, 197.
- Malech, H. L., and Nauseef, W. M. (1997). Primary inherited defects in neutrophil function: etiology and treatment. *Sem. Hematol.* **34**, 279.

- Mayadas, T. N., and Cullere, X. (2005). Neutrophil beta2 integrins: moderators of life or death decisions. *Trends Immunol* **26**, 388.
- Mayadas, T. N., Johnson, R. C., Rayburn, H., Hynes, R. O., and Wagner, D. D. (1993). Leukocyte rolling and extravasation are severely compromised in P-selectin-deficient mice. *Cell* **74**, 541.
- Mayer-Scholl, A., Averhoff, P., and Zychlinshy, A. (2004). How do neutrophils and pathogens interact? *Curr. Opin. Micro.* **7**, 62.
- McClenahan, D. J., Fagliari, J. J., Evanson, O. A., and Weiss, D. J. (1999). Evaluation of structural and functional alterations of circulating neutrophils in calves with experimentally induced pneumonic pasteurellosis. *Am. J. Vet. Res.* **60**, 1307.
- McClenahan, D. J., Fagliari, J. J., Evanson, O. A., and Weiss, D. J. (2000). Role of platelet-activating factor in alveolar septal injury associated with experimentally induced pneumonic pasteurellosis in calves. *Am. J. Vet. Res.* **61**, 248.
- McClenahan, D. J., Evanson, O. A., and Weiss, D. J. (2002). In vitro evaluation of the role of platelet-activating factor and interelukin-8 in Mannheimiahaemolytica-induced bovine pulmonary endothelial cell injury. *Am. J. Vet. Res.* **63**, 294.
- McEver, R. P., Beckstead, J. H., Moore, K. L., Marshall, C. L., and Bainton, D. F. (1989). GMP-140, a platelet alpha-granule membrane protein, is also synthesized by vascular endothelial cells and is localized in Weibel-Palade bodies. *J. Clin. Invest.* **84**, 92.
- McGuire, R. L., and Babiuk, L. A. (1983/1984). *Vet. Immunol. Immunopathol.* **5**, 259.
- McTaggart, C., Yovich, J. V., Penhale, J., and Raidal, S. L. (2001). A comparison of foal and adult horse neutrophil function using flow cytometric techniques. *Res. Vet. Sci.* **71**, 73.
- Metchnikoff, E. (1893). "Lectures on the Comparative Pathology of Inflammation." Kegan, Paul, Trench, and Trubner, London.
- Mills, E. L., and Noya, F. J. D. (1993). In "The Neutrophil" (J. S. Abraham and J. G. Wheeler, Eds.), p. 183. IRL Press, New York.
- Moore, K. L., Patel, K. D., Bruehl, R. E., Li, F., Johnson, D. A., Lichenstein, H. S., Cummings, R. D., Bainton, D. F., and McEver, R. P. (1995). P-selectin glycoprotein ligand-1 mediates rolling of human neutrophils on P-selectin. *J. Cell Biol.* **128**, 661.
- Moritz, A., Walcheck, B. K., Deye, J., and Weiss, D. (2003). Effects of short-term racing activity on platelet and neutrophil activation in dogs. *Am. J. Vet. Res.* **64**, 855.
- Murata, H., Takahashi, H., and Matsumoto, K. (1987). The effects of road transportation on peripheral blood lymphocyte subpopulations, lymphocyte blastogenesis and neutrophil function in calves. *Brit. Vet. J.* **143**, 166.
- Nagahata, H. (2004). Bovine leukocyte adhesion deficiency (BLAD): a review. *J. Vet. Med. Sci.* **66**, 1475.
- Nobis, U., Pries, A. R., Cokelet, G. R., and Gaetgens, P. (1985). Radial distribution of white cells during blood flow in small tubes. *Microvasc. Res.* **29**, 295.
- Paape, M. J., Wergin, W. P., Guidry, A. J., and Schultze, W. D. (1981). Phagocytic defense of the ruminant mammary gland. *Adv. Exp. Med. Biol.* **137**, 555.
- Paape, M. J., Bannerman, D. D., Zhao, X., and Lee, J. (2003). The bovine neutrophil: Structure and function in blood and milk. *Vet. Res.* **34**, 597.
- Palecanda, A., Walcheck, B., Bishop, D. K., and Jutila, M. A. (1992). Rapid activation independent shedding of leukocyte L-selectin induced by cross-linking of the surface antigens. *Eur. J. Immunol.* **22**, 1279.
- Petrofsky, M., and Bermudez, L. E. (1999). Neutrophils from *Mycobacterium avium*-infected mice produce TNF-alpha, IL-12, and IL-1 beta and have a putative role in early host response. *J. Appl. Biomaterials.* **91**, 354.
- Peyron, P., Maridonneau-Parini, I., and Stegmann, T. (2001). Fusion of human neutrophil phagosomes with lysosomes in vitro: involvement of tyrosine kinases of the Src family and inhibition by mycobacteria. *J. Biol. Chem.* **276**, 35512.
- Piccinini, R., Bronzo, V., Moroni, P., Luzzago, C., and Zecconi, A. (1999). Study on the relationship between milk immune factors and *Staphylococcus aureus* intramammary infections in dairy cows. *J. Dairy Sci.* **66**, 501.
- Pouyani, T., and Seed, B. (1995). PSGL-1 recognition of P-selectin is controlled by a tyrosine sulfation consensus at the PSGL-1 amino terminus. *Cell* **83**, 333.
- Raidal, S. L., Love, D. N., Bailey, G. D., and Rose, R. J. (2000). Effects of single bouts of moderate and high intensity exercise and training on equine peripheral blood neutrophil function. *Res. Vet. Sci.* **68**, 141.
- Rambeaud, M., and Pighetti, G. M. (2005). Impaired neutrophil migration associated with specific bovine CXCR2 genotypes. *Infect. Immun.* **73**, 4955.
- Renshaw, H., Chatburn, C., Bryan, G. M., Bartsch, R. C., and Davis, W. C. (1975). Canine granulocytopeny syndrome: neutrophil dysfunction in a dog with recurrent infections. *J. Am. Vet. Med. Assoc.* **166**, 443.
- Rizoli, S. B., Rotstein, O. D., and Kapus, A. (1999). Cell volume-dependent regulation of L-selectin shedding in neutrophils; A role for p38 mitogen-activated protein kinase. *J. Biol. Chem.* **274**, 22072.
- Roos, D., van Bruggen, R., and Meischl, C. (2003). Oxidative killing of microbes by neutrophils. *Microbes Infect.* **5**, 1307.
- Rot, A., and von Andrian, U. H. (2004). Chemokines in innate and adaptive host defense: basic chemokines grammar for immune cells. *Annu Rev Immunol* **22**, 891.
- Roth, J. A., Kaeberle, M. L., and Griffith, R. W. (1981). Effects of bovine viral diarrhea virus infection on bovine polymorphonuclear leukocyte function. *Am. J. Vet. Res.* **42**, 244.
- Sako, D., Chang, X. J., Barone, K. M., Vachino, G., White, H. M., Shaw, G., Veldman, G. M., Bean, K. M., Ahern, T. J., Furie, B., Cumming, D. A., and Larsen, G. R. (1993). Expression cloning of a functional glycoprotein for P-selectin. *Cell* **75**, 1179.
- Sako, D., Comess, K. M., Barone, K. M., Camphausen, R. T., Cumming, D. A., and Shaw, G. D. (1995). A sulfated peptide segment at the amino terminus of PSGL-1 is critical for P-selectin binding. *Cell* **83**, 323.
- Schmid-Schonbein, G. W., Usami, S., Skalak, R., and Chien, S. (1980). The interaction of leukocytes and erythrocytes in capillary and post-capillary vessels. *Microvasc. Res.* **19**, 45.
- Segal, A. W. (2005). How neutrophils kill microbes. *Annu. Rev. Immunol.* **23**, 197.
- Seidelin, J. B., Nielsen, O. H., and Strom, J. (2002). Soluble L-selectin levels predict survival in sepsis. *Intensive Care Med.* **28**, 1613.
- Serfass, R. E., and Ganther, H. E. (1975). Defective microbicidal activity in glutathione peroxidase-deficient neutrophils of selenium-deficient rats. *Nature* **255**, 640.
- Shuster, D. E., Kehrl, M. E., Jr., Ackermann, M. R., and Gilbert, R. O. (1992). Identification and prevalence of a genetic defect that causes leukocyte adhesion deficiency in Holstein cattle. *Proc. Natl. Acad. Sci. USA* **89**, 9225.
- Shuster, D. E., Lee, E. K., and Kehrl, M. E. (1996). Bacterial growth, inflammatory cytokine production, and neutrophil recruitment during coliform mastitis in cows within ten days after calving, compared with cows at midlactation. *Am. J. Vet. Res.* **57**, 1569.
- Simon, S. I., and Green, C. E. (2005). Molecular mechanisms and dynamics of leukocyte recruitment during inflammation. *Annu. Rev. Biomed. Eng.* **7**, 151.

- Skoutelis, A. T., Kaleridis, V. E., Gogos, C. A., and Athanassiou, G. M. (2000). Effects of cytokines and colony-stimulating factors on passive polymorphonuclear leukocyte deformability in vitro. *Cytokine* **12**, 1737.
- Sperandio, M., Smith, M. L., Forlow, S. B., Olson, T. S., Xia, L., McEver, R. P., and Ley, K. (2003). P-selectin glycoprotein ligand-1 mediates L-selectin-dependent leukocyte rolling in venules. *J. Exp. Med.* **197**, 1355.
- St. Hill, C. A., Alexander, S. R., and Walcheck, B. (2003). Indirect capture augments leukocyte accumulation on P-selectin in flowing whole blood. *J. Leukoc. Biol.* **73**, 464.
- Stegmaier, M., Levinovitz, A., Isenmann, S., Borges, E., Lenter, M., Kocher, H. P., Kleuser, B., and D. Vestweber, D. (1995). The E-selectin-ligand ESL-1 is a variant of a receptor for fibroblast growth factor. *Nature* **373**, 615.
- Stossel, T. P. (1974). Phagocytosis. *New Engl. J. Med.* **290**, 774.
- Tacchini-Cottier, F., Zweifel, C., Belkaid, Y., Mukankundiye, C., Vasei, M., Launois, P., Milon, G., and Louis, J. A. (2000). An immunomodulatory function of neutrophils during the induction of a CD4+ Th2 response in BALB/c mice infected with *Leishmania major*. *J. Immunol.* **165**, 2628.
- Tailleux, L., Neyrolles, O., Honore-Bouakline, S., Perret, E., Sanchez, F., Abastado, J., Lagarange, P. H., Gluckman, J. C., Rosenzqajg, M., and Hermann, J. (2003). Constrained intracellular survival of *Mycobacterium tuberculosis* in human dendritic cells. *J. Immunol.* **170**, 1939.
- Tedder, T. F., Steeber, D. A., and Pizcueta, P. (1995). L-selectin-deficient mice have impaired leukocyte recruitment into inflammatory sites. *J. Exp. Med.* **181**, 2259-2264.
- Terajima, S., Higaki, M., Igarashi, Y., Nogita, T., and Kawashima, M. (1998). An important role of tumor necrosis factor-alpha in the induction of adhesion molecules in psoriasis. *Arch. Dermatol. Res.* **290**, 246.
- Van der Vieren, M., Le Trong, H., Wood, C. L., Moore, P. F., St. John, T., Staunton, D. E., and Gallatin, W. M. (1995). A novel leukointegrin, alpha d beta s, binds preferentially to ICAM 3. *Immunity* **3**, 683.
- VanSteenhouse, J. L. (1987). Free radicals: relation to tissue damage - a review. *Vet. Clin. Pathol.* **16**, 29.
- Via, L. E., Deretic, D., Ulmer, R. J., Hibler, N. S., Huber, L. A., and Deretic, V. (1997). Arrest of mycobacterial phagosome maturation is caused by a block in vesicle fusion between stages controlled by rab5 and rab7. *J. Biol. Chem.* **272**, 13326.
- Vieira, O. V., Botelho, R. J., and Grinstein, S. (2002). Phagosome maturation: aging gracefully. *Biochem. J.* **366**, 689.
- Venturi, G. M., Tu, L., Kadono, T., Khan, A. I., Fujimoto, Y., Oshel, P., Bock, C. B., Miller, A. S., Albrecht, R. M., Kubes, P., Steeber, D. A., and Tedder, T. F. (2003). Leukocyte migration is regulated by L-selectin endoproteolytic release. *Immunity* **19**, 713.
- Virchow, R. (1871). "Die cellular Pathologie in ihrer Begründung auf physiologische und pathologische Gewebelehre." Verlag von August Hirschwald, Berlin.
- von Andrian, U. H. (1996). Intravital microscopy of the peripheral lymph node microcirculation in mice. *Microcirculation* **3**, 287.
- von Andrian, U. H., Chambers, J. D., Berg, E. L., Michie, S. A., Brown, D. A., Karolak, D., Ramezani, L., Berger, E. M., Arfors, K. E., and Butcher, E. C. (1993). L-selectin mediates neutrophil rolling in inflamed venules through sialyl LewisX-dependent and -independent recognition pathways. *Blood* **82**, 182.
- von Andrian, U. H., Chambers, J. D., McEvoy, L. M., Bargatze, R. F., Arfors, K. E., and Butcher, E. C. (1991). Two-step model of leukocyte-endothelial cell interaction in inflammation: distinct roles for LECAM-1 and the leukocyte beta 2 integrins in vivo. *Proc. Natl. Acad. Sci. USA*, **88**, 7538.
- von Andrian, U. H., Hansell, P., Chambers, J. D., Berger, E. M., Filho, I. T., Butcher, E. C., and Arfors, K. E. (1992). L-selectin function is required for beta 2-integrin-mediated neutrophil adhesion at physiological shear rates in vivo. *Am. J. Physiol.* **263**, H1034.
- von Haller, A. (1756). "Deux memoires sur le mouvement du sang, et sur les effets de la saignée; fondés sur des experiences faites sur des animaux." M.M. Bosquet, Paris.
- Wagner, R. (1839). "Erläuterungstafeln zur Physiologie und Entwicklungsgeschichte." Leopold Voss, Leipzig.
- Walcheck, B., Kahn, J., Fisher, J. M., Wang, B. B., Fisk, R. S., Payan, D. G., Feehan, C., Betageri, R., Darlak, K., Spatola, A. F., and Kishimoto, T. K. (1996). Neutrophil rolling altered by inhibition of L-selectin shedding in vitro. *Nature* **380**, 720.
- Walcheck, B., Moore, K. L., McEver, R. P., and Kishimoto, T. K. (1996). Neutrophil neutrophil interactions under hydrodynamic shear stress involves L-selectin and PSGL-1. A mechanism that amplifies initial leukocyte accumulation of P-selectin in vitro. *J. Clin. Invest.* **98**, 1081.
- Watson, M. L., Kingsmore, S. F., Johnston, G. I., Siegelman, M. H., Le Beau, M. M., Lemons, R. S., Bora, N. S., Howard, T. A., Weissman, I. L., McEver, R. P., and Seldin, M. F. (1990). Genomic organization of the selectin family of leukocyte adhesion molecules on human and mouse chromosome 1. *J. Exp. Med.* **172**, 263.
- Wehrle-Haller, B., and Imhof, B. A. (2003). Integrin-dependent pathologies. *J. Pathol* **200**, 481.
- Weis, W. I., Taylor, M. E., and Drickamer, K. (1998). The C-type lectin superfamily in the immune system. *Immunol. Rev.* **163**, 19.
- Weiss, D. J., and Evanson, O. A. (2003). Evaluation of activated neutrophils in the blood of horses with colic. *Am. J. Vet. Res.* **64**, 1364.
- Weiss, D. J., Evanson, O. A., McClenahan, D., Fagliari, J. J., Dunnwiddie, C. T., and Wells, R. E. (1998a). Effects of a competitive inhibitor of platelet aggregation on experimentally induced laminitis in ponies. *Am. J. Vet. Res.* **59**, 814.
- Weiss, D. J., Evanson, O. A., Fagliari, J. J., and Valberg, S. (1998b). Evaluation of platelet activation and platelet-neutrophil aggregates in Thoroughbreds undergoing near-maximal treadmill exercise. *Am. J. Vet. Res.* **59**, 393.
- Weiss, D. J., and Rashid, J. (1998). The sepsis-coagulant axis. *J. Vet. Intern. Med.* **12**, 317.
- Weiss, D. J., Welle, M., Moritz, A., and Walcheck, B. (2004). Evaluation of leukocyte cell surface markers in dogs with septic and nonseptic inflammatory diseases. *Am. J. Vet. Res.* **65**, 59.
- Weiss, J., Elsbach, P., Plsson, I., and Odeberg, H. (1978). Purification and characterization of a potent bactericidal and membrane active protein from the granules of human polymorphonuclear leukocytes. *J. Biol. Chem.* **253**, 2664.
- Weller, A., Isenmann, S., and Vestweber, D. (1992). Cloning of the mouse endothelial selectins. Expression of both E- and P-selectin is inducible by tumor necrosis factor alpha. *J. Biol. Chem.* **267**, 15176.
- Whiteley, L. O., Maheswaran, S. K., Weiss, D. J., Ames, T. R., and Kannon, M. S. (1992). Pasteurella haemolytica A1 and bovine respiratory disease: pathogenesis. *J. Vet. Intern. Med.* **6**, 11.
- Wichtel, M. G., Anderson, K. L., Johnson, T. V., Nathan, U., and Smith, L. (1991). Influence of age on neutrophil function in foals. *Eq. Vet. J.* **23**, 466.
- Wild, M. K., Luhn, K., Marquardt, T., and Vestweber, D. (2002). Leukocyte adhesion deficiency II: therapy and genetic defect. *Cells Tissues Organs* **172**, 161.
- Woodard, L. F., Eckblad, W. P., Olson, D. P., Bull, R. C., and Everson, D. O. (1980). Effects of maternal protein-energy malnutrition and cold



- stress on neutrophil function of bovine neonates. *Am. J. Vet. Res.* **41**, 1208.
- Yang, J., Hirata, T., Croce, K., Merrill-Skoloff, G., Tchernychev, B., Williams, E., Flaumenhaft, R., Furie, B. C., and Furie, B. (1999). Targeted gene disruption demonstrates that P-selectin glycoprotein ligand 1 (PSGL-1) is required for P-selectin-mediated but not E selectin-mediated neutrophil rolling and migration. *J. Exp. Med.* **190**, 1769.
- Yang, L., Froio, R. M., Sciuto, T. E., Dvorak, A. M., Alon, R., and Luscinskas, F. W. (2005). ICAM-1 regulates neutrophil adhesion and transcellular migration of TNF-alpha-activated vascular endothelium under flow. *Blood* **106**, 584.
- Zwahlen, R. D., Wyder-Walther, M., and Roth, D. R. (1992). Fc receptor expression, concanavalin A capping, and enzyme content of bovine neonatal neutrophils: a comparative study with adult cattle. *J. Leuko. Biol.* **51**, 264.

# Diagnostic Enzymology of Domestic Animals

Walter E. Hoffmann

*Department of Veterinary Pathobiology  
College of Veterinary Medicine  
University of Illinois, Urbana, Illinois*

Philip F. Solter

*Department of Veterinary Pathobiology  
College of Veterinary Medicine  
University of Illinois, Urbana, Illinois*

---

## I. INTRODUCTION

## II. HISTORY OF CLINICAL ENZYMOLOGY

## III. FACTORS AFFECTING SERUM ENZYME ACTIVITY

- A. Organ Mass and Enzyme Tissue Concentration
- B. Cell Location
- C. Mechanisms of Release of Cytoplasmic Enzymes or Other Protein Biomarkers from Cells to Blood
- D. Mechanisms of Release of Membrane-Bound Enzymes
- E. Blood Clearance Rates of Enzymes
- F. Enzyme Induction

## IV. SPECIFIC ENZYMES

- A. Alanine Aminotransferase
- B. Aspartate Aminotransferase
- C. Sorbitol Dehydrogenase
- D. Glutamate Dehydrogenase
- E. Gamma Glutamyltransferase
- F. Alkaline Phosphatase
- G. Lipase
- H. Amylase
- I. Trypsin and Trypsinogen
- J. Creatine Kinase
- K. Other Enzymes

## V. FUTURE OF SERUM ENZYMOLOGY

## REFERENCES

---

## I. INTRODUCTION

The detection of proteins in serum by their catalytic activity as a reporter of tissue damage is a cornerstone of medical laboratory analyses (Rej, 1998).

Clinical enzymology is the discipline that studies and tests enzyme activity in serum, plasma, urine, or other body fluids for the purpose of helping to establish the diagnosis and prognosis of disease and to screen for abnormal organ function. Although not the subject of this chapter, it should be noted that some enzymes are also of major importance as

analytical reagents. This chapter first explores the universal factors affecting changes in enzyme content of bodily fluids and then delves into specific details relevant to particular enzymes. Discussion of basic concepts in enzymology, such as enzyme structure, kinetics, or analysis, is limited to those that are of clinical relevance or that add insight into interpreting changes in body fluid enzyme activity. Additional information regarding enzyme structure and enzyme kinetics can be found in numerous biochemistry texts as well as clinical texts such as *Tietz Fundamentals of Clinical Chemistry* (Burtis and Ashwood, 2001) and the previous edition of this book. In addition, the methodology of the various enzyme assays can be found in the literature provided by the vendors of enzyme assay reagents.

## II. HISTORY OF CLINICAL ENZYMOLOGY

Although the presence of enzymes in cells and plasma was first recognized in the 1800s, the development of clinical enzymology began after the introduction of an assay for serum amylase by Wohlgemuth in 1908 and the report in 1916 that serum amylase activity in blood and urine was a reliable test for pancreatic disorders (Rosenfeld, 1999). This finding was followed in 1927 by the discovery of alkaline phosphatase (ALP) in bone and the description of serum alkaline phosphatase as a diagnostic test (Rosenfeld, 1999). The development and marketing by Sigma Chemical Company in St. Louis in the 1950s of simplified enzyme assays in kit form, such as aspartate and alanine aminotransferases, and an ALP assay that used p-nitrophenylphosphate as substrate (Technical Bulletin 104), were major factors in their routine clinical use and encouraged additional studies in diagnostic enzymology (Berger, 1993; Bessey *et al.*, 1946; Reitman and Frankel, 1957). In addition to assay reagent development, an equally significant contribution to the development of clinical enzymology was the invention by Leonard Skeggs of a multichannel autoanalyzer that was

marketed by Technicon in 1964 (Skeggs, 2000). The auto-analyzer increased the availability of reduced cost serum enzyme analyses, which ultimately led to their routine use in both human and veterinary diagnostic medicine.

The advancement of clinical enzymology included the development and evaluation of enzyme assays for use in nonhuman animal species, some of which have been found useful, whereas others have been dropped for various reasons. In some cases, the decision to investigate an enzyme for diagnostic use may have related not only to its potential clinical relevance but also to the efficiency of offering the test. In spite of recognition of species differences, veterinary medicine has often followed human medicine in its choice of diagnostic tests. The bias toward enzyme assays used in human medicine is due in part to their availability on automated analyzers, making all tests low-cost, on-demand assays with a high degree of precision and accuracy.

The automation of enzyme assays, and the popularity of the serum chemistry profile in veterinary medicine, has allowed retrospective studies to be conducted and has given the veterinarian an opportunity to critically evaluate the diagnostic function of the common assays in a large number of animals on a regular basis, as well as gain a “feel” for the results, thereby allowing for more subtle clinical interpretations. It is likely that diagnostic tests that are not automated are less understood and interpreted in a more rigid manner with less appreciation for nuances and significance of the test result. Interestingly, during the first approximately 30 years of serum enzyme testing in veterinary medicine, these tests were often viewed as “diagnostic” tests, whereas in the past approximately 20 years their variable and often somewhat limited degree of diagnostic specificity has been appreciated and they are now most often recognized as “screening” tests.

Although serum enzyme activity is reported as part of numerous studies published in the literature, the number of studies directed primarily at answering specific questions regarding the enzymes appears to have decreased since the late 1990s from what might be considered the heyday of clinical enzymology in the 1960s to mid-1990s.

### III. FACTORS AFFECTING SERUM ENZYME ACTIVITY

As the field of clinical enzymology has developed, so has our understanding of the physiological factors responsible for the alterations in serum enzyme activity that occur with disease, although several unanswered questions remain. Organ specificity, subcellular location of the enzyme, the mechanism of enzyme release from cells, the clearance from blood, and the rate of induction of enzyme synthesis all affect to a lesser or greater extent the diagnostic accuracy of the various enzyme assays (Hoffmann and Solter, 1989; Solter, 2005). This section discusses the physiological,

biochemical, and anatomical factors that affect changes to serum enzyme activity.

#### A. Organ Mass and Enzyme Tissue Concentration

The roles that enzyme tissue concentration and organ mass play on the magnitude of blood enzyme activity are relatively straightforward. Organs with a high concentration of an enzyme have the potential to cause a greater increase in serum enzyme activity with disease. For example, the intracellular to extracellular concentration gradient of hepatocellular alanine aminotransferase (ALT) is 100,000:1. Injury to hepatocytes, therefore, has the potential of causing markedly increased serum ALT activity. The higher the concentration gradient of the enzyme or protein marker between the cell and the interstitial space, the faster is the translocation of significant quantities of the enzyme to the interstitial space and ultimately the blood (Mair, 1999). Likewise, the liver has a large mass, thereby adding to the potential increase in serum ALT activity.

#### B. Cell Location

The location of cellular enzymes relative to the blood, urine, or other fluids is an especially significant determinant of whether an increase in enzyme activity will occur with enzyme release and in which fluid it will be found. A well-known example is renal tubular gamma glutamyltransferase (GGT) located on the luminal surface of renal tubular epithelial cells. Injury to these cells results in release of the gamma GT into urine but not into blood. Similarly, alkaline phosphatase (ALP) located on the luminal surface of enterocytes is lost into the gut lumen rather than blood with enterocyte injury. Hepatocellular ALP, however, with activity over both bile canalicular and sinusoidal surfaces, can be increased in both bile and blood.

#### C. Mechanisms of Release of Cytoplasmic Enzymes or Other Protein Biomarkers from Cells to Blood

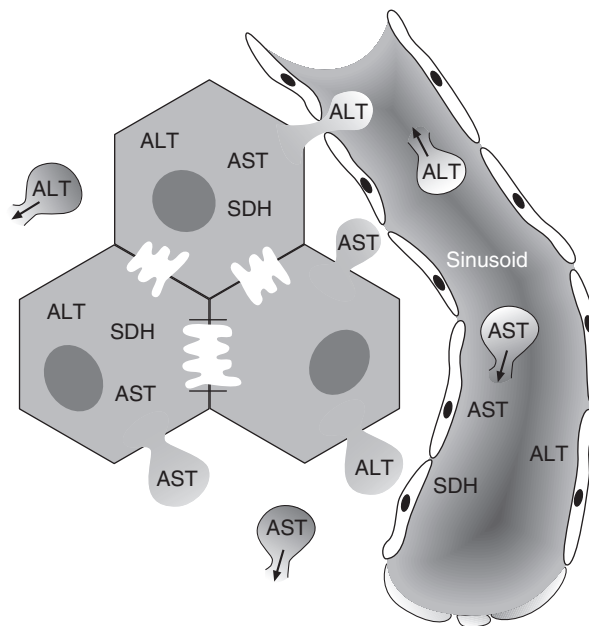
Cytoplasmic enzymes are contained within cell membranes. Healthy plasma membranes are thought to be impermeable to macromolecules such as enzymes. Therefore, alteration in the cell membrane is necessary to allow cytoplasmic enzymes to gain access to the blood. In the event of cell necrosis, perforations and tears of the cell membrane allow the release of cytosolic contents in a relatively straightforward process. However, increases of serum enzymes do not always correlate to the degree of histological evidence of cell necrosis. Hence, it has been long postulated that under certain circumstances, cytoplasmic enzymes may “leak” from

diseased cells that remain viable, perhaps through membrane pores or tears. However, it is difficult to envision that a cell could develop a pore or tear large enough to allow “leakage” of macromolecules such as enzymes while maintaining the intracellular-to-extracellular electrolyte ratios necessary to remain viable. An alternative mechanism by which a cell could sustain damage from which it survives and yet allows the release of cytoplasmic enzymes is the formation of membrane blebs (Coltran *et al.*, 1999; Gores *et al.*, 1990; Lemasters *et al.*, 1983; Mair, 1999). These blebs then are ruptured or are released as vesicles into the blood where they are eventually broken down, releasing their contents, including cytoplasmic enzymes. The body of knowledge supporting this concept has been growing since the 1980s (Gore *et al.*, 1990; Kristensen, 1994; Mair, 1999; Solter, 2005).

Cell membrane bleb formation has been recognized following hypoxic insults and likely reflects two sequential developments. Depletion in energy stores in the form of ATP is followed by several events including the influx of calcium into the cell (Coltran *et al.*, 1999). This calcium influx results in activation of intracellular phospholipases, endonucleases, and proteases and ultimately in disruption in the phosphorylation state of cytoskeletal proteins and an alteration in lipid membrane content. A combination of the altered cytoskeletal proteins, lipid membrane content, and osmotic swelling of the cell leads to bleb formation, release of these blebs, and resealing of the cell membrane (Fig. 12-1). Hepatocyte bleb formation, projection of these blebs through the fenestrations of endothelial cells, and release of these blebs during hypoxia are clearly shown in scanning electron micrographs (Lemasters *et al.*, 1983). Bleb formation has been described with many conditions including ischemia, shock, viral infections, toxemia, and cholestasis. The magnitude of serum enzyme increase with reversible cell injury and bleb formation is not clearly understood, but it is likely that the magnitude of release and resultant increase activity in serum are considerably less than what might be observed with cell necrosis. Hence, it is reasonable to assume that the greater the magnitude of serum enzyme increase, the greater likelihood of some irreversible cell death, whereas mild serum enzyme activity increases may be associated with reversible cell injury.

Although cytoplasmic enzymes may be released from cells into blood because of bleb formation, enzymes associated with the mitochondria are not released by this mechanism (Kamiike *et al.*, 1989). Appreciable loss of membrane integrity and presumably cell death are necessary for release of mitochondrial aspartic aminotransferase (mAST) from hepatocytes. Ischemic liver does not lose mAST until almost all cytoplasmic aspartic aminotransferase (cAST) is lost.

Regardless of the mechanism of release of the enzymes, there is evidence that the enzymes are released into the interstitial space where the greater portion is carried by lymphatics to the thoracic duct and emptied into the blood



**FIGURE 12-1** Membrane bleb formation in reversible injury, allowing the release of cytoplasmic enzymes either directly into blood or into the interstitial space where they can be carried by lymphatics to blood.

(Bolter and Critz, 1976; Lindena *et al.*, 1986). Lymph-to-serum ratios of most enzymes are greater than 1:1, providing support for the delivery of enzymes to blood via the lymphatics. However, the direct delivery of the enzyme from the injured cell to blood cannot be discounted and is supported by the electron micrographs of cell blebs extending through the fenestrations of the endothelium as discussed earlier. This delivery of the enzyme from the injured cell to blood, whether directly or indirectly via lymphatics, likely affects the time of maximum serum increase of the enzyme after injury and duration of the presence of the increase of the enzyme in blood as suggested by the longer half-life of CK when injected intramuscularly as opposed to intravenous injection (Aktas *et al.*, 1995).

#### D. Mechanisms of Release of Membrane-Bound Enzymes

Those enzymes attached to the external surface of cell membranes such as alkaline phosphatase (ALP), gamma-glutamyl transferase (GGT), and 5' nucleotidase (5'N) are released from cells to blood by distinctly different mechanisms than enzymes derived from the cytoplasm.

Of historical interest, increases of serum ALP activity were perhaps first thought to result from a failure of excretion of bone ALP by the liver. This concept was put to rest many years ago and followed by the concept that cholephilic enzymes were shed from the bile canalicular surface of hepatocytes or biliary epithelial cells into bile and then regurgitated into blood through tight junctions. Support for

this pathway was provided by evidence of disruptive changes to tight junctions in cholestasis and by experimental observations of infused horseradish peroxidase moving through tight junctions (Boyer, 1993; Lowe *et al.*, 1988). However, increases of serum ALP and GGT activity have been shown to occur in the absence of increased biliary pressure and any evidence of alterations in tight junctions, and it is unlikely that this paracellular pathway is a significant contributor to the appearance of cholephilic enzymes in serum in most cases (Debroe *et al.*, 1985; Putzki, 1989; Toyota *et al.*, 1983). An alternative pathway of movement of cholephilic enzymes to blood has been suggested as a retrograde vesicular transport system following the observation that retrograde infusion of ferritin and polymeric and secretory forms of IgA undergo reversed transcytosis from the biliary or apical surface of the hepatocytes to the basolateral or sinusoidal surface during cholestasis (Carpino *et al.*, 1981; Jones *et al.*, 1984). However, neither of these pathways allows explanation of the appearance of ALP and GGT activity in blood in the absence of cholestasis. Studies using a choledochocaval shunt model show that within 12h of shunting of bile or taurocholic acid into blood, there is a marked induction of ALP synthesis, appearance of ALP on the basolateral membranes, and a parallel increase in serum ALP activity (Ogawa *et al.*, 1990). This occurs in the absence of increased biliary pressure and any evidence of alterations in tight junctions (Toyota *et al.*, 1983). These observations along with others led to a third and more likely mechanism of the appearance of cholephilic enzymes, especially ALP, in blood. The basolateral appearance of enzymes typically considered to be on the apical membrane or bile canalicular surface is not unexpected as following synthesis all apical membrane proteins are believed to first be transported to the basolateral surfaces before vesicular transport to their final site on the bile canalicular membrane (Bartles *et al.*, 1987; Maurice *et al.*, 1994; Schell *et al.*, 1992). Therefore, these so-called biliary enzymes or proteins have a brief period of residence on the sinusoidal surface of the hepatocytes with the enzyme on the external surface in the space of Disse so that they can potentially be released into blood if and when a suitable release mechanism exists. In addition, the quantity of enzyme available on the basolateral membrane and accessible for release into blood is increased at any time there is increased synthesis of the enzyme as described previously with the choledochocaval shunt model, as occurs with cholestasis and as may occur during hormonal or drug-driven induction of enzyme synthesis (Ogawa *et al.*, 1990; Putzki *et al.*, 1989; Solter and Hoffmann, 1999; Solter *et al.*, 1997). Although positioned on the basolateral membrane facing the space of Disse for a brief period allows the possibility of release into blood, this does not occur without appropriate conditions to cleave the hydrophobic anchor. Alkaline phosphatase and 5' nucleotidase are anchored to the membrane via a hydrophobic phosphatidylinositol glycan anchor, whereas GGT is anchored via a transmembrane peptide therefore requiring

different mechanisms of release. These release mechanisms will be discussed specifically in the sections dealing with each of these enzymes.

## E. Blood Clearance Rates of Enzymes

The amount of enzyme activity in blood is very dependent on the rate of clearance of the enzyme from the blood following its release from cells. The half-lives of various enzymes range from minutes to hours to days, and the mechanisms or factors that determine the half-life of the various enzymes vary.

The actual mechanisms of removal of enzymes from blood are not well established but likely are varied. Some small-molecular-weight enzymes such as amylase and lipase are, in part, filtered through the glomerulus. Enzymes that are glycoproteins are likely endocytosed by the galactose receptors on hepatocytes either directly via exposed galactose molecules or after loss of terminal sialic acid molecules resulting in exposed galactose residues, or are endocytosed by mannose receptors on Kupffer cells. Other enzymes may be degraded by proteases or are labile and activity is lost while the protein continues to circulate. The rate of clearance of enzymes from blood can be affected by disease and may complicate the correct interpretation of diagnostic test results. For example, pancreatic amylase activity, which is normally cleared by the kidneys, will increase in patients with renal failure because of the decreased glomerular filtration rate. A false-positive test result for pancreatitis could result.

## F. Enzyme Induction

Changes to serum enzyme activity may in some cases reflect changes in enzyme production by the cells, rather than cell injury. Although there is certainly evidence of varying concentrations of cytoplasmic enzymes in cells, these generally do not result in dramatic changes in the serum activity of these enzymes. Marked increases in serum enzymes as a result of induction are most often associated with enzymes that are membrane bound where they can readily be released from the membrane into the lymphatics or blood or secreted by the cell. This induction can be as a result of hormonal changes, pathophysiological events such as cholestasis, or can be drug induced.

# IV. SPECIFIC ENZYMES

## A. Alanine Aminotransferase

Alanine aminotransferase (EC 2.6.1.2) (ALT), formerly known as glutamic pyruvate transaminase, catalyzes the reversible transamination of L-alanine and 2-oxoglutarate to pyruvate and L-glutamate. ALT, along with other transaminases,

plays a role in amino acid catabolism and interorgan nitrogen transport. Pyridoxal 5'-phosphate (PP) is the cofactor of ALT, thus forming the active holoenzyme. PP is generally present in serum in sufficient quantities to provide near maximum activity of the ALT with only a reported 11% and 7% inactive apoenzyme in dog and cat serum, respectively (Stokol and Erb, 1998). There was no difference found between the percentage of inactive apoenzyme in the serum of normal animals and those with hepatic disease. However, two dogs were identified with 14,225% and 336% greater serum ALT activity when PP was added (Mesher *et al.*, 1998). Approximately half the ALT in serum from a group of exercising Thoroughbred horses was in the inactive apoenzyme form (Rej *et al.*, 1990). Hence, because there are cases in which PP seems to be limiting the measured ALT activity, some, but not all, commercial assays for ALT now contain added PP reagent.

ALT activity is found in several body organs, but the magnitude of activity varies dramatically with species. In dogs, the ALT activity per gram of liver is at least four times greater than in other organs, although considerable activity is found in both heart and skeletal muscle (Clampitt and Hart, 1978; Keller, 1981; Zinkl *et al.*, 1971). Similar findings are true for cats, but in horses, cattle, and swine, the ALT activity per gram of tissue differs little in liver when compared to muscle. Hence, based on tissue concentrations of ALT, increased serum ALT activity is somewhat specific for hepatic injury in dogs and cats but offers no specificity for detection of liver injury in horses and cattle.

ALT, found in the cytoplasm of hepatocytes, is also found in mitochondria but generally at considerably lower concentrations, depending on species and tissue. Although it has been suggested that the mitochondrial enzyme may be released into blood more slowly following hepatocellular injury, this activity is still poorly understood and has not been utilized as a diagnostic tool.

The half-life of ALT in blood is not clearly defined, although the circulation time is obviously adequately long to evaluate organ injury and release of ALT into blood for hours to days after the event. In dogs, reports have suggested half-lives of 3, 20, 45, and 60h (Fleisher and Wakim, 1963; Reichard, 1959; Zinkl *et al.*, 1971). Semilogarithmic plots of the decline in serum ALT activity following peak activity induced by acute CCl<sub>4</sub> exposure suggest a half-life of between 45 and 60h in dogs, although this may be a slight overestimation, as injured tissue is still likely present and contributing to the blood pool (unpublished data). The half-life of ALT from feline liver extracts, administered intravenously to cats, was estimated as 3 to 4h (Nilkumuhaug and Thornton, 1979). This is consistent with the half-life of 6h for ALP activity in the blood of cats (Hoffman *et al.*, 1977).

Serum ALT has been recognized as a marker of hepatocellular injury since the 1950s (Chimsky *et al.*, 1956;

Cornelius, 1958). The use of ALT as a diagnostic tool was expedited by the development in the mid-1950s of a simple coupled assay for ALT activity in serum that eliminated the problem of product inhibition (Reitman and Frankel, 1957). Numerous studies using carbon tetrachloride have clearly shown the value of serum ALT as an indicator of hepatocellular necrosis, especially in dogs and cats, but to a much lesser extent in horses, cattle, swine, sheep, and goats (Cornelius *et al.*, 1958; Everett *et al.*, 1977; Noonan, 1981; Noonan and Meyer, 1979; Spano *et al.*, 1983; Turgut *et al.*, 1997; Zinkl *et al.*, 1971). The length of time that serum ALT activity is increased ranges from 9 to 23 days in dogs, which suggests prolonged injury to the liver but also supports the longer half-life suggested earlier (Guelfi *et al.*, 1982; Noonan, 1981; Turgut *et al.*, 1997). Relatively mild increases in serum ALT activity occur in dogs and cats with biliary obstructive diseases that cause serum ALP activity to increase markedly (Everett *et al.*, 1977; Spano *et al.*, 1983). Hence, the ratio of serum ALT-to-ALP activity is far greater in cases of hepatic necrosis than with cholestasis, suggesting that very general interpretive conclusions can be made by comparing the magnitude of increase of serum activity of these two enzymes. Increased serum ALT activity occurs with a wide range of other disorders including hypoxia secondary to anemia, metabolic diseases such as lipidosis, nutritional disorders such as copper toxicosis, inflammatory or infectious diseases, neoplastic diseases, and traumatic liver injury. Increased serum ALT activity has also been associated with numerous drugs; in many cases, these are likely idiosyncratic reactions causing hepatocellular toxicity. Exposure to carbon tetrachloride, mushroom alkaloids, or acetaminophen is clearly a hepatotoxic event.

Mild to moderate increases in serum ALT activity are also observed in dogs and cats with endocrine diseases such as diabetes mellitus, hyperthyroidism, hyperadrenocorticism, and hypothyroidism. For example, 163 (78%) dogs with diabetes mellitus have increased serum ALT activity (Hess *et al.*, 2000). Cats with diabetic ketoacidosis commonly have increased serum ALT activity (Bruskiewicz *et al.*, 1997). Increased serum ALT activity is common in dogs with hyperadrenocorticism or dogs treated with glucocorticoids (DeNova and Prasse, 1983; Dillon *et al.*, 1980; Solter *et al.*, 1994). It has been shown in rats that ALT synthesis may be induced by glucocorticoids in order to increase function of the gluconeogenic pathways. However, experimental treatment of healthy dogs with glucocorticoids did not result in an increase in the concentration of hepatic tissue ALT activity, suggesting that increased hepatic mass plays a larger role than increased hepatocellular enzyme induction for an observed increased serum ALT activity (Solter *et al.*, 1994).

Although early studies of increased serum ALT activity following experimentally induced hepatocellular injury and the studies demonstrating much higher ALT activity

in liver than other organs led to the early conclusion that increases of ALT activity in serum are specific for hepatocellular injury, there is clear evidence that serum ALT activity can also be increased as a result of injury to myocytes as well. Dogs in a colony with canine X-linked muscular dystrophy and ongoing muscle necrosis had increased serum CK, AST, and up to a 25-fold increase in ALT activity but a normal SDH activity, suggesting that myonecrosis contributed to the increased serum ALT activity (Valentine *et al.*, 1988). This is consistent with the presence of some ALT activity in cardiac and skeletal muscle of dogs. In a case report of a cat with myokymia and neuromyotonia, the CK activity was 28,380, whereas the ALT activity was only 195 U/l; in a study of rhabdomyolysis in three dystrophin-deficient cats, the CK activity ranged up to 2040 times the upper limit of the reference range, whereas the ALT activity only increased to 19 times the upper limit of the reference range, suggesting only a minimal increase of serum ALT activity should be expected with muscle injury in this species (Galano *et al.*, 2005; Gaschen *et al.*, 1998).

Although at least one early study in dogs showed a correlation between the magnitude of serum ALT activity and histological evidence of necrosis, other studies have reported little correlation (VanVleet and Albert, 1968). Similarly, bile duct ligation of dogs led to a 25-fold increase in serum ALT activity with minimal evidence of hepatocellular necrosis. As discussed in the introduction, the recognition of the formation of membrane blebs on hepatocytes and the rupture of these blebs during various conditions such as endotoxic shock, carbon tetrachloride-induced injury, cholestasis, and experimentally induced hypoxia have led to the understanding that there can be an increase of serum enzymes derived from the cytoplasm of the cell in cases of reversible cellular injury. In summary, the observation of increased serum ALT activity indicates hepatocellular (or myocyte) injury, but it does not necessarily imply irreversible injury and does not suggest a specific cause.

## B. Aspartate Aminotransferase

Aspartate aminotransferase (AST: EC 2.6.1.1) (formerly glutamic oxaloacetic transaminase; GOT) catalyzes the transamination of L-aspartate and 2-oxoglutarate to oxaloacetate and glutamate. As with ALT, pyridoxal-5'-phosphate (PP) is required as a cofactor. Although serum ALT was poorly saturated with PP in a study following exercise in horses, 94% of the AST was saturated and present as the holoenzyme (Rej *et al.*, 1990). Providing PP in the assay reagent may be less of a concern when determining serum AST activity than when determining serum ALT activity.

AST activity is relatively high and in similar amounts in liver and in skeletal and cardiac muscle, but it varies between species (Boyd, 1983; Keller, 1981). It is routinely

used in equine and food animal medicine as a screening test for injury to both organs. Serum AST activity is readily available on the biochemical profile, has a longer blood half-life than sorbitol dehydrogenase and creatine kinase, and is stable for days in serum at room temperature, refrigerated, or frozen. AST is found in erythrocytes, and the addition of erythrocyte lysate to serum increases the apparent AST activity (unpublished data).

AST is located in the cytosol but is in higher concentrations in mitochondria. There is only 48.1% amino acid sequence homology between cytosolic AST (cAST) and mitochondrial AST (mAST) from horse heart (Doonan *et al.*, 1986). Likewise, the nucleotide sequences of cDNA of bovine mAST and cAST are also distinctly different (Aurila *et al.*, 1993; Palmisano *et al.*, 1995). Although there have been some efforts to show enhanced ability to identify organ-specific injury by assays for mAST and cAST, this has been shown to be of no diagnostic value (Jones and Blackmore, 1982). It may be theoretically possible to estimate the magnitude of reversible versus irreversible cell injury by determining mAST and cAST separately; however, this has not been studied empirically.

Although the half-life of AST has been reported to be as long as 7 to 8 days in horses and as short as 163 min in dogs, neither of these seems reasonable based on data obtained following carbon tetrachloride toxicity (Fleisher and Wakim, 1963; Zinkl *et al.*, 1971). Decreasing serum AST activity in horses recovering from CCl<sub>4</sub>-induced hepatotoxicity, as well as studies of equine myoglobinuria, suggests a half-life of 3 to 4 days (Bernard and Divers, 1989; Cardinet *et al.*, 1967; Noonan, 1981). In cattle with mild CCl<sub>4</sub>-induced hepatotoxicity, serum AST activity during recovery suggests a half-life of approximately 1 day (Yonezawa *et al.*, 2005). Serum AST has a longer half-life than creatine kinase, and therefore it would be expected to have increased diagnostic sensitivity during recovery from myocyte or hepatocyte injury.

Increased serum AST activity is observed with both reversible and irreversible injury to hepatocytes and can be seen following hepatocellular injury and cholestasis, similar to serum ALT activity in dogs and cats. Likewise, serum AST is increased following myocyte injury. In either case, the definitive disease process cannot be identified, only that cellular injury in muscle or liver has occurred. Because serum AST activity cannot differentiate between hepatocellular or myocyte injury, further testing is often required using organ-specific enzymes such as sorbitol dehydrogenase or creatine kinase. Markedly increased serum AST and sorbitol dehydrogenase activity suggest acute or active hepatocellular injury, and markedly increased serum AST with modest to moderate sorbitol dehydrogenase activity suggests chronic hepatic injury or recovery from acute liver injury. Similar conclusions can be drawn using serum AST and creatine kinase activity. As with other cytosolic enzymes, serum AST activity cannot distinguish between

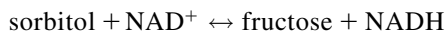
reversible and irreversible cell injury as the cAST can be released by mechanisms involving nonlethal cell membrane blebbing. However, because a major portion of AST is of mitochondrial origin, the magnitude of increase during reversible cell injury is expected to be less than in irreversible injury, but this has yet to be clearly shown.

The diagnostic sensitivity of serum AST activity in horses has been reported as 72% for hepatic necrosis and 100% for hepatic lipidosis (West, 1989). The specificity of serum AST activity was variable, and it decreased with primary gastrointestinal and orthopedic conditions secondary to affects on liver and skeletal muscle, respectively. In cattle, the sensitivity is reported to be 94% for hepatic lipidosis, 100% for leptospirosis, but only 53% for hepatic abscessation, and 46% for fascioliasis (West, 1991). Specificity was again variable depending on the primary condition.

In summary, serum AST determinations are still part of many biochemical profiles because of their relatively high sensitivity for detection of hepatocyte injury and myocyte injury and stability in serum. However, serum AST activity clearly lacks specificity when compared to tissue-specific enzymes, such as sorbitol dehydrogenase and glutamate dehydrogenase for the detection of hepatocyte injury and creatine kinase for the detection of myocyte injury.

### C. Sorbitol Dehydrogenase

Sorbitol dehydrogenase (SDH; EC 1.1.1.14), also known as iditol dehydrogenase, catalyzes the following reaction:



The active sites of SDH contain  $\text{Zn}^{2+}$ . Hence, when EDTA blood collection tubes are used, SDH activity is inhibited. Serum or heparinized plasma can be used for analysis. Sample stability has also been of concern for the use of SDH in diagnostic medicine with bovine serum SDH activity stable for at least 5h at room temperature, 24h refrigerated, and 72h frozen, whereas in equine serum SDH remains stable for 5h at room temperature, 5h refrigerated, and 48h frozen (Horney *et al.*, 1993). In another study, bovine SDH activity was stable for 1 month at  $-20^\circ\text{C}$  (West, 1991).

SDH is not membrane bound and is located in the cytoplasm of cells. The highest concentration of SDH activity is in liver followed by kidney, but it is also found in most other tissues at much lower amounts (Boyd, 1983; Keller, 1981; Nilkumang and Thornton, 1979). SDH activity is considered liver specific in all species, and there have been no reports of nephrotoxicity causing increased serum SDH activity.

The  $T_{1/2}$  of SDH in blood is likely relatively short in all species. Its reported  $T_{1/2}$ , based on intravenous administration of cat or dog liver extracts, is 3 to 4h for cats and 5h for dogs (Nilkumhang and Thornton, 1979; Zinkl *et al.*, 1971). The  $T_{1/2}$  of SDH in swine is reported as 1.6h. In dogs

and horses treated with  $\text{CCl}_4$ , a rapid decrease in SDH activity following peak activity, supports a  $T_{1/2}$  of less than 12h. The short circulatory half-life may be due in part to the labile nature of the enzyme, similar to that observed in serum samples *in vitro*. This short  $T_{1/2}$  limits to some extent the usefulness of the test, as it is easy to miss peak activity following a hepatic insult, and serum SDH activity may be within reference intervals in chronic hepatic disease.

Because of its short half-life and the labile nature of SDH activity in serum, SDH activity is less favored for detection of hepatic disease in dogs than serum ALT activity. However, there are two occasions when SDH analysis may be useful in dogs. First, in dogs with traumatic muscle injury, where there is increased serum ALT and CK activity, a determination of SDH activity will quickly rule out whether there is concurrent hepatic injury. A second use of SDH activity determination in dogs might be in conjunction with ALT activity to determine if there is persistent hepatocellular injury. If the ALT activity is markedly increased and SDH activity is not, recovery is likely, but if both are markedly elevated, an ongoing insult to the liver is likely present. This sort of interpretation, however, is highly subjective and would require repeated monitoring to be of value.

Serum SDH activity is of greater value than serum AST activity in large animals because of its increased specificity for hepatocellular injury. Marked increases of serum SDH activity occur within hours of experimentally induced hepatic necrosis in horses and cattle (Noonan, 1981). Serum SDH activity has been reported as a value for the detection of hepatic lipidosis, hepatic necrosis, leptospirosis, fascioliasis, and hepatic abscessation in cattle, and detection of hepatic necrosis, lipidosis, and cirrhosis in horses (Cebra *et al.*, 1997; Lechtenberg and Nagaraja, 1991; West, 1989, 1991). Whereas the specificity of serum SDH activity in both cattle and horses with nonhepatic disease is 100%, the sensitivity for detecting hepatic lipidosis, hepatic abscessation, and leptospirosis in cattle was less than 50%; for detecting hepatic cirrhosis and lipidosis in horses it was less than 50%; and for detecting hepatic necrosis in horses it was 76% (West, 1989, 1991). In essentially all conditions evaluated in these two species, serum AST and glutamate dehydrogenase (GDH) activity were more sensitive than SDH activity. However, the specificity of serum AST and GDH was generally less than the specificity of SDH activity. The lower sensitivity may be in part due to the short half-life of the enzyme in circulation; especially in chronic low-grade conditions where large numbers of cells are not injured at any one time, the SDH activity may not exceed the reference range.

### D. Glutamate Dehydrogenase

Glutamate dehydrogenase (GDH) (EC 1.4.1.3) is a mitochondrial enzyme that catalyzes the removal of hydrogen from L-glutamate to form the corresponding ketimine acid that then undergoes spontaneous hydrolysis to



2-oxoglutarate. The liver has by far the highest concentration of GDH activity (Boyd, 1983; Keller, 1981). Lesser amounts are found in the kidney and small intestine, where the GDH activity is located in the proximal and distal tubular epithelial cells and in the mucosal epithelial cells, respectively. The GDH activity of nonhepatic tissues is relatively small compared to that found in liver, where GDH is concentrated in the central areas of the lobule. In all species, increases in serum GDH activity are considered liver specific. As a result, there has been little or no interest in investigating isoenzymes of GDH in serum for diagnostic purposes. GDH is a zinc-containing enzyme whose activity can be inhibited by EDTA.

Bovine serum GDH activity reported as stable for greater than 1 month at  $-20^{\circ}\text{C}$  and was considered more stable than SDH (West, 1991). The *in vivo* half-life in six cows was reported as 14h (Collis *et al.*, 1979). This value is consistent with data from cattle recovering from hepatic injury and suggests that the half-life of serum GDH is greater than SDH but slightly less than the half-life of AST (Braun *et al.*, 1995). The half-life of circulating GDH in dogs is reported as 8h, based on intravenous injection of liver extract (Zinkl *et al.*, 1971).

Serum GDH activity is used most commonly in food animals and horses. Because of its location within mitochondria, GDH should be released only with irreversible cell injury. Following carbon tetrachloride-induced hepatic necrosis in calves and sheep, GDH activity increases but peaks approximately 1 day later than serum AST activity (Boyd, 1962). This may be due to the intramitochondrial location of GDH. Nevertheless, serum GDH activity was shown to significantly increase in acute, subacute, and chronic grass sickness in horses (Marrs *et al.*, 2001). However, serum GDH activity was found to be highly variable in ponies exposed to pyrrolizidine alkaloids, suggesting that GDH activity may only be diagnostically useful in the acute stages of liver injury (Craig *et al.*, 1991). This study found that serum GDH activity was increased with zone 1 hepatocyte necrosis, but it returned to normal reference intervals once all cells in this region were destroyed. These findings are consistent with the reported hepatic location of GDH in humans (Burtis and Ashwood, 1994). Increases in GDH activity of approximately 12-fold and AST activity two-fold were observed 24h following halothane anesthesia in horses, which also may reflect the centrolobular location of GDH activity (Durongphongtom *et al.*, 2006).

As suggested earlier, the sensitivity of GDH activity varies depending on the nature of the disease. For example, in a study of calves with hepatic disease, GDH activity increased in only 60% of the animals (Pearson *et al.*, 1995). Similarly, in cattle, the sensitivity of GDH activity for the detection of hepatic lipidosis, hepatic abscessation, leptospirosis, and fascioliasis was only 28%, 53%, 71%, and 72%, respectively (West, 1991). However, with all categories of hepatic disease described, the sensitivity of GDH activity

was higher than SDH activity. The specificity for GDH was slightly less than that of SDH. In a similarly designed study in horses, the sensitivity of GDH activity for detection of hepatic necrosis, hepatic lipidosis, and hepatic cirrhosis was 78%, 86%, and 44%, respectively (West, 1989). The sensitivity was higher than that of SDH and comparable to that observed with serum AST activity. The specificity of GDH in this study was nearly 100%, which was comparable to the specificity of SDH and superior to that of AST activity. In a more recent study of the sensitivity of increased liver enzymes for diagnosis of hepatic disease, GDH showed a sensitivity of 63% (Durham *et al.*, 2003). The determination of GDH activity is best done in conjunction with the determination of other hepatic enzymes and other indicators of hepatic injury or disease.

Serum GDH determinations for diagnosis of hepatic disease in domestic animals have received less attention in the United States than in some other countries. However, the increased stability of the enzyme, longer half-life, and apparent greater sensitivity discussed earlier suggest it may be a more useful test for horses and food-producing animals than the determination of SDH activity.

## E. Gamma Glutamyltransferase

Gamma glutamyltransferase (GGT) (EC 2.3.2.2) functions in the gamma glutamyl cycle where it catalyzes the transfer of gamma glutamyl groups from gamma glutamyl peptides such as the tripeptide glutathione to other peptides, amino acids, and water. In conjunction with a peptidase, GGT plays a major role in regulation of intracellular glutathione by hydrolysis of the tripeptide glutathione outside the cell into its three components, which can readily be taken up by the cells and be available for glutathione synthesis as needed within the cell. GGT also functions in the GSH transferase/GGT pathway that cleaves gamma glutamyl moieties from GSH conjugates, which aids in the detoxification of xenobiotics and carcinogens by rendering them more water soluble and readily excreted (Lieberman *et al.*, 1995). This pathway also plays a role in metabolism of mediators such as leukotrienes, heparin, and prostaglandins.

The tissue distribution of GGT has been studied in numerous domestic species with the highest concentration found in kidney, pancreas, intestines, and the mammary glands of dogs, cattle, goats, and sheep but at much lower concentration in mammary gland of horses. Less GGT activity is found in liver, spleen, intestine, lung, and seminal vesicles. The GGT activity per gram of liver tissue is consistently lower than in kidney but varies between species, with the highest liver GGT activity in cattle, horses, sheep, and goats. Serum GGT reference values are consequently higher in those species than in dogs and cats (Braun *et al.*, 1983, 1987; Milne and Doxey, 1985; Rico *et al.*, 1977a, 1977b; Shull and Hornbuckle, 1979).

GGT is a membrane-bound enzyme on the external surface of cells and is bound to the cell membrane via a hydrophobic transmembrane peptide. The cellular location of GGT is of interest as it affects the organ specificity when used as a diagnostic test in serum. GGT is located on the luminal surface of the proximal tubular cells of the kidney where it is shed into urine during tubular injury. In the pancreas, GGT is located on the luminal surface of cells lining the acini and pancreatic ducts. Increases of serum GGT activity are not generally associated with injury to the pancreas or kidney. The location of GGT in liver is of considerable interest because the liver likely contributes most if not all of the serum GGT activity. In liver, GGT activity is primarily associated with the biliary epithelial cells. Early reports suggested GGT was not present on hepatocyte membranes; however, when GSH was used in the fixative solution to prevent fixation-induced inhibition of GGT activity, GGT activity was identified on both the canalicular and sinusoidal surfaces of hepatocytes of rats, although to a considerably lesser extent than on biliary epithelial cells (Lanca and Israel, 1991). GGT mRNA has been detected in hepatocytes of normal rats and rats depleted of glutathione, supporting the presence of GGT on hepatocytes (Moriya *et al.*, 1994). Whether GGT activity is present on the hepatocyte membranes of domestic animals is not documented to our knowledge.

Efforts have been made to determine the presence of isoenzymes of GGT in laboratory animals and humans, but it is likely that only one form of GGT exists. Variations in sialic acid content have been reported and likely explain the ability to separate different fractions of GGT by various means, such as isoelectric focusing (Mortensen and Huseby, 1997). Only one band of GGT activity was found with cellulose acetate electrophoresis of serum from dogs (Milne and Doxey, 1985).

Removal of GGT activity from blood likely involves endocytosis by the asialoglycoprotein or galactose receptor, as purified human liver GGT that has been fractionated by ion exchange chromatography and infused into rats has shown that the slowest rate of clearance is associated with the most sialated forms (Mortensen and Huseby, 1997). Clearance can be blocked with asialofetuin, also suggesting that clearance of GGT is via the asialoglycoprotein or galactose receptor on hepatocytes. GGT is apparently eliminated from blood without prior desialylation via exposed galactose units binding with low affinity to the receptor. The rate of removal of each molecule may be related to the number of available galactose molecules not blocked by sialic acid.

The half-life of GGT activity in blood is not known, as there have been no definitive studies done in domestic animals to our knowledge. However, in dogs, serum GGT and ALP activity increase and decrease in parallel during cholestasis, suggesting that in dogs the half-life of GGT may be similar to the approximate 3-day half-life of liver ALP. A half-life of 3 days is also suggested for GGT activity in horses (Barton and Morris, 1998). In any event, the

half-life of liver GGT activity is of sufficient length that increases are maintained throughout the disease process and diagnostic sensitivity is not lost because of a rapid return of the GGT activity to reference ranges.

Conditions such as hepatic necrosis and reversible hepatocellular injury induced by CCl<sub>4</sub>, dibromobenzene, chloroform toxicity, and trauma result in minimal or no changes in serum GGT activity in dogs (Barakat and Ford, 1988; Guelfi *et al.*, 1982; Noonan and Meyer, 1979). However, some increase in serum GGT activity is observed with chloroform toxicity in horses, although no increase is observed in calves and sheep (Barakat and Ford, 1988). Following administration of CCl<sub>4</sub> to ponies, a four-fold increase in serum GGT activity was observed, which persisted up to 10 days with no increase in serum ALP activity (Hoffmann *et al.*, 1987). The minimal increase in GGT activity in serum following hepatocellular injury is likely due to the fact that GGT in liver is primarily associated with biliary epithelial cells and the absence of significant increase of bile acids to release the hydrophobic transmembrane attachment to the cell membrane. Increases in serum GGT are most often observed with cholestasis and conditions resulting in biliary hyperplasia in all species, as observed in experimentally induced cholestasis (DeNovo and Prasse, 1983; Hoffmann *et al.*, 1987; Shull and Hornbuckle, 1979; Spano *et al.*, 1983).

Serum GGT activity is an especially useful clinical indicator of cholestasis in horses and cattle because of relatively high liver GGT activity compared to dogs and cats. Serum GGT activity in horses and cattle has relatively higher sensitivity for the identification of cholestatic disorders than serum ALP activity. Only a two-fold increase of serum ALP activity was observed with cholestasis, whereas serum GGT activity rose nine-fold in horses (Hoffmann *et al.*, 1987). Although the magnitude of increase is greatest in cholestasis, serum GGT activity can be used in large animals as a screening test for generalized hepatic disease as well. In a retrospective study of 50 cases of hepatic disease in horses, of the serum chemistry parameters evaluated only serum GGT activity increased in all cases (McGorum *et al.*, 1999). Similarly, serum GGT activity showed 75% sensitivity and 90% specificity for detecting subclinical liver disease in horses exposed to pyrrolizidine alkaloids, whereas serum ALP activity showed only 58% sensitivity (Curran *et al.*, 1996). Serum GGT activity was shown to be the most sensitive serum enzyme for detection of hepatic injury secondary to proximal enteritis in horses (Davis *et al.*, 2003). Increases in serum GGT activity in numerous cases of plant-related hepatotoxicity in both cattle and horses have also been reported (Craig *et al.*, 1991; Curran *et al.*, 1996; Mendel *et al.*, 1988).

Serum GGT activity in cats and dogs is often interpreted in conjunction with serum ALP activity. The suggested advantage of serum GGT activity determination over serum ALP activity in dogs is increased specificity, as GGT activity is derived solely from liver whereas serum ALP activity is derived from bone and liver as well as the

canine corticosteroid induced isoenzyme of ALP. A study of 270 dogs with suspected hepatic disease had the results of hepatic biopsies compared to serum hepatic enzyme results (Center *et al.*, 1992). Hepatic disease was confirmed by histology in 207 of the 270 cases. The sensitivity of serum ALP and GGT activity to detect histologically confirmed hepatic disease was 85% and 46%, respectively. However, the specificity of serum ALP was only 51%, whereas the specificity of serum GGT was 87%. In a study of 69 cats with suspected hepatic disease, of which 54 had histological evidence of hepatic disease, the overall sensitivity of serum ALP and GGT activity was 48% and 83%, respectively (Center *et al.*, 1886). Serum GGT activity was more sensitive than serum ALP activity for detection of extrahepatic cholestasis, cholangiohepatitis, and cirrhosis. In contrast, the percentage increase of serum ALP activity was greater than serum GGT activity in 11 of 15 cats with hepatic lipidosis. This is likely because hepatic lipidosis is a form of intracellular cholestasis, ALP is primarily associated with hepatocytes, and GGT is primarily associated with the biliary epithelial cells.

Several laboratory animal models have been used to study the mechanism of increase of serum GGT activity. These include bile duct ligation, treatment of the animals with alpha naphthyl isothiocyanate (ANIT) to cause necrosis of biliary epithelial cells, and a choledochocaval shunt (CCS) model that shunts bile from the common bile duct directly into the anterior vena cava (Bulle *et al.*, 1990; Hardison *et al.*, 1983; Kryszewski *et al.*, 1973; Leonard *et al.*, 1984; Putzki *et al.*, 1989). In the bile duct ligation model, there is an initial increase of serum GGT activity and a decrease in liver tissue GGT activity. The rise in serum GGT activity is associated with a parallel increase in serum bile acids, and it is almost certain that the bile acids alone or in conjunction with a hydrolytic enzyme facilitate solubilization or release of GGT from the membrane. With persistence of cholestasis, there is a proliferation of biliary epithelial cells and an increase in bile duct volume in the liver, which is paralleled by an increase in GGT activity in the liver and a second phase of increase in serum GGT activity. In the ANIT model, chronic treatment with ANIT results in repeated necrosis of the biliary epithelial cells and bile duct proliferation. As the bile duct mass increases, there is a persistent increase in serum GGT activity. These two models both support the concept that there is an initial release of GGT activity from injury to biliary epithelial cells and retention of bile, the magnitude of which is determined in part by whether the species has low or high tissue GGT activity. Persistently increased serum GGT activity may indicate biliary hyperplasia that provides an increased source of GGT for release. Although not confirmed experimentally, clinical observations suggest that domestic animals with markedly increased serum GGT activity often have biliary hyperplasia.

The CCS model in rats is unique in that it provides persistently increased liver and blood bile acids and increased bile flow, but without increased biliary pressure

(Hardison *et al.*, 1983). In this model, within 24h, serum GGT activity nearly equals that seen with experimental bile duct ligation, suggesting that bile acids or other bile constituents mediate the release of GGT into serum. Moreover, increased biliary pressure and regurgitation of GGT through tight junctions are not necessary for the observation of increased serum GGT activity (Putzki *et al.*, 1989). The actual pathway traveled by GGT from the biliary epithelial cells to blood is unclear. It is also unclear if the amount of GGT on the sinusoidal surfaces of hepatocytes is adequate to account for the magnitude of increase of serum GGT activity observed in any of the three models described previously. A mechanism of release from hepatocytes analogous to that described for ALP, but with a different hydrolytic enzyme, might be considered.

Increased serum GGT activity in calves led to the recognition that species that produce large amounts of GGT activity in mammary glands may excrete or release GGT into colostrum. Colostral GGT is taken up by passive transfer in the newborn and serves as an easy, inexpensive, and automated test for successful passive transfer (Braun *et al.*, 1982; Perino *et al.*, 1993; Wilson *et al.*, 1999; Zanker *et al.*, 2001). The difference between presuckling and postsuckling serum GGT activity can be more than a 100 fold in calves (Braun *et al.*, 1982). This increase correlates well enough with increased serum immunoglobulin to allow serum GGT activity to substitute as a test of adequate immunoglobulin transfer (Perino *et al.*, 1993). However, GGT activity decreases steadily for the first 18 to 20 days, so the ability of serum GGT activity to accurately conclude failure of passive transfer is reduced after approximately 8 days (Wilson *et al.*, 1999). In a review of failure of passive transfer in calves, the authors concluded that the loss of correlation between serum GGT activity and immunoglobulin concentrations after the first few days of suckling negates the value of the test, and its use should be discouraged in cattle (Weaver *et al.*, 2000). Serum GGT activity also indicates passive transfer of immunoglobulins in goats, but in foals there is no difference in pre- and postsuckling serum GGT activity (Braun *et al.*, 1984; Patterson and Brown, 1986). In canine pups postsuckling serum GGT activity can reach up to 100 times the upper interval because of high colostrum GGT activity (Center *et al.*, 1991).

Although renal tissue has the highest concentration of GGT activity per gram of tissue in all species studied, there is no evidence supporting the presence of renal tubular GGT in blood. This is likely the result of the location of GGT on the luminal surface of the tubular epithelial cells and possibly rapid clearance from blood by the galactose receptor on hepatocytes. However, the location of GGT on the tubular epithelial cells means that the enzyme is readily shed into urine and can indicate renal tubular cell injury. Because of the variability of urine volume, urine GGT activity must be normalized to urine creatinine concentration using a GGT activity:creatinine ratio. Numerous reports show that the urine GGT activity:creatinine ratio in dogs is a sensitive

and early indicator of chemical-induced nephrotoxicity with several compounds including maleic acid, aminoglycosides, and cyclosporine (Clemo, 1998; Graur *et al.*, 1995; Nahas *et al.*, 1997; Rivers *et al.*, 1996). Furthermore, both 24h excretion of GGT and the GGT activity:creatinine ratio of single urine samples have proven useful in detecting tubular injury in dogs (Gosset *et al.*, 1987; Rivers *et al.*, 1996). Although there is no apparent circadian variation (Uechi *et al.*, 1994), it has been suggested that the within-day variation of the GGT activity:creatinine ratio limits its usefulness (Gosset *et al.*, 1987). As in dogs, the urine GGT activity:creatinine ratio in horses and cattle has proven of value in detecting nephrotoxicity (Meyer *et al.*, 2005; Rossier *et al.*, 1995; Ulutas and Sahal, 2005). The magnitude in all species is greatest in the acute phase of injury after which the GGT activity in urine drops rapidly during the chronic stage. These studies support the use of urine GGT activity as a screening test of potentially nephrotoxic drug exposure. Evaluation of more than one enzyme and at multiple time points is required to properly evaluate for nephrotoxicity. It should also be noted that the urinary GGT activity:creatinine ratio is extremely sensitive and increases can be observed with no clinical signs of nephrotoxicity or azotemia (van der Harst *et al.*, 2005). For example, normal horses and horses with pneumonia who are both treated with gentamycin show significant increases in the urinary GGT activity:creatinine ratio but retain normal serum creatinine concentrations (Rossier *et al.*, 1995).

Dogs treated with glucocorticoids or dogs with hyperadrenocorticism generally have increased serum GGT activity (Abraham *et al.*, 2005; DeNovo and Prasse, 1983; Solter *et al.*, 1994). However, the ratio of serum GGT-to-liver tissue GGT activity in glucocorticoid-treated dogs is similar to that of untreated controls, suggesting that increased serum GGT activity is a result of increased liver tissue GGT and increased synthesis of the enzyme (Solter *et al.*, 1994).

## F. Alkaline Phosphatase

The alkaline phosphatases (ALP) (EC 3.1.3.1) have been relatively well studied. They have been shown to hydrolyze a range of monophosphates or pyrophosphates at alkaline pH, as well as at physiological pH although at a lesser rate. There are likely several *in vivo* functions of ALP. A role for ALP in bone mineralization had been speculated since the 1920s and was first substantiated in human beings who suffer from hypophosphatasemia, which results from several different mutations that lead to a nonactive ALP and markedly defective bone mineralization in children (Mumm *et al.*, 2002; Whyte *et al.*, 1996). The role of ALP in bone mineralization has been subsequently confirmed in numerous studies using bone ALP gene knockout mice to create hypophosphatasemia, resulting in the impaired mineralization of bone (Anderson *et al.*, 2004). One specific function

of ALP in bone is the hydrolysis of pyrophosphate, which is a potent inhibitor of mineralization, thus allowing mineralization to proceed. Other suggested functions of ALP are the *in vivo* dephosphorylation of bacterial endotoxin, which diminishes its toxic effects (Poelstra *et al.*, 1997; van Veen *et al.*, 2005; Xu *et al.*, 2002), and as a rate-limiting step in intestinal fat absorption (Narisawa *et al.*, 2003).

Although many tissues or cell types have some ALP activity, cells from liver, bone, kidney, intestinal mucosa, and placenta have the greatest ALP activity on a per gram of tissue basis with intestinal mucosa having the most (Clampitt and Hart, 1978; Nagode *et al.*, 1969). Serum ALP activity, however, is not generally a reflection of tissue concentration. In most domestic species, intestinal ALP (IALP) is not found in serum, and liver, which has relatively low ALP activity, contributes over half the serum activity.

The alkaline phosphatases are ectoenzymes attached to the cell membrane via a hydrophobic phosphatidylinositol-glycan (PIG) anchor. Extraction of ALP from tissue requires butanol, bile salts, or detergent in the presence of an acidic buffer to allow the hydrolytic activity of endogenous phosphatidylinositol-specific phospholipase D (PIPLD) to cleave the ALP PIG anchor (Low, 1987; Solter and Hoffmann, 1995; Solter *et al.*, 1997). In intestine, especially the small intestines, ALP is located on the tips of villi of the enterocytes (Watanabe and Fishman, 1964), whereas in kidney the ALP is located on the luminal surface of the proximal tubular epithelial cells (Wachstein and Bradshaw, 1965). Although the ALP in bone is well recognized to be located on the osteoblasts and the matrix vesicles derived from osteoblasts, staining liver for ALP activity reveals that most of the ALP is found on the bile canalicular surface of hepatocytes in normal animals although this may vary with species. During conditions in which hepatic ALP is increased, sinusoidal and lateral surfaces of the hepatocytes also show substantial ALP activity (Ogawa *et al.*, 1990; Sanecki *et al.*, 1987; Solter *et al.*, 1997). Because many newly synthesized bile canalicular (apical) membrane proteins traffic from the Golgi to the sinusoidal (basolateral) membrane before their transcytosis to the bile canalicular surface of hepatocytes, the presence of ALP on sinusoidal membrane during disease conditions likely represents increased synthesis of ALP rather than a difference in enzyme trafficking (Kipp and Arias, 2000; Maurice *et al.*, 1994; Zegers and Hoekstra, 1998). ALP activity is presumably present on the sinusoidal membrane at all times, but because of the short time in residence before transcytosis to the canalicular membrane and relatively small amount of ALP, the insensitivity of enzymatic staining and light microscopy make it difficult to visualize the small fraction of ALP present.

In the human, chimpanzee, and orangutan, at least three genes express ALP and are named for the primary organ of their expression. These are the intestinal ALP, placental ALP, and the tissue-nonspecific or bone/liver/kidney ALP (Goldstein *et al.*, 1982). In humans, a fourth gene is

expressed in the germ cell that is similar to the placental isoenzyme (Millan and Manes, 1988). In domestic species, there are two genes, namely the intestinal gene and the tissue-nonspecific ALP gene that is expressed in bone, liver, kidney, and placenta and to a lesser extent in some other tissues. Although true ALP isoenzymes result from specific genes, posttranslational modification (primarily varied glycosylation) is generally organ specific and results in additional isoforms. For example, liver ALP and bone ALP are the products of the same gene but are glycosylated differently, resulting in isoforms or isoenzymes that can be differentiated by a number of techniques. True ALP isoenzymes expressed by different genes differ enzymatically, biochemically, and antigenically, and they respond to inhibitors such as L-phenylalanine and levamisole in a different manner; isoforms of ALP tend to behave enzymatically and antigenically in a similar manner and are equally inhibited by L-phenylalanine and levamisole, although there are some exceptions. Although these isoforms are not true isoenzymes, historical and clinical precedence has resulted in these isoforms also being referred to as isoenzymes.

Liver ALP is highly glycosylated with terminal sialic acid residues, which results in a marked anodal migration on electrophoresis. It is generally inhibited by greater than 95% with levamisole but is relatively insensitive to L-phenylalanine inhibition. LALP is only moderately sensitive to heat inhibition at 56°C.

Bone ALP is a product of the TNS ALP gene, as is the liver ALP, but has a slightly slower anodal electrophoretic migration and is more sensitive to heat inhibition (Hoffmann and Dorner, 1975). The bone ALP isoform is more susceptible to precipitation by wheat germ lectin (WGL) than is the LALP as a result of differing glycosylation (Hank *et al.*, 1993; Kidney and Jackson, 1988; Sanecki *et al.*, 1993). Antibodies produced against liver ALP or bone ALP generally cross-react with the other isoforms from the same gene. However, there are commercially available immunoassays for human BALP that have been validated for use in canine, feline, and equine BALP analysis (Allen *et al.*, 2000; Delaurier *et al.*, 2002; Jackson *et al.*, 1996).

Intestinal ALP (IALP) is a product of the intestinal ALP gene, and it is distinctly different from BALP and LALP. IALP is more heat stable and more readily inhibited by L-phenylalanine, but it shows less than 10% inhibition with levamisole at concentrations adequate to inhibit greater than 95% of BALP and LALP (Eckersal *et al.*, 1986; Hoffmann *et al.*, 1987; Nagode *et al.*, 1969). IALP is generally thought of as an asialoglycoprotein; however, some identifiable sialic acid is present on canine IALP (Sanecki *et al.*, 1990). The reduced number of sialic acid residues is responsible for the fact that IALP has minimal anodal migration on agarose or cellulose acetate electrophoresis. Typically, IALP produces a broad band rather than a sharp narrow band when compared to LALP and BALP.

Alkaline phosphatases in other organs, such as kidney and placenta, are usually a product of the TNS gene. These alkaline phosphatases are not fully sialated and have less anodal migration on electrophoresis than BALP and LALP. However, the ALP extracted from horse kidney is likely a product of the intestinal gene as it is similar to IALP in levamisole inhibition and antigenic recognition by anti-equine IALP antibodies (Hoffmann *et al.*, 1983a).

The so-called corticosteroid-induced isoenzyme of ALP (CALP) has been identified in dogs treated with corticosteroids, dogs with hyperadrenocorticism, or in some older dogs with chronic disease or possibly chronic stress (Sanecki *et al.*, 1990; Solter *et al.*, 1993; Wellman *et al.*, 1982). This enzyme has not been identified in any other species; however, it is similar to one of the two forms of ALP expressed in the liver of rabbits (Noguchi *et al.*, 1987). CALP is a highly glycosylated isoform of IALP, produced in the liver from the intestinal gene. It has markedly greater anodal migration than IALP on cellulose acetate electrophoresis, but it is antigenically similar to IALP with both monoclonal and polyclonal antibodies and responds to levamisole and L-phenylalanine inhibition in a similar manner. It also has the identical N-terminal amino acid sequence to IALP but has markedly higher concentrations of N-acetylglucosamine, mannose, galactose, and sialic acid. Hence, CALP differs from IALP only in glycosylation. Northern blot analysis with a 1338bp cloned segment of the CALP gene, which is identical to the IALP sequence, has confirmed the liver as the origin of CALP production (Wiedmeyer *et al.*, 2002a, 2002b).

The epididymal and seminiferous tubular epithelium of the dog is rich in ALP activity. This ALP is a product of the TNS gene, but it is glycosylated differently than either BALP or LALP based on electrophoretic migration (Kutzler *et al.*, 2003). ALP activity is also present in epididymal fluid from horses (Gobella *et al.*, 2002).

Serum alkaline phosphatase isoenzyme analyses have been conducted in many species with numerous publications describing techniques and diagnostic value of the analyses. The techniques described include electrophoresis on a number of mediums, isoelectric focusing, heat inhibition, chemical inhibition, immunochemistry, and selective lectin binding. Although electrophoresis is still in use, a combination of inhibition with levamisole and selective precipitation of BALP with wheat germ lectin is an effective means to quantitatively evaluate BALP, LALP, and CALP in dog serum; BALP, LALP, and IALP in rat serum; and BALP and LALP in horse, cat, and cow serum (Hank *et al.*, 1993; Hoffman *et al.*, 1988; Hoffmann *et al.*, 1994; Sanecki *et al.*, 1993). Very likely, the combination of levamisole inhibition and wheat germ lectin precipitation will be compatible with many other species that have not yet been tried. Immunoassays for BALP in canine, feline, and equine serum have also been used (Allen *et al.*, 2000; Delaurier *et al.*, 2002; Delaurier *et al.*, 2004; Jackson *et al.*, 1996; Price *et al.*, 1995).

Studies of the blood half-lives of the various alkaline phosphatase isoenzymes are of interest in that they help to explain the magnitude and time of increase of serum ALP activity following insult to an organ. Unlike in most species, IALP is always identified in rat serum and is often identified in human serum. It has not been observed in serum from dogs, cats, horses, and cattle (Hoffmann and Dorner, 1975; Hoffmann *et al.*, 1983b). The clearance of intravenously injected IALP in dogs has a half-life of shorter than 5.4min, whereas the half-life of phase 2 of rat IALP is 54.1 to 68.3min (Hoffmann and Dorner, 1977; Young *et al.*, 1984). The rate of clearance of IALP from dog blood can be inhibited by simultaneous injection of galactose-terminated bovine serum albumin, supporting the theory that IALP is cleared by hepatocyte asialoglycoprotein or galactose receptors (Kuhlenschmidt *et al.*, 1991). However, the clearance of IALP from rat blood is not blocked by asialofetuin but is blocked by glucosamine-terminated bovine serum albumin, suggesting that IALP in rats is cleared by mannose/N-acetylglucosamine-specific receptors on hepatic reticuloendothelial cells (Young *et al.*, 1984). The presence of IALP in rat serum and not dog serum may be explained in part by the differences in IALP serum half-lives between the two species. However, the description in rats of a surfactant-like secretory particle containing ALP may offer a second mechanism for increased IALP in the blood of rats (Eliakim *et al.*, 1991).

The half-life of IALP in cats following intravenous injection is approximately 4min, and in horses it is approximately 8min, which likely explains in part the absence of IALP in the serum of these two species (Hoffmann *et al.*, 1977, 1983b).

The half-life of intravenously injected LALP and CALP into dogs is approximately 3 days (Hoffmann and Dorner, 1977). The removal of the ALP under normal conditions is not known but may involve the slow hydrolysis of sialic acid from the carbohydrate portion of the molecule allowing recognition and uptake by the galactose receptor on hepatocytes. The half-life of intravenously injected cat LALP is approximately 5.8h (Hoffmann *et al.*, 1977). Likewise canine LALP intravenously injected into cats has a half-life of approximately 5h. Therefore, the difference in half-life of dog LALP and cat LALP (3 days versus 5h) is likely a species difference in removal of the enzyme and not a difference in the enzyme. The mechanism of removal of ALP from the blood of cats is not known.

The blood half-life of BALP is not known, but has an electrophoretic migration near that of LALP from dogs, cats, and horses, suggesting that a full compliment of sialic acid is present resulting in a half-life similar to LALP.

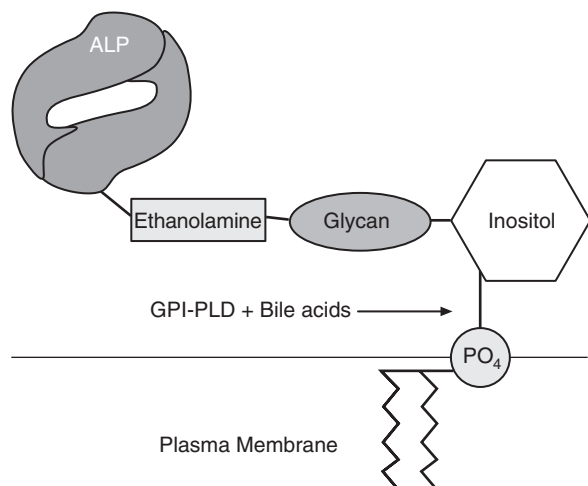
The half-life of renal and placental ALP from dogs is less than 6min (Hoffmann and Dorner, 1977). They have minimal anodal migration on electrophoresis, suggesting that they have little or no sialic acid and are likely removed by the asialoglycoprotein or galactose receptor on hepatocytes.

Approximate percentages of BALP and LALP in adult dogs are 30% and 70%, respectively, with an increasing percentage of LALP in older age, whereas in adult horses, there is approximately 20% BALP and 80% LALP (Allen *et al.*, 2000; Hank *et al.*, 1993).

Cholestasis is the most common cause of significant increases in serum LALP in most species. Experimentally induced cholestasis in dogs, generally by bile duct ligation, results in marked increases in serum LALP activity beginning after approximately 24h and reaching a maximum of 30 to 40 times normal serum ALP activity at 4 to 7 days (Guelfi *et al.*, 1982; Shull and Hornbuckle, 1979). A similar response time of ALP increase was seen in two cats following bile duct ligation, but the magnitude of the increase was approximately 10% of that seen in the dog (Hoffmann *et al.*, 1978). This marked difference in the magnitude of increase between the two species is in part due to the 12-fold shorter serum half-life of LALP in cats as compared to dogs. The marked increase of serum LALP in cholestasis is paralleled by a marked increase in LALP activity in the liver as well. Numerous studies in rats have shown that this increase results from increased synthesis, regulated at the level of transcription or translation (Kaplan *et al.*, 1983; Schlaeger, 1975).

For many years, the mechanism of increased LALP in blood was thought to involve regurgitation from bile through tight junctions into blood. Although there is evidence of disruptive changes within tight junctions during cholestasis (Boyer, 1983), it is doubtful if these alterations permit passage of macromolecules the size of ALP (Debroe *et al.*, 1985). Studies using a cholelithocaval shunt model show that within 12h of shunting of bile or taurocholic acid into blood, there is a marked induction of ALP synthesis and appearance of ALP on the basolateral membranes and a parallel increase in serum ALP (Ogawa *et al.*, 1990). This occurs in the absence of increased biliary pressure and any evidence of alterations in tight junctions (Toyota *et al.*, 1983). Bile acids appear to participate in both induction and release of ALP into serum.

A second model to study the mechanism of release of ALP from liver into serum utilizes the observation that dogs acutely treated with high doses of prednisone first induce LALP synthesis in the absence of cholestasis, as evidenced by a lack of increase of serum or hepatic tissue bile acids (Solter *et al.*, 1994, 1997). This model results in the appearance of easily identified LALP activity on the basolateral surface and marked increases of serum LALP activity. The appearance of LALP activity on the basolateral membrane is likely a transient appearance of the protein before it is sorted to the apical or bile canalicular membrane as part of the normal trafficking of bile canalicular membrane proteins (Bartles *et al.*, 1987; Maurice *et al.*, 1994). The ALP on the sinusoidal or basolateral membrane is susceptible to release into blood or hepatic lymph. However, in contrast to the cholelithocaval shunt model, where bile acid concentrations



**FIGURE 12-2** The glycosylphosphatidylinositol membrane anchor of alkaline phosphatase and the site of release of ALP from the membrane anchor by phosphatidylinositol-specific phospholipase D, which is facilitated by bile acids.

are increased in both blood and hepatic tissue and facilitate the release of ALP from its membrane attachment, serum and tissue bile acids are not increased in the prednisone-treated model. However, within 2 to 4h following cholecystokinin (CCK) administration to initiate the enterohepatic circulation and a flux of bile acids through the portal vein and liver, there is a significant increase in the serum LALP activity (Solter *et al.*, 1997). This provides support for a bile acid-facilitated release of ALP from hepatocyte sinusoidal membranes, most likely by activation of PIPLD and cleavage of the phosphatidylinositol anchor (Fig. 12-2). Whether the bile acids actually activate the PIPLD or simply allow accessibility to the PI anchor of ALP is unclear.

The marked increase of serum CALP and presence of CALP on the sinusoidal membrane of dogs with spontaneous hyperadrenocorticism or chronically treated with glucocorticoids and an absence of cholestasis provides additional support to the conclusion that the mechanism of serum ALP increase from liver does not require regurgitation. Because CALP is attached to the membrane by the same PI anchor as LALP, it is released by PIPLD during flux of bile acids through the liver (Solter and Hoffmann, 1995).

Although cholestasis is the most recognized cause of increased LALP activity, increases in serum LALP activity are also observed in steroid hepatopathy in dogs, especially early in the condition (Solter *et al.*, 1994, 1997; Syakalima *et al.*, 1997). Mild to moderate increases in serum LALP are also observed in dogs with other hepatic diseases and secondary to primary conditions ranging from enteritis to pancreatitis. In cats, increased serum LALP activity is most commonly associated with cholestasis, cholangiohepatitis, hepatic lipidosis, and hyperthyroidism. Increase in serum LALP activity is the first observed laboratory abnormality observed in cats with experimentally induced hepatic

lipidosis, occurring before the onset of hyperbilirubinemia (Biourge *et al.*, 1994). Although the increased serum ALP activity in hyperthyroid cats is attributed to both LALP and BALP activity, LALP activity is the most consistently increased isoenzyme and makes up the major portion of the ALP activity (Archer and Taylor, 1996; Foster and Thoday, 2000).

An increase in serum BALP activity is generally associated with increased osteoblastic activity and has been increasingly evaluated as a marker of bone formation in several domestic species (Allen *et al.*, 1998; DeLaurier *et al.*, 2002; Price *et al.*, 2001). Increased serum BALP activity is observed in all young animals and is up to 10-fold greater in puppies than adult dogs (Allen *et al.*, 2000; Sanecki *et al.*, 1993). In newborn foals, serum BALP activity is nearly 100-fold greater than in adult serum, but it drops precipitously during the first 3 weeks after birth and then more gradually over the next 2 to 4 years (Hank *et al.*, 1993; Price *et al.*, 1995). Increased serum BALP activity can be observed in dogs with hyperparathyroidism, renal disease, and during fracture healing. Peak serum total ALP activity (presumably BALP) is reported to occur in dogs at approximately 10 days after surgical fixation of long bone fractures and returns to normal within 2 months with normal healing but can remain increased 3 to 5 months with delayed union (Komneou *et al.*, 2005). This study reported no increase in serum ALP activity in dogs that had nonunions and suggested that monitoring serum ALP activity may be a useful tool for identifying dogs at risk for progressing to nonunion. Familial hyperphosphatemia with increased BALP activity has been reported in a family of Siberian huskies (Lawler *et al.*, 1996).

By far the highest values of serum BALP have been observed in selected cases of canine osteosarcoma, but this is not consistently observed. Hence, serum BALP activity has poor diagnostic sensitivity for osteosarcoma. However, serum BALP is of prognostic value as increased preoperative serum BALP activity is associated with shorter survival time and disease-free (metastasis) intervals following surgery and chemotherapy (Ehrhart *et al.*, 1998; Garzotto *et al.*, 2000; Kirpensteijn *et al.*, 2002). Furthermore, whereas a drop in serum BALP activity is often noted following surgical removal of the primary tumor, persistence of increased serum BALP activity following surgery is associated with a shorter survival time. Dogs with increased serum total ALP activity did not benefit from additional chemotherapy; however, dogs with serum ALP activity in the normal range did benefit (Kirpensteijn *et al.*, 2002). The absence of increased serum BALP activity in a majority of dogs with osteosarcoma presents an intriguing question. Cells obtained via fine needle aspirates of all canine osteosarcomas stain positive for ALP activity (Barger *et al.*, 2005). The mechanism that allows some of these patients to have increased serum BALP activity but not others is unclear but does not appear to relate to tumor mass (Ehrhart *et al.*, 1998).

Serum CALP activity is a good screening test for hyperadrenocorticism because of its high sensitivity for detecting increased cortisol secretion over time. It is not a diagnostic test because of its low specificity for the diagnosis of hyperadrenocorticism (Solter *et al.*, 1993; Teske *et al.*, 1989). Increased serum CALP activity observed in animals with disease processes other than hyperadrenocorticism is consistent with a presumed increase in cortisol secretion as indicated by reportedly abnormal low-dose dexamethasone suppression tests or ACTH stimulation tests in dogs with nonadrenal disease (Kaplan *et al.*, 1995).

Hypophosphatasemia is uncommon in domestic species, although it is observed in humans with the genetic mutations to the TNS ALP gene. Similar genetic mutations have not been reported in domestic species to our knowledge, but reduced alkaline phosphatase activity has been associated with zinc deficiency in cattle (Machen *et al.*, 1996; Sharma and Joshi, 2005).

Significant amounts of ALP activity have been found in seminal plasma from numerous species. Low seminal ALP activity has been proposed as a means of differentiating partial or complete blockage of the epididymal and deferent ducts from testicular azoospermia and oligospermia (Stornelli *et al.*, 2003; Turner and McDonnell, 2003).

The serum activity of several diagnostic enzymes appears to be induced by various pharmaceutical agents. Anecdotally, serum ALP is the enzyme most often increased in drug safety trials. There are likely many drugs that stimulate some increase in liver ALP activity; however, an incomplete understanding of the factors regulating ALP synthesis in many cases makes it difficult to determine if increased ALP activity is due to primary induction of synthesis, a secondary response of the liver to drug-mediated cytokines, or drug-induced hepatic injury.

Glucocorticoids are well-recognized inducers of ALP activity in dogs. The initial response to treatment of dogs with high doses of glucocorticoids is an increase of LALP activity in the liver and serum (Solter *et al.*, 1994). This is followed after approximately 5 to 7 days with the appearance of the CALP isoenzyme. Interestingly, the magnitude of the increase in CALP activity in the experimental treatment of normal dogs has never been shown to reach the magnitude of CALP activity in many clinical patients. This suggests that the induction of CALP synthesis may result from glucocorticoids acting in a synergistic manner with other cytokines that are increased in various pathological conditions. Glucocorticoids do not have the same ability to induce ALP activity in cats and horses (Ellison and Jacobs, 1990; Hoffmann *et al.*, 1978).

Markedly increased serum CALP activity has also been observed in vacuolar hepatopathy of Scottish terriers (Twedt, 2004). Although the hepatopathy is similar to steroid hepatopathy, and all of the dogs have the increased CALP activity, they have normal serum GGT activity, ALT activity, and bilirubin concentration, along with normal ACTH

stimulation and low-dose dexamethasone suppression tests. Preliminary evidence indicates that these dogs have increased serum 17-hydroxyprogesterone or progesterone concentrations, suggesting that other adrenal hormones may result in increased CALP activity and vacuolar hepatopathy.

Phenobarbital is another drug routinely associated with increased serum ALP activity. It is not known whether this occurs as a result of enzyme induction or hepatotoxicity. However, increased serum ALP activity is considered a frequent observation in epileptic dogs treated with phenobarbital, whereas hepatotoxicity is an infrequent observation (Foster *et al.*, 2000; Muller *et al.*, 2000). In a retrospective study of 78 dogs treated with phenobarbital for epilepsy, 19 had serum ALP activity greater than two-fold the upper limit of the reference interval, with 11 having predominantly CALP activity and 7 having predominantly LALP activity (Gaskill *et al.*, 2004). However, pretreatment serum ALP activity was not reported. In a prospective study of 23 otherwise healthy epileptic dogs treated with phenobarbital, 8 had ALP activity greater than the reference range and 3 had ALP activity two-fold greater than the upper limit of the reference range (Gaskill *et al.*, 2004). Two of these 3 dogs had predominantly the CALP isoenzyme, and 1 the LALP isoenzyme. In a subsequent study of 11 phenobarbital-treated dogs with increased serum ALP activity, the predominant isoenzyme in 6 of the dogs was CALP and in 5 was LALP (Gaskill *et al.*, 2005). Histopathological evaluation of liver biopsies from these 11 dogs revealed more severe and frequent abnormalities than in controls but no increase of ALP activity in liver tissue. Focal areas of injury may have enhanced the release of ALP from the membranes and an increase of serum ALP. These studies, however, do not explain why CALP is present in a few phenobarbital-treated dogs but not others, with or without evidence of hepatic disease.

## G. Lipase

The lipase (EC 3.1.1.3) that is of interest in the diagnosis of pancreatic disease is a low-molecular-weight protein of approximately 42kDa that hydrolyzes triglycerides at the 1 and 3 positions, leaving a monoglyceride. Pancreatic lipase binds at the lipid-water interface emulsified in the presence of bile salts, colipase, and calcium. The original pancreatic lipase assay described used an incubation medium consisting of an emulsion of long chain triglycerides in a buffer containing glycocholic acid and colipase. Such assays minimize nonpancreatic lipase and esterase activity but do not completely inhibit it, which tends to broaden the diagnostic reference intervals. This decreases the sensitivity of total serum lipase activity to detect pancreatic disease and decreases specificity because of an increased false-positive rate. To further illustrate the phenomenon of nonpancreatic lipase in serum, serum lipase activity has been determined in two conditions in which serum lipase activity would be



anticipated to be low or nonexistent. First, the serum lipase activity of pancreatectomized dogs remains near 50% of the presurgery activity, pointing to the presence of nonpancreatic lipase and strongly suggesting that the reference interval of serum lipase activity is broadened by nonpancreatic sources (Simpson *et al.*, 1991). Second, in a study of dogs with exocrine pancreatic insufficiency (EPI), there was no difference in the mean serum lipase activity between the dogs with EPI and the control dogs, suggesting again that a significant portion of normal serum lipase is of nonpancreatic origin (Steiner *et al.*, 2006). Lipase assays that are likely specific for pancreatic lipase include a canine immunoreactive pancreatic lipase assay (cPLI) (Steiner *et al.*, 2003). Using immunohistochemistry, it was demonstrated that test antibody recognizes lipase in pancreatic acinar cells and no other tissues (Steiner *et al.*, 2002).

Although there are nonpancreatic lipases and esterases in serum, there is apparently only one gene for canine pancreatic lipase (Mickel *et al.*, 1989). Likewise, only one protein with a molecular weight of approximately 50.7kDa was recovered from dog pancreas by affinity purification of tissue lipase (Steiner and Williams, 2002), suggesting that isoenzymes of pancreatic lipase do not exist.

The blood half-life of lipase activity from pancreatic juice or extracts in dogs is 1 to 3 hours (Hayakawa *et al.*, 1992; Hudson and Strombeck, 1978). The half-life was found to increase from 2 to 11 hours following nephrectomy, suggesting that there is renal clearance or inactivation of lipase (Hudson and Strombeck, 1978). Only a small amount of lipase activity is identified in urine, and it is assumed the renal tubular cells metabolize the filtered lipase.

Activity assays for serum lipase have been used classically for the diagnosis of acute pancreatitis in dogs. Typically, an approximately 25-fold increase in serum lipase activity is observed within 2 to 5 days following experimentally induced pancreatitis (Brobst *et al.*, 1970; Mia *et al.*, 1978; Simpson *et al.*, 1989). This increase tends to parallel increased serum amylase activity, but it may persist a few days longer. The sensitivity of serum lipase for the diagnosis of pancreatitis ranges from approximately 60% to 75% (Cook *et al.*, 1993; Graca *et al.*, 2005; Mansfield and Jones, 2000). The low sensitivity of some assays is likely associated with the broad reference range usually seen for serum lipase (influenced by nonpancreatic lipase activity) and possibly influenced by the relatively short half-life of the enzyme in blood. However, in a study using 1,2-*o*-dilaryl-*rac*-glycero-3-glutaric acid-(6'-methylresorufin) ester as substrate, a sensitivity of 93% was achieved suggesting this substrate may be more appropriate for identifying pancreatic lipase (Graca *et al.*, 2005). The specificity of serum lipase is generally low, ranging from approximately 50% to 75%. These reports point to the variable results associated with assay methodology. The low specificity may be due to the wide range of conditions that can lead to increased serum lipase activity, as well as the release of nonpancreatic

lipase into serum (Cook *et al.*, 1993; Polzin *et al.*, 1983; Rallis *et al.*, 1996; Strombeck *et al.*, 1981). Renal failure, enteritis and gastroenteritis, some hepatic disorders, bile duct carcinoma, and lymphosarcoma of the gastrointestinal tract among others are examples of nonpancreatic disease conditions that have been associated with increased serum lipase activity. In addition, treatment with glucocorticoids is routinely associated with increased serum lipase activity. Dexamethasone-treated dogs had serum lipase increase four-fold from the baseline activity without histological evidence of pancreatitis (Fitts and Bellamy, 1984; Parent, 1982). Whether this increase in serum lipase activity is truly pancreatic lipase has not been determined.

Serum lipase activity may also be useful in differentiating severe from mild pancreatitis, with values of greater than 4010 U/l having a sensitivity of 64% but a specificity of 100% (Mansfield *et al.*, 2003). Some of the most dramatic increases of serum lipase in dogs have been associated with pancreatic or hepatic neoplasia. In three pancreatic carcinomas, two endocrine carcinomas involving liver, and one hepatic carcinoma of unknown origin, serum lipase activity increased from 11 to 93 times the upper limit of the reference interval, whereas serum amylase remained normal (Quigley *et al.*, 2001).

Six cats with experimentally induced acute pancreatitis had increases in serum lipase activity of two- to six-fold within 4 days (Kitchel *et al.*, 1986). However, there were no differences in serum lipase activity found between 12 cats with severe, naturally occurring pancreatitis, and 43 healthy cats or 31 cats with other diseases (Parent *et al.*, 1995). Hence, serum lipase activity assays have little use in the diagnosis of pancreatitis in cats. However, in a study using a radioimmunoassay for determining feline pancreatic lipase immunoreactivity (fPLI), a sensitivity of 100% was demonstrated for cats with moderate to severe pancreatitis and a sensitivity of 54% for cats with mild pancreatitis, resulting in an overall sensitivity of 67% (Forman *et al.*, 2004). In this study, a specificity of 100% was observed for healthy cats.

Serum lipase activity has been of little use in the diagnosis of exocrine pancreatic insufficiency, likely because of the presence of nonpancreatic lipase masking the loss of pancreatic lipase activity in serum. In a study of dogs with EPI and healthy dogs, the range of serum lipase activity was essentially the same in the two groups (Steiner *et al.*, 2006). However, using a cPLI assay, all of the 25 dogs with EPI in the study had cPLI values below the reference range, allowing for 100% diagnostic sensitivity. There was some overlap of the lowest cPLI values in healthy dogs and the highest values in EPI dogs, resulting in the possibility of false-positive test results.

## H. Amylase

Alpha-amylase (EC 3.2.1.1) is a low-molecular-weight enzyme (approximately 45kDa) that cleaves the alpha-D-(1-4)

glycan linkage of starch and glycogen. It has been in use as a diagnostic enzyme longer than any of the other enzymes. It is found in very high concentration in the pancreas in dogs and cats. Human beings and rats have substantial amounts of salivary amylase activity, but in most species there is very little. Amylase is also produced in the small intestines and liver, both of which may contribute to normal serum amylase activity (Murtaugh and Jacobs, 1985; Nothan and Callow, 1971). The liver secretes its amylase in a similar fashion to albumin. Amylase mRNA has been identified by RT-PCR in dog liver, intestine, fallopian tubes, and the pancreas (Mocharla *et al.*, 1990). Pancreatectomy results in up to a 50% decrease in serum amylase, consistent with the assumption of nonpancreatic sources of some serum amylase (Simpson *et al.*, 1991). There have been several attempts to identify isoenzymes of amylase in serum and tissue, with the results dependent on the technique used. There have been four isoenzymes or isoforms of amylase identified using cellulose acetate and agarose gel electrophoresis (Jacobs *et al.*, 1988; Murtaugh and Jacobs, 1985; Simpson *et al.*, 1989). Although fraction three was increased to the greatest extent with experimentally induced pancreatitis suggesting this is the true pancreatic amylase, pancreatectomy did not result in a drop in this fraction (Murtaugh and Jacobs, 1985). Analysis of amylase isoenzymes has not found a place in diagnostic veterinary medicine.

Estimates of the half-life of serum amylase in normal dogs ranges from 1 to 5h (Hayakawa *et al.*, 1992; Hudson and Strombeck, 1978; Yacoub *et al.*, 1969). Following nephrectomy, the half-life increases to 14h (Hudson and Strombeck, 1978; Nakashima *et al.*, 1980). Although nephrectomy increases its serum half-life, less than 1% of pancreatic amylase infused in normal dogs is found in urine, suggesting amylase is catabolized by the kidney. The fact that pancreatic amylase infused into nephrectomized dogs still clears suggests that there are additional means of clearing amylase from blood besides the kidneys. This is supported by an increase in amylase in liver, which could be prevented by blocking the reticuloendothelial system following infusion of pancreatic amylase (Hiatt and Bonorris, 1966).

Serum amylase is routinely used as a screening test for acute pancreatitis. In experimentally induced pancreatitis in dogs, increases of eight- to twelve-fold and as much as 29-fold were seen at 1 to 3 days, and returned to normal in 3 to 5 in one study, and 8 days in another study (Brobst *et al.*, 1970; Mia *et al.*, 1978; Simpson *et al.*, 1989). An increase of serum amylase activity of two-fold or greater above the reference interval, in the absence of renal disease, is generally considered suggestive of pancreatitis. However, the sensitivity of serum amylase activity in the diagnosis of pancreatitis in dogs is low, with reports of 63% and 78% (Cook *et al.*, 1993; Jacobs *et al.*, 1988). The specificity of serum amylase activity has been reported as 77%. Increased serum amylase activity in dogs has been

observed with renal disease, diabetes mellitus, lymphosarcoma, and hemangiosarcoma (Strombeck *et al.*, 1981). Increased serum amylase activity is commonly observed with renal disease in dogs. Ligation of the renal vessel results in a 60% increase in serum amylase activity in 48h (Hudson and Strombeck, 1978). A 2.5-fold increase above the reference interval was observed in dogs with both induced and spontaneously occurring renal disease (Polzin *et al.*, 1983). Dogs with renal insufficiency may have both increased serum amylase and urinary amylase (Corazza *et al.*, 1994). The increased serum amylase may be due in part to a decreased glomerular filtration rate, but the authors also detected a macroamylase in 77% of the dogs with proteinuria. The increase in urinary amylase is likely due to reduced renal tubular absorption.

Serum amylase activity for the diagnosis of acute pancreatitis in cats is considered of little value and has been shown to actually decrease in experimentally induced pancreatitis (Kitchell *et al.*, 1986).

Treatment of normal dogs with either low or high doses of dexamethasone results in a statistically significant decrease in serum amylase activity (Parent, 1982). Similar observations have been made in dogs treated with prednisone (Fitts and Bellamy, 1984). However, the stress associated with surgery does not affect the normal serum amylase activity (Bellah and Bell, 1989; Finco and Stevens, 1969), although there was a transient increase in serum amylase activity following endoscopic retrograde pancreatography (Spillmann *et al.*, 2004).

## I. Trypsin and Trypsinogen

Trypsin (EC 3.4.21.4) is a serine proteinase enzyme produced by the pancreas in the form of the proenzyme trypsinogen. The pancreas secretes trypsinogen into the intestine where it is converted by enterokinase to trypsin, the active proteolytic enzyme. Early attempts to evaluate pancreatic function by utilizing assays for the tryptic activity in serum were unsuccessful. This is likely because the enzyme released into the vascular space is trypsinogen and not trypsin and therefore has no tryptic activity (Steiner and Williams, 1999). Hence, the development of species-specific immunoassays for trypsin referred to as trypsin-like immunoreactivity (TLI) (Steiner *et al.*, 1996; Williams and Batt, 1983). These immunoassays detect both trypsin and trypsinogen.

Trypsinogen in serum is thought to be derived primarily from the pancreas. This is supported by the observation that pancreatectomy of healthy dogs reduced serum canine TLI (cTLI) from a mean of 6.2  $\mu\text{g/l}$  to 1.2  $\mu\text{g/l}$  (Simpson *et al.*, 1991). The blood half-life of TLI is not reported, but it is likely relatively short, as these enzymes are rapidly scavenged by endopeptidases whose role it is to inactivate enzymes released from the pancreas (Zoran, 2006). cTLI

has been most useful for the detection of canine exocrine pancreatic insufficiency (EPI). In a group of 25 dogs with EPI, serum cTLI concentrations were all less than  $1.9\mu\text{g/l}$  (reference interval =  $5.2\text{--}34\mu\text{g/l}$ ), resulting in a test sensitivity of 100% (Williams and Batt, 1988). In 50 dogs with small intestinal disease, there was no difference in the cTLI values from normal dogs, suggesting a specificity of 100%. The high degree of sensitivity and specificity of cTLI for the diagnosis of EPI is supported by a more recent study (Steiner *et al.*, 2006). Hence, cTLI has become the gold standard for the diagnosis of EPI in dogs. Serum cTLI may also increase in acute pancreatitis, as evidenced by the observation in one study that, following pancreatic duct ligation of eight dogs, cTLI increased within 24h and remained increased above control values in six of the eight for 5 days (Simpson *et al.*, 1989). Serum cTLI also decreased more rapidly than amylase and lipase activity. In spontaneous pancreatitis, only 6 of 10 dogs with severe pancreatitis and 2 of 5 dogs with mild pancreatitis had serum cTLI greater than the reference range (Mansfield *et al.*, 2003). Because trypsinogen is cleared by the kidneys, decreased glomerular filtration rate may result in increased cTLI (Geokas *et al.*, 1982). The relative lack of sensitivity and the historically longer turnaround time for cTLI determination compared to serum lipase and amylase has made cTLI of little value for determination of pancreatitis in dogs.

When serum fTLI has been evaluated for the diagnosis of pancreatitis in cats, the results have been variable depending on the study. Reported reference ranges have been variable resulting in reported sensitivities ranging from 33% when the cutoff is  $100\mu\text{g/l}$  to 86% when the cutoff is  $49\mu\text{g/l}$  (Gerhardt *et al.*, 2001). Although specificity was not reported in this study, an overlap in TLI values in cats with confirmed pancreatitis and cats without pancreatitis are reported (Forman *et al.*, 2004; Swift *et al.*, 2000). Increased serum fTLI concentration may be associated with azotemia, inflammatory bowel disease, and gastrointestinal lymphoma (Simpson, 2001; Swift *et al.*, 2000). To improve specificity, higher cutoff values must be used, which reduces sensitivity. Even at lower sensitivity, the fTLI concentration was considered a useful diagnostic test in cats because clinical signs in cats are less specific and other minimally invasive tests such as serum amylase and lipase, ultrasonography, and contrast-enhanced computed tomography were insensitive or of no value (Gerhardt *et al.*, 2001; Simpson, 2001; Steiner, 2003). However, a more recent study has demonstrated a higher sensitivity of fPLI (67%) in the diagnosis of feline pancreatitis along with a higher specificity, suggesting that fPLI may supplant determination of fTLI in the diagnosis of pancreatitis in cats (Forman *et al.*, 2004).

Although fewer data are available compared to that for dogs, there is evidence that determination of fTLI concentration is useful for the diagnosis of EPI in cats as well. Of 20 cats with fTLI of  $<8\mu\text{g/l}$  (controls =  $17\text{--}49\mu\text{g/l}$ ),

17 had compelling evidence of EPI (Steiner and Williams, 2000).

## J. Creatine Kinase

Creatine kinase (CK) (EC 2.7.3.2) catalyzes the exchange of a phosphate moiety between creatine phosphate and ATP. In myocardial and skeletal muscle, CK allows energy storage as creatine phosphate when demand is low, but when energy is needed for muscle contraction, CK catalyzes the transfer of the high-energy phosphate from creatine phosphate to ADP to form ATP. A small amount of CK activity is associated with the mitochondria, where it is responsible for transfer of high-energy phosphate to creatine, the cytosolic carrier.

The greatest amount of data for CK in domestic species is available for dogs, as this species has often been used as an experimental model for myocardial disease in humans. Canine CK is reviewed in depth elsewhere (Aktas *et al.*, 1993).

CK activity is in greatest concentration in skeletal muscle followed by heart muscle, diaphragm and smooth muscle, and then brain (Keller, 1981). In most species, the amount of activity is two- to four-fold greater in skeletal muscle than heart muscle, although in cats it is nearly equal (Boyd, 1983). The CK activity in brain tissue is approximately 10% of that in skeletal muscle. CK is primarily found in the cytoplasm; however, there is a mitochondrial form that makes up a small percentage of the total CK activity of the cell. There is evidence of breed differences, with higher skeletal muscle CK activity in greyhounds than mongrels and more CK activity in fast-acting than in slow-twitch muscles (Guy and Snow, 1981; Lindena *et al.*, 1982).

There are two distinct subunits of CK, referred to as the M (muscle) and B (brain) subunits. These combine randomly to form three isoenzymes of CK: CK-MM, CK-BB, and CK-MB. Skeletal muscle of most species has nearly 100% CK-MM (Aktas *et al.*, 1993; Boyd, 1983). Heart muscle has primarily CK-MM, and a variable amount of CK-MB, with dogs and horses having approximately 3% and 10% CK-MB, respectively. The brain has primarily CK-BB with a small percentage of CK-MB and CK-MM. In dogs, intestine and spleen have predominantly CK-BB, followed by CK-MB and then CK-MM. The normal distribution of serum CK isoenzymes in dogs is approximately 50% CK-MM and 40% CK-BB with the remaining being CK-MB (Aktas *et al.*, 1993). Although CK isoenzyme analysis is of great importance in human medicine as an indicator of myocardial infarction, the need for CK isoenzyme analysis in veterinary species has not been demonstrated. However, experimentally induced left ventricular hypertrophy in dogs resulted in a 50% reduction in CK-MM and a 10-fold increase in CK-MB (Ye *et al.*, 2001).

Serum CK-MB, presumably from myocardial injury, has also been shown to increase in foals with sepsis, but there is no difference between survivors and nonsurvivors, thereby suggesting no prognostic value to CK isoenzyme analysis (Slack *et al.*, 2005). The mitochondrial form of CK (MtCK) exists in two isoenzymes encoded by separate genes (Payne and Strauss, 1994). These have no apparent diagnostic value at this time.

The half-life of CK activity in blood is relatively short in all species. The half-life of CK from myocardial extracts is 2 to 3h in dogs (Cairns and Klassen, 1977; Sobel *et al.*, 1977). The mean half-lives for administered CK solution made from skeletal muscle from dogs, sheep, horses, and cattle are 2.61, 2.07, 2.05, and 8.67h, respectively (Aktas *et al.*, 1995; Houpert *et al.*, 1995; Lefebvre *et al.*, 1994; Volfinger *et al.*, 1994; see also Lefebvre *et al.* [1996] for review). The half-life following intramuscular injection of muscle homogenate in dogs was approximately 6.5h with the rate-limiting step being the absorption from the site of injection into blood via lymphatics (Aktas *et al.*, 1995). This half-life may be more clinically relevant as it better reflects the source of CK in blood following muscle injury. The mechanism by which CK is cleared from blood is not known, but it may involve inactivation of enzyme thiol groups. CK activity is not lost via the kidneys, and creation of a portocaval shunt with arrest of hepatic blood flow had no effect on the clearance rate of CK activity in dogs (Oostenbroek *et al.*, 1985).

Reference values for serum CK activity are highest in dogs under 1 month of age and decline until 1 year of age (Aktas *et al.*, 1994). The reference value is nearly two-fold higher in small dogs compared to large dogs. However, these differences are not likely to have significant impact on the diagnostic value of CK activity.

In domestic species, CK activity is mainly used as a marker of skeletal muscle injury associated with trauma, nutritional myopathies, exercise-induced muscle injury, or congenital myopathies. Increased CK activity in dog serum is seen secondary to myocardial diseases such as dirofilariasis and parvovirus infection, but it is unchanged in myocardial hypertrophy (Jacobs *et al.*, 1980; Kitagawa *et al.*, 1991). Markedly increased serum CK activity has been reported in congenital myopathies such as myotonia and X-linked myopathy of golden retrievers (Cooper *et al.*, 1988; Jones *et al.*, 1977; Valentine *et al.*, 1988). Only modest to moderate increases in serum CK activity were observed in acquired myopathies of dogs such as malignant hyperthermia, hyperadrenocorticism, hypothyroidism, and vitamin E-selenium deficiency (Green *et al.*, 1979; Kaelin *et al.*, 1986; O'Brien *et al.*, 1990; Van Vleet, 1975). Serum CK can be expected to increase following surgery. Serum CK activity is often increased with neurological disorders but is usually due to increased CK-MM rather than CK-BB (Hoffmann, 1994). Therefore, the increased serum CK activity is most likely a result of involuntary skeletal muscle contractions. However,

an increase in CK-BB was observed in a Yorkshire terrier with necrotizing encephalitis (Sawashima *et al.*, 1996). The sensitivity and specificity of serum CK activity for diagnosis of skeletal muscle, myocardial, and neurological disease has been assessed in dogs (Aktas *et al.*, 1994). False-positive results, causing a decrease in test specificity, were attributed to the high concentration of CK in muscle, the large muscle mass, and the release of enzyme for nonspecific reasons. There were also several false negatives, thereby lowering the sensitivity, which were attributed to the short half-life of the CK activity in blood.

In cats, increased serum CK activity can be associated with trauma, surgery, and intramuscular injections. There has also been a reported increase (median CK activity of 2529 U/l) observed in anorectic cats (Fascetti *et al.*, 1997), suggesting that serum CK activity could serve as a marker of nutritional status in cats. The increased CK activity with anorexia in cats is thought to result from muscle catabolism secondary to decreased caloric intake. Serum CK activity decreases significantly within 48h of nutritional supplementation.

Serum CK activity is increased in horses in a variety of conditions causing muscle injury. As early as 1967, and in numerous reports since, increased serum CK activity has been associated with paralytic myoglobinuria (Cardinet *et al.*, 1967). A markedly increased serum CK activity has been observed in four horses with severe rhabdomyolysis associated with *Streptococcus equi* infection (Sponseller *et al.*, 2005). Increased serum CK activity has also been described in horses with exertional rhabdomyolysis associated with heritable polysaccharide storage myopathy (Ribeiro *et al.*, 2004). Cattle also have increases in serum CK activity with a variety of muscle injuries and diseases. Increased serum CK activity is common with selenium and vitamin E deficiency (Arthur, 1988; Züst *et al.*, 1996). Large animal species also frequently have increased serum CK activity because of prolonged recumbency or pressure necrosis of muscle.

There are numerous reports of increases in serum CK activity associated with intramuscular injection of drugs. A noninvasive technique using area under the curve and total plasma clearance of CK activity has been proposed for determining postinjection muscle damage in dogs, horses, sheep, and cattle (Aktas *et al.*, 1995; Houpert *et al.*, 1995; Lefebvre *et al.*, 1994; Toutain *et al.*, 1995; see Lefebvre *et al.* [1996] for review). For example, the amount of muscle tissue damaged following an IM injection of imidocarb in a 10-kg beagle is 2.5g (Aktas *et al.*, 1995). This quantitative technique has potential use in evaluating local tolerance of intramuscular administration of new drugs to satisfy regulatory requirements.

There has been some interest in exercise-induced increases of CK activity in horses and dogs. Increases have been observed in sled dogs following long-distance races and in horses in various training programs (Harris *et al.*, 1998; Hinchcliff *et al.*, 1993, 1998; Volfinger *et al.*, 1994).

In long-distance sled dog races, there are marked interindividual variations with activity ranging from unchanged to more than 13-fold increase. However, there is minimal increase in serum CK activity following exercise in untrained beagle dogs (Chanoit *et al.*, 2002). In horses, it has been concluded through kinetic studies that the amount, in grams, of striated muscle damaged is negligible following exercise (Volfinger *et al.*, 1994). It has been reported that increases tend to occur more frequently in fillies, younger animals, and untrained horses (Harris *et al.*, 1998).

In all species, CK has the advantage over serum aspartate aminotransferase in being specific for muscle injury and not affected by hepatocellular injury. The short half-life of the enzyme may tend to reduce the diagnostic sensitivity of the test, but it also offers an effective means of monitoring response to therapy.

## K. Other Enzymes

As mentioned in the introduction, numerous other enzymes have been investigated for use in diagnosis and prognosis of disease and organ dysfunction in nonhuman animals. Some of these have been dropped altogether or receive limited use, such as lactic acid dehydrogenase, 5′nucleotidase, glutathione S-transferase, leucine aminopeptidase, arginase, aldolase, and acid phosphatase, among others. The reasons for their limited use vary but include relatively poor diagnostic accuracy, diagnostic redundancy with already established tests, and a lack of readily available test kits. For example, serum lactic acid dehydrogenase (LDH) activity originates from several tissues including liver, skeletal muscle, heart muscle, and erythrocytes. This resulting decreased test sensitivity and specificity limits the diagnostic accuracy of serum LDH activity. Although LDH isoenzyme analysis may improve tissue specificity, the tests are relatively time consuming, expensive, and still only provide a subjective assessment of the contribution of each organ to the total serum activity. In addition, the test does not offer a substantial improvement over assays to other enzymes such as alanine aminotransferase or creatine kinase. A few laboratories still offer 5′nucleotidase, but it provides much of the same information as ALP and perhaps has lost favor as a result. Arginase is highly specific for injury to hepatocytes but suffers from a short half-life and is not readily available for autoanalyzers.

## V. FUTURE OF SERUM ENZYMOLOGY

Although the number of studies investigating enzyme activity assays for diagnostic purposes has decreased since the 1990s, they are still of immense importance to diagnostic medicine. The currently increasing interest in identifying protein and peptide markers of organ injury or dysfunction will require immunoassays to determine their concentrations

in serum. This is often problematic to veterinarians, as appropriate antibodies to these markers in domestic animals are frequently unavailable. The divergence of human biomarker research away from classical serum enzymology has the unintended consequence of limiting the universality of new biomarker application across species. Although this continues to be a deterrent, there is increased interest in the development and utilization of immunoassays in veterinary medicine as evidenced by the assays for trypsin-like immunoreactivity and pancreatic lipase immunoreactivity in dogs and cats, as well as immunoassays for nonenzymatic proteins, such as the natrurctic peptides and troponins. Problems regarding the availability of immunoassays and long turnaround time from submission to obtaining laboratory results are increasingly being addressed. For example, the development of automated analyzers for immunoassays has allowed test results to be available on the same day as sample submission. Canine TLI is available on the Immulite system from Diagnostic Products Corporation, and more are expected in the future. The fields of serum enzymology and serum protein markers have merged in human medicine as evidenced by the topic section “Proteomics and Protein Markers” in the table of contents of the journal *Clinical Chemistry*. The development of this merger in nonhuman animal medicine is almost certain to happen.

## REFERENCES

- Abraham, G., Gottschalk, J., and Ungemach, F. R. (2005). Evidence of ototopical glucocorticoid-induced decrease of hypothalamic-pituitary-adrenal axis response and liver function. *Endocrinology* **146**, 3163–3171.
- Aktas, M., Auguste, D., Concordet, D., Vinclair, P., Lefebvre, H., Toutain, P. L., and Braun, J. P. (1994). Creatine kinase in dog plasma: preanalytical factors of variation, reference values and diagnostic significance. *Res. Vet. Sci.* **56**, 30–36.
- Aktas, M., Auguste, D., Lefebvre, H. P., Toutain, P. L., and Braun, J. P. (1993). Creatine kinase in the dog: a review. *Vet. Res. Commun.* **17**, 353–369.
- Aktas, M., Lefebvre, H. P., Toutain, P. L., and Braun, J. P. (1995). Disposition of creatine kinase activity in dog plasma following intravenous and intramuscular injection of skeletal muscle homogenates. *J. Vet. Pharmacol. Ther.* **18**, 1–6.
- Allen, L. C. V., Allen, M. J., Greur, G. J., Hoffmann, W. E., and Richardson, D. C. (2000). A comparison of two techniques for the determination of serum bone-specific alkaline phosphatase activity in dogs. *Res. Vet. Sci.* **68**, 231–235.
- Allen, M. J., Hoffmann, W. E., Richardson, D. C., and Breur, G. J. (1998). Serum markers of bone metabolism in the dog. *Am. J. Vet. Res.* **59**, 250–254.
- Anderson, H. C., Sipe, J. B., Hessle, L., Dhanyamraju, R., Atti, E., Camacho, N. P., and Millan, J. L. (2004). Impaired calcification around matrix vesicles of growth plate and bone in alkaline phosphatase-deficient mice. *Am. J. Path.* **164**, 841–847.
- Archer, F. J., and Taylor, S. M. (1996). Alkaline phosphatase bone isoenzyme and osteocalcin in the serum of hyperthyroid cats. *Can. Vet. J.* **37**, 735–739.

- Arthur, J. R. (1988). Effects of selenium and vitamin E status on plasma creatine kinase activity in calves. *J. Nutr.* **118**, 747–755.
- Aurila, Y., Palmisano, A., Ferrara, L., Cubellis, M. V., Sanna, G., and Marino, G. (1993). Cloning and sequence analysis of a cDNA encoding bovine cytosolic aspartate aminotransferase. *Int. J. Biochem.* **25**, 1505–1509.
- Barakat, S. E. D. M., and Ford, E. J. H. (1988). Further studies on the diagnostic value of gamma-glutamyl transpeptidase and 5'-nucleotidase in cattle, sheep and horses. *Res. Vet. Sci.* **44**, 354–360.
- Barger, A., Graca, R., Bailey, K., Messick, J., de Lorimier, L. P., Fan, T., and Hoffmann, W. (2005). Use of alkaline phosphatase staining to differentiate canine osteosarcoma from other vimentin-positive tumors. *Vet. Path.* **42**, 161–165.
- Bartles, J. R., Feracci, H. M., Stieger, B., and Hubbard, A. L. (1987). Biogenesis of the rat hepatocyte plasma membrane in vivo: comparison of the pathways taken by apical and basolateral proteins using subcellular fractionation. *J. Cell Biol.* **105**, 1241–1251.
- Barton, M. H., and Morris, D. D. (1998). Disease of the liver. In "Equine Internal Medicine" (S. M. Reed and W. M. Bayly, Eds.), pp. 707–738. Saunders, Philadelphia.
- Bellah, J. R., and Bell, G. (1989). Serum amylase and lipase activities after exploratory laparotomy in dogs. *Am. J. Vet. Res.* **50**, 1638–1641.
- Berger, L. (1993). Sigma diagnostics: pioneer of kits for clinical chemistry. *Clin. Chem.* **39**, 902–903.
- Bernard, W. V., and Divers, T. J. (1989). Variations in serum sorbitol dehydrogenase, aspartate transaminase, and isoenzyme 5 of lactate dehydrogenase activities in horses given carbon tetrachloride. *Am. J. Vet. Res.* **50**, 622–623.
- Bessey, O. A., Lowry, O. H., and Brock, M. I. (1946). A method for the rapid determination of alkaline phosphatase with five cubic milliliters of serum. *J. Biol. Chem.* **164**, 321–329.
- Biourge, V. C., Groff, J. M., Munn, R. J., Kirk, C. A., Nyland, T. G., Madeiros, V. A., Morris, J. G., and Rogers, O. R. (1994). Experimental induction of hepatic lipidosis in cats. *Am. J. Vet. Res.* **55**, 1291–1302.
- Bolter, C. P., and Critz, J. B. (1976). Plasma enzyme levels in the anesthetized dog during drainage of the thoracic lymph duct. *Enzyme* **21**, 30–38.
- Boyd, J. W. (1962). The comparative activity of some enzymes in sheep, cattle, and rats: normal serum and tissue levels and changes during experimental liver necrosis. *Res. Vet. Sci.* **3**, 419–433.
- Boyd, J. W. (1983). The mechanisms relating to increases in plasma enzymes and isoenzymes in diseases of animals. *Vet. Clin. Path.* **12**, 9–24.
- Boyer, J. L. (1983). Tight junctions in normal and cholestatic liver: does the paracellular pathway have a functional significance? *Hepatology* **3**, 614.
- Braun, J. P., Benard, P., Burgat, V., and Rico, A. G. (1983). Gamma glutamyl transferase in domestic animals. *Vet. Res. Commun.* **6**, 77–90.
- Braun, J. P., Benard, P., Burgat, V., and Rico, A. G. (1984). Transfer of gamma-glutamyltransferase from mother colostrums to newborn goat and foal. *Enzyme* **31**, 193–196.
- Braun, J. P., Bezille, P., Raviart, I., and Rico, A. C. (1987). Distribution of alanine and aspartate aminotransferases, gamma-glutamyltransferase, lactate dehydrogenase, alkaline phosphatases and creatine kinase in the main organs of adult goats and kids. *Ann. Rech. Vet.* **18**, 389–392.
- Braun, J. P., Tainturier, D., Laugier, C., Benard, P., Thouvenot, J. P., and Rico, A. G. (1982). Early variations of blood plasma gamma-glutamyl transferase in newborn calves: a test of colostrums intake. *J. Dairy Sci.* **65**, 2178–2181.
- Braun, U., Pospischil, A., Pusterla, N., and Winder, C. (1995). Ultrasonographic findings in cows with cholestasis. *Vet. Record* **137**, 537–543.
- Bruskiewicz, K. A., Nelson, R. W., Feldman, E. C., and Griffey, S. M. (1997). Diabetic ketosis and ketoacidosis in cats: 42 cases (1980–1995). *J. Am. Vet. Med. Assoc.* **211**, 188–192.
- Brobst, D., Ferguson, A. B., and Carter, J. M. (1970). Evaluation of serum amylase and lipase activity in experimentally induced pancreatitis in the dog. *J. Am. Vet. Med. Assoc.* **157**, 1697–1702.
- Bulle, F., Marvier, P., Zafrani, E. S., Preaux, A. M., Lescs, M. C., Siegrist, S., and Dhumeaux, D. (1990). Mechanism of gamma glutamyltransferase release in serum during intrahepatic and extrahepatic cholestasis in the rat: a histochemical and molecular approach. *Hepatology* **11**, 545–550.
- Burtis, C. A., and Ashwood, E. R. (1994). "Tietz Textbook of Clinical Chemistry," 2nd ed. Saunders, Philadelphia.
- Burtis, C. A., and Ashwood, E. R. (2001). "Tietz Fundamentals of Clinical Chemistry," 5th ed. Saunders, Philadelphia.
- Cairns, J. A., and Klassen, G. A. (1977). The effect of propranolol on canine myocardial CPK distribution space and rate of disappearance. *Circulation* **56**, 284–288.
- Caprino, F., Gaudio, E., Marinozzi, G., Melis, M., and Motta, P. M. (1981). A scanning transmission electron microscopic study of extrahepatic cholestasis in the rat. *J. Submicro. Cyto.* **13**, 581–589.
- Cardinet, G. H., Littrell, J. F., and Freedland, R. A. (1967). Equine myoglobinuria. *Res. Vet. Sci.* **8**, 219–226.
- Cebra, C. K., Garry, F. B., Getzy, D. M., and Fettman, M. J. (1997). Hepatic lipidosis in anorectic, lactating Holstein cattle: a retrospective study of serum biochemical abnormalities. *J. Vet. Intern. Med.* **11**, 231–237.
- Center, S. A., Baldwin, B. H., Dillingham, S., Erb, H. N., and Tennant, B. C. (1986). Diagnostic value of serum gamma-glutamyl transferase and alkaline phosphatase activities in hepatobiliary disease in the cat. *J. Am. Vet. Med. Assoc.* **188**, 507–510.
- Center, S. A., Randolph, J. F., ManWarren, T., and Slater, M. (1991). Effect of colostrum ingestion on gamma-glutamyltransferase and alkaline phosphatase activities in neonatal pups. *Am. J. Vet. Res.* **52**, 499–504.
- Center, S. A., Slater, M. R., ManWarren, T., and Prymak, K. (1992). Diagnostic efficacy of serum alkaline phosphatase and gamma-glutamyltransferase in dogs with histologically confirmed hepatobiliary disease: 270 cases (1980–1990). *J. Am. Vet. Med. Assoc.* **201**, 1258–1264.
- Chanoit, G. P., Concordet, D., Lefebvre, H. P., Orceel, K., and Braun, J. P. (2002). Exercise does not induce major changes in plasma muscle enzymes, creatinine, glucose and total proteins concentrations in untrained beagle dogs. *J. Vet. Med.* **49**, 222–224.
- Chimsky, M., Shmagranoff, G. L., and Sherry, S. (1956). Serum transaminase activity. *J. Lab. Clin. Med.* **47**, 108.
- Clampitt, R. B., and Hart, R. J. (1978). The tissue activities of some diagnostic enzymes in ten mammalian species. *J. Comp. Path.* **88**, 607–621.
- Clemo, F. A. (1998). Urinary enzyme evaluation of nephrotoxicity in the dog. *Toxicol. Path.* **26**, 29–32.
- Collis, K. A., Symonds, H. W., and Sansom, B. F. (1979). The half-life of glutamate dehydrogenase in plasma of dry and lactating cows. *Res. Vet. Sci.* **27**, 267–268.
- Coltran, R. S., Jumar, V., and Collins, T. (1999). "Robbins Pathophysiologic Basis of Disease." Saunders, Philadelphia.
- Cook, A. K., Breitschwerdt, E. B., Levine, J. F., Bunch, S. E., and Linn, L. O. (1993). Risk factors associated with acute pancreatitis in dogs: 101 cases (1985–1990). *J. Am. Vet. Med. Assoc.* **203**, 673–679.
- Cooper, B. J., Winand, J. J., Stedman, H., Valentine, B. A., Hoffman, E. P., Kunkel, L. M., Scott, M. O., Fischbeck, K. H., Kornegay, J. N.,

- Avery, R. J., Williams, J. R., Schmickel, R. D., and Sylvester, J. E. (1988). The homologue of the Duchenne locus is defective in X-linked muscular dystrophy of dogs. *Nature* **334**, 154–156.
- Corazza, M., Tognetti, R., Guidi, G., and Buonaccorsi, A. (1994). Urinary alpha-amylase and serum macroamylase activities in dogs with proteinuria. *J. Am. Vet. Med. Assoc.* **205**, 438–440.
- Cornelius, C. E., Bishop, J., Switzer, J., and Rhode, E. A. (1958). Serum and tissue transaminase activities in domestic animals. *Cornell Vet.* **49**, 116–126.
- Craig, A. M., Pearson, E. G., Meyer, C., and Schmitz, J. A. (1991). Clinicopathologic studies of tansy ragwort toxicosis in ponies: sequential serum and histopathological changes. *Eq. Vet. Sci.* **11**, 261–271.
- Curran, J. M., Sutherland, R. J., and Peet, R. L. (1996). A screening test for subclinical liver disease in horses affected by pyrrolizidine alkaloid toxicosis. *Aust. Vet. J.* **74**, 236–240.
- Davis, J. L., Blikslager, A. T., Catto, K., and Jones, S. L. (2003). A retrospective analysis of hepatic injury in horses with proximal enteritis (1984–2002). *J. Vet. Intern. Med.* **17**, 896–901.
- Debroe, M. E., Roels, F., Mouwen, E. J., Lutgardo, C., and Wieno, R. J. (1985). Liver plasma membrane: the source of high molecular weight alkaline phosphatase in human serum. *Hepatology* **5**, 118–129.
- DeLaurier, A., Jackson, B., Pfeiffer, D., Ingham, K., Horton, M. A., and Price, J. S. (2002). Biochemical markers of bone turnover in the domestic cat: relationships with age and feline osteoclastic resorptive lesions. *J. Nutr.* **132**, 1742S–1744S.
- DeLaurier, A., Jackson, B., Pfeiffer, D., Ingham, K., Horton, M. A., and Price, J. S. (2004). A comparison of methods for measuring serum and urinary markers of bone metabolism in cats. *Res. Vet. Sci.* **77**, 29–39.
- DeNova, R. C., and Prasse, K. W. (1983). Comparison of serum biochemical and hepatic functional alterations in dogs treated with corticosteroids and hepatic duct ligation. *Am. J. Vet. Res.* **44**, 1703–1709.
- Dillon, A. R., Spano, J. S., and Powers, R. D. (1980). Prednisolone induced hematologic, biochemical, and histologic changes in the dog. *J. Am. An. Hosp. Assoc.* **16**, 831–837.
- Doonan, S., Martin, F., Agalaccio, S., Pascarella, S., Barra, D., and Bassa, F. (1986). The complete amino acid sequences of cytosolic and mitochondrial aspartate aminotransferases from horse heart, and inferences on evolution of the isoenzymes. *J. Mol. Evol.* **23**, 328–335.
- Durham, A. F., Smith, K. C., and Newton, J. R. (2003). An evaluation of diagnostic data in comparison to the results of liver biopsy in mature horses. *Eq. Vet. J.* **35**, 554–559.
- Durongphongtom, S., McDowell, W. N., Kerr, C. L., Neto, F. J., and Mirakhur, K. K. (2006). Comparison of hemodynamic, clinicopathologic, and gastrointestinal motility effects and recovery characteristics of anesthesia with isoflurane and halothane in horses undergoing arthroscopic surgery. *Am. J. Vet. Res.* **67**, 32–42.
- Eckersall, P. D., Nash, A. S., Marshall, G. M., and Douglas, T. A. (1986). The measurement of canine steroid-induced alkaline phosphatase by L-phenylalanine inhibition. *J. Sm. An. Pract.* **27**, 411–418.
- Ehrhart, N., Dernel, W. S., Hoffmann, W. E., Weigel, R. M., Powers, B. E., and Withrow, S. J. (1998). The prognostic significance of serum alkaline phosphatase in canine appendicular osteosarcoma. *J. Am. Vet. Med. Assoc.* **213**, 1002–1006.
- Eliakim, R., Mahmood, A., and Alpers, D. H. (1991). Rat intestinal alkaline phosphatase secretion into lumen and serum is coordinately regulated. *Biochim. Biophys. Acta* **1091**, 1–8.
- Ellison, R. S., and Jacobs, R. M. (1990). The isoelectric focusing properties of serum alkaline phosphatase in disease and following prednisolone and phenylbutazone administration in the horse. *Can. J. Vet. Res.* **54**, 126–131.
- Everett, R. M., Duncan, J. R., and Prasse, K. W. (1977). Alkaline phosphatase, leucine aminopeptidase, and alanine aminotransferase activities with obstructive and toxic hepatic disease in cats. *Am. J. Vet. Res.* **38**, 963–966.
- Fascetti, A. J., Mauldin, G. E., and Mauldin, G. N. (1997). Correlation between serum creatine kinase activities and anorexia in cats. *J. Vet. Intern. Med.* **11**, 9–13.
- Finco, D. R., and Stevens, J. B. (1969). Clinical significance of serum amylase activity in the dog. *J. Am. Vet. Med. Assoc.* **155**, 1686–1691.
- Fittschen, C., and Bellamy, J. E. (1984). Prednisone treatment alters the serum amylase and lipase activities in normal dogs without causing pancreatitis. *Can. J. Comp. Med.* **48**, 136–140.
- Fleisher, G. A., and Wakim, D. G. (1963). The fate of enzymes in body fluids: an experimental study. I. Disappearance rates of glutamic-pyruvic transaminase under various conditions. *J. Lab. Clin. Med.* **61**, 76–85.
- Fleisher, G. A., and Wakim, D. G. (1963). The fate of enzymes in body fluids: an experimental study. III. Disappearance rates of glutamic-oxaloacetic transaminase II under various conditions. *J. Lab. Clin. Med.* **61**, 98–106.
- Forman, M. A., Marks, S. L., De Cock, H. E., Hergesell, E. J., Wisner, E. R., Baker, T. W., Kass, P. H., Steiner, J. M., and Williams, D. A. (2004). Evaluation of serum feline pancreatic lipase immunoreactivity and helical computed tomography versus conventional testing for the diagnosis of feline pancreatitis. *J. Vet. Intern. Med.* **18**, 807–815.
- Foster, D. J., and Thoday, K. L. (2000). Tissue sources of alkaline phosphatase in 34 hyperthyroid cats: a qualitative and quantitative study. *Res. Vet. Sci.* **68**, 89–94.
- Foster, S. F., Church, D. B., and Watson, A. D. J. (2000). Effects of phenobarbitone on serum biochemical tests in dogs. *Aust. Vet. J.* **78**, 23–26.
- Galano, H. R., Olby, N. J., Howard, J. F., and Shelton, G. D. (2005). Myokymia and neuromyotonia in a cat. *J. Am. Vet. Med. Assoc.* **227**, 1608–1609.
- Garzotto, C. K., Berg, J., Hoffmann, W. E., and Rand, W. M. (2000). Prognostic significance of serum alkaline phosphatase activity in canine appendicular osteosarcoma. *J. Vet. Intern. Med.* **14**, 587–592.
- Gaschen, F., Gashen, L., Welle, M., Jaunin, V. B., Jmaa, D. G., Neiger-Aeschbacher, G., and Ade-Damilano, M. (1998). Lethal peracute rhabdomyolysis associated with stress and general anesthesia in three dystrophin-deficient cats. *Vet. Path.* **35**, 117–123.
- Gaskill, C. L., Hoffmann, W. E., and Cribb, A. E. (2004). Serum alkaline phosphatase isoenzyme profiles in phenobarbital-treated epileptic dogs. *Vet. Clin. Path.* **33**, 215–222.
- Gaskill, C. L., Miller, L. M., Mattoon, J. S., Hoffmann, W. E., Burton, S. A., Gelens, H. C. J., Ihle, S. L., Miller, J. B., Shaw, D. H., and Cribb, A. E. (2005). Liver histopathology and liver and serum alanine aminotransferase and alkaline phosphatase activities in epileptic dogs receiving phenobarbital. *Vet. Path.* **42**, 147–160.
- Geokas, M. C., Reidelberger, R., O'Rourke, M., Passaro, E., and Largman, C. (1982). Plasma pancreatic trypsinogens in chronic renal failure and after nephrectomy. *Am. J. Physiol.* **242**, G177–G182.
- Gerhardt, A., Steiner, J. M., Williams, D. A., Kramer, S., Fuchs, C., Janthur, M., Hewicker-Trautwein, M., and Nolte, I. (2001). Comparison of the sensitivity of different diagnostic tests for pancreatitis in cats. *J. Vet. Intern. Med.* **15**, 329–333.
- Gobella, C., Castex, G., and Corrada, Y. (2002). Serum and seminal markers in the diagnosis of disorders of the genital tract of the dog: a mini-review. *Theriogenology* **57**, 1285–1291.

- Goldstein, D. J., Rogers, C., and Harris, H. (1982). Evolution of alkaline phosphatases in primates. *Proc. Nat. Acad. Sci. USA* **79**, 879–883.
- Gores, G. J., Horwan, B., and Lemasters, J. J. (1990). Plasma membrane bleb formation and rupture: a common feature of hepatocellular injury. *Hepatology* **11**, 690–698.
- Gosset, K. A., Turnwald, G. H., Kearney, M. T., Greco, D. S., and Cleghorn, B. (1987). Evaluation of gamma-glutamyl transpeptidase-to-creatinine ratio from spot samples of urine supernatant as an indicator of urinary enzyme excretion in dogs. *Am. J. Vet. Res.* **48**, 455–457.
- Graca, R., Messick, J., McCollough, S., Barger, A., and Hoffmann, W. E. (2005). Validation and diagnostic efficacy of a lipase assay using the substrate 1,2-o-dilaryl-rac-glycero-3-glutaric acid-(6'-methylresorufin) ester for the diagnosis of acute pancreatitis in dogs. *Vet. Clin. Path.* **34**, 39–43.
- Graur, G. F., Greco, D. S., Behrend, E. N., Mani, I., Fettman, M. J., and Allen, T. A. (1995). Estimation of quantitative enzymuria in dogs with gentamicin-induced nephrotoxicosis using urine enzyme/creatinine ratios from spot urine samples. *J. Vet. Intern. Med.* **9**, 324–327.
- Green, C. E., Lorenz, M. D., Munnell, J. F., Prasse, K. W., White, N. A., and Bowen, J. M. (1979). Myopathy associated with hyperadrenocorticism in the dog. *J. Am. Vet. Med. Assoc.* **174**, 1310–1315.
- Guelfi, J. F., Braun, J. P., Benard, P., Rico, A. G., and Thouvenot, J. P. (1982). Value of so-called cholestasis markers in the dog: an experimental study. *Res. Vet. Sci.* **33**, 309–312.
- Guy, P. S., and Snow, D. H. (1981). Skeletal muscle fibre composition in the dog and its relationship to athletic ability. *Res. Vet. Sci.* **31**, 244–248.
- Hank, A. M., Hoffmann, W. E., Sanecki, R. K., Schaeffer, D. J., and Dorner, J. L. (1993). Quantitative determination of equine alkaline phosphatase isoenzymes in foal and adult serum. *J. Vet. Int. Med.* **7**, 20–24.
- Hardison, W. G., Weiner, R. G., Hatoff, D. E., and Miyai, D. (1983). Similarities and differences between models of extrahepatic biliary obstruction and complete biliary retention without obstruction in the rat. *Hepatology* **3**, 383–390.
- Harris, P. A., Marlin, D. J., and Gray, J. (1998). Plasma aspartate aminotransferase and creatine kinase activities in thoroughbred racehorses in relation to age, sex, exercise and training. *Vet. J.* **155**, 295–304.
- Hayakawa, T., Kondo, T., Shibata, T., Kitagawa, M., and Naruse, S. (1992). Plasma disappearance of homologous and heterologous pancreatic enzymes in dogs. *J. Gastroent. Hepatol.* **7**, 527–532.
- Hess, R. S., Saunders, H. M., Van Winkle, T. J., and Ward, C. R. (2000). Concurrent disorders in dogs with diabetes mellitus: 221 cases (1993–1998). *J. Am. Vet. Med. Assoc.* **217**, 1166–1173.
- Hiatt, N., and Bonorris, G. (1966). Removal of serum amylase in dogs and the influence of reticuloendothelial blockade. *Am. J. Physiol.* **210**, 133–138.
- Hinchcliff, K. W., Olson, J., Crusberg, C., Kenyon, J., Long, R., Royle, W., Weber, W., and Burr, J. R. (1993). Serum biochemical changes in dogs competing in a long-distance sled race. *J. Am. Vet. Med. Assoc.* **202**, 401–405.
- Hinchcliff, K. W., Shaw, L. C., Vukich, N. S., and Schmidt, K. E. (1998). Effect of distance traveled and speed of racing on body weight and serum enzyme activity of sled dogs competing in a long-distance race. *J. Am. Vet. Med. Assoc.* **213**, 622–639.
- Hoffmann, W. E. (1994). Current status of isoenzymes analysis in veterinary medicine. In "Proceedings of IVth Congress of International Society for Animal Clinical Biochemistry," pp. 179–190. University of California, Davis, CA.
- Hoffmann, W. E., Baker, G., Rieser, S., and Dorner, J. L. (1987). Alterations in selected serum biochemical constituents in equids after induced hepatic disease. *Am. J. Vet. Res.* **48**, 1343–1347.
- Hoffmann, W. E., and Dorner, J. L. (1975). Separation of isoenzymes of canine alkaline phosphatase by cellulose acetate electrophoresis. *J. Am. An. Hosp. Assoc.* **11**, 283–285.
- Hoffmann, W. E., and Dorner, J. L. (1977). Disappearance rates of intravenously injected canine alkaline phosphatase isoenzymes. *Am. J. Vet. Res.* **38**, 1553–1555.
- Hoffmann, W. E., Dorner, J. L., and Morris, H. (1983a). Intestinal alkaline phosphatase-like properties of horse kidney alkaline phosphatase. *Enzyme* **30**, 269–272.
- Hoffmann, W. E., Dorner, J. L., and Morris, H. (1983b). Diagnostic value of intestinal alkaline phosphatase in horse serum. *Vet. Clin. Path.* **12**, 33–38.
- Hoffmann, W. E., Renegar, W. E., and Dorner, J. L. (1977). Serum half-life of intravenously injected intestinal and hepatic alkaline phosphatase isoenzymes in the cat. *Am. J. Vet. Res.* **38**, 1639–1673.
- Hoffmann, W. E., Renegar, W., and Dorner, J. L. (1978). Alkaline phosphatase alkaline phosphatase isoenzymes in the cat. *Vet. Clin. Path.* **4**, 21–24.
- Hoffmann, W. E., Sanecki, R. K., and Dorner, J. L. (1988). A technique for automated quantification of canine glucocorticoid-induced isoenzyme of alkaline phosphatase. *Vet. Clin. Pathol.* **17**, 66–70.
- Horney, B. S., Honor, D. J., MacKenzie, A., and Burton, S. (1993). Stability of sorbitol dehydrogenase activity in bovine and equine sera. *Vet. Clin. Path.* **22**, 5–9.
- Houpert, P., Serthelon, J. P., Lefebvre, H. P., Toutain, P. L., and Braun, J. P. (1995). In vivo non-invasive quantification of muscle damage following a single intramuscular injection of phenylbutazone in sheep. *Vet. Hum. Toxicol.* **37**, 105–110.
- Hudson, E. B., and Strombeck, D. R. (1978). Effects of functional nephrectomy on the disappearance rates of canine serum amylase and lipase. *Am. J. Vet. Res.* **39**, 1316–1321.
- Jacobs, R. M., Swenson, C. L., Davenport, D. J., and Murtaugh, R. J. (1988). Sensitivity and specificity of canine total amylase and isoamylase activity determinations. *Can. J. Vet. Res.* **52**, 473–475.
- Jacobs, R. M., Weiser, M. G., Hall, R. L., and Kowalski, J. J. (1980). Clinopathologic features of canine Parvo viral enteritis. *J. Am. An. Hosp. Assoc.* **16**, 809–814.
- Jackson, B., Eastell, R., and Russell, R. G. G. (1996). Measurement of bone specific alkaline phosphatase in the horse: a comparison of two techniques. *Res. Vet. Sci.* **61**, 160–164.
- Jones, B. R., Anderson, L. J., Barnes, G. R. G., Johnstone, A. C., and Juby, W. B. (1977). Myotonia in related chow chow dogs. *New Zealand Vet. J.* **25**, 217–220.
- Jones, S., and Blackmore, D. J. (1982). Observations on the isoenzymes of aspartate aminotransferase in equine tissues and serum. *Eq. Vet. J.* **14**, 311–316.
- Jones, A. L., Hradet, G. T., Schmuicher, D. L., and Underdown, B. J. (1984). The fate of polymeric and secretory immunoglobulin A after the retrograde infusion in the common bile duct. *Hepatology* **4**, 1173–1183.
- Kaelin, S., Watson, A. D. J., and Church, D. B. (1986). Hypothyroidism in the dog: a retrospective study of sixteen cases. *J. Sm. An. Pract.* **27**, 533–539.
- Kamiike, W., Fujikawa, M., Koseki, M., Sumimura, J., Miyata, M., Kawashima, Y., Wada, H., and Tagawa, K. (1989). Different patterns of leakage of cytoplasmic and mitochondrial enzymes. *Clin. Chim. Acta* **185**, 265–270.



- Kaplan, A. J., Peterson, M. E., and Kemppainen, R. J. (1995). Effects of disease on the results of the diagnostic tests used for detecting hyperadrenocorticism in dogs. *J. Am. Vet. Med. Assoc.* **207**, 445–451.
- Kaplan, M. M., Ohkubo, A., Quaroni, E. G., and Sze-Tu, D. (1983). Increased synthesis of rat liver alkaline phosphatase by bile duct ligation. *Hepatology* **3**, 368–376.
- Keller, P. (1981). Enzyme activities in the dog: tissue analysis, plasma values, and intracellular distribution. *Am. J. Vet. Res.* **42**, 575–582.
- Kidney, B. A., and Jackson, M. L. (1988). Diagnostic value of alkaline phosphatase isoenzyme separation by affinity electrophoresis in the dog. *Can. J. Vet. Res.* **52**, 106–110.
- Kipp, H., and Arias, I. M. (2000). Newly synthesized canalicular ABC transporters are directly targeted from the Golgi to the hepatocytes apical domain in rat liver. *J. Biol. Chem.* **275**, 15917–15925.
- Kirpensteijn, J., Kid, M., Rutteman, G. R., and Teske, E. (2002). Prognostic significance of a new histologic grading system for canine osteosarcoma. *Vet. Path.* **39**, 240–246.
- Kitagawa, H., Kano, M., Sasaki, Y., and Hirano, Y. (1991). Serum creatinine kinase activities in dogs with dirofilariasis. *J. Vet. Med. Sci.* **53**, 557–569.
- Kitchell, B. E., Strombeck, D. R., Cullen, J., and Harrold, D. (1986). Clinical and pathologic changes in experimentally induced acute pancreatitis in cats. *Am. J. Vet. Res.* **47**, 1170–1173.
- Komneou, A., Karayannopoulou, M., Polizopoulou, Z. S., Constantinidis, T. C., and Dessiris, A. (2005). Correlation of serum alkaline phosphatase activity with the healing process of long bone fractures in dogs. *Vet. Clin. Path.* **34**, 35–38.
- Kristensen, S. R. (1994). Mechanisms of cell damage and enzyme release. *Dan. Med. Bull.* **41**, 423–433.
- Kryszewski, A. J., Neale, G., Whitefield, J. B., and Moss, D. W. (1973). Enzyme changes in experimental biliary obstruction. *Clin. Chim. Acta.* **47**, 175–182.
- Kuhlenschmidt, M. S., Hoffmann, W. E., and Rippey, M. K. (1991). Glucocorticoid hepatopathy: effect on receptor mediated endocytosis of asialoglycoproteins. *Biochem. Med. Met. Biol.* **46**, 152–168.
- Kutzler, M. A., Solter, P. F., Hoffmann, W. E., and Volkmann, D. H. (2003). Characterization and localization of alkaline phosphatase in canine seminal plasma and gonadal tissues. *Theriogenology* **60**, 299–306.
- Lanca, A. J., and Israel, Y. (1991). Histochemical demonstration of sinusoidal gamma-glutamyltransferase activity by substrate protection fixation: comparative studies in rat and guinea pig liver. *Hepatology* **14**, 857–863.
- Lawler, D. F., Keltner, D. G., Hoffmann, W. E., Nachreiner, R. F., Hegstad, R. L., Herndon, P. A., and Fischer, B. J. (1996). Benign familial hyperphosphatasemia in Siberian huskies. *Am. J. Vet. Res.* **57**, 612–617.
- Lechtenberg, K. F., and Nagaraja, T. G. (1991). Hepatic ultrasonography and blood changes in cattle with experimentally induced hepatic disease. *Am. J. Vet. Res.* **52**, 803–809.
- Lefebvre, H. P., Laroute, V., Braun, J. P., Lassourd, V., and Toutain, P. L. (1996). Non-invasive and quantitative evaluation of post-injection muscle damage by pharmacokinetic analysis of creatine kinase release. *Vet. Res.* **27**, 343–361.
- Lefebvre, H. P., Toutain, P. L., Serthelon, J. P., Lassourd, V., Gardey, L., and Braun, J. P. (1994). Pharmacokinetic variables and bioavailability from muscle of creatine kinase in cattle. *Am. J. Vet. Res.* **55**, 487–493.
- Lemasters, J. J., Stenkowski, C. J., Ji, S., and Thurman, R. G. (1983). Cell surface changes and enzyme release during hypoxia and reoxygenation in the isolated, perfused rat liver. *J. Cell Biol.* **97**, 778–786.
- Leonard, T. B., Neptun, D. A., and Popp, J. A. (1984). Serum gamma-glutamyltransferase as a specific indicator of bile duct lesions in the rat liver. *Am. J. Path.* **16**, 262–269.
- Lieberman, M. W., Barrios, R., Carter, B. Z., Habib, G. M., Lebovitz, R. M., Rajagopalan, S., Sepulveda, A. R., Shi, Z., and Wan, D. (1995). Gamma-glutamyl transpeptidase: what does the organization and expression of a multipromoter gene tell us about its functions? *Am. J. Path.* **147**, 1175–1185.
- Lindena, J., Kupper, W., Friedel, R., and Trautschold, I. (1979). Lymphatic transport of cellular enzymes from muscle into the intravascular compartment. *Enzyme* **24**, 120–131.
- Lindena, J., Kupper, W., and Trautschold, I. (1982). Effect of transient hypoxia in skeletal muscle on enzyme activities in lymph and plasma. *J. Clin. Chem. Clin. Biochem.* **20**, 95–102.
- Lindena, J., Kupper, W., and Trautschold, I. (1986). Catalytic enzyme activity concentration in thoracic duct, liver, and intestinal lymph of the dog, the rabbit, the rat, and the mouse. *J. Clin. Chem. Clin. Biochem.* **24**, 19–33.
- Low, M. G. (1987). Biochemistry of the glycosyl-phosphatidylinositol membrane protein anchors. *Biochem. J.* **244**, 1–13.
- Lowe, P. J., Miyaik, K., Steinbach, J. H., and Hardison, W. G. (1988). Hormonal regulation of hepatocyte tight junctional permeability. *Am. J. Phys.* **255**, 454–461.
- Machen, M., Montgomery, T., Holland, R., Braselton, E., Dunstan, R., Brewer, G., and Yuzbasiyan-Gurkan, V. (1996). Bovine hereditary zinc deficiency: lethal trait A 46. *J. Vet. Diagn. Invest.* **8**, 217–219.
- Mair, J. (1999). Tissue release of cardiac markers: from physiology to clinical applications. *Clin. Chem. Lab. Med.* **37**, 1077–1084.
- Mansfield, C. S., and Jones, B. R. (2000). Trypsinogen activation peptide in the diagnosis of canine pancreatitis (abstract). *J. Vet. Intern. Med.* **14**, 346.
- Mansfield, C. S., Jones, B. R., and Spillman, T. (2003). Assessing the severity of canine pancreatitis. *Res. Vet. Sci.* **74**, 137–144.
- Marrs, J., Small, J., Milne, E. M., and John, H. A. (2001). Liver and biliary system pathology in equine dysautonomia (grass sickness). *J. Vet. Med. A Phys. Path. Clin. Med.* **48**, 243–255.
- Maurice, M., Schell, M. J., Lardeaux, B., and Hubbard, A. L. (1994). Biosynthesis and intracellular transport of bile canalicular plasma membrane protein: studies in vivo and in the perfused rat liver. *Hepatology* **19**, 648–655.
- McGorum, B. C., Murphy, D., Love, S., and Milne, E. M. (1999). Clinicopathological features of equine primary hepatic disease: a review of 50 cases. *Vet. Rec.* **145**, 134–139.
- Mendel, V. E., Witt, M. R., Gitchell, B. S., Gribble, D. N., Rogers, Q. R., Segall, H. J., and Knight, H. D. (1988). Pyrrolizidine alkaloid-induced liver disease in horses: an early diagnosis. *Am. J. Vet. Res.* **49**, 572–578.
- Meshner, C. I., Rej, R., and Stokol, T. (1998). Alanine aminotransferase apoenzyme in dogs. *Vet. Clin. Path.* **27**, 26–30.
- Meyer, C., Guthrie, A. J., and Stevens, K. B. (2005). Clinical and clinicopathological changes in six healthy ponies following intramuscular administration of multiple doses of imidocarb dipropionate. *J. South African Vet. Assoc.* **76**, 26–32.
- Mia, A. S., Koger, H. D., and Tierney, M. M. (1978). Serum values of amylase and pancreatic lipase in healthy mature dogs and dogs with experimental pancreatitis. *Am. J. Vet. Res.* **39**, 965–969.
- Mickel, F. S., Weidenbach, F., Swarovsky, B., LaForge, K. S., and Scheele, G. A. (1989). Structure of the canine pancreatic lipase gene. *J. Biol. Chem.* **264**, 12895–12901.

- Milan, J. L., and Manes, T. (1988). Seminoma-derived Magao isozyme is encoded by a germ-cell alkaline phosphatase gene. *Proc. Natl. Acad. Sci. USA* **85**, 3028–4024.
- Milne, E. M., and Doxey, D. L. (1985). Gamma-glutamyl transpeptidase and its multiple forms in the tissues and sera of normal dogs. *Res. Vet. Sci.* **39**, 385–387.
- Mocharla, H., Mocharla, R., and Hodes, M. E. (1990). Alpha-amylase gene transcription in tissues of normal dogs. *Nucleic Acids Res.* **18**, 1031–1036.
- Moriya, S., Nagata, S., Yokoyama, H., Kato, S., Horie, Y., Ito, T., Ebihara, Y., and Ishii, H. (1994). Expression of gamma-glutamyl transpeptidase mRNA after depletion of glutathione in rat liver. *Alcohol* **29**(suppl 1), 107–111.
- Mortensen, B., and Huseby, N. (1997). Clearance of circulating G-glutamyltransferase by the asialoglycoprotein receptor. Enzyme forms with different sialic acid content are eliminated at different clearance rates and without apparent desialylation. *Clin. Chim. Acta* **258**, 47–58.
- Muller, P., Taboada, J., and Hosgood, G. (2000). Effects of long-term phenobarbital treatment on the liver in dogs. *J. Vet. Intern. Med.* **14**, 165–171.
- Mumm, S., Jones, J., Finnegan, P., Henthorn, P. S., Podgornik, M. N., and Whyte, M. P. (2002). Denaturing gradient gel electrophoresis analysis of the tissue nonspecific alkaline phosphatase isoenzyme gene in hypophosphatasia. *Mol. Genet. Metab.* **75**, 143–153.
- Murtaugh, R. J., and Jacobs, R. M. (1985). Serum amylase and isoamylases and their origins in healthy dogs and dogs with experimentally induced acute pancreatitis. *Am. J. Vet. Res.* **46**, 742–747.
- Nagode, L. A., Koestner, A., and Steinmeyer, C. L. (1969). Organ identifying properties of alkaline phosphatase in canine tissues. *Clin. Chim. Acta* **26**, 45–54.
- Nahas, K., Provost, J. P., George, C., and Abott, D. (1997). Choice of tests in the biochemical assessment of nephrotoxicity in dogs and rats: a study with maleic acid. *Comp. Haematol. Int.* **7**, 133–142.
- Nakashima, Y., Akita, H., and Appert, H. E. (1980). The contribution of pancreas and kidney in regulating serum amylase levels in dogs. *Gastroent. Jpn.* **15**, 475–479.
- Narisawa, S., Huang, L., Iwasaki, A., Hasegawa, H., Alpers, D. H., and Millan, J. L. (2003). Accelerated fat absorption in intestinal alkaline phosphatase knockout mice. *Mol. Cell Biol.* **23**, 7525–7530.
- Nilkumhang, P., and Thornton, J. R. (1979). Plasma and tissue enzyme activities in the cat. *J. Sm. An. Pract.* **29**, 169–174.
- Noguchi, T., and Yamashita, Y. (1987). The rabbit differs from other mammals in the tissue distribution of alkaline phosphatase isoenzymes. *Biochem. Biophys. Res. Commun.* **143**, 15–19.
- Noonan, N. E. (1981). Variations of plasma enzymes in the pony and dog after carbontetrachloride administration. *Am. J. Vet. Res.* **42**, 674–678.
- Noonan, N. E., and Meyer, D. J. (1979). Use of plasma arginase and gamma-glutamyl transpeptidase as specific indicators of hepatocellular or hepatobiliary disease in the dog. *Am. J. Vet. Res.* **40**, 942–947.
- Notham, M. M., and Callow, A. D. (1971). Investigations on the origin of amylase in serum and urine. *Gastroenterology* **60**, 82–89.
- O'Brien, P. J., Pook, H. A., Britt, B. A., Kalow, B. I., McLaughlin, R. N., Scott, E., and Elliott, M. E. (1990). Canine stress syndrome/malignant hyperthermia susceptibility: calcium-homeostasis defect in muscle and lymphocytes. *Res. Vet. Sci.* **48**, 124–128.
- Ogawa, H., Mink, J., Hardison, W. G. M., and Miyai, H. (1990). Alkaline phosphatase activity in hepatic tissue and serum correlates with amount and type of bile acid load. *Lab. Invest.* **62**, 87–95.
- Oostenbroek, R. J., Willems, G. M., Boumans, M. L. L., Soeters, P. B., and Hermens, W. T. (1985). Liver damage as a potential source of error in the estimation of myocardial infarct size from plasma creatine kinase activity. *Cardiovascular Res.* **19**, 113–119.
- Palmisano, A., Aurila, V., Ferrara, L., Cubellis, M. V., Sanna, G., and Marino, G. (1995). Nucleotide sequence of a cDNA coding for bovine mitochondrial aspartate aminotransferase. *Int. J. Biochem.* **27**, 507–511.
- Parent, C., Washabau, R. J., Williams, D. A., and Steiner, J. M. (1995). Serum trypsin-like immunoreactivity, amylase and lipase in the diagnosis of feline acute pancreatitis (abstract). *J. Vet. Intern. Med.* **9**, 194.
- Parent, J. (1982). Effects of dexamethasone on pancreatic tissue and on serum amylase and lipase activities in dogs. *J. Am. Vet. Med. Assoc.* **180**, 743–746.
- Payne, R. M., and Strauss, A. W. (1994). Expression of the mitochondrial creatine kinase genes. *Mol. Cell. Biochem.* **133–134**, 235–243.
- Patterson, W. H., and Brown, C. M. (1986). Increase of serum gamma-glutamyltransferase in neonatal standardbred foals. *Am. J. Vet. Res.* **47**, 2461–2463.
- Pearson, E. G., Dirksen, G., Meyer, J., Seitz, A., and Rowe, K. E. (1995). Evaluation of liver function tests in neonatal calves. *J. Am. Vet. Med. Assoc.* **207**, 1466–1469.
- Perino, L. J., Sutherland, R. L., and Woollen, N. E. (1993). Serum gamma-glutamyltransferase activity and protein concentration at birth and after suckling in calves with adequate and inadequate passive transfer of immunoglobulin G. *Am. J. Vet. Res.* **54**, 56–59.
- Poelstra, K., Bakker, W. W., Klok, P. A., Kamps, J. A., Hardonk, M. J., and Meijer, D. K. (1997). Dephosphorylation of endotoxin by alkaline phosphatase in vivo. *Am. J. Path.* **151**, 1163–1169.
- Polzin, D. J., Osborne, C. A., Stevens, J. B., and Hayden, D. W. (1983). Serum amylase and lipase activities in dogs with chronic primary renal failure. *Am. J. Vet. Res.* **44**, 404–410.
- Price, J. S., Jackson, B., Eastell, R., Goodship, A. E., Blumsohn, A., Wright, I., Stoneham, S., Lanyon, L. E., and Russell, R. G. (1995). Age related changes in biochemical markers of bone metabolism in horses. *Eq. Vet. J.* **27**, 201–207.
- Price, J. S., Jackson, B. F., Gray, J. A., Harris, P. A., Wright, I. M., Pfeiffer, D. U., Robins, S. P., Eastell, R., and Ricketts, S. W. (2001). Biochemical markers of bone metabolism in growing thoroughbreds: a longitudinal study. *Res. Vet. Sci.* **71**, 37–44.
- Putzki, H., Reichert, B., and Heymann, H. (1989). The serum activities of ALP, gamma-GT, GLDH, GPT, and CHE after complete biliary obstruction and choledochocaval fistula in the rat. *Clin. Chim. Acta* **181**, 81–86.
- Quigley, K. A., Jackson, M. L., and Haines, D. M. (2001). Hyperlipasemia in 6 dogs with pancreatic or hepatic neoplasia: evidence for tumor lipase production. *Vet. Clin. Path.* **30**, 114–120.
- Rallis, T. S., Koutinas, A. F., Kritsepi, M., and Moraitou, K. T. (1996). Serum lipase activity in young dogs with acute enteritis or gastroenteritis. *Vet. Clin. Path.* **25**, 65–68.
- Reichard, H. (1959). Ornithine carbamyl transferase in dog serum on intravenous injection of enzyme, choledochus ligation, and carbon tetrachloride poisoning. *J. Lab. Clin. Med.* **53**, 417–426.
- Reitman, S., and Frankel, S. (1957). A colorimetric method for the determination of serum glutamic oxalacetic and glutamic pyruvic transaminases. *Am. J. Clin. Path.* **28**, 56–63.
- Rej, R. (1998). They use enzymes for everything. *Clin. Chem.* **44**, 1149–1153.
- Rej, R., Rudotsky, U., Magro, A., and Pendergast, J. (1990). Effects of exercise on serum amino-transferase activity and pyridoxal phosphate saturation in thoroughbred horses. *Eq. Vet. J.* **22**, 205–208.

- Ribeiro, W. P., Valberg, S. J., Pagan, J. D., and Gustavsson, B. E. (2004). The effect of varying dietary starch and fat content on serum creatine kinase activity and substrate availability in equine polysaccharide storage myopathy. *J. Vet. Intern. Med.* **18**, 887–894.
- Rico, A. G., Braun, J. P., Benard, P., El Hassan, A. A., and Cazieux, A. (1977a). Tissue distribution and blood levels of gamma-glutamyl transferase in the horse. *Eq. Vet. J.* **9**, 100–101.
- Rico, A. G., Braun, J. P., Benard, P., and Thouvenot, J. P. (1977b). Blood and tissue distribution of gamma glutamyl transferase in the cow. *J. Dairy Sci.* **60**, 1283–1287.
- Rivers, B. J., Walter, P. A., O'Brien, T. D., King, V. L., and Polzin, D. J. (1996). Evaluation of urine gamma-glutamyl transpeptidase-to-creatinine ratio as a diagnostic tool in an experimental model of aminoglycoside-induced acute renal failure in the dog. *J. Am. An. Hosp. Assoc.* **32**, 323–336.
- Rosenfeld, L. (1999). "Four Centuries of Clinical Chemistry." Gordon and Breach Science, Hawthorn, Australia.
- Rossier, Y., Divers, T. J., and Sweeny, R. W. (1995). Variations in urinary gamma glutamyl transferase/urinary creatinine ratios in horses with or without pleuropneumonia treated with gentamycin. *Eq. Vet. J.* **27**, 217–220.
- Sanecki, R. K., Hoffmann, W. E., Dorner, J. L., and Kuhlenschmidt, M. S. (1990). Purification and comparison of corticosteroid-induced and intestinal isoenzymes of alkaline phosphatase in dogs. *Am. J. Vet. Res.* **51**, 1964–1968.
- Sanecki, R. K., Hoffmann, W. E., Gelberg, H., and Dorner, J. L. (1987). Subcellular location of corticosteroid-induced alkaline phosphatase in canine hepatocytes. *Vet. Path.* **24**, 296–301.
- Sanecki, R. K., Hoffmann, Hansen, R., and Schaeffer, D. J. (1993). Quantification of bone alkaline phosphatase in canine serum. *Vet. Clin. Path.* **22**, 17–23.
- Sawashima, Y., Sawashima, K., Taura, Y., Shimada, A., and Umemura, T. (1996). Clinical and pathological findings of Yorkshire terrier affected with necrotizing encephalitis. *J. Vet. Med. Sci.* **58**, 659–661.
- Schell, M. J., Maurice, M., Stieger, B., and Hubbard, A. L. (1992). 5'Nucleotidase is sorted to the apical domain of hepatocytes via an indirect route. *J. Cell Biol.* **119**, 1173–1182.
- Schlaeger, R. (1975). The mechanism of the increase in the activity of liver alkaline phosphatase in experimental cholestasis: measurement of an increased enzyme concentration by immunochemical titration. *Z. Klin. Chem. Klin. Biochem.* **13**, 277–281.
- Sharma, M. C., and Joshi, C. (2005). Therapeutic efficacy of zinc sulphate used in clustered model treatment in alleviating zinc deficiency in cattle and its effect on hormones, vitamins, and production parameters. *Vet. Res. Commun.* **29**, 609–628.
- Shull, R. M., and Hornbuckle, W. (1979). Diagnostic use of serum gamma-glutamyl transferase in canine liver disease. *Am. J. Vet. Res.* **40**, 1321–1324.
- Simpson, K. W. (2001). Editorial: the emergence of feline pancreatitis. *J. Vet. Intern. Med.* **15**, 327–328.
- Simpson, K. W., Batt, R. M., McLean, L., and Morton, D. B. (1989). Circulating concentrations of trypsin-like immunoreactivity and activities of lipase and amylase after pancreatic duct ligation in dogs. *Am. J. Vet. Res.* **50**, 629–632.
- Simpson, K. W., Doxey, D. L., and Keay, G. (1989). Evaluation of serum iso-amylase in the normal dog using an improved electrophoretic technique. *Vet. Res. Commun.* **13**, 441–450.
- Simpson, K. W., Simpson, J. W., Lake, S., Morton, D. B., and Batt, R. M. (1991). Effect of pancreatectomy on plasma activities of amylase, isoamylase, lipase, and trypsin-like immunoreactivity in dogs. *Res. Vet. Sci.* **51**, 78–82.
- Skeggs, L. T. (2000). Persistence . . . and prayer: from the artificial kidney to the autoanalyzer. *Clin. Chem.* **46**, 1153–1425.
- Slack, J. A., McGuirk, S. M., Erb, H. N., Lien, L., Coombs, D., Semrad, S. D., Risebeerg, A., Marques, F., Darien, B., Fallon, L., Burns, P., Murakami, M. A., Apple, E. S., and Peek, S. F. (2005). Biochemical markers of cardiac injury in normal, surviving septic, or nonsurviving septic neonatal foals. *J. Vet. Intern. Med.* **19**, 577–580.
- Sobel, B. E., Markham, J., Karlsberg, R. P., and Roberts, R. (1977). The nature of disappearance of creatine kinase from the circulation and its influence on enzymatic estimation of infarct size. *Circ. Res.* **41**, 836–844.
- Solter, P. F. (2005). Clinical pathology approaches to hepatic injury. *Toxicol. Path.* **33**, 9–161.
- Solter, P. F., and Hoffmann, W. E. (1995). Canine corticosteroid-induced alkaline phosphatase in serum was solubilized by phospholipase activity in vivo. *Am. J. Physiol.* **269**, G278–G286.
- Solter, P. F., and Hoffmann, W. E. (1999). Solubilization of liver alkaline phosphatase isoenzymes during cholestasis in dogs. *Am. J. Vet. Res.* **60**, 1010–1015.
- Solter, P. F., Hoffmann, W. E., Chambers, M. D., and Schaeffer, D. J. (1997). CCK-8 infusion increases plasma LMW alkaline phosphatase coincident with the enterohepatic circulation of bile acids. *Am. J. Physiol.* **273**, G381–G388.
- Solter, P. F., Hoffmann, W. E., Chambers, M. D., Schaeffer, D. J., and Kuhlenschmidt, M. S. (1994). Hepatic total 3-alpha-hydroxy bile acids concentration and enzyme activities in prednisone-treated dogs. *Am. J. Vet. Res.* **55**, 1086–1092.
- Solter, P. F., Hoffmann, W. E., Hungerford, L. L., Peterson, M. E., and Dorner, J. L. (1993). Assessment of corticosteroid-induced alkaline phosphatase isoenzyme as a screening test for hyperadrenocorticism. *J. Am. Vet. Med. Assoc.* **103**, 534–538.
- Spano, J. S., August, J. R., Henderson, R. A., Dumas, M. B., and Groth, A. H. (1983). Serum gamma-glutamyl transpeptidase activity in healthy cats and cats with induced hepatic disease. *Am. J. Vet. Res.* **44**, 2049–2053.
- Spillmann, T., Happonen, I., Sankari, S., Wittker, A., Kahkonen, T., and Westermarck, E. (2004). Evaluation of serum values of pancreatic enzymes after endoscopic retrograde pancreatography in dogs. *Am. J. Vet. Res.* **65**, 615–619.
- Sponseller, B. T., Valberg, S. J., Tennent-Brown, B. S., Foreman, J. H., Kumar, P., and Timoney, J. F. (2005). Severe acute rhabdomyolysis associated with *Streptococcus equi* infection in four horses. *J. Am. Vet. Med. Assoc.* **227**, 1800–1807.
- Steiner, J. M. (2003). Diagnosis of pancreatitis. *Vet. Clinics North America Sm. An. Pract.* **33**, 1181–1195.
- Steiner, J. M., Berridge, B. R., Wojcieszyn, J., and Williams, D. A. (2002). Cellular immunolocalization of gastric and pancreatic lipase in various tissues obtained from dogs. *Am. J. Vet. Res.* **63**, 722–727.
- Steiner, J. M., Medinger, T. L., and Williams, D. A. (1996). Development and validation of a radioimmunoassay for feline trypsin-like immunoreactivity. *Am. J. Vet. Res.* **57**, 1417–1420.
- Steiner, J. M., Rutz, G., and Williams, D. A. (2006). Serum lipase activities and pancreatic lipase immunoreactivity concentrations in dogs with exocrine pancreatic insufficiency. *Am. J. Vet. Res.* **67**, 84–87.
- Steiner, J. M., Teague, S. R., and Williams, D. A. (2003). Development and analytic validation of an enzyme-linked immunosorbent assay for the measurement of canine pancreatic lipase immunoreactivity in serum. *Can. J. Vet. Res.* **67**, 175–182.

- Steiner, J. M., and Williams, D. A. (1999). Feline exocrine pancreatic disorders. *Vet. Clinics North America* **29**, 551–575.
- Steiner, J. M., and Williams, D. A. (2000). Serum feline trypsin-like immunoreactivity in cats with exocrine pancreatic insufficiency. *J. Vet. Intern. Med.* **14**, 627–629.
- Steiner, J. M., and Williams, D. A. (2002). Purification of classical pancreatic lipase from dog pancreas. *Biochimie* **84**, 1245–1253.
- Stokol, T., and Erb, H. (1998). The apo-enzyme content of the aminotransferases in healthy and diseased domestic animals. *Vet. Clin. Path.* **27**, 71–78.
- Stornelli, A., Arauz, M., Baschard, H., and de la Sota, R. I. (2003). Unilateral and bilateral vasectomy in the dog: alkaline phosphatase as an indicator of tubular patency. *Reprod. Domest. An.* **38**, 1–4.
- Strombeck, D. R., Farver, T., and Kaneko, J. J. (1981). Serum amylase and lipase activities in the diagnosis or pancreatitis in dogs. *Am. J. Vet. Res.* **42**, 1966–1970.
- Swift, N. C., Marks, S. L., NacLachlan, N. J., and Norris, C. R. (2000). Evaluation of serum feline trypsin-like immunoreactivity for the diagnosis of pancreatitis in cat. *J. Am. Vet. Med. Assoc.* **217**, 37–42.
- Syakalima, M., Takiguchi, M., Yasuda, J., and Hashimoto, A. (1997). The age dependent levels of serum ALP isoenzymes and the diagnostic significance of corticosteroid-induced ALP during long-term glucocorticoid treatment. *J. Vet. Med. Sci.* **59**, 905–909.
- Teske, E., Rothuizen, J., de Bruijine, J. J., and Rijnberk, A. (1989). Corticosteroid-induced alkaline phosphatase isoenzymes in the diagnosis of canine hypercorticism. *Vet. Rec.* **125**, 12–14.
- Toutain, P. L., Lassourd, B., Costes, G., Alvinerie, M., Bret, L., Lefebvre, H. P., and Braun, J. P. (1995). A non-invasive and quantitative method for the study of tissue injury caused by intramuscular injection of drugs in horses. *J. Vet. Pharmacol. Ther.* **18**, 226–235.
- Toyoto, N., Miai, D., and Hardison, W. G. N. (1983). Effect of biliary pressure versus high bile acid flux on the permeability of hepatocellular tight junction. *Lab. Invest.* **50**, 536.
- Turgut, K., Demir, C., Ok, M., and Ciftci, K. (1997). Pre- and postprandial total serum bile acid concentration following acute liver damage in dogs. *J. Vet. Med., Series A* **44**, 25–29.
- Turner, R. M., and McDonnell, S. M. (2003). Alkaline phosphatase in stallion semen: characterization and clinical applications. *Theriogenology* **60**, 1–10.
- Twedt, D. C. (2004). In Breed associated canine hepatopathies. **October 16–17**, “Proceedings of the 28th Royal Canin/OSU Symposium. 51–56.
- Uechi, M., Terui, H., Nakayama, T., Mishina, M., Wakao, Y., and Takahashi, M. (1994). Circadian variation of urinary enzymes in the dog. *J. Vet. Med. Sci.* **56**, 849–854.
- Ulutas, B., and Sahal, M. (2005). Urinary GGT/creatinine ratio and fractional clearance of electrolytes in diarrhoeic calves. *Acta Vet. Hung.* **53**, 31–359.
- Valentine, B. A., Cooper, B. J., de Lahunta, A., O’Quinn, R., and Blue, J. T. (1988). Canine X-linked muscular dystrophy. An animal model of Duchenne muscular dystrophy: clinical studies. *J. Neurol. Sci.* **88**, 69–81.
- van der Harst, M. R., Bull, S., Laffont, C. M., and Klein, W. R. (2005). Gentamycin nephrotoxicity: a comparison of in vitro findings and in vivo experiments in equines. *Vet. Res. Commun.* **29**, 247–261.
- van Veen, S. Q., van Vliet, A. K., Wulferink, M., Brands, R., Boormeester, M. A., and van Gulik, T. M. (2005). Bovine intestinal alkaline phosphatase attenuates the inflammatory response in secondary peritonitis in mice. *Infect. Immun.* **73**, 4309–4314.
- VanVleet, J. F. (1975). Experimentally induced vitamin E-selenium deficiency in the growing dog. *J. Am. Vet. Med. Assoc.* **166**, 769–774.
- VanVleet, J. F., and Alberts, J. O. (1968). Evaluation of liver function tests and liver biopsy in experimental carbon tetrachloride intoxication and extra hepatic bile duct obstruction. *Am. J. Vet. Res.* **29**, 2119–2131.
- Volfinger, L., Lassourd, V., Michaux, J. M., Braun, J. P., and Toutain, P. L. (1994). Kinetic evaluation of muscle damage during exercise by calculation of amount of creatine kinase released. *Am. J. Physiol.* **266**, R434–R441.
- Wachstein, M., and Bradshaw, M. (1965). Histochemical localization of enzyme activity in the kidneys of three mammalian species during their post natal development. *J. Histochem. Cytochem.* **13**, 44–56.
- Watanabe, K., and Fishman, W. H. (1964). Application of the stereo inhibitor L-phenylalanine to enzyme morphology of intestinal alkaline phosphatase. *J. Histochem. Cytochem.* **12**, 252–260.
- Weaver, D. M., Tyler, J. W., VanMetre, D. C., Hostetler, D. E., and Barrington, G. M. (2000). Passive transfer of colostral immunoglobulins in calves. *J. Vet. Intern. Med.* **14**, 569–577.
- Wellman, M. L., Hoffmann, W. E., Dorner, J. L., and Mock, R. E. (1982). Comparison of the steroid-induced, intestinal and hepatic isoenzymes of alkaline phosphatase in the dog. *Am. J. Vet. Res.* **43**, 1204–1207.
- West, H. J. (1989). Evaluation of total plasma bile acid concentrations for the diagnosis of hepatobiliary disease in horses. *Res. Vet. Sci.* **46**, 264–270.
- West, H. J. (1991). Evaluation of total serum bile acids concentrations for the diagnosis of hepatobiliary disease in cattle. *Res. Vet. Sci.* **51**, 133–140.
- Wiedmeyer, C. E., Solter, P. F., and Hoffmann, W. E. (2002a). Alkaline phosphatase expression in tissues from glucocorticoid-treated dogs. *Am. J. Vet. Res.* **63**, 1083–1088.
- Wiedmeyer, C. E., Solter, P. F., and Hoffmann, W. E. (2002b). Kinetics of mRNA expression of alkaline phosphatase isoenzymes in hepatic tissues from glucocorticoid-treated dogs. *Am. J. Vet. Res.* **63**, 1089–1095.
- Williams, D. A., and Batt, R. M. (1983). Diagnosis of canine exocrine pancreatic insufficiency by the assay of serum trypsin-like immunoreactivity. *J. Sm. An. Pract.* **24**, 583–588.
- Williams, D. A., and Batt, R. M. (1988). Sensitivity and specificity of radioimmunoassay of serum trypsin-like immunoreactivity for the diagnosis of canine exocrine pancreatic insufficiency. *J. Am. Vet. Med. Assoc.* **192**, 195–201.
- Wilson, L. K., Tyler, J. W., Besser, T. E., Parrish, S. M., and Gant, R. (1999). Prediction of serum IgG1 concentration in beef calves based on age and serum gamma-glutamyl-transferase activity. *J. Vet. Int. Med.* **13**, 123–125.
- Whyte, M. P., Walkenhorst, D. A., Fedde, K. N., and Henthorn, P. S. (1996). Hypophosphatasia: levels of bone alkaline phosphatase immunoreactivity in serum reflect disease severity. *J. Clin. Endocrinol. Metab.* **81**, 2142–2148.
- Xu, Q., Lu, Z., and Zhang, X. (2002). A novel role of alkaline phosphatase in protection from immunological liver injury in mice. *Liver* **22**, 8–14.
- Yacoub, R. S., Appert, H. E., and Howard, J. M. (1969). Metabolism of pancreatic amylase and lipase infused intravenously into dogs. *Arch. Surg.* **99**, 54–59.
- Ye, Y., Wang, C., Zhang, J., Cho, Y. K., Gong, G., Murakami, Y., and Bache, R. J. (2001). Myocardial creatine kinase kinetics and isoform expression in hearts with severe LV hypertrophy. *Am. J. Physiol. Heart. Circ. Physiol.* **28**, H376–386.

- Yonezawa, L. A., Kitanaura, S. S., Mirandola, R. M. S., Antonelli, A. C., and Ortolani, E. L. (2005). Preventive treatment with vitamin E alleviates the poisoning effects of  $\text{CCl}_4$  in cattle. *J. Vet. Med. A* **52**, 292–297.
- Young, G. P., Rose, I. S., Cropper, S., Seetharom, S., and Alpers, D. H. (1984). Hepatic clearance of rat plasma intestinal alkaline phosphatase. *Am. J. Physiol.* **247**, G419–G426.
- Zanker, I. A., Hammon, H. M., and Blum, J. W. (2001). Activities of gamma-glutamyltransferase, alkaline phosphatase, and aspartate-aminotransferase in colostrum, milk, and blood plasma of calves fed first colostrum at 0–2, 6–7, 12–13, and 2–25 hours after birth. *J. Vet. Med. A Physiol. Path. Clin. Med.* **48**, 179–185.
- Zegers, M. M., and Hoekstra, D. (1998). Mechanisms and functional features of polarized membrane traffic in epithelial and hepatic cells. *Biochem. J.* **336**, 257–269.
- Zinkl, J. B., Bush, R. M., Cornelius, C. E., and Freedland, R. A. (1971). Comparative studies on plasma and tissue sorbitol, glutamic, lactic, and hydroxybutyric dehydrogenase and transaminase activities in the dog. *Res. Vet. Sci.* **12**, 211–214.
- Zoran, D. L. (2006). Pancreatitis in cats: diagnosis and management of a challenging disease. *J. Am. An. Hosp. Assoc.* **42**, 1–9.
- Zust, J., Hrovatin, B., and Sinundic, B. (1996). Assessment of selenium and vitamin E deficiency in dairy herds and clinical disease in calves. *Vet. Rec.* **139**, 391–394.

# Hepatic Function

Bud C. Tennant

*Department of Clinical Sciences  
New York State College of Veterinary Medicine  
Cornell University  
Ithaca, New York*

Sharon A. Center

*Department of Clinical Sciences  
New York State College of Veterinary Medicine  
Cornell University  
Ithaca, New York*

---

## I. INTRODUCTION

## II. FUNCTIONAL ANATOMY

## III. CLINICAL MANIFESTATIONS OF HEPATIC INSUFFICIENCY

- A. Icterus
- B. Hepatic Encephalopathy
- C. Hepatic Photosensitivity
- D. Ascites

## IV. LABORATORY ASSESSMENT OF HEPATIC FUNCTION

- A. Hepatic Enzymes
- B. Serum Bilirubin
- C. Serum Bile Acids
- D. Serum Proteins
- E. Dye Excretion

## V. OVERVIEW AND CONCLUSIONS

## REFERENCES

---

advances have been made in our understanding of the pathophysiological, biochemical, and molecular mechanisms responsible for hepatic disease. Our current knowledge of veterinary hepatology is the result of the collective work of individuals from a variety of disciplines, including practicing veterinarians, biomedical scientists, and, more recently, molecular and cell biologists and molecular geneticists. No one individual had a more important or sustained impact than Dr. Cornelius, and no one was more active in maintaining a comparative perspective on the subject (Cornelius, 1993). In this chapter, we describe the biochemical mechanisms responsible for the cardinal clinical manifestations of hepatic insufficiency and the biochemical tests used in the clinical diagnosis of liver disease and to assess hepatic function. As in previous editions, the goal is to provide students of veterinary medicine at all stages of career development with information useful for managing the diseases of animal patients.

## I. INTRODUCTION

The liver has an essential role in nutrient metabolism including the control and maintenance of the blood glucose level; in detoxification and excretion of hydrophobic metabolites and xenobiotics; in the synthesis of most plasma proteins; and in digestion through synthesis, biliary secretion, and conservation of bile acids that are essential both for digestion and intestinal absorption of fats and other lipids including fat soluble vitamins. The clinical manifestations of hepatic disease are directly attributable to alterations in the metabolic, excretory, synthetic, and digestive functions of the liver. The liver has great reserve, and signs of hepatic failure often do not develop until 70% or more of functional capacity is lost. Importantly, even when a major fraction of the hepatocellular mass has been lost following acute injury, recovery is possible because of the unique regenerative capacity of the liver.

Since Dr. Charles E. Cornelius wrote this chapter for earlier editions of this textbook (Cornelius, 1970), remarkable

## II. FUNCTIONAL ANATOMY

During embryological development, the liver arises as an outgrowth of the primitive gut and is located cranial to the abdominal viscera and other abdominal organs between the splanchnic and the peripheral (systemic) circulatory systems. Unlike other mammalian organs, afferent blood to the liver is derived from two sources, the hepatic artery and the hepatic portal vein. Efferent blood leaves the liver by the hepatic vein and enters the systemic circulation via the caudal vena cava. Twenty to 30% of afferent blood comes from the hepatic artery, and the remainder from the hepatic portal vein, which drains the pancreas, spleen, stomach, small intestine, and all but the most terminal portion of the large intestine.

The peripheral border of the classical liver lobule is formed by the most peripheral row of hepatocytes (the terminal plate) and by two, three, or more portal tracks (portal triads) that contain preterminal branches of the hepatic artery, the hepatic portal vein, and bile ductules.

Lymphatic vessels also are present in the portal tracts, but because of their small size and thin walls they are difficult to recognize morphologically. Although the classical lobular architecture of the liver remains in use for the morphological description of pathological lesions of the liver, most analyses indicate that the functional unit of the liver is the hepatic acinus in which blood flows from terminal hepatic artery and terminal portal vein of the portal tracts toward two, three, or more terminal collecting veins (central veins). Significant structural and functional heterogeneity has been demonstrated between hepatocytes of the periphery of the hepatic acinus (zone 1), the midzonal hepatocytes (zone 2), and perivenous hepatocytes (zone 3) (Jungermann and Katz, 1989). The functional significance of some of these differences will be discussed in this chapter.

Hepatocytes are the principal cell type of the liver and make up approximately 70% of the total volume. Kupffer cells are the macrophages of the liver located in the sinusoids with pseudopodia that are attached to endothelial cells and hepatocytes. The Kupffer cells and other perisinusoidal cells are responsible for local inflammatory and other immune responses. The stellate cells or Ito cells are found in the space of Disse where they are identified are the vitamin A-containing vacuoles in the cytoplasm. When activated by Kupffer cells, the stellate cells transform into myofibroblasts and are responsible for the production of collagen in liver diseases that are associated with fibrosis or cirrhosis.

The hepatocytes are arranged in single-cell plates separated by sinusoids lined by vascular endothelial cells. Blood from the terminal branches of the hepatic artery and the hepatic portal vein enters and mixes in the periphery of the liver acinus and percolates through the sinusoids to the terminal hepatic vein. The vascular endothelium lining the hepatic sinusoids differs from that of other capillaries in two ways. Under normal conditions, hepatocytes do not rest on a basement membrane but are separated from endothelial cells by the perisinusoidal space of Disse. Second, dynamic fenestrations of the sinusoidal endothelium are responsible for formation of hepatic lymph that has a protein content much higher than that of the lymph formed in other tissues, which is an ultrafiltrate of plasma with a characteristically low protein content.

Blood exits the liver through branches of the hepatic vein and obstruction of hepatic vein outflow increases the formation of hepatic lymph that is rich in protein. This may occur in congestive heart failure, in mechanical obstruction of hepatic vein outflow (Budd-Chisari syndrome), and in the early stages of hepatic fibrosis. In advanced hepatic cirrhosis, dense intracellular matrix forms in the space of Disse. "Capillarization" of the sinusoids develops reducing the fenestrations of the sinusoidal endothelium, and in formation of hepatic lymph that is typically low in protein, closely resembling the lymph produced by other normal tissues (see Section III.D).

Bile is secreted via the microvillous membrane of bile canaliculus located in the apical cell membrane of the hepatocyte and flows in the direction of the portal tracts in channels formed by the canaliculi of 2, 3, or more adjacent hepatocytes. These channels converge near the portal tracts forming the canals of Herring through which bile drains into the bile ductules of the portal tracts and finally into the ducts of the biliary tree. Hepatic lymph formed in the space of Disse flows in a similar direction and exits the liver via lymphatics vessels located in the portal tracts. Hepatic lymph leaves the liver primarily via the hilar lymphatic, hilar lymph nodes, and the thoracic duct. Hepatic lymph also leaves the liver by lymph vessels associated with the hepatic vein.

Cells of the periportal Zone 1 of the acinus are more likely to divide than other hepatocytes (Grisham, 1959). Mitochondria are larger and more numerous in Zone 1 hepatocytes than are those of Zone 3 (Loud, 1968; Uchiyama and Asari, 1984). Fenestrae of Zone 1 sinusoidal endothelial cells are larger than those of the Zone 3 region, and this may account for selective uptake of large, more complex molecules such as remnants of chylomicrons by Zone 1 hepatocytes (Wisse *et al.*, 1985).

A significant oxygen gradient has been demonstrated between sinusoids of Zones 1 and 3. The concentrations of glucose and amino acids that arrive primarily from the hepatic portal vein are higher in zone 1 sinusoids during digestion. Such metabolic differences are associated with important functional differences between Zones 1 and 3. The enzymes of glycolysis, gluconeogenesis, and glycogen metabolism have different activities within zones. Glucose-6-phosphatase, phosphoenolpyruvate carboxykinase, and fructose-1,6-diphosphatase activities are higher in periportal hepatocytes, whereas glucokinase and pyruvate kinase activities are higher in pericentral hepatocytes (Zakim, 1996). Glycogen appears to be uniformly distributed within the cells of the acinus during steady-state conditions, but during fasting, glycogen of periportal hepatocytes is utilized more rapidly and, during feeding, is replaced more rapidly.

Two plasma membrane transporters for glucose are expressed in the liver. Glut-2 is the primary glucose transporter of the liver and is expressed in plasma membranes of all hepatocytes. The  $K_m$  of Glut-2 for glucose is 15 to 20mM, a concentration of glucose that can be reached or exceeded in the hepatic portal vein during and immediately after feeding. Under these conditions, glucose is transported into hepatocytes for the synthesis of glycogen, amino acids, and triglycerides. Between meals, the glucose concentration in the portal vein is approximately 5mM and is similar to that in the peripheral circulation. During the interdigestive period, the concentration of glucose in hepatocytes is high relative to that of sinusoidal blood. Glut-2 also facilitates transport of glucose from the cytoplasm of hepatocytes into the sinusoid. Glucose reaching the systemic circulation, maintains the peripheral blood glucose

concentration, and contribute to meeting systemic energy requirements. The Glut-1 transporter is present only in the plasma membranes of Zone 3 (Tal *et al.*, 1990). The affinity of Glut-1 for glucose is much higher ( $K_m$  1–2mM) than that of Glut-2. The Glut-1 gene is transcribed and translated by all hepatocytes of the acinus; however, by means of a post-translational control mechanism, Glut-1 is inserted into the plasma membrane of only pericentral hepatocytes (Bilir *et al.*, 1993).

The liver plays a critical role in the removal of ammonia from the blood. Two separate reactions within the liver acinus are involved. The concentration of ammonia in the Zone 1 sinusoids is high compared to that of the Zone 3 sinusoids. Most of the ammonia that enters the liver diffuses into the hepatocytes of Zones 1 and 2, and a relatively small amount of ammonia reaches the hepatocytes of Zone 3. Hepatocytes of Zones 1 and 2 contain carbamoyl phosphate synthase and other enzymes of the urea cycle that are responsible for conversion of ammonia to urea. The activity of glutamine synthase is confined to the hepatocytes located adjacent to the terminal hepatic vein, and in these perivenous hepatocytes, glutamate synthase is responsible for the use of ammonia in the catalytic amination of glutamate forming glutamine. The  $K_m$  of carbamoyl phosphate synthase for ammonia is approximately 1.2mM, whereas that of glutamine synthase for ammonia is 0.3mM (Gumucio and Berkowitz, 1992; Gumucio *et al.*, 1994). Synthesis of urea from ammonia in periportal hepatocytes and of glutamine from ammonia in pericentral hepatocytes represents complementary enzymatic processes. Ammonia is first seen by hepatocytes that synthesize urea utilizing a low-affinity, high-capacity system. At the end of passage through the hepatic sinusoid, the small amount of ammonia remaining is removed for glutamine synthesis using a relatively high-affinity, low-capacity mechanism.

Zone 1 and 2 hepatocytes are responsible primarily for the bile salt-dependent fraction of bile formation and appear to be the primary site of bile salt synthesis. The enzymes necessary for fatty acid synthesis, CoA carboxylase and fatty acid synthase, are located primarily in Zone 3 hepatocytes. Drug-metabolizing enzymes of the cytochrome P-450 family are located predominantly in Zone 2 and 3 hepatocytes, explaining hepatocellular damage and fatty metamorphosis preferentially in Zone 3 hepatocytes (Jungermann and Katz, 1989) after exposure to toxins such as carbon tetrachloride.

### III. CLINICAL MANIFESTATIONS OF HEPATIC INSUFFICIENCY

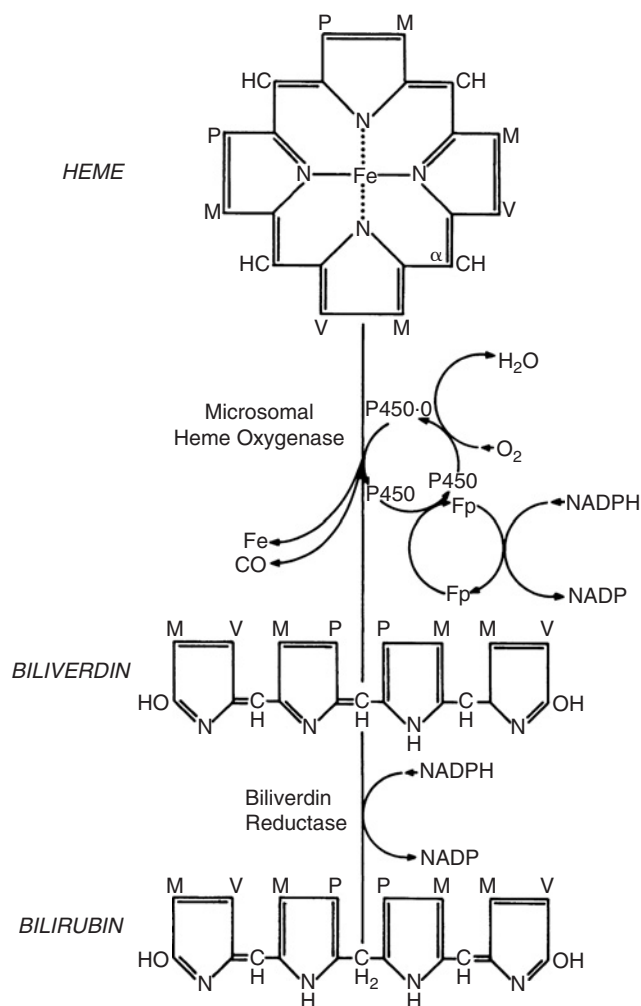
#### A. Icterus

##### 1. Formation of Bile Pigments

Bilirubin is a yellow pigment produced by the enzymatic degradation of heme. Approximately 80% of the bilirubin

produced normally by mammals is derived from the removal of senescent erythrocytes from the circulation by the reticuloendothelial systems (Landau and Winchell, 1970; Robinson *et al.*, 1966). Degradation of heme from other sources (myoglobin, cytochromes, peroxidase, catalase, guanylate cyclase) accounts for production of the remaining bilirubin. Significant amounts of microsomal cytochromes (P-450,  $b_5$ ) are present in the liver and are the most important non-erythroid source of bilirubin.

The initial step in bilirubin formation is the opening of the heme (ferriprotoporphyrin) ring at the  $\alpha$ -methene bridge (Fig. 13-1). This reaction is catalyzed by microsomal heme oxygenase (Tenhunen *et al.*, 1968, 1969, 1970a, 1970b). Cytochrome P450 serves as the terminal oxidase and requires reduced nicotinamide adenine dinucleotide phosphate (NADPH) and molecular oxygen. The products of heme degradation are equimolar amounts of iron, biliverdin, and carbon monoxide (Sassa, 2004; Tenhunen *et al.*, 1968, 1969). It has been estimated that more than 86% of



**FIGURE 13-1** Enzymatic degradation of heme (ferriprotoporphyrin) and formation of bilirubin.



endogenously produced carbon monoxide is derived from the enzymatic breakdown of heme (Ryter *et al.*, 2006), and quantitation of respiratory carbon monoxide has been used as an indirect measurement of bilirubin production (Landaw and Winchell, 1970). A minor amount of carbon monoxide arises from other metabolic processes including peroxidation of lipids (Archakov *et al.*, 2002; Vreman *et al.*, 1998). In primary hepatocyte cultures, degradation of hepatic heme also has been shown to use pathways that do not yield carbon monoxide (Bissell and Guzelian, 1980).

Bilirubin is formed by the catalytic reduction of biliverdin by the cytosolic enzyme biliverdin reductase, which, like heme oxygenase, requires NADPH (Tenhunen *et al.*, 1970b). In most mammals, hepatic biliverdin reductase activity is sufficient and normally is not rate limiting in the synthesis of bilirubin. Biliverdin reductase activity, however, is almost completely lacking in birds; consequently, in avian species, biliverdin is the major pigment of bile. Biliverdin also is the predominant bile pigment of the rabbit, in which 70% of bile pigment is biliverdin and biliverdin reductase activity is low (George *et al.*, 1989; Munoz *et al.*, 1986).

Heme oxygenase is most active in the tissues that remove erythrocytes and degrade heme. The spleen is the most important in this regard, followed by the liver and the bone marrow (Tenhunen *et al.*, 1968, 1969, 1970a). The kidney normally plays a minor role in heme degradation but in hemolytic disorders associated with hemoglobinuria, the kidney has a quantitatively more important role in heme degradation. When intravascular hemolysis begins, glomerular filtration of hemoglobin is initially prevented by the binding of hemoglobin to the plasma protein haptoglobin. When the haptoglobin binding capacity is exceeded, however, glomerular filtration of hemoglobin occurs. Depending on the amount filtered, some hemoglobin is reabsorbed by renal tubular epithelium. This induces formation of heme oxygenase and production of bilirubin by the kidney (de Schepper and Van Der Stock, 1972a, 1972b; Pimstone *et al.*, 1971). Degradation of hemoglobin in this manner may have a homeostatic function that conserves iron and diminishes renal injury associated with hemoglobinuria.

## 2. Hepatic Excretion of Bilirubin

Bilirubin is not soluble in aqueous solution and is transported in plasma from sites of synthesis to the liver bound to albumin. Bilirubin dissociates from albumin (Listowsky *et al.*, 1978), and hepatocellular uptake is facilitated across the basolateral (sinusoidal) plasma membrane by the organic anion transport polypeptide (OATP), a sodium- and energy-independent process. OATP also has a role in the hepatic uptake of a wide range of other organic anions (e.g., certain drugs, other xenobiotics, sulfobromophthalein [BSP]) and in the sodium-independent hepatic uptake

of bile salts (Hata *et al.*, 2003). The primary mechanism for the hepatic uptake of conjugated bile salts is sodium dependent and utilizes the sodium taurocholate cotransporting polypeptide (NTCP) (Hata *et al.*, 2003; Jacquemin *et al.*, 1991, 1994; Wolkoff *et al.*, 1985).

Localization of OATP in the sinusoidal plasma membrane of the hepatocyte is determined by PDZ1, a 70-kDa PDZ binding motif that is present in the liver and kidney. (PDZ is an acronym that combines the first letters of the three proteins in which its binding domain was first identified; Hung and Sheng [2002].) PDZ domains function in protein targeting and in the assembly of specific protein-protein complexes involved in signal transduction or transport. In PDZK1 knockout mice, the expression of OATP1a1 in the liver is almost normal, but OATP1a1 is present only in the cytoplasm and is absent from its normal position in the plasma membrane. BSP clearance is diminished in PDZK1 knockout mice, suggesting that oligomerization of OATP1a1 with PDZK1 determines the subcellular localization and the function of OATP1a1 (Wang *et al.*, 2005).

Upon entry into the hepatocyte, bilirubin binds to ligandin, a major cytosolic protein that has both transport and detoxification functions. Ligandin is a glutathione S-transferase that catalyzes conjugation of reduced glutathione with a variety of endogenous substrates and xenobiotics including porphyrins and certain steroid hormones including cortisol, BSP, and indocyanine green (Habig *et al.*, 1974; Kaplowitz *et al.*, 1973). By binding bilirubin and inhibiting the efflux of pigment back into the plasma, ligandin serves as a driving force for initial hepatic uptake (Listowsky *et al.*, 1978).

Conjugation of bilirubin with glucuronic acid is catalyzed by bilirubin uridine-diphosphate glucuronosyltransferase-1 (UGT1) in a reaction in which one or both propionic acid side chains of bilirubin IX are esterified. UGT1 is a microsomal isoenzyme that produces water-soluble bilirubin mono- and diglucuronide. The UGT family of enzymes is among the most important mammalian detoxification mechanisms.

Bilirubin diglucuronide represents more than 80% of the total bile pigment in healthy adult human bile. Glucuronic acid esters of bilirubin have been identified in the bile of a variety of species including the dog (Talafant, 1956), rat (Grodsky and Carbone, 1957), guinea pig (Schmid, 1956), and in the bile of the horse, pig, cat, sheep, and cattle (Cornelius *et al.*, 1960). Gordon *et al.* (1976) have shown that the diglucuronide is the major bilirubin conjugate excreted in canine bile. There is evidence, however, that the bile of dogs (Fevery *et al.*, 1971; Heirwegh *et al.*, 1975; Noir, 1976) and other species (Cornelius *et al.*, 1975a, 1975b) also contains bilirubin conjugates of glucose and xylose.

When the activity of bilirubin-UGT in the liver is diminished, production of bilirubin mono- and diglucuronide decreases. Reduction of conjugating enzyme activity to

approximately 30% of normal results in a modest increase in the serum bilirubin concentration. Greater deficiency of bilirubin-UGT leads to ineffective esterification of bilirubin and to more severe unconjugated hyperbilirubinemia and icterus. Bilirubin conjugation in the liver of neonatal animals is relatively low compared to the adult. Coupled with the high rate of bilirubin production related to accelerated neonatal erythrocyte turnover, the risk of hyperbilirubinemia and icterus may be increased in the neonate. Defective bilirubin conjugation as a result of inherited UDP-glucuronosyltransferase deficiency causes the severe unconjugated hyperbilirubinemia of the Crigler-Najjar syndrome of humans and the Gunn rat. Gilbert's disease is a more benign, inherited form of UDP-glucuronosyltransferase deficiency in humans that is characterized by intermittent unconjugated hyperbilirubinemia and icterus. A similar enzyme deficiency may explain the benign unconjugated hyperbilirubinemia observed in some horses.

The final step in hepatic excretion is the transport of conjugated bilirubin across the bile canaliculus and into the biliary system. The experimental intravenous infusion of unconjugated bilirubin at a rate that exceeds the maximal hepatic excretory capacity results in accumulation of conjugated bilirubin in plasma. This indicates that under normal conditions, the rate-limiting step in the transfer of bilirubin from plasma to bile is canalicular transport rather than either hepatic uptake or conjugation (Arias *et al.*, 1961). The concentration of bilirubin glucuronide in bile is 150-fold greater than in hepatocytes.

The unidirectional transport of bilirubin conjugates from the cytoplasm across the canalicular plasma membrane into bile is mediated by the multidrug resistance-associated protein 2 (Mrp2; ABCC2; canalicular multispecific organic anion transporter, cMOAT), a member of the ATP-binding cassette (ABC) superfamily, and an integral part of the bile canaliculus (Chowdhury *et al.*, 1994; Nies and Keppler, 2007). The Mrp2 transport mechanism is functionally distinct from the ATP-dependent, bile salt export pump of the canaliculus described later in the section on bile acids (Bsep; Alpert *et al.*, 1969; Arias *et al.*, 1993; Muller *et al.*, 1991; Stieger *et al.*, 2007). Although mechanistically separate from the Mrp2 system, bile salt excretion enhances bile flow and increases the maximum transport capacity for bilirubin and other organic anions (Goresky *et al.*, 1974).

Mutations of the Mrp2 gene are responsible for the Dubin-Johnson syndrome of humans, a benign, inherited hepatic disease associated with conjugated hyperbilirubinemia and accumulation of melanin like pigment in hepatocytes. A similar disease has been observed in two separate strains of rats. In the GY/TR(-) rat (Jansen *et al.*, 1985; Paulusma *et al.*, 1996) and in the similar Eisai hyperbilirubinemic rat (EHBR; Ito *et al.*, 1997, 2001; Takikawa *et al.*, 1991), genetic sequence variants lead to premature stop codons

and to the absence of the Mrp2 gene product in the canaliculus. A similar genetic abnormality is likely in Corriedale sheep, which develop an inherited disease that is clinically and biochemically identical to the Dubin-Johnson syndrome of humans (Cornelius *et al.*, 1965a, 1968b) and rats (Kitamura *et al.*, 1990).

### 3. Extrahepatic Metabolism of Bilirubin

From the bile, conjugated bilirubin enters the intestine. Conjugated bilirubin, a polar compound, is poorly absorbed in the small intestine and passes to the large intestine where it is reduced to a series of colorless derivatives collectively called urobilinogens (stercobilinogens). Reduction is catalyzed by dehydrogenases of anaerobic colonic bacteria. In germ-free animals that lack intestinal microorganisms, bilirubin passes unaltered into the feces and urobilinogen is not produced (Gustafsson and Lanke, 1960). Most of the urobilinogen formed in the colon is passed in the feces, but some is absorbed into the portal circulation, transported to the liver, and most of that is excreted in the bile. A small fraction (1% to 5%) of absorbed urobilinogen, however, passes into the general circulation and is excreted by the kidney. In the dog, urobilinogen is excreted by both glomerular filtration and tubular secretion, the latter being enhanced in acid urine (Levy *et al.*, 1968).

Although the liver is the principal site of bilirubin conjugation and excretion, alternate pathways have been demonstrated. In normal animals, these alternate mechanisms are of minor significance but may become quantitatively more important in liver disease. After total hepatectomy, dogs have been shown to develop moderate hyperbilirubinemia and bilirubinuria. In addition to unconjugated bilirubin, the plasma of hepatectomized dogs contains the monoglucuronide conjugate (Hoffman *et al.*, 1960) and, in some studies, the diglucuronide of bilirubin (Royer *et al.*, 1965). The kidney and intestine both have been shown experimentally to be sites with the capacity to conjugate bilirubin (Royer *et al.*, 1974). Differences in extrahepatic metabolism of bilirubin may explain some of the remarkable differences between species in the bilirubin levels reached after bile duct obstruction (see the following section).

### 4. Icterus

The clinical sign of *icterus* or *jaundice* develops when the yellow pigment bilirubin accumulates in plasma and other tissues. Yellow discoloration of tissues can first be noted by careful observation when the plasma bilirubin value exceeds 2 to 3 mg/dl and can be appreciated even by an untrained observer when the concentration exceeds 3 to 4 mg/dl. The correlation between the plasma bilirubin concentration and the degree of clinical icterus is not, however,

perfect. Elevated plasma bilirubin values are usually present for one or more days before clinical icterus is apparent, and there may be a delay between the time plasma bilirubin returns to normal and the clearance of the yellow discoloration of tissues. Conjugated bilirubin is said to have a greater affinity for connective tissue than the unconjugated pigment, possibly because conjugated pigment is less avidly bound to albumin (With, 1968).

Visible yellow discoloration of tissues is readily recognized in animals in the unpigmented sclera. The normal red color of the visible mucous membranes makes detection of a slight yellow cast more difficult. It is possible to apply pressure to the mucous membranes and temporarily reduce blood flow to the area, so that the underlying discoloration of the tissue can be better assessed.

The color of plasma (icteric index) may be useful clinically in the evaluation of icterus. Normal canine, feline, and ovine plasma is often water clear and free of yellow color. The finding of yellow plasma in these species is highly suggestive of hyperbilirubinemia. Cattle absorb and transport significant quantities of carotene in plasma. Because in cattle the icteric index varies with the dietary intake of carotene, measurement has limited use in this species. Equine plasma normally has a high icteric index, which in part is due to a plasma bilirubin concentration that normally is higher than that of other domestic species. There are other, as yet uncharacterized, noncarotene pigments, however, that may contribute to the color of equine plasma.

Notable species differences occur in the frequency with which icterus is observed in association with liver disease. In sheep and cattle with terminal hepatic insufficiency, there usually is a significant biochemical elevation in plasma bilirubin, but elevation may be insufficient to result in clinical icterus (Finn and Tennant, 1974; Hjerpe *et al.*, 1971). This is due possibly to the residual capacity of the liver to excrete bilirubin or to extrahepatic mechanisms for bilirubin excretion or degradation. Clinical icterus in ruminants is often associated with hemolytic anemia in which production of bilirubin exceeds excretory capacity (e.g., anaplasmosis in cattle and copper poisoning in sheep). In severe fatty liver, cattle that are critically ill may exhibit some degree of clinical icterus.

The assessment of clinical icterus in the horse is somewhat more complicated than in other species. The sclera and visible mucous membranes of most normal horses do not appear icteric, but in 10% to 15% of normal horses, a slight but definite yellow discoloration of the sclera or oral mucous membranes can be detected (Tennant *et al.*, 1975). Scleral icterus of a moderate degree may also be observed in horses with a variety of illnesses that do not involve the liver directly (e.g., pneumonia, impaction of the large intestine, enteritis). Reduction in food intake is a common factor in such disorders, and fasting in the horse causes a rapid increase in plasma bilirubin concentration. In both

hemolytic anemia and hepatic failure in the horse, the degree of icterus is usually remarkably greater than that seen under physiological conditions or that is associated with reduced food intake. In the horse, severe clinical icterus is almost invariably present in acute hepatic necrosis (Tennant *et al.*, 1975; Thomsett, 1971). However, in chronic hepatic disease, icterus may be a more variable sign. In a series of 34 cases of hepatic cirrhosis in the horse, significant icterus was a presenting sign in 70% (Tennant *et al.*, 1975). Icterus was even less frequent (40%) in another series of horses with cirrhosis (Gibbons *et al.*, 1950).

The dog and cat appear to be intermediate between ruminants and the horse in the propensity to develop clinical icterus. Hemolytic disease, severe hepatocellular dysfunction, and extrahepatic bile duct obstruction are characteristically associated with icterus in dogs and cats. In experimental extrahepatic bile duct obstruction in the dog, the plasma bilirubin increases at once following obstruction and clinical icterus is observed within 1 to 3 days. After 2 to 3 weeks, however, the plasma bilirubin of some dogs declines. As in sheep and cattle, this may be related to adaptation of extrahepatic mechanisms of bilirubin excretion, particularly the kidney. The kidney of the dog is capable of adapting so that the rate of renal excretion of bilirubin equals the rate of formation. In cats with complete extrahepatic bile duct obstruction, however, no such decrease is observed, and persistent hyperbilirubinemia and deep icterus are characteristic.

## B. Hepatic Encephalopathy

Hepatic encephalopathy is the syndrome of disturbances in cerebral function that is caused by hepatic insufficiency or hepatic failure. Severity of neurological signs may vary from subtle and intermittent changes in behavior associated with lethargy or stupor, to bizarre, belligerent behavior, mania, convulsions, and hepatic coma. Typically, such signs are attributable to severe acute or chronic liver disease or in dogs to congenital malformation of the portal vein (portosystemic shunt).

Hepatic encephalopathy is a prominent clinical feature of hepatic failure in the horse. In one series of cases, 82% of horses presenting with acute hepatitis and 32% with cirrhosis had prominent neurological abnormalities (Tennant *et al.*, 1973). Varying degrees of CNS derangement may be observed. Some horses stand quietly with the feet apart and the head lowered, nodding the head occasionally and appearing somnolent. Pupillary response to light may be normal or moderately sluggish, but, in some cases, vision is lost. Compulsive walking in a circle or in a single direction may be observed, and affected individuals may appear oblivious to their surroundings, walking over or through objects in their path (“walking disease”; Rose *et al.*, 1957).

In fulminant cases, horses may become delirious with the head pressed forcibly against a wall for long periods of time, or they may assume a variety of other unusual positions or fall suddenly to the ground. Numerous unproductive attempts to rise can be followed by violent thrashing. When successful in rising, horses with hepatic encephalopathy may be completely uncontrollable, lunging forward violently and becoming a menace to attending personnel and equipment.

The syndrome of hepatic encephalopathy in cattle may have an abrupt onset and characteristically represents a terminal manifestation of chronic liver disease (Fowler, 1968; Pearson, 1977). Affected calves initially may be dull, anorectic, and stand apart from other calves in a herd. Behavioral abnormalities may include unprovoked, violent charging or unusual and unrestrained bawling. Progressive dysmetria and ataxia are followed by recumbency and affected cattle may be unable to rise or even to assume a sternal position. Tenesmus has been reported to be a conspicuous clinical feature associated with prolapse of the rectal mucosa and dribbling of urine. Characteristically, death occurs within 2 days after onset of CNS signs (Finn and Tennant, 1974).

Hepatic encephalopathy is observed frequently in dogs with congenital or acquired portosystemic vascular shunts and may be one of the most prominent presenting clinical features of this form of liver disease (Audell *et al.*, 1974; Barrett *et al.*, 1976; Cornelius *et al.*, 1975a, 1975b; Ewing *et al.*, 1974; Maddison, 1992; Schermerhorn *et al.*, 1996). Neurological signs associated with portosystemic shunts often are episodic and may be present for some months before recognition of the underlying hepatic disturbance. Depression and stupor with amaurotic blindness are observed in approximately half the cases of congenital portacaval shunts in dogs, with circling, head pressing, and intermittent seizures observed less frequently. Hepatic encephalopathy also has been associated with other primary diseases of the canine liver (Center, 1996; Oliver, 1965; Strombeck *et al.*, 1975b).

Inherited diseases involving the urea cycle are recognized in domestic animals in which failure of urea synthesis results in significant elevations in blood ammonia and in signs of encephalopathy. Two cases of encephalopathy in dogs have been reported that were linked to a deficiency of argininosuccinate synthetase (Strombeck *et al.*, 1975a). Inherited argininosuccinate synthetase deficiency has been described in neonatal cattle in which rapidly progressive and fatal encephalopathy was associated with hyperammonemia and citrullinemia (Harper *et al.*, 1986, 1988, 1989). The argininosuccinate synthetase gene of cattle has been cloned, sequenced, and the mutation of affected Holstein calves described (Dennis *et al.*, 1989). Suspected ornithine transcarbamylase deficiency has been described in a cat (Washizu *et al.*, 2004), and encephalopathy in two Morgan foals associated with elevated blood ammonia has been

recognized and described as being similar to the human syndrome of hyperornithinemia, hyperammonemia, and homocitrullinuria (McCornico *et al.*, 1997). A syndrome of hyperammonemia and encephalopathy associated with acute gastrointestinal disease has been described in adult horses (Gilliam *et al.*, 2007; Hasel *et al.*, 1999; Peek *et al.*, 1997; Stickle *et al.*, 2006). The pathogenesis of this syndrome has not been fully explained, but the evidence suggests that increased production and absorption of ammonia from the colon are sufficient to exceed the detoxifying capacity of the liver (Stickle *et al.*, 2006).

Hepatic encephalopathy must be differentiated clinically from primary inflammatory, degenerative, or neoplastic diseases of the brain, and this can be accomplished by demonstrating the existence of underlying severe hepatic disease. In the horse with acute hepatitis, clinical icterus almost always is present at the time neurological signs are observed. In the dog and in cattle, frank clinical icterus is observed variably in animals with hepatic encephalopathy so that other tests of hepatic function or liver biopsy are required. In cases of primary hyperammonemia resulting from deficiency of urea cycle enzymes, conventional hepatic function tests are not expected to be abnormal (Strombeck *et al.*, 1975a).

Factors responsible for encephalopathy associated with hepatic failure are not completely understood. Ammonia is present in normal peripheral blood at a concentration of 2 to 5 mM/l. In portal venous blood, the concentration may be five times higher. Normally, most of the ammonia in the hepatic portal vein is removed by the normal liver to form urea, with only a small fraction passing into the systemic circulation. In hepatic failure, synthesis of urea is reduced, and in the horse (Cornelius *et al.*, 1965a, 1965b; Tennant *et al.*, 1975) and dog (Barrett *et al.*, 1976; Strombeck, 1975b), significant elevations of blood ammonia have been demonstrated. Ammonia has potent neurotoxic effects, and many of the neurological signs of hepatic encephalopathy can be produced when toxic doses of ammonium salts are administered intravenously (Hooper, 1972).

The reactions of blood ammonia are determined by the physicochemical principles that apply to gases in solution and to the dissociation of weak bases. The ammonia: ammonium ion buffer system of blood can be described by the Henderson-Hasselbalch equation:

$$\text{pH} = \text{pKa} - \log \frac{\text{NH}_3}{\text{NH}_4^+}$$

The pKa for this system in the dog is approximately 9.1 (Bromberg *et al.*, 1960), meaning that at physiological pH (7.4), almost all of the ammonia of blood is ionized to form (NH<sub>4</sub><sup>+</sup>). As blood pH increases, the relative amount of free ammonia (NH<sub>3</sub>) increases, and as pH decreases, NH<sub>3</sub> decreases. Cells are almost impermeable to NH<sub>4</sub><sup>+</sup> but are readily permeable to NH<sub>3</sub>, passing through the plasma

membrane by nonionic diffusion (Castell and Moore, 1971; Stabenau *et al.*, 1959; Warren and Nathan, 1958). These principles are important in determining the amount of ammonia absorbed from the gastrointestinal tract or the amount that can pass from blood into the brain and to other tissues (Dimski, 1994).

Because of its influence on acid-base parameters, potassium status may be an important determinant of  $\text{NH}_3$  toxicity. Potassium deficiency ultimately favors the development of metabolic alkalosis that, in turn, causes a shift in the  $\text{NH}_3/\text{NH}_4^+$  equilibrium in the direction of the toxic freebase.

Blood ammonia ultimately is derived from dietary nitrogen. The gastrointestinal tract is the major source of blood  $\text{NH}_3$ , but other tissues also produce  $\text{NH}_3$  (e.g., muscle and kidney). Renal ammonia is produced from glutamine and to a lesser extent from other amino acids. Synthesis of ammonium ion by the kidney represents a normal physiological mechanism for  $\text{H}^+$  excretion. The renal excretion of  $\text{NH}_4^+$  is related directly to the pH gradient between blood and urine, and total urinary excretion of  $\text{NH}_4^+$  is high in acid urine and proportionately low in alkaline urine.

The gastrointestinal tract is the major source of blood  $\text{NH}_3$  based on the high concentration of  $\text{NH}_3$  found in portal blood compared to peripheral venous blood. Part of the ammonia in the hepatic portal vein is derived from the action of bacterial enzymes on dietary amino and amide nitrogen and part is derived from urea, which is present in alimentary tract secretions and is hydrolyzed by bacterial urease of the gastrointestinal tract. The question of whether gastrointestinal urease is produced in part by mammalian cells or is entirely of bacterial origin was the subject of controversy for many years. Using germ-free rats, it was demonstrated that gastrointestinal urease was exclusively of bacteria in origin (Levenson and Tennant, 1963), and this observation has been confirmed in germ-free dogs (Nance *et al.*, 1974).

The relative importance of  $\text{NH}_3$  produced by gastrointestinal bacteria and that produced from nonbacterial sources is still not fully known. Nance *et al.* (1971, 1974) and Nance and Kline (1971) have demonstrated that germ-free dogs with Eck fistulae develop encephalopathy associated with hyperammonemia. This suggests that at least with vascular shunts, endogenous sources of  $\text{NH}_3$  contribute to encephalopathy. The intestine metabolizes significant quantities of glutamine independent of intestinal bacteria, and at least 30% of the glutamine nitrogen that reaches the intestine appears in the portal blood as  $\text{NH}_3/\text{NH}_4^+$  (Windmuller and Spaeth, 1974).

The liver plays a critical role in maintenance of the blood glucose concentration, and marked hypoglycemia is sometimes associated with liver failure. In fulminant hepatic failure in the horse, the blood glucose has been reported in some cases to be as low as 20mg/dl or less (Hjerpe, 1964; Tennant *et al.*, 1975). Hypoglycemia also has been reported in dogs with hepatic insufficiency associated

with vascular shunts (Cornelius *et al.*, 1975b; Ewing *et al.*, 1974).

Other neurotoxic substances may be involved in the pathogenesis of hepatic encephalopathy, and the role of these factors has been reviewed (Center, 1996; Maddison, 1992). Indole and indolyl derivatives that are formed from tryptophan by intestinal bacteria have been suggested as encephalotoxic compounds capable of inducing coma (Zieve *et al.*, 1974). Other studies have incriminated short chain fatty acids and, in experimental models of hepatic failure, total volatile fatty acids (VFA) increase significantly before death (Zieve *et al.*, 1968). Increased plasma VFA concentrations also have been observed in spontaneous hepatic encephalopathy and, when infused intravenously into experimental animals, VFA produces cerebral depression followed by coma.

The etiological role of ammonia in hepatic encephalopathy is generally recognized, and there is convincing evidence that cerebral edema is important in pathogenesis (Ahboucha and Butterworth, 2007; Butterworth, 1994). Astrocytes are recognized as a target of ammonia in the CNS (Albrecht and Norenberg, 2006), but how ammonia brings about astrocyte swelling, brain edema, and cerebral hypertension is not fully understood. It has been suggested that as a result of ammonia detoxification, glutamine accumulates in astrocytes and the resulting osmotic force of glutamine leads to cell swelling. In experimentally induced hepatic encephalopathy, accumulation of cerebral ammonia was associated with increased cerebral glutamine, with the development of Alzheimer type II astrocytes, and with a significant increase in the level of water in the brain (Jover *et al.*, 2006). Based on studies of cultured astrocytes, Jayakuman *et al.* (2006) concluded, however, that glutamine was not acting as an osmolyte but rather that ammonia evoked oxidative stress or abnormalities of mitochondrial function (mitochondrial permeability transition) that caused injury and swelling of astrocytes (Albrecht and Norenberg, 2006; Norenberg *et al.*, 2005, 2007).

The management of hepatic encephalopathy involves restriction of protein intake and provision of a readily digestible dairy or vegetable protein source. Further control is directed at the reduction of the production and absorption of ammonia and other neurotoxic substances from the intestine. One approach is the oral administration of a nonabsorbable disaccharide such as lactulose, which upon reaching the colon is fermented by resident bacteria to produce short chain fatty acids and which has a cathartic effect. By decreasing colonic pH, the equilibrium between ammonium ion and the freebase is shifted to poorly absorbed ammonium ion. An alternative approach is the administration of a nonabsorbable, broad spectrum antibiotic. The antibiotic inhibits production of ammonia and other organic toxins produced by bacteria in the colon (Festi *et al.*, 2006; Rothenber and Keeffe, 2005).

### C. Hepatic Photosensitivity

Photosensitivity is the result of hypersensitivity to sunlight induced by the presence of exogenous or of endogenously produced photodynamic substances. Clinical signs develop when photosensitive animals are exposed to light and are caused by inflammation and necrosis of unpigmented skin (photodermatitis). A distinction is made between sunburn and photosensitization. Animals with unpigmented skin that are maintained for long periods of time indoors and are abruptly exposed to sunlight may sustain sunburn, which is a direct response of the unpigmented and unprotected skin to ultraviolet radiation ( $320\mu\text{M}$ ). Photosensitization is, characteristically, a more severe reaction caused by the interaction of a photodynamic substance and solar radiation. The effective wavelength of light causing photosensitization is determined by the absorption spectrum of the photosensitizing substance, which may extend into the visible region of light. Sunburn and photosensitization also differ in that sunburn apparently can develop in the absence of molecular oxygen, whereas photosensitization occurs only in the presence of molecular oxygen (Cook and Blum, 1959; Schothorst *et al.*, 1970). With sunburn, there is a characteristic delay between exposure to light and the development of erythema of the skin, soreness, or pruritus. With photosensitization, initial clinical signs may be noted within minutes after exposure to sunlight.

In domestic animals, three forms of photosensitization are recognized. Photosensitivity may occur when a photodynamic substance not present normally in the diet is ingested and absorbed. Examples are the ingestion of the poisonous plants *Hypericum perforatum* (St. John's wort, Klamath weed) and *Fagopyrum esculentum* (buckwheat). Photosensitization caused by administration of the parasiticide phenothiazine also is a form of primary photosensitization. The photosensitizing compound is phenothiazine sulfoxide, which accumulates in the skin and in the aqueous humor inducing keratitis. A second form of photosensitization is caused by photosensitizing compounds that are produced endogenously. Congenital porphyria (pink tooth) of cattle is one of the best characterized examples in which a marked increase in production of uroporphyrin I results in deposition of the porphyrin in the teeth and bones, and large quantities are excreted in the urine. The teeth and urine readily fluoresce when exposed to ultraviolet light. The photodermatitis and hemolytic anemia associated with the disease are directly related to the photodynamic effects of endogenous porphyrins (Kaneko *et al.*, 1971; Scott *et al.*, 1979). Other inherited forms of porphyria in domestic animals (reviewed by Tennant [1998]) are described in Chapter 8.

A third group of diseases associated with photosensitivity are those that are secondary to hepatic disease (hepatic photosensitization). Photodermatitis associated with both acute and chronic liver disease is recognized primarily in

herbivorous animals. The photodynamic agent responsible for hepatic photosensitivity is phylloerythrin, a porphyrin derivative from chlorophyll (Rimington and Quin *et al.*, 1934). Chlorophyll is converted to phylloerythrin by microorganisms of the rumen or large intestine that remove the magnesium atom from the chlorophyll molecule and hydrolyze the phytyl and carboxy methoxy side chains leaving the porphyrin nucleus of chlorophyll intact. Phylloerythrin produced in the alimentary tract is excreted primarily in the feces. A small fraction of the relatively nonpolar phylloerythrin is absorbed into the portal circulation. In normal animals, phylloerythrin is quantitatively removed by the liver and excreted in the bile and does not reach the peripheral circulation. Phylloerythrin may be found in the bile and feces of herbivores that are consuming chlorophyll-containing diets and may be demonstrated in other species that ingest chlorophyll. The comparatively large amount excreted by ruminants is attributed to their frequently high chlorophyll intake and to the favorable conditions for microbial production of phylloerythrin within the gastrointestinal tract.

In hepatic insufficiency, phylloerythrin is incompletely cleared from the hepatic portal circulation, enters the systemic circulation, and ultimately accumulates in the skin. In the superficial layers of the unpigmented skin, phylloerythrin absorbs solar energy resulting in formation of free radicals. Reactive oxygen species cause peroxidation of cellular lipids and cellular components (e.g., lysosomes). Inflammation and necrosis of the skin are the result of direct oxidative injury and the secondary action of lysosomal enzymes (Slater and Riley, 1966). The critical range of wavelengths (action spectrum) that result in photodermatitis in hepatic photosensitivity was shown in geeldikkop to be between 380 and  $650\mu\text{m}$  (Riemersmid and Quin, 1941) and in facial eczema between 400 to  $620\sigma\text{m}$ , ranges that are consistent with the known absorption spectrum of phylloerythrin.

The types of hepatic disease of ruminants and horses that are associated with photosensitivity vary considerably, but the effects attributable to the photodynamic action of phylloerythrin are similar. The nature and severity of the cutaneous lesions depend on the amount of phylloerythrin in the skin and on the intensity and the duration of light exposure. The most common site of photodermatitis in the horse is the muzzle, which has a sparse protective covering of hair and often is unpigmented. Unpigmented areas of the distal extremities also are frequently affected (Fowler, 1965; Tennant *et al.*, 1973). In cattle, unpigmented areas of the muzzle, back, escutcheon, and the lateral aspects of teats are especially susceptible to photodynamic injury.

The areas of skin affected in sheep are those that receive the greatest exposure to light and that lack protection provided by black pigment or wool and include the ears, eyelids, face, lips, and coronets (Riemerschmid and Quin, 1941). The first clinical signs of photodermatitis in

sheep may be apparent restlessness with shaking of the head or rubbing of affected parts. Individual animals may seek relief in the shade. Erythema and edema are the first cutaneous manifestations of photosensitization. Swelling of the lips, ears, and face have led to the descriptive terms “big head” and “facial eczema.” Following edema, serum may ooze from damaged skin. Ultimately, second- or third-degree burns may develop, and the morbidity and mortality attributable to lesions of the skin may be more important than any other aspect of the underlying liver disease (Riemerschmid and Quin, 1941). In the early stages of the disease, Southdown sheep with congenital photosensitivity have no morphological abnormalities of the liver, but the photodermatitis that is observed as soon as affected lambs begin to consume green plants is associated with significant biochemical defects in hepatic organic anion excretion (Cornelius and Gronwall, 1968).

#### D. Ascites

The clinical sign of ascites is the result of abnormal accumulation of fluid in the peritoneal cavity. In normal animals, there is significant bidirectional movement of fluid, electrolytes, and, to a lesser degree, protein across mesenteric capillaries, through the interstitial space, and across the peritoneal mesothelium into the abdominal cavity. Such movements are determined by osmotic and hydrostatic forces that are described by Starling's equation: plasma colloidal osmotic pressure minus ascitic fluid colloidal osmotic pressure equals portal capillary pressure minus intra-abdominal hydrostatic pressure. Normal portal capillary pressure on the arterial side of the capillary bed favors formation of an ultrafiltrate of plasma, which is nearly protein free. On the venous side of the capillary bed, reabsorption of interstitial fluid occurs because the hydrostatic pressure is below that of the colloidal osmotic pressure primarily exerted by plasma proteins within the capillary bed. Under normal conditions, only a small volume of free fluid is present in the peritoneal cavity.

During investigation of the mechanical factors that influence formation of lymph, Starling (1894) observed that obstruction of hepatic venous flow by ligation of the thoracic vena cava cranial to the site of entry of the hepatic veins produced significant increase in lymph flow through the thoracic duct, and the lymph was high in protein. Obstruction of the hepatic portal vein as it entered the liver also increased the flow of thoracic duct lymph, but the protein content was found to be low. Starling concluded that the increased flow of thoracic duct lymph following ligation of the thoracic vena cava arose from hepatic lymph, and after ligation of the portal vein, increased thoracic duct lymph was derived from mesenteric capillaries.

Hepatic lymph is produced primarily in the sinusoids and contributes 25% to 50% of lymph flow in the thoracic

duct (Brauer, 1963). In the dog and other species, hepatic lymph has a much higher protein content than lymph from other tissues because hepatocytes are not associated with a conventional basement membrane and because of the unique permeability of the sinusoids to plasma proteins because of fenestrations between the endothelial cells that line the sinusoids (Bissel and Maher, 1996). In experimental cirrhosis in the dog and other species, the flow rate of thoracic duct lymph is increased two to five times and the protein content is higher than that of lymph derived from other tissues (Nix *et al.*, 1951a, 1951b).

Ascites caused by cirrhosis of the liver may be associated with increased portal vein pressure (portal hypertension). Experimental ligation of the portal vein before it enters the liver, however, results only in minimal and transient ascites or no ascites (Schilling *et al.*, 1952; Volwiler *et al.*, 1950). In the dog, ligation of either the hepatic vein (Orloff and Snyder, 1961a, 1961b; Orloff *et al.*, 1963, 1964a, 1964b, 1966) or the caudal vena cava at a site cranial to entry of the hepatic vein (Berman and Hull, 1952; Schilling *et al.*, 1952; Witte *et al.*, 1968, 1969a, 1969b) produces prompt and intractable ascites. Lymph fluid has been observed to form droplets said to “weep” from the surface of the liver following experimental obstruction of hepatic vein outflow (Hyatt *et al.*, 1955). Because of its origin as hepatic lymph, the protein content of such ascitic fluid may be 3.0 to 3.5 g/dl or higher. This observation is consistent with the finding that the protein content of ascitic fluid in the initial stages of cirrhosis may be higher than that of conventional transudates (a modified transudate) because of its hepatic origin. As progressive fibrosis and “capillarization” of the hepatic sinusoids develop (Bissell and Maher, 1996), the protein content of hepatic lymph decreases and correspondingly the protein content of ascitic fluid decreases. It is probable in cases of cirrhosis that there is increased production of both hepatic lymph and mesenteric lymph and that ascites develops when lymph from both sources fails to return to the systemic venous circulation (Witte *et al.*, 1971a, 1971b). The protein content of ascitic fluid is influenced not only by the relative proportions of mesenteric and hepatic lymph but by the protein concentration of plasma. In advanced cirrhosis, when hypoalbuminemia may be present, the protein content of ascitic fluid can be expected to be proportionately low.

Although experimental portal vein obstruction per se does not result in ascites, only transient portal hypertension is actually produced by this procedure. When persistent portal hypertension is produced experimentally by aortic-portal anastomosis or when such anastomoses occur congenitally, the ascitic fluid is characteristically low in protein content because of its origin in mesenteric capillaries.

Serum albumin is synthesized exclusively in the liver and is the major determinant of plasma and tissue fluid oncotic pressure. Hypoalbuminemia associated with

chronic liver disease has been considered a factor contributing to the development of ascites, but current evidence suggests the role is not primary. The intravascular and total body albumin pools may not be greatly diminished in cirrhosis, although the concentrations of albumin in plasma often are decreased (Rothschild *et al.*, 1973; Witte *et al.*, 1971a, 1971b). For ascites to develop, total body sodium and water must expand. Excessive sodium chloride intake greatly enhances development of ascites (Berman and Hull, 1952), and ascites is preceded by increased sodium retention by the kidney. Aldosterone levels have been shown to be significantly increased in dogs with ascites caused by hepatic vein obstruction (Howards *et al.*, 1968; Orloff *et al.*, 1965).

When associated with liver disease, ascites indicates a chronic process and characteristically presents with cirrhosis. There are important species differences in the occurrence of ascites in chronic liver disease. In dogs with advanced hepatic cirrhosis, ascites is a relatively common sign. Ascites is almost never observed in horses with cirrhosis (Tennant *et al.*, 1975), and conspicuous ascites is unusual in cattle with cirrhosis (Finn and Tennant, 1974; Whitlock and Brown, 1969) but may be observed at necropsy (Pearson, 1977). Ascites has been observed in cattle with thrombosis of the caudal vena cava secondary to liver abscess (Braun *et al.*, 1995), and, in such cases, marked hepatomegaly was characteristic (Breeze *et al.*, 1976; Selman *et al.*, 1974) and due apparently to obstruction of hepatic vein outflow. In sheep, ascites has been observed in cirrhosis but is unusual in cases of severe sclerosing cholangitis associated with fascioliasis (Hjerpe *et al.*, 1971).

It is important clinically to differentiate between ascites caused by liver disease and ascites caused by other primary diseases. Biochemical and cytological examination of ascitic fluid may be useful but alone is seldom diagnostic. The protein concentration of ascitic fluid associated with clinical cirrhosis may be variable depending on the stage of the disease (Center, 1996). In early stages, the protein content may be expected to exceed 2 to 2.5 g/dl because it is a reflection of the high protein content of hepatic lymph but later, when the serum albumin has decreased and when sinusoidal fibrosis and capillarization have developed, the protein content of ascitic fluid will be correspondingly lower (1 to 1.5 g/dl). The ascitic fluid associated with peritonitis is high, whereas in neoplastic diseases of the abdomen, the protein concentration is generally below 1.5 to 2.0 g/dl. Pembleton-Corbett *et al.* (2000) examined the serum albumin/peritoneal effusion albumin (SA/EA) gradient in dogs with ascites. They found the gradient was significantly higher in dogs with liver disease than in those with ascites of other causes. In 25 dogs with abdominal effusions associated with hepatic disease, 23 had serum albumin-effusion albumin (SA/EA) gradients equal to or greater than 1.1 and the median SA/EA gradient was 1.4 (range 0.7 to 3.1). In human patients, SA/EA gradients

of 1.1 or greater are considered to indicate the presence of portal hypertension. The clinical observations of Pembleton-Corbett (2000) suggested that portal hypertension is a significant factor in the pathogenesis of ascites in dogs with hepatobiliary disease.

Total nucleated cell counts in ascitic fluid from dogs with cirrhosis are seldom greater than 1000 to 2000 per  $\mu$ l. Bloody or turbid fluid typically results from inflammatory or neoplastic processes (e.g., feline infectious peritonitis, bacterial peritonitis, neoplasia), and nucleated cell counts are elevated. "Bile ascites" or bile peritonitis is recognized most frequently in the dog and cat associated with abdominal trauma. In this case, the concentration of bilirubin in peritoneal fluid exceeds that of plasma.

## IV. LABORATORY ASSESSMENT OF HEPATIC FUNCTION

The pathogenesis of the hepatic diseases of domestic animal species is remarkably complex, involving acute and chronic forms of hepatitis, cirrhosis, bile duct obstruction, intrahepatic forms of cholestasis, neoplasia, and disorders of hepatic vasculature. The frequency of these diseases varies with species, breed, age, and, in some cases, by environment (diet, geographical location). The differential diagnosis of hepatic disease involves the evaluation of clinical history, physical examination, biochemical tests, hepatic imaging, and histopathological examination of hepatic biopsies. The following section describes the biochemical tests used to assess hepatic disease.

There are several diagnostic categories with which the clinician dealing with problems of liver disease must be concerned. In clinical patients with a history and signs suggestive of hepatic disease, laboratory tests are used for confirmation. Laboratory tests are used to assess the severity of liver injury, to establish prognosis, to define treatable complications of hepatic insufficiency (e.g., ascites, encephalopathy), and to monitor clinical progress. Finally, biochemical tests of hepatic function may be performed on clinically healthy patients that are known to be at high risk of developing liver disease (e.g., exposure to infectious agents that cause hepatitis, or a familial history of chronic liver disease that requires screening for inherited diseases of the liver).

### A. Hepatic Enzymes

The presence of liver disease often is recognized on the basis of elevated serum activities of enzymes of hepatic origin. Although they are sometimes referred to as "liver function tests," serum enzymes do not measure hepatic function directly but indicate alteration in the integrity of the cell membrane of the hepatocyte, necrosis of hepatocytes or biliary epithelium, impeded bile formation or bile



flow (cholestasis), or the induction of enzyme synthesis (Center, 2007).

The serum enzymes used in the clinical assessment of hepatobiliary disease have high activity in the liver. In hepatocellular or cholestatic forms of liver injury, these enzymes are released into the serum and the increased activity is used diagnostically. The duration of elevation in serum activity of the enzymes of hepatic origin depends on a variety of factors including molecular size, intracellular location, rate of plasma clearance, rate of enzyme inactivation, and, in some cases (e.g., alkaline phosphatase [AP] and glutamyltranspeptidase [GGT]), the rate of hepatic synthesis.

The serum enzyme activities that increase when hepatic necrosis is present are alanine aminotransferase (ALT), aspartate aminotransferase (AST), ornithine carbamoyltransferase (OCT), glutamic dehydrogenase (GD), sorbitol dehydrogenase (SDH), and arginase. Elevated serum activities of AP, GGT, and 5' nucleotidase (5'-ND) are considered to indicate either intrahepatic or extrahepatic cholestasis.

Because of its location between the splanchnic and systemic circulation, the liver is exposed to a wide variety of toxins, drugs and drug metabolites, bacterial toxins, and to infectious agents that may influence the serum activity of enzymes from the liver. The clinical assessment of aberrations in liver enzymes should consider the type of enzyme change (hepatocellular versus cholestatic), the degree of increase in serum enzyme activity, the rate at which the increase or decrease in serum activity occurs, and whether fluctuations in enzyme activity occur over time or if there is a unidirectional pattern of change in enzyme activity. The reference range is characteristically established as that within  $\pm 2$  standard deviations of the mean value observed in a "normal" animal population. By definition, this means that up to 2.5% of individuals from a "normal" population can be expected to have values above such a reference range.

### 1. Serum Alanine and Aspartate Aminotransferases

The serum activity of the aminotransferases, AST and ALT, are measured to detect hepatocellular injury. These enzymes catalyze the transfer of the  $\alpha$ -amino nitrogen of aspartate or alanine to  $\alpha$ -ketoglutaric acid resulting in formation of glutamate. AST and ALT have key roles in gluconeogenesis and in formation of urea. In the liver, ALT catalyzes the transfer of the  $\alpha$ -amino nitrogen of alanine to  $\alpha$ -ketoglutarate forming pyruvate, which can be utilized in gluconeogenesis. In muscle, ALT transaminates pyruvate to form alanine, which then transports non-ionized nitrogen from muscle to the liver for processing (glucose-alanine cycle).

The activity of ALT is higher in the liver than in other tissues and in the dog, hepatic ALT is 10,000-fold higher than in plasma. Hepatic ALT activity is also high in cats, humans, and experimental rodent species in which measurement of serum ALT is used routinely in the assessment of hepatocellular injury. Hepatic ALT activity is lower in horses, cattle, sheep, and swine, and in these species, serum ALT is not measured routinely.

The activity of AST is high in the liver of all domestic species and the serum activity is used routinely in all for evaluation of liver cell injury. However, AST activity also is high in the kidney, heart, and skeletal muscle, so elevations in serum AST are considered less specific for liver disease than elevations in serum ALT.

There are differences in the intracellular distribution of ALT and AST within the hepatocyte. In the dog, most hepatic ALT and AST activity resides within the cytosol. An important fraction of AST (20%) and a lesser component of ALT are present within mitochondria (Keller, 1981). Distribution of the transaminases within the zones of the acinus also differs. ALT has the highest activity in Zone 1 hepatocytes, and AST has the highest activity in Zone 3 hepatocytes and the relative activity of ALT or AST in serum may reflect the acinar zone in which liver injury occurs (Rej, 1989).

The largest increases in serum ALT are observed with hepatocellular inflammation and necrosis. In such conditions, progressive decreases in ALT activity may be a sign of recovery, and a 50% or greater reduction in serum ALT activity over several days is considered a favorable prognostic sign. Some animals with severe hepatic disease, however, may have normal serum ALT activity, and declining serum ALT activity may represent a significant reduction in viable hepatocytes or reduction in transaminase synthesis (e.g., microcystins, aflatoxin).

Following severe, acute hepatocellular necrosis, in the dog serum ALT activity may increase by more than 100-fold within 24 to 48 h, peaking during the first 5 postinjury days. If the source of the injury is eliminated, ALT activity will return more gradually to normal within 2 to 3 weeks. Hepatotoxicity induced by acetaminophen is associated with marked increases in serum ALT followed by a return to near normal values within 72 h (Hjelle and Grauer, 1986; Ortega *et al.*, 1985). Acute hepatocellular necrosis associated with infectious canine hepatitis (adenovirus) results in increased plasma ALT activity of 30-fold, peaking within 4 days (Wigton *et al.*, 1976). Thereafter, a sustained increase in ALT activity may indicate development of chronic hepatitis.

In all domestic species, the activity of AST is high in the liver and serum activity characteristically is increased in acute and chronic liver injury. Because AST activity also is high in the muscle, kidney, pancreas, and erythrocytes, when cells of these tissues are damaged, the AST activity of serum also can be expected to be elevated. There is no

simple, specific, or direct method for determining the origin of increased serum AST activity, but additional laboratory tests may be useful. When AST is increased because of skeletal muscle disease including trauma (e.g., intramuscular injections) or degenerative disease, it may be useful to measure serum creatine kinase (CK). In muscle disease, AST and CK both are expected to be elevated. In acute muscle injury, elevation in the CK activity of serum may occur before AST is maximally elevated, and CK activity characteristically decreases before AST activity fully declines. When coincidental myopathy and liver disease occur in dogs and cats, measurement of serum ALT may be useful, but severe primary muscle disease is sometimes associated with increased serum ALT activity.

Transaminase activity is known to increase following vigorous exercise in dogs (Valentine *et al.*, 1990), but the origin of the enzyme is not clear (Bolter and Critz, 1974; Loegering and Critz, 1971). A 1.4- to 2-fold increase in plasma AST in dogs associated with increases in CK and lactic dehydrogenase has been observed after short-term exercise and similar increases in plasma AST and lactic dehydrogenase activity were detected following electrophysiological stimulation of hind limb muscles (Heffron *et al.*, 1976).

The results of measurement of the half-life of transaminases following intravenous injection of hepatic homogenates have varied widely. In one study, three dogs injected with a 20% liver homogenate and sampled over 3 days, the average  $T_{1/2}$  for AST was 263min and for ALT was 149min (Zinkl *et al.*, 1971). In another study, seven dogs received the supernatant of a liver homogenate intravenously, and a much longer time period was required for clearance with the  $T_{1/2}$  for ALT determined to be  $59 \pm 9$ h and for AST  $22 \pm 1.6$ h (Dossin *et al.*, 2005). The plasma  $T_{1/2}$  of AST in the cat has been estimated to be 77min (Nilkumhang and Thornton, 1979). Sustained elevations in transaminase in acute liver disease may be the result of delayed clearance. Catabolism of plasma transaminases, in part, is the result of endocytosis by hepatocytes, and enzyme clearance may be delayed because of the underlying hepatic disease (acquired portosystemic shunting, nodular regeneration, hepatic fibrosis; Horuichi *et al.*, 1985; Kamimoto *et al.*, 1985).

The major value of serum AST and ALT measurements is in detecting hepatocellular injury and monitoring clinical progress (Table 13-1). Because both enzymes are increased in a variety of hepatic diseases, they are of limited value for differential diagnosis. Although elevations of the aminotransferases are generally considered indicative of hepatocellular injury, in severe forms of liver disease, both hepatocellular and cholestatic forms of hepatic injury often coexist. The highest aminotransferase levels are associated with acute hepatitic injury, but more modest increases in aminotransferase activity are seen in chronic liver disease including chronic hepatocellular disease, cirrhosis, parasitic hepatopathy, and primary or metastatic neoplasia.

**TABLE 13-1** Serum Alanine Aminotransferase (ALT) Activity of Normal Animals

Species	U/liter	Reference
Dog	15–50	Crawford <i>et al.</i> (1985)
	2.5–25	Van Vleet and Alberts (1968)
	0–69	Abdelkader and Hauge (1986)
	20–45	Bunch <i>et al.</i> (1985)
	5–80	Johnson <i>et al.</i> (1982)
	3–61	Mia and Koger (1979)
Cat	0–36	Center <i>et al.</i> (1983a)
	10–80	Peterson <i>et al.</i> (1983)
	$16 \pm 9$	Meyer (1983)
	30 (1–59)	Mia and Koger (1979)
Minipig	$35 \pm 12$	Kroker and Romer (1984)
Pig	71 (37–106)	Mia and Koger (1979)

## 2. Sorbitol Dehydrogenase

Because of the relatively low ALT activity in the livers of large domestic species (Cornelius, 1963; Keller *et al.*, 1985), other liver-specific enzymes have been validated for clinical use. One of these, SDH, is a zinc metalloenzyme that is responsible for the conversion of sorbitol to fructose using  $NAD^+$  as a cofactor. SDH is one of the enzymes in the polyol pathway believed to have a central role in the pathogenesis of some of the complications of diabetes mellitus (Hoshi *et al.*, 1996; Lee *et al.*, 1995). SDH is found in abundance primarily in the liver and kidney, and the serum activity of SDH (Table 13-2) has been shown to be useful in assessment of hepatocellular injury in most domestic species including the dog (Noonan, 1981; Valentine *et al.*, 1990; Zinkl *et al.*, 1971), horses (Asquith *et al.*, 1980; Bortell *et al.*, 1983; Johnson *et al.*, 2006; Noonan, 1981), and ruminants (Kalaitzakis *et al.*, 2007). Clinically, SDH is used as a liver-specific enzyme primarily for the large domestic species. In dogs and cats, it appears to have no advantage over ALT (Center, 2006). SDH activity is not stable in serum and activity declines rapidly. Therefore, it is necessary to perform the assay for SDH as soon after the sample is taken as possible, optimally within 8 to 12h.

## 3. Arginase

Arginase is responsible for the terminal step of the urea cycle in which arginine is converted to urea and ornithine. In mammals, two isoforms of arginase exist, arginase type I and type II, which are encoded by different genes and differ in tissue distribution, intracellular location, and in molecular and immunochemical characteristics (Grody *et al.*, 1989; Jenkinson *et al.*, 1996). Arginase type I is a cytosolic enzyme (Ikemoto *et al.*, 1990) that is expressed primarily in the liver where it has a key role in urea synthesis. Arginase

**TABLE 13-2** Serum Sorbitol (Iditol) Dehydrogenase (SOH) Activity of Normal Animals

Species	U/liter	Reference
Dog	28 ± 20	Zinkl <i>et al.</i> (1971)
	5.5–18	Noonan and Meyer (1979)
	1–9	Abdelkader and Hauge (1986)
	0–6	Keller (1981)
	10 ± 3	Anwer <i>et al.</i> (1976)
Pony	14.7 ± 3.6	Anwer <i>et al.</i> (1976)
Calf	14.7 ± 1.3	Anwer <i>et al.</i> (1976)
Cow	4.3–15.4	Putnam <i>et al.</i> (1986)
Sheep	16.5 ± 1.5	Anwer <i>et al.</i> (1986)
	7.9 ± 2.3	Alemu <i>et al.</i> (1977)

type II is a mitochondrial enzyme that is expressed in most tissues including the kidney (Morris *et al.*, 1997; Shi *et al.*, 1998). Type II arginase appears to control the availability of the arginine used for nitric oxide synthesis (Gotoh and Mori, 1999) and has an important role in the synthesis of ornithine, which is a precursor of polyamines, glutamate, and proline (Jenkinson *et al.*, 1996).

Because the activity of arginase in liver is higher than in other organs (Aminlari and Vaseghi, 1992; Aminlari *et al.*, 2007), elevations in serum arginase activity have been considered to be liver specific (Cornelius *et al.*, 1963; Dittrich *et al.*, 1974) and a convenient assay has been validated for measurement (Mia and Koger, 1978). Following acute liver injury, serum arginase increases and then decreases rapidly (Aminlari *et al.*, 1994; Cornelius *et al.*, 1963). Sustained elevation in serum arginase activity suggests an unfavorable prognosis. Elevations in serum arginase have been demonstrated in naturally occurring liver disease of horses (Wolf *et al.*, 1967), cattle, sheep (Ross, 1966), goats, and dogs (Harvey and Hoe, 1971). When serum arginase and GGT activities are measured simultaneously, their respective specificities for hepatocellular injury and cholestasis can be useful (Noonan and Meyer, 1979).

#### 4. Glutamate Dehydrogenase

GD is a mitochondrial enzyme with a key role in the detoxification of ammonia. GD serves as an ammonia scavenger by catalyzing the amination of  $\alpha$ -ketoglutarate to form glutamate. Glutamate produced by GD is converted by mitochondrial AST to aspartate, which is urea synthesis. Glutamate also is used in the mitochondrial synthesis of N-acetylglutamate, the allosteric activator of carbamoyl phosphate synthase that is the enzyme responsible for the first step in urea synthesis (Caldovic and Tuchman, 2003; Caldovic *et al.*, 2006; Nissim *et al.*, 2003).

**TABLE 13-3** Serum Glutamic Dehydrogenase (GD) Activity of Normal Animals

Species	U/liter	Reference
Dog	0–9	Abdelkader and Hauge (1986)
	1–6	Keller (1981)
	0–1.2	Freedland <i>et al.</i> (1965)
Sheep	0–9	Alemu <i>et al.</i> (1977)
	2.6 ± 1.0	Harvey and Obeid (1974)
Goat	3.4 ± 0.9	Harvey and Obeid (1974)

GD has been shown to be useful in the assessment of hepatic necrosis in sheep, goats, and cattle (Table 13-3). GD activity is highly concentrated in ovine and bovine liver (Keller, 1971) as well as in the liver of other domestic species (Keller *et al.*, 1985). Elevated GD activity has been reported in ruminants with hepatic necrosis (Fowler, 1971), associated with parturition (Treacher and Collis, 1977) and with obstruction of the bile duct (Ford and Gopinath, 1976).

#### 5. Ornithine Carbamoyltransferase

OCT catalyzes the reaction between ornithine and carbamoyl phosphate forming citrulline and inorganic phosphate. The enzyme is located in mitochondria and functions as a part of the urea cycle. OCT is considered a liver-specific enzyme for the detection of hepatocellular necrosis in domestic species (Treacher and Sansom, 1969). Nearly all OCT activity is confined to the liver of cattle (Treacher and Collis, 1977) and of pigs (Dittrich *et al.*, 1974). OCT and ALT are similar in sensitivity as diagnostic tests for hepatic necrosis in the dog. A similar association of OCT with hepatocellular injury has been observed in swine (Wilson *et al.*, 1972), and Markiewicz *et al.* (1975) have reported that serum OCT activity is correlated with the severity of hepatic fascioliasis in cattle.

#### 6. Serum Alkaline Phosphatase

The APs are a group of zinc metalloenzymes that are present in most tissues. High concentrations are found in the intestine, kidney, bone, and liver. Light and electron microscopic studies have demonstrated that alkaline phosphatase activity is highest on the absorptive or secretory surfaces of cells (Kaplan, 1972). Within liver cells, alkaline phosphatase is bound to membranes and AP activity sediments with the microsomal and plasma membrane fractions (Emmelot *et al.*, 1964).

The actual physiological functions of alkaline phosphatase are not fully understood. Localization of the enzyme to cell surfaces known to be responsible for active absorption or secretion suggests a role in membrane transport. There is evidence suggesting that the alkaline phosphatase of

**TABLE 13-4** Total Serum Alkaline Phosphatase (AP) Activity of Normal Adult Animals

Species	U/liter	Reference
Dog	39–222	Abdelkader and Hauge (1986)
	30.6 ± 9.9	Meyer and Noonan (1981)
	10–82	Bunch <i>et al.</i> (1982)
Cat	8 ± 0.7	Spano <i>et al.</i> (1983)
	10–80	Peterson <i>et al.</i> (1983)
	8.4 ± 2.9	Meyer (1983)
	1–39	Center <i>et al.</i> (1986)
Horse	184 ± 57	Gossett and French (1984)
Cow	41 ± 16	Rico <i>et al.</i> (1977b)
	7–43	Putnam <i>et al.</i> (1986)
	2–809	Allcroft and Folley (1941)
Sheep	91 ± 41	Braun <i>et al.</i> (1978b)
	63 ± 28	Alemu <i>et al.</i> (1977)
	21–1178	Allcroft and Folley (1941)
	35–234	Leaver (1968)
Pig	100 ± 35	Rico <i>et al.</i> (1977c)
	<27	Van Leenhoff <i>et al.</i> (1974)
Minipig	49 ± 11	Kroker and Romer (1984)

osteoblasts may be involved in bone calcification. Activity against both natural and synthetic nucleotides suggests a role in nucleic acid metabolism.

In normal animals, the AP of serum (Table 13-4) originates primarily from liver and bone (Hoffman and Dorner, 1975; Rogers, 1976). Elevations of serum AP are observed in normal growing animals or in adult animals with increased osteoblastic activity. Serum AP activity may be elevated in acute and chronic liver diseases. More marked elevations indicate cholestasis, with the highest serum AP activities observed in animals with cholangitis, biliary cirrhosis, or extrahepatic bile duct obstruction.

The isozymes of alkaline phosphatase from various tissues may be differentiated on the basis of differences in heat stability, urea denaturation, inhibition by L-phenylalanine, or by electrophoretic mobility (Nagode *et al.*, 1969a, 1969b; Ruegnitz and Schwartz, 1971). Alternatively, the origin and significance of elevated serum AP may be determined by measuring other related serum enzymes that are specific for biliary tract disease. These include leucine aminopeptidase (Everett *et al.*, 1977), 5'NT (Righetti and Kaplan, 1972), and GGT. When serum AP is significantly elevated, overt clinical signs may allow separation of diseases of the liver from those of tissues such as bone.

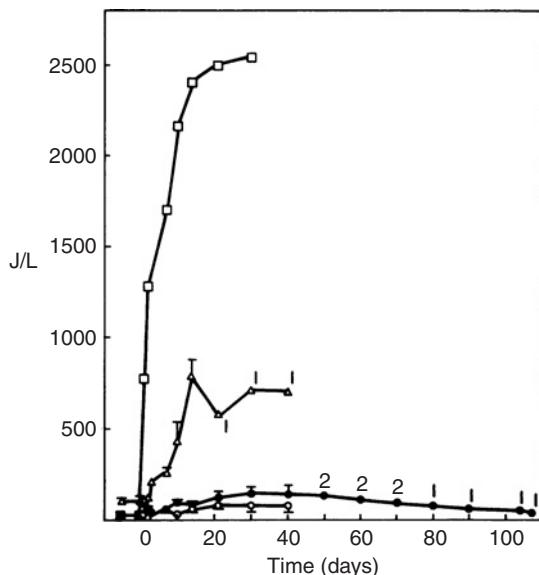
Unlike serum AST and ALT, elevations in AP are not due simply to leakage of enzyme from damaged cells. It was once believed that the high AP level of serum observed in cholestatic liver disease was the result of decreased biliary excretion of the enzyme because bile contains a great

deal of AP activity. It now is known that experimental obstruction of bile flow stimulates *de novo* synthesis of hepatic AP (Kaplan and Righetti, 1969, 1970), and the newly synthesized enzyme is refluxed into the circulation. Partial hepatectomy also stimulates increased synthesis of AP in the regenerating liver (Pekarthy *et al.*, 1972). It seems likely that increased synthesis of AP is involved in clinical extrahepatic bile duct obstruction, in intrahepatic cholestasis, in infiltrative diseases of the liver (e.g., lymphoma, hepatic metastases) in which terminal branches of the biliary tree may be obstructed, and in the regenerative processes that occur following liver injury.

There are significant species differences in the magnitude of elevation of serum AP activity in bile duct obstruction (Fig. 13-2). It has been recognized that cats differed from dogs because in cases of extrahepatic bile duct obstruction in cats there was inconsistent or negligible elevation of AP. This was thought to be due to urinary excretion of AP. Other studies have established that cholestatic liver disease in cats can be expected to cause modest but significant elevations in AP (Everett *et al.*, 1977), and induction of alkaline phosphatase synthesis following bile duct obstruction occurs in cats as it does in other species (Sebesta *et al.*, 1964).

In dogs, three AP isoenzymes (intestinal, steroid induced, and hepatic) have been identified (Wellman *et al.*, 1982b). Two genes appear to be responsible for AP production in dogs (Hoffmann and Dorner, 1977; Solter and Hoffmann, 1995, 1999). The first is the AP gene responsible for the AP isoforms of the liver, bone, and kidney in which differences in posttranslational processing are responsible for differences in glycosylation patterns (Solter and Hoffmann, 1995). The second gene codes for intestinal AP and is specific for the AP isoenzyme of the intestinal mucosa (Solter and Hoffmann, 1995). AP can be induced in dogs, but not in cats, by endogenous or exogenous steroidogenic hormones and the steroid-induced isoenzyme is of hepatic origin (Wellman *et al.*, 1982a). Increased serum activity of the hepatic AP isoenzyme in cholestasis is due to enhanced translation and not to increased gene expression (Seetharam *et al.*, 1986). Hepatic AP enters the serum either from the biliary canaliculus via the paracellular shunt pathway or is derived directly from plasma membranes. Increased bile acid concentrations associated with cholestasis are believed to contribute to the release and transport of solubilized hepatic AP to the serum (Everett *et al.*, 1977; Sanecki *et al.*, 1987, 1990; Schlaeger *et al.*, 1982).

Although measurement of serum GGT activity has the advantage of specificity, total serum AP activity remains the test most often performed in the assessment of cholestasis in horses, dogs, and cats. Serum AP is less valuable in the evaluation of cholestatic syndromes of cattle and sheep because of wide fluctuations in normal AP activity (Ford, 1958; Harvey and Hoe, 1971).



**FIGURE 13-2** Comparative changes in serum alkaline phosphatase activity associated with bile duct obstruction in sheep, cats, horses, and dogs. Symbols: ●, ovine (5); ○, feline (6); △, equine (3); □, canine (2). Courtesy of Dr. D. Levy.

Increases in serum AP have been described in a variety of canine cholestatic liver diseases (Abdelkader and Hauge, 1986; Center *et al.*, 1985b; Hoe and Jabara, 1967; Solter and Hoffmann, 1995, 1999). Modest increases in serum AP occur with hepatic necrosis (Noonan and Meyer, 1979). Following the experimental production of hepatic necrosis in dogs, the serum activities of arginase, ALT, and AP increase within 1 day, a time point at which GGT is not elevated. Following bile duct obstruction, the serum activity of both AP and GGT increases remarkably along with moderate elevations in ALT and AST, but arginase activity does not increase. This has suggested that arginase (for necrosis) and GGT (for cholestasis) may have the highest specificity in evaluating the type of hepatobiliary disease in the dog (Noonan and Meyer, 1979). Although serum GGT activity may be less affected during hepatocellular necrosis than AP, GGT activity may not be as highly elevated as AP in bile duct obstruction (Guelfi *et al.*, 1982).

### 7. $\gamma$ -Glutamyltranspeptidase

GGT is a membrane-bound enzyme that catalyzes the transfer of  $\gamma$ -glutamyl groups from  $\gamma$ -glutamylpeptides such as glutathione to other amino acids or peptides. Glutathione and glutathione conjugates are the most abundant physiological substrates (Hanigan, 1998). GGT is found primarily in cells with high rates of secretion or absorption, and significant GGT activity is present in the liver, kidney, pancreas, and intestine. GGT is considered a serum marker primarily for diseases of the hepatobiliary system associated with cholestasis (Table 13-5; Braun *et al.*, 1983)

**TABLE 13-5** Serum  $\gamma$ -Glutamyltransferase (GGT) Activity of Normal Animals

Species	U/liter	Reference
Dog	11 $\pm$ 10	Guelfi <i>et al.</i> (1982)
	0–11	Abdelkader and Hauge (1986)
	0–10	Shull and Hornbuckle (1979)
	<5	Bunch <i>et al.</i> (1985)
	2–4	Bunch <i>et al.</i> (1982)
	3 $\pm$ 1	Meyer and Noonan (1981)
Cat	0.4 $\pm$ 0.3	Center <i>et al.</i> (1986)
	0.3 $\pm$ 0.2	Meyer (1983)
Horse	4.5–32.5	Yamaoka <i>et al.</i> (1978)
	13 $\pm$ 6	Rico <i>et al.</i> (1977a)
	6–24	Braun <i>et al.</i> (1982)
Cow	19 $\pm$ 6	Rico <i>et al.</i> (1977b)
	6–17	Keller (1978)
	1 $\pm$ 5	Unglaub <i>et al.</i> (1973)
Calf	15 $\pm$ 4	Braun <i>et al.</i> (1978a)
Sheep	33 $\pm$ 7	Braun <i>et al.</i> (1978b)
	17–69	Towers and Stratton (1978)
	23 $\pm$ 5	Malherbe <i>et al.</i> (1977)
Goat	27 $\pm$ 3	Moursi <i>et al.</i> (1979)
Pig	35 $\pm$ 21	Rico <i>et al.</i> (1977c)
Piglet (8 weeks)	16 $\pm$ 8	Enigk <i>et al.</i> (1976)

and is in general used for the diagnosis of liver diseases of animals (Table 13-6). GGT activity is relatively high in the livers of cows, horses, sheep, and goats, but GGT activity is considerably lower in the livers of dogs and cats. Although activity is present in many tissues and is high in the kidney, remarkable elevations in serum GGT activity are observed primarily in diseases of the liver. Urinary excretion of GGT, however, has been measured to assess renal injury (Ford, 1974; Shaw, 1976).

In experimental bile duct obstruction, serum GGT activity is increased significantly in the dog (Noonan and Meyer, 1979; Shull and Hornbuckle, 1979), sheep (Ford, 1974), and cattle. The sensitivity of GGT has been reported to be similar to that of AP as an indicator of cholestasis in the cat (Spano *et al.*, 1983; Zawie and Garvey, 1984). Within a given species, there often is a direct relationship between the activities of serum GGT and serum AP in cholestatic liver injury. In primary hepatocellular disease, elevations in GGT characteristically are not increased as remarkably as AP (Meyer, 1983).

Acute exposure to oxidative stress increases GGT transcription, indicating that expression is an adaptive response protecting the cell from oxidative injury. Although increased enzyme synthesis contributes to elevated serum GGT activity in hepatocellular injury, elevations in cholestatic disorders are believed to be, in part, related to

**TABLE 13-6** Serum  $\gamma$ -Glutamyltransferase (GGT) Activity in Animals with Hepatobiliary Diseases

Species	Condition	References
Dog	Bile duct obstruction; chronic hepatitis Lipidosis; necrosis; cirrhosis; neoplasia Corticoid therapy	Braun <i>et al.</i> (1983) Hauge and Abdelkader (1984) De Novo and Prasse (1983)
Cat	Bile duct obstruction; cholangiohepatitis; cirrhosis; lymphosarcoma; necrosis	Center <i>et al.</i> (1986)
Horse	Toxic hepatic failure Subclinical hepatopathy Hyperlipemia	Divers <i>et al.</i> (1983) Yamaoka <i>et al.</i> (1978) Wensing <i>et al.</i> (1973)
Cow	Ragwort poisoning; fascioliasis lipidosis Fascioliasis metacercariae migrations and chronicity Metacercariae migrations Senecio poisoning	Blackshaw (1978) Simesen <i>et al.</i> (1973) Bulgin and Anderson (1984) Johnson and Molyneux (1984)
Sheep	Bile duct obstruction; sporidesmin; toxicity; fascioliasis Lupinosis Cobalt deficiency (white liver disease) Ketosis	Ford and Evans (1985) Malherbe <i>et al.</i> (1977) Sutherland <i>et al.</i> (1979) Meissonier and Rousseau (1976)
Pig	Cysticercus tenuicollis infection Arsanilic acid toxicity	Enigk <i>et al.</i> (1976) Ferslew and Edds (1979)

mobilization (“solubilization”) of GGT from its membrane anchor related to elevated levels of bile salts (Center, 2007).

Highest tissue levels of GGT in the dog and cat are present in the kidney and pancreas with lesser amounts in the liver, gallbladder, intestines, spleen, heart, lungs, skeletal muscle, and erythrocytes (Badylak *et al.*, 1982; Braun *et al.*, 1983; Guelfi *et al.*, 1982). The activity of GGT in serum is derived primarily from the liver although, as stated previously, there is considerable species variation in GGT activity within this organ. Hepatic localization has been demonstrated in the canaliculus, in bile ducts, and in Zone 1 hepatocytes (Aronsen *et al.*, 1968; Braun *et al.*, 1983; Center, 2005).

The diagnostic value of GGT has been assessed in clinical patients with and without liver disease (Center *et al.*, 1986, 1992; Guelfi *et al.*, 1982). Experimental studies in dogs and cats undergoing acute, severe diffuse necrosis have shown either no change in serum GGT or only mild increases in activity (1- to 3-fold normal) that resolve over the ensuing 10 days. In the dog, extrahepatic bile duct obstruction causes serum GGT activity to increase 1- to 4-fold within 4 days, and 10- to 50-fold within 1 to 2 weeks. Thereafter, values may plateau or continue to increase as high as 100-fold that of normal (Guelfi *et al.*, 1982; Kokot *et al.*, 1965; Noonan and Meyer, 1979). In the cat with extrahepatic bile duct obstruction, serum GGT

activity may increase up to 2-fold within 3 days, 2- to 6-fold within 5 days, and 4- to 16-fold that of normal within 2 weeks (Meyer, 1983; Spano *et al.*, 1983).

Glucocorticoids and certain other microsomal enzyme inducers may stimulate production of GGT in the dog similar to the influence of such drugs or other xenobiotics on AP. Administration of dexamethasone (3mg/kg SID) or prednisone (4.4 mg/kg SID IM) increased GGT activity within 1 week 4- to 7-fold and up to 10-fold within 2 weeks (Badylak and Van Vleet, 1981, 1982; Stein *et al.*, 1989). It is assumed that the increased production of GGT following glucocorticoid administration originates in the liver. In comparison to glucocorticoid induction, dogs treated with the anticonvulsants phenytoin or primidone develop only modest increases in serum GGT activity up to 2- or 3-fold that of normal unless they develop serious anticonvulsant hepatotoxicosis (Bunch *et al.*, 1985, 1987).

Some cats with advanced necroinflammatory liver disease, major bile duct obstruction, or intrahepatic cholestasis develop relatively greater increases in GGT than in AP activity (Center *et al.*, 1986). In other species, cholestasis is known to enhance enzyme synthesis as well as membrane release of GGT. It remains undetermined whether glucocorticoids or other enzyme inducers increase the expression of GGT in cats. It is noteworthy that the normal range for feline serum GGT activity is narrower and lower than that of the dog, so the interpretation of feline GGT activity

using the canine reference range will lead to erroneous conclusions. Additionally, because of the comparatively low serum GGT activity of cats, assay sensitivity may be a problem and low GGT activity may be undetectable.

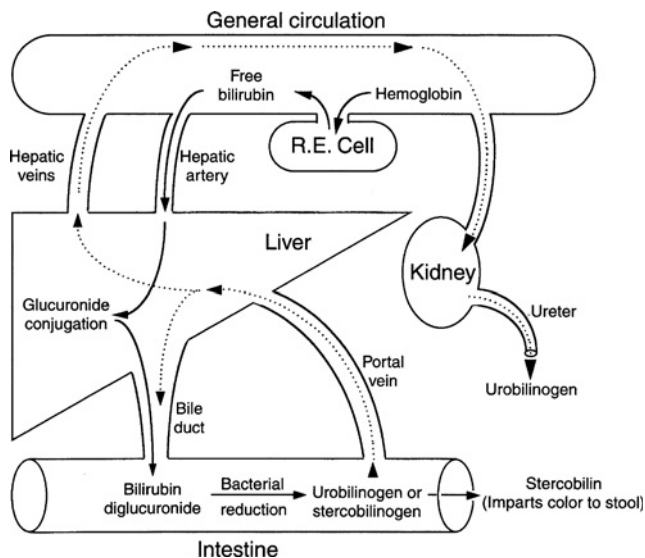
Remarkable elevations of serum GGT have been observed in dogs and cats with primary hepatic or pancreatic neoplasia. Although a unique GGT isozyme is associated with hepatocellular carcinoma in humans, it has not been determined that a similar phenomenon occurs in dogs or cats. In humans, GGT also is used in surveillance for hepatic metastasis but is not suitable for this application in either the dog or the cat.

Neonatal animals of several species develop elevated levels of serum GGT activity following the ingestion of colostrum. In neonatal calves, the direct relationship between serum GGT activity and immune globulin levels allows serum GGT activity to serve as a surrogate for successful passive immune transfer (Parish *et al.*, 1997; Perino *et al.*, 1993). Similar transient neonatal elevations of serum GGT are observed following ingestion of colostrum by neonatal lambs (Maden *et al.*, 2003; Tessman *et al.*, 1997), crias (Johnston *et al.*, 1997), and pups (Center *et al.*, 1991b) but apparently not kittens (Crawford *et al.*, 2006; Levy *et al.*, 2006).

## B. Serum Bilirubin

Bilirubin in serum is measured by the van den Bergh or “diazo” reaction in which bilirubin is coupled with diazotized sulfanilic acid. Azo pigments produced by this reaction are dipyrroles that are stable, and this characteristic has been useful in studies of the structure of bilirubin conjugates. Conjugated bilirubin, which is water soluble, reacts promptly with diazotized sulfanilic acid in aqueous solution (the van den Bergh “direct reaction”), but unconjugated bilirubin reacts slowly. Only after addition of an accelerator such as methanol or ethanol to the aqueous solution can the diazo reaction with unconjugated bilirubin be completed (“the indirect reaction”). It is said that approximately 10% of the unconjugated bilirubin in plasma can react with the diazo reagent giving a false “direct” reaction.

The requirement of an organic solvent for the diazo reaction with unconjugated bilirubin to occur suggests the delay was related to water insolubility. There is evidence, however, that intramolecular hydrogen bonding may be more important than aqueous solubility in determining the reaction of unconjugated bilirubin with the diazo reagent (Fog and Jellum, 1963; Nichol and Morrell, 1969). The two propionic acid side chains of bilirubin that are esterified with glucuronic acid or other carbohydrates disrupt intramolecular hydrogen bonding (Fog and Jellum, 1963) and allow the direct diazo reaction to occur. Accelerators of the *van den Bergh* reaction may have a similar effect

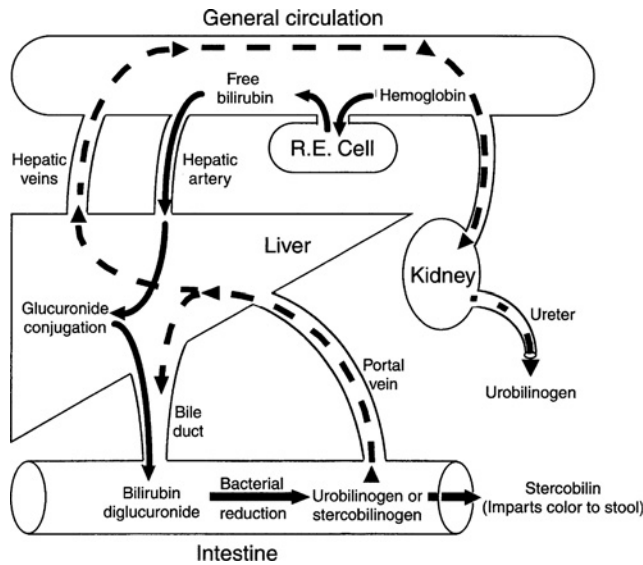


**FIGURE 13-3** Normal formation, excretion, and enterohepatic circulation of bilirubin and other bile pigments.

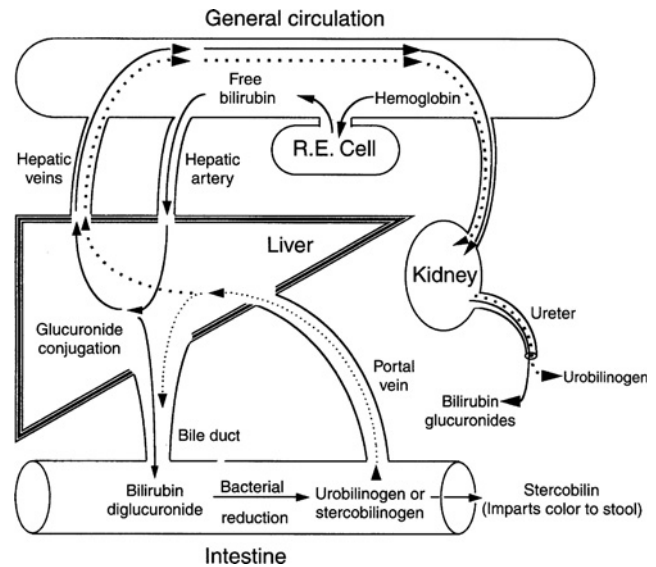
on the intramolecular hydrogen bonds of unconjugated bilirubin.

The following is a discussion of the physiologic mechanisms of bilirubin conjugation and interpretation of the Van den Bergh reaction. There are limitations in clinical application, however, because of differences that exist in duration and severity between the spontaneous liver diseases of domestic animals and experimental liver disease models. Figure 13-3 summarizes the normal production and excretion of bilirubin and other bile pigments. Unconjugated hyperbilirubinemia is observed when there is increased production of bilirubin (e.g., hemolytic anemia) or when either hepatic uptake or conjugation of bilirubin is diminished. Although the unconjugated bilirubin of serum may be significantly increased in such disorders, essentially none of the albumin bound unconjugated bilirubin is filtered by the glomerulus. Consequently, bilirubinuria is not characteristic in animal patients with unconjugated hyperbilirubinemia. In hemolytic disease, the amount of bilirubin excreted by the liver and, therefore, the amount that reaches the intestine may be remarkably increased. This results in increased formation and urinary excretion of urobilinogen (Fig. 13-4).

Hyperbilirubinemia of the conjugated type is caused either by intrahepatic cholestasis (Fig. 13-5) or extrahepatic bile duct obstruction (Fig. 13-6). When the primary defect is impaired excretion of bilirubin into bile, hepatic uptake and conjugation may proceed at a relatively normal rate, but conjugated bilirubin is effluxed into the plasma. The plasma concentration of conjugated bilirubin increases, and the conjugated pigment, which is less avidly bound to albumin, is readily filtered by the glomerulus, resulting in bilirubinuria (Fulop *et al.*, 1965; Laks *et al.*, 1963). Because bilirubin excretion into the intestine is either significantly reduced or absent in cholestasis, formation of urobilinogen



**FIGURE 13-4** Formation, excretion, and enterohepatic circulation of bilirubin and other bile pigments associated with overproduction of bilirubin as a result of hemolysis.



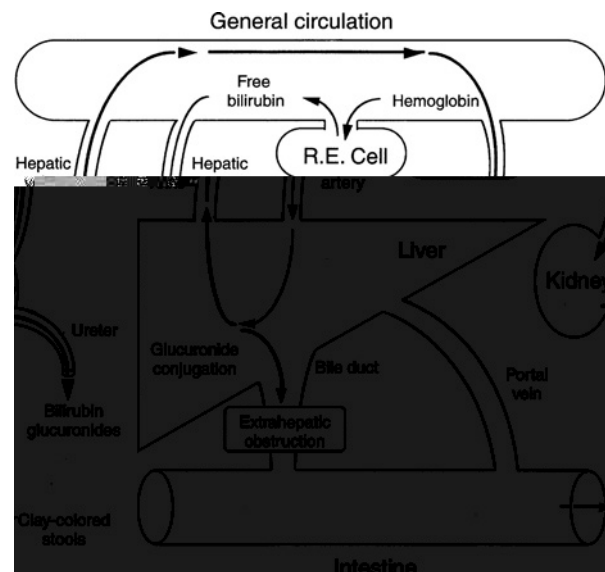
**FIGURE 13-5** Formation, excretion, and enterohepatic circulation of bilirubin and other bile pigments associated with hepatocellular injury and intrahepatic cholestasis.

by intestinal bacteria is remarkably reduced, and the test for urinary urobilinogen is characteristically negative in complete extrahepatic obstruction (Fig. 13-6). The therapeutic administration of oral, broad-spectrum antibiotics to patients may diminish the metabolic activity of intestinal bacteria and result in a spuriously negative test for urobilinogen in the urine in the absence of cholestasis.

The biochemical differentiation between unconjugated and conjugated hyperbilirubinemia using the van den Bergh reaction can be useful in the assessment of prehepatic or posthepatic causes of hyperbilirubinemia. In severe primary hepatic diseases of varying cause, the excretory steps of uptake, conjugation, and excretion all may be deranged and result in elevations of both conjugated and unconjugated pigment.

Important species characteristics should be considered when interpreting results of the van den Bergh reaction. In general, the interpretation in dogs and cats is similar. Typically, in cholestatic disease, the conjugated fraction is elevated, representing 50% to 75% of the total serum bilirubin (Fig. 13-7). The normal horse has a much higher total serum bilirubin than any of the other domestic species (Fig. 13-8), and values as high as 4.0 mg/dl or higher have been observed in otherwise healthy individuals. In addition to hepatic and hemolytic diseases, hyperbilirubinemia is observed in horses with intestinal obstruction and in a variety of other serious systemic diseases. Food restriction alone causes an abrupt increase in the unconjugated serum bilirubin of the horse (Gronwall and Mia, 1972; Tennant *et al.*, 1975), and decreased bile flow is a probable factor of the hyperbilirubinemia observed in fasting horses (Fig. 13-9).

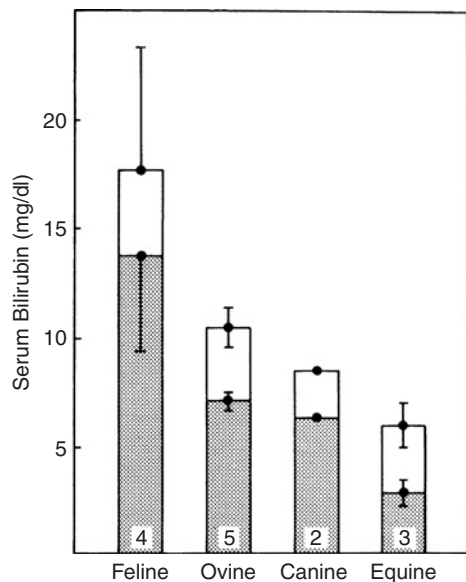
In cattle and sheep, hyperbilirubinemia of sufficient magnitude to produce clinical icterus ( $\geq 3\text{mg/dl}$ ) is caused



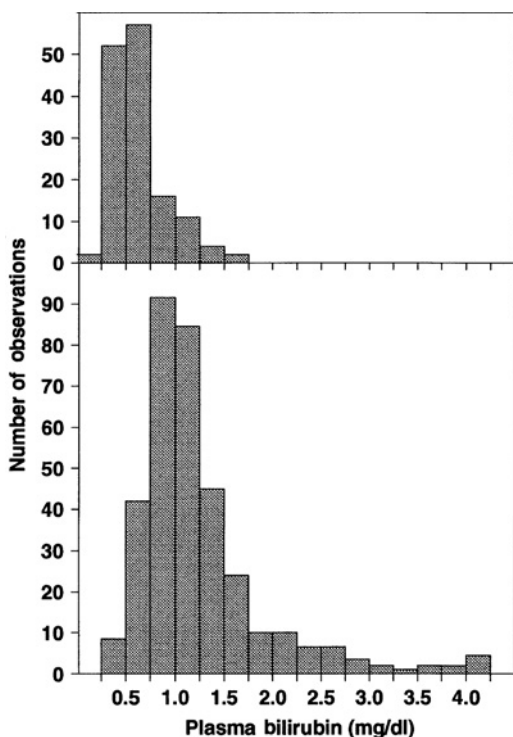
**FIGURE 13-6** Formation, excretion, and enterohepatic circulation of bilirubin and other bile pigments in extrahepatic bile duct obstruction.

most frequently by hemolytic disease. Biochemical hyperbilirubinemia (1 to 2mg/dl) without clinical icterus may be observed in sheep and in cattle with fatty liver associated with ketosis/acetonemia, and in such cases, the predominant pigment is unconjugated bilirubin. Greater elevations in serum bilirubin and clinical icterus in ruminants associated with fatty liver and ketosis are unusual. Mild to moderate conjugated hyperbilirubinemia has been observed in sheep with sclerosing cholangitis caused by *Fasciola hepatica* infestation (Hjerpe *et al.*, 1971) and in cattle with hepatic cirrhosis (Finn and Tennant, 1974).





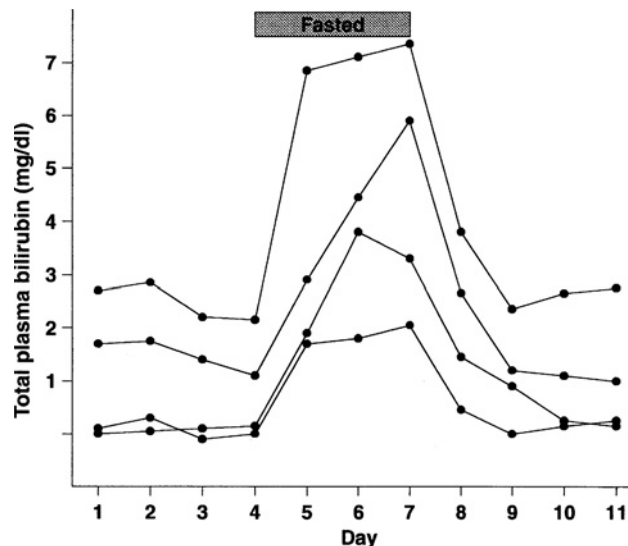
**FIGURE 13-7** Comparative changes in total and conjugated (“direct reacting”) serum bilirubin 14 days following complete experimental bile duct obstruction in cats, sheep, dogs, and horses. Shaded portion of bar: direct reacting; bar height: total. Courtesy of Dr. D. Levy.



**FIGURE 13-8** Total serum bilirubin concentrations of 23 normal Shetland ponies (upper; 143 observations) and 103 normal standard-sized horses (lower; 345 observations). Note the higher median values of standard-sized horses and the wide range of values in clinically healthy adults.

### C. Serum Bile Acids

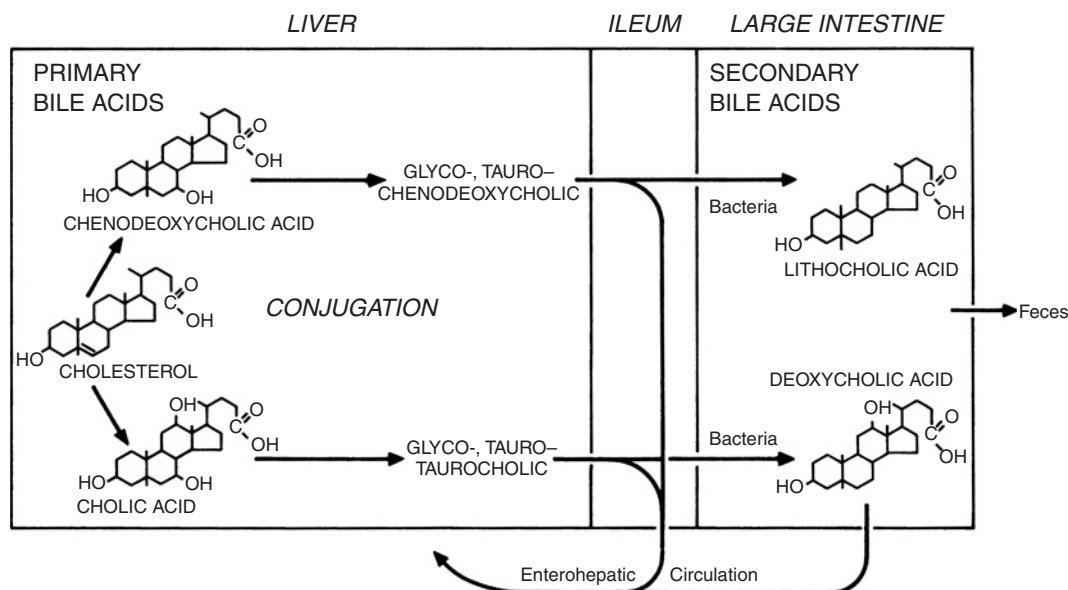
Synthesis of the primary bile acids is the principal pathway for catabolism of cholesterol. Multiple enzymatic



**FIGURE 13-9** Serum bilirubin of horses before, during, and following a 3-day period of total fasting.

steps are required for hepatic synthesis of the primary bile acids of most species, cholic acid and, chenodeoxycholic acid (Fig. 13-10). In swine, hyocholic acid is derived in the liver from chenodeoxycholic acid and is the major primary bile acid of swine. The classic pathway of bile acid synthesis is initiated by the liver-specific enzyme, cholesterol  $7\alpha$ -hydroxylase (CYP7A1), which converts cholesterol to  $7\alpha$ -hydroxycholesterol. This is the initial, rate-limiting step in the synthesis of cholic acid. Alternate pathways are recognized that are initiated by (1) sterol  $27$ -hydroxylase (CYP27), an enzyme expressed in the liver and in multiple other tissues; (2) cholesterol  $25$ -hydroxylase that is present in the heart, lung, and kidney; or (3) cholesterol  $24$ -hydroxylase (CYP46) that is present primarily in the brain. Oxysterols produced by these three enzymes are transported by the circulation to the liver where  $25$ - and  $27$ -hydroxycholesterol are hydroxylated further by an oxysterol  $7\alpha$ -hydroxylase (CYP7B1) and where  $24$ -hydroxycholesterol is hydroxylated by another  $7\alpha$ -hydroxylase (CYP39A1). The  $7\alpha$  steroids produced by the alternate pathways are preferentially utilized as precursors of chenodeoxycholic acid (Beigneux *et al.*, 2002). In knockout mice in which the CYP7A1 gene is missing (CYP7A1 $^{-/-}$ ), CYP7A1 activity was not detectable, but total oxysterol  $7\alpha$ -hydroxylase activity in CYP7A1 $^{-/-}$  mice was similar to that of controls. Bile acid synthesis in CYP7A1 $^{-/-}$  mice was remarkably reduced and total bile acid secretion was diminished. Because oxysterol  $7\alpha$ -hydroxylase activity was not elevated in CYP7A1 $^{-/-}$  mice, the results suggested that in normal mice the alternate pathway may account for as much as 40% of total bile acid synthesis (Schwarz *et al.*, 1998).

Following synthesis, primary bile acids are conjugated either with taurine or glycine and transported across the bile canalicular membrane primarily by the bile salt export



**FIGURE 13-10** Metabolism of bile acids in the liver and intestinal tract. The primary bile acids are formed in the liver and the secondary bile acids in the large intestine.

pump (BSEP, Sister of P-glycoprotein [Spgp], ABCB11) a multidrug resistance P-glycoprotein that belongs to the ATP-binding cassette (ABC) superfamily of transport proteins. The sodium and ATP-mediated BSEP carrier determines the bile salt dependent fraction of canalicular bile flow. The important bile salt independent fraction of bile flow is determined by canalicular MrP2 which is responsible for transport of glutathione, glutathione conjugates, and conjugates of glucuronic acid including bilirubin glucuronide. In the dog, horse, and sheep, taurine conjugates of bile acids predominate, and in the cat, bile acids are conjugated exclusively with taurine. In cattle, the bile is rich in taurine conjugated bile acids and contains glycine conjugates of chenodeoxycholate and deoxycholate (Haslewood, 1967). Bile acids are transported from the canaliculus through bile ducts to the lumen of the duodenum. In the duodenum and jejunum, bile acids have an important role in the digestion and absorption of dietary fat and other lipids including fat-soluble vitamins.

In the terminal ileum, almost all of the bile acids secreted by the liver are absorbed by highly efficient transport mechanisms of the ileal epithelium and enter the hepatic portal vein (the enterohepatic circulation; see Chapter 14). Normally, only a small fraction (5%) of the bile acids that enter the duodenum reach the large intestine where bacteria are responsible for deconjugation and for the formation of secondary bile acids by dehydroxylation. Dehydroxylation of cholic acid at the  $7\alpha$  position results in formation of deoxycholic acid, and  $7\alpha$  dehydroxylation of chenodeoxycholic acid results in production of lithocholic acid. The secondary bile acids formed in the large intestine may be absorbed and return to the liver by the enterohepatic circulation or excreted in the feces.

Taurocholate is the major bile acid of mice and rats. These species have the unique capacity to rehydroxylate deoxycholate at the C- $7\alpha$  position in the liver to reform cholic acid (Haslewood, 1967). The entire bile acid pool passes from the liver to the intestine and back to the liver via the enterohepatic circulation several times each day and under steady state conditions, approximately 5% of the bile acid pool is lost and replaced by hepatic synthesis.

The primary and secondary bile acids are transported to the liver via the hepatic portal vein and are transferred across the sinusoidal (basolateral) cell membrane of the hepatocyte by the NTCP, which is responsible primarily for the absorption of conjugated bile acids or by the sodium-independent OATP. Following entry, unconjugated bile acids are conjugated with taurine or glycine, are bound to cytosolic bile acid binding proteins, and finally are transferred actively across the bile canaliculus by the BSEP. Cholestasis may be caused by drugs that inhibit BSEP and by hereditary defects of BSEP that prevent BSEP expression and result in severe progressive familial intrahepatic cholestasis in which the bile contains almost no bile acids (Alrefai and Gill, 2007).

The canalicular Mrp2 transporter, which has a primary role in the excretion of bilirubin conjugates, BSP, and a wide range of glutathione, glucuronic acid, and sulfate conjugates (see Section III.A.2), mediates the canalicular transport of bile acid conjugates of sulfate or glucuronic acid but lacks the capacity to transport monovalent bile acids (Ito *et al.*, 2001; Trauner and Boyer, 2003). The canaliculus also contains the multidrug resistance 2 P-glycoprotein (Mdr2), which is responsible for the transport of cholesterol and phospholipids into bile. Defects in the Mdr2 gene product or the absence of Mdr2 in the canaliculus results in

cholestatic liver injury and in susceptibility to development of hepatocellular carcinoma (Mauad *et al.*, 1994). Finally, Mdr1 that is present in the canalculus is responsible for transport of organic cations (Trauner and Boyer, 2003).

In cholestasis, bile acids may accumulate in hepatocytes and their toxicity may cause cell death (Webster *et al.*, 2002; Webster and Anwer, 1998, 2001). In cholestatic syndromes, expression of the multidrug resistance-associated protein 3 (Mrp3), another ABC transporter located in the sinusoidal plasma membrane, is increased. Mrp3 has broad affinity for organic anions, has the capacity to excrete both mono- and divalent bile acids (Hirohashi *et al.*, 2000; Ito *et al.*, 2001), and is believed to compensate for impaired function of BSEP or Mrp2 in cholestatic syndromes (Bohan *et al.*, 2003; Chen *et al.*, 2007).

In liver disease, synthesis of primary bile acids may be decreased, the proportions of cholic acid and chenodeoxycholic acid may be altered, or unusual bile acids may be produced. Removal of bile acids from the hepatic portal vein may be diminished by impaired hepatocellular function or by vascular shunts, which divert portal blood from the liver vasculature to the peripheral circulation. This is particularly noticeable after meals in animals with congenital or acquired hepatoportal shunts. The plasma bile acid concentration is increased continuously in biliary obstruction and, characteristically, urinary excretion of bile acids is increased. Increases in the serum bile acid concentration are seen in many forms of hepatic disease.

The measurement of total serum bile acids for assessment of liver disease has been greatly facilitated by development of a spectrophotometric assay that has now been validated for use in most domestic species. The predictive value of the serum bile acid test is remarkably high in the dog (Center, 1993; Center *et al.*, 1984, 1991a). In dogs with portocaval vascular shunts, the fasting serum bile acid concentration may be within normal limits but is increased diagnostically 2h following a meal (Center *et al.*, 1985a). Serum bile acid concentrations  $\leq 20$   $\mu\text{M/L}$  in cats and  $\leq 25$   $\mu\text{M/L}$  in dogs are predictive of significant histopathological abnormalities of the hepatobiliary system or of portosystemic vascular anastomoses (Center *et al.*, 1991a, 1995).

The serum bile acid concentration has been used to assess clinical hepatic function in cattle (Craig *et al.*, 1992; Garry *et al.*, 1994; Pearson *et al.*, 1992; West, 1991) and in horses (Barton and LeRoy, 2007; Durham *et al.*, 2003; McGorum *et al.*, 1999). In the horse, fasting alone has been reported to increase the plasma bile acid concentration by decreasing hepatic clearance (Engelking and Gronwall, 1979), so in the horse it is necessary to consider food intake when interpreting the serum bile acid values.

#### D. Serum Proteins

The liver is the exclusive site of synthesis of albumin, the most abundant of the plasma proteins. Unlike most plasma

proteins, which are glycoproteins, albumin contains no carbohydrate. Degradation of albumin occurs in the liver and in other tissues including muscle, kidney, and skin. Degradation of albumin is probably favored in the liver because of the fenestrated endothelial lining cells that allow access of plasma proteins directly to the space of Disse and to the sinusoidal surface of the hepatocyte. In the general circulation, albumin has two major functions. It is the most important determinant of plasma oncotic pressure (colloid osmotic pressure) and is a major transport protein for hydrophobic or amphiphilic metabolites and xenobiotics that, because of albumin binding, remain in stable aqueous solution in the plasma.

The plasma albumin concentration is determined by the hepatic synthetic rate that normally is in equilibrium with degradation. Hypoalbuminemia may be caused by defective albumin synthesis associated with severe hepatocellular disease or may be caused by increased albumin loss resulting from either glomerulopathy (protein-losing nephropathy), severe intestinal inflammation, or intestinal lymphangiectasia (protein-losing enteropathy). In severe, chronic hepatopathy, there is a tendency for elevations in IgM, IgG, and IgA. Both decreased albumin and increased globulin result in a decrease in the albumin/globulin (A/G) ratio.

The liver is the exclusive site of synthesis of coagulation factors I (fibrinogen), II (prothrombin), V, VII, IX, X, XI, and of protein C, protein S, and antithrombin. Factor VIII is synthesized both in the liver and in multiple other organs including the kidney and spleen (Hollestelle *et al.*, 2001; Wion *et al.*, 1985). Synthesis of coagulation proteins tends to be diminished in liver disease, and decreased plasma prothrombin synthesis is associated with a corresponding increase in the prothrombin time. Factors that contribute to increased prothrombin time include diminished hepatic protein synthesis, increased consumption of clotting factors associated with hemorrhage or hypercoagulation states, and, in some cases, vitamin K deficiency related to decreased intake or diminished absorption. Vitamin K is essential not only for the hepatic synthesis of prothrombin but also for factors VII, IX, X, and protein C. Parenteral administration of vitamin K to individual animal patients may result in improvement in prothrombin time, but coagulation time may remain prolonged. Individuals with obstructive jaundice absorb vitamin K poorly, and defects in their clotting tests can be improved rapidly by parenteral vitamin K administration. Fibrinogen is an acute phase reactant, and its concentration in plasma may be greatly increased in chronic inflammatory diseases or in neoplasia. Plasma fibrinogen is generally normal in mild or moderate liver disease, but it may be detectably decreased in more severe acute or chronic liver disease. Because of the rapid turnover of fibrinogen and prothrombin, the concentrations of these proteins in the plasma may decrease rapidly in fulminant hepatic injury. The turnover rate of albumin is longer and the concentration of albumin

is diminished primarily in chronic liver disease in which there is significant loss of hepatocellular mass.

Measurement of protein C has been validated for use as a biomarker for the assessment of experimental liver injury (Saha *et al.*, 2007), and when combined with other conventional laboratory tests, it was shown to be of value in the recognition of portosystemic shunts and other severe clinical forms of hepatobiliary disease in dogs (Toulza *et al.*, 2006).

Plasmin, a serine protease synthesized by the liver, is necessary for the degradation of fibrin. Antithrombin has potent protease activity against thrombin, plasmin, and other coagulation factors, and its primary physiological function is to modulate the activity of thrombin. Heparin enhances the inhibition of thrombin by antithrombin.

The complement system plays a critical role in the inflammatory response and in host defense mechanisms against infection, and most of the plasma proteins of the complement system are synthesized in the liver. *De novo* synthesis of C2, C3, C4, factor B, and other complement proteins has been demonstrated in cultured mammalian hepatocytes (Anthony *et al.*, 1985; Ramadori *et al.*, 1986). The liver also is the site of synthesis of the protease inhibitor  $\alpha$ -1-antitrypsin, a major plasma protein that inhibits serine proteases including granulocyte elastase, and  $\alpha$ -2-macroglobulin, an inhibitor of a variety of other proteases.

## E. Dye Excretion

The rate of removal of organic anions can be measured and used to assess the functional capacity of the liver and hepatic blood flow. Sulfobromophthalein (BSP, bromsulphalein; Fig. 13-11) and indocyanine green (ICG; Fig. 13-12) have been used most frequently to assess hepatic function. Following bolus intravenous administration, these dyes are removed rapidly from the plasma primarily by the liver and excreted in the bile. Delayed plasma clearance is taken to be indicative of abnormal hepatocellular or biliary tract function or hepatic circulation (Center *et al.*, 1983c).

The overall process of hepatic excretion of BSP is similar but not identical to that of bilirubin. Hepatic uptake of BSP across the sinusoidal plasma membrane is facilitated primarily by sodium-independent OATP, but the sodium-dependent NTCP also may contribute significantly (Hagenbuch *et al.*, 1996; Hata *et al.*, 2003). Within the cell, BSP competes with other organic anions for binding to cytosolic ligandin, which by serving as an ion "sink" is a driving force for hepatic uptake (Levi *et al.*, 1969). The conjugation mechanisms for bilirubin and BSP are completely separate. BSP is conjugated with glutathione by action of the cytosolic enzyme glutathione-S-aryl transferase-B. Although conjugation appears to facilitate BSP excretion, it is not a required step because approximately 50% of the BSP in bile is unconjugated. The canalicular transport of BSP is similar to that of conjugated bilirubin and involves Mrp2.

Hepatic uptake of ICG is similar to that of BSP, but canalicular transport into bile is remarkably different and involves Mdr2, the canalicular transport protein responsible for transport of cholesterol and phospholipids into bile (Huang and Vore, 2001).

In the icteric patient, the question arises whether competition between BSP and bilirubin alters the results of the BSP excretion test. In general, the BSP test is seldom justified in hyperbilirubinemic patients because hepatic disease is evident and no important additional information is likely to be provided. In general, dye excretion tests are most useful for situations in which a suggestion of occult liver disease exists but in which the results of other liver function tests are equivocal. The net competitive effect of bilirubin on BSP excretion is not great. For example, horses starved for 72 h developed a three-fold elevation in total serum bilirubin Fig. 13-9, but BSP excretion was delayed less than 25% (Tennant, unpublished).

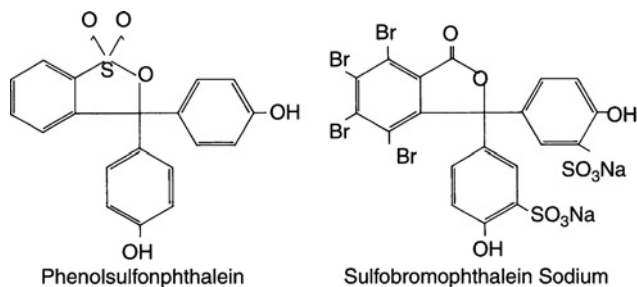
In the dog and cat, a standard dose of 5mg/kg of BSP is administered as an intravenous bolus. A sample of blood is removed at 30 min, and the BSP concentration is determined spectrophotometrically. It is assumed that the original dose of BSP (5mg/kg) is distributed in a plasma volume of 5 ml/kg so that the concentration of BSP in plasma at time zero is (by definition) 1 mg/ml. The percentage retention at 30min is calculated from the ratio of the concentration at time zero and at 30 min. Retention of 5% or less is considered to be within normal limits (Cornelius, 1970).

In the large domestic species, because it is inconvenient or impossible to obtain body weight, plasma clearance of BSP is measured. The initial slope of the disappearance curve is independent of BSP dose and a standard 1.0g dosage is administered to normal-sized horses (450kg) or a dose of 0.5g to smaller horses. Blood samples are obtained at 6, 9, and 12 min following injection and the fractional clearance rate or plasma half-life ( $T_{1/2}$ ) is calculated (Fig. 13-13). In the horse, normal plasma  $T_{1/2}$  values range from 2.5 and 3.5min. In cattle, the rate of BSP excretion is similar to the horse. Sheep have a more rapid excretion rate requiring samples to be taken at 3, 5, and 7min following injection. Normal  $T_{1/2}$  values for sheep range from 1.6 to 2.7min (Cornelius, 1970).

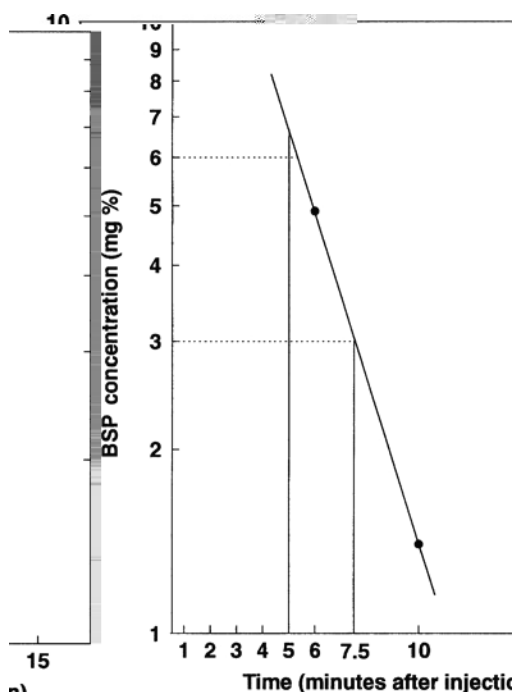
The BSP test is safe although the dye is irritating if infiltrated perivascularly. The test should be used only when cardiovascular function is normal. If hypovolemia or hypotension is present, hepatic perfusion will be reduced and erroneously prolong the rate of BSP clearance.

The clearance rate of ICG provides a useful estimate of hepatic excretory function. Since the hepatic extraction ratio approaches 1, and hepatic clearance corresponds to hepatic blood flow. In contrast to BSP, the plasma disappearance of ICG generally follows a single exponential after mixing. Unlike BSP, ICG is available commercially and is the dye excretion test most readily available for clinical use.

ICG clearance has been used to estimate circulation time and hepatic blood flow. The ICG clearance rate from



**FIGURE 13-11** Phenolsulfonphthalein (PSP) is a dye that is cleared exclusively by the kidney and used in renal function tests. Sulfobromophthalein (BSP) is closely related structurally, but the modifications result in excretion almost entirely by the liver and its use in assessment of hepatic function.



**FIGURE 13-12** Calculation of  $T_{1/2}$  for sulfobromophthalein (BSP) in the horse. After bolus injection intravenously, serum samples were obtained at 6 and 10 min, and the  $T_{1/2}$  was calculated to be 2.5 min (normal).

plasma is measured after the intravenous injection of bolus doses of dye (Warren *et al.*, 1984). Because disappearance of the dye from plasma follows Michaelis-Menten kinetics, Lineweaver-Burke analysis provides apparent  $K_m$  and  $V_{max}$  values for the removal of ICG (Paumgartner *et al.*, 1970). The maximal dye removal capacity can be estimated from a small number of submaximal clearance values. Although such multiple tests are not useful for routine practice, they provide clinical investigators a sensitive index of hepatic dye clearance that is independent of blood flow.

For clinical application liver function test as a  $T_{1/2}$  and fractional clearance (K) is determined after a single

intravenous injection of ICG. Three plasma samples are usually taken between 3 and 15 min after administration and the ICG concentration measured spectrophotometrically. It also is possible to estimate plasma volume and hepatic blood flow (Ketterer *et al.*, 1960). Normal ICG plasma  $T_{1/2}$  and  $K$  values for the dog using 0.5 mg/kg ICG ( $0.64 \mu\text{mol/kg}$ ) were reported to be  $8.4 \pm 2.3$  min and  $0.089 \pm 0.027/\text{minute}$  (Bonasch and Cornelius, 1964). Using an ICG dose of 1.0 mg/kg ( $1.3 \mu\text{mol/kg}$ ), Center *et al.* (1983c) reported an ICG  $T_{1/2}$  for dogs of  $9.0 \pm 2.0$  min, a clearance rate  $3.7 \pm 0.7 \text{ ml/min/kg}$ , and a 30-min retention of  $14.7 \pm 5.0\%$ . In cats that received an ICG dose of 1.5 mg/kg, Center *et al.* (1983b) reported a  $T_{1/2}$  of  $3.8 \pm 0.9$  min, a clearance rate of  $8.6 \pm 4.1$ , and 30-min retention of  $7.3 \pm 2.9\%$ . Using an ICG dose of 0.5 mg/kg ( $0.64 \mu\text{mol/kg}$ ) in sheep, Sato (1984) reported a  $T_{1/2}$  of  $4.8 \pm 0.5$  min, and for heifers using a dose of 0.75 mg/kg ( $0.97 \mu\text{mol/kg}$ ), the  $T_{1/2}$  was  $3.5 \pm 0.8$  min.

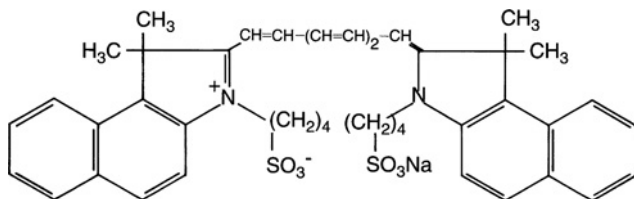
## V. OVERVIEW AND CONCLUSIONS

Conventional tests for hepatic disease provide information about the integrity of the hepatocytes (ALT, AST, SDH) and the status of the biliary system (AP, GGT). Hepatic function can be assessed by estimating the excretory capacity (bilirubin, bile acids  $\text{NH}_3$ ) and synthetic functions ( $\text{NH}_3/\text{urea}$ , albumin, fibrinogen, and prothrombin) of the liver.

For the results of clinical laboratory tests to be of optimal value, it is essential that the specific purpose(s) of the test(s) being performed be defined. Tests for hepatic disease are performed for a variety of purposes including to confirm the existence of liver disease, to assess the nature (e.g., hepatocellular injury, cholestasis) and severity of the disease to determine prognosis, to monitor the clinical course and response to therapy, and to screen individuals at risk for the existence of occult liver disease.

Many of the standard tests for liver disease are based on rather simple biochemical procedures that have been automated for use in multichannel autoanalyzers. One seldom obtains the result of a single test for liver disease but rather a panel of results or a "liver profile." In some situations, the results of multiple tests of liver injury and function may be received even when there is no specific clinical indication for them because, with autoanalyzers, it may be more efficient to perform a large series of tests than to be selective.

In a given population of animals, some will have liver disease and some will not. If a test is applied to the whole population, a certain number of those with the disease will have a positive test result (true positives), and some with the disease will have a negative test result (false negatives). Similarly, among those without the disease, some will have a positive test result (false positives), and in some, the test



**FIGURE 13-13** Indocyanine green used for quantitative assessment of hepatic excretory function.

will be negative (true negatives). A laboratory test is said to be sensitive to the extent that it detects individuals with the disease (true positives divided by the total number with the disease [i.e., true positives plus false negatives]). The test is said to be *specific* to the extent that a negative result detects patients that are free of the disease (true negatives divided by the number of subjects without the disease [i.e., true negatives plus false positives]).

In the clinical setting, the sensitivity and the specificity of hepatic tests are less important than the *positive predictive value*, defined as the probability that a positive test result indicates the presence of the disease (true positives divided by true positives plus the false positives), and the *negative predictive value*, the probability that a negative test result indicates the absence of the disease (true negatives divided by the true negatives plus false negatives). The predictive value of a test, unfortunately, depends on the population being studied and the proportion of individuals in the population with the disease (prevalence). Even when test sensitivity and specificity are high and the number of false-positive tests is low, if there are few subjects with the disease in the population, a positive test result will have relatively low positive predictive value, whereas a negative test result will have proportionately high negative predictive value. If the prevalence of a disease in a population is high, however, a positive result for a test with even low sensitivity and specificity will have high positive predictive value, whereas a negative result would have proportionately low predictive value for the absence of the disease.

Although the sensitivity of a test is often discussed, the prevalence of the disease and the positive and negative predictive values of tests are often ignored in discussions of interpretation of laboratory results. Importantly, laboratory test results from a selected group of individuals with a high prevalence of liver disease cannot be compared to a population in which the prevalence is low or to that in which the predictive value of a test in one population is similar to that of the other population.

As indicated previously, it is unusual that a single test for hepatic injury or function is performed, but rather a “profile” of hepatic test results ordinarily is obtained. The combined results of a panel of tests often provide increased sensitivity and specificity and improved predictive value in assessing severity or in differentiating between acute and

chronic forms of liver disease. It often is impossible to differentiate between different hepatic diseases on the basis of multiple laboratory tests alone, and hepatic imaging or liver biopsy is required. Hepatic tests, however, continue to have an important place in evaluating and monitoring clinical patients with liver disease and in understanding the underlying pathophysiological mechanisms essential for successful treatment.

## REFERENCES

- Abdelkader, S. V., and Hauge, J. G. (1986). Serum enzyme determination in the study of liver disease in dogs. *Acta Vet. Scand.* **27**, 59–70.
- Ahboucha, S., and Butterworth, R. F. (2007). The neurosteroid system: implication in the pathophysiology of hepatic encephalopathy. *Metab. Brain Dis.* **22**, 291–308.
- Albrecht, J., and Norenberg, M. D. (2006). Glutamine: a Trojan horse in ammonia neurotoxicity. *Hepatology* **44**, 788–794.
- Alemu, P., Forsyth, G. W., and Searcy, G. P. (1977). A comparison of parameters used to assess liver damage in sheep treated with carbon tetrachloride. *Can. J. Comp. Med.* **41**, 420–427.
- Allcroft, W. M., and Folley, S. J. (1941). Observations on the serum phosphatase of cattle and sheep. *Biochem. J.* **35**, 254–266.
- Alpert, S., Mosher, M., Shanske, A., and Arias, I. M. (1969). Multiplicity of hepatic excretory mechanisms for organic anions. *Gen. Physiol.* **53**, 238–247.
- Alrefai, W. A., and Gill, R. K. (2007). Bile acid transporters: structure, function, regulation and pathophysiological implications. *Pharm. Res.* **24**, 1803–1823.
- Aminlari, M., and Vaseghi, T. (1992). Arginase distribution in tissues of domestic animals. *Comp. Biochem. Physiol. B* **103**, 385–389.
- Aminlari, M., Shahbazkia, H. R., and Esfandiari, A. (2007). Distribution of arginase in tissues of cat (*Felis catus*). *J. Feline Med. Surg.* **9**, 133–139.
- Aminlari, M., Vaseghi, T., Sajedianfard, M. J., and Samsami, M. (1994). Changes in arginase, aminotransferases and rhodanese in sera of domestic animals with experimentally induced liver necrosis. *J. Comp. Pathol.* **110**, 1–9.
- Anthony, R., Morrison, L., MacSween, R. N. M., and Whaley, K. (1985). Biosynthesis of complement components by cultured rat hepatocytes. *Biochemistry J.* **232**, 93–98.
- Anwer, M. S., Engelking, L. R., Gronwall, R., and Kientz, R. D. (1976). Plasma bile acid elevation following CCl<sub>4</sub> induced liver damage in dogs, sheep, calves and ponies. *Res. Vet. Sci.* **20**, 127–130.
- Archakov, A. I., Karuzina, I. I., Petushkova, N. A., Lisitsa, A. V., and Zgoda, V. G. (2002). Production of carbon monoxide by cytochrome P450 during iron-dependent lipid peroxidation. *Toxicol. In Vitro* **16**, 1–10.
- Arias, I. M., Che, M., Gtmaitan, I., Lerville, C., Nishida, T., and St. Pierre, M. (1993). The biology of the bile canaliculus. *Hepatology* **17**, 318–329.
- Arias, I. M., Johnson, L., and Wolfson, S. (1961). Biliary excretion of injected conjugated and unconjugated bilirubin by normal and Gunn rats. *Am. J. Physiol.* **200**, 1091–1094.
- Aronsen, K. F., Hägerstrand, I., and Nordén, J. G. (1968). Enzyme studies in dogs with extra-hepatic biliary obstruction. *Scan. J. Gastroenterol.* **3**, 355–368.
- Asquith, R. L., Edds, G. T., Aller, W. W., and Bortell, R. (1980). Plasma concentration of iditol dehydrogenase (sorbitol dehydrogenase) in ponies treated with aflatoxin B<sub>1</sub>. *Am. J. Vet. Res.* **41**, 925–927.

- Audell, L., Jonsson, L., and Lannek, B. (1974). Congenital portacaval shunts in the dog: a description of three cases. *Zentralbl. Veterinaermed. [A]*, **21**, 797–805.
- Badylak, S. F., and Van Vleet, J. F. (1981). Sequential morphologic and clinicopathologic alterations in dogs with experimentally induced glucocorticoid hepatopathy. *Am. J. Vet. Res.* **24**, 1310–1318.
- Badylak, S. F., and Van Vleet, J. F. (1982). Tissue gamma-glutamyl transpeptidase activity and hepatic ultrastructural alterations in dogs with experimentally induced glucocorticoid hepatopathy. *Am. J. Vet. Res.* **43**, 649–655.
- Barton, M. H., and LeRoy, B. E. (2007). Serum bile acids concentrations in healthy and clinically ill neonatal foals. *J. Vet. Intern. Med.* **21**, 508–805.
- Barrett, R. E., deLahunta, A., Roenick, W. J., Hoffer, R. E., and Coons, F. H. (1976). Four cases of congenital portacaval shunt in the dog. *J. Small Anim. Pract.* **17**, 71–85.
- Beigneux, A., Hofmann, A. F., and Young, S. G. (2002). Human CYP7A1 deficiency: progress and enigmas. *J. Clin. Invest.* **110**, 29–31.
- Berman, J. K., and Hull, J. E. (1952). Experimental ascites: its production and control. *Surgery* **32**, 67–75.
- Bilir, B. M., Gong, L., Kwasiborski, V., Shen, C. S., Fillmore, C. S., Berkowitz, C. M., and Gumucio, J. J. (1993). Novel control of the position-dependent expression of genes in hepatocytes. The GLUT-1 transporter. *J. Biol. Chem.* **268**, 19776–19784.
- Bissell, D. M., and Guzelian, P. S. (1980). Degradation of endogenous hepatic heme by pathways not yielding carbon monoxide. Studies in normal rat liver and in primary hepatocyte culture. *J. Clin. Invest.* **65**, 1135–1140.
- Bissell, D. M., and Maher, J. J. (1996). Hepatic fibrosis and cirrhosis. In “Hepatology, A Textbook of Liver Disease, 3rd Ed.” (D. Zakim and T. D. Boyer, Eds.), Vol. 1, pp. 506–525. W.B. Saunders Co, Philadelphia.
- Bissell, D. M., and Maher, J. J. (1996). Hepatic fibrosis and cirrhosis. In “Hepatology: A Textbook of Liver Disease” (D. Zakim and T.D. Boyer, Eds.), 3rd ed., vol. 1, p. 506. Saunders, Philadelphia.
- Blackshaw, C. (1978). Serum gamma glutamyltransferase in the diagnosis of liver disease in cattle. *New Zealand Vet. J.* **26**, 25–26.
- Bohan, A., Chen, W.-S., Denson, L. A., Held, M. A., and Boyer, J. L. (2003). TNF $\alpha$  dependent up-regulation of Lrh-1 and Mrp3(Abc3) reduces liver injury in obstructive cholestasis. *J. Biol. Chem.* **10**, 1074.
- Bolter, C. P., and Critz, J. B. (1974). Changes in plasma enzyme activity elicited by running exercise in the dog. *Proc. Soc. Exp. Biol. Med.* **145**, 1359–1362.
- Bonasch, H., and Cornelius, C. E. (1964). Indocyanine green clearance: a liver function test for the dog. *Am. J. Vet. Res.* **25**, 254–259.
- Bortell, R., Asquith, R. L., Edds, G. T., Simpson, C. F., and Aller, W. W. (1983). Acute experimentally induced aflatoxicosis in the weanling pony. *Am. J. Vet. Res.* **44**, 2110–2114.
- Brauer, R. W. (1963). Liver circulation and function. *Physiol. Rev.* **43**, 115–213.
- Braun, J. P., Benard, P., Burgat, V., and Rico, A. G. (1983). Gamma glutamyl transferase in domestic animals. *Vet. Res. Commun.* **6**, 77–90.
- Braun, J. P., Rico, A. G., Benard, P., Thouvenot, J. P., and Bonnefis, M. J. (1978a). Blood and tissue distribution of gamma glutamyl transferase in calves. *J. Dairy Sci.* **61**, 596–599.
- Braun, J. P., Rico, A. G., Benard, P., Thouvenot, J. P., and Bonnefis, M. J. (1978b). Tissue and blood distribution of gamma-glutamyl transferase in the lamb and in the ewe. *Res. Vet. Sci.* **25**, 37–40.
- Braun, U., Pusterla, N., and Wild, K. (1995). Ultrasonographic findings in 11 cows with a hepatic abscess. *Vet. Rec.* **137**, 284–290.
- Breeze, R. G., Pirie, H. M., Selman, I. E., and Wiseman, A. (1976). Pulmonary arterial thrombo-embolism and pulmonary arterial mycotic aneurysms in cattle with vena caval thrombosis: a condition resembling the Hughes-Stovin syndrome. *J. Pathol.* **119**, 229–237.
- Bromberg, P. A., Robin, E. D., and Forkner, C. E., Jr. (1960). The existence of ammonia in blood in vivo with observations on the significance of the NH<sub>4</sub> plus minus NH<sub>3</sub> system. *J. Clin. Invest.* **39**, 332–341.
- Bulgin, M. S., and Anderson, B. C. (1984). Serum gamma glutamyl transpeptidase activity in cattle with induced fascioliasis. *Res. Vet. Sci.* **37**, 167–171.
- Bunch, S. E., Castleman, W. L., Baldwin, B. H., Hornbuckle, W. E., and Tennant, B. C. (1985). Effects of long-term primidone and phenytoin administration on canine hepatic function and morphology. *Am. J. Vet. Res.* **46**, 105–115.
- Bunch, S. E., Castleman, W. L., Hornbuckle, W. E., and Tennant, B. C. (1982). Hepatic cirrhosis associated with long-term anticonvulsant drug therapy in dogs. *J. Am. Vet. Med. Assoc.* **181**, 357–362.
- Bunch, S. E., Conway, M. B., Center, S. A., Castleman, W. L., Baldwin, B. H., Hornbuckle, W. E., and Tennant, B. C. (1987). Toxic hepatopathy and intrahepatic cholestasis associated with phenytoin administration in combination with other anticonvulsant drugs in three dogs. *J. Am. Vet. Med. Assoc.* **190**, 194–198.
- Butterworth, R. O. (1994). Hepatic encephalopathy. In “The Liver. Biology and Pathobiology” (I. M. Arias, J. L. Boyer, N. Fausto, W. B. Jacoby, D. Schachter, and D. A. Schafritz, Eds.), p. 1193. Raven Press, New York.
- Caldovic, L., Lopez, G. Y., Haskins, N., Panglao, M., Shi, D., Morizono, H., and Tuchman, M. (2006). Biochemical properties of recombinant human and mouse N-acetylglutamate synthase. *Mol. Genet. Metab.* **87**, 226–232.
- Caldovic, L., and Tuchman, M. (2003). N-acetylglutamate and its changing role through evolution. *Biochem. J.* **372**, 279–290.
- Castell, D. O., and Moore, E. W. (1971). Ammonia absorption from the human colon: the role of nonionic diffusion. *Gastroenterology* **60**, 33–42.
- Center, S. A. (1996). Diagnostic procedures for evaluation of hepatic diseases. In “Strombeck’s Small Animal Gastroenterology” (W. G. Guilford, S. A. Center, D. R. Strombeck, D. A. William, and D. J. Meyer, Eds.), pp. 130–188. W. B. Saunders Co, Philadelphia.
- Center, S. A. (1993). Serum bile acids in companion animal medicine. *Vet. Clin. North Am. Small Anim. Pract.* **23**, 625–657.
- Center, S. A. (1996). Diagnostic procedures for evaluation of hepatic diseases. In “Strombeck’s Small Animal Gastroenterology” (W. G. Guilford, S. A. Center, D. R. Strombeck, D. A. William, and D. J. Meyer, Eds.), p. 553. Saunders, Philadelphia.
- Center, S. A. (2007). Interpretation of liver enzymes. *Vet. Clin. North Am. Small Anim. Pract.* **37**, 297–333.
- Center, S. A., Baldwin, B. H., deLahunta, A., Dietze, A. E., and Tennant, B. C. (1985a). Evaluation of serum bile acid concentrations for the diagnosis of portosystemic venous anomalies in the dog and cat. *J. Am. Vet. Med. Assoc.* **186**, 1090–1094.
- Center, S. A., Baldwin, B. H., Dillingham, S., Erb, H. N., and Tennant, B. C. (1986). Diagnostic value of serum gamma-glutamyl transferase and alkaline phosphatase activities in hepatobiliary disease in the cat. *J. Am. Vet. Med. Assoc.* **188**, 507–510.
- Center, S. A., Baldwin, B. H., Erb, H. N., and Tennant, B. C. (1985b). Bile acid concentrations in the diagnosis of hepatobiliary disease in the dog. *J. Am. Vet. Med. Assoc.* **187**, 935–940.
- Center, S. A., Baldwin, B. H., King, J. M., and Tennant, B. C. (1983a). Hematologic and biochemical abnormalities associated with induced



- extrahepatic bile duct obstruction in the cat. *Am. J. Vet. Res.* **44**, 1822–1827.
- Center, S. A., Bunch, S. E., Baldwin, B. H., Hornbuckle, W. E., and Tennant, B. C. (1983b). Comparison of sulfobromophthalein and indocyanine green clearances in the cat. *Am. J. Vet. Res.* **44**, 727–730.
- Center, S. A., Bunch, S. E., Baldwin, B. H., Hornbuckle, W. E., and Tennant, B. C. (1983c). Comparison of sulfobromophthalein and indocyanine green clearances in the dog. *Am. J. Vet. Res.* **44**, 722–726.
- Center, S. A., Erb, H. N., and Joseph, S. A. (1995). Measurement of serum bile acids concentrations for diagnosis of hepatobiliary disease in cats. *J. Am. Vet. Med. Assoc.* **207**, 1048–1054.
- Center, S. A., Leveille, C. R., Baldwin, B. H., and Tennant, B. C. (1984). Direct spectrometric determination of serum bile acids in the dog and cat. *Am. J. Vet. Res.* **45**, 2043–2050.
- Center, S. A., ManWarren, T., Slater, M. R., and Wilentz, E. (1991a). Evaluation of twelve-hour preprandial and two-hour postprandial serum bile acids concentrations for diagnosis of hepatobiliary disease in dogs. *J. Am. Vet. Med. Assoc.* **199**, 217–226.
- Center, S. A., Randolph, J. F., ManWarren, T., and Slater, M. (1991b). Effect of colostrum ingestion on gamma-glutamyltransferase and alkaline phosphatase activities in neonatal pups. *Am. J. Vet. Res.* **52**, 499–504.
- Chen, W., Cai, S.-Y., Xu, S., Denson, L. A., Soroka, C. J., and Boyer, J. L. (2007). Nuclear receptors RXR $\alpha$ :RAR $\alpha$  are repressors for human MRP3 expression. *Am. J. Physiol. Gastrointest. Liver Physiol.* **292**, 1221–1227.
- Chowdhury, J. R., Chowdhury, N. R., Wolkoff, A. W., and Arias, I. M. (1994). Heme and bile pigment metabolism. In “The Liver: Biology and Pathophysiology” (I. M. Arias, J. L. Boyer, N. Fausto, W. B. Jacoby, D. Schachter, and D. A. Shafritz, Eds.), p. 471–504. Raven Press, New York.
- Cook, J. S., and Blum, H. F. (1959). Dose relationships and oxygen dependence in ultraviolet and photodynamic hemolysis. *J. Cell. Comp. Physiol.* **53**, 41–60.
- Cornelius, C. E. (1963). Relation of body-weight to hepatic glutamic pyruvic transaminase activity. *Nature* **200**, 580–581.
- Cornelius, C. E. (1970). Liver function. In “Clinical Biochemistry of Domestic Animals” (J. J. Kaneko and C. E. Cornelius, Eds.), vol. 1, p. 161–230. Academic Press, New York.
- Cornelius, C. E. (1993). Fasting hyperbilirubinemia in Bolivian squirrel monkeys with a Gilbert’s-like syndrome. *Adv. Vet. Sci. Camp. Med.* **37**, 127–147.
- Cornelius, C. E., Arias, I. M., and Osburn, B. I. (1965a). Hepatic pigmentation with photosensitivity: a syndrome in Corriedale sheep resembling Dubin-Johnson syndrome in man. *J. Am. Vet. Med. Assoc.* **146**, 709–713.
- Cornelius, C. E., Ben-Ezzer, J., and Arias, I. M. (1967). Binding of sulfobromophthalein sodium (BSP) and other organic anions by isolated hepatic cell plasma membranes in vitro. *Proc. Exp. Biol. Med.* **124**, 557–665.
- Cornelius, C. E., Douglas, G. M., Gronwall, R. R., and Freedland, R. A. (1963). Comparative studies on plasma arginase and transaminases in hepatic necrosis. *Cornell Vet.* **53**, 181–191.
- Cornelius, C. E., Gazmuri, G., Gronwall, R., and Rhode, E. A. (1965b). Preliminary studies on experimental hyperbilirubinemia and hepatic coma in the horse. *Cornell Vet.* **55**, 110–120.
- Cornelius, C. E., and Gronwall, R. R. (1968). Congenital photosensitivity and hyperbilirubinemia in Southdown sheep in the United States. *Am. J. Vet. Res.* **29**, 291–295.
- Cornelius, C. E., Kelley, K. C., and Himes, J. A. (1975a). Congenital photosensitivity and hyperbilirubinemia in Southdown sheep in the United States. *Cornell Vet.* **65**, 90–99.
- Cornelius, C. E., Kilgore, W. W., and Wheat, J. D. (1960). Chromatographic identification of bile pigments in several species. *Cornell Vet.* **50**, 47–53.
- Cornelius, C. E., Osborn, B. I., Gronwall, R. R., and Cardinet, G. H. (1968b). Dubin-Johnson syndrome in immature sheep. *Am. J. Dig. Dis.* **13**, 1072–1076.
- Cornelius, L. M., Thrall, D. E., Halliwell, W. H., Frank, G. M., Kern, A. J., and Woods, C. B. (1975b). Anomalous portosystemic anastomoses associated with chronic hepatic insufficiency in six young dogs. *J. Am. Vet. Med. Assoc.* **167**, 220–228.
- Crawford, P. C., Levy, J. K., and Werner, L. L. (2006). Evaluation of surrogate markers for passive transfer of immunity in kittens. *J. Am. Vet. Med. Assoc.* **228**, 1038–1041.
- Crawford, M. A., Schall, W. D., Jensen, R. K., and Tasker, J. B. (1985). Chronic active hepatitis in 26 Doberman pinschers. *J. Am. Vet. Med. Assoc.* **187**, 1343–1350.
- Craig, A. M., Pearson, E. G., and Rowe, K. (1992). Serum bile acid concentration in clinically normal cattle: comparison by type, age, and stage of lactation. *Am. J. Vet. Res.* **53**, 1784–1786.
- Dennis, J. A., Healy, P. J., Beaudet, A. L., and O’Brien, W. E. (1989). Molecular definition of bovine argininosuccinate synthetase deficiency. *Proc. Natl. Acad. Sci. USA* **86**, 7947–7951.
- De Novo, R. C., and Prasse, K. W. (1983). Comparison of serum biochemical and hepatic functional alterations in dogs treated with corticosteroids and hepatic duct ligation. *Am. J. Vet. Res.* **44**, 1703–1709.
- de Schepper, J., and Van Der Stock, J. (1972a). Increased urinary bilirubin excretion after elevated free plasma haemoglobin levels. I. Variations in the calculated renal clearances of bilirubin in whole dogs. *Arch. Int. Physiol. Biochim.* **80**, 279–291.
- de Schepper, J., and Van Der Stock, J. (1972b). Increased urinary bilirubin excretion after elevated free plasma haemoglobin levels. II. Variations in the calculated renal clearances of bilirubin in isolated normothermic perfused dog’s kidneys. *Arch. Int. Physiol. Biochim.* **80**, 339–348.
- Dimski, D. S. (1994). Ammonia metabolism and the urea cycle: function and clinical implications. *J. Vet. Int. Med.* **8**, 73–78.
- Dittrich, C., Stockl, W., and Desser, H. (1974). Determination of enzymes of the urea cycle, glutaminase and asparaginase in cattle and pigs. *Zentralbl. Veterinaermed. Reihe A* **21**, 165–170.
- Divers, T. J., Warner, A., Vaala, W. E., Whitlock, R. H., Acland, H. A., Mansmann, R. A., and Palmer, J. E. (1983). Toxic hepatic failure in newborn foals. *J. Am. Vet. Med. Assoc.* **183**, 1407–1413.
- Dossin, O., Rives, A., Germain, C., Braun, J. P., and Lefebvre, H. (2005). Pharmacokinetics of liver transaminases in healthy dogs: potential clinical relevance for assessment of liver damage. Abstract # 152, ACVIM Annual Meeting. *J. Vet. Int. Med.* **19**, 442.
- Durham, A. E., Smith, K. C., and Newton, J. R. (2003). An evaluation of diagnostic data in comparison to the results of liver biopsies in mature horses. *Equine Vet. J.* **35**, 554–559.
- Emmelot, P., Bos, C. J., Benedetti, E. L., and Rumke, P. H. (1964). Studies on plasma membranes. I. Chemical composition and enzyme content of plasma membranes isolated from rat liver. *Biochim. Biophys. Acta* **90**, 126–145.
- Engelking, L. R., and Gronwall, R. (1979). Effects of fasting on hepatic bile acid clearance. *Proc. Soc. Exp. Biol. Med.* **161**, 123–127.
- Enigk, K., Feder, H., and Dey-Hazra, A. (1976). Mineral content and enzyme activity of *Cysticercus tenuicollis* in sheep and swine. *Zbl. Vet. Med.* **23A**, 255–264.



- Everett, R. M., Duncan, J. R., and Prasse, K. W. (1977). Alkaline phosphatase, leucine aminopeptidase, and alanine aminotransferase activities with obstructive and toxic hepatic disease in cats. *Am. J. Vet. Res.* **38**, 963–966.
- Ewing, G. O., Suter, P. F., and Bailey, C. S. (1974). Hepatic insufficiency associated with congenital anomalies of the portal vein in dogs. *J. Amer. An. Hosp. Assoc.* **10**, 463–476.
- Festi, D., Vestito, A., Mazzella, G., Roda, E., and Colecchia, A. (2006). Management of hepatic encephalopathy: focus on antibiotic therapy. *Digestion* **73**, 94–101.
- Ferslew, K. K., and Edds, G. T. (1979). Effects of arsenic acids on growth, serum enzymes, hematologic values, and residual arsenic in young swine. *Am. J. Vet. Res.* **1**, 1365–1369.
- Fevry, J., Van Hees, G. P., Leroy, P., Compennolle, F., and Heirwegh, K. P. M. (1971). Excretion in dog bile of glucose and xylose conjugates of bilirubin. *Biochem. J.* **125**, 803–810.
- Finn, J. P., and Tennant, B. (1974). Hepatic encephalopathy in cattle. *Cornell Vet.* **64**, 136–153.
- Fog, J., and Jellum, E. (1963). Structure of bilirubin. *Nature* **198**, 88–89.
- Ford, E. J. H. (1958). The content and distribution of alkaline phosphatase in the biliary tract of the sheep. *J. Anat.* **92**, 447–452.
- Ford, E. J. H. (1974). Activity of gamma-glutamyl transpeptidase and other enzymes in the serum of sheep with liver or kidney damage. *J. Comp. Pathol.* **84**, 231–243.
- Ford, E. J. H., and Evans, J. (1985). Distribution of 5'-nucleotidase in the tissues of sheep and the effect of kidney and liver lesions on the activity of the enzyme in plasma and urine. *Res. Vet. Sci.* **39**, 103–109.
- Ford, E. J. H., and Gopinath, C. (1976). The excretion of phyloerythrin and bilirubin by calves and sheep. *Res. Vet. Sci.* **21**, 12–18.
- Fowler, J. S. (1971). Toxicity of carbon tetrachloride and other fasciocidal drugs in sheep and chickens. *Br. Vet. J.* **237**, 304–312.
- Fowler, M. E. (1965). Clinical manifestations of primary hepatic insufficiency in the horse. *J. Amer. Vet. Med. Assoc.* **147**, 55–64.
- Fowler, M. E. (1968). Pyrrolizidine alkaloid poisoning in calves. *J. Amer. Vet. Med. Assoc.* **152**, 1131–1137.
- Freedland, R. A., Hjerpe, C. A., and Cornelius, C. E. (1965). Comparative studies on plasma enzyme activities in experimental hepatic necrosis in the horse. *Res. Vet. Sci.* **6**, 18–23.
- Fulop, M., Sandson, J., and Brazeau, P. (1965). Dialyzability, protein binding, and renal excretion of plasma conjugated bilirubin. *J. Clin. Invest.* **44**, 666–680.
- Garry, F. B., Fettman, M. J., Curtis, C. R., and Smith, J. A. (1994). Serum bile acid concentrations in dairy cattle with hepatic lipidosis. *J. Vet. Intern. Med.* **8**, 432–438.
- George, J. W., Nulk, K., Weiss, A., Bruss, M. L., and Cornelius, C. E. (1989). Biliverdin reductase activity in cattle, sheep, rabbits and rats. *Int. J. Biochem.* **21**, 477–481.
- Gibbons, W. J., Hokanson, J. F., Wiggins, A. M., and Schmitz, M. B. (1950). Cirrhosis of the liver in horses. *North Am. Vet.* **31**, 229–232.
- Gilliam, L. L., Holbrook, T. C., Dechant, J. E., and Johnson, B. J. (2007). Postmortem diagnosis of idiopathic hyperammonemia in a horse. *Vet. Clin. Pathol.* **36**, 196–199.
- Gordon, E. R., Goresky, C. A., Chang, T.-H., and Perlin, A. S. (1976). The isolation and characterization of bilirubin diglucuronide, the major bilirubin conjugate in dog and human bile. *Biochem. J.* **155**, 477–486.
- Goresky, C. A., Haddad, H. H., Kluger, W. S., Nadeau, B. E., and Bach, G. G. (1974). The enhancement of maximal bilirubin excretion with taurocholate-induced increments in bile flow. *Can. J. Physiol. Pharmacol.* **52**, 389–403.
- Gossett, K. A., and French, D. D. (1984). Effect of age on liver enzyme activities in serum of healthy quarter horses. *Am. J. Vet. Res.* **45**, 354–356.
- Gotoh, T., and Mori, M. (1999). Arginase II downregulates nitric oxide (NO) production and prevents NO-mediated apoptosis in murine macrophage-derived RAW 264.7 cells. *J. Cell Biol.* **144**, 427–434.
- Grisham, J. W. (1959). Lobular distribution of hepatic nuclei labeled with tritiated-thymidine in partially hepatectomized rats. *Fed. Proc.* **18**, 478.
- Grodsky, G. M., and Carbone, J. V. (1957). The synthesis of bilirubin glucuronide by tissue homogenates. *J. Biol. Chem.* **226**, 449–458.
- Grody, W. W., Argyle, C., Kern, R. M., Dizikes, G. J., Spector, E. B., Strickland, A. D., Klein, D., and Cederbaum, S. D. (1989). Differential expression of the two human arginase genes in hyperargininemia. Enzymatic, pathologic, and molecular analysis. *J. Clin. Invest.* **83**, 602–609.
- Gronwall, R., and Mia, A. S. (1972). Fasting hyperbilirubinemia in horses. *Am. J. Dig. Dis.* **17**, 473–476.
- Guelfi, J. F., Braun, J. P., and Rico, A. G. (1982). Value of so called cholestasis markers in the dog: an experimental study. *Res. Vet. Sci.* **33**, 309–312.
- Gumucio, J. J., and Berkowitz, C. M. (1992). Structural organization of the liver and function of the hepatic acinus. In "Liver and Biliary Disease" (C. Kaplanski, Ed.), pp. 2–17. Williams and Wilkins, Baltimore.
- Gumucio, J. J., Bilir, B. M., Moseley, R. H., and Berkowitz, C. M. (1994). The biology of the liver cell plate. In "The Liver Biology and Pathology" (I. M. Arias, J. L. Boyer, N. Fausto, W. B. Jacoby, D. Schachter, and D. A. Shafritz, Eds.), pp. 1116–1143. Raven Press, New York.
- Gustafsson, B. E., and Lanke, L. S. (1960). Bilirubin and urobilins in germ-free, ex-germfree, and conventional rats. *J. Exp. Med.* **112**, 975–981.
- Habig, W. H., Pabst, M. J., Fleischner, G., Gatmaitan, I., Arias, I. M., and Jakoby, W. B. (1974). The identity of glutathione S-transferase B with ligandin, a major binding protein of liver. *Proc. Natl. Acad. Sci. USA* **71**, 3879–3882.
- Hagenbuch, B., Scharschmidt, B. F., and Meier, P. J. (1996). Effect of antisense oligonucleotides on the expression of hepatocellular bile acid and organic anion uptake systems in *Xenopus laevis* oocytes. *Biochem. J.* **316**, 901–904.
- Hanigan, M. H. (1998). gamma-Glutamyl transpeptidase, a glutathionase: its expression and function in carcinogenesis. *Chem. Biol. Interact.* **111–112**, 333–342.
- Harper, P. A., Healy, P. J., and Dennis, J. A. (1989). Animal model of human disease. Citrullinemia (argininosuccinate synthetase deficiency). *Am. J. Pathol.* **135**, 1213–1215.
- Harper, P. A., Healy, P. J., Dennis, J. A., and Martin, A. B. (1988). Ultrastructural findings in citrullinaemia in Holstein-Friesian calves. *Acta Neuropathol.* **76**, 306–310.
- Harper, P. A., Healy, P. J., Dennis, J. A., O'Brien, J. J., and Rayward, D. H. (1986). Citrullinemia as a cause of neurological disease in neonatal Friesian calves. *Aust. Vet. J.* **63**, 378–379.
- Harvey, D. G., and Hoe, C. M. (1971). The application of some liver function tests to sheep dosed with carbon tetrachloride and hexachlorophene. *Vet. Rec.* **29**, 562–569.
- Harvey, D. G., and Obeid, H. M. (1974). The application of certain liver function tests including serum alkaline phosphatase estimations to domesticated animals in the Sudan. *Br. Vet. J.* **130**, 544–555.
- Hasel, K. M., Summers, B. A., and De Lahunta, A. (1999). Encephalopathy with idiopathic hyperammonemia and Alzheimer type II astrocytes in equidae. *Equine Vet. J.* **31**, 478–482.

- Haslewood, G. A. (1967). Bile salt evolution. *J. Lipid Res.* **8**, 535–550.
- Hata, S., Wang, P., Eftychiou, N., Ananthanarayanan, M., Batta, A., Salen, G., Pang, K. S., and Wolkoff, A. W. (2003). Substrate specificities of rat oatp1 and ntcp: implications for hepatic organic anion uptake. *Am. J. Physiol. Gastrointest. Liver Physiol.* **285**, G829–G839.
- Hauge, J. G., and Abdelkader, S. V. (1984). Serum bile acids as an indicator of liver disease in dogs. *Acta Vet. Scand.* **25**, 495–503.
- Heffron, J. J. A., Bomzon, L., and Pattinson, R. A. (1976). Observations on plasma creatine phosphokinase activity in dogs. *Vet. Rec.* **98**, 338–340.
- Heirwegh, K. P. M., Fevery, J., Michiels, R., Van Hees, G. P., and Compennolle, F. (1975). Separation by thin-layer chromatography and structure elucidation of bilirubin conjugates isolated from dog bile. *Biochem. J.* **145**, 185–199.
- Hirohashi, T., Suzuki, H., Takikawa, H., and Sugiyama, Y. (2000). ATP-dependent transport of bile salts by rat multidrug resistance-associated protein 3 (Mrp3). *J. Biol. Chem.* **275**, 2905–2910.
- Hjelle, J. J., and Grauer, G. F. (1986). Acetaminophen-induced toxicosis in dogs and cats. *J. Am. Vet. Med. Assoc.* **188**, 742–746.
- Hjerpe, C. A. (1964). Serum hepatitis in the horse. *J. Amer. Vet. Med. Assoc.* **144**, 734–740.
- Hjerpe, C. A., Tennant, B. C., Crenshaw, G. L., and Baker, N. F. (1971). Ovine fascioliasis in California. *J. Amer. Vet. Med. Assoc.* **159**, 1266–1267.
- Hoe, C. M., and Jabara, A. G. (1967). The use of serum enzymes as diagnostic aids in the dog. *J. Compo. Pathol.* **77**, 245–254.
- Hoffman, H. N., Whitcomb, F. F., Jr., Butt, H. R., and Bollman, J. L. (1960). Bile pigments of jaundice. *J. Clin. Invest.* **39**, 132–142.
- Hoffmann, W. E., and Dorner, J. L. (1975). Separation of isoenzymes of canine alkaline phosphatase by cellulose acetate electrophoresis. *J. Amer. An. Hosp. Assoc.* **11**, 283–285.
- Hoffman, W. E., and Dorner, J. L. (1977). Serum half-life of intravenously injected intestinal and hepatic alkaline phosphatase isoenzymes in the cat. *Am. J. Vet. Res.* **38**, 1637–1639.
- Hollestelle, M. J., Thinnis, T., Craïn, K., Stiko, A., Kruijt, J. K., van Berkel, T. J., Loskutoff, D. J., and van Mourik, J. A. (2001). Tissue distribution of factor VIII gene expression in vivo: a closer look. *Thromb. Haemost.* **86**, 855–861.
- Hooper, P. T. (1972). Spongy degeneration in the brain in relation to hepatic disease and ammonia toxicity in domestic animals. *Vet. Rec.* **90**, 37–38.
- Horiuchi, S., Kamimoto, Y., and Morino, Y. (1985). Hepatic clearance of rat liver aspartate aminotransferase isozymes: evidence for endocytotic uptake via different binding sites on sinusoidal liver cells. *Hepatology* **5**, 376–382.
- Hoshi, A., Takahashi, M., Fujii, J., Myint, T., Kaneto, H., Suzuki, K., Yamasai, Y., Kamada, T., and Taniguchi, N. (1996). Glycation and inactivation of sorbitol dehydrogenase in normal and diabetic rats. *Biochem. J.* **318**, 119–123.
- Howards, S. S., Davis, J. O., Johnston, C. I., and Wright, F. S. (1968). Steroidogenic response in normal dogs receiving blood from dogs with caval constriction. *Am. J. Physiol.* **214**, 990–996.
- Huang, L., and Vore, M. (2001). Multidrug resistance p-glycoprotein 2 is essential for the biliary excretion of indocyanine green. *Drug Metab. Dispos.* **29**, 634–637.
- Hung, A. Y., and Sheng, M. (2002). PDZ domains: structural modules for protein complex assembly. *J. Biol. Chem.* **277**, 5699–5702.
- Hyatt, R. E., Lawrence, G. H., and Smith, J. R. (1955). Observations on the origin of ascites from experimental hepatic congestion. *J. Lab. Clin. Med.* **45**, 274–280.
- Ikemoto, M., Tabata, M., Miyake, T., Kono, T., Mori, M., Totani, M., and Murachi, T. (1990). Expression of human liver arginase in *Escherichia coli*. Purification and properties of the product. *Biochem. J.* **270**, 697–703.
- Ito, K., Suzuki, H., Hirohashi, T., Kume, K., Shimizu, T., and Sugiyama, Y. (1997). Molecular cloning of canalicular multispecific organic anion transporter defective in EHBR. *Am. J. Physiol.* **272**, G16–22.
- Ito, K., Suzuki, H., and Sugiyama, Y. (2001). Single amino acid substitution of rat MRP2 results in acquired transport activity for taurocholate. *Am. J. Physiol. Gastrointest. Liver Physiol.* **281**, G1034–G1043.
- Jacquemin, E., Hagenbuch, B., Stieger, B., Wolkoff, A. W., and Meier, P. J. (1991). Expression of the hepatocellular chloride-dependent sulfobromophthalein uptake system in *Xenopus laevis* oocytes. *J. Clin. Invest.* **88**, 2146–2149.
- Jacquemin, E., Hagenbuch, B., Stieger, B., Wolkoff, A. W., and Meier, P. J. (1994). Expression cloning of a rat liver Na(+)-independent organic anion transporter. *Proc. Nat. Acad. Sci. USA* **91**, 133–137.
- Jansen, P. L., Peters, W. H., and Lamers, W. H. (1985). Hereditary chronic conjugated hyperbilirubinemia in mutant rats caused by defective hepatic anion transport. *Hepatology* **5**, 573–579.
- Jayakumar, A. R., Rao, K. V., Murthy, Ch. R., and Norenberg, M. D. (2006). Glutamine in the mechanism of ammonia-induced astrocyte swelling. *Neurochem. Int.* **48**, 623–628.
- Jenkinson, C. P., Grody, W. W., and Cederbaum, S. D. (1996). Comparative properties of arginases. *Comp. Biochem. Physiol.* **114**, 107–132.
- Johnson, A. L., Divers, T. J., Freckleton, M. L., McKenzie, H. C., Mitchell, E., Cullen, J. M., and McDonough, S. P. (2006). Fall panicum (*Panicum dichotomiflorum*) hepatotoxicosis in horses and sheep. *J. Vet. Intern. Med.* **20**, 1414–1421.
- Johnston, N. A., Parish, S. M., Tyler, J. W., and Tillman, C. B. (1997). Evaluation of serum gamma-glutamyltransferase activity as a predictor of passive transfer status in crias. *J. Am. Vet. Med. Assoc.* **211**, 1165–1166.
- Jover, R., Rodrigo, R., Felipe, V., Insausti, R., Sáez-Valero, J., Garccia-Ayllón, M. S., Suárez, I., Candela, A., Compañ, A., Esteban, A., Cauli, O., Ausó, E., Rodríguez, E., Gutiérrez, A., Girona, E., Erceg, S., Berbel, P., and Pérez-Mateo, M. (2006). Brain edema and inflammatory activation in bile duct ligated rats with diet-induced hyperammonemia: a model of hepatic encephalopathy in cirrhosis. *Hepatology* **43**, 1257–1266.
- Jungermann, K., and Katz, N. (1989). Functional specialization of different hepatocyte populations. *Physiol. Rev.* **69**, 708–764.
- Kalaitzakis, E., Roubies, N., Panousis, N., Pourliotis, K., Kaldrymidou, E., and Karatzaias, H. (2007). Clinicopathologic evaluation of hepatic lipidosis in periparturient dairy cattle. *J. Vet. Intern. Med.* **21**, 835–845.
- Kamimoto, Y., Horiuchi, S., Tanase, S., and Morino, Y. (1985). Plasma clearance of intravenously injected aspartate aminotransferase isozymes: evidence for preferential uptake by sinusoidal liver cells. *Hepatology* **5**, 367–375.
- Kaneko, J. J., Zinkl, J. G., and Keeton, K. S. (1971). Erythrocyte porphyrin and erythrocyte survival in bovine erythropoietic porphyria. *Am. J. Vet. Res.* **32**, 1981–1985.
- Kaplan, M. M. (1972). Alkaline phosphatase. *Gastroenterology* **62**, 452–468.
- Kaplan, M. M., and Righetti, A. (1969). Induction of liver alkaline phosphatase by bile duct ligation. *Biochim. Biophys. Acta* **184**, 667–669.
- Kaplan, M. M., and Righetti, A. (1970). Induction of rat liver alkaline phosphatase: the mechanism of the serum elevation in bile duct obstruction. *J. Clin. Invest.* **49**, 508–516.

- Kaplowitz, N., Percy-Robb, I. W., and Javitt, N. B. (1973). Role of hepatic anion-binding protein in bromsulphthalein conjugation. *J. Exp. Med.* **138**, 483–487.
- Keller, P. (1971). Serum enzymes in cattle: organ analysis and normal values. *Schweiz. Arch. Tierhk.* **113**, 615–626.
- Keller, P. (1981). Enzyme activities in the dog: tissue analyses, plasma values, and intracellular distribution. *Am. J. Vet. Res.* **42**, 575–582.
- Keller, P., Ruedi, D., and Gutzwiller, A. (1985). Tissue distribution of diagnostically useful enzymes in zoo animals. *J. Zoo Anim. Med.* **16**, 28–49.
- Ketterer, S. G., Wiegand, B. D., and Rapapon, E. (1960). Hepatic uptake and biliary excretion of indocyanine green and its use in estimation of hepatic blood flow in dogs. *Am. J. Physiol.* **199**, 481–484.
- Kitamura, T., Jansen, P., Hardenbrook, C., Kamimoto, Y.I., Gatmaitan, Z., and Arias, I. M. (1990). Defective ATP-dependent bile canalicular transport of organic anions in mutant (TR-) rats with conjugated hyperbilirubinemia. *Proc. Natl. Acad. Sci. USA.* **87**, 3557–3561.
- Kokot, F., Grzybek, H., and Kuska, J. (1965). Experimental studies on gamma-glutamyl transpeptidase (GGTP). IV. Histo enzymatic and biochemical changes in parenchymatous hepatitis in rabbits and in obstructive jaundice in dogs. *Acta Med. Pol.* **6**, 379–388.
- Kroker, R., and Romer, C. (1984). The significance of serum bile acid concentrations as indicator of hepatic dysfunction in the mini-pig. *Zbl. Vet. Med.* **31**, 287–295.
- Laks, M. M., Pincus, I. J., and Goldberg, D. (1963). Renal excretion of bilirubin in the common duct ligated dog. *Gastroenterology* **44**, 469–474.
- Landaw, S. A., and Winchell, H. S. (1970). Endogenous production of <sup>14</sup>CO: a method for calculation of RBC life-span in vivo. *Blood* **36**, 642–656.
- Leaver, D. D. (1968). Sporidesmin poisoning in the sheep. II. A comparison of some changes in clinical signs and serum constituents following sporidesmin. *Res. Vet. Sci.* **9**, 265–273.
- Lee, F. K., Lee, A. Y. W., Lin, C. X. F., Chung, S. S. M., and Chung, S. K. (1995). Cloning, sequencing, and determination of the sites of expression of mouse sorbitol dehydrogenase cDNA. *Eur. J. Biochem.* **230**, 1059–1065.
- Levenson, S. M., and Tennant, B. (1963). Some metabolic and nutritional studies with germfree animals. *Fed. Proc.* **22**, 109–119.
- Levi, A. J., Gatmaitan, Z., and Arias, I. M. (1969). Two hepatic cytoplasmic protein fractions, Y and Z, and their possible role in the hepatic uptake of bilirubin, sulfobromophthalein, and other anions. *J. Clin. Invest.* **48**, 2156–2167.
- Levy, J. K., Crawford, P. C., and Werner, L. L. (2006). Effect of age on reference intervals of serum biochemical values in kittens. *J. Am. Vet. Med. Assoc.* **228**, 1033–1037.
- Levy, M., Lester, R., and Levinsky, N. G. (1968). Renal excretion of urobilinogen in the dog. *J. Clin. Invest.* **47**, 2117–2124.
- Listowsky, I., Gatmaitan, Z., and Arias, I. M. (1978). Ligandin retains and albumin loses bilirubin binding capacity in liver cytosol. *Proc. Nat. Acad. Sci. USA* **75**, 1213–1216.
- Loegering, D. J., and Critz, J. B. (1971). Effect of hypoxia and muscular activity on plasma enzyme levels in dogs. *Am. J. Physiol.* **220**, 100–104.
- Loud, A. V. (1968). A quantitative stereological description of the ultrastructure of normal rat liver parenchymal cells. *J. Cell Biol.* **37**, 27–46.
- Maddison, J. E. (1992). Hepatic encephalopathy. Current concepts of the pathogenesis. *J. Vet. Int. Med.* **6**, 341–353.
- Maden, M., Altunok, V., Birdane, F. M., Asian, F., and Nizamlioglu, M. (2003). Blood and colostrum/milk serum gamma-glutamyltransferase activity as a predictor of passive transfer status in lambs. *J. Vet. Med. B Infect. Dis. Vet. Public Health* **50**, 128–131.
- Malherbe, W. D., Kellerman, T. S., Krick, N. P. J., and Haupt, W. H. (1977). Gamma-glutamyl transpeptidase activity in sheep serum: normal values and an evaluation of its potential for detecting liver involvement in experimental lupinosis. *Onderstepoort J. Vet. Res.* **44**, 29–38.
- Mauad, T. H., van Nieuwkerk, C. M., Dingemans, K. P., Smit, J. J., Schinkel, A. H., Notenboom, R. G., van den Bergh Weerman, M. A., Verkruijsen, R. P., Groen, A. K., Oude Elferink, R. P., van Borst, M. A., and Offerhaus, G. J. A. (1994). Mice with homozygous disruption of the *mdr2* P-glycoprotein gene. A novel animal model for studies of nonsuppurative inflammatory cholangitis and hepatocarcinogenesis. *Am. J. Pathol.* **145**, 1237–1245.
- McCornico, R. S., Duckett, W. M., and Wood, P. A. (1997). Persistent hyperammonemia in two related Morgan weanlings. *J. Vet. Intern. Med.* **11**, 246–264.
- McGorum, B. C., Murphy, D., Love, S., and Milne, E. M. (1999). Clinicopathological features of equine primary hepatic disease: a review of 50 cases. *Vet. Rec.* **145**, 134–139.
- Meyer, D. J. (1983). Serum gamma-glutamyltransferase as a liver test in cats with toxic and obstructive hepatic disease. *J. Am. Anim. Hosp. Assoc.* **19**, 1023–1026.
- Meyer, D. J., and Noonan, N. E. (1981). Liver tests in dogs receiving anti-convulsant drugs (diphenylhydantoin and primidone). *J. Am. Anim. Hosp. Assoc.* **17**, 261–264.
- Mia, A. S., and Koger, H. D. (1978). Direct colorimetric determination of serum arginase in various domestic animals. *Am. J. Vet. Res.* **39**, 1381–1382.
- Morris, S. M., Bhamidipati, D., and Kepka-Lenhardt, D. (1997). Human type II arginase: sequence analysis and tissue-specific expression. *Gene* **193**, 157–161.
- Moursi, S. A. H., Atef, M., and Al-Khaygot, A. A. (1979). Hepatotoxicity of chloramphenicol in normal goats by the assay of serum enzyme activity. *Zbl. Vet. Med.* **26A**, 715–720.
- Muller, M., Ishikawa, R., Berger, U., Klunemann, C., Luckas, L., Schreyer, A., Kannich, C., Rutter, W., Kurz, C., and Keppler, K. (1991). ATP-dependent transport of taurocholate across the hepatocyte canalicular membrane mediated by a 110-kDa glycoprotein binding ATP and bile salt. *J. Biol. Chem.* **266**, 18920–18926.
- Munoz, M. E., Gonzalez, J., and Esteller, A. (1986). Bile pigment formation and excretion in the rabbit. *Comp. Biochem. Physiol. A* **85**, 67–71.
- Nagode, L. A., Koestner, A., and Steinmeyer, C. L. (1969a). Organ-identifying properties of alkaline phosphatases from canine tissues. *Clin. Chim. Acta* **26**, 45–54.
- Nagode, L. A., Koestner, A., and Steinmeyer, C. L. (1969b). The effects of purification and serum proteins on the organ identifying properties of alkaline phosphatases from canine tissues. *Clin. Chim. Acta* **26**, 55–65.
- Nance, F. C., Batson, R. C., and Kline, D. G. (1971). Ammonia production in germ-free Eck fistula dogs. *Surgery* **70**, 169–174.
- Nance, F. C., Kaufman, H. J., and Kline, D. G. (1974). Role of urea in the hyperammonemia of germ-free Eck fistula dogs. *Gastroenterology* **66**, 108–112.
- Nance, F. C., and Kline, D. G. (1971). Eck's fistula encephalopathy in germfree dogs. *Ann. Surg.* **174**, 856–862.
- Nichol, A. W., and Morrell, D. B. (1969). Tautomerism and hydrogen bonding in bilirubin and biliverdin. *Biochim. Biophys. Acta* **177**, 599–609.
- Nies, A. T., and Keppler, D. (2007). The apical conjugate efflux pump ABCB2 (MRP2). *Eur. J. Physiol.* **453**, 643–659.

- Nilkumhang, P., and Thornton, J. R. (1979). Plasma and tissue enzyme activities in the cat. *J. Small Anim. Pract.* **20**, 169–174.
- Nissim, I., Horyn, O., Luhovvy, B., Lazarow, A., Daikhin, Y., Nissim, I., and Yudkoff, M. (2003). Role of the glutamate dehydrogenase reaction in furnishing aspartate nitrogen for urea synthesis: studies in perfused rat liver with  $^{15}\text{N}$ . *Biochem. J.* **376**, 179–188.
- Nix, J. T., Flock, E. V., and Bollman, J. L. (1951a). Influence of cirrhosis on proteins of cisternal lymph. *Am. J. Physiol.* **164**, 117–118.
- Nix, J. T., Mann, F. C., Bollman, J. L., Grindlay, J. H., and Flock, E. V. (1951b). Alterations of protein constituents of lymph by specific injury to the liver. *Am. J. Physiol.* **164**, 119–122.
- Noir, B. A. (1976). Bilirubin conjugates in bile of man, rat and dog. Semi-quantitative analysis of bile composition by thin-layer chromatography. *Biochem. J.* **155**, 365–373.
- Noonan, N. E. (1981). Variations of plasma enzymes in the pony and the dog after carbon tetrachloride administration. *Am. J. Vet. Res.* **42**, 674–678.
- Noonan, N. E., and Meyer, D. J. (1979). Use of plasma arginase and gamma-glutamyl transpeptidase as specific indicators of hepatocellular or hepatobiliary disease in the dog. *Am. J. Vet. Res.* **40**, 942–947.
- Norenberg, M. D., Jayakumar, A. R., Rama, Rao, K. V., and Panickar, K. S. (2007). New concepts in the mechanism of ammonia-induced astrocyte swelling. *Metab. Brain Dis.* **22**, 219–234.
- Norenberg, M. D., Rao, K. V., and Jayakumar, A. R. (2005). Mechanisms of ammonia-induced astrocyte swelling. *Metab. Brain. Dis.* **20**, 303–318.
- Oliver, J. E., Jr. (1965). Hepatic neuropathies: a review with two case histories. *V. M. /S. A. C.* **60**, 498–502.
- Orloff, M. J., Lipman, C. A., Noel, S. M., Halasz, N. A., and Neesby, T. (1965). Hepatic regulation of aldosterone secretion by a humoral mediator. *Surgery* **58**, 225–247.
- Orloff, M. J., Ross, T. H., Baddeley, R. M., Nutting, R. O., Spitz, B. R., Sloop, R. D., Neesby, T., and Halasz, N. A. (1964a). Experimental ascites. VI. The effects of hepatic venous outflow obstruction and ascites on aldosterone secretion. *Surgery* **56**, 83–98.
- Orloff, M. J., and Snyder, G. B. (1961a). Experimental ascites. I. Production of ascites by gradual occlusion of the hepatic veins with an internal vena caval cannula. *Surgery* **50**, 789–797.
- Orloff, M. J., and Snyder, G. B. (1961b). Experimental ascites. II. The effects of portacaval shunts on ascites produced with an internal vena cava cannula. *Surgery* **50**, 220–230.
- Orloff, M. J., Spitz, B. R., Wall, M. H., Thomas, H. S., and Halasz, N. A. (1964b). Experimental ascites. IV. Comparison of the effects of end-to-side and side-to-side portacaval shunts on intractable ascites. *Surgery* **56**, 784–799.
- Orloff, M. J., Wall, M. H., Hickman, E. B., and Spitz, B. R. (1963). Experimental ascites. III. Production of ascites by direct ligation of hepatic veins. *Surgery* **54**, 539–627.
- Orloff, M. J., Wright, P. W., DeBenedetti, M. J., Halasz, N. A., Annetts, D. L., Musicant, M. E., and Goodhead, B. (1966). Experimental ascites. VII. The effects of external drainage of the thoracic duct on ascites and hepatic hemodynamics. *Arch. Surg.* **93**, 119.
- Ortega, L., Landa Garcia, J. I., Torres Garcia, A., Silecchia, G., Arenas, J., Suarez, A., Moreno Azcoitia, M., Sanz Esponera, J., Moreno Gonzalez, E., and Balibrea Cantero, J. L. (1985). Acetaminophen-induced fulminant hepatic failure in dogs. *Hepatology* **5**, 673–676.
- Parish, S. M., Tyler, J. W., Besser, T. E., Gay, C. C., and Krytenberg, D. (1997). Prediction of serum IgG1 concentration in Holstein calves using serum gamma glutamyltransferase activity. *J. Vet. Intern. Med.* **11**, 344–347.
- Paulusma, C. C., Bosma, P. J., Zaman, G. J., Bakker, C. T., Otter, M., Scheffer, G. L., Scheper, R. J., Borst, P., and Oude Elferink, R. P. (1996). Congenital jaundice in rats with a mutation in multidrug resistance-associated protein gene. *Science* **271**, 1126–1128.
- Paumgartner, G., Probst, P., Kraines, R., and Levy, C. D. (1970). Kinetics of indocyanine green removal from the blood. *Ann. NY Acad. Sci.* **170**, 134.
- Pearson, E. G. (1977). Clinical manifestations of tansy ragwort poisoning. *Mod. Vet. Pract.* **58**, 421–424.
- Pearson, E. G., Craig, A. M., and Rowe, K. (1992). Variability of serum bile acid concentrations over time in dairy cattle, and effect of feed deprivation on the variability. *Am. J. Vet. Res.* **53**, 1780–1783.
- Peek, S. F., Divers, T. J., and Jackson, C. J. (1997). Hyperammonemia associated with encephalopathy and abdominal pain with evidence of liver disease in four mature horses. *Equine Vet. J.* **29**, 70–74.
- Pekarthy, J. M., Short, J., Lansing, A. I., and Lieberman, I. (1972). Function and control of liver alkaline phosphatase. *J. Biol. Chem.* **247**, 1767–1774.
- Pembleton-Corbett, J. R., Center, S. A., Schermerhorn, T., Yeager, A. E., and Erb, H. N. (2000). Serum-effusion albumin gradient in dogs with transudative abdominal effusion. *J. Vet. Intern. Med.* **14**, 613–618.
- Perino, L. J., Suterland, R. L., and Woolen, N. E. (1993). Serum gamma-glutamyltransferase activity and protein concentration at birth and after suckling in calves with adequate and inadequate passive transfer of immunoglobulin G. *Am. J. Vet. Res.* **54**, 56–59.
- Peterson, M. E., Kintzer, P. P., Cavanagh, P. G., Fox, P. R., Ferguson, D. C., Johnson, G. F., and Becker, D. V. (1983). Feline hyperthyroidism: pretreatment clinical and laboratory evaluation of 131 cases. *J. Am. Vet. Med. Assoc.* **183**, 103–110.
- Pimstone, N. R., Engel, P., Tenhunen, R., Seitz, P. T., Marver, H. S., and Schmid, R. (1971). Inducible heme oxygenase in the kidney: a model for the homeostatic control of hemoglobin catabolism. *J. Clin. Invest.* **50**, 2042–2050.
- Putnam, M. R., Qualls, C. W., Rice, L. E., Dawson, L. J., and Edwards, W. C. (1986). Hepatic enzyme changes in bovine hepatogenous photosensitivity caused by water-damaged alfalfa hay. *J. Am. Vet. Med. Assoc.* **189**, 77–82.
- Ramadori, G., Heinz, H.-P., Martur, H., zum Buschenfelde, K.-H. M., and Loos, M. (1986). Biosynthesis of the subcomponents C1q, C1r and C1s of the first component of complement (C1) by guinea pig hepatocyte primary cultures. *Eur. J. Immunol.* **16**, 667–687.
- Rej, R. (1989). Aminotransferases in disease. *Clin. Lab. Med.* **9**, 667–687.
- Rico, A. G., Braun, J. P., Benard, P., El-Hassan, A. A., and Caziueux, A. (1977a). Tissue distribution and blood levels of gamma-glutamyl transferase in the horse. *Equine Vet. J.* **9**, 100–101.
- Rico, A. G., Braun, J. P., Benard, P. C., and Thouvelot, J. P. (1977b). Blood and tissue distribution of gamma glutamyl transferase in the cow. *J. Dairy Sci.* **60**, 1283–1287.
- Rico, A. G., Braun, J. P., Benard, P. C., and Thouvelot, J. P. (1977c). Tissue and blood gamma-glutamyl transferase distribution in the pig. *Res. Vet. Sci.* **23**, 395–396.
- Riemerschmid, G., and Quin, J. I. (1941). Studies on the photosensitization of animals in South Africa. XI. The reaction of the sensitized Merino skin to radiation in different regions of the spectrum. *Onderstepoort J. Vet. Sci. Anim. Ind.* **17**, 89–104.
- Righetti, A. B.-B., and Kaplan, M. M. (1972). Disparate responses of serum and hepatic alkaline phosphatase and 5' nucleotidase to bile duct obstruction in the rat. *Gastroenterology* **62**, 1034–1039.
- Rimington, C., and Quin, J. I. (1934). Studies on the photosensitization of animals in South Africa. VII. The nature of the photosensitizing agent in Geeldikkop. *Onderstepoort J. Vet. Sci. Anim. Ind.* **3**, 137–157.

- Robinson, S. H., Tsong, M., Brown, B. W., and Schmid, R. (1966). The sources of bile pigment in the rat: studies of the "early labeled" fraction. *J. Clin. Invest.* **45**, 1569–1586.
- Rogers, W. A. (1976). Source of serum alkaline phosphatase in clinically normal and diseased dogs: a clinical study. *J. Amer. Vet. Med. Assoc.* **168**, 934–937.
- Rose, A. L., Gardner, C. A., McConnell, J. D., and Bull, L. B. (1957). Field and experimental investigation of "walk about" disease of horses (Kimberley horse disease) in Northern Australia: crotalaria poisoning in horses. Part II. *Aust. Vet. J.* **33**, 49–62.
- Ross, D. B. (1966). The diagnosis, prevention and treatment of chronic copper poisoning in housed lambs. *Br. Vet. J.* **122**, 279–284.
- Rothenberg, M. E., and Keeffe, E. B. (2005). Antibiotics in the management of hepatic encephalopathy: an evidence-based review. *Rev. Gastroenterol. Disord.* **5**, 26–35.
- Rothschild, M. A., Gratz, M., and Schreiber, S. S. (1973). Albumin metabolism. *Gastroenterology* **64**, 324–337.
- Royer, M., Noir, B., de Walz, A. T., and Lozzio, B. (1965). Bilirubin conjugation in hepatectomized dogs. *Rev. Int. Hepat.* **15**, 1351–1357.
- Royer, M., Noir, B. A., Sfarich, D., and Nanet, H. (1974). Extrahepatic bilirubin formation and conjugation in the dog. *Digestion* **10**, 423–434.
- Ruegnitz, P. C., and Schwartz, E. (1971). Effects of chemical inhibition of alkaline phosphatase isoenzymes in the dog. *Am. J. Vet. Res.* **32**, 1525–1531.
- Ryter, S. W., Alam, J., and Choi, A. M. (2006). Heme oxygenase-1/carbon monoxide: from basic science to therapeutic applications. *Physiol. Rev.* **86**, 583–650.
- Saha, J. K., Xia, J., Sandusky, G. E., Chen, YU. F., Gerlitz, B., Grinnell, B., and Jakubowski, J. A. (2007). Study of plasma protein C and inflammatory pathways: biomarkers for dimethylnitrosamine-induced liver fibrosis in rats. *Eur. J. Pharmacol.* **575**, 158–167.
- Sanecki, R. K., Hoffmann, W. E., Dorner, J. L., and Kuhlenschmidt, M. S. (1990). Purification and comparison of corticosteroid-induced and intestinal isoenzymes of alkaline phosphatase in dogs. *Am. J. Vet. Res.* **51**, 1964–1968.
- Sanecki, R. K., Hoffmann, W. E., Gelberg, H. B., and Dorner, J. L. (1987). Subcellular location of corticosteroid-induced alkaline phosphatase in canine hepatocytes. *Vet. Pathol.* **24**, 296–301.
- Sassa, S. (2004). Why heme needs to be degraded to iron, biliverdin IX alpha, and carbon monoxide? *Antioxid. Redox Signal.* **6**, 819–824.
- Sato, T. (1984). Application of indocyanine green clearance test in dairy cows. *Jpn. J. Vet. Sci.* **46**, 687–692.
- Schermerhorn, T., Center, S. A., Dykes, N. L., Rowland, P. H., Yeager, A. E., Erb, H. N., Oberhansley, K., and Bonda, M. (1996). Characterization of hepatoportal microvascular dysplasia in a kindred of cairn terriers. *J. Vet. Intern. Med.* **10**, 219–230.
- Schilling, J. A., McCoord, A. B., Clausen, S. W., Troup, S. B., and McKee, F. W. (1952). Experimental ascites; studies of electrolyte balance in dogs with partial and complete occlusion of the portal vein and of the vena cava above and below the liver. *J. Clin. Invest.* **31**, 702–710.
- Schlaeger, R., Haux, P., and Kattermann, P. (1982). Studies on the mechanism of the increase in serum alkaline phosphatase activity in cholestasis: significance of the hepatic bile acid concentration for the leakage of alkaline phosphatase from rat liver. *Enzyme* **28**, 3–13.
- Schmid, R. (1956). Direct-reacting bilirubin, bilirubin glucuronide, in serum, bile and urine. *Science* **124**, 76–77.
- Schothorst, A. A., Van Steveninck, J., Went, L. N., and Suurmond, D. (1970). Protoporphyrin-induced photohemolysis in protoporphyria and in normal red blood cells. *Clin. Chim. Acta* **28**, 41–49.
- Schwarz, M., Russell, D. W., Dietschy, J. M., and Turley, S. D. (1998). Marked reduction in bile acid synthesis in cholesterol 7 $\alpha$ -hydroxylase-deficient mice does not lead to diminished tissue cholesterol turnover or to hypercholesterolemia. *J. Lipid Res.* **39**, 1833–1843.
- Scott, D. W., Mort, J. D., and Tennant, B. C. (1979). Dermatohistopathologic changes in bovine congenital porphyria. *Cornell Vet.* **69**, 145–158.
- Sebesta, D. G., Bradshaw, F. J., and Prockop, D. J. (1964). Source of the elevated serum alkaline phosphatase activity in biliary obstruction: studies utilizing isolated liver perfusion. *Gastroenterology* **47**, 166–170.
- Seetharam, S., Sussman, N. L., Komoda, T., and Alpers, D. H. (1986). The mechanism of elevated alkaline phosphatase activity after bile duct ligation in the rat. *Hepatology* **6**, 374–380.
- Selman, I. E., Wiseman, A., Petrie, L., Pirie, H. M., and Breeze, R. G. (1974). A respiratory syndrome in cattle resulting from thrombosis of the posterior vena cava. *Vet. Rec.* **94**, 459–466.
- Shi, O., Kepka-Lenhardt, D., Morris, S. M., and O'Brien, W. E. (1998). Structure of the murine arginase II gene. *Mamm. Genome* **9**, 822–824.
- Shaw, F. D. (1976). The effect of mercuric chloride intoxication on urinary psi-glutamyl transpeptidase excretion in the sheep. *Res. Vet. Sci.* **20**, 226–228.
- Shull, R. M., and Hornbuckle, W. (1979). Diagnostic use of serum gamma-glutamyltransferase in canine liver disease. *Am. J. Vet. Res.* **40**, 1321–1324.
- Simesen, M., Nielsen, K., and Nansen, P. (1973). Some effects of experimental *Fasciola hepatica* infection in cattle on the serum activities of gamma-glutamyl transpeptidase and glutamic oxaloacetic transaminase. *Res. Vet. Sci.* **15**, 32–36.
- Slater, T. F., and Riley, P. A. (1966). Photosensitization and lysosomal damage. *Nature* **209**, 151–154.
- Solter, P. F., and Hoffmann, W. E. (1995). Canine corticosteroid-induced alkaline phosphatase in serum was solubilized by phospholipase activity in vivo. *Am. J. Physiol.* **32**, G278–G286.
- Solter, P. F., and Hoffmann, W. E. (1999). Solubilization of liver alkaline phosphatase isoenzyme during cholestasis in dogs. *Am. J. Vet. Res.* **66**, 1010–1015.
- Spano, J. S., August, J. R., Henderson, R. A., Dumas, M. B., and Groth, A. H. (1983). Serum gamma-glutamyl transpeptidase activity in healthy cats and cats with induced hepatic disease. *Am. J. Vet. Res.* **44**, 2049–2053.
- Stabenau, J. R., Warren, K. S., and Rail, D. P. (1959). The role of pH gradient in the distribution of ammonia between blood and cerebrospinal fluid, brain and muscle. *J. Clin. Invest.* **38**, 373–383.
- Starling, E. H. (1894). The influence of mechanical factors on lymph production. *J. Physiol.* **16**, 224–267.
- Stein, T. A., Burns, G. P., and Wise, L. (1989). Diagnostic value of liver function tests in bile duct obstruction. *J. Surg. Res.* **46**, 226–229.
- Stickle, J. E., McKnight, C. A., Williams, K. J., and Carr, E. A. (2006). Diarrhea and hyperammonemia in a horse with progressive neurologic signs. *Vet. Clin. Path.* **35**, 250–253.
- Stieger, B., Meier, Y., and Meier, P. J. (2007). The bile salt export pump. *Pflugers. Arch.* **453**, 611–620.
- Strombeck, D. R., Weiser, M. G., and Kaneko, J. J. (1975b). Hyperammonemia and hepatic encephalopathy in the dog. *J. Amer. Vet. Med. Assoc.* **166**, 1105–1108.
- Strombeck, D. R., Meyer, D. J., and Freedland, R. A. (1975a). Hyperammonemia due to a urea cycle enzyme deficiency in two dogs. *J. Amer. Vet. Med. Assoc.* **166**, 1109–1111.

- Sutherland, R. J., Cordes, D. O., and Carthew, G. C. (1979). Ovine white liver disease—an hepatic dysfunction associated with vitamin B12 deficiency. *New Zealand Vet. J.* **17**, 227–232.
- Takikawa, H., Sano, N., Narita, T., Uchida, Y., Yamanaka, M., Horie, T., Mikami, T., and Tagaya, O. (1991). Biliary excretion of bile acid conjugates in a hyperbilirubinemic mutant Sprague-Dawley rat. *Hepatology* **14**, 352–360.
- Tal, M., Schneider, D. L., Thorens, B., and Lodish, H. F. (1990). Restricted expression of the erythroid/brain glucose transporter isoform to perivenous hepatocytes in rats: modulation by glucose. *J. Clin. Invest.* **86**, 986–992.
- Talafant, E. (1956). Properties and composition of the bile pigment giving a direct diazo reaction. *Nature* **178**, 312.
- Tenhunen, R., Marver, H. S., and Schmid, R. (1968). The enzymatic conversion of heme to bilirubin by microsomal heme oxygenase. *Proc. Natl. Acad. Sci. USA* **61**, 748–755.
- Tenhunen, R., Marver, H. S., and Schmid, R. (1969). Microsomal heme oxygenase. Characterization of the enzyme. *J. Biol. Chem.* **244**, 6388–6394.
- Tenhunen, R., Marver, H. S., and Schmid, R. (1970a). The enzymatic catabolism of hemoglobin: stimulation of microsomal heme oxygenase by hemin. *J. Lab. Clin. Med.* **75**, 410–421.
- Tenhunen, R., Ross, M. E., Marver, H. S., and Schmid, R. (1970b). Reduced nicotinamide-adenine dinucleotide phosphate dependent biliverdin reductase: partial purification and characterization. *Biochemistry* **9**, 298–303.
- Tennant, B. C. (1998). Lessons from the porphyrias of animals. *Clin. Dermatol.* **16**, 307–315.
- Tennant, B., Baldwin, B., Evans, C. D., and Kaneko, J. J. (1975). Diseases of the equine liver. *21st Proc. Am. Assoc. Equine Pract.*, 410–426.
- Tennant, B., Evans, C. D., Schwartz, L. W., Gribble, D. H., and Kaneko, J. J. (1973). Equine hepatic insufficiency. *Vet. Clin. North Am.* **3**, 279–289.
- Tessman, R. K., Tyler, J. W., Parish, S. M., Johnson, D. L., Grant, R. G., and Grasseschi, H. A. (1997). Use of age and serum gamma-glutamyltransferase activity to assess passive transfer status in lambs. *J. Am. Vet. Med. Assoc.* **211**, 1163–1164.
- Thomsett, L. R. (1971). Acute hepatic failure in the horse. *Equine Vet. J.* **3**, 15–19.
- Toulza, O., Center, S. A., Brooks, M. B., Erb, H. N., Warner, K. L., and Deal, W. (2006). Evaluation of plasma protein C activity for detection of hepatobiliary disease and portosystemic shunting in dogs. *J. Am. Vet. Med. Assoc.* **229**, 1761–1771.
- Towers, N. R., and Stratton, C. G. (1978). Serum gamma-glutamyltransferase as a measure of sporidesmin-induced liver damage in sheep. *New Zealand Vet. J.* **26**, 109–112.
- Trauner, M., and Boyer, J. L. (2003). Bile salt transporters: molecular characterization, function, and regulation. *Physiol. Rev.* **83**, 633–671.
- Treacher, R. J., and Sansom, B. F. (1969). Liver function in dairy cows at parturition. *Res. Vet. Sci.* **10**, 461–468.
- Treacher, R. J., and Collis, K. A. (1977). The effect of protein intake on the activities of liver specific enzymes in the plasma of dairy cows. *Res. Vet. Sci.* **22**, 101–104.
- Uchiyama, Y., and Asari, A. (1984). A morphometric study of the variations in subcellular structures of rat hepatocytes during 24 hours. *Cell Tissue Res.* **236**, 305–315.
- Unglaub, W., Afschar, A., and Marx, D. (1973). Activity of gamma-GT (gamma-glutamyltransferase) in bovine serum. *Dtsch. Tierarztl. Wschr.* **80**, 131–134.
- Valentine, B. A., Blue, J. T., Shelley, S. M., and Cooper, B. J. (1990). Increased serum alanine aminotransferase activity associated with muscle necrosis in the dog. *J. Vet. Intern. Med.* **4**, 140–143.
- Van Leenhoff, J. W., Hickman, R., Saunders, S. J., and Terblanche, J. (1974). Massive liver cell necrosis induced in the pig with carbon tetrachloride. *S. Afr. Med. J.* **12**, 1201–1204.
- Van Vleet, J. F., and Alberts, J. O. (1968). Evaluation of liver function tests and liver biopsy in experimental carbon tetrachloride intoxication and extrahepatic bile duct obstruction in the dog. *Am. J. Vet. Res.* **29**, 2119–2131.
- Volwiler, W., Grindlay, J. H., and Bollman, J. L. (1950). The relation of portal vein pressure to the formation of ascites; an experimental study. *Gastroenterology* **14**, 40–55.
- Vreman, H. J., Wong, R. J., Sanesi, C. A., Dennery, P. A., and Stevenson, D. K. (1998). Simultaneous production of carbon monoxide and thiobarbituric acid reactive substances in rat tissue preparations by an iron-ascorbate system. *Can. J. Physiol. Pharmacol.* **76**, 1057–1065.
- Wang, P., Wang, J. J., Xiao, Y., Murray, J. W., Novikoff, P. M., Angeletti, R. H., Orr, G. A., Lan, D., Silver, D. L., and Wolkoff, A. W. (2005). Interaction with PDZK1 is required for expression of organic anion transporting protein 1A1 on the hepatocyte surface. *J. Biol. Chem.* **280**, 30143–30149.
- Warren, D., Cornelius, C., and Ford, B. (1984). Liver function studies on rhesus monkeys (*Macaca mulatta*) following the administration of hydrazine sulfate. *Hum. Toxicol.* **26**, 295–299.
- Warren, K. S., and Nathan, D. G. (1958). The passage of ammonia across the blood-brain-barrier and its relation to blood pH. *J. Clin. Invest.* **37**, 1724–1728.
- Washizu, T., Washizu, M., Zhang, C., Matsumoto, I., Sawamura, M., and Suzuki, T. (2004). A suspected case of ornithine transcarbamylase deficiency in a cat. *J. Vet. Med. Sci.* **66**, 701–703.
- Webster, C., and Anwer, A. (1998). Cyclic adenosine monophosphate mediated protection from bile acid induced apoptosis in cultured rat hepatocytes. *Hepatology* **27**, 1324–1331.
- Webster, C. R. L., and Anwer, M. S. (2001). Phosphoinositide 3-kinase, but not mitogen activated protein kinase, pathway is involved in hepatocyte growth factor mediated protection against bile acid induced apoptosis in cultured rat hepatocytes. *Hepatology* **33**, 608–615.
- Webster, C. R. L., Usechak, P., and Anwer, M. S. (2002). cAMP inhibits bile-acid induced apoptosis by blocking caspase activation and cytochrome c release. *Am. J. Physiol. Gastrointest. Liver Physiol.* **283**, G727–G738.
- Webster, C. R., Usechak, P., and Anwer, M. S. (2002). cAMP inhibits bile acid-induced apoptosis by blocking caspase activation and cytochrome C release. *Am J Physiol Gastrointest Liver Physiol* **283**, G727–738.
- Witte, C. L., Chung, Y. C., Witte, M. H., Sterle, O. F., and Coke, W. R. (1969a). Lymph circulation in hepatic cirrhosis: effect of portacaval shunt. *Ann. Surg.* **170**, 1002–1015.
- Wolff, W. A., Lumb, W. V., and Ramsay, M. K. (1967). Effects of halothane and chloroform anesthesia on the equine liver. *Am. J. Vet. Res.* **28**, 1363–1372.
- Wellman, M. L., Hoffmann, W. E., Domer, J. L., and Mock, R. E. (1982a). Comparison of the steroid-induced, intestinal, and hepatic isoenzymes of alkaline phosphatase in the dog. *Am. J. Vet. Res.* **43**, 1204–1207.
- Wellman, M. L., Hoffmann, W. E., Domer, J. L., and Mock, R. E. (1982b). Immunoassay for the steroid-induced isoenzyme of alkaline phosphatase in the dog. *Am. J. Vet. Res.* **43**, 1200–1203.
- Wensing, T., Schotman, A. J. H., and Kroneman, J. (1973). Various new clinical chemical data in the blood of normal ponies and ponies affected with hyperlipaemia (hyperlipoproteinaemia). *Tidjschr. Diergeneesk.* **14**, 673–680.

- West, H. M. (1991). Evaluation of total serum bile acid concentrations for the diagnosis of hepatobiliary disease in cattle. *Res. Vet. Sci.* **51**, 133–140.
- Whitlock, R. H., and Brown, W. R. (1969). Chronic cholangiohepatitis in a dairy cow. A case report. *Cornell Vet.* **59**, 515–524.
- Wigton, D. H., Kociba, G. J., and Hoover, E. A. (1976). Infectious canine hepatitis: animal model for viral-induced disseminated intravascular coagulation. *Blood* **47**, 287–296.
- Wilson, G. D., Harvey, D. G., and Snook, C. R. (1972). A review of factors affecting blood biochemistry in the pig. *Br. Vet. J.* **128**, 596–610.
- Windmueller, H. G., and Spaeth, A. E. (1974). Uptake and metabolism of plasma glutamine by the small intestine. *J. Biol. Chem.* **249**, 5070–5079.
- Wion, K. L., Kelly, D., Summerfield, J. A., and Tuddenham, E. G. (1985). Distribution of factor VIII mRNA and antigen in human liver and other tissues. *Nature* **317**, 726–729.
- Wisse, E., DeZanger, R. B., Charles, K., van der Smissen, P., and McCuskey, R. S. (1985). The liver sieve: considerations concerning the structure and function of endothelial fenestrae, the sinusoidal wall and the space of Disse. *Hepatology* **5**, 683–692.
- With, T. K. (1968). Bile pigments in feces. In “Chemical, Biological and Clinical Aspects,” pp. 585–613. Academic Press, New York.
- Witte, C. L., Chung, Y. C., Witte, M. H., Sterle, O. F., and Coke, W. R. (1969a). Lymph protein in hepatic cirrhosis and experimental hepatic and portal venous hypertension. *Ann. Surg.* **170**, 1002–1015.
- Witte, C. L., Witte, M. H., Dumont, A. E., Frist, J., and Cole, W. R. (1968). Lymph protein in hepatic cirrhosis and experimental hepatic and portal venous hypertension. *Ann. Surg.* **168**, 567–577.
- Witte, C. L., Witte, M. H., Kintner, K., Cole, W. R., and Dumont, A. E. (1971a). Colloid osmotic pressure in hepatic cirrhosis and experimental ascites. *Surg. Gynecol. Obstet.* **133**, 65–71.
- Witte, M. H., Dumont, A. E., Cole, W. R., Witte, C. L., and Kintner, K. (1969b). Lymph circulation in hepatic cirrhosis: effect of portacaval shunt. *Ann. Intern. Med.* **70**, 303–310.
- Witte, M. H., Witte, C. L., and Dumont, A. E. (1971b). Progress in liver disease: physiological factors involved in the causation of cirrhotic ascites. *Gastroenterology* **61**, 742–750.
- Wolkoff, A. W., Sosiak, A., Greenblatt, H. C., Van Renswoude, J., and Stockert, R. J. (1985). Immunological studies of an organic anion-binding protein isolated from rat liver cell plasma membrane. *J. Clin. Invest.* **76**, 454–459.
- Yamaoka, S., Ikeda, S., Watanabe, H., Nagasawa, Y., Takizawa, I., and Hasegawa, M. (1978). Clinical and enzymological findings of tying-up syndrome in Thoroughbred racehorses in Japan. *Exp. Rep. Equine Hlth. Lab.* **15**, 62–78.
- Zakim, D. (1996). In “Hepatology: A Textbook of Liver Disease” (D. Zakim, and T.D. Boyer, Eds.), 3rd ed., vol. 1, p. 58. Saunders, Philadelphia.
- Zawie, D. A., and Garvey, M. S. (1984). Feline hepatic disease. *Vet. Clin. North Am.* **14**, 1201–1230.
- Zieve, F. J., Zieve, L., Doizaki, W. M., and Gilsdorf, R. B. (1974). Synergism between ammonia and fatty acids in the production of coma: implications for hepatic coma. *Pharmacol. Exp. Ther.* **191**, 10–16.
- Zieve, L., Nicoloff, D. M., and Mahadevan, V. (1968). Effect of hepatectomy on volatile free fatty acids of the blood. *Gastroenterology* **54**, 1285.
- Zinkl, J. G., Bush, R. M., Cornelius, C. E., and Freedland, R. A. (1971). Comparative studies on plasma and tissue sorbitol, glutamic, lactic and hydroxybutyric dehydrogenase and transaminase activities in the dog. *Res. Vet. Sci.* **12**, 211–214.
- Zakim, D. (1996). Hepatology, a textbook of liver disease. In “Hepatology, A Textbook of Liver Disease, 3rd Ed.” (D. Zakim and T. D. Boyer, Eds.), Vol. 1, p. 58. W. B. Saunders Co., Philadelphia.

# Gastrointestinal Function

**William E. Hornbuckle**

*Department of Clinical Sciences  
New York State College of Veterinary Medicine  
Cornell University  
Ithaca, New York*

**Kenneth W. Simpson**

*Department of Clinical Sciences  
New York State College of Veterinary Medicine  
Cornell University  
Ithaca, New York*

**Bud C. Tennant**

*Department of Clinical Sciences  
New York State College of Veterinary Medicine  
Cornell University  
Ithaca, New York*

## I. INTRODUCTION

## II. SALIVARY SECRETIONS

- A. Mechanisms of Secretion
- B. Composition of Saliva
- C. Functions of Saliva

## III. GASTRIC SECRETIONS

- A. Composition of Gastric Secretions
- B. Control of Gastric Secretion

## IV. BILIARY SECRETIONS

- A. Composition of Bile
- B. Properties of Bile
- C. Synthesis of Bile Acids
- D. Enterohepatic Circulation of Bile Acids

## V. EXOCRINE PANCREATIC SECRETIONS

- A. Composition of Pancreatic Juice
- B. Control of Pancreatic Secretions

## VI. OTHER GASTROINTESTINAL HORMONES

- A. Motilin
- B. Somatostatin
- C. Enteroglucagon

## VII. DIGESTION AND ABSORPTION

- A. Water and Electrolytes
- B. Carbohydrate Digestion and Absorption
- C. Proteins
- D. Lipids
- E. Cobalamin

## VIII. DISTURBANCES OF GASTROINTESTINAL FUNCTION

- A. Vomition
- B. Gastric Dilatation-Volvulus
- C. Ischemia-Reperfusion Injury
- D. Acute Diarrheas
- E. Malabsorption
- F. Tests of Malabsorption
- G. Bacterial Overgrowth
- H. Helicobacteria
- I. Intestinal Permeability
- J. Protein-Losing Enteropathy
- K. Ulcerative Colitis

L. Equine Hyperammonemia

M. Clostridial-Associated Diseases in Horses and Cows

## IX. DISTURBANCES OF RUMEN FUNCTION

- A. Acute Rumen Indigestion (Rumen Overload, Lactic Acidosis)
- B. Acute Rumen Tympany (Bloat)
- C. Urea Poisoning

## REFERENCES

## I. INTRODUCTION

The digestive system is composed of the gastrointestinal (GI) tract or the alimentary canal, salivary glands, the liver, and the exocrine pancreas. The principal functions of the gastrointestinal tract are to digest and absorb ingested nutrients and to excrete waste products of digestion. Most nutrients are ingested in a form that is either too complex for absorption or insoluble and therefore indigestible or incapable of being digested. Within the GI tract, much of these substances are solubilized and further degraded enzymatically to simple molecules, sufficiently small in size and in a form that permits absorption across the mucosal epithelium. This chapter describes the normal biochemical processes of intestinal secretion, digestion, and absorption. Once these issues have been put in perspective, the chapter explores the pathogenesis of the important gastrointestinal diseases of domestic animals and the biochemical basis for their diagnosis and treatment.

## II. SALIVARY SECRETIONS

### A. Mechanisms of Secretion

Saliva is produced by three major pairs of salivary glands and by small glands distributed throughout the buccal mucosa and submucosa. Two types of secretory cells are found in the acinar portions of the salivary glands: (1) the mucous cells, which contain droplets of mucus, and (2) the serous cells, which contain multiple secretory granules.



In those species that produce salivary amylase (e.g., pig and human), the secretory granules are the zymogen precursors of this enzyme. A third cell type is found lining the striated ducts. The striations along the basal borders of these cells are caused by vertical infoldings of the cell membrane, a characteristic of epithelial cells involved in rapid movement of water and electrolytes. The primary secretion of the acinar cells is modified by active transport processes of the ductal epithelium.

The distribution of the different types of secretory cells in the salivary glands varies among species. The parotid glands of most animals are serous glands, which produce a secretion of low-specific gravity and osmolality containing electrolytes and proteins including certain hydrolytic enzymes. The mandibular (submaxillary) and sublingual glands are mixed salivary glands that contain both mucous and serous types of cells and produce a more viscous secretion that contains large amounts of mucus (Dukes, 1955).

## B. Composition of Saliva

### 1. Mucus

Mucus is an aqueous mixture of proteoglycans and glycoproteins. One of the most completely studied glycoproteins is mucin. Salivary mucins are O-glycosylated and consist of peptides with many oligosaccharides linked covalently to the hydroxyamino acid serine or threonine. The carbohydrate portion of submaxillary mucin from sheep is a disaccharide of N-acetylneuraminic acid (sialic acid) and N-acetylgalactosamine (Carlson *et al.*, 1973). The enzymes that link protein with hexosamine have been purified from the mandibular glands of sheep (Carlson *et al.*, 1973) and swine (Schachter *et al.*, 1971).

The physiological functions of mucin are related to its high viscosity. N-acetylneuraminic acid is the component responsible for the formation of viscous aqueous solutions and, at physiological pH, causes expansion and stiffening of the mucin molecule. The resistance of mucin to enzymatic

breakdown is also due to the presence of disaccharide residues. Removal of terminal N-acetylneuraminic acid residues by action of neuraminidase significantly increases the susceptibility of peptide bonds to trypsin.

### 2. Electrolytes

The principal inorganic constituents of saliva are sodium, potassium, chloride, and bicarbonate, which, with the exception of bicarbonate, originate directly from the plasma. Rates of salivary flow vary depending on stimulation, and there are wide variations in electrolyte concentration. Saliva is formed by a process that initially requires uptake of sodium and other electrolytes from the interstitium of the terminal structural unit of the salivary gland, the acinus or end piece. Water flows passively. This primary or precursor fluid has a sodium concentration similar to plasma, and the potassium concentration is similar to or slightly higher than plasma. As the primary fluid passes from the acinus along the duct system, the concentration of sodium, potassium, and other electrolytes changes. In most species, there is net sodium absorption and potassium secretion. Wide variations in electrolyte composition may occur depending on the flow rate (Young and Schneyer, 1981), the salivary gland of origin, and the species (Table 14-1).

### 3. Amylase

The saliva of rodents contains the  $\alpha$ -amylase, ptyalin, but this enzyme activity is absent in the saliva of dogs, cats, horses, cattle, and sheep (Dukes, 1955; Young and Schneyer, 1981). Salivary amylase splits the  $\alpha$ 1,4-glycosidic bonds of various polysaccharides. Salivary amylase is similar in major respects to pancreatic  $\alpha$ -amylase, which is described in Section V.B. Salivary amylase initiates digestion of starch and glycogen in the mouths of those species that secrete the enzyme. The optimal pH for amylase activity is approximately 7, so that this activity ceases when the enzyme mixes with acidic gastric contents.

**TABLE 14-1** Electrolyte Concentration of Mandibular Gland and Parotid Gland Saliva Observed during Maximum Rates of Secretion (mmol/l)

	Mandibular Gland			Parotid Gland		
	Na <sup>+</sup>	K <sup>+</sup>	HCO <sub>3</sub> <sup>-</sup>	Na <sup>+</sup>	K <sup>+</sup>	HCO <sub>3</sub> <sup>-</sup>
Sheep	20	7	23	160–175	9–10	113–140
Dog	70–100	12–15	10–30	80–110	6–14	50
Cat	40–51	9–10	26	—	—	—
Rabbit	50–100	10–40	25	110–140	10	12–30

#### 4. Lipase

Lingual lipase is secreted by Von Ebner's gland of the tongue and is important in the digestive processes of the human newborn, rats, and preruminant calves (Cook *et al.*, 1994; Plucinski *et al.*, 1979).

### C. Functions of Saliva

Saliva continuously bathes the oral cavity, which protects the surface epithelium. Ingested food is moistened and lubricated by saliva, thereby facilitating mastication and swallowing. Saliva also protects teeth from decay by washing food particles from the surfaces of the teeth and using its buffering capacity to neutralize the organic acids produced by bacteria normally present in the mouth. Saliva is necessary for vocalization, and, in some species that groom themselves, saliva promotes cooling as it evaporates. Additionally, it may be a source of pheromones. Salivary glands contain large numbers of growth factors, vasoactive serine proteases, and regulatory peptides (Cook *et al.*, 1994). There is reason to believe that these glandular constituents affect a wide range of biological functions not necessarily limited to the alimentary system.

Ruminants produce much greater quantities of saliva than do simple-stomached animals, and their saliva has a higher pH and bicarbonate ion concentration. In ruminants, saliva serves several unique functions (Phillipson, 1977). It is required for maintenance of the fluid composition of the contents of the rumen. The great buffering capacity of ruminant saliva is necessary to neutralize the large amounts of organic acids that are end products of rumen fermentation.

Rumen bacteria for protein synthesis can utilize the urea in saliva. Protein synthesized in the rumen is then used to meet dietary protein requirements. In this way, urea nitrogen can be "recycled" through the amino acid pool of the body, and in ruminants it need not be considered an end stage in protein catabolism. The ability to reutilize urea has also been demonstrated in the horse, and this may be of particular benefit during periods of protein deficiency (Houpt and Houpt, 1971).

### III. GASTRIC SECRETIONS

The stomach is divided into two main regions on the basis of secretory function. The oxyntic gland area corresponds approximately to the body of the stomach in most species of domestic animals and also to the fundus in the dog and cat. The oxyntic glands contain (1) oxyntic or parietal cells that produce hydrochloric (HCl) acid, (2) peptic (zymogenic, chief) cells that produce pepsinogen, and (3) mucous cells. The pyloric gland area contains mucus-producing pyloric glands whose secretion is slightly alkaline. This area also contains the G cells, which produce the polypeptide hormone, gastrin.

### A. Composition of Gastric Secretions

#### 1. Basal versus Stimulated Secretion

There are two components of gastric secretion. The surface epithelial cells and other mucus-producing cells continuously secrete the basal component. This component is neutral or slightly alkaline pH. The electrolyte composition is similar to that of an ultrafiltrate of plasma (Table 14-2). The basal secretion contains large amounts of mucus, which has a cytoprotective effect on the epithelium. The secretory component produced by the oxyntic gland cells in response to stimulation contains free HCl and pepsinogen, the principal enzyme of gastric digestion.

The composition of gastric juice depends on the relative amounts of the basal and secretory components in the juice and, in turn, is a function of the flow rate of each. In the dog, gastric juice is produced in the resting state at a rate of approximately 5 ml/h. The composition is similar to that of the basal component, containing practically no peptic activity or HCl. When the flow of gastric juice is stimulated maximally, the dog may produce 80 ml or more per hour of a secretion containing large amounts of peptic activity and HCl.  $\text{Na}^+$ , the principal cation in the basal secretion, is replaced to a large extent by  $\text{H}^+$  ion. The concentration of  $\text{K}^+$  is similar in both basal and stimulated secretions and, therefore, remains relatively constant at the various rates of flow.

HCl and pepsinogen are secreted by separate mechanisms, but their production appears closely linked under physiological conditions. Stimulation of the vagus nerve or intravenous injection of gastrin increases pepsinogen and HCl levels together. Other stimuli may affect the two processes differently; for example, in the dog histamine infusion stimulates HCl production maximally but appears to inhibit pepsinogen secretion (Emas and Grossman, 1967).

**TABLE 14-2** Composition of Parietal and Nonparietal Secretions of Canine Gastric Mucosa<sup>a</sup>

Component	Parietal Secretion <sup>a</sup> (mmol/liter)	Nonparietal Secretion <sup>a</sup> (mmol/liter)	Nonparietal Secretion <sup>b</sup> (mmol/liter)
$\text{Na}^+$	—	155.0	138.0
$\text{H}^+$	159.0	—	—
$\text{K}^+$	7.4	7.4	4.0
$\text{Ca}^{2+}$	—	3.7	5.0
$\text{Cl}^-$	166.0	133.0	117.0
pH	<1.0	7.54 <sup>c</sup>	7.42

<sup>a</sup> Determined in vivo using dogs with gastric fistulas (Gray and Bucher, 1941).

<sup>b</sup> Determined in vitro with isolated gastric mucosa (Altamirano, 1963).

<sup>c</sup> Calculated from bicarbonate concentration assuming  $p\text{CO}_2$  of 40 Torr.

## 2. Pepsin

Pepsinogen is the zymogen, or inactive precursor, of pepsin, the principal proteolytic enzyme of gastric juice. Pepsinogen was first crystallized from the gastric mucosa of swine, and several pepsinogens have now been separated. The porcine pepsinogen has a molecular weight of approximately 43kd and is composed of the pepsin molecule and several smaller peptides. One of these peptides has a molecular weight of 3.2kd and is an inhibitor of peptic activity. Activation of pepsin from pepsinogen occurs by selective cleavage of this small basic peptide from the parent pepsinogen (Neurath and Walsh, 1976). Autocatalytic conversion begins below pH 6. At pH 5.4, the inhibitor peptide dissociates from the parent molecule, and at pH 3.5 to 4, the inhibitor is completely digested by pepsin.

Pepsin has a very acidic isoelectric point and is stable in acidic solution below pH 6, but it is irreversibly denatured at pH 7 or above. In contrast, pepsinogen is stable in neutral or slightly alkaline solution. The optimal pH for peptic activity is generally between 1.6 and 2.5, but the effect of pH may vary with the substrate. Pepsin is capable of hydrolyzing peptide bonds of most proteins, mucin being one important exception. Pepsin splits bonds involving phenylalanine, tyrosine, and leucine most readily but can hydrolyze almost all other peptide bonds.

## 3. Gastric Lipase

In canines, gastric lipase is secreted in response to penta-gastrin, histamine, prostaglandin E<sub>2</sub>, and secretin (Simpson, 2005). It parallels the secretion of gastric mucosa and plays a role in fat digestion. Unlike pepsin, it is not dependent on an acid pH, remains active in the small intestine, and constitutes up to 30% of the total lipase secreted over a 3-hour period. Gastric lipase as well as pepsin are not essential in fat digestion, but resulting fatty acids and peptides help coordinate gastric emptying and pancreatic secretion.

## 4. Rennin

Rennin is another proteolytic enzyme produced by the gastric mucosa and has characteristics that are similar to those of pepsin. It has been separated from pepsin in preparations from the stomachs of newborn calves. Rennin splits a mucopeptide from casein to form paracasein, which then reacts with calcium ion to form an insoluble coagulum. The coagulated milk protein probably delays gastric emptying and increases the efficiency of protein digestion in young calves.

## 5. HCL

The oxyntic cells produce HCl. When the normal mucosa is stimulated, both Cl<sup>-</sup> and H<sup>+</sup> are secreted together, but

current evidence suggests that H<sup>+</sup> and Cl<sup>-</sup> are secreted by separate, closely coupled mechanisms. Unstimulated oxyntic cells continuously secrete small amounts of Cl<sup>-</sup> in the absence of H<sup>+</sup> secretion, and this mechanism is responsible for the negative charge of the resting mucosal surface of the stomach relative to the serosa. For every H<sup>+</sup> secreted, an electron is removed that ultimately is accepted by oxygen to form OH<sup>-</sup>, which is neutralized within the cell by H<sup>+</sup> from H<sub>2</sub>CO<sub>3</sub>. The HCO<sub>3</sub><sup>-</sup> then enters the venous blood by means of a Cl<sup>-</sup>/HCO<sub>3</sub><sup>-</sup> exchange (“alkaline tide”), and during HCl secretion, the pH of gastric venous blood frequently is greater than that of arterial blood (Davenport, 1966).

The membrane-bound enzyme responsible for transport of H<sup>+</sup> by the oxyntic cell is a K<sup>+</sup>-stimulated ATPase (Sachs *et al.*, 1976; Wallmark *et al.*, 1980) that serves as an H<sup>+</sup>/K<sup>+</sup> exchange pump. At the time of oxyntic cell stimulation, the secretory membrane is altered to provide augmented K<sup>+</sup> and Cl<sup>-</sup> conductances (Wolosin, 1985). KCl leaves the apical cell membrane passively, and net production of HCl results from the electroneutral exchange of K<sup>+</sup> for H<sup>+</sup> (Fig. 14-1).

## B. Control of Gastric Secretion

### 1. General

A variety of stimuli can initiate gastric secretion. The sight or smell of food or the presence of food within the mouth causes gastric secretion by a reflex mechanism involving the vagus nerve. The presence of certain foods within the stomach or distension of the stomach alone can also initiate both intrinsic and vagal nerve reflexes, which cause secretion of gastric fluid. In addition to neural reflexes, these stimuli also cause the release of the gastrin from the pyloric gland area, which enters the bloodstream, stimulating gastric secretion. The release of gastrin from G cells is inhibited by excess H<sup>+</sup>, and this negative feedback mechanism is important in the control of HCl production.

### 2. Gastrin

Gastrin has been isolated in pure form from the antral mucosa of swine (Gregory *et al.*, 1964). When administered intravenously, the purified hormone causes the secretion of HCl and pepsin and stimulates gastrointestinal motility and pancreatic secretion. Two separate peptides have been obtained from porcine gastric mucosa and have been designated gastrin I and gastrin II. Gastrin is a heptadecapeptide amide, with a pyroglutamyl N-terminal residue and with the amide of phenylalanine as the C-terminal residue (Fig. 14-2). In the center of the molecule is a sequence of five glutamyl residues, which give the molecule its acidic properties. Gastrin II differs from gastrin I only in the presence of a sulfate ester group linked to the single tyrosyl residue. The C-terminal tetrapeptide amide,

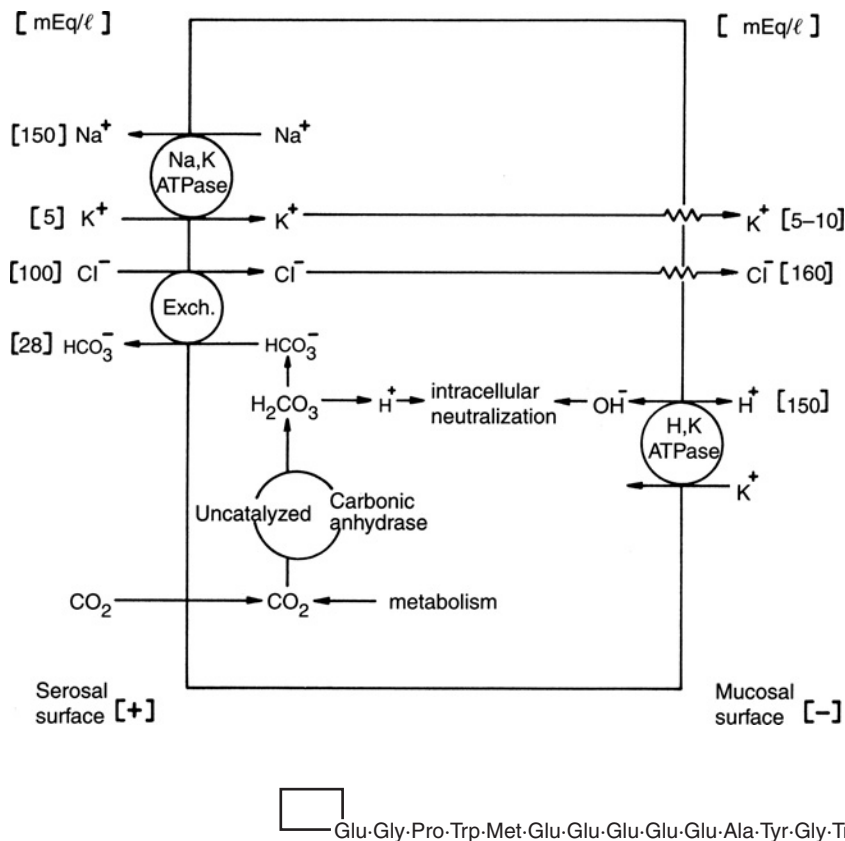


FIGURE 14-1 Movement of ions across the mucosal (apical) and serosal (basal) cell membranes of the parietal during HCl secretion.



FIGURE 14-2 Amino acid sequence of porcine gastrin I (Gregory, 1966). Gastrin II differs from gastrin I by the presence of a sulfate ester group on the single tyrosyl residue.

Trp-Met-Asp-Phe-NH<sub>2</sub>, is identical in all species so far studied (Gregory, 1967). The tetrapeptide has all of the activities of the natural hormone. It is not as potent as the parent molecule, but lengthening of the peptide chain can increase activity.

Gastrin-releasing peptide—as well as luminal peptides, digested protein, and acetylcholine—stimulates gastrin secretion from G cells and affects histamine release from enterochromaffin-like cells (Simpson, 2005). Gastrin is the only hormone known to stimulate HCl (Walsh and Grossman, 1975).

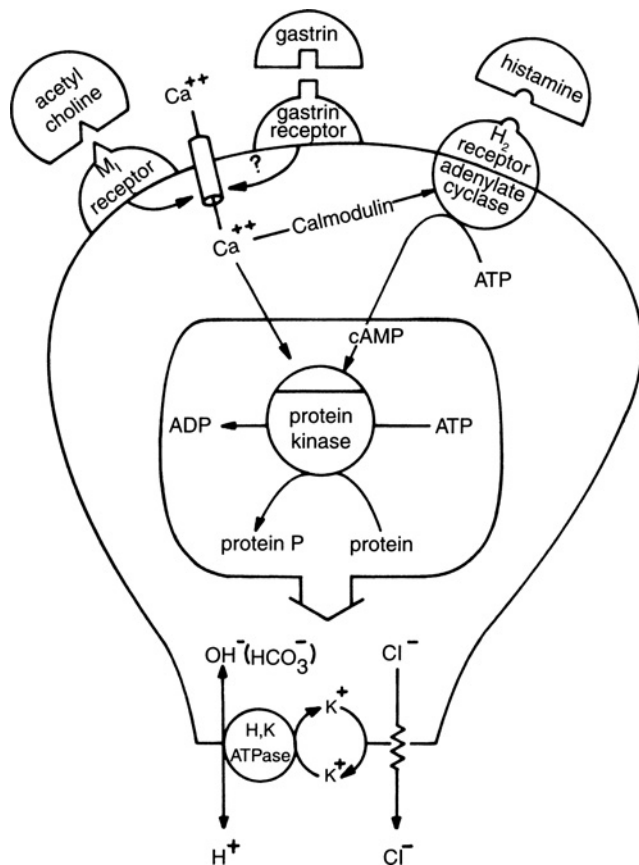
### 3. Histamine

Histamine secreted locally within the mucosa has a major effect on the function of oxyntic cells (Soll and Grossman, 1978). For many years, histamine has been recognized as a potent stimulant of HCl production, but this effect was not inhibited by traditional antihistaminic drugs (H<sub>1</sub> antagonists), and until the demonstration by Black *et al.* (1972) of H<sub>2</sub> receptors in the stomach (the atrium and uterus), the physiological role of histamine in HCl secretion was controversial. Specific H<sub>2</sub> antagonists (cimetidine) now have been shown to inhibit the secretory response not only to

histamine but to other secretory stimuli as well (Grossman and Konturek, 1974).

The complex of oxyntic cell receptors involved in the control of oxyntic cell function is shown in Figure 14-3. When the H<sub>2</sub> receptor of the oxyntic cell is occupied by histamine, basal lateral adenylate cyclase is activated, resulting in increased cellular cyclic AMP (cAMP) and in a sustained secretory response. The secretogogue action of cAMP is mediated by the activity of cAMP-dependent protein kinases (Chew, 1985).

Cholinergic stimulation of the oxyntic cell involves type I muscarinic receptors and a calcium activation pathway. Calmodulin inhibitors such as trifluoperazine inhibit H<sup>+</sup> secretion (Raphael *et al.*, 1984). The Ca-calmodulin system may influence the rate of cAMP synthesis, and a more distal site of action has been suggested by the identification of a Ca-dependent protein kinase activity in a membrane fraction prepared from oxyntic cells that was rich in H<sup>+</sup>, K<sup>+</sup>-ATPase (Schlatz *et al.*, 1981). A specific receptor for gastrin has been demonstrated on oxyntic cells and a specific gastrin antagonist, proglutamide, inhibits H<sup>+</sup> production. Gastrin appears to act synergistically with histamine and acetylcholine (AcCh) to regulate H<sup>+</sup> production but the actual mechanism of action of gastrin is unknown.



**FIGURE 14-3** Pathways of secretagogue action on the parietal cell. Stimulation by gastrin and acetylcholine is mediated by entry of  $\text{Ca}^{2+}$  onto the cell. Histamine activates adenylate cyclase with production of cAMP, the action of which is mediated by protein kinase.

#### 4. Prostaglandins

Prostaglandins, in addition to inhibiting HCl secretion, also act on a mucosal cell population that is distinct from oxyntic cells, which secrete cytoprotective substances (mucin, glycosaminoglycans). The ulcerogenic effects of inhibitors of prostaglandin synthesis (indomethacin, aspirin) apparently are the result of inhibition of the protective effect of endogenous prostaglandins.

Knowledge of the molecular aspects of receptor function of HCl secretion by oxyntic cells now provides the opportunity for specific pharmacological intervention for the control and treatment of ulcerative diseases of the upper gastrointestinal tract that appear to be the result of HCl-induced mucosal injury (Aclund *et al.*, 1983; Becht and Byars, 1986; Campbell-Thompson and Merritt, 1987). Potential therapeutic target sites are listed in Table 14-3. Famotidine is commonly administered to dogs and cats. Injectable ranitidine is administered to foals and horses during critical stages of gastrointestinal ulceration before switching to oral administration of omeprazole.

**TABLE 14-3** Inhibitors of Oxyntic Cell Function

A. Inhibitors of $\text{H}^+$ , $\text{K}^+$ -ATPase: omeprazole, verapamil, vanadate
B. Inhibitors of carbonic anhydrase: acetazolamide
C. Inhibitors of cell activation or response <ol style="list-style-type: none"> <li>1. Calcium channel antagonists: verapamil, lanthanum</li> <li>2. Prostaglandin <math>\text{E}_2</math></li> </ol>
D. Receptor antagonists <ol style="list-style-type: none"> <li>1. <math>\text{H}_2</math>-receptor antagonists: cimetidine, ranitidine</li> <li>2. Gastrin antagonists: proglumide, benzotript</li> <li>3. Anticholinergic agents: atropine</li> </ol>
E. Inhibitors of calmodulin: trifluoperazine

## IV. BILIARY SECRETIONS

### A. Composition of Bile

The hepatocytes continuously secrete bile into the bile canaliculi; it is transported through a system of ducts to the gallbladder, where it is modified, concentrated, and stored. During digestion, bile is discharged into the lumen of the duodenum, where it aids in emulsification, hydrolysis, and solubilization of dietary lipids. The digestive functions of bile are accomplished almost exclusively by the detergent action of its major components, the bile salts and phospholipids.

### B. Properties of Bile

The carboxyl group of the bile acids is completely ionized at the pH of bile and is neutralized by  $\text{Na}^+$  resulting in the formation of bile salts. These bile salts are effective detergents. They are amphipathic molecules that have both hydrophobic and hydrophilic regions. In low concentrations, bile salts form molecular or ideal solutions, but when their concentration increases above a certain critical level, they form polymolecular aggregates known as micelles. The concentration at which these molecules aggregate is called the critical micellar concentration (CMC).

Bile salt micelles are spherical and consist of a central nonpolar core and an external polar region. Fatty acids, monoglycerides, and other lipids are solubilized when they enter the central core of the micelle and are covered by the outside polar coat. Solubilization occurs only when the CMC is reached. For the bile salt-monoglyceride-fatty acid-water system present during normal fat digestion, the CMC is approximately 2 mM, which normally is exceeded both in bile and in the contents of the upper small intestine (Hofmann, 1963, 1967). Phospholipids, principally lecithin, are also major components of bile. In the lumen of

the small intestine, pancreatic phospholipase catalyzes the hydrolysis of lecithin, forming free fatty acid and lysolecithin. The latter compound also is a potent detergent, which acts with the bile salts to disperse and solubilize lipids in the aqueous micellar phase of the intestinal contents.

### C. Synthesis of Bile Acids

The primary bile acids (BA) are C-24 carboxylic acids synthesized by the liver from cholesterol. BA synthesis is the major end-stage pathway for cholesterol metabolism (Danielsson, 1963). Cholic acid (3 $\alpha$ ,7 $\alpha$ ,12 $\alpha$ -trihydroxy-5 $\beta$ -cholanoic acid) (CA) and chenodeoxycholic acid (3 $\alpha$ -,7 $\alpha$ -dihydroxy-5 $\beta$ -cholanoic acid) (CDCA) are the primary BA synthesized by most species of domestic animals. In swine, CDCA is hydroxylated at the 6 $\alpha$  position by the liver to yield hyocholic acid (HCA), which is a major primary BA in this species.

BA are secreted as amino acid conjugates of either glycine or taurine. Taurine conjugates predominate in the dog, cat, and rat. In the rabbit, the conjugating enzyme system appears to be almost completely specific for glycine (Bremer, 1956). Both taurine and glycine conjugates are present in ruminants. In the newborn lamb, 90% of the bile acids are conjugated with taurine. As the lamb matures, glycine conjugates increase to reach one-third of the total BA in mature sheep (Peric-Golia and Socic, 1968).

Under normal conditions, only conjugated BA are present in the bile and in the contents of the proximal small intestine. In the large intestine, the conjugated BA are hydrolyzed rapidly by bacterial enzymes so that in the contents of the large intestine and in the feces, free or unconjugated BA predominate. Several genera of intestinal bacteria, including clostridium, enterococcus, bacteroides, and lactobacillus, are capable of splitting the amide bonds of conjugated BA.

Intestinal bacteria also modify the basic structure of the BA. One such reaction is the removal of the  $\alpha$ -hydroxyl group at the 7 position of CA or CDCA. These bacterial reactions yield the secondary BA, deoxycholic acid (DCA), and lithocholic acid (LCA) (Gustafsson *et al.*, 1957). LCA is relatively insoluble and is not reabsorbed to any great extent (Gustafsson and Norman, 1962). DCA is reabsorbed from the large intestine in significant quantities and is either rehydroxylated by the liver to CA and secreted (Lindstedt and Samuelsson, 1959) or secreted as the conjugated DCA. The extent to which bacteria transform the primary BA depends on the nature of the diet, the composition of the intestinal microflora, and the influences of these and other factors on intestinal motility (Gustafsson, 1969; Gustafsson *et al.*, 1966; Gustafsson and Norman, 1969).

### D. Enterohepatic Circulation of Bile Acids

The enterohepatic circulation begins as conjugated BA enter the duodenum and mix with the intestinal contents, forming

emulsions and micellar solutions. The BA are not absorbed in significant amounts from the lumen of the proximal small intestine. Absorption occurs primarily in the ileum (Lack and Weiner, 1961, 1966; Weiner and Lack, 1962) where an active transport process has been demonstrated (Dietschy *et al.*, 1966). The absorbed conjugated BA pass unaltered into the portal circulation (Playoust and Isselbacher, 1964) and return to the liver, where the cycle begins again. This arrangement provides for optimal concentrations of BA in the proximal small intestine where fat digestion occurs and then for efficient absorption after these functions have been accomplished. Absorption of unconjugated BA from the large intestine accounts for 3% to 15% of the total enterohepatic circulation (Weiner and Lack, 1968).

In dogs, the total BA pool was estimated to be 1.1 to 1.2 g. The half-life of the bile acids in the pool ranged between 1.3 and 2.3 days, and the rate of hepatic synthesis was 0.3 to 0.7 g/day. Because the daily requirement for bile acids greatly exceeds the normal synthetic rate, the repeated reutilization of the BA is facilitated by the enterohepatic circulation. Under steady-state conditions, the total BA pool passes through the enterohepatic circulation approximately 10 times each day.

The size of the BA pool depends on the diet, the rate of hepatic synthesis, and the efficiency of the enterohepatic circulation. Surgical removal of the ileum in dogs interrupts the enterohepatic circulation, thereby increasing the BA turnover and reducing the size of the BA pool (Playoust *et al.*, 1965). In diseases of the ileum, there may be defective BA reabsorption and a bile salt deficiency. If the deficiency is severe, the utilization of dietary fat may be impaired, resulting in steatorrhea and impaired absorption of the fat-soluble vitamins.

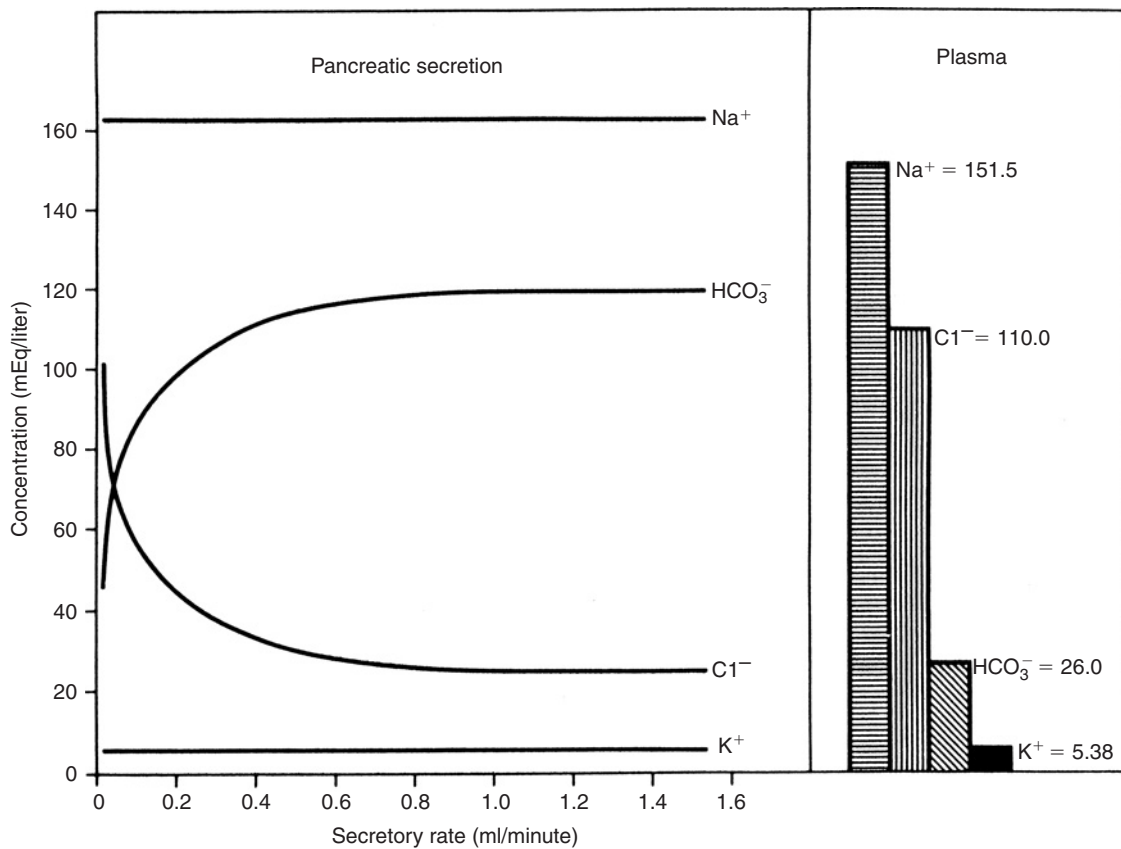
## V. EXOCRINE PANCREATIC SECRETIONS

The exocrine pancreas is an acinus gland with a general structure that is similar to the salivary glands. The cytoplasm of the secretory cells contains numerous zymogen granules, which vary in size and number depending on the activity of the gland. These granules contain the precursors of the hydrolytic enzymes responsible for digestion of the major components of the diet. Cells of the terminal ducts appear to secrete the HCO<sup>3-</sup> responsible for neutralizing the HCl, which enters the duodenum from the stomach.

### A. Composition of Pancreatic Juice

#### 1. Electrolyte Composition

The cation content of pancreatic secretion is similar to that of plasma, Na<sup>+</sup> being the predominant cation and the concentrations of K<sup>+</sup> and Ca<sup>2+</sup> being much lower. A unique



**FIGURE 14-4** Influence of secretory rate on the electrolyte composition of canine pancreatic juice. From Bro-Rasmussen *et al.* (1956).

characteristic of pancreatic fluid is its high  $\text{HCO}_3^-$  concentration and alkaline pH. In the dog, the pH ranges from 7.4 to 8.3, depending on  $\text{HCO}_3^-$  content. The volume of pancreatic secretion is directly related to its  $\text{HCO}_3^-$  content, and the pH increases and  $\text{Cl}^-$  concentration decreases as the rate of flow increases. The  $\text{Na}^+$  and  $\text{K}^+$  concentrations and osmolality appear to be independent of the secretory rate (Fig. 14-4).

## 2. $\alpha$ -Amylase

The amylase produced by the pancreas catalyzes the specific hydrolysis of  $\alpha$ -1,4-glycosidic bonds, which are present in starch and glycogen ( $\alpha$ -1,4-glycan-4-glycan hydrolase). Pancreatic amylase appears to be essentially identical to the amylase of saliva. It is a calcium-containing metalloenzyme. Removal of calcium by dialysis inactivates the enzyme and markedly reduces the stability of the apoenzyme. Pancreatic amylase has an optimal pH for activity of 6.7 to 7.2 and is activated by  $\text{Cl}^-$ .

After synthesis of pancreatic  $\alpha$ -amylase in the ribosomes, the enzyme is transferred from the endoplasmic reticulum to cytoplasmic zymogen granules for storage. It is secreted in active form upon stimulation of the acinar cells. Newborn calves and pigs secrete amylase at a significantly lower rate than mature animals. The rate of synthesis

is also influenced by diet. Animals fed a high-carbohydrate diet synthesize amylase at several times the rate of animals on a high-protein diet.

Unbranched  $\alpha$ -1,4-glycosidic chains, such as those found in starch, are hydrolyzed in two steps. The first is rapid and results in formation of the maltose and maltotriose. The second step is slower and involves hydrolysis of maltotriose into glucose and maltose. Polysaccharides such as amylopectin and glycogen contain branched chains with both  $\alpha$ -1,4- and  $\alpha$ -1,6-glycosidic linkages. When  $\alpha$ -amylase attacks these compounds, the principal products are maltose ( $\alpha$ -1,4-glycosidic bond), isomaltose ( $\alpha$ -1,6-glycosidic bond), and small amounts of glucose. Final hydrolysis of the maltose and isomaltose occurs at the surface of the mucosal cell, where the enzymes maltase and isomaltase are integral parts of the microvillous membrane.

## 3. Proteolytic Enzymes

The proteolytic enzymes of the pancreas are responsible for the major portion of protein hydrolysis, which occurs within the lumen of the gastrointestinal tract. The pancreas secretes two types of peptidases. Trypsin, chymotrypsin, and elastase are endopeptidases that attack peptide bonds along the polypeptide chain to produce smaller peptides.

**TABLE 14-4** Relationships among the Activities of Pancreatic Endopeptidases and Exopeptidases

Enzyme	Type	Activity
Trypsin	Endopeptidase	Produces peptides with C-terminal basic amino acids
Carboxypeptidase B	Exopeptidase	Removes C-terminal basic amino acids
Chymotrypsin	Endopeptidase	Produces peptides with C-terminal aromatic amino acids
Elastase	Endopeptidase	Produces peptides with C-terminal nonpolar amino acids
Carboxypeptidase A	Exopeptidase	Removes C-terminal aromatic and nonpolar amino acids

The exopeptidases attack either the carboxy-terminal or amino-terminal peptide bonds, releasing single amino acids. The principal exopeptidases secreted by the pancreas are carboxypeptidases A and B. The endopeptidases and exopeptidases act in complementary fashion (Table 14-4), ultimately producing free amino acids or very small peptides. The free amino acids are absorbed directly, and the small peptides are further hydrolyzed by the aminopeptidases of the intestinal mucosa.

The pancreatic peptidases are secreted as the inactive proenzymes (zymogens), trypsinogen, chymotrypsinogen, and the procarboxypeptidases A and B. Trypsinogen is converted to active trypsin in two ways. At alkaline pH, trypsinogen can be converted autocatalytically to trypsin. The activated enzyme is then capable of converting more zymogen to active enzyme. Trypsinogen also can be activated by the enzyme enterokinase, which is produced by duodenal mucosa. The latter reaction is highly specific in that enterokinase will activate trypsinogen but not chymotrypsinogen. Chymotrypsinogen, proelastase, and the procarboxypeptidases A and B are converted to active enzymes by the action of trypsin.

The amino acid sequences and other structural characteristics of bovine trypsinogen and chymotrypsinogen have been determined (Brown and Hartley, 1966; Hartley *et al.*, 1965; Hartley and Kauffman, 1966). The polypeptide chain of trypsinogen contains 229 amino acid residues. Activation of trypsinogen occurs with hydrolysis of a single peptide bond located in the 6 position between lysine and

isoleucine. As the C-terminal hexapeptide is released, enzyme activity appears along with a helical structure of the parent molecule. Chymotrypsinogen A is composed of 245 amino acid residues and has numerous structural similarities to trypsinogen. Activation of the chymotrypsinogen also occurs with cleavage of a single peptide bond.

#### 4. Lipase

The pancreas produces several lipolytic enzymes with different substrate specificities. The most important of these from a nutritional viewpoint is the lipase responsible for hydrolysis of dietary triglyceride. This enzyme has the unique property of requiring an oil-water interface for activity so that only emulsions can be effectively attacked. The principal products of lipolysis are glycerol, monoglycerides, and fatty acids. The monoglycerides and fatty acids accumulate at the oil-water interface and can inhibit lipase activity. Transfer of these products from the interface to the aqueous phase is favored by  $\text{HCO}_3^-$  secreted by the pancreas and by the bile salts.

Two other carboxylic ester hydrolases have been characterized in pancreatic secretion. Both enzymes have an absolute requirement for bile salts, in contrast to glycerol ester hydrolase, which is actually inhibited by bile salts at pH 8. One of the enzymes requiring bile salts is a sterol ester hydrolase responsible for hydrolysis of cholesterol esters, and the other enzyme hydrolyzes various water-soluble esters. The pancreas also secretes phospholipase A, which in the presence of bile converts lecithin to lysolecithin, an effective detergent that contributes to the emulsification of dietary fat.

## B. Control of Pancreatic Secretions

### 1. Hormonal Control

Pancreatic secretion is controlled and coordinated by both neural and endocrine mechanisms. When ingesta or HCl enters the duodenum, the hormone secretin, which is produced by the duodenal mucosa, is released into the circulation. Secretin increases the volume, pH, and  $\text{HCO}_3^-$  concentration of the pancreatic secretion.

Secretin is a polypeptide hormone containing 27 amino acid residues, and all 27 amino acids are required to maintain the helical structure of the molecule and its activity (Bodanszky *et al.*, 1969). The C-terminal amide of secretin is a property shared with other polypeptide hormones such as gastrin and vasopressin, which act on the flow of water in biological systems (Mutt and Jorpes, 1967). In addition to its effects on the pancreas, secretin also increases the rate of bile formation.

The secretin-stimulated pancreatic juice has a large volume, high  $\text{HCO}_3^-$  concentration but a low enzyme activity.



**TABLE 14-5** Gastrointestinal Peptide Hormones

Hormone	Source	Action
Gastrin	G cells of pyloric antrum	Gastric acid secretion
Secretin	S cells of duodenum and jejunum	Pancreatic fluid and HCO <sub>3</sub> <sup>-</sup> secretion, bile secretion
Cholecystokinin (pancreozymin)	Duodenal and jejunal mucosa; myenteric plexus	Pancreatic enzyme secretion, gallbladder contraction, and sphincter of Oddi relaxation
Somatostatin	D cells of pancreas, CNS, gastric and intestinal mucosa	Inhibits effect of gastrin on gastric secretion, inhibits pancreatic enzyme secretion, stimulates ileal water and NaCl
Enteroglucagon	L cells of small intestine, canine stomach	Control of intestinal cell growth
Gastric inhibitory polypeptide	Duodenal and jejunal mucosa	Inhibits gastric secretion and stimulates intestinal secretion
Motilin	Upper small intestinal mucosa	Stimulates gastrointestinal motility

Stimulation of the vagus nerve causes a significant rise in pancreatic enzyme concentration. This type of response also is produced by cholecystokinin (pancreozymin), another polypeptide hormone produced by the duodenal mucosa, which also causes contraction of the gallbladder. The C-terminal pentapeptide of cholecystokinin-pancreozymin is exactly the same as that of gastrin. This fascinating relationship suggests that gastrin and cholecystokinin-pancreozymin participate in some integrated yet poorly understood system of digestive control.

Several molecular forms of cholecystokinin (CCK) exist (Ward and Washabau, 2005). CCK-33, CCK-39, and CCK-59 are the predominant forms that account for most of the gastrointestinal hormone responses. Endocrine cells in the duodenum and jejunum secrete CCK in response to intraduodenal fatty acids, amino acids, and H<sup>+</sup> ion. CCK-8 is particularly important in cats. Intraluminal distension will activate CCK-8 containing neurons, resulting in acetylcholine release from the myenteric plexus and subsequent peristaltic reflexes in the ileum and colon. CCK-8 neurons in the brain are involved in mediating the satiety response following eating.

## VI. OTHER GASTROINTESTINAL HORMONES

A large number of polypeptides have been isolated from the gastrointestinal mucosa and have been classified as gut hormones (Table 14-5). Some of these substances have not yet met all the rigid physiological requirements of true hormones. Some may have paracrine rather than endocrine activities—that is, their actions are on cells and tissues in the immediate vicinity of the cells of origin rather than being released into the vascular system.

### A. Motilin

Motilin is a polypeptide containing 22 amino acids that was originally isolated from porcine duodenal mucosa (Brown *et al.*, 1971). The amino acid composition and sequence have been described (Brown *et al.*, 1972, 1973). Immunoreactive motilin has been found in the enterochromaffin cells of the duodenum and jejunum of several species (Polak *et al.*, 1975), and, by means of radioimmunoassay, motilin has been identified in the plasma of dogs (Dryburgh and Brown, 1975). Motilin has been shown to stimulate pepsin output and motor activity of the stomach (Brown *et al.*, 1971) and to induce lower esophageal sphincter contractions (Jennewein *et al.*, 1975). Studies by Itoh *et al.* (1978) suggest that motilin plays an important role in initiating interdigestive gastrointestinal contractions, which are referred to as the interdigestive motility complex or the migrating motility complex (MMC).

The cyclic release of motilin from the intestinal mucosa coordinates gastric, pancreatic, and biliary secretions with phase III of the MMC (Ward and Washabau, 2005). Erythromycin has been shown to induce an MMC similar to motilin and, along with other macrolide-like antibiotics, might be useful in selected cases with motility disorders.

### B. Somatostatin

Somatostatin, which is named for its activity of inhibitory release of growth hormone from the pituitary gland, has been purified from ovine and bovine hypothalamus. The hypothalamic hormone is composed of 14 amino acids. Somatostatin also has been demonstrated in the stomach, pancreas, and intestinal mucosa in concentrations higher than in the brain (Pearse *et al.*, 1977). Somatostatin from porcine intestine has been isolated and sequenced, and it

contains 28 amino acids and apparently is a prohormone (Pradayrol *et al.*, 1980). Somatostatin is a potent inhibitor of insulin and glucagon release. It also inhibits gastrin release and gastric acid secretion (Barros D'Sa *et al.*, 1975; Bloom *et al.*, 1974), apparently acting independently on parietal cells and on G cells. These and a variety of other physiological effects suggest that somatostatin has important gastrointestinal regulatory functions.

### C. Enteroglucagon

Enteroglucagon is the hyperglycemic, glycogenolytic factor isolated from the intestinal mucosa. It occurs in two forms, one a 3.5 kd form and another somewhat larger (Valverde *et al.*, 1970). Enteroglucagon differs from pancreatic glucagon biochemically, immunologically, and in its mode of release. The physiological function of enteroglucagon is not known, but its release from the mucosa following a meal and the associated increase in circulating blood levels have suggested a regulatory role on bowel function (Pearse *et al.*, 1977). Enteroglucagon also differs significantly from the glucagon produced by the A cells of the gastric mucosa of the dog (Sasaki *et al.*, 1975). Canine gastric glucagon is biologically and immunochemically identical to pancreatic glucagon. Gastric glucagon appears to be unique to the dog, similar activity not being observed in the stomach of the pig or the abomasum of cattle and sheep.

## VII. DIGESTION AND ABSORPTION

### A. Water and Electrolytes

#### 1. Mechanisms of Mucosal Transport

The microvillous membrane of the intestinal mucosa, because of its lipid composition, acts as a barrier to water and water-soluble substances. Water and polar solutes penetrate the mucosa in one of three ways. They may pass through aqueous pores or channels that connect the luminal surface of the cell with the apical cytoplasm, they may attach to membrane carriers that facilitate passage through the lipid phase of the mucosal cell membrane, or they may pass paracellularly through tight junctions (shunt pathway). Transport of water and water-soluble compounds is influenced by the permeability characteristics of the limiting membrane and by the nature of the driving forces that provide energy for transport. Passive movement occurs either by simple diffusion or as a result of concentration gradients (activity), pH, osmotic pressure, or electrical potential that may exist across the membrane. The movement of an ion in the direction of an electrochemical gradient is considered passive in nature. Active transport is said to occur when a substance moves in a direction opposite that of an established electrochemical gradient.

Most water-soluble compounds, such as monosaccharides and amino acids, cannot diffuse across the intestinal

mucosal membrane at rates that are adequate to meet nutritional requirements. The transport of these nutrients requires membrane carriers, which are integral parts of the membrane and their binding is highly specific. Carrier-mediated transport systems can be saturated and competitively inhibited by related compounds.

Three types of carrier transport mechanisms are recognized (Curran and Schultz, 1968). (1) *Active transport*, as stated previously, involves movement of electrolytes against an electrochemical gradient. In the case of nonelectrolytes such as glucose, active transport is defined as movement against a concentration gradient. Active transport requires metabolic energy and is inhibited by various metabolic blocking agents or by low temperature. (2) *Facilitated diffusion* occurs when the passive movement of a substance is more rapid than can be accounted for by simple diffusion. Facilitated diffusion systems may increase the rate of movement across the membrane by two or three orders of magnitude. The responsible carrier mechanism is similar to that involved in active transport in that it displays saturation kinetics, may be inhibited competitively, and is temperature dependent. However, transport does not occur against concentration or electrochemical gradients, and direct expenditure of energy is not required. (3) *Exchange diffusion* is a transfer mechanism similar to facilitated diffusion and was postulated originally to explain the rapid transfer of radioactive  $\text{Na}^+$  across epithelial cell membranes *in vitro*. The mechanism involves the exchange of one ion for another of like charge (e.g.,  $\text{Na}^+$  and  $\text{H}^+$  or  $\text{Cl}^-$  and  $\text{HCO}_3^-$ ), not giving rise to net transport but contributing in a major way to unidirectional flux rate.

In the intestine, net water absorption is the result of bulk flow through pores. Diffusion in the usual sense plays no important role in water movement. When bulk flow of water occurs, it is possible for solutes to move across the membrane in the direction of flow by a phenomenon called *solvent drag*. The effect of solvent drag on the transport of a given solute depends on the rate of volume flow and on the reflection coefficient, an expression of the relationship between the radius of membrane pores and the radius of the solute molecule being transported. By means of solvent drag, it is possible for a solute such as urea to be transported by the intestine against a concentration gradient (Hakim and Lifson, 1964).

#### 2. Sodium and Chloride Absorption

$\text{Na}^+$  and  $\text{Cl}^-$  are the major ions in the fluid that are transported by the intestine during absorption or secretion, and under most conditions, transport of these two ions is coupled. The transport of water and electrolytes by the intestinal mucosa is a dynamic process, with rapid unidirectional fluxes of both occurring continuously. Net absorption occurs when the flow from lumen to plasma exceeds that from plasma to lumen. Active transport of  $\text{Na}^+$  can occur along

the entire length of the intestine, but the rate and net absorption is greatest in the ileum and colon.  $\text{Na}^+$  transport is by an energy-requiring “sodium pump” mechanism that is intimately associated with the  $\text{Na}^+$ - $\text{K}^+$ -ATPase located within the basolateral cell membrane of the absorptive epithelial cell. Three mechanisms exist for the entry of  $\text{Na}^+$  at the brush border: (1) electrodiffusion down a concentration gradient, (2) cotransport of electrolytes that either enter ( $\text{Cl}^-$ ) or exit ( $\text{H}^+$ ) the cell as  $\text{Na}^+$  enters, and (3)  $\text{Na}^+$  entry coupled with organic nonelectrolytes (glucose, amino acids). Current evidence suggests that in the absence of the absorption of nonelectrolytes, electroneutral uptake accounts for most  $\text{NaCl}$  absorption. At the brush border,  $\text{Na}^+$  enters down a concentration gradient but exits at the basolateral cell surface against a substantial gradient. Maintenance of the transmembrane  $\text{Na}^+$  gradient by the  $\text{Na}$  pump requires continual metabolism and generation of ATP. The  $\text{Na}^+$ - $\text{K}^+$ -ATPase can be inhibited by cardiac glycosides such as ouabain, which are effective inhibitors of  $\text{Na}^+$  transport. The  $\text{Na}^+$  gradient ultimately serves as an energy source for transport of other solutes (Schultz and Curran, 1970).

In the jejunum, net absorption of sodium occurs slowly unless nonelectrolytes, such as glucose or amino acids, are absorbed simultaneously. In the ileum,  $\text{Na}^+$  absorption is independent of glucose absorption. Net water absorption in the jejunum is almost entirely dependent on the absorption of glucose and other nonelectrolytes, whereas absorption from the ileum is unaffected by glucose. The differential effect of glucose on absorption from the jejunum and ileum is the result of fundamental differences in electrolyte transport mechanisms in these two regions of the intestine.

As  $\text{Na}^+$  is transported across the mucosa, an equivalent amount of anion must be transported to maintain electrical neutrality. A major fraction of  $\text{Cl}^-$  absorption can be accounted for by passive cotransport with  $\text{Na}^+$ . Under certain circumstances,  $\text{Cl}^-$  enters the cell in exchange for  $\text{HCO}_3^-$ .

### 3. Potassium Absorption

Dietary  $\text{K}^+$  is absorbed almost entirely in the proximal small intestine. Absorption across the intestinal mucosa occurs down a concentration gradient (high luminal concentration to a low concentration in plasma). The intestinal fluid reaching the ileum from the jejunum has a  $\text{K}^+$  concentration and a  $\text{Na}^+/\text{K}^+$  ratio that are similar to plasma. In the ileum and colon, the rate of  $\text{Na}^+$  absorption is much greater than that of  $\text{K}^+$  so that, under normal conditions, the  $\text{Na}^+/\text{K}^+$  ratio in the feces is much lower than that of plasma, approaching a ratio of 1.

### 4. Water Absorption

The absorption of water has been one of the most extensively studied aspects of intestinal transport. Water movement is the result of bulk flow through membranous pores, and simple diffusion plays only a minor role. The question

of whether water is actively or passively transported has been the subject of considerable controversy, and the controversy itself points to the fundamental difficulties that arise in trying to establish a definition of active transport. Hypertonic saline solutions can be absorbed from canine intestine *in vivo* and from canine and rat intestine *in vitro*. These observations indicate that water absorption can occur against an activity gradient and that the process is dependent on metabolic energy. This suggests that an active transport process is involved, but Curran (1965) presented an alternate interpretation, which is now generally accepted. This view is that water transport occurs secondarily to active solute transport and is the result of local gradients established within the mucosal membrane. Water transport is then coupled to the energy-dependent processes responsible for solute transport but is one step removed from it.

In the dog and probably other carnivores, the ileum is the main site of net  $\text{Na}^+$  and water absorption. In the dog, the colon accounts for no more than perhaps 20% of the total. In herbivorous animals that have a well-developed large intestine, there may actually be a net secretion of water within the small intestine during digestion. For example, in the guinea pig (Powell *et al.*, 1968) and horse (Argenzio, 1975), all net absorption of water takes place in the cecum and colon.

Vasoactive intestinal polypeptide (VIP) and acetylcholine have an important role in fluid and electrolyte balance (Hall and German, 2005). As mediators of secretion, they increase intracellular calcium and cyclic adenosine monophosphate (cAMP), inhibit neutral sodium and chloride absorption, and facilitate transcellular chloride efflux. Some bacterial infections result in diarrhea because of an increase in cAMP; functional tumors of VIP-producing cells can also produce diarrhea. Noradrenaline, somatostatin, and opioids, which are the important regulators of absorption, lower intracellular cAMP and calcium concentrations and stimulate neutral  $\text{NaCl}$  absorption. For these reasons, they can have antidiarrheal effects.

## B. Carbohydrate Digestion and Absorption

### 1. Polysaccharide Digestion

#### a. Starch and Glycogen

Carbohydrate is present in the diet primarily in the form of polysaccharides. The most common polysaccharides are starch, glycogen, and cellulose. Starch and glycogen are composed of long chains of glucose molecules linked together by repeating  $\alpha$ -1,4-glucosidic bonds. Branch points of the chains are linked by  $\alpha$ -1,6-glucosidic bonds. In those species that secrete salivary amylase, digestion of starch and glycogen begins in the mouth when this enzyme mixes with food. The action of salivary amylase is interrupted in the stomach, however, because of the low pH of the gastric secretion.

Starch digestion begins again in the proximal small intestine with the highly specific action of pancreatic amylase

**TABLE 14-6** Enzymes of the Intestinal Brush Border

Enzyme	Substrate	Product	Reference
Lactase	Lactose	Glucose, galactose	Alpers (1969), Forstner <i>et al.</i> (1968)
Sucrase	Sucrose; 1,4% dextrins	Glucose, fructose; residual 1,6-oligosaccharides	Gray <i>et al.</i> (1979)
Isomaltase	1,6% Dextrins	Glucose	Gray <i>et al.</i> (1979), Rodriguez <i>et al.</i> (1984)
%-Limit dextrinase	1,6% Dextrins	Glucose	Taraval <i>et al.</i> (1983)
Trehalase	Trehalose	Glucose	Eichholtz (1967), Nakano <i>et al.</i> (1977)
Enterokinase	Trypsinogen	Trypsin	Grant and Herman-Taylor (1976)
Aminopeptidase A	Acidic amino-terminal amino acids	Acidic amino acids	Benajiba and Maroux (1980)
Aminopeptidase N	Neutral amino-terminal amino acids	Neutral amino acids	Kim and Brophy (1976), Erickson <i>et al.</i> (1983)
(-Glutamyl transferase)	Peptides with (-glutamyl bonds)	(-Glutamyl amino acids)	Benajaba and Maroux (1980), Hughey and Curthoys (1976)
Alkaline phosphatase	Phosphate esters	Inorganic phosphate	Eichholz (1967), Forstner <i>et al.</i> (1968)

on  $\alpha$ -1,4-glucosidic bonds. This enzyme catalyzes a series of stepwise hydrolytic reactions, resulting in formation of the principal end products of starch digestion, the disaccharides maltose and isomaltose, and small amounts of glucose. Glucose is absorbed directly by the intestinal mucosa and transported to the portal vein. Enzymes of the intestinal cell brush border hydrolyze the disaccharides further.

#### b. Cellulose

Cellulose, like starch, is a polysaccharide of glucose but differs from starch in that the glucose molecules are linked by  $\beta$ -1,4-glucosidic bonds. All species can utilize starch, but only animals that have extensive bacterial fermentation within the gastrointestinal tract utilize cellulose indirectly as a significant source of energy. Ruminant species digest cellulose most efficiently, but other animals in which the large intestine is well developed (e.g., the horse) also utilize cellulose as an important energy source.

In ruminants, hydrolysis of cellulose is accomplished by cellulitic bacteria, which are part of the complex rumen microflora. The primary end products of cellulose fermentation are short-chain fatty acids: acetic, propionic, and butyric acids. These are absorbed directly from the rumen and serve as the major source of energy for ruminants. Propionic acid is the major precursor for carbohydrate synthesis in mature ruminants.

#### 2. Disaccharide Digestion

Maltose and isomaltose are the disaccharides (glucose-glucose) produced as end products of starch digestion.

The diet also may contain lactose (galactose-glucose) and sucrose (fructose-glucose). There is general agreement that disaccharide digestion is completed at the surface of the cell by disaccharidases (Gray, 1975), which are components of the brush border (Table 14-6).

The disaccharidases have been solubilized from the brush border and partially purified. Sucrase and isomaltase have been purified together as a two-enzyme complex (Gray *et al.*, 1979; Kolinska and Semenza, 1967), and this enzyme complex accounts for the total hydrolysis of the products of amylase digestion (Gray *et al.*, 1979; Rodriguez *et al.*, 1984). The mutual mucosa contains two enzymes with lactase activity. One of these is a nonspecific  $\beta$ -galactosidase that hydrolyzes synthetic  $\beta$ -galactosides effectively but hydrolyzes lactose at a slow rate. This enzyme has an optimal pH of 3 and is associated with the lysosomal fraction of the cell. The other lactase hydrolyzes lactose readily, is associated with the brush border fraction of the cell, and is the enzyme of primary importance in the digestive process (Alpers, 1969).

Maltase, isomaltase, and sucrase are almost completely absent from the intestine in newborn pigs (Dahlqvist, 1961) and calves. The activity of these disaccharidases increases after birth and reaches adult levels during the first months of life. Lactase activity is highest at birth and decreases gradually during the neonatal period. The relatively high lactase activity may be an advantage to the newborn in utilizing the large quantities of lactose present in their diets. Bywater and Penhale (1969) demonstrated lactase deficiency following acute enteric infections and suggested that lactose utilization may be decreased in such cases.

### 3. Monosaccharide Transport

#### a. Specificity of Monosaccharide Transport

Regardless of whether monosaccharides originate in the lumen of the intestine or are formed at the surface of the mucosal cell, transport across the mucosa involves processes that have a high degree of chemical specificity. Glucose and galactose are absorbed from the intestine more rapidly than other monosaccharides. Fructose is absorbed at approximately half the rate of glucose, and mannose is absorbed at less than one-tenth the rate of glucose (Kohn *et al.*, 1965).

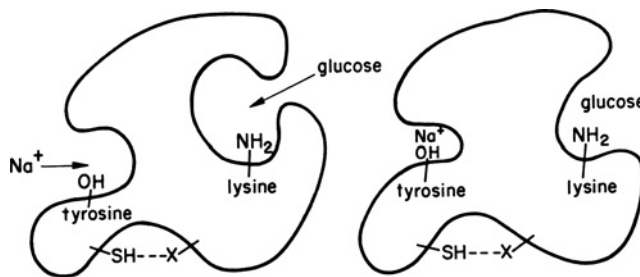
Glucose and galactose can be absorbed against a concentration gradient. The monosaccharides that are transported most efficiently against gradients have common structural characteristics: (1) the presence of a pyranose ring, (2) a carbon atom attached to C-5, and (3) a hydroxyl group at C-2 with the same stereoconfiguration as D-glucose, but these features are not absolute requirements. Both D-xylose, which has no substituted carbon atom at C-5, and D-mannose, which lacks the appropriate hydroxyl configuration at C-2, can be transported against concentration gradients under specific experimental conditions (Alvarado, 1966b).

Glucose transport is competitively inhibited by galactose (Fisher and Parsons, 1953) and by a variety of substituted hexoses that compete with glucose for carrier binding sites. The glucoside phlorizin is a potent inhibitor (Alvarado and Crane, 1962; Parsons *et al.*, 1958). Phlorizin also competes for binding sites but has a much higher affinity for these sites than does glucose.

The absorptive surface of the mucosal cell is the microvillous membrane, or brush border. It is through this part of the plasma membrane that glucose must pass during the initial phase of mucosal transport. Techniques have been developed for isolating highly purified preparations of microvillous membranes from mucosal homogenates (Forstner *et al.*, 1968). Faust *et al.* (1967) studied the binding of various sugars to these isolated membrane fractions. They found that D-glucose was bound by the membrane preferentially to L-glucose or to D-mannose and that glucose binding was completely inhibited by 0.1mM phlorizin. The specificity of their observations suggested that binding represented an initial step in glucose transport, namely, attachment to a membrane carrier.

#### b. Sodium Requirement

The absorption of glucose and other monosaccharides is influenced significantly by  $\text{Na}^+$  (Kimmich, 1973; Schultz and Curran, 1970). When  $\text{Na}^+$  is present in the solution bathing the intestinal mucosa, glucose is absorbed rapidly, but when  $\text{Na}^+$  is removed and replaced by equimolar amounts of other cations, glucose absorption virtually stops (Bihler and Crane, 1962; Bihler *et al.*, 1962; Csaky, 1961; Riklis and Quastel, 1958). Glucose absorption is inhibited by ouabain, digitalis, and other cardiac glycosides that are also inhibitors of  $\text{Na}^+$ - $\text{K}^+$ -ATPase activity and  $\text{Na}^+$  transport



**FIGURE 14-5** Model of a  $\text{Na}^+$ -activated glucose carrier of the intestinal brush border. (From Wright and Peerce, 1985).

(Csaky and Hara, 1965; Schultz and Zalusky, 1964). These observations demonstrate the close relationship between the transport of glucose and  $\text{Na}^+$ .

#### c. Characteristics of the $\text{Na}^+$ -Glucose Transporter (Carrier)

The concentrative step in the active transport of glucose occurs at the brush border membrane, and energy for this process is derived from an electrochemical  $\text{Na}^+$  gradient (Schultz, 1977; Schultz and Curran, 1970). Under conditions of net influx,  $\text{Na}^+$  and glucose enter in a ratio of 1:1 (Goldner *et al.*, 1969; Hopfer and Groseclose, 1980). Cotransport of glucose and  $\text{Na}^+$  involves a membrane transporter or carrier that is believed to be a 75-kd polypeptide (Wright and Peerce, 1985).  $\text{Na}^+$  activates glucose transport primarily by increasing the affinity of the carrier for glucose. A model showing two hypothetical forms of the glucose carrier is presented in Figure 14-5. A galent channel or pore mechanism has been proposed in which the glucose binding site is located within the membrane. The translocation of glucose in this model is believed to be the result of a  $\text{Na}^+$ -induced conformational change in the transporter (Semenza *et al.*, 1984).

## C. Proteins

### 1. Enzymatic Hydrolysis

The initial step in protein digestion is the enzymatic hydrolysis of peptide bonds by proteases with formation of smaller peptides and amino acids. The endopeptidases hydrolyze peptide bonds within the protein molecule and also hydrolyze certain model peptides. Exopeptidases hydrolyze either the carboxy-terminal (carboxypeptidase) or the amino-terminal (aminopeptidase) amino acids of peptides and certain proteins. Thus, a mixture of exopeptidases and endopeptidases cleaves long chain polypeptides from the ends as well as within the length of the chain resulting in sequentially shorter and shorter polypeptide chains and amino acids.

Dietary proteins first come in contact with proteolytic enzymes in the stomach. The best known of the gastric proteases is the family of pepsins (Samloff, 1971), which

hydrolyze most proteins with the exception of keratins, protamines, and mucins. Pepsins are relatively nonselective and hydrolyze peptide bonds involving many amino acids, the most readily hydrolyzed of which involve leucine, phenylalanine, tyrosine, and glutamic acid.

The extent of proteolysis in the stomach depends on the nature of the dietary protein and the duration of time the protein remains in the stomach. The food bolus mixed with saliva has a neutral or slightly alkaline pH as it enters the stomach, and a period of time is required for it to mix with gastric secretions and become acidified. Proteolytic digestion begins when the pH of the gastric contents approaches 4 and occurs optimally in two pH ranges, 1.6 to 2.4 and 3.3 to 4 (Taylor, 1959a, 1959b). Because of the relative lack of specificity of the pepsins, some peptide bonds of almost all dietary proteins are split during passage through the stomach. The gastric phase of protein digestion may have a minor and possibly dispensable role in overall protein assimilation (Freeman and Kim, 1978), but the reservoir function of the stomach contributes to the gradual release of nutrients, ensuring more efficient utilization in the small intestine.

Partially digested peptides pass from the stomach to the duodenum, where the acidic contents are neutralized by sodium bicarbonate present in bile and pancreatic juice. Peptic activity persists in the duodenum only during the period required to raise the pH above 4. The major peptidases that are active within the lumen of the small intestine are the pancreatic enzymes trypsin, chymotrypsin, elastase, and carboxypeptidases A and B. The action of these enzymes is integrated so that the endopeptidases produce peptides with C-terminal amino acids, which then become substrates for the exopeptidases. Trypsin produces peptides with basic C-terminal amino acids that are particularly suited for the action of carboxypeptidase B. Chymotrypsin produces peptides with aromatic amino acids in the C-terminal position, and elastase produces peptides with C-terminal amino acids that are nonpolar. Carboxypeptidase A hydrolyzes both types of C terminal peptide bonds (Table 14-4).

The final steps in peptide digestion are associated with mucosal epithelial cells. Almost all of the aminopeptidase activity is associated with the mucosa, and very little activity is present in luminal contents. Mucosal aminopeptidase activity is located both in the cytosol and in the brush border membrane fractions of the epithelial cell (Heizer and Laster, 1969; Kim *et al.*, 1972). These physically separate enzymes have remarkably different substrate specificities (Kim *et al.*, 1974). The brush border enzyme has more than 50% of the activity for tripeptides yet less than 10% of the total activity for dipeptides relative to the cytosolic enzyme(s) (Kim *et al.*, 1972; Peters, 1970). Almost all activity for tetrapeptides is present in the brush border (Freeman and Kim, 1978). Proline-containing peptides are hydrolyzed almost exclusively by cytosolic peptidases, whereas leucine aminopeptidase activity is located primarily in the brush border. The brush border peptidases appear

to have digestive functions similar to the disaccharidases and oligosaccharidases of the brush border. Endopeptidase activity of the intestinal mucosa is associated primarily within the lysosomal fraction of the cell.

## 2. Absorption of Proteolytic Products

Despite the long interest in the subject of this section, the relative amounts of the various protein digestion products (i.e., peptides versus amino acids) that are actually absorbed by intestinal mucosal cells during normal digestion remain problematic. It is a difficult process to investigate because the products of proteolysis are absorbed rapidly after they are formed and, therefore, studies of luminal contents give only an estimate of the overall rate of protein digestion. Equally important, dietary protein is continually mixed with endogenous protein in the form of digestive secretions and extruded mucosal cells. Most endogenous proteins are hydrolyzed and the amino acids absorbed in a manner similar to that of dietary protein, and the two processes occur simultaneously. Endogenous protein accounts for a significant part of the amino acids of the intestinal contents. Even when dietary protein is labeled with a radioactive tracer, there is such rapid utilization that the tracer soon reenters the lumen in the form of endogenous protein secretion.

In adult mammals, protein is not absorbed from the intestine in quantities of nutritional significance without previous hydrolysis. Most neonatal animals absorb significant amounts of immunoglobulin and other colostral proteins, but this capacity is lost soon after birth. The intestinal mucosa, however, is not totally impermeable to large polypeptide molecules. The absorption of insulin (MW 5700; Danforth and Moore, 1959; Laskowski *et al.*, 1958), ribonuclease (MW 13,700; Alpers and Isselbacher, 1967), ferritin, and horseradish peroxidase (Warshaw *et al.*, 1971) has been demonstrated.

During the digestion of protein, the amino acid content of portal blood increases rapidly, but attempts to demonstrate parallel increases in peptides in the portal blood have not been uniformly successful. This has been regarded as evidence that only amino acids can be absorbed by the intestinal mucosa and that the absorption of peptides does not occur. Although it seems clear that most dietary protein is absorbed by the mucosal epithelium in the form of free amino acids, peptides also may be taken up by the mucosal cell in quantitatively significant amounts. Peptides so absorbed may be hydrolyzed either at the cell surface or intracellularly, and individual amino acids finally enter the portal circulation via the basolateral cell membrane.

Small peptides, under certain circumstances, may cross the intestinal epithelium intact and enter the portal circulation. Webb (1986) suggested that intact peptide absorption accounted for more than half of luminal amino acid nitrogen in the calf. The amount of peptide nitrogen entering the portal circulation in other species characteristically has

been lower and variable depending on the source of protein and on the digestibility of the peptide being investigated (Gardner, 1984).

### 3. Transport of Amino Acids

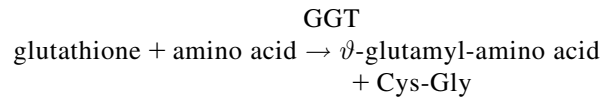
Amino acids, like glucose and certain other monosaccharides, are absorbed and transferred to the portal circulation by active transport processes. The same type of saturation kinetics observed in studies of monosaccharide absorption are observed with amino acids, which suggests the presence of carrier transport mechanisms. Certain monosaccharides inhibit amino acid transport (Newey and Smyth, 1964; Saunders and Isselbacher, 1965), and whereas inhibition generally has been of the noncompetitive type, competitive inhibition between galactose and cycloleucine has been demonstrated (Alvarado, 1966a), which suggests that a common carrier may be involved.

Most amino acids are transported against concentration and electrochemical gradients, and the overall transport process requires metabolic energy. The chemical specificity of these transport mechanisms is shown by the fact that the natural l-forms of various amino acids are absorbed more rapidly than the corresponding d-forms and that only the l-amino acids appear to be actively transported. For most transport systems, Na<sup>+</sup> is necessary for absorption of amino acids as it is for a variety of other nonelectrolyte substances (Gray and Cooper, 1971; Schultz and Curran, 1970).

Separate transport systems exist for different groups of amino acids. Each member of a group inhibits the transport of other members competitively, suggesting that they share the same carrier. There is demonstrable overlap between groups, indicating that the overall transport process is complex (Christensen, 1984, 1985; Stevens *et al.*, 1984). The following is a summary of the designations and substrates of the recognized amino acid transport systems of the intestinal brush border (Stevens *et al.*, 1984):

1. The neutral brush border (NBB) pathway is responsible for monoaminomonocarboxylic (neutral) amino acids and histidine. Na<sup>+</sup> is required, and these amino acids show mutual competition for transport.
2. The monoaminodicarboxylic acids (aspartic and glutamic acid) pathway (XGA) requires Na<sup>+</sup>. Aspartic and glutamic acids are not transported against concentration gradients. Following uptake, they are transaminated by the intestinal mucosa and under physiological conditions enter the portal vein as alanine.
3. Imino acids (IMINO), proline, hydroxyproline, methylaminoisobutyric acid, and N-substituted glycine derivatives sarcosine (N-methyl glycine) and betaine (N-dimethylglycine). This pathway also has a Na<sup>+</sup> requirement.
4. Dibasic amino acids (Y<sup>+</sup>), including lysine, arginine, ornithine, and the neutral amino acid cystine.
5. Phenylalanine and methionine share the PHE amino acid transport system.

The  $\vartheta$ -glutamyl cycle has been proposed as a possible transport system for amino acids (Meister and Tate, 1976).  $\vartheta$ -Glutamyltransferase (GGT) is a membrane-bound enzyme that is present in a number of mammalian tissues and catalyzes the initial step in glutathione degradation. The 0-glutamyl moiety of glutathione is transferred to amino acid (or peptide) receptors with the production of cysteinylglycine:



The highest GGT activity is present in tissues that are known to transport amino acids actively (e.g., the jejunal villus, the proximal convoluted tubule of the kidney and liver). Meister and his colleagues (1976) have suggested that GGT may function in translocation by interaction with extracellular amino acids and with intracellular glutathione. The hypothetical mechanism involves the noncovalent binding of extracellular amino acids to the plasma membrane, whereas intracellular glutathione interacts with GGT to yield a  $\vartheta$ -glutamyl-enzyme complex. When the  $\vartheta$ -glutamyl moiety is transferred to the membrane-bound amino acid, a  $\vartheta$ -glutamyl-amino acid complex is formed, which, when released from the membrane binding site, moves into the cell. The  $\vartheta$ -glutamyl-amino acid complex is split by the action of  $\vartheta$ -glutamyl cyclotransferase, an enzyme appropriately located in the cytosol. Glutathione is regenerated by means of the  $\vartheta$ -glutamyl cycle, which is a good substrate for GGT (Thompson and Meister, 1975).

The  $\vartheta$ -glutamyl cycle does not require sodium, and the cycle would not explain the previously demonstrated sodium dependence for amino acid transport. The cycle is not considered to be the only amino acid transport system, and its quantitative significance in individual tissues is unknown.

### 4. Neonatal Absorption of Immunoglobulin

At birth, most domestic species, including the calf, foal, lamb, pig, kitten, and pup, absorb significant quantities of colostrum protein from the small intestine. Immune globulin (Ig) either is absent in the serum of domestic species at birth or the level is low. Within a few hours after ingestion of colostrum, the serum Ig levels rise. This represents the principal mechanism by which the young of most domestic animal species acquire maternal immunity. Under normal environmental conditions, ingestion of colostrum is an absolute requirement for health during the neonatal period. The rabbit is the exception in that maternal Ig is received primarily *in utero* by transplacental transfer.

Protein enters the neonatal absorptive cell by pinocytosis and passes through the cell to the lymphatics. The process

is not selective because many proteins other than Ig can be absorbed (Payne and Marsh, 1962). The ability to absorb intact protein is lost by domestic species soon after birth. In the piglet, "closure" occurs within 1 to 2 days (Leary and Lecce, 1978; Westrom *et al.*, 1984) beginning in the duodenum and occurring last in the ileum. In rodents, protein absorption normally continues for approximately 3 weeks. The mechanism of intestinal "closure" was studied, and researchers found that complete starvation of pigs lengthened the period of protein absorption to 4 to 5 days, whereas early feeding shortened the period (Lecce, 1965; Lecce and Morgan, 1962; Lecce *et al.*, 1964). Feeding different fractions of colostrum including lactose and galactose resulted in loss of protein absorptive capacity. The route of feeding may not be the critical factor, however. Calves that are prevented from eating but that receive nutrients parenterally lose the ability to absorb protein at the same time as control calves (Deutsch and Smith, 1957).

In the neonatal calf, Ig deficiency resulting from a failure of colostrum Ig absorption plays a role in the pathogenesis of Gram-negative septicemia (Gay, 1965; Smith, 1962). Most calves deprived of colostrum develop septicemia early in life and may develop acute diarrhea before death (Smith, 1962; Tennant *et al.*, 1975; Wood, 1955). Hypogammaglobulinemia is almost always demonstrable in calves dying of Gram-negative septicemia and is the result either of insufficient Ig intake or of insufficient intestinal absorption. The Ig fraction is the essential factor in colostrum that protects against systemic infections (Penhale *et al.*, 1971).

Serum immunoglobulin values of neonatal calves vary, and a 10% incidence of hypogammaglobulinemia may occur in clinically normal calves (Braun *et al.*, 1973; House and Baker, 1968; Smith *et al.*, 1967; Tennant *et al.*, 1969; Thornton *et al.*, 1972). Most such individuals probably have insufficient colostrum intake. Even when calves were given the opportunity to ingest colostrum, however, a surprising number were hypogammaglobulinemic. Some of the reasons for varying gammaglobulinemia values are recognized, but the relative importance of each is not known. The concentration of lactoglobulin, the volume consumed (Selman *et al.*, 1971), the time elapsed from birth to ingestion of colostrum (Selman *et al.*, 1971), and the method of ingestion (natural suckling versus bucket feeding) may have an important influence on the serum IgG (McBeath *et al.*, 1971; Smith *et al.*, 1967). Calves that suckle their dams usually attain serum IgG concentrations that are higher than those attained by calves given colostrum from a bucket. The frequency of hypogammaglobulinemia may be influenced by season (Gay *et al.*, 1965b; McEwan *et al.*, 1970a), although this relationship is not consistent (Smith *et al.*, 1967; Thornton *et al.*, 1972). Familial factors also may influence development of hypogammaglobulinemia (Tennant *et al.*, 1969).

Regardless of cause, the mortality of hypogammaglobulinemic calves is higher than that of calves with normal serum IgG levels (Boyd, 1972; Gay, 1965; House

and Baker, 1968; McEwan *et al.*, 1970a; Naylor *et al.*, 1977; Thornton *et al.*, 1972). In addition to having more septicemic infections (Gay, 1965; McEwan *et al.*, 1970a; Roberts *et al.*, 1954; Smith, 1962; Wood, 1955), hypogammaglobulinemic calves have a greater prevalence of acute diarrheal disease (Boyd, 1972; Gay *et al.*, 1965a; Naylor *et al.*, 1977; Penhale *et al.*, 1970), which indicates that the local protective effects of Ig in the intestine are important (Fisher *et al.*, 1975; Logan and Penhale, 1971).

The prevalence of hypogammaglobulinemia and the high mortality associated with it has led to the development of several rapid tests for identification of hypogammaglobulinemic calves (Aschaffenburg, 1949; Fisher and McEwan, 1967b; McBeath *et al.*, 1971; Patterson, 1967; Stone and Gitter, 1969). The zinc sulfate turbidity test (Kunkel, 1947) was the first to be used to determine the serum immunoglobulin concentrations of neonatal calves (McEwan *et al.*, 1970b). A close correlation has been established between test results and the amount of serum IgG and IgM (Fisher and McEwan, 1967b, 1967b; McEwan *et al.*, 1970b).

The sodium sulfite turbidity test is similar to the zinc sulfate test and also has been used to identify hypogammaglobulinemic calves (Pfeiffer and McGuire, 1977; Stone and Gitter, 1969). Failure of turbidity to develop when serum is added to a saturated solution of sodium sulfite indicates immunoglobulin deficiency. A semiquantitative assessment of the Ig concentration is made by grading the degree of turbidity (Stone and Gitter, 1969).

The refractometer is used as a rapid test for Ig deficiency (Boyd, 1972; McBeath *et al.*, 1971). There is a close relationship between the concentration of IgG and total serum protein (TSP) in neonatal calves (Tennant *et al.*, 1969), and the wide variations in TSP were due to variations in IgG. Direct linear correlation between the refractive index (RI) and the Ig concentration has also been observed (McBeath *et al.*, 1971). The regression line for this relationship was independently confirmed (Tennant *et al.*, 1978). The Y intercepts in these studies were identical (4 g/dl). The refractometer has a value as a rapid field instrument for the assessment of Ig status, but in cases of hemoconcentration it has limitations (Boyd, 1972).

The glutaraldehyde coagulation test was used originally in cattle to detect hypergammaglobulinemia in samples of whole blood (Sandholm, 1974). Glutaraldehyde has also been used in a semiquantitative test to evaluate IgG in canine (Sandholm and Kivisto, 1975) and human serum (Sandholm, 1976). This procedure has been modified to detect hypogammaglobulinemic calves. Calves with a negative test result (serum IgG #0.4g/dl) had markedly higher mortality than calves with positive results (Table 14-7) (Tennant *et al.*, 1979), which is similar to results obtained by using the zinc sulfate turbidity test (Gay *et al.*, 1965a; McEwan *et al.*, 1970a) or other estimates of circulating IgG. Many tests can be initiated quickly using the glutaraldehyde coagulation test, and results can be evaluated rapidly without instrumentation.



**TABLE 14-7** Relationship between Results of the Glutaraldehyde Coagulation Test, Serum (-Globulin) Concentration, and Death Rate

Source of Calves	No.	Glutaraldehyde Reaction	Serum (-Globulin (/dl))		Death Rate (%)
			Mean ( $\pm$ SD)	Extremes	
Calves before ingestion of colostrums	10	Negative	0.18 ( $\pm$ 0.06)	0.1–0.25	— <sup>a</sup>
Calves from production unit	60	Negative	0.35 ( $\pm$ 0.13)	0.11–0.63	16.7 <sup>b</sup>
	13	Incomplete	0.60 ( $\pm$ 0.13)	0.42–0.85	7.7
	208	Positive	1.46 ( $\pm$ 0.63)	0.42–4.4	3.4

<sup>a</sup> Samples of serum were obtained at birth, but no follow-up of calves was made.

<sup>b</sup> The death rate of calves that were test-negative was significantly ( $p < 0.01$ ) greater than that of test-positive calves, using t-test for significance of differences between two percentages.

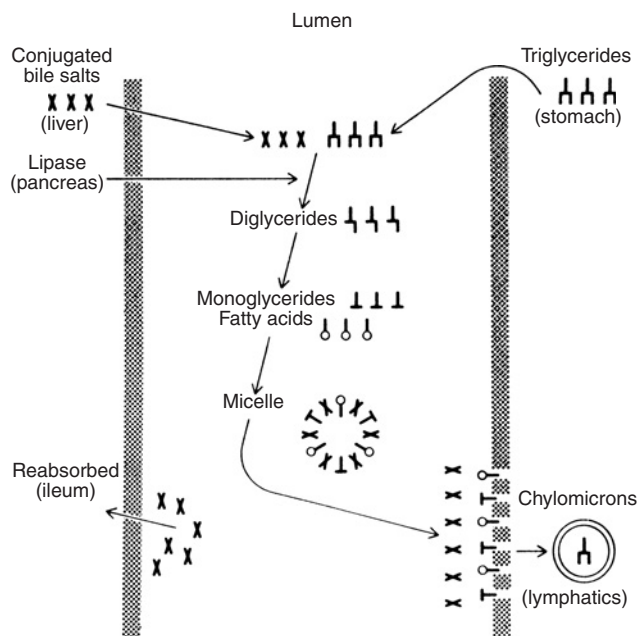
## D. Lipids

### 1. Absorption of Fats

#### a. Luminal Phase

The fat in the diet is primarily in the form of triglycerides or long-chain fatty acids. In the dog, gastric lipase plays a credible role in fat digestion, leading to the formation of fatty acids, which help coordinate gastric emptying and pancreatic secretions. In other species, the initial step in utilization of triglycerides occurs in the lumen of the proximal small intestine, where hydrolysis is catalyzed by pancreatic lipase. The pancreas secretes lipase in active form. The enzyme requires an oil-water interface for activity, so only emulsions of fat can be hydrolyzed. Enzyme activity is directly related to the surface area of the emulsion, so the smaller the emulsion particle, the greater the total surface area of a given quantity of triglyceride and the greater the rate of hydrolysis (Benzonana and Desnuelle, 1965). Bile salts are not an absolute requirement but favor hydrolysis by their detergent action, which causes formation of emulsions with small particle sizes and by stimulating lipase activity within the physiological pH range of the duodenum. A colipase is present in the pancreatic secretion, which facilitates the interaction of lipase with its triglyceride substrate and protects lipase from inactivation (Borgstrom and Erlanson, 1971).

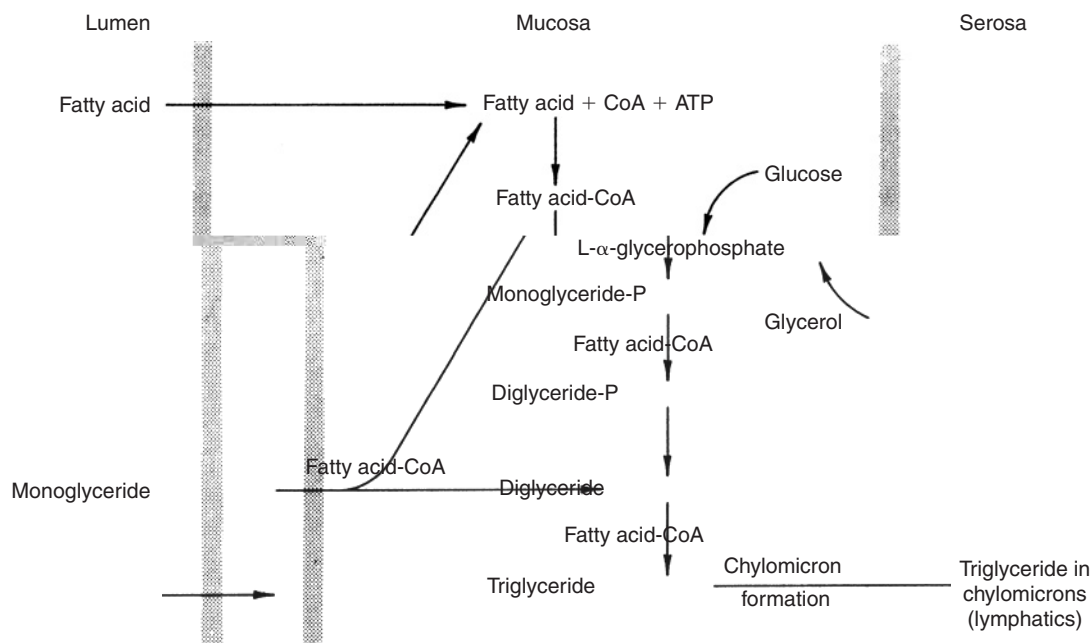
Pancreatic lipase splits the ester bonds of triglycerides preferentially at the 1 and 3 positions so that the major end products of hydrolysis are 2-monoglycerides and free fatty acids. Both compounds are relatively insoluble in water but are brought rapidly into micellar solution by the detergent action of bile salts. The mixed micelles so formed have a diameter of approximately 2nm and are believed to be the form in which the products of fat digestion are actually taken up by the mucosal cell (Hofmann and Small, 1967). The intraluminal events that occur in fat absorption are schematically summarized in Figure 14-6.



**FIGURE 14-6** Intraluminal events during fat absorption. From Isselbacher (1967).

#### b. Mucosal Phase

The initial step in intestinal transport of fat is the uptake of fatty acids and monoglycerides by the mucosal cell from micellar solution. The precise mechanism is yet unclear, but present evidence suggests that the lipid contents of the micelle are somehow discharged at the cell surface and enter the mucosal cell in molecular rather than micellar form (Isselbacher, 1967). The net effect is the absorption of the end products of lipolysis and the exclusion of bile salts, which are absorbed farther down the intestine, primarily in the ileum. Uptake of fatty acids appears to be a passive process having no requirement for metabolic energy.



**FIGURE 14-7** Biochemical reactions involved in intestinal transport of long chain fatty acids and monoglycerides. From Isselbacher (1966).

Within the mucosal cell, the fatty acids are transported by a soluble binding protein to the endoplasmic reticulum, where the fatty acids and monoglycerides are rapidly reesterified to triglyceride (Ockner and Isselbacher, 1974; Ockner and Manning, 1974). The two biochemical pathways for triglyceride biosynthesis in the intestine are summarized in Figure 14-7. Direct acylation of monoglyceride occurs in the intestine and is the major pathway for lipogenesis in the intestine during normal fat absorption. The initial step in this series of reactions involves activation of fatty acids by acyl-CoA synthetase, a reaction that requires  $Mg^{2+}$ , ATP, and CoA and that has a marked specificity for long-chain fatty acids. This specificity explains the observation by Bloom *et al.* (1951) that medium- and short-chain fatty acids are not incorporated into triglycerides during intestinal transport but enter the portal circulation as nonesterified fatty acids. The activated fatty acids then react sequentially with mono- and diglycerides to form triglycerides in steps catalyzed by mono- and diglyceride transacylases. The enzymes responsible for this series of reactions are present in the microsomal fraction of the cell (Rao and Johnston, 1966). These enzymes occur together in the endoplasmic reticulum as a “triglyceride-synthetase” complex.

An alternate route that is available for fatty acid esterification involves L- $\alpha$ -glycerophosphate derived either from glucose or from dietary glycerol by the action of intestinal glycerokinase. Activated fatty acid CoA derivatives react with L- $\alpha$ -glycerophosphate to form lysophosphatidic acid (monoglyceride phosphate), which by a second acylation forms phosphatidic acid (diglyceride phosphate). Phosphatidic acid phosphatase then hydrolyzes the phosphate

ester bond, forming diglyceride, and by means of a transacylase step similar to that described previously, triglyceride is formed. Although this pathway appears to be of minor importance for triglyceride synthesis in the intestine, intermediates in this sequence of reactions are important in the synthesis of phospholipids, which are essential for stabilization of the chylomicron.

The next step in fat transport is formation of chylomicrons within the endoplasmic reticulum. The chylomicron is composed primarily of triglyceride and has an outer membranous coating of cholesterol, phospholipid, and protein (Zilversmit, 1965). The  $\beta$ -lipoprotein component of the chylomicron is synthesized by the intestinal mucosal cell. Inhibition of protein synthesis by puromycin or acetoxycycloheximide interferes with chylomicron formation and significantly reduces fat transport (Sabesin and Isselbacher, 1965).

The final step in fat absorption is extrusion of the chylomicra into the intercellular space opposite the basal lateral portion of the absorptive cell by reverse pinocytosis. From the intercellular space, the chylomicra pass through the basement membrane and enter the lacteal. The chylomicra then pass from the lacteals into lymph ducts and into the general circulation, thereby completely bypassing the liver during the initial phase of absorption.

## 2. Absorption of Other Lipids

### a. Cholesterol

Dietary cholesterol is present in both free and esterified forms, but only nonesterified cholesterol is absorbed.

Cholesterol esters are hydrolyzed within the lumen of the intestine by sterol esterases secreted by the pancreas. Bile salts are required both for the action of this enzyme and for the absorption of nonesterified cholesterol. In the mucosal cell, cholesterol is reesterified and transferred by way of the lymph to the general circulation. The type of triglyceride present in the diet significantly affects the absorption of cholesterol and its distribution in lymph lipids (Ockner *et al.*, 1969).

#### b. Vitamin A

The diet contains vitamin A activity in two principal forms: (1) as esters of preformed vitamin A alcohol (retinol) and fatty acids and (2) as provitamin A, primarily  $\beta$ -carotene. Vitamin A ester is hydrolyzed by a pancreatic esterase within the lumen (Murthy and Ganguly, 1962), and the free alcohol is absorbed in the upper small intestine. Vitamin A alcohol is reesterified in the mucosa primarily with palmitic acid. The vitamin A ester is absorbed by way of the lymph, and after reaching the general circulation, it is rapidly cleared from the plasma and stored in the liver. In the postabsorptive state, vitamin A circulates as the free alcohol, the form released as needed from the liver by the action of hepatic retinylpalmitase esterase. The blood level of vitamin A is independent of liver reserves, and, as long as a small amount of vitamin A is present in the liver, the blood level remains normal (Dowling and Wald, 1958).

In diets that lack animal fat, the carotenes, primarily  $\beta$ -carotene, serve as the major precursor of vitamin A. The intestinal mucosa has a primary role in conversion of provitamin A to the active vitamin, although conversion can occur to a limited degree in other tissues. The mechanism involves central cleavage of  $\beta$ -carotene into two active vitamin A alcohol molecules that are subsequently esterified and absorbed by the lymphatics as with preformed vitamin A.

Bile salts are required for the mucosal uptake of  $\beta$ -carotene and for the conversion of  $\beta$ -carotene to vitamin A. Uptake of carotene and release of vitamin A ester into the lymph are rate-limiting steps. Cattle absorb substantial amounts of  $\beta$ -carotene without prior conversion to vitamin A, and these pigments are responsible for much of the yellow color of the plasma. Most other species have no  $\beta$ -carotene in the plasma, and extraintestinal conversion is thought to be more efficient in these species than in cattle (Ganguly and Murthy, 1967).

#### c. Vitamin D

Vitamin D, like cholesterol, is a sterol that is absorbed by the intestine and transported via the lymph (Schachter *et al.*, 1964). Intestinal absorption differs, however, in that vitamin D is transported to the lymph in nonesterified form. The uptake of vitamin D by the mucosal cell is favored by the presence of bile salts. Simultaneous absorption

of fat from micellar solutions increases transport of vitamin D out of the cell into the lymph, the limiting step.

One of the major actions of vitamin D is to enhance the intestinal absorption of calcium. Wasserman and coworkers (1968) (Wasserman and Taylor, 1966, 1968) have described the mechanism of action of vitamin D. They have shown that vitamin D causes synthesis of a calcium-binding protein that plays a central role in the transport of calcium.

### E. Cobalamin

Following ingestion, cobalamin is released from food in the stomach (Batt and Morgan, 1982; Simpson *et al.*, 2001). It is then bound to a nonspecific cobalamin-binding protein of salivary and gastric origin called haptocorrin. Intrinsic factor (IF), a cobalamin-binding protein that promotes cobalamin absorption in the ileum, is produced by parietal cells and cells at the base of antral glands in the dog but not the cat; IF is produced in the pancreas of cats. The affinity of cobalamin for haptocorrin is higher at acid pH than for IF, so most is bound to haptocorrin in the stomach. Upon entering the duodenum, haptocorrin is degraded by pancreatic proteases, and cobalamin is transferred from haptocorrin to IF, a process facilitated by the high affinity of IF for cobalamin at neutral pH. Cobalamin-IF complexes traverse the intestine until they bind to specific receptors (previously called IFCR, but recently dubbed cubilin) located in the microvillous pits of the apical brush border membrane of ileal enterocytes. Cobalamin is then transcytosed to the portal bloodstream and binds to a protein called transcobalamin 2 (TC II), which mediates cobalamin absorption by target cells. A portion of cobalamin taken up by hepatocytes is rapidly (within an hour in the dog) reexcreted in bile bound to haptocorrin. Cobalamin of hepatobiliary origin, in common with dietary derived cobalamin, undergoes transfer to IF and receptor mediated absorption, thus establishing enterohepatic recirculation of the vitamin.

Low serum cobalamin concentrations in dogs have been associated with exocrine pancreatic insufficiency (EPI), severe intestinal disease, IF-Cbl receptor abnormalities, and conditions associated with the proliferation of enteric bacteria (e.g., stagnant loops). Cobalamin deficiency in cats and dogs results in a significant metabolic disorder, which can be ameliorated by treatment or correction of the underlying cause.

Dietary folate polyglutamate is deconjugated by folate deconjugase to folate monoglutamate, which is absorbed by specific carriers in the proximal small intestine. Folate deconjugase is a jejunal brush border enzyme. Folic acid, which is produced by microorganisms in the small intestine, is also absorbed and can increase existing serum levels of folate. Serum levels of folate are expected to decrease when the absorptive capacity of the proximal intestine is severely compromised, as might occur with infiltrative bowel disease.

## VIII. DISTURBANCES OF GASTROINTESTINAL FUNCTION

### A. Vomition

Vomiting is a coordinated reflex act that results in rapid, forceful expulsion of gastric contents through the mouth. The reflex may be initiated by local gastric irritation caused by a variety of toxic irritants, infectious agents, foreign bodies, gastric tumors, obstructions of the pyloric canal or the small intestine, or by drugs such as apomorphine or other toxic substances that act centrally on the “vomiting center” of the medulla.

Severe vomiting produces loss of large quantities of water and of  $H^+$  and  $Cl^-$  ions. These losses cause dehydration, metabolic alkalosis with increased plasma  $HCO_3^-$ , and hypochloremia. Chronic vomiting may also be associated with the loss of significant tissue  $K^+$  and with hypokalemia. The  $K^+$  deficit is caused primarily by increased urinary excretion resulting from alkalosis (Leaf and Santos, 1961). Gastric secretions contain significant quantities of  $K^+$ , and losses in the vomitus also contribute to the  $K^+$  deficiency.  $K^+$  deficiency, which develops initially because of the alkalosis, perpetuates the alkalotic state by interfering with the ability of the kidney to conserve  $H^+$  (Brazeau *et al.*, 1956; Darrow, 1964). Both  $K^+$  and the hypovolemia caused by dehydration may result in renal tubular damage and in renal failure.

Vomiting occurs frequently in the dog, cat, and pig but is an unusual sign in the horse, which has anatomical restrictions of the esophagus that interfere with expulsion of gastric contents. In cattle, sheep, and goats, the physiological process of rumination utilizes neuromuscular mechanisms similar to those involved in vomiting. Uncontrolled expulsion of ruminal contents is an uncommon sign, most frequently occurring after ingestion of toxic materials or associated with traumatic reticulitis and resulting “vagal indigestion.” The contents of the abomasum are not expelled directly even when the pyloric canal is obstructed. Pyloric outflow obstruction does occur in cattle, which is similar metabolically to that observed in nonruminants. This obstruction may be observed in right-sided displacement of the abomasum with or without torsion, occasionally with left-sided displacement of the abomasum, in cows with functional pyloric obstruction as a result of reticuloperitonitis and from “vagal indigestion.” When the pylorus is obstructed, abomasal contents are retained, causing distension of the abomasum, which in turn stimulates further secretion and retention. Retained abomasal contents may be regurgitated into the large reservoir of the rumen and sequestered there from other fluid compartments of the body. The net result is loss of  $H^+$  and  $Cl^-$  ions and development of metabolic alkalosis, hypochloremia, and hypokalemia. This metabolic syndrome often is associated with fluid distension of the rumen related to pyloric outflow obstruction. Similar distension of the rumen in the absence of hypochloremic, hypokalemic

metabolic alkalosis suggests more proximal obstruction of rumen outflow, namely the omasum.

Brachycephalic, middle-aged, small breed dogs (e.g., Shih Tzus) seem predisposed to hypertrophy of the pyloric mucosa or muscularis (Simpson, 2005); this syndrome, as well as other causes of pyloric outflow obstruction, can result in vomiting, metabolic alkalemia, and paradoxical aciduria. Chronic hypertrophic gastritis, which resembles Menetrier’s disease in humans, has been demonstrated in the dog (Happe and van der Gagg, 1977; Kippins, 1978; van der Gagg *et al.*, 1976; Van Kruiningen, 1977). Van Kruiningen’s series of cases were basenjis that had concomitant lymphocytic-plasmocytic enteritis. The primary disease, however, has been observed in other breeds without intestinal lesions. Signs of illness usually involve chronic vomiting, weight loss, and occasionally diarrhea. Hypoalbuminemia occurs in most cases. In humans, hyperchlorhydria or achlorhydria can occur. The morphological changes in the stomach wall (hypertrophic rugae) and some of the clinical features help to differentiate this disease from gastric neoplasia.

Functional gastrinomas have been rarely diagnosed in the dog and have been compared to the Zollinger-Ellison syndrome in humans (English *et al.*, 1988; Straus *et al.*, 1977; van der Gagg and Happe, 1978). Clinical disease is associated with hypergastrinemia, hyperchlorhydria, hypertrophic gastritis, peptic esophagitis, and duodenal ulcers. A more recent overview by Simpson (2000) revealed a wide variety of breeds with a mean age of 9 years; no sex bias was identified. The diagnostic workup usually centered around the problems of vomiting, weight loss and anorexia, and the pursuit of localizing findings of melena, hematemesis, and abdominal pain. Some of these dogs had signs associated with gastrointestinal preformation/peritonitis. Surgical treatment or medical management, to include omeprazole, famotidine, sucralfate, or octreotide, is indicated. Because metastasis is frequently present, the prognosis for recovery is poor.

### B. Gastric Dilatation-Volvulus

Gastric dilatation-volvulus (GDV) is an acute gastrointestinal disorder associated with high mortality (Leib and Blass, 1984; Morgan, 1982). It typically occurs in large deep-chested dogs but has been reported in smaller dogs, the cat, and other species. Gastric dilatation precedes development of volvulus and is the result of the accumulation of gas and fluid in the stomach as a result either of mechanical or functional disturbances in pyloric outflow. As the stomach distends and rotates about the distal esophagus, displacement and occlusion of the pylorus and duodenum occur. Necrosis and perforation of the stomach wall and peritonitis are common causes of death.

Distension and displacement of the stomach cause obstruction of the caudal vena cava and portal vein resulting

in venous stasis and sequestration of blood in splanchnic, renal, and posterior muscular capillary beds. This decrease in circulating blood volume (venous return) and subsequent decrease in cardiac output, arterial blood pressure, and tissue perfusion culminate in hypovolemic shock. Endotoxemia, a consequence of portal vein occlusion, contributes to the shock syndrome. The release of myocardial depressant factors from ischemic pancreatic tissue impairs the clearance of endotoxins by the reticuloendothelial system as well as causing direct cardiodepressant effects. Altered microvascular perfusion with hypoxemia and endotoxemia favors development of disseminated intravascular coagulopathy (DIC) (Lees *et al.*, 1977).

Increased plasma gastrin immunoreactivity has been reported in dogs with GDV (Leib *et al.*, 1984). Preexisting conditions of relative hypergastrinemia may predispose to GDV. Gastrin can increase caudal esophageal sphincter pressure, delay gastric emptying, and predispose to pyloric outflow obstruction by causing gastric mucosal and pyloric muscular hypertrophy.

Experimental gastric dilatation and dilatation with torsion have been studied in the dog (Wingfield *et al.*, 1974). Hyperkalemia and hyperphosphatemia were consistent findings in dogs with gastric dilatation and torsion (Wingfield *et al.*, 1974). This was the result of hypovolemia, decreased renal perfusion, and renal insufficiency on the one hand and the loss of intracellular  $K^+$  from damaged tissue on the other. Increased blood urea nitrogen (BUN) and serum creatinine (Cr) levels persisted after decompression of the stomach. Hemoconcentration and increased TSP were attributed to fluid shifts from the vascular compartment into the lumen of the alimentary tract, wall of the stomach, and peritoneal cavity. Increased alanine aminotransferase (ALT) and aspartate aminotransferase (AST) were most apparent following decompression of the stomach and were attributed to alteration of hepatocytes and smooth muscle of the stomach and spleen. Increased levels of creatine kinase (CK) resulted from the effects of tissue hypoxia on striated muscle. Metabolic acidosis was attributed in part to increased production of lactic acid caused by tissue hypoxia.

A wide range of acid-base and electrolyte disturbances has been reported in clinical patients with GDV (Kagan and Schaer, 1983; Muir, 1982; Wingfield *et al.*, 1982). Dogs presenting with GDV may have normal acid-base status. Metabolic acidosis and hypokalemia commonly occur. Metabolic alkalemia and respiratory alkalosis also have been observed. Hyperkalemia is unusual. The absence of an increase in anion gap in one study indicated that the production of volatile fatty acids and lactic acid was not excessive (Wingfield *et al.*, 1982).

### C. Ischemia-Reperfusion Injury

Ischemia-reperfusion injury is a contributing cause of death in horses with strangulating intestinal obstruction

(Moore *et al.*, 1995) and in dogs with GDV. Together with luminal occlusion of the alimentary tract, functional constriction or mechanical obstruction of intestinal vasculature occurs. Depending on the duration and severity of ischemia, oxygenation of tissue is compromised, and there is a subsequent attenuation of oxidative phosphorylation and a decrease in ATP. Anaerobic glycolysis ensues, leading to intracellular acidosis and increased intracellular concentrations of  $Ca^{2+}$ . Unless timely restoration of blood flow and oxygenation occurs, these metabolic derangements eventually contribute to cellular edema, lysosomal release of degradative enzymes, autolytic destruction of cellular organelles, and cell death.

When intestinal obstruction is relieved and tissue perfusion is reestablished, reoxygenation of tissue can result in a cascade of biochemical events that can aggravate ischemia-induced tissue injury. The resulting reperfusion injury is caused in part by oxygen-free radicals (OFR), particularly superoxide ( $O_2^-$ ) and hydroxyl-free radicals (OH $\cdot$ ), and is characterized by increased microvascular and mucosal permeability and mucosal necrosis (Moore *et al.*, 1995). The formation of OFRs is preceded by accumulation of hypoxanthine in endothelial cells and intestinal mucosal cells during ischemia. The conversion of xanthine dehydrogenase to xanthine oxidase also occurs during ischemia, a reaction that is facilitated by high intracellular levels of calcium ions and the protease, calpain. When reperfusion occurs, xanthine oxidase converts hypoxanthine to uric acid and superoxide radicals.  $O_2^-$  and hydrogen peroxide ( $H_2O_2$ ), a product of superoxide dismutase (SOD) reduction, are converted to highly reactive OH $\cdot$  in the presence of an iron catalyst. OH $\cdot$  initiates structural and functional cellular membrane damage via lipid peroxidation. The release of inflammatory mediators attending lipoperoxidation contributes to tissue injury.

Malondialdehyde (MDA) is a stable by-product of lipoperoxidation, and investigators can utilize its detection as an indicator of ischemia-reperfusion injury (Moore *et al.*, 1995).

Neutrophils are recruited into ischemic and reperfused tissue by xanthine oxidase-derived OFRs and chemoattractants released from cellular membranes during lipid peroxidation. Increased cytosolic calcium concentrations during ischemia and subsequent lipoperoxidation activate phospholipase A2, which in turn causes the release of platelet-activating factor (PAF), metabolites of arachidonic acid (leukotrienes and prostaglandins), and lysophosphatidylcholine. Leukotriene B4, thromboxane A2, and PAF are the primary products of phospholipid metabolism that promote infiltration and degranulation of neutrophils in affected tissue.

When neutrophils attach to endothelium, they release elastase and lactoferrin, which promotes extravasation (Moore *et al.*, 1995). The conversion of oxygen to  $O_2^-$  within neutrophils is facilitated by the NADPH oxidase

system. These  $O_2^-$  are metabolized to  $H_2O_2$ , and the latter reacts with  $Cl^-$  to form hypochlorous acid. Myeloperoxidase (MPO), an enzyme contained in neutrophils, catalyzes this reaction. MPO activity in intestinal mucosa correlates well with the degree of neutrophil infiltration and mucosal injury.

Serine proteases are believed to play a contributing role in ischemia-reperfusion injury (Moore *et al.*, 1995). The pancreas is an important source of endoproteases (trypsin, chymotrypsin, and elastase), which can cause mucosal injury, particularly in the small intestine. Proteases produced by granulocytes, as well as lysosomes, are more important in mucosal injury of the large bowel, elastase, neutral proteases, and cathepsin G are released from granulocytes during phagocytosis. Cathepsin B is a lysosomal protease that has trypsin-like activity.

Several pharmacological agents have been used in experimental and clinical studies of ischemia-reperfusion injury (Moore *et al.*, 1995). The mechanistic rationale for many of these agents is comparable to the role of endogenous antioxidants. Examples of commonly used agents include xanthine oxidase inhibitors (allopurinol), deferoxamine, 21-aminosteroids, inhibitors of PLA<sub>2</sub>, cyclooxygenase, and lipoxygenase. Superoxide dismutase (SOD), catalase, and glutathione peroxidase (Gpx) are free radical scavenging enzymes. Mannitol, albumin, dimethyl sulfoxide (DMSO), dimethyl thiourea, and manganese chloride represent nonenzymatic free radical scavengers. Other agents that have been studied include nitric acid, protease inhibitors, hydroxyethyl starch, and neutrophil-directed agents. Although there has been demonstrable efficacy of the aforementioned agents in some studies, there are many inconsistencies. From a clinical perspective, success has been limited with single agents, and there is more interest in combination or multimodal therapy.

#### D. Acute Diarrheas

The term *diarrhea* is used to generically describe the passage of abnormally fluid feces with increased frequency, increased volume, or both. The significance of diarrhea depends primarily on the underlying cause and on the

secondary nutritional and metabolic disturbances that are caused by excessive fecal losses.

There are theoretically three factors that can act independently or in combination to produce diarrhea. An increase in the rate of intestinal transit is one factor believed important in functional disorders of the gastrointestinal tract in which "hypermotility" has been considered to be the primary cause. Although increased intestinal motility may be a factor in certain types of diarrheal disease, when motility patterns have been investigated, diarrheal disease has actually been associated with decreased motility (Christensen *et al.*, 1972). A second factor in the pathogenesis of diarrhea is decreased intestinal assimilation of nutrients that may result either from decreased intraluminal hydrolysis of nutrients (e.g., *maldigestion* resulting from pancreatic exocrine insufficiency), bile salt deficiency, or defective mucosal transport of nutrients (i.e., *malabsorption*) that results from various types of inflammatory bowel disease, villus atrophy, intestinal lymphoma, or intrinsic biochemical defects in the mucosal cell that interfere with digestion or absorption. Finally, increased intestinal secretion of water and electrolytes is a major factor in the pathogenesis of certain types of acute diarrhea.

Enteropathogenic strains of *Escherichia coli* produce soluble enterotoxins (Kohler, 1968; Moon, 1978; Smith and Halls, 1967), which alter bidirectional  $Na^+$  and water flux (Fig. 14-8). The most extensively studied enterotoxin is that produced by *Vibrio cholerae*. This bacterium produces a large-molecular-weight, heat-labile toxin (CT), one subunit of which has properties similar to those of the heat-labile (LT) enterotoxin produced by certain strains of *E. coli* (Richards and Douglas, 1978). The mechanism of action of CT is believed to involve the activation of adenylate cyclase. This membrane-bound enzyme converts ATP to cAMP, which through the action of protein kinase is responsible for the greatly increased secretion of water and electrolytes by the intestinal mucosa. Although species differences have been observed (Forsyth *et al.*, 1978), this mechanism appears to be important in the mode of action of LT of *E. coli* as well (Richards and Douglas, 1978).

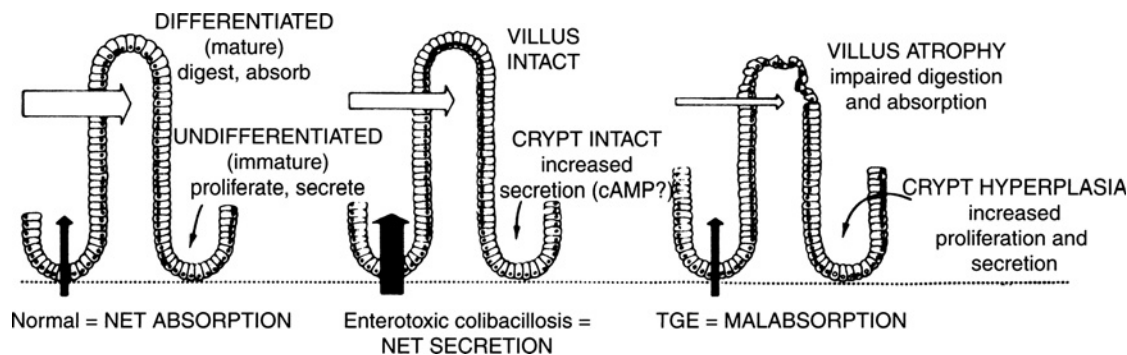
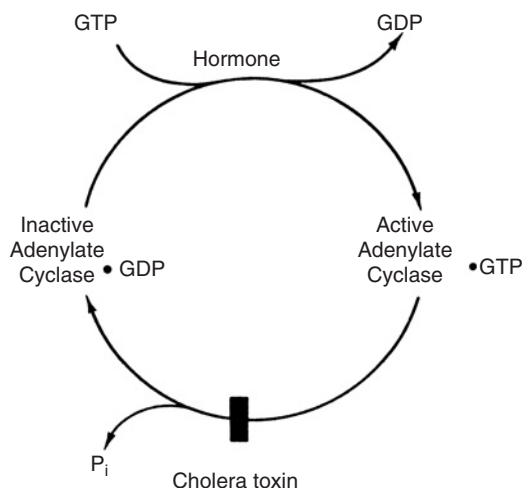


FIGURE 14-8 Pathogenesis of diarrhea caused by *E. coli* enterotoxin and by coronaviruses. From Moon (1978).





**FIGURE 14-9** Mechanism of action of cholera toxin, which inhibits hydrolysis of GTP, thereby increasing adenylate cyclase activity. From Cassell and Selinger (1978).

Additional extensive studies have centered on the molecular mechanism of action of CT. Under physiological conditions, adenylate cyclase is activated by the binding of guanosine triphosphate to the inactive enzyme. An associated GTPase inactivates the enzyme by converting enzyme-bound GTP to GDP and inorganic phosphate. This GTP-GDP system plays a critical role in the physiological regulation of adenylate cyclase. Cholera toxin is believed to bind to the adenyl cyclase in a way that inhibits hydrolysis of GTP, thereby maintaining the enzyme in an activated state (Cassel and Pfeuffer, 1978; Johnson *et al.*, 1978; Levinson and Blume, 1977) (Fig. 14-9).

Certain enteropathogenic strains of *E. coli* produce a low-molecular-weight, heat-stable toxin (ST) alone or in addition to LT (Moon, 1978; Richards and Douglas, 1978). In epidemiological studies of neonatal diarrheal diseases of calves, most isolated strains of *E. coli* produce only ST (Braaten and Myers, 1977; Lariviere *et al.*, 1979; Moon *et al.*, 1976). In contrast to LT and CT, which induce intestinal Na<sup>+</sup> and water secretion only after a lag phase of several hours, ST induces intestinal secretion immediately. ST induces intestinal secretion by activating guanylate cyclase and the mediator of intestinal secretion induced by ST is cyclic 3',5'-guanosine monophosphate (Field *et al.*, 1978; Hughes *et al.*, 1978).

Enterotoxin-induced intestinal secretion may be blocked by cycloheximide, an inhibitor of protein synthesis (Serebro *et al.*, 1969). The lack of specificity and the toxicity of cycloheximide precluded its clinical use, but acetazolamide has been shown to inhibit intestinal fluid secretion (Moore *et al.*, 1971; Norris *et al.*, 1969). Ethacrynic acid, another potent diuretic, has been shown to inhibit enterotoxin-induced fluid secretion (Carpenter *et al.*, 1969). Unfortunately, the diuretic effects of these drugs preclude their clinical use but similar drugs with

“intestinal specificity” would have significant therapeutic potential. Adenosine analogues also have been shown to inhibit cholera toxin-stimulated intestinal adenylate cyclase.

Prostaglandin E<sub>1</sub> (PgE<sub>1</sub>) and CT have similar effects on electrolyte transport in rabbit ileum. Application of either to the mucosa inhibits NaCl absorption and stimulates Cl<sup>+</sup> secretion. Both indomethacin (Gots *et al.*, 1974) and aspirin (Farris *et al.*, 1976) inhibit enterotoxin-induced intestinal secretion in laboratory animal models, and the prostaglandins do not function as mediators in the pathogenesis of cholera (Schwartz *et al.*, 1975). However, Jones *et al.* (1977) demonstrated a positive therapeutic response to a new prostaglandin inhibitor in calves with acute enteritis.

The effects of the *E. coli* ST can be inhibited *in vitro* by the calcium channel blockers diltiazem and lodoxamide tromethamine and the prostaglandin synthesis inhibitors indomethacin and quinacrine (Knoop and Abbey, 1981; Thomas and Knoop, 1983). Neither class of drug blocks the effect of cGMP, suggesting that calcium and prostaglandin influence the earliest step(s) in ST response: either its brush border binding or the activation of guanylate cyclase.

The autonomic nervous system has important effects on intestinal ion transport and water absorption (Tapper *et al.*, 1978). Catecholamines stimulate formation of cAMP in a variety of mammalian cells (Schultz *et al.*, 1975), apparently by activating the GTP-GDP system described above (Cassel and Selinger, 1978). Adrenergic blocking agents, such as chlorpromazine (Holmgren *et al.*, 1978) and propranolol (Donowitz and Charney, 1979), have significant inhibitory effects on enterotoxin-induced intestinal secretion. Although the mechanism of action of these two adrenergic blockers is not known, they represent still another class of drugs that may be of therapeutic benefit.

The intestinal “adsorbent” drug, Pepto Bismol, containing bismuth subsalicylate, and attapulgit, a heat-treated silicate, have antienterotoxic effects (Drucker *et al.*, 1977; Ericsson *et al.*, 1977; Gyles and Zigler, 1978). Therapeutic trials with bismuth subsalicylate have significant therapeutic benefit in certain large-volume diarrheal diseases of humans, which are enterotoxigenic in origin (DuPont, 1978; DuPont *et al.*, 1977; Portnoy *et al.*, 1976). The mechanism of the intestinal secretion inhibition is not known, but the chemical relation of bismuth subsalicylate to other known prostaglandin inhibitors is known. It is possible that such drugs, by decreasing endogenous production of prostaglandin, decrease the basal level of cyclic nucleotides, which in turn causes an increase in the threshold of response to enterotoxin. Salicylates also may stimulate sodium chloride absorption (Powell *et al.*, 1979). Collectively, these observations suggest that new, innovative methods for therapy and control of acute clinical diarrheal disease may be developed.

Acute diarrhea represents the leading cause of morbidity and mortality in neonatal calves and pigs. The pathogenesis

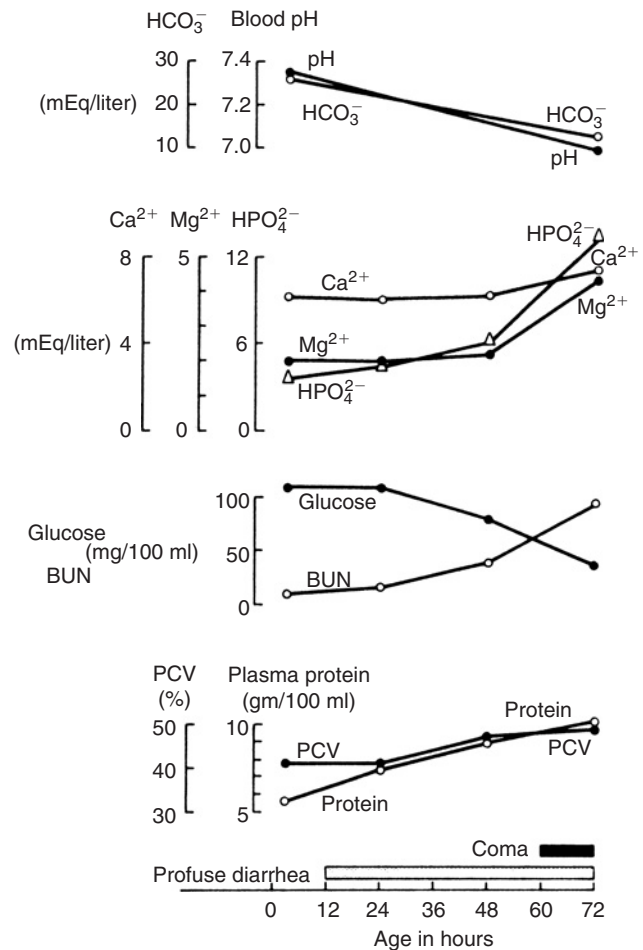
of the neonatal enteric infection is complex, often involving nutritional or environmental factors as well as infectious agents, such as enteropathogenic strains of *E. coli*, the transmissible gastroenteritis virus (TGE), rotaviruses, and other bacterial and viral pathogens. The severe clinical signs and frequently fatal outcome of acute diarrheal disease are often directly related to dehydration and to associated  $H^+$  and electrolyte disturbances (Dalton *et al.*, 1965; Fisher and McEwan, 1967a; Tennant *et al.*, 1972, 1978).

In acute diarrhea with large-volume, watery stools, the fecal fluid originates primarily from the small intestine. The electrolyte composition of the stool in such cases is similar to that of the fluid found normally in the lumen of the small intestine, which in turn is similar to that of an ultrafiltrate of the plasma. The rapid dehydration that accompanies acute enteritis in the newborn soon produces hemoconcentration and leads to hypovolemic shock. These cases are characterized by metabolic acidosis (Dalton *et al.*, 1965) caused by (1) decreased excretion of  $H^+$  resulting from decreased renal perfusion and (2) increased production of organic acids, the result of which is observed characteristically in young, severely dehydrated animals. Hyperkalemia in such cases is the result of increased movement of cellular  $K^+$  into the extracellular fluid and to decreased renal excretion. Cardiac irregularities caused by hyperkalemia can be demonstrated with the electrocardiogram, and cardiac arrest related to hyperkalemia is a direct cause of death in calves with acute diarrhea (Fisher, 1965; Fisher and McEwan, 1967b). Marked hypoglycemia also has been observed occasionally before death in calves with acute enteric infections. Hypoglycemia is believed to be due to decreased gluconeogenesis and increased anaerobic glycolysis, the result of hypovolemic shock (Tennant *et al.*, 1968). The sequence of metabolic changes that occur during acute neonatal diarrhea is summarized in Figure 14-10.

In chronic forms of diarrheal disease, excessive fecal losses of electrolyte and fluid are compensated in part by renal conservation mechanisms and in part by ingestion. If water is consumed without adequate ingestion of electrolytes, hyponatremia and hypokalemia may develop (Patterson *et al.*, 1968). In such cases, the osmolality of the plasma is significantly decreased and hypotonic dehydration occurs. In longer-standing cases of chronic diarrhea, the plasma  $K^+$  concentration may become dangerously low. It is imperative, in this case, that intravenous fluids contain sufficient  $K^+$  to prevent further reduction in concentration and to avoid additional cardiac irregularities or cardiac arrest.

### E. Malabsorption

Decreased absorption of nutrients may occur either as a result of defective intraluminal digestion (maldigestion) associated with pancreatic insufficiency (juvenile pancreatic atrophy, chronic pancreatitis) or because of defects in mucosal transport (malabsorption). Intestinal malabsorption is



**FIGURE 14-10** Metabolic alterations during the course of fatal enteric infection in a neonatal calf. From Tennant *et al.* (1972).

associated with several types of intestinal disease including chronic inflammatory diseases (lymphocytic-plasmacytic enteropathy, eosinophilic enteritis), granulomatous diseases (Johne's disease, intestinal parasitism), and lymphoma. The cardinal clinical signs of malabsorption include persistent or recurrent diarrhea, steatorrhea, and weight loss. In the horse, small intestinal malabsorption such as that associated with granulomatous enteritis may be associated with weight loss, but diarrhea may not be present because of the compensatory capacity of the uninvolved cecum and colon.

The initial reports of primary or idiopathic intestinal malabsorption in dogs (Kaneko *et al.*, 1965; Vernon, 1962) were compared to nontropical sprue (adult celiac disease, gluten-induced enteropathy) of humans, but association with gluten sensitivity was not demonstrated. Wheat-sensitive enteropathy has been described in the Irish setter breed (Batt *et al.*, 1984). Most of the dogs were seen between 7 months to 2 years of age and had poor weight gain, weight loss, inappetence, or hyperphagia. Diarrhea was not a consistent observation. The most consistent morphological abnormality in peroral jejunal biopsies was partial villus atrophy.



Enzymatic changes included decreased mucosal alkaline phosphatase and peptidases, whereas disaccharidases and GGT activities were unaffected. Recovery of morphological and biochemical abnormalities occurred in affected dogs that received cereal-free diets but recurred when wheat flour was added to the ration. A variety of other causes of intestinal malabsorption have been reported in the dog (Anderson, 1975, 1977; Burrows *et al.*, 1979; Ewing, 1971; Hill, 1972; Hill and Kelly, 1974; Schall, 1974; Van Kruiningen, 1968; Van Kruiningen and Hayden, 1973). An enteropathy said to resemble tropical sprue in humans has been described in German shepherds (Batt *et al.*, 1983, 1984). Affected dogs were 5 years of age or older and had diarrhea and weight loss for at least 4 months before the diagnosis was made. Peroral jejunal biopsies revealed partial villus atrophy and variable infiltrations of lymphocytes and plasma cells in the lamina propria. Subcellular biochemical studies of jejunal enterocytes revealed decreased activity of many brush border enzymes and increased lysosomal enzymes.

Enteropathy associated with bacterial overgrowth of the small intestine also has been observed in German shepherds (Batt and McLean, 1987). The dogs were 2 years of age or younger, and all had chronic histories of intermittent diarrhea with or without weight loss. Bacterial counts of greater than  $10^6$  colonies per milliliter were observed in duodenal fluid. *Enterococci*, *E. coli*, and *Clostridium* spp. were identified in cultures. Peroral jejunal biopsies revealed no characteristic histopathological changes. A deficiency of the immunoglobulin, IgA, may explain the vulnerability of these German shepherds to intestinal bacterial overgrowth (Whitbread *et al.*, 1984).

Early reports of intestinal malabsorption in the cat (Wilkinson, 1969) gave the impression that this condition was more common in dogs. This has changed since inflammatory bowel disease or intestinal infiltrations of small cell lymphoma have been diagnosed more often in cats. Malabsorption syndromes similar to those recognized in dogs are being recognized with increased frequency in farm animals (Blood *et al.*, 1979). Cimprich (1974), Merritt *et al.* (1976), and Meuten *et al.* (1978), have reported malabsorption in the horse secondary to chronic granulomatous enteritis, and specific amino acid malabsorption has been reported in Johne's disease (Patterson and Berrett, 1969).

Steatorrhea, the presence of excessive amounts of fat in the feces, is a prominent sign of intestinal malabsorption in dogs. The stools are bulky, gray or tan, and, grossly, may have an oily appearance. The normal dog excretes 3 to 5 g of fat in the stool each day. This level of fecal fat is quite constant and is independent of dietary fat intake over a wide range of 15 to 48g/day. In intestinal malabsorption, the ability to absorb fat is decreased and fecal fat excretion increases significantly. Under these conditions, the amount of fecal fat excreted becomes proportional to dietary intake.

Merritt *et al.* (1979) reported that body weight is an important factor in fat output. In small dogs (i.e., less than

10 to 15 kg body weight) with intestinal malabsorption, the abnormality in fecal fat output was quantitatively less severe than in larger dogs. Fecal fat excretion for normal dogs was  $0.24 \pm 0.01$ g/kg body weight per day.

Steatorrhea can be documented qualitatively by staining the fresh stool with a lipophilic stain, such as Sudan III, and observing increased numbers of oil droplets under the light microscope. In experienced hands, this method is a reliable diagnostic procedure (Drumme *et al.*, 1961). The following methods can be used to demonstrate neutral and split fats. For neutral fat, two drops of water are added to a stool sample on a glass slide and mixed. Two drops of 95% ethanol are then added and mixed followed by several drops of a saturated solution of Sudan III in 95% ethanol. A coverslip is applied to the mixture, which is then examined for yellow or pale orange refractile globules of fat, particularly at the edges of the coverslip. Normally, two or three fat droplets per high-power field are present. A large number of neutral fat droplets suggest a lack of pancreatic lipase activity (i.e., exocrine pancreatic insufficiency).

For free fatty acids (split fats), several drops of 36% acetic acid are added to a stool sample on a glass slide and mixed. Several drops of Sudan III solution are then added and mixed. A coverslip is applied, and the slide is gently heated over an alcohol burner until it begins to boil. The slide is air-cooled and then quickly heated again; this procedure is repeated two or three times. The warm slide is examined for stained free fatty acid droplets, which, when warm, appear as deep orange fat droplets from which spicules and soaps, resembling the pinna of the ear, form as the preparation cools. Normal stools may contain many tiny droplets of fatty acids (up to 100 per high-power field). With increasing amounts of split fats, the droplets become larger and more numerous, which suggests an abnormality in fat absorption.

Quantitation of fecal fat is the most accurate method of assessing steatorrhea (Burrows *et al.*, 1979) with dietary fat balance being determined for a period of 48 to 72 h. Fecal fat is analyzed using a modification of the technique of van de Kamer *et al.* (1949), which employs ether extraction of fecal lipid and titration of fatty acids. The results are expressed as grams of neutral fat excreted per 24 h. Merritt *et al.* (1979) have suggested that dogs be fed 50 g fat per kilogram per day for 2 to 3 days before fecal collection. Analysis of a 24-hour collection of stool when this is done is believed to be as accurate as a 72-hour stool collection. Results are expressed as fat excretion in grams per kilogram body weight.

In addition to malabsorption of fat, the canine malabsorption syndrome is associated with decreased absorption of other nutrients. These defects in absorption are responsible for the progressive malnutrition that is a cardinal feature of the disease. There may be malabsorption of vitamin D or calcium that results in osteomalacia. Anemia may result from malabsorption of iron or of the B vitamins required for normal erythropoiesis. Malabsorption of vitamin K can result in hypoprothrombinemia and delayed

clotting of blood. Glucose malabsorption has been documented by Kaneko *et al.* (1965) and it is likely that amino acids are similarly malabsorbed at the small intestinal level. Carbohydrate and fat malabsorption unquestionably contribute to the energy deficit that results in weight loss. Amino acid malabsorption may contribute to the development of hypoproteinemia, although increased intestinal loss of plasma proteins is believed to be more important.

The diagnosis of idiopathic canine malabsorption is made only after ruling out other primary inflammatory, neoplastic, or parasitic diseases of the intestine and diseases of the pancreas, liver, or stomach that result in defective intraluminal digestion. The presence of parasitic infection is established by examining the feces for parasite cysts or ova. Other inflammatory or neoplastic diseases of the intestine may be suggested on the basis of clinical or radiological examination, but a definitive diagnosis usually depends on histopathological examination of an intestinal biopsy specimen.

Both idiopathic and secondary intestinal malabsorption must be differentiated from those diseases in which there is decreased intraluminal hydrolysis of nutrients. The latter are due most frequently to pancreatic exocrine insufficiency as a result of chronic pancreatitis or juvenile atrophy. In these diseases, hydrolysis of the major dietary constituents is reduced because of the lack of pancreatic enzymes. Intraluminal hydrolysis of fat may also be decreased because of a deficiency of bile salts caused either by decreased hepatic secretion or by bile duct obstruction. Experimentally, however, complete diversion of bile flow in the dog actually has a quantitatively small effect on fat absorption (Hill and Kidder, 1972a).

A radioimmunoassay for trypsin-like immunoreactivity (TLI) is currently widely used to identify dogs with pancreatic exocrine insufficiency (Williams *et al.*, 1987) and is useful in differentiating maldigestion from primary malabsorption. The TLI in normal dog serum is trypsinogen. The route of entry of trypsinogen into the systemic circulation is believed to be the pancreatic venous or lymphatic vessels. Trypsinogen release in inflammatory pancreatic disease (i.e., acute or chronic pancreatitis) may increase TLI values. Increased TLI values have been reported in a dog with confirmed pancreatic exocrine insufficiency that had normal PABA values and fecal proteolytic activity (Williams and Batt, 1986). In most cases of pancreatic exocrine insufficiency, TLI is remarkably reduced compared to normal dogs or dogs with intestinal malabsorption (Williams and Batt, 1988).

An indirect method to detect chymotrypsin activity has been described as a means to differentiate dogs with pancreatic exocrine insufficiency from those with intestinal malabsorption (Batt *et al.*, 1979; Batt and Mann, 1981; Imondi *et al.*, 1972; Strombeck, 1978; Strombeck and Harrold, 1982; Zimmer and Todd, 1985). The synthetic peptide N-benzoyl-tyrosine-P-aminobenzoic acid (bentiromide) is orally administered to dogs. If chymotrypsin is present in the duodenum,

hydrolysis of the bentiromide occurs, and P-aminobenzoic acid (PABA) is released, which is subsequently absorbed and then excreted in the urine within 6h. The urine or plasma is analyzed for PABA. Less than 43% PABA excretion identifies dogs with suspected pancreatic exocrine insufficiency (Strombeck, 1978). Thirty- or 60-min blood levels of PABA are used to detect dogs with pancreatic exocrine disease (Zimmer and Todd, 1985), but this method did not identify dogs with exocrine pancreatic insufficiency as consistently as the 6h urinary excretion (Strombeck and Harrold, 1982). Factors that may influence results of the bentiromide test include the rate of gastric emptying, intestinal absorption of the PABA, and the peptide cleavage by other peptidases (Batt *et al.*, 1979).

## F. Tests of Malabsorption

### 1. Cobalamin and Folate Absorption

The measurement of circulating serum concentrations of cobalamin and folate (Batt and Morgan, 1982; Waters and Mollin, 1961) may give an indication of the site of intestinal dysfunction in dogs and cats, but it does not define the existing lesion or etiology. The use of cobalamin and folate concentrations as an indirect indicator of intestinal and pancreatic disease has been reported less frequently in the cat; the authors have documented cobalamin deficiency in cats with severe inflammatory bowel disease and intestinal lymphosarcoma. Low concentrations have also been encountered in cats with pancreatitis and exocrine pancreatic insufficiency. Low cobalamin levels are associated with increased levels of methylmalonic acid (Ruarux *et al.*, 2005; Simpson *et al.*, 2001).

Plasma concentrations of cobalamin and folate are labile and reflect the balance among dietary intake, bacterial utilization and production, intestinal absorption, and body losses. The interpretation of plasma concentrations of cobalamin and folate concentrations with regard to small intestinal disease is only valid if exocrine pancreatic insufficiency, oral supplementation, and parenteral administration have been excluded and attention is paid to dietary vitamin content. Plasma cobalamin and folate concentrations may also be affected by certain medications (e.g., sulfasalazine). Although serum folate levels can decrease markedly within several days, the folate concentration within erythrocytes decreases much more slowly, so low erythrocyte folate values may be a more accurate indicator of a chronic disorder.

Low serum cobalamin concentrations have been observed in dogs with EPI, severe intestinal disease, and apparent idiopathic small intestinal bacterial overgrowth (SIBO). Absolute cobalamin deficiency has been recognized in giant schnauzers with inappetence and failure to thrive with laboratory findings of anemia, leukopenia, and methylmalonyl aciduria. This deficiency appears to be a consequence of the

defective synthesis of the ileal cobalamin-intrinsic factor receptor and signs are completely reversed by the parenteral administration of cobalamin. Some shar-peis also appear to have a deficiency of cobalamin. The physiological significance of the low cobalamin concentrations detected in other gastrointestinal diseases has not been reported.

Low serum folate concentrations have been observed in dogs with severe jejunal disease and some Irish setters with a gluten-sensitive enteropathy. High folate concentrations have been reported in experimentally induced SIBO (blind loops), EPI, German shepherds with antibiotic-responsive enteropathy, and other Irish setters with gluten-sensitive enteropathy.

In the authors' experience, the finding of a low folate or low cobalamin concentration is useful in supporting the presence of an intestinal problem. Where low cobalamin is detected and EPI and intestinal abnormalities of the GI tract (blind loops) have been excluded, localization of the problem to the ileum can be inferred. Serum cobalamin and folate are inadequate markers of predicting response to antibiotics. Concomitant increases in folate and cobalamin are consistent with high intake or supplementation. Finally, normal serum concentrations of cobalamin and folate neither exclude nor support a diagnosis of intestinal disease.

## 2. Glucose Absorption

The absorption of glucose can be evaluated by the oral glucose tolerance test (OGTT) where an oral test dose of glucose is given and the blood glucose levels are measured at half-hour intervals for 3 to 4h. In canine malabsorption, the OGTT curve of blood glucose is diminished or flat (Kaneko *et al.*, 1965). The test also has been used in the horse for evaluation of small intestinal malabsorption (Roberts and Hill, 1973). Dogs with pancreatic exocrine deficiency may have "prediabetic" or high OGTT curves (Hill and Kidder, 1972b). The major disadvantage of this test is that it does not differentiate between decreased intestinal absorption and increased tissue uptake after absorption. This problem can be alleviated by comparing results of the OGTT with those of the intravenous glucose tolerance test (IVGTT). Hill and Kidder (1972b) reported that normal dogs on low-carbohydrate/high protein diets can have "diabetic" tolerance curves so that test dogs should be on a high-carbohydrate diet for 3 to 5 days before testing.

## 3. D-Xylose Absorption

D-xylose is used clinically to evaluate intestinal absorption (Craig and Atkinson, 1988). The body does not metabolize D-xylose to any significant degree, and the problems of evaluating tissue utilization that occur with glucose are avoided. Because large amounts of D-xylose must be used, the rate of absorption is proportional to luminal concentration and independent of active transport processes.

Van Kruiningen (1968) has described a D-xylose absorption test for dogs. In this procedure, a standard 25-g dose of D-xylose is administered by stomach tube. During the 5-h period after administration, the patient is confined in a metabolism cage and urine is collected. At the end of the 5-h test period, the urine remaining in the bladder is removed by catheter and the total quantity excreted in 5h is determined. Normal dogs excreted an average of 12.2g of the 25-g dose during the test period, with a range of 9.1 to 16.5g. Because this test is dependent on the rate of intestinal absorption as well as the rate of renal excretion, it is necessary to establish that kidney function is normal.

A modified D-xylose tolerance test is now most widely used clinically (Hayden and Van Kruiningen, 1973; Hill *et al.*, 1970). Dogs are fasted overnight, a baseline blood sample is taken, and D-xylose is administered by stomach tube at the rate of 0.5g/kg. A control test is performed on a normal dog simultaneously. Blood samples are taken at 0.05, 1, 2, 3, 4, and 5h after administration. The D-xylose concentration in the blood is determined by the phloroglucinol microassay (Merritt and Duely, 1983). The phloroglucinol procedure is more economical, requires less plasma, and is technically easier than the orcinol-ferric chloride procedure of Roe and Rice (Merritt and Duely, 1983). Maximal blood levels of D-xylose are normally reached at 1h after administration. A D-xylose level of at least 45mg/dl within 60 to 90min is expected in normal dogs (Hill *et al.*, 1970).

The D-xylose absorption test is also used for differential diagnosis of equine diarrheal diseases (Roberts, 1974). Bolton *et al.* (1976) reported that a dosage of 0.5-g D-xylose/kg bw was useful in detecting horses with intestinal malabsorption. The peak plasma concentration in normal horses is less than one-third that seen in normal dogs given D-xylose at comparable doses.

## 4. Oleic Acid and Triolein Absorption

Several tests have been developed for the clinical evaluation of intestinal absorptive capacity. The absorption of <sup>131</sup>I-labeled oleic acid and <sup>131</sup>I-labeled triolein has been studied extensively in normal dogs (Michaelson *et al.*, 1960; Turner, 1958), and Kaneko *et al.* (1965) used this test to study dogs with intestinal malabsorption. The day before administration of the <sup>131</sup>I-labeled compound, a small amount of Lugol's iodine solution is administered to block thyroidal uptake of the isotope. Tracer amounts of the test substances are mixed with nonradioactive carrier and are administered orally. Absorption is determined by measuring the radioactivity of the plasma at intervals following administration and calculating the percentage of the dose absorbed on the basis of plasma volume.

The <sup>131</sup>I-oleic acid and <sup>131</sup>I-triolein tests performed in sequence are used to differentiate steatorrhea caused by pancreatic enzyme deficiency from that caused by a primary defect in absorption (Kallfelz *et al.*, 1968). If steatorrhea is

caused by a lack of pancreatic lipase, oleic acid absorption will be normal, whereas that of triolein, which requires lipolysis for absorption, will be significantly reduced. The absorption of both compounds is reduced in intestinal malabsorption.

### 5. Vitamin A Absorption

The vitamin A absorption test measures intestinal lipid absorption (Hayden and Van Kruiningen, 1976). Normal absorption of vitamin A requires secretion of bile and pancreatic enzymes. After oral administration of 200,000 units of vitamin A in normal dogs, serum vitamin A concentrations reach their peak at 6 to 8h, with values ranging between three and five times fasting serum levels. There are small differences in vitamin A absorption between breeds and delayed gastric emptying will also alter results.

### 6. Other Tests for Assessment of Intestinal Function

Simultaneous evaluation of pancreatic exocrine function and intestinal absorptive function is used in dogs (Rogers *et al.*, 1980; Stradley *et al.*, 1979) and cats (Hawkins *et al.*, 1986; Sherding *et al.*, 1982). The combined bentiromide and D-xylose absorption tests have proved to be useful diagnostically in dogs. Blood is normally taken at 0,  $\frac{1}{2}$ , 1,  $1\frac{1}{2}$ , 2,  $2\frac{1}{2}$ , and 3h after oral administration of the test solution but a single blood sample taken at  $1\frac{1}{2}$ h was adequate for differential diagnostic purposes (Stradley *et al.*, 1979). The combined bentiromide/D-xylose absorption test was of limited usefulness in cats because of marked individual variations. Peak blood PABA levels (60 to 120min) and peak blood D-xylose levels (30 to 120min) in healthy cats were less than those of normal dogs, and blood D-xylose levels in cats with infiltrative small bowel disease were not abnormal (Hawkins *et al.*, 1986).

The content of exhaled hydrogen gas has been evaluated as an indicator of carbohydrate malassimilation in the dog (Washabau *et al.*, 1986), cat (Muir *et al.*, 1991), calves (Holland *et al.*, 1986), and humans (Perman, 1991). Unabsorbed carbohydrate is fermented by bacteria in the colon to  $H_2$  and organic acids. Ten to 14% of the  $H_2$  is absorbed and excreted by the lungs (Washabau *et al.*, 1986). Increases in pulmonary  $H_2$  excretion can occur in normal dogs fed rations containing wheat or corn flour. Increased  $H_2$  excretion normally occurs in most species receiving lactulose. Mild increases in  $H_2$  excretion occur in normal humans and dogs receiving xylose but not in the cat.

Breath  $H_2$  excretion has diagnostic value in determining mouth-to-cecum transit time and for identifying small intestinal bacterial overgrowth (Muir *et al.*, 1991). False-negative  $H_2$  breath tests have been seen in humans receiving antibiotics. Diet as well as variations in bacterial flora can also cause false-positive test results.

The nitrosonaphthol test qualitatively measures urinary excretion of 4-hydroxyphenylacetic acid and related compounds, which are intestinal bacterial degradation products of tyrosine. The test has been used to differentiate pancreatic or small intestinal diarrheal diseases from those associated primarily with large bowel disease (Burrows and Jezyk, 1983). The test was positive in 77% of the dogs with pancreatic and small intestinal disease and in only 9.5% of those dogs with large bowel disease. Positive tests were associated with bacterial overgrowth of the small intestine and became negative during antibiotic treatment that resulted in clinical improvement. The test may be useful in dogs to select patients with small intestinal bacterial overgrowth, which might respond to antibiotic therapy.

## G. Bacterial Overgrowth

The bacterial flora of the canine intestine increases in number from the duodenum to colon. Factors maintaining this aboral gradient are luminal patency, intestinal motility, limited substrate availability, various bacteriostatic/cidal secretions, and an intact ileocecolic valve. Abnormalities of these control mechanisms facilitate small intestinal bacterial overgrowth (SIBO). SIBO is usually secondary to another disease process, but it has been reported as a primary idiopathic form. Many clinicians prefer to use the term *antibiotic-responsive diarrhea* instead of *idiopathic SIBO* (German *et al.*, 2003). Regardless, bacterial overgrowth can interfere with the absorption of nutrients and fluid by reducing microvillar enzyme activity, increasing cellular or intercellular permeability, deconjugating bile acids, and hydroxylating fatty acids.

A number of diseases (Rutgers *et al.*, 1988, 1993, 1995; Simpson *et al.*, 1990; Williams *et al.*, 1987) need to be ruled out before making a diagnosis of idiopathic SIBO. This includes exocrine pancreatic insufficiency (EPI), partial or complete intestinal obstruction, intestinal stasis, resection of the ileocecolic valve, and intestinal mucosal diseases that cause malabsorption (e.g., moderate to severe inflammatory bowel disease), lymphoma, and lymphangiectasia. Dogs and cats with partial intestinal obstruction often have a history of chronic diarrhea and weight loss, which responds to antibiotics (Batt *et al.*, 1988). Much of the literature pertains to German shepherd dogs (GSD) with subnormal levels of IgA (Delles *et al.*, 1993, 1994; Willard *et al.*, 1994a, 1994b). SIBO has also been reported in beagles with normal IgA levels (Batt *et al.*, 1992).

In the dog, total bacterial counts exceeding  $10^5$  colony-forming units per milliliter (cfu/ml) of proximal jejunal or duodenal fluid and anaerobic bacterial counts exceeding  $\geq 10^5$  cfu/ml have been reported (Burrows *et al.*, 1994). Culture of duodenal juice has been regarded as the gold standard for detecting bacterial counts  $\geq 10^5$  cfu/ml; this assumption has been questioned because of the variability

of counts in other reports, which detail duodenal bacterial counts ranging from  $\leq 10^2$  to  $10^7$  cfu/ml; counts of  $\geq 10$  cfu/ml in clinically healthy GSD, beagles, and greyhounds.

Healthy cats have higher numbers of bacterial flora in their small intestine than do other species (Johnston *et al.*, 1993), in numbers that approximate those for SIBO in dogs and humans. Bacterial counts  $\geq 10^5$  cfu/ml are being increasingly documented in other breeds with clinical signs of weight loss, chronic diarrhea, borborygmi, intestinal cramping, or vomiting, with no evidence of intestinal obstruction, EPI, or severe mucosal infiltrates; clinical signs are often responsive to antibiotic therapy.

A comprehensive review of the literature, to include the aforementioned studies, by Johnston (1999) refuted the existing criterion for defining bacterial overgrowth. She concluded that defining SIBO as greater than 10 fifth cfu/ml in the duodenum or proximal jejunum was not appropriate for dogs and cats. Furthermore, she believed future investigations need to separate patients who have SIBO from those who have other antibiotic-responsive enteropathies.

Dogs with idiopathic SIBO may be subclinical or have chronic gastrointestinal signs. Chronic SIBO can cause inflammatory bowel disease. The lesions consist of villus atrophy and infiltrations of lymphocytes and plasmacytes in the lamina propria. There is substantial but reversible biochemical injury to enterocytes of the brush border membrane (Batt and McLean, 1987). Aerobic bacteria, such as enterococci and *Escherichia coli*, cause a selective loss of brush border alkaline phosphatase activity and peroxisomal catalase, as well as changes that are consistent with mitochondrial disruption. There are exceptions but aerobic overgrowth is typical for the dog, in contrast to anaerobic overgrowth in humans. The high floral counts in the intestine of cats are thought to predispose them to certain nutritional deficiencies, such as taurine deficiency, and intestinal disturbances attributed to deconjugated bile salts (Johnston *et al.*, 1993).

The culturing and quantitation of intestinal bacterial flora (Simpson *et al.*, 1990) are the definitive means of diagnosing SIBO. Less invasive diagnostic methods include determination of serum cobalamin/folate levels, the measurement of breath hydrogen or intestinal permeability, and the nitrosonaphthol test on urine (Burrows *et al.*, 1995; Simpson, 2005). Deconjugation of bile acids by intestinal flora, with subsequent disproportionate increase in unconjugated bile acids in the circulation, is seen in humans with bacterial overgrowth (Einarsson *et al.*, 1992).

The treatment of SIBO is directed at correcting the underlying structural abnormalities, treating EPI, and controlling the abnormal flora with antibiotics. Patients with IBD often require treatment of SIBO and the mucosal infiltrate. In dogs with suspected idiopathic SIBO, antibiotic therapy is usually given for 28 days. Suitable antibiotics include oxytetracycline (10 to 20 mg/kg TID PO), tylosin (10 mg/kg TID PO), or metronidazole (15 mg/kg BID

PO). Dietary supplementation with fructooligosaccharide in IgA-deficient German shepherds resulted in decreased bacterial counts in luminal fluid and intestinal mucosa tissue (Willard *et al.*, 1994a, 1994b). Plasma-cell infiltrations in jejunal villi were decreased by feeding different protein sources (Edwards *et al.*, 1995). There is also anecdotal evidence that supports the use of highly digestible, low-fat diets, which may less be likely to metabolize to hydroxy fatty acids and stimulate colonic secretions.

The overall prognosis for idiopathic SIBO is guarded and the prognosis for secondary SIBO depends on the underlying disease. Many animals with suspected idiopathic SIBO relapse when antibiotics are stopped and require further courses or long-term maintenance.

## H. Helicobacteria

*Helicobacter pylori* have been associated with chronic gastritis, atrophic gastritis, peptic ulcers, and gastric adenocarcinoma and lymphosarcoma in humans (Handt *et al.*, 1994; Isaacson 1994; Paarsonnett *et al.*, 1991). Studies in other animals have led to the discovery of *H. mustelae* in ferrets with gastritis and peptic ulcers, *H. acinonychis* in cheetahs with severe gastritis, and *H. Heilmannii* in pigs with gastric ulcers. The presence of gastric *Helicobacter*-like organisms (HLO) in the stomachs of dogs and cats has been known for many years, but the relationship of these organisms to gastric disease remains controversial. *H. felis*, "*H. heilmannii*," *H. bizzozeronii*, and *H. pametensis* have been detected in gastric mucosa of pet cats. *H. bizzozeronii*, *H. heilmannii*, *H. felii*, *H. salomonis*, *H. rappini*, and *H. bilis* have been isolated from dogs. Simultaneous colonization of the stomach with multiple species of *Helicobacter* has been observed in the dog and cat.

*Helicobacter pylori*, which is the predominant pathogen in humans, can cause infection in other animals (anthroponosis). Although it has not been isolated from the stomachs of pet dogs and cats, experimental infections have been produced in the nonhuman primates, cats, dogs, and pigs. Studies of the pathogenicity of *H. felis*, as well as *H. pylori*, in laboratory cats have demonstrated gastritis, lymphoid follicular hyperplasia, and seroconversion. Many of these cats did not exhibit clinical signs of illness. "*H. heilmannii*," the predominant species in pet cats and 20% to 40% pet dogs, is also found in the mucosa of 0.4% to 4.0% of people. The zoonotic risk posed by dogs and cats was regarded as small because their 16s rDNA sequences were not consistent with *H. heilmannii* type I, which is the principal subtype in people; subtypes in dogs and cats were predominantly types II and IV.

*Helicobacter* spp. isolated from the stomachs of dogs and cats are spiral-shaped or curved or sometimes coccoid Gram-negative bacteria that inhabit the glands, parietal cells, and mucus of the stomach. They are morphologically indistinguishable by light microscopy and are classified into several

*Helicobacter* spp. on the basis of 16S rRNA sequencing, DNA hybridization, and electron microscopic appearance. The majority of studies in cats and dogs with naturally acquired *Helicobacter* infections demonstrates that the fundus and cardia are more densely colonized than the pylorus. Large HLO colonize the superficial mucus and gastric glands and may also be observed intracellularly. Degeneration of the gastric glands, with vacuolation, pyknosis, and necrosis of parietal cells, is more common in infected than uninfected dogs and cats. Inflammatory infiltrates in the gastric mucosa of infected animals are generally mononuclear and range from mild to moderate in severity.

Analysis of gastric juice and biopsies from kittens in an *H. pylori*-infected cat colony, using rapid urease tests, *UreB* PCR patterns, and histopathology demonstrated *H. pylori* in nine of 17 kittens by 8 weeks and in 16 by 14 weeks of age. *UreB* PCR patterns and sequences of PCR products from gastric mucosa were identical in mothers and kittens. Bacterial densities were similar in the stomach and the presence of circulating anti-*Helicobacter* IgG antibodies and histopathological findings were consistent with infection.

Studies have been done in cats chronically infected with *H. pylori* to measure the development of inflammatory and immune responses, and their relationship to the putative bacterial virulence factors *cag* pathogenicity island (*cagPAI*), *vacA* allele, and *oipA* in combination with bacterial colonization density. Infecting *H. pylori* strains were positive for *vacAsI* but lacked the *cagPAI* and an active *oipA* gene. Colonization density was uniform throughout the stomach. Up-regulation of IFN-gamma, IL-1a, IL-B, IL-8, and increased severity of infiltrates and fibrosis were observed in infected cats. The median number and total area of lymphoid aggregates were five and ten times greater, respectively, in the stomachs of infected cats than uninfected cats. Secondary lymphoid follicles were frequent and positive for BLA.36, CD79a, and CD3 but negative for B220. Cats with *H. pylori* can also develop antigastric antibodies that cross-react with *Helicobacter* antigens, as well as changes in gastric acid secretion and serum gastrin levels.

The evaluation of cytokines in cats with naturally acquired *Helicobacter* spp. seems to complement histopathological changes in the stomach. Compared to uninfected cats, infected cats have up-regulation of IL-8 and IL-1beta, but not IFN-gamma or IL-10 and gastric lymphoid follicle hyperplasia is more common and extensive. Circulating anti-*Helicobacter* IgG has been detected in sera of naturally infected cats. To date, there has been no association made between infection and gastrointestinal ulcers or gastric neoplasia in cats. Spontaneous gastritis in the dog is typically consistent with lymphoplasmacytic infiltrations and the expression of IL-10 and IFN-gamma. *Helicobacter* spp. infection is associated with increased expression of TGF- $\beta$  and fibrosis.

HLO have been observed in gastric biopsies from 41% to 100% clinically healthy cats, 67% to 100% healthy dogs,

57% to 100% of vomiting cats, 74% to 90% vomiting dogs, and 100% laboratory beagles. The prevalence of individual *Helicobacter* spp. has not been thoroughly investigated because of specialized techniques. The high prevalence of gastric colonization with HLO in healthy and sick dogs and cats indicates that there is no simple "infection = disease" relationship. An uncontrolled treatment trial of pets with gastritis and *Helicobacter* infection showed that clinical signs in 90% of 63 dogs and cats responded to treatment, with a combination of metronidazole, amoxicillin, and famotidine, and that 74% of 19 animals reendoscoped had no evidence of *Helicobacter* in gastric biopsies. However, controlled studies in asymptomatic cats suggest that it is difficult to eradicate gastric organisms with a variety of therapeutic agents.

### I. Intestinal Permeability

Changes in intestinal mucosal permeability can be a factor in the pathogenesis of mucosal injury and subsequent gastrointestinal disease (Burrows *et al.*, 1995; Sanderson and Walker 1993). Whether as a primary or secondary disorder, increased permeability predisposes to the passage of intraluminal macromolecules across the intestinal mucosa. Depending on the noxious or antigenic characteristics of these macromolecules, pathological features of toxic or immune-mediated injury may occur. A primary mucosal permeability defect is suspected in humans and Irish setters with gluten-induced enteropathy (Hall and Batt, 1991a, 1991b). Enhanced mucosal permeability resulting from small intestinal bacterial overgrowth has been reported in clinically healthy beagles (Batt *et al.*, 1992). Secondary permeability disorders have been resolved by appropriate treatment of giardiasis and bacterial overgrowth in dogs (Hall and Batt, 1990).

Clinicopathological evaluation of intestinal permeability is based on the oral administration of simple, nondigestible molecules (probes) and their recovery in urine (Elwood *et al.*, 1993; Papisoulitis *et al.*, 1993). Inappropriate levels of these probes in urine indicate abnormal macromolecular permeation through transcellular or paracellular pathways. Polyethylene glycols, <sup>51</sup>CR-labeled ethylenediaminetetraacetate (<sup>51</sup>EDTA) (Batt *et al.*, 1992; Hall *et al.*, 1989; Hall and Batt 1991a, 1991b), and nonhydrolyzable sugars have been used in permeability tests. The disaccharides, cellobiose and lactulose, and the monosaccharides, mannitol and L-rhamnose, are unable to penetrate healthy enterocytes (Papisoulitis *et al.*, 1993). In the presence of abnormal mucosal permeability, the disaccharides diffuse passively through the mucosa via paracellular pathways, and the monosaccharides passively diffuse transcellularly.

Differential sugar absorption and calculated disaccharide-to-monosaccharide excretion ratio are preferred over single sugar measurements. The use of lactulose and

mannitol in the evaluation of intestinal permeability has been reported in healthy cats (Papasouliotis *et al.*, 1993). The cellobiose-to-mannitol urinary excretion ratio was increased in Irish setters with gluten-sensitive enteropathy (Hall and Batt, 1991a, 1991b). Simultaneous quantification of rhamnose, lactulose, 3-O-methyl-D-glucose, and xylose in urine by a unique chromatographic technique has been reported to assess both intestinal function and permeability (Sorensen *et al.*, 1993).

## J. Protein-Losing Enteropathy

Albumin, IgG, and other plasma proteins are present in low concentration in normal gastrointestinal secretions. Because protein usually undergoes complete degradation within the intestinal lumen, it has been suggested that the gastrointestinal tract must have a physiological role in the catabolism of plasma proteins. The relative significance of this pathway, however, has been the subject of considerable controversy. Some investigators have concluded, for example, that as much as 50% or more of the normal catabolism of albumin (Campbell *et al.*, 1961; Glenert *et al.*, 1961, 1962; Wetterfors, 1964, 1965; Wetterfors *et al.*, 1965) and  $\theta$ -globulin (Andersen *et al.*, 1963) may occur in the gastrointestinal tract. Others believe that the physiological role of the intestine in plasma protein catabolism is far less significant, accounting for about 10% of the total catabolism (Franks *et al.*, 1963a, 1963b; Katz *et al.*, 1961; Waldmann *et al.*, 1967, 1969).

Regardless of questions concerning the physiological significance of the gastrointestinal tract in plasma protein catabolism, it is well established that normal intestinal losses are substantially increased in a variety of gastrointestinal diseases, collectively referred to as the protein-losing enteropathies (PLE). The increased loss causes hypoproteinemia (especially hypoalbuminemia), which may be observed in various types of chronic enteric diseases. The excessive losses are the result of ulcerations or other mucosal changes that alter permeability or obstruct lymphatic drainage from the intestine. If severe, hypoalbuminemia may result in retention of fluid with development of ascites and subcutaneous edema of pendant areas.

Excessive plasma protein loss has been seen in swine with chronic ileitis (Nielsen, 1966), in calves with acute enteric infections (Marsh *et al.*, 1969), in cattle with parasitic or other inflammatory abomasal disease (Halliday *et al.*, 1968; Murray, 1969; Nielsen and Nansen, 1967), and in Johne's disease (Patterson *et al.*, 1967; Patterson and Berrett, 1969). In addition to the classic mucosal and submucosal lesions of Johne's disease, secondary intestinal lymphangiectasia can occur. Meuten *et al.* (1978) observed PLE associated with granulomatous enteritis in two horses.

PLE is seen with some frequency in the dog (Campbell *et al.*, 1968; Farrow and Penny, 1969; Finco *et al.*, 1973; Hayden and Van Kruiningen, 1973; Hill, 1972; Hill and

Kelly, 1974; Mattheeuws *et al.*, 1974; Milstein and Sanford, 1977; Olson and Zimmer, 1978). The most common cause appears to be lymphocytic-plasmacytic enteropathy. Intestinal lymphangiectasia also has been reported as a cause of increased intestinal protein loss; it is most commonly seen in small terrier breeds (e.g., Yorkshire, Maltese) and the Norwegian Lundehund, suggesting a genetic predisposition (Simpson, 2005). Increased plasma protein loss from the stomach has been seen in dogs with hypertrophic gastritis.

Familial protein-losing enteropathy (PLE) and protein-losing nephropathy (PLN) have been described in soft-coated wheaten terriers (Littman *et al.*, 2000). Dogs with PLE were diagnosed earlier than dogs with PLN or with both diseases. Clinical signs included vomiting, diarrhea, weight loss, pleural and peritoneal effusions, and thromboembolic disease. Panhypoproteinemia and hypocholesterolemia were consistent findings and intestinal lesions included inflammatory bowel disease, dilated lymphatics, and lipogranulomatous lymphangitis. In another study, food hypersensitivities were identified in six affected dogs (Vaden *et al.*, 2000), but the presence of preexisting inflammatory disease made it impossible to determine if food allergies were the cause or result of enteric disease.

Increased intestinal protein loss is the most likely cause of the hypoalbuminemia associated with certain other enteric diseases including lymphoma and malabsorptive syndromes. Munro (1974) demonstrated that protein loss in dogs with experimentally induced protein-losing gastropathy occurs by an intercellular route. Isotope-labeled polyvinylpyrrolidone ( $^{131}\text{I}$ -PVP),  $^{51}\text{Cr}$ -labeled ceruloplasmin, and  $^{51}\text{Cr}$ -labeled albumin have been used to evaluate enteric protein loss in the dog (Finco *et al.*, 1973; Hill and Kelly, 1974; Olson and Zimmer, 1978; van der Gagg *et al.*, 1976).

Fecal alpha 1-proteinase inhibitor ( $\alpha$ 1-PI) is minimally degraded as it passes down the gastrointestinal tract. In conditions where there is excessive loss of plasma protein into the gut, there is an increase in fecal  $\alpha$ 1-PI (Williams *et al.*, 1990). The value of this test has been reported in dogs with chronic gastrointestinal disease (Murphy *et al.*, 2003; Ruaux *et al.*, 2004) and in cats with inflammatory bowel disease or gastrointestinal neoplasia (Fetz *et al.*, 2006a, 2006b).

Murphy *et al.* (2003) reported that fecal  $\alpha$ 1-PI concentrations in dogs with gastrointestinal diseases associated with histological abnormalities (median 60.6  $\mu\text{g/g}$ , range 7.4–201.7  $\mu\text{g/g}$ ) were higher than dogs with gastrointestinal disease and normal histology (median 3.8, 0.7–74) and control dogs (9.9, 0.0–32.1). Although there was no direct correlation with serum albumin levels, the fecal  $\alpha$ 1-PI was believed to be a useful test in identifying early stages of PLE before decreased levels of serum albumin occurred. Moreover, the test was useful in justifying gastrointestinal biopsies in some cases. Ruaux *et al.* (2004) reported that

increased fecal loss of  $\alpha$ 1-proteinase inhibitor in dogs with PLE is associated with a significant decrease in fecal proteolytic activity and may result in a false-positive diagnosis of exocrine pancreatic insufficiency.

The studies performed by Fetz *et al.* (2006b) proved that cats with chronic gastrointestinal disease can be associated with gastrointestinal protein loss. The upper limit of the reference range for mean fecal  $\alpha$ 1-PI concentrations in healthy cats was 1.6 $\mu$ g/g; the concentrations in eight of the nine study cats ranged from 2.2 to 180.77. Fetz *et al.* (2006a) reported that increased fecal  $\alpha$ 1-PI concentrations in association with low serum albumin and total protein levels are common findings in cats with inflammatory bowel disease (IBD) and gastrointestinal neoplasia. Furthermore, fecal  $\alpha$ 1-PI concentrations tend to be higher in cats with severe IBD or neoplasia when compared to cats with mild to moderate IBD.

### K. Ulcerative Colitis

Canine ulcerative colitis, including granulomatous colitis of boxer dogs, has been reported (Ewing and Gomez, 1973; Gomez *et al.*, 1977; Kennedy and Cello, 1966; Koch and Skelley, 1967; Russell *et al.*, 1971; Sander and Langham, 1968; Van Kruiningen *et al.*, 1965). In boxer dogs, the disease is characterized by intractable diarrhea that is often hemorrhagic. Histopathologically, there is a granulomatous or histiocytic submucosal infiltrate and the macrophages are laden with periodic-acid-Schiff-positive material. Immunopathological studies describe an increase in IgG3 and IgG4 plasma cells, PAS positive macrophages and CD3-T cells, L1- and MHC11-positive cells, with pathological lesions similar to human ulcerative colitis (German *et al.*, 2003). Electron photomicrography demonstrated bacteria in the macrophages (Russell *et al.*, 1971), and, in some instances, these organisms resembled *Chlamydia*. *Mycoplasma* has been cultured from the colon and regional lymph nodes in four boxers, but attempts to reproduce granulomatous colitis with *Mycoplasma* have been unsuccessful. Until recently, this failure to identify or isolate an infectious agent has led to the belief that granulomatous colitis of boxers is an immune-mediated disease.

The development of culture-independent techniques utilizing PCR probes has renewed suspicion that granulomatous colitis in normal dogs is an infectious disease (Simpson *et al.*, 2006). Colonic biopsies from affected dogs (13 boxers with colitis) and 38 control dogs were examined by fluorescent *in situ* hybridization (FISH) with a eubacterial 16s rRNA probe. Culture, 16s rDNA sequencing, and histochemistry were used to define invasive flora and guide subsequent FISH. Intramucosal bacteria, predominantly Gram-negative coccobacilli, were present in the affected boxers, but none of the controls. Culture and 16s rDNA sequencing yielded mostly *Enterobacteriaceae*

and invasive bacteria hybridized with FISH probes to *E. coli*. These findings complement the observation that affected boxers often respond to enrofloxacin alone or in combination with amoxicillin and metronidazole.

Cases of ulcerative colitis in dogs have also been attributed to trichuriasis, balantidiasis, protothecosis, histoplasmosis, eosinophilic ulcerative colitis, or neoplasia (Lorenz, 1975). Severe ulcerative colitis has also been reported in cats and in some the feline leukemia virus (FeLV) is demonstrated. Feline panleukopenia can also cause colonic lesions.

Biochemical manifestations of ulcerative colitis depend on the duration and severity of illness, the degree of colorectal involvement, and the presence of systemic complications. In severe cases of long duration with extensive colorectal involvement, hypoalbuminemia and hypergammaglobulinemia are often observed. Hypoalbuminemia is attributed to increased loss of plasma through the denuded and inflamed colorectal mucosa and hypergammaglobulinemia is the response to continuing chronic inflammation.

### L. Equine Hyperammonemia

Hyperammonemia and subsequent neurological signs have been documented in horses with liver disease (Divers *et al.*, 2006), adult horses with gastrointestinal disease and presumed bacterial overgrowth (Desrochers *et al.*, 2003; Peek *et al.*, 1997; Sharkey *et al.*, 2006), nursing foals with portosystemic shunts (Fortier *et al.*, 1996), and weanling Morgan foals with a genetic abnormality in hepatic ammonia metabolism (McCornico *et al.*, 1997). The shunt foals and Morgan weanlings are discussed elsewhere.

Pertinent to this chapter is the incidence of hyperammonemia in horses with gastrointestinal dysfunction (i.e., colic and diarrhea) that do not have hepatic disease. There is an increased absorption of ammonia across inflamed intestinal mucosa, or massive overproduction of ammonia within the lumen of the gut, or a combination of both. Under normal circumstances, ammonia is delivered to liver via portal circulation and is metabolized by the Krebs-Hensleit cycle to urea and glutamine. Systemic hyperammonemia results when this cycle is overwhelmed. Ammonia readily crosses the blood-brain barrier and, in high concentrations, has a toxic effect on neuronal cell membranes. Resulting encephalopathic signs may be reversible if the underlying intestinal lesion or ammonia-producing bacteria are treated in an appropriate manner.

A diagnosis of idiopathic hyperammonemia of intestinal origin is based on the absence of infectious, toxic, or developmental causes. In some of the reported cases, recent travel or suspected changes in feeding or husbandry preceded the acute onset of gastrointestinal signs. Increased blood ammonia levels and subsequent encephalopathy developed within a matter of hours. Hyperglycemia and metabolic acidemia were also unique to the cases described by Peek *et al.*



(1997). Although Gram-negative bacilli such as *Escherichia coli*, *Klebsiella*, *Proteus*, and *Pseudomonas* spp. are known to be potent ammonia producers, reports pertaining to the role of specific organisms in affected horses has been limited to *Clostridium sordelli* (Desrochers *et al.*, 2003).

Urea toxicity and ammonia intoxication, as well as ingestion of high protein feeds, were ruled out as causes of hyperammonemia in horses described by Peek *et al.* (1997). Horses would have to ingest a large amount of urea to become toxic for a couple of reasons: (1) most of the urea is absorbed in the small intestine before reaching the caecum, which is the predominant site of urease activity; (2) urease activity in the horse's caecum is much less than that in the cow's rumen. Although horses are much more susceptible to ammonia salts than urea, none of the horses were on pastures that had been fertilized with ammonia salts.

### M. Clostridial-Associated Diseases in Horses and Cows

*Clostridium difficile* has been reported in several sources as a cause of colitis in horses and various small bowel disorders in horses, foals, and ponies. The potential role of this organism in causing duodenitis-proximal jejunitis (DPJ) in horses was proposed by Arroyo *et al.* (2006). DPJ was previously thought to be an idiopathic condition characterized by inflammation and edema of the duodenum and jejunum. Affected horses acutely developed signs of colic, depression, ileus, fluid accumulation in the small intestine and stomach, and endotoxemia. In the study reported by Arroyo and his coinvestigator, toxigenic strains of *C. difficile* were isolated from 10/10 horses with DPJ, and only 1 of 16 horses with other causes of nasogastric reflux. *C. perfringens* or *Salmonella* spp. were ruled out as causes of DPF in affected horses.

Horses with proximal enteritis are predisposed to hepatic injury (Davis *et al.*, 2003). When compared to horses with small intestinal strangulation obstruction (SISO), horses with proximal enteritis had significantly higher serum gamma-glutamyltransferase (GGT), aspartate aminotransferase, and alkaline phosphatase activities. Horses with proximal enteritis were 12.1 times more likely to have high GGT activities than were horses with SISO. Suspected mechanisms for hepatic injury were ascending infection from the common bile duct, absorption of endotoxin or inflammatory mediators from the portal circulation, or hepatic hypoxia resulting from systemic inflammation and endotoxemic shock.

Hemorrhagic bowel syndrome (HBS) or jejunal hemorrhage syndrome is an acute sporadic enteric disease recognized most frequently in dairy cattle (Berghaus *et al.*, 2005). Affected cows develop clinical signs consistent with intestinal obstruction, which is attributed to segmental necrohemorrhagic enteritis and large intraluminal blood

clots. *Clostridium perfringens* and *Aspergillus fumigatus* have received the most attention as possible etiological agents. The implementation of management practices to achieve high milk production, as well as increased consumption of high-energy rations, seems to be predisposing a risk factor. The fatality risk is very high, and seldom does medical and surgical intervention change the outcome.

## IX. DISTURBANCES OF RUMEN FUNCTION

The digestive process of ruminants differs from that of other animals because rumen microbial digestion occurs before other normal digestive processes. The short-chain fatty acids (acetic, propionic, and butyric acids) are the primary end products of rumen fermentation and are the chief sources of energy available to ruminants from the diet. Cellulose, which undergoes only limited digestion in most simple-stomached animals, is readily digested because of the cellulitic bacteria in the rumen. Ruminal bacteria can also use significant quantities of nonprotein nitrogen (NPN) for protein synthesis, and this bacterial protein subsequently can be utilized to meet the protein requirements of the animal. Under experimental conditions, ruminants may grow and reproduce while receiving diets containing only NPN (e.g., urea) sources of nitrogen. Bacterial production of vitamins can also meet essentially all the requirements of ruminants.

Although nutritionally essential, bacterial fermentation within the rumen presents certain unusual hazards for ruminants. For example, when rapid changes in diet occur, the products of fermentation can be released more rapidly than they can be removed or utilized. Acute rumen tympany, acute indigestion or D-lactic acidosis, and urea poisoning are diseases that result from such abrupt changes in diet (Hungate, 1966, 1968).

### A. Acute Rumen Indigestion (Rumen Overload, Lactic Acidosis)

Acute rumen indigestion occurs in sheep or cattle consuming high-roughage diets when they inadvertently are allowed access to large amounts of readily fermentable carbohydrate (e.g., grain or apples) (Dunlop, 1972). *Streptococcus bovis* is the rumen microorganism believed to be chiefly responsible for rapid fermentation and for production of large quantities of lactic acid (Hungate *et al.*, 1952; Krogh, 1963a, 1963b).

When lactic acid accumulates more rapidly than it is absorbed, rumen pH falls and rumen atony develops. Rumen bacteria produce a racemic mixture of lactic acid. Some L-lactate is absorbed and metabolized by the liver and other tissues, but D-lactate cannot be utilized and contributes significantly to the acid load of the body. The excessive lactic acid production results in metabolic acidosis

characterized by reduced blood pH and  $\text{HCO}_3^-$  concentration and by a fall in urine pH from a normal alkaline value to as low as pH 5. Fluid accumulates in the rumen because of the increased osmolality of the rumen fluid. This accumulation of fluid into the rumen causes hemoconcentration, which in turn may lead to hypovolemic shock and death. If affected animals survive the initial period of rapid fermentation, chemical rumenitis induced by the hyperosmolality of the rumen fluid and by the excess lactic acid may develop. Secondary mycotic rumenitis may then follow, which in severe cases can be fatal. In surviving cattle, metastatic hepatic abscesses may also occur.

### B. Acute Rumen Tympany (Bloat)

The rumen of mature cattle can produce 1.2 to 2 liters of gas per minute (Hungate *et al.*, 1955, 1961). The gas is the product of rumen fermentation and is composed primarily of carbon dioxide ( $\text{CO}_2$ ) and methane.  $\text{CO}_2$  is also released when salivary  $\text{HCO}_3^-$  comes in contact with the organic acids in the rumen. Under normal conditions, these large amounts of gas are continually removed by eructation.

Any factor that interferes with eructation can produce acute tympany of the rumen (bloat) leading to rapid death. Interruption of the normal eructation reflex or mechanical obstruction of the esophagus typically results in free gas bloat. The most important form of bloat, however, is seen in cattle consuming large quantities of legumes or in feedlot cattle on high-concentrate diets. The primary factor in these more common forms of bloat is a change in the ruminal contents to a foamy or frothy character because of altered surface tension. Gas becomes trapped in small bubbles within the rumen and cannot be eliminated by eructation (Clarke and Reid, 1974).

The chemical changes that cause foam to form within the rumen are not fully understood. Some reports (Nichols, 1966; Nichols and Deese, 1966) suggest that plant pectin and pectin methyl esterase, a plant enzyme, are critical factors. The enzyme acts on pectin to release pectic and galacturonic acids, which greatly increase the viscosity of the rumen fluid, resulting in formation of a highly stable foam. A soluble legume protein fraction with ribulose diphosphate carboxylase activity has been suggested as another important dietary factor in the pathogenesis of bloat (Howarth, 1975). Slime-producing bacteria also have been incriminated in the pathogenesis of frothy bloat. These microorganisms produce an extracellular polysaccharide that results in stable foam formation.

Effective medical treatment and control are directed toward decreasing or preventing foam formation. This has been accomplished with certain nonionic detergents with surfactant properties that break up or prevent formation of foam within the rumen (Bartley, 1965). Another approach has been the prophylactic administration of sodium alkyl sulfonate, which inhibits pectin methyl esterase activity

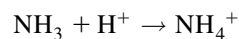
and prevents foam formation by eliminating the products of this enzyme reaction (Nichols, 1963). Antifoaming agents such as poloxalene administered before ingestion of bloat-producing diets have been shown to be effective prophylactically (Howarth, 1975). Silicone antifoaming agents also have been used for this purpose (Clark and Reid, 1974). Genetic selection of cattle that are less susceptible to rumen tympany has also been pursued (Howarth, 1975).

### C. Urea Poisoning

Unlike monogastric animals, ruminants, via their microbial flora, can effectively use nonprotein nitrogen (NPN) to meet some of their dietary protein requirements. Urea, biuret (Oltjen *et al.*, 1969), and ammonium salts (Webb *et al.*, 1972) can serve as dietary NPN sources. Urea, which is the most frequently used, is hydrolyzed by ruminal bacterial urease into  $\text{CO}_2$  and  $\text{NH}_3$ . The free  $\text{NH}_3$  is incorporated into amino acids and protein by the rumen microorganisms. The bacterial protein is digested and absorbed in the abomasum and small intestine along with dietary protein.

Signs of urea poisoning typically develop within minutes after consumption of food containing toxic amounts of urea. Clinical manifestations reflect the encephalotoxic effects of excess absorbed  $\text{NH}_3$  (Word *et al.*, 1969). Tolerance to urea may be significantly increased by increasing the amount of urea in the diet gradually or by adding readily fermentable carbohydrate to the diet. Ruminants can actually adapt and thrive on a diet in which urea is the sole source of dietary nitrogen. However, if urea is fed at more than 3% in the diet in unadapted animals, toxic effects are likely to occur.

Urea poisoning may occur accidentally when animals engorge on large amounts of urea-containing dietary supplement, when there has been an error in formulation of bulk feed, or when the urea-containing additive is incompletely mixed. Oral administration of acetic acid has been shown to reduce acute urea toxicity, apparently by decreasing absorption of free  $\text{NH}_3$  from the rumen. Normally,  $\text{NH}_3$  is in equilibrium:



with only 1% in the free form. Acidification shifts the equilibrium farther to the right, thereby reducing the amount of the  $\text{NH}_3$ . Because only the free form crosses cell membranes, the net effect is a reduction of absorption of  $\text{NH}_3$  by the cell. Acetic acid is used as a treatment for urea poisoning, but it is of more value as a prophylactic agent (Word *et al.*, 1969).

### REFERENCES

- Aclund, H. M., Gunson, D. E., and Gillette, D. M. (1983). Ulcerative duodenitis in foals. *Vet. Pathol.* **20**, 653–661.

- Alpers, D. H. (1969). Separation and isolation of rat and human intestinal beta-galactosidases. *J. Biol. Chem.* **244**, 1238–1246.
- Alpers, D. H., and Isselbacher, K. J. (1967). Protein synthesis by rat intestinal mucosa: the role of ribonuclease. *J. Biol. Chem.* **242**, 5617–5622.
- Altamirano, M. (1963). Alkaline secretion produced by intra-arterial acetylcholine. *J. Physiol.* **168**, 787–803.
- Alvarado, F. (1966a). D-xylose active transport in the hamster small intestine. *Biochim. Biophys. Acta* **112**, 292–306.
- Alvarado, F. (1966b). Transport of sugars and amino acids in the intestine: evidence for a common carrier. *Science* **151**, 1010–1013.
- Alvarado, F., and Crane, R. K. (1962). Phlorizin as a competitive inhibitor of the active transport of sugars by hamster small intestine, in vitro. *Biochim. Biophys. Acta* **56**, 170–172.
- Anderson, N. V. (1975). *In* ~~Review~~

- Brown, J. C., Cook, M. A., and Dryburgh, J. R. (1973). Motilin, a gastric motor activity stimulating polypeptide: the complete amino acid sequence. *Can. J. Biochem.* **51**, 533–537.
- Brown, J. C., Mutt, V., and Dryburgh, J. R. (1971). The further purification of motilin, a gastric motor activity stimulating polypeptide from the mucosa of the small intestine of hogs. *Can. J. Physiol. Pharmacol.* **49**, 399–405.
- Brown, J. R., and Hartley, B. S. (1966). Location of disulphide bridges by diagonal paper electrophoresis. The disulphide bridges of bovine chymotrypsinogen A. *Biochem. J.* **101**, 214–228.
- Burrows, C. F., Hall, E. J., Willard, M. D., and Williams, D. A. (1994). Small animal bacterial overgrowth. Compendium on Continuing Education for the Practicing Veterinarian. Veterinary Exchange, supplement to Compendium, December.
- Burrows, C. F., Batt, R. M., and Sherding, R. G. (1995). Diseases of the small intestine. In "Textbook of Veterinary Medicine" (S. J. Ettinger and E. C. Feldman, Eds.), 4th ed., p. 1169–1232. Saunders, Philadelphia.
- Burrows, C. F., and Jezyk, P. F. (1983). Nitrosonaphthol test for screening of small intestinal diarrheal disease in the dog. *J. Am. Vet. Med. Assoc.* **183**, 318–322.
- Burrows, C. F., Merritt, A. M., and Chiapella, A. M. (1979). Determination of fecal fat and trypsin output in the evaluation of chronic canine diarrhea. *J. Am. Vet. Med. Assoc.* **174**, 62–66.
- Bywater, R. J., and Penhale, W. J. (1969). Depressed lactase activity in the intestinal mucous membrane of calves after neonatal diarrhoea. *Res. Vet. Sci.* **10**, 591–593.
- Campbell, R. M., Cuthbertson, D. P., Mackie, W., McFarlane, A. S., Phillipson, A. T., and Sudsaneh, S. (1961). Passage of plasma albumin into the intestine of the sheep. *J. Physiol. (London)* **158**, 113–131.
- Campbell, R. S. F., Brobst, D. F., and Bisgard, G. (1968). Intestinal lymphangiectasia in a dog. *J. Am. Vet. Med. Assoc.* **153**, 1051–1054.
- Campbell-Thompson, M. L., and Merritt, A. M. (1987). Effect of ranitidine on gastric acid secretion in young male horses. *Am. J. Vet. Res.* **48**, 1511.
- Carlson, D. M., McGuire, E. J., Jourdian, G. W., and Roseman, S. (1973). The sialic acids. XVI. Isolation of a mucin sialyltransferase from sheep submaxillary gland. *J. Biol. Chem.* **248**, 5763–5773.
- Carpenter, C. C. J., Curlin, G. T., and Greenough, W. B. (1969). Response of canine Thiry-Vella jejunal loops to cholera exotoxin and its modification by ethacrynic acid. *J. Infect. Dis.* **120**, 332–338.
- Cassel, D., and Pfeuffer, T. (1978). Mechanism of cholera toxin action: covalent modification of the guanyl nucleotide-binding protein of the adenylate cyclase system. *Proc. Natl. Acad. Sci. USA* **75**, 2669–2673.
- Cassel, D., and Selinger, Z. (1978). Mechanism of adenylate cyclase activation through the beta-adrenergic receptor: catecholamine-induced displacement of bound GDP by GTP. *Proc. Natl. Acad. Sci. USA* **75**, 4155–4159.
- Chew, C. S. (1985). Parietal cell protein kinases. Selective activation of type I cAMP-dependent protein kinase by histamine. *J. Biol. Chem.* **260**, 7540–7550.
- Christensen, H. N. (1984). Organic ion transport during seven decades: the amino acids. *Biochim. Biophys. Acta* **779**, 255–269.
- Christensen, H. N. (1985). On the strategy of kinetic discrimination of amino acid transport systems. *J. Membr. Biol.* **84**, 97–103.
- Christensen, J., Weisbrodt, N. W., and Hauser, R. L. (1972). Electrical slow wave of the proximal colon of the cat in diarrhea. *Gastroenterology* **62**, 1167–1173.
- Cimprich, R. E. (1974). Equine granulomatous enteritis. *Vet. Pathol.* **11**, 535–547.
- Clarke, R. T. J., and Reid, C. S. W. (1974). Foamy bloat of cattle: a review. *J. Dairy Sci.* **57**, 753–785.
- Cook, D. L., Van Lennep, E. W., Roberts, M. L., and Young, J. A. (1994). Secretion by the major salivary gland. In "Physiology of the Gastrointestinal Tract" (L. R. Johnson, Ed.), 3rd ed, vol. 2, p. 1061–1117. Raven Press, New York.
- Craig, R. M., and Atkinson, A. J. (1988). D-xylose testing: a review. *Gastroenterology* **95**, 223–231.
- Csaky, T. Z. (1961). Significance of sodium ions in active intestinal transport of nonelectrolytes. *Am. J. Physiol.* **201**, 999–1001.
- Csaky, T. Z., and Hara, Y. (1965). Inhibition of active intestinal sugar transport by digitalis. *Am. J. Physiol.* **209**, 467–472.
- Curran, P. F. (1965). Ion transport in intestine and its coupling to other transport processes. *Fed. Proc., Fed. Am. Soc. Exp. Biol.* **24**, 993–999.
- Curran, P. F., and Schultz, S. G. (1968). Transport across membranes: general principles. In "Handbook of Physiology" (J. Field, Ed.), *Am. Physiol. Soc.*, Sect. 6, vol. III, p. 1217–1243. Williams and Wilkins, Baltimore.
- Dahlqvist, A. (1961). Intestinal carbohydrases of a new-born pig. *Nature* **190**, 31–32.
- Dalton, R. G., Fisher, E. W., and McIntyre, W. I. M. (1965). Changes in blood chemistry, body weight and haematocrit of calves affected with neonatal diarrhoea. *Br. Vet. J.* **121**, 34–42.
- Danforth, E., and Moore, R. O. (1959). Intestinal absorption of insulin in the rat. *Endocrinology* **65**, 118–123.
- Danielsson, H. (1963). Present status of research on catabolism and excretion of cholesterol. *Adv. Lipid Res.* **1**, 335–385.
- Darrow, D. C. (1964). "A Guide to Learning Fluid Therapy." Thomas, Springfield, IL.
- Davenport, H. W. (1966). "Physiology of the Digestive Tract," 2nd ed. Yearbook, Chicago, IL.
- Davis, J. L., Blikslager, A. T., Catto, K., and Jones, S. L. (2003). A retrospective analysis of hepatic injury in horses with proximal enteritis (1984–2002). *J. Vet. Int. Med.* **17**(6), 896–901.
- Delles, E. K., Willard, M. D., Simpson, R. B., Fossum, T. W., Slater, M. R., Kolp, D., Lees, G. E., Helman, R., and Reinhart, G. A. (1994). Comparison of species and numbers of bacteria in concurrently cultured samples of proximal small intestinal fluid and endoscopically obtained duodenal mucosa in dogs with intestinal bacterial overgrowth. *Am. J. Vet. Res.* **55**, 957–964.
- Delles, E. K., Willard, M. D., Simpson, R. B., Fossum, T. W., Slater, M. R., and Reinhart, G. A. (1993). (abstract) *J. Vet. Int. Med.* **7**, 132.
- Desrochers, A. M., Dallap, B. L., and Wilkins, P. A. (2003). Clostridium sordelli infection as a suspected cause of transient hyperammonemia in an adult horse. *J. Vet. Intern. Med.* **17**, 238–241.
- Deutsch, H. F., and Smith, V. R. (1957). Intestinal permeability to proteins in the newborn herbivore. *Am. J. Physiol.* **191**, 271–276.
- Dietschy, J. M., Salomon, H. S., and Siperstein, M. D. (1966). Bile acid metabolism. I. Studies on the mechanisms of intestinal transport. *J. Clin. Invest.* **45**, 832–846.
- Divers, T. J., Cummings, J. E., de Lahunta, A., Hintz, H. F., and Mohammed, H. O. (2006). Evaluation of the risk of motor neuron disease in horses fed a diet low in vitamin E and high in copper and iron. *Am. J. Vet. Res.* **67**, 120–126.
- Donowitz, M., and Charney, A. N. (1979). Propranolol prevention of cholera enterotoxin-induced intestinal secretion in the rat. *Gastroenterology* **76**, 482–491.
- Dowling, J. E., and Wald, G. (1958). Vitamin A deficiency and night blindness. *Proc. Natl. Acad. Sci. USA* **44**, 648–661.
- Drucker, M. M., Ogra, P. L., Goldhar, J., and Neter, E. (1977). The effect of attapulgit and charcoal on enterotoxicity of *Vibrio cholerae* and *Escherichia coli* enterotoxins in rabbits. *Infection* **5**, 211–213.

- Drumme, G. D., Benson, J. A., and Jones, C. M. (1961). Microscopical examination of the stool for steatorrhea. *N. Engl. J. Med.* **264**, 85–87.
- Dryburgh, J. R., and Brown, J. C. (1975). Radioimmunoassay for motilin. *Gastroenterology* **68**, 1169–1176.
- Dukes, H. H. (1955). "The Physiology of Domestic Animals," 7th ed. Cornell Univ. Press (Comstock), Ithaca, New York.
- Dunlop, R. H. (1972). Pathogenesis of ruminant lactic acidosis. *Adv. Vet. Sci. Comp. Med.* **16**, 259–302.
- DuPont, H. L. (1978). Interventions in diarrheas of infants and young children. *J. Am. Vet. Med. Assoc.* **173**, 649–653.
- DuPont, H. L., Sullivan, P., Pickering, L. K., Haynes, G., and Ackerman, P. B. (1977). Symptomatic treatment of diarrhea with bismuth subsalicylate among students attending a Mexican university. *Gastroenterology* **73**, 715–718.
- Edwards, J. F., Fossum, T. W., Willard, M. D., Cohen, N. D., Patterson, W. B., and Carey, D. P. (1995). Changes in the intestinal mucosal cell populations of German shepherd dogs fed diets containing different protein sources. *Am. J. Vet. Res.* **56**, 340–348.
- Eichholz, A. (1967). Structural and functional organization of the brush border of intestinal epithelial cells. 3. Enzymic activities and chemical composition of various fractions of trisdisrupted brush borders. *Biochim. Biophys. Acta* **135**, 474–482.
- Einarsson, K., Bergstrom, M., Eklof, R., Nord, C. E., and Bjorkhem, I. (1992). Comparison of the proportion of unconjugated to total serum cholic acid and the [<sup>14</sup>C]-xylose breath test in patients with suspected small intestinal bacterial overgrowth. *Scand. J. Clin. Lab. Invest.* **52**, 425–430.
- Elwood, C. M., Rutgers, H. C., Sorensen, S. H., Proud, F. J., and Batt, R. M. (1993). A novel method of assessing canine intestinal permeability and function using a multiple sugar test. (abstract). *J. Vet. Int. Med.* **7**, 131.
- Emas, S., and Grossman, M. I. (1967). Comparison of gastric secretion in conscious dogs and cats. *Gastroenterology* **52**, 29–34.
- English, R. V., Breitschwerdt, E. B., Grindem, C. B., Thrall, D. E., and Grainsburg, L. A. (1988). Zollinger-Ellison syndrome and myelofibrosis in a dog. *J. Am. Vet. Med. Assoc.* **10**, 1430–1434.
- Erickson, R. H., Bella, A. M., Jr., Brophy, E. J., Kobata, A., and Kim, Y. S. (1983). Purification and molecular characterization of rat intestinal brush border membrane dipeptidyl aminopeptidase IV. *Biochim. Biophys. Acta* **756**, 258–165.
- Ericsson, C. D., Evans, D. G., DuPont, H. L., Evans, D. J., and Pickering, L. K. (1977). Bismuth subsalicylate inhibits activity of crude toxins of *Escherichia coli* and *Vibrio cholerae*. *J. Infect. Dis.* **136**, 693–696.
- Ewing, G. O. (1971). Intestinal malabsorption. In "Current Veterinary Therapy" (R. W. Kirk, Ed.), 4th ed., pp. 551–553. Saunders, Philadelphia.
- Ewing, G. O., and Gomez, J. A. (1973). Canine ulcerative colitis. *J. Am. Anim. Hosp. Assoc.* **9**, 395–406.
- Farris, R. K., Tapper, E. J., Powell, D. W., and Morris, S. M. (1976). Effect of aspirin on normal and cholera toxin-stimulated intestinal electrolyte transport. *J. Clin. Invest.* **57**, 916–924.
- Farrow, B. R. H., and Penny, R. (1969). Protein-losing enteropathy in a dog. *J. Small Anim. Pract.* **10**, 513–517.
- Faust, R. G., Wu, S. L., and Faggard, M. L. (1967). D-glucose: preferential binding to brush borders disrupted with tris(hydroxymethyl)aminomethane. *Science* **155**, 1261–1263.
- Fetz, K., Steiner, J. M., Brousard, J. D., Alvarez, M., Ruau, C. G., Suchodolski, J. S., and Williams, D. A. (2006a). Increased fecal alpha-1 proteinase inhibitor concentration in cats with gastrointestinal disease. (abstract) ACTIM Forum Proceedings.
- Fetz, K., Steiner, J. M., Ruau, C. G., Suchodolski, J. S., and Williams, D. A. (2006b). Evaluation of fecal alpha-1 proteinase inhibitor concentrations in cats with inflammatory bowel disease and cats with gastrointestinal neoplasia. ACVIM Forum Proceedings (abstract) ACTIM Forum Proceedings.
- Field, M., Graf, L. H., Laird, W. J., and Smith, P. L. (1978). Heat-stable enterotoxin of *Escherichia coli*: in vitro effects on guanylate cyclase activity, cyclic GMP concentration, and ion transport in small intestine. *Proc. Natl. Acad. Sci. USA* **75**, 2800–2804.
- Finco, D. R., Duncan, J. R., Schall, W. B., Hooper, B. E., Chandler, F. W., and Keating, K. A. (1973). Chronic enteric disease and hypoproteinemia in 9 dogs. *J. Am. Vet. Med. Assoc.* **163**, 262–271.
- Fisher, E. W. (1965). Death in neonatal calf diarrhoea. *Br. Vet. J.* **121**, 13213–13218.
- Fisher, E. W., and McEwan, A. D. (1967a). Death in neonatal calf diarrhoea. Part. II: the role of oxygen and potassium. *Br. Vet. J.* **123**, 4–7.
- Fisher, E. W., and McEwan, A. D. (1967b). Simple laboratory tests for gamma globulin in calf sera. (abstract). *Vet. Rec.* **80**, 290.
- Fisher, E. W., Martinez, A. A., Trainin, Z., and Meirum, R. (1975). Studies of neonatal calf diarrhoea. II. Serum and faecal immune globulins in enteric colibacillosis. *Br. Vet. J.* **131**, 402–415.
- Fisher, R. B., and Parsons, D. S. (1953). Galactose absorption from the surviving small intestine of the rat. *J. Physiol.* **119**, 224–232.
- Forstner, C. G., Sabesin, S. M., and Isselbacher, K. J. (1968). Rat intestinal microvillus membranes: purification and biochemical characterization. *Biochem. J.* **106**, 381–390.
- Forsyth, G. W., Hamilton, D. L., Goertz, K. E., and Johnson, M. R. (1978). Cholera toxin effects on fluid secretion, adenylate cyclase, and cyclic AMP in porcine small intestine. *Infect. Immun.* **21**, 373–380.
- Fortier, L. A., Fubini, S. I., Flanders, J. A., and Divers, T. J. (1996). The diagnosis and surgical correction of congenital portosystemic vascular anomalies in two calves and two foals. *Vet. Surg.* **25**, 154–160.
- Franks, J. J., Edwards, K. W., Lackey, W. W., and Fitzgerald, J. B. (1963b). The role of the gut in albumin catabolism. II. Studies in enterectomized rabbits. *J. Gen. Physiol.* **46**, 427–434.
- Franks, J. J., Mosser, E. L., and Anstadt, G. L. (1963a). The role of the gut in albumin catabolism. I. Studies in the jejunoilectomized rabbit. *J. Gen. Physiol.* **46**, 415–425.
- Freeman, H. J., and Kim, Y. S. (1978). Digestion and absorption of protein. *Annu. Rev. Med.* **29**, 99–116.
- Ganguly, J., and Murthy, S. K. (1967). Biogenesis of vitamin A and carotene. In "The Vitamins" (W. H. Sebrell, Jr., and R. S. Harris, Eds.), 2nd ed., vol. 1, p. 125–153. Academic Press, New York.
- Gardner, M. G. (1984). Intestinal assimilation of intact peptides and proteins from the diet: a neglected field? *Biol. Rev.* **59**, 289–331.
- Gay, C. C. (1965). *Escherichia coli* and neonatal disease of calves. *Bacteriol. Rev.* **29**, 75–101.
- Gay, C. C., Anderson, N., Fisher, F. W., and McEwan, A. D. (1965a). Gamma globulin levels and neonatal mortality in market calves. *Vet. Rec.* **77**, 148–149.
- Gay, C. C., Fisher, E. W., and McEwan, A. D. (1965b). Seasonal variations in gamma globulin levels in neonatal market calves. *Vet. Rec.* **77**, 994.
- German, A. J., Day, M. J., Ruau, C. G., Steiner, J. M., Williams, D. A., and Hall, E. J. (2003). Comparison of direct and indirect tests for small intestinal bacterial overgrowth and antibiotic-responsive diarrhea in dogs. *J. Vet. Int. Med.* **17**, 33–43.
- Glenert, J., Jarnum, S., and Riemer, S. (1961). Experimental plasma protein loss into the digestive tract in dogs. *Acta Chir. Scand.* **121**, 242–252.

- Glenert, J., Jarnum, S., and Riemer, S. (1962). The albumin transfer from blood to gastrointestinal tract in dogs. *Acta Chir. Scand.* **124**, 63–74.
- Goldner, A. M., Schultz, S. G., and Curran, P. E. (1969). Sodium and sugar fluxes across the mucosal border of rabbit ileum. *J. Gen. Physiol.* **53**, 362–383.
- Gomez, J. A., Russell, S. W., Trowbridge, J., and Lee, J. (1977). Canine histiocytic ulcerative colitis. An ultrastructural study of the early mucosal lesion. *Am. J. Dig. Dis.* **22**, 485–496.
- Gots, R. E., Formal, S. B., and Giannella, R. A. (1974). Indomethacin inhibition of Salmonella typhimurium, Shigella flexneri, and cholera-mediated rabbit ileal secretion. *J. Infect. Dis.* **130**, 280–284.
- Grant, D. A. W., and Herman-Taylor, J. (1976). The purification of human enterokinase by affinity chromatography and immunoabsorption: some observations on its molecular characteristics and comparisons with the pig enzyme. *Biochem. J.* **155**, 243–254.
- Gray, G. M. (1975). Carbohydrate digestion and absorption. Role of the small intestine. *N. Engl. J. Med.* **292**, 1225–1230.
- Gray, G. M., and Cooper, H. L. (1971). Protein digestion and absorption. *Gastroenterology* **61**, 535–544.
- Gray, G. M., Lally, B. C., and Conklin, K. A. (1979). Action of intestinal sucrase-isomaltase and its free monomers on an alpha-limit dextrin. *J. Biol. Chem.* **254**, 6038–6043.
- Gray, J. S., and Bucher, G. R. (1941). The composition of gastric juice as a function of the rate of secretion. *Am. J. Physiol.* **133**, 542–550.
- Gregory, R. A. (1966). Memorial lecture: the isolation and chemistry of gastrin. *Gastroenterology* **51**, 953–959.
- Gregory, R. A. (1967). Isolation and chemistry of gastrin. In “Handbook of Physiology” (J. Field, Ed.), *Am. Physiol. Soc.*, Sect. 6 vol. II, p. 827–834. Williams and Wilkins, Baltimore.
- Gregory, R. A., Hardy, P. M., Jones, D. S., Kenner, G. W., and Sheppard, R. C. (1964). The antral hormone gastrin. Structure of gastrin. *Nature (London)* **204**, 931–933.
- Grossman, M. I., and Konturek, S. J. (1974). Inhibition of acid secretion in dog by metiamide, a histamine antagonist acting on H<sub>2</sub> receptors. *Gastroenterology* **66**, 517–521.
- Gustafsson, B. E. (1969). Influence of the diet on the composition of faecal bile acids in rats. *Br. J. Nutr.* **23**, 627–635.
- Gustafsson, B. E., Bergstrom, S., Lindstedt, S., and Norman, A. (1957). Turnover and nature of fecal bile acids in germfree and infected rats fed cholic acid-24-14C; bile acids and steroids 41. *Soc. Exp. Biol. Med.* **94**, 467–471.
- Gustafsson, B. E., Midtvedt, T., and Norman, A. (1966). Isolated fecal microorganisms capable of 7-alpha-dehydroxylating bile acids. *J. Exp. Med.* **123**, 413–432.
- Gustafsson, B. E., and Norman, A. (1962). Comparison of bile acids in intestinal contents of germfree and conventional rats. *Proc. Soc. Exp. Biol. Med.* **110**, 387–389.
- Gustafsson, B. E., and Norman, A. (1969). Influence of the diet on the turnover of bile acids in germ-free and conventional rats. *Br. J. Nutr.* **23**, 429–442.
- Gyles, C. L., and Zigler, M. (1978). The effect of adsorbant and anti-inflammatory drugs on secretion in ligated segments of pig intestine infected with *Escherichia coli*. *Can. J. Comp. Med. Vet. Sci.* **42**, 260–268.
- Hakim, A. A., and Lifson, N. (1964). Urea transport across dog intestinal mucosa in vitro. *Am. J. Physiol.* **206**, 1315–1320.
- Hall, E. J., and Batt, R. M. (1990). Enhanced intestinal permeability to 51Cr-labeled EDTA in dogs with small intestinal disease. *J. Am. Med. Assoc.* **196**, 91–95.
- Hall, E. J., and Batt, R. M. (1991a). Abnormal permeability precedes the development of a gluten sensitive enteropathy in Irish setter dogs. *Gut* **32**, 749–753.
- Hall, E. J., and Batt, R. M. (1991b). Differential sugar absorption for the assessment of canine intestinal permeability: the cellobiose/mannitol test in gluten-sensitive enteropathy of Irish setters. *Res. Vet. Sci.* **51**, 83–87.
- Hall, E. J., Batt, R. M., and Brown, A. (1989). Assessment of canine intestinal permeability, using 51Cr-labeled ethylenediaminetetraacetate. *Am. J. Vet. Res.* **50**, 2069–2074.
- Hall, E. J., and German, A. J. (2005). Diseases of the small intestine. In “Textbook of Veterinary Internal Medicine, Diseases of the Dog and Cat” (S. J. Ettinger and E. C. Feldman, Eds.), 6th ed., pp. 1332–1378.
- Halliday, G. J., Mulligan, W., and Dalton, R. G. (1968). Parasitic hypoalbuminaemia: studies on type II ostertagiasis of cattle. *Res. Vet. Sci.* **9**, 224–230.
- Handt, L. K., Fox, J. G., Dewhirst, F. E., Fraser, G. J., Paster, B. J., Yan, L. L., Rozmirek, H., Rufo, R., and Stalis, I. H. (1994). *Helicobacter pylori* isolated from the domestic cat: public health implications. *Infect. Immun.* **62**, 2367–2374.
- Happe, R. P., and van der Gagg, I. (1977). Multiple polyps of the gastric mucosa in two dogs. *J. Small Anim. Pract.* **18**, 179–189.
- Hartley, B. S., Brown, J. R., Kauffman, D. L., and Smillie, L. B. (1965). Evolutionary similarities between pancreatic proteolytic enzymes. *Nature (London)* **207**, 1157–1159.
- Hartley, B. S., and Kauffman, D. L. (1966). Corrections to the amino acid sequence of bovine chymotrypsinogen A. *Biochem. J.* **101**, 229–231.
- Hawkins, E. C., Meric, S. M., Washabau, R. J., Feldman, E. C., and Turrel, J. M. (1986). Digestion of bentrimide and absorption of xylose in healthy cats and absorption of xylose in cats with infiltrative intestinal disease. *Am. J. Vet. Res.* **47**, 567–569.
- Hayden, D. W., and Van Kruiningen, H. J. (1973). Eosinophilic gastroenteritis in German shepherd dogs and its relationship to visceral larva migrans. *J. Am. Vet. Med. Assoc.* **162**, 379–384.
- Hayden, D. W., and Van Kruiningen, H. J. (1976). Control values for evaluating gastrointestinal function in the dog. *J. Am. Anim. Hosp. Assoc.* **12**, 31–36.
- Heizer, W. D., and Laster, L. (1969). Hydrolases in the mucosa of rat small intestine for phenylalanine-containing dipeptides. *Biochim. Biophys. Acta*, **185**, 409–423.
- Hill, F. W. G. (1972). Malabsorption syndrome in the dog: a study of thirty-eight cases. *J. Small Anim. Pract.* **13**, 575–594.
- Hill, F. W. G., and Kelly, D. F. (1974). Naturally occurring intestinal malabsorption in the dog. *Am. J. Dig. Dis.* **19**, 649–665.
- Hill, F. W. G., and Kidder, D. E. (1972a). Fat assimilation in dogs, estimated by a fat-balance procedure. *J. Small Anim. Pract.* **13**, 23–25.
- Hill, F. W. G., and Kidder, D. E. (1972b). The oral glucose tolerance test in canine pancreatic malabsorption. *Br. Vet. J.* **128**, 207–214.
- Hill, F. W. G., Kidder, D. E., and Frew, J. (1970). A xylose absorption test for the dog. *Vet. Rec.* **87**, 250–255.
- Hofmann, A. F. (1963). The function of bile salts in fat absorption: the solvent properties of dilute micellar solutions of conjugated bile salts. *Biochem. J.* **89**, 57–68.
- Hofmann, A. F., and Small, D. M. (1967). Detergent properties of bile salts: correlation with physiological function. *Annu. Rev. Med.* **18**, 333–376.
- Holland, R. E., Herdt, T. H., and Refsal, K. R. (1986). Breath hydrogen concentration and small intestinal malabsorption in calves. *Am. J. Vet. Res.* **47**, 2020–2004.
- Holmgren, J., Lange, S., and Lonnroth, I. (1978). Reversal of cyclic AMP-mediated intestinal secretion in mice by chlorpromazine. *Gastroenterology* **75**, 1103–1108.

- Hopfer, U., and Groseclose, R. (1980). The mechanism of Na<sup>+</sup>-dependent D-glucose transport. *J. Biol. Chem.* **255**, 4453–4462.
- Haupt, T. R., and Haupt, K. A. (1971). Nitrogen conservation by ponies fed a low-protein ration. *Am. J. Vet. Res.* **32**, 579–588.
- House, J. A., and Baker, J. A. (1968). Comments on combination vaccines for bovine respiratory diseases. *J. Am. Vet. Med. Assoc.* **152**, 893–894.
- Howarth, R. E. (1975). A review of bloat in cattle. *Can. Vet. J.* **16**, 281–294.
- Hughes, J. M., Murad, F., Chang, B., and Guerrant, R. L. (1978). Role of cyclic GMP in the action of heat-stable enterotoxin of *Escherichia coli*. *Nature (London)* **271**, 755–756.
- Hughey, R. P., and Curthoys, N. (1976). Comparison of the size and physical properties of gamma-glutamyltranspeptidase purified from rat kidney following solubilization with papain or with Triton X-100. *J. Biol. Chem.* **251**, 8763–8770.
- Hungate, R. E. (1966). “The Rumen and Its Microbes.” Academic Press, New York.
- Hungate, R. E. (1968). Rumenal fermentation. In “Handbook of Physiology” (J. Field, Ed.), *Am. Physiol. Soc.*, Sect. 6, vol. V, p. 2725–2745. Williams and Wilkins, Baltimore.
- Hungate, R. E., Dougherty, R. W., Bryant, M. P., and Cello, R. M. (1952). Microbiological and physiological changes associated with acute indigestion in sheep. *Cornell Vet.* **42**, 423–449.
- Hungate, R. E., Fletcher, D. W., Dougherty, R. W., and Barrentine, B. F. (1955). Microbial activity in the bovine rumen: its measurement and relation to bloat. *Appl. Microbiol.* **13**, 161–173.
- Hungate, R. E., Mah, R. A., and Simesen, M. (1961). Rates of production of individual volatile fatty acids in the rumen of lactating cows. *Appl. Microbiol.* **9**, 554–561.
- Imondi, A. R., Stradley, R. P., and Wolgemuth, R. (1972). Synthetic peptides in the diagnosis of exocrine pancreatic insufficiency in animals. *Gut* **13**, 726–731.
- Isaacson, P. G. (1994). Gastric lymphoma and *Helicobacter pylori*. *N. Engl. J. Med.* **330**, 1310–1311.
- Isselbacher, K. J. (1966). Biochemical aspects of absorption. *Gastroenterology* **50**, 78–82.
- Isselbacher, K. J. (1967). Biochemical aspects of lipid malabsorption. *Fed. Proc., Fed. Am. Soc. Exp. Biol.* **26**, 1420–1425.
- Itoh, Z., Takeuchi, S., Aizawa, I., Mori, K., Taminato, T., Seino, Y., Imura, H., and Yanaiharu, N. (1978). Changes in plasma motilin concentration and gastrointestinal contractile activity in conscious dogs. *Am J. Dig. Dis.* **23**, 929–935.
- Jennewein, H. M., Hummelt, H., Siewert, R., and Waldeck, F. (1975). The motor-stimulating effect of natural motilin on the lower esophageal sphincter fundus, antrum and duodenum in dogs. *Digestion* **13**, 246–250.
- Johnson, G. L., Kaslow, H. R., and Bourne, H. R. (1978). Reconstitution of cholera toxin-activated adenylate cyclase. *Proc. Natl. Acad. Sci. USA* **75**, 3113–3117.
- Johnston, K. L. (1999). Small intestinal bacterial overgrowth (review). In “The Veterinary Clinics of North America: Small Animal Practice” (K. W. Simpson, Ed.), pp. 29, 523–550. Saunders, Philadelphia, PA.
- Johnston, K., Lampert, A., and Batt, R. M. (1993). An unexpected bacterial flora in the proximal small intestine of normal cats. *Vet. Rec.* **132**, 362–363.
- Jones, E. W., Hamm, D., and Bush, L. (1977). Calf diarrhea: a brief resume with observations on treatment and prevention. *Bovine Pract.* **10**, 48–54.
- Kagan, K. G., and Schaer, M. (1983). Gastric dilatation and volvulus in a dog: a case justifying electrolyte and acid-base assessment. *J. Am. Vet. Med. Assoc.* **182**(7), 703–705.
- Kallfelz, F. A., Norrdin, R. W., and Neal, T. M. (1968). Intestinal absorption of oleic acid 131-I and triolein 131-I in the differential diagnosis of malabsorption syndrome and pancreatic dysfunction in the dog. *J. Am. Vet. Med. Assoc.* **153**(1), 43–46.
- Kaneko, J. J., Moulton, J. E., Brodey, R. S., and Perryman, V. D. (1965). Malabsorption syndrome resembling nontropical sprue in dogs. *J. Am. Vet. Med. Assoc.* **146**, 463–473.
- Katz, J., Rosenfeld, S., and Sellers, A. L. (1961). Sites of plasma albumin catabolism in the rat. *Am. J. Physiol.* **200**, 1301–1306.
- Kennedy, P. C., and Cello, R. M. (1966). Colitis of boxer dogs. *Gastroenterology* **51**(5), 926–931.
- Kim, Y. S., Birtwhistle, W., and Kim, Y. W. (1972). Peptide hydrolases in the brush border and soluble fractions of small intestinal mucosa of rat and man. *J. Clin. Invest.* **51**(6), 1419–1430.
- Kim, Y. S., and Brophy, E. J. (1976). Rat intestinal brush border membrane peptidases. I. Solubilization, purification, and physicochemical properties of two different forms of the enzyme. *J. Biol. Chem.* **251**, 3199–3205.
- Kim, Y. S., Kim, Y. W., and Slesinger, M. H. (1974). Studies on the properties of peptide hydrolases in the brush-border and soluble fractions of small intestinal mucosa of rat and man. *Biochim. Biophys. Acta*, **370**, 283–296.
- Kimmich, G. A. (1973). Coupling between Na<sup>+</sup> and sugar transport in small intestine. *Biochim. Biophys. Acta*, **300**(1), 31–78.
- Kippins, R. M. (1978). Focal cystic hypertrophic gastropathy in a dog. *J. Am. Vet. Med. Assoc.* **173**(2), 182–184.
- Knoop, F. C., and Abbey, D. M. (1981). Effect of chemical and pharmacological agents on the secretory activity induced by *Escherichia coli* heat-stable enterotoxin. *Can. J. Microbiol.* **27**(8), 754–758.
- Koch, S. A., and Skelley, J. F. (1967). Colitis in a dog resembling Whipple’s disease in man. *J. Am. Vet. Med. Assoc.* **150**, 22–26.
- Kohler, E. M. (1968). Enterotoxic activity of filtrates of *Escherichia coli* in young pigs. *Am. J. Vet. Res.* **29**(12), 2263–2274.
- Kohn, P., Dawes, E. D., and Duke, J. W. (1965). Absorption of carbohydrates from the intestine of the rat. *Biochim. Biophys. Acta* **107**(2), 358–362.
- Kolínská, J., and Semenza, G. (1967). Studies on intestinal sucrase and on intestinal sugar transport. V. Isolation and properties of sucrase-isomaltase from rabbit small intestine. *Biochim. Biophys. Acta* **146**(1), 181–195.
- Krogh, N. (1963a). Clinical and microbiological studies on spontaneous cases of acute indigestion in ruminants. *Acta Vet. Scand.* **4**, 27–40.
- Krogh, N. (1963b). Identification of the Gram-positive rumen flora of cattle and sheep in clinical cases of acute indigestion. *Acta Vet. Scand.* **4**, 41–51.
- Kunkel, H. G. (1947). Estimation of alterations of serum gamma globulin by a turbidimetric technique. *Proc. Soc. Exp. Biol. Med.* **66**, 217–224.
- Lack, L., and Weiner, I. M. (1961). *In vitro* absorption of bile salts by small intestine of rats and guinea pigs. *Am. J. Physiol.* **200**, 313–317.
- Lack, L., and Weiner, I. M. (1966). Intestinal bile salt transport: structure-activity relationships and other properties. *Am. J. Physiol.* **210**, 1142–1152.
- Larivière, S., Lallier, R., and Morin, M. (1979). Evaluation of various methods for the detection of enteropathogenic *Escherichia coli* in diarrheic calves. *Am. J. Vet. Res.* **40**(1), 130–134.
- Laskowski, M., Jr., Haessler, H. A., Miech, R. P., Peanasky, R. J., and Laskowski, M. (1958). Effect of trypsin inhibitor on passage of insulin across the intestinal barrier. *Science* **127**(3306), 1115–1116.
- Leaf, A., and Santos, R. F. (1961). Physiologic mechanisms in potassium deficiency. *N. Engl. J. Med.* **16**, 335–341.
- Leary, H. L., Jr., and Lecce, J. G. (1978). Effect of feeding on the cessation of transport of macromolecules by enterocytes of neonatal pig intestine. *Biol. Neonate* **34**(3–4), 174–176.

- Lecce, J. G. (1965). Absorption of macromolecules by neonatal intestine. *Biol. Neonate* **9**, 50–61.
- Lees, G. E., Leighton, R. L., and Hart, R. (1977). Management of gastric dilatation-volvulus and disseminated intravascular coagulation in a dog: a case report. *J. Am. Anim. Hosp. Assoc.* **13**, 463–469.
- Lecce, J. G., and Morgan, D. O. (1962). Effect of dietary regimen on cessation of intestinal absorption of large molecules (closure) in the neonatal pig and lamb. *J. Nutr.* **78**, 263–268.
- Lecce, J. G., Morgan, D. O., and Matrone, G. (1964). Effect of feeding colostrum and milk components on the cessation of intestinal absorption of large molecules (closure) in neonatal pigs. *J. Nutr.* **84**, 43–48.
- Leib, M. S., and Blass, C. E. (1984). Plasma gastrin immunoreactivity in dogs with acute gastric dilatation-volvulus. *Compend. Cont. Educ. Pract. Vet.* **6**, 961–969.
- Leib, M. S., Wingfield, W. E., Twedt, D. C., and Bottoms, G. D. (1984). Plasma gastrin immunoreactivity in dogs with acute gastric dilatation-volvulus. *J. Am. Vet. Med. Assoc.* **185**(2), 205–208.
- Levinson, S. L., and Blume, A. J. (1977). Altered guanine nucleotide hydrolysis as basis for increased adenylate cyclase activity after cholera toxin treatment. *J. Biol. Chem.* **252**(11), 3766–3774.
- Lindstedt, S., and Samuelsson, B. (1959). Bile acids and steroids. LXXXIII. On the interconversion of cholic and deoxycholic acid in the rat. *J. Biol. Chem.* **234**(8), 2026–2030.
- Littman, M. P., Dambach, D. M., Vaden, S. L., and Giger, U. (2000). Familial protein-losing enteropathy and protein-losing nephropathy in soft coated wheaten terriers: 222 cases (1983–1997). *J. Vet. Intern. Med.* **14**(1), 68–80.
- Logan, E. F., and Penhale, W. J. (1971). Studies of the immunity of the calf to colibacillosis. 3. The local protective activity of colostrum within the gastrointestinal tract. *Vet. Rec.* **89**(24), 628–632.
- Lorenz, M. D. (1975). Diseases of the large bowel. In “Textbook of Veterinary Internal Medicine: Diseases of the Dog and Cat” (S. J. Ettinger, Ed.), vol. 2, pp. 1192–1218. Saunders, Philadelphia.
- McBeath, D. G., Penhale, W. J., and Logan, E. F. (1971). An examination of the influence of husbandry on the plasma immunoglobulin level of the newborn calf, using a rapid refractometer test for assessing immunoglobulin content. *Vet. Rec.* **88**, 266–270.
- McCormico, R. S., Duckett, V. M., and Wood, P. A. (1997). Persistent hyperammonemia in two related Morgan weanlings. *J. Vet. Intern. Med.* **11**, 264–266.
- McEwan, A. D., Fisher, E. W., and Selman, I. E. (1970a). Observations on the immune globulin levels of neonatal calves and their relationship to disease. *J. Comp. Pathol.* **80**, 259–265.
- McEwan, A. D., Fisher, E. W., Selman, I. E., and Penhale, W. J. (1970b). A turbidity test for the estimation of immune globulin levels in neonatal calf serum. *Clin. Chim. Acta* **27**, 155–163.
- Marsh, C. L., Mebus, C. A., and Underdahl, N. R. (1969). Loss of serum proteins via the intestinal tract in calves with infectious diarrhea. *Am. J. Vet. Res.* **30**, 163–166.
- Mattheeuws, A., DeRick, H., Thoonen, H., and Van der Stock, J. (1974). Intestinal lymphangiectasia in a dog. *J. Small Anim. Pract.* **15**, 757–761.
- Meister, A., and Tate, S. S. (1976). Glutathione and related gamma-glutamyl compounds: biosynthesis and utilization. *Annu. Rev. Biochem.* **45**, 559–604.
- Merritt, A. M., and Duelly, P. (1983). Phloroglucinol microassay for plasma xylose in dogs and horses. *Am. J. Vet. Res.* **44**, 2184–2185.
- Merritt, A. M., Burrows, C. F., and Cowgill, L. (1979). Fecal fat and trypsin in dogs fed a meat-base or cereal-base diet. *J. Am. Vet. Med. Assoc.* **174**, 59–61.
- Merritt, A. M., Cimprich, R. E., and Beech, J. (1976). Granulomatous enteritis in nine horses. *J. Am. Vet. Med. Assoc.* **169**, 603–609.
- Meuten, D. J., Butler, D. G., Thomsen, G. W., and Lumsden, J. H. (1978). Chronic enteritis associated with the malabsorption and protein-losing enteropathy in the horse. *J. Am. Vet. Med. Assoc.* **172**, 326–333.
- Michaelson, S. M., El-Tamami, M. Y., Thomson, R. A. E., and Howland, J. W. (1960). Absorption of I<sup>131</sup>-labeled fat in the dog. *Am. J. Vet. Res.* **21**, 364–366.
- Milstein, M., and Sanford, S. E. (1977). Intestinal lymphangiectasia in a dog. *Can. Vet. J.* **18**, 127–130.
- Moon, H. W. (1978). Mechanisms in the pathogenesis of diarrhea: a review. *J. Am. Vet. Med. Assoc.* **172**, 443–448.
- Moon, H. W., Whipp, S. C., and Skartvedt, S. M. (1976). Etiologic diagnosis of diarrheal disease of calves: frequency and methods for detecting enterotoxin and K99 antigen production by *Escherichia coli*. *Am. J. Vet. Res.* **37**, 1025–1029.
- Moore, R. M., Muir, W. W., and Granger, D. N. (1995). Mechanisms of gastrointestinal ischemia-reperfusion injury and potential therapeutic interventions: a review and its implications in the horse. *J. Vet. Intern. Med.* **9**, 115–132.
- Moore, W. L., Jr., Bieberdorf, F. A., Morawski, S. G., Finkelstein, R. A., and Fordtran, J. S. (1971). Ion transport during cholera-induced ileal secretion in the dog. *J. Clin. Invest.* **50**, 312–318.
- Morgan, R. V. (1982). Acute gastric dilatation-volvulus syndrome. *Compend. Cont. Educ. Pract. Vet.* **4**, 677–682.
- Muir, P., Papsouliatis, K., Gruffydd-Jones, T. J., Cripps, P. J., and Harbour, D. A. (1991). Proteoglycan synthesis and content in articular cartilage and cartilage repair tissue in horses. *Am. J. Vet. Res.* **52**, 1004–1009.
- Muir, W. W. (1982). Acid-base and electrolyte disturbances in dogs with gastric dilatation-volvulus. *J. Am. Vet. Med. Assoc.* **181**, 229–231.
- Munro, D. R. (1974). Route of protein loss during a model protein-losing gastropathy in dogs. *Gastroenterology* **66**, 960–972.
- Murphy, K. F., German, A. J., Ruaus, J. M., Steiner, J. M., and Williams, D. A. (2003). Fecal alpha1-proteinase inhibitor concentration in dogs with chronic gastrointestinal disease. *Vet. Clin. Pathol.* **32**, 67–72.
- Murry, M. (1969). Structural changes in bovine ostertagiasis associated with increased permeability of the bowel wall to macromolecules. *Gastroenterology* **56**, 763–772.
- Murthy, S. K., and Ganguly, J. (1962). Studies on cholesterol esterases of the small intestine and pancreas of rats. *Biochem. J.* **83**, 460–469.
- Mutt, V., and Jorpes, J. E. (1967). Contemporary developments in the biochemistry of the gastrointestinal hormones. *Recent Prog. Horm. Res.* **23**, 483–503.
- Nakano, M., Sumi, Y., and Miyakawa, M. (1977). Purification and properties of trehalase from rat intestinal mucosal cells. *J. Biochem. (Tokyo)* **81**, 1041–1049.
- Naylor, J. M., Kronfeld, D. S., Bech-Nielsen, S., and Bartholomew, R. C. (1977). Plasma total protein measurement for prediction of disease and mortality in calves. *J. Am. Vet. Med. Assoc.* **171**, 635–638.
- Neurath, H., and Walsh, K. A. (1976). Role of proteolytic enzymes in biological regulation (a review). *Proc. Natl. Acad. Sci. USA* **73**, 3825–3832.
- Newey, H., and Smyth, D. H. (1964). Effects of sugars on intestinal transfer of amino-acids. *Nature (London)* **202**, 400–401.
- Nichols, R. E. (1963). The control of experimental legume bloat with an enzyme inhibitor, alkyl aryl sulfonate sodium. *J. Am. Vet. Med. Assoc.* **143**, 998–999.
- Nichols, R. E. (1966). A factor in ruminal contents that inhibits the gelling of pectin by pectin methyl esterase: its relationship to legume bloat. *Am. J. Vet. Res.* **27**, 369–372.



- Nichols, R. E., and Deese, D. (1966). Bloat producing capacity and pectin methyl esterase activity of alfalfa stands of various moisture levels. *Am. J. Vet. Res.* **27**, 623–627.
- Nielsen, K. (1966). Metabolism and distribution of I131-labelled albumin in pigs with gastrointestinal disease. *Acta. Veta. Scand.* **7**, 321–329.
- Nielsen, K., and Nansen, P. (1967). Metabolism of bovine immunoglobulin. II. Metabolism of bovine IgG in cattle with secondary hypoinmunoglobulinemia. *Can. J. Comp. Med. Vet. Sci.* **31**, 106–110.
- Norris, H. T., Curran, P. F., and Schultz, S. G. (1969). Modification of intestinal secretion in experimental cholera. *J. Infect. Dis.* **119**, 117–125.
- Ockner, R. K., Hughes, F. B., and Isselbacher, K. J. (1969). Very low density lipoproteins in intestinal lymph: role in triglyceride and cholesterol transport during fat absorption. *J. Clin. Invest.* **48**, 2367–2373.
- Ockner, R. K., and Isselbacher, K. J. (1974). Recent concepts of intestinal fat absorption. *Rev. Physiol. Biochem. Pharmacol.* **71**, 107–146.
- Ockner, R. K., and Manning, J. (1974). Fatty acid-binding protein in small intestine. Identification, isolation, and evidence for its role in cellular fatty acid transport. *J. Clin. Invest.* **54**, 326–338.
- Olson, N. C., and Zimmer, J. F. (1978). Protein-losing enteropathy secondary to intestinal lymphangiectasia in a dog. *J. Am. Vet. Med. Assoc.* **173**, 271–274.
- Oltjen, R. R., Williams, E. E., Slyter, L. L., and Richardson, G. V. (1969). Urea versus biuret in a roughage diet for steers. *J. Anim. Sci.* **29**, 816–822.
- Papasoulotis, K., Gruffydd-Jones, T. J., Sparkes, A. H., Cripps, P. J., and Millard, W. J. (1993). Lactulose and mannitol as probe markers for in vivo assessment of passive intestinal permeability in healthy cats. *Am. J. Vet. Res.* **54**, 840–844.
- Parsonnet, J., Friedman, M. D., Vandersteen, D. P., Chagn, Y., Vogelman, J. H., Orentreich, N., and Sibley, R. K. (1991). Helicobacter pylori infection and the risk of gastric carcinoma. *N. Engl. J. Med.* **325**, 1127–1131.
- Parsons, B. J., Smyth, D. H., and Taylor, C. B. (1958). The action of phlorrhizin on the intestinal transfer of glucose and water in vitro. *J. Physiol. (London)* **144**, 387–402.
- Patterson, D. S. P. (1967). Simple laboratory tests for (-)globulins in calf sera. *Vet. Rec.* **80**, 260–261.
- Patterson, D. S. P., Allen, W. M., Berret, S., Ivins, L. N., and Sweasey, D. (1968). Some biochemical aspects of clinical Johne's disease in cattle. *Res. Vet. Sci.* **9**, 117–129.
- Patterson, D. S. P., Allen, W. M., and Lloyd, M. K. (1967). Clinical Johne's disease as a protein losing enteropathy. *Vet. Rec.* **81**, 717–718.
- Patterson, D. S. P., and Berrett, S. (1969). Malabsorption in Johne's disease in cattle: an in-vitro study of L-histidine uptake by isolated intestinal tissue preparations. *J. Med. Microbiol.* **2**, 327–334.
- Payne, L. C., and Marsh, C. L. (1962). Gamma globulin absorption in the baby pig: the nonselective absorption of heterologous globulins and factors influencing absorption time. *J. Nutr.* **76**, 151–158.
- Pearse, A. G. E., Polak, J. M., and Bloom, S. R. (1977). The newer gut hormones. Cellular sources, physiology, pathology, and clinical aspects. *Gastroenterology* **72**, 746–761.
- Peek, S. F., Divers, T. J., and Jackson, C. J. (1997). Hyperammonaemia associated with encephalopathy and abdominal pain without evidence of liver disease in four mature horses. *Equine. Vet. J.* **29**(1), 70–74.
- Penhale, W. J., Christie, G., McEwan, A. D., Fisher, E. W., and Selman, I. E. (1970). Quantitative studies on bovine immunoglobulins. II. Plasma immunoglobulin levels in market calves and their relationship to neonatal infection. *Br. Vet. J.* **126**, 30–37.
- Penhale, W. J., Logan, E. F., and Stenhouse, A. (1971). Studies on the immunity of the calf to colibacillosis. II. Preparation of an IgM-rich fraction from bovine serum and its prophylactic use in experimental colisepticaemia. *Vet. Rec.* **89**, 623–628.
- Peric-Golia, L., and Socic, H. (1968). Biliary bile acids and cholesterol in developing sheep. *Am. J. Physiol.* **215**, 1284–1287.
- Perman, J. A. (1991). Clinical application of breath hydrogen measurements. *Can. J. Physiol. Pharmacol.* **69**, 111–115.
- Peters, T. J. (1970). The subcellular localization of di- and tri-peptide hydrolase activity in guinea-pig small intestine. *Biochem. J.* **120**, 195–203.
- Pfeiffer, N. E., and McGuire, T. C. (1977). A sodium sulfite-precipitation tests for assessment of colostral immunoglobulin transfer to calves. *J. Am. Vet. Med. Assoc.* **170**, 809–811.
- Phillipson, A. T. (1977). Ruminant digestion. In "Dukes Physiology of Domestic Animals" (M. J. Swenson, Ed.), p. 250. Cornell Univ. Press, Ithaca, New York.
- Playoust, M. R., and Isselbacher, K. J. (1964). Studies on the intestinal absorption and intramucosal lipolysis of a medium chain triglyceride. *J. Clin. Invest.* **43**, 878–885.
- Playoust, M. R., Lack, L., and Weiner, I. M. (1965). Effect of intestinal resection on bile salt absorption in dogs. *Am. J. Physiol.* **208**, 363–369.
- Plucinski, T. M., Hamosh, M., and Hamosh, P. (1979). Fat digestion in rat: role of lingual lipase. *Am. J. Physiol.* **237**, E541–E547.
- Polak, J. M., Pearse, A. G. E., and Heath, C. M. (1975). Complete identification of endocrine cells in the gastrointestinal tract using semithin sections to identify motilin cells in human and animal intestine. *Gut* **16**, 225–229.
- Portnoy, B. L., DuPont, H. L., Pruitt, D., Abdo, J. A., and Rodriguez, J. T. (1976). *J. Am. Vet. Med. Assoc.* **236**, 844–846.
- Powell, D. W., Malawer, S. J., and Plotkin, G. R. (1968). Secretion of electrolytes and water by the guinea pig small intestine in vivo. *Am. J. Physiol.* **215**, 1226–1233.
- Powell, D. W., Tapper, E. J., and Morris, S. M. (1979). Aspirin-stimulated intestinal electrolyte transport in rabbit ileum in vitro. *Gastroenterology* **76**, 1429–1437.
- Pradayrol, L., Jornvall, H., Mutt, V., and Ribet, A. (1980). N-terminally extended somatostatin: the primary structure of somatostatin-28. *FEBS Lett.* **109**, 55–58.
- Rao, G. A., and Johnston, J. M. (1966). Purification and properties of triglyceride synthetase from the intestinal mucosa. *Biochim. Biophysica. Acta* **125**, 465–473.
- Raphael, N., Ekblad, E. B., and Machen, T. E. (1984). Reversible effects of phenothiazines on frog gastric stimulation. *Am. J. Physiol.* **247**, G366–G376.
- Richards, K. L., and Douglas, S. D. (1978). Pathophysiological effects of Vibrio cholerae and enterotoxigenic Escherichia coli and their exotoxins on eucaryotic cells. *Microbiol. Rev.* **42**, 592–613.
- Riklis, E., and Quastel, J. H. (1958). Effects of cations on sugar absorption by isolated surviving guinea pig intestine. *Can. J. Biochem. Physiol.* **36**, 347–362.
- Roberts, H. E., Worden, A. N., and Evans, E. T. (1954). Observations on some effects of colostrum deprivation in the calf. *J. Comp. Pathol.* **64**, 283–305.
- Roberts, M. C. (1974). The D(+) xylose absorption test in the horse. *Equine Vet. J.* **6**, 28–30.
- Roberts, M. C., and Hill, F. W. (1973). The oral glucose tolerance test in the horse. *Equine Vet. J.* **5**, 171–173.
- Rodriguez, I. R., Taraval, F. R., and Whelan, W. J. (1984). Characterization and function of pig intestinal sucrase-isomaltase and its separate subunits. *Euro. J. Biochem./FEBS* **143**, 575–582.
- Rogers, W. A., Stradley, R. P., Sherding, R. G., Powers, J., and Cole, C. R. (1980). Simultaneous evaluation of pancreatic exocrine function and

- intestinal absorptive function in dogs with chronic diarrhea. *J. Am. Vet. Med. Assoc.* **177**, 1128–1131.
- Ruau, C. G., Steiner, J. M., and Williams, D. A. (2001). Metabolism of amino acids in cats with severe cobalamin deficiency. *Am. J. Vet. Res.* **62**, 1852–1858.
- Ruau, C. G., Steiner, J. M., and Williams, D. A. (2005). Early biochemical and clinical responses to cobalamin supplementation in cats with signs of gastrointestinal disease and severe hypocobalaminemia. *J. Vet. Intern. Med./Am. Coll. Vet. Intern. Med.* **19**, 155–160.
- Russell, S. W., Gomez, J. A., and Trowbridge, J. O. (1971). Canine histiocytic ulcerative colitis. The early lesion and its progression to ulceration. *Lab. Invest.; J. Tech. Meth. Pathol.* **25**, 509–515.
- Rutgers, H. C., Batt, R. M., Elwood, C. M., and Lampport, A. (1995). Small intestinal bacterial overgrowth in dogs with chronic intestinal disease. *J. Am. Vet. Med. Assoc.* **206**, 187–193.
- Rutgers, H. C., Batt, R. M., and Kelly, D. F. (1988). Lymphocytic-plasmacytic enteritis associated with bacterial overgrowth in a dog. *J. Am. Vet. Med. Assoc.* **192**, 1739–1742.
- Rutgers, H. C., Lampport, A., Simpson, K. W., Elwood, C. E., and Batt, R. M. (1993). Bacterial overgrowth in dogs with chronic intestinal disease. (abstract). *J. Vet. Intern. Med.* **7**, 133.
- Sabesin, S. M., and Isselbacher, K. J. (1965). Protein synthesis inhibition: mechanism for the production of impaired fat absorption. *Science* **147**, 1149–1151.
- Sachs, G., Chang, H. H., Rabon, E., Schackman, R., Lewin, M., and Saccomani, G. (1976). A nonelectrogenic H<sup>+</sup> pump in plasma membranes of hog stomach. *J. Biol. Chem.* **251**, 7690–7698.
- Samloff, I. M. (1971). Pepsinogens, pepsins, and pepsin inhibitors. *Gastroenterology* **60**, 586–604.
- Sander, C. H., and Langham, R. F. (1968). Canine histiocytic ulcerative colitis. A condition resembling Whipple's disease, colonic histiocytosis, and malakoplakia in man. *Arch. Pathol.* **85**, 94–100.
- Sanderson, I. R., and Walker, W. A. (1993). Uptake and transport of macromolecules by the intestine: possible role in clinical disorders (an update). *Gastroenterology* **104**, 622–639.
- Sandholm, M. (1974). A preliminary report of a rapid method for the demonstration of abnormal gammaglobulin levels in bovine whole blood. *Res. Vet. Sci.* **17**, 32–35.
- Sandholm, M. (1976). Coagulation of serum by glutaraldehyde. *Clin. Biochem.* **9**, 39–41.
- Sandholm, M., and Kivisto, A. K. (1975). Determination of gamma-globulin in dog serum by glutaraldehyde. *J. Small Animal Prac.* **16**, 201–205.
- Sasaki, H., Rubacalva, B., Baetes, D., Blazquez, E., Srikant, C. B., Orci, L., and Unger, R. H. (1975). Identification of glucagon in the gastrointestinal tract. *J. Clin. Invest.* **56**, 135–145.
- Saunders, S. J., and Isselbacher, K. J. (1965). Inhibition of intestinal amino acid transport by hexoses. *Biochim. Biophys. Acta* **102**, 397–409.
- Schachter, D., Finkelstein, J. D., and Kowarski, S. (1964). Metabolism of vitamin D. Preparation of radioactive vitamin D and its intestinal absorption in the rat. *J. Clin. Invest.* **43**, 787–796.
- Schachter, H., McGuire, E. J., and Roseman, S. (1971). Sialic acids. 13. A uridine diphosphate D-galactose: mucin galactosyltransferase from porcine submaxillary gland. *J. Biol. Chem.* **246**, 5321–5328.
- Schall, W. D. (1974). Malabsorption syndromes (malassimilation). In "Current Veterinary Therapy" (R. W. Kirk, Ed.), 5th ed., pp. 742–747. Saunders, Philadelphia.
- Shaltz, L. J., Bools, C., and Reimann, E. M. (1981). Phosphorylation of membranes from the rat gastric mucosa. *Biochim. Biophys. Acta* **673**, 539–551.
- Schultz, G., Schultz, K., and Hardman, J. G. (1975). Effects of norepinephrine on cyclic nucleotide levels in the ductus deferens of the rat. *Metabolism: Clin. Experim.* **24**, 429–437.
- Schultz, S. G. (1977). Sodium-coupled solute transport of small intestine: a status report. *Am. J. Physiol.* **233**, E249–E254.
- Schultz, S. G., and Curran, P. F. (1970). Coupled transport of sodium and organic solutes. *Physiol. Rev.* **50**, 637–718.
- Schultz, S. G., and Zalusky, R. (1964). Ion transport in isolated rabbit ileum. II. The interaction between active sodium and active sugar transport. *J. Gen. Physiol.* **47**, 1043–1059.
- Schwartz, C. J., Kimberg, D. V., and Ware, P. (1975). Adenylate cyclase in intestinal crypt and villus cells: stimulation by cholera enterotoxin and prostaglandin E<sub>1</sub>. *Gastroenterology* **68**, 94–104.
- Selman, I. E., McEwan, A. D., and Fisher, E. W. (1971). Studies on dairy calves allowed to suckle their dams at fixed times post partum. *Res. Vet. Sci.* **12**, 1–6.
- Semenza, G., Kessler, M., Hosang, M., Weber, J., and Schmidt, U. (1984). Biochemistry of the Na<sup>+</sup>, D-glucose cotransporter of the small-intestinal brush-border membrane. The state of the art in 1984. *Biochim. Biophys. Acta* **779**, 343–379.
- Serebro, H. A., Iber, F. L., Yardley, J. H., and Hendrix, T. R. (1969). Inhibition of cholera toxin action in the rabbit by cycloheximide. *Gastroenterology* **56**, 506–511.
- Sharkey, L. C., DeWitt, S., and Stockman, C. (2006). Neurologic signs and hyperammonemia in a horse with colic. *Vet. Clin. Pathol./Am. Soc. Vet. Clin. Pathol.* **35**, 254–258.
- Sherding, R. G., Stradley, R. P., Rogers, W. A., and Johnson, S. E. (1982). Bentriomide: xylose test in healthy cats. *Am. J. Vet. Res.* **43**, 2272–2273.
- Simpson, K. W. (2000). Gastrinoma in dogs. In "Kirk's Current Veterinary Therapy" (J. D. Bonagura, Ed.), XIII ed., pp. 617–624. Saunders, Philadelphia.
- Simpson, K. W. (2005). Diseases of the intestine. In "Textbook of Veterinary Internal Medicine" (S. J. Ettinger and E. C. Feldman, Eds.), 6th ed., pp. 1310–1331. Saunders, Philadelphia.
- Simpson, K. W., Batt, R. M., Jones, D., and Morton, D. B. (1990). Effects of exocrine pancreatic insufficiency and replacement therapy on the bacterial flora of the duodenum in dogs. *Am. J. Vet. Res.* **51**, 203–206.
- Simpson, K. W., Dogan, B., Rishniw, M., Goldstein, R. E., Klaessig, S., and McDonough, P. L. (2006). Adherent and invasive *Escherichia coli* is associated with granulomatous colitis in boxer dogs. *Infect. Immun.* **74**, 4778–4792.
- Simpson, K. W., Fyfe, J., Cornetta, A., Sachs, A., Strauss-Ayali, D., Lamb, S. V., and Reimers, T. S. (2001). Subnormal concentrations of serum cobalamin (vitamin B<sub>12</sub>) in cats with gastrointestinal disease. *J. Vet. Intern. Med./Am. Coll. Vet. Intern. Med.* **15**, 26–32.
- Smith, H. W. (1962). Observations on the aetiology of neonatal diarrhoea (scours) in calves. *J. Pathol. Bacteriol.* **84**, 147–168.
- Smith, H. W., and Halls, S. (1967). Studies on *Escherichia coli* enterotoxin. *J. Pathol. Bacteriol.* **93**, 531–543.
- Smith, H. W., Simmons, E. J., and O'Neil, J. A. (1967). The immune globulin content of the serum of calves in England. *Vet. Rec.* **80**, 664–666.
- Soll, A. H., and Grossman, M. I. (1978). Cellular mechanisms in acid secretion. *Ann. Rev. Med.* **29**, 495–507.
- Sorensen, S. H., Proud, F. J., Adam, A., Rutgers, H. C., and Batt, R. M. (1993). A novel HPLC method for the simultaneous quantification of monosaccharides and disaccharides used in tests of intestinal function and permeability. *Clin. Chim. Acta; Intl. J. Clin. Chem.* **221**, 115–125.

- Stevens, B. R., Kaunitz, J. D., and Wright, E. M. (1984). Intestinal transport of amino acids and sugars: advances using membrane vesicles. *Ann. Rev. Physiol.* **46**, 417–433.
- Stone, S. S., and Gitter, M. (1969). The validity of the sodium sulphite test for detecting immunoglobulins in calf sera. *Brit. Vet. J.* **125**, 68–73.
- Stradley, R. P., Stern, R. J., and Heinhold, N. B. (1979). A method for the simultaneous evaluation of exocrine pancreatic function and intestinal absorptive function in dogs. *Am. J. Vet. Res.* **40**, 1201–1205.
- Straus, E., Johnson, G. F., and Yalow, R. S. (1977). Canine Zollinger-Ellison syndrome. *Gastroenterology* **72**, 380–381.
- Strombeck, D. R. (1978). New method for evaluation of chymotrypsin deficiency in dogs. *J. Am. Vet. Med. Assoc.* **173**, 1319–1323.
- Strombeck, D. R., and Harrold, D. (1982). Evaluation of 60-minute blood p-aminobenzoic acid concentration in pancreatic function testing of dogs. *J. Am. Vet. Med. Assoc.* **180**, 419–421.
- Tapper, E. J., Powell, D. W., and Morris, S. M. (1978). Cholinergic-adrenergic interactions on intestinal ion transport. *Am. J. Physiol.* **235**, E402–E409.
- Taylor, W. H. (1959a). Studies on gastric proteolysis. 1. The proteolytic activity of human gastric juice and pig and calf gastric mucosal extracts below pH5. *Biochem. J.* **71**, 73–83.
- Taylor, W. H. (1959b). Studies on gastric proteolysis. 2. The nature of the enzyme-substrate interaction responsible for gastric proteolytic pH-activity curves with two maxima. *Biochem. J.* **71**, 373–383.
- Tennant, B., Baldwin, B. H., Braun, R. K., Norcross, N. L., and Sandholm, M. (1979). Use of the glutaraldehyde coagulation test for detection of hypogammaglobulinemia in neonatal calves. *J. Am. Vet. Med. Assoc.* **174**, 848–853.
- Tennant, B., Harrold, D., and Reina-Guerra, M. (1968). Hypoglycemia in neonatal calves associated with acute diarrhea. *Cornell Vet.* **58**, 136–146.
- Tennant, B., Harrold, D., and Reina-Guerra, M. (1972). Physiologic and metabolic factors in the pathogenesis of neonatal enteric infections in calves. *J. Am. Vet. Med. Assoc.* **161**, 993–1007.
- Tennant, B., Harrold, D., and Reina-Guerra, M. (1975). Hematology of the neonatal calf. II. Response associated with acute enteric infections, Gram-negative septicemia, and experimental endotoxemia. *Cornell Vet.* **65**, 457–475.
- Tennant, B., Harrold, D., Reina-Guerra, M., and Laben, R. C. (1969). Neonatal alterations in serum gamma globulin levels of Jersey and Holstein-Friesian calves. *Am. J. Vet. Res.* **30**, 345–354.
- Tennant, B., Ward, D. E., Braun, R. K., Hunt, E. L., and Baldwin, B. H. (1978). Clinical management and control of neonatal enteric infections of calves. *J. Am. Vet. Med. Assoc.* **173**, 654–661.
- Thomas, D. D., and Knoop, F. C. (1983). Effect of heat-stable enterotoxin of *Escherichia coli* on cultured mammalian cells. *J. Infect. Dis.* **147**, 450–459.
- Thompson, G. A., and Meister, A. (1975). Utilization of L-cystine by the gamma-glutamyl transpeptidase-gamma-glutamyl cyclotransferase pathway. *Proc. Natl. Acad. Sci. USA* **72**, 1985–1988.
- Thornton, J. R., Willoughby, R. A., and McSherry, B. J. (1972). Studies on diarrhea in neonatal calves: the plasma proteins of normal and diarrhetic calves during the first ten days of age. *Can. J. Compar. Med. Revue Canadienne de Medecine Comparee* **36**, 17–25.
- Turner, D. A. (1958). The absorption, transport, and deposition of fat; application of a new method for the determination of I 131-lipid activity in dogs and man. I. *Am. J. Digest. Dis.* **3**, 594–640.
- Vaden, S. L., Hammerberg, B., Davenport, D. J., Orton, S. M., Trogdon, M. M., Melgarejo, L. T., VanCamp, S. D., and Williams, D. A. (2000). Food hypersensitivity reactions in soft coated wheaten terriers with protein-losing enteropathy or protein-losing nephropathy or both: gastroscopic food sensitivity testing, dietary provocation, and fecal immunoglobulin E. *J. Vet. Intern. Med.* **14**, 60–67.
- Valverde, I., Rigopoulou, D., Marco, J., Faloona, G. R., and Unger, R. H. (1970). Characterization of glucagon-like immunoreactivity (GLI). *Diabetes* **19**, 614–623.
- van de Kamer, J. H., ten Bokkel Huinink, H., and Weyers, H. A. (1949). Rapid method for the determination of fat in feces. *J. Biol. Chem.* **177**, 347–355.
- van der Gagg, I., and Happe, R. P. (1978). Zollinger-Ellison syndrome in the dog. (abstract) *Vet. Pathol.* **15**, 573.
- van der Gagg, I., Happe, R. P., and Wolvehomp, W. T. C. (1976). A boxer dog with chronic hypertrophic gastritis resembling Menetrier's disease in man. *Vet. Pathol.* **13**, 172–185.
- Van Kruiningen, H. J. (1968). The malabsorption syndrome. In "Current Veterinary Therapy" (R. W. Kirk, Ed.), 3rd ed., pp. 521–526. Saunders, Philadelphia.
- Van Kruiningen, H. J. (1977). Giant hypertrophic gastritis of Basenji dogs. *Vet. Pathol.* **14**, 19–28.
- Van Kruiningen, H. J., and Hayden, D. W. (1973). Interpreting problem diarrheas of dogs. *Vet. Clin. North Am.* **2**, 29–47.
- Van Kruiningen, H. J., Montali, R. J., Strandberg, J. D., and Kirk, R. W. (1965). A granulomatous colitis of dogs with histologic resemblance to Whipple's disease. *Pathol. Vet.* **2**, 521–544.
- Vernon, D. F. (1962). Idiopathic sprue in a dog. *J. Am. Vet. Med. Assoc.* **140**, 1062–1067.
- Waldmann, T. A., Morell, A. G., Wochner, R. D., Strober, W., and Sternlieb, I. (1967). Measurement of gastrointestinal protein loss using ceruloplasmin labeled with copper. *J. Clin. Invest.* **46**, 10–20.
- Waldmann, T. A., Wochner, R. D., and Strober, W. (1969). The role of the gastrointestinal tract in plasma protein metabolism. Studies with <sup>51</sup>Cr-albumin. *Am. J. Med.* **46**, 275–285.
- Wallmark, B., Stewart, H. B., Rabon, E., Saccomani, G., and Sachs, G. (1980). The catalytic cycle of gastric (H<sup>+</sup> + K<sup>+</sup>)-ATPase. *J. Biol. Chem.* **255**, 5313–5319.
- Walsh, J. H., and Grossman, M. I. (1975). Gastrin (first of two parts). *N. Engl. J. Med.* **292**, 1324–1334.
- Ward, C. R., and Washabau, R. J. (2005). Gastrointestinal endocrine disease. In "Textbook of Veterinary Internal Medicine" (S. J. Ettinger and E. C. Feldman, Eds.), 6th ed., pp. 1622–1632. Saunders, Philadelphia.
- Warshaw, A. L., Walker, W. A., Cornell, R., and Isselbacher, K. J. (1971). Small intestinal permeability to macromolecules. Transmission of horseradish peroxidase into mesenteric lymph and portal blood. *Lab. Invest.* **25**, 675–684.
- Washabau, R. J., Strombeck, D. R., Buffington, C. A., and Harrold, D. (1986). Evaluation of intestinal carbohydrate malabsorption in the dog by pulmonary hydrogen gas excretion. *Am. J. Vet. Res.* **47**, 1402–1406.
- Wasserman, R. H., Corradino, R. A., and Taylor, A. N. (1968). Vitamin D-dependent calcium-binding protein: purification and some properties. *J. Biol. Chem.* **243**, 3978–3986.
- Wasserman, R. H., and Taylor, A. N. (1966). Vitamin D3-induced calcium-binding protein in chick intestinal mucosa. *Science* **152**, 791–793.
- Wasserman, R. H., and Taylor, A. N. (1968). Vitamin D-dependent calcium-binding protein: response to some physiological and nutritional variables. *J. Biol. Chem.* **243**, 3987–3993.
- Waters, A. H., and Mollin, D. L. (1961). Studies on the folic acid activity of human serum. *J. Clin. Path.* **14**, 335–344.
- Webb, D. W., Bartley, E. E., and Meyer, R. M. (1972). A comparison of nitrogen metabolism and ammonia toxicity from ammonium acetate and urea in cattle. *J. Anim. Sci.* **35**, 1263–1270.

- Webb, K. E., Jr. (1986). Amino acid and peptide absorption from the gastrointestinal tract. *Fed. Proc.* **45**, 2268–2271.
- Weiner, I. M., and Lack, L. (1962). Absorption of bile salts from the small intestine in vivo. *Am. J. Physiol.* **202**, 155–157.
- Weiner, I. M., and Lack, L. (1968). Bile salt absorption: enterohepatic circulation. In "Handbook of Physiology" (J. Field, Ed.), *Am. Physiol. Soc.*, Sect. 6, vol. III, p. 1439. Williams and Wilkins, Baltimore.
- Westrom, B. R., Svendsen, J., Ohlsson, B. G., Tagesson, C., and Karlsson, B. W. (1984). Intestinal transmission of macromolecules (BSA and FITC-labelled dextrans) in the neonatal pig. Influence of age of piglet and molecular weight of markers. *Biol. Neonate* **46**, 20–26.
- Wetterfors, J. (1964). The normal passage of serum-albumin into the gastro-intestinal tract and its role in the catabolism of albumin: an experimental study in dogs. *Acta Med. Scand.* **176**, 787–799.
- Wetterfors, J. (1965). Catabolism and distribution of serum-albumin in the dog: an experimental study with homologous <sup>131</sup>I-albumin. *Acta Med. Scand.* **177**, 243–256.
- Wetterfors, J., Liljedahl, S.-O., Plantin, L.-O., and Birke, G. (1965). The acute radiation syndrome—the importance of the gastro-intestinal injury in the catabolism and distribution of serum-albumin. *Acta Med. Scand.* **177**, 227–242.
- Whitbread, T. J., Batt, R. M., and Garthwaite, G. (1984). Relative deficiency of serum IgA in the german shepherd dog: a breed abnormality. *Res. Vet. Sci.* **37**, 350–352.
- Wilkinson, G. T. (1969). Some preliminary clinical observations on the malabsorption syndrome in the cat. *J. Small Anim. Pract.* **10**, 87–94.
- Willard, M. D., Simpson, R. B., Delles, E. K., Cohen, N. D., Fossum, T. W., Kolp, D., and Reinhart, G. (1994a). Effects of dietary supplementation of fructo-oligosaccharides on small intestinal bacterial overgrowth in dogs. *Am. J. Vet. Res.* **55**, 654–659.
- Willard, M. D., Simpson, R. B., Fossum, T. W., Cohen, N. D., Delles, E. K., Kolp, D. L., Carey, D. P., and Reinhart, G. A. (1994b). Characterization of naturally developing small intestinal bacterial overgrowth in 16 German shepherd dogs. *J. Am. Vet. Med. Assoc.* **204**, 1201–1206.
- Williams, D. A., and Batt, R. M. (1986). Exocrine pancreatic insufficiency diagnosed by radioimmunoassay of serum trypsin-like immunoreactivity in a dog with a normal BT-PABA test result. *J. Am. Anim. Hosp. Assoc.* **22**, 671–674.
- Williams, D. A., and Batt, R. M. (1988). Sensitivity and specificity of radioimmunoassay of serum trypsin-like immunoreactivity for the diagnosis of canine exocrine pancreatic insufficiency. *J. Am. Vet. Med. Assoc.* **192**, 195–201.
- Williams, D. A., Batt, R. M., and McLean, L. (1987). Bacterial overgrowth in the duodenum of dogs with exocrine pancreatic insufficiency. *J. Am. Vet. Med. Assoc.* **191**, 201–206.
- Williams, D. A., Reed, S. D., and Perry, L. (1990). Fecal proteolytic activity in clinically normal cats and in a cat with exocrine pancreatic insufficiency. *J. Am. Vet. Med. Assoc.* **197**, 210–212.
- Wingfield, W. E., Cornelius, L. M., and DeYoung, D. W. (1974). Experimental acute gastric dilation and torsion in the dog. 1. Changes in biochemical and acid-base parameters. *J. Small Anim. Pract.* **15**, 41–45.
- Wingfield, W. E., Twedt, D. C., Moore, R. W., Leib, M. S., and Wright, M. (1982). Acid-base and electrolyte values in dogs with acute gastric dilatation-volvulus. *J. Am. Vet. Med. Assoc.* **180**, 1070–1072.
- Wolosin, J. M. (1985). Ion transport studies with H<sup>+</sup>-K<sup>+</sup>-ATPase-rich vesicles: implications for HCl secretion and parietal cell physiology. *Am. J. Physiol.* **248**, G596–G607.
- Wood, P. C. (1955). The epidemiology of white scours among calves kept under experimental conditions. *J. Pathol. Bacteriol.* **70**, 179–193.
- Word, J. D., Martin, L. C., Williams, D. L., Williams, E. I., Panciera, R. J., Nelson, T. E., and Tillman, A. D. (1969). Urea toxicity studies in the bovine. *J. Anim. Sci.* **27**, 786–791.
- Wright, E. M., and Pearce, B. E. (1985). Sodium-dependent conformational changes in the intestinal glucose carrier. *Ann. NY Acad. Sci.* **456**, 108–114.
- Young, J. A., and Schneyer, C. A. (1981). Composition of saliva in mammalia. *Austr. J. Exp. Biol. Med. Sci.* **59**, 1–53.
- Zilversmit, D. B. (1965). The composition and structure of lymph chylomicrons in dog, rat, and man. *J. Clin. Invest.* **44**, 1610–1622.
- Zimmer, J. F., and Todd, S. E. (1985). Further evaluation of bentiromide in the diagnosis of canine exocrine pancreatic insufficiency. *Cornell Vet.* **75**, 426–440.

# Skeletal Muscle Function

Stephanie J. Valberg

*Department of Veterinary Population Medicine*

*College of Veterinary Medicine*

*University of Minnesota*

*St. Paul, Minnesota*

## I. INTRODUCTION

### II. SPECIALIZATION OF THE SARCOLEMMA AND SARCOPLASM FOR MUSCULAR CONTRACTION

- A. Neuromuscular Transmission: Excitation-Conduction
- B. Coupling Excitation to Contraction
- C. Muscular Contraction
- D. Muscular Energetics

### III. HETEROGENEITY OF SKELETAL MUSCLE

- A. Gross Muscle Coloration
- B. Physiological Properties
- C. Motor Units
- D. Histology and Histochemistry
- E. Quantitative Biochemistry
- F. Muscle Fiber Composition
- G. Muscle Fiber Recruitment

### IV. ORIGINS OF FIBER DIVERSITY

### V. EXERCISE AND ADAPTATIONS TO TRAINING

- A. Exercise Intensity and Sources of Energy
- B. Adaptations to Exercise Training

### VI. DIAGNOSTIC LABORATORY METHODS FOR THE EVALUATION OF NEUROMUSCULAR DISORDERS

- A. Muscle-Specific Serum Enzyme Determinations Used in the Diagnosis of Neuromuscular Disorders
- B. Muscle-Specific Serum Proteins and Antibodies

### VII. MUSCLE BIOPSY AND HISTOCHEMISTRY IN THE DIAGNOSIS OF NEUROMUSCULAR DISORDERS

### VIII. MOLECULAR DIAGNOSTIC TESTING

### IX. SELECTED NEUROMUSCULAR DISORDERS OF DOMESTIC ANIMALS

- A. Ion Channelopathies
- B. Cytoskeletal Dystrophin Deficiency and Muscular Dystrophy
- C. Immune-Mediated Canine Masticatory Muscle Myositis

D. Disorders of Glyco(genol)ysis Affecting Skeletal Muscle

E. Mitochondrial Myopathies

F. Endocrine Myopathies

## REFERENCES

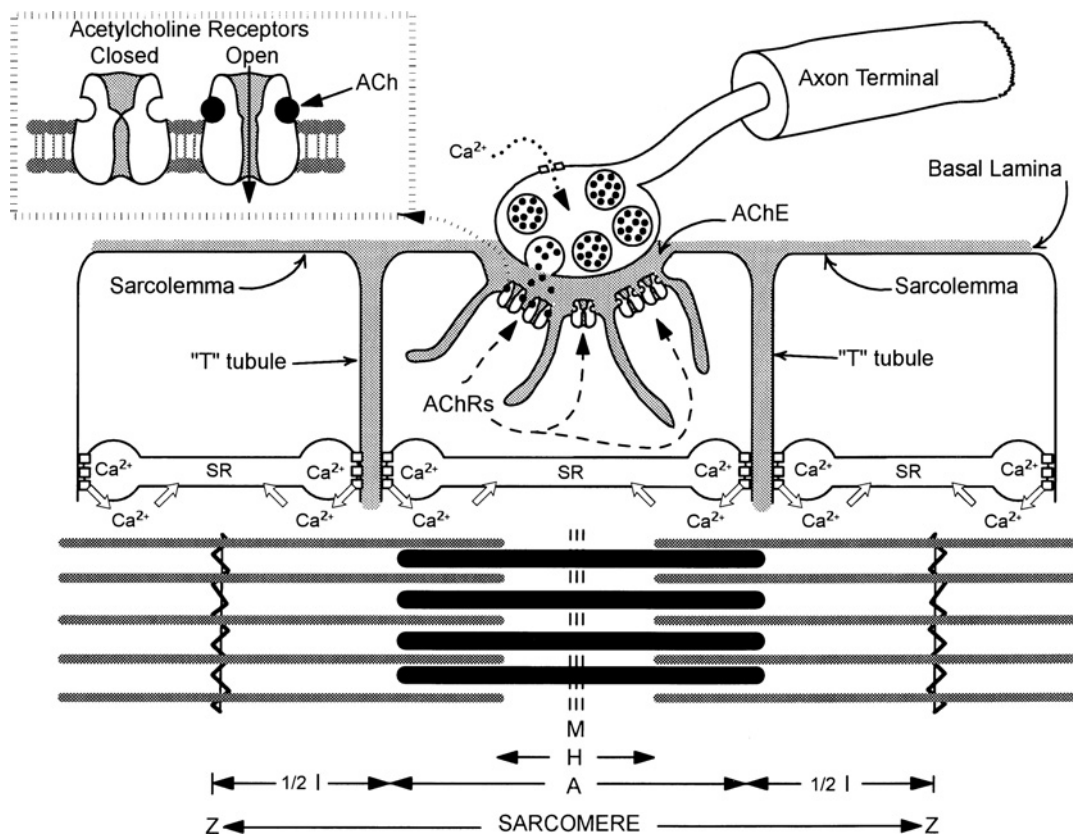
### I. INTRODUCTION

This chapter outlines skeletal muscle form and function, reviews mechanisms of assessment, and introduces selected neuromuscular diseases that highlight the close relationship between muscle form and function. Skeletal muscle comprises approximately 50% of the body's mass. It is largely composed of long multinucleated spindle shaped skeletal muscle cells (myofibers) that are highly specialized by virtue of a structured array of muscle-specific contractile proteins and conductile membranes containing ion channels and pumps. Muscles in the body differ in their constituent myofiber populations and vascular and nerve supply, which affects the speed and force developed during muscle contraction as well as the neuromuscular disorders with which they are afflicted.

### II. SPECIALIZATION OF THE SARCOLEMMA AND SARCOPLASM FOR MUSCULAR CONTRACTION

#### A. Neuromuscular Transmission: Excitation-Conduction

The plasmalemma (sarcolemma) of the skeletal myofiber is an electrically excitable membrane that can activate the contractile machinery in response to signals received from the motor nerve. The properties of excitation and conduction largely result from the presence of membrane-spanning ion conducting pathways and channel gaits that regulate the selective and nonselective conductance of sodium, potassium, calcium, and chloride across the sarcolemma. They activate (open) in response to ligands,



**FIGURE 15-1** Excitation of myofibers to contract involves neuromuscular transmission and the subsequent release of calcium ions into the sarcoplasm. Arrival of an impulse at the axon terminal activates voltage-gated calcium ion channels, resulting in the influx of calcium ions that initiate the calcium-dependent release of the neurotransmitter acetylcholine (ACh) by exocytosis. Liberated ACh diffuses across the synaptic cleft to bind with ACh receptors (two molecules of ACh per receptor) on the postsynaptic sarcolemma. Binding of ACh with AChRs increases the conductance of sodium and potassium ions across the postsynaptic membrane to produce a local end-plate potential at the neuromuscular junction. The end-plate potential generates a muscle action potential that spreads away from the neuromuscular junction in all directions over the surface of the myofiber and into its depths via the transverse (T) tubules. Within the depths of the myofibers, excitation is coupled to contraction through the release of calcium ions from terminal cisternae of the sarcoplasmic reticulum (SR) through calcium release channels of the terminal cisternae. The calcium release channels form small "feet" that extend from the terminal cisternae to the T tubules. The liberated calcium ions bind to the regulatory protein troponin and release the inhibitory action of the regulatory proteins on the contractile events that lead to sliding of the thin (actin) and thick (myosin) filaments. The liberated ACh is subsequently hydrolyzed by AChE (acetylcholinesterase) within the basal lamina of the synaptic cleft.

transmitters, or changes in voltage and inactivate (close) by intrinsic regulatory processes. Voltage-gated channels contain additional voltage-sensing transmembrane domains and are essential for the generation and modification of action potentials. Ligand-gated ion channels are essential for setting myoplasmic calcium concentrations and establishing signal transduction pathways. Abnormal function of these ion channels produces muscle weakness or altered muscle contractions through altered excitability of the sarcolemma.

The neuromuscular junction or motor end plate is the synaptic site for chemical transmission of excitation from the presynaptic axon terminal of a motor neuron to the postsynaptic skeletal myofiber (Fig. 15-1). The position of the

neuromuscular junction on a muscle fiber can vary among species, among muscles in a species, and among fibers in a given muscle. The axon terminal rests within a primary depression of sarcolemma, the primary cleft, and contains numerous small vesicles that contain acetylcholine (ACh), the neurotransmitter for excitation of skeletal myofibers. Each vesicle contains a quantum of neurotransmitter, consisting of 6000 to 8000 molecules of ACh. Arising from the primary cleft underlying the axon terminal are numerous smaller secondary clefts and complementary folds. The space within the primary and secondary clefts, located between the axon terminal and the postsynaptic sarcolemma, comprises the synaptic cleft. This space is filled with basal lamina containing acetylcholinesterase (AChE). The synaptic

basal lamina also plays an important role in the development and regeneration of the neuromuscular junction.

The arrival of a nerve action potential at the axon terminal results in activation of voltage-gated calcium ion channels in the presynaptic membrane. The calcium influx initiates a calcium-dependent exocytosis of ACh-containing vesicles from the active zone of the presynaptic membrane. Voltage-gated potassium channels in the presynaptic membrane close the voltage-gated calcium channels and restore resting membrane potential in the axon. The ACh released diffuses across the synaptic cleft to bind with acetylcholine receptors (AChRs), which are concentrated on the crests of the secondary folds of the postsynaptic sarcolemma. The structure of the AChR is similar among animal species. The AChR molecule is an integral transmembrane protein that is formed of five homologous subunits that form a central pore through which ions can flow. It consists of two alpha subunits and single  $\delta$ ,  $\gamma$ , and  $\epsilon$  subunits, which possesses a binding site for ACh at the external interfaces of the  $\alpha/\delta$  and the  $\alpha/\epsilon$  subunits. Somewhat deeper within the troughs of the secondary folds are voltage-gated sodium ion channels, which are also present within the sarcolemma throughout nonjunctional regions of the myofiber (Engel, 2004).

Excitation of the myofiber is initiated by the reversible binding of ACh with AChRs. The binding of ACh with AChR (two ACh molecules/receptor) results in a local depolarization of the postsynaptic membrane caused by the transient-increased conductance of the AChR cation ion channels to sodium and potassium ions. The amplitude of the end-plate potential (depolarization) is proportional to the number of ACh-AChR complexes formed. At rest, individual quanta of ACh are spontaneously released at a slow rate and cause transient, low-amplitude depolarizations at the end plate. These are referred to as miniature end-plate potentials (MEEPs). The interior of a resting muscle fiber has a resting potential of about  $-95$  mV. The binding of ACh to AChRs is transient, and its effects are abolished by diffusion of ACh away from the receptors and its hydrolysis by AChE. With the arrival of a nerve action potential, approximately 200 quanta of ACh are released, and with the increased number of ACh-AChR combinations, there is a greater conductance of sodium and potassium ions that form a large amplitude depolarization, the end-plate potential (EEP). When the amplitude of the EEP exceeds threshold (approximately  $-50$  mV), a wave of depolarization (muscle action potential, MAP) is generated over the sarcolemma, away from the end plate in all directions. The MAP is propagated by voltage-gated sodium channels over the surface of the myofiber and into its depths via transverse (T) tubules. The T tubules are invaginations of the sarcolemma that tranverse the long axis of the myofiber, and their lumina openly communicate with the extracellular fluid space (Engel, 2004).

## B. Coupling Excitation to Contraction

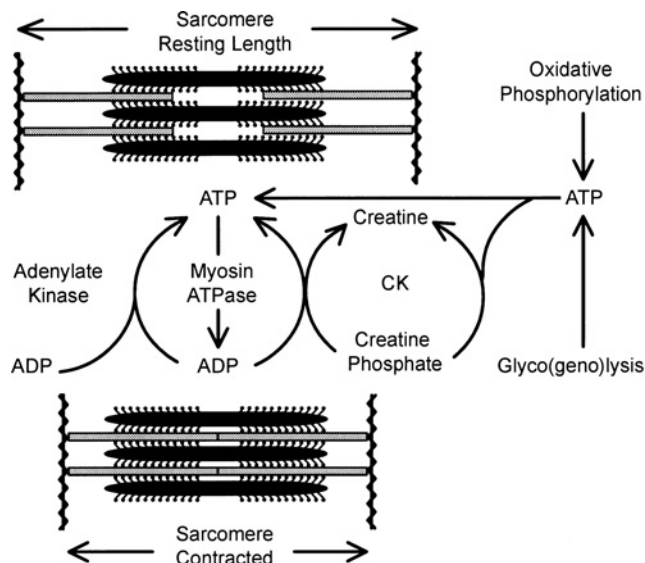
Excitation-contraction coupling involves the transformation of depolarizing events in the sarcolemma into the initiation of mechanical shortening of the myofibrils within the myofiber by calcium ions released from the terminal cisternae of the sarcoplasmic reticulum (SR). These events occur within the depths of the myofiber at “triads” where the T tubules form junctional complexes with adjacent terminal cisternae of the SR. A triad occurs twice in each sarcomere. The sarcoplasmic reticulum functions in the uptake, storage, and release of calcium ions to regulate the concentration of calcium ions in the aqueous sarcoplasm bathing the myofilaments and other organelles. The concentration of calcium in the SR is aided by the presence of calsequestrin, a calcium-binding protein that is maintained in the lumen of the cisternae by triadin and junctin.

At the T-SR junctional complex of triads, the sarcolemma contains voltage-sensitive dihydropyridine receptors (DHPRs) and the terminal cisternae of the SR possess ryanodine-sensitive calcium ion channels (ryanodine receptors) that form “feet” that fill the gap between the terminal cisternae and T tubules. Accessory proteins that regulate ryanodine receptor function include calmodulin and FK-506 binding protein. With depolarization of the sarcolemma within the T tubules, DHPRs interact with ryanodine receptors to mediate the voltage-dependent release of calcium ions from the SR into the sarcoplasm, elevating the calcium ion concentration from  $10^{-7}$  to  $10^{-5}$  M. This elevation in calcium ion concentrations initiates contraction through its interaction with the calcium binding proteins such as troponin C and calmodulin, a component of the myosin light chain kinase system (Magleby, 2004).

Relaxation is initiated by a reduction in the sarcoplasmic calcium ion concentration through active transport of calcium ions into the lumen of the SR by the SR calcium-ATPase (SERCA). At low calcium concentrations, SERCA activity is inhibited by phospholamban. However, relaxation is promoted by SERCA at higher myoplasmic calcium concentrations generated by stimulation of the ryanodine receptor. Further details concerning the structures and functions involved in neuromuscular transmission and coupling of excitation to contraction are available elsewhere (Engel, 2004; Magleby, 2004; Martonosi and Pikula, 2003; Numa *et al.*, 1990).

## C. Muscular Contraction

The ability of skeletal muscle to contract is conferred by the elementary contractile unit, the sarcomere (Fig. 15-2). The sarcomere has three crucial properties: (1) the ability to shorten rapidly and efficiently, (2) the ability to switch on and off in milliseconds, and (3) precision self-assembly and structural regularity. There are three major functional classes



**FIGURE 15-2** Muscular contraction involves the shortening of sarcomeres by sliding of the overlapping arrays of thick (myosin) and thin (actin) myofilaments. The energy for contraction is derived from the hydrolysis of ATP in the presence of an actin-activated ATPase present within the head regions of the myosin thick filament cross-bridges. The ATP is generated by the energy metabolism of the myofiber, principally by anaerobic glycolysis or oxidative phosphorylation. The utilization of ATP may be direct from those sources or indirect from the phosphorylation of ADP from creatine phosphate by creatine kinase (CK).

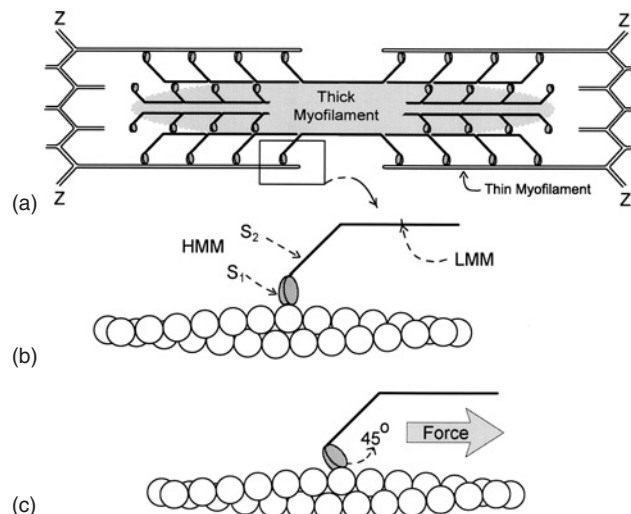
of constituent proteins that form the sarcomere: contractile, regulatory, and structural.

### 1. Myofilaments and Contractile Proteins

Together, myosin, the principal contractile protein component of thick myofilaments, and actin, the principal component of thin myofilaments, account for more than 70% of myofibrillar protein. Lateral projections of the myosin thick myofilaments (myosin cross-bridges) form reactive sites with actin, which cyclically associate and disassociate during contraction and relaxation. The force-generating step for sliding of the filaments past each other results from changes in the angle of the cross-bridge attachments (Fig. 15-3).

#### a. Thick Myofilaments and Myosin

To understand the physicochemical changes that occur at the cross-bridges, the composition and properties of myosin need to be considered. Myosin is an asymmetric protein with both structural and enzymatic properties. It is composed of two identical heavy chains (polypeptide chains with an approximate molecular mass of 200kDa) and two pairs of light chains (polypeptide chains with molecular masses ranging from 16 to 27kDa). The two myosin heavy chains are arranged in a double helix to form a long stable tail at one end, and at the other end each heavy chain is folded to



**FIGURE 15-3** Schematic presentation of myosin cross-bridges on thick myofilaments. Portions of the myosin molecules (cross-bridges) project from the thick myofilaments and make contact with the thin myofilaments (a). The light meromyosin (LMM) portion of myosin molecules forms the major structural component (backbone) of the thick myofilament, whereas the heavy meromyosin (HMM) component forms the cross-bridge connections between the thick and thin myofilaments (b). The cross-bridges of myosin are composed of two fractions: (1) the  $S_1$  fraction, a globular protein fraction composed of two heads, each possessing binding capacities for ATP and actin and the actin-activated ATPase activity of myosin, and (2) the  $S_2$  fraction, a fibrous protein fraction that forms the flexible linkage between the  $S_1$  fraction and the LMM portion of myosin (b). The force for sliding of the myofilaments results from a change in the angle of attachment (i.e., a change from 90 to 45 degrees) between the  $S_1$  globular head and actin filament (c).

form one globular pear-shaped head. The four myosin light chains are contained within the globular heads (two per head) near the junction of the head and neck domains.

The composition of myosin heavy chains within sarcomeres varies among species, among individual muscles, and among individual muscle cells. Mammalian skeletal muscle cells may express six distinct heavy chain genes: perinatal (or neonatal), fast type IIa, fast type IIx (or IIc), fast type IIb, and extraocular. The speed of contraction of these myosin heavy chain isoforms increases in the order listed here. Three additional sarcomeric myosin heavy chain genes (super fast, slow A, and slow B) exist, but their expression is unknown, with the exception of expression of superfast myosin in jaw muscles (Sweeney and Houdusse, 2004).

A range of myosin light chain isoforms also exist in skeletal muscle that may affect their function. Skeletal muscle possesses both fast skeletal and slow skeletal muscle isoforms of essential light chains as well as regulatory light chains. Biochemically, two classes of light chains can be distinguished: (1) two identical DTNB light chains, which disassociate from their globular heads with the thiol reagent 5,5'-dithiobis(2-nitrobenzoic acid) (DTNB), which correspond to regulatory light chains, and (2) two related



but different species of 1/alkali light chains (AI and A2), which disassociate at a high pH corresponding to essential light chains (Lowey *et al.*, 1969; Sweeney and Houdusse, 2004; Weeds, 1969).

The myosin molecule is composed of head, neck, and tail domains. Proteolytic digestion with trypsin results in the formation of two fragments: (1) heavy meromyosin (HMM), which is composed of the two globular heads of myosin and a short neck domain composed of the initial segment of the fibrous portion; and (2) light meromyosin (LMM), the tail domain composed of the remaining long fibrous portion. The HMM fragments correspond structurally to the cross-bridges, whereas the LMM fragments comprise the bulk of the thick filaments (Fig. 15-3). The actin-binding capacity, ATP-binding capacity, and actin-activated ATPase activity of myosin reside in the globular head. The actin-activated ATPase activity of myosin appears to reside primarily in the heavy chains and is greatly boosted by interaction of the heads with myosin (Sweeney and Houdusse, 2004).

#### b. Thin Myofilaments and Actin

The thin filaments are composed of two F-actin strands arranged in a double helical configuration. The F-actin strands are polymers of the globular protein G-actin, and each G-actin monomer possesses a complementary binding site for the myosin globular head. Upon combining with myosin, actin activates the ATPase activity of the myosin globular head (Huxley *et al.*, 1983).

### 2. Regulatory Proteins

Two proteins (tropomyosin and troponin) work in concert with calcium to regulate muscle contraction. Tropomyosin, a fibrous protein, is arranged along the length of the thin filaments, within the grooves of the two F-actin strands. Troponin is a globular protein complex composed of three subunits: TN-I (troponin inhibitory component), TN-T (tropomyosin-binding component), and TN-C (calcium-binding component). The TN-T component attaches the complex to tropomyosin at intervals along the thin myofilaments. With low sarcoplasmic calcium concentrations ( $10^{-7}$ M), tropomyosin molecules block the myosin-binding sites on actin, which prevents the interaction of actin and myosin. At higher concentrations ( $10^{-6}$ M), calcium ions combine with the TN-C component to initiate a conformational change in the TN-I component, which results in the movement of tropomyosin to free the myosin-binding sites on actin. With the myosin-binding site on actin exposed, actin and myosin combine and initiate the cyclical changes associated with that interaction. When calcium ion concentrations are reduced through uptake of calcium by SERCA, the process is reversed and the interaction of actin and myosin is inhibited.

### 3. Structural Proteins

The organization of myofilaments within sarcomeres and the organization of myofibrils are supported by a complex cytoskeletal network of intermediate filaments (Wang and Ramirez-Mitchell, 1983). Intermediate filaments, and a number of accessory proteins that form fine filaments, (1) maintain the alignment of myofilaments and sarcomeres, (2) attach and maintain alignment of adjacent myofibrils, (3) attach the sarcomeres of peripheral myofibrils to the sarcolemma, and (4) connect terminal sarcomeres to the sarcolemma at myotendinous junctions. Collectively, the cytoskeletal filaments maintain the structural and functional relationships of the myofilaments and transfer the forces developed by the myofilaments to the sarcolemma.

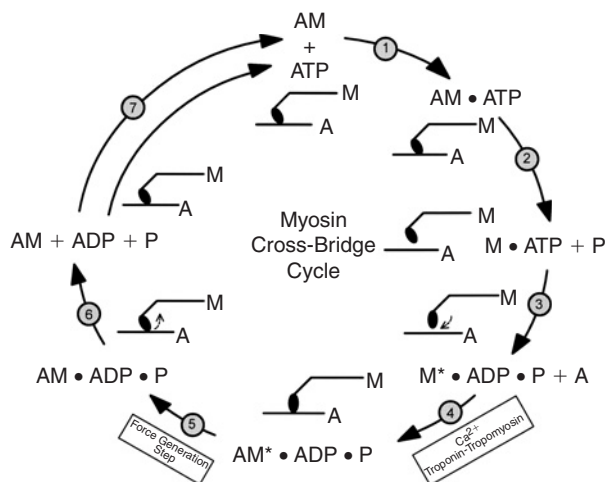
#### a. Alignment of Myofilaments, Sarcomeres, and Myofibrils

Thick myofilaments are attached to Z lines by small filaments composed of the protein titin (Labeit *et al.*, 1997; Maruyama, 1999). The titin filaments arise near the M line within the axes of the thick filaments and span the length of the thick filament as well as the I-band region to attach to the Z line. Within the I-band region, the titin filaments provide an elastic attachment to the Z line, which imparts a passive elasticity to sarcomeres. Myosin-binding proteins attach to the thick filaments and titin and appear to serve a structural role as well as a role in myofibrillogenesis. An additional protein, nebulin, forms small filaments that run the length of thin myofilaments and may regulate the length of thin myofilaments. The M line within the sarcomere stabilizes the thick filament lattice by linking neighboring filaments to each other and has an enzymatic role as well. It is composed of creatine kinase, myomesin, and M protein (Craig and Padron, 2004).

At the periphery of myofibrils, adjacent Z lines within the same sarcomere are connected by intermediate filaments of desmin. Also, intermediate filaments of desmin encircle the circumference of Z lines and appear to form linkages with Z lines of adjacent myofibrils to aid in the alignment of sarcomeres in register with adjacent myofibrils.

#### b. Attachment of Myofilaments to the Sarcolemma

At the periphery of myofibrils adjacent to the sarcolemma there are riblike attachments (costomeres), which are present on either side of Z lines (Franzini-Armstrong and Horowitz, 2004; Maruyama, 1999). Desmin filaments appear to be anchored to the sarcolemma by a number of adhesion proteins such as vinculin. At myotendinous junctions, the thin myofilaments of the last sarcomere attach to the sarcolemma, which is thrown into numerous villous projections. The thin myofilaments are anchored by the proteins  $\alpha$ -actinin and vinculin, among others. Growth in the length of muscle fibers occurs at the myotendinous junctions by the addition of new sarcomeres (Griffin *et al.*, 1971).



**FIGURE 15-4** Muscular contraction results from the cyclical association and disassociation of actin (A) and myosin (M) in which conformational changes occur in the cross-bridge linkages between the thick and thin myofilaments, associated with the hydrolysis of ATP.

## D. Muscular Energetics

Muscular contraction results from the transformation of chemical energy into mechanical energy. The energy for contraction is derived from the hydrolysis of adenosine triphosphate (ATP) into adenosine diphosphate (ADP) and inorganic phosphate (Fig. 15-2) catalyzed by myosin adenosine triphosphatase (ATPase) activity in the myosin head. Chemically, the transformation of energy is associated with the cyclical association and disassociation of the contractile proteins actin and myosin, whereas mechanically the transformation is associated with shortening of sarcomeres, which is achieved by conformational changes of the myosin molecules that result in sliding of the overlapping arrays of thick and thin myofilaments (Fig. 15-4) (Eisenberg *et al.*, 1972; Huxley *et al.*, 1983; Lynn and Taylor, 1971).

In the noncontracting state, actin and myosin are combined at the cross-bridges (step 1, Fig. 15-4), and the angle of attachment between the cross-bridge heads and the actin filaments is 45 degrees. Binding of ATP to each globular head (two molecules ATP/myosin molecule) results in a rapid disassociation of actin and myosin (step 2, Fig. 15-4). ATP hydrolysis is rapid when myosin is not associated with actin resulting in the release of phosphate and ADP. The globular head of myosin moves to a new location on the thin filament (step 3, Fig. 15-4), which permits the angle of attachment to become 90 degrees when the globular head recombines with the actin filament (step 4, Fig. 15-4). This recombination step between the globular head and actin is controlled by the regulatory proteins troponin and tropomyosin in response to calcium ion concentrations. The force for contraction is generated by movement of the cross-bridge head to a 45 degree angle of attachment (step 5, Fig. 15-4), and the cycle is completed with the detachment of the hydrolytic products of ATP from the head (step 6, Fig. 15-4). With the formation of ATP through rephosphorylation (step 7, Fig. 15-4), the

cycle may be repeated. Measurements indicate that each cycle (stroke) shortens a sarcomere by 12 nm (Barden and Mason, 1978).

Rigor mortis, the rigid and stiff condition of skeletal muscles that develops following death, involves cessation of the cross-bridge cycle in the post-force-generating step (step 6, Fig. 15-4). After death, when all ATP stores have been utilized, disassociation of actin and myosin will not occur, and the contraction cycle is terminated with a large number of actin myosin complexes formed with the myosin heads set at 45 degrees.

## III. HETEROGENEITY OF SKELETAL MUSCLE

### A. Gross Muscle Coloration

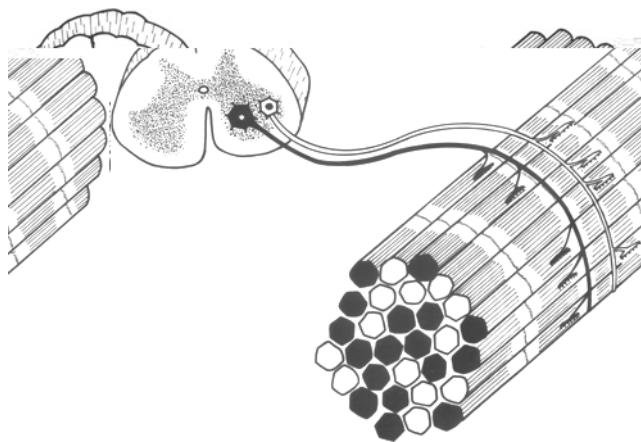
The first indication that different muscles had different physiological prosperities arose from the observation that there was variation in muscle coloration not only among species of animals, but also among individual muscles within the same individual. As a result of these differences in coloration, the terms “red” and “white” were introduced to distinguish between muscles of different gross coloration. Red coloration of muscles was subsequently found to be due to the presence of myoglobin and other cytochromes within the myofibers. Numerous biochemical, histochemical, and physiological studies have since been conducted to detail a variety of differences in both the metabolic and contractile properties of “red” and “white” skeletal muscle.

### B. Physiological Properties

The speed of contraction of red muscles was most often found to be slower than that of white muscles in a variety of animals. In addition, redness of a muscle was associated with the development of tetanus at lower frequencies of stimulation, the development of smaller twitch tensions, and a greater resistance to fatigue. Conversely, white muscles required greater frequencies of stimulation for the development of tetanus, developed larger twitch tensions, and tended to fatigue quickly. From this data, the terminology of slow-contracting or slow-twitch and fast-contracting or fast-twitch muscles evolved. Moreover, because speed of contraction was closely associated with gross muscle coloration, the terms “red” and “white” came to be used interchangeably with “slow” and “fast,” respectively. However, there are numerous exceptions to this association of gross coloration with physiological properties of contraction. Therefore, direct associations must not be assumed.

### C. Motor Units

The morphological and functional unit of skeletal muscles is the motor unit (Fig. 15-5). The motor unit is composed

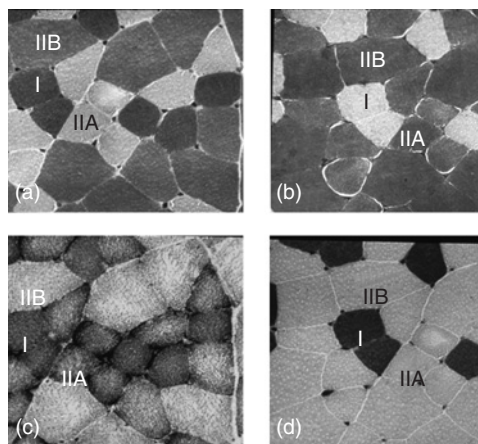


**FIGURE 15-5** Schematic representation of the homogeneity of skeletal muscle motor units. Motor units have a homogeneous myofiber-type composition whereby slow-twitch motor units are composed of only type I myofibers (light staining for myosin ATPase), whereas fast-twitch units are composed of only type 2a (fast-twitch, fatigue resistant) myofibers, or only type 2b (fast-twitch, fatigable) myofibers (dark staining for myosin ATPase).

of (1) the motor neuron, consisting of its cell body located within the central nervous system (selected cranial nerve nuclei or the ventral horn of the spinal cord), and its axon, which extends along the ventral root and peripheral nerve; (2) the neuromuscular junctions; and (3) the myofibers innervated by the motor neuron.

Motor neurons may differ based on their rates of discharge: (1) phasic motor neurons with a fast discharge rate and (2) tonic motor neurons with a slow discharge rate. In addition, the phasic motor neurons are characterized by shorter after hyperpolarization potentials, faster conduction velocities, and larger axons than the tonic motor neurons. Investigations of these parameters in motor neurons of slow-contracting and fast-contracting muscles indicate that tonic motor neurons, which discharge at rates of 10 to 20 per second, innervate slow-contracting muscles, and phasic motor neurons, which discharge at rates of 30 to 60 per second, innervate fast-contracting muscle. Thus, there are at least two types of motor units, which differ in their physiological properties and type of motor neuron innervation (Eccles *et al.*, 1958).

Physiological measurements performed on isolated motor units in the cat have revealed two types of fast-twitch motor units and one type of slow-twitch unit (Burke, 1975). Some fast-twitch motor units are resistant to fatigue and designated FR units (i.e., fast-twitch, resistant to fatigue); others fatigue rapidly and are designated FF units (i.e., fast-twitch, fatigable). All of the slow-twitch units are resistant to fatigue and are therefore designated as S units (i.e., slow-twitch). The average number of muscle fibers per motor unit in cats ranges from 550 to 650. Subsequent immunohistochemical studies (discussed later) reveal that slow-twitch motor units contain type I myosin isoforms, and most FR motor units contain type IIa or IIa/x myosin isoforms and most FF motor units contain type IIx (mammals) or IIb (rodent) myosin isoforms.



**FIGURE 15-6** Serial sections of cat medial gastrocnemius muscle incubated for the histochemical demonstration of (a) myofibrillar ATPase, incubated at pH 9.4; (b) myofibrillar ATPase, preincubated at pH 4.5; (c) NADH-tetrazolium reductase. Type I myofibers comprise slow-twitch motor units that are resistant to fatigue. Type IIA myofibers comprise fast-twitch motor units that are resistant to fatigue, whereas type IIB myofibers comprise fast-twitch motor units that fatigue rapidly. Dark NADH staining indicates high mitochondrial content; and (d) myofibrillar ATPase, preincubated at pH 4.2.

## D. Histology and Histochemistry

### 1. Histochemical Properties of Myofibers

#### a. Histochemical Properties Associated with Myosin-ATPase

Myofibers have been differentiated histochemically into type I and type II myofibers based on their staining reaction for myosin ATPase (Fig. 15-6) (Dubowitz and Brooke, 1973). Furthermore, type II myofibers, classified by the myosin ATPase staining reaction, may be further subdivided into type IIA, type IIB, and type IIC myofibers based on the lability of their ATPase activity following preincubation in acid and alkaline media (Fig. 15-6) (Brooke and Kaiser, 1970). If the actin-activated myosin ATPase activity is rate limiting in the speed of contraction, it follows that the histochemical method for myosin ATPase would be a specific method for the differentiation of myofiber types based on their speed of contraction. This classification scheme is generally applicable to all mammalian species except for canine muscles, which do not contain classical type IIB myofibers (Braund *et al.*, 1978; Orvis and Cardinet, 1981).

#### b. Immunocytochemical Identification of Myosin Isoforms

More recently, immunohistochemical differentiation of fiber types based on antibodies directed against myosin heavy chain isoforms have been used to identify contractile muscle fiber types (Gorza, 1990). To henceforth distinguish between the two methods for fiber-type identification roman numerals will be used for histochemical fiber types

and Arabic numbers will be used for myosin isoforms. Immunohistochemical staining for myosin isoforms reveals that the true number of distinctly identified muscle fiber types supersedes the number recognized by histochemistry alone. Myosin isoforms include neonatal and slow-twitch myosin isoforms as well as five distinct fast-twitch isoforms (Rubenstein and Kelly, 2004). Type 2a, type 2b, and type 2x are the most widely expressed skeletal muscle isoforms in the body with 2m fibers found in the jaw muscles of carnivores and 2eom in extraocular muscles. Unfortunately, type IIB fibers distinguished histochemically by myosin ATPase activity do not correspond to type 2b fibers distinguished by immunohistochemical staining for myosin heavy chains. Rather type IIB fibers correspond more closely with type 2x fibers (also called 2d) found in many mammalian species whereas 2b fibers correspond to myosin found in rapidly contracting muscle fibers found in rodents and camelids (Gorza, 1990). Moreover patterns of contractile protein isoforms and enzyme activities recognized in developing or pathological muscles do not correlate with standard histochemically derived fiber types (Linnane *et al.*, 1999). Hence, though useful as a screening tool for pathologists and physiologists, histochemical techniques have limitations.

Most limb muscles are “mixed” and contain variable proportions of type 1, type 2a, and type 2x myofibers. Intermediate fiber types called type IIC by myosin ATPase histochemistry or neonatal by immunohistochemistry are normally rare in mature muscle. These fibers presumably represent fibers capable of transitioning between type 1 and type 2 myofibers (Brooke and Kaiser, 1970).

### c. Histochemical Properties Associated with Aerobic and Anaerobic Energy Metabolism

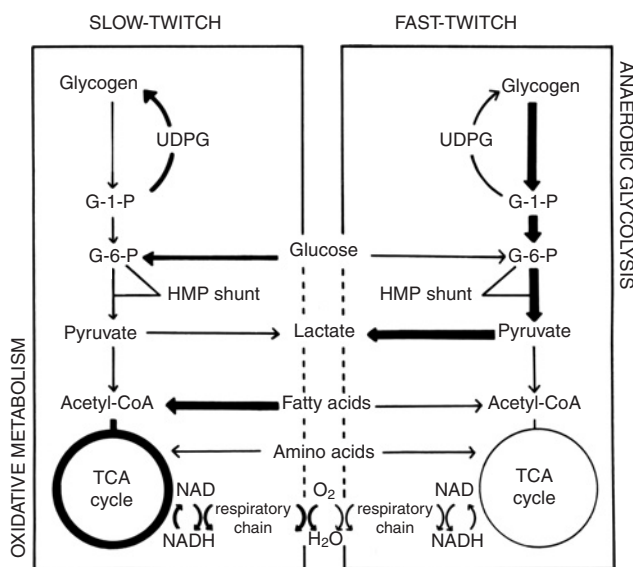
Histochemical studies show that type 1 myofibers have higher activities of oxidative enzymes such as succinate dehydrogenase (SDH), reduced nicotinamide adenine dinucleotide tetrazolium reductase (NADH-TR) (Fig. 15-6), and reduced nicotinamide adenine dinucleotide phosphate-tetrazolium reductase (NADPH-TR) than type 2 fibers (Dubowitz and Brooke, 1973). In conjunction with electron microscopic observations, the activities of these enzymes have been localized to mitochondria, which are present in abundance in type I fibers. Associated with the large mitochondrial volume of type 1 myofibers are lipid inclusions. Type II fibers in general stain darkly with glyco(genol)ytic stains such as phosphorylase or phosphofructokinase activity. Because various intermediate histochemical reactions of myofibers also exist, a classification system that describes type 1, type 2 oxidative, and type 2 glycolytic is often used.

### d. Relationships with Functional Properties

Each motor unit is homogeneous with respect to its myofiber-type composition. Motor units with slow-twitch fibers

**TABLE 15-1** Metabolic Properties of Muscle Fiber Types in an Untrained Animal

	Type 1	Type 2a	Type 2x
Speed of Contraction	Slow	Intermediate	Fast
Myoglobin Content	High	Intermediate	Low
Fatigue Resistance	High	Intermediate	Low
Oxidative Capacity	High	Intermediate	Low
Fat Content	High	Intermediate	Low
Glycolytic Capacity	Low	High	High
Glycogen Content	Low	High	High



**FIGURE 15-7** Schematic representation of some differences in energy-yielding metabolic pathways of slow-twitch and fast-twitch muscles. In slow-twitch muscles, energy for contraction is derived primarily by oxidative phosphorylation resulting from the oxidation of fatty acids, carbohydrates, and perhaps amino acids via the tricarboxylic acid cycle (TCA). Fast-twitch muscles derive their energy primarily via anaerobic glycolysis and glycogenolysis through the degradation of glycogen and glucose to lactate. Aerobic glycolysis via the HMP (hexose monophosphate) shunt is a minor pathway in both types of muscle.

are fatigue resistant and corresponded to type 1 fibers in histochemical stains. Two types of fast-contracting motor units exist; fast-twitch fatigue resistant, corresponding to type 2a fibers, and fast-twitch rapidly fatigable corresponding to type 2x fibers identified histochemically (Burke, 1975).

The physiological and histochemical properties and classifications of myofibers are summarized in (Table 15-1) and illustrated in Figure 15-6 and Figure 15-7.

## E. Quantitative Biochemistry

### 1. Metabolic Pathway for Utilization of Energy (ATP) for Contraction

As previously discussed, the actin-activated myosin ATPase activity catalyzes the cyclical physiochemical interactions of actin and myosin during contraction (Fig. 15-4). Furthermore, the intrinsic speed of contraction (sarcomere shortening) has been demonstrated to be proportional to the activity of actin-activated myosin-ATPase, and differences exist between the myosin-ATPase activities of type I and type II muscle fibers. From those observations it is postulated that the rate-limiting step of sarcomere shortening during contraction is the hydrolysis of ATP. The ATPase activity of type I fibers is lower than in type II fibers, and their pH dependency and liability in acid and alkaline conditions also differ (Barany, 1967; Seidel, 1967).

### 2. Metabolic Pathways That Generate Energy (ATP) for Contraction

Quantitative differences in enzyme activities and various substrate concentrations have been reported between slow-twitch type 1 and fast-twitch muscle fibers type 2 as well as between fibers expressing myosin isoforms type 2a and 2x. Those biochemical differences between fiber types reflect differences in their principal metabolic pathways active in the generation of energy (ATP) for muscular contraction (Fig. 15-7).

The ATP required for contraction is not stored in significant quantities. Therefore, ATP must be readily produced through the metabolism of fats, carbohydrates, and creatine phosphate stores to support the energy requirements for contraction. Aerobically, ATP is produced in muscle mitochondria by oxidative phosphorylation coupled to electron transport. Anaerobically, ATP is produced in the aqueous sarcoplasm through substrate phosphorylation of ADP by (1) creatine kinase, utilizing creatine phosphate stores; (2) glyco-(geno)lysis, utilizing muscle glycogen stores, and (3) myokinase kinase, utilizing ADP produced by the ATP hydrolysis.

#### a. Aerobic and Anaerobic Energy Metabolism

In general, fast-twitch muscle fibers in the untrained state are biochemically suited to derive energy for contraction by anaerobic glyco-(geno)lysis. Fast-twitch fibers, particularly type IIx, tend to have higher concentrations of glycogen and creatine phosphate as well as higher activities of enzymes associated with glycogenolysis and glycolysis (Table 15-1). Slow-twitch type I fibers, on the other hand, generally have higher concentrations of triglycerides and myoglobin and are better suited to derive their energy by oxidative phosphorylation via the electron transport system following the oxidation of fatty acids and glucose via the Krebs cycle (Table 15-1). Type IIa fibers are intermediate

in their glycolytic and oxidative capacity between type IIx and type I fibers (Adhihetty *et al.*, 2003; Rubenstein and Kelly, 2004).

Triglycerides and glycogen serve as primary substrates for muscle metabolism. In general, the rate of glycogen utilization is greatest with high-intensity anaerobic exercise, whereas low-intensity submaximal exercise results in a lower rate of glycogen utilization and reliance on oxidation of fatty acids as fuel (Kiens, 2006). Under conditions of restricted energy intake or prolonged exercise, amino acids may also serve as energy substrates within skeletal muscle (Rennie *et al.*, 2006).

#### b. Purine Nucleotide Cycle

With strenuous exercise when the regeneration of ATP fails to meet energy demands, the myokinase reaction can be used to generate ATP from accumulated ADP. The accumulation of the additional product of this reaction, AMP, stimulates the purine nucleotide cycle, which removes AMP thereby preventing product inhibition of the myokinase reaction. The deamination of AMP by AMP deaminase in the purine nucleotide cycle results in the production of ammonia and inosine monophosphate (IMP) (Lowenstein, 1972). The cycle further involves the regeneration of AMP through deamination of aspartate and the hydrolysis of guanosine triphosphate to form adenylosuccinate, and the cleavage of adenylosuccinate to form fumarate and AMP. The activity of AMP deaminase is greater in type II compared to type I muscle fibers.

The purine nucleotide cycle regulates energy requirements for muscular contraction through (1) maintenance of a high ATP:ADP ratio by regulating the relative AMP, ADP, and ATP levels; (2) regulation of phosphofructokinase (PFK) activity through activation of this enzyme by ammonia; (3) regulation of phosphorylase activity through activation by IMP; (4) replenishment of citric acid cycle intermediates by the production of fumarate; and (5) deamination of amino acids for oxidative metabolism through the formation of aspartate (Tullson and Terjung, 1991).

From the foregoing, it is evident that the deamination of AMP can promote ATP synthesis by (1) stimulating anaerobic glyco-(geno)lysis through the activation of phosphorylase b by IMP, and the activation of PFK by ammonia, and (2) supporting oxidative metabolism through the production of intermediates into the TCA cycle. The degradation of adenine nucleotides in equine muscle appears to occur mainly through deamination of AMP. Reported AMP deaminase activities are greatest for equine middle gluteal muscles, which were approximately double reported values for muscles of the rat and rabbit (Cutmore *et al.*, 1986).

#### c. AMP Kinase

Another emerging key sensor and regulator of energy metabolism in skeletal muscle is AMP-activated protein



kinase (AMPK), which monitors astonishingly small shifts in the cellular AMP:ATP ratio (Hardie, 2004). The activation of AMPK—either by allosteric interactions of AMP, phosphorylation by AMPK kinase, or both—triggers a shift from energy-consuming pathways, such as glycogen, fatty acid, and cholesterol synthesis, to ATP-generating pathways via the phosphorylation of key regulatory enzymes (Carling, 2004). AMPK activity may be necessary for contraction-stimulated glucose transport. AMPK has also been implicated in regulating gene transcription and, therefore, may function in some of the cellular adaptations to training.

## F. Muscle Fiber Composition

Most muscles in domestic animals contain a mixture of muscle fiber types (Fig. 15-6). The muscle fiber composition, the percentage of type 1, 2a, and 2x fibers, and muscle fiber cross-sectional areas vary greatly among species, muscle groups, individuals, and breeds. When comparing the fiber-type composition of different individuals, a standardized site must be used as fiber-type proportions vary along the length and depth of a muscle. Locomotor muscles in most domestic animals have a combination of type 1, 2a, and 2x fibers (or I, IIA, and IIB depending on the technique used for fiber typing). Locomotor muscles in dogs contain type I and type IIA fibers and no type 2B fibers using ATPase stains for fiber typing; however, histochemical type IIA fiber types appear to correspond to both type 2a and hybrid type 2a/x MHC isoforms (Strbenc *et al.*, 2004). Camelid muscles contain an unusual mixture of 1, 2a, 2b, and 2x fibers (Graziotti *et al.*, 2001). Horses have a high proportion of type 2a and 2x fibers relative to type 1 fibers in their locomotor muscles. Breed differences have been extensively studied in horses (Snow and Valberg, 1994). In general, quarter horses and Thoroughbreds have the highest percentage of fast-twitch muscle fibers, 80% to 90%; standardbreds have an intermediate number, 75%; and donkeys have the lowest percentage of fast-twitch fibers in locomotor muscles (Snow and Valberg, 1994).

Fiber-type composition is not constant, as growth and training can alter the fiber-type composition and fiber size in the same muscle over time. With growth and training, there is a change in the length and breadth of a fiber as well as a change in the proportion of fiber types rather than an increase in the number of muscle fibers. Growth and training at speed results in an increase in the proportion of type IIA (2a) fibers and a concomitant decrease in type IIB (2x) fibers (Eto *et al.*, 2003, 2004).

## G. Muscle Fiber Recruitment

When a muscle contracts during exercise, it does so in response to a predetermined recruitment of particular muscle fibers. This orderly recruitment of muscle fibers leads

to smooth, coordinated movement. As exercise begins, a select number of motor units are recruited to provide the power to advance the limb. Motor units are recruited with respect to their contractile speed and oxidative capacities (Burke, 1975; Valberg, 1986). At slow exercise intensities, type I and a small number of type II fatigue-resistant muscle fibers are stimulated. The force produced by any muscle is proportional to the cross-sectional area that is active. As the speed or duration of exercise increases, more muscle fibers are recruited, and this occurs in the order of their contractile speed from type I to type IIA and type IIB (Lindholm *et al.*, 1974; Valberg, 1986). With moderate intensity, type I and type IIA myofibers are preferentially recruited, whereas moderate intensity of long duration or maximal exercise intensity is required for recruitment of type IIB myofibers.

More recent studies suggest that muscle fiber recruitment may be regulated by the central nervous system, with the subconscious brain producing an anticipated regulated response governed by peripheral feedback mechanisms and predetermined patterns of recruitment acquired from training and modulated by conscious motivation (Noakes *et al.*, 2004).

## IV. ORIGINS OF FIBER DIVERSITY

The origins of muscle fiber-type composition appear to lie in lineage directives that developing embryonic myoblasts obtain from their progenitors, which limit to some extent the plasticity of the adult myofibers (Rubenstein and Kelly, 2004). Specification to become slow- or fast-twitch fibers appears to exist already in the myoblast stage and manifests when myotubes express one or the other MHC isoform. Subtypes of fast-twitch fibers become established following the commitment to the fast-twitch phenotype and occur in concert with the development of thyroid function (Russell *et al.*, 1988). In the embryo, the primordial myoblasts migrate to their position in the limb of the embryo where their fiber type is further influenced by temporal and positional factors, synaptogenesis, imposed neuronal activity, and activation of specific signal transduction pathways. At least two signal transduction pathways may contribute to fiber-specific synthesis of slow myosin. These include calcineurin, a calcium-regulated serine/threonine phosphatase, and Ras (Rubenstein and Kelly, 2004). A mosaic of fiber types subsequently forms with fiber-type predominance programmed in certain muscles or portions of muscles.

In mature muscle, the nerve has important trophic influences on the innervated muscle, which regulate its structural and metabolic properties. Motor units contain fibers of the same type. When motor neurons that normally innervate slow muscles are cross-innervated to supply muscles that are normally fast, and motor neurons that normally innervate fast muscles come to innervate muscles that are normally

slow, a reversal of contractile properties occurs—that is, fast-twitch muscles become slow, and slow-twitch muscles become fast. Accompanying this is a corresponding change in the enzyme histochemical profiles of the myofibers. Therefore, the motor neuron influences (1) the type of energy metabolism employed by a myofiber and all the structural changes in fiber organelles that this implies and (2) the myofiber's physiological properties of contraction. More recent cross-innervation studies, however, demonstrate that the embryogenic determination of muscle fiber types provides an inherent bias toward an original phenotype. Transplantation of myoblasts from cat jaw muscles (type 2m fibers) into the fast-twitch extensor digitorum limb muscle results in expression of their 2m myosin isoform even when enervated by the extensor digitorum nerve (Hoh and Hughes, 1988). Conversely, when jaw muscle myoblasts are transplanted into the slow-twitch soleus muscle, the soleus nerve can override type 2m expression and switch fibers to myosin heavy chain type 1 expression. Taken together, these studies suggest that muscle fiber type is determined by competitive interactions between endogenous programming and exogenous cues from motor neurons that require continual reinforcement (Rubenstein and Kelly, 2004).

## V. EXERCISE AND ADAPTATIONS TO TRAINING

### A. Exercise Intensity and Sources of Energy

The rate of energy utilization during intense exercise can be as much as 200 times greater than at rest and the rate of ATP utilization is closely associated with the rate of ATP synthesis (Holloszy, 1982a). Hence, the availability of ATP is a central requirement for sustaining the rate and duration of exercise. Because the stores of creatine phosphate and ATP available for immediate use within myofibers are small, the metabolic pathways for ATP synthesis serve a vital function in the maintenance of exercise. A number of interdependent factors appear to influence the metabolic pathways used for energy production during exercise. These include the speed and duration of exercise, the muscle fiber composition, the metabolic properties of the muscle fibers recruited, and the availability of oxygen and different energy substrates.

Aerobic pathways such as the Krebs cycle,  $\beta$  oxidation of free fatty acids (FFA) and the electron transport chain are located within mitochondria and provide the bulk of ATP for the cell as long as oxygen is plentiful. The efficiency of mitochondrial pathways is demonstrated by the ability to generate 38 molecules of ATP from oxidation of one molecule of glucose or the generation of up to 146 molecules of ATP from  $\beta$  oxidation of an FFA. Anaerobic pathways such as glycolysis, creatine phosphate, and the purine nucleotide cycle are found within the cell cytoplasm. Anaerobic glycolysis

converts glucose to pyruvate, and then lactate provides only two molecules of ATP for each molecule of glucose metabolized. Anaerobic glycolysis, although less efficient, rapidly supplies ATP even when oxygen is not available.

The main fuels for aerobic muscular contraction are FFA and glucose, which are supplied by intramuscular (lipid droplets,  $\beta$  glycogen particles) and extramuscular (liver and adipose tissue) depots during exercise. The rate-limiting factor in the supply of plasma free fatty acid (FFA) to muscle appears to be the rate of FFA release from adipose tissues (Bennard *et al.*, 2005). The rate-limiting factor in the extramuscular supply of glucose to working muscle is glucose uptake by the myofibers. It is estimated that 65% or more of the oxygen utilization during moderate to heavy exercise is accounted for by the oxidation of carbohydrates (Holloszy, 1982a; Sahlin, 1986). Glycogen is the primary fuel metabolized to synthesize ATP during anaerobic metabolism (Holloszy, 1982a).

At rest, oxidation of FFA and stored triglycerides contributes the bulk of the fuel used for maintaining muscle tone, whereas the oxidation of glucose accounts for only 10% to 20% of the  $\text{CO}_2$  produced (Havel *et al.*, 1967). At the onset of exercise, energy is initially derived from creatine phosphate and anaerobic glyco(genol)ysis. However, as the duration of exercise is increased and blood flow increases, there is a shift to aerobic metabolism in which glucose, FFA, and triglycerides are oxidized. At low to moderate exercise intensities, the oxidation of fatty acids provides the major source of energy. At moderate to high aerobic exercise intensities, the oxidation of fatty acids decreases and carbohydrates account for 50% or more of the amount of substrate utilized (Wahren, 1977). At moderately high aerobic exercise intensities, muscle glycogen accounts for the majority of the glucose oxidized, and oxidized FFA are primarily derived from muscle triglyceride depots. By using FFA, intramuscular glycogen stores are spared. Metabolic events within skeletal muscle, which are believed to contribute to fatigue during prolonged submaximal exercise, involve a combination of the following: intramuscular glycogen concentrations become depleted, muscle temperatures become markedly elevated, electrolyte concentrations are altered, or neuromuscular fatigue occurs. Very little lactic acid accumulates at fatigue during submaximal exercise.

At maximal exercise speeds, oxygen consumption peaks, oxidative energy metabolism is maximal, and further energy must be generated by anaerobic glycolysis or deamination of ATP. Glycogen serves as the major fuel utilized at maximal speeds and exponential accumulation of lactate results. Depletion of glycogen stores normally does not appear to limit maximal exercise because marked depletion is not observed before the onset of fatigue. Conventional theories regarding muscle fatigue with maximal exercise have hypothesized that an acidosis, arising from accumulation of lactic acid, is the primary determinant of muscle fatigue. Lactic acid was said to inhibit the activity of phosphofructokinase,

the rate-limiting step in glycolysis, and possibly impair muscle contractile mechanisms (Sahlin *et al.*, 1981). Muscle pH can fall as low as 6.4 following maximal exercise. However, more recent studies show that PKF activity is not inhibited at pH 6.4 (Spriet, 1991), and hydrolysis of ATP, which generates ADP, free phosphate, and hydrogen ion, is a more likely source of acidosis than lactic acidosis (Lindinger *et al.*, 2005; Robergs *et al.*, 2004). When ATP demands of muscle are met by mitochondrial respiration, hydrogen ions are used by the mitochondria for oxidative phosphorylation. With maximal exercise, when ATP is largely generated by glycolysis, hydrogen ions accumulate creating an acidosis. Under more current thinking, lactate is generated to prevent pyruvate accumulation and generate  $\text{NAD}^+$  to facilitate glycolysis and serves as an anion to actually buffer hydrogen ion accumulation (Lindinger *et al.*, 2005). Thus, lactate serves as a marker for acidosis but is not directly involved in acidotic conditions within muscle cells (Lindinger *et al.*, 2005). The ability to buffer or remove hydrogen ions remains very important for muscle function during maximal exercise.

Further metabolic limitations to maximal high intensity exercise may relate to the demand for ATP outstripping the myofiber's innate ability to produce ATP at maximal speeds. Under these circumstances, the cell turns to its last venue of energy production, the purine nucleotide cycle (Harris *et al.*, 1991). Short term, this produces ATP for muscle contraction from the accumulated ADP. However, the total nucleotide pool becomes depleted from deamination of AMP to IMP. For intracellular stores of ADP and ATP to be replenished, at least 30 to 60 min is required for reamination of IMP. Whole muscle concentrations of ATP rarely decline by more than 50% with maximal exercise; however, ATP in individual fibers during maximal exercise can be minimal, and concentrations in individual fibers may be more important for the onset of fatigue than the measured concentrations in whole muscle samples (Essen-Gustavsson *et al.*, 1997).

A more complex model of fatigue has recently been developed that refutes the classic model of peripheral fatigue of muscle contraction arising from inadequate oxygen delivery or substrate depletion. In this newly proposed model, fatigue is not a physical limit within muscle but rather a sensation that arises from conscious perception of subconscious regulatory processes in the brain that control muscle fiber recruitment. Termination of exercise occurs when a conscious desire to continue exercising is overridden by the summation of negative sensations arising from afferent feedback from physiological systems that would include sensors of substrate availability and muscle pain (Noakes *et al.*, 2004).

## B. Adaptations to Exercise Training

Exercise induces major biochemical adaptations in skeletal muscle. The nutritional state, intensity and duration of exercise, and degree of physical fitness are all factors

that qualitatively and quantitatively affect the metabolic pathways used in the generation of energy for muscular contraction.

The principal metabolic adaptation of skeletal muscles to training is an increase in the oxidative capacity to utilize fat, carbohydrate, and ketones (Grobler *et al.*, 2004; Hurley *et al.*, 1986). Muscle glycogen content often increases with training (Gollnick *et al.*, 1972), whereas glycogenolytic and glycolytic enzyme activities are largely unchanged (Baldwin *et al.*, 1973; Holloszy, 1982b). In contrast, the mitochondrial protein content increases approximately 60% with training (Holloszy, 1982b). The activities of enzymes that transport FFA into the mitochondria, the capacity for oxidation of FFA, as well as the activities of oxidative enzymes in the citric acid cycle increase in response to a training program (Gollnick *et al.*, 1972; Holloszy, 1982b; Mole *et al.*, 1973; Saltin *et al.*, 1977). In horses, training studies most frequently show increased activities of oxidative enzyme markers such as citrate synthase and variable to no measurable increase in markers for fat oxidation such as 3-OH-acyl-CoA dehydrogenase and glycolysis (Cutmore *et al.*, 1986; Golland *et al.*, 2003; Hodgson, 1985).

Histochemical studies show that the increase in oxidative capacity that occurs with training occurs most notably in type 2 and particularly type 2x (IIB) fibers of horses and the capillarization of all fiber types increases (Henckel, 1983; Serrano *et al.*, 2000; Yamano *et al.*, 2005). Most studies indicate that over time the cross-sectional area of type 2x (IIB) muscle fibers decreases with training and type 1 and type 2a fibers increase in size (Rivero *et al.*, 1993). These metabolic adaptations favor the delivery of oxygen and blood-borne substrates, the early activation of oxidative metabolism, and the utilization of FFA in muscle fibers. By sparing muscle glycogen, endurance is enhanced, and fatigue is delayed. At high exercise intensities, improved oxidative capacity decreases the rate of hydrogen and lactate ion accumulation in trained versus untrained subjects performing the same exercise. Although an increase in oxidative capacity may be metabolically advantageous, a decrease in the percentage of type 2x fibers and a decrease in their cross-sectional areas may also deleteriously affect their speed and force of contraction. Obviously a balance is required between skeletal muscle fiber metabolic and contractile properties for optimum speed and endurance. Because the muscle fiber composition and fiber properties vary so greatly among individuals, achievement of this balance may be different for each horse and each type of equestrian competition.

In summary, the major metabolic consequences of the adaptations of muscle to endurance exercise are a slower utilization of muscle glycogen and blood glucose, a greater reliance on fat oxidation, and less lactate production during a given intensity. At workloads below maximal  $\text{O}_2$  utilization, aerobic pathways are the principal sources of energy through the oxidation of FFA and glucose. This



correlates with the evidence that type 1 and type 2a myofibers are activated first and their metabolic orientation is toward aerobic pathways. With workloads approaching maximal O<sub>2</sub> utilization and beyond, the sources of energy are derived principally from anaerobic pathways through glyco(geno)lysis. Type 2x (IIB) myofibers are recruited with increased workload intensities, and their metabolic energy derivation is mainly by anaerobic pathways.

## VI. DIAGNOSTIC LABORATORY METHODS FOR THE EVALUATION OF NEUROMUSCULAR DISORDERS

Neuromuscular diseases are classified, whenever possible, as to the origin or site of the primary lesion. Myopathies are those diseases in which the primary defect or disease process is considered to be limited to the myofibers, and neuropathies are those diseases of muscle that are secondary changes resulting from defects or diseases of the neuron (e.g., denervation).

Muscular weakness, abnormal muscle contraction, and stiffness or muscular pain are principal clinical signs of neuromuscular disorders. Manifestations of muscular weakness may be functional (e.g., paresis, paralysis, gait abnormalities, exercise-related weakness, dysphagia, regurgitation, dyspnea, and dysphonia) or physical (e.g., gross atrophy, hypotrophy, hypertrophy, and skeletal deformities). Abnormal muscle contraction may be a functional disturbance of neuronal or muscular excitation/conduction. Muscle pain is often the result of physical disruption of muscle cells or sustained muscle contractions.

Instituting measures of prevention or therapy for neuromuscular disorders depend on an accurate definition of the functional and physical manifestations of muscle weakness/contraction/pain and the identification of the specific pathoanatomic motor unit component(s) involved (i.e., neurons in neuropathies, neuromuscular junctions in disorders of neuromuscular transmission, or myofibers in myopathies) and, when possible, identification of the specific cellular dysfunctions underlying the muscular dysfunction.

The evaluation of neuromuscular disorders requires a coordinated approach and special examinations, some of which fall outside the scope of this chapter. This approach involves the neurological examination and includes the signalment (e.g., species, breed, age, sex), history (e.g., congenital or acquired, course of the disease, exposures, and responses to treatment), clinical findings (e.g., presence and distribution of signs, neurological deficits, and abnormal reflexes) and electrodiagnostic tests that involve electromyography (EMG), and the evaluation of sensory and motor nerve conduction velocity measurements and evoked MAPs.

Standard hematological and clinical chemistry panels are indicated to provide general screening that would suggest possible infectious, immune, or metabolic abnormalities.

Exercise testing may be revealing in cases of exertional myopathies or exercise intolerance. In addition to these evaluations, there are some more specific tests that provide insight into the pathoanatomic involvement and in some instances specific identification of the etiology and pathogenesis of the muscular weakness.

### A. Muscle-Specific Serum Enzyme Determinations Used in the Diagnosis of Neuromuscular Disorders

A valuable adjunct to the clinical diagnosis of neuromuscular diseases has been the utilization of serum enzyme determinations. The activities or concentrations of the enzymes are usually low in serum or plasma because they are normally located within healthy myofibers. Necrosis of myofibers is a primary example of a process by which serum activities of intracellular enzymes are elevated, and the elevations are roughly proportional to the mass of tissue involved. Elevations in serum enzyme activities may also occur in association with increased cell permeability (leakage), increased enzyme production by the parenchymal cells, obstructions to normal enzyme excretory routes, increased amount of enzyme-forming tissue, delayed removal, or inactivation of enzyme (Cornelius *et al.*, 1959; Dawson and Fine, 1967).

The initial examination of a patient with muscle disorders should always include the measurement of muscle-specific enzyme activities. This provides immediate information concerning the possible presence of muscle necrosis and provides a course-grain analysis for distinguishing between myopathies and neuropathies.

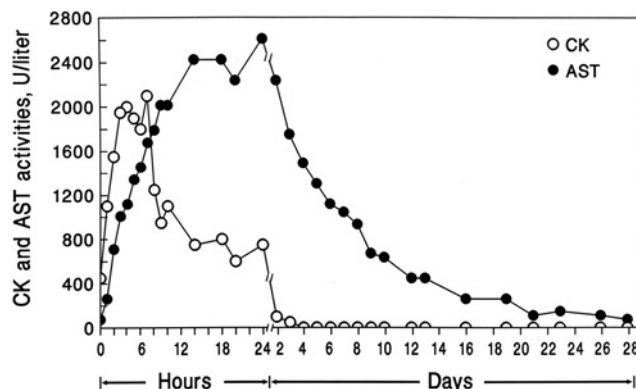
#### 1. Creatine Kinase

The most widely used serum enzyme determination in neuromuscular diseases of domestic animals is creatine kinase (CK), previously designated creatine phosphokinase (CPK). In muscle, this enzyme provides ATP for contraction by phosphorylation of ADP from creatine phosphate (Fig. 15-2). Analysis of tissues from humans indicates that significant CK activities are present in skeletal muscle, myocardium, and brain, with lesser amounts in the gastrointestinal tract, uterus, urinary bladder, kidney, and thyroid (Dawson and Fine, 1967). The diversity of organs tested in other animals is not as broad, but those tested correlate well with these findings. The liver has negligible amounts of CK (Dawson and Fine, 1967). Normal values for CK activity vary with physical activity, restraint, age, and sex (Anderson, 1975; Blackmore and Elton, 1975; Heffron *et al.*, 1976; Tarrant and McVeigh, 1979). Intramuscular injections may also increase CK activities because of local areas of muscle necrosis (Steiness *et al.*, 1978). The amount of CK liberated following intramuscular injection of a drug depends on

the properties of the injected solution and on such muscle factors as species differences in muscle CK activity, local blood flow, susceptibility of the muscles, and local muscle binding of the drug (Steiness *et al.*, 1978). Therefore, an accurate history is important in evaluating CK activities. A three- to five-fold increase in serum CK from normal values is believed to represent necrosis of approximately 20g of muscle tissue (Volfinger *et al.*, 1994).

There are three principal isoenzymic forms of CK. Creatine kinase has a dimeric structure consisting of M (muscle) subunits and B (brain) subunits, which combine to form the three heterogeneous MM (or CK3), MB (or CK2), and BB (or CK1) isoenzymes (Dawson *et al.*, 1968; Dawson and Fine, 1967). A fourth variant form, CK-Mt, is found in mitochondrial membranes and may account for up to 15% of the total cardiac CK activity. The isoenzymes can be separated by three methods: (1) electrophoresis, (2) immunological techniques, and (3) ion-exchange chromatography (Fiolet *et al.*, 1977). The pattern of isoenzyme distribution varies among the organs of different species. Thus, identification of the isoenzymes present can be used to help determine the tissue source of elevations in CK (Bulcke and Sherwin, 1969). Ontogenic studies in the rat revealed that all organs investigated contained only BB-CK in early stages of fetal development. In skeletal muscle, BB-CK forms slowly disappear and are initially replaced by MB-CK forms followed by CK-MM forms. Mixtures of isoenzymes occur during the transition. In the adult pattern, MB-CK forms have been variously reported to be present or absent in skeletal muscle. The inconsistency in noting the presence of MB-CK forms in skeletal muscle of animals may be due to the source of skeletal muscle sampled, because all skeletal muscles may not contain the MB-CK isoenzyme (Bulcke and Sherwin, 1969; Thorstenson *et al.*, 1976). However, other studies indicate that, although there is more MM-CK in white muscle of the rat than in red, there is no MB-CK fraction in either (Dawson and Fine, 1967). Reasons for the discrepancies in the detection of MB-CK forms in mammalian skeletal muscles are not evident. The adult isoenzyme pattern in muscles of the rat appears at 90 days after birth, whereas in cardiac muscle, the shift occurs earlier and the adult pattern has both MB-CK and MM-CK forms. In the brain, BB-CK is the major isoenzyme throughout life (Eppenberger *et al.*, 1964). Determinations of serum isoenzyme patterns have found clinical application in human medicine. The determination of MB forms has been used as a biochemical diagnostic tool for acute myocardial infarction (Hamdan *et al.*, 2006). However, studies of the isoenzyme composition in cardiac muscle of the horse reveal that less than 1.5% to 3.9% of the total CK activity is attributable to the MB-CK form. Hence, its determination cannot be used for detection of myocardial disorders in the horse (Argiroudis *et al.*, 1982).

Elevations in total CK activities have been reported in a wide variety of species with muscle disorders typified



**FIGURE 15-8** The difference in the time course of elevations in AST and CK activities as a result of muscle necrosis (equine exertional rhabdomyolysis). The AST activity remained elevated for much longer periods than CK activity. Adapted from Cardinet *et al.* 1967).

by myofibers necrosis. Pre- and 4h postexercise CK determinations have been useful when combined with exercise testing to identify patients with exertional rhabdomyolysis (Valberg *et al.*, 1999). Peak serum CK activity occurs about 4 to 6h after muscle damage and declines fairly rapidly with a half-life in serum of approximately 108 min in horses (Fig. 15-8) (Cardinet *et al.*, 1967; Valberg *et al.*, 1993a). CK activity in itself, however, does not provide information relative to the etiology of the disease process. More precise information regarding the etiology of muscle diseases can be obtained by the use of histological and histochemical examination of muscle biopsies.

## 2. Aspartate Transaminase

Another enzyme that has been used as a diagnostic aid in neuromuscular disorders of domestic animals is serum aspartate transaminase (AST), formerly called serum glutamic oxaloacetic transaminase (SGOT). Normal values do not appear to differ greatly between sexes, although reported values for cows are somewhat higher than values for bulls (Cornelius *et al.*, 1959; Roussel and Stallcup, 1966). Differences associated with age have been reported in sheep (Lagace *et al.*, 1961), and there are seasonal differences in bulls (Lagace *et al.*, 1961; Roussel and Stallcup, 1966). Also, physical activity is associated with higher values in horses (Blackmore and Elton, 1975; Cardinet *et al.*, 1963, 1967; Cornelius *et al.*, 1963).

Elevations of AST activities have been reported in numerous muscle disorders characterized by myofiber necrosis. Although the use of AST determinations has proven valuable as a diagnostic aid, the enzyme lacks organ specificity because in addition to high concentrations in skeletal and cardiac muscle, AST activities are also high in the liver as well as other organs and tissues, including the red blood cells (RBCs) (Cardinet *et al.*, 1967; Cornelius *et al.*, 1959; Loeb *et al.*, 1966).

Combined determination of CK and AST can be of value in assessing the course of rhabdomyolysis (Fig. 15-8). Elevations in AST activities are present for weeks after the onset of clinical disease, whereas CK activities remain elevated for only a few days after myonecrosis. The course of elevations of these enzymes in this disease can be directly attributed to different half-lives and disappearance rates of their activity in the plasma. Although CK is more specific for myonecrosis than AST, the simultaneous determinations of AST and CK in the horse are potentially valuable diagnostic and prognostic aids owing to the different disappearance rates of their serum or plasma activities: (1) elevated CK activities indicate that myonecrosis is active or has recently occurred; (2) persistent elevations of CK indicate that myonecrosis continues to be active; and (3) elevated AST resulting from myonecrosis accompanied by decreasing or normal CK activities indicates that myonecrosis is no longer active.

### 3. Lactate Dehydrogenase

Lactate dehydrogenase (LDH) activities are high in various tissues of the body. Therefore, measurements of LDH are not organ specific. Molecules of LDH are tetrameric, made up of four subunits of the two parent molecules, M (muscle) and H (heart). Various combinations of those subunits result in five isoenzymes of LDH, which can be separated by electrophoresis. The M monomer is found in purest form in skeletal muscle as the isoenzyme M4 (or LDH5), whereas the H monomer is found predominantly in the heart muscle as the isoenzyme H4 (or LDH1). The other three forms are molecular hybrids forming the isoenzymes M3H (or LDH4), M2H2 (or LDH3), and MH3 (or LDH2), and they are found in various amounts in different organs. The H4 isoenzyme is maximally active at low concentrations of pyruvate and strongly inhibited by excess pyruvate, which favors the oxidation of lactate (Dawson and Romanul, 1964). The M form, on the other hand, maintains activity at relatively high pyruvate concentrations, which favors anaerobic reduction of pyruvate (Dawson and Fine, 1967). Thus, tissues with essentially aerobic metabolism, such as heart muscle, contain mostly heart-specific isoenzymes, whereas tissues with more viable or flexible metabolic properties, such as skeletal muscle, contain predominantly the muscle-specific isoenzyme. Elevated LDH activities have been reported in numerous muscle disorders characterized by myonecrosis as well as a variety of hepatic disorders. Therefore, unless isoenzyme analysis is utilized, the measurements of LDH elevations are not organ specific.

## B. Muscle-Specific Serum Proteins and Antibodies

With the advent of immunochemical procedures such as enzyme-linked immunosorbent assay (ELISA), radial immunodiffusion assays, radioimmunoassays, and

immunocytochemical assays, sensitive tests for the detection of tissue-specific proteins and antibodies in serum are being applied to the diagnosis of neuromuscular disorders.

### 1. Myoglobin

Myoglobin is a 17, 500-Da heme protein that stores and transports oxygen in myofibers. Elevated levels of myoglobin have been found in myopathies of humans (Sieb and Penn, 2004). The specificity of myoglobin for skeletal and cardiac muscle and its plasma clearance make myoglobin determinations a potentially effective method for monitoring myonecrosis (Holmgren and Valberg, 1992). In horses, myoglobin concentrations peak shortly after myonecrosis occurs, and clearance from the blood stream is more rapid than CK activity (Valberg *et al.*, 1993b).

### 2. Troponin

Troponin I assays have been used to identify myocardial degeneration in several species (Burgener *et al.*, 2006; Fuchs *et al.*, 1999; Slack *et al.*, 2005). These assays offer improved specificity and sensitivity for differentiating myocardial versus skeletal myofiber necrosis. However, a false-positive rate of 17% may still occur when using troponin I to assess myocardial necrosis in patients with marked rhabdomyolysis (Li *et al.*, 2005).

### 3. Carbonic Anhydrase III

Serum carbonic anhydrase III has been proposed as a marker for rhabdomyolysis. It increases and decreases in concentration more rapidly than creatine kinase (Nishita *et al.*, 1995).

### 4. Acetylcholine Receptor Antibodies

Detection of circulating autoantibodies to acetylcholine receptors (AChR) is a valuable adjunct to the diagnosis of immune-mediated myasthenia gravis (MG) in humans (Engel and Hohfield, 2004) and dogs (Dewey *et al.*, 1997; Palmer, 1977; Pflugfelder *et al.*, 1981). It has been estimated that approximately 80% of human patients with MG have detectable AChR antibodies (Engel and Hohfield, 2004). Positive serum antibody titers to acetylcholine receptors measured by immunoprecipitation radioimmunoassay are normally less than 0.6nmol/l (Shelton *et al.*, 1990). A valuable immunocytochemical screening test for circulating AChR antibodies in canine MG employs staphylococcal protein A conjugated to horseradish peroxidase (SPA-HRP), a reagent that localizes IgG. Control sections of muscle containing neuromuscular junctions when incubated with canine MG patient sera and subsequently with SPA-HRP localizes IgG at neuromuscular junctions (Pflugfelder *et al.*, 1981). This immunoreagent has also served to detect antinuclear antibodies, antistriated antibodies, and sarcolemmal-associated antibodies in immune-mediated myasthenia gravis and

inflammatory muscle disorders in the dog (Shelton and Cardinet, 1987).

## VII. MUSCLE BIOPSY AND HISTOCHEMISTRY IN THE DIAGNOSIS OF NEUROMUSCULAR DISORDERS

Muscle biopsies provide an excellent opportunity to evaluate the integrity of myofibers, neuromuscular junctions, intramuscular nerve branches, connective tissues, and blood vessels in various neuromuscular disorders. As discussed previously, histochemical examination of skeletal muscle provides information relative to the morphological, biochemical, and metabolic properties of myofibers. Therefore, the application of histochemical techniques in conjunction with routine light and electron microscopic examination of muscle biopsies offers the potential to evaluate and integrate the pathoanatomical, biochemical, and physiological manifestations of neuromuscular disorders. Further, the advent of immunocytochemistry has extended our ability to recognize immunopathological mechanisms and disorders as well.

The application of histochemical techniques has become an essential diagnostic procedure for the evaluation of neuromuscular disorders in humans, dogs, cats, and horses (Cardinet and Holliday, 1979; Dubowitz and Brooke, 1973; Engel and Franzini-Armstrong, 2004; Schatzberg and Shelton, 2004; Valberg, 1999). Their application has been most helpful in determining which portion of the motor unit (neuron, myofiber, or both) is involved in the disease process or providing profiles specific for selected neuromuscular disorders (Dubowitz and Brooke, 1973). Neuropathic disorders frequently produce angular atrophy of type 1 and type 2 muscle fibers. In contrast, myopathic disorders may be characterized by angular atrophy of type 2 fibers, muscle fiber necrosis, inflammatory infiltrates, or abnormal storage products. Common histochemical stains used with frozen sections include myosin ATPase stains for fiber typing, trichrome and NADH staining of mitochondria, oil-red-O and periodic-acid Schiff's staining for lipid and glycogen, respectively, acid phosphatase stains for lysosomal storage products, and a variety of stains for enzymatic activity of phosphorylase, PFK, and cytochrome oxidase. Appropriate immunostains can be used to identify deficiencies in interstitial components such as dystrophin, to adherent immunoglobulin to end plates or myofibers, as well as to subtype lymphocytic infiltrates. A detailed consideration of muscle biopsy techniques in the evaluation of neuromuscular diseases is beyond the scope of this chapter. For details, refer to Dubowitz and Brooke (1973) and Engel and Franzini-Armstrong (2004).

## VIII. MOLECULAR DIAGNOSTIC TESTING

Advances in the understanding of the genetic basis for a number of myopathies in dogs, horses, swine, and cattle have led

to the development of new molecular diagnostic tests. These tests are often performed on hair roots or blood samples and distinguish the presence of a mutation (homozygous or heterozygous) in a specific portion of a gene that has previously been shown to be associated with a disease. A selection of these genetic diseases is reviewed in Section IX.

## IX. SELECTED NEUROMUSCULAR DISORDERS OF DOMESTIC ANIMALS

Neuromuscular disorders in animals are associated with spontaneous and inherited endocrine, immune-mediated, infectious, toxic, metabolic, and neoplastic diseases. This section presents a selection of neuromuscular disorders to highlight the spectrum of acquired and genetic myopathies found in domestic animals. With continued application of advanced histochemical, biochemical, and molecular techniques and sequencing of animal genomes, undoubtedly many heretofore unrecognized neuromuscular disorders in animals will be recognized.

### A. Ion Channelopathies

#### 1. *Acetylcholine Receptor Ion Channels and Myasthenia Gravis*

Myasthenia gravis is a disorder of neuromuscular transmission in which there is a reduction in the number of ligand-gated AChR ion channels on the postsynaptic sarcolemmal membrane (PSM). This condition results in weakness because of the reduced sensitivity of the PSM to the transmitter, ACh. Two basic forms of MG exist: (1) acquired autoimmune MG and (2) congenital MG. Different mechanisms are responsible for the reduction of AChRs in these two disorders.

##### a. Acquired Autoimmune Myasthenia Gravis

Acquired MG is an immune-mediated disorder of humans (Engel and Hohfield, 2004), dogs, and cats (Dewey *et al.*, 1997; Shelton, 2002; Shelton *et al.*, 2000) in which autoantibodies are produced against AChRs. The density of AChRs is reduced by the complement-mediated destruction, accelerated internalization, and degradation of AChRs by cross-linking of the receptors by antibody. In humans and dogs, the autoantibody response is heterogeneous. Most antibodies are IgG and directed against the main immunogenic region (MIR), a specific external portion of the  $\alpha$ -subunit that is distinct from the ACh-binding site; however, autoantibodies are also produced against all of the other subunits (Engel and Hohfield, 2004; Shelton, 1999). Only a small percentage of antibodies is directed against the ACh-binding sites on the  $\alpha$ -subunits.

Dogs with MG usually exhibit some form of muscular weakness; however, this can be quite variable and may

include the following presentations: acute quadriplegia, degrees of exercise-related weakness, gait abnormalities, no apparent limb muscle weakness with dysphagia, or regurgitation associated with a megaesophagus. There appears to be a bimodal distribution in the onset of this disease in dogs (early and late onset). Dogs are rarely affected before 1 year of age and peak frequencies were found at 3 and 10 years of age; the prevalence did not appear to be gender related (Dewey *et al.*, 1997; Shelton *et al.*, 1988). Frequently, overt signs may be limited to esophageal dysfunction. In a study of 152 dogs afflicted with idiopathic megaesophagus, 40 to 57 dogs (26% to 38%) had MG (Shelton *et al.*, 1990).

A definitive diagnosis of MG is provided by detection of circulating antibodies to the AChR. Additional diagnostic tests that provide for a presumptive diagnosis include clinical, pharmacological, electrodiagnostic, and immunocytochemical methods of evaluation (Dewey *et al.*, 1997; Shelton, 2002). When clinical signs permit the objective assessment of strength, pharmacological testing can be employed through the intravenous administration of 1 to 10mg of edrophonium chloride, an ultra-short-acting anticholinesterase agent. Improved strength with edrophonium provides a presumptive diagnosis of MG. A presumptive diagnosis of MG is also suggested when the application of low-frequency (2 to 10Hz), repetitive nerve stimulation results in the reduced amplitude of the first few evoked compound MAPs (decrementing response). Immunocytochemical procedures provide presumptive tests for MG. In muscle biopsies of human and canine MG patients that contain neuromuscular junctions, it is possible to localize the IgG bound to the PSM using the immunoreagent (Engel and Hohfield, 2004; Pflugfelder *et al.*, 1981). A more specific diagnosis can be established by measuring acetylcholine receptor antibody titer in serum samples from affected animals (Dewey *et al.*, 1997; Shelton, 2002).

#### b. Congenital Myasthenia Gravis

Congenital MG is a developmental disorder of humans and dogs (Dickinson *et al.*, 2005; Engel *et al.*, 2004; Shelton, 2002). In the dog, the synthesis of AChRs appears to be normal, and degradation does not appear to be accelerated. The reduced AChR density is believed to be due to a low insertion rate of AChRs into the PSM (Engel *et al.*, 2004). In humans, several congenital myasthenic syndromes are recognized, which result from a number of inherited defects that may be presynaptic (7% of cases), synaptic basal lamina-associated (14%), or postsynaptic (79%) defects (Engel *et al.*, 2004). Because congenital MG is not immune mediated, the immunodiagnostic tests used in acquired MG are of no value in establishing the diagnosis of congenital MG.

#### 2. Sodium Ion Channels and Periodic Paralysis

Hyperkalemic periodic paralysis (HyPP) is a dominantly inherited disorder of muscle in quarter horses, American

paint horses, Appaloosas, and quarter horse crossbred animals that causes episodes of tremors, myotonia, weakness, or paralysis in association with elevated serum potassium (Naylor, 1997; Spier *et al.*, 1990). Weakness or paralysis can be induced by the ingestion of potassium. HyPP is caused by a single base pair sequence defect within the gene encoding the voltage-dependent equine skeletal muscle sodium channel  $\alpha$ -subunit (Rudolph *et al.*, 1992). The point mutation produces a Phe to Leu substitution in the transmembrane domain IVS3. Patients are usually heterozygous and express both normal and mutant  $\alpha$ -subunits, although homozygous HyPP horses have been identified. The primary physiological defect in the mutant sodium channels is impaired inactivation (Cannon *et al.*, 1995). This results in a resting membrane potential that is closer to firing than in normal horses. Sodium channels are normally briefly activated during the initial phase of the muscle action potential. The HyPP mutation results in a failure of a subpopulation of sodium channels to inactivate when serum potassium concentrations are increased. As a result, an excessive inward flux of sodium and outward flux of potassium ensues, resulting in persistent depolarization of muscle cells and temporary weakness. It appears likely that the clinical variability and severity of signs are associated with the ratio of mutant-to-normal sodium ion channels expressed in the skeletal muscles of heterozygous horses (Zhou *et al.*, 1994). This disorder in horses is similar to HyPP in humans in which there are also a number of mutations involving the gene encoding the sodium ion channel  $\alpha$ -subunit (Lehmann-Horn *et al.*, 2002). A definitive diagnosis is possible by base-pair analysis of the DNA sequence responsible for encoding of the  $\alpha$ -subunit (Rudolph *et al.*, 1992).

#### 3. Chloride Ion Channels and Myotonia

Myotonia is a clinical sign in which uncontrolled, prolonged, and painless contraction of skeletal muscles occurs. The condition is due to hyperexcitability of the sarcolemma and the abnormal production of repetitive depolarizations of the sarcolemma followed by delayed repolarization and relaxation. Affected patients exhibit varying degrees of muscle stiffness with the onset of exercise. The stiffness will often subside with continued exercise or repeated movements and is not aggravated by cold. Muscles may be grossly hypertrophied with well-defined muscle groups. Percussion of muscles results in local contractions that create dimpling of the surface overlying the contracting muscles.

Two principal myotonic disorders occur in humans: (1) myotonia congenita and (2) myotonic dystrophy (Harper and Monckton, 2004). Myotonia congenita is a nonprogressive childhood disorder in which there is a diminished chloride conductance across the sarcolemma caused by mutations of the skeletal muscle chloride ion channel (Heine *et al.*, 1994). A similar form of myotonia congenita occurs as a recessive trait in miniature schnauzers

and goats (Bryant and Conte-Camerino, 1991; Vite *et al.*, 1998). Histopathological changes in skeletal muscle are usually minimal and nonspecific. The canine mutation results in a threonine residue in the D5 transmembrane segment with methionine (Bhalerao *et al.*, 2002; Rhodes *et al.*, 1999). Functional characterization of the mutation demonstrates a profound effect on the voltage dependence of activation such that mutant channels have a greatly reduced open probability at voltages near the resting membrane potential of skeletal muscle.

Myotonic dystrophy differs from congenital myotonia in that it is progressive and variably involves a variety of other systems (e.g., smooth muscle of hollow organs, heart, brain and peripheral nerves, endocrine glands, eyes, skeletal system, and integument) (Harper and Monckton, 2004). In humans, this disorder results from repeat expansion in the untranslated region of the DMPK (dystrophic myotonia protein kinase) gene (Davis *et al.*, 1997) or a specific zinc-finger gene (Liquori *et al.*, 2001). Part of the unique molecular pathogenesis of these repeat expansions appears to involve production of toxic RNA repeats, which lead to aberrant splicing of many other proteins. The systemic features are most helpful in differentiating between myotonia congenita and myotonic dystrophy in addition to consistent histopathological features, which include increased central nuclei, ringed fibers, sarcoplasmic masses, and type I fiber atrophy. Myotonic disorders have been described in horses that have similar histopathological and electromyographic abnormalities (Hegreberg and Reed, 1990; Montagna *et al.*, 2001; Reed *et al.*, 1988). The precise molecular mechanism for myotonic dystrophy in horses is unknown.

#### 4. Calcium Release Channels of the Sarcoplasmic Reticulum and Malignant Hyperthermia

Malignant hyperthermia (MH) is an inherited pharmacogenetic disorder of humans, swine, dogs, and horses. When exposed to halogenated anesthetics or succinylcholine, genetically MH susceptible (MHS) individuals exhibit tachycardia, hyperthermia, elevated carbon dioxide production, and death if the anesthetic is not discontinued. Metabolic acidosis and muscle rigidity are severe in both swine and humans, whereas in dogs metabolic acidosis is usually moderate and muscle rigidity is minimal (Nelson, 1991). In swine, stresses such as fighting, transport, and exercise also trigger its onset. During an attack, serum CK and AST enzyme activities are markedly elevated because of extensive myonecrosis. MH is inherited as an autosomal recessive gene in swine (Fujii *et al.*, 1991) but as an autosomal dominant gene in humans, horses, and dogs (Monnier *et al.*, 2005; Roberts *et al.*, 2001; Aleman *et al.*, 2004). Genetic mapping of the MH locus in pigs and humans placed it in the vicinity of the RYR1 gene, which encodes the sarcoplasmic reticulum ryanodine receptor (calcium release channel). In addition, many biochemical and physiological measurements implicated this very large

protein as the site of the defect in both pigs and humans (Mickelson and Louis, 1996). Base pair sequence defects in the RYR1 have now been identified for pigs (Fujii *et al.*, 1991), humans (Treves *et al.*, 2005), dogs (Roberts *et al.*, 2001), and horses (Aleman *et al.*, 2004).

The clinical signs of increased muscle metabolism and muscle contracture are likely due to the effects of the RYR1 mutation on the gating properties of this channel. Many studies have shown that calcium release channels in MHS have a greater open probability, allowing greater rates of calcium efflux from the SR terminal cisternae into the myoplasm, which is exacerbated by the MH triggering agents (Mickelson and Louis, 1996). The SR calcium ATPase is unable to re-sequester the calcium back into the SR lumen fast enough, and the myoplasmic calcium concentration rises. The resulting MH episode is due to calcium stimulation of phosphorylase, myofilament contractile activity, and the resultant activation of aerobic and anaerobic metabolism to fuel the contraction.

No specific histopathological features are present in most susceptible individuals apart from nonspecific findings of central nuclei. One specific form of MH seen in children with muscle weakness produces central core disease. Biopsies in these cases are characterized by lack of mitochondrial and myofibrillar staining in discrete areas of type I fibers (Treves *et al.*, 2005).

Molecular genetic testing for the specific mutations in RYR1 provides the most specific means of testing swine, dogs, and horses and has largely replaced standardized *in vitro* contracture tests.

#### B. Cytoskeletal Dystrophin Deficiency and Muscular Dystrophy

Duchenne muscular dystrophy is an X-linked recessive disorder of skeletal muscle in humans, dogs, and cats (Kornegay *et al.*, 1988; Shelton, 2004; Shelton and Engvall, 2002, 2005). The disorder is due to a deficiency of a subsarcolemmal cytoskeletal protein dystrophin that participates in the attachment of myofibrils to the sarcolemma (Hoffman *et al.*, 1987). Dystrophin in concert with a transmembrane protein complex (dystrophin-associated protein) is believed to provide stability to the sarcolemma. The deficiency of dystrophin presumably creates structural instability of the sarcolemma allowing uncontrolled focal ingress of extracellular fluid components such as calcium.

A number of mutations of the dystrophin gene have been identified. Golden retrievers have a splice site mutation in the dystrophin gene, which causes a premature termination codon in exon 8 and a peptide that is 5% the size of normal dystrophin (Sharp *et al.*, 1992). The mutation in the cat has not been identified.

The expression of the disease varies among species but may be characterized as a progressive degenerative disorder

of muscle in which there is a marked increase in serum CK and AST enzyme activities, gross hypertrophy of some muscle groups, and weakness and atrophy of other muscles in dogs and cats. Affected individuals may also have a cardiomyopathy, as the dystrophin deficiency also involves cardiac myofibers (Moise *et al.*, 1991). In dogs, the onset of clinical signs is usually evident by 2 to 4 months of age and somewhat later in cats. In dogs, this disorder was first observed in golden retrievers and has subsequently been identified in other breeds, including Irish terriers, rottweilers, German short-haired pointers, and Samoyeds.

Histological sections reveal focal lesions consisting of myofiber clusters undergoing the spectrum of change from myonecrosis through macrophage infiltration and phagocytosis to regeneration. Individual fibers may be atrophic or hypertrophic, calcified, and hypercontracted, and may possess central nuclei. Beyond clinical signs and biopsy features, immunoblotting and immunocytochemical staining for dystrophin within muscle biopsies and genetic screening are valuable diagnostic methods for detecting dystrophin deficiency.

### C. Immune-Mediated Canine Masticatory Muscle Myositis

The muscles of mastication are selectively affected in an inflammatory muscle disorder in dogs known as masticatory muscle myositis (Evans *et al.*, 2004). Limb muscles are essentially spared. The muscles of mastication in the dog are principally composed of type 2m myofibers, fast-twitch fibers that possess a unique isoform of myosin, heavy and light chains (Shelton *et al.*, 1985). This disorder appears to be an MHC-1-restricted CD8(+) T-cell-mediated autoimmune disease (Shelton and Paciello, 2006). Dogs afflicted with this disorder produce autoantibodies directed against type 2m fibers LC2-M (myosin light chain 2-masticatory), which has little cross-reaction with type 2a fibers of limb muscles. Diagnosis of the disorder includes muscle biopsy demonstration of lymphocytic and plasmacytic cellular infiltrates around muscle fibers and in perivascular locations. Occasionally eosinophils are present as the predominant infiltrate. In chronic cases, muscle atrophy and fibrosis are apparent. Localization of immunoglobulins fixed to type 2m fibers within the biopsy and demonstration of circulating antibodies against type 2m fibers employing SPA-HRP are more specific diagnostic tests (Shelton *et al.*, 1987).

### D. Disorders of Glyco(genol)ysis Affecting Skeletal Muscle

Disorders of glyco(genol)ysis affecting skeletal muscles variably involve some excess storage of glycogen within affected myofibers, resulting in the presence of glycogen-containing vacuoles. In humans, glycogen storage diseases

(GSD) affecting muscle include deficiencies of  $\alpha$ -1,4-glucosidase (GSD-II), debranching enzyme (GSD-III), branching enzyme (GSD-IV), myophosphorylase (GSD-V), phosphofructokinase (GSDVII), phosphorylase b kinase (VIII), phosphoglycerate kinase (GSD-IX), phosphoglycerate mutase (GSD-X), and lactate dehydrogenase (XI) (Tsuji *et al.*, 2000). Though variably documented, some of these disorders also occur in domestic animals.

#### 1. $\alpha$ -1,4-Glucosidase Deficiency (GSD II)

Lysosomal  $\alpha$ -1,4-glucosidase deficiency, also known as Pompe's disease, generalized type II glycogenosis, and acid maltase deficiency, occurs in humans with childhood (infantile and juvenile) and adult forms, which are variations of the same disorder based on the age of onset and tissue and organ involvement (Reuser *et al.*, 1995). This disorder is inherited as an autosomal recessive trait. This disorder has also been reported in shorthorn and Brahman cattle (Dennis *et al.*, 2000). Both infantile and late-onset equivalent variations have been described (Dorling *et al.*, 1981; Howell *et al.*, 1981). Clinical signs in Brahman calves become evident at 2 to 3 months of age with a loss of condition, poor growth, and lethargy followed by incoordination and muscle tremors with death by 9 months of age. Although the onset of clinical signs may also occur within the first 2 to 3 months of age, some affected shorthorn calves appear clinically normal until 5 to 9 months of age when weight gains are not maintained and progressive muscular weakness develops with death by 12 to 16 months of age. Excessive accumulation of glycogen occurs in skeletal and cardiac muscle, brain, and spinal cord (Howell *et al.*, 1981). The disorder in cattle is also inherited as an autosomal recessive trait. Two mutations have been identified in Brahmans, and one in shorthorns, that lead to generalized glycogenosis. All three mutations result in premature termination of translation (Dennis *et al.*, 2000). In other species, single cases of generalized glycogenoses in which  $\alpha$ -glucosidase deficiency was demonstrated include the Lapland dog (Walvoort *et al.*, 1982) and Japanese quail (Murakami *et al.*, 1980).

#### 2. Debranching Enzyme Deficiency (GSD III)

Debranching enzyme possesses two activities,  $\alpha$ -1,4glucan transferase and  $\alpha$ -1,6-glucosidase. In the hydrolysis of glycogen, myophosphorylase acts on the  $\alpha$ -1,4 linkages of the terminal glucose residues up to the last four glucose residues preceding the  $\alpha$ -1,4 linkages. The  $\alpha$ -1,4-glucan transferase transfers the last three residues to another branch and the  $\alpha$ -1,6-glucosidase hydrolyses the  $\alpha$ -1,6 branch point. Several presumed cases of debranching enzyme deficiency have been described in the dog (Ceh *et al.*, 1976; Otani and Mochizuki, 1977; Rafiquzzaman *et al.*, 1976). Biochemical demonstration of debranching enzyme deficiency is limited to a single case (Ceh *et al.*, 1976). There is diffuse organ involvement with glycogen storage. Onset of signs appears

at 2 months of age, and the disorder is progressive with death by 10 to 15 months.

### 3. Branching Enzyme Deficiency (GSD IV)

Glycogen storage associated with branching enzyme deficiency has been reported in a family of Norwegian forest cats (Fyfe, 1995; Fyfe *et al.*, 1992) and in quarter horses (Render *et al.*, 1999; Valberg *et al.*, 2001). Clinical signs and involved organs include skeletal muscle, heart, and the central nervous system. Abnormal glycogen is evident in tissues at birth and abortion or stillbirths are common. GSD-IV is an autosomal recessive disorder in both species. Eight percent of quarter horses are carriers of the mutation, and at least 3% of abortions can be attributed to the disease (Wagner *et al.*, 2006). Diagnosis in foals is made by identifying characteristic amylase-resistant PAS-positive globular inclusions in tissues and, in horses, was confirmed by DNA testing for the point mutation in exon 1 (Ward *et al.*, 2004).

### 4. Myophosphorylase Deficiency (GSD V)

Myophosphorylase deficiency (McArdle's disease) is an inherited, autosomal recessive, glycogenosis in humans (DiMauro *et al.*, 1995; Tsujino *et al.*, 2000), Charolais cattle (Angelos *et al.*, 1995), and sheep (Tan *et al.*, 1997). In cattle, clinical signs include recumbency and fatigue with forced exercise and elevated serum CK and AST activity. Muscle glycogen concentrations are elevated 1.6 times higher than controls, and histopathological changes are modest with some vacuolated myofibers that do not appear to contain glycogen. A rapid diagnosis is possible by genetic testing for the autosomal recessive point mutation in the myophosphorylase gene (Bilstrom *et al.*, 1998).

### 5. Phosphofructokinase Deficiency (GSD VII)

Phosphofructokinase (PFK) is a key enzyme of the Embden-Meyerhof pathway in all tissues, and inherited deficiencies of this enzyme in humans are expressed primarily as a myopathy in which it is designated as type VII glycogen storage disease (GSD-VII). There is a partial expression of hemolysis, and the deficiency is otherwise quite heterogeneous (Giger *et al.*, 1988a; Harvey and Reddy, 1989). Deficiency of PFK was reported in springer spaniel dogs that presented a clinical picture remarkably similar to that seen in humans. The dogs presented with a history of intermittent severe hemolytic episodes, and total erythrocyte PFK activity was 10% of normal controls (Giger *et al.*, 1985). The disorder is inherited as an autosomal recessive trait (Giger *et al.*, 1986).

Mammalian PFK is present in different tissues as tetramers of three subunits: PFK-M (muscle), PFK-L (liver), and PFK-P (platelets). Human muscle and liver contain homogeneous tetrameric PFK-M4 and PFK-L4, respectively. The erythrocytes contain an admixture of PFK-M

and PFK-L tetramers. In normal dogs, a similar isoenzymic distribution pattern exists except in the erythrocytes where the PFK tetramers consist of an admixture of PFK-M and PFK-P subunits. As in humans, PFK deficiency was found to be a deficiency of the PFK-M subunits, and the erythrocytic hybrids consisted of the PFK-L and PFK-P subunits. Giger *et al.* (1985) speculated that exertional stresses inducing hyperventilation and respiratory alkalosis in turn directly or indirectly enhance the alkaline fragility of their erythrocytes and subsequent hemolysis.

Early reports suggested that affected dogs did not manifest severe muscle-related signs, which were possibly masked by signs referable to hemolysis. However, biochemical studies have revealed reduced glycolysis in muscle (Giger *et al.*, 1988a, 1988b), and pathological studies have established the presence of a myopathy that included the presence of PAS-positive polysaccharide storage vacuoles in up to 10% of the myofibers (Harvey *et al.*, 1990). Lack of M-PFK enzyme activity is caused by a nonsense mutation in the penultimate exon of the M-PFK gene, leading to rapid degradation of a truncated (40 amino acids) and therefore unstable M-PFK protein. A genetic test can identify M-PFK-deficient and carrier animals (Smith *et al.*, 1996).

### 6. Polysaccharide Storage Myopathy

An inherited polysaccharide storage myopathy (PSSM) has been described in quarter horses, quarter horse crossbreeds, American paints, and Appaloosa horses (Valberg *et al.*, 1992). The horses have chronic episodes of exertional rhabdomyolysis and myoglobinuria. In addition, draft horse breeds and their derivatives also have polysaccharide storage myopathy (Firshman *et al.*, 2005). Up to 30% of the type 2 muscle fibers have subsarcolemmal vacuoles as well as cytoplasmic vacuoles that contained acid mucopolysaccharide inclusions that are brilliantly stained with the periodic-acid Schiff's (PAS) stain and resistant to amylase digestion. These inclusions consisted of  $\beta$ -glycogen particles and filamentous material. Glycogen concentrations are approximately 1.5 times higher in the muscles of horses with these polysaccharide inclusions (Annandale *et al.*, 2004). Glycogen accumulation in PSSM quarter horses appears to have a novel basis related to enhanced insulin sensitivity, muscle glucose uptake, and glycogen synthesis (Annandale *et al.*, 2004; De La Corte *et al.*, 1999). An arginine to histidine mutation in the gene encoding glycogen synthase (GYS1) was recently identified (McCue *et al.*, 2008). The connection between increased synthesis of glycogen and rhabdomyolysis has yet to be fully explained but appears to be related to decreased energy generation in individual muscle fibers (Annandale *et al.*, 2005). A genetic test can identify this disease.

## E. Mitochondrial Myopathies

A large number of complex mitochondrial myopathies have been described in humans (DiMauro and Bonilla, 2004),



and, recently, there have been reports of mitochondrial muscle disorders in animals (Breitschwerdt *et al.*, 1992; Houlton and Herrtage, 1980; Paciello *et al.*, 2003; Valberg *et al.*, 1994; Vijayasarathy *et al.*, 1994). When the utilization of oxygen is reduced, lactate formation is favored and results in elevated blood lactate even with low-intensity exercise. Disorders of the respiratory chain often result in increased numbers of abnormal mitochondria and aggregates of mitochondria under the sarcolemma. In sections, these mitochondrial aggregates impart a “ragged-red” appearance to the periphery of myofibers when stained with the modified trichrome stain. The presence of ragged red myofibers and elevated lactate concentrations with exercise warrant investigation of metabolic abnormalities involving mitochondria.

### 1. Respiratory Chain Complex I (NADH Ubiquinone Oxidoreductase) Deficiency

A deficiency of complex I was observed in an Arabian mare with severe limitations to even mild exercise in which there was an elevated venous pO<sub>2</sub>, low oxygen consumption and lactic acidosis (Valberg *et al.*, 1994). Complex I of the respiratory chain is one of four complexes involved in oxidative phosphorylation and transfers electrons from NADH to CoQ in the conversion of oxygen to water.

### 2. Cytochrome c Oxidase Deficiency

An episodic weakness reported in Old English sheepdog littermates is accompanied by elevated serum enzymes, lactic acidosis, and increased pO<sub>2</sub> (Breitschwerdt *et al.*, 1992). This disorder may involve a reduction in cytochrome c oxidase (Vijayasarathy *et al.*, 1994).

### 3. Lipid Storage Disorders

Abnormal accumulation of lipid droplets has been observed in type 1 fibers of dogs with generalized myalgia, weakness, and muscle atrophy (Platt *et al.*, 1999; Shelton *et al.*, 1998). In human beings, lipid storage myopathies have been attributed to several different deficiencies of enzymes involved with lipid transport into mitochondria (carnitine palmityl transferase deficiency) or beta oxidation of free fatty acids. Clinical features include muscle necrosis and myoglobinuria without painful contractures. A specific enzyme deficiency remains to be defined for the lipid storage myopathies in dogs.

## F. Endocrine Myopathies

Signs referable to muscle weakness are frequently observed as part of the clinical presentations of endocrine disorders.

### 1. Corticosteroid Myopathy

Hyperadrenocorticism causes muscle wasting (atrophy) and weakness in dogs and horses with Cushing's disease

and following corticosteroid administration (Braund *et al.*, 1980a, 1980b; Duncan *et al.*, 1977); (Aleman *et al.*, 2006). The muscle wasting is due to a rather selective anguloid to angular atrophy of type 2 myofibers; however, quantitative studies reveal atrophy of type 1 fibers as well. Myotonia is a variable accompanying sign of this disorder (Duncan *et al.*, 1977). Muscle wasting appears to be due to catabolism with decreased protein synthesis and increased protein degradation mediated by altered transcription in protein metabolism.

### 2. Hypothyroid Myopathy

Thyroid status has a profound affect on skeletal muscle, and hypothyroid states are often accompanied by manifestations of neuromuscular disease. However, descriptions of muscle disorders in clinical veterinary medicine are limited (Braund *et al.*, 1981). Selective type 2 myofiber atrophy and type 1 myofiber predominance (or type 2 myofiber paucity) are common findings in canine hypothyroidism. Experimental studies reveal that the proportion of myofiber types is influenced by thyroid status in which thyroidectomy results in type 1 myofiber predominance and thyroid excess results in type 2 myofiber predominance (Li *et al.*, 1996; Li and Larsson, 1997).

## REFERENCES

- Adihetty, P. J., Irrcher, I., Joseph, A. M., Ljubicic, V., and Hood, D. A. (2003). Plasticity of skeletal muscle mitochondria in response to contractile activity. *Exp. Physiol.* **88**, 99–107.
- Aleman, M., Riehl, J., Aldridge, B. M., Lecouteur, R. A., Stott, J. L., and Pessah, I. N. (2004). Association of a mutation in the ryanodine receptor 1 gene with equine malignant hyperthermia. *Muscle Nerve* **30**, 356–365.
- Aleman, M., Watson, J. L., Williams, D. C., Lecouteur, R. A., Nieto, J. E., and Shelton, G. D. (2006). Myopathy in horses with pituitary pars intermedia dysfunction (Cushing's disease). *Neuromuscul. Disord.*
- Anderson, M. G. (1975). The influence of exercise on serum enzyme levels in the horse. *Equine Vet. J.* **7**, 160–165.
- Angelos, S., Valberg, S. J., Smith, B. P., McQuarrie, P. S., Shanske, S., Tsujino, S., DiMauro, S., and Cardinet, G. H., III. (1995). Myophosphorylase deficiency associated with rhabdomyolysis and exercise intolerance in 6 related Charolais cattle. *Muscle Nerve* **18**, 736–740.
- Annandale, E. J., Valberg, S. J., and Essen-Gustavsson, B. (2005). Effects of submaximal exercise on adenine nucleotide concentrations in skeletal muscle fibers of horses with polysaccharide storage myopathy. *Am. J. Vet. Res.* **66**, 839–845.
- Annandale, E. J., Valberg, S. J., Mickelson, J. R., and Seaquist, E. R. (2004). Insulin sensitivity and skeletal muscle glucose transport in horses with equine polysaccharide storage myopathy. *Neuromuscul. Disord.* **14**, 666–674.
- Argiroudis, S. A., Kent, J. E., and Blackmore, D. J. (1982). Observations on the isoenzymes of creatine kinase in equine serum and tissues. *Equine Vet. J.* **14**, 317–321.

- Baldwin, K. M., Winder, W. W., Terjung, R. L., and Holloszy, J. O. (1973). Glycolytic enzymes in different types of skeletal muscle: adaptation to exercise. *Am. J. Physiol.* **225**, 962–966.
- Barany, M. (1967). ATPase activity of myosin correlated with speed of muscle shortening. *J. Gen. Physiol.* **50**(suppl 218), 197–218.
- Barden, J. A., and Mason, P. (1978). Muscle crossbridge stroke and activity revealed by optical diffraction. *Science* **199**, 1212–1213.
- Bennard, P., Imbeault, P., and Doucet, E. (2005). Maximizing acute fat utilization: effects of exercise, food, and individual characteristics. *Can. J. Appl. Physiol.* **30**, 475–499.
- Bhalerao, D. P., Rajpurohit, Y., Vite, C. H., and Giger, U. (2002). Detection of a genetic mutation for myotonia congenita among miniature schnauzers and identification of a common carrier ancestor. *Am. J. Vet. Res.* **63**, 1443–1447.
- Bilstrom, J. A., Valberg, S. J., Bernoco, D., and Mickelson, J. R. (1998). Genetic test for myophosphorylase deficiency in Charolais cattle. *Am. J. Vet. Res.* **59**, 267–270.
- Blackmore, D. J., and Elton, D. (1975). Enzyme activity in the serum of thoroughbred horses in the United Kingdom. *Equine Vet. J.* **7**, 34–39.
- Braund, K. G., Dillon, A. R., August, J. R., and Ganjam, V. K. (1981). Hypothyroid myopathy in two dogs. *Vet. Pathol.* **18**, 589–598.
- Braund, K. G., Dillon, A. R., and Mikeal, R. L. (1980a). Experimental investigation of glucocorticoid-induced myopathy in the dog. *Exp. Neurol.* **68**, 50–71.
- Braund, K. G., Dillon, A. R., Mikeal, R. L., and August, J. R. (1980b). Subclinical myopathy associated with hyperadrenocorticism in the dog. *Vet. Pathol.* **17**, 134–148.
- Braund, K. G., Hoff, E. J., and Richardson, E. Y. (1978). Histochemical identification of fiber types in canine skeletal muscle. *Am. J. Vet. Res.* **39**, 561–565.
- Breitschwerdt, E. B., Kornegay, J. N., Wheeler, S. J., Stevens, J. B., and Baty, C. J. (1992). Episodic weakness associated with exertional lactic acidosis and myopathy in Old English sheepdog littermates. *J. Am. Vet. Med. Assoc.* **201**, 731–736.
- Brooke, M. H., and Kaiser, K. K. (1970). Muscle fiber types: how many and what kind? *Arch. Neurol.* **23**, 369–379.
- Bryant, S. H., and Conte-Camerino, D. (1991). Chloride channel regulation in the skeletal muscle of normal and myotonic goats. *Pflugers Arch.* **417**, 605–610.
- Bulcke, J. A., and Sherwin, A. L. (1969). Organ specificity of creatine phosphokinase muscle isoenzyme. *Immunochemistry* **6**, 681–687.
- Burgener, I. A., Kovacevic, A., Mauldin, G. N., and Lombard, C. W. (2006). Cardiac troponins as indicators of acute myocardial damage in dogs. *J. Vet. Intern. Med.* **20**, 277–283.
- Burke, R. E. (1975). Motor unit properties and selective involvement in movement. *Exerc. Sport Sci. Rev.* **3**, 31–81.
- Cannon, S. C., Hayward, L. J., Beech, J., and Brown, R. H., Jr. (1995). Sodium channel inactivation is impaired in equine hyperkalemic periodic paralysis. *J. Neurophysiol.* **73**, 1892–1899.
- Cardinet, G. H., III, and Holliday, T. A. (1979). Neuromuscular diseases of domestic animals: a summary of muscle biopsies from 159 cases. *Ann. NY Acad. Sci.* **317**, 290–313.
- Cardinet, G. H., III, Fowler, M. E., and Tyler, W. S. (1963). The effects of training, exercise, and tying-up on serum transaminase activities in the horse. *Am. J. Vet. Res.* **24**, 980–984.
- Cardinet, G. H., Littrell, J. F., and Freedland, R. A. (1967). Comparative investigations of serum creatine phosphokinase and glutamic-oxaloacetic transaminase activities in equine paralytic myoglobinuria. *Res. Vet. Sci.* **8**, 219–226.
- Carling, D. (2004). The AMP-activated protein kinase cascade: a unifying system for energy control. *Trends Biochem. Sci.* **29**, 18–24.
- Ceh, L., Hauge, J. G., Svenkerud, R., and Strande, A. (1976). Glycogenesis type III in the dog. *Acta Vet. Scand.* **17**, 210–222.
- Cornelius, C. E., Bishop, J., Switzer, J., and Rhode, E. A. (1959). Serum and tissue transaminase activities in domestic animals. *Cornell Vet.* **49**, 116–126.
- Cornelius, C. E., Burnham, L. G., and Hill, H. E. (1963). Serum transaminase activities of thoroughbred horses in training. *J. Am. Vet. Med. Assoc.* **142**, 639–642.
- Craig, R. W., and Padron, R. (2004). Molecular structure of the sarcomere. In “Myology: Basic and Clinical” (A. G. Engel and C. Franzini-Armstrong, Eds.), pp. 129–166. McGraw-Hill, New York.
- Cutmore, C. M., Snow, D. H., and Newsholme, E. A. (1986). Effects of training on enzyme activities involved in purine nucleotide metabolism in Thoroughbred horses. *Equine Vet. J.* **18**, 72–73.
- Davis, B. M., McCurrach, M. E., Taneja, K. L., Singer, R. H., and Housman, D. E. (1997). Expansion of a CUG trinucleotide repeat in the 3′ untranslated region of myotonic dystrophy protein kinase transcripts results in nuclear retention of transcripts. *Proc. Natl. Acad. Sci. USA* **94**, 7388–7393.
- Dawson, D. M., Eppenberger, H. M., and Eppenberger, M. E. (1968). Multiple molecular forms of creatine kinases. *Ann. NY Acad. Sci.* **151**, 616–626.
- Dawson, D. M., and Fine, I. H. (1967). Creatine kinase in human tissues. *Arch. Neurol.* **16**, 175–180.
- Dawson, D. M., and Romanul, F. C. (1964). Enzymes in muscles. II. Histochemical and quantitative studies. *Arch. Neurol.* **11**, 369–378.
- De La Corte, F. D., Valberg, S. J., MacLeay, J. M., Williamson, S. E., and Mickelson, J. R. (1999). Glucose uptake in horses with polysaccharide storage myopathy. *Am. J. Vet. Res.* **60**, 458–462.
- Dennis, J. A., Moran, C., and Healy, P. J. (2000). The bovine alpha-glucosidase gene: coding region, genomic structure, and mutations that cause bovine generalized glycogenosis. *Mamm. Genome* **11**, 206–212.
- Dewey, C. W., Bailey, C. S., Shelton, G. D., Kass, P. H., and Cardinet, G. H., III. (1997). Clinical forms of acquired myasthenia gravis in dogs: 25 cases (1988–1995). *J. Vet. Intern. Med.* **11**, 50–57.
- Dickinson, P. J., Sturges, B. K., Shelton, G. D., and Lecouteur, R. A. (2005). Congenital myasthenia gravis in smooth-haired miniature dachshund dogs. *J. Vet. Intern. Med.* **19**, 920–923.
- DiMauro, S., and Bonilla, E. (2004). Mitochondrial encephalomyopathies. In “Myology: Basic and Clinical” (A. G. Engel and C. Franzini-Armstrong, Eds.), pp. 1623–1662. McGraw-Hill, New York.
- DiMauro, S., Tsujino, S., Shanske, S., and Rowland, L. P. (1995). Biochemistry and molecular genetics of human glycogenoses: an overview. *Muscle Nerve* **3**, S10–S17.
- Dorling, P. R., Howell, J. M., and Gawthorne, J. M. (1981). Skeletal muscle alpha-glucosidases in bovine generalized glycogenosis type II. *Biochem. J.* **198**, 409–412.
- Dubowitz, V., and Brooke, M. H. (1973). “Muscle Biopsy: A Modern Approach.” pp. 1–471. Saunders, Philadelphia.
- Duncan, I. D., Griffiths, I. R., and Nash, A. S. (1977). Myotonia in canine Cushing’s disease. *Vet. Rec.* **100**, 30–31.
- Eccles, J. C., Eccles, R. M., and Lundberg, A. (1958). The action potentials of the alpha motoneurons supplying fast and slow muscles. *J. Physiol.* **142**, 275–291.
- Eisenberg, E., Dobkin, L., and Kielley, W. W. (1972). Binding of actin to heavy meromyosin in the absence of adenosine triphosphate. *Biochemistry* **11**, 4657–4660.
- Engel, A., and Franzini-Armstrong, C. (2004). “Myology: Basic and Clinical.” McGraw-Hill, New York.

- Engel, A. G. (2004). Neuromuscular junction. In "Myology: Basic and Clinical" (A. G. Engel and C. Franzini-Armstrong, Eds.), pp. 325–373. McGraw-Hill, New York.
- Engel, A. G., and Hohfield, R. (2004). Acquired autoimmune myasthenia gravis. In "Myology: Basic and Clinical" (A. G. Engel and C. Franzini-Armstrong, Eds.), pp. 1755–1790. McGraw-Hill, New York.
- Engel, A. G., Ohno, K., and Sine, S. (2004). Congenital myasthenia gravis. In "Myology: Basic and Clinical" (A. G. Engel and C. Franzini-Armstrong, Eds.), pp. 1801–1844. McGraw-Hill, New York.
- Eppenberger, H. M., Eppenberger, M., Richterich, R., and Aebi, H. (1964). The ontogeny of creatine kinase isozymes. *Dev. Biol.* **10**, 1–16.
- Essen-Gustavsson, B., Roneus, N., and Poso, A. R. (1997). Metabolic response in skeletal muscle fibres of standardbred trotters after racing. *Comp. Biochem. Physiol. B Biochem. Mol. Biol.* **117**, 431–436.
- Eto, D., Yamano, S., Kasashima, Y., Sugiura, T., Nasu, T., Tokuriki, M., and Miyata, H. (2003). Effect of controlled exercise on middle gluteal muscle fibre composition in thoroughbred foals. *Equine Vet. J.* **35**, 676–680.
- Eto, D., Yamano, S., Mukai, K., Sugiura, T., Nasu, T., Tokuriki, M., and Miyata, H. (2004). Effect of high intensity training on anaerobic capacity of middle gluteal muscle in thoroughbred horses. *Res. Vet. Sci.* **76**, 139–144.
- Evans, J., Levesque, D., and Shelton, G. D. (2004). Canine inflammatory myopathies: a clinicopathologic review of 200 cases. *J. Vet. Intern. Med.* **18**, 679–691.
- Fiolet, J. W., Willebrands, A. F., Lie, K. I., and ter Welle, H. F. (1977). Determination of creatine kinase isoenzyme MB (CK-MB): comparison of methods and clinical evaluation. *Clin. Chim. Acta* **80**, 23–35.
- Firshman, A. M., Baird, J. D., and Valberg, S. J. (2005). Prevalences and clinical signs of polysaccharide storage myopathy and shivers in Belgian draft horses. *J. Am. Vet. Med. Assoc.* **227**, 1958–1964.
- Franzini-Armstrong, C., and Horowitz, A. R. (2004). The cytoskeleton: maintenance of muscle fiber integrity. In "Myology: Basic and Clinical" (A. G. Engel and C. Franzini-Armstrong, Eds.), pp. 443–454. McGraw-Hill, New York.
- Fuchs, S., Kornowski, R., Mehran, R., Satler, L. F., Pichard, A. D., Kent, K. M., Hong, M. K., Slack, S., Stone, G. W., and Leon, M. B. (1999). Cardiac troponin I levels and clinical outcomes in patients with acute coronary syndromes: the potential role of early percutaneous revascularization. *J. Am. Coll. Cardiol.* **34**, 1704–1710.
- Fujii, J., Otsu, K., Zorzato, F., De, L. S., Khanna, V. K., Weiler, J. E., O'Brien, P. J., and MacLennan, D. H. (1991). Identification of a mutation in porcine ryanodine receptor associated with malignant hyperthermia. *Science* **253**, 448–451.
- Fyfe, J. C. (1995). Glycogen storage disease in cats. *J. Am. Vet. Med. Assoc.* **206**, 286.
- Fyfe, J. C., Giger, U., Van Winkle, T. J., Haskins, M. E., Steinberg, S. A., Wang, P., and Patterson, D. F. (1992). Glycogen storage disease type IV: inherited deficiency of branching enzyme activity in cats. *Pediatr. Res.* **32**, 719–725.
- Giger, U., Argov, Z., Schnall, M., Bank, W. J., and Chance, B. (1988a). Metabolic myopathy in canine muscle-type phosphofructokinase deficiency. *Muscle Nerve* **11**, 1260–1265.
- Giger, U., Harvey, J. W., Yamaguchi, R. A., McNulty, P. K., Chiapella, A., and Beutler, E. (1985). Inherited phosphofructokinase deficiency in dogs with hyperventilation-induced hemolysis: increased in vitro and in vivo alkaline fragility of erythrocytes. *Blood* **65**, 345–351.
- Giger, U., Kelly, A. M., and Teno, P. S. (1988b). Biochemical studies of canine muscle phosphofructokinase deficiency. *Enzyme* **40**, 25–29.
- Giger, U., Reilly, M. P., Asakura, T., Baldwin, C. J., and Harvey, J. W. (1986). Autosomal recessive inherited phosphofructokinase deficiency in English springer spaniel dogs. *Anim. Genet.* **17**, 15–23.
- Golland, L. C., Evans, D. L., McGowan, C. M., Hodgson, D. R., and Rose, R. J. (2003). The effects of overtraining on blood volumes in standardbred racehorses. *Vet. J.* **165**, 228–233.
- Gollnick, P. D., Armstrong, R. B., Saubert, C. W., Piehl, K., and Saltin, B. (1972). Enzyme activity and fiber composition in skeletal muscle of untrained and trained men. *J. Appl. Physiol.* **33**, 312–319.
- Gorza, L. (1990). Identification of a novel type 2 fiber population in mammalian skeletal muscle by combined use of histochemical myosin ATPase and anti-myosin monoclonal antibodies. *J. Histochem. Cytochem.* **38**, 257–265.
- Graziotti, G. H., Rios, C. M., and Rivero, J. L. (2001). Evidence for three fast myosin heavy chain isoforms in type II skeletal muscle fibers in the adult llama (*Lama glama*). *J. Histochem. Cytochem.* **49**, 1033–1044.
- Griffin, G. E., Williams, P. E., and Goldspink, G. (1971). Region of longitudinal growth in striated muscle fibres. *Nat. New Biol.* **232**, 28–29.
- Grobler, L. A., Collins, M., Lambert, M. I., Sinclair-Smith, C., Derman, W., St Clair, G. A., and Noakes, T. D. (2004). Skeletal muscle pathology in endurance athletes with acquired training intolerance. *Br. J. Sports Med.* **38**, 697–703.
- Hamdan, A., Zafrir, N., Sagie, A., and Kornowski, R. (2006). Modalities to assess myocardial viability in the modern cardiology era. *Coron. Artery Dis.* **17**, 567–576.
- Hardie, D. G. (2004). AMP-activated protein kinase: a key system mediating metabolic responses to exercise. *Med. Sci. Sports Exerc.* **36**, 28–34.
- Harper, P. S., and Monckton, D. G. (2004). Myotonic dystrophy. In "Myology: Basic and Clinical" (A. G. Engel and C. Franzini-Armstrong, Eds.), pp. 1039–1076. McGraw-Hill, New York.
- Harris, R. C., Marlin, D. J., Snow, D. H., and Harkness, R. A. (1991). Muscle ATP loss and lactate accumulation at different work intensities in the exercising Thoroughbred horse. *Eur. J. Appl. Physiol. Occup. Physiol.* **62**, 235–244.
- Harvey, J. W., Calderwood Mays, M. B., Gropp, K. E., and Denaro, F. J. (1990). Polysaccharide storage myopathy in canine phosphofructokinase deficiency (type VII glycogen storage disease). *Vet. Pathol.* **27**, 1–8.
- Harvey, J. W., and Reddy, G. R. (1989). Postnatal hematologic development in phosphofructokinase-deficient dogs. *Blood* **74**, 2556–2561.
- Havel, R. J., Ekelund, L. G., and Holmgren, A. (1967). Kinetic analysis of the oxidation of palmitate-1-<sup>14</sup>C in man during prolonged heavy muscular exercise. *J. Lipid Res.* **8**, 366–373.
- Heffron, J. J., Bomzon, L., and Pattinson, R. A. (1976). Observations on plasma creatine phosphokinase activity in dogs. *Vet. Rec.* **98**, 338–340.
- Hegreberg, G. A., and Reed, S. M. (1990). Skeletal muscle changes associated with equine myotonic dystrophy. *Acta Neuropathol. (Berl.)* **80**, 426–431.
- Heine, R., George, A. L., Jr., Pika, U., Deymeer, F., Rudel, R., and Lehmann-Horn, F. (1994). Proof of a non-functional muscle chloride channel in recessive myotonia congenita (Becker) by detection of a 4 base pair deletion. *Hum. Mol. Genet.* **3**, 1123–1128.
- Henckel, P. (1983). Training and growth induced changes in the middle gluteal muscle of young Standardbred trotters. *Equine Vet. J.* **15**, 134–140.
- Hodgson, D. R. (1985). Muscular adaptations to exercise and training. *Vet. Clin. North Am. Equine Pract.* **1**, 533–548.
- Hoffman, E. P., Brown, R. H., Jr., and Kunkel, L. M. (1987). Dystrophin: the protein product of the Duchenne muscular dystrophy locus. *Cell* **51**, 919–928.
- Hoh, J. F., and Hughes, S. (1988). Myogenic and neurogenic regulation of myosin gene expression in cat jaw-closing muscles regenerating in fast and slow limb muscle beds. *J. Muscle Res. Cell Motil.* **9**, 59–72.

- Holloszy, J. O. (1982a). Muscle metabolism during exercise. *Arch. Phys. Med. Rehabil.* **63**, 231–234.
- Holloszy, O. (1982b). Enzymatic adaptations of skeletal muscle to endurance exercise. *Curr. Probl. Clin. Biochem.* **11**, 118–121.
- Holmgren, N., and Valberg, S. (1992). Measurement of serum myoglobin concentrations in horses by immunodiffusion. *Am. J. Vet. Res.* **53**, 957–960.
- Houlton, J. E., and Herrtage, M. E. (1980). Mitochondrial myopathy in the Sussex spaniel. *Vet. Rec.* **106**, 206.
- Howell, J. M., Dorling, P. R., Cook, R. D., Robinson, W. F., Bradley, S., and Gawthorne, J. M. (1981). Infantile and late onset form of generalised glycogenosis type II in cattle. *J. Pathol.* **134**, 267–277.
- Hurley, B. F., Nemeth, P. M., Martin, W. H., III, Hagberg, J. M., Dalsky, G. P., and Holloszy, J. O. (1986). Muscle triglyceride utilization during exercise: effect of training. *J. Appl. Physiol.* **60**, 562–567.
- Huxley, H. E., Simmons, R. M., Faruqi, A. R., Kress, M., Bordas, J., and Koch, M. H. (1983). Changes in the X-ray reflections from contracting muscle during rapid mechanical transients and their structural implications. *J. Mol. Biol.* **169**, 469–506.
- Kiens, B. (2006). Skeletal muscle lipid metabolism in exercise and insulin resistance. *Physiol. Rev.* **86**, 205–243.
- Kornegay, J. N., Tuler, S. M., Miller, D. M., and Levesque, D. C. (1988). Muscular dystrophy in a litter of golden retriever dogs. *Muscle Nerve* **11**, 1056–1064.
- Labeit, S., Kolmerer, B., and Linke, W. A. (1997). The giant protein titin: emerging roles in physiology and pathophysiology. *Circ. Res.* **80**, 290–294.
- Lagace, A., Bell, D. S., Moxon, A. L., and Pounden, W. D. (1961). Serum transaminase in the blood of lambs given preventive treatments for white muscle disease. *Am. J. Vet. Res.* **22**, 686–688.
- Lehmann-Horn, F., Jurkat-Rott, K., and Rudel, R. (2002). Periodic paralysis: understanding channelopathies. *Curr. Neurol. Neurosci. Rep.* **2**, 61–69.
- Li, S. F., Zapata, J., and Tillem, E. (2005). The prevalence of false-positive cardiac troponin I in ED patients with rhabdomyolysis. *Am. J. Emerg. Med.* **23**, 860–863.
- Li, X., Hughes, S. M., Salvati, G., Teresi, A., and Larsson, L. (1996). Thyroid hormone effects on contractility and myosin composition of soleus muscle and single fibres from young and old rats. *J. Physiol.* **494**(pt. 2), 555–567.
- Li, X., and Larsson, L. (1997). Contractility and myosin isoform compositions of skeletal muscles and muscle cells from rats treated with thyroid hormone for 0, 4 and 8 weeks. *J. Muscle Res. Cell Motil.* **18**, 335–344.
- Lindholm, A., Bjerneld, H., and Saltin, B. (1974). Glycogen depletion pattern in muscle fibres of trotting horses. *Acta Physiol. Scand.* **90**, 475–484.
- Lindinger, M. I., Kowalchuk, J. M., and Heigenhauser, G. J. (2005). Applying physicochemical principles to skeletal muscle acid-base status. *Am. J. Physiol. Regul. Integr. Comp. Physiol.* **289**, R891–R894.
- Linnane, L., Serrano, A. L., and Rivero, J. L. (1999). Distribution of fast myosin heavy chain-based muscle fibres in the gluteus medius of untrained horses: mismatch between antigenic and ATPase determinants. *J. Anat.* **194**(pt. 3), 363–372.
- Liquori, C. L., Ricker, K., Moseley, M. L., Jacobsen, J. F., Kress, W., Naylor, S. L., Day, J. W., and Ranum, L. P. (2001). Myotonic dystrophy type 2 caused by a CCTG expansion in intron 1 of ZNF9. *Science* **293**, 864–867.
- Loeb, W. F., Nagode, L. A., and Frajola, W. J. (1966). The distribution of four enzymes between canine serum and erythrocytes. *Enzymol. Biol. Clin. (Basel)* **7**, 215–224.
- Lowenstein, J. M. (1972). Ammonia production in muscle and other tissues: the purine nucleotide cycle. *Physiol. Rev.* **52**, 382–414.
- Lowe, S., Slayter, H. S., Weeds, A. G., and Baker, H. (1969). Substructure of the myosin molecule. I. Subfragments of myosin by enzymic degradation. *J. Mol. Biol.* **42**, 1–29.
- Lymn, R. W., and Taylor, E. W. (1971). Mechanism of adenosine triphosphate hydrolysis by actomyosin. *Biochemistry* **10**, 4617–4624.
- Magleby, A. L. (2004). Neuromuscular transmission. In “Myology: Basic and Clinical” (A. G. Engel and C. Franzini-Armstrong, Eds.), pp. 373–396. McGraw-Hill, New York.
- Martonosi, A. N., and Pikula, S. (2003). The network of calcium regulation in muscle. *Acta Biochim. Pol.* **50**, 1–30.
- Maruyama, K. (1999). Comparative aspects of muscle elastic proteins. *Rev. Physiol. Biochem. Pharmacol.* **138**, 1–18.
- McCue, M. E., Valberg, S. J., Miller, M. B., Wade, C., DiMauro, S., Akman, H. O., and Mickelson, J. R. (2008). Glycogen synthase (GYS1) mutation causes a novel skeletal muscle glycogenesis. *Genomics* **91**, 458–466.
- Mickelson, J. R., and Louis, C. F. (1996). Malignant hyperthermia: excitation-contraction coupling, Ca<sup>2+</sup> release channel, and cell Ca<sup>2+</sup> regulation defects. *Physiol. Rev.* **76**, 537–592.
- Moise, N. S., Valentine, B. A., Brown, C. A., Erb, H. N., Beck, K. A., Cooper, B. J., and Gilmour, R. F. (1991). Duchenne’s cardiomyopathy in a canine model: electrocardiographic and echocardiographic studies. *J. Am. Coll. Cardiol.* **17**, 812–820.
- Mole, P. A., Baldwin, K. M., Terjung, R. L., and Holloszy, J. O. (1973). Enzymatic pathways of pyruvate metabolism in skeletal muscle: adaptations to exercise. *Am. J. Physiol.* **224**, 50–54.
- Monnier, N., Kozak-Ribbens, G., Krivosic-Horber, R., Nivoche, Y., Qi, D., Kraev, N., Loke, J., Sharma, P., Tegazzin, V., Figarella-Branger, D., Romero, N., Mezin, P., Bendahan, D., Payen, J. F., Depret, T., MacLennan, D. H., and Lunardi, J. (2005). Correlations between genotype and pharmacological, histological, functional, and clinical phenotypes in malignant hyperthermia susceptibility. *Hum. Mutat.* **26**, 413–425.
- Montagna, P., Liguori, R., Monari, L., Strong, P. N., Riva, R., Di, S. V., Gandini, G., and Cipone, M. (2001). Equine muscular dystrophy with myotonia. *Clin. Neurophysiol.* **112**, 294–299.
- Murakami, T., Saito, I., and Mochizuki, K. (1980). Glycogen in the specialized cardiac muscle of the quail. *Nippon Juigaku. Zasshi* **42**, 99–101.
- Naylor, J. M. (1997). Hyperkalemic periodic paralysis. *Vet. Clin. North Am. Equine Pract.* **13**, 129–144.
- Nelson, T. E. (1991). Malignant hyperthermia in dogs. *J. Am. Vet. Med. Assoc.* **198**, 989–994.
- Nishita, T., Ohohashi, T., and Asari, M. (1995). Determination of carbonic anhydrase III isoenzyme concentration in sera of racehorses with exertional rhabdomyolysis. *Am. J. Vet. Res.* **56**, 162–166.
- Noakes, T. D., St Clair, G. A., and Lambert, E. V. (2004). From catastrophe to complexity: a novel model of integrative central neural regulation of effort and fatigue during exercise in humans. *Br. J. Sports Med.* **38**, 511–514.
- Numa, S., Tanabe, T., Takeshima, H., Mikami, A., Niidome, T., Nishimura, S., Adams, B. A., and Beam, K. G. (1990). Molecular insights into excitation-contraction coupling. *Cold Spring Harb. Symp. Quant. Biol.* **55**, 1–7.
- Orvis, J. S., and Cardinet, G. H., III. (1981). Canine muscle fiber types and susceptibility of masticatory muscles to myositis. *Muscle Nerve* **4**, 354–359.
- Otani, T., and Mochizuki, H. (1977). [Glycogen storage disease (III ?) of dogs]. *Jikken Dobutsu* **26**, 172–173.

- Paciello, O., Maiolino, P., Fatone, G., and Papparella, S. (2003). Mitochondrial myopathy in a German shepherd dog. *Vet. Pathol.* **40**, 507–511.
- Palmer, A. C. (1977). Myasthenia gravis in the dog. *Vet. Rec.* **101**, 313.
- Pflugfelder, C. M., Cardinet, G. H., III, Lutz, H., Holliday, T. A., and Hansen, R. J. (1981). Acquired canine myasthenia gravis: immunocytochemical localization of immune complexes at neuromuscular junctions. *Muscle Nerve* **4**, 289–295.
- Platt, S. R., Chrisman, C. L., and Shelton, G. D. (1999). Lipid storage myopathy in a cocker spaniel. *J. Small Anim. Pract.* **40**, 31–34.
- Rafiqzaman, M., Svenkerud, R., Strande, A., and Hauge, J. G. (1976). Glycogenesis in the dog. *Acta Vet. Scand.* **17**, 196–209.
- Reed, S. M., Hegreberg, G. A., Bayly, W. M., Brown, C. M., Paradis, M. R., and Clemmons, R. M. (1988). Progressive myotonia in foals resembling human dystrophin myotonia. *Muscle Nerve* **11**, 291–296.
- Render, J. A., Common, R. S., Kennedy, F. A., Jones, M. Z., and Fyfe, J. C. (1999). Amylopectinosis in fetal and neonatal quarter horses. *Vet. Pathol.* **36**, 157–160.
- Rennie, M. J., Bohe, J., Smith, K., Wackerhage, H., and Greenhaff, P. (2006). Branched-chain amino acids as fuels and anabolic signals in human muscle. *J. Nutr.* **136**(suppl. 1), 264S–268S.
- Reuser, A. J., Kroos, M. A., Hermans, M. M., Bijvoet, A. G., Verbeet, M. P., van Diggelen, O. P., Kleijer, W. J., and Van der Ploeg, A. T. (1995). Glycogenesis type II (acid maltase deficiency). *Muscle Nerve* **3**, S61–S69.
- Rhodes, T. H., Vite, C. H., Giger, U., Patterson, D. F., Fahlke, C., and George, A. L., Jr. (1999). A missense mutation in canine CIC-1 causes recessive myotonia congenita in the dog. *FEBS Lett.* **456**, 54–58.
- Rivero, J. L., Serrano, A. L., Henckel, P., and Aguera, E. (1993). Muscle fiber type composition and fiber size in successfully and unsuccessfully endurance-raced horses. *J. Appl. Physiol.* **75**, 1758–1766.
- Robergs, R. A., Ghiasvand, F., and Parker, D. (2004). Biochemistry of exercise-induced metabolic acidosis. *Am. J. Physiol. Regul. Integr. Comp. Physiol.* **287**, R502–R516.
- Roberts, M. C., Mickelson, J. R., Patterson, E. E., Nelson, T. E., Armstrong, P. J., Brunson, D. B., and Hogan, K. (2001). Autosomal dominant canine malignant hyperthermia is caused by a mutation in the gene encoding the skeletal muscle calcium release channel (RYR1). *Anesthesiology* **95**, 716–725.
- Roussel, J. D., and Stallcup, O. T. (1966). Influence of age and season on phosphatase and transaminase activities in blood serum of bulls. *Am. J. Vet. Res.* **27**, 1527–1530.
- Rubenstein, N. A., and Kelly, A. M. (2004). The diversity of muscle fiber types and its origin during development. In “Myology: Basic and Clinical” (A. G. Engel and C. Franzini-Armstrong, Eds.), pp. 87–103. McGraw-Hill, New York.
- Rudolph, J. A., Spier, S. J., Byrns, G., Rojas, C. V., Bernoco, D., and Hoffman, E. P. (1992). Periodic paralysis in quarter horses: a sodium channel mutation disseminated by selective breeding. *Nat. Genet.* **2**, 144–147.
- Russell, S. D., Cambon, N., Nadal-Ginard, B., and Whalen, R. G. (1988). Thyroid hormone induces a nerve-independent precocious expression of fast myosin heavy chain mRNA in rat hindlimb skeletal muscle. *J. Biol. Chem.* **263**, 6370–6374.
- Sahlin, K. (1986). Muscle fatigue and lactic acid accumulation. *Acta Physiol. Scand. Suppl.* **556**, 83–91.
- Sahlin, K., Edstrom, L., Sjöholm, H., and Hultman, E. (1981). Effects of lactic acid accumulation and ATP decrease on muscle tension and relaxation. *Am. J. Physiol.* **240**, C121–C126.
- Saltin, B., Henriksson, J., Nygaard, E., Andersen, P., and Jansson, E. (1977). Fiber types and metabolic potentials of skeletal muscles in sedentary man and endurance runners. *Ann. NY Acad. Sci.* **301**, 3–29.
- Schatzberg, S. J., and Shelton, G. D. (2004). Newly identified neuromuscular disorders. *Vet. Clin. North Am. Small Anim. Pract.* **34**, 1497–1524.
- Seidel, J. C. (1967). Studies on myosin from red and white skeletal muscles of the rabbit. II. Inactivation of myosin from red muscles under mild alkaline conditions. *J. Biol. Chem.* **242**, 5623–5629.
- Serrano, A. L., Quiroz-Rothe, E., and Rivero, J. L. (2000). Early and long-term changes of equine skeletal muscle in response to endurance training and detraining. *Pflugers Arch.* **441**, 263–274.
- Sharp, N. J., Kornegay, J. N., Van Camp, S. D., Herbstreith, M. H., Secore, S. L., Kettle, S., Hung, W. Y., Constantinou, C. D., Dykstra, M. J., Roses, A. D., and Bartlett, R. J. (1992). An error in dystrophin mRNA processing in golden retriever muscular dystrophy, an animal homologue of Duchenne muscular dystrophy. *Genomics* **13**, 115–121.
- Shelton, G. D. (1999). Acquired myasthenia gravis: what we have learned from experimental and spontaneous animal models. *Vet. Immunol. Immunopathol.* **69**, 239–249.
- Shelton, G. D. (2002). Myasthenia gravis and disorders of neuromuscular transmission. *Vet. Clin. North Am. Small Anim. Pract.* **32**, 189–206. Comment: vii.
- Shelton, G. D. (2004). Muscular dystrophies: expanding our knowledge in companion animals. *Vet. J.* **168**, 6–8.
- Shelton, G. D., and Cardinet, G. H., III. (1987). Pathophysiologic basis of canine muscle disorders. *J. Vet. Intern. Med.* **1**, 36–44.
- Shelton, G. D., Cardinet, G. H., III., and Bandman, E. (1987). Canine masticatory muscle disorders: a study of 29 cases. *Muscle Nerve* **10**, 753–766.
- Shelton, G. D., Cardinet, G. H., III., Bandman, E., and Cuddon, P. (1985). Fiber type-specific autoantibodies in a dog with eosinophilic myositis. *Muscle Nerve* **8**, 783–790.
- Shelton, G. D., Cardinet, G. H., and Lindstrom, J. M. (1988). Canine and human myasthenia gravis autoantibodies recognize similar regions on the acetylcholine receptor. *Neurology* **38**, 1417–1423.
- Shelton, G. D., and Engvall, E. (2002). Muscular dystrophies and other inherited myopathies. *Vet. Clin. North Am. Small Anim. Pract.* **32**, 103–124.
- Shelton, G. D., and Engvall, E. (2005). Canine and feline models of human inherited muscle diseases. *Neuromuscul. Disord.* **15**, 127–138.
- Shelton, G. D., Ho, M., and Kass, P. H. (2000). Risk factors for acquired myasthenia gravis in cats: 105 cases (1986–1998). *J. Am. Vet. Med. Assoc.* **216**, 55–57.
- Shelton, G. D., Nyhan, W. L., Kass, P. H., Barshop, B. A., and Haas, R. H. (1998). Analysis of organic acids, amino acids, and carnitine in dogs with lipid storage myopathy. *Muscle Nerve* **21**, 1202–1205.
- Shelton, G. D., and Paciello, O. (2006). Evidence for MHC-1-restricted CD8+ T-cell-mediated immunopathology in canine masticatory muscle myositis and polymyositis. *Muscle Nerve* **34**, 122–123.
- Shelton, G. D., Willard, M. D., Cardinet, G. H., III., and Lindstrom, J. (1990). Acquired myasthenia gravis. Selective involvement of esophageal, pharyngeal, and facial muscles. *J. Vet. Intern. Med.* **4**, 281–284.
- Sieb, J. P., and Penn, A. S. (2004). Myoglobinuria. In “Myology: Basic and Clinical” (A. G. Engel and C. Franzini-Armstrong, Eds.), pp. 1677–1692. McGraw-Hill, New York.
- Slack, J. A., McGuirk, S. M., Erb, H. N., Lien, L., Coombs, D., Semrad, S. D., Riseberg, A., Marques, F., Darien, B., Fallon, L., Burns, P.,

- Murakami, M. A., Apple, F. S., and Peek, S. F. (2005). Biochemical markers of cardiac injury in normal, surviving septic, or nonsurviving septic neonatal foals. *J. Vet. Intern. Med.* **19**, 577–580.
- Smith, B. F., Henthorn, P. S., Rajpurohit, Y., Stedman, H., Wolfe, J. H., Patterson, D. F., and Giger, U. (1996). A cDNA encoding canine muscle-type phosphofructokinase. *Gene* **168**, 275–276.
- Snow, D. H., and Valberg, S. J. (1994). Muscle-anatomy: adaptations to exercise and training. In “The Athletic Horse” (R. J. Rose and D. H. Hodgson, Eds.), pp. 145–179. Saunders, Philadelphia.
- Spier, S. J., Carlson, G. P., Holliday, T. A., Cardinet, G. H. III., and Pickar, J. G. (1990). Hyperkalemic periodic paralysis in horses. *J. Am. Vet. Med. Assoc.* **197**, 1009–1017.
- Spriet, L. L. (1991). Phosphofructokinase activity and acidosis during short-term tetanic contractions. *Can. J. Physiol. Pharmacol.* **69**, 298–304.
- Steiness, E., Rasmussen, F., Svendsen, O., and Nielsen, P. (1978). A comparative study of serum creatine phosphokinase (CPK) activity in rabbits, pigs and humans after intramuscular injection of local damaging drugs. *Acta Pharmacol. Toxicol. (Copenh.)* **42**, 357–364.
- Strbenc, M., Smerdu, V., Zupanc, M., Tozon, N., and Fazarinc, G. (2004). Pattern of myosin heavy chain isoforms in different fibre types of canine trunk and limb skeletal muscles. *Cells Tissues Organs* **176**, 178–186.
- Sweeney, H. L., and Houdusse, A. (2004). Mammalian myosin. In “Myology: Basic and Clinical” (A. G. Engel and C. Franzini-Armstrong, Eds.), pp. 167–186. McGraw-Hill, New York.
- Tan, P., Allen, J. G., Wilton, S. D., Akkari, P. A., Huxtable, C. R., and Laing, N. G. (1997). A splice-site mutation causing ovine McArdle’s disease. *Neuromuscul. Disord.* **7**, 336–342.
- Tarrant, P. V., and McVeigh, J. M. (1979). The effect of skeletal muscle needle biopsy on blood constituents, muscle glycogen and heart rate of cattle. *Res. Vet. Sci.* **27**, 325–328.
- Thorstensson, A., Elwin, K., Sjodin, B., and Karlsson, J. (1976). Isozymes of creatine phosphokinase and myokinase in human heart and skeletal muscle. *Scand. J. Clin. Lab. Invest.* **36**, 821–826.
- Treves, S., Anderson, A. A., Ducreux, S., Divet, A., Bleunven, C., Grasso, C., Paesante, S., and Zorzato, F. (2005). Ryanodine receptor 1 mutations, dysregulation of calcium homeostasis and neuromuscular disorders. *Neuromuscul. Disord.* **15**, 577–587.
- Tsujino, S., Nonaka, I., and DiMauro, S. (2000). Glycogen storage myopathies. *Neurol. Clin.* **18**, 125–150.
- Tullson, P. C., and Terjung, R. L. (1991). Adenine nucleotide metabolism in contracting skeletal muscle. *Exerc. Sport Sci. Rev.* **19**, 507–537.
- Valberg, S. (1986). Glycogen depletion patterns in the muscle of standardbred trotters after exercise of varying intensities and durations. *Equine Vet. J.* **18**, 479–484.
- Valberg, S., Haggendal, J., and Lindholm, A. (1993a). Blood chemistry and skeletal muscle metabolic responses to exercise in horses with recurrent exertional rhabdomyolysis. *Equine Vet. J.* **25**, 17–22.
- Valberg, S., Jonsson, L., Lindholm, A., and Holmgren, N. (1993b). Muscle histopathology and plasma aspartate aminotransferase, creatine kinase and myoglobin changes with exercise in horses with recurrent exertional rhabdomyolysis. *Equine Vet. J.* **25**, 11–16.
- Valberg, S. J. (1999). Spinal muscle pathology. *Vet. Clin. North Am. Equine Pract.* **15**, vii–87.
- Valberg, S. J., Cardinet, G. H. III., Carlson, G. P., and DiMauro, S. (1992). Polysaccharide storage myopathy associated with recurrent exertional rhabdomyolysis in horses. *Neuromuscul. Disord.* **2**, 351–359.
- Valberg, S. J., Carlson, G. P., Cardinet, G. H. III., Birks, E. K., Jones, J. H., Chomyn, A., and DiMauro, S. (1994). Skeletal muscle mitochondrial myopathy as a cause of exercise intolerance in a horse. *Muscle Nerve* **17**, 305–312.
- Valberg, S. J., Mickelson, J. R., Gallant, E. M., MacLeay, J. M., Lentz, L., and de la Corte, F. D. (1999). Exertional rhabdomyolysis in quarter horses and thoroughbreds: one syndrome, multiple aetiologies. *Equine Vet. J. Suppl.* **30**, 533–538.
- Valberg, S. J., Ward, T. L., Rush, B., Kinde, H., Hirasagi, H., Nahey, D., Fyfe, J., and Mickelson, J. R. (2001). Glycogen branching enzyme deficiency in quarter horse foals. *J. Vet. Intern. Med.* **15**, 572–580.
- Vijayarathy, C., Giger, U., Prociuk, U., Patterson, D. F., Breitschwerdt, E. B., and Avadhani, N. G. (1994). Canine mitochondrial myopathy associated with reduced mitochondrial mRNA and altered cytochrome c oxidase activities in fibroblasts and skeletal muscle. *Comp. Biochem. Physiol. A Physiol.* **109**, 887–894.
- Vite, C. H., Cozzi, F., Rich, M., Klide, A. K., Volk, S. W., and Lombardo, R. (1998). Myotonic myopathy in a miniature schnauzer: case report and data suggesting abnormal chloride conductance across the muscle membrane. *J. Vet. Intern. Med.* **12**, 394–397.
- Volfinger, L., Lassourd, V., Michaux, J. M., Braun, J. P., and Toutain, P. L. (1994). Kinetic evaluation of muscle damage during exercise by calculation of amount of creatine kinase released. *Am. J. Physiol.* **266** (pt. 2), R434–R441.
- Wagner, M. L., Valberg, S. J., Ames, E. G., Bauer, M. M., Wiseman, J. A., Penedo, M. C. T., Kinde, H., Abbitt, B., and Mickelson, J. R. (2006). Allele frequency and likely impact of the glycogen branching enzyme deficiency gene in quarter horse and paint horse populations. *J. Vet. Intern. Med.* **20**, 1207–1211.
- Wharen, J. (1977). Glucose turnover during exercise in man. *Ann. NY Acad. Sci.* **301**, 45–55.
- Walvoort, H. C., Slee, R. G., and Koster, J. F. (1982). Canine glycogen storage disease type II. A biochemical study of an acid alpha-glucosidase-deficient Lapland dog. *Biochim. Biophys. Acta* **715**, 63–69.
- Wang, K., and Ramirez-Mitchell, R. (1983). A network of transverse and longitudinal intermediate filaments is associated with sarcomeres of adult vertebrate skeletal muscle. *J. Cell Biol.* **96**, 562–570.
- Ward, T. L., Valberg, S. J., Adelson, D. L., Abbey, C. A., Binns, M. M., and Mickelson, J. R. (2004). Glycogen branching enzyme (GBE1) mutation causing equine glycogen storage disease IV. *Mamm. Genome* **15**, 570–577.
- Weeds, A. G. (1969). Light chains of myosin. *Nature* **223**, 1362–1364.
- Yamano, S., Eto, D., Kasashima, Y., Hiraga, A., Sugiura, T., and Miyata, H. (2005). Evaluation of developmental changes in the coexpression of myosin heavy chains and metabolic properties of equine skeletal muscle fibers. *Am. J. Vet. Res.* **66**, 401–405.
- Zhou, J., Spier, S. J., Beech, J., and Hoffman, E. P. (1994). Pathophysiology of sodium channelopathies: correlation of normal/mutant mRNA ratios with clinical phenotype in dominantly inherited periodic paralysis. *Hum. Mol. Genet.* **3**, 1599–1603.

# Kidney Function and Damage

Jean-Pierre Braun

*Department of Physiopathology and Experimental Toxicology  
National School of Veterinary Medicine of Toulouse  
Toulouse, France*

Herve P. Lefebvre

*Department of Physiopathology and Experimental Toxicology  
National School of Veterinary Medicine of Toulouse  
Toulouse, France*

## I. INTRODUCTION

### II. KIDNEY MORPHOLOGY AND FUNCTION

- A. General Structure of the Kidneys
- B. Glomerulus and Filtration
- C. Tubule: Reabsorption and Secretion

### III. TESTS OF KIDNEY FUNCTION

- A. Indirect Tests of Glomerular Function
- B. Direct Tests of Glomerular Function
- C. Tests of Tubule Function

### IV. TESTS OF KIDNEY DAMAGE

- A. Glomerular Damage
- B. Tubule Damage

### V. BIOCHEMICAL CHANGES IN KIDNEY DISEASE

- A. Chronic Renal Failure
- B. Acute Renal Failure
- C. Nephrotic Syndrome
- D. Fanconi-Like Syndromes

## REFERENCES

## I. INTRODUCTION

Clinical biochemistry in nephrology is mainly used to diagnose and monitor renal dysfunction or damage. This is of special importance in human medicine, because of the frequent observation of renal failure in elderly people, and in canine and feline medicine, especially for the early detection of chronic renal failure (CRF), which is frequent. In U.S. private practice, however, renal disease was not reported as one of the 29 most common disorders in dogs and was ranked 17th in cats (Lund *et al.*, 1999), and in a survey of Australian practices, the expected frequency of renal failure ranged from one case per week to one case every 2 weeks (Watson *et al.*, 2001). A British survey indicated that 0.2% of dogs were presented with suspected renal disease, which was confirmed in 25% of the cases with no evidence of breed or sex predisposition (MacDougall *et al.*, 1986). The reported prevalence of CRF in a U.S. university hospital was three times higher in cats than in dogs (Polzin *et al.*,

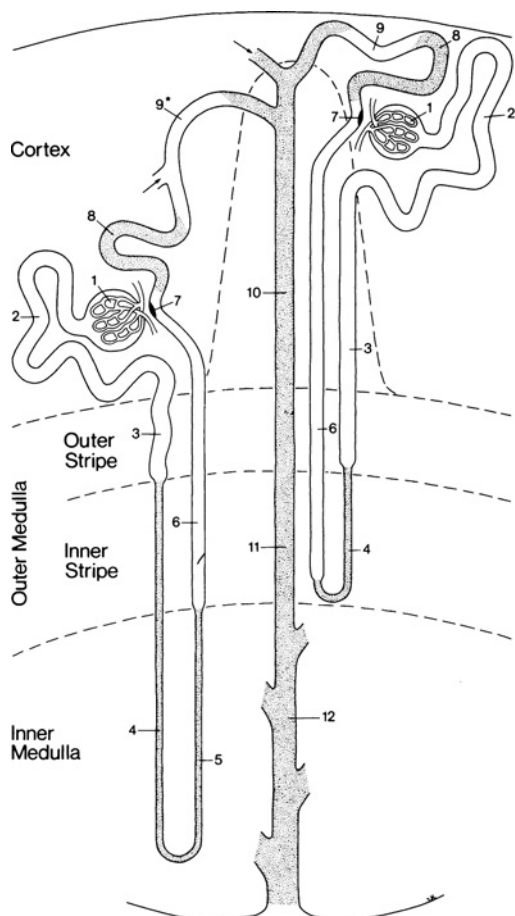
1992). However, the frequency of renal disease increases with age, especially in dogs and cats, as in humans (Cowgill and Spangler, 1981; Gobar *et al.*, 1998; McCall Kaufman, 1984). In U.S. veterinary university hospitals, renal disease was observed in 15% of dogs more than 10 years old, in 33% of cats more than 15 years old (Polzin *et al.*, 1989), in 3% of cats aged 7 to 10 years, and in 30% of cats more than 15 years old (Krawiec and Gelberg, 1989).

Kidney diseases are uncommon in equids and cattle (Fetcher, 1985). The latter show better resistance to a loss of kidney function than monogastric animals because of the filtration function of the rumen epithelium as shown by bilateral nephrectomy (Fetcher, 1986).

## II. KIDNEY MORPHOLOGY AND FUNCTION

### A. General Structure of the Kidneys

The mammalian kidney consists of tens of thousands to millions of nephrons that function as parallel units. The larger the species, the greater the number of nephrons per kidney (Kunkel, 1930; Rytand, 1937–1938; Vimtrup, 1928). This ranges from about 10,000 in mice (Cullen-McEwen *et al.*, 2003), 175,000 in cats (Brown *et al.*, 1993), 300 to 700,000 in dogs (Finco and Duncan, 1972), and 7 million in elephants, as compared to about 1 million in humans. The number of nephrons progressively increases during fetal development and is complete at birth (e.g., in sheep or humans) or during the few days following birth (e.g., in rat) (Gimonet *et al.*, 1998). The number of nephrons in the dog decreases slightly (5%) during the 2 first months of life, whereas the glomerular volume increases by 33% (Horster *et al.*, 1971). However, great interindividual variability is observed within species. In dogs, the size or the weight has little influence on the number of glomeruli, but the size of these latter is larger in larger breeds (Finco and Duncan, 1972; Kunkel, 1930). In sheep, the number of nephrons in twins was about 30% lower than in single lambs (Mitchell *et al.*, 2004) or showed no difference (Bains *et al.*, 1996).



**FIGURE 16-1** Schematic representation and international nomenclature of the parts of the nephron. 1: Renal corpuscle including Bowman's capsule and the glomerulus (glomerular tuft). 2: Proximal convoluted tubule. 3: Proximal straight tubule. 4: Descending thin limb. 5: Ascending thin limb. 6: Distal straight tubule (thick ascending limb). 7: Macula densa located within the final portion of the thick ascending limb. 8: Distal convoluted tubule. 9: Connecting tubule; 9\*: Connecting tubule of the juxtamedullary nephron that forms an arcade. 10: Cortical collecting duct. 11: Outer medullary collecting duct. 12: Inner medullary collecting duct. Reproduced with permission of the publisher from Kriz and Bankir (1988).

The general architecture of the nephrons is identical in all species (Fig. 16-1) (Kriz and Bankir, 1988), but their disposition within the kidney differs between species (Bankir and de Rouffignac, 1985).

Blood is supplied to the kidneys by the renal arteries. These divide into interlobar and arcuate arteries located at the corticomedullary junction. Branches of the latter supply blood to the afferent arterioles of the tuft of capillaries in the glomerulus, from which it is collected by the efferent arterioles. Depending on the location of the glomeruli, blood is then supplied to a network perfusing the cortical tubules or to the vasa recta vessels, which penetrate deep into the medulla in "hairpins" parallel to the loops of Henle. See the review in Pallone *et al.* (1998). The total blood supply to the kidneys (renal blood flow, RBF) is very high, about 20% of the cardiac output, and most of it goes to the cortex. Only a fraction of the plasma flow (renal plasma flow, RPF) is



**FIGURE 16-2** Electron micrograph of the glomerular filtration barrier. 1: Footlike processes of the podocytes; arrow shows the slit diaphragm of a filtration slit. 2: glomerular basement membrane. 3: fenestrated endothelium of the glomerular capillaries. Reproduced with permission of the publisher from Poirier *et al.* (1999).

filtered resulting in the glomerular filtration rate (GFR). This is the filtration fraction (FF), which generally amounts to 20% to 30% of RPF:  $GFR = RPF \times FF$ .

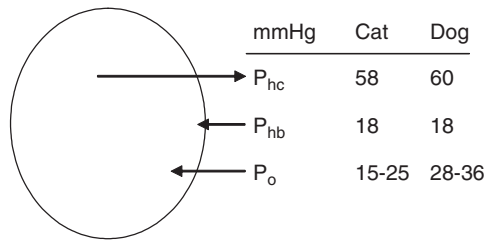
The RBF remains quite stable, because of autoregulation, even with variations in systemic blood pressure. The precise mechanism of autoregulation is unknown but results from vasoconstriction/dilation of the afferent and efferent glomerular arterioles, which maintains an almost constant hydrostatic pressure within the glomerulus. Autoregulation is efficient in healthy dogs between 70 to 180 mmHg and may be altered in disease, especially during CRF (Brown *et al.*, 1995).

## B. Glomerulus and Filtration

Each glomerulus consists of a tuft of anastomosed capillaries within the Bowman's capsule, which collects the primitive urine formed by plasma filtration and opens into the tubule conducting urine to the renal pelvis. The filter between the plasma and urine consists of three layers (Fig. 16-2) (see reviews in Deen *et al.* [2001], and Rennke and Venkatachalam [1977]):

- The fenestrated endothelium of the capillaries, allowing direct contact between the plasma and the basal membrane via large pores and fenestrae (~50 to 100 nm); the luminal face is coated with sulfated glycosaminoglycans and glycoproteins.
- The basement membrane made of a gel containing approximately 90% water and negatively charged sulfated glycosaminoglycans.
- The filtration slits (~25 nm) between the footlike processes of the podocytes (i.e., the visceral epithelial cells covering the external surface of the capillaries) (Gubler, 2003). The slits are made porous by the slit diaphragm in which proteins, consisting mainly of the extracellular part of the nephrin molecule anchored in the membrane of the





**FIGURE 16-3** Pressures involved in glomerular filtration within a glomerular capillary. The driving force is the hydrostatic pressure in the capillary ( $P_{hc}$ ), which is opposed by hydrostatic pressure within Bowman's space ( $P_{hb}$ ) and oncotic pressure in the capillary ( $P_o$ ). Values are pressures in dogs and cats.

podocytes, are arranged in zipper-like fashion (Wartiovaara *et al.*, 2004). This slit diaphragm seems to be the basis of filter selectivity, although this has long been considered a function of the basement membrane; it may also act as a signaling system to modulate filtration (Benzing, 2004).

The driving force of filtration is hydrostatic pressure of cardiac origin (Fig. 16-3). This is opposed by plasma colloidal (oncotic) pressure produced by plasma proteins and urine hydrostatic pressure within the Bowman's capsule. The colloidal pressure in the Bowman's capsule is negligible because of the almost total absence of proteins. As a result, the effective filtration pressure is 10 to 15mmHg (Navar *et al.*, 1977).

The limits of filtration (see the review in Tryggvason, 1999) are as follows:

- **Size and shape:** Neutral molecules with a diameter <2.5nm diffuse freely. Then as diameter increases, filtration decreases to approximately 0 when the diameter is >3.5nm (i.e., the approximate diameter of the albumin molecule).
- **Charge:** Because of the high concentration of sulfated glycosaminoglycans at the surface of endothelial cells and in the GBM, the filtration slit tends to repel negatively charged molecules (i.e., most plasma proteins at blood pH).

As a result of glomerular filtration, all small hydrosoluble plasma molecules, including water and ions, are freely filtered but high molecular weight proteins are not. Albumin, which has an MW ~67,000 and a pI = 4.9 (Purtell *et al.*, 1979), is very close to the limit of filtration so that only a minimal amount is filtered by "normal" kidneys. The albumin concentration in primitive urine is ~20 to 30mg/l and many smaller proteins are also present, most of which are reabsorbed in the tubule.

## C. Tubule: Reabsorption and Secretion

### 1. Parts of the Tubule

The tubule is divided into different segments (Fig. 16-2) (see standard nomenclature in Kriz and Bankir, 1988):

- The proximal tubule begins with a convoluted portion followed by a straight section dipping toward the medulla;

the epithelium of the proximal tubule consists of thick cuboidal cells with a very dense brush border on the luminal side, which provides an immense surface of exchange with the glomerular urine; this is the portion of the nephron where most solutes and water are reabsorbed.

- The loop of Henle produces a "hairpin" bend within the medulla, ending close to the glomerulus at the juxtaglomerular apparatus. Long and short loops descend only into the inner or outer medulla, respectively. The loop of Henle is essential to urine concentration mechanism and it is often stated that long loops are mostly observed in species living in desert areas, and thus related to higher concentrating ability. Almost all the nephrons in dogs and cats are long looped (Bulger *et al.*, 1986), whereas those in humans and pigs are mostly short looped (Bankir and de Rouffignac, 1985), and the average urines are more concentrated in dogs and cats than in humans or swine. The two main points regarding function are that (1) the water and urea permeability of the descending thin limb is high, because of the presence of the aquaporin 1 water channel and (2) the ascending thin limb shows very low water and high sodium chloride permeability.

- The juxtaglomerular apparatus is a morphological entity at the confluence of the afferent and efferent arterioles of the glomerulus and a differentiated part of the loop called the macula densa (Spangler, 1979a, 1979b). The cells in the macula densa respond to decreases in blood pressure or hyponatremia by secreting renin stored in the granules, thus activating the angiotensin-aldosterone response.

- The distal convoluted tubule stretches from the macula densa to the confluence into a collecting tubule within the cortex. The reabsorption capacity is lower than in the proximal nephron (e.g., only ~5% to 10% of sodium and chloride), and secretion of potassium may occur. See the review in Reilly and Ellison (2000).

- The collecting tubules leading to the renal pelvis. The final regulation of urine volume and solute excretion occurs in the final segment of the distal tubule and the collecting tubule, and it is partly regulated by hormones.

### 2. Functions of the Tubule

The main tubule functions are the reabsorption of water, electrolytes, and small molecules and, to a lesser extent, the secretion of ions and small molecules. Reabsorption is dominant in healthy animals and mainly occurs in the proximal tubule by active and passive transport. Further adjustment of urine excretion occurs in the distal tubule and is controlled by hormones, so that the final urine is usually more concentrated than the ultrafiltrate. See the review in Reilly and Ellison (2000). Reabsorption and secretion continually adapt to maintain an almost constant plasma composition, whereas the intake and utilization of ions and small molecules vary with food and water supply,

proximity of meals, environment, physical effort, and so on. This is why the following occurs:

- Urine composition can show large variations in the same healthy or diseased subject.
- A notable overlap of urinary analyte concentrations is observed in healthy and diseased animals.
- The reference intervals for urine analytes are of little relevance when determining spot urine compositions.

#### a. Small Hydrophilic Molecules

Glucose, amino acids, and low-molecular-weight proteins are mostly reabsorbed in the proximal tubule. Almost 100% of the glucose, amino acids, and proteins are reabsorbed. The former return to the plasma, whereas small proteins are degraded in the tubular cells. Other small hydrophilic molecules are not or only poorly reabsorbed (e.g., creatinine) (see Section II.A.1.a).

Glucose reabsorption is permitted by the SGLT1 (sodium glucose transporter) in the apical membrane, which couples glucose reabsorption with sodium transport down a gradient produced by an Na/K-ATPase in the basolateral membrane, across which glucose diffuses in a concentration gradient by means of GLUT-2 transporters. This glucose reabsorption capacity is limited by the finite number of transporters: maximal tubular reabsorption ( $T_m$ ) is attained when plasma glucose concentration (P-Glucose) is about 12 mmol/l in dogs, 15 to 18 mmol/l in cats, and 8 to 10 mmol/l in cows.

No urea reabsorption occurs before the medullary part of the collecting duct because of the presence of urea transporters activated by antidiuretic hormone (ADH). This is part of the mechanism creating a high inner medullary osmolality. A small amount of urea is even secreted into the medullary part of the ascending branch of the loop of Henle. Urea reabsorption is increased when urine flow is low (e.g., during dehydration or volume depletion). Urea is central to the concentrating mechanism in the kidney and is ensured by the presence of urea transporters at the thin extremity of the descending loop of Henle and corresponding segments of the vasa recta, which enable urea diffusing from the medullary part of the collecting tubule to enter the nephron and to a lesser degree the blood. See the review on urea transporters in Smith and Rousselet (2001).

#### b. Electrolytes

Electrolytes are mostly reabsorbed in the proximal tubule. The rate of reabsorption differs considerably according to the internal balance of each ion. Under “normal” conditions it is almost 100% for sodium, chloride, calcium, and phosphates, but much lower for potassium, especially in ruminants owing to their high dietary intake.

The extent of reabsorption can be estimated from the fractional excretion (FE) of solutes (i.e., the fraction of the filtered load of an electrolyte that is finally excreted in urine) (see Section II.C.3):

- Sodium concentration is kept low in tubule cells, as in other cells, by an Na/K-ATPase in the basolateral membrane. See the review in Feraille and Doucet (2001). This active transport of sodium ions from the urine accounts for most sodium reabsorption. It also creates a sodium concentration gradient that allows cotransport of amino acids, glucose and other ions, and so on. See the review in De Weer (1992). Further reabsorption of sodium and chloride occurs in the ascending branch of the loop of Henle via an Na-K-2Cl cotransporter in the luminal membrane. See the review in Russell (2000). Final adjustment in the distal part of the nephron is hormonally controlled by aldosterone and natriuretic peptides.

- Chloride is the most abundant anion in the extracellular compartment. The plasma concentration and elimination of chloride are usually concomitant with those of sodium, except in the case of acid-base disorders. In metabolic acidosis, bicarbonate ions secreted by the kidney cells are exchanged with chloride by an Na-independent Cl/HCO<sub>3</sub> exchanger, thus increasing urine chloride elimination and the plasma anion gap.

- Potassium is reabsorbed in the proximal tubule (~70%) and in the ascending part of the loop of Henle, the distal tubule, and the medullary collecting duct. Potassium is also secreted by the distal tubule and cortical collecting duct, mainly during hyperkalemia (Berliner and Kennedy, 1948). See the review in Hebert *et al.* (2005). Part of this process is based on aldosterone secretion, which induces the synthesis of Na/K-ATPases, thereby favoring potassium excretion and sodium reabsorption.

- The inorganic phosphates ( $P_i$ ) in plasma comprise about 80% HPO<sub>4</sub><sup>2-</sup> and 20% H<sub>2</sub>PO<sub>4</sub><sup>-</sup>. They are reabsorbed in the proximal tubule by a sodium cotransporter, which is inhibited by PTH, thus increasing phosphodiuresis. Some newly identified peptides may also decrease tubular phosphate reabsorption without any alteration of glucose and amino acid reabsorption and thus lead to renal loss of phosphates. See the reviews in Laroche and Boyer (2005) and Ritz *et al.* (2003). The  $T_m$  for phosphate reabsorption is higher in ruminants than in other species (Summerill and Lee, 1985; Symonds and Manston, 1974).

- Calcium: Free and complexed calcium ions are freely filtered by the glomerulus. Calcium is mostly reabsorbed in the proximal tubule and in the ascending branch of the loop of Henle, except in horse and rabbit, which excrete significant amounts of this ion when supply is sufficient. Reabsorption occurs by paracellular route. Epithelial channels in the distal part of the nephron permit the transcellular transport of about 15% of filtered calcium. See the

reviews in Hoenderop and Bindels (2005) and Hoenderop *et al.* (2005). This final reabsorption is mainly under the hormonal control of PTH.

- **Magnesium:** Non-protein-bound magnesium is filtered by the glomerulus. Only about 25% are reabsorbed in the proximal tubule. Most reabsorption occurs in the ascending branch of the loop of Henle (50% to 60%) (Rosol and Capen, 1996).

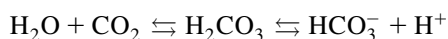
### c. Water

Most water (~75%) is reabsorbed passively in the proximal tubule along with ions and small hydrophilic molecules, so that the fluid entering the descending branch is isotonic. Water is reabsorbed in the descending branch of Henle's loop as a result of the corticopapillary osmolar gradient, whereas the ascending branch is impermeable to water. Final reabsorption occurs in the collecting tubule, mainly under the hormonal control of the antidiuretic hormone (ADH). This hypothalamic nonapeptide is secreted by the posthypophysis when osmolality increases and during hypovolemia or decreased blood pressure. Receptors in the collecting tubule cells trigger the AMPc-dependent synthesis and shuttling of aquaporins, mainly the AQP2 water channel, into the apical and basolateral membrane, thereby permitting water reabsorption and the final adjustment of urine concentration. See the review in Nielsen *et al.* (2002). The final urine concentration is usually much greater than that of the glomerular filtrate (Fig. 16-4).

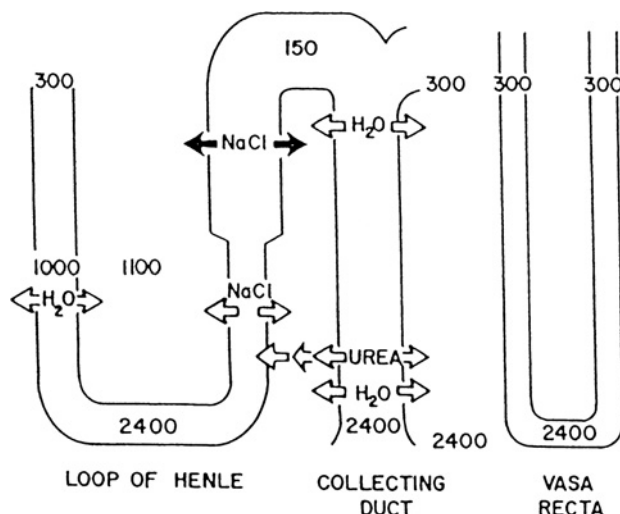
### d. Acid-Base Regulation

The main organs involved in acid-base regulation are the kidneys and lungs. The lungs modulate the elimination of CO<sub>2</sub> and the kidneys the elimination of protons and generation of bicarbonate ions.

The carbonic acid (H<sub>2</sub>CO<sub>3</sub>)-bicarbonate (HCO<sub>3</sub><sup>-</sup>) buffer system is the most efficient extracellular buffer system. It is based on the low dissociation of carbonic acid (pKa ~6.1) at the pH of the extracellular/intravascular compartment and the fact that it is an open system eliminating CO<sub>2</sub> in the lungs. Its efficiency is enhanced by the action of carbonic anhydrase, which accelerates the hydration of carbonic anhydride (CO<sub>2</sub>) into carbonic acid. High concentrations of carbonic anhydrase occur in many tissues including the kidney tubule. The relationship between CO<sub>2</sub>, H<sub>2</sub>CO<sub>3</sub>, and HCO<sub>3</sub><sup>-</sup> is expressed in the following equation:



Bicarbonate ions filtered by the glomerulus are mainly reabsorbed in the proximal tubule (~80%) as CO<sub>2</sub>, which is lipophilic and able to diffuse across the membrane. Within the cell, CO<sub>2</sub> is hydrated by carbonic anhydrase into carbonic acid, which dissociates into bicarbonate ions and protons. The secretion of protons into the tubule lumen ensures the



**FIGURE 16-4** Water reabsorption in the kidney tubule (values are osmolalities). The corticomedullary osmotic gradient results from reabsorption of sodium and chloride without concomitant reabsorption of water in the ascending limb of the loop of Henle and from urea reabsorption in the medullary part of the collecting ducts. Owing to water permeability of the descending limb of the loop of Henle plasma isoosmotic urine flowing from the proximal tubule is first concentrated in the descending branch of the loop of Henle, then is diluted by escape of NaCl and water retention in the ascending branch, and finally is concentrated along the collecting ducts. Reproduced with permission of the publisher from Finco (1995b).

conservation of bicarbonate and its transfer to the plasma. This occurs principally in the distal tubule, where protons are excreted and buffered in urine with filtered organic anions, phosphate, and ammonia generated from glutamine in the tubule cells by the action of glutaminase and glutamate dehydrogenase. This process is enhanced during acidosis, when distal tubule and collecting tubule cells excrete protons against a concentration gradient by the action of an H<sup>+</sup>-ATPase in the basolateral membrane.

### e. Endocrine Functions

Two major hormones, erythropoietin (EPO) and 1 $\alpha$ , 25-dihydroxycholecalciferol (calcitriol), are synthesized by the kidneys and released into the blood.

EPO is a cytokine that regulates erythrocyte production synthesized in the peritubular cells in response to hypoxia. Minor amounts are also produced in the liver, mainly in the newborn. EPO binds to receptors of bone marrow progenitor cells and acts synergistically with other growth factors to proliferate and mature the erythroid progenitor cells. In advanced chronic renal disease, the synthesis of EPO decreases and is insufficient to meet the demands for new red cell production, resulting in anemia. See the review in Fisher (2003).

Calcitriol is a secosteroid hormone derived from vitamin D<sub>3</sub>. It is produced in the proximal tubule cells by the

action of  $1\alpha$ -hydroxylase on 25-hydroxyvitamin D<sub>3</sub> produced by liver hydroxylation of vitamin D<sub>3</sub>. Calcitriol is a major antihypocalcemic hormone acting at the transcriptional level to induce active intestinal absorption of calcium. It acts in synergy with PTH to activate calcium release from bone. PTH increases the expression and activity of  $1\alpha$ -hydroxylase activity during calcium and vitamin D<sub>3</sub> deficiency. The direct modulating effects of calcium and phosphates are weaker.  $1\alpha$ -Hydroxylase activity was recently shown to be down-regulated by phosphaturic peptides called phosphatonins. See the reviews in Ebert *et al.* (2006), Jones *et al.* (1998), and Kumar (1984). Calcitriol synthesis is decreased in CRF, and its administration is recommended for the treatment of animals with CRF and concomitant hyperparathyroidism. See the review in Nagode *et al.* (1996).

### III. TESTS OF KIDNEY FUNCTION

Kidney function can be evaluated from the concentrations of plasma or urine analytes, which are mainly dependent on their elimination (e.g., P-Creatinine). These indirect markers can be easily and rapidly measured, but their sensitivity is poor and generally remains unaltered until 75% of renal function has been lost and their concentrations may be modified by extrarenal factors. Direct tests of kidney function are based on the elimination kinetics of markers of glomerular filtration, blood flow, or tubule reabsorption/secretion and are based on the clearance concept. These tests are more difficult and take longer to perform but allow earlier detection of reduced function.

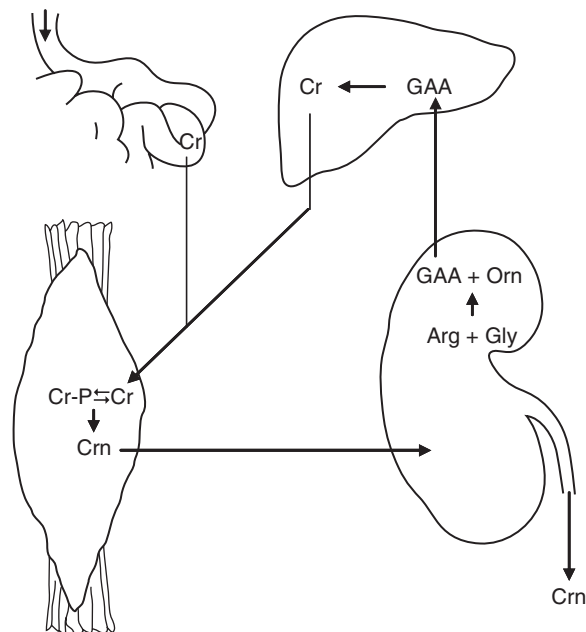
#### A. Indirect Tests of Glomerular Function

P-Creatinine is the test most often used to diagnose and monitor kidney disease in human and animal clinical pathology. P-Urea is also used frequently but is subject to more numerous extrarenal factors of variation. These molecules are almost totally eliminated by glomerular filtration, so that in the case of kidney failure their plasma concentration increases. However, neither test is sensitive in the early diagnosis of kidney disease because of the large functional reserve of the kidneys. Moreover, variations of P-Urea and P-Creatinine are not proportional to the number of functional nephrons (e.g., a mean increase of 85% in P-Creatinine and of 140% in P-Urea was observed after a two-fold reduction of GFR, with values close to the upper limit of the reference interval) (Lefebvre *et al.*, 1999).

##### 1. Creatinine

###### a. Creatinine Metabolism

Creatinine is a small molecule (MW 113) produced by degradation of creatine and creatine-phosphate, an energy-storing



**FIGURE 16-5** Schematic representation of creatinine metabolism. The first step is the transamination of arginine and glycine yielding guanidinoacetic acid (GAA) by the kidney enzyme arginine:glycine amidinotransferase. In the liver, N-methylation of guanidinoacetate into creatine is catalyzed by guanidinoacetate methyltransferase, using methyl groups donated by S-adenosylmethionine. Creatine is distributed to muscle cells where it is reversibly phosphorylated to creatine phosphate by creatine kinase. Creatinine is the product of the spontaneous, irreversible, non-enzymatic, internal dehydration of creatine, and dephosphorylation of creatine phosphate.

molecule mainly present in skeletal muscles. See the reviews in Braun *et al.* (2003), Perrone *et al.* (1992), and Wyss and Kaddurah-Daouk (2000). Creatine is synthesized from the amino acids glycine, arginine, and methionine, the final step occurring in the liver (Fig. 16-5). It is then taken up by the muscles where it is reversibly phosphorylated by creatine-kinase into creatine-phosphate. Skeletal muscles contain about 95% of the total body creatine and creatine-phosphate pool. The estimated turnover of creatine-phosphate (about 2%) is fairly constant in a given individual. The resulting estimated daily input of endogenous creatinine into plasma was  $380 \pm 45 \mu\text{mol/kg BW}$  in healthy beagles and 10% to 20% lower in animals with reduced kidney mass (Watson *et al.*, 2002a). In carnivores and omnivores, creatinine can also originate from the creatine and creatinine in food (Harris and Lowe, 1995; Harris *et al.*, 1997).

Creatinine mainly circulates in a free form in the plasma and is distributed into the whole body water compartment (Schloerb, 1960; Watson *et al.*, 2002a). It was reported that, in dog plasma, 6% were bound to plasma proteins (Kennedy *et al.*, 1952). Creatinine is freely filtered by the glomerulus and is not reabsorbed or secreted in cats (Finco and Barsanti, 1982) and ponies (Finco and Groves, 1985), but it may be strongly secreted in horses

(Bickhardt *et al.*, 1996). In dogs, either no secretion has been observed (Finco *et al.*, 1993; Watson *et al.*, 2002a) or very weak proximal tubule secretion has been reported in males but not in females (O'Connell *et al.*, 1962; Swanson and Hakim, 1962). This secretion is slightly increased following reduction of the renal mass (Robinson *et al.*, 1974). Secretion of creatinine by active transport in the proximal tubule has been reported in humans, in whom it is nonuniformly increased in renal failure (Walser *et al.*, 1988), also in sheep (Bickhardt and Dungalhof, 1994), rabbit (Matos *et al.*, 1998), pig (Wendt *et al.*, 1990), and goat (Ladd *et al.*, 1957). Creatinine is reabsorbed by the tubules in newborn rabbits and humans, probably by back-leak through the immature tubules (Matos *et al.*, 1998).

As observed in humans and rats, extrarenal intestinal catabolism may be suspected in cases of renal failure. This may involve the bacterial flora, as demonstrated in the rat by accumulation creatine bacterial catabolites including methylguanidine (Jones and Burnett, 1972; Mitch *et al.*, 1980). This hypothesis is supported by the observed increase in cats with ARF (Ohashi *et al.*, 1995). Finally, creatinine is rapidly cleared from plasma (half-life of 3 h in dogs; Watson *et al.*, 2002a) and eliminated in urine, where its total excretion depends on body weight (Gartner *et al.*, 1987).

#### b. Preanalytical Factors of Variation

- Specimen: Serum and plasma creatinine concentrations are identical, although a slightly higher serum value has been reported in dogs (Thoresen *et al.*, 1992). Differences between jugular and cephalic vein may be overlooked ( $5\mu\text{mol/l}$  in dogs) (Jensen *et al.*, 1994). Canine P-Creatinine is not changed by storage at  $-20^{\circ}\text{C}$  or  $-70^{\circ}\text{C}$  for up to 8 months (Thoresen *et al.*, 1995) or by three freeze-thaw cycles (Reynolds *et al.*, 2006).

In human urines, the creatinine concentration decreased by about 20% to 30% in 1 week at any temperature between  $4^{\circ}\text{C}$  and  $-80^{\circ}\text{C}$ , and was not altered by five freeze-thaw cycles (Schneider *et al.*, 2002), whereas others found that it was stable up to 30 days when stored at  $4^{\circ}\text{C}$  and minimally decreased at  $25^{\circ}\text{C}$  (Spierto *et al.*, 1997).

- Diet and meals: P-Creatinine in dogs and cats was increased by meals containing meat, especially when this was cooked (Epstein *et al.*, 1984; Evans, 1987; Harris and Lowe, 1995; Lowe *et al.*, 1998; Sagawa *et al.*, 1995; Watson and Church, 1980; Watson *et al.*, 1981) or after oral loading with creatine (Lowe *et al.*, 1998), although large interindividual differences were observed. P-Creatinine was higher in dogs fed chicken-based diets than egg- or casein-based diets (Bartges *et al.*, 1995a). No differences in P-Creatinine were observed between cats receiving high- or low-protein diets (Adams *et al.*, 1993). P-Creatinine was moderately higher in young dogs on a low-salt diet (Bagby and Fuchs, 1989) and about 50% higher in goats fed on a low-protein diet (Valtonen *et al.*, 1982).

- Hydration status: P-Creatinine was only moderately increased in dogs deprived of water for 4 days, even when the weight loss was  $\geq 10\%$  (English *et al.*, 1980; Hardy and Osborne, 1979).

- Physical exercise: P-Creatinine was decreased (by about 40%) by physical training in sled dogs (Kronfeld *et al.*, 1977; Querengaesser *et al.*, 1994). It was not significantly changed after strenuous physical exercise in untrained dogs (Chanoit *et al.*, 2002). It was increased by about  $20\mu\text{mol/l}$  after a 400m sprint in greyhounds (Rose and Bloomberg, 1989; Snow *et al.*, 1988) and by approximately 50% after strenuous sprint efforts in sled dogs (Hammel *et al.*, 1997; Querengaesser *et al.*, 1994), but not after very long races (up to 415 miles) (Hinchcliff *et al.*, 1993; Querengaesser *et al.*, 1994).

- Housing: P-Creatinine was slightly higher ( $10$  to  $20\mu\text{mol/l}$ ) in dogs kept indoors than outdoors (Kuhn and Hardegg, 1988; Rautenbach, 1988), whereas others found no difference (Spangenberg *et al.*, 2006).

- Drugs: P-Creatinine was decreased in dogs receiving glucocorticoids (Braun *et al.*, 1981), whereas U-Creatinine was increased (Iversen *et al.*, 1997). P-Creatinine was unchanged or little affected by a single dose of nonsteroidal anti-inflammatory drugs (NSAID) (Lobetti and Joubert, 2000; Mathews *et al.*, 2001) or by halothane anesthesia (Lobetti and Lambrechts, 2000), and moderately increased by furosemide administration (Adin *et al.*, 2003) and high-dose trimethoprim-sulfadiazine in dogs (Lording and Bellamy, 1978). P-Creatinine could increase (Kitagawa *et al.*, 1997), remain unchanged (Atkins *et al.*, 2002), or decrease (Pouchelon *et al.*, 2004) in dogs treated with ACE inhibitors for heart failure.

#### c. Analytical Factors of Variation

HPLC is considered to be the reference method (Blijenberg *et al.*, 1994; Hanser *et al.*, 2001), but routine analyses are based on the nonspecific Jaffé reaction (alkaline picrate) and enzymatic procedures (Guder *et al.*, 1986). See the reviews on creatinine measurement in Spencer (1986) and recommendations for improvement in Myers *et al.*, (2006). The enzymatic methods give slightly lower results than HPLC and Jaffé reaction,  $\sim 5$  and  $20\mu\text{mol/l}$ , respectively, in dog plasma (Evans, 1987; Palm and Lundblad, 2005). The main interferences in the Jaffé reaction are glucose, ketones, and hemoglobin, but canine plasma was unaffected by hemolysis up to  $25\text{g/l}$  (Jacobs *et al.*, 1991, 1992; O'Neill and Feldman, 1989). Interference in the kinetic Jaffé technique is limited in normal dog plasma as the other chromogens react more slowly than creatinine (Palm and Lundblad, 2005). There is less interference in urine because of the lower proportion of Jaffé chromogens, so that calculated creatinine clearances may differ greatly according to the technique used, as shown in rats (Jung *et al.*, 1987).

The accuracy of plasma creatinine measurement is far from satisfactory in human medicine and cannot be

expected to be better in veterinary medicine (Miller *et al.*, 2005; Myers *et al.*, 2006). The measurement of urine creatinine has not been validated in animals, but a poor correlation between different techniques was shown in dogs, especially in concentrated urines (Trumel *et al.*, 2004).

#### d. Reference Intervals and Physiological Factors of Variation

$$100\mu\text{mol/l} = 1.13\text{mg/dl}$$

Reference intervals for P-Creatinine have been poorly defined in most species because of animal selection and the chosen analytical method. The reference intervals for dogs were shown to differ considerably from one textbook to another (Lefebvre *et al.*, 1998b), so that any interchanging of reference limits or decision levels would be risky:

- **Breed:** P-Creatinine is higher in large breeds of dogs (Braun *et al.*, 2002; Feeman *et al.*, 2003; Hilppo, 1986; Medaille *et al.*, 2004), even in puppies (Kühl *et al.*, 2000).

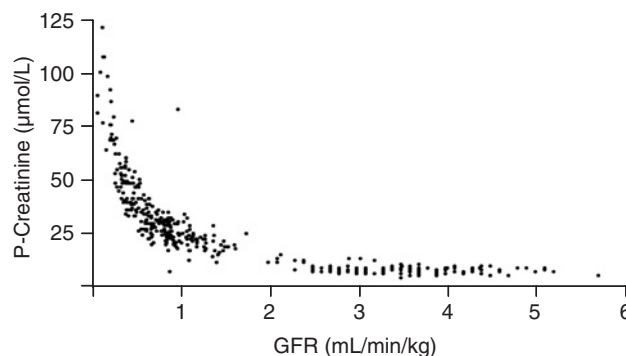
- **Gender:** No differences related to gender were observed in dogs (Broulet *et al.*, 1986; Passing, 1981), although moderately higher concentrations ( $\sim +10\%$ ) were observed in 1- to 3-year-old and 9- to 11-year-old male beagles (Fukuda *et al.*, 1989).

- **Age:** A high P-Creatinine concentration was reported in newborn calves, puppies, and foals, probably because of the accumulation of creatinine ingested from the allantoic fluid (9 to 23 mmol/l in bovines) (Edwards *et al.*, 1990; Klee *et al.*, 1985; Kühl *et al.*, 2000; Lupke *et al.*, 1967). This decreased during the following weeks and then showed a moderate increase again. In dogs and cats, P-Creatinine almost doubled from the first weeks to 1 year of age, then remained stable up to 10 years (Kraft *et al.*, 1996; Passing and Brunk, 1981; Strasser *et al.*, 1993, 1997; Swanson *et al.*, 2004; Vajdovich *et al.*, 1997; Wolford *et al.*, 1988), although other authors reported a regular decrease with age in dogs (Fukuda *et al.*, 1989; Lowseth *et al.*, 1990). In piglets, P-Creatinine almost doubled between 2 and 6 months of age (Krogh *et al.*, 1979).

- **Biological rhythms:** Both a circadian and a seasonal rhythm were observed in dogs, but they were of limited significance (Singer and Kraft, 1988; Sothorn *et al.*, 1993; Strasser *et al.*, 2001), whereas no such rhythms were reported in bulls (Boehnke, 1980). In healthy sheep, creatinine was 25% higher in summer than in winter (Nawaz and Shah, 1984).

#### e. Variations of P-Creatinine in Disease

An inverse curvilinear relationship was observed between P-Creatinine and GFR in dogs (Fig. 16-6) (Finco *et al.*, 1995, 1993; Miyamoto, 2001a; Westhoff *et al.*, 1993). This was the same in both sexes (Finco *et al.*, 1995). The assessment



**FIGURE 16-6** Relationship between P-Creatinine and GFR in dogs. Observe that (1) on the right-hand part of the graph, GFR can be decreased from about 6 to 2 mL/min/kg without any significant change of P-Creatinine; (2) on the left-hand part of the graph, dramatic reductions of P-Creatinine, as observed during animal rehydration in clinics, do not imply a significant increase in GFR. Reproduced with permission of the publisher from Finco (1995a).

of GFR from creatinine is hazardous because of interindividual variability (e.g., P-Creatinine = 200  $\mu\text{mol/l}$  could be observed in dogs with GFR ranging from 0.4 to 1.4 mL/min/kg) (Finco *et al.*, 1995). In cats the relationship is almost linear (Haller *et al.*, 2003).

The sensitivity and specificity of P-Creatinine for the diagnosis of CRF are not very high in dogs and neither are the predictive values (Braun and Lefebvre, 2005; Gleadhill, 1994). The critical difference for P-Creatinine in dogs is 35  $\mu\text{mol/l}$  (Jensen and Aaes, 1993). These criteria have not been reported for other species.

It was suggested that the evolution of renal disease in dogs could be monitored by repeated creatinine measurement and that the time of death could be predicted from the 1/P-Creatinine versus the time curve (Allen *et al.*, 1987); however, this approach gave false estimates in humans (Walser *et al.*, 1988).

P-Creatinine is the most efficient indirect marker of GFR in mammals. It is increased in chronic and acute renal failure, and also in some conditions not directly involving the kidney. For example, see the review as it pertains to dogs in Table 16-1 and in Braun *et al.* (2003). Similar variations were also observed in cats, equines, and bovines.

## 2. Urea

### a. Urea Metabolism

Urea is a small hydrosoluble molecule (MW 60) synthesized in the liver from bicarbonate and ammonium in the Krebs-Henseleit cycle. Urea is the main form in which nitrogen is eliminated in mammals. After synthesis, it is distributed into the total body water compartment (Dunegan *et al.*, 1978; Schloerb, 1960). It is freely filtered by the kidney glomeruli and reabsorbed from the collecting tubule. Its passive reabsorption is increased when urine flow in the tubule is reduced (Park and Rabinowitz, 1969),



**TABLE 16-1** Main Causes of Variations of P-Creatinine in the Dog

➔ P-Creatinine	
Primary renal disease	Intoxication by arsenate
amyloidosis	fluoride
glomerulosclerosis	citrinin
polycystic disease	ochratoxin
uremic crisis	vitamin D
kidney graft rejection	
congenital renal diseases	
<hr/>	
Secondary renal disease	
babesiosis	leishmaniasis
leptospirosis	borreliosis
trypanosomiasis	encephalitozoonosis
histiocytosis	heartworm disease
<hr/>	
Extrarenal disease	
ureteral obstruction	uroperitoneum
<hr/>	
➔ P-Creatinine	
portosystemic shunts	cachexia
early babesiosis	kidney graft
hyperthyroidism	

For references, see Braun *et al.* (2003).

which can lead to increased P-Urea in dehydrated patients or in patients with hemorrhage or to decreased P-Urea in overhydrated patients. Some urea also filters into the intestine, where it is degraded by bacteria into ammonium, which is absorbed and provides a notable proportion of the ammonium supply to the liver. Another important source of ammonium is the catabolism of amino acids. Proteins are thus a major source of ammonium for urea synthesis. Intense recycling of urea occurs in ruminants by transfer to the gastrointestinal tract and to saliva. Urea can also be added to ruminant food (Cirio *et al.*, 2000; Marini and Van Amburgh, 2003), whence it is incorporated into bacterial proteins. The dietary supply of urea is low in other species.

#### b. Preanalytical Factors of Variation

- **Specimen:** No difference between canine serum and heparin plasma was observed and only minor changes were noted when specimens were stored frozen for up to 8 months (Thoresen *et al.*, 1995). P-Urea is little affected by hemolysis (up to 25 g hemoglobin/l) and icterus in cattle, horses, cats, or dogs; it is decreased by lipemia in dogs (Jacobs *et al.*, 1992; O'Neill and Feldman, 1989). P-Urea is stable in plasma and whole blood stored for up to 3 days at 20°C (Thoresen *et al.*, 1992) and in serum or plasma stored frozen at -20°C and at -70°C up to 8 months (Thoresen *et al.*, 1995).

- **Diet and meals:** P-Urea is increased in dogs after meals. Peak postprandial increase can be as high as 7 mmol/l about 6 h after the meal and last for more than 18 h; it is greater with high-protein diets or in animals fed large amounts (Anderson and Edney, 1969; Epstein

*et al.*, 1984; Evans, 1987; Vogin *et al.*, 1967). In most species, basal P-Urea reflects the balance between nitrogen utilization and excretion and can be greatly influenced by nutrition (Kohn *et al.*, 2005). The fasting concentration of P-Urea was lower in dogs on low-protein diets with normal or reduced renal function (Polzin *et al.*, 1983, 1991; Reynolds *et al.*, 1999), in horses (Doreau and Martin-Rosset, 1985), in sheep (Rabinowitz *et al.*, 1973), in goats (Valtonen *et al.*, 1982), and in cats (Hesta *et al.*, 2005). P-Urea was also increased by prolonged fasting, because of catabolism of body proteins (Rabinowitz *et al.*, 1973).

- **Hydration status:** Dehydration had little effect on P-Urea in dogs ( $\leq 12.5$  mmol/l in 4 days, with weight loss up to 16%) (Hardy and Osborne, 1979), but it produced a two-fold increase in calves within 4 days (Bianca *et al.*, 1965).

- **Drugs:** P-Urea was unchanged by halothane anesthesia in dogs (Lobetti and Lambrechts, 2000) and was increased at high doses of trimethoprim-sulfadiazine (Lording and Bellamy, 1978).

- **Physical exercise:** P-Urea in sled dogs was higher after 12 weeks of training, probably as a result of increased protein intake (Reynolds *et al.*, 1999). In greyhounds, P-Urea was unchanged by a 235 m sprint and moderately increased 30 min after a 420 m run (Snow *et al.*, 1988).

#### c. Analytical Factors of Variation

Most techniques are based on the specific action of a bacterial urease. The accuracy of P-Urea measurements is not usually reported.

#### d. Reference Intervals and Physiological Factors of Variation

1 mmol/l = 6 mg/dl. There is no good reason to continue using BUN, as the analytical procedure was abandoned long ago and is merely a source of confusion. If required, the factors are  $\text{BUN (mg/dl)} \times 0.356 = \text{Urea (mmol/l)}$ , and  $\text{BUN (mg/dl)} \times 21.4 = \text{Urea (mg/l)}$ .

- Gender: No significant effect of gender was observed in young beagles (Passing and Brunk, 1981) or in adult dogs (Broulet *et al.*, 1986).

- Age: P-Urea decreases in dogs (by about 50%) between birth and 1 to 2 months (Kühl *et al.*, 2000; Wolford *et al.*, 1988), after which irregular but moderate variations have been reported (Broulet *et al.*, 1986; Cowgill and Spangler, 1981; Lowseth *et al.*, 1990; Passing and Brunk, 1981; Strasser *et al.*, 1993, 1997; Vajdovich *et al.*, 1997). P-Urea increased from birth to 6 months in Great Danes, except those fed on low-protein diets (Nap *et al.*, 1991). P-Urea was similar in adult horses and newborn foals, decreasing by about 50% in foals on the first day and remaining low for at least 2 months (Edwards *et al.*, 1990). P-Urea decreased during the first week in calves (Hartmann *et al.*, 1987), although others did not report any change during this time (Klee *et al.*, 1985).

- Individuals: Intraindividual variations in horses were more important than the variations observed before and after foaling (Doreau and Martin-Rosset, 1985).

- Biological rhythms: P-Urea in sheep was 30% higher in summer than in winter (Nawaz and Shah, 1984), but other authors found no seasonal difference in dogs (Strasser *et al.*, 2001).

#### e. Pathological Factors of Variation

The efficiency of P-Urea in renal failure diagnosis has not been reported. The critical difference in dogs was 2.4 mmol/l around a mean value of 5 mmol/l (Jensen and Aaes, 1993). A threshold of decision of 10 mmol/l has been suggested for cattle with suspected renal disease (Campbell and Watts, 1970).

The relationship between P-Urea and P-Creatinine in dogs was reported to be low (Gabrisch, 1973) or high and linear (Toutain *et al.*, 2000), except for frequent increases in P-Urea concentration, with normal P-Creatinine likely the result of poor preanalytical conditions (Medaille *et al.*, 2004). Because of great interindividual variations, differences in the urea/creatinine ratio cannot be related to specific diseases (Finco and Duncan, 1976).

The variations in P-Urea with disease are similar to those of P-Creatinine, but numerous extrarenal factors may contribute to increased P-Urea, such as gastrointestinal hemorrhage, fasting, or sepsis, which increase protein catabolism; thyrotoxicosis, which lowers P-Urea by increasing GFR; and decreased renal perfusion, which increases

renal reabsorption (DiBartola *et al.*, 1996; Prause and Grauer, 1998). Other factors of decreased P-Urea include portosystemic shunts, malnutrition (Davenport *et al.*, 1994), liver insufficiency, and Krebs-Henseleit cycle enzyme defects. See the reviews in Dial (1995) and Sutherland (1989). These extrarenal factors of variation explain why P-Urea is less specific than P-Creatinine for the diagnosis and management of CRF and should not be recommended as a test of renal function. However, as P-Urea greatly depends on protein supply, it is a useful tool for monitoring the effects of dietary protein restriction (Devaux *et al.*, 1996).

P-Urea is less effective in cattle than P-Creatinine to evaluate decreased GFR in diarrheic calves (Brooks *et al.*, 1997), and only 30% of cattle with P-Urea above the upper limit of the reference interval had renal disease (Campbell and Watts, 1970).

#### f. Effects of Prolonged Increases of P-Urea: Carbamylated Hemoglobin

The carbamylation of proteins is an irreversible nonenzymatic reaction occurring between amino groups of proteins and isocyanate, the active form resulting from cyanate isomerization. This latter is derived from the spontaneous dissociation of urea in solution into ammonium and cyanate ions. Thus, the higher and longer the concentration of P-Urea, the higher the concentration of carbamylated proteins, for instance, of hemoglobin (a process analogous to protein glycation in diabetes mellitus). As proposed in human medicine (Stim *et al.*, 1995; Wynckel *et al.*, 2000), carbamylated hemoglobin may be useful for assessing canine CRF and distinguishing it from ARF (Heiene *et al.*, 2001b), whereas others found a significant overlap with specificity and sensitivity equal to 96% and 84%, respectively, at a 100  $\mu\text{g/g}$  Hb threshold (Vaden *et al.*, 1997a).

### 3. Cystatin C

Cystatin C is a small constitutive protein (MW ~14,000) synthesized by all nucleated cells and only cleared by glomerular filtration. The plasma concentration is thus increased in cases of renal failure. Cystatin C is considered the most sensitive marker of renal failure in humans. See the reviews in Filler *et al.* (2005), Laterza *et al.* (2002), and Price (2000). It can be measured with reagents used in humans in plasma from dogs (Almy *et al.*, 2002; Jensen *et al.*, 2001; Martin *et al.*, 2002) but not cats (Martin *et al.*, 2002). A 50% decrease of P-Cystatin C was reported in dogs following a meal, so sampling should be done after a 12-hour fast (Braun *et al.*, 2002). The upper limit of the reference interval in dogs is 1.3 mg/l (Braun *et al.*, 2002) and similar to the human threshold. P-Cystatin C is well correlated with P-Creatinine and GFR in normal dogs and in dogs with reduced GFR (Almy *et al.*, 2002; Braun *et al.*, 2002). At present, no diagnostic advantage of P-Cystatin C over P-Creatinine has been demonstrated in dogs.



## B. Direct Tests of Glomerular Function

The determination of glomerular filtration rate (GFR)—that is, the volume of ultrafiltrate produced per unit of time (e.g., ml/min) by glomerular filtration—is considered the best way to evaluate kidney function. This is based on the hypothesis of the “intact nephron”: as “the surviving nephrons of the diseased kidney largely retain their essential functional integrity” and “retain a remarkably uniform relationship between glomerular and tubular function” (Bricker *et al.*, 1997).

GFR depends on the size of the animal, so different modes of expression have been proposed. One of the most frequently used is to relate GFR to body weight (ml/min/kg) or better still to lean body mass in humans (Swaminathan *et al.*, 2000). Another approach is to use the body area (ml/min/m<sup>2</sup>), but as the equations used to calculate this from BW have not been validated in all species, this may introduce further inaccuracy (Price and Frazier, 1998). Another mode of expression consists of relating GFR to the volume of the extracellular compartment, as one kidney function is the regulation of body water content. This indexing is rarely adopted but has been used in humans (Peters *et al.*, 2000) and dogs (Gleadhill, 1994; Gleadhill and Michell, 1996).

### 1. Determination of GFR

There is no easy method for determining GFR from a single blood or urine specimen. In human clinical pathology, there are equations to estimate GFR from P-Creatinine, gender, weight, and age. The most frequently used are the Cockcroft-Gault's equations, but these are imprecise and the results depend on the techniques used for P-Creatinine (Grubb and Nordin, 2006; Wuyts *et al.*, 2003). No such equations are available for use in animals. To our knowledge, the only study relating GFR to P-Creatinine showed that the estimation of canine GFR from P-Creatinine was imprecise, and the authors did not recommend using the equation to estimate GFR (Finco *et al.*, 1995).

The measurement of GFR is based on the clearance of markers freely filtered by the glomerulus and having no or minor secretion and reabsorption. See the review in Heiene and Moe (1998). The accepted reference for GFR determination is the urinary clearance of inulin, a low-molecular-weight polysaccharide (Shannon, 1935). The total amount of this marker eliminated in urine over a period of time is equal to the filtered load:

$$\text{Total amount eliminated during time } t = (\text{U-Inulin}) \times (\text{U-Volume}) = \text{GFR} \times (\text{P-Inulin})$$

$$\text{GFR} = (\text{U-Volume}) \times (\text{U-Inulin}) / (\text{P-Inulin}) \times t$$

in which U-Inulin and P-Inulin are in the same units, volume is in ml, and time in min, thus GFR is in ml/min.

However, such determinations are labor intensive; they necessitate the maintenance of a constant plasma

concentration by constant infusion of the marker, the accurate determination of urine volume, and precise and accurate measurement of the marker. Urine collection is often impractical as the total urine is required, which implies careful washing of metabolic cages (Watson *et al.*, 2002a) or the use of indwelling catheters. See the review on urine collection and preservation in cats and dogs in Osborne (1995).

Easier procedures have been proposed, based on the following:

- The use of other markers: Some markers; such as ferrocyanide (Ladd *et al.*, 1956), thiosulphate (Bing and Effersoe, 1948; Dalton, 1968), and sulfanilate (Maddison *et al.*, 1984; Ross and Finco, 1981) have been abandoned. The endogenous or exogenous clearance of creatinine is the most frequently used technique, whatever the species. Iodinated radiocontrast media (e.g., iohexol) provide a good alternative to inulin, but most laboratories are not equipped to measure iodine (Westhoff *et al.*, 1993, 1994). The metabolism of these various markers has not been documented in domestic animals. In some cases extrarenal metabolism can be significant, as shown in cats for diethylenetriaminepentaacetic acid (DTPA), which first concentrates in the heart and lung, then accumulates moderately in the liver before being concentrated in the kidneys (Drost *et al.*, 2000; Uribe *et al.*, 1992). Radiolabeled markers (see the review in Daniel *et al.* [1999]) allow easier and more accurate measurement of concentrations, but their use is restricted to specially equipped centers: <sup>131</sup>I-Inulin, <sup>51</sup>Cr-EDTA (Biewenga and van den Brom, 1981; van den Brom and Biewenga, 1981), and <sup>99m</sup>Tc-DTPA (Gleadhill *et al.*, 1999). They have also been used in large species such as horses (Matthews *et al.*, 1992; Walsh and Royal, 1992).

- The technique of administration: Single injection instead of continuous infusion and determination of plasma clearance of the marker, with calculations based on the decreased plasma concentration of the marker (Pihl and Nosslin, 1974; Summerville and Treves, 1986).

- The use of nuclear imaging techniques and <sup>99m</sup>Tc-labeled tracers such as DTPA. These permit the functions of each kidney to be evaluated separately (Assailly *et al.*, 1977; Drost *et al.*, 2000; Krawiec *et al.*, 1988), as these may be similar in healthy but not always in diseased dogs (Cowgill and Hornhof, 1986; Lourens *et al.*, 1982). Determination of GFR by imaging is not as precise as clearance methods (Barthez *et al.*, 1998; Kampa *et al.*, 2002).

### 2. Variations of Results of GFR Determination According to Procedure

#### a. Preanalytical Factors of Variation

- Anesthesia: In most cases, anesthesia/sedation was reported to have little or no effect on GFR determination in the dog (Bostrom *et al.*, 2006; Gagnon *et al.*, 1982; Lourens

*et al.*, 1982; Newell *et al.*, 1997), but a decrease was reported after acepromazine alone (Lourens *et al.*, 1982) and others found that GFR was slightly higher in anesthetized than in nonanesthetized dogs (Balint and Forgacs, 1967), maybe as a consequence of the intravenous fluids. Anesthesia could lead to reduction of GFR in dogs with reduced renal mass (Stone *et al.*, 1981). Thiopental anesthesia had no effect on GFR in sheep (Cirio *et al.*, 1990).

- Hydration status: GFR was higher in dogs that were hyperhydrated, so hydration status should be standardized (Kerr, 1958; Kunze *et al.*, 2006; Tabaru *et al.*, 1993). In cats, infusion of Ringer lactate at 1 to 2ml/min produced on average a 40% increase of GFR (Rasmussen *et al.*, 1985). In sheep, GFR was lower in summer than in winter because of hemoconcentration (Nawaz and Shah, 1984).

- Diet: GFR was higher in dogs fed animal proteins rather than other proteins (Bartges *et al.*, 1995a, 1995b, 1995d; Kerr, 1958). It was higher with high levels of proteins in the diet in normal dogs and cats and after renal mass reduction (Adams *et al.*, 1994; Bartges *et al.*, 1995c; Bovee, 1992; Bovee and Kronfeld, 1981; Robertson *et al.*, 1986). In partially nephrectomized dogs, low- or high-sodium diets had little influence on GFR (Greco *et al.*, 1994). In cats, GFR was moderately reduced by low-sodium diets (Buranakar *et al.*, 2004), unchanged in cats receiving potassium-depleted food, but lowered when the same food was acidified with ammonium chloride (Dow *et al.*, 1990). In cows, GFR was unchanged by mineral supply (Hartmann *et al.*, 2001). GFR was higher in sheep fed a normal or high rather than a low protein diet (Cirio and Boivin, 1990a, 1990b; Cirio *et al.*, 1990; Eriksson and Valtonen, 1982; Rabinowitz *et al.*, 1973; Valtonen *et al.*, 1982).

- Meals: GFR increases ranging from 10% to 45% were observed after a meal of proteins in normal dogs and in dogs with renal mass reduction (Bourgoignie *et al.*, 1987; Brown, 1992; Ewald, 1967; Jolliffe and Smith, 1932; Moustgaard, 1947; O'Connor and Summerill, 1976; Reinhardt *et al.*, 1975). This postprandial increase of GFR was not observed in dogs with experimental Fanconi's syndrome (Woods and Young, 1991). It was not reduced by fasting for more than 1 day (Moustgaard, 1947). No difference in GFR was observed when ponies were fed twice a day or received the same amount of food every 2h (Clarke *et al.*, 1990).

- Exercise: GFR was unchanged by training in horses and dogs (McKeever *et al.*, 1985, 2002) or by submaximal exercise for 20 or 60min despite hemoconcentration (Hinchcliff *et al.*, 1990; McKeever *et al.*, 1991). During effort under anaerobic conditions in horses, GFR decreased sharply then returned to prerun values within 15min (Schott *et al.*, 1991).

- Drugs: In dogs and sheep, GFR was increased by glucocorticoids, probably by an increase of plasma flow rate as in rats (Baylis and Brenner, 1978; Gans, 1975). GFR

was decreased by furosemide in dogs and cats (Bostrom *et al.*, 2003; Hanna *et al.*, 1988). Controversial effects of NSAIDs were reported in dogs: either no change of GFR with meloxicam, carprofen, and ketoprofen (Crandell *et al.*, 2004; Ko *et al.*, 2000; Narita *et al.*, 2005) or a moderate decrease with carprofen or ketoprofen (Forsyth *et al.*, 2000). GFR was moderately decreased after repeated excretory urograms in dogs (Feeney *et al.*, 1980a). In cats with experimental CRF, the ACE inhibitor benazepril increased GFR up to 30% (Brown *et al.*, 2001), whereas ACE inhibitors could decrease GFR in sodium-restricted dogs (Hall *et al.*, 1979).

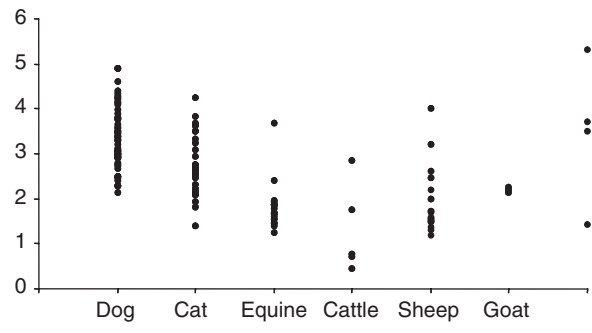
- Biopsy: GFR was not affected after repeated renal biopsies in dogs (Drost *et al.*, 2000; Groman *et al.*, 2004).

## b. Techniques of GFR Measurement

The procedures used to calculate plasma clearances may also influence the results as they depend on the mathematical model chosen (Heiene and Moe, 1999; Powers *et al.*, 1977; Watson *et al.*, 2002a) and on the proposed limited sampling strategies (Barthez *et al.*, 2001; Blavier *et al.*, 2001; Finco, 2005; Watson *et al.*, 2002a). Others have suggested measuring the concentration of an exogenous marker at a given time after injection (e.g., P-Creatinine after I.V. load in dogs) (Labato and Ross, 1991; Watson *et al.*, 2002a).

The measurement of creatinine concentrations by Jaffé technique (discussed earlier) led to erroneously high values for creatinine clearance in early studies. Because of the larger proportion of interfering substances in plasma than in urine with the Jaffé technique, P-Creatinine was overestimated in comparison to U-Creatinine (e.g., in dog urine) (Shannon *et al.*, 1932). This discrepancy between creatinine and inulin clearances does not exist when the measurements are based on the more accurate enzymatic techniques (Finco *et al.*, 1993).

The results of GFR determination may vary according to the technique so their transferability is limited (Driehuys *et al.*, 1998; Finco, 2005; Gagnon *et al.*, 1971; Izzat and Rosborough, 1989; Oester *et al.*, 1968; Rogers *et al.*, 1991), and caution is required when using decision limits from other laboratories or from the literature. Correcting factors have been proposed in some cases, for instance, for iohexol plasma clearance and exogenous creatinine urinary clearance in dogs (Finco *et al.*, 2001; Gleadhill and Michell, 1996). However, such results remain controversial. The estimation of GFR based on iohexol clearance, for example, was considered reliable in dogs and cats (Brown *et al.*, 1996), whereas others showed differences of up to 0.95ml/min/kg with creatinine clearance (Miyamoto, 2001b). The urine clearance of endogenous creatinine and the urine and plasma clearance of exogenous creatinine gave similar results (Finco *et al.*, 1981, 1991; Lee *et al.*, 1983; Watson *et al.*, 2002a), but plasma DTPA clearance was 1.15 time higher than plasma iohexol clearance in dogs (Moe and Heiene, 1995).



2000) and almost the same in both kidneys of dogs (Groman *et al.*, 2004).

- Biological rhythms: Creatinine clearance remained almost stable over 1 day in dogs (Hartenbower *et al.*, 1974; Uechi *et al.*, 1994b), horses (Morris *et al.*, 1984), cats (Uechi *et al.*, 1998), and sheep (Garry *et al.*, 1990c).

#### d. Variations with Disease

Decreased GFR is the gold standard of renal failure, whatever its cause or subsequent evolution (discussed later). A critical approach should always be applied in the clinical evaluation of renal function (Finco and Barsanti, 1989), especially as the results obtained differ according to the method used (discussed earlier).

Alterations of GFR may be secondary to many extrarenal diseases. GFR is decreased in hypothyroidism (Adams *et al.*, 1997) and hypoxia (Lobetti *et al.*, 1996). It may be decreased or not in experimental or spontaneous diabetes mellitus (Kaneko *et al.*, 1978, 1979). GFR evaluation is also useful for monitoring the toxicity of drugs eliminated by renal filtration (e.g., carboplatin) (Bailey *et al.*, 2004; Shapiro *et al.*, 1988) and as an indicator of the effects of renal dysfunction on the pharmacokinetics of drugs (e.g., oxytetracyclin in dogs) (Duffee *et al.*, 1990).

## C. Tests of Tubule Function

### 1. Concentrating Ability

#### a. Urine Osmolality versus Urine-Specific Gravity

One of the most important functions of the kidney in mammals is to reabsorb more than 99% of the filtered water, so that the final urine is more concentrated than the glomerular ultrafiltrate.

Urine concentration is best evaluated by osmolality (Bovee, 1969)—that is, the concentration of particles in a solution, independently of their chemical characteristics (1 sodium ion has the same osmotic effect as 1 molecule of urea or as 1 molecule of albumin). The main determinant of specific gravity in dog urine is urea (Meyer *et al.*, 1997). The laws of osmolality are only valid for dilute solutions in which the different particles are completely independent and this is not verified in urine or plasma. See the review in Sweeney and Beuchat (1993).

The urine concentration is determined in routine tests from the specific gravity (U-SG)—that is, the ratio of the weight of 1l of solution to 1l of water, which depends on the relative proportions and the molecular weight of all the compounds in solution (for instance, 300mOsm/kg solutions of NaCl, urea, and glucose would have SGs of approximately 1.009, 1.014, and 1.054, respectively; the latter would correspond to ~1mOsm/kg solution of albumin).

Urine osmolality and specific gravity were highly correlated in dogs (Bovee, 1969; Dossin *et al.*, 2003; Harvey, 1973; Hendriks *et al.*, 1978; Meyer *et al.*, 1997), sheep (English and Hogan, 1979), and cats (Lees and Osborne,

1979). The correlation was weaker in calves (Thornton and English, 1976). Maximum concentrations could be as high as 1400mOsm/l in rabbits, 2400mOsm/l in dogs, and 3200mOsm/l in cat and sheep (Anderson, 1982).

#### b. Preanalytical Factors of Variation

- Specimen: In cats, U-SG was not changed by freezing (Lees and Osborne, 1979). Spot urines could give very different U-SG results in the same animal depending on the time of sampling.

- Diet: U-SG was lower in cats supplied with moist food than with dry food (Palmore *et al.*, 1978). In cows, U-osmolality was little changed when the mineral supply was reduced by 50% or increased to 200%, but the urine volume was greatly increased during the high mineral supply period (Hartmann *et al.*, 2001).

- Physical exercise: In greyhounds, U-Osmolality was decreased (~8%) by training because of increased diuresis resulting from plasma volume expansion (McKeever *et al.*, 1985). U-SG was transiently decreased for 1 to 2h after an effort under anaerobic conditions in horses (Schott *et al.*, 1991). The 25% to 75% interval for U-SG in posttrace Thoroughbred horses was 1.021 to 1.033 (Cohen *et al.*, 2002).

- Environment: Water intake, urine volume, and osmolality differed significantly in sheep depending on whether the environment was cool or hot, dry or humid (Guerrini *et al.*, 1980).

- Drugs: U-SG was increased in dogs after the administration of radiographic contrast media (Feeney *et al.*, 1980b). In dogs, urine volume was increased and osmolality decreased after medetomidine (Burton *et al.*, 1998) and after glucocorticoids administration, which interferes with the action of vasopressin on the kidney (Joles *et al.*, 1980; Sirek and Best, 1952; Waters *et al.*, 1997). In horses, U-Osmolality was increased after oral sodium bicarbonate loading (Rivas *et al.*, 1997) and was low after treatment with furosemide (median 1.018) (Cohen *et al.*, 2002).

- Anesthesia: U-SG was not changed by halothane anesthesia in dogs (Lobetti and Lambrechts, 2000) but was decreased by isoflurane anesthesia in horses because of increased diuresis, maybe from the fluid support (Watson *et al.*, 2002b). In horses, U-Volume was increased, and U-SG and U-Osmolality were decreased by xylazine and detomidine (Gasthuys *et al.*, 1986, 1987; Nunez *et al.*, 2004; Steffey and Pascoe, 2002; Thurmon *et al.*, 1984; Trim and Hanson, 1986).

#### c. Analytical Factors of Variation

Measuring osmolality requires expensive equipment, thus is not easy to do in most veterinary clinics. Freeze-point osmometers are usually unsuitable for the direct measurement of highly concentrated urines, especially in cats (Lees and Osborne, 1979).

U-SG must be measured by refractometry. See the review in George (2001). The reagent strips available for U-SG

determination in humans should not be used for animal urine. The measurement is based on changes in ionic strength and gave satisfactory results with 80% to 90% of human urines (Burkhardt *et al.*, 1982), but it was less accurate than refractometry (Dorizzi *et al.*, 1987). Results with these test strips did not correlate with osmolality or refractometry in dogs (Allchin *et al.*, 1987; Dossin *et al.*, 2003; Paquignon *et al.*, 1993; van Vonderen *et al.*, 1995). To the authors' knowledge this test strip has not been validated in other domestic species.

#### d. Reference Values and Physiological Factors of Variation

The range of variations of U-SG or U-Osmolality in healthy animals is large in all species, so that reference intervals are devoid of any relevance for spot urines.

- Breed: U-SG was higher in miniature schnauzers than in labradors and might be a factor in oxalate stone formation (Stevenson and Markwell, 2001).
- Gender: Sex had no effect on canine U-SG (van Vonderen *et al.*, 1997).
- Age: U-SG was lower in aged dogs than in young adults (van Vonderen *et al.*, 1997). U-SG was low at birth in puppies, then increased over the first 2 months to values higher than those of mature dogs (Faulks and Lane, 2003; Laroute *et al.*, 2005). U-SG/osmolality in newborn foals was similar to or moderately lower than that of adults, then it decreased to a state of hyposthenuria during the first day of life and remained so for at least 2 months (Edwards *et al.*, 1990).
- Inter- and intraindividual variability: U-SG high in canine urine, CVs were in the range of 30% to 40% (van Vonderen *et al.*, 1997).
- Biological rhythms: U-SG in dogs was slightly lower in evening than in morning samples (van Vonderen *et al.*, 1997).

#### e. Pathological Factors of Variation

As variations in healthy animals can be large, hypo- or isosthenuria must either be confirmed on repeated samples or observed in moderately dehydrated or azotemic animals to be interpreted as an indicator of kidney dysfunction.

A concentrating ability below the commonly accepted limits of 1.030 and 1.035, in dogs and cats, respectively, is considered inadequate. See the review as this pertains to dogs in Watson (1998).

## 2. Tests of Water Deprivation

When plasma osmolality increases, osmoreceptors in the hypothalamus stimulate the release of ADH in blood, thus increasing water reabsorption and equilibrating plasma osmolality. Diabetes insipidus is an uncommon condition characterized by polyuria and polydipsia without glucosuria. It can be congenital or acquired (Harb *et al.*, 1996) and results from decreased secretion of ADH by the hypothalamus

(central diabetes insipidus) or from insensitivity of kidney cells to the effects of ADH. See the reviews in Cohen and Post (2002) and Neiger and Hagemoser (1985).

Tests of water deprivation are based on the fact that sudden or progressive withholding of water produces progressive dehydration. The resulting increase in extracellular fluid osmolality triggers the release of ADH, thus an increase of U-Osmolality and U-SG in healthy subjects. The concentrating ability after exogenous ADH administration can be measured to test whether the absence of urine concentration results from a central defect of ADH secretion or from peripheral resistance to ADH. See the review in Finco (1995a). Protocols for test combination have been proposed (Mulnix *et al.*, 1976), as well as for ADH measurement, but they have not gained wide acceptance (Biewenga *et al.*, 1987). In dogs as in humans, urinary excretion of aquaporin-2 occurs in parallel to ADH action and can be used as a marker of collecting duct responsiveness (van Vonderen *et al.*, 2004).

Water deprivation tests may be hazardous, so should only be used to investigate polydipsia-polyuria once significant kidney damage has been ruled out (MacDougall, 1981). They are contraindicated in dehydrated, azotemic, or hypercalcemic dogs or cats (Barsanti *et al.*, 2000).

Water restriction in 10-month-old beagles produced maximum U-SG = 1.070 after up to 23h of water deprivation (Balazs *et al.*, 1971). In adult dogs, maximum U-Osmolality was 2738mOsm/kg with corresponding U-SG of 1.076 after 72h and a weight loss of 16% (Hardy and Osborne, 1979). In horses, water deprivation for 72h led to an average loss of weight of 8%, and an increase in U-SG (mean ~1.050), the hematocrit, and P-Proteins (Genetzky *et al.*, 1987; Rumbaugh *et al.*, 1982).

## 3. Urine Excretion of Ions

### a. Fractional Excretion

Many electrolytes are intensely reabsorbed after filtration, mainly in the proximal tubule; their excretion is thus increased when tubule dysfunction occurs. Urine electrolyte concentrations also depend on the alimentary supply as the homeostatic mechanisms aimed to stabilize plasma concentration modulate tubule reabsorption. They can thus greatly differ as a function of the diet in all species and on the proximity of meals in monogastric animals.

The most meaningful information would be obtained from daily urine excretion, which is often impossible to obtain because of the difficulties associated with urine collection. Expressing the urinary elimination of a solute (X) as the ratio of the filtered load that is found in urine has been proposed, whence the name fractional excretion (FE):

$$FE_X = \frac{\text{amount in urine}}{\text{amount filtered}} = \frac{(U-X \times U\text{-Volume})}{(P-X \times GFR)}$$

in which U-X and P-X are the urine and plasma concentration of X respectively.

If creatinine clearance is used as a measurement of GFR, it can be demonstrated that FE is equal to the ratio of the solute clearance to creatinine clearance, thus the synonym fractional clearance may be preferred (Constable, 1991). FEs can easily be determined in “spot” samples of plasma and urine according to the following equation:

$$FE_X = (U-X/P-X) \times (P\text{-Creatinine}/U\text{-Creatinine})$$

Such spot measurements are often well correlated with daily elimination. See the reviews in Coffman (1980) and King (1994). However, spot determinations in cats are highly variable compared with 72-h values, and should thus be interpreted with caution (Finco *et al.*, 1997).  $FE_{Na}$  and  $FE_K$  are poor indicators of the daily excretion of these ions in animals with renal failure (Adams *et al.*, 1991). FEs and standard clearances are highly correlated in horses for sodium, potassium, and phosphates (Traver *et al.*, 1977) (e.g., spot measurements of  $FE_{Pi}$  are within 0.1% of the calculated 24h value) (Lane and Merritt, 1983). In sheep  $FE_{Na}$ ,  $FE_K$ ,  $FE_{Cl}$ , and  $FE_{Pi}$  are highly correlated with the respective daily urine excretion of these ions (Garry *et al.*, 1990c).

#### b. Preanalytical Factors of Variation of Ion Excretion

- **Diet:** Daily elimination and  $FE_{Na}$ ,  $FE_K$ ,  $FE_{Ca}$ , and  $FE_{Mg}$  are higher in fed than in nonfed healthy dogs, whereas the excretion of phosphate is unchanged (Lulich *et al.*, 1991). Diuresis and urine mineral composition differ according to food composition and intake in dogs (Zentek *et al.*, 1994) and cats (Sauer *et al.*, 1985a, 1985b) (e.g., cats fed a low K diet had lower  $FE_K$  and higher  $FE_{Cl}$ ) (Dow *et al.* 1990); cats supplemented with magnesium showed a four-fold increase of  $FE_{Mg}$  (Norris *et al.*, 1999a), and  $FE_{Ca}$  was increased in phosphate-depleted dogs (Goldfarb *et al.*, 1977).  $FE_{Pi}$  is lower in dogs fed low-phosphate diets (Polzin *et al.*, 1991) and low-protein diets (Polzin and Osborne, 1988). In cattle (see a review in Lunn and McGuirk [1990]), the composition of the diet greatly influences electrolyte balance, especially for calcium and magnesium (Gray *et al.*, 1988):  $FE_{Mg}$  was about three times higher in cows receiving oral magnesium hydroxide than in controls (Kasari *et al.*, 1990) and is mainly used to test magnesium status (Sutherland *et al.*, 1986). In cows receiving a high mineral diet,  $FE_{Ca}$ ,  $FE_{Mg}$ , and  $FE_{Pi}$  were increased (Hartmann *et al.*, 2001). In sheep artificially loaded with NaCl by oral or intraruminal route, GFR,  $FE_{Na}$ , and  $FE_K$  increased, whereas P-Sodium remained stable (Meintjes and Engelbrecht, 1993). In cattle, sodium bicarbonate loading increased  $FE_{Na}$  and  $FE_{HCO_3}$ , decreased  $FE_{Mg}$  and  $FE_{Ca}$ , but had no effect on  $FE_K$ ,  $FE_{Cl}$ , and  $FE_{Pi}$  (Roby *et al.*, 1987). In mares,  $FE_{Ca}$  and  $FE_{Pi}$  are dependent on the diet (e.g.,  $FE_{Pi}$  ranged from almost 0% to 20% when mares fed on pasture alone or with a high-P mineral supplement) (Cagle *et al.*, 1982a, 1982b).  $FE_{Ca}$ ,  $FE_{Mg}$ , and  $FE_{Pi}$  were

increased in cows receiving a high-mineral diet (Hartmann *et al.*, 2001).

- **Meals:** In cats, urine excretion of phosphates and magnesium is moderately higher in the postprandial period (Finco *et al.*, 1986). Postprandial variations of  $FE_{Na}$  and  $FE_{Pi}$  were observed in cats fed a high-phosphate high-sodium diet (Finco *et al.*, 1989). FEs were altered after large meals in ponies (Clarke *et al.*, 1990)

- **Physical exercise:** In horses,  $FE_K$ ,  $FE_{Na}$ , and  $FE_{Cl}$  were decreased by training (McKeever *et al.*, 2002).  $FE_{Na}$  was increased, whereas  $FE_{Cl}$  was decreased, and  $FE_K$  remained unchanged during submaximal exercise (McKeever *et al.*, 1991) or transiently decreased immediately after effort under anaerobic conditions (Schott *et al.*, 1991).

- **Drugs and fluid therapy:** In dogs,  $FE_K$  is increased in volume expansion by NaCl infusion (Massry *et al.*, 1969).  $FE_K$  and  $FE_{Cl}$  but not  $FE_{Na}$  are increased after medetomidine administration in dogs (Burton *et al.*, 1998). In horses, I.V. infusions of glucose or saline solutions increased  $FE_{Na}$ ,  $FE_{Cl}$ , and  $FE_{Pi}$ , and  $FE_K$  was also increased after glucose infusion (Roussel *et al.*, 1993). In ponies, administration of xylazine increased  $FE_K$ ,  $FE_{Na}$ , and  $FE_{Cl}$  (Trim and Hanson, 1986).

#### c. Analytical Factors of Variation

Ion concentrations in urine are usually measured with the same techniques as in plasma with ad hoc dilutions when necessary, but techniques have not been validated in animal species. An interfering substance in the urine of sheep, cattle, horses, and cats, but not dogs, causes falsely low results for potassium but not sodium with ion-selective electrodes (Brooks *et al.*, 1988).

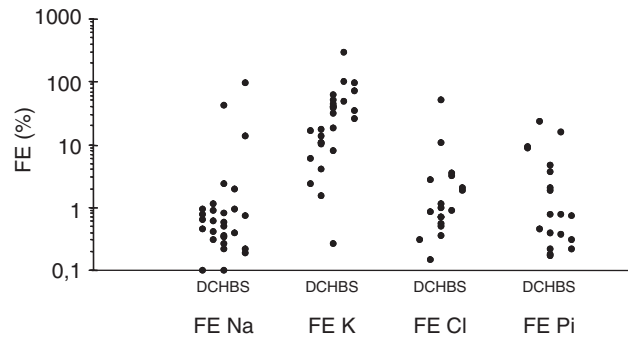
#### d. Reference Intervals and Physiological Factors of Variation

Mean values of FEs collected from the literature are summarized in Figure 16-8. It should be remembered, as emphasized in horses (Morris *et al.*, 1984), that interindividual variations are large and the values observed in individuals may be outside the limits of each group.

- **Age:** In puppies,  $FE_{Na}$  increased during the first 6 months of life, whereas  $FE_K$  peaked at about 4 months, and  $FE_{Cl}$ ,  $FE_{Ca}$ , and  $FE_{Pi}$  were little changed (Lane *et al.*, 2000).

- **Pregnancy-lactation:** In cows, significant changes in  $FE_{Na}$ ,  $FE_K$ ,  $FE_{Cl}$ ,  $FE_{Ca}$ , and  $FE_{Pi}$  were observed prepartum and during lactation (Ulutas *et al.*, 2003).  $FE_{Na}$ ,  $FE_K$ , and  $FE_{Cl}$  were unchanged with the stage of lactation, whereas  $FE_{Pi}$ ,  $FE_{Ca}$ , and  $FE_{Mg}$  differed (Fleming *et al.*, 1992).

- **Biological rhythms:** In fasted dogs,  $FE_{Na}$  and  $FE_{Ca}$  were higher in the morning and  $FE_{Pi}$  in early afternoon (Hartenbower *et al.*, 1974). In cows,  $FE_{Na}$ ,  $FE_K$ ,  $FE_{Cl}$ ,  $FE_{Ca}$ ,  $FE_{Pi}$ , and  $FE_{Mg}$  did not vary significantly over 24h



**FIGURE 16-8** Mean values of FE of sodium, potassium, chloride, and inorganic phosphates. Each point is the result of an original study in dogs (D), cats (C), horse (H), bovine (B), and sheep (S). The y-axis has a logarithmic scale.

**FE<sub>Na</sub>** \*Dog: Burton *et al.*, 1998; Clarke *et al.*, 1990; Deguchi and Akuzawa, 1997; Finco *et al.*, 1997; Fleming *et al.*, 1991; Gagnon *et al.*, 1982. \*Cat: Gans, 1975; Garry *et al.*, 1990a, 1990b; Gelsa, 1979. \*Horse: Izzat and Rosborough, 1989; Kohn and Strasser, 1986; Lobetti and Joubert, 2000; Lobetti and Lambrechts, 2000; Lulich *et al.*, 1991; McKeever *et al.*, 1991; Morris *et al.*, 1984; Neiger and Hagemoser, 1985. \*Sheep: Roussel *et al.*, 1993. \*Cattle: Adams *et al.*, 1991; Bickhardt and Dungalhoef, 1994; Buranakarl *et al.*, 2004.

**FE<sub>K</sub>** \*Cattle: Adams *et al.*, 1992; Beech *et al.*, 1993; Bickhardt and Dungalhoef, 1994. \*Dog: Buranakarl *et al.*, 2004; Burton *et al.*, 1998; Clarke *et al.*, 1990. \*Cat: Clarke *et al.*, 1990; Deguchi and Akuzawa, 1997; Dow *et al.*, 1990; Edwards, 1989; Finco *et al.*, 1997; Fleming *et al.*, 1991. \*Horse: Gans, 1975; Garry *et al.*, 1990a, 1990b; Gelsa, 1979; Lulich *et al.*, 1991; McKeever *et al.*, 1991; Morris *et al.*, 1984; Neiger and Hagemoser, 1985. \*Sheep: Roussel *et al.*, 1993; Russo *et al.*, 1986; Toribio *et al.*, 2005; Traver *et al.*, 1977; Ulutas *et al.*, 2003.

**FE<sub>Cl</sub>** \*Cattle: Buranakarl *et al.*, 2004; Burton *et al.*, 1998; Dow *et al.*, 1990. \*Dog: Edwards, 1989. \*Cat: Fleming *et al.*, 1991; Garry *et al.*, 1990a, 1990b. \*Horse: Gelsa, 1979; Kohn and Strasser, 1986; McKeever *et al.*, 1991; Morris *et al.*, 1984; Neiger and Hagemoser, 1985; Roussel *et al.*, 1993; Russo *et al.*, 1986. \*Sheep: Toribio *et al.*, 2005; Ulutas *et al.*, 2003.

**FE<sub>Pi</sub>** \*Cattle: Bickhardt and Dungalhoef, 1994; Caple *et al.*, 1982. \*Dog: Caple *et al.*, 1982; Edwards, 1989. \*Cat: Finco *et al.*, 1997. \*Horse: Fleming *et al.*, 1991; Garry *et al.*, 1990a, 1990b; Gelsa, 1979; Kohn and Strasser, 1986; Lane and Merritt, 1983; Lulich *et al.*, 1991; Neiger and Hagemoser, 1985; Roussel *et al.*, 1993; Russo *et al.*, 1986. \*Sheep: Toribio *et al.*, 2005; Traver *et al.*, 1977; Ulutas *et al.*, 2003.

but most showed great interindividual variability (Fleming *et al.*, 1991). Other authors have observed significant changes in Pi, Na, and K total excretion and FEs with maximal values at the middle of the day, which did not depend on age or production category (high or low) (Fleming *et al.*, 1992).

#### e. Pathological Factors of Variation

The main difficulty when interpreting FEs in the diagnosis of renal disease is that they are greatly influenced by all extrarenal factors involved in the regulation of plasma electrolyte balance, mainly by dietary supply (Finco and Barsanti, 1989; Finco *et al.*, 1992a). As a result, the interpretation of increased FEs in terms of tubular dysfunction is often hypothetical. Only repeated measurements under well-controlled conditions (e.g., experimental settings) may offer some relevance.

In cats with severe CRF, the FEs of ions were normal in most animals, and their measurement did not seem to improve diagnosis (Filippich, 1992). In dogs, it was shown that FE<sub>Pi</sub> was a less accurate indicator of CRF than P-Creatinine (Gleadhill, 1994).

FEs are also changed in nonrenal diseases. In diabetic cats, FE<sub>Mg</sub> was about 20 times higher than in controls and could be responsible for the frequent hypomagnesemia observed in diabetes mellitus (Norris *et al.*, 1999b). In the cat, a case of increased FE<sub>Pi</sub> with normal P-Phosphates is described, probably because of deficient reabsorption and resulting in rickets-like symptoms (Henik *et al.*, 1999). In

horses, FE<sub>K</sub> is moderately but insignificantly lower during rhabdomyolysis (Beech *et al.*, 1993)

## IV. TESTS OF KIDNEY DAMAGE

### A. Glomerular Damage

#### 1. Proteinuria

Proteinuria is one of the most frequent abnormalities in routine urinalysis and was observed in about 43% and 50% of canine and feline samples submitted to a university hospital (Barlough *et al.*, 1981). See the review on human proteinuria in Waller *et al.* (1989). Although glomerular damage is the cause of the most intense proteinurias, it is not the only one: these can also originate from the tubules and their cause may be pre- or postrenal (Table 16-2). See the consensus statement on canine proteinuria in Lees *et al.* (2005).

The following systematic approach is required in cases of confirmed proteinuria: (1) check that it is persistent, (2) evaluate the magnitude, and (3) localize the origin. See the reviews in Hurley and Vaden (1995), Kunze *et al.* (2006), and Lees *et al.* (2005).

#### a. Origin of Urinary Proteins

The characteristics of the glomerular filtration slit (see Section I.B) are such that almost no or very little plasma protein is filtered. The MW of albumin is closest to the filtration threshold, so this is the first plasma protein to

**TABLE 16-2** Categories of Causes of Proteinuria Based on the Site or Mechanism of the Underlying Abnormality

<p><b>Prerenal</b> (Definition: due to abnormal plasma content of proteins that traverse glomerular capillary walls having normal permselectivity properties.)</p> <p>Normal proteins that are not normally present free in the plasma (e.g., hemoglobin or myoglobin). Abnormal proteins (e.g., immunoglobulin light chains) (Bence-Jones proteins).</p>
<p><b>Renal</b> (Definition: due to abnormal renal handling of normal plasma proteins.)</p> <p><b>Functional</b> (Definition: proteinuria that is due to altered renal physiology during or in response to certain transient phenomena [e.g., strenuous exercise, fever, and so on].) The key distinction here is that the proteinuria is not attributable to presence of renal lesions. The hallmarks of this type of proteinuria are that it is mild and transient—that is, it promptly resolves when the condition that is generating it resolves.</p> <p><b>Pathological</b> (Definition: proteinuria that is attributable to structural or functional lesions within the kidneys, regardless of their magnitude or duration.)</p> <p><b>Glomerular</b> (Definition: due to lesions altering the permselectivity properties of the glomerular capillary wall.)</p> <p><b>Tubular</b> (Definition: due to lesions that impair the tubular recovery of plasma proteins that ordinarily traverse glomerular capillary walls having normal permselectivity properties.) These plasma proteins traffic into the urine from glomerular capillaries. They consist mainly of low-molecular-weight proteins but may also include small amounts of moderate molecular weight proteins (e.g., albumin).</p> <p><b>Interstitial</b> (Definition: due to inflammatory lesions or disease processes [i.e., acute interstitial nephritis] causing exudation of proteins into the urinary space.) These proteins traffic into the urine from peritubular capillaries.</p>
<p><b>Postrenal</b> (Definition: due to entry of protein into the urine after it enters the renal pelvis.)</p> <p><b>Urinary</b> (Definition: due to entry of proteins derived from hemorrhagic or exudative processes affecting the walls of the urine excretory pathway, renal pelvis, ureter, urinary bladder, and urethra [including into the urethra from the prostate gland in males].)</p> <p><b>Extraurinary</b> (Definition: due to entry of proteins derived from secretions or from hemorrhagic and/or exudative processes affecting the genital tract and/or external genitalia during voiding or in the process of collecting urine for analysis.)</p>

Reproduced from Lees et al. (2005) with permission of IVIM.

escape into urine in the case of glomerular disturbance. See the review in Mathieson (2004). Filtered proteins are almost totally reabsorbed in the tubule, and the remaining molecules are substantially degraded before excretion in human or rat urine; this may lead to underestimation of U-Proteins with certain techniques but has not been documented in domestic animals (Greive *et al.*, 2001).

A mixture of serum-derived proteins can be identified in normal dog urine (Porter, 1964, 1966), but their concentrations are very low, except for albumin, and undetected by routine techniques. Other “normal” urinary proteins (i.e., Tamm-Horsfall protein secreted by the distal tubule) (see the review in Pressac [2000]), urokinase, and secretory immunoglobulins A are added in the tubule. Tamm-Horsfall protein is the major constituent of proteinaceous casts (Sanders *et al.*, 1990) and may be involved in vitamin A excretion in dogs (Schweigert *et al.*, 2002) and in urine stone formation as its excretion is about 10 times lower in stone formers (Raila *et al.*, 2003).

#### b. Protein Concentration versus Daily Protein Output versus U-(Protein/Creatinine) Ratio

Spot urine protein concentration can differ considerably within a given animal, depending mainly on the urine concentration. Better estimates of proteinuria would be obtained by measuring total daily excretion, but this is difficult due to the need to collect urine for 24h. The concentration of creatinine, which is inversely related to urine dilution, is used as

a correction in spot samples as its excretion in a given animal is supposed to be fairly constant. Urine protein excretion is thus expressed as the U-(Protein/Creatinine) ratio (U-P/C), in which the concentrations of the two analytes are expressed in mg/l. This ratio has gained general acceptance in clinical pathology. See the reviews in Lulich and Osborne (1990) and Price *et al.* (2005).

The U-P/C ratio in spot urines is well correlated with 24-h urine excretion in healthy and CRF dogs and cats (Adams *et al.*, 1992; Barsanti and Finco, 1979; Grauer *et al.*, 1985; Monroe *et al.*, 1989; White *et al.*, 1984).

#### c. Preanalytical Factors of Variation

- **Specimen:** The method of urine collection (natural voiding, catheterization, cystocentesis) was not found to have a significant effect on U-Proteins in dogs (Barsanti and Finco, 1979). U-P/C could be increased in cases of cystitis and blood contamination of urine (Bagley *et al.*, 1991).
- **Diet and meals:** U-Protein was higher in dogs with CRF, fed high-protein diets (Polzin *et al.*, 1983, 1984). U-P/C is moderately decreased 4 to 8h after a meal (Jergens *et al.*, 1987).
- **Housing:** U-P/C was higher in hospitalized non-proteinuric dogs than in nonhospitalized ones and was generally lower than 0.5 (McCaw *et al.*, 1985).
- **Drugs:** In dogs, long-term glucocorticoid therapy produced a regular increase of U-P/C > 0.5 at 2 weeks



and peaked slightly above 1.0 after 4 weeks (Waters *et al.*, 1997). Nephroangiography often produces transient proteinuria (Holtas *et al.*, 1981).

#### d. Techniques

- **Detection:** The different screening techniques do not provide the same results. See the review in human medicine (Thysell, 1969). Proteinuria detection is most often based on the use of test strips, the detection limit being 0.25 to 0.30g/l for albumin but much higher for globulins (Behr *et al.*, 2003). Moreover, as the reagent patch is based on a pH indicator, falsely positive results are often observed in alkaline urines. Hemoglobin interference remains negligible as long as the urine is not colored, even if the “blood” patch is strongly positive (Jansen and Lumsden, 1985; Vaden *et al.*, 2004). False positives are not encountered with denaturation tests such as the sulfosalicylic acid and nitric acid ring tests, which give identical reactions with globulins and albumin. Caution should be taken in the interpretation of dipstick results for the effects of urine dilution/concentration, and readings must be interpreted with U-SG as a possible correction factor.

- **Quantification:** The quantification and fractionation of proteins should preferably be performed in nonconcentrated urines, although the U-Protein content is usually low, necessitating special procedures. Concentration techniques may alter the relative composition of urine proteins in human urines (Ala-Houahala *et al.*, 1984). The biuret reaction cannot be used unmodified as its quantification limit is too high (a few g/l). Older methods based on heat denaturation, turbidimetry (Hendriks *et al.*, 1976), and more recent ones using special stains such as Ponceau S and Coomassie Blue have mostly been abandoned. The main stain currently used is pyrogallol red, which gives slightly higher results with albumin than with globulins (Behr *et al.*, 2003). Calibrations are performed with different specimens (albumin, dilution of serum, concentrated urines, etc.), thus urine protein measurements can greatly differ from one laboratory to another, as with older techniques (Barsanti and Finco, 1979). U-Protein and U-P/C can be measured in canine but not feline urine with special dipsticks used for human urine (Welles *et al.*, 2006).

#### e. Reference Values and Physiological Factors of Variation

Proteinuria is not detected by routine techniques in urines of healthy animals, except for possible “traces” or “+” readings in highly concentrated urines. In most species, the upper limit of U-Proteins is about 0.3 to 0.4g/l as observed in piglets (Ruhmann *et al.*, 1986) and horses (Edwards *et al.*, 1989). In normal dogs, the urinary loss of proteins is very low and the median is 6mg/kg BW/day. The value in 80% of dogs was  $\leq 10$ mg/kg/day (Biewenga *et al.*, 1982),

whereas others reported 14mg/kg/day (DiBartola *et al.*, 1980a). The upper limits of U-Proteins in cats were  $< 21$  mg/kg/d and 27mg/kg/d in females and males, respectively (Monroe *et al.*, 1989). The commonly accepted reference limits for U-P/C are 0.5 and 0.4 in dogs and cats, respectively (Lees *et al.*, 2005; Elliot, 2007).

- **Age:** In puppies, total proteinuria and U-P/C decreased in the first 6 months of life (Lane *et al.*, 2000). Total daily excretion of proteins was lower in 2-month-old puppies than in adults (Laroute *et al.*, 2005), but others detected proteins in urines of almost all dogs aged less than 3 months (Faulks and Lane, 2003). In newborn piglets there was a transient increase of U-Proteins between 6 and 24h (Parker and Aherne, 1980) because of absorption of fragments of colostral IgGs during the first day of life, and after 3 days proteins become almost undetectable (Martinsson, 1972).

- **Gender:** U-Protein is higher in naturally voided urine of male than female dogs; the difference is not observed in urines obtained by cystocentesis (Barsanti and Finco, 1979).

- **Intra- and interindividual variations:** Interindividual variations in proteinuria are much greater in adult dogs than in 2-month-old puppies (Laroute *et al.*, 2005) and are very large in cats (Russo *et al.*, 1986). In sheep, total protein excreted per 4h and U-P/C were stable for 2 days (Garry *et al.*, 1990c).

- **Biological rhythms:** In dogs, no differences in protein output and U-P/C were observed between night and day samples (McCaw *et al.*, 1985).

#### f. Pathological Factors of Variation

In human medicine, U-PC is considered a safe method to rule out the possibility of significant excessive 24-hour protein excretion (Price *et al.*, 2005). One-quarter of a colony of beagles 4 to 6 years old with no clinical signs and normal U-SG showed transient or permanent proteinuria (Stuart *et al.*, 1975).

Glomerulopathies are the cause of the most severe urine protein losses. See the review in Lulich *et al.* (1996). Dramatic increases in protein excretion are observed in canine and feline amyloidosis and membranous glomerulonephritis with values attaining 900mg/kg/day and U-P/C  $> 10$  (Biewenga and Gruys, 1986; Center *et al.*, 1985, 1987; DiBartola *et al.*, 1980b; Minkus *et al.*, 1994). Proteinuria is the earliest sign of glomerular disease in experimental glomerulonephritis of the cat (Bishop *et al.*, 1991).

Proteinuria is also observed in extrarenal conditions: exercise in the dog (Epstein and Zambraski, 1979) as in humans, plasma protein overload in dogs when P-Proteins exceed 95 to 100g/l (Terry *et al.*, 1948), and urinary infections in 90% to 95% of cases when leukocytes or bacteria are identified (Fettman, 1987, 1989). About half of the dogs

with pituitary-dependent hyperadrenocorticism show moderate increases of U-P/C (Hurley and Vaden, 1998; Ortega *et al.*, 1996).

## 2. Albuminuria-Microalbuminuria

More than 99% of filtered albumin is reabsorbed in the proximal tubule. See the review in Gekle (1998). Maximal reabsorption capacity is lower in rodents, so that a minimal increase in plasma concentration results in urine excretion, which is not observed in dogs (Gartner, 1981). The word *microalbuminuria* is used to qualify the urinary elimination of traces of albumin, below the detection limit of urine total proteins (i.e., below ~300mg/l) but above 20 to 30mg/l. These thresholds correspond to those used in human medicine for the early diagnosis of renal complications of diabetes mellitus.

Microalbuminuria cannot be detected in canine or feline urine with tests used for human microalbuminuria (Pressler *et al.*, 2002). Special tests are commercialized for the semi-quantitative evaluation of microalbuminuria in canine urines (Pressler *et al.*, 2002). Preliminary studies showed that microalbuminuria was observed in a large proportion of dogs without any clinical sign of renal disease, but the upper limit of “normal” urine elimination of albumin and the effects of possible factors of variation have not been determined in dogs. Moreover, the detection of microalbuminuria does not provide any information about the existence of a possible evolutive disease of the kidney. More basic studies will be required before any use of this new test.

U-albumin in human urine is stable for up to 5 months when stored at  $-20^{\circ}\text{C}$  and correctly homogenized after thawing (Brinkman *et al.*, 2005). An ELISA test with a limit of quantification of 10mg/l has been set up for use in dog urine (Vaden *et al.*, 2004). Albuminuria is unchanged in dogs after exercise for 20 min at 8km/h (Gary *et al.*, 2004).

## 3. Urine Protein Electrophoresis

The diagnostic use of electrophoresis of urinary proteins is based on the identification of selective proteinuria versus unselective proteinuria. The latter results from severe glomerular damage allowing massive transfer of all plasma proteins (unselective) including high MW immunoglobulins. The former is observed during the first stages of glomerular damage, when only low MW plasma proteins are eliminated or when tubular damage impairs the reabsorption of filtered low MW proteins, thus producing selective proteinuria. Protein identifications are most frequently performed in SDS-agarose gels where the proteins are separated according to their MW (Meyer-Lindenberg *et al.*, 1997; Muller-Peddinghaus and Trautwein, 1977; Schultze and Jensen, 1998). Protein electrophoresis permits the identification of severe glomerulo- and tubulointerstitial nephropathies but not their differentiation (Zini, 2004). The technique is 100% sensitive for glomerular damage but only 40% specific in

dogs (Zini *et al.*, 2004). A more selective identification of urine proteins can be obtained by mass spectrometry; for instance, retinol-binding protein is only present in the urine of dogs with kidney damage and Tamm-Horsfall protein excretion is reduced in kidney disease (Forterre *et al.*, 2004).

In normal dogs and cats, electrophoresis shows only traces of albumin and rarely of proteins migrating in the globulin zone—that is, mainly transferrin and  $\alpha$ 1-microglobulin (Groulade *et al.*, 1977, 1978; Harvey and Hoe, 1966; Meyer-Lindenberg *et al.*, 1997; Pages and Trouillet, 1990; Yalcin and Cetin, 2004) and sometimes low-molecular-weight proteins (Muller-Peddinghaus and Trautwein, 1977; Zaragoza *et al.*, 2003).

Monoclonal or polyclonal immunoglobulin light chains (Bence-Jones proteins) are identified in ~40% of cases of monoclonal gammopathy (Leifer and Matus, 1986; Matus *et al.*, 1986), in spontaneous ehrlichiosis (Varela *et al.*, 1997), and in plasma cell malignancy (Hurvitz *et al.*, 1971).

## B. Tubule Damage

### 1. Urine Enzyme Activities

#### a. Pathopathology

The enzymes found in urine have two origins. See the reviews in Dubach and Schmidt (1979) and Jung *et al.* (1992). Low MW plasma enzymes are filtered by the glomerulus (e.g., lysozyme or amylase) and are almost totally or partially reabsorbed by the tubule. High MW plasma enzymes cannot be filtered by the glomerulus, but they can be released by the tubule cell. The release of enzymes by other parts of the urinary tract seems negligible.

Most of the enzyme markers used in routine analysis occur mainly in the proximal tubule cell. Renal damage causes their excretion into urine to increase, but there are no increases in plasma enzyme activity, except in severe cases (Shaw, 1976). The kidney specificity of enzymes used as markers of tubule damage is not an issue as long as the MW of the enzymes is large enough to preclude glomerular filtration of the corresponding plasma circulating enzyme.

The localization of enzymes along the nephron is not homogeneous. In rats, proximal and distal tubule damage can be distinguished by measuring the respective glutathione-S-transferase and lactate dehydrogenase (Bomhard *et al.*, 1990) but this has not been used in domestic species. The intracellular localization of enzymes differs considerably, for example, alkaline phosphatase (ALP), alanine aminopeptidase (AAP), GPDAP (glycyl-prolyl-dipeptidyl aminopeptidase), and gamma-glutamyl transferase (GGT) occur in the brush borders,  $\beta$ -glucuronidase, N-acetyl- $\beta$ -glucosaminidase (NAG) in the lysosomes, lactate dehydrogenase (LDH) and glutathione-S-transferase (GST) in the cytoplasm, and glutamate dehydrogenase (GLD) in the mitochondria. This has been used in experimental toxicology to study the progression of cell damage (Bret *et al.*, 1993), but it has not been used in clinical cases.

Enzymes cannot accumulate in urine, as they do in plasma because of their elimination with each urination. Thus, the amount of enzyme eliminated in a urine sample reflects the amount of kidney damage that has occurred since the preceding urination. However, the urine concentration of enzymes not only depends on the release of these latter from the kidneys but also on urine concentration/dilution, hence the frequent use of the U-(Enzyme/Creatinine) ratio as a correction factor in the determination in spot urines (Gossett *et al.*, 1987).

#### b. Preanalytical Factors of Variation

- Specimen: Many enzymes are unstable in refrigerated canine urine and are almost totally inactivated by freezing (e.g., GGT, LDH, and amylase) (Keller and Freudiger, 1984), whereas NAG and AAP are stable for one month at 4°C and -18°C after gel filtration (Reusch *et al.*, 1991). GGT is stable for 3 days at +4°C (Adams *et al.*, 1985; Gossett *et al.*, 1987).
- Anesthesia: U-GGT and U-(GGT/Cr) were increased after prolonged sevoflurane anesthesia in horses (Driessen *et al.*, 2002).

#### c. Analytical Factors of Variation

No technique has been validated for the measurement of urine enzyme activities, so results may differ greatly from one laboratory to another.

Better measurements of AAP and NAG enzyme activities in dog urine are obtained after the elimination of small-molecular-weight inhibitors by dialysis or gel filtration (Reusch *et al.*, 1991). Others have reported that GGT and NAG in urine from dogs (Sato *et al.*, 2002a), cattle (Sato *et al.*, 1997), horses (Adams *et al.*, 1985; Gossett *et al.*, 1987), and cats (Sato *et al.*, 2002b) can be measured without prior preparation.

#### d. Reference Intervals and Physiological Factors of Variation

As with plasma enzyme activity measurements, no validly transferable reference intervals are available for urine enzymes because of the lack of standard techniques and primary control material to ensure interlaboratory controls of accuracy. It is thus unwise to take such information from the literature without checking values of the laboratory.

- Gender: U-NAG was approximately two times higher in male dogs than in females (Nakamura *et al.*, 1983; Reusch *et al.*, 1991; Sato *et al.*, 1997), and was reduced by castration and by vasectomy (Higashiyama *et al.*, 1983). U-NAG was also higher in steers than in cows, but the U-(NAG/Creatinine) ratio was not influenced by sex in cattle (Sato *et al.*, 1997) and cats (Sato *et al.*, 2002b). U-GPDAP activity was higher in males than in females (Uechi *et al.*, 1997).

- Age: Neither age nor gender affected U-GGT and U-ALP activities in horses (Brobst *et al.*, 1986).

- Individuals: Inter- and intraindividual variations were large in dogs and cats (Ogura, 1986; Reusch *et al.*, 1991).

- Biological rhythms: No circadian rhythm of U-GGT or U-NAG was observed in cats (Uechi *et al.*, 1998), but the excretion of both enzymes in dogs was higher between 12:00 and 16:00 (Uechi *et al.*, 1994b) and that of GPDAP was higher between 8:00 and 12:00 (Uechi *et al.*, 1997). U-GGT and U-ALP were moderately higher in morning urines in horses (Brobst *et al.*, 1986).

#### e. Pathological Factors of Variation

Increased urine enzyme excretion is a sign of acute kidney damage, whatever its cause, but does not imply organ dysfunction (Ellis *et al.*, 1973b, 1973c). In many cases, significant increases of urine enzyme excretion are observed without or earlier than any alteration of the function markers (Rivers *et al.*, 1996). Urine enzyme excretion shows little or no modification in chronic renal diseases (e.g., canine CRF) (Heiene *et al.*, 1991).

Although NAG is largely used in toxicology, GGT is often preferred in routine clinical practice because of its easy measurement without urine predialysis and use of readily available reagents. Only urine NAG was increased initially when primary damage was located in the papillary zone of dogs (e.g., ethyleneimine) (Ellis *et al.*, 1973a).

Enzymuria is probably the most sensitive test for monitoring kidney damage induced by treatments with potentially nephrotoxic drugs such as gentamicin in dogs (Adelman *et al.*, 1979; Davies *et al.*, 1998; Grauer *et al.*, 1994, 1995; Greco *et al.*, 1985; Lora-Michiels *et al.*, 2001; Martinez *et al.*, 1996; Spangler *et al.*, 1980), sheep (Brown and Garry, 1988; Garry *et al.*, 1990a), and horses (Rossier *et al.*, 1995). Similar changes were observed in horses treated with neomycin: enzyme excretion was increased whereas creatinine clearance and plasma creatinine concentration were unaltered (Edwards *et al.*, 1989).

Urine enzyme excretion was also increased in renal damage secondary to extrarenal disease, such as canine leishmaniasis (Palacio *et al.*, 1997), approximately 40% of cases of pyometra (de Schepper *et al.*, 1989a, 1989b; Heiene *et al.*, 2001a), and in heartworm disease (Uechi *et al.*, 1994a). The U-NAG and U-(NAG/Creatinine) ratios were increased in cows with interstitial nephritis and amyloidosis (Sato *et al.*, 1999).

## 2. Blood

Hematuria can originate from any part of the kidney or the urinary tract. See the review in Forrester (2004). It is detected by the color of the urine, ranging from light pink to red in macrohematuria, or more frequently by routine urinalysis for invisible microhematuria. This latter is detected by the peroxidase activity of hemoproteins and can therefore give false positives with other proteins such as myoglobin or catalase. The limit of detection of hemoproteins is low, so that occult blood can be detected in the absence of a positive reaction for proteins. See the review on techniques of blood detection in Syed *et al.* (2002).

Idiopathic kidney bleeding has been reported in Weimaraners (Hitt *et al.*, 1985). See the review in Hitt (1986). Occult blood could be detected in approximately 25% of cases in 2-month-old dogs (Faulks and Lane, 2003). Blood in urine can result from sample collection, especially catheterization, as in large animals when indwelling systems are used (Godeau *et al.*, 1990). Macroscopic and microscopic hematuria could result from kidney biopsy in cats (Nash *et al.*, 1983) but only rarely (Osborne, 1971).

## V. BIOCHEMICAL CHANGES IN KIDNEY DISEASE

Renal or kidney disease is a pathological process affecting any part of the kidney and may or may not be associated with alterations in kidney function. Kidney or renal failure (insufficiency) is characterized by a decrease in one or several kidney functions, first the urine concentrating ability, then the elimination of small-molecular-weight molecules from the plasma, characterizing azotemia (i.e., increases of P-Urea and/or P-Creatinine). Uremia is the syndrome resulting from renal failure. Cases of azotemia are not always primary renal azotemia caused by parenchymal damage but may be prerenal or postrenal azotemia resulting from reduced kidney perfusion and interferences with urine excretion, respectively. See the reviews in DiBartola (2005b) and Osborne and Polzin (1983).

Although the etiology of renal diseases and associated lesions may differ markedly, the differential diagnosis, prognosis, and monitoring of disease evolution or therapy is mainly based on clinical biochemistry. However, clinical biochemistry cannot identify the cause of the renal dysfunction/lesion, which requires other tools, such as renal biopsy, imaging, genetic testing, urine culture, cytology, and so on. Most of the literature available is concerned with dogs and cats and, to a much lesser degree, horses. The major renal syndromes of interest to the clinical pathologist are chronic renal failure, acute renal failure, nephrotic syndrome, and Fanconi-like syndromes because of their specific pattern of alterations in biochemical variables and the time course of these changes.

### A. Chronic Renal Failure

Chronic renal failure is a slow irreversible deterioration of kidney function, which, on account of the very large functional reserve of the kidneys, occurs without clinical or biological signs over a long period. Chronic renal failure in dogs and cats is highly prevalent in old animals and is a frequent cause of death: it usually evolves more or less rapidly from early renal disease by a largely unknown process. See the reviews in Brown *et al.* (1997) and Finco *et al.* (1999). As renal disease does not necessarily imply CRF, the main challenge is to detect any kidney disease as early as possible to limit its progression by appropriate dietary and therapeutic

renoprotective maneuvers. See the reviews in Braun and Lefebvre (2005), Grauer (1985, 2005), Greco (2005), and Lees *et al.* (1998).

### 1. Development and Progression of Renal Failure

Experimental models of chronic renal failure have helped to extend our knowledge of CRF progression and of the concomitant changes in biochemical variables. However, some results obtained in rodents seem not to be applicable to cats and dogs. The most commonly used model is the remnant kidney model, based on nephrectomy of the right kidney and reduction of the left kidney mass by selective ligatures of the renal arteries or by electrocoagulation of the left renal cortex. The intensity of left kidney mass reduction determines the postoperative decrease in renal function quantified by the decrease of GFR between the control and postoperative periods.

In dogs, a 5/6 renal mass reduction led to a 65% decrease in GFR and only moderate increases of P-Creatinine and P-Urea, which remained within the reference limits (Brown *et al.*, 2000). One month after the renal mass had been reduced to 1/16 in dogs, GFR was approximately 0.75ml/min/kg and P-Creatinine approximately 300 $\mu$ mol/l (Finco *et al.*, 1992b). In cats, 3/4 and 5/6 reductions of renal mass led to reductions in renal function of one-half and two-thirds, respectively (Adams *et al.*, 1994; Miyamoto, 1998).

The only compensatory mechanism observed was hypertrophy of the remaining tissue except after subtotal kidney mass reduction, when hyperplasia occurred (Filippich *et al.*, 1985). For example, the removal of one kidney in dogs was followed by a 40% increase in weight of the remaining kidney (Carriere, 1978). Compensation was progressive, being rapid for the first 2 to 12 weeks, then slower (Churchill *et al.*, 1999). This explains why the immediate postoperative GFR value is not indicative of the GFR measured several weeks later (Lefebvre *et al.*, 1998a). The GFR decrease was generally less than expected from the reduction of renal mass, and hypermetabolism was observed in the remaining kidney tissue (Fine, 1991). It is thus recommended to wait at least 6 to 8 weeks after surgery to obtain stationary conditions before testing renal function.

Compensation is dependent on many factors, especially nutrition. It was less effective in dogs fed a low-protein (White *et al.*, 1991) or a high-phosphorus diet (Finco *et al.*, 1992b) and in the case of hypertension (Finco, 2004), whereas dietary sodium supply had no effect, except when very low (Greco *et al.*, 1994). Cats with experimental CRF fed a low-sodium diet had lower GFR values than cats fed a normal diet (Buranakar *et al.*, 2004).

The progression of renal disease is poorly understood (Terzi *et al.*, 1998) and leads to clinical disturbances of increasing severity. This has led experts to propose dividing canine and feline CRF into four stages based on P-Creatinine

**TABLE 16-3** Staging of Chronic Renal Failure in Dogs and Cats According to the IRIS Group of Experts

Stage	Creatinine ( $\mu\text{mol/L}$ )	Comments
I	<125 dogs <140 cats	Nonazotemic Some other renal abnormality present (e.g., inadequate urinary concentrating ability without identifiable nonrenal cause); abnormal renal palpation or abnormal renal imaging findings; proteinuria of renal origin; abnormal renal biopsy results; increasing plasma creatinine concentration noted when serial samples have been collected
II	125–179 dogs 140–249 cats	Mild renal azotemia (lower end of the range lies within the reference range for many laboratories, but the insensitivity of creatinine as a screening test means that animals with creatinine values close to the upper reference limit often have excretory failure) Clinical signs usually mild or absent
III	180–440 dogs 250–440 cats	Moderate renal azotemia Many extrarenal clinical signs may be present
IV	>440 dogs and cats	Severe renal azotemia Many extrarenal clinical signs are usually present

Reproduced from Elliott (2007).

at presentation (Table 16-3) and substagings based on proteinuria and blood pressure (Elliott, 2007). Experimental CRF does not necessarily lead to self-perpetuating renal disease (i.e., a spontaneous decline of GFR over time). Kidney function in dogs with a 75% reduction of renal mass was stable up to 4 years, except in some animals fed low-protein diets (Bovee *et al.*, 1979), but not in others (Robertson *et al.*, 1986). Following uninephrectomy in 7- to 8-year-old dogs,  $^{23}_{31}$  animals survived 4 years, and the GFR remained stable at  $\sim 3.5\text{ml/min/kg}$ , irrespective of dietary protein content (18% and 24%) (Finco *et al.*, 1994). GFR was stable for 1 year, and U-P/C was moderately increased but remained below 0.3 after uninephrectomy in young cats (Finco *et al.*, 1998). After 15/16 nephrectomy, renal function decreased rapidly in dogs fed a high-Ca, high-P diet (Brown *et al.*, 1991).

Spontaneous CRF results mainly from tubular-interstitial disease, amyloidosis, and glomerulonephritis, which progress to the uremic syndrome (multiple organ dysfunctions) when end-stage renal failure is reached (Polzin *et al.*, 2000). These dysfunctions probably result from the accumulation of solutes normally excreted by the kidney, the so-called uremic toxins. Ninety molecules, most of them nonidentified, are considered to be potential uremic toxins. See the reviews in Boure and Vanholder (2004), Vanholder and De Smet (1999), Vanholder and Glorieux (2003), and Yavuz *et al.* (2005), but urea and creatinine have little or no toxicity.

Familial renal diseases in dogs and cats provide unique models for human medicine, as most of them lead to the development of CRF. See the reviews in DiBartola (2005a) and Lees (1996). The biochemical findings in such patients when clinical signs are present are the same as in dogs with CRF (see the review in DiBartola, 2000). Proteinuria and hypercholesterolemia are present in primary glomerular disease, as observed in Bernese mountain dogs. Glucosuria may be observed in primary renal tubular defects in

Norwegian elkhounds and basenjis (see later Fanconi-like syndromes). The major laboratory finding in Welsh corgis with renal telangiectasia is marked hematuria.

## 2. Biochemical Changes in Animals with Spontaneous CRF

The most frequent biochemical findings in CRF are isosthenuria, proteinuria, azotemia, hyperphosphatemia, and metabolic hyperchloremic acidosis. When the CRF diagnosis cannot be confirmed, GFR should be measured. Although it is relatively rare in horses, CRF produces biochemical alterations similar to those observed in dogs and cats. See the review in Schott (2004).

- Azotemia is a common finding in dogs and cats with CRF and is sometimes the only biochemical criterion used to diagnose CRF. However, it was absent or mild at presentation in about 50% of dogs with glomerulonephritis or renal amyloidosis (Cook and Cowgill, 1996; DiBartola *et al.*, 1989). It was commonly observed in cats and sharpei dogs with amyloidosis (Grauer and DiBartola, 2000). Survival was inversely correlated to P-Creatinine in cats and dogs with CRF (Allen *et al.*, 1987; Elliott *et al.*, 2000). The variations of P-Urea in dogs and cats with CRF are usually similar to those of P-Creatinine, except in cases when P-Urea synthesis is decreased (e.g., in animals with liver insufficiency). Serial P-Urea measurements to determine the need to adapt dietary protein level in dogs with CRF have been recommended (Devaux *et al.*, 1996).

- Isosthenuria is a frequent finding in dogs with CRF and is the earliest observable urine alteration. It probably results from the increased filtration by remaining nephrons leading to a high urinary volume that overwhelms reabsorptive capacity, thereby producing urine dilution, polyuria, and polydipsia. See the review in Hughes (1992). Isosthenuria in azotemic or dehydrated animals is a good

indicator of the inability of the kidney to concentrate urine. U-SG and P-Creatinine are inversely related in cats (Elliott *et al.*, 2000), but cats with CRF retained concentrating ability longer than dogs (Ross and Finco, 1981), although decreased U-SG was frequently observed in cases of severe CRF (Deguchi and Akuzawa, 1997; Elliott and Barber, 1998). As U-SG is higher in puppies than in adult dogs (noted earlier), the cutoff value for abnormally low U-SG should therefore be higher.

- Proteinuria may or may not be present in CRF. The identification of proteinuria does not mean that its cause is renal and this needs to be ascertained by rational diagnosis. When proteinuria is observed in dogs and cats with CRF, it is generally mild to moderate. However, there is some evidence that the presence of proteinuria in CRF dogs or cats aggravates prognosis (Brown *et al.*, 1998a, Grauer, 2005). The persistence of proteinuria should be confirmed by repeated measurement over time (Lees *et al.*, 2005). Although U-P/C is usually higher in dogs with amyloidosis than in dogs with glomerulonephritis, and higher in the latter than in dogs with interstitial nephritis, proteinuria cannot be relied on for differential diagnosis of the underlying renal disease, which requires a renal biopsy (Grauer and DiBartola, 2000). When renal proteinuria is present in dogs or cats, the current recommendation is to treat it to avoid complications, when the U-P/C in nonazotemic animals is higher than 1, and in azotemic patients, higher than 2. See reviews in Lees *et al.* (2005) and Lulich *et al.* (1996). Angiotensin-converting enzyme inhibitors are the currently used antiproteinuric agents. The administration of such agents was shown to decrease U-P/C in dogs (Grauer *et al.*, 2000) and cats (Brown *et al.*, 2001). The magnitude of proteinuria may decrease in end-stage renal disease, when GFR decrease is severe (Jaenke and Allen, 1986).

- Hypoalbuminemia occurs in many dogs and cats with glomerular disease as a consequence of increased urinary loss of proteins. Severe hypoalbuminemia (<21 g/l) was observed in 70% of dogs with amyloidosis (DiBartola *et al.*, 1989).

- Hyperphosphatemia is a frequent finding in clinical CRF, but it is uncommon in patients with subclinical renal disease. It is currently considered that hyperphosphatemia per se does not directly contribute to clinical signs but is the main cause of renal secondary hyperparathyroidism, which is observed in models of CRF (Grunbaum *et al.*, 1984) and in spontaneous cases (e.g., in about 84% of cats with CRF) (Barber and Elliott, 1998). The precise pathophysiology of secondary hyperparathyroidism in dogs remains unclear. See reviews in Nagode *et al.* (1996) and Yaphé and Forrester (1994). Phosphate retention is increased as renal failure progresses. As a result of phosphate binding and decreased formation of calcitriol in the kidney, the ionized calcium concentration progressively decreases, thus inducing a progressive increase of PTH

secretion, which enhances calcium mobilization from bone and absorption from the intestine and phosphate elimination by the kidney. Finally at the ESRF stage, PTH secretion becomes resistant to calcium suppression, leading to tertiary hyperparathyroidism. In rare cases, hyperphosphatemia may lead to renal osteodystrophy (Nagode and Chew, 1992), but PTH probably contributes to the pathophysiology of the uremic syndrome and may be a uremic toxin. The parathyroid concentration therefore needs to be measured in uremic animals for hyperparathyroidism diagnosis (Polzin *et al.*, 2000), and results should be interpreted with regard to serum calcium concentration, especially that of ionized calcium. In small animal nephrology, minimizing hyperphosphatemia and hyperparathyroidism by dietary phosphorus restriction, the use of intestinal phosphate binding agents, and the possible administration of calcitriol is a therapeutic goal (Nagode *et al.*, 1996). Careful monitoring of phosphatemia is therefore recommended in dogs and cats with CRF.

- Hyperphosphatemia is frequently associated with moderate hypocalcemia, which may be masked when hypercalcemia is the cause of renal disease. See the reviews in Kruger and Osborne (1994a, 1994b) and Kruger *et al.* (1996). In horses, CRF usually produced hypercalcemia and hypophosphatemia (Brobst *et al.*, 1977, 1978a; Roberts and Seiler, 1979) but hyperphosphatemia was also observed in a few cases (Brobst *et al.*, 1977). This hypercalcemia may result from the fact that calcium is more strongly excreted by the horse kidney than in other species (see excretion of crystals of calcium carbonates) (Kruger *et al.*, 1996). Hypocalcemia and hyperphosphatemia were observed in 70% of azotemic cattle but did not permit differentiation of prerenal from renal or postrenal causes (Brobst *et al.*, 1978b).

- Electrolyte and water disturbances are frequent, especially in advanced stages of CRF. Dehydration is highly prevalent in cats (~70%) (Lulich *et al.*, 1992) and should be regularly determined during renal disease from repeated measurements of PCV, total proteins, and body weight. Metabolic hyperchloremic acidosis is due to the decreased excretion of hydrogen ions, bicarbonate wasting, and chloride retention. The estimated overall prevalence in cats was 63% to 80% (DiBartola *et al.*, 1987; Lulich *et al.*, 1992), or 0% in nonuremic cats to about 50% in cats with end-stage CRF (Elliott and Barber, 1998). Thus, the acid-base status should be investigated in all uremic patients. Acidosis may have several adverse effects on cardiovascular physiology, promote protein malnutrition, and induce bone demineralization. Hypokalemia has been reported in cats with CRF (Lulich *et al.*, 1992) but is apparently uncommon in dogs. The muscle potassium content decreased in normokalemic cats with CRF (Theisen *et al.*, 1997). The cause-effect relationship between kalemia and CRF remains unclear, but hypokalemia may be

responsible for general weakness, anorexia, and decreased renal function.

- **Hyperlipidemia and hypercholesterolemia** have been reported in dogs with glomerular diseases and nephrotic syndrome (Cook and Cowgill, 1996; DiBartola *et al.*, 1989). For example, the estimated prevalence of hypercholesterolemia in dogs with glomerular amyloidosis was 86% (DiBartola *et al.*, 1989). These changes probably result from a combination of increased hepatic synthesis and decreased catabolism of proteins and lipoproteins. Hypercholesterolemia and hyperlipidemia may contribute to further renal damage.

- **Hematological alterations:** CRF is associated with the development of progressive nonregenerating anemia. The main cause in dogs and cats (Oishi *et al.*, 1993) is the decreased synthesis of erythropoietin (EPO). See the review in Cowgill (1992). However, an overlap of EPO concentrations was observed in anemic dogs or cats with and without CRF (Oishi *et al.*, 1995; Pechereau *et al.*, 1997). A loss of antithrombin III by increased filtration and platelet hypersensitivity resulting from hypoalbuminemia was reported in canine nephrotic syndrome and other forms of glomerulonephritis (Greco and Green, 1987; Green *et al.*, 1985), resulting in the thrombus formation reported in cases of amyloidosis (Slauson and Gribble, 1971).

## B. Acute Renal Failure

### 1. Definition, Etiology, and Pathophysiology

Acute renal failure (ARF) is “a clinical syndrome characterized by the sudden onset of hemodynamic, filtration and excretory failure of the kidneys with subsequent accumulation of metabolic (uremic) toxins and dysregulation of fluid, electrolyte and acid-balance” (Cowgill and Elliott, 2000). ARF is generally reversible (unlike CRF) if diagnosed early and given adequate therapy. Whereas CRF results from a progressive decline of GFR, the cause of which most often remains unknown, ARF is associated with an acute decline in GFR frequently caused by an ischemic or toxic insult. Probably, one of the most difficult challenges in nephrology is to differentiate ARF from end-stage CRF as the clinical signs (depression, vomiting, diarrhea, anorexia, and dehydration) and laboratory findings (azotemia, hyperphosphatemia, hyperkalemia, metabolic acidosis, and isosthenuria) are identical.

The etiology of ARF is generally classified as prerenal, intrinsic renal parenchymal, and postrenal (Narins *et al.*, 1992). Prerenal ARF is a functional decline in glomerular filtration resulting from a decrease in renal blood flow or perfusion pressure. Azotemia and increased U-SG are hallmarks of this condition. However, increased urine concentration may be masked by concomitant diseases (e.g., CRF, hepatic insufficiency) that impair the kidney's ability

to concentrate urine. Renal parenchymal ARF is produced by intrinsic damage to the kidney caused by toxic insults, CRF, systemic diseases affecting renal function, or by prerenal ARF. Postrenal ARF is the consequence of obstruction or diversion of urine outflow, and accumulation of excretory products in the body. See the review in Cowgill and Elliott (2000). Three consecutive phases of ARF have been described: the initiation phase (subclinical lasting from hours to days) in which the kidneys are subjected to the renal insult; the maintenance phase (lasting from a few days to 2 to 3 weeks), which develops when lesions of the renal tubules have been established; and the recovery phase associated with an improvement of renal function. The initiation phase is difficult to identify from a pathological point of view unless the onset of ARF is relatively slow. In such conditions, GFR decreases progressively, P-Creatinine and P-Urea increase but may remain within the reference intervals, urine-concentrating ability may change, and urine abnormalities (proteinuria, cylindruria, enzymuria) may be present. The maintenance phase is characterized by the most severe clinical signs and by plasma and urine biochemical alterations. The clinical signs and biochemical findings are generally resolved during the recovery phase unless the lesions are irreversible. Polyuria is usually observed. See the reviews in (Grauer and Lane, 1995; Lane *et al.*, 1994a, 1994b; Lulich *et al.*, 1992).

Experimental models of ARF in various domestic animal species were first based on binephrectomy in ponies (Tennant *et al.*, 1981), sheep (Simesen *et al.*, 1979), and bulls (Watts and Campbell, 1970, 1971). Ruminants survived longer than monogastric animals (about 7 days) and showed almost linear increases of P-Urea and P-Creatinine, whereas P-Phosphates and P-Potassium were little changed and P-Calcium was decreased. Many other models based on nephrotoxic agents such as mercuric chloride, uranyl acetate, and so on, surgery, radiation have been used, but the resulting alterations in urine/plasma biochemistry tend to differ as the various agents do not produce the same initial events and subsequent cascade (Stein *et al.*, 1975). Moreover, the biochemical alterations may differ considerably, according to the renal status of the animal. For example, in gentamicin-induced nephrotoxicity, polyuric hypokalemic ARF is observed in dogs with normal renal function or renal impairment at the onset of treatment, and this can lead respectively to reversible polyuric hypokalemic ARF or to fatal oligoanuric hyperkalemic ARF (Frazier *et al.*, 1986).

### 2. Urine and Plasma Biochemical Findings in ARF

Urine and plasma biochemical findings are essential to distinguish between types of ARF. Generally, in prerenal ARF, hypersthenuric urine is produced as the ability of the kidney

to concentrate urine is not impaired. If azotemia is present and the U-SG decreased, then renal parenchymal ARF should be considered. Distinction from CRF may be difficult. Nonregenerative anemia, normo- or hypokalemia, is more common in CRF (Grauer and Lane, 1995). Metabolic acidosis is generally more severe in ARF. For a similar degree of azotemia, animals with ARF exhibited more severe electrolyte disturbances than animals with prerenal azotemia or CRF (Cowgill and Elliott, 2000). The commonest life-threatening electrolyte disturbance in ARF is hyperkalemia, which may cause weakness, cardiac arrhythmia, and possible death of the animal. However, hypokalemia may also develop during the diuretic stage of ARF. Moreover, abnormally low plasma concentrations of sodium, calcium, magnesium, and potassium may exacerbate the development of ARF, especially in case of nephrotoxicity (e.g., caused by gentamicin) (Grauer, 1996). GFR measurements are not indicated in ARF as hydration status and renal function may vary considerably from one hour to another. Once the animal has recovered, GFR determination may permit quantification of the residual renal function, as ARF events may predispose to CRF development. In spontaneous ARF of dogs, P-Urea, P-Creatinine, or P-Phosphates were ineffective predictors of outcome, whereas oliguria was the best indicator of poor prognosis (Behrend *et al.*, 1996).

Diagnosis of postrenal ARF is based on history, clinical signs, and imaging. Hematuria and peritoneal fluid with a higher creatinine concentration than that of plasma and similar to the urine creatinine concentrations are observed when rupture of the urinary tract occurs. Casts were detected in about 30% of dogs with ARF (Vaden *et al.*, 1997b).

Urine enzyme activities are useful early markers of cell damage in ARF principally in nephrotoxicity studies, as they are more sensitive than other markers. In dogs treated with gentamicin, urine excretion of GGT increased by day 2 of administration, P-Creatinine remained below  $180\mu\text{mol/l}$  until day 9, and endogenous creatinine clearance remained within normal values until day 8 (Greco *et al.*, 1985). The intensity of total enzyme excretion may help to quantify the extent of renal damage. The use of enzymuria in routine nephrology remains questionable except in toxicological settings and to monitor the effects of potentially nephrotoxic drugs.

Proteinuria is often detected in uremic animals because of frequent evidence of inflammation and hemorrhage in the urine sediment. However, its relevance in the differential diagnosis, prognosis, and follow-up of ARF patients, in contrast to CRF, remains unknown.

Unusual causes of ARF in dogs and cats have been reviewed recently (Stokes and Forrester, 2004). Many cases of spontaneous acute renal failure result from intoxications. A common example is the ingestion of ethylene-glycol (antifreeze) by dogs and cats, which is oxidized by alcohol dehydrogenase in the liver to glycolaldehyde and acids, with oxalic acid the terminal metabolite. These metabolites are responsible for severe metabolic acidosis and

ARF with dramatic increases of P-Urea and P-Creatinine, proteinuria, and calcium oxalate crystalluria. In the initial phase, affected animals are polyuric with decreased U-SG and U-pH (Connally *et al.*, 1996; Fox *et al.*, 1987; Grauer *et al.*, 1984; Hamlin, 1986; Thrall *et al.*, 1984). In ruminants, equids, and swine, ARF is more frequently caused by nephrotoxic plants or mycotoxins than by infections; for example, ochratoxin A and citrinin produced increases in urinary enzyme excretion, proteinuria, and decreased U-SG in pigs (Szczzech *et al.*, 1973, 1974). Diagnosis is based on increases of P-Urea and P-Creatinine and a decrease of U-SG (Divers *et al.*, 1982; Gouda *et al.*, 1986).

Treatments with nephrotoxic drugs can also cause ARF. Cisplatin toxicosis is mainly due to damage of the lower segment of the proximal tubule. This produces a decrease of GFR in dogs and no change or increases of P-Urea or P-Creatinine and increases of  $\text{FE}_{\text{Mg}}$  and  $\text{FE}_{\text{Pi}}$ , and of U-GGT and U-GGT/Creatinine (Forrester *et al.*, 1993; Hardie *et al.*, 1991). A decrease of GFR, U-SG, and P-Potassium was observed with amphotericin B, as was an increase of P-Urea and P-Creatinine (Randall *et al.*, 1996).

Gentamicin nephrotoxicity determines progressive renal failure characterized by increases of urinary enzyme excretion, proteinuria, hematuria and cylindruria, azotemia, hyperphosphatemia, hypoalbuminemia, hyper- or hypokalemia, reduction of GFR, and an increase of  $\text{FE}_{\text{Na}}$  and  $\text{FE}_{\text{K}}$  in dogs (Daugaard *et al.*, 1987; Riviere *et al.*, 1984), cats (Hardy *et al.*, 1985; Mealey and Boothe, 1994), and sheep (Garry *et al.*, 1990b).

### C. Nephrotic Syndrome

Nephrotic syndrome is characterized by the presence of proteinuria, hypoalbuminemia, hypercholesterolemia, and edema or ascites. It is mainly a consequence of diabetic nephropathy in humans. See the review in Orth and Ritz (1998). In dogs and cats, it is caused by glomerular renal disease, mainly by immune-mediated glomerulonephritis and amyloidosis. See the reviews in Osborne and Jeraj (1980) and Relford and Lees (1996). A model has been obtained in dogs by repeated administration of cationized bovine albumin after endotoxin sensitization (Choi and Lee, 2004). The hallmark of nephrotic syndrome is severe proteinuria in the absence of active sediment. The prevalence of hypoalbuminemia and hypercholesterolemia in dogs ranged from 61% (Center *et al.*, 1987) to 100% (Jeraj *et al.*, 1984; Kurtz *et al.*, 1972). Edema was usually less prevalent (from 0% to 15%) (Center *et al.*, 1987; Kurtz *et al.*, 1972). When the GFR decrease is substantial, animals with nephrotic syndrome become azotemic and present the clinical signs and biological findings characteristic of CRF and ARF. The prevalence of azotemia in dogs with glomerular disease varied from 20% (Wright *et al.*, 1981) to 100% (Jeraj *et al.*, 1984; Kurtz *et al.*, 1972). In cats, azotemia, hypercholesterolemia, hypoalbuminemia, anemia, and edema/ascites



were reported to occur in 67%, 77%, 96%, 63%, and 75% of cases, respectively (Arthur *et al.*, 1986).

## D. Fanconi-Like Syndromes

Fanconi-like syndromes are observed in some breeds of dogs, mainly basenjis (Noonan and Kay, 1990). They are characterized by multiple defects in the reabsorption of glucose, sodium, potassium, calcium, phosphate, amino acids, and water by the tubule (Bovee *et al.*, 1979; Settles and Schmidt, 1994) producing decreased U-SG, proteinuria, and glucosuria (Darrigrand-Haag *et al.*, 1996; Easley and Breitschwerdt, 1976). They may also be acquired as a result of gentamicin toxicity (Brown *et al.*, 1986) or calcitriol deficiency (Freeman *et al.*, 1994), they may be experimentally produced by maleic acid (Al-Bander *et al.*, 1985) or 4-pentaenoate administration (Gougoux *et al.*, 1989), or they may be transient and of unknown etiology (Hostutler *et al.*, 2004; Jamieson and Chandler, 2001).

GFR in dogs with Fanconi-like syndrome may be decreased or remained unchanged (Bovee *et al.*, 1979; Breitschwerdt *et al.*, 1983). Glucosuria, which is one of the major findings in Fanconi-like syndromes, was not correlated with a reduction in GFR or with defective reabsorption of phosphate and sodium (Bovee *et al.*, 1978a,b). The cause of death is apparently not progressive nonspecific renal failure, as the final events are papillary necrosis and pyelonephritis (Bovee *et al.*, 1978b, 1979).

## REFERENCES

- Adams, L. G., Polzin, D. J., Osborne, C. A., and O'Brien, T. D. (1991). Comparison of fractional excretion and 24-hour urinary excretion of sodium and potassium in clinically normal cats and cats with induced chronic renal failure. *Am. J. Vet. Res.* **52**, 718–722.
- Adams, L. G., Polzin, D. J., Osborne, C. A., and O'Brien, T. D. (1992). Correlation of urine protein/creatinine ratio and twenty-four-hour urinary protein excretion in normal cats and cats with surgically induced chronic renal failure. *J. Vet. Intern. Med.* **6**, 36–40.
- Adams, L. G., Polzin, D. J., Osborne, C. A., and O'Brien, T. D. (1993). Effects of dietary protein and calorie restriction in clinically normal cats and in cats with surgically induced chronic renal failure. *Am. J. Vet. Res.* **54**, 1653–1662.
- Adams, L. G., Polzin, D. J., Osborne, C. A., O'Brien, T. D., and Hostetter, T. H. (1994). Influence of dietary protein/calorie intake on renal morphology and function in cats with 5/6 nephrectomy. *Lab. Invest.* **70**, 347–357.
- Adams, R., McClure, J. J., Gossett, K. A., Koonce, K. L., and Ezigbo, C. (1985). Evaluation of a technique for measurement of gamma-glutamyltranspeptidase in equine urine. *Am. J. Vet. Res.* **46**, 147–150.
- Adams, W. H., Daniel, G. B., and Legendre, A. M. (1997). Investigation of the effects of hyperthyroidism on renal function in the cat. *Can. J. Vet. Res.* **61**, 53–56.
- Adelman, R. D., Spangler, W. L., Beasom, F., Ishizaki, G., and Conzelman, G. M. (1979). Furosemide enhancement of experimental gentamicin nephrotoxicity: comparison of functional and morphological changes with activities of urinary enzymes. *J. Infect. Dis.* **140**, 342–352.
- Adin, D. B., Taylor, A. W., Hill, R. C., Scott, K. C., and Martin, F. G. (2003). Intermittent bolus injection versus continuous infusion of furosemide in normal adult greyhound dogs. *J. Vet. Intern. Med.* **17**, 632–636.
- Al-Bander, H., Etheredge, S. B., Paukert, T., Humphreys, M. H., and Morris, R. C., Jr. (1985). Phosphate loading attenuates renal tubular dysfunction induced by maleic acid in the dog. *Am. J. Physiol.* **248**, F513–F521.
- Ala-Houahala, I., Parviainen, M. T., and Pasternack, A. (1984). A comparison of three different methods of concentration of urinary proteins. *Clin. Chim. Acta* **142**, 339–342.
- Allchin, J. P., Evans, G. O., and Parsons, C. E. (1987). Pitfalls in the measurement of canine urine concentration. *Vet. Rec.* **120**, 256–257.
- Allen, T. A., Jaenke, R. S., and Fettman, M. J. (1987). A technique for estimating progression of chronic renal failure in the dog. *J. Am. Vet. Med. Assoc.* **190**, 866–868.
- Almy, F. S., Christopher, M. M., King, D. P., and Brown, S. A. (2002). Evaluation of cystatin C as an endogenous marker of glomerular filtration rate in dogs. *J. Vet. Intern. Med.* **16**, 45–51.
- Anderson, R. S. (1982). Water balance in the dog and cat. *J. Small. Anim. Pract.* **233**, 588–598.
- Anderson, R. S., and Edney, A. T. (1969). Protein intake and blood urea in the dog. *Vet. Rec.* **84**, 348–349.
- Arant, B. S., Jr., Edelman, C. M., Jr., and Nash, M. A. (1974). The renal reabsorption of glucose in the developing canine kidney: a study of glomerulotubular balance. *Pediatr. Res.* **8**, 638–646.
- Arthur, J. E., Lucke, V. M., Newby, T. J., and Bourne, F. J. (1986). The long-term prognosis of feline idiopathic membranous glomerulopathy. *J. Am. Anim. Hosp. Assn.* **22**, 731–737.
- Asheim, A., Persson, F., and Persson, S. (1961). Renal clearance in dogs with regards to variations according to age and sex. *Acta Physiol. Scand.* **51**, 150–162.
- Assailly, J., Pavel, D. G., Bader, C., Chanard, J., Ryerson, T. W., Cotard, J. P., and Funck-Brentano, J. L. (1977). Noninvasive experimental determination of the individual kidney filtration fraction by means of a dual-tracer technique. *J. Nucl. Med.* **18**, 684–691.
- Atkins, C. E., Brown, W. A., Coats, J. R., Crawford, M. A., DeFrancesco, T. C., Edwards, J., Fox, P. R., Keene, B. W., Lehmkuhl, L., Luethy, M., Meurs, K., Petrie, J. P., Pipers, F., Rosenthal, S., Sidley, J. A., and Straus, J. (2002). Effects of long-term administration of enalapril on clinical indicators of renal function in dogs with compensated mitral regurgitation. *J. Am. Vet. Med. Assoc.* **221**, 654–658.
- Bagby, S. P., and Fuchs, E. (1989). Chronic CEI alters effect of low Na diet in normal and coarcted pups, I. BP, renin, and GFR. *Am. J. Physiol.* **256**, R523–R530.
- Bagley, R. S., Center, S. A., Lewis, R. M., Shin, S., Dougherty, S. A., Randolph, J. F., and Erb, H. (1991). The effect of experimental cystitis and iatrogenic blood contamination on the urine protein/creatinine ratio in the dog. *J. Vet. Intern. Med.* **5**, 66–70.
- Bailey, D. B., Rassnick, K. M., Erb, H. N., Dykes, N. L., Hoopes, P. J., and Page, R. L. (2004). Effect of glomerular filtration rate on clearance and myelotoxicity of carboplatin in cats with tumors. *Am. J. Vet. Res.* **65**, 1502–1507.
- Bains, R. K., Sibbons, P. D., Murray, R. D., Howard, C. V., and Van Velzen, D. (1996). Stereological estimation of the absolute number of glomeruli in the kidneys of lambs. *Res. Vet. Sci.* **60**, 122–125.
- Balazs, T., Sekella, R., and Pauls, F. (1971). Renal concentration test in beagle dogs. *Lab. Anim. Sci.* **21**, 546–548.
- Balint, P., and Forgacs, I. (1967). Parameters of renal function in the anaesthetized and the unanaesthetized dog. *Acta Physiol. Acad. Sci. Hung.* **31**, 99–106.

- Bankir, L., and de Rouffignac, C. (1985). Urinary concentrating ability: insights from comparative anatomy. *Am. J. Physiol* **249**, R643–R666.
- Barber, P. J., and Elliott, J. (1998). Feline chronic renal failure: calcium homeostasis in 80 cases diagnosed between 1992 and 1995. *J. Small Anim. Pract.* **39**, 108–116.
- Barlough, J. E., Osborne, C. A., and Stevens, J. B. (1981). Canine and feline urinalysis: value of macroscopic and microscopic examinations. *J. Am. Vet. Med. Assoc.* **178**, 61–63.
- Barsanti, J. A., DiBartola, S. P., and Finco, D. R. (2000). Diagnostic approach to polyuria and polydipsia. In “Kirk’s Current Veterinary Therapy XIII Small Animal Practice” (J. D. Bonagura, Ed.), pp. 831–835. Saunders, Philadelphia.
- Barsanti, J. A., and Finco, D. R. (1979). Protein concentration in urine of normal dogs. *Am. J. Vet. Res.* **40**, 1583–1588.
- Bartges, J. W., Osborne, C. A., Felice, L. J., Allen, T. A., Brown, C., Koehler, L. A., Bird, K. A., Unger, L. K., and Chen, M. (1995a). Influence of four diets containing approximately 11% protein (dry weight) on uric acid, sodium urate, and ammonium urate urine activity product ratios of healthy beagles. *Am. J. Vet. Res.* **56**, 60–65.
- Bartges, J. W., Osborne, C. A., Felice, L. J., Allen, T. A., Brown, C., Unger, L. K., Koehler, L. A., Bird, K. A., and Chen, M. (1995b). Diet effect on activity product ratios of uric acid, sodium urate, and ammonium urate in urine formed by healthy beagles. *Am. J. Vet. Res.* **56**, 329–333.
- Bartges, J. W., Osborne, C. A., Felice, L. J., Brown, C., Allen, T. A., Koehler, L., Unger, L., Bird, K., and Chen, M. (1995c). Influence of two amounts of dietary casein on uric acid, sodium urate, and ammonium urate urinary activity product ratios of healthy beagles. *Am. J. Vet. Res.* **56**, 893–897.
- Bartges, J. W., Osborne, C. A., Felice, L. J., Unger, L. K., and Chen, M. (1995d). Influence of allopurinol and two diets on 24-hour urinary excretions of uric acid, xanthine, and ammonia by healthy dogs. *Am. J. Vet. Res.* **56**, 595–599.
- Barthez, P. Y., Chew, D. J., and DiBartola, S. P. (2001). Simplified methods for estimation of <sup>99m</sup>Tc-pentetate and <sup>131I</sup>-orthoiodohippurate plasma clearance in dogs and cats. *J. Vet. Intern. Med.* **15**, 200–208.
- Barthez, P. Y., Hornof, W. J., Cowgill, L. D., Neal, L. A., and Mickel, P. (1998). Comparison between the scintigraphic uptake and plasma clearance of <sup>99m</sup>Tc-diethylenetriaminepentacetic acid (DTPA) for the evaluation of the glomerular filtration rate in dogs. *Vet. Radiol. Ultrasound* **39**, 470–474.
- Baylis, C., and Brenner, B. M. (1978). Mechanism of the glucocorticoid-induced increase in glomerular filtration rate. *Am. J. Physiol.* **234**, F166–F170.
- Beech, J., Lindborg, S., and Braund, K. G. (1993). Potassium concentrations in muscle, plasma and erythrocytes and urinary fractional excretion in normal horses and those with chronic intermittent exercise-associated rhabdomyolysis. *Res. Vet. Sci.* **55**, 43–51.
- Behr, S., Trumel, C., Palanche, F., and Braun, J. P. (2003). Assessment of a pyrogallol red technique for total protein measurement in the cerebrospinal fluid of dogs. *J. Small Anim. Pract.* **44**, 530–533.
- Behrend, E. N., Grauer, G. F., Mani, I., Groman, R. P., Salman, M. D., and Greco, D. S. (1996). Hospital-acquired acute renal failure in dogs: 29 cases (1983–1992). *J. Am. Vet. Med. Assoc.* **208**, 537–541.
- Benzing, T. (2004). Signaling at the slit diaphragm. *J. Am. Soc. Nephrol* **15**, 1382–1391.
- Berliner, R. W., and Kennedy, T. J. (1948). Renal tubular secretion of potassium in the normal dog. *Proc. Soc. Exp. Biol. Med.* **67**, 542–545.
- Berry, L. M., Ikegami, M., Woods, E., and Ervin, M. G. (1995). Postnatal renal adaptation in preterm and term lambs. *Reprod. Fertil. Dev.* **7**, 491–498.
- Bianca, W., Findlay, J. D., and McLean, J. A. (1965). Responses of steers to water restriction. *Res. Vet. Sci.* **35**, 38–55.
- Bickhardt, K. (1994). Clinical studies of kidney function in sheep. II. Effect of pregnancy, lactation and feed restriction and metabolic diseases on kidney function. *Dtsch. Tierarztl. Wochenschr.* **101**, 467–471.
- Bickhardt, K., Deegen, E., and Espelage, W. (1996). Kidney function tests in horses—methods and reference values in healthy animals. *Dtsch. Tierarztl. Wochenschr.* **103**, 117–122.
- Bickhardt, K., and Dungenhoef, R. (1994). Clinical studies of kidney function in sheep. I. Methods and reference values of healthy animals. *Dtsch. Tierarztl. Wochenschr.* **101**, 463–466.
- Biewenga, W. J., and Gruys, E. (1986). Proteinuria in the dog: a clinicopathological study in 51 proteinuric dogs. *Res. Vet. Sci.* **41**, 257–264.
- Biewenga, W. J., Gruys, E., and Hendriks, H. J. (1982). Urinary protein loss in the dog: nephrological study of 29 dogs without signs of renal disease. *Res. Vet. Sci.* **33**, 366–374.
- Biewenga, W. J., and van den Brom, W. E. (1981). Assessment of glomerular filtration rate in dogs with renal insufficiency: analysis of the <sup>51</sup>Cr-EDTA clearance and its relation to the plasma concentrations of urea and creatinine. *Res. Vet. Sci.* **30**, 158–160.
- Biewenga, W. J., van den Brom, W. E., and Mol, J. A. (1987). The use of arginine vasopressin measurements in the polyuric dog. *Tijdschr. Diergeneesk.* **112**(suppl 1), 117S–120S.
- Bing, J., and Effersoe, P. (1948). Comparative tests of the thiosulphate and creatinine clearance in rabbits and cats. *Acta Physiol. Scand.* **15**, 231–236.
- Bishop, S. A., Lucke, V. M., Stokes, C. R., and Gruffydd-Jones, T. J. (1991). Plasma and urine biochemical changes in cats with experimental immune complex glomerulonephritis. *J. Comp. Pathol.* **104**, 65–76.
- Blavier, A., Keroack, S., Denerolle, P., Goy-Thollot, I., Chabanne, L., Cadore, J. L., and Bourdoiseau, G. (2001). Atypical forms of canine leishmaniosis. *Vet. J.* **162**, 108–120.
- Blijenberg, B. G., Brouwer, H. J., Kuller, T. J., Leeneman, R., and van Leeuwen, C. J. M. (1994). Improvement in creatinine methodology: a critical assessment. *Eur. J. Clin. Chem. Clin. Biochem.* **32**, 529–537.
- Boehnke, E. (1980). Untersuchungen zur Kreatininausscheidung bei Mastkälbern und zur endogenen Kreatininclearance bei Jungbullen. *Zbl. Vet. Med. A.* **27**, 421–428.
- Bolliger, C., Walshaw, R., Kruger, J. M., Rosenstein, D. S., Richter, M. A., Hauptman, J. G., and Mauer, W. A. (2005). Evaluation of the effects of nephrotomy on renal function in clinically normal cats. *Am. J. Vet. Res.* **66**, 1400–1407.
- Bomhard, E., Maruhn, D., Vogel, O., and Mager, H. (1990). Determination of urinary glutathione S-transferase and lactate dehydrogenase for differentiation between proximal and distal nephron damage. *Arch. Toxicol.* **64**, 269–278.
- Bostrom, I., Nyman, G., Kampa, N., Haggstrom, J., and Lord, P. (2003). Effects of acepromazine on renal function in anesthetized dogs. *Am. J. Vet. Res.* **64**, 590–598.
- Bostrom, I. M., Nyman, G., Hoppe, A., and Lord, P. (2006). Effects of meloxicam on renal function in dogs with hypotension during anesthesia. *Vet. Anesth. Analg.* **33**, 62–69.
- Boure, T., and Vanholder, R. (2004). Biochemical and clinical evidence for uremic toxicity. *Artif. Organs* **28**, 248–253.
- Bourgoignie, J. J., Gavellas, G., Martinez, E., and Pardo, V. (1987). Glomerular function and morphology after renal mass reduction in dogs. *J. Lab. Clin. Med.* **109**, 380–388.

- Bovee, K. C. (1969). Urine osmolality as a definitive indicator of renal concentrating capacity. *J. Am. Vet. Med. Assoc.* **155**, 30–34.
- Bovee, K. C. (1992). High dietary protein intake does not cause progressive renal failure in dogs after 75% nephrectomy or aging. *Semin. Vet. Med. Surg. (Small Anim.)* **7**, 227–236.
- Bovee, K. C., and Joyce, T. (1979). Clinical evaluation of glomerular function: 24-hour creatinine clearance in dogs. *J. Am. Vet. Med. Assoc.* **174**, 488–491.
- Bovee, K. C., Joyce, T., Blazer-Yost, B., Goldschmidt, M. S., and Segal, S. (1979). Characterization of renal defects in dogs with a syndrome similar to the Fanconi syndrome in man. *J. Am. Vet. Med. Assoc.* **174**, 1094–1099.
- Bovee, K. C., and Kronfeld, D. S. (1981). Reduction of renal hemodynamics in uremic dogs fed reduced protein diets. *J. Am. Anim. Hosp. Assoc.* **17**, 277–285.
- Bovee, K. C., Joyce, T., Reynolds, R., et al. (1978). The Fanconi syndrome in Basenji dogs: a new model for renal transport defects. *Science* **201**, 1129–1131.
- Bovee, K. C., Joyce, T., Reynolds, R., et al. (1978). Spontaneous Fanconi syndrome in the dog. *Metabolism* **27**, 45–52.
- Braun, J. P., Guelfi, J. F., Thouvenot, J. P., and Rico, A. G. (1981). Haematological and biochemical effects of a single intramuscular dose of 6-methylprednisolone acetate in the dog. *Res. Vet. Sci.* **31**, 236–238.
- Braun, J. P., and Lefebvre, H. P. (2005). Early detection of renal disease in the canine patient. *Eur. J. Comp. Anim. Pract.* **15**, 59–64.
- Braun, J. P., Lefebvre, H. P., and Watson, A. D. (2003). Creatinine in the dog: a review. *Vet. Clin. Pathol.* **32**, 162–179.
- Braun, J. P., Perxachs, A., Pechereau, D., and de La Farge, F. (2002). Plasma cystatin C in the dog: reference values and variations with renal failure. *Comp. Clin. Path.* **11**, 44–49.
- Bret, L., Hasim, M., Lefebvre, H., Fournie, G. J., and Braun, J. P. (1993). Kidney tubule enzymes and extracellular DNA in urine as markers of nephrotoxicity in guinea pig. *Enzyme. Protein* **47**, 27–36.
- Breitschwerdt, E. B., Ochoa, R., and Waltman, C. (1983). Multiple endocrine abnormalities in Basenji dogs with renal tubular dysfunction. *J. Am. Vet. Med. Assoc.* **182**, 1348–1353.
- Bricker, N. S., Morrin, P. A., and Kime, S. W., Jr. (1997). The pathologic physiology of chronic Bright's disease. An exposition of the "intact nephron hypothesis." *J. Am. Soc. Nephrol.* **8**, 1470–1476.
- Brinkman, J. W., de Zeeuw, D., Duker, J. J., Gansevoort, R. T., Kema, I. P., Hillege, H. L., de Jong, P. E., and Bakker, S. J. L. (2005). Falsely low urinary albumin concentrations after prolonged frozen storage of urine samples. *Clin. Chem.* **51**, 2181–2183.
- Brobst, D. F., Carroll, R. J., and Bayly, W. M. (1986). Urinary enzyme concentrations in healthy horses. *Cornell. Vet.* **76**, 299–305.
- Brobst, D. F., Grant, B. D., Hilbert, B. J., Nickels, F. A., Wagner, P., and Waugh, S. L. (1977). Blood biochemical changes in horses with prerenal and renal disease. *J. Am. Anim. Hosp. Assoc.* **1**, 171–177.
- Brobst, D. F., Lee, H. A., and Spencer, G. R. (1978a). Hypercalcemia and hypophosphatemia in a mare with renal insufficiency. *J. Am. Vet. Med. Assoc.* **173**, 1370–1372.
- Brobst, D. F., Parish, S. M., Torbeck, R. L., Frost, O. L., and Bracken, F. K. (1978b). Azotemia in cattle. *J. Am. Vet. Med. Assoc.* **173**, 481–485.
- Brooks, C. L., Garry, F., and Swartout, M. S. (1988). Effect of an interfering substance on determination of potassium by ion-specific potentiometry in animal urine. *Am. J. Vet. Res.* **49**, 710–714.
- Brooks, H. W., Gleadhill, A., Wagstaff, A. J., and Michell, A. R. (1997). Fallibility of plasma urea and creatinine as indices of renal function in diarrhoeic calves treated with conventional or nutritional oral rehydration solutions. *Vet. J.* **154**, 35–39.
- Broulet, V., Fayolle, P., Braun, J. P., Thouvenot, J. P., and Rico, A. G. (1986). Influence du sexe et de l'âge sur les valeurs usuelles de l'hématologie et de la biochimie sérique de chiens "tout-venant." *Prat. Med. Chir. Anim. Comp.* **21**, 221–225.
- Brown, S. A. (1992). Dietary protein restriction: some unanswered questions. *Semin. Vet. Med. Surg. (Small Anim.)* **7**, 237–243.
- Brown, S. A., Barsanti, J. A., and Finco, D. R. (1993). Determinants of glomerular ultrafiltration in cats. *Am. J. Vet. Res.* **54**, 970–975.
- Brown, S. A., Brown, C. A., Crowell, W. A., Barsanti, J. A., Kang, C. W., Allen, T., Cowell, C., and Finco, D. R. (2000). Effects of dietary polyunsaturated fatty acid supplementation in early renal insufficiency in dogs. *J. Lab. Clin. Med.* **135**, 275–286.
- Brown, S. A., Brown, C. A., Jacobs, G., Stiles, J., Hendi, R. S., and Wilson, S. (2001). Effects of the angiotensin converting enzyme inhibitor benazepril in cats with induced renal insufficiency. *Am. J. Vet. Res.* **62**, 375–383.
- Brown, S. A., Crowell, W. A., Barsanti, J. A., et al. (1991). Beneficial effects of dietary mineral restriction in dogs with marked reduction of functional renal mass. *J. Am. Soc. Nephrol.* **1**, 1169–1179.
- Brown, S. A., Crowell, W. A., Brown, C. A., Barsanti, J. A., and Finco, D. R. (1997). Pathophysiology and management of progressive renal disease. *Vet. J.* **154**, 93–109.
- Brown, S. A., Finco, D. R., Bartges, J. W., Brown, C. A., and Barsanti, J. A. (1998a). Interventional nutrition for renal disease. *Clin. Tech. Small Anim. Pract.* **13**, 217–223.
- Brown, S. A., Finco, D. R., Boudinot, F. D., Wright, J., Tarver, S. L., and Cooper, T. (1996). Evaluation of a single injection method, using iohexol, for estimating glomerular filtration rate in cats and dogs. *Am. J. Vet. Res.* **57**, 105–110.
- Brown, S. A., Finco, D. R., Crowell, W. A., et al. (1991). Dietary protein intake and the glomerular adaptations to partial nephrectomy in dogs. *J. Nutr.* **121**, S125–S127.
- Brown, S. A., and Finco, D. R. (1992). Characterization of the renal response to protein ingestion in dogs with experimentally induced renal failure. *Am. J. Vet. Res.* **53**, 569–573.
- Brown, S. A., Finco, D. R., and Brown, C. A. (1998b). Is there a role for dietary polyunsaturated fatty acid supplementation in canine renal disease? *J. Nutr.* **128**, 2765S–2767S.
- Brown, S. A., Finco, D. R., and Navar, L. G. (1995). Impaired renal autoregulatory ability in dogs with reduced renal mass. *J. Am. Soc. Nephrol.* **5**, 1768–1774.
- Brown, S. A., and Garry, F. B. (1988). Comparison of serum and renal gentamicin concentrations with fractional urinary excretion tests as indicators of nephrotoxicity. *J. Vet. Pharmacol. Toxicol.* **11**, 330–337.
- Brown, S. A., Rakich, P. M., Barsanti, J. A., Finco, D. R., and Kickbush, C. (1986). Fanconi syndrome and acute renal failure associated with gentamicin therapy in a dog. *J. Am. Anim. Hosp. Assoc.* **22**, 635–640.
- Bulger, R. E., Burke, T. J., Cronin, R. E., Schrier, R. W., and Doby, D. C. (1986). Morphology of norepinephrine-induced acute renal failure in the dog. *Anat. Rec.* **214**, 341–347.
- Buranakarl, C., Mathur, S., and Brown, S. A. (2004). Effects of dietary sodium chloride intake on renal function and blood pressure in cats with normal and reduced renal function. *Am. J. Vet. Res.* **65**, 620–627.
- Burkhardt, A. E., Johnston, K. G., Waszak, C. E., Jackson, C. E., and Shafer, S. R. (1982). A reagent strip for measuring the specific gravity of urine. *Clin. Chem.* **28**, 2068–2072.
- Burton, S., Lemke, K. A., Ihle, S. L., and Mackenzie, A. L. (1998). Effects of medetomidine on serum osmolality; urine volume, osmolality and

- pH; free water clearance; and fractional clearance of sodium, chloride, potassium, and glucose in dogs. *Am. J. Vet. Res.* **59**, 756–761.
- Campbell, J. R., and Watts, C. (1970). Blood urea in the bovine animal. *Vet. Rec.* **87**, 127–132.
- Caple, I. W., Bourke, J. M., and Ellis, P. G. (1982a). An examination of the calcium and phosphorus nutrition of thoroughbred racehorses. *Aust. Vet. J.* **58**, 132–135.
- Caple, I. W., Doake, P. A., and Ellis, P. G. (1982b). Assessment of the calcium and phosphorus nutrition in horses by analysis of urine. *Aust. Vet. J.* **58**, 125–131.
- Carriere, S. (1978). Compensatory renal hypertrophy in dogs: single nephron glomerular filtration rate. *Yale J. Biol. Med.* **51**, 307–313.
- Center, S. A., Smith, C. A., Wilkinson, E., Erb, H. N., and Lewis, R. M. (1987). Clinicopathologic, renal immunofluorescent, and light microscopic features of glomerulonephritis in the dog: 41 cases (1975–1985). *J. Am. Vet. Med. Assoc.* **190**, 81–90.
- Center, S. A., Wilkinson, E., Smith, C. A., Erb, H., and Lewis, R. M. (1985). 24-Hour urine protein/creatinine ratio in dogs with protein-losing nephropathies. *J. Am. Vet. Med. Assoc.* **187**, 820–824.
- Chaiyabutr, N., Buranakari, C., Tesapateep, T., et al. (1987). Changes in renal functions during beta-blocker carazolol administration in acute heat-stressed pigs. *Br. Vet. J.* **143**, 448–453.
- Chanoit, G. P., Concordet, D., Lefebvre, H. P., Orceel, K., and Braun, J. P. (2002). Exercise does not induce major changes in plasma muscle enzymes, creatinine, glucose and total protein concentrations in untrained Beagle dogs. *J. Vet. Med. A.* **49**, 222–224.
- Choi, E. W., and Lee, C. W. (2004). Development of a canine nephrotic syndrome model. *J. Vet. Med. Sci.* **66**, 169–174.
- Churchill, J. A., Feeney, D. A., Fletcher, T. F., et al. (1999). Effects of diet and aging on renal measurements in uninephrectomized geriatric bitches. *Vet. Radiol. Ultrasound* **40**, 233–240.
- Cirio, A., and Boivin, R. (1990a). [Renal extraction of para-aminohippurate and inulin from sheep on low-protein diets]. *Ann. Rech. Vet.* **21**, 167–170.
- Cirio, A., and Boivin, R. (1990b). [Renal plasma flow and glomerular filtration in conscious sheep: effect of a free-protein diet]. *Reprod. Nutr. Dev.* (suppl 2), 239s–240s.
- Cirio, A., Boivin, R., and Grancher, D. (1990). [Diuresis, renal plasma flow and glomerular filtration in conscious and anesthetized sheep: the effects of a diet deficient in proteins]. *Ann. Rech. Vet.* **21**, 23–32.
- Cirio, A., Meot, F., Delignette-Muller, M. L., and Boivin, R. (2000). Determination of parotid urea secretion in sheep by means of ultrasonic flow probes and a multifactorial regression analysis. *J. Anim. Sci.* **78**, 471–476.
- Clarke, L. L., Argenzio, R. A., and Roberts, M. C. (1990). Effect of meal feeding on plasma volume and urinary electrolyte clearance in ponies. *Am. J. Vet. Res.* **51**, 571–576.
- Coffman, J. (1980). Clinical chemistry and pathophysiology of horses. Percent creatinine clearance ratios. *Vet. Med. Small. Anim. Clin.* **12**, 671–676.
- Cohen, M., and Post, G. S. (2002). Water transport in the kidney and nephrogenic diabetes insipidus. *J. Vet. Intern. Med.* **16**, 510–517.
- Cohen, N. D., Peck, K. E., Smith, S. A., and Ray, A. C. (2002). Values of urine specific gravity for thoroughbred horses treated with furosemide prior to racing compared with untreated horses. *J. Vet. Diagn. Invest.* **14**, 231–235.
- Connally, H. E., Thrall, M. A., Forney, S. D., Grauer, G. F., and Hamar, D. W. (1996). Safety and efficacy of 4-methylpyrazole for treatment of suspected or confirmed ethylene glycol intoxication in dogs: 107 cases (1983–1995). *J. Am. Vet. Med. Assoc.* **209**, 1880–1883.
- Constable, P. D. (1991). Letter to the editor. *J. Vet. Intern. Med.* **5**, 357–358.
- Cook, A. K., and Cowgill, L. D. (1996). Clinical and pathological features of protein-losing glomerular disease in the dog: a review of 137 cases (1985–1992). *J. Am. Anim. Hosp. Assoc.* **32**, 313–322.
- Cowgill, L. D. (1992). Pathophysiology and management of anemia in chronic progressive renal failure. *Semin. Vet. Med. Surg. (Small. Anim.)* **7**, 175–182.
- Cowgill, L. D., and Elliott, D. A. (2000). Acute renal failure. In “Textbook of Veterinary Internal Medicine” (S. J. Ettinger and E. C. Feldman, Eds.), 5th ed., pp. 1615–1633. Saunders, Philadelphia.
- Cowgill, L. D., and Hornhof, W. J. (1986). Assessment of individual kidney function by quantitative renal scintigraphy. In “Current Veterinary Therapy IX Small Animal Practice” (R. W. Kirk, Ed.), pp. 110–118. Saunders, Philadelphia.
- Cowgill, L. D., and Spangler, W. L. (1981). Renal insufficiency in geriatric dogs. *Vet. Clin. N. Amer. Small. Anim. Pract.* **11**, 727–748.
- Crandell, D. E., Mathews, K. A., and Dyson, D. H. (2004). Effect of meloxicam and carprofen on renal function when administered to healthy dogs prior to anesthesia and painful stimulation. *J. Am. Vet. Med. Assoc.* **65**, 1384–1390.
- Cullen-McEwen, L. A., Kett, M. M., Dowling, J., Anderson, W. P., and Bertram, J. F. (2003). Nephron number, renal function, and arterial pressure in aged GDNF heterozygous mice. *Hypertension* **41**, 335–340.
- Dalton, R. G. (1968). Renal function in neonatal calves: inulin, thio-sulphate, and para-aminohippuric acid clearance. *Br. Vet. J.* **124**, 498–502.
- Daniel, G. B., Mitchell, S. K., Mawby, D., Sackman, J. E., and Schmidt, D. (1999). Renal nuclear medicine: a review. *Vet. Radiol. Ultrasound* **40**, 572–587.
- Darrigrand-Haag, R. A., Center, S. A., Randolph, J. F., Lewis, R. M., and Wood, P. A. (1996). Congenital Fanconi syndrome associated with renal dysplasia in 2 Border terriers. *J. Vet. Intern. Med.* **10**, 412–419.
- Daugaard, G., Abilgaard, U., Larsen, S., Holstein-Rathlou, N.H., Amtorp, O., Olesen, H. P., and Leyssac, P. P. (1987). Functional and histopathological changes in dog kidneys after administration of cisplatin. *Renal. Physiol.* **10**, 54–64.
- Davenport, D. J., Mostardi, R. A., Richardson, D. C., Gross, K. L., Greene, K. A., and Blair, K. (1994). Protein-deficient diet alters serum alkaline phosphatase, bile acids, proteins and urea nitrogen in dogs. *J. Nutr.* **124**, 2677S–2679S.
- Davies, C., Forrester, S. D., Troy, G. C., Saunders, G. K., Shell, L. G., and Johnston, S. A. (1998). Effects of a prostaglandin E1 analogue, misoprostol, on renal function in dogs receiving nephrotoxic doses of gentamicin. *Am. J. Vet. Res.* **59**, 1048–1054.
- de Schepper, J., Capiou, E., van Bree, H., and de Cock, I. (1989a). The diagnostic significance of increased urinary and serum amylase activity in bitches with pyometra. *Zentralbl. Veterinarmed. A* **36**, 431–437.
- de Schepper, J., de Cock, I., and Capiou, E. (1989b). Urinary gamma-glutamyl transferase and the degree of renal dysfunction in 75 bitches with pyometra. *Res. Vet. Sci.* **46**, 396–400.
- de Weer, P. (1992). Cellular sodium-potassium transport. In “The Kidney: Physiology and Physiopathology” (D. W. Seldin and G. Giebisch, Eds.), 2nd ed., pp. 93–112. Raven Press, New York.
- Deen, W. M., Lazzara, M. J., and Myers, B. D. (2001). Structural determinants of glomerular permeability. *Am. J. Physiol. Renal. Physiol.* **281**, F579–F596.
- Deetz, L. E., Tucker, R. E., Mitchell, G. E., Jr., and DeGregorio, R. M. (1982). Renal function and magnesium clearance in young and old cows given potassium chloride and sodium citrate. *J. Anim. Sci.* **55**, 680–689.

- Deguchi, E., and Akuzawa, M. (1997). Renal clearance of endogenous creatinine, urea, sodium, and potassium in normal cats and cats with chronic renal failure. *J. Vet. Med. Sci.* **59**, 509–512.
- Devaux, C., Polzin, D. J., and Osborne, C. A. (1996). What role does dietary protein restriction play in the management of chronic renal failure in dogs? *Vet. Clin. North. Am. Small. Anim. Pract.* **26**, 1247–1267.
- Dial, S. M. (1995). Clinicopathologic evaluation of the liver. *Vet. Clin. North. Am. Small. Anim. Pract.* **25**, 257–273.
- DiBartola, S. P. (2000). Clinical approach and laboratory evaluation of renal disease. In “Textbook of Veterinary Internal Medicine” (S. J. Ettinger and E. C. Feldman, Eds.), 5th ed., pp. 1600–1614. Saunders, Philadelphia.
- DiBartola, S. P. (2005a). Familial renal disease in dogs and cats. In “Textbook of Veterinary Internal Medicine” (S. J. Ettinger and E. C. Feldman, Eds.), 6th ed., pp. 1819–1824. Elsevier Saunders, St. Louis, MO.
- DiBartola, S. P. (2005b). Renal disease: clinical approach and laboratory evaluation. In “Textbook of Veterinary Internal Medicine” (S. J. Ettinger and E. C. Feldman, Eds.), 6th ed., pp. 1716–1730. Elsevier Saunders, St. Louis, MO.
- DiBartola, S. P., Broome, M. R., Stein, B. S., and Nixon, M. (1996). Effect of treatment of hyperthyroidism on renal function in cats. *J. Am. Vet. Med. Assoc.* **208**, 875–878.
- DiBartola, S. P., Chew, D. J., and Jacobs, G. (1980a). Quantitative urinalysis including 24-hour protein excretion in the dog. *J. Am. Anim. Hosp. Assoc.* **16**, 537–546.
- DiBartola, S. P., Rutgers, H. C., Zack, P. M., et al. (1987). Clinicopathologic findings associated with chronic renal disease in cats: 74 cases (1973–1984). *J. Am. Vet. Med. Assoc.* **19**, 1196–1202.
- DiBartola, S. P., Spaulding, G. L., Chew, D. J., and Lewis, R. M. (1980b). Urinary protein excretion and immunopathologic findings in dogs with glomerular disease. *J. Am. Vet. Med. Assoc.* **177**, 73–77.
- DiBartola, S. P., Tarr, M. J., Parker, A. T., Powers, J. D., and Pultz, J. A. (1989). Clinicopathologic findings in dogs with renal amyloidosis: 59 cases (1976–1986). *J. Am. Vet. Med. Assoc.* **195**, 358–364.
- Divers, T. J., Crowell, W. A., Duncan, J. R., and Whitlock, R. H. (1982). Acute renal disorders in cattle: a retrospective study of 22 cases. *J. Am. Vet. Med. Assoc.* **181**, 694–699.
- Doreau, M., and Martin-Rosset, W. (1985). Uraemia in the mare: effects of seasonal variations, of energy level of the diet and individual differences. *Ann. Rech. Vet.* **16**, 87–91.
- Dorizzi, R., Pradella, M., Bertoldo, S., and Rigolin, F. (1987). Refractometry, test strip, and osmometry compared as measures of relative density of urine. *Clin. Chem.* **33**, 190.
- Dossin, O., Germain, C., and Braun, J. P. (2003). Comparison of the techniques of evaluation of urine dilution/concentration in the dog. *J. Vet. Med. A. Physiol. Pathol. Clin. Med.* **50**, 322–325.
- Dow, S. W., Fettman, M. J., Smith, K. R., Hamar, D. W., Nagode, L. A., Refsal, K. R., and Wilke, W. L. (1990). Effects of dietary acidification and potassium depletion on acid-base balance, mineral metabolism and renal function in adult cats. *J. Nutr.* **120**, 569–578.
- Driehuys, S., Van Winkle, T. J., Sammarco, C. D., and Drobatz, K. J. (1998). Myocardial infarction in dogs and cats: 37 cases (1985–1994). *J. Am. Vet. Med. Assoc.* **213**, 1444–1448.
- Driessen, B., Zaruco, L., Steffey, E. P., McCullough, C., Del Piero, F., Melton, L., Puschner, B., and Stover, S. M. (2002). Serum fluoride concentrations, biochemical and histopathological changes associated with prolonged sevoflurane anaesthesia in horses. *J. Vet. Med. A. Physiol. Pathol. Clin. Med.* **49**, 337–347.
- Drost, W. T., Henry, G. A., Meinkoth, J. H., Woods, J. P., Payton, M. E., and Rodebush, C. (2000). The effects of a unilateral ultrasound-guided renal biopsy on renal function in healthy sedated cats. *Vet. Radiol. Ultrasound* **41**, 57–62.
- Dubach, U. C., and Schmidt, U. (1979). “Diagnostic Significance of Enzymes and Proteins in Urine.” Hans Huber, Bern, Switzerland.
- Duffee, N. E., Bevill, R. F., Koritz, G. D., and Schaeffer, D. J. (1990). An experimental model for pharmacokinetic analysis in renal failure. *J. Pharmacokinet. Biopharm.* **18**, 71–86.
- Dunegan, L. J., Knight, D. C., Brennan, M. F., and Moore, F. D. (1978). Urea distribution in renal failure. *J. Surg. Res.* **24**, 401–403.
- Easley, J. R., and Breitschwerdt, D. B. (1976). Glucosuria associated with renal tubular dysfunction in three Basenji dogs. *J. Am. Vet. Med. Assoc.* **168**, 938–943.
- Ebert, R., Schütze, N., Adamski, J., and Jacob, F. (2006). Vitamin D signaling is modulated on multiple levels in health and disease. *Mol. Cell. Endocrinol.* **248**, 149–159.
- Edwards, D. J., Brownlow, M. A., and Hutchins, D. R. (1989). Indices of renal function: reference values in normal horses. *Aust. Vet. J.* **66**, 60–63.
- Edwards, D. J., Brownlow, M. A., and Hutchins, D. R. (1990). Indices of renal function: values in eight normal foals from birth to 56 days. *Aust. Vet. J.* **67**, 251–254.
- Edwards, D. J., Love, D. N., Raus, J., and Baggott, J. D. (1989). The nephrotoxic potential of neomycin in the horse. *Equine. Vet. J.* **21**, 206–210.
- Elliott, J. (2007). Staging chronic kidney disease. In “BSAVA Manual of Canine and Feline Nephrology and Urology” (J. Elliott and G. F. Grauer, Eds.), 2nd ed., pp. 159–166. BSAVA, Gloucester, UK.
- Elliott, J., and Barber, P. J. (1998). Feline chronic renal failure: clinical findings in 80 cases diagnosed between 1992 and 1995. *J. Small Anim. Pract.* **39**, 78–85.
- Elliott, J., and Barber, P. J. (1998). Feline chronic renal failure: clinical findings in 80 cases diagnosed between 1992 and 1995. *J. Small Anim. Pract.* **39**, 78–85.
- Elliott, J., Rawlings, J. M., Markwell, P. J., and Barber, P. J. (2000). Survival of cats with naturally occurring chronic renal failure: effect of dietary management. *J. Small. Anim. Pract.* **41**, 235–242.
- Ellis, B. G., Price, R. G., and Topham, J. C. (1973a). The effect of papillary damage by ethyleneimine on kidney function and some urinary enzymes in the dog. *Chem. Biol. Interact.* **7**, 131–141.
- Ellis, B. G., Price, R. G., and Topham, J. C. (1973b). The effect of tubular damage by mercuric chloride on kidney function and some urinary enzymes in the dog. *Chem. Biol. Interact.* **7**, 101–113.
- Ellis, B. G., Price, R. G., and Topham, J. C. (1973c). Urinary enzymes and the detection of kidney damage in the dog. *Biochem. Soc. Transac.* **1**, 995–997.
- English, P. B., Filippich, L. J., and Thompson, H. L. (1980). Clinical assessment of renal function in the dog with a reduction in nephron number. *Aust. Vet. J.* **56**, 305–312.
- English, P. B., and Hogan, A. E. (1979). A comparison of urinary specific gravity and osmolality in sheep. *Aust. Vet. J.* **55**, 584–586.
- English, P. B., Hogan, A. E., and McDougall, H. L. (1997). Changes in renal function with reductions in renal mass. *Am. J. Vet. Res.* **38**, 1317–1322.
- Epstein, J. B., and Zambraski, E. J. (1979). Proteinuria in the exercising dog. *Med. Sci. Sports* **11**, 348–350.
- Epstein, M. E., Barsanti, J. A., Finco, D. R., and Cowgill, L. M. (1984). Postprandial changes in plasma urea nitrogen and plasma creatinine concentrations in dogs fed commercial diets. *J. Am. Anim. Hosp. Assoc.* **20**, 779–782.

- Eriksson, L., and Valtonen, M. (1982). Renal urea handling in goats fed high and low protein diets. *J. Dairy Sci.* **65**, 385–389.
- Evans, G. O. (1987). Post-prandial changes in canine plasma creatinine. *J. Small. Anim. Pract.* **28**, 311–315.
- Ewald, B. H. (1967). Renal function tests in normal Beagle dogs. *Am. J. Vet. Res.* **28**, 741–749.
- Faulks, R. D., and Lane, I. F. (2003). Qualitative urinalyses in puppies 0 to 24 weeks of age. *J. Am. Anim. Hosp. Assoc.* **39**, 369–378.
- Feeman, W. E., 3rd, Couto, C. G., and Gray, T. L. (2003). Serum creatinine concentrations in retired racing Greyhounds. *Vet. Clin. Pathol.* **32**, 40–42.
- Feeney, D. A., Osborne, C. A., and Jessen, C. R. (1980a). Effect of multiple excretory urograms on glomerular filtration of normal dogs: a preliminary report. *Am. J. Vet. Res.* **41**, 960–963.
- Feeney, D. A., Osborne, C. A., and Jessen, C. R. (1980b). Effects of radiographic contrast media on results of urinalysis, with emphasis on alteration in specific gravity. *J. Am. Vet. Med. Assoc.* **176**, 1378–1381.
- Feraille, E., and Doucet, A. (2001). Sodium-potassium-adenosinetriphosphatase-dependent sodium transport in the kidney: hormonal control. *Physiol. Rev.* **81**, 345–418.
- Fetcher, A. (1985). Renal disease in cattle. Causative agents. *Comp. Cont. Educ. Pract. Vet.* **7**, S701–S707.
- Fetcher, A. (1986). Renal disease in cattle. Part II. Clinical signs, diagnosis, and treatment. *Comp. Cont. Educ. Pract. Vet.* **8**, S338–S345.
- Fettman, M. J. (1987). Evaluation of the usefulness of routine microscopy in canine urinalysis. *J. Am. Vet. Med. Assoc.* **190**, 892–896.
- Fettman, M. J. (1989). Comparison of urinary protein concentration and protein/creatinine ratio vs routine microscopy in urinalysis of dogs: 500 cases (1987–1988). *J. Am. Vet. Med. Assoc.* **195**, 926–972.
- Fettman, M. J., Allen, T. A., Wilke, W. L., et al. (1985). Single-injection method for evaluation of renal function with <sup>14</sup>C-inulin and <sup>3</sup>H-tetraethylammonium bromide in dogs and cats. *Am. J. Vet. Res.* **46**, 482–485.
- Filippich, L. J. (1992). Renal clearance studies in cats with chronic renal disease: dietary implications. *J. Small. Anim. Pract.* **33**, 191–196.
- Filippich, L. J., English, P. B., and Ainscow, J. (1985). Assessment of compensatory renal function and [<sup>125</sup>I]iothalamate clearance in sheep. *Am. J. Vet. Res.* **46**, 2311–2316.
- Filler, G., Bokenkamp, A., Hofmann, W., Le Bricon, T., Martinez-Bru, C., and Grubb, A. (2005). Cystatin C as a marker of GFR—history, indications, and future research. *Clin. Biochem.* **38**, 1–8.
- Finco, D. R. (2004). Association of systemic hypertension with renal injury in dogs with induced renal failure. *J. Vet. Intern. Med.* **18**, 289–294.
- Finco, D. R. (1995a). Evaluation of renal functions. In “Canine and Feline Nephrology and Urology” (C. A. Osborne and D. R. Finco, Eds.), pp. 216–229. Williams and Wilkins, Baltimore.
- Finco, D. R. (1995b). Kidney function. In “Clinical Biochemistry of Domestic Animals” (J. J. Kaneko, J. W. Harvey, and M. L. Bruss, Eds.), 5th ed., pp. 441–484. Academic Press, San Diego, CA.
- Finco, D. R. (2005). Measurement of glomerular filtration rate via urinary clearance of inulin and plasma clearance of Tc 99m pentetate and exogenous creatinine in dogs. *Am. J. Vet. Res.* **66**, 1046–1055.
- Finco, D. R. (1971). Simultaneous determination of phenolsulphonphthalein excretion and endogenous creatinine clearance in the normal dog. *J. Am. Vet. Med. Assoc.* **159**, 336–340.
- Finco, D. R., Adams, D. D., Crowelle, W. A., Stattelman, A. J., Brown, S. A., and Barsanti, J. A. (1986). Food and water intake and urine composition in cats: influence of continuous versus periodic feeding. *Am. J. Vet. Res.* **47**, 1638–1642.
- Finco, D. R., and Barsanti, J. A. (1982). Mechanism of urinary excretion of creatinine by the cat. *Am. J. Vet. Res.* **43**, 2207–2209.
- Finco, D. R., and Barsanti, J. A. (1989). Clinical evaluation of renal function. In “Current Veterinary Therapy X Small Animal Practice” (R. W. Kirk and J. D. Bonagura, Eds.), pp. 1123–1126. Saunders, Philadelphia.
- Finco, D. R., Barsanti, J. A., and Brown, S. A. (1989). Influence of dietary source of phosphorus on fecal and urinary excretion of phosphorus and other minerals by male cats. *Am. J. Vet. Res.* **50**, 263–266.
- Finco, D. R., Barsanti, J. A., and Brown, S. A. (1992a). Solute fractional excretion rates. In “Current Veterinary Therapy XI” (R. W. Kirk and J. D. Bonagura, Eds.), pp. 818–820. Saunders, Philadelphia.
- Finco, D. R., Braselton, W. E., and Cooper, T. A. (2001). Relationship between plasma iothexol clearance and urinary exogenous creatinine clearance in dogs. *J. Vet. Intern. Med.* **15**, 368–373.
- Finco, D. R., Brown, S. A., Barsanti, J. A., Bartges, J. W., and Cooper, T. A. (1997). Reliability of using random urine samples for “spot” determination of fractional excretion of electrolytes in cats. *Am. J. Vet. Res.* **58**, 1184–1187.
- Finco, D. R., Brown, S. A., Brown, C. A., Crowell, W. A., Cooper, T. A., and Barsanti, J. A. (1999). Progression of chronic renal disease in the dog. *J. Vet. Intern. Med.* **13**, 516–528.
- Finco, D. R., Brown, S. A., Crowell, W. A., and Barsanti, J. A. (1991). Exogenous creatinine clearance as a measure of glomerular filtration rate in dogs with reduced renal mass. *Am. J. Vet. Res.* **52**, 1029–1032.
- Finco, D. R., Brown, S. A., Crowell, W. A., Groves, C. A., Duncan, J. R., and Barsanti, J. A. (1992b). Effects of phosphorus/calcium-restricted and phosphorus/calcium-replete 32% protein diets in dogs with chronic renal failure. *Am. J. Vet. Res.* **53**, 157–163.
- Finco, D. R., Brown, S. A., Vaden, S. L., and Ferguson, D. C. (1995). Relationship between plasma creatinine concentration and glomerular filtration rate in dogs. *J. Vet. Pharmacol. Ther.* **18**, 418–421.
- Finco, D. R., Brown, S. A., Crowell, W. A., et al. (1994). Effects of aging and dietary protein intake on uninephrectomized geriatric dogs. *Am J Vet Res* **55**, 1282–1290.
- Finco, D. R., Brown, S. A., Brown, C. A., et al. (1998). Protein and calorie effects on progression of induced chronic renal failure in cats. *Am. J. Vet. Res.* **59**, 575–582.
- Finco, D. R., and Cooper, T. L. (2000). Soy protein increases glomerular filtration rate in dogs with normal or reduced renal function. *J. Nutr.* **130**, 745–748.
- Finco, D. R., Coulter, D. B., and Barsanti, J. A. (1981). Simple, accurate method for clinical estimation of glomerular filtration rate in the dog. *Am. J. Vet. Res.* **42**, 1874–1877.
- Finco, D. R., and Duncan, J. R. (1972). Relationship of glomerular number and diameter to body size of the dog. *Am. J. Vet. Res.* **33**, 2447–2450.
- Finco, D. R., and Duncan, J. R. (1976). Evaluation of blood urea nitrogen and serum creatinine concentrations as indicators of renal dysfunction: a study of 111 cases and a review of related literature. *J. Am. Vet. Med. Assoc.* **168**, 593–601.
- Finco, D. R., and Groves, C. (1985). Mechanism of renal excretion of creatinine by the pony. *Am. J. Vet. Res.* **46**, 1625–1628.
- Finco, D. R., Tabaru, H., Brown, S. A., and Barsanti, J. A. (1993). Endogenous creatinine clearance measurement of glomerular filtration rate in dogs. *Am. J. Vet. Res.* **54**, 1575–1578.
- Fine, A. (1991). Remnant kidney metabolism in the dog. *J. Am. Soc. Nephrol.* **2**, 70–76.
- Fisher, J. W. (2003). Erythropoietin: physiology and pharmacology update. *Exp. Biol. Med. (Maywood)* **228**, 1–14.

- Fleming, S. A., Hunt, E. L., Brownie, C., Rakes, A., and McDaniel, B. (1992). Fractional excretion of electrolytes in lactating dairy cows. *Am. J. Vet. Res.* **53**, 222–224.
- Fleming, S. A., Hunt, E. L., Riviere, J. E., and Anderson, K. L. (1991). Renal clearance and fractional excretion of electrolytes over four 6-hour periods in cattle. *Am. J. Vet. Res.* **52**, 5–8.
- Forrester, S. D. (2004). Diagnostic approach to hematuria in dogs and cats. *Vet. Clin. North. Am. Small. Anim. Pract.* **34**, 849–866.
- Forrester, S. D., Fallin, E. A., Saunders, G. K., and Kenny, J. E. (1993). Prevention of cisplatin-induced nephrotoxicosis in dogs, using hypertonic saline solution as the vehicle of administration. *Am. J. Vet. Res.* **54**, 2175–2178.
- Forsyth, S. F., Guilford, W. G., and Pfeiffer, D. U. (2000). Effect of NSAID administration on creatinine clearance in healthy dogs undergoing anesthesia and surgery. *J. Small. Anim. Pract.* **41**, 547–550.
- Forster, S., Raila, J., and Schweigert, F. J. (2004). Protein profiling of urine from dogs with renal disease using ProteinChip analysis. *J. Vet. Diagn. Invest.* **16**, 271–277.
- Fox, L. E., Grauer, G. F., Dubielzig, R. R., and Bjorling, D. E. (1987). Reversal of ethylene glycol-induced nephrotoxicosis in a dog. *J. Am. Vet. Med. Assoc.* **191**, 1433–1435.
- Frazier, D. L., Dix, L. P., Bowman, K. F., Thompson, C., and Riviere, J. E. (1986). Increased gentamicin nephrotoxicity in normal and diseased dogs administered identical serum drug concentration profiles: increased sensitivity in subclinical renal dysfunction. *J. Pharmacol. Exp. Ther.* **239**, 946–951.
- Freeman, L. M., Breitschwerdt, E. B., Keene, B. W., and Hansen, B. (1994). Fanconi's syndrome in a dog with primary hypoparathyroidism. *J. Vet. Intern. Med.* **8**, 349–354.
- Fukuda, S., Kawashima, N., Iida, H., Aoki, J., and Tokita, K. (1989). Age dependency of hematological values and concentrations of serum biochemical constituents in normal Beagles from 1 to 14 years of age. *Jpn. J. Vet. Sci.* **51**, 636–641.
- Gabrisch, K. (1973). Serumharnstoff und Serumkreatinine als Indikatoren der Nierenfunktion beim Hund. *Kleintier. Praxis* **18**, 133–135.
- Gagnon, J. A., Felipe, I., Nelson, L. D., and Butkus, D. E. (1982). Influence of thiopental anesthesia on renal sodium and water excretion in the dog. *Am. J. Physiol.* **243**, F265–F270.
- Gagnon, J. A., Schrier, R. W., Weis, T. P., Kokotis, W., and Mailloux, L. U. (1971). Clearance of iothalamate-125 I as a measure of glomerular filtration rate in the dog. *J. Appl. Physiol.* **30**, 774–778.
- Gans, J. H. (1975). Effects of triamcinolone and of desoxycorticosterone on renal function in sheep. *Proc. Soc. Exp. Biol. Med.* **150**, 244–248.
- Garry, F., Chew, D. J., and Hoffsis, G. F. (1990a). Enzymuria as an index of renal damage in sheep with induced aminoglycoside nephrotoxicosis. *Am. J. Vet. Res.* **51**, 428–432.
- Garry, F., Chew, D. J., and Hoffsis, G. F. (1990b). Urinary indices of renal function in sheep with induced aminoglycoside nephrotoxicosis. *Am. J. Vet. Res.* **51**, 420–427.
- Garry, F., Chew, D. J., Rings, D. M., Tarr, M. J., and Hoffsis, G. F. (1990c). Renal excretion of creatinine, electrolytes, protein, and enzymes in healthy sheep. *Am. J. Vet. Res.* **51**, 414–419.
- Gartner, K., Reulecke, W., Hackbarth, H., and Wollnik, F. (1987). Zur Abhängigkeit von Muskelmasse und Körpergröße im Vergleich von Maus, Ratte, Kaninchen, Hund, Mensch, und Pferd. *Dtsch. Tierärztl. Wschr.* **94**, 52–53.
- Gartner, W. (1981). Zur physiologischen Ausscheidung von Plasmaeiveiss mit dem Harn bei gesunden Tieren. *Dtsch. Tierärztl. Wschr.* **88**, 420–422.
- Gary, A. T., Cohn, L. A., Kerl, M. E., and Jensen, W. A. (2004). The effects of exercise on urinary albumin excretion in dogs. *J. Vet. Intern. Med.* **18**, 52–55.
- Gasthuys, F., Terpstra, P., van den Hende, C., and De Moor, A. (1987). Hyperglycaemia and diuresis during sedation with detomidine in the horse. *Zentralbl. Veterinarmed. A* **34**, 641–648.
- Gasthuys, F., van den Hende, C., and de Moor, A. (1986). Study of some ionary parameters in horse serum and urine during halothane anaesthesia with xylazine premedication. *Zentralbl. Veterinarmed. A* **33**, 791–800.
- Gekle, M. (1998). Renal proximal tubular albumin reabsorption: daily prevention of albuminuria. *News. Physiol. Sci.* **13**, 5–11.
- Gelsa, H. (1979). The renal clearance of inulin, creatinine, trimethoprim and sulphadoxine in horses. *J. Vet. Pharmacol. Therap.* **2**, 257–264.
- Genetzky, R. M., Loparco, F. V., and Ledet, A. E. (1987). Clinical pathologic alterations in horses during a water deprivation test. *Am. J. Vet. Res.* **48**, 1007–1011.
- George, J. W. (2001). The usefulness and limitations of hand-held refractometers in veterinary laboratory medicine: an historical and technical review. *Vet. Clin. Pathol.* **30**, 201–210.
- Gimonet, V., Bussieres, L., Medjebeur, A. A., Gasser, B., Lelongt, B., and Laborde, K. (1998). Nephrogenesis and angiotensin II receptor subtypes gene expression in the fetal lamb. *Am. J. Physiol.* **274**, F1062–F1069.
- Gleadhill, A. (1994). Evaluation of screening tests for renal insufficiency in the dog. *J. Small. Anim. Pract.* **35**, 391–396.
- Gleadhill, A., Marlin, D., Harris, P. A., and Michell, A. R. (1999). Use of a three-blood-sample plasma clearance technique to measure GFR in horses. *Vet. J.* **158**, 204–209.
- Gleadhill, A., and Michell, A. R. (1996). Evaluation of iohexol as a marker for the clinical measurement of glomerular filtration rate in dogs. *Res. Vet. Sci.* **60**, 117–121.
- Gobar, G. M., Case, J. T., and Kass, P. H. (1998). Program for surveillance of causes of death of dogs, using the Internet to survey small animal veterinarians. *J. Am. Vet. Med. Assoc.* **213**, 251–256.
- Godeau, J. M., Dehareng, D., Beaussart, F., Ndibualonji, B., and Debue, P. (1990). Mesure nyctémérale de la clairance rénale de l'urée chez la vache sondée: influence des hématuries accidentelles. *Ann. Méd. Vét.* **134**, 455–463.
- Goldfarb, S., Westby, G. R., Goldberg, M., and Agus, Z. S. (1977). Renal tubular effects of chronic phosphate depletion. *J. Clin. Invest.* **59**, 770–779.
- Gossett, K. A., Turnwald, G. H., Kearney, M. T., Greco, D. S., and Cleghorn, B. (1987). Evaluation of gamma-glutamyl transpeptidase-to-creatinine ratio from spot samples of urine supernatant, as an indicator of urinary enzyme excretion in dogs. *Am. J. Vet. Res.* **48**, 455–457.
- Gouda, I. M., Abdel Aziz, S. A., Lofti, M. M., Ahmed, A. A., and Soliman, M. M. (1986). Changes in some kidney functions in experimentally lead-poisoned goats. *Arch. Exp. Veterinarmed.* **40**, 242–249.
- Gougoux, A., Zan, N., Dansereau, D., and Vinay, P. (1989). Experimental Fanconi's syndrome resulting from 4-pentenoate infusion in the dog. *Am. J. Physiol.* **257**, F959–F966.
- Grauer, G. F. (1985). Clinicopathologic evaluation of early renal disease in dogs. *Comp. Cont. Educ. Pract. Vet.* **7**, 32–38.
- Grauer, G. F. (1996). Prevention of acute renal failure. *Vet. Clin. North. Am. Small. Anim. Pract.* **26**, 1447–1459.
- Grauer, G. F. (2005). Canine glomerulonephritis: new thoughts on proteinuria and treatment. *J. Small. Anim. Pract.* **46**, 469–478.
- Grauer, G. F., and DiBartola, S. P. (2000). Glomerular disease. In "Textbook of Veterinary Internal Medicine" (S. J. Ettinger and E. C. Feldman, Eds.), 5th ed., pp. 1662–1678. Saunders, Philadelphia.

- Grauer, G. F., Greco, D. S., Behrend, E. N., Fettman, M. J., Jaenke, R. S., and Allen, T. A. (1994). Effects of dietary protein conditioning on gentamicin-induced nephrotoxicosis in healthy male dogs. *Am. J. Vet. Res.* **55**, 90–97.
- Grauer, G. F., Greco, D. S., Behrend, E. N., Mani, I., Fettman, M. J., and Allen, T. A. (1995). Estimation of quantitative enzymuria in dogs with gentamicin-induced nephrotoxicosis using urine enzyme/creatinine ratios from spot urine samples. *J. Vet. Intern. Med.* **9**, 324–327.
- Grauer, G. F., Greco, D. S., Getzy, D. M., Cowgill, L. D., Vaden, S. L., Chew, D. J., Polzin, D. J., and Barsanti, J. A. (2000). Effects of enalapril versus placebo as a treatment for canine idiopathic glomerulonephritis. *J. Vet. Intern. Med.* **14**, 526–533.
- Grauer, G. F., and Lane, I. F. (1995). Acute renal failure: ischemic and chemical nephrosis. In "Canine and Feline Nephrology and Urology" (C. A. Osborne and D. R. Finco, Eds.), pp. 441–459. Williams and Wilkins, Baltimore.
- Grauer, G. F., Thomas, C. B., and Eicker, S. W. (1985). Estimation of quantitative proteinuria in the dog, using the urine protein-to-creatinine ration from a random, voided sample. *Am. J. Vet. Res.* **46**, 2116–2119.
- Grauer, G. F., Thrall, M. A., Henre, B. A., Grauer, R. M., and Hamar, D. W. (1984). Early clinicopathologic findings in dogs ingesting ethylene glycol. *Am. J. Vet. Res.* **45**, 2299–2303.
- Graves, T. K., Olivier, N. B., Nachreiner, R. F., Kruger, J. M., Walshaw, R., and Stickle, R. L. (1994). Changes in renal function associated with treatment of hyperthyroidism in cats. *Am. J. Vet. Res.* **55**, 1745–1749.
- Gray, J., Harris, P., and Snow, D. H. (1988). Preliminary investigations into the calcium and magnesium status of the horse. In "Animal Clinical Biochemistry: The Future" (D. J. Blackmore, P. D. Eckersall, G. O. Evans, H. Sommer, M. D. Stonard, and D. D. Woodman, Eds.), pp. 307–317. Cambridge University Press, Cambridge.
- Greco, D. S., and Green, R. A. (1987). Coagulation abnormalities associated with thrombosis in a dog with nephrotic syndrome. *Comp. Cont. Educ. Pract. Vet.* **9**, 653–659.
- Greco, D. S., Lees, G. E., Dzendzel, G., and Carter, A. B. (1994). Effects of dietary sodium intake on blood pressure measurements in partially nephrectomized dogs. *Am. J. Vet. Res.* **55**, 160–165.
- Greco, D. S., Turwald, G. H., Adams, R., Gossett, K. A., Kearney, M., and Casey, H. (1985). Urinary g-glutamyltranspeptidase activity in dogs with gentamicin-induced nephrotoxicity. *Am. J. Vet. Res.* **46**, 2332–2335.
- Greco, G. F. (2005). Early detection of renal damage and disease in dogs and cats. *Vet. Clin. Small. Anim.* **35**, 581–596.
- Green, R. A., Russo, E. A., Greene, R. T., and Kabel, A. L. (1985). Hypoalbuminemia-related platelet hypersensitivity in two dogs with nephrotic syndrome. *J. Am. Vet. Med. Assoc.* **186**, 458–485.
- Greive, K. A., Balazs, N. D. H., and Comper, W. D. (2001). Protein fragments in urine have been considerably underestimated by various protein assays. *Clin. Chem.* **47**, 1717s–1719s.
- Groman, R. P., Bahr, A., Berridge, B. R., and Lees, G. E. (2004). Effects of serial ultrasound-guided renal biopsies on kidneys of healthy adolescent dogs. *Vet. Radiol. Ultrasound* **45**, 62–69.
- Groulade, J., Gros Lambert, P., and Groulade, P. (1978). Electrophorèse des protéinuries du chat. *Bull. Soc. Sci. Vet. Med. Comp.* **80**, 213–217.
- Groulade, J., Groulade, P., and Gros Lambert, P. (1977). Electrophorèse des protéines urinaires chez le chien. *Bull. Acad. Vet. Fr.* **50**, 499–506.
- Grubb, A., and Nordin, G. (2006). Notable steps in obtaining improved estimates for glomerular filtration rate. *Clin. Chem.* **52**, 169–170.
- Grunbaum, D., Wexler, M., Antos, M., Gascon-Barre, M., and Goltzman, D. (1984). Bioactive parathyroid hormone in canine progressive renal insufficiency. *Am. J. Physiol.* **247**, E442–E448.
- Gubler, M. C. (2003). Podocyte differentiation and hereditary proteinuria/nephrotic syndromes. *J. Am. Soc. Nephrol.* **14**, S22–S26.
- Guder, W. G., Hoffmann, G. E., Hubbuch, A., Poppe, W. A., Siedel, J., and Price, C. P. (1986). Multicentre evaluation of an enzymatic method for creatinine determination using a sensitive colour reagent. *J. Clin. Chem. Clin. Biochem.* **24**, 889–902.
- Guerrini, V. H., Koster, N., and Bertchinger, H. (1980). Effect of ambient temperature and humidity on urine output in sheep. *Am. J. Vet. Res.* **41**, 1851–1853.
- Guignard, J. P., and Drukker, A. (1999). Why do newborn infants have a higher plasma creatinine? *Pediatrics* **103**, e49.
- Hall, J. E., Guyton, A. C., Smith, M. J., and Coleman, T. G. (1979). Chronic blockade of angiotensin II formation during sodium deprivation. *Am. J. Physiol.* **237**, F424–F432.
- Haller, M., Muller, W., Binder, H., Estelberger, W., and Arnold, P. (1998). Single-injection inulin clearance: a simple method for measuring glomerular filtration rate in dogs. *Res. Vet. Sci.* **64**, 151–156.
- Haller, M., Rohner, K., Muller, W., Reutter, F., Binder, H., Estelberger, W., and Arnold, P. (2003). Single-injection inulin clearance for routine measurement of glomerular filtration rate in cats. *J. Feline. Med. Surg.* **5**, 175–181.
- Hamlin, R. (1986). Ethylene glycol (antifreeze) poisoning in a cat. *Southwest. Vet.* **37**, 99–104.
- Hammel, E. P., Kronfeld, D. S., Ganjam, V. K., and Dunlap, H. L. (1997). Metabolic responses to exhaustive exercise in racing sled dogs fed diets containing medium, low, or zero carbohydrate. *Am. J. Clin. Nutr.* **30**, 409–418.
- Hanna, R. M., Borchard, R. E., and Schmidt, S. L. (1988). Effect of diuretics on ketamine and sulfanilate elimination in cats. *J. Vet. Pharmacol. Ther.* **11**, 121–129.
- Hanser, A. M., Hym, B., Michotey, O., Gascht, D., Marchal, A., Minery, M., Parent, X., and Capolaghi, B. (2001). Comparaison des méthodes de dosage de la créatinine sérique. *Ann. Biol. Clin.* **59**, 737–742.
- Harb, M. F., Nelson, R. W., Feldman, E. C., Scott-Moncrieff, J. C., and Griffey, S. M. (1996). Central diabetes insipidus in dogs: 20 cases (1986–1995). *J. Am. Vet. Med. Assoc.* **209**, 1848–1884.
- Hardie, E. M., Page, R. L., Williams, P. L., and Fischer, W. D. (1991). Effect of time of cisplatin administration on its toxicity and pharmacokinetics in dogs. *Am. J. Vet. Res.* **52**, 1821–1825.
- Hardy, M. L., Hsu, R. C., and Short, C. R. (1985). The nephrotoxic potential of gentamicin in the cat: enzymuria and alterations in urine concentrating capability. *J. Vet. Pharmacol. Ther.* **8**, 382–392.
- Hardy, R. M., and Osborne, C. A. (1979). Water deprivation test in the dog: maximal normal values. *J. Am. Vet. Med. Assoc.* **174**, 479–483.
- Harris, R. C., and Lowe, J. A. (1995). Absorption of creatine from meat or other dietary sources by the dog. *Vet. Record* **137**, 595.
- Harris, R. C., Lowe, J. A., Warnes, K., and Orme, C. E. (1997). The concentration of creatine in meat, offal and commercial dog food. *Res. Vet. Sci.* **62**, 58–62.
- Hartenbower, D. L., Friedler, R. M., Coburn, J. W., Massry, S. G., and Sellers, A. (1974). Spontaneous variations in electrolyte excretion in the awake dog. *Proc. Soc. Exp. Biol. Med.* **145**, 648–653.
- Hartmann, H., Bandt, C., and Glatzel, P. S. (2001). [Influence of changing oral mineral supply on kidney functions including renal fractional excretion of calcium, magnesium and phosphate in cows]. *Berl. Munch. Tierarztl. Wochenschr.* **114**, 267–272.
- Hartmann, H., Schmietendorf, L., Devaux, S., Finsterbusche, L., Meyer, H., and Rudolph, C. (1987). Beziehungen zwischen Durchfallerkrankung und Nierenfunktion beim Kalb. *Arch. Exp. Vet. Med.* **41**, 129–139.



- Harvey, D. G. (1973). The measurement of specific gravities in dog urine by refractometry. *Vet. Rec.* **92**, 671–672.
- Harvey, D. G., and Hoe, C. M. (1966). The use of paper electrophoresis for the routine identification of urinary proteins in the dog. *J. Small Anim. Pract.* **7**, 431–443.
- Hebert, S. C., Desir, G., Giebisch, G., and Wang, W. (2005). Molecular diversity and regulation of renal potassium channels. *Physiol. Rev.* **85**, 319–371.
- Heiene, R., Biewenga, W. J., and Koeman, J. P. (1991). Urinary alkaline phosphatase and g-glutamyltransferase as indicators of acute renal damage in dogs. *J. Small Anim. Pract.* **32**, 521–524.
- Heiene, R., and Moe, L. (1998). Pharmacokinetic aspects of measurement of glomerular filtration rate in the dog: a review. *J. Vet. Intern. Med.* **12**, 401–414.
- Heiene, R., and Moe, L. (1999). The relationship between some plasma clearance methods for estimation of glomerular filtration rate in dogs with pyometra. *J. Vet. Intern. Med.* **13**, 587–596.
- Heiene, R., Moe, L., and Molmen, G. (2001a). Calculation of urinary enzyme excretion, with renal structure and function in dogs with pyometra. *Res. Vet. Sci.* **70**, 129–137.
- Heiene, R., Vulliet, P. R., Williams, R. L., and Cowgill, L. D. (2001b). Use of capillary electrophoresis to quantitate carbamylated hemoglobin concentrations in dogs with renal failure. *Am. J. Vet. Res.* **62**, 1302–1306.
- Hendriks, H. J., de Bruijne, J. J., and van den Brom, W. E. (1978). The clinical refractometer: a useful tool for the determination of specific gravity and osmolality in canine urine. *Tijdschr. Diergeneesk.* **103**, 1065–1068.
- Hendriks, H. J., Haage, A., and de Bruyne, J. J. (1976). Determination of the protein concentration in canine urine. *Zentralbl. Veterinarmed. A* **23**, 683–687.
- Henegar, J. R., Bigler, S. A., Henegar, L. K., et al. (2001). Functional and structural changes in the kidney in the early stages of obesity. *J. Am. Soc. Nephrol.* **12**, 1211–1217.
- Henik, R. A., Forrest, L. J., and Friedman, A. L. (1999). Rickets caused by excessive renal phosphate loss and apparent abnormal vitamin D metabolism in a cat. *J. Am. Vet. Med. Assoc.* **215**, 1620–1621, 1644–1649.
- Hesta, M., Hoornaert, E., Verlinden, A., and Janssens, G. P. (2005). The effect of oligofructose on urea metabolism and faecal odour components in cats. *J. Anim. Physiol. Anim. Nutr. (Berl.)* **89**, 208–214.
- Higashiyama, N., Nishiyama, S., Itoh, T., and Nakamura, M. (1983). Effect of castration on urinary N-acetyl-beta-D-glucosaminidase levels in male beagles. *Ren. Physiol.* **6**, 226–231.
- Hilppo, M. (1986). Some hematological and clinical-chemical parameters of sight Hounds (Afghan Hound, Saluki and Whippet). *Nord. Vet. Med.* **38**, 148–155.
- Hinchcliff, K. W., McKeever, K. H., Schmall, L. M., Kohn, C. W., and Muir, W. W., 3rd. (1990). Renal and systemic hemodynamic responses to sustained submaximal exertion in horses. *Am. J. Physiol.* **258**, R1177–R1183.
- Hinchcliff, K. W., Olson, J., Crusberg, C., Kenyon, J., Long, R., Royle, W., Weber, W., and Burr, J. (1993). Serum biochemical changes in dogs competing in a long-distance sled race. *J. Am. Vet. Med. Assoc.* **202**, 401–405.
- Hitt, M. E. (1986). Hematuria of renal origin. *Comp. Cont. Educ. Pract. Vet.* **8**, 14–22.
- Hitt, M. E., Straw, R. C., Lattimer, J. C., Shaw, D. P., Weide, K. D., and Smith, C. (1985). Idiopathic hematuria of unilateral renal origin in a dog. *J. Am. Vet. Med. Assoc.* **187**, 1371–1373.
- Hoenderop, J. G., and Bindels, R. J. (2005). Epithelial Ca<sup>2+</sup> and Mg<sup>2+</sup> channels in health and disease. *J. Am. Soc. Nephrol.* **16**, 15–26.
- Hoenderop, J. G., Nilius, B., and Bindels, R. J. (2005). Calcium absorption across epithelia. *Physiol. Rev.* **85**, 373–422.
- Holliday, M. A., and Egan, T. J. (1962). Renal function in man, dog and rat. *Nature* **193**, 748–750.
- Holtas, S., Billstrom, A., and Tejler, L. (1981). Proteinuria following nephroangiography. IX. Chemical and morphological analysis in dogs. *Acta Radiol. Diagn. (Stockh.)* **22**, 427–433.
- Horster, M. (1977). Nephron function and perinatal homeostasis. *Ann. Rech. Vet.* **8**, 468–482.
- Horster, M., Kemler, B. J., and Valtin, H. (1971). Intracortical distribution of number and volume of glomeruli during postnatal maturation in the dog. *J. Clin. Invest.* **50**, 796–800.
- Horster, M., and Valtin, H. (1971). Postnatal development of renal function: micropuncture and clearance studies in the dog. *J. Clin. Invest.* **50**, 779–795.
- Hoskins, J. D., Turnwald, G. H., Kearney, M. T., Gossett, K. A., and Fakier, N. (1991). Quantitative urinalysis in kittens from four to thirty weeks after birth. *Am. J. Vet. Res.* **52**, 1295–1299.
- Hostutler, R. A., DiBartola, S. P., and Eaton, K. A. (2004). Transient proximal renal tubular acidosis and Fanconi syndrome in a dog. *J. Am. Vet. Med. Assoc.* **224**, 1605, 1611–1614.
- Houck, C. R. (1948). Statistical analysis of filtration rate and effective renal plasma flow related to weight and surface area in dogs. *Am. J. Physiol.* **153**, 169–175.
- Hughes, D. (1992). Polyuria and polydipsia. *Comp. Cont. Educ. Pract. Vet.* **14**, 1161–1175.
- Hurley, K. J., and Vaden, S. L. (1995). Proteinuria in dogs and cats: a diagnostic approach. In “Current Veterinary Therapy XII Small Animal Practice” (J. D. Bonagura and R. W. Kirk, Eds.), pp. 937–940. Saunders, Philadelphia.
- Hurley, K. J., and Vaden, S. L. (1998). Evaluation of urine protein content in dogs with pituitary-dependent hyperadrenocorticism. *J. Am. Vet. Med. Assoc.* **212**, 369–373.
- Hurvitz, A. I., Kehoe, J. M., Capra, J. D., and Prata, R. (1971). Bence Jones proteinemia and proteinuria in a dog. *J. Am. Vet. Med. Assoc.* **159**, 1112–1116.
- Iversen, L., Petersen, T. K., Koch, J., Hoier, R., and Jensen, A. L. (1997). Urinens creatininhold som indledende klinisk patologisk markor for Cushings syndrom hos hunde. *Dansk. Vet. Tidsskr.* **80**, 778–781.
- Izzat, N. N., and Rosborough, J. P. (1989). Renal function in conscious dogs: potential effect of gender on measurement. *Res. Exp. Med.* **189**, 371–379.
- Jacobs, R. M., Lumsden, J. H., and Grift, E. (1992). Effect of bilirubemia, hemolysis, and lipemia on clinical chemistry analytes in bovine, canine, equine, and feline sera. *Can. Vet. J.* **33**, 605–608.
- Jacobs, R. M., Lumsden, J. H., Taylor, J. A., and Grift, E. (1991). Effects of interferents on the kinetic Jaffé reaction and an enzymatic colorimetric test for serum creatinine concentration determination in cats, cows, dogs and horses. *Can. J. Vet. Res.* **55**, 150–154.
- Jaenicke, R. S., and Allen, T. A. (1986). Membranous nephropathy in the dog. *Vet. Pathol.* **23**, 718–733.
- Jamieson, P. M., and Chandler, M. L. (2001). Transient renal tubulopathy in a Labrador retriever. *J. Small Anim. Pract.* **42**, 546–549.
- Jansen, B. S., and Lumsden, J. H. (1985). Sensitivity of routine tests for urine protein to hemoglobin. *Can. Vet. J.* **26**, 221–223.
- Jensen, A. L., and Aaes, H. (1993). Critical differences of clinical chemical parameters in blood from dogs. *Res. Vet. Sci.* **54**, 10–14.

- Jensen, A. L., Bomholt, M., and Moe, L. (2001). Preliminary evaluation of a particle-enhanced turbidimetric immunoassay (PETIA) for the determination of serum cystatin C-like immunoreactivity in dogs. *Vet. Clin. Pathol.* **30**, 86–90.
- Jensen, A. L., Wenck, A., Koch, J., and Poulsen, J. S. D. (1994). Comparison of results of haematological and clinical chemical analyses of blood samples obtained from the cephalic and external jugular veins in dogs. *Res. Vet. Sci.* **56**, 24–29.
- Jeraj, K. P., Vernier, R. L., Polzin, D., Klausner, J. K., Osborne, C. A., Stevens, J. B., and Michael, A. F. (1984). Idiopathic immune complex glomerulonephritis in dogs with multisystem involvement. *Am. J. Vet. Res.* **45**, 1699–1705.
- Jergens, A. E., McCaw, D. L., and Hewett, J. E. (1987). Effects of collection time and food consumption on the urine protein/creatinine ratio in the dog. *Am. J. Vet. Res.* **48**, 1106–1109.
- Joles, J. A., Rijnberk, A., Brom, v. d., and W. E., D., J. (1980). Studies on the mechanism of polyuria induced by cortisol excess in the dog. *Vet. Quarterly* **2**, 199–205.
- Jolliffe, N., and Smith, H. W. (1932). The excretion of urine in the dog. II. The urea and creatinine clearance on cracker meal diet. *Am. J. Physiol.* **99**, 101–107.
- Jones, G. R. D., Strugnell, S. A., and DeLuca, H. F. (1998). Current understanding of the molecular action of vitamin D. *Physiol. Rev.* **78**, 1193–1231.
- Jones, J. D., and Burnett, P. C. (1972). Implication of creatinine and gut flora in the uremic syndrome: induction of “creatininase” in colon contents of the rat by dietary creatinine. *Clin. Chem.* **18**, 280–284.
- Jones, J. D., and Burnett, P. C. (1974). Creatinine metabolism in humans with decreased renal function: creatinine deficit. *Clin. Chem.* **20**, 1204–1212.
- Jung, K., Mattenheimer, H., and Burchardt, U. (1992). “Urinary Enzymes in Clinical and Experimental Medicine.” Springer Verlag, Berlin.
- Jung, K., Wesslau, C., Priem, F., Schreiber, G., and Zubek, A. (1987). Specific creatinine determination in laboratory animals using the new enzymatic test kit “creatinine-PAP.” *J. Clin. Chem. Clin. Biochem.* **25**, 357–361.
- Kampa, N., Bostrom, I., Lord, P., Wennstrom, U., Ohagen, P., and Maripuu, E. (2003). Day-to-day variability in glomerular filtration rate in normal dogs by scintigraphic technique. *J. Vet. Med. A. Physiol. Pathol. Clin. Med.* **50**, 37–41.
- Kampa, N., Wennstrom, U., Lord, P., Twardock, R., Maripuu, E., Eksell, P., and Fredriksson, S. O. (2002). Effect of region of interest selection and uptake measurement on glomerular filtration rate measured by <sup>99m</sup>Tc-DTPA scintigraphy in dogs. *Vet. Radiol. Ultrasound* **43**, 383–391.
- Kaneko, J. J., Mattheeuws, D., Rottiers, R. P., and Vermeulen, A. (1978). Renal function, insulin secretion, and glucose tolerance in mild streptozotocin diabetes in the dog. *Am. J. Vet. Res.* **39**, 807–809.
- Kaneko, J. J., Mattheeuws, D., Rottiers, R. P., and Vermuelen, A. (1979). Renal clearance, insulin secretion and glucose tolerance in spontaneous diabetes mellitus of dogs. *Cornell. Vet.* **69**, 375–383.
- Kasari, T. R., Woodbury, A. H., and Morcom-Kasari, E. (1990). Adverse effect of orally administered magnesium hydroxide on serum magnesium concentration and systemic acid-base balance in adult cattle. *J. Am. Vet. Med. Assoc.* **196**, 735–742.
- Keller, P., and Freudiger, U. (1984). Enzymaktivitäten im Urin, im Liquor cerebrospinalis, in der Blasengalle, im Speichel und im Ejakulat des Hundes. *Kleintier. Praxis* **29**, 15–34.
- Kennedy, T. J., Hilton, J. G., and Berliner, R. W. (1952). Comparison of inulin and creatinine clearance in the normal dog. *Am. J. Physiol.* **171**, 164–168.
- Kerr, W. S. (1958). Maximum clearances (GFR and ERPF) in dogs. *J. Urol.* **80**, 205–207.
- King, C. (1994). Practical use of urinary fractional excretion. *J. Eq. Vet. Med.* **14**, 464–468.
- Kitagawa, H., Wakamiya, H., Kitoh, K., Kuwahara, Y., Ohba, Y., Isaji, M., Iwasaki, T., Nakano, M., and Sasaki, H. (1997). Efficacy of monotherapy with benazepril, an angiotensin converting enzyme inhibitor, in dogs with naturally acquired mitral insufficiency. *J. Vet. Med. Sci.* **59**, 513–520.
- Klee, W., Seitz, A., and Elmer-Englhard, D. (1985). Untersuchungen über den Kreatinin- und harnstoff-Blutspiegel gesunder neugeborener Kälber im Hinblick auf deren Nierenfunktion. *Dtsch. Tierärztl. Wochenschr.* **92**, 405–407.
- Kleinman, L. I., and Lubbe, R. J. (1972). Factors affecting the maturation of glomerular filtration rate and renal plasma flow in the new-born dog. *J. Physiol.* **223**, 395–409.
- Knudsen, E. (1959). Renal clearance studies in the horse. I. Inulin, endogenous creatinine and urea. *Acta. Vet. Scand.* **1**, 52–66.
- Ko, J. C. H., Miyabayashi, T., Mandsager, R. A., Heaton-Jones, T. G., and Mauragis, D. F. (2000). Renal effects of carprofen administered to healthy dogs anesthetized with propofol and isoflurane. *J. Am. Vet. Med. Assoc.* **217**, 346–349.
- Kohn, R. A., Dinneen, M. M., and Russek-Cohen, E. (2005). Using blood urea nitrogen to predict nitrogen excretion and efficiency of nitrogen utilization in cattle, sheep, goats, horses, pigs, and rats. *J. Anim. Sci.* **83**, 879–889.
- Kohn, C. W., and Strasser, S. L. (1986). 24-hour renal clearance and excretion of endogenous substances in the mare. *Am. J. Vet. Res.* **47**, 1332–1337.
- Kraft, W., Hartmann, K., and Dereser, R. (1996). Altersabhängigkeiten von Labowerten bei Hund und Katze. teil III: Bilirubin, Kreatinin und Protein im Blutserum. *Tierärztl. Praxis* **24**, 610–615.
- Krawiec, D. R., and Gelberg, H. B. (1989). Chronic renal disease in cats. In “Current Veterinary Therapy X Small Animal Practice” (R. W. Kirk and J. D. Bonagura, Eds.), pp. 1170–1173. Saunders, Philadelphia.
- Krawiec, D. R., Twardock, A. R., Badertscher, R. R., 2nd, Daniel, G. B., and Dugan, S. J. (1988). Use of <sup>99m</sup>Tc diethylenetriaminepentaacetic acid for assessment of renal function in dogs with suspected renal disease. *J. Am. Vet. Med. Assoc.* **192**, 1077–1180.
- Kriz, W., and Bankir, L. (1988). A standard nomenclature for structures of the kidney. The Renal Commission of the International Union of Physiological Sciences (IUPS). *Kidney Int.* **33**, 1–7.
- Krogh, P., Elling, F., Friis, C., Hald, B., Larsen, A. E., Lillehoj, E. B., Madsen, A., Mortensen, H. P., Rasmussen, F., and Ravnskov, U. (1979). Porcine nephropathy induced by long-term ingestion of ochratoxin A. *Vet. Pathol.* **16**, 466–475.
- Kronfeld, D. S., Hammel, E. P., Ramberg, C. F., and Dunlap, H. L. (1977). Hematological and metabolic responses to training in racing sled dogs fed diets containing medium, low or zero carbohydrate. *Am. J. Clin. Nutr.* **30**, 419–430.
- Kruger, J. M., and Osborne, C. A. (1994a). Canine and feline hypercalcemic nephropathy. Part I. Causes and consequences. *Comp. Cont. Educ. Pract. Vet.* **16**, 1299–1315.
- Kruger, J. M., and Osborne, C. A. (1994b). Canine and feline hypercalcemic nephropathy. Part II. Detection, cure, and control. *Comp. Cont. Educ. Pract. Vet.* **16**, 1445–1459.
- Kruger, J. M., Osborne, C. A., Nachreiner, R. F., and Refsal, K. R. (1996). Hypercalcemia and renal failure. Etiology, pathophysiology, diagnosis, and treatment. *Vet. Clin. North. Am. Small. Anim. Pract.* **26**, 1417–1445.

- Kühl, S., Mischke, R., Lund, C., and Günzel-Apel, A. R. (2000). Referenzwerte klinisch-chemischer Blutparameter bei Hundewelpen in den ersten acht Lebenswochen. *Dtsch. Tierärztl. Wschr.* **107**, 438–443.
- Kuhn, G., and Hardegg, W. (1988). Effects of indoor and outdoor maintenance of dogs upon food intake, body weight, and different blood parameters. *Z. Versuchstierk* **31**, 2005–2214.
- Kumar, R. (1984). Metabolism of 1,25-dihydroxyvitamin D3. *Physiol. Rev.* **64**, 487–504.
- Kunkel, P. A. (1930). The number and size of the glomeruli in the kidney of several species. *Bull. John. Hopkins. Hosp.* **47**, 285–291.
- Kunze, C., Bahr, A., and Lees, G. E. (2006). Evaluation of 99mTc-diethylenetriaminepentaacetic acid renal scintigram curves in normal dogs after induction of diuresis. *Vet. Radiol. Ultrasound* **47**, 103–107.
- Kurtz, J. M., Russell, S. W., Lee, J. C., Slauson, D. O., and Schechter, R. D. (1972). Naturally occurring canine glomerulonephritis. *Am. J. Pathol.* **67**, 471–482.
- Labato, M. A., and Ross, L. A. (1991). Plasma disappearance of creatinine as a renal function test in the dog. *Res. Vet. Sci.* **50**, 253–258.
- Ladd, M., Liddle, L., and Gagnon, J. A. (1956). Renal excretion of inulin, creatinine, and ferrocyanide, at normal and reduced clearance levels in the dog. *Am. J. Physiol.* **184**, 505–514.
- Ladd, M., Liddle, L., Gagnon, J. A., and Clarke, R. W. (1957). Glomerular and tubular functions in sheep and goats. *J. Appl. Physiol.* **10**, 249–255.
- Lane, I. F., Grauer, G. F., and Fettman, M. J. (1994a). Acute renal failure. Risk factors, prevention, and strategies for protection. *Comp. Cont. Educ. Pract. Vet.* **16**, 15–29.
- Lane, I. F., Grauer, G. F., and Fettman, M. J. (1994b). Acute renal failure. Part II. Diagnosis, management, and prognosis. *Comp. Cont. Educ. Pract. Vet.* **16**, 625–642.
- Lane, I. F., Shaw, D. H., Burton, S. A., and Donald, A. W. (2000). Quantitative urinalysis in healthy Beagle puppies from 9 to 27 weeks of age. *Am. J. Vet. Res.* **61**, 577–581.
- Lane, V. M., and Merritt, A. M. (1983). Reliability of single-sample phosphorus fractional excretion determination as a measure of daily phosphorus renal clearance in equids. *Am. J. Vet. Res.* **44**, 500–502.
- Laroche, M., and Boyer, J. F. (2005). Phosphate diabetes, tubular phosphate reabsorption and phosphatonins. *Joint Bone Spine* **72**, 376–381.
- Laroute, V., Chetboul, V., Roche, L., Maurey, C., Costes, G., Pouchelon, J. L., De La Farge, F., Boussouf, M., and Lefebvre, H. P. (2005). Quantitative evaluation of renal function in healthy Beagle puppies and mature dogs. *Res. Vet. Sci.* **79**, 161–167.
- Laterza, O. F., Price, C. P., and Scott, M. G. (2002). Cystatin C: an improved estimator of glomerular filtration rate? *Clin. Chem.* **48**, 699–707.
- Lee, K. E., Behrendt, U., Kaczmarczyk, G., Mohnhaupt, R., and Reinhardt, H. W. (1983). Estimation of glomerular filtration rate in conscious dogs following a bolus of creatinine. Comparison with simultaneously determined inulin clearance. *Pflugers Arch.* **396**, 176–178.
- Lees, G. E. (1996). Congenital renal diseases. *Vet. Clin. North Am. Small Anim. Pract.* **26**, 1379–1399.
- Lees, G. E., Brown, S. A., Elliott, J., Grauer, G. E., and Vaden, S. L. (2005). Assessment and management of proteinuria in dogs and cats: 2004 ACVIM Forum Consensus Statement (small animal). *J. Vet. Intern. Med.* **19**, 377–385.
- Lees, G. E., Helman, R. G., Homco, L. D., Millichamp, N. J., Hunter, J. F., and Frey, M. S. (1998). Early diagnosis of familial nephropathy in English cocker spaniels. *J. Am. Anim. Hosp. Assoc.* **34**, 189–195.
- Lees, G. E., and Osborne, C. A. (1979). Antibacterial properties of urine: a comparative review. *J. Am. Anim. Hosp. Assn.* **15**, 135–141.
- Lefebvre, H. P., Laroute, V., Concordet, D., and Toutain, P. L. (1999). Effects of renal impairment on the disposition of orally administered enalapril, benazepril, and their active metabolites. *J. Vet. Intern. Med.* **13**, 21–27.
- Lefebvre, H. P., Schneider, M., Dupouy, V., Laroute, V., Costes, G., Delesalle, L., and Toutain, P. L. (1998a). Effect of experimental renal impairment on disposition of marbofloxacin and its metabolites in the dog. *J. Vet. Pharmacol. Ther.* **21**, 453–461.
- Lefebvre, H. P., Watson, A. D. J., Toutain, P. L., and Braun, J. P. (1998b). Absence de validation technique et biologique de la créatininémie du chien: une des difficultés de l'interprétation. *Revue. Med. Vet.* **149**, 7–14.
- Leifer, C. E., and Matus, R. E. (1986). Chronic lymphocytic leukemia in the dog: 22 cases (1974–1984). *J. Am. Vet. Med. Assoc.* **189**, 214–217.
- Lobetti, R., and Lambrechts, N. (2000). Effects of general anesthesia and surgery on renal function in healthy dogs. *Am. J. Vet. Res.* **61**, 121–124.
- Lobetti, R. G., and Joubert, K. E. (2000). Effect of administration of non-steroidal anti-inflammatory drugs before surgery on renal function in clinically normal dogs. *Am. J. Vet. Res.* **61**, 1501–1506.
- Lobetti, R. G., Reyers, F., and Nesbit, J. W. (1996). The comparative role of haemoglobinaemia and hypoxia in the development of canine babesial nephropathy. *J. S. Afr. Vet. Assoc.* **67**, 188–198.
- Lora-Michiels, M., Anzola, K., Amaya, G., and Solano, M. (2001). Quantitative and qualitative scintigraphic measurement of renal function in dogs exposed to toxic doses of gentamicin. *Vet. Radiol. Ultrasound* **42**, 553–561.
- Lording, P. M., and Bellamy, J. E. C. (1978). Trimethoprim and sulfadiazin: adverse effects of long-term administration in dogs. *J. Am. Anim. Hosp. Assoc.* **14**, 410–417.
- Lourens, D. C., Dormehl, I., and Goosen, D. J. (1982). The feasibility of a renogram study in dogs with radiopharmaceutical 99mTc-DTPA. *J. Sth. Afr. Vet. Assoc.* **53**, 243–248.
- Lowe, J. A., Murphy, M., and Nash, V. (1998). Changes in plasma and muscle creatine concentration after increases in supplementary dietary creatine in dogs. *J. Nutr.* **128**, 2691S–2693S.
- Lowseth, L. A., Gillett, N. A., Gerlach, R. F., and Muggenburg, B. A. (1990). The effects of aging on hematology and serum chemistry values in the beagle dog. *Vet. Clin. Pathol.* **19**, 13–19.
- Lulich, J. P., and Osborne, C. A. (1990). Interpretation of urine protein-creatinine ratios in dogs with glomerular and nonglomerular disorders. *Comp. Cont. Educ. Pract. Vet.* **12**, 59–73.
- Lulich, J. P., Osborne, C. A., O'Brien, T. D., and Polzin, D. J. (1992). Feline renal failure: questions, answers, questions. *Comp. Cont. Educ. Pract. Vet.* **14**, 127–152.
- Lulich, J. P., Osborne, C. A., and Polzin, D. J. (1996). Diagnosis and long-term management of protein-losing glomerulonephropathy: a 5-year case-based approach. *Vet. Clin. North Am. Small Anim. Pract.* **26**, 1401–1416.
- Lulich, J. P., Osborne, C. A., Polzin, D. J., Johnston, S. D., and Parker, M. L. (1991). Urine metabolite values in fed and nonfed clinically normal Beagles. *Am. J. Vet. Res.* **52**, 1573–1578.
- Lund, E. M., Armstrong, P. J., Kirk, C. A., Kolar, L. M., and Klausner, J. S. (1999). Health status and population characteristics of dogs and cats examined at private veterinary practices in the United States. *J. Am. Vet. Med. Assoc.* **214**, 1336–1341.
- Lunn, D. P., and McGuirk, S. M. (1990). Renal regulation of electrolyte and acid-base balance in ruminants. *Vet. Clin. N. Amer. Food. Anim. Pract.* **6**, 1–28.

- Lupke, H., Mulling, M., and Sohn, E. (1967). [Investigations of maternal-fetal correlations of cattle. 2. The content of total nitrogen, urea, uric acid and creatinine of the amniotic and allantoic fluid]. *Berl. Munch. Tierarztl. Wochenschr.* **80**, 449–450.
- MacDougall, D. F. (1981). Assessment of renal function in the dog. *Vet. Rec.* **108**, 232–234.
- MacDougall, D. F., Cook, T., Steward, A. P., and Cattell, V. (1986). Canine chronic renal disease: prevalence and types of glomerulonephritis in the dog. *Kidney Int.* **29**, 1144–1151.
- Maddison, J. E., Pascoe, P. J., and Jansen, B. S. (1984). Clinical evaluation of sodium sulfanilate clearance for the diagnosis of renal disease in dogs. *J. Am. Vet. Med. Assoc.* **185**, 961–965.
- Marini, J. C., and Van Amburgh, M. E. (2003). Nitrogen metabolism and recycling in Holstein heifers. *J. Anim. Sci.* **81**, 545–552.
- Martin, C., Pêchereau, D., de la Farge, F., and Braun, J. P. (2002). Cystatine C plasmatique chez le chat: les techniques actuelles ne permettent pas de l'utiliser comme marqueur d'insuffisance rénale. *Revue. Med. Vet.* **153**, 305–310.
- Martinez, E. A., Mealey, K. L., Wooldridge, A. A., Mercer, D. E., Cooper, J., Slater, M. R., and Hartsfield, S. M. (1996). Pharmacokinetics, effects on renal function, and potentiation of atracurium-induced neuromuscular blockade after administration of a high dose of gentamicin in isoflurane-anesthetized dogs. *Am. J. Vet. Res.* **57**, 1623–1626.
- Martinsson, K. (1972). Studies on the proteinuria of newborn piglets with special reference to IgG fragments. *Acta Vet. Scand.* **13**, 87–95.
- Massry, S. G., Coburn, J. W., and Kleeman, C. R. (1969). The influence of extracellular volume expansion on renal phosphate reabsorption in the dog. *J. Clin. Invest.* **48**, 1237–1245.
- Mathews, K. A., Pettifer, G., Foster, R. A., and McDonnell, W. (2001). Safety and efficacy of preoperative administration of meloxicam, compared with that of ketoprofen and butorphanol in dogs undergoing abdominal surgery. *Am. J. Vet. Res.* **62**, 882–888.
- Mathieson, P. W. (2004). The cellular basis of albuminuria. *Clin. Sci.* **107**, 533–538.
- Matos, P., Duarte-Silva, M., Drukker, A., and Guignard, J. P. (1998). Creatinine reabsorption by the newborn rabbit kidney. *Pediatr. Res.* **44**, 639–641.
- Matthews, H. K., Andrews, F. M., Daniel, G. B., Jacobs, W. R., and Held, J. P. (1992). Comparison of standard and radionuclide methods for measurement of glomerular filtration rate and effective renal blood flow in female horses. *Am. J. Vet. Res.* **53**, 1612–1616.
- Matus, R. E., Leifer, C. E., MacEwen, E. G., and Hurvitz, A. I. (1986). Prognostic factors for multiple myeloma in the dog. *J. Am. Vet. Med. Assoc.* **188**, 1288–1292.
- McCall Kaufman, G. (1984). Renal function in the geriatric dog. *Comp. Cont. Educ. Pract. Vet.* **6**, 1087–1095.
- McCaw, D. L., Knapp, D. W., and Hewett, J. E. (1985). Effect of collection time and exercise restriction on the prediction of urine protein excretion, using urine protein/creatinine ratio in dogs. *Am. J. Vet. Res.* **46**, 1665–1669.
- McKeever, K. H., Hinchcliff, K. W., Schmall, L. M., and Muir, W. W., 3rd. (1991). Renal tubular function in horses during submaximal exercise. *Am. J. Physiol.* **261**, R553–R560.
- McKeever, K. H., Scali, R., Geiser, S., and Kearns, C. F. (2002). Plasma aldosterone concentration and renal sodium excretion are altered during the first days of training. *Equine Vet. J. (suppl)*, 524–531.
- McKeever, K. H., Schurg, W. A., and Convertino, V. A. (1985). Exercise training-induced hypervolemia in greyhounds: role of water intake and renal mechanisms. *Am. J. Physiol.* **248**, R422–R425.
- Mealey, K. L., and Boothe, D. M. (1994). Nephrotoxicosis associated with topical administration of gentamicin in a cat. *J. Am. Vet. Med. Assoc.* **204**, 1919–1921.
- Medaille, C., Trumel, C., Concordet, D., Vergez, F., and Braun, J. P. (2004). Comparison of plasma/serum urea and creatinine concentrations in the dog: a 5-year retrospective study in a commercial veterinary clinical pathology laboratory. *J. Vet. Med. A Physiol. Pathol. Clin. Med.* **51**, 119–123.
- Meintjes, R. A., and Engelbrecht, H. (1993). Changes in kidney function and faecal excretion of water and electrolytes with sodium chloride loading in sheep. *J. S. Afr. Vet. Assoc.* **64**, 13–19.
- Mercer, H. D., Teske, R. H., Helferich, W. G., et al. (1979). Use of the double-isotope single-injection method for estimating renal function in normal cross-bred swine. *Am. J. Vet. Res.* **40**, 567–570.
- Mercer, H. D., Willett, L. B., Schandbacher, F. L., et al. (1978). Use of the double-isotope, single-injection method for estimating renal function in normal and polybrominated biphenyl-exposed dairy cows. *Am. J. Vet. Res.* **39**, 1262–1268.
- Meyer-Lindenberg, A., Wohlsein, P., Trautwein, G., and Nolte, I. (1997). [Urine protein analysis with the sodium-dodecyl-sulfate-polyacrylamide gel-electrophoresis (SDS-PAGE) in healthy cats and cats with kidney diseases]. *Zentralbl. Veterinarmed. A* **44**, 39–54.
- Meyer, H., Zentek, J., Behnsen, K., and Hess, M. (1997). Nutritive Einflussfaktoren auf das spezifische Gewicht des Harns bei Hunden. *Kleintier. Praxis* **42**, 43–50.
- Miller, W. G., Myers, G. L., Ashwood, E. R., Killeen, A. A., Wang, E., Thienpont, L. M., and Siekmann, L. (2005). Creatinine measurement. State of the art in accuracy and interlaboratory harmonizations. *Arch. Pathol. Lab. Sci.* **129**, 297–304.
- Minkus, G., Reusch, C., Hörauf, A., Breuer, W., Darbès, J., Kraft, W., and Hermanns, W. (1994). Evaluation of renal biopsies in cats and dogs: histopathology in comparison with clinical data. *J. Small Anim. Pract.* **35**, 465–472.
- Mitch, W. E., Collier, V. U., and Walser, M. (1980). Creatinine metabolism in chronic renal failure. *Clin. Sci.* **58**, 327–335.
- Mitchell, E. K. L., Louey, S., Cock, M. L., Harding, R., and Black, M. J. (2004). Nephron endowment and filtration surface area in the kidney after growth restriction of fetal sheep. *Pediatr. Res.* **55**, 769–773.
- Miyamoto, K. (1998). Evaluation of a single-injection method of inulin and creatinine as a renal function test in normal cats. *J. Vet. Med. Sci.* **60**, 327–332.
- Miyamoto, K. (2001a). Clinical application of plasma clearance of iohexol on feline patients. *J. Feline Med. Surg.* **3**, 143–147.
- Miyamoto, K. (2001b). Use of plasma clearance of iohexol for estimating glomerular filtration rate in cats. *Am. J. Vet. Res.* **62**, 572–575.
- Moe, L., and Heiene, R. (1995). Estimation of glomerular filtration rate in dogs with 99m-Tc-DTPA and iohexol. *Res. Vet. Sci.* **58**, 138–143.
- Monroe, W. E., Davenport, D. J., and Saunders, G. K. (1989). Twenty-four hour urinary protein loss in healthy cats and the urinary protein-creatinine ratio as an estimate. *Am. J. Vet. Res.* **50**, 1906–1909.
- Morris, D. D., Divers, T. J., and Whitlock, R. H. (1984). Renal clearance and fractional excretion of electrolytes over a 24-hour period in horses. *Am. J. Vet. Res.* **45**, 2431–2435.
- Moustgaard, J. (1947). Variation of the renal function in normal and unilaterally nephrectomized dogs. *Am. J. Vet. Res.* **8**, 301–306.
- Muller-Peddinghaus, R., and Trautwein, G. (1977). [Urine analysis using SDS-polyacrylamide gel electrophoresis in the dog]. *Zentralbl. Veterinarmed. A* **24**, 731–755.
- Mulnix, J. A., Rijnberk, A., and Hendriks, H. J. (1976). Evaluation of a modified water-deprivation test for diagnosis of polyuric disorders in dogs. *J. Am. Vet. Med. Assoc.* **169**, 1327–1330.
- Myers, G. L., Miller, W. G., Coresh, J., Fleming, J., Greenberg, N., Greene, T., Hostetter, T., Levey, A. S., Panteghini, M., Welch, M., and Eckfeldt, J. H. (2006). Recommendations for improving serum

- creatinine measurement: a report from the Laboratory Working Group of the National Kidney Disease Education Program. *Clin. Chem.* **52**, 5–18.
- Nagode, L. A., and Chew, D. J. (1992). Nephrocalcinosis caused by hyperparathyroidism in progression of renal failure: treatment with calcitriol. *Semin. Vet. Med. Surg. (Small Anim.)* **7**, 202–220.
- Nagode, L. A., Chew, D. J., and Podell, M. (1996). Benefits of calcitriol therapy and serum phosphorus control in dogs and cats with chronic renal failure. Both are essential to prevent or suppress toxic hyperparathyroidism. *Vet. Clin. North Am. Small Anim. Pract.* **26**, 1293–1330.
- Nakamura, M., Itoh, T., Miyata, K., Higashiyama, N., Takesue, H., and Nishiyama, S. (1983). Difference in urinary N-acetyl-beta-D-glucosaminidase activity between male and female beagle dogs. *Ren. Physiol.* **6**, 130–133.
- Nap, R. C., Hazewinkel, H. A. W., Voorhout, G., van den Brom, W. E., Goedegebuure, S. A., and van T'Klooster, A. T. (1991). Growth and skeletal development in Great Dane pups fed different levels of protein intake. *J. Nutr.* **121**, S107–S113.
- Narins, R. G., Krishna, G. G., and Riley, L. J. (1992). Assessment of renal function: characteristics of the functional and organic forms of acute renal failure. In “The Kidney: Physiology and Physiopathology” (D. W. Seldin and G. Giebisch, Eds.), 2nd ed., pp. 3063–3084. Raven Press, New York.
- Narita, T., Tomizawa, N., Sato, R., Goryo, M., and Hara, S. (2005). Effects of long-term oral administration of ketoprofen in clinically healthy beagle dogs. *J. Vet. Med. Sci.* **67**, 847–853.
- Nash, A. S., Boyd, J. S., Minto, A. W., and Wright, N. G. (1983). Renal biopsy in the normal cat: an examination of the effects of a single needle biopsy. *Res. Vet. Sci.* **34**, 347–356.
- Navar, L. G., Bell, P. D., White, R. W., Watts, R. L., and Williams, R. H. (1977). Evaluation of the single nephron glomerular filtration coefficient in the dog. *Kidney Int.* **12**, 137–149.
- Nawaz, M., and Shah, B. H. (1984). Renal clearance of endogenous creatinine and urea in sheep during summer and winter. *Res. Vet. Sci.* **36**, 220–224.
- Neiger, R. D., and Hagemoser, W. A. (1985). Renal percent clearance ratios in cattle. *Vet. Clin. Pathol.* **14**, 31–35.
- Nesje, M., Flaoyen, A., and Moe, L. (1997). Estimation of glomerular filtration rate in normal sheep by the disappearance of iothexol from serum. *Vet. Res. Commun.* **21**, 29–35.
- Newell, S. M., Ko, J. C., Ginn, P. E., Heaton-Jones, T. G., Hyatt, D. A., Cardwell, A. L., Mauragis, D. F., and Harrison, J. M. (1997). Effects of three sedative protocols on glomerular filtration rate in clinically normal dogs. *Am. J. Vet. Res.* **58**, 446–450.
- Nielsen, S., Frokiaer, J., Marples, D., Kwon, T. H., Agre, P., and Knepper, M. A. (2002). Aquaporins in the kidney: from molecules to medicine. *Physiol. Rev.* **82**, 205–244.
- Noonan, C. H., and Kay, J. M. (1990). Prevalence and geographic distribution of Fanconi syndrome in Basenjis in the United States. *J. Am. Vet. Med. Assoc.* **197**, 345–349.
- Norris, C. R., Christopher, M. M., Howard, K. A., and Nelson, R. W. (1999a). Effect of magnesium-deficient diet on serum and urine magnesium concentrations in healthy cats. *Am. J. Vet. Res.* **60**, 1159–1163.
- Norris, C. R., Nelson, R. W., and Christopher, M. M. (1999b). Serum total and ionized magnesium concentrations and urinary fractional excretion of magnesium in cats with diabetes mellitus and diabetic ketoacidosis. *J. Am. Vet. Med. Assoc.* **215**, 1455–1459.
- Nunez, E., Steffey, E. P., Ocampo, L., Rodriguez, A., and Garcia, A. A. (2004). Effects of alpha2-adrenergic receptor agonists on urine production in horses deprived of food and water. *Am. J. Vet. Res.* **65**, 1342–1346.
- O’Connell, J. M. B., Romeo, J. A., and Mudge, G. H. (1962). Renal tubular secretion of creatinine in the dog. *Am. J. Physiol.* **203**, 985–990.
- O’Connor, W. J., and Summerill, R. A. (1976). The effect of a meal on glomerular filtration rate in dogs at normal urine flows. *J. Physiol.* **256**, 81–91.
- O’Neill, S. L., and Feldman, B. F. (1989). Hemolysis as a factor in clinical chemistry and hematology of the dog. *Vet. Clin. Pathol.* **18**, 58–68.
- Oester, A., Olesen, S., and Madsen, P. O. (1968). Determination of glomerular filtration rate: old and new methods. A comparative study in dogs. *Invest. Urol.* **6**, 315–321.
- Ogura, T. (1986). Assay of urinary enzymes in the dog and cat. *Jpn. J. Vet. Res.* **34**, 149.
- Ohashi, F., Awaji, T., Shimada, T., and Shimada, Y. (1995). Plasma methylguanidine and creatinine concentrations in cats with experimentally induced acute renal failure. *J. Vet. Med. Sci.* **57**, 965–966.
- Oishi, A., Sakamoto, H., and Shimizu, R. (1995). Canine plasma erythropoietin levels in 124 cases of anemia. *J. Vet. Med. Sci.* **57**, 747–749.
- Oishi, A., Sakamoto, H., Shimizu, R., Ohashi, F., and Takeuchi, A. (1993). Evaluation of erythropoietin production in dogs with reduced functional renal tissue. *J. Vet. Med. Sci.* **55**, 543–548.
- Ortega, T. M., Feldman, E. C., Nelson, R. W., Willits, N., and Cowgill, L. D. (1996). Systemic arterial blood pressure and urine protein/creatinine ratio in dogs with hyperadrenocorticism. *J. Am. Vet. Med. Assoc.* **209**, 1724–1729.
- Orth, S. R., and Ritz, E. (1998). The nephrotic syndrome. *N. Engl. J. Med.* **338**, 1202–1211.
- Osbaldiston, G. W., and Fuhrman, W. (1970). The clearance of creatinine, inulin, paraaminohippurate and phenolsulphophtalein in the cat. *Can. J. Comp. Med.* **34**, 138–141.
- Osborne, C. A. (1971). Clinical evaluation of needle biopsy of the kidney and its complications in the dog and cat. *J. Am. Vet. Med. Assoc.* **158**, 1213–1228.
- Osborne, C. A. (1995). Techniques of urine collection and preservation. In “Canine and Feline Nephrology and Urology” (C. A. Osborne and D. R. Finco, Eds.), pp. 100–121. Williams and Wilkins, Baltimore.
- Osborne, C. A., and Jeraj, K. (1980). Glomerulonephropathy and the nephrotic syndrome. In “Current veterinary therapy VII Small animal practice” (R. W. Kirk, Ed.), pp. 1053–1062. W.B. Saunders Co., Philadelphia.
- Osborne, C. A., and Polzin, D. J. (1983). Azotemia: a review of what’s old and what’s new. Part I. Definition of terms and concepts. *Comp. Cont. Educ. Pract. Vet.* **5**, 497–508.
- Pages, J. P., and Trouillet, J. L. (1990). Les protéinuries. *Prat. Med. Chir. Anim. Comp.* **25**, 585–597.
- Palacio, J., Liste, F., and Gascon, M. (1997). Enzymuria as an index of renal damage in canine leishmaniasis. *Vet. Rec.* **140**, 477–480.
- Pallone, T. L., Silldorff, E. P., and Turner, M. R. (1998). Intrarenal blood flow: microvascular anatomy and the regulation of medullary perfusion. *Clin. Exp. Pharmacol. Physiol.* **25**, 383–392.
- Palm, M., and Lundblad, A. (2005). Creatinine concentration in plasma from dog, rat, and mouse: a comparison of 3 different methods. *Vet. Clin. Pathol.* **34**, 232–236.
- Palmore, W. P., Gaskin, J. M., and Nielson, J. T. (1978). Effects of diet on feline urine. *Lab. Anim. Sci.* **28**, 551–555.
- Paquignon, A., Tran, G., and Provost, J. P. (1993). Evaluation of the Clinitek 200 urinary test-strip reader in the analysis of dog and rat urines in pre-clinical toxicology studies. *Lab. Anim.* **27**, 240–246.
- Park, R., and Rabinowitz, L. (1969). Effect of reduced glomerular filtration rate on the fractional excretion of urea in the dog. *Proc. Soc. Exp. Biol. Med.* **132**, 27–29.

- Parker, R. O., and Aherne, F. X. (1980). Serum and urine concentrations of protein, urea, sodium, and potassium during the immediate postnatal period of the suckling pig. *Biol. Neonate* **38**, 11–15.
- Passing, H., and Brunk, R. (1981). Statistische Untersuchungen auf alters- und geschlechtsspezifische Unterschiede von Blutparametern an englischen Beagle-Hunden. II. Klinische Chemie. *Berl. Münch. Tierärztl. Wschr.* **94**, 432–436.
- Pechereau, D., Martel, P., and Braun, J. P. (1997). Plasma erythropoietin concentrations in dogs and cats: reference values and changes with anaemia and/or chronic renal failure. *Res. Vet. Sci.* **62**, 185–188.
- Pelayo, J. C., Fildes, R. D., and Jose, P. A. (1984). Age-dependent renal effects of intrarenal dopamine infusion. *Am. J. Physiol.* **247**, R212–R216.
- Perrone, R. D., Madias, N. E., and Levey, A. S. (1992). Serum creatinine as an index of renal function: new insights into old concepts. *Clin. Chem.* **38**, 1933–1953.
- Peters, A. M., Henderson, B. L., and Lui, D. (2000). Indexed glomerular filtration rate as a function of age and body size. *Clin. Sci.* **98**, 439–444.
- Pihl, B., and Nosslin, B. (1974). The single injection technique for determination of renal clearance. I. Clearance of iothalamate and iodohipurate in dogs. *Scand. J. Urol. Nephrol.* **8**, 138–146.
- Poirier, J., Ribadeau Dumas, J. L., Catala, M., Anfré, J. M., Gherardi, R. K., and Bernaudin, J. F. (1999). “Histologie Moléculaire: Texte et Atlas.” Masson, Paris.
- Polzin, D. J., and Osborne, C. A. (1988). The importance of egg protein in reduced protein diets designed for dogs with renal failure. *J. Vet. Intern. Med.* **2**, 15–21.
- Polzin, D. J., Osborne, C. A., Adams, L. D., and O’Brien, T. D. (1989). Dietary management of canine and feline chronic renal failure. *Vet. Clin. North Am. Small Anim. Pract.* **19**, 539–560.
- Polzin, D. J., Osborne, C. A., Adams, L. G., and Lulich, J. P. (1992). Medical management of feline chronic renal failure. In “Current Veterinary Therapy XI Small Animal Practice” (R. W. Kirk and J. D. Bonagura, Eds.), pp. 848–853. Saunders, Philadelphia.
- Polzin, D. J., Osborne, C. A., Hayden, D. W., and Stevens, J. B. (1983). Effects of modified protein diets in dogs with chronic renal failure. *J. Am. Vet. Med. Assoc.* **183**, 980–986.
- Polzin, D. J., Osborne, C. A., Hayden, D. W., and Stevens, J. B. (1984). Influence of reduced protein diets on morbidity, mortality, and renal function in dogs with induced chronic renal failure. *Am. J. Vet. Res.* **45**, 506–517.
- Polzin, D. J., Osborne, C. A., Jacob, F., and Ross, S. (2000). Chronic renal disease. In “Textbook of Veterinary Internal Medicine” (S. J. Ettinger and E. C. Feldman, Eds.), 5th ed., pp. 1634–1662. Saunders, Philadelphia.
- Polzin, D. J., Osborne, C. A., and Lulich, J. P. (1991). Effects of dietary protein/phosphate restriction in normal dogs and dogs with chronic renal failure. *J. Small Anim. Pract.* **32**, iD [c23.9(C.natTc (183)Tj /F3.)-44TD -0.rhC.natTc 1.natu. J.327so

- Reusch, C., Vochezer, R., and Weschta, E. (1991). Enzyme activities of urinary alanine aminopeptidase (AAP) and N-acetyl-beta-D-glucosaminidase (NAG) in healthy dogs. *Zentralbl. Veterinarmed. A* **38**, 90–98.
- Reynolds, A. J., Reinhart, G. A., Carey, D. P., Simmerman, D. A., Frank, D. A., and Kallfelz, F. A. (1999). Effect of protein intake during training on biochemical and performance variables in sled dogs. *Am. J. Vet. Res.* **60**, 789–795.
- Reynolds, B., Taillade, B., Médaille, C., Palanché, F., Craig, A., Trumel, C., and Lefebvre, H. P. (2006). Effect of repeated-thaw cycles on routine plasma biochemical constituents in canine plasma. *Vet. Clin. Pathol.* **35**, 339–340.
- Ritz, E., Haxsen, V., and Zeier, M. (2003). Disorders of phosphate metabolism pathomechanisms and management of hypophosphatemic disorders. *Best. Pract. Res. Clin. Endocrinol. Metab.* **17**, 547–558.
- Rivas, L. J., Hinchcliff, K. W., Kohn, C. W., Sams, R. A., and Chew, D. J. (1997). Effect of sodium bicarbonate administration on renal function of horses. *Am. J. Vet. Res.* **58**, 664–671.
- Rivers, B. J., Walter, P. A., O'Brien, T. D., King, V. L., and Polzin, D. J. (1996). Evaluation of urine gamma-glutamyl transpeptidase-to-creatinine ratio as a diagnostic tool in an experimental model of aminoglycoside-induced acute renal failure in the dog. *J. Am. Anim. Hosp. Assoc.* **32**, 323–336.
- Riviere, J. E., Carver, M. P., Coppoc, G. L., Carlton, W. W., Lanz, G. C., and Shy-Modejska, J. (1984). Pharmacokinetics and comparative nephrotoxicity of fixed-dose versus fixed-interval reduction of gentamicin dosage in subtotal nephrectomized dogs. *Toxicol. Appl. Pharmacol.* **75**, 496–509.
- Roberts, M. C., and Seiler, R. J. (1979). Renal failure in a horse with chronic glomerulonephritis and renal oxalosis. *J. Am. Vet. Med. Assoc.* **3**, 278–283.
- Robertson, J. L., Goldschmidt, M., Kronfeld, D. S., Tomaszewski, J. E., Hill, G. S., and Bovee, K. C. (1986). Long-term renal responses to high dietary protein in dogs with 75% nephrectomy. *Kidney Int.* **29**, 511–519.
- Robinson, T., Harbison, M., and Bovee, K. C. (1974). Influence of reduced renal mass on tubular secretion of creatinine in the dog. *Am. J. Vet. Res.* **35**, 487–491.
- Roby, K. A., Chalupa, W., Orsini, J. A., Elser, A. H., and Kronfeld, D. S. (1987). Acid-base and electrolyte balance in dairy heifers fed forage and concentrate rations: effects of sodium bicarbonate. *Am. J. Vet. Res.* **48**, 1012–1016.
- Rogers, K. S., Komkov, A., Brown, S. A., Lees, G. E., Hightower, D., and Russo, E. A. (1991). Comparison of four methods of estimating glomerular filtration rate in cats. *Am. J. Vet. Res.* **52**, 961–964.
- Rose, R. J., and Bloomberg, M. S. (1989). Responses to sprint exercise in the Greyhound: effects on hematology, serum biochemistry and muscle metabolites. *Res. Vet. Sci.* **47**, 212–218.
- Rosol, T. J., and Capen, C. C. (1996). Pathophysiology of calcium, phosphorus, and magnesium metabolism in animals. *Vet. Clin. North Am. Small Anim. Pract.* **26**, 1155–1184.
- Ross, L. A., and Finco, D. R. (1981). Relationship of selected clinical renal function tests to glomerular filtration rate and renal blood flow in cats. *Am. J. Vet. Res.* **42**, 1704–1710.
- Rossier, Y., Divers, T. J., and Sweeney, R. W. (1995). Variations in urinary gamma glutamyl transferase/urinary creatinine ratio in horses with or without pleuropneumonia treated with gentamicin. *Equine Vet. J.* **27**, 217–220.
- Roussel, A. J., Cohen, N. D., Ruoff, W. W., Brumbaugh, G. W., Schmitz, D. G., and Kuesis, B. S. (1993). Urinary indices of horses after intravenous administration of crystalloid solutions. *J. Vet. Intern. Med.* **7**, 241–246.
- Ruhrmann, A., Hambitzer, R., and Bent, E. (1986). Referenzwerte verschiedener Harninhaltsstoffe bei Sauen. *Dtsch. Tierärztl. Wschr.* **93**, 115–120.
- Rumbaugh, G. E., Carlson, G. P., and Harrold, D. (1982). Urinary production in the healthy horse and in horses deprived of feed and water. *Am. J. Vet. Res.* **43**, 735–737.
- Russell, J. M. (2000). Sodium-potassium-chloride cotransport. *Physiol. Rev.* **80**, 211–276.
- Russel, F. G., Wouterse, A. C., Hekman, P., et al. (1987). Quantitative urine collection in renal clearance studies in the dog. *J. Pharmacol. Methods* **17**, 125–136.
- Russo, E. A., Lees, G. E., and Hightower, D. (1986). Evaluation of renal function in cats, using quantitative urinalysis. *Am. J. Vet. Res.* **47**, 1308–1312.
- Rytand, D. A. (1937–1938). The number and size of mammalian glomeruli as related to kidney and to body weight, with methods for their enumeration and measurement. *Am. J. Anat.* **62**, 507–520.
- Sagawa, M., Kaneko, T., Akagawa, S., and Ono, K. I. (1995). Plasma creatinine levels and food creatinine contents in cats. *J. Jpn. Vet. Med. Assoc.* **48**, 871–874.
- Sanders, P. W., Boker, B. B., Bishop, J. B., and Cheung, H. C. (1990). Mechanisms of intranephronal proteinaceous cast formation by low molecular weight proteins. *J. Clin. Invest.* **85**, 570–576.
- Sato, R., Nakajima, N., Soeta, S., Sato, J., and Naito, Y. (1997). Urine N-acetyl-beta-D-glucosaminidase activity in healthy cattle. *Am. J. Vet. Res.* **58**, 1197–1200.
- Sato, R., Sano, Y., Sato, J., and Naito, Y. (1999). N-acetyl-beta-D-glucosaminidase activity in urine of cows with renal parenchymal lesions. *Am. J. Vet. Res.* **60**, 410–413.
- Sato, R., Soeta, S., Miyazaki, M., Syuto, B., Sato, J., Miyake, Y., Yasuda, J., Okada, K., and Naito, Y. (2002a). Clinical availability of urinary N-acetyl-beta-D-glucosaminidase index in dogs with urinary diseases. *J. Vet. Med. Sci.* **64**, 361–365.
- Sato, R., Soeta, S., Syuto, B., Yamagishi, N., Sato, J., and Naito, Y. (2002b). Urinary excretion of N-acetyl-beta-D-glucosaminidase and its isoenzymes in cats with urinary disease. *J. Vet. Med. Sci.* **64**, 367–371.
- Sauer, L. S., Hamar, D., and Lewis, L. D. (1985a). Effect of diet composition on water intake and excretion by the cat. *Feline Pract.* **15**, 16–20.
- Sauer, L. S., Hamar, D., and Lewis, L. D. (1985b). Effect of dietary mineral composition on urinary mineral concentration and excretion by the cat. *Feline Pract.* **15**, 10–15.
- Schloerb, P. R. (1960). Total body water distribution of creatinine and urea in nephrectomized dogs. *Am. J. Physiol.* **199**, 661–665.
- Schneider, U., Schober, E. A., Streich, N. A., and Breusch, S. J. (2002). Urinary creatinine instability falsely increases the deoxypyridinoline/creatinine quotient. *Clin. Chim. Acta* **324**, 81–88.
- Schott, H. C. (2004). Chronic renal failure. In “Equine Internal Medicine” (S. M. Reed, W. V. Bayly, and D. C. Sellon, Eds.), 2nd ed., pp. 1231–1253. Saunders, Philadelphia.
- Schott, H. C., Hodgson, D. R., Bayly, W. M., and Gollnick, P. D. (1991). Renal response to high intensity exercise. *Eq. Exer. Physiol.* **3**, 361–367.
- Schultze, A. E., and Jensen, R. K. (1998). Sodium dodecyl sulfate polyacrylamide gel electrophoresis of canine urinary proteins for the analysis and differentiation of tubular and glomerular diseases. *Vet. Clin. Pathol.* **18**, 93–97.

- Schweigert, F. J., Raila, J., and Haebel, S. (2002). Vitamin A excreted in the urine of canines is associated with a Tamm-Horsfall like protein. *Vet. Res.* **33**, 299–311.
- Sellers, A. F., Pritchard, W. R., Weber, A. F., and Sautter, J. H. (1958). Renal function studies on normal dairy cattle and those with postparturient albuminuria. *Am. J. Vet. Res.* **19**, 580–584.
- Settles, E. L., and Schmidt, D. (1994). Fanconi syndrome in a Labrador retriever. *J. Vet. Intern. Med.* **8**, 390–393.
- Shannon, J. A. (1935). The excretion of inulin in the dog. *Am. J. Physiol.* **112**, 405–413.
- Shannon, J. A., Jolliffe, N., and Smith, H. W. (1932). The excretion of urine in the dog. VI. The filtration and secretion of exogenous creatinine. *Am. J. Physiol.* **102**, 534–550.
- Shapiro, W., Fossum, T. W., Kitchell, B. E., Couto, G. C., and Theilen, G. H. (1988). Use of cisplatin for treatment of appendicular osteosarcoma in dogs. *J. Am. Vet. Med. Assoc.* **192**, 507–511.
- Shaw, F. D. (1976). The effect of mercuric chloride intoxication on urinary gamma-glutamyl transpeptidase excretion in the sheep. *Res. Vet. Sci.* **20**, 226–228.
- Simesen, M. G., Aalund, O., and Husager, L. (1979). Biochemical changes following bilateral nephrectomy in the ovine. *Acta Vet. Scand.* **20**, 595–597.
- Singer, U., and Kraft, H. (1988). Biologische Rhythmen beim Hund. *Kleintierpraxis* **34**, 167–174.
- Sirek, O. V., and Best, C. H. (1952). Intramuscular cortisone administration to dogs. *Proc. Soc. Exp. Biol. Med.* **80**, 594–598.
- Slauson, D. O., and Gribble, D. H. (1971). Thrombosis complicating renal amyloidosis in dogs. *Vet. Pathol.* **8**, 352–363.
- Smith, C. P., and Rousselet, G. (2001). Facilitative urea transporters. *J. Membr. Biol.* **183**, 1–14.
- Snow, D. H., Harris, R. C., and Stuttard, E. (1988). Changes in haematology and plasma biochemistry during maximal exercise in Greyhounds. *Vet. Record* **123**, 487–489.
- Sothern, R. B., Farber, M. S., and Gruber, S. A. (1993). Circannual variations in baseline blood values of dogs. *Chronobiol. Int.* **10**, 364–382.
- Spangenberg, E. M. F., Björklund, L., and Dahlborn, K. (2006). Outdoor housing of laboratory dogs: effects on activity, behaviour, and physiology. *Appl. Anim. Behav. Sci.* **96**, 260–276.
- Spangler, W. L. (1979a). Pathophysiologic response of the juxtaglomerular apparatus to dietary sodium restriction in the dog. *Am. J. Vet. Res.* **40**, 809–819.
- Spangler, W. L. (1979b). Ultrastructure of the juxtaglomerular apparatus in the dog in a sodium-balanced state. *Am. J. Vet. Res.* **40**, 802–808.
- Spangler, W. L., Adelman, R. D., Conzelman, G. M., Jr., and Ishizaki, G. (1980). Gentamicin nephrotoxicity in the dog: sequential light and electron microscopy. *Vet. Pathol.* **17**, 206–217.
- Spencer, K. (1986). Analytical reviews in clinical biochemistry: the estimation of creatinine. *Ann. Clin. Biochem.* **23**, 1–25.
- Spierto, F. W., Hannon, W. H., Gunter, E. W., and Smith, S. J. (1997). Stability of urine creatinine. *Clin. Chim. Acta* **264**, 227–232.
- Steffey, E. P., and Pascoe, P. J. (2002). Detomidine reduces isoflurane anesthetic requirement (MAC) in horses. *Vet. Anesth. Analg.* **29**, 223–227.
- Stein, J. H., Gottschall, J., Osgood, R. W., and Ferris, T. F. (1975). Pathophysiology of a nephrotoxic model of acute renal failure. *Kidney Int.* **8**, 27–41.
- Stevenson, A. E., and Markwell, P. J. (2001). Comparison of urine composition of healthy Labrador retrievers and miniature schnauzers. *Am. J. Vet. Res.* **62**, 1782–1786.
- Stim, J., Shaykh, M., Anwar, F., Ansari, A., Arruda, J. A., and Dunea, G. (1995). Factors determining hemoglobin carbamylation in renal failure. *Kidney Int.* **48**, 1605–1610.
- Stokes, J. E., and Forrester, S. D. (2004). New and unusual causes of acute renal failure in dogs and cats. *Vet. Clin. North Am. Small Anim. Pract.* **34**(vi), 909–922.
- Stone, E. A., Rawlings, C. A., Finco, D. R., and Crowell, W. A. (1981). Renal function after prolonged hypotensive anesthesia and surgery in dogs with reduced renal mass. *Am. J. Vet. Res.* **42**, 1675–1680.
- Strasser, A., Niedermüller, H., Hofecker, G., and Laber, G. (1993). The effect of aging on laboratory values in dogs. *J. Vet. Med. A* **40**, 720–730.
- Strasser, A., Seiser, M., Heizmann, V., and Niedermüller, H. (2001). Einfluss der Jahreszeit auf hämatologische und klinische Parameter in einer Beagleskohorte. *Kleintierpraxis* **46**, 793–804.
- Strasser, A., Seiser, M., Simunek, M., Heizmann, V., and Niedermüller, H. (1997). Physiologische Altersveränderungen beim Hund (longitudinalstudie in einer Beagle-Kolonie). *Wien. Tierärztl. Mschr.* **84**, 189–198.
- Stuart, B. P., Phemister, R. D., and Thomassen, R. W. (1975). Glomerular lesions associated with proteinuria in clinically healthy dogs. *Vet. Pathol.* **12**, 125–144.
- Summerill, R. A., and Lee, K. E. (1985). Phosphate excretion and reabsorption in the conscious dog. *Q. J. Exp. Physiol.* **70**, 169–176.
- Summerville, D. A., and Treves, S. T. (1986). Single plasma sample technique of glomerular filtration rate measurement. *J. Nucl. Med. Allied. Sci.* **30**, 177–184.
- Sutherland, R. J. (1989). Biochemical evaluation of the hepatobiliary system in dogs and cats. *Vet. Clin. North Am. Small Anim. Pract.* **19**, 899–927.
- Sutherland, R. J., Bell, K. C., MsSporran, K. D., and Carthew, G. W. (1986). A comparative study of diagnostic tests for the assessment of heard magnesium status in cattle. *N. Zealand Vet. J.* **34**, 133–135.
- Swaminathan, R., Major, P., Snieder, H., and Spector, T. (2000). Serum creatinine and fat-free mass (lean body mass). *Clin. Chem.* **46**, 1695–1696.
- Swanson, K. S., Kuzmuk, K. N., Schook, L. B., and Fahey, G. C. (2004). Diet affects nutrient digestibility, hematology, and serum chemistry of senior and weanling dogs. *J. Anim. Sci.* **82**, 1713–1724.
- Swanson, R., and Hakim, A. A. (1962). Stop-flow analysis of creatinine excretion in the dog. *Am. J. Physiol.* **203**, 980–984.
- Sweeney, T. E., and Beuchat, C. A. (1993). Limitations of methods of osmometry: measuring the osmolality of biological fluids. *Am. J. Physiol.* **264**, R469–R480.
- Syed, A. A., Silwadi, M. F., and Khatoon, B. A. (2002). Detection and diagnosis of blood in feces and urine: an overview. *Clin. Chim. Acta* **318**, 1–17.
- Symonds, H. W., and Manston, R. (1974). The response of the bovine kidney to increasing plasma inorganic phosphorous concentrations. *Res. Vet. Sci.* **16**, 131–133.
- Szczecz, G. M., Carlton, W. W., and Lund, J. E. (1974). Determination of enzyme concentrations in urine for diagnosis of renal damage. *J. Am. Anim. Hosp. Assoc.* **10**, 171–174.
- Szczecz, G. M., Carlton, W. W., and Tuite, J. (1973). Ochratoxicosis in beagle dogs. I. Clinical and clinicopathological features. *Vet. Pathol.* **10**, 135–154.
- Tabaru, H., Finco, D. R., Brown, S. A., and Cooper, T. (1993). Influence of hydration status on renal functions of dogs. *Am. J. Vet. Res.* **54**, 1758–1764.
- Tennant, B., Lowe, J. E., and Tasker, J. B. (1981). Hypercalcemia and hypophosphatemia in ponies following bilateral nephrectomy. *Proc. Soc. Exp. Biol. Med.* **167**, 365–368.



- Terry, R., Hawkins, D. R., Church, E. H., and Whipple, G. H. (1948). Proteinuria related to hyperproteinemia in dogs following plasma given parenterally. A renal threshold for plasma proteins. *J. Exp. Med.* **87**, 561–573.
- Terzi, F., Burtin, M., and Friedlander, G. (1998). Early molecular mechanisms in the progression of renal failure: role of growth factors and protooncogenes. *Kidney Int.* **65(suppl)**, S68–S73.
- Theisen, S. K., DiBartola, S. P., Radin, M. J., et al. (1997). Muscle potassium content and potassium gluconate supplementation in normokalemic cats with naturally occurring chronic renal failure. *J. Vet. Intern. Med.* **11**, 212–217.
- Thoresen, S. I., Havre, G., Morberg, H., and Mowinckel, P. (1992). Effects of storage time on chemistry results from canine whole blood, serum and heparinized plasma. *Vet. Clin. Pathol.* **21**, 88–94.
- Thoresen, S. I., Tverdal, A., Havre, G., and Morberg, H. (1995). Effects of storage time and freezing temperature on clinical chemical parameters from canine serum and heparinized plasma. *Vet. Clin. Pathol.* **24**, 129–133.
- Thornton, J. R., and English, P. B. (1976). Specific gravity and osmolality as measures of urine concentration in the calf. *Aust. Vet. J.* **52**, 335–337.
- Thrall, M. A., Grauer, G. F., and Mero, K. N. (1984). Clinicopathologic findings in dogs and cats with ethylene glycol intoxication. *J. Am. Vet. Med. Assoc.* **184**, 37–41.
- Thurmon, J. C., Steffey, E. P., Zinkl, J. G., Woliner, M., and Howland, D., Jr. (1984). Xylazine causes transient dose-related hyperglycemia and increased urine volumes in mares. *Am. J. Vet. Res.* **45**, 224–227.
- Thysell, H. (1969). A comparison between Albustix, Hema-Combistix, Labstix, the sulphosalicylic-acid test, Heller's nitric-acid test, and a biuret method. Diagnosis of proteinuria. *Acta Med. Scand.* **185**, 401–407.
- Toribio, R. E., Kohn, C. W., Hardy, J., et al. (2005). Alterations in serum parathyroid hormone and electrolyte concentrations and urinary excretion of electrolytes in horses with induced endotoxemia. *J. Vet. Intern. Med.* **19**, 223–231.
- Toutain, P. L., Lefebvre, H. P., and Laroute, V. (2000). New insights on effect of kidney insufficiency on disposition of angiotensin-converting enzyme inhibitors: case of enalapril and benazepril in dogs. *J. Pharmacol. Exp. Ther.* **292**, 1094–1103.
- Traver, D. S., Salem, C., Coffman, J. R., Garner, H. E., Moore, J. N., Johnson, J. H., Trischler, L. G., and Amend, J. F. (1977). Renal metabolism of endogenous substances in the horse: volumetric vs. clearance ration methods. *J. Am. Anim. Hosp. Assoc.* **1**, 378–382.
- Trim, C. M., and Hanson, R. R. (1986). Effects of xylazine on renal function and plasma glucose in ponies. *Vet. Rec.* **118**, 65–67.
- Trumel, C., Diquelou, A., Lefebvre, H., and Braun, J. P. (2004). Inaccuracy of routine creatinine measurement in canine urine. *Vet. Clin. Pathol.* **33**, 128–132.
- Tryggvason, K. (1999). Unraveling the mechanism of glomerular filtration. *J. Am. Soc. Nephrol.* **10**, 2440–2445.
- Uechi, M., Nogami, Y., Terui, H., Nakayama, T., Ishikawa, R., Wakao, Y., and Takahashi, M. (1994a). Evaluation of urinary enzymes in dogs with early renal disorder. *J. Vet. Med. Sci.* **56**, 555–556.
- Uechi, M., Terui, H., Nakayama, T., Mishina, M., Wakao, Y., and Takahashi, M. (1994b). Circadian variation of urinary enzymes in the dog. *J. Vet. Med. Sci.* **56**, 849–854.
- Uechi, M., Uechi, H., Nakayama, T., Wakao, Y., Ogasawara, T., Takase, K., and Takahashi, M. (1998). The circadian variation of urinary N-acetyl-beta-D-glucosaminidase and gamma-glutamyl transpeptidase in clinically healthy cats. *J. Vet. Med. Sci.* **60**, 1033–1034.
- Uechi, M., Uechi, H., Nakayama, T., Wakao, Y., and Takahashi, M. (1997). The variation in excretory urinary glycyl-prolyl dipeptidyl aminopeptidase in dogs. *Res. Vet. Sci.* **63**, 97–99.
- Ulutas, B., Ozlem, M. B., Ulutas, P. A., Eren, V., and Pasa, S. (2003). Fractional excretion of electrolytes during pre- and postpartum periods in cows. *Acta Vet. Hung.* **51**, 521–628.
- Uribe, D., Krawiec, D. R., Twardock, A. R., and Gelberg, H. B. (1992). Quantitative renal scintigraphic determination of the glomerular filtration rate in cats with normal and abnormal kidney function, using <sup>99m</sup>Tc-diethylenetriaminepentaacetic acid. *Am. J. Vet. Res.* **53**, 1101–1107.
- Vaden, S. L., Gookin, J., Trogdon, M., Langston, C. E., Levine, J., and Cowgill, L. D. (1997a). Use of carbamylated hemoglobin concentration to differentiate acute from chronic renal failure in dogs. *Am. J. Vet. Res.* **58**, 1193–1196.
- Vaden, S. L., Levine, J., and Breitschwerdt, E. B. (1997b). A retrospective case-control of acute renal failure in 99 dogs. *J. Vet. Intern. Med.* **11**, 58–64.
- Vaden, S. L., Pressler, B. M., Lappin, M. R., and Jensen, W. A. (2004). Effects of urinary tract inflammation and sample blood contamination on urine albumin and total protein concentrations in canine urine samples. *Vet. Clin. Pathol.* **33**, 14–19.
- Vajdovich, P., Gaal, T., Szilagy, A., and Harnos, A. (1997). Changes in some red blood cell and clinical laboratory parameters in young and old beagle dogs. *Vet. Res. Commun.* **21**, 463–470.
- Valtonen, M. H., Uusi-Rauva, A., and Eriksson, L. (1982). The effect of protein deprivation on the validity of creatinine and urea in evaluation of renal function. An experimental study in the goat. *Scand. J. Clin. Lab. Invest.* **42**, 507–512.
- van der Brom, W. E., and Biewenga, W. J. (1981). Assessment of the glomerular filtration rate in normal dogs: analysis of the <sup>51</sup>Cr-EDTA clearance and its relation to several endogenous parameters of glomerular filtration. *Res. Vet. Sci.* **30**, 152–157.
- van Vonderen, I. K., Kooistra, H. S., and de Bruijne, J. J. (1995). [Evaluation of a test strip for the determination of urine specific gravity in the dog]. *Tijdschr. Diergeneesk.* **120**, 400–402.
- van Vonderen, I. K., Kooistra, H. S., and Rijnberk, A. (1997). Intra- and interindividual variations in urine osmolality and urine specific gravity in healthy pet dogs of various ages. *J. Vet. Intern. Med.* **11**, 30–35.
- van Vonderen, I. K., Wolfswinkel, J., van den Ingh, T. S., Mol, J. A., Rijnberk, A., and Kooistra, H. S. (2004). Urinary aquaporin-2 excretion in dogs: a marker for collecting duct responsiveness to vasopressin. *Domest. Anim. Endocrinol.* **27**, 141–153.
- Vanholder, R., and De Smet, R. (1999). Pathophysiologic effects of uremic retention solutes. *J. Am. Soc. Nephrol.* **10**, 1623–1815.
- Vanholder, R. C., and Glorieux, G. L. (2003). An overview of uremic toxicity. *Hemodial. Int.* **7**, 156wx–161wx.
- Varela, F., Font, X., Valladares, J. E., and Alberola, J. (1997). Thrombocytopenia and light-chain proteinuria in a dog naturally infected with *Ehrlichia canis*. *J. Vet. Intern. Med.* **11**, 309–311.
- Vimtrup, B. J. (1928). On the number, shape, structure, and surface area of the glomeruli in the kidneys of man and mammals. *Am. J. Anat.* **41**, 123–151.
- Vogin, E. E., Skeggs, H. R., Bokelman, D. L., and Mattis, P. A. (1967). Liver function: postprandial urea nitrogen elevation and indocyanine green clearance in the dog. *Toxicol. Appl. Pharmacol.* **10**, 577–585.
- Waller, K. W., Ward, K. M., Mahan, J. D., and Wismatt, D. K. (1989). Current concepts in proteinuria. *Clin. Chem.* **35**, 755–765.
- Walser, M., Drew, H. H., and LaFrance, N. D. (1988). Creatinine measurements often yielded false estimates of progression in chronic renal failure. *Kidney Int.* **34**, 412–418.

- Walsh, D. M., and Royal, H. D. (1992). Evaluation of a single injection of <sup>99m</sup>Tc-labeled diethylenetriaminepentaacetic acid for measuring glomerular filtration rate in horses. *Am. J. Vet. Res.* **53**, 776–780.
- Wartiovaara, J., Ofverstedt, L. O., Khosnoodi, J., Zhang, J., Makela, E., Sandin, S., Ruotsalainen, V., Cheng, R. H., Jalanko, H., Skoglund, U., and Tryggvason, K. (2004). Nephron strands contribute to a porous slit diaphragm scaffold as revealed by electron tomography. *J. Clin. Invest.* **114**, 1475–1483.
- Waters, C. B., Adams, L. G., Scott-Moncrieff, J. C., DeNicola, D. B., Snyder, P. W., White, M. R., and Gasparini, M. (1997). Effects of glucocorticoid therapy on urine protein-to-creatinine ratios and renal morphology in dogs. *J. Vet. Intern. Med.* **11**, 172–177.
- Watson, A. D. (1998). Urine specific gravity in practice. *Aust. Vet. J.* **76**, 392–398.
- Watson, A. D., Lefebvre, H. P., Concordet, D., Laroute, V., Ferre, J. P., Braun, J. P., Conchou, F., and Toutain, P. L. (2002a). Plasma exogenous creatinine clearance test in dogs: comparison with other methods and proposed limited sampling strategy. *J. Vet. Intern. Med.* **16**, 22–33.
- Watson, A. D. J., and Church, D. B. (1980). Postprandial increase in plasma creatinine concentration in dogs fed cooked meat. *Aust. Vet. J.* **56**, 9.
- Watson, A. D. J., Church, D. B., and Fairburn, A. J. (1981). Postprandial changes in plasma urea and creatinine concentrations in dogs. *Am. J. Vet. Res.* **42**, 1878–1880.
- Watson, A. D. J., Mitten, R. W., Filippich, L. J., and O’Leary, C. (2001). Survey of veterinary practitioners about their experience with urinary disorders in dogs and cats. *Aust. Vet. Practit.* **31**, 50–53.
- Watson, Z. E., Steffey, E. P., VanHoogmoed, L. M., and Snyder, J. R. (2002b). Effect of general anesthesia and minor surgical trauma on urine and serum measurements in horses. *Am. J. Vet. Res.* **63**, 1061–1065.
- Watts, C., and Campbell, J. R. (1970). Biochemical changes following bilateral nephrectomy in the bovine. *Res. Vet. Sci.* **11**, 508–514.
- Watts, C., and Campbell, J. R. (1971). Further studies on the effect of total nephrectomy in the bovine. *Res. Vet. Sci.* **12**, 234–245.
- Welles, E. G., Whatley, E. M., Hall, A. S., and Wright, J. C. (2006). Comparison of Multistix Pro dipsticks with other biochemical assays for determining urine protein (UP), urine creatinine (UC), and UP/UC ration in dogs and cats. *Vet. Clin. Pathol.* **35**, 31–36.
- Wendt, M., Waldmann, K. H., and Bickhardt, K. (1990). Vergleichende Untersuchungen der Inulin- und Creatinin-Clearance beim Schwein. *J. Vet. Med. A* **37**, 752–759.
- Westhoff, A., Meyer-Lindenberg, A., Nolte, I., Wohlstein, P., Trautwein, G., and Grünberg, W. (1994). Eignung und Aussagekraft der Jodkontrastmittel-Clearance zur Messung der glomerulären Filtrationsrate beim Hund. *Kleintierpraxis* **39**, 593–606.
- Westhoff, A., Meyer-Lindenberg, A., Wohlstein, P., and Nolte, I. (1993). Messung des glomerulären Filtrationsrate (GFR) beim Hund mittels nichtradioaktiver Jod-Kontrastmittel Clearance durch den renalyzer PRX. *Mh. Vet. Med.* **48**, 573–582.
- White, J. V., Finco, D. R., Crowell, W. A., et al. (1991). Effect of dietary protein on functional, morphologic, and histologic changes of the kidney during compensatory renal growth in dogs. *Am. J. Vet. Res.* **52**, 1357–1365.
- White, J. V., Olivier, N. B., Reimann, K., and Johnson, C. (1984). Use of protein-to-creatinine ratio in a single urine specimen for quantitative estimation of canine proteinuria. *J. Am. Vet. Med. Assoc.* **185**, 882–885.
- Wolford, S. T., Schroer, R. A., Gohs, F. X., Gallo, P. P., Falk, H. B., and Dente, A. R. (1988). Effect of age on serum chemistry profile, electrophoresis and thyroid hormones in Beagle dogs two weeks to one year of age. *Vet. Clin. Pathol.* **17**, 35–42.
- Woods, L. L., and Young, E. W. (1991). Impaired renal hemodynamic response to protein feeding in dogs with experimental Fanconi syndrome. *Am. J. Physiol.* **261**, F14–F21.
- Wright, N. G., Nash, A. S., Thompson, H., and Fisher, E. W. (1981). Membranous nephropathy in the cat and dog: a renal biopsy and follow-up study of sixteen cases. *Lab. Invest.* **45**, 269–277.
- Wuyts, B., Bernard, D., Van den Noortgate, N., Van de Walle, J., Van Vlem, B., De Smet, R., De Geeter, F., Vanholder, R., and Delanghe, J. R. (2003). Reevaluation of formulas for predicting creatinine clearance in adults and children, using compensated creatinine methods. *Clin. Chem.* **49**, 1011–1014.
- Wynckel, A., Randoux, C., Millart, H., Desroches, C., Gillery, P., Canivet, E., and Chanard, J. (2000). Kinetics of carbamylated haemoglobin in acute renal failure. *Nephrol. Dial. Transplant* **15**, 1183–1188.
- Wyss, M., and Kaddurah-Daouk, R. (2000). Creatine and creatinine metabolism. *Physiol. Rev.* **80**, 1107–1203.
- Yalcin, A., and Cetin, M. (2004). Electrophoretic separation of urine proteins of healthy dogs and dogs with nephropathy and detection of some urine proteins of dogs using immunoblotting. *Revue. Med. Vet.* **155**, 104–112.
- Yaphé, W., and Forrester, S. D. (1994). Renal secondary hyperparathyroidism: pathophysiology, diagnosis, and treatment. *Comp. Cont. Educ. Pract. Vet.* **16**, 173–181.
- Yavuz, A., Tetta, C., Ersoy, F. F., D’Intini, V., Ratanarat, R., De Cal, M., Bonello, M., Bordoni, V., Salvatori, G., Andrikos, E., Yakupoglu, G., Levin, N. W., and Ronco, C. (2005). Uremic toxins: a new focus on an old subject. *Semin. Dial.* **18**, 203–211.
- Zaragoza, C., Barrera, R., Centeno, F., Tapia, J. A., and Mane, M. C. (2003). Characterization of renal damage in canine leptospirosis by sodium dodecyl sulphate-polyacrylamide gel electrophoresis (SDS-PAGE) and Western blotting of the urinary proteins. *J. Comp. Pathol.* **129**, 169–178.
- Zatzman, M. L., Clarke, L., Ray, W. J., et al. (1982). Renal function of the pony and the horse. *Am. J. Vet. Res.* **43**, 608–612.
- Zentek, J., Meyer, H., and Behnsen, K. (1994). Einfluss der Fütterung auf die Mengenelementgehalte im Harn beim Hund. *Kleintier. Praxis* **39**, 825–836.
- Zini, E., Bonfanti, U., and Zatelli, A. (2004). Diagnostic relevance of qualitative proteinuria evaluated by use of sodium dodecyl sulfate-agarose electrophoresis and comparison with renal histologic findings in dogs. *Am. J. Vet. Res.* **65**, 964–971.

# Fluid, Electrolyte, and Acid-Base Balance

Gary P. Carlson

*Department of Medicine and Epidemiology  
School of Veterinary Medicine  
University of California, Davis  
Davis, California*

Michael Bruss

*Department of Anatomy, Physiology, and Cell Biology  
School of Veterinary Medicine  
University of California, Davis  
Davis, California*

---

## I. INTRODUCTION

## II. PHYSIOLOGY OF FLUID AND ELECTROLYTE BALANCE

## III. BODY FLUID COMPARTMENTS

- A. Total Body Water
- B. Extracellular Fluid Volume
- C. Intracellular Fluid Volume

## IV. REGULATION OF BODY FLUIDS AND ELECTROLYTES

- A. Effective Circulating Volume
- B. Antidiuretic Hormone
- C. Renin-Angiotensin
- D. Aldosterone
- E. Atrial Natriuretic Factor

## V. PHYSIOLOGY OF ACID-BASE BALANCE

- A. Definition of pH
- B. Buffers
- C. Acidosis
- D. Alkalosis
- E. Mixed Acid-Base Imbalances
- F. Anion Gap
- G. Bicarbonate and Total CO<sub>2</sub>
- H. Buffer Base, Standard Bicarbonate, and Base Excess or Base Deficit
- I. Nontraditional or Strong Ion Approach to Acid-Base Balance
- J. Dietary Factors in Acid-Base Balance

## VI. EVALUATION OF IMBALANCES

- A. Water
- B. Sodium
- C. Potassium
- D. Chloride

## VII. CLINICAL FEATURES OF FLUID AND ELECTROLYTE BALANCE

- A. History
- B. Clinical Signs

## VIII. CLINICOPATHOLOGICAL INDICATORS OF FLUID AND ELECTROLYTE IMBALANCE

- A. Packed Cell Volume and Total Plasma Protein
- B. Serum Sodium
- C. Serum Potassium
- D. Serum Chloride
- E. Osmolality

## REFERENCES

---

## I. INTRODUCTION

The body fluids are arranged in dynamic, but orderly, functional compartments. Maintenance of these compartments in terms of volume and composition is essential for sustaining normal physiological and biochemical events. The electrolytes dissolved in body fluids fulfill vital roles in virtually all of life's processes. Transmembrane movements of electrolytes are responsible for the electrical events that result in nerve conduction and muscular contraction, and the electrical stability of membranes is highly dependent on the concentration of electrolytes on both sides. Electrolytes also serve as essential cofactors in many enzymatically mediated metabolic reactions. The pH of body fluids is maintained within narrow limits. This fine control is necessary to maintain the structure and function of proteins essential for normal progression of metabolic events. Virtually every organ system participates in the maintenance of fluid and electrolyte balance or is adversely affected by imbalances. In many disease states, impaired fluid intake, excessive fluid losses, or organ damage and dysfunction will lead to a state of altered fluid and electrolyte balance. Regardless of whether fluid and electrolyte alterations are the primary problem or simply represent secondary manifestations of some other disease process, successful patient management depends on correct evaluation and appropriate therapy. To achieve this goal, one must have a clear understanding of the anatomy

and physiology of the body fluids, the pathological mechanisms by which normal processes become deranged, the means by which these disturbances can be identified accurately, and finally the procedures that can be used to correct such disturbances in a prompt, safe, and effective manner (Tasker, 1980).

## II. PHYSIOLOGY OF FLUID AND ELECTROLYTE BALANCE

A variety of units have been used in the quantitative evaluation of biological specimens. To avoid confusion, this chapter describes the units of measure that apply directly to the body fluids and electrolytes. An international standard for clinical chemistry units, the "Système Internationale d'Unités" (SI units), was developed to provide consistent terminology and usage. Although SI units are the international standard, they may not be familiar to all students or clinicians. All solute concentrations are expressed in moles or millimoles per l, blood gas partial pressure in kilopascals, and osmolality in millikelvins of freezing point depression.

Electrolytes are substances that exist as positive or negative charged particles in aqueous solution. The positively charged particles are "cations," and the negatively charged particles are "anions." For univalent ions such as sodium, potassium, chloride, and bicarbonate, 1 mole equals 1 equivalent. For multivalent ions, 1 equivalent is equal to the molecular weight in grams (i.e., 1 mole) divided by the charge on the particle. To maintain electrical neutrality in biological fluids, there must be an equal number of equivalents or milliequivalents of anions and cations in solution. Electrolytes in solution combine equivalent for equivalent, not on a gram for gram or mole for mole basis.

The osmotic properties of a solute in solution are related to the number of particles in solution and not to its weight or its charge. One osmole of a nondissociable substance is equal to its molecular weight in grams. One osmole of any substance that dissociates in solution into two or more particles is equal to the molecular weight in grams divided by the number of particles into which each molecule dissociates. Osmolarity is defined as the number of osmoles per l of final solution, whereas osmolality is the number of osmoles per kilogram of water. Although the expressions are similar, osmolality more correctly describes the osmotic properties as measured in the clinical laboratory.

Most solutes in biological fluids are present in relatively dilute concentrations, and it is more convenient to express these concentrations as millimoles, milliequivalents, or milliosmoles. These simply represent one-thousandth of the standard unit. Conventional terms are milligrams per deciliter (mg/dl), millimoles per l (mmol/l), milliequivalent/l (mEq/l), and milliosmole per kg water (mOsm/kg). The concentrations of the principal anions and cations in plasma are presented in Table 17-1 as expressed in these conventional terms.

## III. BODY FLUID COMPARTMENTS

Before discussing the assessment of fluid deficits or imbalances, it is necessary to consider the organization and composition of the fluid compartments from which these losses occur. An understanding of the forces that govern the relative volume and composition of the body fluid compartments is central to understanding both the clinical and clinicopathological manifestations of altered fluid balance.

### A. Total Body Water

Water is the most abundant compound in the body, and most of life's essential processes take place in this aqueous environment. Although there is substantial variation, the total body water (TBW) of most domestic animals is approximately 60% of body weight (0.60l/kg). In a 500-kg horse, this amounts to approximately 300l (Carlson, 1983c), whereas in a 20-kg dog, it amounts to just over 12l (Kohn and DiBartola, 1992).

Adipose tissue contains little water, and the amount of body fat has a major impact on the relative TBW. The average body water content of women is 0.45 to 0.50l/kg as compared to 0.55 to 0.60l/kg for men (Edelman *et al.*, 1958; Elkinton and Danowski, 1955). This difference is largely the result of the larger fat deposits in the adult woman and the larger muscle mass of the adult man (Elkinton and Danowski, 1955). Clear sex-associated differences in body fat are not appreciated in domestic animals. However, certain species of domestic animals such as fattened swine or sheep have a large amount of body fat. Although lighter sheep had a TBW of near 0.65l/kg (Wade and Sasser, 1970), the TBW of these fattened animals may be less than 0.50l/kg (English, 1966b; Hansard, 1964), whereas the TBW of the athletic horse is generally greater than 0.65l/kg (Dieterich and Holleman, 1973; Judson and Mooney, 1983; Robb *et al.*, 1972). The relative water content of newborn animals is much higher than adults. Data in human infants, calves, foals, and lambs suggest a water content in excess of 75% of body weight at birth (Bennett, 1975; Dalton, 1964; Edelman and Leibman, 1959; Phillips *et al.*, 1971; Pownall and Dalton, 1973). The large TBW is primarily the result of the very large extracellular fluid (ECF) volume, which exceeds 0.40l/kg at birth in most species (Bennett, 1975; Kami *et al.*, 1984; Spensley *et al.*, 1987; Tollert, 1964). There is an initial rapid decline during the first few days to weeks of life with TBW, and ECF volumes approach adult levels by 6 months of age (Spensley *et al.*, 1987).

The TBW consists of two major compartments, the intracellular fluid (ICF) volume and the ECF volume. The distribution of body water is illustrated in Figure 17-1 indicating the normal fluid balance of a 450-kg horse. The ICF accounts for approximately one-half to two-thirds of the TBW, and the ECF accounts for the remainder. Although these two compartments differ markedly in electrolyte

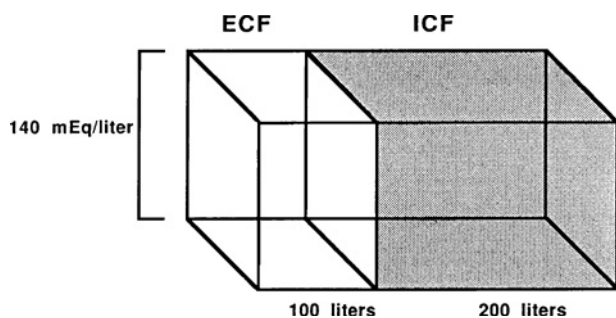
**TABLE 17-1** Plasma Electrolyte Concentrations Expressed in Different Units<sup>a</sup>

Plasma Electrolyte	Normal Concentration			
	mOsmol/kg	mg/dl	mmol/l	mEq/l
<b>Cations</b>				
Sodium (Na <sup>+</sup> )	326.6	142.0	142.0	142.0
Potassium (K <sup>+</sup> )	16.8	4.3	4.3	4.3
Calcium (Ca <sup>2+</sup> ) <sup>b</sup>	5.0	1.25	2.5	1.25
Magnesium (Mg <sup>2+</sup> ) <sup>b</sup>	1.3	0.55	1.1	0.55
Total cations	349.7	148.1	149.9	148.1
<b>Anions</b>				
Chloride (Cl <sup>-</sup> )	369.2	104.0	104.0	104.0
Bicarbonate (HCO <sub>3</sub> <sup>-</sup> )	146.4	24.0	24.0	24.0
Phosphate (H <sub>2</sub> PO <sub>4</sub> <sup>-</sup> , HPO <sub>4</sub> <sup>2-</sup> ) <sup>c</sup>	3.4	1.1	2.0	1.1
Proteins <sup>b</sup>	7000.0	2.5	14.0	2.5
Others (sulfate lactate, etc.)	—	5.5	5.9	5.5
Total anions	7519.0	135.5	149.9	137.0
Total milliosmoles from electrolytes				285.1

<sup>a</sup> From Tasker (1980).

<sup>b</sup> Only ionized calcium and magnesium have been considered here.

<sup>c</sup> Phosphate concentration is that of organic phosphorus. Because a variable equilibrium exists between H<sub>2</sub>PO<sub>4</sub><sup>-</sup> and HPO<sub>4</sub><sup>2-</sup>, the actual valence and milliequivalents must be estimated. The same variability is true of protein anions as well.



**FIGURE 17-1** Body fluid compartments in a normal 450-kg horse. Serum sodium concentration is 140 mEq/l (140 mmol/l). Extracellular fluid (ECF) volume is 100l and intracellular fluid (ICF) volume is 200l.

composition, they are in osmotic equilibrium, and water is freely diffusible between them. The relative volume distribution of water between these two compartments is largely governed by the number of osmotically active particles in each compartment. The ECF sodium content determines the ECF volume, whereas ICF volume is a function of ICF potassium content. The relationship between the exchangeable cation

content (sodium in the ECF, potassium in the ICF) and the total body water was defined by Edelman *et al.* (1958):

$$\text{serum sodium mEq/l H}_2\text{O} \quad (\text{exchangeable sodium} \\ + \text{potassium}) \text{ total body water} \quad (17-1)$$

Because most cell membranes are very permeable to water, there are no major osmotic gradients between the ECF and the ICF, and serum sodium concentration and osmolality reflect the osmolality of the ICF compartment as well as that of the ECF compartment (Edelman *et al.*, 1958; Saxton and Seldin, 1986; Scribner, 1969).

### B. Extracellular Fluid Volume

The ECF should be viewed as a physiological rather than a strictly definable anatomical space (Carlson *et al.*, 1979a). The ECF volume of adult animals ranges from 0.15 to 0.30l/kg body weight (Carlson *et al.*, 1979a; English, 1966b; Evans, 1971; Hankes *et al.*, 1973; Hix *et al.*, 1953; Kohn, 1979; Spurlock *et al.*, 1985; Thornton and English, 1977; Zweens *et al.*, 1975), depending on the species and

the volume dilution procedure used. Regulation of ECF volume is a complex process in which a variety of factors interact. The ECF consists of all the fluids located outside the cells and includes the plasma (0.05 l/kg), interstitial fluid and lymph (0.15 l/kg), and the transcellular fluids (Edelman and Leibman, 1959; Rose, 1984; Saxton and Seldin, 1986). The transcellular fluids, which include the fluid content of the gastrointestinal tract, are generally considered a subcomponent of the ECF. In small animal species, the fluid content of the gastrointestinal tract is relatively small (Strombeck, 1979). In the large animal herbivore species, a substantial volume of fluid is normally present within the gastrointestinal tract. In the horse, this may amount to 30 to 45 l (Carlson, 1979a), and in cattle, the forestomach may contain as much as 30 to 60 l of fluid (Phillipson, 1977). During periods of water restriction and certain other forms of dehydration, this gastrointestinal fluid reservoir can be called on to help maintain effective circulating volume (McDougall *et al.*, 1974). All of the fluids of the ECF contain sodium in approximate concentrations of 130 to 150 mEq/l H<sub>2</sub>O. Sodium provides the osmotic skeleton for the ECF, and the sodium content is the single most important determinant of ECF volume (Rose, 1984). Sodium deficits result in decreases in ECF volume, whereas sodium excess is most often associated with water retention and results in edema (McKeown, 1986; Rose, 1984).

### C. Intracellular Fluid Volume

The ICF volume represents the fluid content within the body's cells. This volume cannot be measured directly but is calculated as the difference between the measured TBW and the measured ECF volume. Potassium provides the osmotic skeleton for the ICF in much the same way that sodium provides the osmotic skeleton for the ECF. Because water is freely diffusible into and out of the cell, changes in the tonicity of the ECF are rapidly reflected by similar changes in ICF tonicity (Saxton and Seldin, 1986). This is largely the result of the movement of water across the cell membrane with resultant changes of ICF volume. Thus, whereas plasma sodium concentration decreases in response to water retention, ICF volume increases (Humes, 1986). On the other hand, with water depletion resulting in hypernatremia, ICF volume decreases (Humes, 1986). Relatively little is known about the organization of intracellular water into the various subcellular compartments and organelles.

## IV. REGULATION OF BODY FLUIDS AND ELECTROLYTES

### A. Effective Circulating Volume

The effective circulating volume refers to that part of the ECF that is within the vascular space and is effectively perfusing the tissues (Rose, 1984). Effective circulating

volume tends to vary with ECF volume, and both parameters vary with the total body sodium stores (Rose, 1984). Sodium loading produces volume expansion, whereas sodium depletion leads to volume depletion.

Effective circulating volume is not a quantitatively measurable entity but refers to the rate of perfusion of the capillary circulation. Effective circulating volume is maintained by varying vascular resistance, cardiac output, as well as renal sodium and water excretion (Rose, 1984). Decreases in effective circulating volume result in decreased venous return, decreased cardiac output, and decreased blood pressure. Decreased volume and pressure are recognized by special volume receptors in the cardiopulmonary circulation and kidney, which trigger increased sympathetic tone resulting in increased arterial and venous constriction as well as increased cardiac contractility and heart rate. These responses tend to correct for the volume deficit by increasing cardiac output and systemic blood pressure. Volume and pressure changes associated with decreases in effective circulating volume also result in activation of the renin-angiotensin system with subsequent enhancement of aldosterone secretion by the adrenal cortex (Brobst, 1984). Aldosterone acts to enhance renal sodium resorption, which is a critical factor for maintaining and eventually restoring effective circulating volume. Additional factors that influence sodium resorption in response to changes in fluid volume include alterations in glomerular filtration rate, renal hemodynamics, atrial natriuretic factor, and plasma sodium concentration.

### B. Antidiuretic Hormone

Antidiuretic hormone (ADH) plays a primary role in the regulation of the osmolality of the body fluids. Antidiuretic hormone is synthesized in the hypothalamus, stored in the neurohypophysis, and released in response to changes in plasma osmolality. Because sodium concentration is the primary determinant of plasma osmolality, ADH-release is closely correlated to plasma sodium concentration. Special sensors in the hypothalamus recognize increases in plasma osmolality, and the normal response is increased thirst to enhance water intake and the release of ADH, which increases water reabsorption by the renal collecting tubules. Antidiuretic hormone exerts its activity on the collecting tubules by activating adenylyl cyclase; this results in the generation of cyclic adenosine monophosphate (cyclic AMP) and protein kinases, which in turn alter the permeability of the tubules to water (Rose, 1984). Antidiuretic hormone also is released in response to decreases in effective circulating fluid volume, although the renin-angiotensin system exerts primary control over volume changes. Antidiuretic hormone acts extrarenally as an arterial vasoconstrictor, thus increasing blood pressure. Plasma osmolality decreases in response to a water load, and ADH release is inhibited. The resultant reduction in ADH-mediated reabsorption of water in the collecting tubules allows for appropriate renal excretion of the water load and a return of plasma osmolality toward normal.

This highly sensitive system responds rapidly to small changes in osmolality, and as a result, plasma osmolality is normally maintained within a relatively narrow range.

### C. Renin-Angiotensin

The renin-angiotensin system plays an important role in the maintenance of effective circulating fluid volume. Renin is a proteolytic enzyme produced by special juxtaglomerular cells of the glomerular afferent arteriole. Renin is released in response to reduced renal perfusion produced by hypotension, volume depletion, or increased sympathetic activity. Renin converts the circulating globulin angiotensinogen to angiotensin I, which is subsequently converted by an enzyme in the lung and vascular endothelial cells to the biologically active form, angiotensin II. Angiotensin II exerts a variety of systemic effects that tend to correct hypovolemia and hypotension. Angiotensin II increases renal retention of sodium and water by enhancing secretion of aldosterone from the adrenal cortex as well as having direct effects on the renal tubule. Angiotensin II exerts hemodynamic effects, which tend to increase blood pressure by inducing arteriolar vasoconstriction.

### D. Aldosterone

Aldosterone plays a central role in the maintenance of effective circulating fluid volume and potassium balance largely through its effects on renal resorption of sodium in exchange for potassium and hydrogen ion. Aldosterone is produced in the adrenal cortex and exerts its effects on sensitive cells, such as the renal collecting tubules, by interacting with specific cytoplasmic receptors. The aldosterone receptor complexes subsequently enhance RNA-mediated production of specific proteins, which actually mediate the physiological effects of the hormone. There is evidence for aldosterone-mediated effects on gastrointestinal sodium and potassium absorption as well as effects on sweat glands to alter the electrolyte composition of sweat in response to sodium depletion (Michell, 1974). Aldosterone secretion is enhanced by the renin-angiotensin system in response to changes in effective circulating fluid volume.

### E. Atrial Natriuretic Factor

Atrial natriuretic factor (ANF), also known as atrial natriuretic peptide (ANP), exists as a group of diverse peptide hormones produced in the heart and released into the circulation in response to processes that increase central venous pressure and thereby stretch the atrial wall (Inagami, 1994). The actions of ANF that tend to reduce cardiac output and systemic blood pressure are mediated by transmembrane receptors, which result in the production of cyclic guanine monophosphate generated by guanylyl cyclase (Inagami, 1994). ANF results in natriuresis and diuresis by the kidneys. ANF also causes vasodilatation and reduces

fluid volume by acting directly on vascular smooth muscle and inhibiting the release of aldosterone from the adrenal cortex and norepinephrine from peripheral adrenergic neurons. Additionally, ANF has been found in the brain, and centrally mediated effects on fluid volume regulation may be important. Elevated plasma ANF has been noted in humans with a variety of diseases ranging from congestive heart failure to obstructive lung disease to chronic renal failure. However, the physiological importance of ANF in these disease processes is not completely resolved. In humans, Bartter's syndrome and Gordon's syndrome are thought to be due to an excess or deficiency of ANF, respectively (Christensen, 1993). In horses, the elevation of plasma ANF has been associated with treadmill exercise (McKeever *et al.*, 1991).

## V. PHYSIOLOGY OF ACID-BASE BALANCE

The hydrogen ion concentration of the ECF is maintained within remarkably narrow limits and is normally approximately 40 nmol/l. This concentration is roughly one-millionth the concentration of other common electrolytes. Even at these extremely low concentrations, hydrogen ions have profound effects on metabolic events largely through interaction with cellular proteins. These interactions alter protein configuration and thus alter protein function. Most enzymatic reactions have a narrowly defined range of pH optimum, and changes in hydrogen ion concentration have direct effects on the rates of reaction and, thus, many basic biological processes.

### A. Definition of pH

Although the hydrogen ion concentration can be expressed in nmol/l a more useful expression is that of pH. The pH of a solution is equal to the negative logarithm of the hydrogen ion concentration.

$$\text{pH} = -\log[\text{H}^+] \quad (17-2)$$

It is important to remember that the pH varies inversely with hydrogen ion concentration. When hydrogen concentration in the blood increases, pH decreases, and the animal develops an acidosis. When the hydrogen ion concentration in the blood decreases, the pH rises, and the animal develops an alkalosis. The traditional view of acid-base balance involves the following:

1. Extracellular and intracellular buffering
2. Regulation of the rate of alveolar ventilation to control carbon dioxide concentration
3. Regulation of renal hydrogen excretion

### B. Buffers

A buffer system consists of a weakly dissociated acid and the salt of that acid. The body buffers are able to take up

or release hydrogen ions so that changes in hydrogen ion concentration are minimized. According to the law of mass action, the dissociation of a weak acid, HA, into  $H^+$  and  $A^-$  can be written

$$K_a = \frac{[H^+][A^-]}{[HA]} \quad (17-3)$$

where  $K_a$  is the dissociation constant for the reaction. The equation can be rewritten

$$[H^+] = K_a \frac{[HA]}{[A^-]} \text{ or } [H^+] = K_a \frac{[\text{Acid}]}{[\text{Salt}]} \quad (17-4)$$

Taking the negative logarithm of both sides of the equation yields

$$-\log [H^+] = -\log K_a - \log \frac{[HA]}{[A^-]} \quad (17-5)$$

Substituting pH for  $-\log [H^+]$ ,  $\log [A^-]/[HA]$  for  $-\log [HA]/[A^-]$  and defining  $pK_a$  as  $-\log K_a$ , the formula now reads

$$\text{pH} = pK_a - \log \frac{[A^-]}{[HA]} \quad (17-6)$$

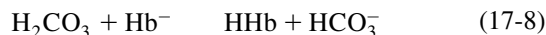
This formula is the familiar Henderson-Hasselbalch equation for the dissociation of a weak acid. The buffering capacity of the body includes the extracellular buffers, intracellular buffers, and bone. The extracellular buffers include the bicarbonate ( $HCO_3^-/H_2CO_3$ ) and phosphate ( $HPO_4^{2-}/H_2PO_4^-$ ) buffer pairs as well as the plasma proteins. The intracellular buffers include protein; organic and inorganic phosphates; and in the red cell, hemoglobin. Cation exchange involving the intracellular movement of hydrogen ion in exchange for potassium and (to a much lesser extent) sodium is an additional and important means whereby cellular mechanisms buffer an acid load. The carbonate in bone provides a large and often overlooked buffer store. Although difficult to accurately measure, it has been estimated that bone carbonate may contribute up to 40% of the buffering capacity of an acute acid load. It is important to remember that a change in hydrogen ion concentration will affect all the body's buffer pairs. Thus, evaluation of any one buffer pair reflects the changes that occur in all of the buffer pairs.

### 1. Bicarbonate/Carbonic Acid Buffer System

Large amounts of carbon dioxide are produced by oxidative metabolism each day. Although carbon dioxide is not an acid, it combines with water as it is added to the bloodstream resulting in the formation of carbonic acid. The enzyme carbonic anhydrase in red blood cells and other cells facilitates this reaction:



The ensuing elevation in the hydrogen concentration is minimized because most of the excess  $H^+$  ions combine with the intracellular buffers, particularly hemoglobin (Hb):



The bicarbonate generated by this reaction then leaves the erythrocyte and enters the extracellular fluid in exchange for extracellular chloride ion. The net effect is that  $CO_2$  is primarily carried in the venous circulation as  $HCO_3^-$  with little change in the extracellular pH. These processes are reversed in the alveoli. As HHb is oxygenated,  $H^+$  is released and combines with  $HCO_3^-$  to form  $H_2CO_3$ , which dissociates to  $CO_2$  and  $H_2O$ . Carbon dioxide then is excreted by alveolar ventilation.

From a clinical and physiological standpoint, the bicarbonate-carbonic acid buffer pair is clearly the most important. Bicarbonate is present in relatively high concentrations, it is relatively easy to measure, and it is the buffer system over which the body has the greatest control. The Henderson-Hasselbalch equation applied to this buffer pair becomes

$$\text{pH} = 6.1 - \log \frac{[HCO_3^-]}{[H_2CO_3]} \quad (17-9)$$

where  $6.1 = pK_a$  for the  $HCO_3^-/H_2CO_3$  buffer pair.

Plasma pH is determined by the concentration of bicarbonate and carbonic acid or, more importantly, the ratio between bicarbonate and carbonic acid. An equilibrium exists between the partial pressure of  $CO_2$  in the alveolar air, the partial pressure of gaseous  $CO_2$  dissolved in the blood, and the carbonic acid concentration of the blood. The conventional method of evaluating carbonic acid is the determination of the partial pressure of carbon dioxide ( $pCO_2$ ) in the blood. The carbonic acid concentration can be calculated by multiplying  $pCO_2$  by 0.03 (0.03 is the solubility constant for carbon dioxide in plasma). The Henderson-Hasselbalch equation for this buffer pair then becomes

$$\text{pH} = 6.1 - \log \frac{[HCO_3^-]}{0.03 (pCO_2)} \quad (17-10)$$

The four primary acid-base imbalances and their compensating responses are presented in Table 17-2. Acidosis is associated with a decrease in pH resulting from an increase in hydrogen ion concentration. Alkalosis is due to a decrease in hydrogen ion concentration, which is reflected by an increase in pH. In the metabolic disorders, the primary imbalance is due to changes in bicarbonate concentration.

The compensating response is mediated by the respiratory system, which, within limits, alters the  $pCO_2$  so as to counterbalance the primary imbalance and to partially restore the pH toward normal. As the name implies, the primary imbalances of the respiratory disorders are related to alterations in alveolar ventilation, which result in increases in  $pCO_2$  in respiratory acidosis and decreases in  $pCO_2$  with



**TABLE 17-2** Acid-Base Imbalances and Compensating Responses

Disorder	pH	[H <sup>+</sup> ]	Primary Imbalance	Compensating Response
Metabolic acidosis			[HCO <sub>3</sub> <sup>-</sup> ]	pCO <sub>2</sub>
Metabolic alkalosis			[HCO <sub>3</sub> <sup>-</sup> ]	pCO <sub>2</sub>
Respiratory acidosis			pCO <sub>2</sub>	[HCO <sub>3</sub> <sup>-</sup> ]
Respiratory alkalosis			pCO <sub>2</sub>	[HCO <sub>3</sub> <sup>-</sup> ]

respiratory alkalosis. The compensating responses for these primary respiratory imbalances are mediated by the kidney through alterations in the excretion or retention of hydrogen ions or bicarbonate.

Blood samples drawn for acid-base evaluation must be drawn anaerobically and sealed so as to avoid alteration in the blood gas tension. Heparin is the anticoagulant of choice. The rectal temperature of the patient should be taken so that appropriate temperature corrections can be made. For evaluation of blood gases during intense exercise, central blood temperature should be used for this correction because rectal temperature may not accurately reflect blood temperature under these non-steady-state conditions. The temperature correction usually has a greater impact on the  $pO_2$  and  $pCO_2$  than bicarbonate or base balance. Arterial blood samples are generally preferred and are essential for the evaluation of primary respiratory disorders or the patient's status under general anesthesia. Venous blood samples provide reliable data on metabolic acid-base abnormalities, and because they are easier to obtain, they are routinely used. Acid-base parameters of venous blood are significantly influenced by the acid-base status of the tissues from which the blood is draining. Central veins (e.g., vena cava) provide blood that better reflects the acid-base status of the body as a whole. As a general rule, blood gas determination should be made as soon after collection as possible. However, appropriately collected blood samples can be held in ice water for as long as 4 h and still yield reliable results.

The effects of various sampling sites (arterial, venous, and capillary blood) on blood gas determination have been evaluated in dogs (Ilkiw *et al.*, 1991; van Sluijs *et al.*, 1982), horses (Littlejohn and Mitchell, 1969; Speirs, 1980), and swine (Hannon *et al.*, 1990). Consistent differences were demonstrated between arterial and venous blood. Arterial blood samples yield higher values for pH and lower values for  $pCO_2$  and bicarbonate than venous blood, but calculated base balances tend to be similar for both arterial and venous blood samples. In horses, venous-arterial differences in bicarbonate can exceed 10 mEq/l during intense exercise. The higher venous bicarbonate reflects the important role of bicarbonate as a means of CO<sub>2</sub> transport in the venous circulation (Carlson, 1995). At rest and during exercise, more

than 70% of the CO<sub>2</sub> produced in the tissues is transported in the venous circulation to the lungs as bicarbonate. This process is greatly facilitated by erythrocyte carbonic anhydrase and the mechanism of the "chloride shift." The effects of temperature on oxygen content of dog blood have been studied (Hedey-Whyte and Laver, 1964), as has the oxygen affinity and Bohr coefficient of dog blood (Reeves *et al.*, 1982). Recumbency in neonatal patients and body position during general anesthesia may have a significant impact on both arterial and mixed venous blood gas data (Madigan *et al.*, 1992; Mason *et al.*, 1987; Steffey *et al.*, 1977). Nomograms have been developed relating the effects of temperature, CO<sub>2</sub> content, and hemoglobin saturation for dog blood (Rossing and Cain, 1966). The use of blood gas data for the evaluation of acid-base imbalances for clinical problems has been reviewed (DiBartola, 1992a, 1992b, 1992c; George, 1994; de Morais, 1992a, 1992b).

## C. Acidosis

### 1. Metabolic

Metabolic acidosis is characterized by a decrease in pH and bicarbonate. Metabolic acidosis, as traditionally viewed, can be produced by the addition of hydrogen ions or a loss of bicarbonate ions. The initial buffering of an acid load is by the ECF buffers, primarily the bicarbonate-carbonic acid buffer pair (Rose, 1984). Intracellular buffers, particularly protein and phosphate, assist in the buffering process. The intracellular movement of hydrogen in exchange for potassium helps to prevent an excessive increase of the ECF hydrogen ion concentration in the face of an acid load. This exchange is called the "cation shift" and can result in hyperkalemia even though the total body potassium stores have been depleted due to renal or gastrointestinal losses.

#### a. Causes of Metabolic Acidosis

The most common causes include lactic acidosis; ketoacidosis; gastrointestinal problems, such as indigestion colic or diarrhea; and renal failure, which may result in a decreased ability to excrete hydrogen and thus to retain bicarbonate (Emmett and Nairns, 1977). It has long been held that

the acidosis in calves associated with diarrhea was largely due to the loss of bicarbonate into the bowel. This view has been challenged in an elegant paper utilizing a quantitative strong ion approach to assess the mechanism of the acid-base abnormality (Constable *et al.*, 2005). A profound metabolic acidosis without dehydration leading to depression, recumbency, and death has been described in goat kids (Tremblay *et al.*, 1991), which appears to be similar to reports in calves (Kasari and Naylor, 1984, 1986). The cause was undetermined, but the acidosis was usually associated with an increased anion gap. Sodium bicarbonate therapy, if initiated early in the course of the disease, was often curative. The acidosis observed in these calves may have been associated with increases in both D and L isomers of lactate generated by bacterial fermentation as described in several recent clinical and research studies of calves with indigestion associated with milk ingestion (Ewaschuk *et al.*, 2003, 2004; Lopez *et al.*, 2004; Lorenz *et al.*, 2005; Omole *et al.*, 2001; Stampfli, 2005). Additional causes of a metabolic acidosis include ingestion of certain medications or toxic compounds such as salicylate, methanol, ethylene glycol, or paraldehyde, which result in the accumulation of exogenous anions (DiBartola, 1992b).

#### b. Compensation

A metabolic acidosis is recognized quickly, and the compensating respiratory response of increased ventilation will begin reduction of the  $p\text{CO}_2$  within minutes. In dogs, the anticipated respiratory response is a reduction of  $p\text{CO}_2$  by 0.7 mmHg for each mEq/l decrease in bicarbonate (de Moraes, 1992a, 1992b). This minimizes the fall in pH, but the protective effects of the respiratory response are relatively short lived, lasting only a few days. Long-term correction of a metabolic acidosis requires renal bicarbonate retention and enhanced renal acid excretion, primarily as ammonium ion because there is little ability to increase the titratable acidity, which consists primarily of phosphate buffers (Rose, 1984). Complete correction of a metabolic acidosis may be difficult in patients with intrinsic renal disease or diseases that would impair the kidney's ability to excrete acid or retain bicarbonate such as renal tubular acidosis.

## 2. Respiratory

A respiratory acidosis is characterized by a decrease in pH and an increase in  $p\text{CO}_2$ . Respiratory acidosis develops because of decreased effective alveolar ventilation or breathing an atmosphere with elevated  $\text{CO}_2$ . The initial buffering of the acid load produced by a respiratory acidosis is almost exclusively by the intracellular buffers. The principal ECF buffer, the bicarbonate-carbonic acid buffer pair, cannot buffer a respiratory acidosis. Carbon dioxide diffuses through the lung much more readily than  $\text{O}_2$ ; thus, diseases that compromise ventilation normally result in decreases in  $p\text{O}_2$  before significant increases in  $p\text{CO}_2$

develop. The respiratory center is extremely sensitive to minor changes in  $p\text{CO}_2$ , and increased  $p\text{CO}_2$  normally provides the major stimulus to ventilation (Rose, 1984). In contrast, hypoxemia does not begin to promote enhanced ventilation until the arterial  $p\text{O}_2$  is substantially decreased. If, however, the arterial  $p\text{CO}_2$  is held at normal values or is elevated because of intrinsic lung disease, then ventilation begins to be enhanced as the arterial  $p\text{O}_2$  falls below 70 to 80 mmHg (Rose, 1984).

#### a. Causes of Respiratory Acidosis

Any disorder that interferes with normal effective ventilation may produce a respiratory acidosis. The most common causes are primary pulmonary diseases ranging from acute upper respiratory obstruction, to pneumonia, to pneumothorax, and chronic obstructive lung disease. Diseases or drugs that affect the central nervous system may inhibit the medullary respiratory center and can produce a profound respiratory acidosis. An additional cause of special importance in veterinary medicine is general anesthesia with volatile agents using a closed system. Under these conditions, ventilation may be seriously reduced without producing hypoxia. The high oxygen content of the gas mixture maintains high  $p\text{O}_2$  in the blood, but depression of the respiratory center may result in insufficient alveolar ventilation so that  $\text{CO}_2$  accumulates. This problem can be overcome through the use of a positive pressure ventilatory apparatus and careful monitoring of arterial blood gases during general anesthesia.

#### b. Compensation

The compensating response for a respiratory acidosis is renal retention of bicarbonate and increased excretion of hydrogen ion. This response requires several days, and thus the response is seen only in a chronic respiratory acidosis. In dogs with chronic respiratory acidosis, a compensating increase of 0.35 mEq/l of bicarbonate is anticipated for each mmHg increase in  $p\text{CO}_2$  (de Moraes, 1992a, 1992b). The extent of the rise in the plasma bicarbonate concentration in chronic respiratory acidosis is determined by increased renal hydrogen secretion (Rose, 1984). Exogenous bicarbonate is unnecessary, and should bicarbonate be administered to patients with a respiratory acidosis, it would be excreted without affecting the final plasma bicarbonate concentration.

## D. Alkalosis

### 1. Metabolic Alkalosis

Metabolic alkalosis is characterized by an increase in pH and bicarbonate. Metabolic alkalosis occurs with some frequency in domestic animals and is commonly observed in association with digestive disturbances in ruminants. The development of a metabolic alkalosis requires an initiating process capable of generating an alkalosis and the additional factors that are necessary for maintaining the alkalosis (Rose, 1984). Generation of a metabolic alkalosis can be due to excessive

hydrogen loss, bicarbonate retention, or as a contraction alkalosis. A contraction alkalosis occurs with reduction of ECF fluid volume resulting from a loss or sequestration of sodium and chloride containing fluid without commensurate loss of bicarbonate (Garella *et al.*, 1975). Excessive hydrogen ion losses can result in a metabolic alkalosis.

#### a. Causes of Metabolic Alkalosis

The most common causes of increased hydrogen loss are gastrointestinal losses of chloride-rich fluids associated with vomiting in small animals (Strombeck, 1979) or sequestration of chloride-rich fluid in the abomasum and forestomach of ruminants (Gingerich and Murdick, 1975b; McGuirk and Butler, 1980). Excessive renal hydrogen loss associated with mineralocorticoid excess, diuretic usage (particularly the loop diuretics such as furosemide), and low chloride intake may cause or contribute to the generation of a metabolic alkalosis (Rose, 1984). Most of these disorders are also associated with the development of significant sodium and chloride deficits and resultant decreases in effective circulating volume. These deficits and the responses that decreased effective circulating volume induce are central features of the processes that maintain and perpetuate a metabolic alkalosis. Hydrogen loss from the ECF can also occur with hydrogen movement into the cells in response to potassium depletion (Irvine and Dow, 1968). Excessive bicarbonate administration is an additional potential cause of metabolic alkalosis. Most normal animals can tolerate large doses of bicarbonate, and excesses are rapidly eliminated by renal excretion (Rumbaugh *et al.*, 1981). However, patients with decreases in effective circulating blood volume or with potassium or chloride deficits may not tolerate a bicarbonate load because renal clearance of excess bicarbonate is likely to be impaired.

The factors that are responsible for the maintenance of a metabolic alkalosis all impair renal bicarbonate excretion. These factors may include decreased glomerular filtration of bicarbonate seen in some types of renal failure. However, the most common factor is increased renal tubular bicarbonate resorption, which is associated with the renal response to decreases in the effective circulating fluid volume, potassium depletion, or chloride depletion (Rose, 1984). Sodium resorption is enhanced in response to hypovolemia to help restore normal effective circulating fluid volume. The maintenance of electroneutrality requires that sodium resorption in the proximal tubule must be accompanied by a resorbable anion such as chloride, whereas in the distal tubule, sodium resorption is associated with the secretion of a cation, usually hydrogen or, to a lesser extent, potassium. The only resorbable anion normally present in appreciable quantities in the proximal tubular fluid is chloride. In a metabolic alkalosis, plasma bicarbonate is increased and chloride concentration is generally decreased as the result of disproportionately high chloride losses that result from vomiting, sequestration of gastric fluid (Whitlock *et al.*, 1975b), diuretic usage, or heavy

sweat losses in exercising horses (Carlson, 1975, 1979b). The relative lack of the resorbable anion, chloride, in the proximal tubule thus allows a larger amount of sodium to reach the distal tubule where the action of aldosterone enhances hydrogen loss into the tubular lumen in exchange for sodium. The maintenance of effective circulating volume is so critical that the body chooses to maintain circulating volume by enhanced sodium resorption by whatever means necessary, even at the expense of extracellular pH. Renal hydrogen excretion is directly linked with bicarbonate resorption. Thus, it is not possible to eliminate the excess bicarbonate, and the metabolic alkalosis is maintained (Rose, 1984). This mechanism is the reason for the paradoxical acid urine seen in some patients with metabolic alkalosis (Gingerich and Murdick, 1975a, 1975b; McGuirk and Butler, 1980). Hypokalemia is another factor that contributes to the maintenance of a metabolic alkalosis. Hypokalemia is associated with an increase in intracellular hydrogen ion concentration. Increased renal tubular cell hydrogen ion concentration may enhance hydrogen secretion and thus bicarbonate reabsorption by the tubular cells.

#### b. Compensation

Chemoreceptors in the respiratory center sense the alkalosis, and the respiratory response to a metabolic alkalosis is hypoventilation resulting in an increase in  $p\text{CO}_2$ . In dogs, the expected compensating response is an increase of  $p\text{CO}_2$  of 0.7 mmHg for each mEq/l increase in bicarbonate.

### 2. Respiratory Alkalosis

Respiratory alkalosis is associated with an increase in pH and a decrease in  $p\text{CO}_2$ .

#### a. Causes of Respiratory Alkalosis

Respiratory alkalosis is due to hyperventilation, which may be stimulated by hypoxemia associated with pulmonary disease, congestive heart failure, or severe anemia. Hyperventilation may also be associated with psychogenic disturbances or neurological disorders that stimulate the medullary respiratory center such as salicylate intoxication or Gram-negative sepsis. Respiratory alkalosis may be seen in animals in pain or under psychological stress. Hyperventilation may occur in dogs and other nonsweating animals as they employ respiratory evaporative processes for heat loss to prevent overheating (Tasker, 1980).

#### b. Compensation

The initial compensating response to an acute respiratory alkalosis is a modest decline in ECF bicarbonate concentration as the result of cellular buffering. Subsequent renal responses result in decreased ECF bicarbonate concentration through reduced renal bicarbonate reabsorption. These responses require 2 to 3 days for completion. The decline in bicarbonate is partially offset by chloride retention in order to retain electroneutrality. Thus, hyperchloremia

and decreased  $p\text{CO}_2$  may be associated with compensated respiratory alkalosis as well as compensated metabolic acidosis. Compensating responses for chronic respiratory alkalosis lasting several weeks may actually be sufficient to return pH to normal. In dogs, anticipated renal compensation for a chronic respiratory alkalosis results in a decrease of bicarbonate of 0.55 mEq/l for each mmHg decrease in  $p\text{CO}_2$  (de Morais, 1992a, 1992b).

### E. Mixed Acid-Base Imbalances

Mixed acid-base disorders occur when several primary acid-base imbalances coexist (de Morais, 1992a). Metabolic acidosis and alkalosis can coexist and either or sometimes both of these metabolic abnormalities may occur with either respiratory acidosis or alkalosis (Nairns and Emmett, 1980; Wilson and Green, 1985). Evaluation of mixed acid-base abnormalities requires an understanding of the anion gap, the relationship between the change in serum sodium and chloride concentration, and the limits of compensation for the primary acid-base imbalances (Saxton and Seldin, 1986; Wilson and Green, 1985). Clinical findings and history are also necessary to define the factors that may contribute to the development of mixed acid-base disorders. The following are important considerations in evaluating possible mixed acid-base disorders:

1. Compensating responses to primary acid-base disturbances do not result in overcompensation.
2. With the possible exception of chronic respiratory acidosis, compensating responses for primary acid-base disturbances rarely correct pH to normal. In patients with acid-base imbalances, a normal pH indicates a mixed acid-base disturbance.
3. A change in pH in the opposite direction to that predicted for a known primary disorder indicates a mixed disturbance.
4. With primary acid-base disturbances, bicarbonate and  $p\text{CO}_2$  always deviate in the same direction. If these parameters deviate in opposite directions, a mixed abnormality exists.

Although mixed acid-base abnormalities undoubtedly occur in animals and have been documented in the veterinary literature, they are often overlooked (Wilson and Green, 1985). An appreciation of the potential for the development of mixed abnormalities is essential for the correct interpretation of clinical and clinicopathological data, which would otherwise be quite confusing. Care should be taken when evaluating suspected mixed acid-base abnormalities that sufficient time has elapsed so that anticipated compensating responses could have occurred (de Morais, 1992a).

### F. Anion Gap

The anion gap can be calculated as the difference between the major cation (sodium) and the measured anions (chloride +

**TABLE 17-3** Causes of Alterations in Anion Gap

Decreased anion gap:
Increased cationic protein
Polyclonal gammopathy (IgG)
Hypoalbuminemia
Hyperchloremic acidosis
Altered protein anionic equivalents
Laboratory error
Increased anion gap:
Metabolic acidosis
Organic acids (lactic, keto acids)
Hypovolemic shock
Anaerobic exercise
Diabetes
Grain overload
Ketosis
Nonmetabolizable acids
Inorganic acids (sulfate, phosphate)
Uremic acidosis
Intoxication or poisoning
Salicylate
Paraldehyde
Metaldehyde
Methanol
Ethylene glycol
Laboratory error

bicarbonate) (Emmett and Narins, 1977). Some investigators prefer to use the following formula:

$$\text{anion gap} = (\text{sodium} + \text{potassium}) - (\text{chloride} + \text{bicarbonate}) \quad (17-11)$$

The addition of potassium to the equation, however, adds little to the diagnostic utility of this calculation (Emmett and Narins, 1977; Epstein, 1984; Oh and Carroll, 1977); the anion gap calculated with the inclusion of potassium concentration will be about 4 mEq/l higher. Because most of the published data on the anion gap in animal species are the result of calculations using the second equation (Eq. 17-11), this form will be used in Table 17-3. Provided the component determinations are valid, the calculated anion gap provides an approximation of the so-called “unmeasured anions.” Normally, these unmeasured anions consist primarily of negatively charged plasma proteins because the charges of the unmeasured cations (potassium, calcium, and magnesium) tend to balance out the charges of the unmeasured anions (phosphate, sulfate, and organic ions). The anion gap is most useful in situations where the concentrations of phosphate and plasma proteins, particularly albumin, are within the normal range (see Section V.I). The anion gap for most species of domestic animals appears to be similar to that defined for human subjects (i.e., approximately 10 to 20 mEq/l) (10 to 20 mmol/l). However, there

do appear to be significant differences in the normal range of the anion gap of different species as indicated in Table 17-4 (Adroque *et al.*, 1978; Bristol, 1982; Feldman and Rosenberg, 1981; Gossett and French, 1983; Polzin *et al.*, 1982; Shull, 1978, 1981). Age-related changes in anion gap have been reported in horses (Gossett and French, 1983), with young foals having a significantly larger anion gap than adults. Further experimental data will be necessary to more clearly establish the normal range for the anion gap of animals under varying conditions.

The simple calculation of anion gap can be employed in the categorization of acid-base disorders with regard to potential causal factors and may serve as a prognostic guide in a variety of circumstances (Bristol, 1982; Garry and Rings, 1987; Shull, 1978). Decreases in anion gap can be seen with increases in cationic proteins associated with polyclonal gammopathy or multiple myeloma. Decreases in anion gap resulting from decreases in unmeasured anions occur most commonly with hypoalbuminemia and hyperchloremic metabolic acidosis, but they also may be noted with overhydration. The causal factors associated with a hyperchloremic metabolic acidosis with a normal to low anion gap can often be differentiated based on the serum potassium concentration. Hyperchloremic metabolic acidosis associated with gastrointestinal fluid losses from diarrhea or renal causes such as renal tubular acidosis most often manifests a hypokalemia (Saxton and Seldin, 1986; Ziemer *et al.*, 1987a, 1987b). Hyperchloremic metabolic acidosis associated with decreased mineralocorticoid secretion or activity such as seen in Addison's disease or renal failure generally presents with a hyperkalemia (Saxton and Seldin, 1986). There are indications that changes in hydrogen ion concentration may alter protein equivalency and thus alter the anion gap in either an acidosis or alkalosis (Adroque *et al.*, 1978; Madias *et al.*, 1979).

Dehydration and alkalosis are potential, but minor, causes of increased anion gap. Most commonly, elevations of anion gap are associated with the development of a metabolic acidosis in which there is an increase in anions, which are not routinely measured in the clinical laboratory. This is called a high anion gap acidosis and may be associated with an accumulation of metabolizable acids as in a lactic acidosis associated with anaerobic exercise, grain overload, or hypovolemic shock or ketoacidosis resulting from diabetes or ketosis or with the accumulation of nonmetabolizable acids as in uremic acidosis or various intoxications (see Table 17-3). The presence of a metabolic acidosis with a high anion gap thus provides grounds to undertake a thorough investigation of disease processes capable of producing an accumulation of these unmeasured anions. The anion gap also may be useful in the identification of mixed acid-base imbalances. When the change in the anion gap does not approximate the change in bicarbonate, a mixed metabolic acid-base imbalance should be suspected. In cases of grain overload in herbivores, a large ion gap may be due to increased ECF levels of D-lactic acid,

which is not detected by the usual assays for lactic acid because they detect only the L-isomer produced in mammalian metabolism. Either a special assay for D-lactate must be performed, or an increased level of D-lactate may be assumed based on history and other clinical data.

## G. Bicarbonate and Total CO<sub>2</sub>

If respiratory disturbances can be eliminated, the metabolic component of acid-base balance is indicated by the bicarbonate concentration. Bicarbonate is usually estimated by determination of the "CO<sub>2</sub> content" or "total CO<sub>2</sub>" of plasma or serum samples.

Bicarbonate actually accounts for approximately 95% of the measured total CO<sub>2</sub>, and thus the total CO<sub>2</sub> provides a measure of metabolic changes in acid-base balance. The bicarbonate determined in this fashion will be decreased in a metabolic acidosis and increased in a metabolic alkalosis. Estimates of bicarbonate are often provided in automated chemistry profiles. These determinations may indicate the metabolic acid-base status. However, if acid-base abnormalities are suspected, a proper blood gas evaluation should be undertaken.

## H. Buffer Base, Standard Bicarbonate, and Base Excess or Base Deficit

These values are mathematically derived from the measurements of blood pH and *p*CO<sub>2</sub> and provide an indication of the metabolic component of acid-base balance. It should be noted that the metabolic changes indicated by these parameters do not always reflect the primary acid-base imbalances but may represent compensating responses for primary respiratory disorders.

The buffer base indicates the sum of all the buffer anions in blood under standardized conditions. The standard bicarbonate is the plasma bicarbonate concentration that would be found under specific conditions, which eliminate respiratory influences on the values obtained. The base excess, which is sometimes considered as the base deficit when the value is negative, indicates the deviation of the buffer base from normal. This derived value is often supplied in routine assessment of acid-base balance and is generally taken as an indication of the deviation of bicarbonate from normal. In an animal with a metabolic acidosis, the calculated base deficit provides a means of estimating the amount of bicarbonate required to correct acid-base balance to normal. This estimate is calculated by multiplying the base deficit by the probable bicarbonate space (which is variably estimated from 0.25 to 0.55 l/kg body weight). In newborn animals, the bicarbonate may be even higher, 0.40 to 0.65 l/kg body weight. The usual figure used is 0.3 to 0.4 l/kg. For a 20-kg

animal with a base deficit of 10 mEq/l (10 mmol/l), the bicarbonate required would be calculated as follows:

$$\begin{aligned} \text{bicarbonate required} &= 20\text{kg} \times 0.3\text{l/kg} \times 10\text{mEq/l} \\ &= 60\text{mEq} \end{aligned} \quad (17-12)$$

This calculation provides only a crude guide to bicarbonate requirements, but it can be a useful step in the quantitative approach for correcting a serious primary metabolic acidosis.

## I. Nontraditional or Strong Ion Approach to Acid-Base Balance

Peter Stewart (Stewart 1981, 1983) was the first to describe a quantitative physiochemical approach to acid-base balance. In this approach, the acid-base status of the aqueous solutions of the body is determined not only by the Henderson-Hasselbalch equation but also by a series of seven other relationships, all of which could be represented by equations which must be satisfied simultaneously. Acid-base balance is determined by three independent variables: (1) strong ion difference [SID], (2) the partial pressure of CO<sub>2</sub>, and (3) the total concentration of nonvolatile weak acids [Atot], the principal component of which is the plasma proteins but also includes inorganic phosphate. Bicarbonate and hydrogen ion concentration, and thus pH, are dependent variables determined by the independent variables listed here. The appeal of Stewart's approach is the focus on factors that are causally related to acid-base balance, the independent variables. The interested reader is referred to Stewart's original work. A number of authors have attempted to adapt Stewart's approach for practical application in human and veterinary medicine (de Morais, 1992b; Fencel and Leith, 1993; Fencel and Rossing, 1989; Frischmeyer and Moon 1994; Gilfix *et al.*, 1993; Jones, 1990; Kowalchuck and Scheuermann, 1994; Whitehair *et al.*, 1995). Many of these early papers directed to animal species used the human values for Atot and Ka, which may not be appropriate. Species-specific data are now available.

In a landmark paper, Peter Constable (1997) refined Stewart's model and developed an approach that he called the simplified strong ion model of acid-base equilibrium. The simplified strong ion model was developed from the assumption that plasma ions act as strong ions, volatile buffer ions (HCO<sub>3</sub><sup>-</sup>), or nonvolatile buffer ions. Plasma pH is determined by five independent variables: pCO<sub>2</sub>, strong ion difference, concentration of individual nonvolatile plasma buffers (albumin, globulin, and phosphate), ionic strength, and temperature. The simplified strong ion model conveys, on a fundamental level, the mechanism for change in acid-base status, explains many of the anomalies when the Henderson-Hasselbalch equation is applied to plasma, and is conceptually and algebraically simpler than

Stewart's strong ion model. The model has provided an *in vitro* method for determination of species-specific values for [Atot] and Ka, which has been applied to the plasma of horses, dogs, cattle, pigeons, and humans (Constable, 1997; Constable and Stampfli, 2005; Stampfli *et al.*, 1999, 2006; Stampfli and Constable, 2003).

Strong electrolytes are completely dissociated in aqueous solution and chemically nonreactive. The [SID] is simply the difference between the total concentration of strong cations (sodium, potassium, and magnesium) and the total concentration of strong anions (chloride, sulfate, lactate, acetoacetate, and 3-OH-hydroxybutyrate). Because they are present in higher concentrations in the body fluids, sodium, potassium, and chloride are normally the principal determinants of [SID]. The [SID] is synonymous with buffer base as described by Singer and Hastings (1948) and, as such, can be considered as roughly equivalent to the metabolic component of the traditional approach to acid-base balance. In fluids such as the CSF, which are normally devoid of protein, bicarbonate concentration is the same as the [SID]. Abnormalities in pCO<sub>2</sub> are viewed in essentially the same manner in both the traditional and nontraditional approach to acid-base balance as described earlier. The contribution of plasma proteins to acid-base balance is not considered in the traditional approach to acid-base balance. The plasma proteins, or, perhaps more correctly, plasma albumin, make up the majority of [Atot], whereas inorganic phosphate normally accounts for less than 5% of [Atot]. The [Atot] in body fluids exists in both dissociated [A<sup>-</sup>] and undissociated [HA] forms. A decrease in [Atot] because of hypoalbuminemia causes an alkalosis with an increase in bicarbonate, whereas hyperalbuminemia has the opposite effect. Hypoalbuminemia is one of the most common causes of alkalosis in older human patients (McAuliffe *et al.*, 1986). Changes in A<sup>-</sup> associated with changes in albumin concentration also have a direct and frequently overlooked effect on anion gap. Increases in A<sup>-</sup> result in an increase in anion gap, whereas decreases in A<sup>-</sup> cause a decrease in anion gap (McAuliffe *et al.*, 1986). Change in protein concentration may potentiate or ameliorate the effects of alterations in SID on acid-base balance. As an example, in a vomiting dog, the elevated plasma protein associated with dehydration may reduce the bicarbonate increase anticipated for a given change in chloride concentration and SID.

Protein and inorganic phosphate remain within the normal range in many clinical situations, and acid-base balance is then largely controlled by changes in pCO<sub>2</sub> mediated by the respiratory system, whereas changes in [SID] are largely under the control of the kidneys. Renal compensation for primary respiratory disorders and respiratory compensation for primary metabolic acid-base disturbances are thought to be similar in both the traditional and nontraditional approach. Precise quantification of the anticipated compensating responses to primary acid-base disturbances based on change in SID has not yet been determined.

Vomiting in a dog; heavy sweat loss in an endurance horse; displaced abomasum in a cow; and the administration of the loop diuretic, furosemide, in a cat result in similar acid-base disturbances. In each circumstance, a disproportionate loss of chloride relative to sodium results in a hypochloremia and an increase in [SID]. Correction of the alkalosis is brought about by the provision of chloride, generally as sodium chloride or potassium chloride, which results in a decrease in [SID] and thus a return of the dependent variables, bicarbonate and pH (hydrogen ion), toward normal. A metabolic acidosis with a large base deficit is generally treated with sodium bicarbonate. In the traditional approach, the calculated bicarbonate requirement is administered as sodium bicarbonate to replace the bicarbonate deficit, whereas in the strong ion approach, the sodium bicarbonate is administered to provide the strong cation, sodium, without a strong anion. Other metabolizable anions could be substituted for bicarbonate and achieve a similar effect. In practice, both approaches work, but the rationale is substantially different.

Calculation of SID is simple and provides useful insight in patients with metabolic acid-base disturbances. Factors that influence SID range from changes in free water, to sodium-chloride imbalances that result from excessive losses or disproportionate retention of sodium or chloride, to the accumulation of strong organic anions. Organic acidosis can be produced by the accumulation of exogenous as well as endogenous organic anions. Examples of exogenous anions include salicylate, glycolate and formate associated with the ingestion of aspirin, ethylene glycol, and methanol, respectively. Many of these endogenous and exogenous organic anions are not routinely monitored in the diagnostic laboratory. This situation can create problems when calculating the SID because the presence of these unmeasured strong anions may not be appreciated. Although the anion gap can be helpful, it does not always accurately predict the presence of these compounds. More sophisticated mathematical methods have been suggested as a means for the detection of unmeasured anions the strong ion gap (Constable *et al.*, 1998; Stewart, 1981) and, more recently, the simplified strong ion gap (Constable and Stampfli, 2005). In animals with major changes in protein or albumin concentration, the primary concern must be a thorough investigation of the cause of the increase or decrease in protein. The acid-base consequences of change in protein and albumin concentration tend to be modest but are a potential source of confusion when evaluating acid-base data.

The traditional approach and the nontraditional or strong ion approach to acid-base balance each has its supporters, and discussion over the benefits and limitations of either approach has at times been strident. However, this need not be an either-or situation. Both approaches have proven useful to address practical problems in both research and medical settings. The traditional approach based on the Henderson-Hasselbalch equation is simpler, more user

friendly, and more widely accepted. Bicarbonate concentration estimates the severity of the acid-base disorder, but the strong ion approach may provide a better understanding as to why the bicarbonate is changing because it integrates acid-base and electrolyte disorders (de Moraes, 2005). The strong ion approach has been gaining acceptance from the critical care community, which finds it useful in the analysis of the complex fluid, electrolyte, and acid-base problems presented to intensive care units. A number of computer programs adaptable to hand-held electronic devices have been developed and take some of the mathematical fear out of using the strong ion approach.

## J. Dietary Factors in Acid-Base Balance

Dietary factors, particularly the dietary cation-anion balance (DCAB), have been extensively studied in cattle, swine, poultry, and horses. The calculation of DCAB of a dry feed ration is remarkably similar to the calculation SID of body fluids. The DCAB in mEq is generally represented as (sodium + potassium) – (chloride + sulfate) per kg of dry matter of the diet. Diets with a high DCAB, such as alfalfa hay, have an alkalinizing effect and are an important factor in the alkaline urine of most herbivores. High grain rations tend to have a lower DCAB. Manipulation of the DCAB has been employed to enhance milk yield in dairy cattle, to reduce the incidence and severity of gastric ulceration in swine, to decrease the incidence of milk fever in cattle, and to alter the urine pH and calcium balance in horses. The addition of sodium bicarbonate to the ration of lactating dairy cattle to raise the DCAB from –100 to +200 mEq/kg diet DM resulted in an increase of milk production of over 8%, which was due, in part, to more effective ruminal digestion (Block, 1984). On the other hand, supplementation of the diet of late-term cattle with calcium chloride or ammonium chloride so as to lower the DCAB and have an acidifying effect has been shown to reduce the incidence of milk fever by enhancing the mobilization of calcium from the bone (Block, 1984). As the application of these dietary practices becomes more widespread, it is essential that we appreciate the implications of dietary factors and electrolyte supplementation on mineral metabolism and acid-base balance (Fredeen *et al.*, 1988).

Sodium bicarbonate supplementation has been used as a prerace ergogenic aid in racehorses. Relatively large doses, 500 g or more of sodium bicarbonate, often mixed with sugar and water and referred to as “milk shakes,” have been given via nasogastric tube and result in a marked metabolic alkalosis. Although experimental studies have often failed to detect a measurable performance benefit from sodium bicarbonate supplementation, practical experience suggests that some horses, particularly standardbreds, show marked improvement in race times. Administration of any substance with intent to alter the performance is illegal in most racing jurisdictions. In many racing states,

horses must meet specific guidelines for venous blood pH and bicarbonate or risk disqualification.

## VI. EVALUATION OF IMBALANCES

It is important to understand the difference between volume regulation and osmoregulation. Osmoregulation is governed by osmoreceptors influencing ADH and thirst, whereas volume disturbances are sensed by multiple volume receptors that activate effectors such as aldosterone. Antidiuretic hormone increases water resorption (and therefore urine osmolality), but it does not affect sodium transport directly. Aldosterone enhances sodium reabsorption but not directly that of water. Thus, osmoregulation is achieved by changes in water balance and volume regulation mostly by changes in sodium balance.

Water balance is achieved when water intake from all sources is equal to water output by all routes. Water is available as drinking water, as water content of feedstuffs, and as metabolic water derived by oxidative metabolism. Oxidation of 1g of fat, carbohydrate, or protein results in the production of 1.07, 0.06, or 0.41g of water, respectively. Water is normally lost from the body by four basic routes: urine, feces, insensible loss (respiratory and cutaneous evaporation), and sensible perspiration (sweat) in some animal species. Water intake and output may vary considerably from day to day, but normal animals are able to maintain water balance within remarkably narrow limits and, at the same time, maintain the critical interrelationship between water balance and electrolyte balance.

For human subjects, there are well-established normal values for water intake and output via various routes. Although there is a substantial amount of data on water balance for many domestic animals (English, 1966a; Fonnesebeck, 1968; Hinton, 1978; Kamal *et al.*, 1972; Leitch and Thomson, 1944; Sufit *et al.*, 1985; Tasker, 1967a; Yoshida *et al.*, 1967), these data vary markedly from species to species and are valid only for the specific experimental conditions under which they were collected. Animals eat to meet their caloric requirements. The nursing or grazing animal may have a feed intake that is greater than 90% water as compared to animals on dry hay or dried prepared pet food, which may contain less than 10% water. Some desert rodents are so well adapted that they are able to maintain water balance without water intake and rely on the water content of feedstuffs and metabolic water derived from oxidative metabolism. The koala in its native state in Australia obtains virtually all its water from the leaves of specific species of eucalyptus trees, which constitute its entire diet. Dehydration because of water restriction with and without heat stress has been studied widely in a variety of animal species (Bianca *et al.*, 1965; Brobst and Bayly, 1982; Carlson *et al.*, 1979a; Elkinton and Taffel, 1942; Genetzky *et al.*, 1987; Hix *et al.*, 1953; Kamal *et al.*, 1972;

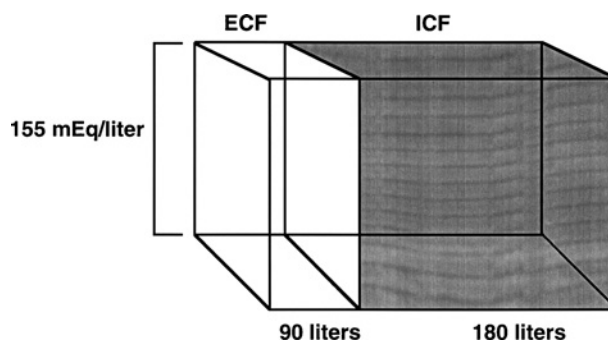
Rumbaugh *et al.*, 1982; Rumsey and Bond, 1976; Schultze *et al.*, 1972; Tasker, 1967b).

Quantitative assessment of the compartmental distribution of TBW between the ECF and the ICF has largely been based on the volume dilution of certain compounds or isotopic tracers. These studies require steady-state conditions and take a substantial period of time; as such, they are not well suited to the dynamic and often rapidly changing fluid balance characteristic of many clinical situations. Bioelectrical impedance analysis (BIA) may prove a useful tool in this regard. Bioelectrical impedance has been used for the assessment of body fat and fluid balance in humans and many animal species. Multifrequency bioelectrical impedance analysis has been successfully employed to monitor the rapid fluid changes in small animal patients undergoing dialysis. Algorithms for multifrequency BIA have been developed for use in the horse (Fielding *et al.*, 2004).

### A. Water

#### 1. Depletion-Dehydration

Dehydration is a relatively common problem in domestic animals. Dehydration results from inadequate fluid intake in the face of normal to increased fluid losses. When water losses occur with little or no electrolyte losses (i.e., panting or feed and water restriction), serum sodium concentration and osmolality increase. This situation is called a hypertonic dehydration and occurs when water losses exceed losses of the exchangeable cations sodium and potassium (Carlson, 1987). This imbalance between total body water and exchangeable cations is best characterized as a relative water deficit (Scribner, 1969). The effects of a pure water loss of 30l in a 450-kg horse are illustrated in Figure 17-2. In this theoretical example, there has been a 10% loss of body water but no change in electrolyte balance. Plasma

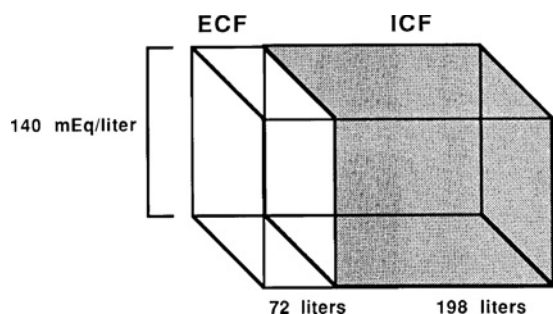


**FIGURE 17-2** Body fluid compartments in a 450-kg horse with a pure water loss of 30l. Hypertonic fluid volume contraction is indicated by the increase in serum sodium concentration from 140 mEq/l (140 mmol/l) to 155 mEq/l (155 mmol/l). Fluid losses are shared by the extracellular fluid (ECF) volume and the intracellular fluid (ICF) volume.



sodium concentration has increased from a normal of 140 mEq/l (140 mmol/l) to 155 mEq/l (155 mmol/l). Fluid losses are shared proportionately by the ICF and ECF, and few other clinical or clinicopathological abnormalities will be noted until the fluid losses become more severe. Hypernatremia is associated with contraction of the ICF volume and shrinkage of the cells.

When water losses are associated with proportionate losses of exchangeable cations (i.e., 130 to 150 mEq [130 to 150 mmol] of sodium plus potassium per l of water lost), an isotonic fluid volume contraction develops. Despite what at times may be large water and electrolyte losses, plasma sodium concentration and osmolality remain unchanged. The ECF and ICF share the fluid losses in a distribution that reflects the relative losses of sodium and potassium as proportional of the initial content in their respective fluid compartments. In many instances, isotonic dehydration may occur in which sodium loss exceeds potassium loss. This type of dehydration is observed with heavy sweat loss in horses, with acute diarrhea in most species, and with inappropriate diuretic administration. The effects of an isotonic fluid loss of 30 l of water, 3800 mEq (3800 mmol) of sodium, and 400 mEq (400 mmol) of potassium in a 450-kg horse are illustrated in Figure 17-3. With this type of isotonic fluid loss, plasma sodium concentration remains within normal limits despite the development of large sodium deficits. These animals manifest clinical signs of inadequate circulating fluid volume reflecting the sodium deficit and the associated decrease in plasma and ECF volume as has been shown in human subjects (McCance, 1937, 1938). When a substantial portion of the water deficit is replaced by water consumption or free water administration in these animals, the serum sodium concentration and osmolality decline, and a hypotonic, hypovolemic dehydration can develop (Sufit *et al.*, 1985). The hyponatremia noted in this circumstance is best considered as an indication of a relative water excess (Scribner, 1969).



**FIGURE 17-3** Body fluid compartments in a 450-kg horse with an isotonic fluid loss of 30 l of water, 3800 mEq (3800 mmol) sodium, and 400 mEq (400 mmol) potassium. Serum sodium remains unchanged at 140 mEq/l (140 mmol/l) despite the development of the substantial sodium deficit. Fluid losses are borne primarily by the extracellular fluid (ECF) volume.

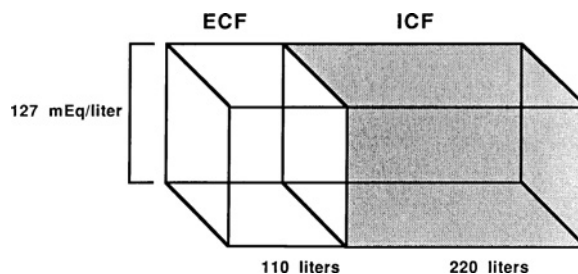
## 2. Water Excess-Overhydration

The effects of the administration and retention of 30 l of water in a 450-kg horse are illustrated in Figure 17-4. In this example, total body water has been increased by 30 l, and there is an absolute as well as relative water excess. The primary effect of this water load is to dilute the electrolytes in the body fluids producing a substantial decline in plasma sodium concentration and osmolality. These changes occur despite the fact that there has been no change in sodium or potassium balance. In this example, the ECF and ICF share the water excess proportionately. The hyponatremia is associated with expansion of ICF and thus swelling of the cells.

Overhydration rarely occurs in normal individuals. The large water load described in Figure 17-4, if administered to a normal animal, would produce only transient changes, and the excess water would be eliminated by renal excretion. Even animals with psychogenic polydipsia ordinarily are able to maintain normal water balance through appropriate renal water excretion unless sodium depletion and renal medullary washout occur. However, overhydration can occur iatrogenically as the result of excessive fluid administration to patients with compromised renal function. If these fluids provide free water, as with 5% dextrose, plasma sodium concentration will decrease reflecting the change in relative water balance. If these fluids consist of isotonic sodium-containing replacement fluids such as saline or lactated Ringer's solution, there will be little or no change in plasma sodium concentration (Carlson and Rumbaugh, 1983; Cornelius *et al.*, 1978), but there will be an increase in plasma and ECF volume with the potential for cardiovascular overload, pulmonary edema, or generalized edema formation. In this instance, the primary problem is sodium retention, and the changes in water balance are secondary.

## B. Sodium

The ECF volume contains approximately one-half to one-third of the body's sodium. Most of the remaining sodium is bound in skeletal bone, relatively little of which is rapidly



**FIGURE 17-4** Body fluid compartments in a 450-kg horse after administration and retention of 30 l of water. Although no sodium or potassium losses have occurred, serum sodium concentration has declined from 140 mEq/l (140 mmol/l) to 127 mEq/l (127 mmol/l) reflecting a relative water excess. Water retention results in proportionate expansion of extracellular fluid (ECF) volume and intracellular fluid (ICF) volume.

exchangeable (McKeown, 1986). The ECF volume thus contains essentially all of the body's readily available and exchangeable sodium. The exchangeable sodium content is the principal determinant of ECF volume, and sodium deficits are the principal causes of decreased ECF volume (Saxton and Seldin, 1986). Increases in sodium content result in expansion of ECF volume, which may lead to the development of hypertension or edema formation (Dow *et al.*, 1987b; McKeown, 1986). In either instance, the observed plasma sodium concentration will primarily depend on relative water balance. Because monitoring daily electrolyte balance is difficult in most animal species, urinary fractional excretion or creatinine clearance ratios have been useful to provide an index of daily intake or potential deficits of sodium, potassium, chloride, and other electrolytes. Normal values have been established for dogs, cats, horses (Morris *et al.*, 1984), and cattle (Fleming *et al.*, 1992).

### 1. Sodium Depletion

Sodium depletion is rarely the result of dietary sodium deficiency (Aitken, 1976). This is true even for herbivores whose feedstuffs are normally very low in sodium. Chronic sodium depletion has been reported in lactating dairy cows on a low salt diet (Whitlock *et al.*, 1975a), but the sodium deficit was most probably the result of sodium losses in milk (Michell, 1985). Mastitis markedly enhances sodium loss in milk and could play a role in sodium depletion in lactating cows maintained on a low-salt diet (Michell, 1985). Sodium depletion almost invariably is associated with excessive losses of sodium-containing fluid (McKeown, 1986; Rose, 1984), most often occurring as the result of gastrointestinal losses through vomiting or diarrhea (Fisher and Martinez, 1976; Lakritz *et al.*, 1992). Excessive renal sodium losses can occur with intrinsic renal disease or as the result of diuretic therapy (Rose, 1984; Rose and Carter, 1979; Rose *et al.*, 1986). Cutaneous losses via sweating are important in the exercising horse and may occur in any animal with extensive exfoliative dermatitis or burns. Salivary losses as the result of esophagostomy have been reported as a cause of sodium depletion in horses (Stick *et al.*, 1981). A history suggestive of excessive loss of sodium-containing fluid is thus an extremely important criterion for the diagnosis of sodium depletion in domestic animals. The foregoing discussion applies indirectly to the so-called third space problems associated with a sequestration or compartmentalization of a portion of the ECF volume (Rose, 1984). This situation can occur with obstructive bowel disease or with the sudden accumulation of fluid within the abdomen or thorax resulting from peritonitis, ruptured bladder, ascites, or pleural effusion. These fluids have an electrolyte composition similar to the ECF and initially are drawn from the plasma volume and interstitial fluids. The resultant change in plasma volume and effective circulating fluid volume produce the same clinical and clinicopathological changes as those observed with excessive

external losses of sodium containing fluid (Billig and Jordan, 1969). In these cases, fluids have not been lost from the body, but there has been an internal sequestration of fluid which can be mobilized if treatment is effective.

### 2. Sodium Excess

Sodium excess occurs most often in association with an increase in body water leading to an isotonic expansion of ECF volume and the development of hypertension or generalized edema (Saxton and Seldin, 1986). Congestive heart failure, hypoalbuminemia, and hepatic fibrosis may lead to a failure to maintain effective circulating volume, which then, in turn, results in compensating renal sodium retention (Rose, 1984). In these cases, expanded ECF volume represents an attempt to restore effective circulating fluid volume, and, at least initially, plasma volume may decrease whereas ECF volume expands. An expansion of ECF volume of 20% to 30% may be necessary before edema is first evident (Scribner, 1969). Sodium excess and edema can develop iatrogenically as the result of the excessive administration of sodium-containing fluid to patients with severely compromised renal function.

Most domestic animals can tolerate a large sodium intake provided they have adequate drinking water (Aitken, 1976; Buck *et al.*, 1976; Pierce, 1957). Excessive salt intake may occur when animals that had been on salt-restricted diets are first allowed free access to salt (Michell, 1985). Salt intoxication can occur in cattle that are feeding in reclaimed salt water marshes or on pastures contaminated by oil field wastes when they are deprived of fresh water (Aitken, 1976; McCoy and Edwards, 1979; Michell, 1985; Pierce, 1957; Sandals, 1978). Salt poisoning in swine also occurs in association with water restriction followed by access to water (Aitken, 1976; Buck *et al.*, 1976). Salt intoxication is generally associated with increases in plasma or cerebrospinal fluid sodium concentrations. Neurological signs associated with excessive salt consumption coupled with water restriction are related to development of cortical edema and, in swine, a characteristic eosinophilic meningoencephalitis (Aitken, 1976).

### C. Potassium

Potassium is largely an intracellular ion with over 98% of the exchangeable potassium located intracellularly (Brobst, 1986; Strombeck, 1979). This distribution of potassium is coupled with the active extrusion of sodium from the cells, which is maintained by an energy-dependent sodium:potassium pump at the cell membrane (Brobst, 1986; Tannen, 1986). Potassium distribution across the cell membrane plays a critical role in the maintenance of cardiac and neuromuscular excitability. Changes in potassium concentration that alter the ratio of intracellular to extracellular potassium alter membrane potential (Tannen, 1986). In general, hypokalemia increases membrane potential, producing a

hyperpolarization block resulting in weakness or paralysis, whereas hyperkalemia decreases membrane potential causing hyperexcitability (Patrick, 1977). These features depend on the state of total body potassium content but also depend on the speed with which hypokalemia or hyperkalemia develops (Saxton and Seldin, 1986). As an example, acute potassium depletion may result in hypokalemia before the development of marked change in intracellular potassium, producing a substantial alteration in the ratio of intracellular-to-extracellular potassium. Acute hypokalemia can produce a much greater alteration in membrane potential and thus more marked clinical signs than a gradually developing hypokalemia of the same magnitude (Saxton and Seldin, 1986). Potassium homeostasis involves regulation of internal balance (i.e., the distribution of potassium between the ECF and ICF) as well as external balance (i.e., the relation of potassium input to output) (Brobst, 1986; Rose, 1984). Internal potassium balance is influenced by changes in acid-base status, glucose and insulin administration, exercise, and catecholamine release and will be discussed in greater detail in the section on factors that influence plasma potassium concentration.

### 1. Potassium Depletion

Potassium depletion is the result of altered external balance in which potassium losses by all routes exceed intake. Potassium is present in relatively high concentrations in most animal feeds. Therefore, dietary deficiency alone is not a common cause for potassium depletion (Tasker, 1980). However, dietary factors were associated with hypokalemia in hospitalized cats, particularly when associated with diseases linked to increased potassium loss (Dow *et al.*, 1987a). Herbivores, such as the horse, fed an all-hay diet may have a daily potassium intake of 3000 to 4000 mEq (3000 to 4000 mmol) per day (Hintz and Schryver, 1976; Tasker, 1967a). Most of this potassium is absorbed in the small intestine and colon with subsequent renal excretion of more than 90% of the daily potassium intake (Hintz and Schryver, 1976). These animals are thus highly adept at excretion of a large daily potassium intake. However, renal compensation for deficient potassium intake is not efficient, and renal conservation of potassium may be delayed for several days when animals normally fed a high-potassium diet are suddenly taken off feed or develop anorexia (Tasker, 1967b).

Potassium depletion most commonly develops as the result of gastrointestinal losses from vomiting or diarrhea. Excessive renal losses can occur as the result of diuretic usage, mineralocorticoid excess, renal tubular acidosis, and in the diuresis state that follows relief of urinary obstruction (Saxton and Seldin, 1986). Potassium depletion may result in decreased ICF volume, altered membrane potential, altered intracellular pH, and alterations of potassium-dependent enzymatically mediated reactions (Elkinton and Winkler, 1944). Clinical features include muscle weakness,

ileus, cardiac arrhythmias, rhabdomyolysis, and renal dysfunction (Dow *et al.*, 1987a, 1987b; Earley and Daugharty, 1969; Tannen, 1986).

### 2. Potassium Excess

Potassium excess occurs relatively rarely and is generally a consequence of some alteration of renal excretion of potassium. Potassium excess may be associated with Addison's disease, some forms of renal disease, and clinical situations associated with hypovolemia and renal shutdown (Rose, 1984; Weldon *et al.*, 1992). Care should be taken to avoid the rapid administration of large amounts of potassium salts orally or intravenously to patients with severely compromised renal function. Even normal animals can develop significant electrocardiographic abnormalities with potassium (Dhein and Wardrop, 1995; Epstein, 1984; Glazier *et al.*, 1982) or calcium infusions (Glazier *et al.*, 1979).

## D. Chloride

Modest changes in hydration tend to produce roughly proportional changes in plasma sodium and chloride relative to sodium concentration. Acid-base alterations are associated with disproportionate changes in plasma chloride concentration (Saxton and Seldin, 1986). A disproportionate hyperchloremia is seen in association with a low to normal anion gap metabolic acidosis. Chloride concentration increases in this type of acidosis as the result of proportionately smaller losses of chloride than bicarbonate and enhanced renal chloride resorption in response to decreased bicarbonate (Saxton and Seldin, 1986). Disproportionate hypochloremia is a consistent feature of metabolic alkalosis (Rose, 1984). Chloride depletion develops in these animals as a result of excessive loss or sequestration of fluids with high chloride content. Changes in water balance can result in modest alterations in the relative concentrations of plasma sodium and chloride. A pure water deficit produces increased sodium concentration, which exceeds the increases in chloride. This contributes to the development of a contraction alkalosis with an increase in bicarbonate. A pure water excess has the opposite effect and can result in an expansion acidosis.

## VII. CLINICAL FEATURES OF FLUID AND ELECTROLYTE BALANCE

It is convenient to discuss the theoretical ramifications of pure water loss or specific electrolyte deficits. However, in practical clinical situations, the issue is almost never so clearly defined, and most often, there is a combination of fluid, electrolyte, and acid-base alterations. Many medical problems result in a consistent pattern of fluid and electrolyte loss with predictable changes in fluid volume, electrolyte concentration, and acid-base balance.

A clear understanding of the interrelationships between specific deficits and their clinicopathological consequences is essential if an appropriate initial diagnosis is to be made. Once treatment has been initiated, all clinical and clinicopathological data will be influenced not only by the primary medical problem and compensating responses but also by the effects of chemotherapeutic agents and fluid therapy as well. Therapeutic intervention may not always be appropriate, organ function may be impaired, and thus the anticipated clinicopathological responses become less predictable. These situations represent the bulk of clinical case material and laboratory data evaluated by clinicians and clinical pathologists. Under these circumstances, it is essential to understand the basic mechanisms that underlie changes in clinicopathological data and how these changes relate to specific imbalances.

Rational fluid therapy depends on accurate evaluation of the fluid and electrolyte deficits, the associated acid-base alterations, and the primary disease processes that underlie these imbalances. Evaluation must include an accurate history, a complete physical examination, and, of course, laboratory evaluation of appropriate parameters.

### A. History

An accurate history is absolutely essential for the evaluation and management of the patient with fluid and electrolyte imbalances. Basic signalment factors of age, sex, breed, pregnancy, and stage of lactation are important because these factors influence the incidence and severity of many disorders. The presence of a preexisting or coexisting disease process and an accurate drug history can be exceedingly important not only in the evaluation of fluid and electrolyte disorders but also in fluid selection and patient management. Of particular importance is the history of prior renal disease, diuretic usage, or exposure to potentially nephrotoxic drugs. Status of feed and water intake is exceedingly useful. Most animals that continue to eat and drink normally are able to maintain fluid balance even in the face of excessive fluid losses. However, reduced or restricted fluid intake in the face of normal to enhanced fluid losses can quickly result in dehydration. Inadequate fluid intake may result from neurological disorders or traumatic injuries to the head or neck, whereas painful or obstructive lesions in the mouth, pharynx, or gastrointestinal tract may restrict feed and water intake. Inadequate water intake is often the result of management errors, broken or frozen water lines, and other factors. A history of polydipsia suggests that excessive fluid losses have occurred. Vomiting and diarrhea are obvious causes of fluid and electrolyte loss, but these findings also reflect gastrointestinal disorders, which may contribute to inadequate fluid and electrolyte intake or absorption.

Excessive fluid losses may be associated with vomiting, diarrhea, polyuria, excessive salivation, copious drainage from cutaneous wounds or burns, and as the result of

heavy sweat losses in exercising horses. The water losses that occur in these situations are generally associated with significant sodium depletion and subsequent decreases in the effective circulating fluid volume. Vomiting in small animals (Clark, 1980), gastrointestinal stasis in ruminants (Gingerich and Murdick, 1975b), and excessive sweat losses in endurance horses (Carlson, 1983b) are associated with large losses or compartmentalization of chloride-rich fluids, which contribute to the metabolic alkalosis that frequently accompanies these disorders.

### B. Clinical Signs

Dehydration is defined as a loss of body water. Clinical signs of dehydration are said to be first apparent with fluid losses equivalent to 4% to 6% of body weight. Moderate dehydration is said to be present with fluid losses of 8% to 10%, and severe dehydration is present when fluid losses exceed 12% of body weight. It is important to realize that although these guidelines have been clinically useful, there is relatively little documentation of this precise quantitative relationship in most animal species. Accurate measurement of fluid intake from all sources and output by all routes is not possible in most clinical situations. In acute situations, changes in body weight provide the most accurate guide to change in net water balance. Repeated measurement of body weight is a key component of the monitoring of patients on fluid therapy. The clinical signs of dehydration include weight loss, altered skin turgor, sunken eyes, and dry mucous membranes. If control of renal function is normal, urine volume is generally markedly reduced. The clinical consequences of dehydration depend much more on the pattern of electrolyte loss than the absolute water deficit.

Clinical signs associated with acute sodium deficits are largely related to hypovolemia and decreases in the effective circulating volume. These signs include increased pulse rate, decreased pulse pressure, delayed jugular distensibility, increased capillary refill time, and decreased blood pressure. Urine output is generally decreased and urine sodium and chloride concentrations are normally reduced. Decreases in ECF volume are always reflected by decreases in plasma volume, but the reverse is not always true. In the absence of blood or protein loss, the PCV and TPP concentrations increase, reflecting the decrease in plasma and ECF volume as will be discussed more fully in Section VIII.A.

## VIII. CLINICOPATHOLOGICAL INDICATORS OF FLUID AND ELECTROLYTE IMBALANCE

### A. Packed Cell Volume and Total Plasma Protein

The packed cell volume (PCV) and total plasma protein (TPP) concentration are simple, convenient, and useful tools

for the evaluation of acute fluid and electrolyte alterations. If one assumes that there has been no gain or loss of erythrocytes or protein from the vascular compartment, changes in PCV and TPP reflect changes in plasma volume (Boyd, 1981). For the estimation of alterations in plasma volume in human subjects, the change in PCV or hemoglobin concentration is preferred over change in protein concentration (van Beaumont *et al.*, 1973). This preference exists because fluxes of protein both into and out of the plasma volume may occur in certain rapidly changing clinical circumstances (Landis and Pappenheimer, 1963; Senay, 1970). There is a substantial extravascular protein pool, and the volume distribution of both albumin and globulins is approximately two to three times that of the plasma volume (Landis and Pappenheimer, 1963; Matteeuws *et al.*, 1966). This situation is one of the reasons that plasma transfusions have limited effects on the plasma protein concentration of hypoproteinemic patients. In most animal species, there is a much wider range of normal for PCV than for TPP. In some of these species, most notably the horse, mobilization of erythrocytes from splenic reserves in response to excitement, pain, or catecholamine release can result in marked variability in PCV, erythrocyte count, or hemoglobin concentration (Carlson, 1987; Persson, 1967; Persson *et al.*, 1973). For these reasons, it has proven most useful to utilize the change in both PCV and TPP as a crude index of change in plasma volume in domestic animals. For these estimations to be valid, initial values for PCV and TPP must be known, and there must have been no loss of blood or protein. The most common causes for decreases in plasma volume are the sequestration or loss of sodium-containing fluid as in obstructive bowel disease, diarrhea, vomiting, renal disease, or in heavily sweating horses. In these circumstances, both PCV and TPP increase in relation to the change in plasma volume, but not necessarily by the same proportion (Boyd, 1981).

If it is assumed that the quantity of plasma proteins within the plasma volume remains constant (this assumption is not always correct), it is possible to calculate the percentage change in plasma volume based on protein concentration (Boyd, 1981):

$$\%PV = [(PP_1/PP_2) - 1] 100 \quad (17-13)$$

**TABLE 17-4** Reference Values for Blood Gas and Electrolyte Determinations<sup>a</sup>

Electrolyte or Gas	Dog	Cat	Horse	Ox	Sheep	Goat	Pig
Sodium (mEq/l)	140–155	147–156	132–146	132–152	139–152	142–155	135–150
Potassium (mEq/l)	3.7–5.8	4.0–5.3	2.6–5.0	3.9–5.8	3.9–5.4	3.5–6.7	4.4–6.7
Chloride (mEq/l)	105–120	115–123	99–109	97–111	95–103	99–110	94–106
Calcium (mg/dl)	9.0–11.3	6.2–10.2	11.2–13.6	9.7–12.4	11.5–12.9	8.9–11.7	7.1–11.6
Magnesium (mg/dl)	1.8–2.4	2.2	2.2–2.8	1.8–2.3	2.2–2.8	2.8–3.6	2.7–3.7
Phosphorus (mg/dl)	2.6–6.2	4.5–8.1	3.1–5.6	5.6–6.5	5.0–7.3	6.5	5.3–9.6
Anion gap (mEq/l)	15–25		6.6–14.7	13.9–20.2			
pH		7.31–7.42	7.24–7.40	7.32–7.44	7.35–7.50	7.32–7.54	7.39
pCO <sub>2</sub> (mmHg)	29–42	29–42	38–46	35–44	37–46		44.3
Bicarbonate (mEq/l)	17–24	17–24	24–30	20–30	20–25		25.6
Osmolality (mOsm/kg H <sub>2</sub> O)	280–305	280–305	270–300		270–300		

<sup>a</sup> In part from Tasker (1980).

When sodium-containing fluids are administered to dehydrated volume-depleted subjects, plasma volume reexpansion is reflected by the return of PCV and TPP toward the normal range (Hayter *et al.*, 1962). Declining PCV and TPP in response to fluid therapy are the two most useful laboratory indicators of return of effective circulating fluid volume and should be correlated with clinical evidence such as return of normal pulse pressure, capillary refill time, and jugular distensibility.

## B. Serum Sodium

Serum sodium concentration varies within relatively narrow limits in the normal individual, but there is substantial interspecies variation in the normal range of sodium, chloride, and osmolality as indicated in Table 17-4. A serum sodium concentration of 134 mEq/l (134 mmol/l), although quite normal for a horse or cow, represents a significant hyponatremia in a dog or cat. Before proceeding with a discussion of the significance of alterations of sodium concentration, some comment on the methods used for electrolyte determination is appropriate. In the past, flame photometry was the standard method for the determination of both sodium and potassium concentrations. Presently, electrolyte concentrations in biological fluids are generally determined utilizing ion-specific electrode technology. Although consistent differences might have been expected, ion-specific electrode instruments, which dilute samples, tend to yield values that are similar to values reported from the flame photometer. This situation may be a function of the mathematical algorithm employed in these devices to

convert changes in electric potential to electrolyte concentration. Interfering substances in the urine of some animal species render urine potassium determinations inaccurate when assessed by ion-specific potentiometry (Brooks *et al.*, 1988).

### 1. Hyponatremia

The common causes of hyponatremia are listed in Table 17-5. A falsely low sodium concentration may be noted when there is marked hyperlipemia or hyperproteinemia. Large quantities of lipid or protein occupy a significant volume in a serum or plasma sample, and because electrolytes are dissolved only in the aqueous phase, the measured concentrations will be falsely low. The presence of obvious lipemia or markedly elevated serum protein concentration should alert the clinician to the probable cause of an accompanying hyponatremia. Should this information not be available, the presence of a false hyponatremia can be determined by comparison of the measured serum osmolality and the calculated osmolality based on sodium, glucose, and urea concentration as explained in Section VIII.E. This potential cause for confusion in interpretation of hyponatremia can be avoided if ion-specific electrodes are used for electrolyte determination.

Marked hyperglycemia associated with diabetes mellitus or the administration of glucose at an excessive rate generally produces a hyponatremia. As glucose concentration increases in the ECF, osmotic forces are generated, which result in the movement of cellular water into the ECF, diluting serum sodium concentration. The actual

**TABLE 17-5** Causes of Hyponatremia

False hyponatremia	
	Hyperlipidemia
	Hyperproteinemia
	Hyperglycemia
Hyponatremia (relative water excess)	
	Decreased effective circulating volume
	Vomiting
	Diarrhea
	Excessive sweating
	Cutaneous loss—burns
	Blood loss
	Repeated pleural drainage
	Pleuritis, chylothorax
	Adrenal insufficiency
	“Third space problems”
	Sequestration of fluid
	Peritonitis
	Ascites
	Ruptured bladder
	Excess circulating volume
	Congestive heart failure
	Chronic liver failure
	Nephrotic syndrome
Normal effective circulating volume	
	Psychogenic water drinking
	Renal disease
	Inappropriate ADH secretion

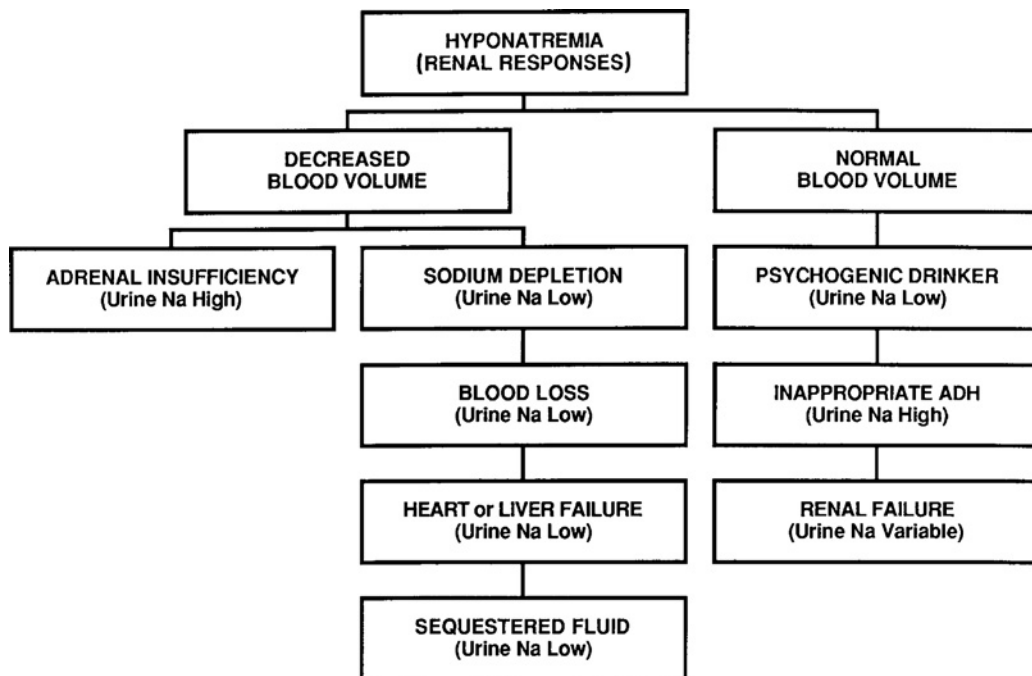
mechanics of this process are complicated by the fact that cells and tissues are variably permeable to glucose, and thus the glucose space clearly exceeds the ECF volume. For practical purposes, it can be anticipated that serum sodium concentration will decline 1.6 mEq/l (1.6 mmol/l) for each 100 mg/dl (5.55 mmol/l) increase in glucose concentration (Saxton and Seldin, 1986). Serum osmolality may be increased by hyperglycemia, but this should not cause a large disparity between the measured and calculated serum osmolality.

Changes in water balance are principally responsible for changes in serum sodium concentration (Leaf, 1962). Hyponatremia should be considered as an indication of a relative water excess (Scribner, 1969). Hyponatremia is often, but not invariably, associated with conditions that cause sodium depletion and resultant decreases in effective circulating volume. These conditions include vomiting, diarrhea, excessive sweat losses, and adrenal insufficiency. Dehydration and volume depletion induce neurohormonal responses that result in increased water consumption via increased thirst and enhanced renal conservation of water as well as sodium (Rose, 1984). Fluid losses in these forms of dehydration are most often hypotonic or isotonic, and initial fluid and electrolyte deficits do not result in hyponatremia until water intake or renal water retention disturbs the balance between the remaining exchangeable cations

and the total body water. Thus, whereas substantial sodium and potassium deficits are associated with these conditions, plasma sodium concentration does not always reflect these deficits, and a diagnosis of sodium depletion should be based on other grounds (Scribner, 1969).

The accumulation of sodium-containing fluid within body cavities as a result of ascites, peritonitis, or a ruptured bladder is referred to as a “third space problem” (Rose, 1984). The fluid that accumulates in the “third space” has a composition similar to the ECF. When this accumulation of fluid occurs rapidly, plasma volume is reduced, and serum sodium concentration then may decrease as the compensating responses result in water retention. A classic example of this situation is the marked hyponatremia associated with ruptured bladder in neonatal foals. As the dilute urine of the neonate accumulates in the abdomen, osmotic equilibrium is established first with the ECF and then with all of the body fluid compartments. Sodium and chloride as well as other ions are drawn from the rest of the ECF into this progressively expanding fluid compartment, and hyponatremia develops despite the fact that there has been no appreciable loss of sodium from the body. The severe neurological signs associated with ruptured bladder in foals are related in large part to the effects of the sudden and marked hypotonic hyponatremia on the central nervous system. Hyponatremia associated with excessive retention of water also can occur without the development of significant sodium depletion or decreases in effective circulating fluid volume. Hyponatremia may be observed with psychogenic polydipsia if the rate of water consumption exceeds renal capacity for free water clearance because of intrinsic renal disease or renal medullary washout (Tyler *et al.*, 1987). This condition also may occur in patients with impaired free water clearance resulting from renal disease or when under the influence of inappropriate release of ADH (McKeown, 1986). Hyponatremia and associated neurological disturbances can develop with naturally occurring disease (Lakritz *et al.*, 1992) or iatrogenically if excessive amounts of free water are administered to patients with altered renal function (Arieff, 1986; Sterns *et al.*, 1986).

Urine sodium concentration can be useful in the differentiation of the causes of hyponatremia as indicated in Figure 17-6. Renal adaptive responses normally result in sodium retention and production of urine with very low sodium concentration in patients with sodium depletion resulting from vomiting, diarrhea, excessive sweat loss, or third space problems (Rose, 1984). Hyponatremia and hypokalemia of adrenal insufficiency are generally associated with a relatively high urine sodium concentration (Rose, 1984). With the syndrome of inappropriate secretion of antidiuretic hormone (SIADH), urine sodium tends to be high in the presence of hyponatremia, whereas urine sodium concentration tends to be low in animals with psychogenic polydipsia. Urine sodium concentration in animals with renal failure can be quite variable.



**FIGURE 17-6** The urinary sodium concentration as an aid in the differentiation of possible causes of hyponatremia. Urinary electrolyte concentration is also influenced by dietary intake.

A form of moderate to pronounced hyponatremia associated with elevated levels of ADH, which develops in the absence of an appropriate osmotic or volume stimuli, has been well recognized in human subjects. This syndrome has been associated with several systemic disorders including malignant neoplasms that produce an ADH-like material, with a variety of brain diseases that apparently stimulate synthesis and release of ADH, or in association with certain pulmonary diseases that may result in abnormal neural inputs from the lung that trigger the inappropriate ADH release from the pituitary.

The diagnosis of SIADH in the absence of readily available procedures for ADH determination depends on ruling out a number of other potential causes for persistent hyponatremia. The diagnostic criteria for SIADH for human subjects include the following (McKeown, 1986):

1. Demonstration of a hypotonic hyponatremia without hypovolemia or edema
2. Normal renal, adrenal, and thyroid function
3. Inappropriately elevated urine osmolality relative to plasma osmolality
4. Relatively high urine sodium concentration
5. Correction of the hyponatremia by strict fluid restriction

The SIADH has been reported in the dog (Breitschwerdt and Root, 1979; Brofman *et al.*, 2003; Crow and Stockham, 1985; Fleeman *et al.*, 2000; Giger and Gorman, 1984; Houston *et al.*, 1989), but the incidence and importance of this problem in other animal species are uncertain. A variant

of SIADH has been described in certain chronically ill and malnourished human subjects that maintain a mild but persistent hyponatremia. In these individuals, ADH secretion remains under osmotic control, but it would appear that the osmoreceptor threshold functions at a lower value than normal (McKeown, 1986). Thus, it is the resetting of the osmostat that results in persistent chronic hyponatremia. Resolution of the underlying medical problem usually results in correction of this variant form of SIADH.

## 2. Hypernatremia

Hypernatremia almost always is associated with elevation of serum osmolality. Hypernatremia occurs in dehydrated subjects when water losses exceed losses of sodium and potassium and should be considered as an indication of a relative water deficit (Scribner, 1969). This situation can occur in the initial stages of diarrhea, vomiting, or renal disease if losses of water exceed the electrolytes lost (see Table 17-6) (Saxton and Seldin, 1986). As water losses are replaced by increased water consumption or enhanced renal water retention, serum sodium concentration tends to decline into or below the normal range. Hypernatremia also develops as the result of an essentially pure water loss, such as the evaporative respiratory water loss in panting animals (Tasker, 1980). Hypernatremia is associated with excessive renal free water loss with either central or nephrogenic diabetes insipidus if water intake is restricted (Breukink *et al.*, 1983). Food and water deprivation in normal individuals is associated with substantial reduction of



**TABLE 17-6** Causes of Hypernatremia

Water losses in excess of electrolyte loss
Digestive
Vomiting
Diarrhea
Cutaneous
Burns
Renal
Diuretics
Diabetes mellitus
Mannitol
Intrinsic renal disease
Pure water losses
Invisible
Panting
Diabetes insipidus
Central
Nephrogenic
Inadequate water intake
Water deprivation
Abnormal thirst mechanism
Sodium excess (water restriction)
Hypertonic saline or sodium bicarbonate
Salt poisoning
Mineralocorticoid excess

renal and fecal output (Brobst and Bayly, 1982; Carlson *et al.*, 1979b; Genetzky *et al.*, 1987; Tasker, 1967b). However, continued cutaneous and respiratory insensible water loss may result in hypernatremia (Carlson *et al.*, 1979b; Elkinton and Taffel, 1942; Genetzky *et al.*, 1987; Rumsey and Bond, 1976). Abnormal thirst mechanisms with resultant hypernatremia have been reported in young dogs (Crawford *et al.*, 1984; Hoskins and Rothschild, 1984). Hypernatremia may occur transiently following administration of hypertonic saline or sodium bicarbonate if water intake is restricted or impaired. The hypernatremia observed with salt poisoning in cattle and swine is, in fact, triggered by water restriction in animals with a high salt intake (Padovan, 1980; Pearson and Kallfelz, 1982). So long as adequate water is available, salt poisoning does not occur. In human subjects, hypernatremia is reported with mineralocorticoid excess (McKeown, 1986).

### C. Serum Potassium

Serum potassium concentration does not always reflect potassium balance but is influenced by factors that alter internal balance (i.e., the distribution of potassium across the cell membrane between the ECF and ICF) as well as factors that change external balance (i.e., potassium intake and output) (Brobst, 1986; Patrick, 1977; Rose, 1984). The effective adjustment of external and internal balance in normal

individuals in response to either large potassium loads or excessive potassium losses usually maintains serum potassium concentration within normal limits. However, changes in potassium concentration occur in a wide variety of clinical circumstances and have profound neuromuscular effects largely because of changes in cell membrane potential (Brobst, 1986). The compensating responses to change in circulating fluid volume distribution and acid-base balance can result in confusing and contradictory findings. As an example, calves with acute diarrhea may develop significant depletion of body potassium stores because of excessive losses and inadequate intake (Phillips and Knox, 1969). However, the serum potassium concentration in these calves may actually be normal to increased as the result of renal shutdown and the metabolic acidosis induced by dehydration and sodium depletion with resultant decreases in the effective circulating fluid volume. Electrolyte replacement fluids given to these calves should include potassium (Fettman *et al.*, 1986). Correct interpretation of serum potassium concentration thus requires a knowledge of probable intake and sources of excessive loss as well as the status of renal function and acid-base balance. Measurement of erythrocyte potassium concentration has been suggested as an aid in the assessment of the potassium status of horses with exercise-related myopathy (Bain and Merritt, 1990; Muylle *et al.*, 1984a, 1984b). However, experimental studies have failed to demonstrate a close correlation between erythrocyte potassium concentration and potassium depletion.

#### 1. Hypokalemia

Hypokalemia occurs relatively frequently in domestic animals and may result from depletion of the body's potassium stores or from a redistribution of potassium from the ECF into the ICF space (Brobst, 1986), as indicated in Table 17-7. Hypokalemia most often is associated with excessive potassium losses from the gastrointestinal tract as the result of vomiting or diarrhea (Tasker, 1967c). Excessive renal loss of potassium results from the action of mineralocorticoid excess, the action of certain diuretics, and as the result of altered renal tubular function in animals with renal tubular acidosis or postobstructive states. Chronic dietary potassium deficiency eventually can lead to modest hypokalemia even in normal individuals (Aitken, 1976; Dow *et al.*, 1987a). A rapidly developing and profound hypokalemia can occur in animals with reduced dietary intake as a result of anorexia when coupled with other causes of excessive potassium loss (Tasker, 1980).

Hypokalemia may develop without potassium depletion as the result of intracellular movement of potassium from the ECF space. This situation occurs with an acute alkalosis (Burnell *et al.*, 1966) and in patients treated with insulin and glucose infusions (Tannen, 1986). In fact, medical management of severe life-threatening hyperkalemia often involves the administration of glucose, insulin, and,

**TABLE 17-7** Causes of Hypokalemia

Hypokalemia resulting from altered external balance

Gastrointestinal losses

Vomiting

Diarrhea

Renal losses

Mineralocorticoid excess

Diuretics

Renal tubular acidosis

Postobstruction diuresis

Hypokalemic nephropathy in cats

Dietary deficiency

Hypokalemia as a result of altered internal balance

Excessively rapid bicarbonate administration

Insulin with glucose administration

Catecholamine release

Hypokalemic periodic paralysis

in some circumstances, bicarbonate in an effort to shift potassium intracellularly. Catecholamines exert a biphasic effect on potassium concentration (Tannen, 1986). The initial response to catecholamine administration is a modest transient increase in potassium as the result of  $\beta$ -adrenergic stimulation followed by hypokalemia as the result of  $\alpha$ -adrenergic receptor responses (Bendheim *et al.*, 1985; Clausen *et al.*, 1980; Williams *et al.*, 1985).  $\alpha$ -Adrenergic agents have been used for the treatment of hyperkalemic periodic paralysis (Bendheim *et al.*, 1985). The relationship between catecholamine release, receptor stimulation, and potassium balance may play a significant role in the development of exertional fatigue in human and equine athletes (Carlson, 1987; Sjogaard *et al.*, 1985).

## 2. Hyperkalemia

Hyperkalemia can be produced iatrogenically by the excessive administration of potassium salts but does not usually result from high dietary intake in individuals with normal renal function (Aitken, 1976). There are three major causes of hyperkalemia as indicated in Table 17-8. Hyperkalemia may develop *in vitro* in blood sample containers because of hemolysis or prolonged storage of blood samples before the serum or plasma has been separated from erythrocytes in the sample. This leakage of erythrocyte potassium can result in significant errors in those species (horse, pig, most cattle) with a high potassium content in their erythrocytes (Tasker, 1980). The erythrocytes of cats and most dogs have a high sodium content and relatively low potassium. Slight hemolysis will have little effect on serum or plasma potassium concentration in these species. There are, however, polymorphisms in intracellular cation content of certain breeds of sheep, cattle, and dogs, which relate to sodium-potassium ATPase activity of mature erythrocytes.

**TABLE 17-8** Causes of Hyperkalemia

False hyperkalemia

Hemolysis

Markedly elevated leukocyte or platelet count

Hyperkalemia as a result of altered external balance

Addison's disease

Renal disease

Ruptured bladder

Urethral obstruction

Hypovolemia with renal shutdown

Hyperkalemia as a result of altered internal balance

Metabolic acidosis

Diabetes

Tissue necrosis

Hyperkalemic periodic paralysis

Vigorous exercise

Release of potassium from leukocytes or platelets into the serum following clot formation in the sample collection vial is a potential cause of hyperkalemia in subjects with a marked leukocytosis or thrombocytosis (Degan, 1986; Mandell *et al.*, 1988).

Hyperkalemia may be associated with excessive renal potassium retention in conditions such as Addison's disease, acute renal failure, and renal shutdown secondary to inadequate effective circulatory fluid volume. Hyperkalemia results, in a number of circumstances, from the movement of intracellular potassium into the ECF without change in external potassium balance. Hyperkalemia develops in association with a metabolic acidosis, particularly when the acidosis results from volume depletion complicated by renal shutdown. Hyperkalemia may be noted in patients with diabetes or transiently in animals with massive muscle necrosis. Interestingly, most horses with exertional rhabdomyolysis do not develop hyperkalemia or a metabolic acidosis (Koterba and Carlson, 1982). Vigorous short-term exercise at high intensity results in a profound hyperkalemia in horses. Serum potassium as high as 9 to 10 mEq/l (9 to 10 mmol/l) has been observed transiently in horses exercising at maximal intensity on a high performance treadmill (Harris and Snow, 1986). Muscular exhaustion in these horses appeared to be related to the hyperkalemia and the profound lactic acidosis seen in the immediate postexercise state (Carlson, 1987; Krzywanek, 1974; Krzywanek *et al.*, 1976; Milne *et al.*, 1976). An interesting and unusual condition of episodic hyperkalemia and muscular weakness has been recognized in the

dog (Jezyk, 1982) and certain quarter horses (Cox, 1985; Pickar *et al.*, 1991; Spier *et al.*, 1990, 1993; Steiss and Naylor, 1986). In the horse, the condition closely resembles the heritable disease hyperkalemic periodic paralysis, which has been reported in human subjects and is due to an alteration in the voltage-regulated sodium channel (Rudolph *et al.*, 1992a, 1992b). Sudden marked increases in serum potassium concentration result from the transcellular movement of potassium. Serum potassium concentration can reach 8 to 9 mEq/l (8 to 9 mmol/l) and is associated with profound electrocardiographic abnormalities and fluid shifts, which result in marked increases in PCV and protein concentration. The disease is inherited as an autosomal dominant, and all affected horses can be traced back to a common ancestor. A DNA test that can detect the single base pair substitution responsible for this disease has been developed (Rudolph *et al.*, 1992ba). Using this procedure, it is possible to identify individuals that are heterozygous or homozygous for this trait.

#### D. Serum Chloride

It long has been assumed that the anion, chloride, which combines with sodium to form common salt, simply follows sodium in the physiological processes that regulate body fluid and electrolyte balance. It is becoming increasingly apparent that this may not always be true and that some of the problems ascribed to sodium retention do not occur unless chloride is present in excess as well (Kurtz *et al.*, 1987). Causes of alterations in chloride concentration are given in Table 17-9. The hyperchloremia and hypochloremia, which are normally seen in association with roughly proportional changes in sodium concentration, are due to changes in body water balance.

Changes in chloride concentration that are not associated with a similar change in sodium concentration are usually associated with acid-base imbalances (Divers *et al.*, 1986). Chloride concentration tends to vary inversely with bicarbonate concentration. A disproportionate increase in chloride most commonly is associated with a normal to low anion gap hyperchloremic metabolic acidosis such as renal tubular acidosis and may be seen as a compensating response for a primary respiratory alkalosis (Saxton and Seldin, 1986). Disproportionate decreases in chloride characteristically are seen in a metabolic alkalosis but also may be seen as part of the compensating response for a chronic primary respiratory acidosis (Saxton and Seldin, 1986).

#### E. Osmolality

It has been demonstrated that the concentration of sodium in serum water is closely correlated with the serum osmolality over an extremely wide range of physiological and pathological states provided appropriate corrections are

**TABLE 17-9** Causes of Alterations in Chloride Concentration

Hyperchloremia	
With proportional increase in sodium	Dehydration (relative water deficit)
Without proportional increase in sodium	Hyperchloremic metabolic acidosis
	Compensation for respiratory alkalosis
Hypochloremia	
With proportional decrease in sodium	Overhydration (relative water excess)
Without proportional decrease in sodium	Hypochloremic metabolic alkalosis
	Compensation for respiratory acidosis

made for the contributions made by variations in glucose and urea concentrations (Edelman *et al.*, 1958). The measurement of serum osmolality has two specific and very useful purposes (Gennari, 1984): first, to determine whether serum water content deviates widely from normal and, second, to screen for the presence of foreign low-molecular-weight substances in the blood. Interpretation of serum osmolality for these purposes requires simultaneous comparison of the measured osmolality and the calculated osmolality as determined from the measured concentrations of the major solutes in serum (sodium, glucose, and urea). The difference between the measured and the calculated osmolality is sometimes referred to as the “osmolal gap” (Feldman and Rosenberg, 1981; Shull, 1978, 1981).

Sodium is the principal cation in serum, and sodium is balanced by a number of different anions (chloride, bicarbonate, protein, sulfate, and phosphate). Sodium concentration thus provides a reasonable estimate of the total electrolyte concentration (anions and cations) in the sample and, in this calculation, is usually multiplied by a factor of 2. As mentioned earlier, the water content of serum samples is approximately 94%. Correction for the water content of serum is not necessary because, fortuitously, it is counterbalanced by the fact that sodium chloride does not dissociate completely and has an osmotic coefficient of 0.93 in serum (Dahms *et al.*, 1968; Rose, 1984; Wolf, 1966). The osmolality can thus be calculated using the measured sodium concentration, and the concentration of the two nonelectrolyte components of serum that are normally present in amounts sufficient to influence osmolality:

$$\text{mOsm/kg H}_2\text{O} = 2 \times \text{sodium} + \text{glucose} + \text{urea} \quad (17-15)$$

This calculation is valid if concentrations of sodium, glucose, and urea are expressed in mmol/l. Conversion of glucose concentration from mg/dl to mmol/l requires division by 18, and urea concentration in mg/dl can be converted to mmol/l by dividing by 2.8.

Decreases in osmolar gap indicate laboratory error. Increases in osmolar gap ( $>10$  mOsm/kg) could also represent laboratory error but generally result from one of two circumstances: either a decrease in serum water content or the addition of low-molecular-weight substances in serum. Decreases in serum water content occur with marked hyperlipidemia or hyperproteinemia, and the calculated osmolality will exceed the measured osmolality. This is the cause of the false hyponatremia discussed in Section VI.B. The presence of a similar disparity between the measured and calculated osmolality in the absence of hyperlipidemia or hyperproteinemia should prompt an alert for the presence of exogenous substances in abnormally high concentrations in the serum. These substances could include a variety of exogenous and potentially toxic compounds, such as mannitol, ethanol, methanol, ethylene glycol, isopropanol, ethyl ether, acetone, trichloroethane, and paraldehyde (Saxton and Seldin, 1986).

## REFERENCES

- Adroque, H. J., Brensilver, J., and Madias, N. E. (1978). Changes in the plasma anion gap during chronic metabolic acid-base disturbances. *Am. J. Physiol.* **235**, F291–F297.
- Aitken, F. C. (1976). "Sodium and Potassium in Nutrition of Mammals," Technical Communication No. 26, Commonwealth Bureau of Nutrition, Commonwealth Agricultural Bureaux, Farnham Royal, England.
- Arief, A. I. (1986). Hyponatremia, convulsions, respiratory arrest, and permanent brain damage after elective surgery in healthy women. *N. Engl. J. Med.* **314**, 1529–1535.
- Bain, F. T., and Merritt, A. M. (1990). Decreased erythrocyte potassium concentration associated with exercise-related myopathy in horses. *J. Am. Vet. Med. Assoc.* **196**, 1259–1261.
- Bendheim, P. E., Reale, E. O., and Berg, B. O. (1985).  $\beta$ -Adrenergic treatment of hyperkalemic periodic paralysis. *Neurology* **35**, 746–749.
- Bennett, E. J. (1975). Fluid balance in the newborn. *Anesthesiology* **43**, 210–224.
- Bianca, W., Findlay, J. D., and McLean, J. A. (1965). Responses of steers to water restriction. *Res. Vet. Sci.* **6**, 38–55.
- Billig, D. M., and Jordan, P. H. (1969). Hemodynamic abnormalities secondary to extracellular fluid depletion in intestinal obstruction. *Surg. Gynecol. Obstet.* **129**, 1274–1282.
- Block, E. (1984). Manipulating dietary anions and cations for prepartum dairy cows to reduce incidence of milk fever. *J. Dairy Sci.* **67**, 2939–2948.
- Boyd, J. W. (1981). The relationships between blood haemoglobin concentration, packed cell volume and plasma protein concentration in dehydration. *Br. Vet. J.* **137**, 166–172.
- Breitschwerdt, E. B., and Root, C. R. (1979). Inappropriate secretion of antidiuretic hormone in a dog. *J. Am. Vet. Med. Assoc.* **175**, 181–186.
- Breukink, H. J., Van Wegen, P., and Schotman, J. H. (1983). Idiopathic diabetes insipidus in a Welsh pony. *Equine Vet. J.* **15**, 284–287.
- Bristol, D. G. (1982). The anion gap as a prognostic indicator in horses with abdominal pain. *J. Am. Vet. Med. Assoc.* **181**, 63–65.
- Brobst, D. (1984). Abnormalities of plasma sodium concentration and water balance: a review. *Calif. Vet.* **38**(9), 20–23, 48.
- Brobst, D. (1986). Review of the pathophysiology of alterations in potassium homeostasis. *J. Am. Vet. Med. Assoc.* **188**, 1019–1025.
- Brobst, D. F., and Bayly, W. M. (1982). Responses of horses to a water deprivation test. *J. Equine Vet. Sci.* **2**, 51–56.
- Brofman, P. J., Knostman, K. A., and DiBartola, S. P. (2003). Granulomatous amebic meningoencephalitis causing the syndrome of inappropriate secretion of antidiuretic hormone in a dog. *J. Vet. Int. Med.* **17**, 230–234.
- Brooks, C. L., Garry, F., and Swartout, M. S. (1988). Effect of an interfering substance on determination of potassium by ion-specific potentiometry in animal urine. *Am. J. Vet. Res.* **49**, 710–714.
- Buck, W. B., Osweiler, G. D., and Van Gelder, G. A. (1976). Water deprivation—sodium salt. In "Clinical and Diagnostic Veterinary Toxicology" (W. B. Buck, G. D. Osweiler, and G. A. Van Gelder, Eds.), 2nd ed., pp. 83–86. Kendall/Hunt, Dubuque, IA.
- Burnell, J. M., Villamil, M. F., Uyeno, B. T., and Scribner, B. H. (1966). The effect in humans of extracellular pH change on the relationship between serum potassium concentration and intracellular potassium. *J. Clin. Invest.* **35**, 935–939.
- Carlson, G. P. (1975). Fluid and electrolyte alterations in endurance-trained horses. In "Proc. 1st Int. Symp. Equine Hematol," pp. 473–480. Am. Assoc. Equine Pract., Golden, CO.
- Carlson, G. P. (1979a). Fluid therapy in horses with acute diarrhea. *Vet. Clin. N. Am. Lg. Anim. Pract.* **1**, 313–329.
- Carlson, G. P. (1979b). Physiologic responses to endurance exercise. *Proc. Ann. Convent. Am. Assoc. Equine Pract.* **25**, 459–468.
- Carlson, G. P. (1983a). Fluid therapy. In "Current Therapy in Equine Medicine" (N. E. Robinson, Ed.), pp. 311–318. Saunders, Philadelphia.
- Carlson, G. P. (1983b). Medical management of the exhausted horse. In "Current Therapy in Equine Medicine" (N. E. Robinson, Ed.), pp. 318–321. Saunders, Philadelphia.
- Carlson, G. P. (1983c). Thermoregulation and fluid balance in the exercising horse. In "Equine Exercise Physiology" (D. H. Snow, S. G. B. Persson, and R. J. Rose, Eds.), pp. 291–309. Granta Editions, Cambridge, UK.
- Carlson, G. P. (1987). Hematology and body fluids in the athlete: a review. In "Equine Exercise Physiology 2" (J. R. Gillespie and N. E. Robinson, Eds.), pp. 393–426. ICEEP, Davis, CA.
- Carlson, G. P. (1995). Interrelationships between fluid, electrolyte and acid-base balance during maximal exercise. *Equine Vet. J. Suppl.* **18**, 261–265.
- Carlson, G. P., Harrold, D., and Rumbaugh, G. E. (1979a). Volume dilution of sodium thiocyanate as a measure of extracellular fluid volume in the horse. *Am. J. Vet. Res.* **40**, 587–589.
- Carlson, G. P., and Rumbaugh, G. E. (1983). Response to saline solution of normally fed horses and horses dehydrated by fasting. *Am. J. Vet. Res.* **44**, 964–968.
- Carlson, G. P., Rumbaugh, G. E., and Harrold, D. R. (1979b). Physiologic alterations in the horse produced by food and water deprivation during periods of high environmental temperatures. *Am. J. Vet. Res.* **40**, 982–985.
- Christensen, G. (1993). Cardiovascular and renal effects of atrial natriuretic factor. *Scand. J. Lab. Invest.* **53**, 203–209.
- Clark, A. M. (1980). Parenteral fluid therapy in small animals. *Vet. Rec.* **106**, 146–149.
- Clausen, T., Wang, P., Orskov, H., and Kristensen, O. (1980). Hyperkalemic periodic paralysis. Relationships between changes in

- plasma water, electrolytes, insulin and catecholamines during attacks. *Scand. J. Clin. Lab. Invest.* **40**, 211–220.
- Constable, P. D. (1997). A simplified strong ion model for acid-base equilibria: application to horse plasma. *J. Appl. Physiol.* **83**, 297–311.
- Constable, P. D., Hinchcliff, K. W., and Muir, W. W. (1998). Comparison of anion gap and strong ion gap as predictors of unmeasured strong ion concentration in plasma and serum from horses. *Am. J. Vet. Res.* **59**, 881–887.
- Constable, P. D., and Stampfli, H. R. (2005). Experimental determination of net protein charge and A(tot) and K(a) of nonvolatile buffers in canine plasma. *J. Vet. Int. Med.* **19**, 507–514.
- Constable, P. D., Stampfli, H. R., Navetat, H., Berchtold, J., and Schelcher, F. (2005). Use of a quantitative strong ion approach to determine the mechanism for acid-base abnormalities in sick calves with or without diarrhea. *J. Vet. Int. Med.* **19**, 581–589.
- Cornelius, L. M., Finco, D. R., and Culver, D. H. (1978). Physiologic effects of rapid infusion of Ringer's lactate solution into dogs. *Am. J. Vet. Res.* **39**, 1185–1190.
- Cox, J. H. (1985). An episodic weakness in four horses associated with intermittent serum hyperkalemia and the similarity of the disease to hyperkalemic periodic paralysis in man. *Proc. Ann. Convent. Am. Assoc. Equine Pract.* **31**, 383–391.
- Crawford, M. A., Kittleson, M. D., and Fink, G. D. (1984). Hyponatremia and adipsia in a dog. *J. Am. Vet. Med. Assoc.* **184**, 818–821.
- Crow, S. E., and Stockham, S. L. (1985). Profound hyponatremia associated with glucocorticoid deficiency in a dog. *J. Am. Anim. Hosp. Assoc.* **21**, 393–400.
- Dahms, H., Rock, R., and Seligson, D. (1968). Ionic activities of sodium, potassium, and chloride in human serum. *Clin. Chem.* **14**, 859–870.
- Dalton, R. G. (1964). Measurement of body water in calves with urea. *Br. Vet. J.* **120**, 378–384.
- Degan, M. A. (1986). Correlation of spurious potassium elevation and platelet count in dogs. *Vet. Clin. Path.* **15**, 20–22.
- de Moraes, H. A. (1992a). Mixed acid-base disorders. In "Fluid Therapy in Small Animal Practice" (S. P. DiBartola, Ed.), pp. 276–296. Saunders, Philadelphia.
- de Moraes, H. A. (1992b). A nontraditional approach to acid-base disorders. In "Fluid Therapy in Small Animal Practice" (S. P. DiBartola, Ed.), pp. 297–320. Saunders, Philadelphia.
- de Moraes, H. A. (2005). Has Stewart finally arrived in the clinic? *J. Vet. Int. Med.* **19**, 489–490.
- Dhein, C. R., and Wardrop, K. J. (1995). Hyperkalemia associated with potassium chloride administration in a cat. *J. Am. Vet. Med. Assoc.* **206**, 1565–1566.
- DiBartola, S. P. (1992a). Introduction to acid-base disorders. In "Fluid Therapy in Small Animal Practice" (S. P. DiBartola, Ed.), pp. 193–215. Saunders, Philadelphia.
- DiBartola, S. P. (1992b). Metabolic acidosis. In "Fluid Therapy in Small Animal Practice" (S. P. DiBartola, Ed.), pp. 216–243. Saunders, Philadelphia.
- DiBartola, S. P. (1992c). Metabolic alkalosis. In "Fluid Therapy in Small Animal Practice" (S. P. DiBartola, Ed.), pp. 244–257. Saunders, Philadelphia.
- Dieterich, R. A., and Holleman, D. F. (1973). Hematology, biochemistry, and physiology of environmentally stressed horses. *Can. J. Zool.* **51**, 867–873.
- Divers, T. J., Freeman, D. E., Ziemer, E. L., and Becht, J. L. (1986). Interpretation of electrolyte abnormalities in clinical disease in the horse. *Proc. Ann. Convent. Am. Assoc. Equine Pract.* **32**, 69–80.
- Dow, S. W., Fettman, M. J., LeCouteur, R. A., and Hamar, D. W. J. (1987a). Potassium depletion in cats: renal and dietary influences. *J. Am. Vet. Med. Assoc.* **191**, 1569–1575.
- Dow, S. W., LeCouteur, R. A., Fettman, M. J., and Spurgeon, T. L. (1987b). Potassium depletion in cats: hypokalemic polymyopathy. *J. Am. Vet. Med. Assoc.* **191**, 1563–1568.
- Earley, L. E., and Daugharty, T. M. (1969). Sodium metabolism. *N. Engl. J. Med.* **281**, 72–86.
- Edelman, I. S., and Leibman, J. (1959). Anatomy of body water and electrolytes. *Am. J. Med.* **27**, 256–277.
- Edelman, I. S., Leibman, J., O'Meara, P., and Birkenfeld, L. W. (1958). Interrelations between serum sodium concentration, serum osmolality and total exchangeable sodium, total exchangeable potassium and total body water. *J. Clin. Invest.* **37**, 1236–1256.
- Elkinton, J. R., and Danowski, T. S. (1955). "The Body Fluids: Basic Physiology and Practical Therapeutics." Williams and Wilkins, Baltimore.
- Elkinton, J. R., and Taffel, M. (1942). Prolonged water deprivation in the dog. *J. Clin. Invest.* **21**, 787–794.
- Elkinton, J. R., and Winkler, A. W. (1944). Transfers of intracellular potassium in experimental dehydration. *J. Clin. Invest.* **23**, 93–101.
- Emmett, M., and Narins, R. G. (1977). Clinical use of the anion gap. *Medicine* **56**, 38–54.
- English, P. B. (1966a). A study of water and electrolyte metabolism in sheep. I. External balances of water, sodium, potassium and chloride. *Res. Vet. Sci.* **7**, 233–257.
- English, P. B. (1966b). A study of water and electrolyte metabolism in sheep. II. The volumes of distribution of antipyrine, thiosulphate and T1824 (Evans blue) and values for certain extracellular fluid constituents. *Res. Vet. Sci.* **7**, 258–275.
- Epstein, V. (1984). Relationship between potassium administration, hyperkalemia and the electrocardiogram: an experimental study. *Equine Vet. J.* **16**, 453–456.
- Evans, J. W. (1971). Effect of fasting, gestation, lactation and exercise on glucose turnover in horses. *J. Anim. Sci.* **33**, 1001–1004.
- Ewaschuk, J. B., Naylor, J. M., Palmer, R., Whiting, S. J., and Zello, G. A. (2004). D-lactate production and excretion in diarrheic calves. *J. Vet. Int. Med.* **18**, 744–747.
- Ewaschuk, J. B., Naylor, J. M., and Zello, G. A. (2003). Anion gap correlates with serum D- and DL-lactate concentration in diarrheic neonatal calves. *J. Vet. Int. Med.* **17**, 940–942.
- Feldman, B. F., and Rosenberg, D. P. (1981). Clinical use of anion and osmolal gaps in veterinary medicine. *J. Am. Vet. Med. Assoc.* **178**, 396–398.
- Fencl, V., and Leith, D. H. (1993). Stewart's quantitative acid-base chemistry: applications in biology and medicine. *Resp. Physiol.* **91**, 1–16.
- Fencl, V., and Rossing, T. H. (1989). Acid-base disorders in critical care medicine. *Ann. Rev. Med.* **40**, 17–29.
- Fettman, M. J., Brooks, P. A., Burrows, K. P., and Phillips, R. W. (1986). Evaluation of commercial oral replacement formulas in healthy neonatal calves. *J. Am. Vet. Med. Assoc.* **188**, 397–401.
- Fielding, C. L., Magdesian, K. G., Elliott, D. A., Cowgill, L. D., and Carlson, G. P. (2004). Use of multifrequency bioelectrical impedance analysis for estimation of total body water and extracellular and intracellular fluid volumes in horses. *Am. J. Vet. Res.* **65**, 320–326.
- Fisher, E. W., and Martinez, A. A. (1976). Aspects of body fluid dynamics of neonatal calf diarrhoea. *Res. Vet. Sci.* **20**, 302–305.
- Fleeman, L. M., Irwin, P. J., Phillips, P. A., and West, J. (2000). Effects of an oral vasopressin receptor antagonist (OPC-31260) in a dog with

- syndrome of inappropriate secretion of antidiuretic hormone. *Aust. Vet. J.* **78**, 825–830.
- Fleming, S. A., Hunt, E. L., Brownie, C., Rakes, A., and McDaniel, B. (1992). Fractional excretion of electrolytes in lactating dairy cows. *Am. J. Vet. Res.* **53**, 222–224.
- Fonnesbeck, P. V. (1968). Consumption and excretion of water by horses receiving all hay and hay-grain diets. *J. Anim. Sci.* **27**, 1350–1356.
- Fredeen, A. H., DePeters, E. J., and Baldwin, R. L. (1988). Effects of acid-base disturbances caused by differences in dietary fixed ion balance on kinetics of calcium metabolism in ruminants with high calcium demand. *J. Anim. Sci.* **66**, 174–184.
- Frishmeyer, K. J., and Moon, P. F. (1994). Evaluation of quantitative acid-base balance and determination of unidentified anions in swine. *Am. J. Vet. Res.* **55**, 1153–1157.
- Garella, S., Chang, B. S., and Kahn, S. I. (1975). Dilution acidosis and contraction alkalosis: review of a concept. *Kidney Int.* **8**, 279–283.
- Garry, F., and Rings, D. M. (1987). Anion gap and bovine gastrointestinal obstruction. *Proc. Ann. Vet. Med. Forum.* **5**, 823–826.
- Genetzky, R. M., Loparco, F. V., and Ledet, A. E. (1987). Clinical pathologic alterations in horses during a water deprivation test. *Am. J. Vet. Res.* **48**, 1007–1011.
- Gennari, F. J. (1984). Current concepts. Serum osmolality. Uses and limitations. *N. Engl. J. Med.* **310**, 102–105.
- George, J. W. (1994). Water, electrolytes, and acid base. In “Veterinary Laboratory Medicine Clinical Pathology” (J. R. Duncan, K. W. Prasse, and E. A. Mahaffey, Eds.), 3rd ed., pp. 94–111. Iowa State University Press, Ames.
- Giger, U., and Gorman, N. T. (1984). Oncologic emergencies in small animals. Part II. Metabolic and endocrine emergencies. *Comp. Cont. Ed. Pract. Vet.* **6**, 805–812.
- Gilfix, B. M., Bique, M., and Magder, S. (1993). A physical chemical approach to the analysis of acid-base balance in the clinical setting. *J. Crit. Care* **8**, 187–197.
- Gingerich, D. A., and Murdick, P. W. (1975a). Experimentally induced intestinal obstruction in sheep: paradoxical aciduria in metabolic alkalosis. *Am. J. Vet. Res.* **36**, 663–668.
- Gingerich, D. A., and Murdick, P. W. (1975b). Paradoxical aciduria in bovine metabolic alkalosis. *J. Am. Vet. Med. Assoc.* **166**, 227–230.
- Glazier, D. B., Littledike, E. T., and Evans, R. D. (1979). Electrocardiographic changes in induced hypocalcemia and hypercalcemia in horses. *J. Equine Med. Surg.* **3**, 489–494.
- Glazier, D. B., Littledike, E. T., and Evans, R. D. (1982). Electrocardiographic changes in induced hyperkalemia in ponies. *Am. J. Vet. Res.* **43**, 1934–1937.
- Gossett, K. A., and French, D. D. (1983). Effect of age on anion gap in clinically normal Quarter Horses. *Am. J. Vet. Res.* **44**, 1744–1745.
- Hankes, G. H., Nelson, A. W., and Swan, H. (1973). Chlorine-36 as a continuing indicator of extracellular fluid volume in the dog. *Am. J. Vet. Res.* **34**, 221–229.
- Hannon, J. P., Bossone, C. A., and Wade, C. E. (1990). Normal physiological values for conscious pigs used in biomedical research. *Lab. An. Sci.* **40**, 293–299.
- Hansard, S. L. (1964). Total body water in farm animals. *Am. J. Physiol.* **206**, 1369–1372.
- Harris, P., and Snow, D. H. (1986). Alterations in plasma potassium concentrations during and following short-term strenuous exercise in the horse. *J. Physiol.* **376**, 46P.
- Hayter, C. J., Clapham, W. F., Mills, I. H., and Wardener, H. E. (1962). Red blood cell and plasma “disappearance” during rapid plasma volume expansion. *Clin. Sci.* **23**, 229–236.
- Hedley-Whyte, J., and Laver, M. B. (1964). O<sub>2</sub> solubility in blood and temperature correction factors for pO<sub>2</sub>. *J. Appl. Physiol.* **19**, 901–906.
- Hinton, M. (1978). On the watering of horses: a review. *Equine Vet. J.* **10**, 27–31.
- Hintz, H. F., and Schryver, H. F. (1976). Potassium metabolism in ponies. *J. Anim. Sci.* **3**, 637–643.
- Hix, E. L., Evans, L. E., and Underbjerg, G. K. L. (1953). Extracellular water and dehydration in sheep. *J. Anim. Sci.* **12**, 459–473.
- Hopper, J., Elkinton, J. R., and Winkler, A. W. (1944). Plasma volume of dogs in dehydration, with and without salt loss. *J. Clin. Invest.* **23**, 111–117.
- Hoskins, J. D., and Rothschild, J. (1984). Hypernatremic thirst deficiency in a dog. *Vet. Med.* **79**, 489–491.
- Houston, D. M., Allen, D. G., and Kruth, S. A. (1989). Syndrome of inappropriate antidiuretic hormone secretion in a dog. *Can. Vet. J.* **30**, 423–425.
- Humes, H. D. (1986). Disorders of water metabolism. In “Fluids and Electrolytes” (J. P. Kokko and R. L. Tannen, Eds.), pp. 118–149. Saunders, Philadelphia.
- Ilkiw, J. E., Rose, R. J., and Martin, I. C. A. (1991). A comparison of simultaneously collected arterial, mixed venous, jugular venous and cephalic venous blood samples in the assessment of blood-gas and acid-base status in the dog. *J. Vet. Int. Med.* **5**, 294–298.
- Inagami, T. (1994). Atrial natriuretic factor as a volume regulator. *J. Clin. Pharmacol.* **34**, 424–426.
- Irvine, R. O. H., and Dow, J. W. (1968). Potassium depletion: effects on intracellular pH and electrolyte distribution in skeletal and cardiac muscle. *Aust. Ann. Med.* **17**, 206–213.
- Jezyk, P. F. (1982). Hyperkalemic periodic paralysis in a dog. *J. Am. Anim. Hosp. Assoc.* **18**, 977–980.
- Jones, N. L. (1990). A quantitative physicochemical approach to acid-base physiology. *Clin. Biochem.* **23**, 189–195.
- Judson, G. J., and Mooney, G. J. (1983). Body water and water turnover rate in Thoroughbred horses in training. In “Equine Exercise Physiology” (D. H. Snow, S. G. B. Persson, and R. J. Rose, Eds.), pp. 371–376. Granta Editions, Cambridge, UK.
- Kamal, T. H., Shehata, O., and Elbanna, I. M. (1972). Effect of heat and water restriction on water metabolism and body fluid compartments in farm animals. In “Isotope Studies on the Physiology of Domestic Animals,” pp. 95–102. Proc. Symp. Int. Atomic Energy Agency, Vienna, pp. 95–102.
- Kami, G., Merritt, A. M., and Duelly, P. (1984). Preliminary studies of plasma and extracellular fluid volume in neonatal ponies. *Equine Vet. J.* **16**, 356–358.
- Kasari, T. R., and Naylor, J. M. (1984). Metabolic acidosis without clinical signs of dehydration in young calves. *Can. Vet. J.* **25**, 394–399.
- Kasari, T. R., and Naylor, J. M. (1986). Further studies on the clinical features and clinicopathological findings of a syndrome of metabolic acidosis with minimal dehydration in neonatal calves. *Can. J. Vet. Res.* **50**, 502–508.
- Kohn, C. W. (1979). Preparative management of the equine patient with an abdominal crisis. *Vet. Clin. N. Am. Large Anim. Pract.* **1**, 289–311.
- Kohn, C. W., and DiBartola, S. P. (1992). Composition and distribution of body fluids in dogs and cats. In “Fluid Therapy in Small Animal Practice” (S. P. DiBartola, Ed.), pp. 1–34. Saunders, Philadelphia.
- Koterba, A., and Carlson, G. P. (1982). Acid-base and electrolyte alterations in horses with exertional rhabdomyolysis. *J. Am. Vet. Med. Assoc.* **180**, 303–306.
- Kowalchuk, J. M., and Scheuermann, B. W. (1994). Acid-base regulation: a comparison of quantitative methods. *Can. J. Physiol. Pharmacol.* **72**, 818–826.

- Krzywanek, H. (1974). Lactic acid concentrations and pH values in trotters after racing. *J. S. Afr. Vet. Assoc.* **45**, 355–360.
- Krzywanek, H., Milne, D. W., Gabel, A. A., and Smith, L. G. (1976). Acid-base values of standardbred horses recovering from strenuous exercise. *Am. J. Vet. Res.* **37**, 291–294.
- Kurtz, T. W., Al-Bander, H. A., and Morris, R. C. (1987). “Salt-sensitive” essential hypertension in men. Is the sodium ion alone important? *New Engl. J. Med.* **317**, 1043–1048.
- Lakritz, J., Madigan, J., and Carlson, G. P. (1992). Hypovolemic hyponatremia and signs of neurologic disease associated with diarrhea in a foal. *J. Am. Vet. Med. Assoc.* **200**, 1114–1116.
- Landis, E. M., and Pappenheimer, J. P. (1963). Exchange of substances through the capillary walls. In “Handbook of Physiology, sect. 2” (W. F. Hamilton, Ed.), vol. II, pp. 961–1034. Williams and Wilkins, Baltimore.
- Leaf, A. (1962). The clinical and physiologic significance of the serum sodium concentration. *N. Engl. J. Med.* **267**, 77–83.
- Leitch, I., and Thomson, M. A. (1944). The water economy of farm animals. *Nutr. Abstr. Rev.* **14**, 197–223.
- Littlejohn, A., and Mitchell, B. (1969). Acid-base and blood gas studies in horses. I. A comparison of capillary and arterial blood samples for the estimation of acid-base values in horses. *Res. Vet. Sci.* **10**, 260–262.
- Lopez, I., Aguilera-Tejero, E., Estepa, J. C., Rodriguez, M., and Felsenfeld, A. J. (2004). Role of acidosis-induced increases in calcium on PTH secretion in acute metabolic and respiratory acidosis in the dog. *Am. J. Physiol.* **286**, E780–E785.
- Lorenz, I., Gentile, A., and Klee, W. (2005). Investigations of D-lactate metabolism and the clinical signs of D-lactataemia in calves. *Vet. Rec.* **156**, 412–415.
- McAuliffe, J. J., Lind, L. J., Leith, D. E., and Fencl, V. (1986). Hypoproteinemic alkalosis. *Am. J. Med.* **81**, 86–90.
- McCance, R. A. (1937). The changes in the plasma and cells during experimental human salt deficiency. *Biochem. J.* **31**, 1278–1284.
- McCance, R. A. (1938). The effect of salt deficiency in man on the volume of the extracellular fluids, and on the composition of sweat, saliva, gastric juice and cerebrospinal fluid. *J. Physiol.* **92**, 208–218.
- McCoy, C. P., and Edwards, W. C. (1979). Sodium ion poisoning in livestock from oil field wastes. *Oklahoma Vet.* **31**, 12–14.
- McDougall, J. G., Coghlan, J. P., Scoggins, B. A., and Wright, R. D. (1974). Effect of sodium depletion on bone sodium and total exchangeable sodium in sheep. *Am. J. Vet. Res.* **35**, 923–929.
- McGuirk, S. M., and Butler, D. (1980). Metabolic alkalosis with paradoxical aciduria in cattle. *J. Am. Vet. Med. Assoc.* **177**, 551–554.
- McKeever, K. H., Hinchcliff, K. W., Schmall, L. M., Lamb, D. R., and Muir, W. W. (1991). Atrial natriuretic peptide during exercise in horses. In “Equine Exercise Physiology 3” (S. G. B. Persson, A. Lindholm, and L. B. Jeffcott, Eds.), pp. 368–373. ICEEP, Davis, CA.
- McKeown, J. W. (1986). Disorders of total body sodium. In “Fluids and Electrolytes” (J. P. Kokko and R. L. Tannen, Eds.), pp. 63–117. Saunders, Philadelphia.
- Madias, N. E., Ayus, J. C., and Adroge, H. J. (1979). Increased anion gap in metabolic alkalosis: the role of plasma-protein equivalency. *N. Engl. J. Med.* **300**, 1421–1423.
- Madigan, J. E., Thomas, W. P., Backus, K. Q., and Powell, W. E. (1992). Mixed venous blood gases in recumbent and upright positions in foals from birth to 14 days of age. *Equine Vet. J.* **24**, 399–401.
- Mandell, C. P., Degen, M. A., Hopper, P. E., and Zinkl, J. G. (1988). Spurious elevation of serum potassium in two cases of thrombocytopenia. *Vet. Clin. Path.* **17**, 32–33.
- Mason, D. E., Muir, W. W., and Wade, A. (1987). Arterial blood gas tensions in the horse during recovery from anesthesia. *J. Am. Vet. Med. Assoc.* **190**, 989–994.
- Mattheeuws, D. R. G., Kaneko, J. J., Loy, R. G., Cornelius, C., and Wheat, J. D. (1966). Compartmentalization and turnover of <sup>131</sup>I-labeled albumin and gamma globulin in horses. *Am. J. Vet. Res.* **27**, 699–705.
- Merritt, A. M., Kohn, C., Ramberg, C. F., Cimprich, R. E., Reid, C. F., and Bolton, J. R. (1977). Plasma clearance of [<sup>51</sup>Cr] albumin into the intestinal tract of normal and chronically diarrheal horses. *Am. J. Vet. Res.* **38**, 1769–1774.
- Michell, A. R. (1974). The sodium transport hypothesis of salt appetite. *Br. Vet. J.* **130**, vi–viii.
- Michell, A. R. (1985). Sodium in health and disease: a comparative review with emphasis on herbivores. *Vet. Rec.* **116**, 653–657.
- Milne, D. W., Skarda, R. T., Gabel, A. A., Smith, L. G., and Ault, B. S. (1976). Effects of training on biochemical values in standardbred horses. *Am. J. Vet. Res.* **37**, 285–290.
- Morris, D. D., Divers, T. J., and Whitlock, R. H. (1984). Renal clearance and fractional excretion of electrolytes over a 24-hour period in horses. *Am. J. Vet. Res.* **45**, 2431–2435.
- Muyllé, E., Nuytten, J., Van den Hende, C., Vlamincck, K., and Oyaert, W. (1984a). Determination of red blood cell potassium content in horses with diarrhoea: a practical approach for therapy. *Equine Vet. J.* **16**, 450–451.
- Muyllé, E., Van den Hende, C., Nuytten, J., Deprez, P., Vlamincck, K., and Oyaert, W. (1984b). Potassium concentration in equine red blood cells: normal values and correlation with potassium levels in plasma. *Equine Vet. J.* **16**, 447–449.
- Nairns, R. G., and Emmett, M. (1980). Simple and mixed acid-base disorders: a practical approach. *Medicine* **59**, 161–187.
- Oh, M. S., and Carroll, H. J. (1977). The anion gap. *N. Engl. J. Med.* **297**, 814–817.
- Omole, O. O., Nappert, G., Naylor, J. M., and Zello, G. A. (2001). Both L- and D-lactate contribute to metabolic acidosis in diarrheic calves. *J. Nutr.* **131**, 2128–2131.
- Padovan, D. (1980). Polioencephalomalacia associated with water deprivation in cattle. *Cornell Vet.* **70**, 153–159.
- Patrick, J. (1977). Assessment of body potassium stores. *Kidney Int.* **11**, 476–490.
- Pearson, E. G., and Kallfelz, F. A. (1982). A case of presumptive salt poisoning (water deprivation) in veal calves. *Cornell Vet.* **72**, 142–149.
- Persson, S. (1967). On blood volume and working capacity in horses: studies of methodology and physiological and pathological variations. *Acta Vet. Scand. Suppl.* **19**, 1–189.
- Persson, S. G. B., Ekman, L., Lydin, G., and Tuvesson, G. (1973). Circulatory effects of splenectomy in the horse. I. Effect on red-cell distribution and variability of haematocrit in the peripheral blood. *Zentralbl. Veterinaermed. Reihe A* **20**, 441–455.
- Phillips, R. W., and Knox, K. L. (1969). Diarrheic acidosis in calves. *J. Comp. Lab. Med.* **3**, 1–3.
- Phillips, R. W., Lewis, L. D., and Knox, K. L. (1971). Alterations in body water turnover and distribution in neonatal calves with acute diarrhea. *Ann. NY Acad. Sci.* **176**, 231–243.
- Phillipson, A. T. (1977). Ruminant digestion. In “Duke’s Physiology of Domestic Animals” (M. J. Swenson, Ed.), 9th ed., pp. 250–286. Comstock, Ithaca, NY.
- Pickar, J. G., Spier, S. J., Snyder, J. R., and Carlsen, R. C. (1991). Altered ionic permeability in skeletal muscle from horses with hyperkalemic periodic paralysis. *Am. J. Physiol.* **260**, C926–C933.

- Pierce, A. W. (1957). Saline content of drinking water for livestock. *Vet. Rev. Annot.* **3**, 37–43.
- Polzin, D. J., Stevens, J. B., and Osborne, C. A. (1982). Clinical application of the anion gap in evaluation of acid-base disorders in dogs. *Comp. Cont. Ed. Pract. Vet.* **4**, 1021–1036.
- Pownall, R., and Dalton, R. G. (1973). Blood and plasma volumes of neonatal pigs expressed relative to bodyweight and total body water. *Br. Vet. J.* **129**, 583–588.
- Reeves, R. B., Park, J. S., Lapennas, G. N., and Olszowka, A. J. (1982). *J. Appl. Physiol.* **53**, 87–95.
- Robb, J., Harper, H. F., Hintz, H. F., Reid, J. T., Lowe, J. E., Schryver, H. F., and Rhee, M. S. S. (1972). Chemical composition and energy value of the body, fatty acid composition of adipose tissue, and liver and kidney size in the horse. *Anim. Prod.* **14**, 25–34.
- Rose, B. D. (1984). "Clinical Physiology of Acid-Base and Electrolyte Disorders," 2nd ed. McGraw-Hill, New York.
- Rose, R. J., and Carter, J. (1979). Some physiological and biochemical effects of acetazolamide in the dog. *J. Vet. Pharmacol. Ther.* **2**, 215–221.
- Rose, R. J., Gibson, K. T., and Suann, C. J. (1986). An evaluation of an oral glucose-glycine-electrolyte solution for the treatment of experimentally induced dehydration in the horse. *Vet. Rec.* **19**, 522–525.
- Rossing, R. G., and Cain, S. M. (1966). A nomogram relating pO<sub>2</sub>, pH, temperature, and hemoglobin saturation in the dog. *J. Appl. Physiol.* **21**, 195–201.
- Rudolph, J. A., Spier, S. J., Byrns, G., and Hoffman, E. P. (1992a). Linkage of hyperkalaemic periodic paralysis in quarter horses to the horse adult skeletal muscle sodium channel gene. *Anim. Genet.* **23**, 241–250.
- Rudolph, J. A., Spier, S. J., Byrns, G., Rojas, C. V., Bernoco, D., and Hoffman, E. P. (1992b). Periodic paralysis in quarter horses: a sodium channel mutation disseminated by selective breeding. *Nat. Genet.* **2**, 144–147.
- Rumbaugh, G. E., Carlson, G. P., and Harrold, D. R. (1981). Clinicopathologic effects of rapid infusion of 5% sodium bicarbonate in 5% dextrose in the horse. *J. Am. Vet. Med. Assoc.* **178**, 267–271.
- Rumbaugh, G. E., Carlson, G. P., and Harrold, D. (1982). Urinary production in the healthy horse and in horses deprived of feed and water. *Am. J. Vet. Res.* **43**, 735–737.
- Rumsey, T. S., and Bond, J. (1976). Cardiorespiratory patterns, rectal temperature, serum electrolytes and packed cell volume in beef cattle deprived of feed and water. *J. Anim. Sci.* **42**, 1227–1238.
- Sandals, W. C. D. (1978). Acute salt poisoning in cattle. *Can. Vet. J.* **19**, 136–137.
- Saxton, D. R., and Seldin, D. W. (1986). Clinical interpretation of laboratory values. In "Fluids and Electrolytes" (J. P. Kokko and R. L. Tannen, Eds.), pp. 3–62. Saunders, Philadelphia.
- Schultze, G., Kirsch, K., and Rucker, L. (1972). Distribution and circulation of extracellular fluid and protein during different states of hydration in the cat. *Pflugers Arch.* **337**, 351–366.
- Scribner, B. H. (1969). "Teaching Syllabus for the Course on Fluid and Electrolyte Balance." University of Washington, School of Medicine, Seattle.
- Senay, L. C. (1970). Movement of water, protein and crystalloids between vascular and extra-vascular compartments in heat-exposed men during dehydration and following limited relief of dehydration. *J. Physiol. (London)* **210**, 617–635.
- Shull, R. (1978). The value of anion gap and osmolal gap determination in veterinary medicine. *Vet. Clin. Pathol.* **7**, 7–14.
- Shull, R. (1981). Anion and osmolal gaps in veterinary medicine. *J. Am. Vet. Med. Assoc.* **178**, 1119–1123.
- Singer, R. B., and Hastings, A. B. (1948). An improved clinical method for the estimation of disturbances of the acid-base balance of human blood. *Medicine* **27**, 223–243.
- Sjogaard, G., Adams, R. P., and Saltin, B. (1985). Water and ion shifts in skeletal muscle of humans with intense dynamic knee extension. *Am. J. Physiol.* **248**, R190–R196.
- Speirs, V. C. (1980). Arteriovenous and arteriocentral venous relationships for pH, PCO<sub>2</sub>, and actual bicarbonate in equine blood samples. *Am. J. Vet. Res.* **41**, 199–203.
- Spensley, M. S., Carlson, G. P., and Harrold, D. (1987). Plasma, red blood cell, total blood, and extracellular fluid volumes in healthy horse foals during growth. *Am. J. Vet. Res.* **48**, 1703–1707.
- Spier, S. J., Carlson, G. P., Harrold, D., Bowling, A., Byrns, G., and Bernoco, D. (1993). Genetic study of hyperkalemic periodic paralysis in horses. *J. Am. Vet. Med. Assoc.* **202**, 933–937.
- Spier, S. J., Carlson, G. P., Holliday, T. A., Cardinet, G. H., and Pickar, J. G. (1990). Hyperkalemic periodic paralysis in horses. *J. Am. Vet. Med. Assoc.* **197**, 1009–1017.
- Spier, S. J., Carlson, G. P., Harrold, D., Bowling, A., Byrns, G., and Bernoco, D. (1993). Genetic study of hyperkalemic periodic paralysis in horses. *J. Am. Vet. Med. Assoc.* **202**, 933–937.
- Speirs, V. C. (1980). Arteriovenous and arteriocentral venous relationships for pH, PCO<sub>2</sub>, and actual bicarbonate in equine blood samples. *Am. J. Vet. Res.* **41**, 199–203.
- Spurlock, G. H., Landry, S. L., Sams, R., McQuirk, S., and Muir, W. W. (1985). Effect of endotoxin administration on body fluid compartments in the horse. *Am. J. Vet. Res.* **46**, 1117–1120.
- Stampfli, H. (2005). D-lactate metabolism and the clinical signs of D-lactataemia in calves. *Vet. Rec.* **156**, 816.
- Stampfli, H. R., and Constable, P. D. (2003). Experimental determination of net protein charge and A<sub>(tot)</sub> and K<sub>(a)</sub> of nonvolatile buffers in human plasma. *J. Appl. Physiol.* **95**, 620–630.
- Stampfli, H. R., Misiaszek, S., Lumsden, J. H., Carlson, G. P., and Heigenhauser, G. J. (1999). Weak acid-concentration A<sub>tot</sub> and dissociation constant K<sub>a</sub> of plasma proteins in racehorses. *Equine Vet. J.* **30**, 438–442.
- Stampfli, H., Taylor, M., McNicoll, C., Gancz, A. Y., and Constable, P. D. (2006). Experimental determination of net protein charge, [A]<sub>tot</sub>, and K<sub>a</sub> of nonvolatile buffers in bird plasma. *J. Appl. Physiol.* **100**, 1831–1836.
- Steffey, E. P., Wheat, J. D., Meagher, D. M., Norrie, R. D., Mckee, J., Brown, M., and Arnold, J. (1977). Body position and mode of ventilation influences arterial pH, oxygen, and carbon dioxide tensions in halothane-anesthetized horses. *Am. J. Vet. Res.* **38**, 379–382.
- Steiss, J. E., and Naylor, J. M. (1986). Episodic muscle tremors in a quarter horse: resemblance to hyperkalemic periodic paralysis. *Can. Vet. J.* **27**, 332–335.
- Sterns, R. H., Riggs, J. E., and Schochet, S. S. (1986). Osmotic demyelination syndrome following correction of hyponatremia. *N. Engl. J. Med.* **314**, 1535–1542.
- Stewart, P. A. (1981). "How to Understand Acid-Base: A Quantitative Acid-Base Primer for Biology and Medicine." Elsevier North Holland, New York.
- Stewart, P. A. (1983). Modern quantitative acid-base chemistry. *Can. J. Physiol. Pharmacol.* **61**, 1444–1461.
- Stick, J. A., Robinson, N. E., and Krehbiel, J. D. (1981). Acid-base and electrolyte alterations associated with salivary loss in the pony. *Am. J. Vet. Res.* **42**, 733–737.



- Strombeck, D. R. (1979). "Small Animal Gastroenterology." Stonegate, Davis, CA.
- Sufit, E., Houpt, K. A., and Sweeting, M. (1985). Physiological stimuli of thirst and drinking patterns in ponies. *Equine Vet. J.* **17**, 12–16.
- Tannen, R. L. (1986). Potassium disorders. In "Fluids and Electrolytes" (J. P. Kokko and R. L. Tannen, Eds.), pp. 150–228. Saunders, Philadelphia.
- Tasker, J. B. (1967a). Fluid and electrolyte studies in the horse. III. Intake and output of water, sodium, and potassium in normal horses. *Cornell Vet.* **57**, 649–657.
- Tasker, J. B. (1967b). Fluid and electrolyte studies in the horse. IV. The effects of fasting and thirsting. *Cornell Vet.* **57**, 658–667.
- Tasker, J. B. (1967c). Fluid and electrolyte studies in the horse. V. The effects of diarrhea. *Cornell Vet.* **57**, 668–677.
- Tasker, J. B. (1980). Fluids, electrolytes, and acid-base balance. In "Clinical Biochemistry of Domestic Animals" (J. J. Kaneko, Ed.), 2nd ed., pp. 402–447. Academic Press, New York.
- Thornton, J. R., and English, P. B. (1977). Radiosulphate: its metabolism and use in measurement of extracellular fluid volume in calves. *Res. Vet. Sci.* **22**, 298–302.
- Tollert, G. (1964). Volume of distribution of tritiated water as a measure of total body water in suckling pigs. *Acta Vet. Scand.* **5**, 24–34.
- Tremblay, R. R. M., Butler, D. G., Allen, J. W., and Hoffman, A. M. (1991). Metabolic acidosis without dehydration in seven goat kids. *Can. Vet. J.* **32**, 308–310.
- Tyler, R. D., Qualls, C. W., Heald, R. D., Cowell, R. L., and Clinkenbeard, K. D. (1987). Renal concentrating ability in dehydrated hyponatremic dogs. *J. Am. Vet. Med. Assoc.* **191**, 1095–1097.
- van Beaumont, W., Strand, J. C., Petrofsky, J. S., Hipskind, S. G., and Greenleaf, J. E. (1973). Changes in total plasma content of electrolytes and proteins with maximal exercise. *J. Appl. Physiol.* **34**, 102–106.
- van Sluijs, F. J., de Vries, H. W., De Bruijne, J. J., and van den Brom, W. E. (1983). Capillary and venous blood compared with arterial blood in the measurement of acid-base and blood gas status of dogs. *Am. J. Vet. Res.* **44**, 459–462.
- Wade, L., and Sasser, L. B. (1970). Body water, plasma volume, and erythrocyte volume in sheep. *Am. J. Vet. Res.* **31**, 1375–1378.
- Weldon, A. D., Moise, N. S., and Rebhun, W. C. (1992). Hyperkalemic atrial standstill in neonatal calf diarrhea. *J. Vet. Int. Med.* **6**, 294–297.
- Whitehair, K. J., Haskins, S. C., Whitehair, J. G., and Pascoe, P. J. (1995). Clinical applications of quantitative acid-base chemistry. *J. Vet. Int. Med.* **9**, 1–11.
- Whitlock, R. H., Kessler, M. J., and Tasker, J. B. (1975a). Salt (sodium) deficiency in dairy cattle: polyuria and polydipsia as prominent clinical features. *Cornell Vet.* **65**, 512–526.
- Whitlock, R. H., Tasker, J. B., and Tennant, B. (1975b). Hypochloremic metabolic alkalosis and hypokalemia in cattle with upper-gastrointestinal obstruction. *Dig. Dis. Sci.* **20**, 595–596.
- Williams, M. E., Gervino, E. V., Rosa, R. M., Landsberg, L., Young, J. B., Silva, P., and Epstein, F. H. (1985). Catecholamine modulation of rapid potassium shifts during exercise. *N. Engl. J. Med.* **312**, 823–827.
- Wilson, E. A., and Green, R. A. (1985). Clinical analysis of mixed acid-base disturbances. *Comp. Cont. Ed. Pract. Vet.* **7**, S364–S371.
- Wolf, A. V. (1966). "Aqueous Solutions and Body Fluids: Their Concentrative Properties and Conversion Tables." Harper & Row, New York.
- Yoshida, S., Sudo, H., Noro, K., and Nokaya, C. (1967). Measurement of drinking water volume in horses. *Exp. Rep. Equine Hlth. Lab.* **4**, 29–36.
- Ziemer, E. L., Parker, H. R., Carlson, G. P., and Smith, B. P. (1987a). Clinical features and treatment of renal tubular acidosis in two horses. *J. Am. Vet. Med. Assoc.* **190**, 294–296.
- Ziemer, E. L., Parker, H. R., Carlson, G. P., Smith, B. P., and Ishizaki, G. (1987b). Renal tubular acidosis in two horses: diagnostic studies. *J. Am. Vet. Med. Assoc.* **190**, 289–293.
- Zweens, J., Frankena, H., Rispens, P., and Zijlstra, W. G. (1975). Determination of extracellular fluid volume in the dog with ferrocyanide. *Pflugers Arch.* **357**, 275–290.

# Pituitary Function

Jan A. Mol

Department of Clinical Sciences of Companion Animals  
Faculty of Veterinary Medicine  
Utrecht University  
Utrecht, The Netherlands

Björn P. Meij

Department of Clinical Sciences of Companion Animals  
Faculty of Veterinary Medicine  
Utrecht University  
Utrecht, The Netherlands

## I. HYPOTHALAMUS-PITUITARY SYSTEM

- A. Anatomical Considerations
- B. Regulation of Pituitary Functions

## II. ANTERIOR LOBE AND INTERMEDIATE LOBE

- A. Proopiomelanocortin-Derived Peptides
- B. Glycoprotein Hormones
- C. Somatomammotrophic Hormones

## III. NEUROHYPOPHYSIS

- A. Vasopressin
- B. Oxytocin

## IV. ASSESSMENT OF PITUITARY FUNCTION

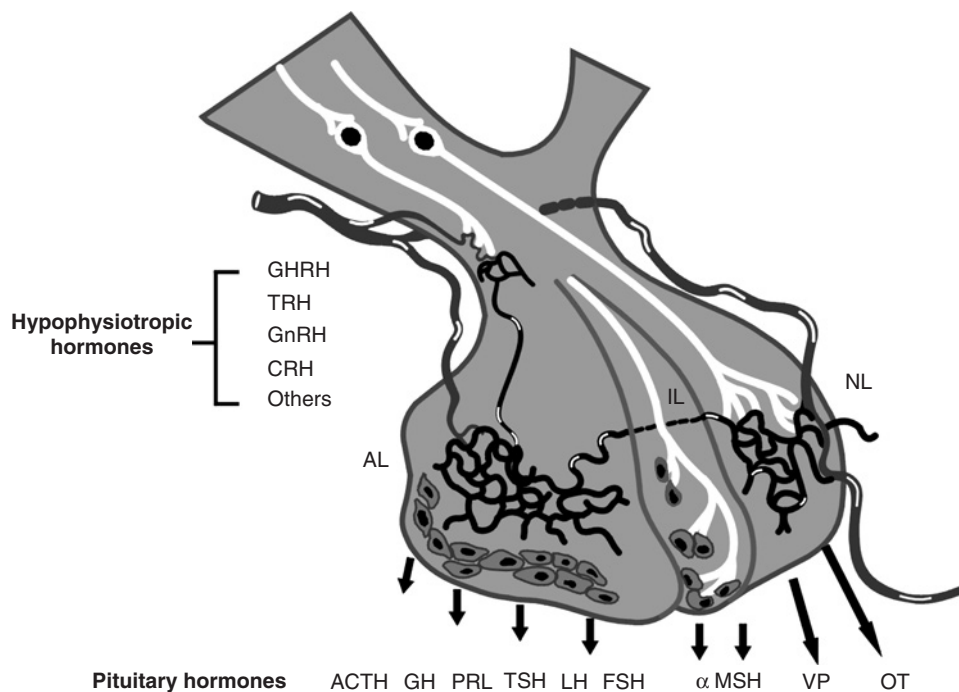
- A. Adenohypophysis
- B. Neurohypophysis

## REFERENCES

## I. HYPOTHALAMUS-PITUITARY SYSTEM

The hypothalamic-pituitary system is a preeminent example of the integration of neural and endocrine control. It consists of three major systems: (1) a neuroendocrine system connected to an endocrine system by a portal circulation, (2) a neurosecretory pathway, and (3) a direct neural regulation of endocrine secretion (Fig. 18-1).

The neuroendocrine system involves clusters of peptide- and monoamine-secreting cells in the anterior and mid-portion of the ventral hypothalamus. Their products reach the median eminence by axonal transport. From there they are released into the capillary vessels of the hypothalamic-pituitary portal system and transported to the pituitary to regulate the secretion of hormones from the anterior lobe (AL) of the adenohypophysis (Amar and Weiss, 2003).



**FIGURE 18-1** Schematic representation of the relationship between the hypothalamus and the pituitary in a generalized mammal. The hypothalamus exerts control over the anterior lobe (AL) by releasing and inhibiting factors. These hormones reach the AL cells via capillaries of the pituitary portal system. The neural lobe (NL) of the pituitary is a downward projection of the hypothalamus. The intermediate lobe (IL) is under direct neurotransmitter control.

The neurosecretory pathway runs from the anterior hypothalamus, traverses the floor of the ventral hypothalamus, and terminates in the neural lobe (NL) of the neurohypophysis on fenestrated blood vessels (Page, 1986). The system is involved in osmoregulation through the production and release of vasopressin, and in parturition and nursing through the secretion of oxytocin.

In the intermediate lobe (IL) the secretory activity is regulated via direct neuronal inhibitory and stimulatory influences (Saland, 2001). In amphibians (Vazquez-Martinez *et al.*, 2003) and reptiles (Dores *et al.*, 1987), the IL plays an important role in adaptation to background color. The function of IL cells in mammals has not been fully established, but they may play a role in opioid-regulated functions.

## A. Anatomical Considerations

The hypothalamus and pituitary control vital functions such as growth, reproduction, lactation, basal metabolism, stress response, parameters of immune function, and the state of hydration. Understanding of the complicated functional relationship of the hypothalamus to the pituitary requires an appreciation of the anatomical relationships.

### 1. Hypothalamus

Hypophysiotropic neurohormones are produced in several areas of the hypothalamus. For example, in an immunofluorescence study of hypothalami of dogs, the majority of cell bodies with immunoreactivity to corticotropin-releasing hormone (CRH) was found in the region of the periventricular and paraventricular nuclei, but they were also found in the supraoptic and suprachiasmatic area as well as craniodorsal to the mammillary bodies (Stolp *et al.*, 1987).

The cell bodies of the neurohormone-producing neurons that project to the median eminence are in part intermingled with cell bodies that also synthesize these neurohormones but project to other brain areas. The majority of the neurons that project to the median eminence are found in the preoptic and suprachiasmatic region of the hypothalamus. Axons containing the same neurohormone may have synaptic contacts that enable regulation of cellular function between these neurons.

The neurohormone-producing cells receive a complex neural input from a variety of chemical messengers, such as neurotransmitters and other neurohormones. Not only the neurohormones CRH and arginine vasopressin (AVP), but in general the combination of a neurohormone and another chemical messenger, may colocalize within a single neuron.

The neurons of the neurohypophyseal system represent a more anatomically distinct entity, with cell bodies located in the paraventricular and supraoptic hypothalamic nuclei (Sawchenko and Swanson, 1983). However, within these areas there are also neurons producing a variety of other neuropeptides.

### 2. Neurotransmitter Systems

The major neurotransmitter systems for intercellular communication within the central nervous system consist of monoamines and peptides. These chemical messengers regulate the biosynthesis and release of the hypophysiotropic neurohormones. Through a network of axodendritic and axoaxonic contacts, these neurons are connected to the neurohormone-producing cells. In addition, many monoamines and peptides are found within the hypophysiotropic hormone-producing cells, where they are released together with the neurohormones into the portal system and modify the effect of hypothalamic hormones on the pituitary.

The biogenic amine neurotransmitters, known to play a regulating/modulating role in the hypothalamic-pituitary system, include catecholamines (dopamine, noradrenalin, and adrenalin), indolamines (serotonin, melatonin), acetylcholine,  $\gamma$ -aminobutyric acid (GABA), and histamine. Neuropharmacological agents can be used to alter neurotransmitter effects and, as a consequence, hypothalamic and pituitary hormone release.

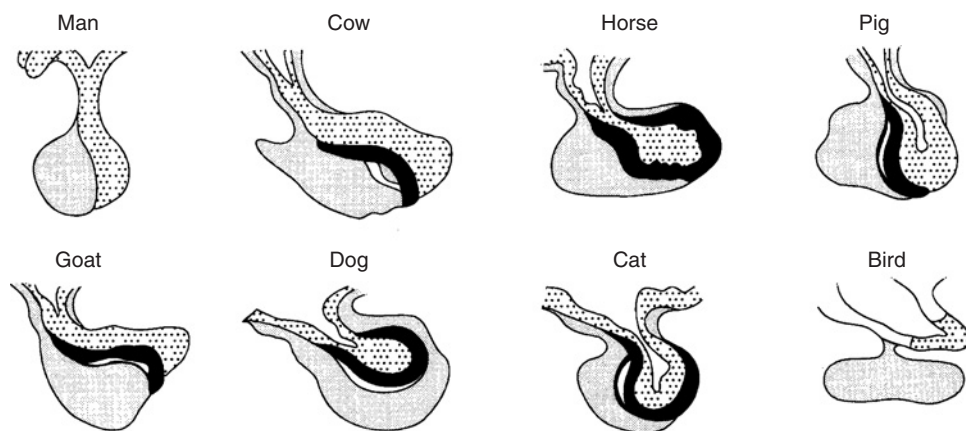
Many of the peptides with potential effects on hypophysiotropic hormone release are widely distributed in hypothalamic and extrahypothalamic areas of the brain. They include, among many others, peptides common to the gastrointestinal tract, such as gastrin, cholecystokinin, and pancreatic polypeptide as well as bombesin, angiotensin II, galanin, substance P, neurotensin, enkephalins, neuropeptide Y, natriuretic peptide, the vasoactive intestinal peptide (VIP), and the peptide histidine isoleucine (PHI). The last three peptides may, through vasoconstriction and vasodilatation activities, play an important role in the control of the portal blood flow.

### 3. Vascular System

The releasing and inhibiting hormones are stored in nerve terminals in the median eminence, where their concentrations are 10 to 100 times as great as elsewhere in the hypothalamus. The uniquely organized capillary plexus (Halasz, 1994; Page, 1986) of the median eminence is in close proximity to nerve terminals of the hypophysiotropic neurons. In contrast to other brain regions, the blood-brain barrier in the area of the median eminence is incomplete, permitting protein and peptide hormones as well as other charged particles to move to the intercapillary spaces and the nerve terminals contained therein. These terminals respond to humoral and neuronal stimuli by secreting releasing and inhibiting factors into the portal system.

The portal capillaries coalesce into a series of vessels that descend through the pituitary stalk and form a second capillary plexus that surrounds the AL cells (Fig. 18-1).

Inferior hypophysial arteries supply the neurohypophysis. From the primary plexus of the neural lobe (NL), blood flows not only to the systemic circulation but also to the AL and the hypothalamus. There is evidence for some degree of



**FIGURE 18-2** Schematic illustration of median sections through mammalian and avian pituitaries. Key □, anterior lobe; ■, intermediate lobe; ▨, neural lobe. Redrawn from Batten and Ingleton (1987).

circulatory flow within the pituitary, that is, from the AL to the NL, from there to the infundibulum, and then back to the AL. The primary capillary plexus of the NL appears to be well positioned in the microcirculatory system, controlling all of the afferent vascular events and many of the efferent vascular events in the pituitary (Page, 1986).

The vascularization of the intermediate lobe is closely linked to that of the neurohypophysis. In spite of the rich blood supply of the NL, the IL is a poorly vascularized structure. In horses the IL is supplied by a vast capillary or sinusoidal plexus, which connects that in the AL with that in the NL (Okada *et al.* 1997).

#### 4. Pituitary Organogenesis and Ontogenesis

During embryogenesis the adenohypophysis develops from Rathke's pouch, which arises from the primitive roof of the mouth in contact with the base of the brain. Rathke's pouch subsequently separates by constriction from the oral cavity. The anterior wall thickens and forms the anterior lobe of the adenohypophysis. This largest portion of the adenohypophysis remains separated from the intermediate lobe by the hypophyseal cleft, which is the residual lumen of Rathke's pouch. In several species (Fig. 18-2), the adenohypophysis also extends into a pars tuberalis that forms a cuff or collar around the proximal neurohypophysis and may even envelop part of the median eminence (Batten and Ingleton, 1987; Hullinger, 1993).

In the embryonic development, the anterior lobe undergoes major cellular proliferation and differentiation (Dubois *et al.* 1997). Totipotent pituitary stem cells give rise to two main cell lineages, the acidophilic (mammatotrophic, somatotrophic, lactotrophic) and the basophilic (corticotrophic, thyrotrophic, and gonadotrophic) differentiated pituitary cell types. Determination of AL cell-type lineages results from a temporally regulated cascade of homeodomain transcription factors that are being dissected by genetic and molecular approaches at a rapid pace (Treier *et al.* 1998). Although most pituitary developmental information has been acquired from murine models, histological and pathogenetic observations

in other mammals and human subjects have corroborated these developmental mechanisms. The transcription factor Rpx (Rathke's pouch homeobox) is the earliest known specific marker for the adenohypophyseal primordium. Rathke's pouch expresses several transcription factors of the LIM homeodomain family, including Lhx3 and Lhx4 (Sheng *et al.* 1997). Lhx3 is one of the earliest markers for cells that are destined to form the AL and the IL and is required for Pit-1 expression (Sheng *et al.* 1996). The homeodomain transcription factor Ptx1 behaves as a universal pituitary regulator and activates transcription of  $\alpha$ -GSU (the  $\alpha$ -subunit of gonadotroph hormones) and POMC (Drouin *et al.* 1998; Lamonerie *et al.*, 1996). Transcription factors Tpit (T box transcription factor) (Lamolet *et al.*, 2001) and NeuroD1 (Lamolet *et al.*, 2004) appear to be a prerequisite for POMC expression and determine the development of the corticotropin cell lineage. TSH and gonadotropin (LH and FSH)-expressing cells share the common  $\alpha$ -GSU expression under developmental control of GATA-2. Prop-1, the prophet of Pit-1, stimulates the Pit-1 gene. Pit-1 (or POU1F1), a POU-homeodomain transcription factor, determines the development and appropriate temporal and spatial expression of cells committed to GH, PRL, and TSH. Corticotroph cell commitment, although occurring earliest during fetal development, is independent of Pit-1-determined cell lineages. Mutations arising within these transcription factors may result in isolated or combined pituitary hormone failure syndromes. German shepherd dogs with pituitary dwarfism have a combined deficiency of GH, TSH, and PRL together with impaired release of gonadotropins, whereas ACTH secretion is intact (Kooistra *et al.*, 2000c). The transcription factors Lhx4 (van Oost *et al.*, 2002), Prop-1 (Lantinga-van Leeuwen *et al.*, 2000a), Pit-1 (Lantinga-van Leeuwen *et al.*, 2000b), and the LIF receptor gene (Hanson *et al.*, 2006b) have been excluded as candidates for pituitary dwarfism in German shepherds and the cause remains to be elucidated.

The posterior wall of Rathke's pouch is closely apposed to the neural tissue of the NL, thereby forming the intermediate lobe (IL), which is well developed in most mammals,

**TABLE 18-1** Molecular Weights of Adenohypophyseal Hormones and Staining Properties of Adenohypophyseal Cells

Cell Type	Hormone	MW <sup>a</sup>	Subunits	Staining	Orange G	PAS <sup>b</sup>	Color <sup>c</sup>
Somatotrope	GH	22,000	—	Acidophil	+	—	Yellow
Lactotrope	PRL	22,500	—	Acidophil	+	—	Yellow
Gonadotrope	LH	30,000	$\alpha/\beta$	Basophil	—	+	Blue
	FSH	32,000	$\alpha/\beta$	Basophil	—	+	Blue
Thyrotrope	TSH	28,000	$\alpha/\beta$	Basophil	—	+	Blue
Corticotrope	ACTH	4,500	—	Basophil	—	+	Red
	$\beta$ -End	3,500	—	Basophil	—	+	Red
Melanotrope	$\alpha$ -MSH	1,700	—	Basophil	—	+	Red

<sup>a</sup>Molecular weight.<sup>b</sup>Periodic-acid-Schiff reaction.<sup>c</sup>Color obtained after costaining with PAS-Orange G and performic acid-Alcian blue.

but not in humans and birds (Fig. 18-2). In humans only during fetal life is a distinct IL found (Amar and Weiss, 2003), whereas there is some debate about the view that in adults “invading” cells of the posterior lobe are homologous with the IL cells of lower vertebrates (McNicol, 1986). Unlike reptiles and mammals, birds have no IL (Batten and Ingleton, 1987). Nevertheless the typical “IL hormone” MSH is present in birds, having been found in the adenohypophysis, where it coexists with ACTH in cells named corticomelanotrophs (Iturriza *et al.*, 1986).

The pituitary stalk (infundibulum) and the neurohypophysis (posterior lobe, neural lobe) develop from the basal outgrowth of the diencephalon in connection with the development of Rathke’s pouch. The cells of the diencephalic outgrowth later develop into glial cells (pituitocytes), whereas nerve fibers from the supraoptic and paraventricular nuclei grow into the NL.

### 5. Cells of the Anterior Lobe (AL)

The peptide hormones secreted by the AL can be divided into three categories: (1) the somatomammotropic hormones growth hormone (GH) and prolactin (PRL); (2) the glycoprotein hormones thyrotropin (TSH), follicle-stimulating hormone (FSH), and luteinizing hormone (LH); and (3) the corticomelanotropins, which are all derived from the precursor molecule proopiomelanocortin (POMC), and the corticomelanotropins include adrenocorticotropin (ACTH),  $\alpha$ -melanotropin ( $\alpha$ -MSH),  $\beta$ -endorphin ( $\beta$ -END), and  $\beta$ -lipotropin ( $\beta$ -LPH).

Identification of the adenohypophyseal cells has been developed by histochemical staining techniques, immunohistochemical methods, and ultrastructural studies. Staining and immune reactions depend on the chemical nature of the hormones that are stored in granules within the cytoplasm. A general identification of adenohypophyseal cells

(Batten and Ingleton, 1987) is given in Table 18-1, although it must be realized that the various cell types do not always give exactly the same reaction in different animal species. Having undergone a number of modifications over the years to improve sensitivity and specificity, immunohistochemistry remains the single most often used method in the identification of normal and diseased AL cell types. Apart from staining for the full spectrum of hormones (GH, PRL, ACTH, FSH, LH, TSH, and  $\alpha$ -subunit), special stains investigate the diseased AL cell, such as staining with MIB-1, a cell proliferation marker that recognizes the KI-67 antigen, or demonstration of the protein p53, the product of a tumor suppressor gene, as parameters for aggressive behavior of cells. Development of sophisticated tools of molecular biology during the 1990s has enabled researchers to study chromosomal defects, genetic abnormalities such as specific mutations, the presence of oncogenes or of tumor suppressor genes, cell membrane receptors, signal transductions mechanisms, and intracellular changes that affect hormone synthesis and release. Pituitary cell cultures (normal and diseased, e.g., murine AtT-20 corticotrope cell line) allow various *in vitro* studies to be undertaken. *In situ* hybridization demonstrates specific messenger RNAs (mRNAs) at the subcellular level, which allows the reliable assessment of gene expression. *In situ* hybridization can be used to demonstrate the mRNA of receptors, growth factors, transcription factors, genes, and other regulatory peptides. Whereas immunocytochemistry provides information regarding cell hormone content, *in situ* hybridization confirms the presence of ongoing hormone synthesis.

Transmission electron microscopy allows the study of AL cells at the ultrastructural level. Applications of immunohistochemical methods at the ultrastructural level have also contributed to the rapid progress in the field. Ultrastructural studies of AL cells demonstrate the presence of distinct varieties of secretory granules and typical

organization of cytoplasmic organelles for peptide synthesis and release. Characteristics such as the form, size, and location of the various organelles and the size and shape of the cells and their nuclei allow identification of adenohypophyseal cells at the ultrastructural level (Batten and Ingleton, 1987; Mikami, 1986).

The distribution of the various secretory cells of the AL is not random, different hormone-secreting cells preferentially accumulate at different sites in the AL. This topological organization of the AL is well known in the human and may also be true for domestic animals. The gland comprises a central “mucoid” wedge containing thyrotropes and corticotropes and lateral wings containing somatotropes and lactotropes. The gonadotropes are distributed diffusely throughout the gland. Also, the numerical contribution of each AL cell type is not the same. In the pituitary anterior lobe of humans the distribution is corticotrope (10% to 15%), thyrotrope (5%), somatotrope (50%), lactotrope (10% to 30%), and gonadotrope (15% to 20%).

The concept of one pituitary cell making one hormone is an oversimplification. Immunoelectron microscopy has shown that one hormone can be produced by the same or different cell populations. In some instances, multiple hormones are produced by the same cell population and have even been visualized within the same secretory granule. The majority of gonadotropes and somatomammotropes is multihormonal cells that contain LH and FSH or GH and PRL, respectively. Also, other combinations such as gonadotroph hormones and ACTH or TSH and ACTH have been described.

In addition to the functionally distinctive AL cell types noted above, cells termed “stellate” or “folliculostellate” also occur within the normal pituitary. Folliculostellate cells lack secretory granules as well as hormone secretion and are characterized by processes that insinuate themselves between the AL cells. The physiological role of folliculostellate cells is uncertain. They are thought to be supportive in nature and synthesize a variety of chemical messengers, intrapituitary growth factors, and cytokines that exert local paracrine effects on cell function and proliferation (Denef, 1994).

#### 6. Cells of the Intermediate Lobe (IL)

The predominant IL cell in mammals is the melanotrope, a cell with immunoreactivity for  $\alpha$ -MSH, which is sparse in the AL (Halmi and Krieger, 1983). In some species, including the dog (Halmi *et al.*, 1981) and the horse (Amann *et al.*, 1987), the IL is cytologically heterogeneous. ACTH-containing cells (B cells) have been found to be dispersed among the predominant melanotropes (A cells). In the dog, the immunoreactive ACTH content of the IL even exceeds that in the AL (Halmi *et al.*, 1981). In ferrets, as in dogs and cats, the melanotropic cell was the most abundant cell type of the IL (Schoemaker *et al.*, 2004). In agreement with the previously mentioned direct neural regulation of

IL secretory activity, the presence of neural elements was demonstrated in the bovine IL (Boyd, 1987). Evidence is accumulating that the cells of the pars intermedia are also involved in the biosynthesis and release of a yet unknown prolactin-releasing factor. The blood supply of the IL is poor, and therefore the peptides released from the IL are thought to mainly act by diffusion in a paracrine manner.

#### 7. Cells of the Neural Lobe (NL)

The NL contains axonal nerve fibers, often swollen by being packed with neurosecretory granules. These nerve fibers and the glial cells (pituicytes) have synaptoid contacts. The pituicytes play an intermediary role in the regulation of the release of vasopressin and oxytocin (Rosso *et al.*, 2004).

### B. Regulation of Pituitary Functions

For the regulation of each of the five major adenohypophyseal hormone systems (ACTH, LH and FSH, TSH, GH, and PRL), there is a feedback (closed-loop) system. AL hormone and hypophysiotropic hormone secretions are suppressed by the products of target endocrine glands such as the thyroid, adrenals, and gonads. Apart from this long-loop feedback, some hormones (e.g., PRL) regulate their own secretion directly by acting on the hypothalamus (short-loop feedback). On this powerful feedback control with primarily blood-borne signals, other signals are superimposed. These may originate within the central nervous system (open loop) and can be mediated through neurotransmitters and hypophysiotropic hormones. Thus, influences are exerted that represent the environment (temperature, light-dark), stress (pain, fear), and intrinsic rhythmicity.

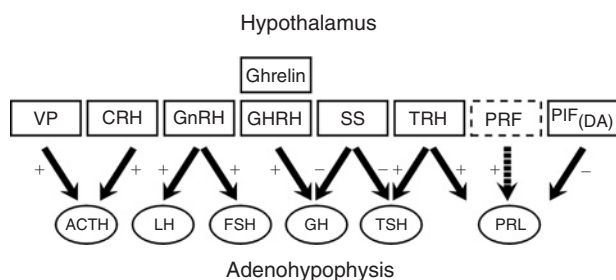
These regulatory factors influence peptide synthesis or release in adenohypophyseal cells, where each of the steps in hormone synthesis and ultimate secretion represents a potential control point in the regulation of circulating hormone concentrations.

#### 1. Hypophysiotropic Hormones

The main hypothalamic neurohormones may stimulate or inhibit the release of a single hormone, or it may affect several hormone-producing cells (Fig. 18-3). The predominant influence of the hypothalamic hormones on the pituitary is stimulatory, and these peptides are known as releasing hormones (Guillemin, 2005). Interference with the integrity of the hypothalamic-pituitary connections results in decreased secretion of pituitary hormones. The exception is PRL, the secretion of which is increased when hypothalamic influence is removed.

As the complexity of the peptide structures of the hypophysiotropic hormones increases, species variation in

sequence may occur. Whereas the structures of TRH, GnRH, and somatostatin (SS) (3, 10, and 14 amino acids, respectively) are identical for mammals, those of GHRH and CRH (44 and 41 amino acids) exhibit species specificity. The one nonpeptide hypophysiotropic hormone is dopamine. In addition to its major role as a neurotransmitter, dopamine is the most important inhibitor of PRL release.

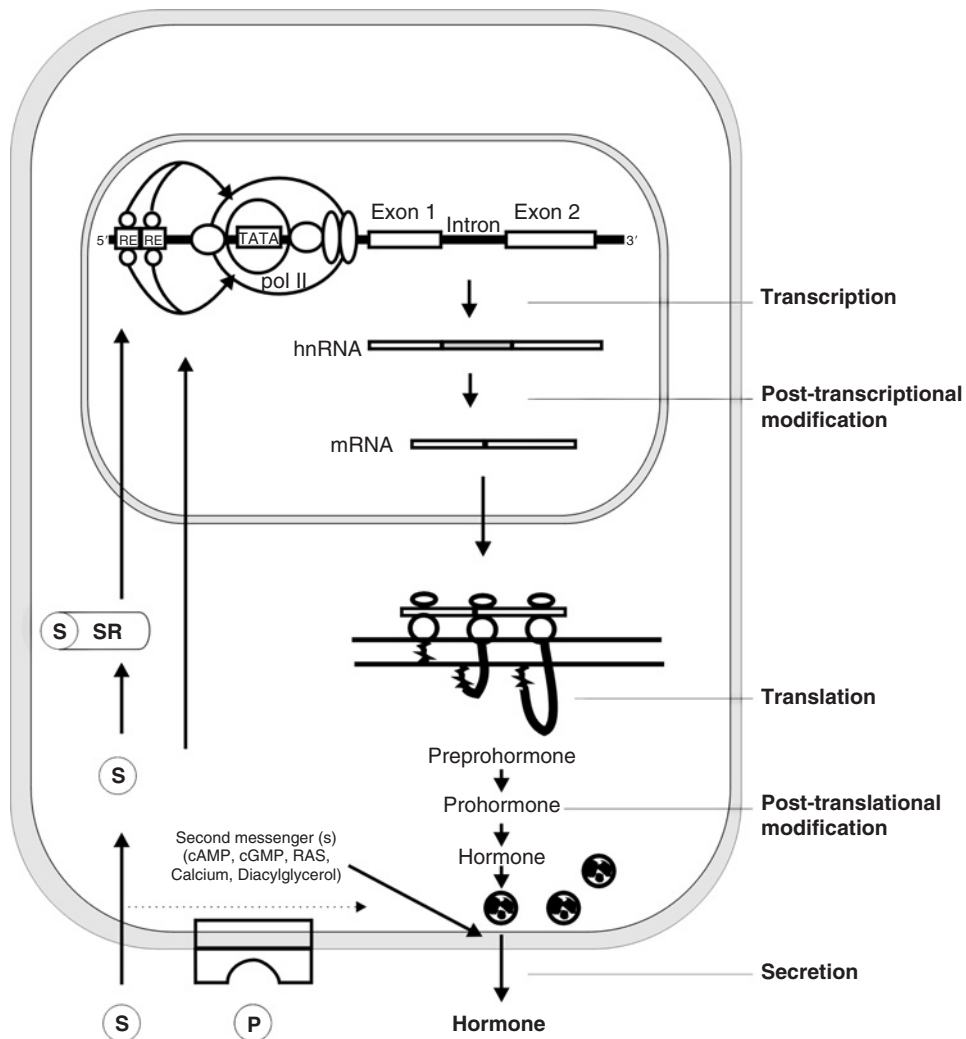


**FIGURE 18-3** Hypophysiotropic regulation of the secretion of pituitary hormones. Solid lines denote hormones whose structures have been determined. Dashed lines indicate a factor whose identity is still unknown.

## 2. Regulation of Gene Expression

The developments in recombinant DNA technology have enabled an increased knowledge on the genes encoding pituitary hormones and the regulatory elements involved in gene transcription. In short, the main elements regulating the gene transcription will be mentioned (Fig. 18-4). Eukaryotic genes encoding peptide hormones consist of a promoter (regulatory) unit and a transcription unit encoding the primary transcript that after appropriate processing will form the messenger RNA (mRNA).

The promoter unit is the upstream part (5') of the gene. The promoter has specific DNA sequences (response elements) permitting the binding of transcription factors that enhance or inhibit gene expression by changes in the stability of the RNA polymerase-TATA box complex at the constitutive promoter. Also, with a higher distance to the gene-specific enhancer elements, or locus control regions as seen with GH expression (Ho *et al.*, 2006), may regulate gene transcription. Tissue-specific silencers and enhancers that are mandatory for gene expression regulate the highly



**FIGURE 18-4** Schematic representation of potential control points in pituitary hormone synthesis and secretion.



specialized hormone production. Methylation patterns of the promoter may also strongly influence the overall expression level (Newell-Price, 2003).

Tissue-specific intracellular transcription factors play a crucial role in the regulation, whether a gene comes to expression. Specific binding of neurohormones from the hypothalamus to membrane receptors of individual AL cells will result in changes in intracellular second messenger concentrations or activity, a process called signal transduction. Using microarray technology important signaling pathways for pituitary hormone expression can be revealed (Ma *et al.*, 2005). Activation of these pathways results in differences in phosphorylation of transcription factors that may bind to a response element (RE) in the promoter unit. Steroid hormones, thyroid hormone, and retinoids will, after binding to specific cytoplasmic or nuclear localized receptors, induce receptor binding to specific areas of the promoter. For example, a glucocorticoid response element (GRE) in the promoter of the gene encoding proopiomelanocortin binds the glucocorticoid-receptor complex resulting in inhibition of gene transcription (negative GRE). Transcription is thus regulated by responses to extracellular signals, which may also be derived by components of the extracellular matrix (ECM) (Paez-Pereda *et al.*, 2005).

After transcription has been initiated, a primary transcript is made containing an RNA copy of the entire transcription unit, the heteronuclear RNA (hnRNA). After excision of the intron areas, a process called splicing, a cap formation at the 5' end and the addition of a poly(A) tail at the 3' end a mature mRNA is formed. Through alternative splicing reactions, length variants of the mRNA may ultimately result in variation of the coding sequence (see Section II.C.1), changes in mRNA stability as found for the insulin-like growth factors (IGFs), or by differences in exon coupling even completely different peptides can be obtained from a single gene as for instance in the gene encoding calcitonin.

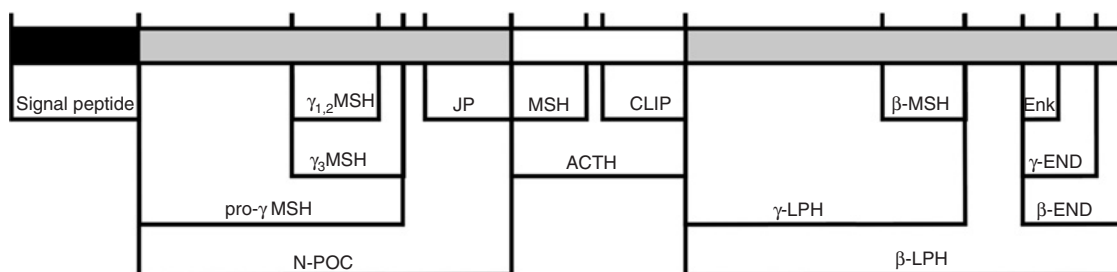
### 3. Prohormone Biosynthesis, Processing, and Release

The process of peptide synthesis occurs principally on the rough endoplasmic reticulum (RER). Messenger RNA (mRNA), encoded by nuclear DNA, passes to cytosolic ribosomes, whereby sequential processing of transfer RNAs (tRNA), with their attached amino acids, the translation process of mRNA to a peptide starts (Fig. 18-4). The beginning of the growing peptide forms a specific signal peptide that facilitates the attachment of the translation complex to the RER and enables the passage into the lumen of the RER. The signal sequence of the preprohormone is cleaved, and the remaining prohormone undergoes several modifications as disulfide formation and glycosylation. The peptide passes along the RER lumen into the Golgi complex, where peptides are packaged and released into the cytoplasm as membrane-bound granules. During storage of these granules, the prohormone is further processed by specific proteolytic cleavage, C-terminal amidation, or N-terminal carboxylation. Characteristic for proteolytic cleavage sites are pairs of the basic amino acids arginine and lysine. The granules are stored until the hormone is released by exocytosis. This process involves fusion of the granule membrane with the cell membrane.

## II. ANTERIOR LOBE AND INTERMEDIATE LOBE

### A. Proopiomelanocortin-Derived Peptides

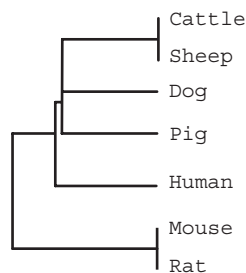
The corticotropic cells of the AL and the melanotropic cells of the IL are both able to synthesize proopiomelanocortin (POMC), the common prohormone for ACTH,  $\alpha$ -MSH,  $\beta$ -lipotropin, and a family of  $\beta$ -endorphin-related peptides (Fig. 18-5).



**FIGURE 18-5** Schematic representation of preproopiomelanocortin (horizontal bar), with four domains: the signal peptide, which is cleaved after entrance to the lumen of the RER; the N-terminal peptide (N-POC), containing the (pro)  $\gamma$ -MSH sequences and the joining peptide (JP); the ACTH domain from which MSH and corticotropin-like intermediate lobe peptide (CLIP) is generated; and the  $\beta$ -lipotropin ( $\beta$ -LPH) domain, including the endorphin (END) family of peptides and a met-enkephalin sequence (Enk). Pairs of basic amino acid residues are indicated with vertical lines, representing potential sites of proteolytic cleavage. In the AL major cleavage products are N-POC, ACTH, and  $\beta$ -LPH. In the IL the major products are N-POC,  $\gamma$ -MSH,  $\alpha$ -MSH, and  $\beta$ -endorphin.



Pig	SYSMEHFRWGKPVG	<b>KKRR</b>	PVKVYPNGAEDELAEAPLEF	39
Dog	-----	-----	-----S-----V--	
Cattle	-----	-----	-----S-Q-----	
Sheep	-----	-----	-----S-Q-----	
Human	-----	-----	-----S-----	
Rat	-----	-----	-----V--N-S-----	
Mouse	-----	-----	-----V--N-S-----	
	*****	*****	***** * * * * *	



**FIGURE 18-6** Comparison of the ACTH sequences from various species using the one-letter code for amino acids. Identical amino acids are given by a single line (-). The asterisk (\*) means an identical sequence for all species. The shaded box indicates the two pairs of basic amino acids prone to proteolytic cleavage. The insert shows a dendrogram indicating the mutual relationship.

## 1. ACTH/ $\alpha$ -MSH

### a. Gene Expression

The gene encoding POMC contains three exon areas. Exon 1 encodes a 5' untranslated region (5'-UTR), and exon 2 encodes the signal peptide and the N-terminal part of the POMC prohormone. The majority of the prohormone, including  $\gamma$ -MSH, is encoded by exon 3. After the splicing process, an mRNA of approximately 1150 nucleotides is formed in the pituitary of most species, including the dog (Mol *et al.*, 1991). In many peripheral tissues, very low expression of shorter POMC mRNA sequences are found, whereas in nonpituitary tumors, an mRNA of 1350 nucleotides can be found (Newell-Price, 2003).

The presence of an unmethylated CpG island in the POMC promoter is a prerequisite for gene expression, whereas methylation completely blocks gene expression (Newell-Price, 2003). These methylation patterns are set during early development. Synergistic stimulation of gene expression requires binding of yet partially characterized transcription factors in the distal and central part of the POMC promoter. The expression of the POMC gene in corticotropes and melanotropes is regulated by the same promoter elements as shown by experiments with transgenic mice (Tremblay *et al.*, 1988). Three important response elements act within the central promoter region. The pituitary homeobox 1 (Ptx1) protein, which is widely expressed in the pituitary, acts in synergy with the corticotrope/melanotrope-specific factors NeuroD1 (Newell-Price, 2003) or Tpit (Quentien *et al.*, 2006) to stimulate POMC gene expression.

Binding of corticotropin-releasing hormone (CRH) stimulates POMC expression in the PD through stimulation of cAMP within the cell (Jacobson and Drouin, 1994). CRH acts synergistically with the leukemia-inhibitory factor (LIF) through binding of the cAMP response element binding protein (CREB) at the response element sites for NUR77 and STAT1-3 (Mynard *et al.*, 2004). Nur77 is an orphan nuclear receptor that antagonizes the negative feedback of glucocorticoids on POMC expression (Martens *et al.*, 2005).

POMC expression in the IL melanotrope is also stimulated by cAMP. *In vitro* experiments in various species point to a possibility that CRH activates this signal transduction system. However, chronic infusion of CRH stimulates the POMC mRNA concentrations in the AL but inhibits mRNA concentration in the IL (Hollt and Haarmann, 1984). IL

POMC expression is also regulated by stimulation with serotonin and norepinephrine or GABAergic and dopaminergic inhibition (Saland, 2001). Glucocorticoids inhibit AL POMC expression but have no effect on the IL expression of POMC.

Extrapituitary POMC expression is found in many tissues (DeBold *et al.*, 1988), also in skin tissue of various species including the dog (Kidney *et al.*, 2004).

### b. (Pro)hormone

POMC prohormone sequences are known for a variety of species and share a common structure (Fig. 18-5). Among species a high sequence homology is found between the N-terminal site (N-POC) of the prohormone (including  $\gamma$ -MSH), the ACTH region, and the  $\beta$ -endorphin region. In contrast, the regions between  $\gamma$ -MSH and ACTH and the first part of  $\beta$ -lipotropin are rather heterogeneous (Mol *et al.*, 1991; Numa and Imura, 1985). Species differences in the sequence of ACTH occur only in the N-terminal part (Fig. 18-6), whereas the ACTH(1-24) sequence, necessary for full biological activity, is identical among mammals. The specificity of immunoassays to measure ACTH concentrations is achieved by directing antibodies toward the ACTH (13-18) epitope, which is absent in MSH and corticotropin-like intermediate lobe peptide (CLIP). These antibodies do, however, cross-react with intact POMC and may result in apparent elevated ACTH concentrations (Goossens *et al.*, 1995). Two-sided assays are more sensitive to variation in the carboxy-terminal part and show insufficient cross-reactivity among the species.

The proteolytic enzymes PC1/PC3 and PC2 are involved in the processing of prohormones in neuroendocrine cells. They cleave the precursor at pairs of basic amino acids, resulting in the formation of biologically active hormones. The PC1/PC3 enzyme present in the AL cleaves POMC to ACTH and  $\beta$ -LPH. PC2 generates the ACTH(1-13) fragment in both the AL and IL. The combination of both enzymes is present in the melanotropes of the IL. In the hypothalamus, these enzymes determine also the availability of POMC-derived melanocortins, which play an essential role in the regulation of energy balance (Bertile and Raclot, 2006; Helwig *et al.*, 2006).

In the melanotrope  $\alpha$ -MSH is formed by C-terminal amidation and N-terminal acetylation of ACTH(1-13). Various degrees of acetylation of MSH result in the storage

**TABLE 18-2** Factors Modulating ACTH Release from the Adenohypophysis

	Stimulating	Inhibiting
Hormones	CRH Vasopressin	Glucocorticoids Enkephalin
Peptides	VIP Neuropeptide Y Angiotensin II Cholecystokinin-8 Leptin Cytokines TRH, GnRH (in the dog)	
Biogenic amines	Norepinephrine Serotonin GABA	Dopamine
Otherwise	Hypoglycemia Hypoxia Stress (physical, emotional)	

of desacetyl-, monoacetyl-, and diacetyl- $\alpha$ MSH in secretory granules. The canine IL contains predominantly the monoacetyl- $\alpha$ MSH (Young *et al.*, 1992).

### c. Secretion by the AL

ACTH is released in frequent pulses, as demonstrated in the pituitary venous effluent of the horse (Alexander *et al.*, 1994; Redekopp *et al.*, 1986a, 1986b). By measurements in peripheral blood (Kemppainen and Sartin, 1984), the episodic secretion of ACTH in dogs was documented, with an average of nine peaks per 24-hour period.

Many factors influence the secretion of ACTH by the AL (Table 18-2). A number of these factors modulate the release of CRH and AVP, which are considered to be the predominant stimulating neurohormones *in vivo* (Antoni, 1986; Keller-Wood and Dallman, 1984). The relative contribution of CRH and AVP to ACTH release varies among species and circumstances. In dogs (van Wijk *et al.*, 1994) and pigs (Minton and Parsons, 1993), both exogenously administered CRH and LVP induce comparably high plasma ACTH concentrations. In sheep, AVP is the predominant ACTH-releasing factor. In horses, AVP is the immediate stimulus for ACTH release, and even ACTH micropulses appear to be regulated by AVP set point (Alexander *et al.*, 1996). On the other hand, CRH secretion and pituitary responsiveness to CRH rise when cortisol falls, suggesting that in horses a major role for CRH is to fix the cortisol set point (Alexander *et al.*, 1996). In the rat, the stimulation of ACTH release by CRH and AVP is synergistic, meaning that the response to CRH + AVP is greater than the sum of the reactions to CRH and AVP separately (Buckingham, 1987).

The basal release of ACTH is regulated by the occupancy of type I or mineralocorticoid receptors (MR) in the hippocampus (Jacobson and Sapolsky, 1991). Decreases in brain MR binding capacity of the dog during aging results in enhanced basal activity of the hypothalamus-pituitary-adrenal axis (Rothuizen *et al.*, 1993). In sheep, basal ACTH release is inhibited by active immunization against AVP (Guillaume *et al.*, 1992a) but not by immunization against AVP (Guillaume *et al.*, 1992b).

Exercise and insulin-induced hypoglycemia stimulate ACTH release. In the horse, exercise-induced ACTH release and mild insulin-induced hypoglycemia are accompanied by increased AVP concentration in pituitary venous blood without changes in CRH concentrations (Alexander *et al.*, 1991). However, when hypoglycemia becomes severe, CRH is released, which augments the ACTH response (Alexander *et al.*, 1996, 1997). In sheep, mild hypoglycemia is accompanied by increases in AVP and CRH concentrations in portal blood, but in severe hypoglycemia the AVP secretion is relatively much higher than the CRH release (Caraty *et al.*, 1990). AVP also regulates the ACTH response on hypoglycemia in the neonatal rat (Muret *et al.*, 1992).

Hypotension induced by nitroprusside (Kemppainen and Sartin, 1987) or by hemorrhage (Lilly *et al.*, 1983) causes ACTH release in the dog, together with large increases in plasma AVP derived from the NL (Raff *et al.*, 1989). Selective neurohypophysectomy results in greatly attenuated ACTH and AVP responses to hypotension and angiotensin II, whereas the ACTH response to CRH injection remains unchanged. By substitution with adequate AVP infusion, the ACTH response to hypotension can be restored (Raff *et al.*, 1992). In sheep, chronic absence of ovarian hormones after ovariectomy reduces the ACTH response to hypotension also, but not to CRH, AVP, or hypoglycemia (Pecins-Thompson and Keller-Wood, 1994).

In the dog, the release of ACTH is stimulated by  $\beta$ -adrenergic agonists (isoproterenol), dopaminergic antagonists (haloperidol), and serotonergic agonists (quipazine maleate). TRH and GnRH stimulate the release of cortisol, probably by stimulating ACTH release (Stolp *et al.*, 1982). In the horse, the  $\alpha$ 2-adrenergic agonist clonidine lowers ACTH secretion primarily by reducing the secretion of AVP and possibly CRH (Alexander and Irvine, 2000). Although direct stimulatory effects of catecholamine on the *in vitro* release of ACTH from ovine pituitary cells have been found, central stimulation of predominantly noradrenergic, but also adrenergic, pathways evokes the highest ACTH response (Liu *et al.*, 1991).

Endogenous opiates (metenkephalin, dynorphin, and  $\beta$ -endorphin) inhibit the release of ACTH in humans (Besser *et al.*, 1987). Conflicting results have been reported on the effect of metenkephalin in the rat, but  $\beta$ -endorphin and dynorphin may exert tonic inhibition of CRH release (Plotsky, 1986). The metenkephalin agonist DAMME stimulates the release of ACTH in the dog (Meij *et al.*, 1990).

Activation of the immune system by infections results in the enhanced production of the cytokine interleukin-1 (IL-1 $\beta$ ), which has the ability to stimulate CRH secretion from the hypothalamus and thus activates the hypothalamus-pituitary-adrenal axis. The biosynthesis and release of IL-6 has been found in the folliculostellate cells of the AL. IL-6 also stimulates the HPA-axis, at both the hypothalamic and the pituitary level (Sweep *et al.*, 1991).

Endogenous corticosteroids inhibit ACTH release predominantly at hypothalamic sites. Synthetic steroids such as dexamethasone may act primarily at the pituitary level (de Kloet *et al.*, 1974). In a review on corticosteroid-mediated feedback, Keller-Wood and Dallman (1984) suggested three different time schedules: a fast feedback that acts on the corticotropic cell but may not be related to nuclear receptor binding, an intermediate feedback that probably acts by inhibition of CRH release, and a slow feedback that acts by a decrease in mRNA encoding POMC in the pituitary gland. The delay in inhibiting ACTH production may be caused by the high stability of the mRNA encoding POMC and not by the absence of direct inhibition of the transcription. Dexamethasone inhibits gene transcription *in vivo* within 30 min in the rat (Fremeau *et al.*, 1986). In the dog, the intermediate-delayed feedback is determined by the mean change in corticosteroid concentration over time (Keller-Wood, 1989). Acute lowering of plasma cortisol in the horse by inhibition of synthesis in the adrenal gland resulted in an increased ratio of ACTH:CRH in pituitary venous blood before CRH concentrations started to rise (Alexander *et al.*, 1993, 1996), indicating that the first effect is the opposite of the fast feedback and is mediated by increased sensitivity of the corticotrope.

#### d. Secretion by the IL

The release of POMC-derived peptides by the IL is under direct neural control. The rat and the mouse have been the mammals in which most studies on the regulation and processing of POMC in the IL have been carried out thus far. In the rat, the release of POMC-derived peptides is regulated predominantly via tonic dopaminergic inhibition and  $\beta$ -adrenergic stimulation (Berkenbosch *et al.*, 1981; Tilders *et al.*, 1985), although GABAergic innervation of the IL has also been demonstrated (Oertel *et al.*, 1982). In addition, Proulx-Ferland *et al.*, (1982) demonstrated that CRH is a potent stimulator of  $\alpha$ -MSH secretion by the IL. In line with the absence of a glucocorticoid receptor in the IL (Antakly *et al.*, 1985), the  $\alpha$ -MSH response to CRH could not be suppressed by dexamethasone administration. The expression of the glucocorticoid receptor in the IL is suppressed by dopamine (Antakly *et al.*, 1987), whereas the CRH receptor content of the rat IL is stimulated by dopamine (Shiver *et al.*, 1992).

In the dog, *in vitro* studies (Mol *et al.*, 1987) and *in vivo* and immunohistochemical observations (Middleton *et al.*, 1987b) have revealed the IL to be resistant to glucocorticoid suppression. There is also evidence from *in vivo* studies

that dopaminergic pathways play a regulatory role in canine IL function (Kemppainen and Sartin, 1986). However, in other respects the situation in the dog is different from that in the rat with regard not only to the heterogeneous cytology (see Section I.A.5) but also to some of the regulation characteristics. Despite the fact that CRH-immunoreactive fibers have been identified in the canine neurointermediate lobe (Stolp *et al.*, 1987) and although *in vitro* CRH stimulates ACTH release from the neurointermediate lobe (Mol *et al.*, 1987), there is no convincing evidence that CRH can stimulate release of ACTH from the IL *in vivo* (Kemppainen and Sartin, 1986, 1987; Middleton *et al.*, 1987a), whereas no (Kemppainen and Sartin, 1986) or a very small (Rijnberk *et al.*, 1987)  $\alpha$ -MSH response to CRH stimulation has been observed. Kooistra *et al.*, (1997a) showed that  $\alpha$ -MSH is secreted in a pulsatile manner in the dog. In contrast, with a significant increase of plasma  $\alpha$ -MSH concentrations after administration of the dopamine antagonist haloperidol, even after pretreatment with dexamethasone to inhibit the contribution of the AL, there were small increases in the plasma concentrations of ACTH and cortisol, which suggests that the canine IL contributes to circulating ACTH concentrations (Kooistra *et al.*, 1997a).

The cat has an actively secreting IL, which is reflected in high plasma concentrations of  $\alpha$ -MSH and  $\beta$ -endorphin, POMC-derived peptides secreted predominantly by melanotropes (Peterson *et al.*, 1994). In the cat as well as in the dog, no stimulation of  $\alpha$ -MSH occurs after CRH administration (Willemse and Mol, 1994). However, cats undergoing handling and skin testing without anesthesia show significant increases in plasma  $\alpha$ -MSH concentrations (Willemse *et al.*, 1993). *In vitro* experiments revealed the sensitivity of feline IL MSH release to dopaminergic inhibition (Willemse and Mol, 1994).

In fetal and newborn lamb and in adult sheep (Newman *et al.*, 1987), the administration of a dopamine-receptor antagonist results in  $\alpha$ -MSH release. Elimination of the inhibitory hypothalamic control in sheep by hypothalamus-pituitary disconnection results in increased  $\alpha$ -MSH release (Clarke *et al.*, 1986). The dopamine inhibition of ACTH secretion in the hyperadrenocorticoid horse (Wilson *et al.*, 1982) suggests that in the normal horse the IL is under dopaminergic control. In the rabbit the dopaminergic control of the IL is absent (Schimchowitsch *et al.*, 1986).

#### e. Action

The predominant action of ACTH is stimulation of steroidogenesis and corticosteroid release from the adrenals (see Chapter 19 on adrenal function). ACTH also exerts a growth-stimulating effect on the adrenal cortex. Moreover, non-ACTH portions of POMC—that is, N-terminal POMC peptides—are involved in adrenocortical growth (Lowry *et al.*, 1987). In pharmacological dosages, ACTH may promote lipolysis in fat cells and amino acid uptake in muscle. The role of intact ACTH produced in hypothalamic neurons

projecting to higher brain centers remains to be elucidated. Distribution patterns have been reported for the cat (Rao *et al.*, 1986). The C-terminal fragment of ACTH (18-39), called corticotropin-like intermediate lobe peptide (CLIP), has been found a potent stimulator of *in vitro* adrenal DNA synthesis (Wulffraat *et al.*, 1987).

Nowadays five different receptors for the melanocortins have been cloned with variable affinities for ACTH(1-39),  $\alpha$ -MSH, and  $\gamma$ -MSH and related peptides. The MC2 receptor is unique because only ACTH(1-39) activates this receptor. The receptor is present in the adrenal cortex of many species and is also shown in adipocytes of mice. The other receptors, MC1R and MC3R, have been found to be expressed throughout the body, whereas MC4R is only found within many brain regions and MC5R only in peripheral tissues. Through these five receptors, the melanocortins play a role in many biological functions such as skin physiology, pain and nerve regeneration, behavior, obesity and energy metabolism, and inflammatory and immune processes (Getting, 2006). The melanocortin system plays a role in regulating feeding behavior and energy balance (Bertile and Raclot, 2006).

In the dog a single mutation in the MC1R gene results in a premature stop codon and is associated with the yellow coat color in Labrador retrievers (Everts *et al.*, 2000).

#### f. Disease

Lesions at the hypothalamic and pituitary level may result in altered synthesis and release of POMC-derived peptides. There have been no reports of the occurrence of isolated ACTH deficiency in domestic animals. There are a few reports of dogs with tumorous (supra)hypophyseal lesions, with indirect evidence for multiple adenohypophyseal and neurohypophyseal deficits (Eigenmann *et al.*, 1983b; Rijnberk, 1971), and one dog reported to have secondary hypoadrenocorticism without information about other pituitary functions (Peterson *et al.*, 1992).

In contrast to the few descriptions of ACTH deficiency, pituitary-dependent hyperadrenocorticism is a common disorder in the dog (Hanson *et al.*, 2005; Meij *et al.*, 2002; Peterson, 1987) and rare in the cat (Meij *et al.*, 2001). The adenomas producing the ACTH excess may originate in the AL or IL (Peterson *et al.*, 1986). Cats with pituitary-dependent hyperadrenocorticism usually have concurrent insulin-resistant diabetes mellitus. Various pituitary neoplasm's have been described in cats such as AL and IL corticotropic adenomas (Meij *et al.*, 2001), corticotropic and somatotropic adenoma (double adenoma) (Meij *et al.*, 2004), and melanotropic adenoma (Meij *et al.*, 2005). Dogs with pituitary-dependent hyperadrenocorticism had significantly lower CRH concentrations in cerebrospinal fluid compared to control dogs indicating that the excessive ACTH secretion is not caused by chronic hyperstimulation with CRH (Van Wijk *et al.*, 1992). The ACTH secretion appeared also to be less sensitive to stimulation with CRH

than with LVP (van Wijk *et al.*, 1994). The expansion of pituitary corticotroph adenomas in dogs is correlated with insensitivity to glucocorticoid feedback (Kooistra *et al.*, 1997b) and plasma concentrations of ACTH precursors (Bosje *et al.*, 2002). Evidence for a genetic involvement in tumorigenesis was found in a family of Dandie Dinmont terriers (Scholten-Sloof *et al.*, 1992). In the horse, the disease originates primarily in the IL (Heinrichs *et al.*, 1990; Orth *et al.*, 1982; van der Kolk *et al.*, 2004; Wilson *et al.*, 1982). In agreement with the characteristics described earlier for the secretion of POMC-derived peptides by the IL, ACTH release by tumors of IL origin in both the dog and the horse tends to be strongly resistant to suppression by dexamethasone (Orth *et al.*, 1982; Peterson *et al.*, 1986). In dogs, the highest plasma  $\alpha$ -MSH concentrations are found in individuals with dexamethasone-resistant ACTH secretion (Meij *et al.*, 1997b). This suggests an IL origin of the disease, although there is evidence that the pituitary lesions do not always maintain the characteristics of the lobe of origin (Rijnberk *et al.*, 1988b). A dog with diabetes insipidus has been described, in which the pituitary tumor released primarily biologically inactive POMC-derived peptides (Goossens *et al.*, 1995). In contrast with the equine IL tumors, these tumors in dogs respond poorly to administration of dopamine agonists in terms of diminished ACTH secretion (Rijnberk *et al.*, 1988b). A dog has been described that had dexamethasone-resistant hyperadrenocorticism and elevated ACTH secretion resulting from multiple endocrine neoplasia—that is, a pituitary corticotropic tumor, bilateral adrenocortical tumors, and pheochromocytoma (Thuroczy *et al.*, 1998).

For details on clinical manifestations, laboratory findings, diagnostics, and treatment of these diseases, including iatrogenic hypoadrenocorticism resulting from corticosteroid therapy, refer to textbooks by Feldman and Nelson (2004) and Rijnberk (1996) and Chapter 19 on adrenocortical function in this volume.

#### g. Tests

Basal levels of circulating POMC-derived peptides are measured for diagnostic purposes in situations of suspected hypo- as well as hypersecretion. ACTH values below or just within the reference range (Table 18-3) may be found in cases of hypothalamus-pituitary disease, as well as in situations where endogenous or exogenous glucocorticoid excess suppresses hormone synthesis in the corticotropic cells. This makes the measurement of basal ACTH levels a useful tool in the differentiation between pituitary-dependent hyperadrenocorticism and hyperadrenocorticism resulting from adrenocortical tumor (Feldman, 1983; Peterson, 1986). In pituitary-dependent hyperadrenocorticism, ACTH values exceeding the reference range may be found, but there is considerable overlap (Meij *et al.*, 1997a). Basal MSH concentrations have been found to be elevated in horses (Orth *et al.*, 1982) and dogs (Meij

**TABLE 18-3** Basal Concentrations of POMC-Derived Peptides in Plasma of Healthy Animals<sup>a</sup>

Hormone (Unit)	Species (n)	Sampling Time	Mean ± SD (Range)	Reference
ACTH (pmol/l)	Dog (160)	08.00–10.00 h	(2.2–19.8)	(Peterson <i>et al.</i> , 1986)
	Cat (130)	After overnight fast	24 ± 26	(Javadi <i>et al.</i> , 2004)
	Horse (10)		7 ± 1	(Orth <i>et al.</i> , 1982)
	Cattle (39)	08.00–14.00 h	0.6 ± 0.04	(Beerda <i>et al.</i> , 2004)
	Pig (11)	Morning	2.4 ± 0.5	(Hari and Pliska, 2005)
	Sheep (male, 6)		15 ± 2	(Gardner <i>et al.</i> , 2006)
	Ferret (21)	14.30–16.00	(11.7–24.0)	(Schoemaker <i>et al.</i> , 2002a)
α-MSH (pmol/l)	Dog (160)	08.00–10.00 h	(1.5–15)	(Peterson <i>et al.</i> , 1986)
	Cat (130)	After overnight fast	180 ± 122	(Javadi <i>et al.</i> , 2004)
	Horse (10)		14.4 ± 1.2	(Orth <i>et al.</i> , 1982)
	Ferret (44)	14.30–16.00	(4–108)	(Schoemaker <i>et al.</i> , 2002a)
β-END (pmol/l)	Dog (160)	08.00–10.00 h	(1.5–17.4)	(Peterson <i>et al.</i> , 1986)
	Horse (10)		18.3 ± 4.4	(Orth <i>et al.</i> , 1982)

<sup>a</sup>Most of the values have been converted to SI units, employing: 1 ng ACTH/liter = 0.22 pmol/l; 1 ng α-MSH/liter = 0.60 pmol/l; 1 ng β-END/liter = 0.29 pmol/l.

**TABLE 18-4** Maximal Plasma Concentrations of POMC-Derived Peptides Following Intravenous Administration of a Variety of Stimulants

Hormone (Unit)	Species (n)	Substance	Dose	Mean ± SEM	Reference
ACTH (pmol/l)	Dog (8)	CRH	1 μg/kg	61 ± 9	(Meij <i>et al.</i> , 1996a)
	Dog (6)	AVP	0.6 μg/kg	50 ± 15	(Kemppainen and Sartin, 1987)
	Dog (16)	LVP	0.2 U/kg	49 ± 5	(van Wijk <i>et al.</i> , 1994)
	Dog (19)	Haloperidol	0.06 mg/kg	62 ± 7	(Rijnberk <i>et al.</i> , 1987)
	Dog (6)	Insulin	0.5 U/kg	85 ± 20	(Kemppainen and Sartin, 1987)
	Cat (6)	CRH	1 μg/kg	29 ± 3	(Willemse and Mol, 1994)
	Sheep (5)	CRH	1 μg/kg	125 ± 52	(Pradier <i>et al.</i> , 1986)
	Sheep (5)	AVP	1 μg/kg	202 ± 77	(Pradier <i>et al.</i> , 1986)
	Pig (4)	CRH	1 μg/kg	18 ± 3	(Hari and Pliska, 2005)
α-MSH (pmol/l)	Dog (19)	Haloperidol	0.06 mg/kg	40 ± 4	(Rijnberk <i>et al.</i> , 1987)
	Cat (6)	CRH	1 μg/kg	No effect	(Willemse and Mol, 1994)
	Cat (4)	Haloperidol	2 mg/kg	125 ± 36	(Peterson <i>et al.</i> , 1994)

*et al.*, 1997b; Peterson *et al.*, 1986; Rijnberk *et al.*, 1987) with pituitary-dependent hyperadrenocorticism of IL origin. In the horse, basal plasma ACTH concentration predicts a pituitary adenoma of the IL with 100% sensitivity (van der Kolk *et al.*, 1995).

Of the dynamic tests, the dexamethasone suppression tests (see Chapter 19 on adrenocortical function) are still the best for the diagnosis and differential diagnosis of excessive ACTH and glucocorticoid secretion. In animals suspected of having pituitary-adrenocortical insufficiency, the secretory capacity for POMC-derived peptides can be measured by provocative testing.

CRH and AVP are also used in the differentiation between pituitary-dependent hyperadrenocorticism and hyperadrenocorticism resulting from adrenocortical tumor. The chronically suppressed corticotropic cells are presumed to be unresponsive to these stimuli. However, Meijer *et al.*,

(1978) found considerable overlap in plasma cortisol value in the AVP test, whereas much less is claimed to occur in the CRH test (Peterson, 1986). It has been demonstrated that LVP stimulates cortisol release by adrenal tumors in a direct way (van Wijk *et al.*, 1994).

It has been shown that dogs with pituitary-dependent hyperadrenocorticism usually remain responsive to single CRH administration (Rijnberk *et al.*, 1987) or combined hypophysiotropic stimulation in spite of persisting hypercortisolism and neoplastic transformation of the corticotropes (Meij *et al.*, 1997a). The cells of the pituitary lesions were found to be less responsive to CRH *in vitro* than were normal corticotropes (Mol *et al.*, 1987) and less sensitive to inhibition by glucocorticoids (van Wijk *et al.*, 1998).

As far as the possibility for manipulation of canine IL function is concerned, of the substances tested only the dopamine agonist haloperidol (Kemppainen and Sartin,

1986; Rijnberk *et al.*, 1987) caused significant increases in circulating  $\alpha$ -MSH. More detailed information pertaining to some of these tests is presented in Section IV and in Table 18-4.

## 2. $\beta$ -Endorphin/ $\beta$ -Lipotropin

### a. Gene Expression and Biosynthesis

Both  $\beta$ -lipotropin and  $\beta$ -endorphin are derived from the precursor protein POMC. The gene expression of POMC has been described in Section II.A.1.  $\beta$ -Lipotropin ( $\beta$ -LPH) consists of the 91 C-terminal amino acids of the POMC precursor. It is synthesized in the corticotropic cells of both the AL and IL. The C-terminal sequence (36-91) is remarkably similar in human, porcine, and ovine pituitaries, whereas the N-terminal sequence (1-36) is rather heterogeneous.  $\beta$ -MSH (sequence 37-58) appears to be an extraction artifact and plays no physiological role.

By proteolytic cleavage at amino acid 61,  $\gamma$ -LPH ( $\beta$ -LPH[1-61]) and a family of endorphins are formed. Through specific deletion of C-terminal amino acids and N-terminal acetylation, a variety of  $\beta$ -END-related peptides are formed. The three main compounds are  $\beta$ -END(61-91),  $\gamma$ -END(61-77), and  $\alpha$ -END(61-76). The corticotropic cells of the AL synthesize approximately equal or higher concentrations of  $\beta$ -LPH than of  $\beta$ -END(1-31) in most species. The equine AL, however, contains primarily  $\beta$ -END(1-31) and N-acetyl- $\beta$ -END(1-27) (Millington *et al.*, 1992).

The corticotropic/melanotropic cells of the IL produce relatively more  $\beta$ -END and related peptides. In the IL of the normal dog, the ratio  $\beta$ -LPH/ $\beta$ -END is less than 0.1 (Krieger, 1983). In the dog,  $\beta$ -END(1-27) is the most abundant form in the IL (Young and Kemppainen, 1994).

### b. Secretion

The stimuli that induce ACTH or  $\alpha$ -MSH release from either the AL or IL cells cause also a release of the  $\beta$ -LPH-related peptides from the same cell. The cellular subset of specific proteolytic, amidating, and acetylating enzymes present in the secretory vesicles defines the ultimate composition of POMC-derived peptides that are secreted into the blood. The secretion of the IL is mainly under control of multiple neurotransmitters (Saland, 2001). In fearful dogs, only marginal increases in plasma  $\beta$ -END were measured after a gunshot test (Hydbring-Sandberg *et al.*, 2004). In horses, a critical exercise threshold exists before plasma  $\beta$ -END concentrations increase (Mehl *et al.*, 2000).

### c. Action

The main action of  $\beta$ -LPH is to mobilize fat from adipose tissues, as demonstrated in the rabbit. Its biological function in humans and other species has not been fully elucidated. Brain tissue can break down  $\beta$ -LPH to form  $\beta$ -END-related peptides. However, it is questionable whether these pituitary

peptides are involved in brain function; in conscious sheep, hemorrhagic stress elevates  $\beta$ -END concentrations in plasma but not in cerebrospinal fluid (Smith *et al.*, 1986).

$\beta$ -END is an endogenous opiate with a potent morphinomimetic action. It is also produced in the hypothalamus where the entire POMC precursor is present. Brain and pituitary endorphin are probably part of separate systems. The role of  $\beta$ -END and other opioid peptides in the secretion of pituitary hormones has been studied with long-acting analogues, opiates, and opioid receptor antagonists (Estienne and Barb, 2005; Molina, 2006).

### d. Disease/Tests

Hypersecretion of  $\beta$ -END is associated with the ACTH hypersecretion of IL tumors in both equine and canine pituitary-dependent hyperadrenocorticism (Orth *et al.*, 1982; Peterson *et al.*, 1986; Rijnberk *et al.*, 1987). As the regulation of the secretion of  $\beta$ -END is similar to that of other POMC-derived peptides from the AL and IL, testing procedures can be applied as mentioned in the section on ACTH and  $\alpha$ -MSH. Elevation of plasma  $\beta$ -END has been documented in horses following running and shipping (Li and Chen, 1987) and in sheep during electroimmobilization and shearing procedures (Jephcott *et al.*, 1987). Treadmill exercise of Thoroughbred horses induces a variable response in plasma  $\beta$ -END concentrations (Art *et al.*, 1994). Elevated plasma  $\beta$ -END concentrations are found in dogs with congestive heart failure (Himura *et al.*, 1994) and are further elevated after naloxone treatment.

## B. Glycoprotein Hormones

The gonadotropes and thyrotropes synthesize the hormones LH, FSH, and TSH, each of which consists of two different peptide chains, termed the  $\alpha$ - and  $\beta$ -subunits. The amino acid sequence of the  $\alpha$ -subunit is identical for LH, FSH, and TSH within a species, as it is for placental chorionic gonadotropin. The  $\beta$ -subunits have unique structures and determine the hormone specificity. Carbohydrate substituents account for 10% to 20% of the molecular weights of these hormones.

### 1. $\alpha$ -Subunit

#### a. Gene Expression

The gene encoding the  $\alpha$ -glycoprotein subunit ( $\alpha$ GSU) varies between 8 and 16.5 kb among the species and contains four exons. The  $\alpha$ -subunit comes to expression in a variety of cells such as thyrotropes, gonadotropes, and syncytiotrophoblasts. The expression in gonadotropes and thyrotropes is in part differently regulated. In the developing pituitary  $\alpha$ GSU is one of the first hormones to be detected and regulated by the transcription factors Pitx1, Lhx3, SF-1, Otx1 (Brown and McNeilly, 1999; Cohen and Radovick,



**FIGURE 18-7** Sequence comparison of the  $\alpha$ -subunit for glycoprotein hormones (LH, FSH, and TSH). See the legend for Figure 18-6.

2002; Jorgensen *et al.*, 2004), and FOXL2 (Ellsworth *et al.*, 2006). In thyrotropes, however, expression of the TSH $\beta$  subunit precedes the expression of the  $\alpha$ GSU. Apart from commonly used elements the promoter of the  $\alpha$ GSU also contains response elements specifically used by gonadotropes, thyrotropes, or trophoblasts (Jorgensen *et al.*, 2004). Also in the horse, this tissue-specific regulation of  $\alpha$ GSU expression is documented (Farmerie *et al.*, 1997). The canine  $\alpha$ GSU has been coexpressed in a baculovirus expression system together with the canine TSH $\beta$  gene (Yang *et al.*, 2000). The steroidogenic factor-1 (SF-1) has been shown in sheep to be essential for  $\alpha$ GSU expression (Baratta *et al.*, 2003).

#### b. (Pro)hormone

Translation of the mRNA results in the formation of a precursor peptide with a molecular weight of approximately 13,500. The  $\alpha$ -subunit has a high degree of homology among species (Fig. 18-7). The human sequence contains 92 amino acids, rather than the 96 as found in all other species studied so far. The shorter human sequence is due to a deletion of 12 nucleotides at the beginning of exon 3. After cleavage of the signal peptide, five disulfide bridges are formed. Two asparagine residues are prone to N-glycosylation, but there is also a putative O-glycosylation site (Fig. 18-7). The  $\alpha$ -subunit is produced in excess of the  $\beta$ -subunit that determines the hormone specificity. The  $\beta$ -subunit formation is rate limiting in the formation of hetero  $\alpha\beta$  dimer.

## 2. TSH

The thyrotropic cells of the anterior pituitary produce thyroid-stimulating hormone (TSH), which stimulates both the synthesis and secretion of thyroid hormone.

#### a. Gene Expression

The rat, human, and canine TSH gene consists of three exons, whereas the mouse gene has five exons. Its expression is restricted to pituitary thyrotropes. For the development of thyrotropes, and also gonadotropes, the same transcription factors are necessary as described for  $\alpha$ GSU expressing cells. For the development of specific thyrotropes, the transcription factor Pit-1 is essential (Dasen and Rosenfeld, 2001). Expression of the TSH $\beta$  gene is stimulated by the transcription factors Pit-1 and GATA2, whereas TSH $\beta$  gene expression is suppressed by the active thyroid hormone T<sub>3</sub> (Nakano *et al.*, 2004; Shupnik, 2000). In contrast with the suppression of TSH $\beta$  synthesis by T<sub>3</sub>, which is produced within the pituitary by selective deiodination of T<sub>4</sub> by type 2 deiodinase (D2), TRH plays a dominant role in the stimulation of TSH synthesis (Nikrodhanond *et al.*, 2006).

The feline TSH has also been cloned and brought to expression (Rayalam *et al.*, 2006).

#### b. (Pro)hormone

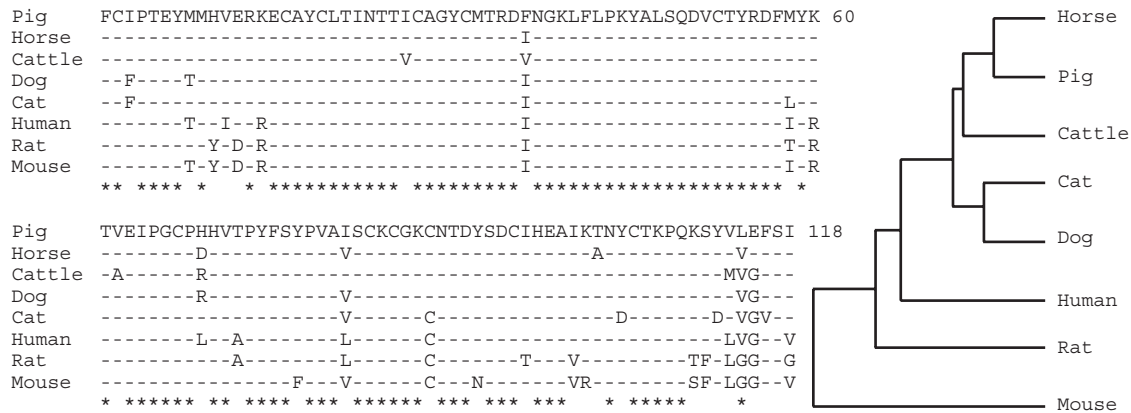
The TSH $\beta$  chain consists of 118 amino acids and forms six intrachain disulfide bonds (Fig. 18-8). There are no free cysteine residues, consistent with the fact that beta subunits form a heterodimer with the  $\alpha$ GSU noncovalently. The TSH $\beta$  subunit has an N-glycosylation site at asparagine 23 and has a molecular weight of 18,000 after appropriate glycosylation.

The  $\alpha$ -subunit is produced in excess of the  $\beta$ -subunit, which determines the hormone specificity, and its formation is rate limiting in the formation of the  $\alpha$ - $\beta$  dimer.

#### c. Secretion

The release of TSH is mainly regulated by stimulation by the hypothalamic thyrotropin-releasing hormone (TRH) and a strong negative feedback by thyroid hormone (Pazos-Moura





**FIGURE 18-8** Sequence comparison of the  $\beta$ -subunit of TSH. See the legend for Figure 18-6.

*et al.*, 2003) at the pituitary and hypothalamic level. The prohormone thyroxine ( $T_4$ ) must therefore be converted locally to the active 3,3',5-triiodothyronine ( $T_3$ ) by type 2 iodothyronine deiodinase (D2) before binding to the nuclear thyroid hormone receptor of the thyrotrope (Christoffolete *et al.*, 2006). Superimposed on this regulatory system, hypothalamic factors (somatostatin, dopamine) may inhibit TSH synthesis and release. Intrapituitary growth factors can also stimulate (EGF) or inhibit (Neuromedin B) TSH release (Pazos-Moura *et al.*, 2003). Evidence has been presented on an ultra-short-loop feedback control by TSH through pituitary folliculostellate cells (Prummel *et al.*, 2004).

In the dog, TRH stimulates plasma TSH concentrations. Single administration of TRH results in slightly higher plasma TSH concentrations than measured after combined stimulation with four releasing hormones (Meij *et al.*, 1996b). In euthyroid dogs, cTSH release is relatively stable with hardly any pulses as measured during a 6-h pulse study, whereas in hypothyroid dogs, an increased basal concentration coincides with higher pulse frequencies (Kooistra *et al.*, 2000b).

**d. Action**

TSH stimulates both synthesis and secretion of thyroid hormones from the thyroid gland. After receptor binding, TSH stimulates via the Gs alpha protein the production of cAMP, which acts as an intracellular second messenger. In addition, intracellular  $Ca^{2+}$  may modulate the biological effect of TSH via the phosphoinositol pathway. As a result of receptor activation  $T_4$ , and to a much lesser extent  $T_3$ , is secreted into the blood. Prolonged stimulation of the thyroid with TSH results not only in hypersecretion of thyroid hormone but also in enlargement of the thyroid gland. Genetic analysis of DNA from hyperplastic or adenomatous thyroid nodules in cats has revealed that somatic mutations in the TSH-receptor or in the Gs alpha protein are the cause of feline thyroid hyperplasia (Peeters *et al.*, 2002; Watson *et al.*, 2005). Apart from the thyroid, TSH receptors have been

found in brain and pituitary where they may have a function in feedback mechanisms, and in lymphocytes, thymus, testis, kidney, adipose tissue, and bone (Davies *et al.*, 2005).

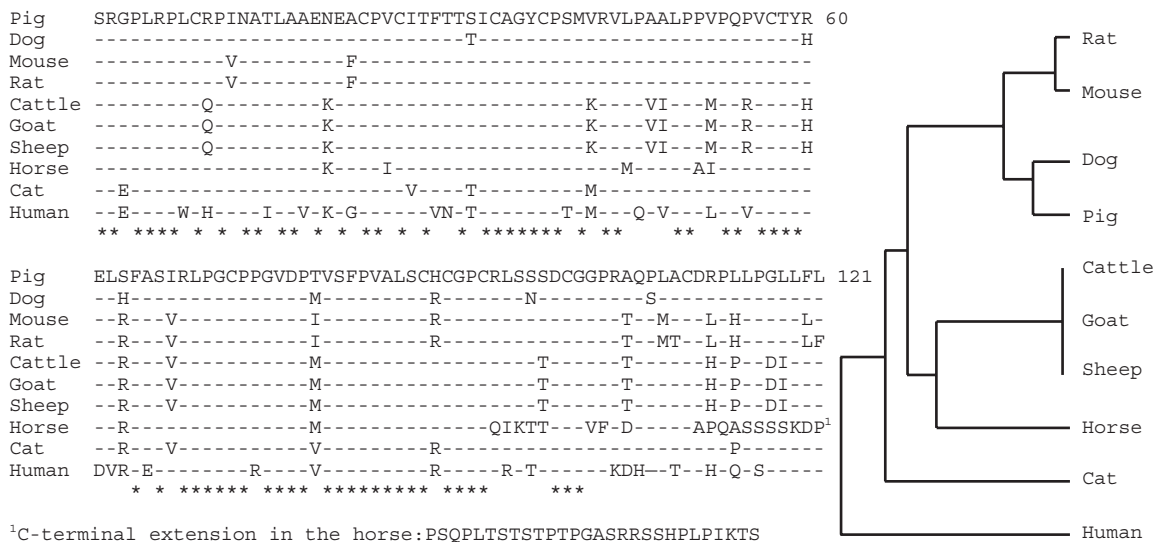
**e. Disease/Tests**

Since 1995, sensitive TSH assays have become available for the dog (Williams *et al.*, 1996). Since then numerous reports have been published on the usefulness of cTSH measurements in the diagnosis of canine hypothyroidism. Low total plasma  $T_4$  concentrations may be caused by decreased binding to plasma TBG—such as seen after long-term glucocorticoid excess in Cushing’s syndrome or interference of  $T_4$  binding to TBG by, for instance, NSAIDs or antiepileptic drugs—and they are therefore not conclusive for the diagnosis of hypothyroidism. Unfortunately some 25% to 40% of dogs with proven hypothyroidism will have plasma cTSH concentrations within the reference range for healthy dogs (Boretti and Reusch, 2004; Peterson *et al.*, 1997). In dogs with nonthyroidal disease also low serum concentrations of total  $T_4$  are seen with serum TSH concentrations that remain within the reference range (Kantrowitz *et al.*, 2001). In a recent study, quantitative measurement of thyroidal  $^{99m}TcO_4^-$  showed no overlap between dogs with primary hypothyroidism and nonthyroidal illness (Diaz Espineira *et al.*, 2007) and may together with a thyroid biopsy be the ultimate proof of primary hypothyroidism.

Secondary hypothyroidism caused by a pituitary tumor (Rijnberk, 1971) or panhypopituitarism caused by a suprasellar tumor (Eigenmann *et al.*, 1983b) is rare. German shepherd dogs with dwarfism have a secondary hypothyroidism, which can be demonstrated by a blunted TSH response on TRH in a combined pituitary function test (Kooistra *et al.*, 2000c). For further details, refer to Chapter 20 on thyroid function.

Chemical induction of hypothyroidism in horses using the antithyroid drug PTU results in a steady increase of plasma TSH concentration and an exaggerated response to TRH administration (Breuhaus, 2002).





**FIGURE 18-9** Sequence comparison of the  $\beta$ -subunit of LH. See the legend for Figure 18-6.

### 3. LH and FSH

Luteinizing hormone (LH), which is identical to the interstitial-cell-stimulating hormone, and follicle-stimulating hormone (FSH) are produced by the gonadotropic cells of the AL.

#### a. Gene Expression

In the gonadotropes  $\alpha$ GSU appears to be the lead protein before the expression of the  $\beta$ -subunits, which determine the hormone specificity (Pope *et al.*, 2006). Next the  $\beta$ -subunits arise in the bihormonal gonadotropes. During development of the pituitary, transcription factors Pitx, Hesx1, Lhx3, SF-1, and Otx1 regulate gonadotropin subunit expression (Brown and McNeilly, 1999). Although LH and FSH are produced within the same gonadotrope, its gene expression and secretion pattern are different.

In primates, multiple copies of LH $\beta$ -related genes have been identified, the chorionic gonadotropins (CG), which are expressed in the placenta for the maintenance of early pregnancy. Apart from primates, only in equids has this placental production of CG been well described (Jorgensen *et al.*, 2004). In the horse, placental eCG $\beta$  is derived from the same gene that encodes pituitary LH $\beta$  (Saneyoshi *et al.*, 2001). For pituitary LH $\beta$  expression, three highly conserved response elements have been found in the promoter region that bind the early growth response protein (Egr-1), the orphan nuclear factor SF-1, and the homeodomain protein Pitx1 (Jorgensen *et al.*, 2004; Melamed *et al.*, 2006).

For the regulation of basal FSH $\beta$  gene expression Lhx3 plays a prominent role, whereas a direct effect of SF-1 on FSH $\beta$  expression is not demonstrated in the ovine pituitary gland (Baratta *et al.*, 2003).

The LH $\beta$  promoter is sensitive to stimulation by GnRH via Egr-1 and inhibition by androgens. The activated androgen receptor (AR) binds SF-1 to block communication via

Pitx1 (Jorgensen *et al.*, 2004). The AR, however, increases FSH $\beta$  gene promoter activity, as also documented for the progesterone receptor (PR) and glucocorticoid receptor (GR) (Thackray *et al.*, 2006). Estrogens activate the LH $\beta$  promoter (Melamed *et al.*, 2006). Inhibin, activin, and follistatin, originally found as hormones from the gonads but they may also be produced within the pituitary, are important regulators of LH and FSH synthesis and release. Activin stimulates FSH $\beta$  gene expression and mRNA stability, whereas inhibin and follistatin inhibit FSH $\beta$  gene expression and accelerate the degradation of FSH $\beta$  mRNA (Gregory and Kaiser, 2004). As activin stimulates and inhibin inhibits expression of GnRH receptors, an indirect effect on LH $\beta$  expression and release also can be found.

#### b. (Pro)hormone

After cleavage of the signal peptide, LH $\beta$  proteins are formed of 121 amino acids (Fig. 18-9). Exception is the horse sequence, which shows a highly variant C-terminal part that is also some 14 to 28 amino acids longer. The  $\beta$ -subunit contains six intrachain disulfide bridges. In humans, LH $\beta$  has one unique N-linked glycosylation at asparagine 30. In the horse, asparagine 13 is glycosylated and in addition 12 O-glycosylation sites have been found (Bousfield *et al.*, 2001). The percentage glycosylation is related to increased plasma half-life and thus bioavailability of the hormones.

The FSH $\beta$  chain consists of 111 amino acids, six intrachain disulfide bridges, and two N-linked glycosylation sites at asparagine 7 and 24. The N-linked oligosaccharide chains are critical for bioactivity. Deglycosylated FSH may act as a potent FSH antagonist (Fares, 2006). The sequence of canine FSH shows the lowest homology (approximately 80%) with the sequences of other species (Fig. 18-10), which may cause limitations to the use of heterologous immunoassays for proper FSH measurements in the dog.



FIGURE 18-10 Sequence comparison of the  $\beta$ -subunit of FSH. See the legend for Figure 18-6.

c. Secretion

As with other pituitary hormones, the gonadotropins are released in a pulsatile fashion, stimulated by pulses of the hypothalamic gonadotropin-releasing hormone GnRH. The release of GnRH in seasonal breeders is tightly regulated by the length of the photoperiod and the subsequent release of melatonin by the pineal gland (Thiery *et al.*, 2002). Pulsatile GnRH secretion has been demonstrated in sheep (Clarke and Cummins, 1982) and the horse (Irvine and Alexander, 1994). GnRH can be used for estrus induction and prevention in the dog (Gobello, 2007). In contrast to single administration of GnRH, continuous administration of GnRH agonists reversibly suppresses gonadotropin secretion because of down-regulation/desensitization of GnRH receptors. Effect of dose and duration of treatment with a GnRH-agonist resulting in a switch from stimulated LH and FSH release toward down-regulation has been reported recently for the dog (Concannon *et al.*, 2006).

In the dog, LH and FSH pulses coincide during different phases of the estrus cycle although the longer duration of FSH pulses may be due to the difference in plasma half-life. During progression from early to late anestrus basal plasma FSH increase without a concomitant increase in basal LH concentrations (Kooistra and Okkens, 2001a; Okkens and Kooistra, 2006). During the early follicular phase, the LH secretion has frequent increases of short duration (Kooistra *et al.*, 1999). The preovulatory FSH in female dogs may start a few hours earlier or may coincide with the LH surge, which is associated with the highest plasma estradiol-17 $\beta$  concentrations and the start of increasing plasma progesterone concentrations (de Gier *et al.*, 2006). During the mid- to late-luteal phase, basal LH concentrations in pregnant bitches were higher with lower peak frequency and height in comparison to nonpregnant bitches. Plasma FSH concentrations were higher during pregnancy (Onclin *et al.*, 2002). Chronic administration of the synthetic progestin MPA has no effect on plasma LH

concentrations, but, like in pregnancy, increased plasma FSH concentrations are found (Beijerink *et al.*, 2007).

Administration of dopamine-agonists to shorten the anestrus interval results in a rapid rise in basal FSH concentration (Okkens and Kooistra, 2006), whereas the serotonin antagonist metergoline, which lowers also plasma prolactin concentrations, does not affect the LH and FSH secretion patterns in the dog (Beijerink *et al.*, 2004).

Low plasma estrogen concentrations inhibit the GnRH and LH release through a negative feedback system, whereas high concentrations of estrogens may exert a positive feedback by stimulating GnRH release. Kiss1 neurons in the periventricular nucleus are thought to be involved in the estrogen and progesterone-induced LH surge (Smith *et al.*, 2006). In the male, LH stimulates the synthesis and release of testosterone in the Leydig cells of the testis, which may in turn exert a negative feedback on LH secretion. This feedback may depend on aromatization of testosterone to estradiol in the brain. In the male dog, both testosterone and estradiol are the major inhibitors of LH and FSH release (Winter *et al.*, 1982).

Finally, FSH can also be regulated by more specific stimulation through activin or by prevention of activin binding and thus inhibition of downstream signaling by inhibin and follistatin (Gregory and Kaiser, 2004; Gregory *et al.*, 2005). Other members of the TGF $\beta$  family such as the bone morphogenic protein-6, BMP-7, and BMP-15 can also exert an effect on FSH secretion.

d. Action

FSH stimulates in the female ovary the folliculogenesis and ripening of the ovaries to the antral follicle stage. LH stimulates changes in the ovarian follicle resulting in ovulation and maintenance of the corpus luteum (Hunter *et al.*, 2004). LH stimulates the production of the androgen precursor androstenedione that is converted, by FSH stimulation, to estradiol-17 $\beta$  and during the luteal phase

progesterone secretion. The LH effects are mediated by LHR containing granulosa cells through the release of EGF-like growth factors (Conti *et al.*, 2006).

FSH is essential for Sertoli cell proliferation and maintenance of sperm quality in the male testis. LH interacts predominantly with Leydig cells and stimulates the production of testosterone.

#### e. Disease/Tests

LH and the LHR are also involved in the pathogenesis of adrenal tumors in ferrets, which develop after castration-induced high plasma LH concentrations (Schoemaker *et al.*, 2002b). In the adrenal carcinomas that secrete predominantly adrenal androgens, the presence of LHR mRNA and protein has been demonstrated.

The LHR is expressed constitutively in urogenital tissues and adrenal glands in rodents, but they need functional maturation at a posttranslational level (Apaja *et al.*, 2005). Dogs have also LHR and FSHR in the lower urinary tract (Ponglowhapan *et al.*, 2006). In long-term spayed bitches, relative lower plasma LH and FSH concentrations were found in dogs with urinary incontinence in comparison with continent dogs (Reichler *et al.*, 2005).

### C. Somatomammotropic Hormones

Growth hormone (GH) and prolactin (PRL) together with the placental lactogen show homology in amino acid composition and some biological activities. Therefore, they may group together as a family of somatolactotropic hormones. There is increasing evidence that these hormones evolved from a single ancestral gene (Seo, 1985; Wallis, 1984).

#### 1. GH

The somatotrophic cells, producing GH, are the most abundant cells of the anterior lobe.

##### a. Gene Expression

In primates, multiplication of the GH gene has resulted in a cluster of five GH-related genes. The GH-N gene is expressed in the pituitary and the other four, consisting of the chorionic somatomammotropins (so-called placental lactogens) and a variant gene (GH-V), are expressed in the placenta during pregnancy. In most nonprimates, a single gene encodes GH, but a family of PRL-like genes (also including placental lactogens) is present. In sheep and goats in some individuals, there are two GH-like genes from which one may be expressed in the placenta. In red deer, two gene sequences encoding GH were found, but this is shown to be related to allelic polymorphism (Wallis *et al.*, 2006).

The GH-producing cells arise from a lineage of TSH-, GH-, and PRL-producing pituitary cells by the action of transcription factor Pit-1 that is under the control of the prophet of Pit-1

(Prop1). The final maturation of GH-producing cells is under the control of transcription factors Pitx1, Zn-15, Lhx3, and Pit1 (Mullis, 2005). Pit1 and GH expression are already found at the 8- to 16-cell stage in bovine embryos (Joudrey *et al.*, 2003). For the activation of the pituitary GH gene, a 5'-remote locus control region in humans 14.5 kb upstream of the GH-N promoter plays an important role (Ho *et al.*, 2006). This site contains also three Pit1 binding sites (Shewchuk *et al.*, 2002). The pituitary somatotroph differentiation is further stimulated by glucocorticoids and thyroid hormone (Porter, 2005).

GH mRNA expression is stimulated by GHRH and ghrelin by inducing cAMP production and subsequently Pit1 mRNA expression (Garcia *et al.*, 2001; Theill and Karin, 1993; Yan *et al.*, 2004). Somatostatin (SS) inhibits in general GH release although in porcine somatotropes SS can also stimulate GH release depending on the dose used. It appeared that SS receptors SST1 and SST2 mediate the inhibitory effects whereas SST5 mediates a stimulatory effect of somatostatin (Luque *et al.*, 2006). The rat GH promoter contains a positive thyroid hormone response element (TRE) and a negative TRE (nTRE) (Sanchez-Pacheco and Aranda, 2003). GH expression is stimulated by the positive TRE. In the absence of T<sub>3</sub> binding the unliganded thyroid hormone receptor (TR) may induce GH expression in nonpituitary cells. In severely hypothyroid dogs elevated plasma GH concentrations have been found, which may be related to this mechanism (Lee *et al.*, 2001). Gonadal steroids modulate also GH production. 17 $\beta$ -Estradiol may reduce the inhibitory effect of SS on GH production, whereas testosterone treatment increases GH mRNA concentrations in adulthood (Chowen *et al.*, 2004).

##### b. Extrapituitary GH Expression

In dogs, endogenous progesterone and exogenous progestins may induce considerable rises in plasma GH concentrations, resulting in acromegalic changes and insulin resistance with the possibility of development of frank diabetes mellitus (Eigenmann *et al.*, 1983a; Selman *et al.*, 1994a). GH excess has only been found to occur in intact female dogs during the progesterone-dominated phase of the sexual cycle or in dogs treated with progestins (Eigenmann and Rijnberk, 1981).

Selman *et al.*, showed the autonomous character of progestin-induced GH secretion (Selman *et al.*, 1991) and found the canine mammary gland to be the source of plasma GH after progestin treatment (Selman *et al.*, 1994b). The mammary origin was confirmed by an arterial-venous gradient across the mammary gland, a rapid decrease and normalization of plasma GH concentrations after complete mastectomy (Selman *et al.*, 1994b), and the presence of GH mRNA in the canine mammary gland as measured by RT-PCR (Mol *et al.*, 1995b). From the 100% sequence identity it is concluded that a single gene encodes pituitary and mammary GH in the dog, in agreement with the fact that only one canine GH gene is found in the published canine genome sequence. The dog is not unique in expressing GH

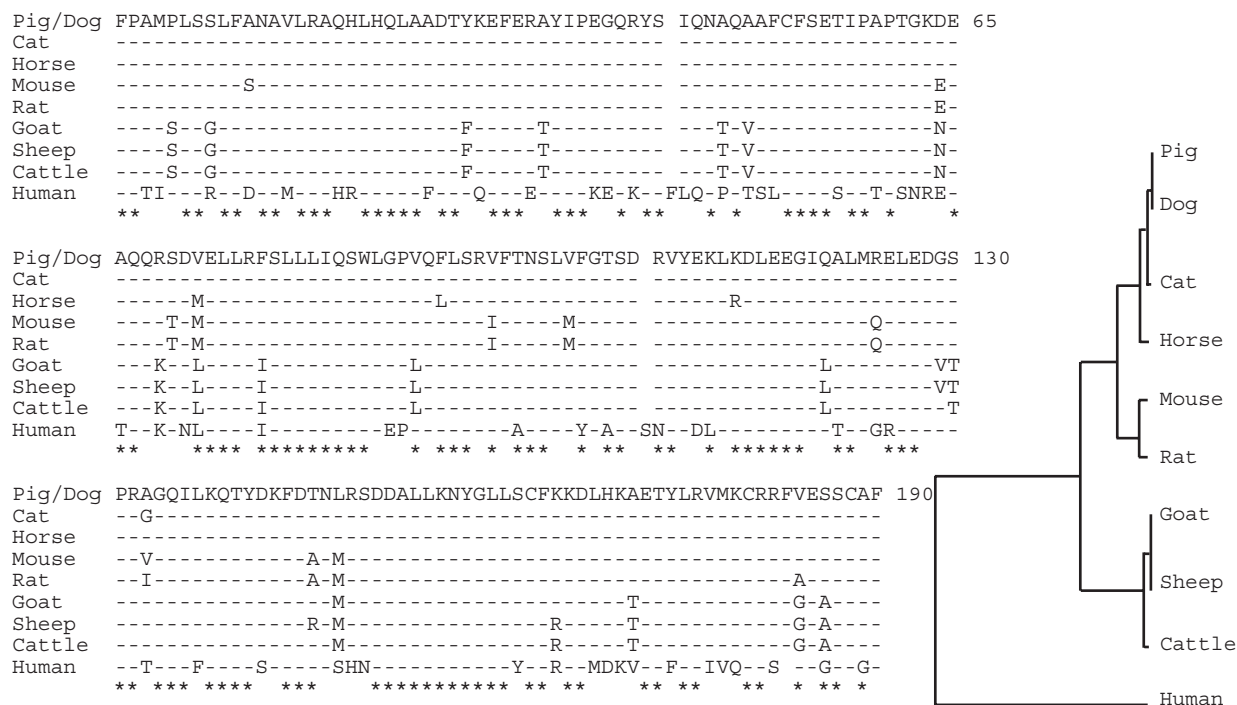


FIGURE 18-11 Sequence comparison of GH. See the legend for Figure 18-6.

in the mammary gland as it is demonstrated also in cats with progestin-induced fibroadenomatous changes of the mammary gland (Mol *et al.*, 1995b), and GH mRNA has been demonstrated in the normal and neoplastic human mammary gland as well (Mol *et al.*, 1995a; Mol *et al.*, 1996). The presence of a putative binding site for the progesterone receptor in the GH promoter of human, rat, mouse, and dog makes it likely that progestin-induced GH expression is a direct effect of activated PRs on the GH gene promoter (Lantinga-van Leeuwen *et al.*, 2002).

Apart from the mammary gland, extrapituitary GH expression seems to be widespread throughout the body. GH functions already as an early local embryonic growth, and differentiation factor, including the neural tube, before pituitary GH expression is detectable (Sanders and Harvey, 2004). Furthermore, GH expression is found in the postnatal rat lung (Beyea *et al.*, 2005), chicken testis (Harvey *et al.*, 2004) and canine lymphomas (Lantinga van Leeuwen *et al.*, 2000), insulinomas (Robben *et al.*, 2002), and growth plate or osteosarcomas (Kirpensteijn *et al.*, 2002).

c. (Pro)hormone

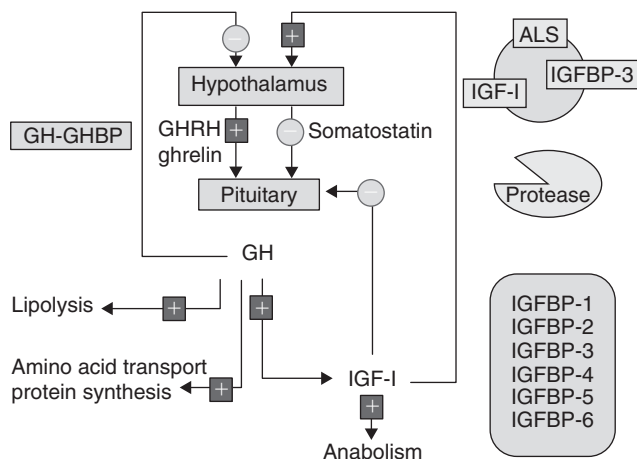
GH is a single-chain polypeptide. It contains two intrachain disulfide bridges and has an apparent molecular weight of 22,000. In humans, a small fraction of circulating GH has a molecular weight of 20kDa because of alternative splicing of the pituitary GH gene. The metabolic effects are comparable to the normal 22kDa form (Hayakawa *et al.*, 2004). The amino acid sequence of GH belongs to the best-known sequences of pituitary hormones among species (Fig. 18-11).

The sequences of canine and porcine GH are identical and very similar to the horse. The canine and porcine sequence is suggested to be identical to the GH sequence for the ancestral placental mammal (Forsyth and Wallis, 2002).

In cattle, a polymorphism in the GH gene exists, resulting in four GH variants that can arise from two possible N-terminal amino acids (phenylalanine or alanine) and two amino acids in position 127 (leucine or valine). The transmission of the trait of high milk production was greater for homozygous leucine-127 in Holstein cows and valine-127 in Jersey cows (Lucy *et al.*, 1993). GH exhibits also heterogeneity because of posttranscriptional processing that may vary in binding to the plasma GH binding protein (GHBP) or biological effects (De Palo *et al.*, 2006). The glycine in the third  $\alpha$ -helix of bovine GH (G118) and human GH (G120) is crucial for biological functioning of GH. Substitution of this glycine results in a molecule without growth-promoting activity that inhibits the actions of GH *in vitro* and *in vivo* (Kopchick, 2003).

d. Secretion

The release of GH by the pituitary is regulated by a variety of factors (Fig. 18-12 and Table 18-5). The integration of all these factors results in a pulsatile release of GH. In the female dog, plasma GH pulse patterns are dependent on the estrus cycle. In the early luteal phase, elevated basal GH concentrations are associated with a low pulse frequency of 2 peaks/12h, whereas at anestrus lower basal GH concentrations are found with an enhanced pulse frequency of



**FIGURE 18-12** Regulation of pituitary GH release, peripheral actions, and feedback.

5 peaks/12 h (Kooistra *et al.*, 2000a). The higher basal concentration and diminished pulsatility in early luteal phase may be caused by a direct or indirect inhibition of pituitary GH release by GH secretion from the mammary glands stimulated by progesterone.

Pituitary somatotropes are not only stimulated by the GH-releasing hormone (GHRH), which was first isolated from human pancreas islet tumors in 1982 and next found in the hypothalamus, but also by the more recently discovered GH-releasing hormone ghrelin, which was originally isolated from rat and human gut. In the pituitary, two GHRH-R isoforms exist generated by alternative splicing. The predominant short form activates somatotropes through the adenylate cyclase/cAMP/PKA pathway. The pituitary contains also two splice variants of a distinct seven-transmembrane helix, G protein coupled receptor for ghrelin, called the GH secretagogue receptor (GHS-R). Only the long type 1a isoform activates pituitary somatotropes via the phospholipase C/IP<sub>3</sub>/PKC pathway. The expression of both receptors is down-regulated by exposure to GHRH as well as ghrelin in porcine pituitary cell cultures (Luque *et al.*, 2004). The release of GH is generally inhibited by somatostatin (SS). In the pituitary all five SS receptors (SST1-5) are expressed. In porcine pituitary cells low SS concentrations may, however, also stimulate GH release. It has been found that the inhibitory effects are mediated by SST1 and SST2 receptors, whereas SST5 mediates the stimulatory effect of SS on GH release *in vitro* (Luque *et al.*, 2006).

In young beagle dogs, 13 to 17 months of age, ghrelin was shown to a more potent GH secretagogue in comparison to GHRH. With aging, 7 to 12 year of age, the GH response to ghrelin was significantly lower, whereas only a moderate decrease in the sensitivity toward GHRH was noticed and GHRH appeared to be at higher age a more potent stimulator of GH release (Bhatti *et al.*, 2006b). In contrast to humans, in the dog ghrelin has hardly any stimulatory effect on ACTH and prolactin release (Bhatti *et al.*,

**TABLE 18-5** Putative Factors Modulating GH Release

	Stimulating	Inhibiting
Hormones	GHRH Ghrelin Glucagon Pentagastrin Enkephalin	Somatostatin (SS) IGF-I, IGF-II Corticosteroid excess
Biogenic amines	$\alpha$ -Adrenergic agonists $\beta$ -Adrenergic antagonists Dopamine	$\alpha$ -Adrenergic antagonists $\beta$ -Adrenergic agonists Serotonin antagonists
Others	Hypoglycemia Fall in free fatty acids Amino acids (arginine) Sleep Stress (emotional) Exercise	Hyperglycemia Rise in free fatty acids

2006b; van der Lely *et al.*, 2004). Plasma concentrations of acylated ghrelin, which is the biologically active form, are higher after fasting and lower after food intake, suggesting a role in feeding control and energy homeostasis also in the dog (Bhatti *et al.*, 2006c, 2006d). No clear relation was found of plasma GH and ghrelin in the study by Bhatti *et al.*, in agreement with a previous study in which also no close relation was found between plasma GH and ghrelin concentrations during the juvenile period in dogs (Yokoyama *et al.*, 2005).

Next to the direct and selective effects of the hypophysiotropic hormones on GH secretion at the pituitary level, there are indirect neuronal influences that modulate GH secretion (see also Table 18-3) (McMahon *et al.*, 2001). In general, the main physiological stimuli of GH secretion are sleep, physical exercise, stress, fasting, catecholamines, hypoglycemia, and certain amino acids. However, this does not apply in every respect to all species. For example, GH secretion in dogs is not related to sleep or day-night cycles, although GH peaks may occur after forced wakefulness at the onset of sleep (Takahashi *et al.*, 1981). Insulin-induced hypoglycemia and arginine administration do not consistently result in GH release in the dog (Eigenmann and Eigenmann, 1981). Of the neurotransmitter systems involved, adrenergic systems seem to play a major role.  $\alpha$ -Adrenergic agonists promote GH secretion, whereas  $\beta$ -adrenergic agonists are inhibitory. Thus, clonidine, a central  $\alpha_2$ -adrenergic agonist, is an effective stimulator of GH secretion in the dog (Eigenmann and Eigenmann, 1981; Selman *et al.*, 1994a). The dopaminergic D2 receptor is important for stimulating GH release, as can be concluded from the dwarfism in the D2 KO mouse (Garcia-Tornadu *et al.*, 2006).

Plasma IGF-I exerts a negative feedback of GH release both at the hypothalamic level where it stimulates SS release and inhibits GHRH release, as well as at the pituitary level. As the majority of plasma IGF-I is bound to specific binding proteins, in plasma predominantly IGFBP3, the free rather than the protein-bound IGF-I determines these feedback regulations (Chen *et al.*, 2005). The elevated GH concentrations in fasting dogs have also been explained as the result of impaired feedback inhibition caused by low IGF-I plasma levels (Eigenmann *et al.*, 1985).

Finally thyroid hormone, sex steroids, and glucocorticoids modulate GH synthesis and release. In contrast to humans and rats where low plasma thyroid hormone concentrations result in attenuated GH secretion, hypothyroidism in the dog is associated with enhanced basal plasma GH concentrations and reduced pulsatility (Lee *et al.*, 2001). In dogs with pituitary-dependent hyperadrenocorticism, no differences exist in the basal plasma GH secretion, but less GH is secreted in pulses in comparison to control dogs (Hanson *et al.*, 2006a; Lee *et al.*, 2003). In dogs, endogenous and exogenous progestins may induce considerable rises in plasma growth hormone concentrations, resulting in acromegalic changes and insulin resistance (Rijnberk *et al.*, 2003; Selman *et al.*, 1994a; Selman *et al.*, 1994b).

#### e. Action

The effects of GH can be divided into two main categories: rapid or metabolic actions and slow or hypertrophic actions. The (acute) metabolic responses are due to direct interaction of growth hormone with the target cell, whereas the slow hypertrophic effects or those on cartilage, bone, and other tissues are indirect. The direct effects of GH result in differentiation of prechondrocytes, enhanced lipolysis in adipose tissue, increased gluconeogenesis, and restricted glucose transport caused by insulin resistance (Eigenmann, 1984; Renaville *et al.*, 2002; Veldhuis *et al.*, 2006). The GH responsiveness of adipose tissue is less dependent on nutrition than that of the liver, which may explain the reduced adiposity in the absence of growth enhancement in GH-treated ruminants (Breier *et al.*, 1986). *In vitro* GH has also a direct positive effect on the maturation of bovine oocytes (Bervers and Izadyar, 2002) and human hematolymphopoiesis (Hanley *et al.*, 2005).

In contrast to these direct catabolic effects, the indirect actions are anabolic and mediated by the insulin-like growth factors IGF-I and IGF-II (Daughaday *et al.*, 1987). In their chemical structure the IGFs have approximately 50% homology with insulin/proinsulin, suggesting they have evolved from a common ancestral molecule. The IGFs are bound to a family of six different high-affinity IGF-binding proteins (Firth and Baxter, 2002). The main IGFBP in plasma is IGFBP3, which forms together with an acid-labile subunit a ternary complex of 150 kDa. As a

consequence, IGFs have a long plasma half-life, which is consistent with their long-term growth promoting action. Specific proteolysis may increase free IGF concentration locally and modulates the IGF receptor signaling (Bunn and Fowlkes, 2003).

Dogs have an extreme variation of body size between breeds. It has been shown that a large body size is associated with GH excess at a young age (Favier *et al.*, 2001). In adult dogs, circulating IGF-I concentrations were found to correlate with body size in different dog breeds (Eigenmann *et al.*, 1988). By studying genetic subgroups within one breed (i.e., standard, miniature, and toy poodles), plasma IGF-I concentrations, and not GH secretory reserve, did parallel body size (Eigenmann *et al.*, 1984a).

#### f. Disease

Inadequate growth hormone secretion at a young age retards growth. Apart from occasional reports on dwarfism in dogs and cats, GH-deficiency dwarfism seems to occur primarily as a genetically transmitted condition in the German Shepherd (Andresen *et al.*, 1974) and in the Karelian bear dog (Andresen and Willeberg, 1977). In the German shepherd, the GH deficiency is associated with TSH and prolactin deficiency and impaired LH and FSH release without disturbances in ACTH secretion (Kooistra *et al.*, 2000c). This indicates that at a defect in the organogenesis of the pituitary resulting from mutation in an essential transcription factor may have occurred. So far the involvement of mutations in Pit-1 (Lantinga-van Leeuwen *et al.*, 2000b), Prop1 (Lantinga-van Leeuwen *et al.*, 2000a), LHX4 (van Oost *et al.*, 2002), and the LIF receptor (Hanson *et al.*, 2006b) has been excluded as candidate genes for pituitary dwarfism.

In adults, growth hormone deficiency causes much less impressive changes. The clinical features remain confined to the skin and coat. Affected dogs are presented with alopecia and hyperpigmentation of the skin. In contrast to dogs with congenital hyposomatotropism, these dogs may have low but detectable plasma GH concentrations, a blunted response to a clonidine or GHRH stimulation test, but plasma IGF-I concentrations within the reference range. This may be caused by a mild and fluctuating hyperadrenocorticism (Rijnberk *et al.*, 1993). In some dogs the alopecia was explained by an adrenal androgen imbalance. Among other treatments, administration of GH has been associated with hair regrowth (Frank, 2005).

Syndromes resulting from GH excess are known to occur in the dog and the cat. In both species, the GH excess gives rise to outgrowth of bone and soft tissues (acromegaly), as well as to insulin resistance with the possibility of development of frank diabetes mellitus. However, the pathogenesis of the excessive GH secretion in these species is completely different. GH-producing canine pituitary adenomas are extremely rare and only reported once (Fracassi, 2007). A physiological, reversible form of extrapituitary GH secretion is found to be stimulated during



**TABLE 18-6** Basal GH and IGF-I Concentrations in Plasma of Healthy Animals

Hormone (Unit)	Species (n)	Breed, Age	Mean $\pm$ SEM (Range)	Reference
GH ( $\mu\text{g/liter}$ )	Dog (63)	Adult	1.9 $\pm$ 0.1	(Eigenmann and Eigenmann, 1981)
	Dog (6)	Great Dane, 6 weeks	9.0 $\pm$ 2.1	(Favier <i>et al.</i> , 2001)
	Dog (6)	Great Dane, 24 weeks	4.6 $\pm$ 1.1	(Favier <i>et al.</i> , 2001)
	Dog (6)	Beagle (anestrus)	0.5 $\pm$ 0.1	(Selman <i>et al.</i> , 1991)
	Dog (6)	Beagle (metestrus)	2.2 $\pm$ 0.4	(Selman <i>et al.</i> , 1991)
	Cat (25)	Adult	3.2 $\pm$ 0.7	(Eigenmann <i>et al.</i> , 1984c)
	Mare (12)	Selle Français, 3–15yr	1.1 $\pm$ 0.1	(Davicco <i>et al.</i> , 1994)
	Cattle (4)	Holstein steer	6.3 $\pm$ 1.4	(Lee <i>et al.</i> , 2005)
	Pig (4)	5 days	9.0 $\pm$ 1.4	(Lee <i>et al.</i> , 1993)
	Pig (4)	170 days	1.5 $\pm$ 0.1	(Lee <i>et al.</i> , 1993)
	Sheep (7)	MRHead, male adult	1.9 $\pm$ 0.4	(Viguie <i>et al.</i> , 2004)
	Sheep (30)	East Frisian, 60 days	154 $\pm$ 16	(Altmann <i>et al.</i> , 2006)
	IGF-I ( $\mu\text{g/liter}$ )	Dog (8)	Cocker spaniel, adult	36 $\pm$ 27
Dog (10)		Beagle, adult	87 $\pm$ 33	(Eigenmann <i>et al.</i> , 1984b)
Dog (10)		Keeshond, adult	117 $\pm$ 34	(Eigenmann <i>et al.</i> , 1984b)
Dog (13)		German shepherd, adult	280 $\pm$ 23	(Eigenmann <i>et al.</i> , 1984b)
Dog (6)		Beagle, 24 weeks	237 $\pm$ 52	(Favier <i>et al.</i> , 2001)
Dog (6)		Great Dane, 24 weeks	307 $\pm$ 31	(Favier <i>et al.</i> , 2001)
Cat (18)		2–19 year	(196–791)	(Reusch <i>et al.</i> , 2006)
Mare (12)		Selle Francais, 7–11yr	(154–318)	(Davicco <i>et al.</i> , 1994)
Cattle (4)		Holstein steer	133 $\pm$ 18	(Lee <i>et al.</i> , 2005)
Pig (4)		170 days	182 $\pm$ 30	(Lee <i>et al.</i> , 1993)
Sheep (7)		MRH, male adult	133 $\pm$ 23	(Viguie <i>et al.</i> , 2004)
Sheep (30)		East Frisian, 60 days	625 $\pm$ 33	(Altmann <i>et al.</i> , 2006)
IGF-II ( $\mu\text{g/liter}$ )		Dog (8)	Beagle, 24 weeks	152 $\pm$ 13
	Dog (6)	Great Dane, 24 weeks	171 $\pm$ 13	(Favier <i>et al.</i> , 2001)
	Pig (4)	170 days	326 $\pm$ 19	(Lee <i>et al.</i> , 1993)

The values can be converted to SI units: 1  $\mu\text{g}$  GH/liter = 0.0455 nmol/l; 1  $\mu\text{g}$  IGF/liter = 0.133 nmol/liter.

pregnancy in the dog. Synthetic progestins or endogenous progesterone may induce hyperplastic ductular changes in the canine mammary gland with foci of immunoreactive GH-producing cells (Selman *et al.*, 1994b). The MPA-induced elevated plasma GH concentrations can be effectively lowered by treatment with the progesterone receptor antagonist aglepristone (Bhatti *et al.*, 2006a). Also canine, feline, and human mammary carcinomas may express GH mRNA within tumor tissue (Mol *et al.*, 1995b, 1999). The GH excess is, next to the acromegalic features and insulin resistance, associated with the development of cystic endometrial hyperplasia (CEH), which does not necessarily have to originate within the mammary gland (Bhatti *et al.*, 2007). Local production of GH has also been documented in canine insulinomas (Robben *et al.*, 2002), in normal growth plates, and in spontaneous osteosarcoma (Kirpensteijn *et al.*, 2002). Enhanced expression of GHR mRNA in duodenal and colonic biopsies of dogs with chronic enteropathies (Spichiger *et al.*, 2005) and distraction-induced osteogenesis (Theyse *et al.*, 2006) points to a role for GH in gastrointestinal and bone repair processes.

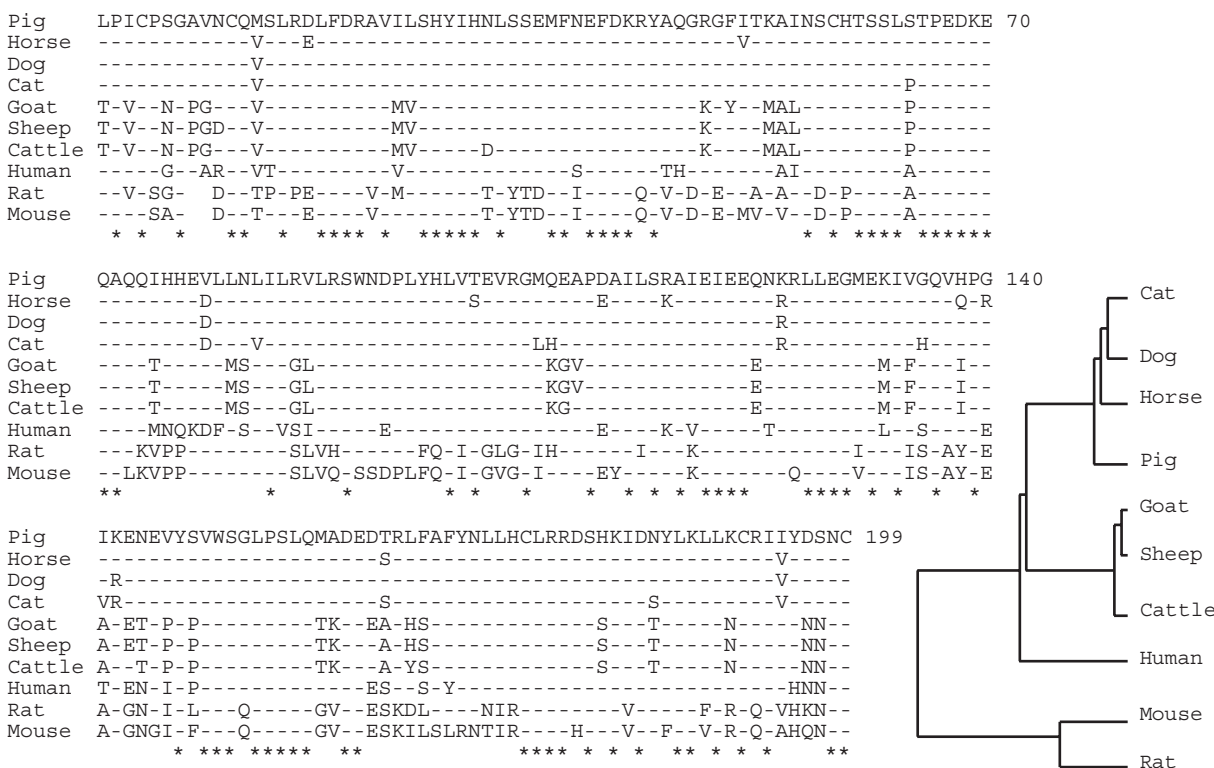
In cats, excessive amounts of GH may be secreted by a pituitary tumor resulting in acromegalic features and

insulin resistance (Hurty and Flatland, 2005). In untreated diabetic cats without concurrent hypersomatotropism, plasma IGF-I concentrations are lower in comparison to control animals, whereas in case of underlying excessive GH secretion, plasma IGF-I concentrations are elevated (Reusch *et al.*, 2006).

#### g. Tests

As GH secretion is pulsatile, single values are of no great diagnostic value. In healthy individuals, basal plasma GH concentrations (Table 18-6) may be very low. Hence, when GH deficiency is suspected, a stimulation test is needed. In the dog stimulation with clonidine, xylazine, GHRH, or ghrelin has proved to be reliable for this purpose, whereas in calves and lambs GHRH stimulation has been used.

Elevated GH values are not definitive proof of acromegaly, not only because of the pulsatile nature of the GH secretion but also because environmental factors may cause sharp increases. Although hypersecretion should be checked by an inhibition test, in case of progestin-induced GH secretion, a blunted stimulation of high basal GH concentrations may support the diagnosis, together with elevated plasma IGF-I concentrations (Selman *et al.*, 1991).



**FIGURE 18-13** Sequence comparison of PRL. See the legend for Figure 18-6.

It should be kept in mind that the reference values for plasma IGF-I concentrations in the dog are breed (=body size) dependent.

## 2. Prolactin

### a. Gene Expression

Prolactin (PRL) is encoded by a single gene in humans. In nonprimates, a family of PRL-related genes is found and only one gene encoding GH. In the rat, a PRL family of at least 24 related genes can be found including the placental lactogens, proliferans, and PRL-like proteins (PLPs) (Alam *et al.*, 2006). In the cow, an expanded PRL family also has been found; however, its members are not orthologous with members of the mouse and rat PRL family genes (Soares, 2004). Expansion of the PRL family does not exist in the dog.

The appearance of specific PRL-producing lactotropes is one of the latest events in pituitary development. It has been proposed that lactotropes arise from somatotropes or at least a common progenitor cell, the somatomammotrope (Burrows *et al.*, 1999). In chicken, however, evidence is presented that lactotropes do not differentiate from somatotropes during embryonic development (Fu *et al.*, 2004). In mouse pituitaries, mammosomatotropes represent only 5% to 6% of somatotropes (Villalobos *et al.*, 2004).

The Pit-1 transcription factor is a prerequisite factor for PRL expression, as it is for GH and TSH. In the PRL gene Pit-1 acts in synergy with an estrogen nuclear receptor

(ER) at a distal enhancer site, with two ETS-domain-containing factors (Ets-1 and ERF) and the Pitx1 and Pitx2 transcription factors (Dasen and Rosenfeld, 2001). The expression and release of PRL are under tonic dopaminergic inhibitory control. No consensus exists on the identity of physiologically relevant PRL releasing factors. In extracts of the bovine posterior pituitary, a PRL-releasing factor was found (Hashizume *et al.*, 2005). The melanocortin peptide  $\gamma$ 3-MSH also stimulates PRL expression (Langouche *et al.*, 2004), whereas a variety of factors are found that stimulate PRL release, such as PRL-releasing peptide (PrRP), TRH, oxytocin, VIP, angiotensin II, PACAP, and intermedin and may also stimulate PRL gene expression.

The PRL gene, like the GH gene, has five exon areas. In the pituitary, a promoter upstream of the Cap site in exon 1b is used, outside the pituitary expression of PRL is regulated by a second promoter upstream of exon 1a initially described for PRL expression in decidua and lymphocytes (Gerlo *et al.*, 2006; Goffin *et al.*, 2002).

### b. (Pro)hormone

Prolactin (PRL) is synthesized as a single polypeptide, which, after cleavage of the signal peptide, has a molecular weight of approximately 23,000 daltons and three intrachain disulfide bridges. There is a good deal of variability in the sequences of PRL from different species. The rat and mouse PRL are most distinct and differ from the other sequences at about 40% of all amino acid residues (Fig. 18-13).



By proteolytic cleavage a variety of N-terminal prolactin variants have been found. These fragments act on endothelial cells to suppress vasodilatation and angiogenesis and promote vascular regression (Clapp *et al.*, 2006). It has been suggested that these fragments should be called “vasoinhibins.” In cartilage, the 16kDa N-terminal fragment is produced from full-length PRL by matrix metalloproteases. The 16kDa fragment is a potent antiangiogenic factor (Macotela *et al.*, 2006).

Prolactin can be phosphorylated at several serine and threonine residues, which may constitute as much as 80% of total pituitary PRL in cattle. The degree of glycosylation may vary from 1% to 60% among species. Finally, dimerization and polymerization may result in high-molecular weight forms that in general have reduced biological activity (Freeman *et al.*, 2000).

### c. Secretion

For two reasons, PRL has a unique place among the AL hormones. First, it is the only hormone that is under tonic inhibition by the hypothalamus. After transplantation of the pituitary under the kidney capsule, PRL synthesis is remarkably enhanced. Second, PRL lacks a specific target organ that produces factors exerting negative feedback.

The main hypothalamic prolactin-inhibiting factor (PIF) is dopamine, released primarily from the tuberoinfundibular dopaminergic neurons located in the arcuate nucleus, with nerve terminals in the median eminence. Dopamine released from these neurones is transported to the pituitary lactotropes via the hypophyseal portal vessels. In addition, dopamine released from the periventricular hypophyseal and tuberohypophyseal dopaminergic neurons is released in the intermediate and neural lobes of the pituitary, respectively, and reaches the anterior pituitary by means of short portal vessels. Dopamine activates D2 receptors on lactotropes to tonically inhibit the release of PRL. In turn, PRL enters the brain through a receptor-mediated process in the choroid plexus and stimulates the activity of all three populations of dopaminergic neurons in the hypothalamus acting through PRL receptors directly on these dopamine neurons. In this manner, PRL can regulate its own release via a short-loop negative feedback (Andrews, 2005).

Apart from this short-loop negative feedback, PRL secretion from the anterior pituitary gland is controlled by neuroendocrine factors originating in the hypothalamus and the posterior pituitary gland, and paracrine factors originating in the anterior pituitary gland. At the hypothalamic level, PRL-inhibiting factors are dopamine and GABA- and PRL-releasing factors are vasoactive intestinal peptide (VIP) and TRH. At the level of the posterior pituitary gland, oxytocin and vasopressin, transported to the lactotropes through the short portal vessels, stimulate PRL release. Tachykinins, paracrine factors present in the pituitary gland and brain, can stimulate PRL release through an indirect (hypothalamus, PRF) or direct stimulatory effect

on lactotropes in the anterior pituitary, or, under some circumstances, they may inhibit PRL secretion by enhancing dopamine release from the hypothalamus (Debeljuk and Lasaga, 2006).

The suckling-, stress-, or estrogen-induced PRL surge cannot be explained by changes in dopaminergic inhibition alone. Therefore, the presence of a prolactin-releasing factor (PRF) has been suggested. Several candidates for the PRF have been proposed. One of the components of hypothalamic extracts known to have a stimulatory effect on PRL release is TRH. This was demonstrated in several mammalian species, including the pig (Bever and Willemse, 1982). However, TRH is probably neither the sole nor the major physiological PRF. Another strong candidate for PRF is vasoactive intestinal peptide (VIP) (Shimatsu *et al.*, 1985).

The rat posterior pituitary was found to contain a potent PRF (Hyde *et al.*, 1987). Further analysis demonstrated that two compounds, oxytocin from the NL and an unidentified peptide from the IL, could function as PRF. The low potency of oxytocin made it a less likely candidate for the physiological regulation of PRL release. The PRF from the IL appeared to be a small peptide that is present in the posterior pituitary of many species. Its chemical nature remains to be determined.

Prolactin-releasing peptide (PrRP) was first isolated from bovine hypothalamus as an orphan G-protein-coupled receptor (Hinuma *et al.*, 1998). PrRP was shown to stimulate PRL secretion *in vitro* and *in vivo* (Matsumoto *et al.*, 1999). However the effect of PrRP on PRL is less than that of TRH, and the idea that PrRP was a real hypophysiotropic PRL-secreting factor has been challenged. Morphological and physiological studies indicate that PrRP may play a wide range of roles in neuroendocrinology other than PRL release, among which the most important are energy metabolism, metabolic homeostasis, and stress responses (Sun *et al.*, 2005).

Like other pituitary hormones, PRL is released in a pulsatile manner, with fluctuations during different stages of the reproductive cycle. Apart from an increase around the time of ovulation (McNeilly *et al.*, 1982), plasma PRL concentrations increase during the luteal phase of the sexual cycle in dogs and cows (Dieleman *et al.*, 1986) but not in cats (Banks *et al.*, 1983). During lactation, very high PRL concentrations have been found in the sow (Bever *et al.*, 1978) and in the dog (Concannon *et al.*, 1978). In addition, distinct increases in PRL concentration have been found in relation to pregnancy and parturition (Taverne *et al.*, 1982).

Progesterone induces GH production from the mammary gland but also modulates the secretion of PRL in the bitch. In pregnant and overtly pseudopregnant bitches, the plasma PRL concentration starts to rise about 1 month after ovulation, which is when the plasma progesterone concentrations begin to decline. Also in healthy bitches, most PRL is released during the second half of the luteal phase. The changes in GH and PRL release during the luteal phase may promote the physiological proliferation

and differentiation of mammary gland tissue in the bitch (De Coster *et al.*, 1983; Kooistra and Okkens, 2001b, 2002; Okkens *et al.*, 1985). In goats with pseudopregnancy, characterized by hydrometra and the presence of a persistent corpus luteum, no correlation was found with the plasma PRL concentration. PRL does not play a crucial role in the etiology of pseudopregnancy in the goat (Hesselink *et al.*, 1995; Kornalijnslipper *et al.*, 1997).

The effect of the lighting regime on PRL secretion in rams is thought to be a direct effect of melatonin on the pituitary gland (Lincoln and Clarke, 1994). In dogs, PRL secretion has a circannual rhythmicity (i.e., the months with longer daylight had significantly higher PRL concentrations than the months with the shortest) (Corrada *et al.*, 2003, 2006). There are also ultradian gender-related differences (i.e., higher basal levels were found in females compared with males) (Corrada *et al.*, 2003, 2006). In male dogs, PRL secretion has been reported relatively constant (Koch *et al.*, 2006) or pulsatile in nature (Corrada *et al.*, 2003, 2006) with a distinct breed difference (i.e., serum PRL concentrations in beagles were significantly higher than in cross-breeds and German shepherds) (Corrada *et al.*, 2003, 2006).

Important modulating factors in the control of PRL secretion are estrogens, especially 17- $\beta$ -estradiol. Estrogens modulate the TRH receptor levels in the pituitary (Lean *et al.*, 1977) and cause a biphasic increase in transcription of the prolactin gene (Gorski *et al.*, 1985). From experiments in rats, it is concluded that progesterone may also stimulate the release of PRL (Deis and Alonso, 1985). Estradiol rapidly induces an enhanced PRL response to TRH in dogs, without changing basal PRL levels (Rutteman *et al.*, 1987). Subsequent administration of medroxyprogesterone acetate did not further affect these findings.

Neurogenic factors also influence PRL secretion. Milking and suckling are almost immediately followed by PRL release. Removal of litters from their dams, for example, piglets from sows (Bever *et al.*, 1978), results in a rapid decline in PRL levels in plasma. Following return of the litters, PRL concentrations rise again.

#### d. Action

PRL is produced mainly by the lactotrope cells of the anterior pituitary and, in mammals, its most apparent function is the regulation of lactation. In addition, PRL has been attributed an important role in reproduction, as was illustrated by the observation that PRL<sup>-/-</sup> mice not only have defects in mammapoiesis but are also sterile (Horseman *et al.*, 1997). Although the bulk of PRL circulating in serum is produced by the lactotrope cells of the pituitary, PRL is also expressed extrapituitary by various tissues including uterine decidualized endometrial cells and leukocytes (Ben-Jonathan *et al.*, 1996). The most familiar role of PRL in mammals is stimulation of mammary gland growth and lactation. PRL increases mitosis of mammary gland epithelial cells not only during development but also during

pregnancy and lactation. It has been relatively difficult to demonstrate *in vitro* effects of PRL on cell proliferation in mammary glands (Friesen *et al.*, 1985). This can be explained by the increasing evidence that the growth-promoting effect of PRL has much in common with that of GH (i.e., intermediate factors comparable to IGF are required for effects on cell proliferation) (Nicoll *et al.*, 1985).

PRL has a wide variety of other physiological actions among vertebrates. It may affect water and electrolyte balance, metabolism, gonadal function, and behavior. Of these, the effect on the ovary has received much attention. PRL has a luteotrophic effect in some animals, such as rodents, sheep, and ferrets (McNeilly *et al.*, 1982), but not in the cow (Bever *et al.*, 1987). Bovine follicles do not bind (ovine) PRL (Bever *et al.*, 1987).

The reciprocal relationship between PRL and LH has been well established in several species, including the sow (Bever *et al.*, 1983) and the cow (Dieleman *et al.*, 1986). This can explain the reduced fertility during lactation that is known in many species. It has been suggested that PRL may also interfere directly at the ovarian level (McNeilly *et al.*, 1982). These effects of PRL also appear to play a role in the maintenance of the long interestrus interval in the bitch. Treatment of bitches with the dopamine agonist bromocriptine results in considerable shortening of the interestrus interval (Okkens *et al.*, 1985).

Mammalian maternal behavior in several species consists of nest building and caring for offspring. Prolactin-induced maternal behavior has been established in some animals. However, the primary role of PRL in inducing mammalian maternal behavior has recently been questioned (Scapagini *et al.*, 1985). There appears to be diversity in the hormonal basis of maternal behavior, and in some species estrogens and progesterone play a crucial role (Rosenblatt, 1984).

#### e. Disease

Prolactinomas are the most common hormonally active pituitary tumors in humans. There is a marked female preponderance, and prolactinoma is relatively rare in men. Mixed GH-PRL adenomas are known to occur in a substantial number of patients with acromegaly, and the concomitant production and secretion of PRL by corticotroph adenomas is not unusual (Ishibashi and Yamaji, 1985). Pituitary PRL production is under tonic inhibitory control by hypothalamic dopamine, such that in humans' pituitary macroadenomas other than prolactinomas cause pituitary stalk interruption and also produce hyperprolactinemia. There have been no well-documented reports on the occurrence of prolactinomas in animals, although in dogs with pituitary-dependent hyperadrenocorticism (PDH), plasma PRL concentrations and the PRL response to stimulation were higher than those in healthy control dogs, probably as a result of cosecretion with ACTH by the transformed corticotrophic cells (Meij *et al.*, 1997a).

Thus, there do not seem to be pathological hyperprolactinemic states in domestic animals that require treatment

**TABLE 18-7** Concentrations of PRL in Plasma of Healthy Animals

Species (n)	Condition	Mean $\pm$ SEM ( $\mu\text{g/liter}$ )	Reference
Dog (6)	1.5 weeks of lactation	86 $\pm$ 19	(Concannon <i>et al.</i> , 1978)
Dog (6)	8–32 h prepartum	117 $\pm$ 24	(Concannon <i>et al.</i> , 1978)
Dog (5)	Ovariectomized females	7.9–11.5	(Rutteman <i>et al.</i> , 1987)
Dog (6)	Females, early luteal phase	2.5 $\pm$ 0.4	(Kooistra and Okkens, 2002)
Dog (6)	Females, anestrus	2.0 $\pm$ 0.1	(Kooistra and Okkens, 2002)
Dog (7)	Females, anestrus	7.0 $\pm$ 1.2 <sup>c</sup>	(Corrada <i>et al.</i> , 2003)
Dog (6)	Females in estrous cycle	3.9 $\pm$ 1.6 <sup>a</sup>	(de Gier <i>et al.</i> , 2006)
Dog (6)	Females in midluteal phase	3.2 $\pm$ 0.2 <sup>b</sup>	(Lee <i>et al.</i> , 2006)
Dog (65)	Males	2.7 $\pm$ 0.2	(Corrada <i>et al.</i> , 2006)
Dog (8)	Males	3.0 $\pm$ 0.3 <sup>b</sup>	(Koch <i>et al.</i> , 2006)
Cat (8)	Early gestation	7.0 $\pm$ 0.3	(Banks <i>et al.</i> , 1983)
Cat (8)	End of gestation	43.5 $\pm$ 4.5	(Banks <i>et al.</i> , 1983)
Cat (8)	4 Weeks post partum	40.6 $\pm$ 7.2	(Banks <i>et al.</i> , 1983)
Cow (5)	Luteal phase	23.3 $\pm$ 4.8	(Dieleman <i>et al.</i> , 1986)
Cow (5)	Follicular phase	15.8 $\pm$ 2.7	(Dieleman <i>et al.</i> , 1986)
Sow (3)	2nd Week of lactation	9.1 $\pm$ 1.4–26.1 $\pm$ 5.0 <sup>c</sup>	(Bever <i>et al.</i> , 1978; Matthews and Parrott, 1992)
Sow (3)	Piglets removed	1.4 $\pm$ 0.3–1.9 $\pm$ 0.1 <sup>c</sup>	(Bever <i>et al.</i> , 1978; Matthews and Parrott, 1992)
Sheep (8)	Males	68 $\pm$ 15.3	(Matthews and Parrott, 1992)

<sup>a</sup>Mean of 3 measurements/24 h during early follicular phase, six measurements/24 h during late follicular phase, and 6 measurements/24 h during early luteal phase.

<sup>b</sup>Mean of 24 measurements at 15-min intervals.

<sup>c</sup>Mean of 8 measurements at 15-min intervals.

with dopaminergic drugs. These drugs are nevertheless often used, the main application being in a physiological condition in the bitch called pseudopregnancy (Janssens, 1981). Administration of the dopamine agonist bromocriptine results in rapid disappearance of the signs, suggesting impending parturition. As treatment with bromocriptine lowers PRL concentrations in plasma (Okkens *et al.*, 1985; Stolp *et al.*, 1986), it is likely that the lactation and maternal behavior of the diestral bitch is PRL dependent.

Isolated PRL deficiency has been reported in few case reports in women that became apparent because these women suffered from galactogenesis after normal pregnancies (Douchi *et al.*, 2001). However, the involvement of a genetic defect in the observed PRL deficiency was not addressed. Isolated PRL deficiency in domestic animals has not been reported.

#### f. Tests

Despite the variations in amino acid sequences of PRLs from different species, plasma concentrations can be measured in heterologous assays, for example, employing labeled porcine PRL with an antibody against ovine PRL in an assay for canine PRL (Stolp *et al.*, 1986). PRL levels in the blood may vary during the reproductive cycle, but the basal levels in both male (Meij *et al.*, 1996a) and anestrus

female dogs are within similar narrow limits (Stolp *et al.*, 1986). Reference values are presented in Table 18-7.

When there is a suspicion of prolactin deficiency, the secretory capacity can be tested with TRH. In healthy dogs intravenous administration of 10  $\mu\text{g}$  TRH per kg body weight resulted in a mean plasma PRL peak level of 19.7  $\pm$  5.8  $\mu\text{g/liter}$  at 5 min following single TRH administration and of 28.5  $\pm$  6.8  $\mu\text{g/liter}$  at 5 min following combined administration of four hypothalamic-releasing hormones (Meij *et al.*, 1996a). In cats, 75  $\mu\text{g}$  TRH caused PRL elevation to seven times the basal levels (Banks *et al.*, 1983). Prolactin concentrations can be suppressed with the dopamine agonist bromocriptine. Both 20  $\mu\text{g/kg}$  intravenously (Stolp *et al.*, 1986) and 10  $\mu\text{g/kg}$  orally (Rijnberk *et al.*, 1987) resulted in protracted decreases lasting at least 8 h after administration.

### III. NEUROHYPOPHYSIS

#### A. Vasopressin

##### 1. Gene Expression

Although there is considerable homology between the genes for vasopressin (VP) and oxytocin (OT), each of the relevant

Arginine vasopressin (AVP)	Cys.	Tyr.	Phe.	Gln.	Asn.	Cys.	Pro.	Arg.	Gly-NH <sub>2</sub>
Lysine vasopressin (LVP)	-	-	-	-	-	-	-	Lys	-
Arginine vasotocin (AVT)	-	-	Ile	-	-	-	-	-	-
Conopressin S (snail venom)	-	Phe.	Ile.	Arg	-	-	-	-	-
Mesotocin (MT)	-	-	Ile	-	-	-	-	Ile	-
Oxytocin (OT)	-	-	Ile	-	-	-	-	Leu	-
	*				*	*	*		*

**FIGURE 18-14** Sequence comparison of vasopressin (VP) and oxytocin (OT)-like peptides. Lines between shaded boxes represent intrachain disulfide bridges. See the legend for Figure 18-6.

hypothalamic neurons produces only one hormone, either VP or OT. The VP and OT genes are located within the same chromosomal locus at a very short distance from each other in a head-to-head orientation organization (Burbach *et al.*, 2001). Regulatory domains in this intergenic region control their hypothalamus-specific expression (Fields *et al.*, 2003).

The VP gene consists of three exons that encode for different functional parts of the VP precursor peptide, the propressophysin. Exon 1 encodes the signal peptide, the nonapeptide VP, and the N-terminal part of neurophysin II (NP-II). Exon 2 encodes the central part of NP-II, and exon 3 encodes the C-terminal part of NP-II and a glycoprotein (GP). The major factors that regulate VP expression are osmotic and hypovolemic stimuli. Water deprivation stimulates hypothalamic VP mRNA most probably through two cAMP response elements (CRE) and an AP2 site within the promoter. Glucocorticoids suppress VP gene expression through a GRE in the VP promoter (Kim *et al.*, 2001).

**2. (Pro)hormone**

After cleavage of the signal peptide, the GP moiety of the VP prohormone is glycosylated, disulfide bonds are generated, and then the prohormone is packaged into a secretory vesicle. The correct sorting of the prohormone into the secretory pathway requires the formation of aggregates. Specific association of VP and NP-II results in dimeric and tetrameric units that are essential for sorting (Burbach *et al.*, 2001). The secretory vesicles are axonally transported to the axon endings in the posterior pituitary. Studies in the dog suggest that approximately 1.5h are required from the time of synthesis to possible release of the nonapeptide (Ivell *et al.*, 1986). During this transport the neurophysin II, VP, and the GP moiety are liberated by proteolytic cleavage. The C-terminal glycine residue of the VP-molecule is finally amidated.

In most mammals, VP contains an arginine residue at position 8 (arginine vasopressin, AVP) and a five-membered ring formed by a disulfide bridge between the cysteine residues at position 1 and 6 (Fig. 18-14). In the members of the pig family, VP contains a lysine residue at position 8. The lysine vasopressin (LVP) is the only form present in the domestic pig. Heterozygotic peccaries, warthogs, and hippopotami may possess both AVP and LVP. Substitution of the phenylalanine residue at position 3 by isoleucine leads to arginine vasotocin (AVT). This peptide

has been identified as a uniquely nonmammalian substance and is probably the most primitive and certainly the most commonly occurring neurohypophyseal peptide.

**3. Secretion**

The major determinant in the release of vasopressin is plasma osmolality. Below a certain plasma osmolality threshold, which may vary considerably between individuals, plasma VP concentration is suppressed to levels that allow maximal free water clearance (Wade *et al.*, 1982). Once plasma osmolality rises to the threshold, the pituitary secretes VP. Although the concentration of plasma VP causing maximal antidiuresis is about 5 to 10pmol/liter, the release of VP is related to plasma osmolality over a much broader range (Robertson, 1983). Biewenga *et al.*, developed a nomogram for this relationship in the dog, which allows analysis of the osmoregulation of VP secretion in terms of sensitivity and threshold (Biewenga *et al.*, 1987). In healthy dogs, VP is secreted in a pulsatile fashion with a wide variation in number of pulses, VP pulse duration, and VP pulse amplitude and height (van Vonderen *et al.*, 2004b). After water deprivation, total and basal VP secretion, the number of significant VP pulses, as well as the pulse characteristics, is not different from basal values. However, during osmotic stimulation with hypertonic saline, there is a large increase in both basal and pulsatile VP secretion, and the number of VP pulses and VP pulse height and amplitude increase significantly (van Vonderen *et al.*, 2004b).

Apart from the influence of osmolality, a significant decrease in circulating blood volume may also cause enhanced VP secretion. The decrease in left atrial pressure triggers receptors. Denervation of these receptors prevents the hypovolemia-mediated VP release. The functional properties of this regulatory system differ from those of the osmoregulatory system. Although the relationship between plasma osmolality and VP appears to be linear, the relationship between blood volume and plasma VP is best described by an exponential function (Vokes and Robertson, 1985a).

Under ordinary circumstances, changes in VP levels are not observed until blood volume decreases by 5% to 10%. With further decreases, plasma VP rises exponentially. The relative insensitivity of VP to modest changes in blood volume means that this regulatory mechanism plays little or no role in the physiological control of water balance. Under ordinary circumstances, total body water rarely changes by more than 1% to 2%, an amount far too small to affect

VP secretion through hemodynamic influences (Wang and Goetz, 1985). In dogs, 24h of fluid deprivation increases plasma VP because of changes in both extracellular volume and tonicity, but the increase in tonicity plays a greater role than the reduction in volume (Wade *et al.*, 1983).

It has been proposed that hemodynamic influences modulate VP secretion by raising or lowering the osmostat (Robertson, 1978). According to this concept, a decrease in plasma volume or pressure will permit normal osmoregulation of VP, but the threshold for release will be lowered by an amount proportional to the degree of hypovolemia or hypotension, associated with increased sensitivity of the VP response to rising plasma osmolality. Conversely, hypervolemia or hypertension increases the threshold and decreases the sensitivity of release (Quillen and Cowley, 1983).

There are numerous other factors that may influence VP secretion. Of these, nausea/vomiting (Rascher *et al.*, 1986), insulin-induced hypoglycemia (Vokes and Robertson, 1985b), and stress (Jorgensen *et al.*, 2002) are the most potent. The effects of opiates and opioid peptides on VP secretion have been studied for many years and have been the subject of some controversy. Both stimulatory and inhibitory effects have been reported. Apart from the substances, doses, and routes of administration used, the animal species is an important factor (Van Wimersma Greidanus, 1987). Intracerebroventricular administration of  $\beta$ -END in conscious rats decreases basal and stimulated VP release (ten Haaf *et al.*, 1986). An opioid inhibition of dehydration-induced VP release has been reported in dogs (Wade, 1985). However, Hellebrekers *et al.*, (1988) could not confirm this endogenous opioid modulation of osmolality-regulated VP release in conscious dogs subjected to hypertonic saline infusion. In contrast, sharp increases in plasma VP have been found in conscious dogs after intravenous administration of the  $\mu$ -type opiate receptor agonist methadone (Hellebrekers *et al.*, 1987).

In addition, a large number of drugs and hormones, among which are glucocorticoids (inhibitory effect), angiotensin II, and corticotropin-releasing factor (stimulatory effect), influence VP secretion (Berl and Robertson, 2000).

#### 4. VP Action and Aquaporin-2

The biological effects of VP are mediated by three receptor subtypes: V1 receptors on blood vessels, V2 receptors on renal collecting duct epithelia, and V3 receptors (also termed V1b) responsible for the stimulation of adrenocorticotropin from the AL (Birnbauer, 2000; Robinson and Verbalis, 2003).

The major role of VP is to regulate body fluid homeostasis by affecting water resorption. An increase in plasma VP results in increased water retention, which maintains plasma osmolality between narrow limits. The antidiuretic effect is achieved by promoting the reabsorption of solute-free water in the distal and collecting tubules of the kidney. In the

absence of VP, this portion of the nephron is not permeable to water and the hypotonic filtrate of the ascending limb of Henle's loop passes unmodified through the distal tubule and collecting duct. In this condition urine osmolality decreases to around 80 mOsm/kg. Binding of VP to its V2 receptor in collecting duct cell membranes initiates a signal transduction cascade leading to an intracellular increase in cAMP (Jard, 1983), activation of protein kinase A (Deen *et al.*, 2000), and subsequent phosphorylation of the water channel protein, the so-called aquaporin-2. In the plasma membranes of highly water-permeable cells, aquaporins (AQPs), a family of integral membrane proteins, function as water-selective channels (Agre *et al.*, 2002; Deen *et al.*, 2000; Nielsen *et al.*, 1995). Seven different renal AQPs (AQP 1-4, 6-8) have been defined thus far, correlating with well-defined segmental permeabilities in the nephron (King and Yasui, 2002). Aquaporin-2 has been characterized as the major VP-regulated water channel and is predominantly localized in the apical membrane and the intracellular vesicles of collecting duct principal cells (Nielsen *et al.*, 1993). In the presence of these water-selective channels, water can move passively along an osmotic gradient—that is, from the distal and collecting duct tubules to the hypertonic renal medulla. After VP withdrawal, aquaporin-2 is redistributed into the cell and water permeability decreases (Nielsen *et al.*, 1995). Urinary excretion of AQP2 closely parallels changes in VP exposure and has been proposed as a reliable marker for collecting duct responsiveness to VP in various physiological states of water homeostasis as well as disorders of water homeostasis. As in humans, urinary AQP2 excretion in dogs closely reflects changes in VP exposure, elicited by water loading, hypertonic saline infusion, and intravenous desmopressin administration and is proposed as a marker for collecting duct responsiveness to VP (van Vonderer *et al.*, 2004c).

Besides this well-known role in the regulation of fluid homeostasis, VP exerts a large variety of effects. Among these is the vasopressor effect, which is mediated by V1 receptors (Liard, 1986). In addition, VP increases glucogenolysis by liver cells, increases ACTH release by adenohypophysis (Lowry *et al.*, 1987), and has several effects on animal behavior (de Wied and Versteeg, 1979). The extrarenal effects on hepatocytes and vascular smooth muscle are exerted through cAMP-independent, calcium-dependent V1 receptors (Jard, 1983).

There is some evidence that in birds AVT, apart from its established antidiuretic action, also has oxytocic properties and participates in normal oviposition (Shimada *et al.*, 1986, 1987). MT does not seem to function in oviposition and its release was found to be negatively correlated with plasma osmolality (Koike *et al.*, 1986).

#### 5. Disease

Disorders of the hypothalamic-neurohypophyseal system resulting in deficiency or excess of VP are known to occur

in domestic animals. Deficient VP release causes the syndrome of diabetes insipidus, which is characterized by insatiable polydipsia and persistent inappropriately dilute urine in the presence of strong osmotic stimuli for VP release. The disease is not uncommon in the dog and cat (Feldman and Nelson, 2004; Rijnberk, 1996) and rare in other species.

VP excess is known as the syndrome of inappropriate ADH (SIADH) secretion or the Schwartz-Bartter syndrome. The VP release is inappropriately high in relation to the plasma osmolality. The resulting defect in water excretion causes hyponatremia, which is the hallmark of SIADH. This condition has been documented as a disease of the dog and at the same time studies of the threshold and sensitivity of VP secretion revealed that it occurred in two forms (Houston *et al.*, 1989; Rijnberk *et al.*, 1988a). The polyuria can be explained by down-regulation of V2 renal receptors resulting from chronic exposure of the kidney to increased VP levels (Rijnberk, 1996; Rijnberk *et al.*, 1988a).

In dogs with primary polydipsia, described as a psychological problem, evidence indicates a primary disturbance in the regulation of VP secretion (van Vonderen *et al.*, 1999) and a wide variation in VP responses to hypertonic stimulation can be found, including a hyperresponse, a hyporesponse, and a nonlinear response (van Vonderen *et al.*, 2004a).

The glucocorticoid excess in Cushing's syndrome is accompanied by (mild) polyuria in the dog. A marked impairment of the osmolality-regulated VP release at the pituitary level may, in concert with a partial VP resistance at the kidney level, be the cause of the corticosteroid-induced polyuria (Biewenga *et al.*, 1991). Chronic liver disease is accompanied by both enhanced activity of the pituitary-adrenocortical axis and disturbances in sodium and water homeostasis. Also in these cases, a profoundly impaired osmoregulation of VP release was found (Rothuizen *et al.*, 1995). Besides hyperadrenocorticism and hepatic failure, other conditions in the dog also lead to secondary or acquired nephrogenic diabetes insipidus. Hypercalcemia (Rijnberk, 1996), pyometra (Heiene *et al.*, 2004), and hyperaldosteronism (Rijnberk *et al.*, 2001) that are marked by polyuria and polydipsia are associated with impaired renal response to VP, either by VP receptor resistance or down-regulation of AQP2.

In dogs with secondary polycythemia, blood hyperviscosity and increased blood volume result in impaired VP release and polyuria (van Vonderen *et al.*, 1997b). In dogs with spontaneous pericardial effusion, moderately elevated plasma VP levels declined rapidly after pericardiocentesis (Stokhof *et al.*, 1994).

## 6. Tests

The diagnosis of VP deficiency requires that it be differentiated from other causes of water diuresis. Following exclusion of conditions such as hyperadrenocorticism,

hyperthyroidism, and hypercalcemia, both nephrogenic diabetes insipidus and primary polydipsia remain as the main differential diagnoses. Urine-specific gravity (Usg) and urine osmolality (Uosm) are used routinely in the dog to assess renal concentrating ability. However, intra- and interindividual variations of these parameters in healthy dogs are much larger than previously thought (van Vonderen *et al.*, 1997a), which complicates the interpretation of findings in pathological conditions. Slightly elevated plasma osmolality may suggest neurogenic or nephrogenic diabetes insipidus, whereas low plasma osmolality may be observed in primary polydipsia. However, in many cases this parameter is not conclusive.

The procedure that is widely used to differentiate these disorders is the modified water-deprivation test, as introduced for the dog by Mulnix *et al.* (1976). In this test maximal urine concentration is induced by several hours of dehydration. Once a plateau in urine osmolality is reached, the effect of an injection with VP is investigated. A further increase in urine osmolality by 50% or more is regarded as diagnostic for VP deficiency.

Although these indirect criteria for VP secretion can usually differentiate between complete neurogenic and complete nephrogenic diabetes insipidus, they cannot differentiate among partial neurogenic, partial nephrogenic, and dipsogenic polyurias. In these situations, direct measurements of plasma VP during hypertonic saline infusion are required (Biewenga *et al.*, 1989). However, the significance of the VP response to hypertonic saline infusion as the gold standard for diagnosis of canine polyuria is complicated by the occurrence in healthy dogs of spontaneous VP pulses and increased VP pulses (to the magnitude of "erratic bursts") during hypertonic saline infusion (van Vonderen *et al.*, 2004b).

Hypersecretion of VP can only be diagnosed by measurements of the circulating concentrations of the hormone (Table 18-8). The basic criterion is the presence of "inappropriately" high VP concentrations in relation to the hypoosmolality of the extracellular fluid. The type of the osmoregulatory defect can best be judged by repeatedly measuring plasma osmolality and VP during administration of hypertonic saline (Rijnberk *et al.*, 1988a). Details of this test are given in Section IV.

Measurement of urinary excretion of AQP2 may become a diagnostic tool in dogs for differentiation of polyuric conditions such as (partial) central or nephrogenic diabetes insipidus, primary polydipsia, and inappropriate VP release (van Vonderen *et al.*, 2004c).

## B. Oxytocin

### 1. Gene Expression

The oxytocin (OT) gene expression is predominantly found in the hypothalamic supraoptic nucleus and paraventricular nucleus (Burbach *et al.*, 1986). The neurons project

**TABLE 18-8** Concentrations of Neurohypophyseal Hormones in Plasma of Healthy Animals<sup>a</sup>

Hormone (Unit)	Species (n)	Condition	Mean ± SEM (Range)	Reference
VP (pmol/liter)	Dog (8)	basal	3.2 ± 0.3	(van Vonderen <i>et al.</i> , 2004b)
	Dog (8)	hypertonic saline	15.3 ± 3.4	(van Vonderen <i>et al.</i> , 2004b)
	Goat	basal	1.3 ± 0.2	(Thornton <i>et al.</i> , 1986)
	Calf (16)	basal	1.3 ± 0.2 <sup>b</sup>	(Doris and Bell, 1984)
	Calf (16)	4 days dehydration	16.9 ± 1.9 <sup>b</sup>	(Doris and Bell, 1984)
OT (pmol/liter)	Dog (10)	1st week lactation	(15–66)	(Eriksson <i>et al.</i> , 1987)
	Cow (334)	before milking	1.6 ± 0.6	(Schams <i>et al.</i> , 1983)
	Sow (9)	6–12 days postpartum	<10	(Porter <i>et al.</i> , 1992)
	Sow (9)	idem, suckling	(24.9–74.6)	(Porter <i>et al.</i> , 1992)
	Goat	basal	4.5 ± 1.0	(Thornton <i>et al.</i> , 1986)

<sup>a</sup> 1 ng/liter VP = 0.932 pmol/liter; 1 ng/liter OT = 0.994 pmol/liter.

<sup>b</sup> In  $\mu$ U/ml.

mainly to the posterior pituitary, where OT is secreted for endocrine stimulation of parturition and lactation, while other neurons project to higher brain centers, where OT may be converted by brain peptidases and exert an effect as a neurotransmitter or neuromodulator (van Wimersma Greidanus *et al.*, 1986). Together with VP, the neuropeptide OT is a critical mediator of partner preference, and plays a central role in monogamy in prairie voles (Young and Wang, 2004). Oxytocin seems to be more important in females and may regulate mother-infant bonding in sheep.

The organization of the OT gene closely resembles that of the VP gene. The exon-intron organization is similar, with the exception that exon 3 lacks a glycoprotein domain. In the cow, among 194 bases of the 3' part of exon 2, no single base is different from the corresponding one in the VP exon 2. Exon 3 shows the least homology between the VP and OT genes (Ivell and Richter, 1985).

The expression of OT mRNA is regulated by the same intergenic region that regulates VP expression (Fields *et al.*, 2003). Estrogens greatly induce bovine OT mRNA expression although the OT promoter has response elements for estrogen receptors. The estrogenic stimulation appeared to be dependent on the nuclear orphan receptor ERR $\alpha$  through the MAP kinase pathway (Koohi *et al.*, 2005).

In bovine granulosa cells, LH has been found to stimulate OT gene transcription. Also, estrogens can stimulate bovine OT expression in heterologous transfection systems in contrast to human and rat OT promoters. Other transcription factors are related to induced (steroidogenic factor-1 [SF-1]) or inhibited (COUP-TF) OT mRNA expression (Stormshak, 2003).

## 2. (Pro)hormone

After translation of the mRNA, proteolytic enzymes cleave OT from neurophysin I, and a C-terminal amidation of OT occurs. This posttranslational processing is time dependent,

as for the biotransformation of the AVP prohormone. Through modification of the first three amino acids a potent OT antagonist is developed, from which newer analogues are designed with even higher OT antioxytotic properties (Flouret *et al.*, 2006).

## 3. Secretion

The release of OT is most abundant during parturition and the lactation period. The main stimuli for the release of OT from the posterior pituitary therefore arise from either the nipples during milking (Lupoli *et al.*, 2001) or suckling, or from vaginal and cervical distension. The suckling-related release of OT has been documented in the dog (Eriksson *et al.*, 1987). The neural regulation of OT release is complex. Both dopamine and opioid peptides (enkephalin and  $\beta$ -endorphin) modulate OT release at the nerve terminals in the NL (Forsling, 1986). Opioid effects on posterior pituitary pituicytes may mediate this interaction. There is some evidence that OT is released in response to osmotic challenge in the rat and some carnivores but not in primates or ungulates (Thornton *et al.*, 1987).

Plasma OT levels may also vary during the reproductive cycle. Generally, a similar secretion pattern is found among domestic animals. Plasma levels increase after the preovulatory LH surge and decrease at the time of luteal regression, in the cow, goat, and sheep (Schams, 1983). In the mare, plasma OT levels are lower in the midluteal phase than on day 2 of estrus and day 5 after ovulation (Burns *et al.*, 1981). The latter is more closely to the pattern of OT release in humans. The high OT content of the corpus luteum of the sheep and the cow may mean that the majority of the circulating OT is derived from the ovary in these species.

Ovarian estrogen may enhance pituitary OT release, whereas progesterone inhibits it. In male animals, mating may be a stimulatory factor. Nonreproductive factors such as stress and plasma osmolality may also influence the OT release (Forsling, 1986).

#### 4. Action

OT causes contraction of the myoepithelial elements of the excretory ducts of the mammary glands, resulting in milk ejection. In addition, it exerts a constricting effect on the uterine muscle. Estrogens increase the response of the uterus to OT, whereas progesterone inhibits it. During pregnancy, the sensitivity of the uterus to OT is greatly reduced. However, during delivery and immediately thereafter, the uterus is particularly sensitive to OT. In birds, AVT is far more active in stimulating the contraction of the oviduct than is OT (Bentley, 1971).

#### 5. Disease/Tests

To our knowledge no pituitary dysfunction concerning OT release in domestic animals has been reported. Basal plasma levels of OT are in approximately the same range as plasma VP concentrations (Table 18-8). In the human and the goat (Thornton *et al.*, 1986), OT release cannot be stimulated by hypertonic saline infusion but does increase in response to insulin-induced hypoglycemia (Nussey *et al.*, 1986). In the rat, nausea-producing chemical agents and cholecystokinin cause a dose-dependent increase in OT (Verbalis *et al.*, 1986).

### IV. ASSESSMENT OF PITUITARY FUNCTION

Endocrine studies in animals with suspected hypothalamus-pituitary disease may be carried out for three reasons: (1) documentation of specific endocrine deficits; (2) insight into the type, size, and progression of the lesion; and (3) characterization of hyperfunction. Specific diagnostic tests for several of the pituitary hormones have been described in the previous sections. Here the discussion will concentrate on a more general approach in an attempt to determine the extent of involvement of AL, IL, or NL.

#### A. Adenohypophysis

##### 1. Anterior Lobe

The species specificity of some of the AL hormones precludes their measurement in several animal species with the assays available. For many other hormones, however, homologous or heterologous assays are available, allowing assessment of AL function.

Although baseline hormone levels can provide much information, the pulsatile nature of AL hormone secretion often makes interpretation difficult. It is particularly difficult to distinguish between normal and low levels of these hormones. For this reason, provocative tests should be used to examine hypothalamus-pituitary adequacy. Now that hypothalamic-releasing hormones have become available and are

applicable in most species, appropriate testing of AL function is possible.

In all instances blood samples are collected at -15, 0, 10, 20, 30, and 45 min (for the short test), and 60, 90, and 120 min (for the long test) for measurement of the pituitary hormones. At time zero the test substance is injected intravenously. It may be one of the following:

1. 1  $\mu$ g GHRH/kg, 2  $\mu$ g ghrelin/kg, or 10  $\mu$ g clonidine/kg to test GH and IGF-1 secretion.
2. 1  $\mu$ g CRH/kg or 0.6  $\mu$ g lysine vasopressin/kg to test ACTH (+cortisol) secretion.
3. 10  $\mu$ g TRH/kg to test PRL or TSH secretion (see Section II.C.2).
4. 10  $\mu$ g GnRH/kg to test FSH or LH secretion.

Because of the rapid proteolytic degradation of some pituitary hormones, blood samples should always be chilled on ice as soon as possible and stored at  $\leq 20^{\circ}\text{C}$  (see also Section V.E of Chapter 19 on adrenocortical function).

Combined function tests are coming into use in humans. The anterior pituitary is stimulated with four hypothalamic-releasing hormones in a single procedure. Despite the fact that there is some interaction of the different releasing hormones, combined administration of releasing hormones seems to be a useful test for the assessment of pituitary function (Schopohl *et al.*, 1986). Such a combined function test has been introduced for the dog. In this test, the anterior pituitary is stimulated with four hypothalamic-releasing hormones (CRH, GHRH, TRH, and GnRH) with measurements of ACTH (+cortisol), GH, PRL, TSH, and LH (Meij *et al.*, 1996a, 1996b). Compared with the single administration of these secretagogues, there is little interference in this test, except for the LH response, which is lower in the combined test than following single GnRH administration. The test has been used successfully to document combined pituitary hormone deficiency in German shepherd dogs with dwarfism (Kooistra *et al.*, 2000c) and to document AL function in bitches treated with medroxyprogesterone acetate (Beijerink *et al.*, 2007).

##### 2. Intermediate Lobe

$\alpha$ -MSH is secreted specifically by the IL. Its release can be stimulated with dopamine agonists such as haloperidol in a dose of 0.2 mg/kg (Table). The times of sampling for  $\alpha$ -MSH can be as for the tests of adenohypophyseal function (see Section IV.A), and the test has been used to document IL function before and after hypophysectomy in dogs (Meij *et al.*, 1997c).

#### B. Neurohypophysis

As explained in Section III.A, VP secretion can be examined indirectly by means of a modified water-deprivation



test and directly by measuring plasma VP during hypertonic saline infusion. Both procedures are described here in detail, as they have been developed for use in the dog (Biewenga *et al.*, 1987; Mulnix *et al.*, 1976). It should be noted that because of interference of plasma proteins, the radioimmunoassay for VP requires prior extraction of the peptide with ethanol and validation of the assay for the dog (Biewenga *et al.*, 1991; Hellebrekers *et al.*, 1987). Antisera against AVP may possess 100% cross-reactivity with AVT (Choy and Watkins, 1986; Hellebrekers *et al.*, 1987).

### 1. Modified Water-Deprivation Test

#### a. Indication

Differentiation between neurogenic and nephrogenic diabetes insipidus, when the administration of DDAVP (Minirin) has not resolved the diagnosis.

#### b. Procedure

Following 12h of fasting, water is withheld and plasma and urine are collected every hour or 2h, depending on the severity of the polyuria. Osmolality is measured in both samples. At each collection the animal is weighed. When the weight loss approaches 5% of initial body weight, the test should be stopped.

When, in the presence of an adequate osmotic stimulus ( $\text{Posm} > 305 \text{ mOsm/kg}$ ), urine concentration is maximal (less than 5% increase in  $\text{Uosm}$  between consecutive collections), 2IU of lysine vasopressin are administered subcutaneously.  $\text{Uosm}$  is measured again 1h later.

#### c. Interpretation

In both nephrogenic diabetes insipidus and neurogenic diabetes insipidus,  $\text{Uosm}$  will remain low during water deprivation. In neurogenic diabetes insipidus,  $\text{Uosm}$  will rise by 50% or more following the injection of vasopressin, whereas in nephrogenic diabetes insipidus, there will be little or no rise in  $\text{Uosm}$ .

However, as mentioned earlier, in some cases the outcome may not be conclusive and erroneous results may also occur.

### 2. VP Measurements during Hypertonic Saline Infusion

#### a. Indications

Differential diagnosis of polyuric conditions and suspicion of inappropriate VP secretion.

#### b. Procedure

The euhydrated animal is infused for 2h via the jugular vein with 20% NaCl solution at a rate of 0.03 ml/kg body weight per minute. Samples for plasma VP and  $\text{Posm}$  are obtained at 20-minute intervals. Especially in the severely polyuric animal, there is a risk of inducing critical

hypertonicity. In these cases the samples collected at 0, 40, and 80 min should be checked for  $\text{Posm}$  immediately.

#### c. Interpretation

The slope of the regression line for  $\text{Posm}$  and plasma VP concentration is used as a measure of the sensitivity of the osmoregulatory system. In the nomogram developed by Biewenga *et al.*, (1987), the 90% range for sensitivity was 0.24 to 2.47 (pg/ml)/(mOsm/kg). The 90% range for the threshold of the system was 276 to 309 mOsm/kg. After hypophysectomy in the dog, there is no VP response to hypertonic saline infusion (Meij *et al.*, 1997c).

However, as mentioned earlier, the occurrence of spontaneous VP pulses makes it difficult to differentiate these from VP pulses (to the magnitude of “erratic bursts”) during hypertonic saline infusion (van Vonderen *et al.*, 2004b).

## REFERENCES

- Agre, P., King, L. S., Yasui, M., Guggino, W. B., Ottersen, O. P., Fujiyoshi, Y., Engel, A., and Nielsen, S. (2002): Aquaporin water channels—from atomic structure to clinical medicine. *J. Physiol.* **542**, 3–16.
- Alam, S. M., Ain, R., Konno, T., Ho-Chen, J. K., and Soares, M. J. (2006): The rat prolactin gene family locus: species-specific gene family expansion. *Mamm. Genome* **17**, 858–877.
- Alexander, S. L., and Irvine, C. H. (2000): The effect of the alpha-2-adrenergic agonist, clonidine, on secretion patterns and rates of adrenocorticotrophic hormone and its secretagogues in the horse. *J. Neuroendocrinol.* **12**, 874–880.
- Alexander, S. L., Irvine, C. H., and Donald, R. A. (1994). Short-term secretion patterns of corticotropin-releasing hormone, arginine vasopressin and ACTH as shown by intensive sampling of pituitary venous blood from horses. *Neuroendocrinology*. **60**, 225–236.
- Alexander, S. L., Irvine, C. H., and Donald, R. A. (1996). Dynamics of the regulation of the hypothalamo-pituitary-adrenal (HPA) axis determined using a nonsurgical method for collecting pituitary venous blood from horses. *Front. Neuroendocrinol.* **17**, 1–50.
- Alexander, S. L., Irvine, C. H., Ellis, M. J., and Donald, R. A. (1991). The effect of acute exercise on the secretion of corticotropin-releasing factor, arginine vasopressin, and adrenocorticotropin as measured in pituitary venous blood from the horse. *Endocrinology* **128**, 65–72.
- Alexander, S. L., Irvine, C. H., Livesey, J. H., and Donald, R. A. (1993). The acute effect of lowering plasma cortisol on the secretion of corticotropin-releasing hormone, arginine vasopressin, and adrenocorticotropin as revealed by intensive sampling of pituitary venous blood in the normal horse. *Endocrinology* **133**, 860–866.
- Alexander, S. L., Roud, H. K., and Irvine, C. H. (1997). Effect of insulin-induced hypoglycaemia on secretion patterns and rates of corticotropin-releasing hormone, arginine vasopressin and adrenocorticotrophin in horses. *J. Endocrinol.* **153**, 401–409.
- Altmann, M., Sauerwein, H., and von Borell, E. (2006). The relationships between leptin concentrations and body fat reserves in lambs are reduced by short-term fasting. *J. Anim. Physiol. Anim. Nutr. (Berl.)* **90**, 407–413.
- Amann, J. F., Smith, R. M., Ganjam, V. K., Paull, W. K., McClure, R. C., Green, E. M., and Garner, H. E. (1987). Distribution and implications

- of beta-endorphin and ACTH-immunoreactive cells in the intermediate lobe of the hypophysis in healthy equids. *Am. J. Vet. Res.* **48**, 323–327.
- Amar, A. P., and Weiss, M. H. (2003). Pituitary anatomy and physiology. *Neurosurg. Clin. N. Am.* **14**, v, 11–23.
- Andresen, E., and Willeberg, P. (1977). Pituitary dwarfism in Carelian bear-dogs: evidence of simple, autosomal recessive inheritance. *Hereditas* **84**, 232–234.
- Andresen, E., Willeberg, P., and Rasmussen, P. G. (1974). Pituitary dwarfism in German shepherd dogs: genetic investigations. *Nord. Vet. Med.* **26**, 692–701.
- Andrews, Z. B. (2005). Neuroendocrine regulation of prolactin secretion during late pregnancy: easing the transition into lactation. *J. Neuroendocrinol.* **17**, 466–473.
- Antakly, T., Mercille, S., and Cote, J. P. (1987). Tissue-specific dopaminergic regulation of the glucocorticoid receptor in the rat pituitary. *Endocrinology* **120**, 1558–1562.
- Antakly, T., Sasaki, A., Liotta, A. S., Palkovits, M., and Krieger, D. T. (1985). Induced expression of the glucocorticoid receptor in the rat intermediate pituitary lobe. *Science* **229**, 277–279.
- Antoni, F. A. (1986). Hypothalamic control of adrenocorticotropin secretion: advances since the discovery of 41-residue corticotropin-releasing factor. *Endocr. Rev.* **7**, 351–378.
- Apaja, P. M., Aatsinki, J. T., Rajaniemi, H. J., and Petaja-Repo, U. E. (2005). Expression of the mature luteinizing hormone receptor in rodent urogenital and adrenal tissues is developmentally regulated at a posttranslational level. *Endocrinology* **146**, 3224–3232.
- Art, T., Franchimont, P., and Lekeux, P. (1994). Plasma beta-endorphin response of thoroughbred horses to maximal exercise. *Vet. Rec.* **135**, 499–503.
- Banks, D. R., Paape, S. R., and Stabenfeldt, G. H. (1983). Prolactin in the cat: I. Pseudopregnancy, pregnancy and lactation. *Biol. Reprod.* **28**, 923–932.
- Baratta, M., Turzillo, A. M., Arreguin-Arevalo, A., Clay, C. M., and Nett, T. M. (2003). Regulation of genes encoding steroidogenic factor-1 (SF-1) and gonadotropin subunits in the ovine pituitary gland. *Domest. Anim. Endocrinol.* **25**, 121–131.
- Batten, T. F. C., and Ingleton, P. M. (1987). The structure and function of the hypothalamus and pituitary gland. In “Fundamentals of Comparative Vertebrate Endocrinology” (I. Chester-Jones, P. M. Ingleton, and J. G. Phillips, Eds.), p. 285. Plenum Press, New York.
- Beerden, B., Kornalijnslijper, J. E., van der Werf, J. T., Noordhuizen-Stassen, E. N., and Hopster, H. (2004). Effects of milk production capacity and metabolic status on HPA function in early postpartum dairy cows. *J. Dairy Sci.* **87**, 2094–2102.
- Beijerink, N. J., Bhatti, S. F., Okkens, A. C., Dieleman, S. J., Mol, J. A., Duchateau, L., Van Ham, L. M., and Kooistra, H. S. (2006). Adenohypophyseal function in bitches treated with medroxyprogesterone acetate. *Domest. Anim. Endocrinol.* **32**, 63–78.
- Beijerink, N. J., Kooistra, H. S., Dieleman, S. J., and Okkens, A. C. (2004). Serotonin antagonist-induced lowering of prolactin secretion does not affect the pattern of pulsatile secretion of follicle-stimulating hormone and luteinizing hormone in the bitch. *Reproduction* **128**, 181–188.
- Ben-Jonathan, N., Mershon, J. L., Allen, D. L., and Steinmetz, R. W. (1996). Extrapituitary prolactin: distribution, regulation, functions, and clinical aspects. *Endocr. Rev.* **17**, 639–669.
- Bentley, P. J. (1971). The Placental Mammals. “Endocrines and Osmoregulation,” p. 111. Springer Verlag, Berlin.
- Berkenbosch, F., Vermes, I., Binnekade, R., and Tilders, F. J. (1981). Beta-adrenergic stimulation induces an increase of the plasma levels of immunoreactive alpha-MSH, beta-endorphin, ACTH and of corticosterone. *Life Sci.* **29**, 2249–2256.
- Berl, T., and Robertson, G. L. (2000). Disorders of water balance. In “Brenner and Rector’s the Kidney” (B. M. Brenner, Ed.), p. 866. Saunders, Philadelphia.
- Bertile, F., and Raclot, T. (2006). The melanocortin system during fasting. *Peptides* **27**, 291–300.
- Beyers, M. M., and Dieleman, S. J. (1987). Effect of chronic treatment with bromocriptine on the corpus luteum function of the cow. *Anim. Reprod. Sci.* **14**, 95.
- Beyers, M. M., Dieleman, S. J., Kruip, T. A. M., and Willemse, A. H. (1987). Follicular development in heifers chronically treated with bromocriptine. In “Follicular Growth and Ovulation Rate in Farm Animals” (J. F. Rocke and D. O’Callaghan, Eds.), p. 45. Martinus Nijhoff, Dordrecht.
- Beyers, M. M., and Izadyar, F. (2002). Role of growth hormone and growth hormone receptor in oocyte maturation. *Mol. Cell. Endocrinol.* **197**, 173–178.
- Beyers, M. M., and Willemse, A. H. (1982). Effect of synthetic TRH on prolactin release in the pig. *Theriogenology* **18**, 303–309.
- Beyers, M. M., Willemse, A. H., and Kruip, T. A. (1978). Plasma prolactin levels in the sow during lactation and the postweaning period as measured by radioimmunoassay. *Biol. Reprod.* **19**, 628–634.
- Beyers, M. M., Willemse, A. H., and Kruip, T. A. (1983). The effect of bromocriptine on luteinizing hormone levels in the lactating sow: evidence for a suppressive action by prolactin and the suckling stimulus. *Acta Endocrinol. (Copenh.)* **104**, 261–265.
- Beyea, J. A., Olson, D. M., and Harvey, S. (2005). Growth hormone expression in the perinatal and postnatal rat lung. *Dev. Dyn.* **232**, 1037–1046.
- Bhatti, S. F., Duchateau, L., Okkens, A. C., Van Ham, L. M., Mol, J. A., and Kooistra, H. S. (2006a). Treatment of growth hormone excess in dogs with the progesterone receptor antagonist aglepristone. *Theriogenology* **66**, 797–803.
- Bhatti, S. F., Duchateau, L., Van Ham, L. M., De Vlieghe, S. P., Mol, J. A., Rijnberk, A., and Kooistra, H. S. (2006b). Effects of growth hormone secretagogues on the release of adenohypophyseal hormones in young and old healthy dogs. *Vet. J.* **172**, 425–515.
- Bhatti, S. F., Hoffland, L. J., van Koetsveld, P. M., Van Ham, L. M., Duchateau, L., Mol, J. A., van der Lely, A. J., and Kooistra, H. S. (2006c). Effects of food intake and food withholding on plasma ghrelin concentrations in healthy dogs. *Am. J. Vet. Res.* **67**, 1557–1563.
- Bhatti, S. F., Rao, N. A., Okkens, A. C., Mol, J. A., Duchateau, L., Ducatelle, R., van den Ingh, T. S., Tshamala, M., Van Ham, L. M., Coryn, M., Rijnberk, A., and Kooistra, H. S. (2006d). Role of progestin-induced mammary-derived growth hormone in the pathogenesis of cystic endometrial hyperplasia in the bitch. *Domest. Anim. Endocrinol.* **33**, 294–312.
- Bhatti, S. F., Van Ham, L. M., Mol, J. A., and Kooistra, H. S. (2006e). Ghrelin, an endogenous growth hormone secretagogue with diverse endocrine and nonendocrine effects. *Am. J. Vet. Res.* **67**, 180–188.
- Biewenga, W. J., Rijnberk, A., and Mol, J. A. (1989). Persistent polyuria in two dogs following adrenocorticolysis for pituitary-dependent hyperadrenocorticism. *Vet. Q.* **11**, 193–197.
- Biewenga, W. J., Rijnberk, A., and Mol, J. A. (1991). Osmoregulation of systemic vasopressin release during long-term glucocorticoid excess: a study in dogs with hyperadrenocorticism. *Acta Endocrinol. (Copenh.)* **124**, 583–588.
- Biewenga, W. J., Van den Brom, W. E., and Mol, J. A. (1987). Vasopressin in Polyuric Syndromes in the Dog. *Front. Horm. Res.* **17**, 139.

- Birnbaumer, M. (2000). Vasopressin receptors. *Trends. Endocrinol. Metab.* **11**, 406–410.
- Boretta, F. S., and Reusch, C. E. (2004). Endogenous TSH in the diagnosis of hypothyroidism in dogs. *Schweiz. Arch. Tierheilkd.* **146**, 183–188.
- Bosje, J. T., Rijnberk, A., Mol, J. A., Voorhout, G., and Kooistra, H. S. (2002). Plasma concentrations of ACTH precursors correlate with pituitary size and resistance to dexamethasone in dogs with pituitary-dependent hyperadrenocorticism. *Domest. Anim. Endocrinol.* **22**, 201–210.
- Bousfield, G. R., Butnev, V. Y., and Butnev, V. Y. (2001). Identification of twelve O-glycosylation sites in equine chorionic gonadotropin beta and equine luteinizing hormone ss by solid-phase Edman degradation. *Biol. Reprod.* **64**, 136–147.
- Boyd, W. H. (1987). Non-secretory neuronal elements in the bovine pituitary intermediate lobe. *Anat. Anz.* **164**, 117–128.
- Breier, B. H., Bass, J. J., Butler, J. H., and Gluckman, P. D. (1986). The somatotrophic axis in young steers: influence of nutritional status on pulsatile release of growth hormone and circulating concentrations of insulin-like growth factor 1. *J. Endocrinol.* **111**, 209–215.
- Breuhaus, B. A. (2002). Thyroid-stimulating hormone in adult euthyroid and hypothyroid horses. *J. Vet. Intern. Med.* **16**, 109–115.
- Brown, P., and McNeilly, A. S. (1999). Transcriptional regulation of pituitary gonadotrophin subunit genes. *Rev. Reprod.* **4**, 117–124.
- Buckingham, J. C. (1987). Vasopressin receptors influencing the secretion of ACTH by the rat adenohypophysis. *J. Endocrinol.* **113**, 389–396.
- Bunn, R. C., and Fowlkes, J. L. (2003). Insulin-like growth factor binding protein proteolysis. *Trends Endocrinol. Metab.* **14**, 176–181.
- Burbach, J. P., Luckman, S. M., Murphy, D., and Gainer, H. (2001). Gene regulation in the magnocellular hypothalamo-neurohypophysial system. *Physiol. Rev.* **81**, 1197–1267.
- Burbach, J. P., Van Tol, H. H., Bakkus, M. H., Schmale, H., and Ivell, R. (1986). Quantitation of vasopressin mRNA and oxytocin mRNA in hypothalamic nuclei by solution hybridization assays. *J. Neurochem.* **47**, 1814–1821.
- Burns, P. J., Kumaresan, P., and Douglas, R. H. (1981). Plasma oxytocin concentrations in cyclic mares and sexually aroused stallions. *Theriogenology* **16**, 531–539.
- Burrows, H. L., Douglas, K. R., Seasholtz, A. F., and Camper, S. A. (1999). Genealogy of the Anterior Pituitary Gland: Tracing a Family Tree. *Trends Endocrinol. Metab.* **10**, 343–352.
- Caraty, A., Grino, M., Locatelli, A., Guillaume, V., Boudouresque, F., Conte-Devolx, B., and Oliver, C. (1990). Insulin-induced hypoglycemia stimulates corticotropin-releasing factor and arginine vasopressin secretion into hypophysial portal blood of conscious, unrestrained rams. *J. Clin. Invest.* **85**, 1716–1721.
- Chen, J. W., Hojlund, K., Beck-Nielsen, H., Sandahl Christiansen, J., Orskov, H., and Frystyk, J. (2005). Free rather than total circulating insulin-like growth factor-I determines the feedback on growth hormone release in normal subjects. *J. Clin. Endocrinol. Metab.* **90**, 366–371.
- Chowen, J. A., Frago, L. M., and Argente, J. (2004). The regulation of GH secretion by sex steroids. *Eur. J. Endocrinol.* **151(suppl 3)**, U95–U100.
- Choy, V. J., and Watkins, W. B. (1986). HPLC separation of vasopressin-like hormones in chicken neurohypophysial extracts. *Neuropeptides* **8**, 183–191.
- Christoffolete, M. A., Ribeiro, R., Singru, P., Fekete, C., da Silva, W. S., Gordon, D. F., Huang, S. A., Crescenzi, A., Harney, J. W., Ridgway, E. C., Larsen, P. R., Lechan, R. M., and Bianco, A. C. (2006). Atypical expression of type 2 iodothyronine deiodinase in thyrotrophs explains the thyroxine-mediated pituitary thyrotropin feedback mechanism. *Endocrinology* **147**, 1735–1743.
- Clapp, C., Gonzalez, C., Macotela, Y., Aranda, J., Rivera, J. C., Garcia, C., Guzman, J., Zamorano, M., Vega, C., Martin, C., Jeziorski, M. C., and de la Escalera, G. M. (2006). Vasoinhibins: a family of N-terminal prolactin fragments that inhibit angiogenesis and vascular function. *Front. Horm. Res.* **35**, 64–73.
- Clarke, I. J., Clements, J. A., Cummins, J. T., Dench, F., Smith, A. I., Robinson, P. M., and Funder, J. W. (1986). Elevated plasma levels of pro-opiomelanocortin-derived peptides in sheep following hypothalamo-pituitary disconnection. *Neuroendocrinology* **44**, 508–514.
- Clarke, I. J., and Cummins, J. T. (1982). The temporal relationship between gonadotropin releasing hormone (GnRH) and luteinizing hormone (LH) secretion in ovariectomized ewes. *Endocrinology* **111**, 1737–1739.
- Cohen, L. E., and Radovick, S. (2002). Molecular basis of combined pituitary hormone deficiencies. *Endocr. Rev.* **23**, 431–442.
- Concannon, P. W., Butler, W. R., Hansel, W., Knight, P. J., and Hamilton, J. M. (1978). Parturition and lactation in the bitch: serum progesterone, cortisol and prolactin. *Biol. Reprod.* **19**, 1113–1118.
- Concannon, P. W., Temple, M., Montanez, A., and Newton, L. (2006). Effects of dose and duration of continuous GnRH-agonist treatment on induction of estrus in beagle dogs: competing and concurrent up-regulation and down-regulation of LH release. *Theriogenology* **66**, 1488–1496.
- Conti, M., Hsieh, M., Park, J. Y., and Su, Y. Q. (2006). Role of the epidermal growth factor network in ovarian follicles. *Mol. Endocrinol.* **20**, 715–723.
- Corrada, Y., Castex, G., Sosa, Y., and Gobello, C. (2003). Secretory patterns of prolactin in dogs: circannual and ultradian rhythms. *Reprod. Domest. Anim.* **38**, 219–223.
- Corrada, Y., Rimoldi, I., Arreseigor, S., Marecco, G., and Gobello, C. (2006). Prolactin reference range and pulsatility in male dogs. *Theriogenology* **66**, 1599–1602.
- Dasen, J. S., and Rosenfeld, M. G. (2001). Signaling and transcriptional mechanisms in pituitary development. *Annu. Rev. Neurosci.* **24**, 327–355.
- Daughaday, W. H., Hall, K., Salmon, W. D., Jr., Van den Brande, J. L., and Van Wyk, J. J. (1987). On the nomenclature of the somatomedins and insulin-like growth factors. *J. Clin. Endocrinol. Metab.* **65**, 1075–1076.
- Davicco, M. J., Faulconnier, Y., Coxam, V., Dubroeuq, H., Martin-Rosset, W., and Barlet, J. P. (1994). Systemic bone growth factors in light breed mares and their foals. *Arch. Int. Physiol. Biochim. Biophys.* **102**, 115–119.
- Davies, T. F., Ando, T., Lin, R. Y., Tomer, Y., and Latif, R. (2005). Thyrotropin receptor-associated diseases: from adenomata to Graves disease. *J. Clin. Invest.* **115**, 1972–1983.
- De Coster, R., Beckers, J. F., Beerens, D., and De Mey, J. (1983). A homologous radioimmunoassay for canine prolactin: plasma levels during the reproductive cycle. *Acta Endocrinol. (Copenh.)* **103**, 473–478.
- de Gier, J., Kooistra, H. S., Djajadiningrat-Laanen, S. C., Dieleman, S. J., and Okkens, A. C. (2006). Temporal relations between plasma concentrations of luteinizing hormone, follicle-stimulating hormone, estradiol-17beta, progesterone, prolactin, and alpha-melanocyte-stimulating hormone during the follicular, ovulatory, and early luteal phase in the bitch. *Theriogenology* **65**, 1346–1359.
- de Kloet, E. R., van der Vies, J., and de Wied, D. (1974). The site of the suppressive action of dexamethasone on pituitary-adrenal activity. *Endocrinology* **94**, 61–73.

- De Palo, E. F., Gatti, R., Antonelli, G., and Spinella, P. (2006). Growth hormone isoforms, segments/fragments: does a link exist with multifunctionality? *Clin. Chim. Acta* **364**, 77–81.
- de Wied, D., and Versteeg, D. H. (1979). Neurohypophyseal principles and memory. *Fed. Proc.* **38**, 2348–2354.
- Debeljuk, L., and Lasaga, M. (2006). Tachykinins and the control of prolactin secretion. *Peptides* **27**, 3007–3019.
- DeBold, C. R., Menefee, J. K., Nicholson, W. E., and Orth, D. N. (1988). Proopiomelanocortin gene is expressed in many normal human tissues and in tumors not associated with ectopic adrenocorticotropin syndrome. *Mol. Endocrinol.* **2**, 862–870.
- Deen, P. M., van Balkom, B. W., and Kamsteeg, E. J. (2000). Routing of the aquaporin-2 water channel in health and disease. *Eur. J. Cell. Biol.* **79**, 523–530.
- Deis, R. P., and Alonso, N. (1985). The role of estrogen in prolactin release induced by progesterone in pseudopregnant rats. In “Prolactin, Basic and Clinical Correlates” (R. M. MacLeod, M. O. Thorner, and U. Scapagini, Eds.), p. 307. Liviana Press, Padova.
- Denef, C. (1994). Paracrine mechanisms in the Pituitary. “Pituitary Gland,” p. 351. Raven, New York.
- Diaz Espineira, M. M., Mol, J. A., Peeters, M. E., Pollak, Y. W. E. A., Iversen, L. I., Van Dijk, J. E., Rijnberk, A., and Kooistra, H. S. (2006). Assessment of thyroid function in dogs with low plasma thyroxine concentration. *J. Vet. Intern. Med.* **21**, 25–32.
- Dieleman, S. J., Bevers, M. M., Van Tol, H. T. M., and Willemse, A. H. (1986). Peripheral plasma concentrations of oestradiol, progesterone, cortisol, LH and prolactin during the oestrous cycle in the cow, with emphasis on the peri-oestrous period. *Anim. Reprod. Sci.* **10**, 275.
- Dores, R. M., Wilhelm, M. W., and Sandoval, D. M. (1987). Steady-state analysis of alpha-melanotropin in the pars intermedia of *Anolis carolinensis*: effect of background adaptation. *Gen. Comp. Endocrinol.* **68**, 153–160.
- Doris, P. A., and Bell, F. R. (1984). Vasopressin in plasma and cerebrospinal fluid of hydrated and dehydrated steers. *Neuroendocrinology* **38**, 290–296.
- Douchi, T., Nakae, M., Yamamoto, S., Iwamoto, I., Oki, T., and Nagata, Y. (2001). A woman with isolated prolactin deficiency. *Acta Obstet. Gynecol. Scand.* **80**, 368–370.
- Drouin, J., Lamolet, B., Lamonerie, T., Lanctot, C., and Tremblay, J. J. (1998). The PTX family of homeodomain transcription factors during pituitary developments. *Mol. Cell. Endocrinol.* **140**, 31–36.
- Dubois, P. M., el Amraoui, A., and Heritier, A. G. (1997). Development and differentiation of pituitary cells. *Microsc. Res. Tech.* **39**, 98–113.
- Eigenmann, J. E. (1984). Acromegaly in the dog. *Vet. Clin. North Am. Small Anim. Pract.* **14**, 827–836.
- Eigenmann, J. E., Amador, A., and Patterson, D. F. (1988). Insulin-like growth factor I levels in proportionate dogs, chondrodystrophic dogs and in giant dogs. *Acta Endocrinol. (Copenh.)* **118**, 105–108.
- Eigenmann, J. E., de Bruijne, J. J., and Froesch, E. R. (1985). Insulin-like growth factor I and growth hormone in canine starvation. *Acta Endocrinol. (Copenh.)* **108**, 161–166.
- Eigenmann, J. E., and Eigenmann, R. Y. (1981). Radioimmunoassay of canine growth hormone. *Acta Endocrinol. (Copenh.)* **98**, 514–520.
- Eigenmann, J. E., Eigenmann, R. Y., Rijnberk, A., van der Gaag, I., Zapf, J., and Froesch, E. R. (1983a). Progesterone-controlled growth hormone overproduction and naturally occurring canine diabetes and acromegaly. *Acta Endocrinol. (Copenh.)* **104**, 167–176.
- Eigenmann, J. E., Lubberink, A. A. M. E., and Koeman, J. P. (1983b). Panhypopituitarism caused by a suprasellar tumor in a dog. *J. Am. Anim. Hosp. Assoc.* **19**, 377.
- Eigenmann, J. E., Patterson, D. F., and Froesch, E. R. (1984a). Body size parallels insulin-like growth factor I levels but not growth hormone secretory capacity. *Acta Endocrinol. (Copenh.)* **106**, 448–453.
- Eigenmann, J. E., Patterson, D. F., Zapf, J., and Froesch, E. R. (1984b). Insulin-like growth factor I in the dog: a study in different dog breeds and in dogs with growth hormone elevation. *Acta Endocrinol. (Copenh.)* **105**, 294–301.
- Eigenmann, J. E., and Rijnberk, A. (1981). Influence of medroxyprogesterone acetate (Provera) on plasma growth hormone levels and on carbohydrate metabolism. I. Studies in the ovariectomized bitch. *Acta Endocrinol. (Copenh.)* **98**, 599–602.
- Eigenmann, J. E., Wortman, J. A., and Haskins, M. E. (1984c). Elevated growth hormone levels and diabetes mellitus in a cat with acromegalic features. *J. Am. Anim. Hosp. Assoc.* **20**, 747–752.
- Ellsworth, B. S., Egashira, N., Haller, J. L., Butts, D. L., Cocquet, J., Clay, C. M., Osamura, R. Y., and Camper, S. A. (2006). FOXL2 in the Pituitary: Molecular, Genetic and Developmental Analysis. *Mol. Endocrinol.* **20**, 2796–2805.
- Eriksson, M., Linden, A., Stock, S., and Uvnäs-Moberg, K. (1987). Increased levels of vasoactive intestinal peptide (VIP) and oxytocin during suckling in lactating dogs. *Peptides* **8**, 411–413.
- Estienne, M. J., and Barb, C. R. (2005). The control of adenohipophysial hormone secretion by amino acids and peptides in swine. *Domest. Anim. Endocrinol.* **29**, 34–42.
- Everts, R. E., Rothuizen, J., and van Oost, B. A. (2000). Identification of a premature stop codon in the melanocyte-stimulating hormone receptor gene (MC1R) in Labrador and Golden retrievers with yellow coat colour. *Anim. Genet.* **31**, 194–199.
- Fares, F. (2006). The role of O-linked and N-linked oligosaccharides on the structure-function of glycoprotein hormones: development of agonists and antagonists. *Biochim. Biophys. Acta* **1760**, 560–567.
- Farmerie, T. A., Abbud, R. A., Budworth, P. R., Clay, C. M., Keri, R. A., McDowell, K. J., Wolfe, M. W., and Nilson, J. H. (1997). Characterization of the equine glycoprotein hormone alpha-subunit gene reveals divergence in the mechanism of pituitary and placental expression. *Biol. Reprod.* **57**, 1104–1114.
- Favier, R. P., Mol, J. A., Kooistra, H. S., and Rijnberk, A. (2001). Large body size in the dog is associated with transient GH excess at a young age. *J. Endocrinol.* **170**, 479–484.
- Feldman, E. C. (1983). Distinguishing dogs with functioning adrenocortical tumors from dogs with pituitary-dependent hyperadrenocorticism. *J. Am. Vet. Med. Assoc.* **183**, 195–200.
- Feldman, E. C., and Nelson, R. W. (2004). “Canine and Feline Endocrinology and Reproduction.” Saunders, Philadelphia.
- Fields, R. L., House, S. B., and Gainer, H. (2003). Regulatory domains in the intergenic region of the oxytocin and vasopressin genes that control their hypothalamus-specific expression in vitro. *J. Neurosci.* **23**, 7801–7809.
- Firth, S. M., and Baxter, R. C. (2002). Cellular actions of the insulin-like growth factor binding proteins. *Endocr. Rev.* **23**, 824–854.
- Flouret, G., Chaloin, O., Borovickova, L., and Slaninova, J. (2006). Design of novel bicyclic analogues derived from a potent oxytocin antagonist. *J. Pept. Sci.* **12**, 412–419.
- Forsling, M. L. (1986). Regulation of oxytocin release., pp. 19–53. In D. Gantner, and D. Pfaff (Eds). *Curr. Top. Neurobiol.* **6**, 19.
- Forsyth, I. A., and Wallis, M. (2002). Growth hormone and prolactin—molecular and functional evolution. *J. Mammary. Gland. Biol. Neoplasia* **7**, 291–312.
- Fracassi, F., Gandini, G., Diana, A., Preziosi, R., Ingh, T. S., Famigli-Bergamini, P., and Kooistra, H. S. (2007). Acromegaly due to a somatroph adenoma in a dog. *Domest Anim Endocrinol* **32**, 43–54.

- Frank, L. A. (2005). Growth hormone-responsive alopecia in dogs. *J. Am. Vet. Med. Assoc.* **226**, 1494–1497.
- Freeman, M. E., Kanyicska, B., Lerant, A., and Nagy, G. (2000). Prolactin: structure, function, and regulation of secretion. *Physiol. Rev.* **80**, 1523–1631.
- Fremeau, R. T., Jr., Lundblad, J. R., Pritchett, D. B., Wilcox, J. N., and Roberts, J. L. (1986). Regulation of pro-opiomelanocortin gene transcription in individual cell nuclei. *Science* **234**, 1265–1269.
- Friesen, H. G., Gertler, A., Walker, A., and Elsholtz, H. (1985). Mechanism of action of prolactin in stimulating cell growth. In “Prolactin, Basic and Clinical Correlates” (R. M. MacLeod, M. O. Thorner, and U. Scapagini, Eds.), vol. 1, p. 259. Liviana Press, Padova.
- Fu, X., Nishimura, S., and Porter, T. E. (2004). Evidence that lactotrophs do not differentiate directly from somatotrophs during chick embryonic development. *J. Endocrinol.* **183**, 417–425.
- Garcia, A., Alvarez, C. V., Smith, R. G., and Dieguez, C. (2001). Regulation of Pit-1 expression by ghrelin and GHRP-6 through the GH secretagogue receptor. *Mol. Endocrinol.* **15**, 1484–1495.
- Garcia-Tornadu, I., Rubinstein, M., Gaylinn, B. D., Hill, D., Arany, E., Low, M. J., Diaz-Torga, G., and Becu-Villalobos, D. (2006). GH in the dwarf dopaminergic D2 receptor knockout mouse: somatotrope population, GH release, and responsiveness to GH-releasing factors and somatostatin. *J. Endocrinol.* **190**, 611–619.
- Gardner, D. S., Van Bon, B. W., Dandrea, J., Goddard, P. J., May, S. F., Wilson, V., Stephenson, T., and Symonds, M. E. (2006). Effect of periconceptual undernutrition and gender on hypothalamic-pituitary-adrenal axis function in young adult sheep. *J. Endocrinol.* **190**, 203–212.
- Gerlo, S., Davis, J. R., Mager, D. L., and Kooijman, R. (2006). Prolactin in man: a tale of two promoters. *Bioessays* **28**, 1051–1055.
- Getting, S. J. (2006). Targeting melanocortin receptors as potential novel therapeutics. *Pharmacol. Ther.* **111**, 1–15.
- Gobello, C. (2007). New GnRH analogs in canine reproduction. *Anim. Reprod. Sci.* **100**, 1–13.
- Goffin, V., Binart, N., Touraine, P., and Kelly, P. A. (2002). Prolactin: the new biology of an old hormone. *Annu. Rev. Physiol.* **64**, 47–67.
- Goossens, M. M., Rijnberk, A., Mol, J. A., Wolfswinkel, J., and Voorhout, G. (1995). Central diabetes insipidus in a dog with a pro-opiomelanocortin-producing pituitary tumor not causing hyperadrenocorticism. *J. Vet. Intern. Med.* **9**, 361–365.
- Gorski, J., Shull, J., Weber, J., and Durrin, L. (1985). Estrogen regulation of prolactin gene transcription and chromatin structure. In “Prolactin, Basic and Clinical Correlates” (R. M. MacLeod, M. O. Thorner, and U. Scapagini, Eds.), vol. 1, p. 259. Liviana Press, Padova.
- Gregory, S. J., and Kaiser, U. B. (2004). Regulation of gonadotropins by inhibin and activin. *Semin. Reprod. Med.* **22**, 253–267.
- Gregory, S. J., Lacza, C. T., Detz, A. A., Xu, S., Petrillo, L. A., and Kaiser, U. B. (2005). Synergy between activin A and gonadotropin-releasing hormone in transcriptional activation of the rat follicle-stimulating hormone-beta gene. *Mol. Endocrinol.* **19**, 237–254.
- Guillaume, V., Conte-Devolx, B., Magnan, E., Boudouresque, F., Grino, M., Cataldi, M., Muret, L., Priou, A., Deprez, P., Figaroli, J. C. (1992a). Effect of chronic active immunization anti-corticotropin-releasing factor on the pituitary-adrenal function in the sheep. *Endocrinology* **130**, 2291–2298.
- Guillaume, V., Conte-Devolx, B., Magnan, E., Boudouresque, F., Grino, M., Cataldi, M., Muret, L., Priou, A., Figaroli, J. C., and Oliver, C. (1992b). Effect of chronic active immunization with antiarginine vasopressin on pituitary-adrenal function in sheep. *Endocrinology* **130**, 3007–3014.
- Guillemin, R. (2005). Hypothalamic hormones a.k.a. hypothalamic releasing factors. *J. Endocrinol.* **184**, 11–28.
- Halasz, B. (1994). Hypothalamus-anterior pituitary system and pituitary portal vessels. In “The Pituitary Gland” (H. Imura, Ed.), p. 1. Raven, New York.
- Halmi, N., and Krieger, D. (1983). Immunocytochemistry of ACTH-related peptides in the hypophysis. “The Anterior Pituitary Gland.” pp. 1–15. Raven Press, New York.
- Halmi, N. S., Peterson, M. E., Colurso, G. J., Liotta, A. S., and Krieger, D. T. (1981). Pituitary intermediate lobe in dog: two cell types and high bioactive adrenocorticotropin content. *Science* **211**, 72–74.
- Hanley, M. B., Napolitano, L. A., and McCune, J. M. (2005). Growth hormone-induced stimulation of multilineage human hematopoiesis. *Stem Cells* **23**, 1170–1179.
- Hanson, J. M., Kooistra, H. S., Mol, J. A., Teske, E., and Meij, B. P. (2006a). Plasma profiles of adrenocorticotrophic hormone, cortisol, alpha-melanocyte-stimulating hormone, and growth hormone in dogs with pituitary-dependent hyperadrenocorticism before and after hypophysectomy. *J. Endocrinol.* **190**, 601–609.
- Hanson, J. M., Mol, J. A., Leegwater, P. A., Kooistra, H. S., and Meij, B. P. (2006b). The leukemia inhibitory factor receptor gene is not involved in the etiology of pituitary dwarfism in German shepherd dogs. *Res. Vet. Sci.* **81**, 316–320.
- Hanson, J. M., van ‘t Hoofd, M. M., Voorhout, G., Teske, E., Kooistra, H. S., and Meij, B. P. (2005). Efficacy of transsphenoidal hypophysectomy in treatment of dogs with pituitary-dependent hyperadrenocorticism. *J. Vet. Intern. Med.* **19**, 687–694.
- Hari, J. J., and Pliska, V. (2005). Hypothalamo-pituitary-adrenocortical axis in stress-susceptible and stress-resistant pigs: endocrine responses to corticotrophin-releasing factor and vasopressin. *J. Anim. Breed. Genet.* **122(suppl 1)**, 87–96.
- Harvey, S., Baudet, M. L., Murphy, A., Luna, M., Hull, K. L., and Aramburo, C. (2004). Testicular growth hormone (GH): GH expression in spermatogonia and primary spermatocytes. *Gen. Comp. Endocrinol.* **139**, 158–167.
- Hashizume, T., Sasaki, T., Nonaka, S., Hayashi, T., Takisawa, M., Horiuchi, M., Hirata, T., and Kasuya, E. (2005). Bovine posterior pituitary extract stimulates prolactin release from the anterior pituitary gland in vitro and in vivo in cattle. *Reprod. Domest. Anim.* **40**, 184–189.
- Hayakawa, M., Shimazaki, Y., Tsushima, T., Kato, Y., Takano, K., Chihara, K., Shimatsu, A., and Irie, M. (2004). Metabolic effects of 20-kilodalton human growth hormone (20K-hGH) for adults with growth hormone deficiency: results of an exploratory uncontrolled multicenter clinical trial of 20K-hGH. *J. Clin. Endocrinol. Metab.* **89**, 1562–1571.
- Heiene, R., van Vonderen, I. K., Moe, L., Molmen, G. S., Larsen, N. H., and Kooistra, H. S. (2004). Vasopressin secretion in response to osmotic stimulation and effects of desmopressin on urinary concentrating capacity in dogs with pyometra. *Am. J. Vet. Res.* **65**, 404–408.
- Heinrichs, M., Baumgartner, W., and Capen, C. C. (1990). Immunocytochemical demonstration of proopiomelanocortin-derived peptides in pituitary adenomas of the pars intermedia in horses. *Vet. Pathol.* **27**, 419–425.
- Hellebrekers, L. J., Lagerweij, E., de Vries, H. W., and van Wimersma Greidanus, T. B. (1988). Volume-regulated arginine vasopressin release in conscious dogs. Evidence for dopaminergic or opioid modulation? *Acta Endocrinol. (Copenh.)* **119**, 106–112.
- Hellebrekers, L. J., Mol, J. A., Van den Brom, W. E., and Van Wimersma Greidanus, T. B. (1987). Effect of methadone on plasma arginine

- vasopressin level and urine production in conscious dogs. *Eur. J. Pharmacol.* **136**, 279–286.
- Helwig, M., Khorooshi, R. M., Tups, A., Barrett, P., Archer, Z. A., Exner, C., Rozman, J., Braulke, L. J., Mercer, J. G., and Klingenspor, M. (2006). PC 1/3 and PC2 gene expression and post-translational endoproteolytic pro-opiomelanocortin processing is regulated by photoperiod in the seasonal Siberian hamster (*Phodopus sungorus*). *J. Neuroendocrinol.* **18**, 413–425.
- Hesselink, J. W., Taverne, M. A., Bevers, M. M., and van Oord, H. A. (1995). Serum prolactin concentration in pseudopregnant and normally reproducing goats. *Vet. Rec.* **137**, 166–168.
- Himura, Y., Liang, C. S., Imai, N., Delehanty, J. M., Woolf, P. D., and Hood, W. B., Jr. (1994). Short-term effects of naloxone on hemodynamics and baroreflex function in conscious dogs with pacing-induced congestive heart failure. *J. Am. Coll. Cardiol.* **23**, 194–200.
- Hinuma, S., Habata, Y., Fujii, R., Kawamata, Y., Hosoya, M., Fukusumi, S., Kitada, C., Masuo, Y., Asano, T., Matsumoto, H., Sekiguchi, M., Kurokawa, T., Nishimura, O., Onda, H., and Fujino, M. (1998). A prolactin-releasing peptide in the brain. *Nature* **393**, 272–276.
- Ho, Y., Elefant, F., Liebhaber, S. A., and Cooke, N. E. (2006). Locus control region transcription plays an active role in long-range gene activation. *Mol. Cell* **23**, 365–375.
- Holt, V., and Haarmann, I. (1984). Corticotropin-releasing factor differentially regulates proopiomelanocortin messenger ribonucleic acid levels in anterior as compared to intermediate pituitary lobes of rats. *Biochem. Biophys. Res. Commun.* **124**, 407–415.
- Horseman, N. D., Zhao, W., Montecino-Rodriguez, E., Tanaka, M., Nakashima, K., Engle, S. J., Smith, F., Markoff, E., and Dorshkind, K. (1997). Defective mammopoiesis, but normal hematopoiesis, in mice with a targeted disruption of the prolactin gene. *Embo. J.* **16**, 6926–6935.
- Houston, D. M., Allen, D. G., Kruth, S. A., Pook, H., Spinato, M. T., and Keough, H. (1989). Syndrome of inappropriate antidiuretic hormone secretion in a dog. *Can. Vet. J.* **30**, 423.
- Hullinger, R. (1993). The Endocrine System. In “Miller’s Anatomy of the Dog” (H. E. Evans, Ed.), p. 559. Saunders, Philadelphia.
- Hunter, M. G., Robinson, R. S., Mann, G. E., and Webb, R. (2004). Endocrine and paracrine control of follicular development and ovulation rate in farm species. *Anim. Reprod. Sci.* **82–83**, 461–477.
- Hurty, C. A., and Flatland, B. (2005). Feline acromegaly: a review of the syndrome. *J. Am. Anim. Hosp. Assoc.* **41**, 292–297.
- Hydbring-Sandberg, E., von Walter, L. W., Hoglund, K., Svartberg, K., Swenson, L., and Forkman, B. (2004). Physiological reactions to fear provocation in dogs. *J. Endocrinol.* **180**, 439–448.
- Hyde, J. F., Murai, I., and Ben-Jonathan, N. (1987). The rat posterior pituitary contains a potent prolactin-releasing factor: studies with perfused anterior pituitary cells. *Endocrinology* **121**, 1531–1539.
- Irvine, C. H., and Alexander, S. L. (1994). The dynamics of gonadotrophin-releasing hormone, LH and FSH secretion during the spontaneous ovulatory surge of the mare as revealed by intensive sampling of pituitary venous blood. *J. Endocrinol.* **140**, 283–295.
- Ishibashi, M., and Yamaji, T. (1985). Functional heterogeneity of human prolactin-producing pituitary adenomas. In “Prolactin, Basic and Clinical Correlates” (R. M. MacLeod, M. O. Thoner, and U. Scapagini, Eds.), vol. 1, p. 693. Liviana Press, Padova.
- Iturriza, F. C., Castro, M. G., and Estivariz, F. E. (1986). On the stimulatory nature of the control of MSH secretion in ducks. *Gen. Comp. Endocrinol.* **64**, 440–445.
- Ivell, R., and Richter, D. (1985). The oxytocin gene and its expression in the hypothalamus and ovary. In “Oxytocin, Clinical and Laboratory Studies” (J. A. Amico and A. G. Robinson, Eds.), p. 115. Elsevier, Amsterdam.
- Ivell, R., Schmale, H., and Richter, D. (1986). Biosynthesis of vasopressin. *J. Cardiovasc. Pharmacol.* **8(suppl 7)**, S3–S4.
- Jacobson, L., and Drouin, J. (1994). Regulation of proopiomelanocortin gene transcription. In “The Pituitary Gland” (H. Imura, Ed.), p. 117. Raven, New York.
- Jacobson, L., and Sapolsky, R. (1991). The role of the hippocampus in feedback regulation of the hypothalamic-pituitary-adrenocortical axis. *Endocr. Rev.* **12**, 118–134.
- Janssens, L. A. (1981). [Bromocriptine (Parlodel) in the treatment of pseudo-pregnancy in bitches (author’s transl)]. *Tijdschr. Diergeneesk.* **106**, 767–770.
- Jard, S. (1983). Vasopressin: mechanisms of receptor activation. *Prog. Brain. Res.* **60**, 383–394.
- Javadi, S., Slingerland, L. I., van de Beek, M. G., Boer, P., Boer, W. H., Mol, J. A., Rijnberk, A., and Kooistra, H. S. (2004). Plasma renin activity and plasma concentrations of aldosterone, cortisol, adrenocorticotrophic hormone, and alpha-melanocyte-stimulating hormone in healthy cats. *J. Vet. Intern. Med.* **18**, 625–631.
- Jephcott, E. H., McMillen, I. C., Rushen, J. P., and Thorburn, G. D. (1987). A comparison of the effects of electroimmobilisation and, or, shearing procedures on ovine plasma concentrations of beta-endorphin/beta-lipoprotein and cortisol. *Res. Vet. Sci.* **43**, 97–100.
- Jorgensen, H., Knigge, U., Kjaer, A., and Warberg, J. (2002). Serotonergic involvement in stress-induced vasopressin and oxytocin secretion. *Eur. J. Endocrinol.* **147**, 815–824.
- Jorgensen, J. S., Quirk, C. C., and Nilson, J. H. (2004). Multiple and overlapping combinatorial codes orchestrate hormonal responsiveness and dictate cell-specific expression of the genes encoding luteinizing hormone. *Endocr. Rev.* **25**, 521–542.
- Joudrey, E. M., Lechniak, D., Petrik, J., and King, W. A. (2003). Expression of growth hormone and its transcription factor, Pit-1, in early bovine development. *Mol. Reprod. Dev.* **64**, 275–283.
- Kantrowitz, L. B., Peterson, M. E., Melian, C., and Nichols, R. (2001). Serum total thyroxine, total triiodothyronine, free thyroxine, and thyrotropin concentrations in dogs with nonthyroidal disease. *J. Am. Vet. Med. Assoc.* **219**, 765–769.
- Keller-Wood, M. (1989). Control of canine ACTH by corticosteroids: an integral feedback effect of steroids. *Am. J. Physiol.* **257**, R427–R430.
- Keller-Wood, M. E., and Dallman, M. F. (1984). Corticosteroid inhibition of ACTH secretion. *Endocr. Rev.* **5**, 1–24.
- Kempainen, R. J., and Sartin, J. L. (1984). Evidence for episodic but not circadian activity in plasma concentrations of adrenocorticotrophin, cortisol and thyroxine in dogs. *J. Endocrinol.* **103**, 219–226.
- Kempainen, R. J., and Sartin, J. L. (1986). In vivo evidence for dopaminergic regulation of the canine pituitary intermediate lobe. *Acta Endocrinol. (Copenh.)* **113**, 471–478.
- Kempainen, R. J., and Sartin, J. L. (1987). *Front. Horm. Res.* **17**, 18.
- Kempainen, R. J., and Sartin, J. L. (1987b). Differential Regulation of Peptide Release by the Canine Pars distalis and Pars intermedia. *Front Horm. Res.* **17**, 18.
- Kidney, C. M., Macdonald, J. M., Angarano, D. W., Insalaco, T. A., Kempainen, R. J., and Sartin, J. L. (2004). Amplification of proopiomelanocortin mRNA in canine skin: preliminary results. *Vet. Dermatol.* **15**, 389–391.
- Kim, J. K., Summer, S. N., Wood, W. M., and Schrier, R. W. (2001). Role of glucocorticoid hormones in arginine vasopressin gene regulation. *Biochem. Biophys. Res. Commun.* **289**, 1252–1256.

- King, L. S., and Yasui, M. (2002). Aquaporins and disease: lessons from mice to humans. *Trends Endocrinol. Metab.* **13**, 355–360.
- Kirpensteijn, J., Timmermans-Sprang, E. P., van Garderen, E., Rutteman, G. R., Lantinga-van Leeuwen, I. S., and Mol, J. A. (2002). Growth hormone gene expression in canine normal growth plates and spontaneous osteosarcoma. *Mol. Cell. Endocrinol.* **197**, 179–185.
- Koch, A., Hoppen, H. O., Dieleman, S. J., Kooistra, H. S., and Gunzel-Apel, A. R. (2006). Effects of the dopamine agonist cabergoline on the pulsatile and TRH-induced secretion of prolactin, LH, and testosterone in male beagle dogs. *Theriogenology* **65**, 1666–1677.
- Koike, T. I., Neldon, H. L., McKay, D. W., and Rayford, P. L. (1986). An antiserum that recognizes mesotocin and isotocin: development of a homologous radioimmunoassay for plasma mesotocin in chickens (*Gallus domesticus*). *Gen. Comp. Endocrinol.* **63**, 93–103.
- Koohi, M. K., Ivell, R., and Walther, N. (2005). Transcriptional activation of the oxytocin promoter by oestrogens uses a novel non-classical mechanism of oestrogen receptor action. *J. Neuroendocrinol.* **17**, 197–207.
- Kooistra, H. S., den Hertog, E., Okkens, A. C., Mol, J. A., and Rijnberk, A. (2000a). Pulsatile secretion pattern of growth hormone during the luteal phase and mid-anestrus in beagle bitches. *J. Reprod. Fertil.* **119**, 217–222.
- Kooistra, H. S., Diaz-Espineira, M., Mol, J. A., van den Brom, W. E., and Rijnberk, A. (2000b). Secretion pattern of thyroid-stimulating hormone in dogs during euthyroidism and hypothyroidism. *Domest. Anim. Endocrinol.* **18**, 19–29.
- Kooistra, H. S., Greven, S. H., Mol, J. A., and Rijnberk, A. (1997a). Pulsatile secretion of alpha-MSH and the differential effects of dexamethasone and haloperidol on the secretion of alpha-MSH and ACTH in dogs. *J. Endocrinol.* **152**, 113–121.
- Kooistra, H. S., and Okkens, A. C. (2001a). Role of changes in the pulsatile secretion pattern of FSH in initiation of ovarian folliculogenesis in bitches. *J. Reprod. Fertil. Suppl.* **57**, 11–14.
- Kooistra, H. S., and Okkens, A. C. (2001b). Secretion of prolactin and growth hormone in relation to ovarian activity in the dog. *Reprod. Domest. Anim.* **36**, 115–119.
- Kooistra, H. S., and Okkens, A. C. (2002). Secretion of growth hormone and prolactin during progression of the luteal phase in healthy dogs: a review. *Mol. Cell. Endocrinol.* **197**, 167–172.
- Kooistra, H. S., Okkens, A. C., Bevers, M. M., Popp-Snijders, C., van Haften, B., Dieleman, S. J., and Schoemaker, J. (1999). Concurrent pulsatile secretion of luteinizing hormone and follicle-stimulating hormone during different phases of the estrous cycle and anestrus in beagle bitches. *Biol. Reprod.* **60**, 65–71.
- Kooistra, H. S., Voorhout, G., Mol, J. A., and Rijnberk, A. (1997b). Correlation between impairment of glucocorticoid feedback and the size of the pituitary gland in dogs with pituitary-dependent hyperadrenocorticism. *J. Endocrinol.* **152**, 387–394.
- Kooistra, H. S., Voorhout, G., Mol, J. A., and Rijnberk, A. (2000c). Combined pituitary hormone deficiency in German shepherd dogs with dwarfism. *Domest. Anim. Endocrinol.* **19**, 177–190.
- Kopchick, J. J. (2003). Discovery and mechanism of action of pegvisomant. *Eur. J. Endocrinol.* **148**(suppl 2), S21–S25.
- Kornalijnslipjer, J. E., Kemp, B., Bevers, M. M., van Oord, H. A., and Taverne, M. A. (1997). Plasma prolactin, growth hormone and progesterone concentrations in pseudopregnant, hysterectomized and pregnant goats. *Anim. Reprod. Sci.* **49**, 169–178.
- Krieger, D. T. (1983). Physiopathology of Cushing's disease. *Endocr. Rev.* **4**, 22–43.
- Lamolet, B., Poulin, G., Chu, K., Guillemot, F., Tsai, M. J., and Drouin, J. (2004). Tpit-independent function of NeuroD1(BETA2) in pituitary corticotroph differentiation. *Mol. Endocrinol.* **18**, 995–1003.
- Lamolet, B., Pulichino, A. M., Lamonerie, T., Gauthier, Y., Brue, T., Enjalbert, A., and Drouin, J. (2001). A pituitary cell-restricted T box factor, Tpit, activates POMC transcription in cooperation with Pitx homeoproteins. *Cell* **104**, 849–859.
- Lamonerie, T., Tremblay, J. J., Lanctot, C., Therrien, M., Gauthier, Y., and Drouin, J. (1996). Ptx1, abicoid-related homeo box transcription factor involved in transcription of the pro-opiomelanocortin gene. *Genes Dev.* **10**, 1284–1295.
- Languouche, L., Hersmus, N., Papageorgiou, A., Vankelecom, H., and Denef, C. (2004). Melanocortin peptides stimulate prolactin gene expression and prolactin accumulation in rat pituitary aggregate cell cultures. *J. Neuroendocrinology* **16**, 695–703.
- Lantinga-van Leeuwen, I. S., Kooistra, H. S., Mol, J. A., Renier, C., Breen, M., and van Oost, B. A. (2000a). Cloning, characterization, and physical mapping of the canine Prop-1 gene (PROP1): exclusion as a candidate for combined pituitary hormone deficiency in German shepherd dogs. *Cytogenet. Cell. Genet.* **88**, 140–144.
- Lantinga-van Leeuwen, I. S., Mol, J. A., Kooistra, H. S., Rijnberk, A., Breen, M., Renier, C., and van Oost, B. A. (2000b). Cloning of the canine gene encoding transcription factor Pit-1 and its exclusion as candidate gene in a canine model of pituitary dwarfism. *Mamm. Genome* **11**, 31–36.
- Lantinga van Leeuwen, I. S., Teske, E., van Garderen, E., and Mol, J. A. (2000). Cloning and characterization of the 5'-flanking region of the canine growth hormone gene. *Anticancer Res.* **20**, 2371–2376.
- Lantinga-van Leeuwen, I. S., Timmermans-Sprang, E. A., and Mol, J. A. (2002). Growth hormone gene expression in normal lymph nodes and lymphomas of the dog. *Mol. Cell. Endocrinol.* **197**, 133–141.
- Lean, A. D., Ferland, L., Drouin, J., Kelly, P. A., and Labrie, F. (1977). Modulation of pituitary thyrotropin releasing hormone receptor levels by estrogens and thyroid hormones. *Endocrinology* **100**, 1496–1504.
- Lee, C. Y., Chung, C. S., and Simmen, F. A. (1993). Ontogeny of the porcine insulin-like growth factor system. *Mol. Cell. Endocrinol.* **93**, 71–80.
- Lee, H. G., Choi, Y. J., Lee, S. R., Kuwayama, H., Hidari, H., and You, S. K. (2005). Effects of dietary protein and growth hormone-releasing peptide (GHRP-2) on plasma IGF-1 and IGF-BPs in Holstein steers. *Domest. Anim. Endocrinol.* **28**, 134–146.
- Lee, W. M., Diaz-Espineira, M., Mol, J. A., Rijnberk, A., and Kooistra, H. S. (2001). Primary hypothyroidism in dogs is associated with elevated GH release. *J. Endocrinol.* **168**, 59–66.
- Lee, W. M., Kooistra, H. S., Mol, J. A., Dieleman, S. J., and Schaefer-Okkens, A. C. (2006). Ovariectomy during the luteal phase influences secretion of prolactin, growth hormone, and insulin-like growth factor-I in the bitch. *Theriogenology* **66**, 484–490.
- Lee, W. M., Meij, B. P., Bhatti, S. F., Mol, J. A., Rijnberk, A., and Kooistra, H. S. (2003). Pulsatile secretion pattern of growth hormone in dogs with pituitary-dependent hyperadrenocorticism. *Domest. Anim. Endocrinol.* **24**, 59–68.
- Li, W. I., and Chen, C. L. (1987). Running and shipping elevate plasma levels of beta-endorphin-like substance (B-END-LI) in thoroughbred horses. *Life. Sci.* **40**, 1411–1421.
- Liard, J. F. (1986). Effects of intra-arterial arginine-vasopressin infusions on peripheral blood flows in conscious dogs. *Clin. Sci. (Lond.)* **71**, 713–721.
- Lilly, M. P., Engeland, W. C., and Gann, D. S. (1983). Responses of cortisol secretion to repeated hemorrhage in the anesthetized dog. *Endocrinology* **112**, 681–688.
- Lincoln, G. A., and Clarke, I. J. (1994). Photoperiodically-induced cycles in the secretion of prolactin in hypothalamo-pituitary disconnected rams: evidence for translation of the melatonin signal in the pituitary gland. *J. Neuroendocrinol.* **6**, 251–260.

- Liu, J. P., Clarke, I. J., Funder, J. W., and Engler, D. (1991). Evidence that the central noradrenergic and adrenergic pathways activate the hypothalamic-pituitary-adrenal axis in the sheep. *Endocrinology* **129**, 200–209.
- Lowry, P. J., Linton, E. A., and Jackson, S. (1987). Physiology and Pathophysiology of the Hypothalamo-Pituitary-Adrenal Axis. *Front. Horm. Res.* **17**, 1.
- Lucy, M. C., Hauser, S. D., Eppard, P. J., Krivi, G. G., Clark, J. H., Bauman, D. E., and Collier, R. J. (1993). Variants of somatotropin in cattle: gene frequencies in major dairy breeds and associated milk production. *Domest. Anim. Endocrinol.* **10**, 325–333.
- Lupoli, B., Johansson, B., Uvnas-Moberg, K., and Svennersten-Sjaunja, K. (2001). Effect of suckling on the release of oxytocin, prolactin, cortisol, gastrin, cholecystokinin, somatostatin and insulin in dairy cows and their calves. *J. Dairy Res.* **68**, 175–187.
- Luque, R. M., Duran-Prado, M., Garcia-Navarro, S., Gracia-Navarro, F., Kineman, R. D., Malagon, M. M., and Castano, J. P. (2006). Identification of the somatostatin receptor subtypes (sst) mediating the divergent, stimulatory/inhibitory actions of somatostatin on growth hormone secretion. *Endocrinology* **147**, 2902–2908.
- Luque, R. M., Kineman, R. D., Park, S., Peng, X. D., Gracia-Navarro, F., Castano, J. P., and Malagon, M. M. (2004). Homologous and heterologous regulation of pituitary receptors for ghrelin and growth hormone-releasing hormone. *Endocrinology* **145**, 3182–3189.
- Ma, Y. Y., Qi, X. F., Song, S. J., Zhao, Z. Y., Zhu, Z. D., Qi, J., Zhang, X., Xiao, H. S., Teng, Y., and Han, Z. G. (2005). cDNA microarray reveals signaling pathways involved in hormones expression of human pituitary. *Gen. Comp. Endocrinol.* **143**, 184–192.
- Macotela, Y., Aguilar, M. B., Guzman-Morales, J., Rivera, J. C., Zermeno, C., Lopez-Barrera, F., Nava, G., Lavallo, C., Martinez de la Escalera, G., and Clapp, C. (2006). Matrix metalloproteases from chondrocytes generate an antiangiogenic 16 kDa prolactin. *J. Cell. Sci.* **119**, 1790–1800.
- Martens, C., Bilodeau, S., Maira, M., Gauthier, Y., and Drouin, J. (2005). Protein-protein interactions and transcriptional antagonism between the subfamily of NGFI-B/Nur77 orphan nuclear receptors and glucocorticoid receptor. *Mol. Endocrinol.* **19**, 885–897.
- Matsumoto, H., Noguchi, J., Horikoshi, Y., Kawamata, Y., Kitada, C., Hinuma, S., Onda, H., Nishimura, O., and Fujino, M. (1999). Stimulation of prolactin release by prolactin-releasing peptide in rats. *Biochem. Biophys. Res. Commun.* **259**, 321–324.
- Matthews, S. G., and Parrott, R. F. (1992). Prolactin secretion in sheep after dehydration followed by restraint or administration of ovine corticotrophin-releasing factor. *Exp. Physiol.* **77**, 357–362.
- McMahon, C. D., Radcliff, R. P., Lookingland, K. J., and Tucker, H. A. (2001). Neuroregulation of growth hormone secretion in domestic animals. *Domest. Anim. Endocrinol.* **20**, 65–87.
- McNeilly, A. S., Glasier, A., Jonassen, J., and Howie, P. W. (1982). Evidence for direct inhibition of ovarian function by prolactin. *J. Reprod. Fertil.* **65**, 559–569.
- McNicol, A. M. (1986). A study of intermediate lobe differentiation in the human pituitary gland. *J. Pathol.* **150**, 169–173.
- Mehl, M. L., Schott, H. C., 2nd, Sarkar, D. K., and Bayly, W. M. (2000). Effects of exercise intensity and duration on plasma beta-endorphin concentrations in horses. *Am. J. Vet. Res.* **61**, 969–973.
- Meij, B., Voorhout, G., and Rijnberk, A. (2002). Progress in transsphenoidal hypophysectomy for treatment of pituitary-dependent hyperadrenocorticism in dogs and cats. *Mol. Cell. Endocrinol.* **197**, 89–96.
- Meij, B. P., Mol, J. A., Bevers, M. M., and Rijnberk, A. (1997a). Alterations in anterior pituitary function of dogs with pituitary-dependent hyperadrenocorticism. *J. Endocrinol.* **154**, 505–512.
- Meij, B. P., Mol, J. A., Bevers, M. M., and Rijnberk, A. (1997b). Residual pituitary function after transsphenoidal hypophysectomy in dogs with pituitary-dependent hyperadrenocorticism. *J. Endocrinol.* **155**, 531–539.
- Meij, B. P., Mol, J. A., Hazewinkel, H. A., Bevers, M. M., and Rijnberk, A. (1996a). Assessment of a combined anterior pituitary function test in beagle dogs: rapid sequential intravenous administration of four hypothalamic releasing hormones. *Domest. Anim. Endocrinol.* **13**, 161–170.
- Meij, B. P., Mol, J. A., and Rijnberk, A. (1996b). Thyroid-stimulating hormone responses after single administration of thyrotropin-releasing hormone and combined administration of four hypothalamic releasing hormones in beagle dogs. *Domest. Anim. Endocrinol.* **13**, 465–468.
- Meij, B. P., Mol, J. A., van den Ingh, T. S., Bevers, M. M., Hazewinkel, H. A., and Rijnberk, A. (1997c). Assessment of pituitary function after transsphenoidal hypophysectomy in beagle dogs. *Domest. Anim. Endocrinol.* **14**, 81–97.
- Meij, B. P., Rijnberk, A., and Mol, J. A. (1990). Effects of a [Met]-enkephalin analogue ([D-Ala<sup>2</sup>,N-Me-Phe<sup>4</sup>,Met-(O)5-ol]-enkephalin) on canine pituitary function. *J. Endocrinol.* **127**, 265–271.
- Meij, B. P., van der Vlugt-Meijer, R. H., van den Ingh, T. S., Flik, G., and Rijnberk, A. (2005). Melanotroph pituitary adenoma in a cat with diabetes mellitus. *Vet. Pathol.* **42**, 92–97.
- Meij, B. P., van der Vlugt-Meijer, R. H., van den Ingh, T. S., and Rijnberk, A. (2004). Somatotroph and corticotroph pituitary adenoma (double adenoma) in a cat with diabetes mellitus and hyperadrenocorticism. *J. Comp. Pathol.* **130**, 209–215.
- Meij, B. P., Voorhout, G., van den Ingh, T. S., and Rijnberk, A. (2001). Transsphenoidal hypophysectomy for treatment of pituitary-dependent hyperadrenocorticism in 7 cats. *Vet. Surg.* **30**, 72–86.
- Meijer, J. C., de Bruijne, J. J., Rijnberk, A., and Croughs, R. J. (1978). Biochemical characterization of pituitary-dependent hyperadrenocorticism in the dog. *J. Endocrinol.* **77**, 111–118.
- Melamed, P., Kadir, M. N., Wijeweera, A., and Seah, S. (2006). Transcription of gonadotropin beta subunit genes involves cross-talk between the transcription factors and co-regulators that mediate actions of the regulatory hormones. *Mol. Cell. Endocrinol.* **252**, 167–183.
- Middleton, D. J., Rijnberk, A., Bevers, M. M., Goos, H. J., Beeftink, E. A., Thijssen, J. H., and Croughs, R. J. (1987a). Some functional aspects of canine corticotrophs. *Horm. Metab. Res.* **19**, 632–635.
- Middleton, D. J., Rijnberk, A., Bevers, M. M., Goos, H. J. T., Beeftink, E. A., Thijssen, J. H. H., and Croughs, R. J. M. (1987b). Some Functional and Morphologic Aspects of Canine Corticotrophs. *Front. Horm. Res.* **17**, 10.
- Mikami, S. (1986). Immunocytochemistry of the avian hypothalamus and adenohypophysis. *Int. Rev. Cytol.* **103**, 189–248.
- Millington, W. R., Dybdal, N. O., Mueller, G. P., and Chronwall, B. M. (1992). N-acetylation and C-terminal proteolysis of beta-endorphin in the anterior lobe of the horse pituitary. *Gen. Comp. Endocrinol.* **85**, 297–307.
- Minton, J. E., and Parsons, K. M. (1993). Adrenocorticotrophic hormone and cortisol response to corticotropin-releasing factor and lysine vasopressin in pigs. *J. Anim. Sci.* **71**, 724–729.
- Mol, J. A., Henzen-Logmans, S. C., Hageman, P., Misdorp, W., Blankenstein, M. A., and Rijnberk, A. (1995a). Expression of the gene encoding growth hormone in the human mammary gland. *J. Clin. Endocrinol. Metab.* **80**, 3094–3096.
- Mol, J. A., Lantinga-van Leeuwen, I. S., van Garderen, E., Selman, P. J., Oosterlaken-Dijksterhuis, M. A., Schalken, J. A., and Rijnberk, A.



- (1999). Mammary growth hormone and tumorigenesis—lessons from the dog. *Vet. Q.* **21**, 111–115.
- Mol, J. A., Slob, A., Middleton, D. J., and Rijnberk, A. (1987). In vitro release of POMC-peptides. *Front. Horm. Res.* **17**, 61.
- Mol, J. A., van Garderen, E., Rutteman, G. R., and Rijnberk, A. (1996). New insights in the molecular mechanism of progestin-induced proliferation of mammary epithelium: induction of the local biosynthesis of growth hormone (GH) in the mammary glands of dogs, cats and humans. *J. Steroid. Biochem. Mol. Biol.* **57**, 67–71.
- Mol, J. A., van Garderen, E., Selman, P. J., Wolfswinkel, J., Rijnberk, A., and Rutteman, G. R. (1995b). Growth hormone mRNA in mammary gland tumors of dogs and cats. *J. Clin. Invest.* **95**, 2028–2034.
- Mol, J. A., van Mansfeld, A. D., Kwant, M. M., van Wolferen, M., and Rothuizen, J. (1991). The gene encoding proopiomelanocortin in the dog. *Acta Endocrinol. (Copenh.)* **125(suppl 1)**, 77–83.
- Molina, P. E. (2006). Opioids and opiates: analgesia with cardiovascular, haemodynamic and immune implications in critical illness. *J. Intern. Med.* **259**, 138–154.
- Mullis, P. E. (2005). Genetic control of growth. *Eur. J. Endocrinol.* **152**, 11–31.
- Mulnix, J. A., Rijnberk, A., and Hendriks, H. J. (1976). Evaluation of a modified water-deprivation test for diagnosis of polyuric disorders in dogs. *J. Am. Vet. Med. Assoc.* **169**, 1327–1330.
- Muret, L., Priou, A., Oliver, C., and Grino, M. (1992). Stimulation of adrenocorticotropin secretion by insulin-induced hypoglycemia in the developing rat involves arginine vasopressin but not corticotropin-releasing factor. *Endocrinology* **130**, 2725–2732.
- Mynard, V., Latchoumanin, O., Guignat, L., Devin-Leclerc, J., Bertagna, X., Barre, B., Fagart, J., Coqueret, O., and Catelli, M. G. (2004). Synergistic signaling by corticotropin-releasing hormone and leukemia inhibitory factor bridged by phosphorylated 3',5'-cyclic adenosine monophosphate response element binding protein at the Nur response element (NurRE)-signal transducers and activators of transcription (STAT) element of the proopiomelanocortin promoter. *Mol. Endocrinol.* **18**, 2997–3010.
- Nakano, K., Matsushita, A., Sasaki, S., Misawa, H., Nishiyama, K., Kashiwabara, Y., and Nakamura, H. (2004). Thyroid-hormone-dependent negative regulation of thyrotropin beta gene by thyroid hormone receptors: study with a new experimental system using CV1 cells. *Biochem. J.* **378**, 549–557.
- Newell-Price, J. (2003). Proopiomelanocortin gene expression and DNA methylation: implications for Cushing's syndrome and beyond. *J. Endocrinol.* **177**, 365–372.
- Newman, C. B., Wardlaw, S. L., Stark, R. I., Daniel, S. S., and Frantz, A. G. (1987). Dopaminergic regulation of alpha-melanocyte-stimulating hormone and N-acetyl-beta-endorphin secretion in the fetal lamb. *Endocrinology* **120**, 962–966.
- Nicoll, C. S., Anderson, T. R., Hebert, N. J., and Russell, S. M. (1985). Comparative aspects of the growth-promoting actions of prolactin on its target organs. In "Prolactin, Basic and Clinical Correlates" (R. M. MacLeod, M. O. Thorner, and U. Scapagini, Eds.), vol. 1, Liviana Press, Padova.
- Nielsen, S., Chou, C. L., Marples, D., Christensen, E. I., Kishore, B. K., and Knepper, M. A. (1995). Vasopressin increases water permeability of kidney collecting duct by inducing translocation of aquaporin-CD water channels to plasma membrane. *Proc. Natl. Acad. Sci. USA* **92**, 1013–1017.
- Nielsen, S., Smith, B. L., Christensen, E. I., and Agre, P. (1993). Distribution of the aquaporin CHIP in secretory and resorptive epithelia and capillary endothelia. *Proc. Natl. Acad. Sci. USA* **90**, 7275–7279.
- Nikrodhanond, A. A., Ortiga-Carvalho, T. M., Shibusawa, N., Hashimoto, K., Liao, X. H., Refetoff, S., Yamada, M., Mori, M., and Wondisford, F. E. (2006). Dominant role of thyrotropin-releasing hormone in the hypothalamic-pituitary-thyroid axis. *J. Biol. Chem.* **281**, 5000–5007.
- Numa, S., and Imura, H. (1985). ACTH and related peptides: gene structure and biosynthesis. "The Pituitary Gland" p. 83. Raven Press, New York.
- Nussey, S. S., Ang, V. T., Finer, N., and Jenkins, J. S. (1986). Responses of neurohypophysial peptides to hypertonic saline and insulin-induced hypoglycaemia in man. *Clin. Endocrinol. (Oxf.)* **24**, 97–105.
- Oertel, W. H., Mugnaini, E., Tappaz, M. L., Weise, V. K., Dahl, A. L., Schmechel, D. E., and Kopin, I. J. (1982). Central GABAergic innervation of neurointermediate pituitary lobe: biochemical and immunocytochemical study in the rat. *Proc. Natl. Acad. Sci. USA* **79**, 675–679.
- Okada, T., Shimomuro, T., Oikawa, M., Nambo, Y., Kiso, Y., Morikawa, Y., Liptrap, R. M., Yamashiro, S., Little, P. B., and Sasaki, F. (1997). Immunocytochemical localization of adrenocorticotropin hormone-immunoreactive cells of the pars intermedia in thoroughbreds. *Am. J. Vet. Res.* **58**, 920–924.
- Okkens, A., and Kooistra, H. (2006). Anoestrus in the dog: a fascinating story. *Reprod. Domest. Anim.* **41**, 291–296.
- Okkens, A. C., Dieleman, S. J., Bevers, M. M., and Willemse, A. H. (1985). Evidence for the non-involvement of the uterus in the lifespan of the corpus luteum in the cyclic dog. *Vet. Q.* **7**, 169–173.
- Onclin, K., Murphy, B., and Verstegen, J. P. (2002). Comparisons of estradiol, LH and FSH patterns in pregnant and nonpregnant beagle bitches. *Theriogenology* **57**, 1957–1972.
- Orth, D. N., Holscher, M. A., Wilson, M. G., Nicholson, W. E., Plue, R. E., and Mount, C. D. (1982). Equine Cushing's disease: plasma immunoreactive proopiomelanocortin peptide and cortisol levels basally and in response to diagnostic tests. *Endocrinology* **110**, 1430–1441.
- Paez-Pereda, M., Kuchenbauer, F., Arzt, E., and Stalla, G. K. (2005). Regulation of pituitary hormones and cell proliferation by components of the extracellular matrix. *Braz. J. Med. Biol. Res.* **38**, 1487–1494.
- Page, R. (1986). The pituitary portal system. In "Morphology of Hypothalamus and Its Connections" (D. Ganten and D. Pfaff, Eds.), p. 1. Springer Verlag, Berlin.
- Pazos-Moura, C. C., Ortiga-Carvalho, T. M., and Gaspar de Moura, E. (2003). The autocrine/paracrine regulation of thyrotropin secretion. *Thyroid* **13**, 167–175.
- Pecins-Thompson, M., and Keller-Wood, M. (1994). Prolonged absence of ovarian hormones in the ewe reduces the adrenocorticotropin response to hypotension, but not to hypoglycemia or corticotropin-releasing factors. *Endocrinology* **134**, 678–684.
- Peeters, M. E., Timmermans-Sprang, E. P., and Mol, J. A. (2002). Feline thyroid adenomas are in part associated with mutations in the G(s alpha) gene and not with polymorphisms found in the thyrotropin receptor. *Thyroid* **12**, 571–575.
- Peterson, M. E. (1986). Canine Hyperadrenocorticism. In "Current Veterinary Therapy IX" (R. W. Kirk, Ed.), p. 963. Saunders, Philadelphia.
- Peterson, M. E. (1987). Pathophysiology of Canine Pituitary-Dependent Hyperadrenocorticism. *Front. Horm. Res.* **17**, 37.
- Peterson, M. E., Kemppainen, R. J., and Orth, D. N. (1992). Effects of synthetic ovine corticotropin-releasing hormone on plasma concentrations of immunoreactive adrenocorticotropin, alpha-melanocyte-stimulating hormone, and cortisol in dogs with naturally acquired adrenocortical insufficiency. *Am. J. Vet. Res.* **53**, 421–425.

- Peterson, M. E., Kemppainen, R. J., and Orth, D. N. (1994). Plasma concentrations of immunoreactive proopiomelanocortin peptides and cortisol in clinically normal cats. *Am. J. Vet. Res.* **55**, 295–300.
- Peterson, M. E., Melian, C., and Nichols, R. (1997). Measurement of serum total thyroxine, triiodothyronine, free thyroxine, and thyrotropin concentrations for diagnosis of hypothyroidism in dogs. *J. Am. Vet. Med. Assoc.* **211**, 1396–1402.
- Peterson, M. E., Orth, D. N., Halmi, N. S., Zielinski, A. C., Davis, D. R., Chavez, F. T., and Drucker, W. D. (1986). Plasma immunoreactive proopiomelanocortin peptides and cortisol in normal dogs and dogs with Addison's disease and Cushing's syndrome: basal concentrations. *Endocrinology* **119**, 720–730.
- Plotsky, P. M. (1986). Opioid inhibition of immunoreactive corticotropin-releasing factor secretion into the hypophysial-portal circulation of rats. *Regul. Pept.* **16**, 235–242.
- Ponglowhapan, S., Church, D. B., Scaramuzzi, R. J., and Khalid, M. (2006). Luteinizing hormone and follicle-stimulating hormone receptors and their transcribed genes (mRNA) are present in the lower urinary tract of intact male and female dogs. *Theriogenology*. **67**, 353–366.
- Pope, C., McNeilly, J. R., Coutts, S., Millar, M., Anderson, R. A., and McNeilly, A. S. (2006). Gonadotrope and thyrotrope development in the human and mouse anterior pituitary gland. *Dev. Biol.* **297**, 172–181.
- Porter, D. G., Ryan, P. L., and Norman, L. (1992). Lack of effect of relaxin on oxytocin output from the porcine neural lobe in vitro or in lactating sows in vivo. *J. Reprod. Fertil.* **96**, 251–260.
- Porter, T. E. (2005). Regulation of pituitary somatotroph differentiation by hormones of peripheral endocrine glands. *Domest. Anim. Endocrinol.* **29**, 52–62.
- Pradier, P., Davicco, M. J., Safwate, A., Tournaire, C., Dalle, M., Barlet, J. P., and Delost, P. (1986). Plasma adrenocorticotrophin, cortisol and aldosterone responses to ovine corticotrophin-releasing factor and vasopressin in sheep. *Acta Endocrinol. (Copenh.)* **111**, 93–100.
- Proulx-Ferland, L., Labrie, F., Dumont, D., Cote, J., Coy, D. H., and Sveiraf, J. (1982). Corticotropin-releasing factor stimulates secretion of melanocyte-stimulating hormone from the rat pituitary. *Science* **217**, 62–63.
- Prummel, M. F., Brokken, L. J., and Wiersinga, W. M. (2004). Ultra short-loop feedback control of thyrotropin secretion. *Thyroid* **14**, 825–829.
- Quentien, M. H., Barlier, A., Franc, J. L., Pellegrini, I., Brue, T., and Enjalbert, A. (2006). Pituitary transcription factors: from congenital deficiencies to gene therapy. *J. Neuroendocrinol.* **18**, 633–642.
- Quillen, E. W., Jr., and Cowley, A. W., Jr., (1983). Influence of volume changes on osmolality-vasopressin relationships in conscious dogs. *Am J Physiol* **244**, H73–hH79.
- Raff, H., Papanek, P. E., and Cowley, A. W., Jr., (1992). Effect of hypotension and hyperosmolality on vasopressin and ACTH responses to hypoglycemia in conscious dogs. *Am. J. Physiol.* **263**, R382–R388.
- Raff, H., Skelton, M. M., and Cowley, A. W., Jr., (1989). Feedback control of vasopressin and corticotrophin secretion in conscious dogs: effect of hypertonic saline. *J. Endocrinol.* **122**, 41–48.
- Rao, J. K., Hu, H., Prasad, C., and Jayaraman, A. (1986). The distribution pattern of adrenocorticotropin-like immunoreactivity in the cat central nervous system. *Neurosci. Lett.* **71**, 48–52.
- Rascher, W., Rauh, W., Brandeis, W. E., Huber, K. H., and Scharer, K. (1986). Determinants of plasma arginine-vasopressin in children. *Acta Paediatr. Scand.* **75**, 111–117.
- Rayalam, S., Eizenstat, L. D., Davis, R. R., Hoenig, M., and Ferguson, D. C. (2006). Expression and purification of feline thyrotropin (fTSH): immunological detection and bioactivity of heterodimeric and yoked glycoproteins. *Domest. Anim. Endocrinol.* **30**, 185–202.
- Redekopp, C., Irvine, C. H., Donald, R. A., Livesey, J. H., Sadler, W., Nicholls, M. G., Alexander, S. L., and Evans, M. J. (1986a). Spontaneous and stimulated adrenocorticotropin and vasopressin pulsatile secretion in the pituitary venous effluent of the horse. *Endocrinology* **118**, 1410–1416.
- Redekopp, C., Livesey, J. H., Sadler, W., and Donald, R. A. (1986b). The physiological significance of arginine vasopressin in potentiating the response to corticotrophin-releasing factor in sheep. *J. Endocrinol.* **108**, 309–312.
- Reichler, I. M., Hung, E., Jochle, W., Piche, C. A., Roos, M., Hubler, M., and Arnold, S. (2005). FSH and LH plasma levels in bitches with differences in risk for urinary incontinence. *Theriogenology* **63**, 2164–2180.
- Renaville, R., Hammadi, M., and Portetelle, D. (2002). Role of the somatotrophic axis in the mammalian metabolism. *Domest. Anim. Endocrinol.* **23**, 351–360.
- Reusch, C. E., Kley, S., Casella, M., Nelson, R. W., Mol, J., and Zapf, J. (2006). Measurements of growth hormone and insulin-like growth factor 1 in cats with diabetes mellitus. *Vet. Rec.* **158**, 195–200.
- Rijnberk, A. (1971). Iodine metabolism and thyroid disease in the dog. "Thesis, Utrecht University." Elinkwijk, Utrecht.
- Rijnberk, A. (1996). Hypothalamus-pituitary system. "Clinical Endocrinology of Dogs and Cats", p. 167. Kluwer Academic, Boston.
- Rijnberk, A., Biewenga, W. J., and Mol, J. A. (1988a). Inappropriate vasopressin secretion in two dogs. *Acta Endocrinol. (Copenh.)* **117**, 59–64.
- Rijnberk, A., Kooistra, H. S., and Mol, J. A. (2003). Endocrine diseases in dogs and cats: similarities and differences with endocrine diseases in humans. *Growth. Horm. IGF. Res.* **13(suppl A)**, S158–S164.
- Rijnberk, A., Kooistra, H. S., van Vonderen, I. K., Mol, J. A., Voorhout, G., van Sluijs, F. J., IJzerc, J., van den Ingh, T. S., Boer, P., and Boer, W. H. (2001). Aldosteronoma in a dog with polyuria as the leading symptom. *Domest. Anim. Endocrinol.* **20**, 227–240.
- Rijnberk, A., Mol, J. A., Kwant, M. M., and Croughs, R. J. (1988b). Effects of brnocriftine on corticotrophin, melanotrophin and corticosteroid secretion in dogs with pituitary-dependent hyperadrenocorticism. *J. Endocrinol.* **118**, 271–277.
- Rijnberk, A., Mol, J. A., Rothuizen, J., Bevers, M. M., and Middleton, D. J. (1987). Circulating Proopiomelanocortin-derived Peptides in Dogs with Pituitary-dependent Hyperadrenocorticism. *Front. Horm. Res.* **17**, 48.
- Rijnberk, A., van Herpen, H., Mol, J. A., and Rutteman, G. R. (1993). Disturbed release of growth hormone in mature dogs: a comparison with congenital growth hormone deficiency. *Vet. Rec.* **133**, 542–545.
- Robben, J. H., Van Garderen, E., Mol, J. A., Wolfswinkel, J., and Rijnberk, A. (2002). Locally produced growth hormone in canine insulinomas. *Mol. Cell. Endocrinol.* **197**, 187–195.
- Robertson, G. L. (1978). Vasopressin. In "The Year Book in Endocrinology" (S. H. Ingbar, Ed.), p. 205. Plenum, New York.
- Robertson, G. L. (1983). Thirst and vasopressin function in normal and disordered states of water balance. *J. Lab. Clin. Med.* **101**, 351–371.
- Robinson, A. G., and Verbalis, J. G. (2003). Posterior Pituitary Gland. In "Williams Textbook of Endocrinology" (P. R. Larsen, H. M. Kronenberg, S. Melmed, and K. S. Polonsky, Eds.), p. 281. Saunders, Philadelphia.
- Rosenblatt, J. S. (1984). Prolactin and parental behavior among selected species. In "Prolactin Secretion: A Multidisciplinary Approach" (F. Mena and C. M. Valverde, Eds.). Academic Press, New York.

- Rosso, L., Peteri-Brunback, B., and Mienville, J. M. (2004). Putative physiological significance of vasopressin Via receptor activation in rat pituitary cells. *J. Neuroendocrinol.* **16**, 313–318.
- Rothuizen, J., Biewenga, W. J., and Mol, J. A. (1995). Chronic glucocorticoid excess and impaired osmoregulation of vasopressin release in dogs with hepatic encephalopathy. *Domest. Anim. Endocrinol.* **12**, 13–24.
- Rothuizen, J., Reul, J. M., van Sluijs, F. J., Mol, J. A., Rijnberk, A., and de Kloet, E. R. (1993). Increased neuroendocrine reactivity and decreased brain mineralocorticoid receptor-binding capacity in aged dogs. *Endocrinology* **132**, 161–168.
- Rutteman, G. R., Stolp, R., Rijnberk, A., Loeffler, S., Bakker, J. A., Bevers, M. M., Meulenberg, P. M., and Eigenmann, J. E. (1987). Medroxy-progesterone acetate administration to ovariohysterectomized, oestradiol-primed beagle bitches. Effect on secretion of growth hormone, prolactin and cortisol. *Acta Endocrinol. (Copenh.)* **114**, 275–282.
- Saland, L. C. (2001). The mammalian pituitary intermediate lobe: an update on innervation and regulation. *Brain. Res. Bull.* **54**, 587–593.
- Sanchez-Pacheco, A., and Aranda, A. (2003). Binding of the thyroid hormone receptor to a negative element in the basal growth hormone promoter is associated with histone acetylation. *J. Biol. Chem.* **278**, 39383–39391.
- Sanders, E. J., and Harvey, S. (2004). Growth hormone as an early embryonic growth and differentiation factor. *Anat. Embryol. (Berl.)* **209**, 1–9.
- Saneyoshi, T., Min, K. S., Jing Ma, X., Nambo, Y., Hiyama, T., Tanaka, S., and Shiota, K. (2001). Equine follicle-stimulating hormone: molecular cloning of beta subunit and biological role of the asparagine-linked oligosaccharide at asparagine(56) of alpha subunit. *Biol. Reprod.* **65**, 1686–1690.
- Sawchenko, P. E., and Swanson, L. W. (1983). The organization and biochemical specificity of afferent projections to the para ventricular and supraoptic nuclei. *Prog. Brain. Res.* **60**, 19–29.
- Scapagini, U., Drago, F., Continella, G., Spadaro, F., Pennisi, G., and Gerenday, I. (1985). Experimental and clinical effects of prolactin on behavior. In “Prolactin, Basic and Clinical Correlates” (R. M. MacLeod, M. O. Thorner, and U. Scapagini, Eds.), vol. 1. Liviana Press, Padova.
- Schams, D. (1983). Oxytocin determination by radioimmunoassay. III. Improvement to subpicogram sensitivity and application to blood levels in cyclic cattle. *Acta Endocrinol. (Copenh.)* **103**, 180–183.
- Schimchowitsch, S., Palacios, J. M., Stoessel, M. E., Schmitt, G., and Porte, A. (1986). Absence of inhibitory dopaminergic control of the rabbit pituitary gland intermediate lobe. *Neuroendocrinology* **42**, 71–74.
- Schoemaker, N. J., Mol, J. A., Lumeij, J. T., and Rijnberk, A. (2002a). I plasma concentrations of adrenocorticotrophic hormone and alpha-melanocyte-stimulating hormone in ferrets (*Mustela putorius furo*) with hyperadrenocorticism. *Am. J. Vet. Res.* **63**, 1395–1399.
- Schoemaker, N. J., Teerds, K. J., Mol, J. A., Lumeij, J. T., Thijssen, J. H., and Rijnberk, A. (2002b). The role of luteinizing hormone in the pathogenesis of hyperadrenocorticism in neutered ferrets. *Mol. Cell. Endocrinol.* **197**, 117–125.
- Schoemaker, N. J., van der Hage, M. H., Flik, G., Lumeij, J. T., and Rijnberk, A. (2004). Morphology of the pituitary gland in ferrets (*Mustela putorius furo*) with hyperadrenocorticism. *J. Comp. Pathol.* **130**, 255–265.
- Scholten-Sloof, B. E., Knol, B. W., Rijnberk, A., Mol, J. A., Middleton, D. J., and Ubbink, G. J. (1992). Pituitary-dependent hyperadrenocorticism in a family of Dandie Dinmont terriers. *J. Endocrinol.* **135**, 535–542.
- Schopohl, J., Losa, M., Konig, A., Muller, O. A., Stalla, G. K., and von Werder, K. (1986). Combined pituitary function-test with four hypothalamic releasing hormones. *Klin. Wochenschr.* **64**, 314–318.
- Selman, P. J., Mol, J. A., Rutteman, G. R., and Rijnberk, A. (1991). Progesterins and growth hormone excess in the dog. *Acta Endocrinol. (Copenh.)* **125(suppl 1)**, 42–47.
- Selman, P. J., Mol, J. A., Rutteman, G. R., and Rijnberk, A. (1994a). Progesterin treatment in the dog. I. Effects on growth hormone, insulin-like growth factor I and glucose homeostasis. *Eur. J. Endocrinol.* **131**, 413–421.
- Selman, P. J., Mol, J. A., Rutteman, G. R., van Garderen, E., and Rijnberk, A. (1994b). Progesterin-induced growth hormone excess in the dog originates in the mammary gland. *Endocrinology* **134**, 287–292.
- Seo, H. (1985). Growth hormone and prolactin chemistry, gene organization, biosynthesis and regulation of gene expression. In “The Pituitary Gland” (H. Imura, Ed.), pp. 57–82. Raven press, New York.
- Sheng, H. Z., Moriyama, K., Yamashita, T., Li, H., Potter, S. S., Mahon, K. A., and Westphal, H. (1997). Multistep control of pituitary organogenesis. *Science* **278**, 1809–1812.
- Sheng, H. Z., Zhadanov, A. B., Mosinger, B., Jr., Fujii, T., Bertuzzi, S., Grinberg, A., Lee, E. J., Huang, S. P., Mahon, K. A., and Westphal, H. (1996). Specification of pituitary cell lineages by the LIM homeobox gene Lhx3. *Science* **272**, 1004–1007.
- Shewchuk, B. M., Liebhaver, S. A., and Cooke, N. E. (2002). Specification of unique Pit-1 activity in the hGH locus control region. *Proc. Natl. Acad. Sci. USA* **99**, 11784–11789.
- Shimada, K., Neldon, H. L., and Koike, T. I. (1986). Arginine vasotocin (AVT) release in relation to uterine contractility in the hen. *Gen. Comp. Endocrinol.* **64**, 362–367.
- Shimada, K., Saito, N., Itogawa, K., and Koike, T. I. (1987). Changes in plasma concentrations of arginine vasotocin after intrauterine injections of prostaglandin F-2 alpha and acetylcholine at various times during the oviposition cycle of the domestic hen (*Gallus domesticus*). *J. Reprod. Fertil.* **80**, 143–150.
- Shimatsu, A., Kato, Y., Ohta, H., Tojo, K., Kabayama, Y., Inoue, T., and Imura, H. (1985). Involvement of vasoactive intestinal polypeptide in serotonergic stimulation of prolactin secretion in rats. In “Prolactin, Basic and Clinical Correlates” (R. M. MacLeod, M. O. Thorner, and U. Scapagini, Eds.), vol. 1, p. 73. Liviana Press, Padova.
- Shiver, T., Familiar, M., and Aguilera, G. (1992). Regulation of intermediate pituitary corticotropin-releasing hormone receptors by dopamine. *Endocrinology* **130**, 2299–2304.
- Shupnik, M. A. (2000). Thyroid hormone suppression of pituitary hormone gene expression. *Rev. Endocr. Metab. Disord.* **1**, 35–42.
- Smith, J. T., Popa, S. M., Clifton, D. K., Hoffman, G. E., and Steiner, R. A. (2006). Kiss1 neurons in the forebrain as central processors for generating the preovulatory luteinizing hormone surge. *J. Neurosci.* **26**, 6687–6694.
- Smith, R., Owens, P. C., Lovelock, M., Chan, E. C., and Falconer, J. (1986). Acute hemorrhagic stress in conscious sheep elevates immunoreactive beta-endorphin in plasma but not in cerebrospinal fluid. *Endocrinology* **118**, 2572–2576.
- Soares, M. J. (2004). The prolactin and growth hormone families: pregnancy-specific hormones/cytokines at the maternal-fetal interface. *Reprod. Biol. Endocrinol.* **2**, 51.
- Spichiger, A. C., Allenspach, K., Ontsouka, E., Gaschen, F., Morel, C., Blum, J. W., and Sauter, S. N. (2005). Abundance of mRNA of growth hormone receptor and insulin-like growth factors-1 and -2 in duodenal and colonic biopsies of dogs with chronic enteropathies\*. *J. Vet. Med. A Physiol. Pathol. Clin. Med.* **52**, 491–497.



- van Wijk, P. A., Rijnberk, A., Croughs, R. J., Wolfswinkel, J., Selman, P. J., and Mol, J. A. (1994). Responsiveness to corticotropin-releasing hormone and vasopressin in canine Cushing's syndrome. *Eur. J. Endocrinol.* **130**, 410–446.
- Van Wimersma Greidanus, T. B. (1987). Opiates, Opioid Peptides and the Release of Vasopressin. *Front. Horm. Res.* **17**, 61.
- van Wimersma Greidanus, T. B., Burbach, J. P., and Veldhuis, H. D. (1986). Vasopressin and oxytocin. Their presence in the central nervous system and their functional significance in brain processes related to behaviour and memory. *Acta Endocrinol. Suppl. (Copenh.)* **276**, 85–94.
- Vazquez-Martinez, R., Castano, J. P., Tonon, M. C., Vaudry, H., Gracia-Navarro, F., and Malagon, M. M. (2003). Melanotrope secretory cycle is regulated by physiological inputs via the hypothalamus. *Am. J. Physiol. Endocrinol. Metab.* **285**, E1039–E1046.
- Veldhuis, J. D., Roemmich, J. N., Richmond, E. J., and Bowers, C. Y. (2006). Somatotropic and gonadotropic axes linkages in infancy, childhood, and the puberty-adult transition. *Endocr. Rev.* **27**, 101–140.
- Verbalis, J. G., McCann, M. J., McHale, C. M., and Stricker, E. M. (1986). Oxytocin secretion in response to cholecystokinin and food: differentiation of nausea from satiety. *Science* **232**, 1417–1419.
- Viguie, C., Chilliard, Y., Gayrard, V., Picard-Hagen, N., Monget, P., Dutour, A., and Toutain, P. L. (2004). Alterations of somatotropic function in prion disease in sheep. *J. Endocrinol.* **183**, 427–435.
- Villalobos, C., Nunez, L., and Garcia-Sancho, J. (2004). Phenotypic characterization of multi functional somatotropes, mammatropes and gonadotropes of the mouse anterior pituitary. *Pflugers Arch.* **449**, 257–264.
- Vokes, T., and Robertson, G. L. Muller (E. E. , MacLeod R. M. , and Frohman, Eds.) L. A. (1985a). In “Neuroendocrine Perspectives,” vol. 4, p. 1. Elsevier, Amsterdam.
- Vokes, T., and Robertson, G. L. (1985b). Effect of insulin on the osmoregulation of thirst and vasopressin. In “Vasopressin” (R. W. Schrier, Ed.), p. 271. Raven, New York.
- Wade, C. E. (1985). Pituitary and adrenal hormone responses to naloxone in euhydrated and dehydrated dogs. *Am. J. Physiol.* **249**, E634–E638.
- Wade, C. E., Bie, P., Keil, L. C., and Ramsay, D. J. (1982). Effect of hypertonic intracarotid infusions on plasma vasopressin concentration. *Am. J. Physiol.* **243**, E522–E526.
- Wade, C. E., Keil, L. C., and Ramsay, D. J. (1983). Role of volume and osmolality in the control of plasma vasopressin in dehydrated dogs. *Neuroendocrinology* **37**, 349–353.
- Wallis, M. (1984). The molecular evolution of prolactin and related hormones. In “Prolactin Secretion, A Multidisciplinary Approach” (F. Mena and C. M. Valverde, Eds.), pp. 1–16. Academic Press, New York.
- Wallis, O. C., Bill, L. J., Burt, E. J., Ellis, S. A., and Wallis, M. (2006). Polymorphism of the growth hormone gene of red deer (*Cervus elaphus*). *Gen. Comp. Endocrinol.* **146**, 180–185.
- Wang, B. C., and Goetz, K. L. (1985). Volume influences on the plasma osmolality-plasma vasopressin relationship mediated by cardiac receptors. In “Vasopressin” (R. W. Schrier, Ed.), p. 221. Raven, New York.
- Watson, S. G., Radford, A. D., Kipar, A., Ibarrola, P., and Blackwood, L. (2005). Somatic mutations of the thyroid-stimulating hormone receptor gene in feline hyperthyroidism: parallels with human hyperthyroidism. *J. Endocrinol.* **186**, 523–537.
- Willemse, T., and Mol, J. A. (1994). Comparison of in vivo and in vitro corticotropin-releasing hormone-stimulated release of proopiomelanocortin-derived peptides in cats. *Am. J. Vet. Res.* **55**, 1677–1681.
- Willemse, T., Vroom, M. W., Mol, J. A., and Rijnberk, A. (1993). Changes in plasma cortisol, corticotropin, and alpha-melanocyte-stimulating hormone concentrations in cats before and after physical restraint and intradermal testing. *Am. J. Vet. Res.* **54**, 69–72.
- Williams, D. A., Scott-Moncrieff, C., Bruner, J., Sustarsic, D., Panosian-Sahakian, N., Unver, E., and el Shami, A. S. (1996). Validation of an immunoassay for canine thyroid-stimulating hormone and changes in serum concentration following induction of hypothyroidism in dogs. *J. Am. Vet. Med. Assoc.* **209**, 1730–1732.
- Wilson, M. G., Nicholson, W. E., Holscher, M. A., Sherrell, B. J., Mount, C. D., and Orth, D. N. (1982). Proopiomelanocortin peptides in normal pituitary, pituitary tumor, and plasma of normal and Cushing's horses. *Endocrinology* **110**, 941–954.
- Winter, M., Pirmann, J., Falvo, R. E., Schanbacher, B. D., and Miller, J. (1982). Steroid control of gonadotrophin secretion in the orchidectomized dog. *J. Reprod. Fertil.* **64**, 449–455.
- Wulffraat, N. M., Drexhage, H. A., Jeucken, P., van der Gaag, R. D., and Wiersinga, W. M. (1987). Effects of ACTH and ACTH fragments on DNA synthesis in guinea-pig adrenal segments kept in organ culture. *J. Endocrinol.* **115**, 505–510.
- Yan, M., Hernandez, M., Xu, R., and Chen, C. (2004). Effect of GHRH and GHRP-2 treatment in vitro on GH secretion and levels of GH, pituitary transcription factor-1, GHRH-receptor, GH-secretagogue-receptor and somatostatin receptor mRNAs in ovine pituitary cells. *Eur. J. Endocrinol.* **150**, 235–242.
- Yang, X., McGraw, R. A., and Ferguson, D. C. (2000). cDNA cloning of canine common alpha gene and its co-expression with canine thyrotropin beta gene in baculovirus expression system. *Domest. Anim. Endocrinol.* **18**, 379–393.
- Yokoyama, M., Murakami, N., Naganobu, K., Hosoda, H., Kangawa, K., and Nakahara, K. (2005). Relationship between growth and plasma concentrations of ghrelin and growth hormone in juvenile beagle dogs. *J. Vet. Med. Sci.* **67**, 1189–1192.
- Young, D. W., and Kempainen, R. J. (1994). Molecular forms of beta-endorphin in the canine pituitary gland. *Am. J. Vet. Res.* **55**, 567–571.
- Young, D. W., Zerbe, C. A., and Kempainen, R. J. (1992). Molecular forms of alpha-melanocyte-stimulating hormone in the canine pituitary anterior and intermediate lobe. *Peptides* **13**, 1061–1066.
- Young, L. J., and Wang, Z. (2004). The neurobiology of pair bonding. *Nat. Neurosci.* **7**, 1048–1054.

# Adrenocortical Function

Björn P. Meij

*Department of Clinical Sciences of Companion Animals  
Faculty of Veterinary Medicine  
Utrecht University  
Utrecht, The Netherlands*

Jan A. Mol

*Department of Clinical Sciences of Companion Animals  
Faculty of Veterinary Medicine  
Utrecht University  
Utrecht, The Netherlands*

## I. ANATOMICAL CONSIDERATIONS

### II. PHYSIOLOGY OF ADRENOCORTICAL HORMONES

- A. Steroid Nomenclature
- B. Biosynthesis
- C. Regulation of Secretion
- D. Transport
- E. Metabolic Breakdown and Excretion
- F. Steroid Receptors and Actions
- G. Physiological Variation, Stress, and the Immune System

### III. ADRENOCORTICAL DISEASES

- A. Hypoadrenocorticism
- B. Hyperadrenocorticism

### IV. ASSESSMENT OF ADRENOCORTICAL FUNCTION

- A. Routine Laboratory Diagnostics
- B. Tests of Basal Adrenocortical Function
- C. Dynamic Tests
- D. Tests for Differential Diagnosis
- E. Collection and Handling of Samples
- F. Protocols

## REFERENCES

### I. ANATOMICAL CONSIDERATIONS

In mammals, the adrenal glands are bilateral structures located craniomedial to the kidneys. The adrenal is, in fact, made up of two glands of different embryological origin. The center of the gland, the medulla, comprises coalesced chromaffin cells of neuroectodermal origin that secrete epinephrine or norepinephrine. The surrounding adrenal cortex arises from mesoderm and can be divided histologically into three zones: (1) zona glomerulosa (or arcuata), (2) zona fasciculata, and (3) zona reticularis. The cells of the zona glomerulosa are arranged in ovoid groups immediately inside the connective tissue capsule. The region may be particularly obvious (e.g., sheep) or difficult to discern (e.g., small rodents). The zona fasciculata accounts for most of the adrenal cortex (>60%) and appears histologically in radial lines. The inner zona reticularis comprises networks of cell cords

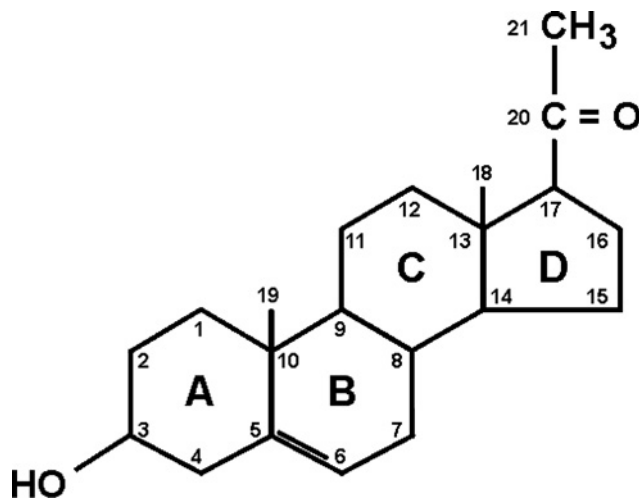
surrounding the large blood sinuses. A notable feature of the ferret adrenal gland is that islands of cortical cells can be found among cells of the medulla. These cells resemble those of the inner part of the zona fasciculata (Holmes, 1961).

In birds, the adrenal glands are also separate, encapsulated organs. The glands lie cranial to the kidney, often wholly or partly covered by the gonads. The adrenocortical and chromaffin tissues are intermingled to varying degrees, depending on the species. The basic unit of avian adrenocortical tissue is a cord of a double row of parenchymal cells, with their long axes in the transverse plane of the strand. The cords radiate from the center of the gland, branch, and anastomose frequently. Groups of chromaffin cells lie between the cords and are also ensheathed within the connective tissue reticulum (Chester-Jones, 1987).

Blood flow of the adrenals is centripetal. In species with separated medulla and cortex, this results in high medullary corticoid concentrations that induce an enzyme in the chromaffin cells, converting norepinephrine to epinephrine. Therefore, species with anatomically separated medulla and cortex predominantly secrete epinephrine and species with intermingled chromaffin and adrenocortical tissue secrete predominantly norepinephrine (Marks, 1983).

### II. PHYSIOLOGY OF ADRENOCORTICAL HORMONES

The secretion of the mammalian adrenal cortex comprises three main categories of hormones, which can be related to some extent to the above-described anatomical zonation. The zona glomerulosa produces mineralocorticoids (aldosterone and deoxycorticosterone), which maintain salt balance. The cells of the zona fasciculata secrete glucocorticoids (cortisol and corticosterone), which are primarily involved in carbohydrate metabolism. The third category of adrenocortical hormones, the androgens (e.g., androstenedione), is produced in the zona reticularis. This zone to a minor degree also secretes glucocorticoids and other hormones such as progesterone and estrogens.



**FIGURE 19-1** Numbers of the carbon atoms and letters designating the rings of the pregnenolone molecule (IUPAC-IUB, 1989).

In birds aldosterone and corticosterone are the main corticosteroids secreted. Zonation of the avian adrenal is less clear than in the mammalian adrenal. However, the outer subcapsular cells, looping in a manner similar to the zona glomerulosa, appear to be the predominant aldosterone secretors. The cells reaching toward the central part of the gland form corticosterone (Kime, 1987).

## A. Steroid Nomenclature

The adrenal steroids contain as their basic structure a cyclopentanoperhydrophenanthrene nucleus consisting of three six-carbon rings (A, B, and C) and a single five-carbon ring (D). The letter designations for the carbon rings, and the numbers of the carbon atoms are shown for pregnenolone (Fig. 19-1), a key biosynthetic intermediate. The Greek letter  $\Delta$  indicates a double bond, as does the suffix -ene. The position of a substituent below or above the plane of the steroid ring is indicated by  $\alpha$  and  $\beta$ , respectively. The  $\alpha$  substituent is drawn with a broken line (e.g.--OH) and the  $\beta$  substituent with a solid line (e.g.-OH). The  $C_{18}$  steroids, which are devoid of a side chain at C-17 and have a substituent at C-18, are estrogens. The  $C_{19}$  steroids, which have substituent methyl groups at positions C-18 and C-19, are androgens (see also Fig. 19-1) (IUPAC-IUB, 1989).

Steroids that have a ketone group at C-17 are termed 17-ketosteroids. The  $C_{21}$  steroids, the corticosteroids and progestagens, are those that have a two-carbon side chain (C-20 and C-21) attached at C-17 and in addition have substituent methyl groups at C-18 and C-19. The  $C_{21}$  steroids that also possess a hydroxyl group at position 17 are termed 17-hydroxy-corticosteroids and may have predominantly glucocorticoid properties.

## B. Biosynthesis

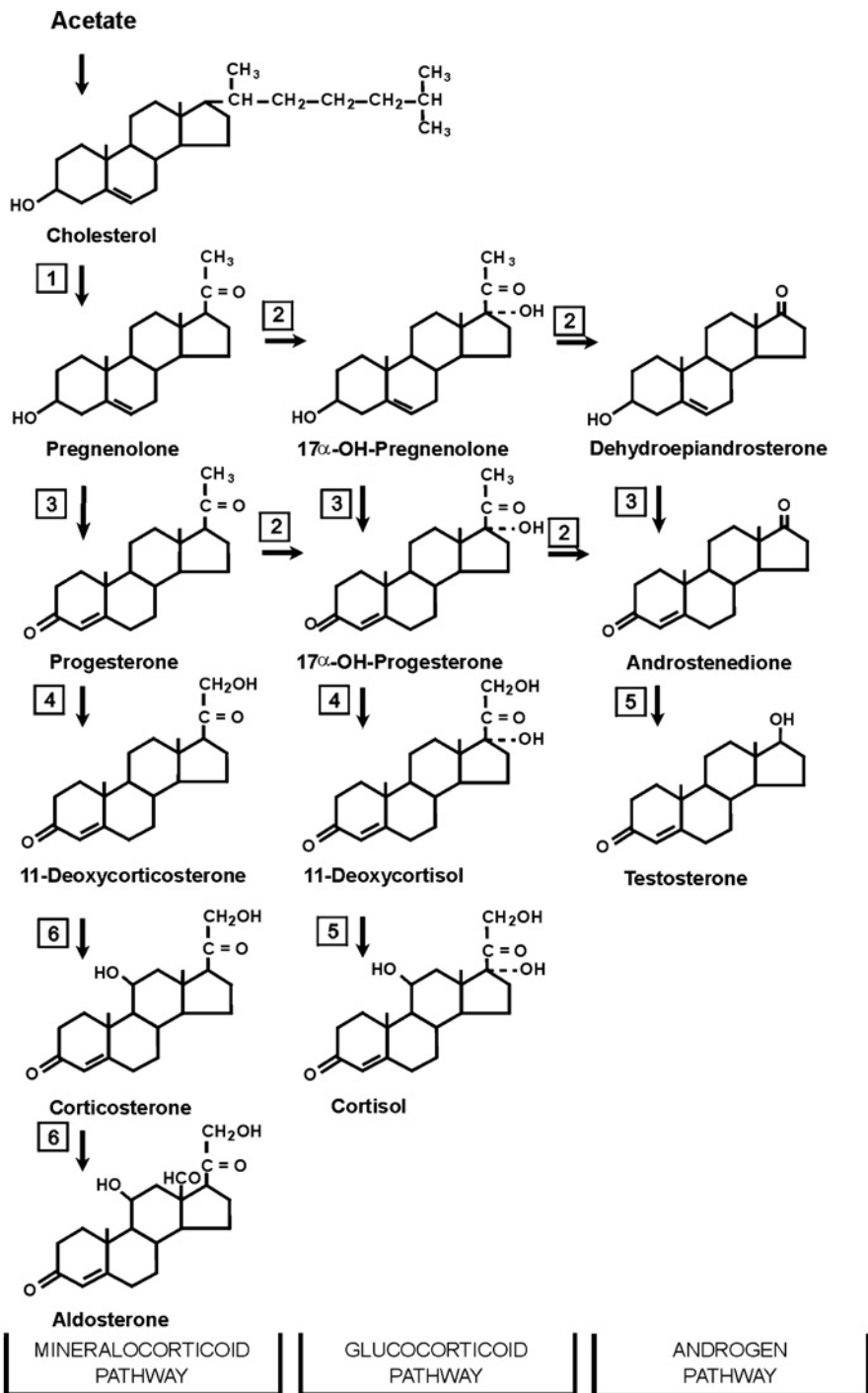
Cholesterol, derived from food and from endogenous synthesis via acetate (Fig. 19-2), is the principal starting compound in steroidogenesis. The adrenal gland is enriched in receptors that internalize low- and high-density lipoproteins. This uptake mechanism increases when the adrenal is stimulated and provides the major cholesterol source. Subsequent steps occur in the mitochondrion or at the endoplasmic reticulum. Two classes of enzymes are involved in the synthesis of steroids, the cytochrome P450 (CYP) heme-containing proteins that catalyze mainly hydroxylation reactions and the hydroxysteroid dehydrogenases (HSD) that are involved in oxidation and reduction reactions (Payne and Hales, 2004). The human CYP enzymes are written with capitals, whereas in mice lower-case is used. For other species no rules are given, but we will use here the abbreviations as used for human.

The precursor cholesterol has a side chain that is cleaved by CYP11A1 resulting in formation of pregnenolone (Fig. 19-2). Mice defective in the *Cyp11a1* gene produce no steroids, survive during embryogenesis, but die after birth (Hsu *et al.*, 2006). The zonal difference in adrenocortical hormone production is due to two steroidogenic enzymes. The mitochondrial CYP11B2 (aldosterone synthase), which converts 11-deoxycorticosterone by 11 $\beta$ -hydroxylation and the formation of a carbon 18 aldehyde group toward aldosterone, is found only in the zona glomerulosa. The characteristic enzymes of the inner zones are the microsomal CYP17 (17 $\alpha$ -hydroxylase/17,20 lyase) and the mitochondrial CYP11B1 (11 $\beta$ -hydroxylase). CYP17 catalyzes the 17 $\alpha$ -hydroxylation of pregnenolone and progesterone as well as the side chain fission of 17 $\alpha$ -hydroxy  $C_{21}$  steroids resulting in the formation of dehydroepiandrosterone (DHEA) or androstenedione (Fig. 19-2). CYP11B1 catalyzes the 11 $\beta$ -hydroxylation in the zona fasciculata and reticularis (Payne and Hales, 2004). The other steroidogenic enzymes are present in all three zones of the adrenal cortex (Müller, 1986).

In rat, mouse, guinea pig, baboon, and hamster two distinct CYP11B forms are found, in contrast with cow, pig, sheep, and frogs where the formation of glucocorticoids and mineralocorticoids is catalyzed by a single 11 $\beta$ -hydroxylase (CYP11B1) (Lisurek and Bernhardt, 2004).

The characteristic microsomal 21-hydroxylating (CYP21) and mitochondrial 11 $\beta$ -hydroxylating (CYP11B1) enzymes appear to have developed at an early stage of evolution and are present in all vertebrates. Also, the 18-oxygenated corticosteroids (CYP11B2) retain their importance as mineralocorticoids in all vertebrates. For the 17 $\alpha$  hydroxylation (CYP17) potential, the situation is different. Most mammals secrete cortisol as the predominant glucocorticoid. However, rodents and birds secrete predominantly 17-deoxycorticosteroids such as corticosterone.

In line with this, steroid determinations in adrenal venous blood of dogs (Hirose *et al.*, 1977) have revealed cortisol/



**FIGURE 19-2** Biosynthetic pathways for adrenal steroid production. Numbers by arrows denote specific enzymes: 1 = CYP11A1; 2 = CYP17; 3 = 3 $\beta$ -HSD; 4 = CYP21; 5 = CYP11B1; 6 = CYP11B2.

corticosterone ratios to range from about 3 to 7. In another study, ratios of secretion rates were found ranging from 1.2 to 2.7 and corticosterone/aldosterone secretion ratios between 7 and 25 (Dor *et al.*, 1973). With HPLC analysis in peripheral blood of ACTH-stimulated dogs, the cortisol/corticosterone ratios ranged from 2.4 to 9.7 with a mean of 5.0 (Lothrop and Oliver, 1984). In addition to glucocorticoids and aldosterone, the adrenal vein blood of

dogs and pigs contains androstenedione, 11-hydroxyandrostenedione, androsterone, pregnenolone, progesterone, and 11-hydroxyprogesterone (Heap *et al.*, 1966; Holzbauer and Newport, 1969), as well as very small amounts of estradiol and estrone (Dor *et al.*, 1973).

In cats, the cortisol/corticosterone ratio has been estimated to range from 1.6 to 12.4, whereas in kittens the ratio is less than unity (Ilett and Lockett, 1969). In the



peripheral blood of horses, higher cortisol/corticosterone ratios (16.0:0.5 and 7.0:0.5) have been reported (James *et al.*, 1970; Zolovick *et al.*, 1966).

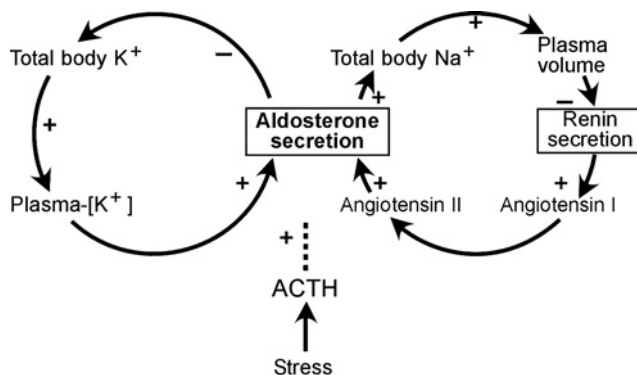
In birds, corticosterone, a glucocorticoid with minor mineralocorticoid properties, is by far the main adrenal secretory product. In the peripheral blood of adult birds, no cortisol could be demonstrated with radioimmunoassay (Walsh *et al.*, 1985; Zenoble *et al.*, 1985) or HPLC analysis (Lumeij *et al.*, 1987). In chickens, the  $17\alpha$ -hydrolyase activity is present in embryonic life but decreases after hatching (Carsia *et al.*, 1987; Nakamura *et al.*, 1978).

### C. Regulation of Secretion

The steroidogenic activity of the two inner zones of the adrenal cortex is predominantly controlled by the pituitary hormone ACTH. The production of aldosterone in the zona glomerulosa is adapted to the sodium and potassium status of the organism by a complex, multifactorial, and mainly extrapituitary control system. For details on the secretion of ACTH by the pituitary and its regulation, refer to Chapter 18. In puppies, the feedback control of the hypothalamic-pituitary-adrenal axis is already operative at the time of birth (Muelheims *et al.*, 1969), although up to the age of 8 weeks basal plasma cortisol concentrations are lower than in mature dogs. There is indirect evidence that this is related to low binding to transport proteins (Randolph *et al.*, 1995).

The action of ACTH on the adrenal gland is rapid; within minutes of its release, the concentration of steroids in the adrenal venous blood increases. The most likely mechanism by which ACTH stimulates steroidogenesis is via activation of membrane-bound adenylate cyclase. This increases the level of cyclic adenosine 3',5'-monophosphate (cAMP), which activates adrenocortical protein kinases. This results in the phosphorylation of enzymes that enhance the rate of conversion of cholesterol to pregnenolone. Within the adrenal gland, a crosstalk exists with the adrenal medulla (Schinner and Bornstein, 2005). *In vitro* coculture of adrenocortical cells with chromaffin cells results in a 10-fold increase of steroidogenic activity (Haidan *et al.*, 1998). Also, many intra-adrenal produced cytokines and growth factors play an important role in the regulation of steroidogenesis (Ehrhart-Bornstein *et al.*, 1998). In adrenal tumors, a variety of ectopic and abnormal hormone receptors may stimulate adrenal corticoid release (Lacroix *et al.*, 2001) (see also the section on adrenocortical diseases).

In the regulation of aldosterone secretion, the two most important effectors are the peptide hormone angiotensin II (ANG II) and the extracellular potassium concentrations. Regulation of aldosterone secretion by the potassium status is direct and rather simple (Fig. 19-3). The second loop, which adapts aldosterone secretion to the sodium balance, is much more complex. These two systems are regulated by negative feedback loops. In contrast, ACTH is a representative of other factors that may stimulate aldosterone release



**FIGURE 19-3** Physiological control of aldosterone secretion (Müller, 1986).

without a link to negative feedback (Williams, 2005). From all factors known to regulate aldosterone production *in vitro*, the stimulation is probably confined under physiological conditions to stimulation by ANG II,  $K^+$ , and ACTH and inhibition by the atrial natriuretic hormone (ANP) (Spat and Hunyady, 2004).

Apart from these factors, other intra-adrenal factors (Ehrhart-Bornstein *et al.*, 1998) and environmental factors may regulate aldosterone production not only at the level of conversion of cholesterol to pregnenolone but also at the level of aldosterone synthase (CYP11B2) (Williams, 2005).

### D. Transport

At normal concentrations, only about 10% of the total blood cortisol and corticosterone is in the free form (i.e., susceptible to ultrafiltration). At body temperature, 70% of the plasma cortisol is bound to a globulin called transcortin or corticosteroid-binding globulin (CBG). Transcortin has a high affinity for cortisol and corticosterone, but its binding capacity is limited. Another 20% of plasma cortisol is bound to albumin although its affinity for cortisol is much less than that of transcortin. In line with these percentages, in the dog the free fraction has been estimated to range from 5% to 12% (Kemppainen *et al.*, 1991; Meyer and Rothuizen, 1993).

Transcortin is ubiquitous in mammals, but plasma concentrations vary considerably, resulting in species differences in total cortisol concentration. Most domestic animals have little corticosteroid-binding activity compared to humans (Rosner, 1969). As the free rather than the protein-bound steroid is biologically active, methods have been developed to measure free cortisol. By employing the combination of ultrafiltration and equilibrium dialysis, it was demonstrated that in dogs with portosystemic encephalopathy the associated hyperadrenocorticism is not only characterized by an increased total cortisol concentration in plasma but also by an increase in the free fraction of plasma cortisol (Meyer and Rothuizen, 1994). Between various pig breeds, a two-fold difference in plasma CBG binding capacity was found and related to increased drip loss in the Meishan breed (Geverink *et al.*, 2006).

Unbound steroids readily diffuse into the salivary glands. Because of the close relationship between free cortisol in blood and saliva (Riad-Fahmy *et al.*, 1982), techniques have been developed for the collection of saliva from cattle (Murphy and Connell, 1970), sheep (Fell *et al.*, 1985), and dogs (Phillips *et al.*, 1983). Saliva cortisol concentrations correlated significantly with plasma cortisol concentrations after an insulin-induced hypoglycemia and varied from 7% to 12% of total plasma concentrations, in line with other reports of free plasma cortisol concentrations in dogs (Beerda *et al.*, 1996). In cow's milk, about 60% of the cortisol is present in the ultrafiltrate. Following parturition, the percentage of unbound cortisol (in colostrum) decreases to 40% (Shutt and Fell, 1985) owing to the higher concentrations of CBG-like protein.

The physiological significance of protein binding probably lies in a buffering effect, which prevents rapid variations of the plasma cortisol level. Transcortin restrains the active cortisol from reaching the target organ and also protects it from rapid inactivation by the liver and excretion through the kidneys.

Plasma aldosterone is predominantly bound to albumin, which has a low affinity. The relatively low degree of protein binding of plasma aldosterone partially explains the very low plasma concentration and the short biological half-life of this hormone.

### E. Metabolic Breakdown and Excretion

Only unbound cortisol and its metabolites are filterable at the glomerulus. Most of this filtered cortisol is reabsorbed, whereby a tubular maximum is only achieved at very high filtered loads of free cortisol (Boonayathap and Marotta, 1974). Less than 20% of the filtered cortisol is excreted unchanged in the urine. Nevertheless, in most mammals the kidneys account for 50% to 80% of the excretion of the metabolized steroids. The remainder is lost via the gut. To render them suitable for renal elimination, the steroids are inactivated and made more water soluble through enzymatic modifications. The liver is the major organ responsible for steroid inactivation and conjugation to form water-soluble compounds, although in the dog—contrary to humans—the kidney and the gastrointestinal tract also contribute to the metabolic clearance of cortisol (McCormick *et al.*, 1974). In the canine, kidney cortisol glucuronide is both secreted and reabsorbed, without a tubular maximum or a plasma threshold (Boonayathap and Marotta, 1974).

Cortisol is cleared from the plasma with a half-life of 60 min or less. For pigs, the metabolic clearance rate of cortisol was calculated to be about  $11 \text{ h}^{-1} \cdot \text{kg}^{-1}$  (Hennesy *et al.*, 1986). In dogs, about 60% of infused cortisol is eliminated within 24 h in the urine (Rijnberk *et al.*, 1968a). The  $11\beta$ -hydroxyl group of cortisol can be oxidized to the ketone, forming cortisone (Fig. 19-4). The reaction is reversible, and in general the equilibrium is shifted to favor the  $11\beta$ -hydroxyl

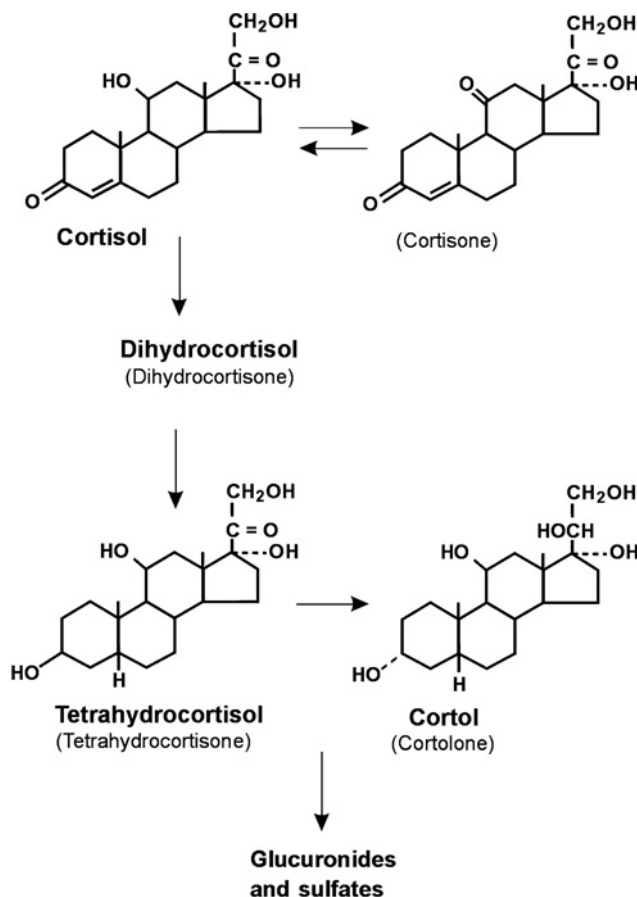


FIGURE 19-4 Metabolism of cortisol in the dog (simplified).

group. However, because the adrenal cortex produces much more cortisol than cortisone (if any), there is substantial cortisol-to-cortisone conversion. These two steroids have similar subsequent metabolic fates.

Apart from this  $11\beta$ -hydroxylation, cortisol metabolism in the dog involves the following: (1) reduction of ring A to tetrahydro derivatives, (2) reduction of the 20-keto group to a hydroxyl, and (3) conjugation with glucuronic acid to form glucuronides (Gold, 1961). In addition, unconjugated 20-hydroxycortisol/cortisone has been found in canine urine.

In total glucuronide fraction of urinary corticoids in dogs, at least steroids reduced at C-20 represent 60%. This is of prime importance when it comes to assessing adrenocortical function by measuring urinary cortisol metabolites. Measurements directed at steroids containing a  $17\alpha,21$ -dihydroxy, 20-keto arrangement (i.e., the Porter-Silber reaction) will detect only a small part of the cortisol metabolites and therefore have limited value (Siegel, 1965). Instead, preferably, measurements are performed involving reduction of the urine metabolites at C-20, followed by oxidation to 17-ketosteroids, which are then quantitated. Further details on this measurement of total 17-hydroxycorticosteroids are given in Section IV.B.3.

Aldosterone is converted not only to tetrahydroaldosterone-3-glucuronide but also to aldosterone-18-glucuronide. Most of aldosterone metabolism takes place in liver and

**TABLE 19-1** Relative Potencies of Corticosteroids

Corticosteroid	Mineralocorticoid Activity	Glucocorticoid Activity
Cortisol	1	1
Cortisone	0.7	0.7
Corticosterone	0.2	2
11-Deoxycorticosterone	0.0	20
Aldosterone	0.1	400
9 $\alpha$ -Fluorocortisone	10	400
Prednisone	4	0.7
Prednisolone	4	0.7
Dexamethasone	30	2
Triamcinolone	3	0
6 $\alpha$ -Methylprednisolone	5	0.5

kidney, but the intestine and spleen might also contribute to a minor degree (Balikian, 1971).

In domestic animals, the catabolism of androgens has not been studied in any detail. For the dog, it is known that little of the secreted androgens can be measured as 17-ketosteroids in urine (Rijnberk *et al.*, 1968b; Siegel, 1967). Probably most of the excretion occurs via the bile.

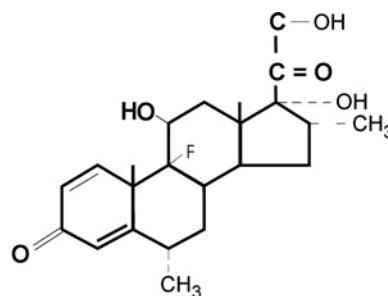
In the cat, glucocorticoid excretion is also largely biliary (Rivas and Borrell, 1971; Taylor, 1971). Feline liver function has several specific features, including a relatively low glucuronyl-transferase activity. Hence, formation of glucuronide conjugates is low, and the conjugates are mainly sulphates, which are mostly excreted via the biliary route. Despite this low urinary excretion of metabolites and conjugates, it was shown that renal excretion of free cortisol is sufficient for diagnostic purposes (Goossens *et al.*, 1995) (see also Section IV.B).

Apart from the use of urinary excretion to examine the glucocorticoid status, fecal glucocorticoid metabolite measures are increasingly being used, especially for zoo and wildlife animals. Interpretation of fecal glucocorticoids may be confounded by a large variety of factors that should be taken into account (Millspaugh and Washburn, 2004).

## F. Steroid Receptors and Actions

### 1. Glucocorticoids

Of the naturally occurring glucocorticoids (cortisol, cortisone, and corticosterone), cortisol is the most potent. Several of the synthetic analogues of cortisol are more potent than cortisol itself (Table 19-1). Figure 19-5 illustrates the structural features that determine glucocorticoid potency.



**FIGURE 19-5** Structure-function relationships of corticosteroids. The bold lines and letters indicate the structure common to all glucocorticoids. Substituents that may enhance glucocorticoid activity are presented by light lines and letters.

In their target organ cells, glucocorticoids act in the same manner as other steroid hormones: diffusion through the cell membrane; binding to the cytoplasmic, glucocorticoid (GR), and mineralocorticoid (MR) receptors; translocation of the hormone receptor complex to the nucleus; and subsequent stimulation of the synthesis of specific RNAs leading to synthesis of specific enzymes. The latter include key enzymes in gluconeogenesis such as fructose-1,6-diphosphatase, glucose-6-phosphatase, and pyruvate carboxylase. In the dog, corticosteroid excess also results in induction of an isoenzyme of alkaline phosphatase. This corticosteroid-induced form of alkaline phosphatase has not yet been found in other species. The marked stability at 65°C allows easy quantitation in plasma as a diagnostic screening tool for cases of suspected hyperadrenocorticism (Teske *et al.*, 1986, 1989).

The traditional view is that the ligand activated GR binds as a homodimer to response elements in promoter

regions of genes. However, apart from this direct interaction, the GR may also bind to other transcription factors and thus regulate gene expression of genes devoid of a classical glucocorticoid responsive element (GRE). Next osmolytes, small molecules that promote protein folding during metabolic extremes, may also contribute to protein:protein interactions at the genomic level (Kumar and Thompson, 2005). A splicing variant of the classical GR $\alpha$  is called GR $\beta$  and may act as a dominant-negative inhibitor of GR $\alpha$  (Charmandari *et al.*, 2005). Glucocorticoids may also act in a way that does not directly and initially influence gene expression, referred to as “nongenomic.” These pathways involve the production of second messengers and activation of signal transduction pathways by either the classical GR or by a membrane glucocorticoid receptor. Apart from “nongenomic” effects, glucocorticoids may also predominantly inhibit the synthesis of a variety of proteins by decreasing their mRNA stability (Dallman, 2005; Stellato, 2004).

The overall effect of glucocorticoids on metabolism is to supply glucose to the organism by the transformation of proteins. This occurs via the above-mentioned induction of gluconeogenic enzymes in the liver. Thus, glucocorticoids divert metabolism from a phase of growth and storage toward increased physical activity and energy consumption, whereas chronic excess leads to catabolic effects such as muscle wasting, skin atrophy, and osteoporosis. The tendency to hyperglycemia is opposed by increased secretion of insulin, which in turn tends to enhance fat synthesis. This along with the increased food intake owing to central appetite stimulation (Debons *et al.*, 1986) explains the (centripetal) fat deposition, manifested by abdominal enlargement.

In situations of glucocorticoid deficiency, water excretion is impaired, whereas glucocorticoid excess may result in polyuria, being most pronounced in the dog. This is in part due to antagonism of cortisol to the action of vasopressin. In addition, glucocorticoid excess causes loss of the sensitivity of the osmoregulation of vasopressin release (Biewenga *et al.*, 1991). Even physiological increases in cortisol may inhibit basal vasopressin release in dogs (Papanek and Raff, 1994).

Glucocorticoids have long been known to have effects on blood cells, including a reduction in the numbers of eosinophils and lymphocytes and an increase in the number of neutrophils and hence in the total number of leukocytes. Glucocorticoid deficiency leads to normochromic, normocytic anemia.

As far as effects on other endocrine glands are concerned, it is shown that canine hyperadrenocorticism results in reversible suppression of growth hormone secretion (Peterson and Altszuler, 1981). The frequently observed lowering of circulating thyroxine concentrations has been ascribed to changes in the thyroid hormone binding capacity of the plasma and to inhibition of lysosomal hydrolysis of colloid in the thyroid follicular cell (Kemppainen *et al.*, 1983; Woltz *et al.*, 1983). Glucocorticoids have multiple effects on peripheral transfer, distribution, and metabolism (Kapteijn *et al.*,

1992), but thyroid function does not seem to be affected (Rijnberk, 1996). The glucocorticoid prednisone was found to inhibit LH secretion in male dogs, leading to reduced testosterone concentrations (Kemppainen *et al.*, 1983).

## 2. Adrenal Androgens

In health, adrenocortical production of androgens is trivial in comparison with the production of these hormones by the gonads. However, a pathological excess of adrenal androgens might induce virilization (i.e., the development of masculine secondary sex characteristics), which would be most noticeable in the female or immature male. So far, no virilization as a consequence of enzyme deficiency has been reported in domestic animals, but in equine hyperadrenocorticism, hirsutism is a common feature (Pauli *et al.*, 1974; Van der Kolk *et al.*, 1993).

## 3. Mineralocorticoids

The widespread MR has equal affinity for aldosterone and the glucocorticoids cortisol and corticosterone, whereas the latter two hormones circulate at much higher concentrations than aldosterone. However, in the classical aldosterone targets (kidney, colon, and salivary gland), the enzyme 11 $\beta$ -hydroxysteroid dehydrogenase (11 $\beta$ HSD) converts cortisol and corticosterone (but not aldosterone!) to the 11-keto analogues. These analogues cannot bind to MR, thereby enabling aldosterone to occupy this receptor (Funder, 2005). Thus, not the receptor but a prereceptor modification provides the tissue specificity.

The synthetic steroid 9 $\alpha$ -fluorocortisone (Table 19-1) binds tightly to mineralocorticoid receptors and is used for mineralocorticoid replacement therapy because it is more stable than aldosterone after oral administration. Mineralocorticoid antagonists such as spironolactone bind to these receptors and in this way block aldosterone action.

Aldosterone controls the volume and the cationic composition of the extracellular fluid by regulating sodium and potassium balance. Its main action is on the tubular apparatus of the kidneys, but aldosterone receptors are also found in the gut, the salivary glands, and the sweat glands. In the kidney, the effect of aldosterone on the distal tubule consists almost entirely of an exchange of sodium with potassium and hydrogen ions. Aldosterone also promotes the excretion of magnesium and ammonium ions.

## G. Physiological Variation, Stress, and the Immune System

In the absence of extraordinary stress, the plasma cortisol concentration of healthy animals varies within certain limits, although adrenocortical secretion does not occur evenly throughout the day but rather in bursts. In humans, most of the secretory bursts occur between midnight and early

morning, leading to a diurnal rhythm of circulating cortisol levels. The temporal coincidence between secretory bursts and plasma ACTH concentrations indicates neuroendocrine control.

In domestic animals and certainly in the dog, initially there has been some controversy as to the occurrence of circadian variation in cortisol concentrations. Later definite evidence for episodic but not circadian fluctuations in plasma cortisol concentrations in dogs was presented (Kempainen and Sartin, 1984a). In the horse (Dybdal *et al.*, 1994) and the pig (Benson *et al.*, 1986; Bottoms *et al.*, 1972; Janssens *et al.*, 1995b; Larsson *et al.*, 1979) as well as in sheep (Fulkerson and Tang, 1979), bulls (Thun *et al.*, 1981), pigeons (Joseph and Meier, 1973; Westerhof *et al.*, 1994), and chickens (Lauber *et al.*, 1987), the occurrence of circadian variations is generally acknowledged. Also in the cat, there have been reports on the occurrence of an (opposite) diurnal rhythm. However, in later reports this was not confirmed (Johnston and Mather, 1979; Leyva *et al.*, 1984). As in the dog, the secretion is episodic without evidence for a diurnal rhythm (Peterson and Randolph, 1989). Apart from relatively short-term changes such as episodic secretion and diurnal variation, plasma cortisol concentration may change with age and during the estrus cycle, during pregnancy, and around the time of parturition. For example, basal cortisol concentrations in puppies 8 weeks of age or younger are lower than in mature dogs, most probably because of reduced binding to plasma proteins rather than to altered secretion patterns (Randolph *et al.*, 1995). In gilts a discrete cortisol peak occurs during the early follicular phase of the sexual cycle, coinciding with the decline in plasma progesterone levels (i.e., at 4 days before the plasma LH surge) (Janssens *et al.*, 1995c). Plasma cortisol concentrations of pregnant cows decrease significantly during the fourth month of pregnancy. Thereafter they remain fairly constant until the fifth and sixth day before parturition, when a sharp rise is seen, and also at around 24 h before parturition plasma corticoids increase again (Eissa and El-Belely, 1990).

A highly significant increase in basal plasma cortisol concentrations occurs with aging in dogs (Goy-Thollot *et al.*, 2006) with no differences in ACTH-stimulated plasma cortisol concentrations. This confirms earlier studies (Rothuizen *et al.*, 1993) where the increased basal activity of the hypothalamo-pituitary-adrenal axis is attributed to a decrease in limbic type-I MR concentrations, whereby no differences were found for the type II GR in canine brain structures. The increase in pituitary type II GR with aging explains the intact feedback in the aging dog (Rothuizen *et al.*, 1993). The ACTH-stimulated increase in plasma aldosterone concentrations was found to be significantly reduced with aging (Goy-Thollot *et al.*, 2006).

Independent of these physiological variations, it is clear that stress may activate the pituitary-adrenocortical system. Factors such as housing (Carlstead *et al.*, 1993;

Cockram *et al.*, 1994; Koelkebeck and Cain, 1984), lactation (Gwazdauskas *et al.*, 1986), exercise (Dybdal *et al.*, 1980; Foss *et al.*, 1971; Rosedale *et al.*, 1982; Sloet van Oldruitenborgh-Oosterbaan *et al.*, 2006), surgery (Robertson *et al.*, 1994), anaesthesia, heat (Gould and Siegel, 1985), emotional strain (Bobek *et al.*, 1986; James *et al.*, 1970; Kirkpatrick *et al.*, 1977), food deprivation (Messer *et al.*, 1995), and anticipation of feeding (Murayama *et al.*, 1986) all lead to increased corticosteroid secretion. In dogs, a visit to a veterinary practice, orthopedic examination, and hospitalization increased the urinary corticoid:creatinine ratio, which is a measure for adrenocortical function (Van Vonderen *et al.*, 1998). In the horse, during exercise increased plasma renin activity results in a considerable rise in aldosterone secretion (Guthrie *et al.*, 1980, 1982). From the lack of any increase in plasma corticosterone in homing pigeons during flight, it was concluded that the animals were not under serious stress (Viswanathan *et al.*, 1987).

With chronic stress, such as during prolonged tethered housing of pigs, an increased responsiveness of the adrenal cortex to ACTH is induced, whereas the sensitivity of the pituitary to stimulation with corticotrophin releasing hormone (CRH) or vasopressin remains unaltered, and the challenge (nose sling)-induced ACTH response is lower than in loosely housed pigs. This indicates that during chronic stress, mitigating mechanisms become operational, most probably mediated by endogenous opioids (Janssens *et al.*, 1995a).

According to Selye's theory of general adaptation, corticosteroids are needed for the (metabolic and circulatory) defense reaction. Administration of cortisol to improve nonspecific resistance is indicated in established pituitary or adrenal insufficiency. From an immunological point of view, stress suppresses defense reactions. Stress-induced glucocorticoid secretion prevents the overshooting of the animal's reactions to stress. The glucocorticoids modulate the mediators of the immune system such as the different lymphokines and mediators of the inflammatory reactions: prostaglandins, leukotrienes, kinins, serotonin, and histamine (Munck *et al.*, 1984).

It is now well established that the interaction of the neuroendocrine system and the immune system is not a one-way but a bidirectional communication. Tissue injury or inflammation elicits production of immunoregulatory cytokines (lymphokines and monokines) by macrophages and monocytes. These cytokines also activate the pituitary-adrenal axis and increase glucocorticoid concentrations, whereas the production and action of these immune mediators are inhibited by glucocorticoids. Thus, there is strong evidence for the existence of a feedback circuit, in which immunoregulatory cytokines act as afferent and ACTH and glucocorticoids as efferent hormonal signals (Besedovsky *et al.*, 1986; Woloski *et al.*, 1985). The regulatory actions of the cytokines are exerted at the level of the hypothalamus, where CRH is the major mediator of the response (Berkenbosch *et al.*, 1987), although cytokines also exert

an influence at the level of the pituitary and the adrenals (Gaillard, 1994).

### III. ADRENOCORTICAL DISEASES

As this chapter is not meant to cope with clinical and pathological details, discussion of adrenocortical diseases is confined to definitions, short statements on occurrence in species, and referral to key references. In textbooks on endocrine diseases of companion animals (Drazner, 1994; Feldman and Nelson, 2004; Rijnberk, 1996), the adrenocortical diseases of the dog and the cat are described in detail.

#### A. Hypoadrenocorticism

Adrenocortical hypofunction includes all conditions in which the secretion of adrenal steroid hormones falls below the requirements of the animal. It may be divided into two categories:

1. Primary hypoadrenocorticism or Addison's disease is the result of deficiency of both glucocorticoid and mineralocorticoid secretion from the adrenal cortices (primary adrenocortical failure). "Idiopathic" or immune-mediated atrophy (Schaer *et al.*, 1986) of all zones is the most frequently observed histopathological lesion, although the lymphocytic adrenalitis may be confined to the zona fasciculata and zona reticularis (Kooistra *et al.*, 1995). It is well known in the dog and rare in the cat (Peterson and Randolph, 1989).

2. Secondary hypoadrenocorticism is the result of pituitary ACTH deficiency, causing decreased glucocorticoid secretion. Because of the almost unaltered aldosterone secretion, it will usually remain unnoticed. It is observed occasionally in dogs with pituitary insufficiency resulting from pituitary cystic lesions leading to an empty sella or as a result of a compressive nonfunctioning (endocrine inactive) pituitary macroadenoma.

Animals receiving long-term corticosteroid treatment, despite physical and biochemical hyperadrenocorticoid changes, develop secondary adrenocortical insufficiency because of prolonged hypothalamo-pituitary suppression. Atrophy of the two inner zones of the adrenal cortex results from the loss of endogenous ACTH stimulation. This is observed in the species in which corticosteroid therapy is common practice such as the dog (Greco and Behrend, 1995; Rijnberk, 1996) and the horse (Hoffsis and Murdock, 1970; Toutain and Brandon, 1983). It has also been observed in dogs and cats treated with progestagens, owing to the glucocorticoid activity that is intrinsic to these drugs (Chastain *et al.*, 1981; Mansfield *et al.*, 1986; Middleton *et al.*, 1987; Selman *et al.*, 1994).

#### B. Hyperadrenocorticism

In principle, the adrenal cortex of animals might, as in humans, give rise to three distinct clinical syndromes of hyperfunction: mineralocorticoid excess or hyperaldosteronism (Conn's syndrome), glucocorticoid excess or hypercortisolism (Cushing's syndrome), and androgen excess (adrenogenital syndrome).

Hypercortisolism is common in the dog though rare in the cat and the horse. In about 15% of hyperadrenocorticoid dogs, the disease is due to a primary adrenocortical tumor (ACTH independent). The excessive secretion of cortisol by these tumors may either be autonomous or associated with aberrant expression of ectopic or overexpression of eutopic adrenocortical receptors (Lacroix *et al.*, 2001). For example, the expression of ectopic receptors for gastric inhibitory polypeptide may result in "food-dependent hypercortisolism." In the other 85% of cases, the (ACTH-dependent) hypercortisolism is associated with a pituitary lesion, producing excess ACTH. The pituitary corticotroph adenomas may reside in either the anterior lobe or the intermediate lobe (Kempainen and Peterson, 1994; Peterson *et al.*, 1982). In rare cases, Cushing's syndrome may also be due to ectopic secretion of ACTH by a neuroendocrine tumor outside the pituitary gland (Galac *et al.*, 2005). In cats, hypercortisolism (Cushing's syndrome) is usually concurrent with diabetes mellitus and may be either primary adrenocortical or pituitary dependent (Meij *et al.*, 2001, 2004; Meijer *et al.*, 1978b; Peterson and Randolph, 1989).

Primary hyperaldosteronism in cats may be due to an adrenocortical tumor (Ash *et al.*, 2005; Flood *et al.*, 1999; Mackay *et al.*, 1999; Moore *et al.*, 2000; Rijnberk *et al.*, 2001) or to bilateral hyperplasia of zona glomerulosa tissue (Javadi *et al.*, 2005). Prominent clinical features in cats with hyperaldosteronism are hypokalemia, episodic weakness, cervical ventroflexion, arterial hypertension, and vision loss resulting from retinal detachment. The nontumorous form of primary hyperaldosteronism in cats is associated with progressive renal disease (Javadi *et al.*, 2005).

In the horse, hypercortisolism (Cushing's syndrome) originates almost invariably in the intermediate lobe of the pituitary (Orth *et al.*, 1982). In domestic ferrets, hyperadrenocorticism is quite common and it is primarily associated with adrenocortical tumor or nodular adrenocortical hyperplasia (Rosenthal *et al.*, 1993). Domestic ferrets with hyperadrenocorticism have no detectable abnormalities in plasma concentrations of ACTH or  $\alpha$ -MSH (Schoemaker *et al.*, 2002a) and increased urinary corticoid/creatinine ratios resistant to dexamethasone suppression (Schoemaker *et al.*, 2004), both indicating ACTH-independent hyperadrenocorticism. Positive staining was found with the LH receptor antibody in hyperplastic or neoplastic adrenal glands of hyperadrenocorticoid ferrets supporting the hypothesis that gonadotropic hormones play a role in the pathogenesis of hyperadrenocorticism in ferrets (Schoemaker *et al.*, 2002b).

## IV. ASSESSMENT OF ADRENOCORTICAL FUNCTION

### A. Routine Laboratory Diagnostics

In both hypoadrenocorticism and hyperadrenocorticism, there are a number of abnormal laboratory findings that are more common than in other diseases. Many of these abnormalities can be derived from the above-described action of glucocorticoids and mineralocorticoids (Section II.F). The essentials are summarized here.

In primary hypoadrenocorticism, the decreased aldosterone production results in hyponatremia and hyperkalemia. The associated hypovolemia leads to prerenal uremia. In hyperadrenocorticism, the classic hematological abnormality is eosinopenia, which may be associated with lymphopenia and occasionally with leukocytosis and erythrocytosis. A common biochemical abnormality is the elevated plasma concentration of alkaline phosphatase (Eckersall and Nash, 1983) that may occur in conjunction with mild elevation of alanine aminotransferase (ALT). In addition, hyperglycemia, hyperlipidemia, and low thyroxine concentrations may be observed. Urine-specific gravity is usually low, and in 5% to 10% of cases glucosuria is found.

Of these abnormalities, the elevated alkaline phosphatase (AP) concentration is the most common laboratory abnormality in dogs with corticosteroid excess (either exogenous or endogenous). This increase is due to the induction of a specific isoenzyme, which has greater heat stability at 65°C than other AP-isoenzymes (Teske *et al.*, 1986) and is therefore easily measured by a routine laboratory procedure. An abnormally elevated AP-65°C value may point to hyperadrenocorticism, but it is unsuitable as a diagnostic test because of its low specificity (Teske *et al.*, 1989). The low thyroxine (T<sub>4</sub>) concentrations in plasma, which may be observed in hyperadrenocorticism, seem to be a consequence of altered transport, distribution, and metabolism of T<sub>4</sub> rather than the result of hyposecretion (Rijnberk, 1996).

There may be other conditions causing these abnormalities, however, and some cases do not present with typical routine laboratory characteristics. Therefore, a detailed understanding of the specific laboratory tests commonly used to investigate adrenocortical function is essential. In addition, the spontaneous forms of hyperadrenocorticism may arise from pituitary ACTH overproduction or from autonomously hypersecreting adrenocortical tumors. Each of these requires a different mode of treatment, and therefore insight into the tests used in the differential diagnosis is of prime importance.

### B. Tests of Basal Adrenocortical Function

The availability of highly specific radioimmunoassays has greatly enhanced and simplified assessment of adrenocortical function. Some of the older (chemical) methods, which

are now seldom used, are mentioned briefly. Methods in common use are described in more detail, which applies especially to the dynamic tests, part of which is used in the differential diagnosis (Section IV.C).

#### 1. Cortisol Production Rate

In the radionuclide dilution method, the rate of cortisol production is determined through administration of radio-labeled cortisol and isolation of cortisol metabolites from urine that is collected over at least 24h. The specific activities of labeled cortisol and tetrahydrocortisol (THF) or tetrahydrocortisone (THE) are compared. Some preliminary work (Rijnberk *et al.*, 1968b) indicated that this test worked for the dog and might potentially be very useful. However, the laborious character of the procedure rules out general availability.

#### 2. Plasma Corticoids

Plasma corticoid concentrations are subject to considerable variation owing to the pulsatile nature of the secretion, physiological variation (see Section II.G), and alterations in transport proteins (Meyer and Rothuizen, 1994). Therefore, single determinations are regarded of little diagnostic value in assessing hypo- or hyperadrenocorticism. Nevertheless, in a considerable percentage of cases, resting values outside the reference ranges may be found. It has been demonstrated recently that calculation of the ratio of plasma cortisol:ACTH concentrations in hypoadrenocorticism did not show an overlap with values of healthy control dogs (Javadi *et al.*, 2006). There are few data on sex and breed differences, and they are not dealt with in Table 19-2. Nevertheless there is evidence that they should be taken into account (Frank *et al.*, 2003a). In dogs, circulating cortisol concentrations do not differ between males and females, but in small dogs higher values are found than in large breed dogs (Reimers *et al.*, 1990), and neutered males may have lower plasma cortisol concentrations in comparison to intact males (Frank *et al.*, 2003b). Also in pigs, breed-specific basal plasma cortisol concentrations exist (Sutherland *et al.*, 2006).

#### 3. Urinary Corticoids

With measurements of urinary corticoids or their metabolites, an integrated reflection of corticoid production over a period of time is obtained, thereby adjusting for the fluctuations in the plasma levels. Indeed, in dogs measurements of 17-hydroxycorticosteroids in 24-hour urine samples were found to have a high discriminatory power (Table 19-3; Rijnberk *et al.*, 1968a). However, the method has been abandoned because of the complicated and time-consuming chemical analysis, in combination with the difficulty of accurate collection of 24-hour urine samples.

**TABLE 19-2** Basal Corticosteroid Concentrations in Healthy Animals

Hormone (Unit)	Species (n)	Fluid	Sampling Time	Mean $\pm$ SD (Range)	Reference
Cortisol (nmol/l)	Dog (14)	Plasma	After overnight fast	46.0 $\pm$ 1.3	(Beerda <i>et al.</i> , 1996)
		Saliva	After overnight fast	4.7 $\pm$ 0.4	(Beerda <i>et al.</i> , 1996)
	Cat (130)	Plasma	After overnight fast	79 $\pm$ 79	(Javadi <i>et al.</i> , 2004)
		Horse (7)	Plasma	06.00h	251 $\pm$ 115
	Saliva		06.00h	3.2 $\pm$ 1.9	(van der Kolk <i>et al.</i> , 2001)
	Cattle (39)	Plasma	18.00h	142.0 $\pm$ 52.9	(van der Kolk <i>et al.</i> , 2001)
		Saliva	18.00h	2.1 $\pm$ 1.4	(van der Kolk <i>et al.</i> , 2001)
	Cattle	Milk	Morning	1.24 $\pm$ 0.13	(Gygax <i>et al.</i> , 2006)
	Pig (6)	Plasma	—	(27–355)	(Cook <i>et al.</i> , 1997)
		Saliva	—	(3.1–21.3)	(Cook <i>et al.</i> , 1997)
	Sheep (4)	Plasma	—	19.0 $\pm$ 4.9	(Turner <i>et al.</i> , 2002)
Ferret (29)	Plasma	—	(3–27)	(Schoemaker <i>et al.</i> , 2003)	
Aldosterone (pmol/l)	Dog (12)	Plasma	After overnight fast	118 $\pm$ 14	(Javadi <i>et al.</i> , 2003)
	Cat (130)	Plasma	After overnight fast	267 $\pm$ 135	(Javadi <i>et al.</i> , 2004)
	Horse (6)	Plasma	—	63.0 $\pm$ 12.8	(McKeever and Malinowski, 1999)
PRA (fmol/l/s)	Dog (12)	Plasma	After overnight fast	201 $\pm$ 25	(Javadi <i>et al.</i> , 2003)
	Cat (130)	Plasma	After overnight fast	240 $\pm$ 165	(Javadi <i>et al.</i> , 2004)

**TABLE 19-3** Molar Urinary Corticoid Creatinine Ratios

Species (n)	Season	Range (Mean $\pm$ SD)	Reference
Dog (28)		1.2–6.9 $\times 10^{-6}$	(Stolp <i>et al.</i> , 1983)
Dog (12)		(9 $\pm$ 4 $\times 10^{-6}$ )	(Jones <i>et al.</i> , 1990)
Dog (20)		0.5–17.7 $\times 10^{-6}$	(Feldman and Mack, 1992)
Dog (31)		0.1–31.2 $\times 10^{-6}$	(Smiley and Peterson, 1993)
Cat (42)		2–36 $\times 10^{-6}$	(Goossens <i>et al.</i> , 1995)
Ferret—intact	Breeding	(6.0 $\pm$ 0.5 $\times 10^{-6}$ )	(Schoemaker <i>et al.</i> , 2004)
Ferret—intact	Nonbreeding	(1.5 $\pm$ 0.2 $\times 10^{-6}$ )	(Schoemaker <i>et al.</i> , 2004)
Ferret—castrated	Nonbreeding	(1.3 $\pm$ 0.1 $\times 10^{-6}$ )	(Schoemaker <i>et al.</i> , 2004)

Meanwhile, for the dog, Stolp *et al.* (1983) have introduced another measurement reflecting cortisol secretion over a period of time. In this approach, the 24-hour urine collection has been replaced by morning samples. The urinary corticoids (largely cortisol) are measured by radioimmunoassay and related to the creatinine concentration. In an assessment (Rijnberk *et al.*, 1988), the corticoid/creatinine ratios were found to have a higher diagnostic accuracy in the diagnosis of hyperadrenocorticism than the commonly used dexamethasone screening test (see Section IV.C.3).

The method has also been introduced for diagnostic use in the cat (de Lange *et al.*, 2004; Goossens *et al.*, 1995) and the ferret (Gould *et al.*, 1995; Schoemaker *et al.*, 2004). Also for these species the determination of the urinary corticoid/creatinine ratio appears to be valuable for the diagnosis of hyperadrenocorticism.

#### 4. Salivary Cortisol

In saliva, the “free” (biologically active) fraction rather than the “total” cortisol is measured. So far in animals, salivary collection devices have been used primarily for research purposes. In the past, a disadvantage has been the anesthesia involved, although it does not inhibit salivary flow (Phillips *et al.*, 1983). In recent years there has been renewed interest in the approach, especially now that a technique has been introduced for saliva collection in unrestrained animals. Cortisol measurements in saliva may serve as a noninvasive indicator of stress in animals. By allowing the animals to chew on large wads of cotton for up to 30sec, adequate saliva samples can be obtained from dogs (Vincent and Michell, 1992). The same method has been used successfully in pigs (Parrott and Misson, 1989) and sheep (Cooper *et al.*,



**TABLE 19-4** Plasma Corticoids (nmol/l) Following ACTH Stimulation

Species	ACTH Dose and Route	Sampling Time	Hormone	Range (Mean $\pm$ SEM)	Reference
Dog	250 $\mu$ g I.V.	90min	Cortisol	120–620	(Meijer <i>et al.</i> , 1978c)
Dog	5 $\mu$ g/kg I.V.	60min	Cortisol Corticosterone	220–560 18–102	(Behrend <i>et al.</i> , 2005) (Behrend <i>et al.</i> , 2005)
Cat	125 $\mu$ g I.V.	60min	Cortisol	(274 $\pm$ 19)	(Peterson and Kempainen, 1993)
Horse	250 $\mu$ g I.V.	120min	Cortisol	308–602	(van der Kolk <i>et al.</i> , 2001)
Cattle	2IU/kg BW <sup>0.75</sup>	60min	Cortisol	(145 $\pm$ 27)	(Beerda <i>et al.</i> , 2004)

1989). It does not seem to be advisable to increase saliva flow by pilocarpine (Blackshaw and Blackshaw, 1989). It has also been reported that in calves (Fell and Shutt, 1986) and goats (Greenwood and Shutt, 1992), saliva can be aspirated from the side of the mouth with minimum restraint.

### 5. Cortisol in Milk

Monitoring adrenocortical activity by measurements in milk may be of value in searching for stressors in the livestock industry (Gygax *et al.*, 2006; Stephens, 1980). In a comparison of different milking systems, no differences in milk cortisol concentrations were found (Gygax *et al.*, 2006). The low concentrations indicate that in milk also the biologically active free fraction instead of the total cortisol fraction is measured.

### 6. Plasma ACTH

Determinations of resting plasma ACTH concentrations are not useful in the diagnosis of hyperadrenocorticism because of the overlapping values for normal dogs and dogs with hyperadrenocorticism. Its value lies mainly in the differential diagnosis of hyperadrenocorticism (discussed later). In animals with primary adrenocortical failure, plasma ACTH concentrations are usually extremely high. However, in most cases such a determination is primarily of academic interest as the diagnosis can be made with the more practical ACTH stimulation test (see Section IV.C.1). Plasma ACTH measurements are useful when in doubt about a primary or secondary adrenocortical insufficiency (Kooistra *et al.*, 1995).

## C. Dynamic Tests

Apart from the above-described measurements of reflections of basal adrenocortical secretions, various maneuvers have been introduced to test the physiology of the hypothalamo-pituitary-adrenocortical axis. As in other areas of endocrinology, stimulation tests are used when hypofunction is suspected, and suppression tests are used when hyperfunction is suspected.

### 1. Tests of Adrenocortical Reserve

The critical feature of the test is that a substantial increase in plasma (or urinary) corticoids must occur in response to ACTH if one is to prove the existence of adrenal reserve (Table 19-4). One method is described in detail in Section IV.F.

In veterinary medicine, ACTH stimulation has also been used to confirm adrenocortical hyperfunction. This is based on the assumption that hyperplastic adrenal cortices have abnormally large cortisol reserves. Indeed, hyperresponsiveness to ACTH or lysine-vasopressin (Meijer *et al.*, 1978a) stimulation is found in pituitary-dependent hyperadrenocorticism, but there is considerable overlap with normal dogs. Over the years, several modifications/combinations of the ACTH stimulation test (Eiler and Oliver, 1980; Eiler *et al.*, 1984; Feldman, 1986) for the diagnosis of hyperadrenocorticism have been used, but it still appears to be a dynamic test with less diagnostic accuracy than the low-dose dexamethasone suppression test (LDDST) (Behrend *et al.*, 2005; Feldman, 1986; Peterson, 1986). This seems to hold true for the horse as well (Dybdal *et al.*, 1994), although the ACTH stimulation test is recommended for the diagnosis of equine hyperadrenocorticism (Van der Kolk *et al.*, 1993). The value of the ACTH stimulation test lies in the diagnosis of hypoadrenocorticism (see Section IV.F). When used for the diagnosis of hyperadrenocorticism, the modification of a combination with a dexamethasone suppression test seems the least desirable, as doses of  $\geq 0.1$  mg of dexamethasone/kg can alter the results of the ACTH stimulation test for at least 3 days (Kempainen *et al.*, 1989). Measurement of plasma corticosterone or 17 $\alpha$ -hydroxyprogesterone after ACTH stimulation is of little additive value as the changes measured are proportionate with changes in cortisol and may be high in dogs with nonadrenal neoplasia as well (Behrend *et al.*, 2005).

### 2. Tests of Pituitary (ACTH) Reserve

In animals with adrenals responsive to ACTH, administration of the 11 $\beta$ -hydroxylase inhibitor metyrapone decreases cortisol secretion and consequently increases ACTH secretion. As a result, cortisol precursor synthesis increases, which can

**TABLE 19-5** Upper Reference Values for Plasma Cortisol Concentrations (nmol/l) after Low-Dose Dexamethasone Suppression Test

Species	Dose and Route	Sampling Time	Cortisol	Reference
Dog	10 $\mu$ g/kg I.V.	8h	<40	(Meijer <i>et al.</i> , 1979)
Dog	15 $\mu$ g/kg im	2, 4, 6, 8h	<28	(Peterson, 1986)
Cat	10 $\mu$ g/kg I.V.	8h	<36	(Smith and Feldman, 1987)
Cat	15 $\mu$ g/kg im	8h	<14	(Peterson and Graves, 1988)
Horse	40 $\mu$ g/kg I.V.	15h	<30	(Dybdal <i>et al.</i> , 1994)

be measured as urinary 17-hydroxycorticosteroids. Although effective in the dog (Siegel, 1968), the cumbersome procedure has prohibited wider use in veterinary medicine. At present, pituitary ACTH reserve is tested by use of physiological suprapituitary stimuli (i.e., vasopressin or CRH) (see Chapter 18). Such tests are mainly useful in the differential diagnosis, whereby it should be noted that vasopressin is the least useful for this purpose, as it can exert a direct stimulatory effect on cortisol release by adrenocortical tumors (Van Wijk *et al.*, 1994).

### 3. Tests of Pituitary-Adrenocortical Suppressibility

The integrity of the feedback system can be tested by giving a potent glucocorticoid and judging suppression of ACTH secretion by measuring either steroids excreted in urine or plasma cortisol levels. A potent glucocorticoid such as dexamethasone is used so that the administered compound may be given in such small amounts as not to contribute significantly to the steroids to be analyzed. In pituitary-dependent hyperadrenocorticism, there is loss of normal sensitivity to suppression, and as a result higher values are found than in normal individuals following dexamethasone administration (Table 19-5).

In the dog, the most frequently used test is still the low-dose dexamethasone suppression test (LDDST) (Meijer *et al.*, 1978a). In this test, 0.01 mg of dexamethasone/kg of body weight is administered intravenously, and a plasma sample for cortisol determination is taken after 8 h. In healthy dogs at this time the plasma cortisol concentrations are still depressed (Kemppainen and Sartin, 1984b). This test is described in detail in Section IV.F. Others recommend intramuscular administration of 0.015 mg of dexamethasone/kg and the collection of plasma samples for cortisol determination 2, 4, 6, and 8 h after injection (Peterson, 1984). Although not necessary for the diagnosis, the results of a 3- or 4-h sample may be informative for differential diagnosis (see Sections IV.D and IV.F).

### D. Tests for Differential Diagnosis

In animals with primary hypoadrenocorticism, the physical and biochemical features are very much determined by the electrolyte disturbances caused by the insufficient mineralocorticoid secretion. In secondary hypoadrenocorticism, mineralocorticoid secretion is practically unchanged, and the presenting signs are usually completely different. Thus, only rarely is there a need for additional tests to distinguish between these two forms of hypoadrenocorticism. However, when doubt exists about the background of the hyporesponsiveness to exogenous ACTH, plasma ACTH concentrations should be measured (see also Section IV.B.6) or the pituitary should be tested for ACTH reserve (see Section IV.C).

For hyperadrenocorticism, the situation is completely different. Once the diagnosis of hyperadrenocorticism has been made by either a basal test or a dynamic test, it is necessary to distinguish between pituitary-dependent hyperadrenocorticism and hyperadrenocorticism arising from an adrenocortical tumor. In principle, these forms of the disease require different modes of treatment. Probably owing to the additional secretion of steroids with mineralocorticoid activity by adrenocortical tumors, a higher incidence of hypokalemia is found than in animals with pituitary-dependent hyperadrenocorticism (Meijer, 1980). However, this sign is not specific enough to allow differentiation between the two forms. As there are no further signs that may be helpful to distinguish the two entities, specific tests are needed. The two most helpful procedures are the measurement of basal plasma ACTH levels and the high-dose dexamethasone suppression test (HDDST). A test of pituitary ACTH reserve may also be helpful.

Normal to high plasma ACTH concentrations ( $\geq 40$  pg/ml) in hyperadrenocorticoid dogs usually indicate ACTH excess of pituitary origin. Low to undetectable concentrations of ACTH are found in dogs with hyperadrenocorticism arising from an adrenocortical tumor in which the feedback control of pituitary ACTH secretion is undisturbed. ACTH concentration may not be low when both disease entities

occur simultaneously (Nothelfer and Weinhold, 1992; Van Sluijs *et al.*, 1995). However useful this measurement may be, in practice it is not the first choice when it comes to the differential diagnosis of hyperadrenocorticism because of the requirements for collecting and handling the samples and the technically difficult assay (see also Section IV.E).

In contrast to the determination of endogenous ACTH, the HDDST is readily available. Despite a decreased sensitivity to the suppression by glucocorticoids, the ACTH secretion of most animals with pituitary-dependent hyperadrenocorticism can be suppressed with a 10-fold dose of 0.1 mg dexamethasone/kg body weight, resulting in a decrease of the adrenocortical secretion. The autonomous hypersecretion by adrenocortical tumors will not be influenced by the high dose of dexamethasone.

Two procedures are used in the dog, one employing plasma cortisol as a reflection of adrenocortical secretion (Meijer *et al.*, 1979) and the other urinary corticoid/creatinine ratios (Rijnberk *et al.*, 1988). In both, a greater than 50% decline from baseline values is regarded as diagnostic for pituitary-dependent hyperadrenocorticism (see Section IV.F). When suppression is less than 50%, the hyperadrenocorticism may be due to either an adrenocortical tumor or a pituitary ACTH excess that is extremely resistant to dexamethasone suppression. For the differentiation between these two forms, the above-mentioned measurement of endogenous ACTH may be necessary, or a CRH test may be performed. In dogs with pituitary-dependent hyperadrenocorticism, CRH administration (1  $\mu$ g/kg I.V.) elevates both plasma ACTH and cortisol, whereas no such rise is seen in dogs with hyperadrenocorticism caused by adrenocortical tumors (Van Wijk *et al.*, 1994). The high cost of the commercially available powder preparation and the necessary pharmaceutical preparation prohibit general use of CRH.

## E. Collection and Handling of Samples

It has become common practice for clinicians to perform endocrine function studies and to mail samples to a laboratory for measurement of cortisol. It is therefore important to rule out nonpathological factors that can alter hormone concentrations. Apart from stress (see Section IV.B), the nutritional state of the animal may also play a role. In a study by Reimers *et al.* (1986), the researchers found that mean serum concentrations of cortisol in dogs fasted 12 or 24h were lower than those in dogs that were not fasted. The concentrations were not further affected by continued fasting for 36h.

Olson *et al.* (1981) have studied several aspects of sample handling, such as uncentrifuged storage and storage time. They concluded that either serum or plasma of dogs is suitable for radioimmunoassay of cortisol, and samples (with and without added anticoagulants) may be left uncentrifuged at 4°C for up to 40h without cortisol degradation. However, prolonged storage of serum at room temperature

is detrimental, particularly for samples that have large concentrations of cortisol. Samples allowed to defrost and sit for more than 3 days en route to a laboratory may have a lower cortisol concentration than they did at the time of collection.

The peptide ACTH is readily inactivated at room temperature. Therefore, blood for ACTH measurements should be collected in EDTA-coated tubes placed in ice, and the blood should be centrifuged at 4°C. The plasma should then be placed in polypropylene tubes and kept frozen until assayed. These requirements are most easily fulfilled when the samples are collected in a clinic with the necessary facilities. If the samples have to be transported, it is imperative that they be kept frozen with dry ice in a Styrofoam container. These strict rules can be alleviated to some extent by adding a protease inhibitor (aprotinin) to the collection tubes (Kemppainen *et al.*, 1994).

## F. Protocols

The protocols presented next are applicable to the dog. With the data presented in some of the tables, extrapolation to other species may be possible.

### 1. ACTH Stimulation Test

#### a. Indications

The ACTH stimulation test is performed when there is suspicion of decreased adrenocortical reserve capacity: (1) primary adrenocortical insufficiency (Addison's disease) and (2) (iatrogenic) secondary adrenocortical insufficiency.

#### b. Performance

Blood for cortisol measurements is collected immediately before and 90 min after intravenous administration of 0.25 mg synthetic ACTH (Cortrosyn [Organon]). In cases in which treatment for adrenocortical insufficiency was already started, on the morning of the test, the cortisone administration is postponed until after completion of the test. When the treatment is already longer than 3 to 4 days, iatrogenic suppression of the adrenals should be taken into consideration.

#### c. Interpretation

In healthy dogs, the cortisol concentrations rise to 270 to 690 nmol/liter (Rijnberk, 1996). In Addison's disease, the control value is usually low and does not increase following ACTH administration. In animals with secondary adrenocortical insufficiency, the basal cortisol values may be low as well, and, depending on the severity (duration) of the ACTH deficiency, the cortisol rise is subnormal or absent.

### 2. Low-Dose Dexamethasone Suppression Test

#### a. Indication

The low-dose dexamethasone suppression test is used when hyperadrenocorticism (Cushing's syndrome) is suspected.

### b. Performance

In the morning, 0.01 mg dexamethasone per kg body weight is administered intravenously. Blood for cortisol measurements is collected immediately before and at 3 and 8 h after dexamethasone administration.

### c. Interpretation

A plasma cortisol concentration exceeding 40 nmol/liter at 8 h after dexamethasone administration can be regarded as diagnostic for hyperadrenocorticism with a diagnostic accuracy of 0.83 (95% confidence limits 0.76 to 0.88) (Rijnberk *et al.*, 1988). The measurements at 0 and 3 h are not needed for the diagnosis of hyperadrenocorticism but may be informative in the differential diagnosis. Quite commonly the high value at 8 h is preceded by a lower value at 3 h. Thus, at 8 h the pituitary-adrenocortical system escapes from the suppression by dexamethasone. If the value at 3 or 8 h is at least 50% lower than the basal value, the disease may be regarded as pituitary dependent.

## 3. High-Dose Dexamethasone Suppression Test

### a. Indication

Differentiation between pituitary-dependent hyperadrenocorticism and hypercorticism arising from adrenocortical tumors is possible with the high-dose dexamethasone suppression test.

### b. Performance

Blood for cortisol determination is collected immediately before and 3 to 4 h after administration of 0.1 mg dexamethasone per kg body weight.

### c. Interpretation

If the plasma cortisol declines by more than 50%, the diagnosis of pituitary-dependent hyperadrenocorticism is justified. A decrease of less than 50% can be due either to an adrenocortical tumor or to dexamethasone-resistant pituitary-dependent hyperadrenocorticism. Differentiation between these two forms requires additional tests (see Section IV.D).

## 4. Urinary Corticoid/Creatinine Ratios (with High-Dose Dexamethasone Test)

### a. Indication

Determination of corticoid/creatinine ratios can be performed when hyperadrenocorticism is suspected.

### b. Performance

The owner is asked to collect morning urine samples at set times (e.g., 7 A.M.) on 3 consecutive days. On the preceding evenings, the animal should have its last walk at identical times (e.g., 11 P.M.). After collection of the second urine sample, dexamethasone is administered orally.

At 8-h intervals, the owner administers 0.1 mg dexamethasone per kg body weight.

### c. Interpretation

Corticoid/creatinine ratios exceeding  $10 \times 10^{-6}$  can be regarded as compatible with hyperadrenocorticism with a diagnostic accuracy of 0.91 (95% confidence limits 0.85 to 0.95) (Rijnberk *et al.*, 1988). When the ratio of the third urine sample is 50% lower than the mean of the first two ratios, the diagnosis of a pituitary-dependent hyperadrenocorticism is justified. A lesser decrease may be due to either adrenocortical tumors or dexamethasone-resistant pituitary-dependent hyperadrenocorticism (for differentiation, see Section IV.D).

### d. Comment

This test is now generally regarded as a sensitive screening test for the diagnosis of hyperadrenocorticism (Feldman, 1995). There has been some debate on its specificity (Feldman, 1992; Rijnberk and Teske, 1992), and recently it was stated that the test lacks specificity (Feldman, 1995). Indeed as with other screening tests the specificity is not 100% (Kaplan *et al.*, 1995; Smiley and Peterson, 1993), and in conditions that are associated with increased adrenocortical function, such as hepatic encephalopathy (Rothuizen *et al.*, 1995), elevated ratios can be found.

In this discussion, two points remain somewhat underexposed. First, a high sensitivity and not a high specificity is essential for a screening test. The predictive value of a positive test result depends on the sensitivity of the test and also on the prevalence of the disease in the population studied. When the testing is limited to dogs suspected of the disease, the population under study will have a high prevalence of disease, and as a result the predictive value of a positive test result will be high. Second, as always, the diagnostic accuracy of a test depends also on the quality of the test procedure. In this respect, it should be mentioned that easily elevated C/C ratios can be obtained when the urines are collected under stressful conditions, such as in the hospital. This will increase the number of false-positive test results (i.e., lower the specificity).

When C/C ratios are measured in a population suspected of hyperadrenocorticism, with urine collections at home, not only is the sensitivity of the test high, but also the specificity (0.77) is comparable to that of the low-dose dexamethasone suppression test (0.73) (Rijnberk *et al.*, 1988).

## REFERENCES

- Ash, R. A., Harvey, A. M., and Tasker, S. (2005). *J. Feline Med. Surg.* **7**, 173.
- Balikian, H. M. (1971). *Endocrinology* **89**, 1309.
- Beerda, B., Kornalijnslipjer, J. E., van der Werf, J. T., Noordhuizen-Stassen, E. N., and Hopster, H. (2004). *J. Dairy Sci.* **87**, 2094–2102.

- Beerda, B., Schilder, M. B., Janssen, N. S., and Mol, J. A. (1996). *Horm. Behav.* **30**, 272–279.
- Behrend, E. N., Kemppainen, R. J., Boozer, A. L., Whitley, E. M., Smith, A. N., and Busch, K. A. (2005). *J. Am. Vet. Med. Assoc.* **227**, 1762–1767.
- Benson, G. J., Langner, P. H., Thurmon, J. C., Nelson, D. R., Neff-Davis, C., Davis, L. E., Tranquilli, J. C., and Gustafsson, B. K. (1986). *Am. J. Vet. Res.* **47**, 1071.
- Berkenbosch, F., van Oers, J., Del Rey, A., Filders, F., and Besedovsky, H. (1987). *Science* **238**, 524.
- Besedovsky, H., Del Rey, A., Sorkin, E., and Dinarello, C. A. (1986). *Science* **233**, 652.
- Biewenga, W. J., Rijnberk, A., and Mol, J. A. (1991). *Acta Endocrinol.* **124**, 583.
- Blackshaw, J. K., and Blackshaw, A. W. (1989). *Vet. Res. Comm.* **13**, 265.
- Bobek, S., Niezgoda, J., Pierzchala, K., Litynski, P., and Sechman, A. (1986). *J. Vet. Med. Assoc.* **33**, 698.
- Boonayathap, U., and Marotta, S. F. (1974). *Horm. Metab. Res.* **6**, 74.
- Bottoms, G. D., Roesel, O. F., Rausch, F. D., and Akins, E. L. (1972). *Am. J. Vet. Res.* **33**, 785.
- Carlstead, K., Brown, J. L., and Strawn, W. (1993). *Appl. Anim. Behav.* **38**, 143.
- Carsia, R. V., Morin, M. E., Rosen, H. D., and Weber, H. (1987). *Proc. Soc. Exp. Biol. Med.* **184**, 436.
- Charmandari, E., Chrousos, G. P., Ichijo, T., Bhattacharyya, N., Vottero, A., Souvatzoglou, E., and Kino, T. (2005). *Mol. Endocrinol.* **19**, 52–64.
- Chastain, C. B., Graham, C. L., and Nichols, C. E. (1981). *Am. J. Vet. Res.* **42**, 2029.
- Chester-Jones, I. (1987). In “Fundamentals of Comparative Vertebrate Endocrinology” (I. Chester-Jones and P. M. Ingleton, Eds.), p. 95. Plenum, New York.
- Cockram, M. S., Ranson, M., Imlak, P., Goddard, P. J., Burrels, C., and Harkiss, G. D. (1994). *Anim. Prod.* **58**, 389.
- Cook, N., Schaefer, A., Lepage, P., and Morgan Jones, S. (1997). *J. Agric. Food Chem.* **45**, 395–399.
- Cooper, T. R., Trunkfield, H. R., Zanella, A. J., and Booth, W. D. (1989). *J. Endocrinol.* **123**, R13.
- Dallman, M. F. (2005). *Front. Neuroendocrinol.* **26**, 103–108.
- de Lange, M. S., Galac, S., Trip, M. R., and Kooistra, H. S. (2004). *J. Vet. Intern. Med.* **18**, 152–155.
- Debons, A. F., Zurek, L. D., Tse, C. S., and Abrahamsen, S. (1986). *Endocrinology* **118**, 1678.
- Dor, P., Keymolen, V., De Roods, M., Levin, S., and Borkowski, A. (1973). *Eur. J. Cancer* **9**, 687.
- Drazner, F. H. (1994). In “Small Animal Endocrinology.” Saunders, Philadelphia.
- Dybdal, N. O., Gribble, D., Madigan, J. E., and Stabenfeldt, G. H. (1980). *Equine Vet. J.* **12**, 137.
- Dybdal, N. O., Hargreaves, K. M., Madigan, J. E., Gribble, D. H., Kennedy, P. C., and Stabenfeldt, G. H. (1994). *J. Am. Vet. Med. Assoc.* **204**, 627.
- Eckersall, P. D., and Nash, A. S. (1983). *Res. Vet. Sci.* **34**, 310.
- Ehrhart-Bornstein, M., Hinson, J. P., Bornstein, S. R., Scherbaum, W. A., and Vinson, G. P. (1998). *Endocr. Rev.* **19**, 101–143.
- Eiler, H., and Oliver, J. W. (1980). *Am. J. Vet. Res.* **41**, 1243.
- Eiler, H., Oliver, J. W., and Legendre, A. M. (1984). *J. Am. Vet. Med. Assoc.* **185**, 289.
- Eissa, H. M., and El-Belely, M. S. (1990). *Brit. Vet. J.* **146**, 24.
- Feldman, E. C. (1986). *J. Am. Vet. Med. Assoc.* **189**, 1562.
- Feldman, E. C. (1992). *J. Am. Vet. Med. Assoc.* **201**, 1140.
- Feldman, E. C. (1995). In “Textbook of Veterinary Internal Medicine” (S. J. Ettinger and E. C. Feldman, Eds.), p. 1557. Saunders, Philadelphia.
- Feldman, E. C., and Mack, R. E. (1992). *J. Am. Vet. Med. Assoc.* **200**, 1637.
- Feldman, E. C., and Nelson, R. W. (2004). In “Canine and Feline Endocrinology and Reproduction.” Saunders, Philadelphia.
- Fell, L. R., and Shutt, D. A. (1986). *Can. J. Anim. Sci.* **66**, 637.
- Fell, L. R., Shutt, D. A., and Bentley, C. J. (1985). *Aust. Vet. J.* **62**, 403.
- Flood, S. M., Randolph, J. F., Gelzer, A. R., and Refsal, K. (1999). *J. Am. Anim. Hosp. Assoc.* **35**, 411.
- Foss, M. L., Barnard, R. J., and Tipton, C. M. (1971). *Endocrinology* **89**, 96.
- Frank, L. A., Hnilica, K. A., Rohrbach, B. W., and Oliver, J. W. (2003a). *Vet. Dermatol.* **14**, 91–97.
- Frank, L. A., Rohrbach, B. W., Bailey, E. M., West, J. R., and Oliver, J. W. (2003b). *Domest. Anim. Endocrinol.* **24**, 43–57.
- Fulkerson, W. J., and Tang, B. Y. (1979). *J. Endocrinol.* **81**, 135.
- Funder, J. W. (2005). *Heart Fail. Rev.* **10**, 15–22.
- Gaillard, R. C. (1994). *Trends Endocr. Metab.* **5**, 303.
- Galac, S., Kooistra, H. S., Voorhout, G., Van den Ingh, T. S. G. A. M., Mol, J. A., Van den Berg, G., and Meij, B. P. (2005). *Domest. Anim. Endocrinol.* **28**, 338.
- Geverink, N. A., Foury, A., Plastow, G. S., Gil, M., Gispert, M., Hortos, M., Font i Furnols, M., Gort, G., Moisan, M. P., and Mormede, P. (2006). *J. Anim. Sci.* **84**, 204–211.
- Gold, N. I. (1961). *J. Biol. Chem.* **236**, 1924.
- Goossens, M. M. C., Meyer, H. P., Voorhout, G., and Sprang, E. P. M. (1995). *Domest. Anim. Endocrinol.* **12**, 355.
- Gould, N. R., and Siegel, H. S. (1985). *Poultry Sci.* **64**, 144.
- Gould, W. J., Reimers, T. J., Bell, J. A., Laurence, H. J., Randolph, J. F., Rowland, P. H., and Scarlett, J. M. (1995). *J. Am. Vet. Med. Assoc.* **206**, 42.
- Goy-Thollot, I., Decosne-Junot, C., and Bonnet, J. M. (2007). *Res. Vet. Sci.* **82**, 195.
- Greco, D. S., and Behrend, E. N. (1995). In “Kirk’s Current Veterinary Therapy XII” (J. D. Bonagura, Ed.), p. 413. Saunders, Philadelphia.
- Greenwood, P. L., and Shutt, D. A. (1992). *Aust. Vet. J.* **69**, 161.
- Guthrie, G. P., Cecil, S. G., Darden, E. D., and Kotchen, T. A. (1982). *Gen. Comp. Endocrinol.* **48**, 296.
- Guthrie, G. P., Cecil, S. G., and Kotchen, T. A. (1980). *J. Endocrinol.* **85**, 49.
- Gwazdauskas, F. C., Keys, J. E., and McGilliard, M. L. (1986). *J. Dairy Sci.* **69**, 2134.
- Gygax, L., Neuffer, I., Kaufmann, C., Hauser, R., and Wechsler, B. (2006). *J. Dairy Sci.* **89**, 3447–3454.
- Haidan, A., Bornstein, S. R., Glasow, A., Uhlmann, K., Lubke, C., and Ehrhart-Bornstein, M. (1998). *Endocrinology* **139**, 772–780.
- Heap, R. B., Holzbauer, M., and Newport, H. M. (1966). *J. Endocrinol.* **36**, 159.
- Hennesy, D. P., Conn, R. J., and Wan, S. S. (1986). *Res. Vet. Sci.* **41**, 361.
- Hirose, T., Matsumoto, J., Aikawa, T., and Suzuki, T. (1977). *J. Endocrinol.* **73**, 539.
- Hoffsis, G. F., and Murdock, P. W. (1970). *J. Am. Vet. Med. Assoc.* **157**, 1590.
- Holmes, R. L. (1961). *J. Anat.* **95**, 325.
- Holzbauer, M., and Newport, H. M. (1969). *J. Physiol.* **200**, 821.
- Hsu, H. J., Hsu, N. C., Hu, M. C., and Chung, B. C. (2006). *Mol. Cell. Endocrinol.* **248**, 160–163.

- Ilett, K. F., and Lockett, M. F. (1969). *J. Endocrinol.* **43**, 313.
- IUPAC-IUB (1989). *Eur. J. Biochem.* **186**, 429–458.
- James, V. H. T., Horner, M. W., Moss, M. S., and Rippon, A. E. (1970). *J. Endocrinol.* **48**, 319.
- Janssens, C. J. J. G., Helmond, F. A., Loyens, L. W. S., Schouten, W. G. P., and Wiegant, V. M. (1995a). *Endocrinology* **136**, 1468.
- Janssens, C. J. J. G., Helmond, F. A., and Wiegant, V. M. (1995b). *Domest. Anim. Endocrinol.* **12**, 167.
- Janssens, C. J. J. G., Houwing, H., Helmond, F. A., Schrama, J. W., and Wiegant, V. M. (1995c). In “Chronic Stress and Pituitary-Adrenal Function in Female Pigs.” Wageningen, The Netherlands.
- Javadi, S., Djajadiningrat-Laanen, S. C., Kooistra, H. S., van Dongen, A. M., Voorhout, G., Van Sluijs, F. J., Van den Ingh, T. S. G. A. M., Boer, W. H., and Rijnberk, A. (2005). *Domest. Anim. Endocrinol.* **28**, 85.
- Javadi, S., Galac, S., Boer, P., Robben, J. H., Teske, E., and Kooistra, H. S. (2006). *J. Vet. Intern. Med.* **20**, 556–561.
- Javadi, S., Kooistra, H. S., Mol, J. A., Boer, P., Boer, W. H., and Rijnberk, A. (2003). *Vet. Rec.* **153**, 521–525.
- Javadi, S., Slingerland, L. I., van de Beek, M. G., Boer, P., Boer, W. H., Mol, J. A., Rijnberk, A., and Kooistra, H. S. (2004). *J. Vet. Intern. Med.* **18**, 625–631.
- Johnston, S. D., and Mather, E. C. (1979). *Am. J. Vet. Res.* **40**, 190.
- Jones, C. A., Refsal, K. R., Lippert, A. C., Nachreiner, R. F., and Schwacha, M. M. (1990). *Domest. Anim. Endocrinol.* **7**, 559.
- Joseph, M. M., and Meier, A. H. (1973). *Gen. Comp. Endocrinol.* **20**, 326.
- Kaplan, A. J., Peterson, M. E., and Kempainen, R. J. (1995). *J. Am. Vet. Med. Assoc.* **207**, 445.
- Kaptein, E. M., Moore, G. E., Ferguson, D. C., and Hoenig, M. (1992). *Endocrinology* **130**, 1669.
- Kempainen, R. J., Clark, T. P., and Peterson, M. E. (1994). *Domest. Anim. Endocrinol.* **11**, 355.
- Kempainen, R. J., and Peterson, M. E. (1994). *Trends Endocrinol. Metab.* **5**, 21.
- Kempainen, R. J., Peterson, M. E., and Sartin, J. L. (1991). *Domest. Anim. Endocrinol.* **10**, 45.
- Kempainen, R. J., and Sartin, J. L. (1984a). *J. Endocrinol.* **103**, 219.
- Kempainen, R. J., and Sartin, J. L. (1984b). *Am. J. Vet. Res.* **45**, 472.
- Kempainen, R. J., Sartin, J. L., and Peterson, M. E. (1989). *Am. J. Vet. Res.* **50**, 1914.
- Kempainen, R. J., Thompson, F. N., Lorenz, M. D., Munnell, J. F., and Chakraborty, P. K. (1983). *J. Endocrinol.* **96**, 293.
- Kime, D. E. (1987). In “Fundamentals of Comparative Vertebrate Endocrinology” (I. Chester-Jones, P. M. Ingleton, and J. G. Philips, Eds.), p. 38. Plenum, New York.
- Kirkpatrick, J. F., Baker, C. B., Wiesner, L., and Angle, M. (1977). *Comp. Biochem. Physiol.* **57A**, 179.
- Koelkebeck, K. W., and Cain, J. R. (1984). *Poultry Sci.* **63**, 2123.
- Kooistra, H. S., Rijnberk, A., and Van den Ingh, T. S. G. A. M. (1995). *Vet. Quart.* **17**, 59.
- Kumar, R., and Thompson, E. B. (2005). *J. Steroid Biochem. Mol. Biol.* **94**, 383–394.
- Lacroix, A., Ndiaye, N., Tremblay, J., and Hamet, P. (2001). *Endocr. Rev.* **22**, 75–110.
- Larsson, M., Edqvist, L. E., Ekman, L., and Persson, S. (1979). *Acta Vet. Scand.* **20**, 16.
- Lauber, J. K., Vriend, J., and Oishi, T. (1987). *Comp. Biochem. Physiol.* **86A**, 73.
- Leyva, H., Addiego, L., and Stabenfeldt, G. (1984). *Endocrinology* **115**, 1729.
- Lisurek, M., and Bernhardt, R. (2004). *Mol. Cell. Endocrinol.* **215**, 149–159.
- Lothrop, C. D., and Oliver, J. W. (1984). *Am. J. Vet. Res.* **45**, 2304.
- Lumeij, J. T., Boschma, Y., Mol, J. A., De Kloet, E. R., and Van den Brom, W. E. (1987). *Avian Pathol.* **16**, 199.
- Mackay, A. D., Holt, P. E., and Sparkes, A. H. (1999). *J. Feline Med. Surg.* **1**, 117.
- Mansfield, P. D., Kempainen, R. J., and Sartin, J. L. (1986). *J. Am. Anim. Hosp. Assoc.* **22**, 515.
- Marks, V. (1983). In “Biochemistry in Clinical Practices” (D. L. Williams and V. Marks, Eds.), p. 617. William Heinemann Medical Books, London.
- McCormick, J. R., Herman, A. H., Lien, W. M., and Egdahl, R. H. (1974). *Endocrinology* **94**, 17.
- McKeever, K. H., and Malinowski, K. (1999). *Equine Vet. J.* **30(suppl)**, 561–566.
- Meij, B. P., Van der Vlugt-Meijer, R. H., Van den Ingh, T. S. G. A. M., and Rijnberk, A. (2004). *J. Comp. Pathol.* **130**, 209.
- Meij, B. P., Voorhout, G., Van den Ingh, T. S. G. A. M., and Rijnberk, A. (2001). *Vet. Surg.* **30**, 72.
- Meijer, J. C. (1980). In “Current Veterinary Therapy VII” (R. W. Kirk, Ed.), p. 975. Saunders, Philadelphia.
- Meijer, J. C., De Bruijne, J. J., Rijnberk, A., and Croughs, R. J. M. (1978a). *J. Endocrinol.* **77**, 111.
- Meijer, J. C., Lubberink, A. A. M. E., and Gruys, E. (1978b). *Tijdschr. Diergeneesk.* **103**, 1048.
- Meijer, J. C., Lubberink, A. A. M. E., Rijnberk, A., and Croughs, R. J. M. (1979). *J. Endocrinol.* **80**, 315.
- Meijer, J. C., Mulder, G. H., Rijnberk, A., and Croughs, R. J. M. (1978c). *J. Endocrinol.* **76**, 209.
- Messer, N. T., Johnson, P. J., Refsal, K. R., Nachreiner, R. F., Ganjam, V. K., and Krause, G. F. (1995). *Am. J. Vet. Res.* **56**, 116.
- Meyer, H. P., and Rothuizen, J. (1993). *Domest. Anim. Endocrinol.* **10**, 45.
- Meyer, H. P., and Rothuizen, J. (1994). *Domest. Anim. Endocrinol.* **11**, 317.
- Middleton, D. J., Watson, A. D. J., Howe, C. J., and Catterson, I. D. (1987). *Can. J. Vet. Res.* **51**, 60.
- Millspaugh, J. J., and Washburn, B. E. (2004). *Gen. Comp. Endocrinol.* **138**, 189–199.
- Moore, L. E., Biller, D. S., and Smith, T. A. (2000). *J. Am. Vet. Med. Assoc.* **217**, 213.
- Muelheims, G. H., Francis, F. E., and Kinsella, R. A. (1969). *Endocrinology* **85**, 365.
- Müller, J. (1986). In “Clinical Endocrinology. Theory and Practice” (A. Labhart, Ed.), p. 351. Springer Verlag, Berlin.
- Munck, A., Guyre, P. M., and Holbrook, N. J. (1984). *Endocr. Rev.* **5**, 25.
- Murayama, S., Moriya, K., and Sasaki, Y. (1986). *Jpn. J. Zootech. Sci.* **57**, 317.
- Murphy, G. M., and Connell, J. A. (1970). *Aust. Vet. J.* **46**, 595.
- Nakamura, T., Tanabe, Y., and Hirano, H. (1978). *Gen. Comp. Endocrinol.* **35**, 302–308.
- Nothelfer, H. B., and Weinhold, K. (1992). *Berl. Münch. Tierärztl. Wschr.* **105**, 305.
- Olson, P. N., Bowen, R. A., Husted, P. W., and Nett, T. M. (1981). *Am. J. Vet. Res.* **42**, 1618.
- Orth, D. N., Holscher, M. A., Wilson, M. G., Nicholson, W. E., Plue, R. E., and Mount, C. D. (1982). *Endocrinology* **110**, 1430.
- Papanek, P. E., and Raff, H. (1994). *Am. J. Physiol.* **266**, R1744.

- Parrott, R. F., and Misson, B. H. (1989). *Brit. Vet. J.* **145**, 501.
- Pauli, B. U., Rossi, G. L., and Straub, R. (1974). *Vet. Pathol.* **11**, 417.
- Payne, A. H., and Hales, D. B. (2004). *Endocr. Rev.* **25**, 947–970.
- Peterson, M. E. (1984). *Vet. Clin. N. Am.* **14**, 731.
- Peterson, M. E. (R. W. Kirk, Ed.) (1986). “Current Veterinary Therapy IX,” vol. 963. Saunders, Philadelphia.
- Peterson, M. E., and Altszuler, N. (1981). *Am. J. Vet. Res.* **42**, 1881.
- Peterson, M. E., and Graves, T. K. (1988). *Res. Vet. Sci.* **44**.
- Peterson, M. E., and Kempainen, R. J. (1993). *Am. J. Vet. Res.* **54**, 300.
- Peterson, M. E., Krieger, D. T., Drucker, W. D., and Halmi, N. S. (1982). *Acta Endocrinol.* **101**, 15.
- Peterson, M. E., and Randolph, J. F. (1989). In “The Cat. Diseases and Clinical Management” (R. G. Sherding, Ed.), p. 1135. Churchill Livingstone, New York.
- Phillips, P. A., Newcomer, C. E., and Schutz, D. S. (1983). *Lab. Anim. Sci.* **33**, 465.
- Randolph, J. F., Center, S. A., Reimers, T. J., Scarlett, J. M., and Corbett, J. R. (1995). *Am. J. Vet. Res.* **56**, 511.
- Reimers, T. J., Lawler, D. F., Sutaria, P. M., Correa, M. T., and Erb, H. N. (1990). *Am. J. Vet. Res.* **51**, 454.
- Reimers, T. J., McGarrity, M. S., and Strickland, D. (1986). *Am. J. Vet. Res.* **47**, 2485.
- Riad-Fahmy, D., Read, G. F., Walker, R. F., and Griffiths, K. (1982). *Endocr. Rev.* **3**, 367.
- Rijnberk, A. (1996). In “Clinical Endocrinology of Dogs and Cats” (A. Rijnberk, Ed.), p. 47. Kluwer, Dordrecht.
- Rijnberk, A., der Kinderen, P. J., and Thijssen, J. H. H. (1968a). *J. Endocrinol.* **41**, 396.
- Rijnberk, A., der Kinderen, P. J., and Thijssen, J. H. H. (1968b). *J. Endocrinol.* **41**, 387.
- Rijnberk, A., and Teske, E. (1992). *J. Am. Vet. Med. Assoc.* **201**, 1139.
- Rijnberk, A., van Wees, A., and Mol, J. A. (1988). *Vet. Rec.* **122**, 178.
- Rijnberk, A., Voorhout, G., Kooistra, H. S., van der Waarden, R. J., Van Sluijs, F. J., Ilzer, J., Boer, P., and Boer, W. H. (2001). *Vet. Q.* **23**, 38.
- Rivas, C., and Borrell, S. (1971). *J. Endocrinol.* **51**, 283.
- Robertson, I. S., Kent, J. E., and Molony, V. (1994). *Res. Vet. Sci.* **56**, 8.
- Rosenthal, K. L., Peterson, M. E., Quensenberry, K. E., Hillyer, E. V., Beeber, N. L., Moroff, S. D., and Lothrop, C. D. (1993). *J. Am. Vet. Med. Assoc.* **203**, 271.
- Rosner, W. (1969). *New Engl. J. Med.* **281**, 658.
- Rossdale, P. D., Burguez, P. N., and Cash, R. S. G. (1982). *Equine Vet. J.* **14**, 293.
- Rothuizen, J., Biewenga, W. J., and Mol, J. A. (1995). *Domest. Anim. Endocrinol.* **12**, 13.
- Rothuizen, J., Reul, J. M., van Sluijs, F. J., Mol, J. A., Rijnberk, A., and de Kloet, E. R. (1993). *Endocrinology* **132**, 161–168.
- Schaer, M., Riley, W. J., Buergelt, C. D., Bowen, D. J., Senior, D. F., Burrows, C. F., and Campbell, G. A. (1986). *J. Am. Anim. Hosp. Assoc.* **22**, 789.
- Schinner, S., and Bornstein, S. R. (2005). *Endocr. Pathol.* **16**, 91–98.
- Schoemaker, N. J., Mol, J. A., Lumeij, J. T., and Rijnberk, A. (2002a). *Am. J. Vet. Res.* **63**, 1395.
- Schoemaker, N. J., Mol, J. A., Lumeij, J. T., Thijssen, J. H., and Rijnberk, A. (2003). *Vet. Rec.* **152**, 591–595.
- Schoemaker, N. J., Teerds, K. J., Mol, J. A., Lumeij, J. T., Thijssen, J. H. H., and Rijnberk, A. (2002b). *Mol. Cell. Endocrinol.* **197**, 117.
- Schoemaker, N. J., Wolfswinkel, J., Mol, J. A., Voorhout, G., Kik, M. J., Lumeij, J. T., and Rijnberk, A. (2004). *Domest. Anim. Endocrinol.* **27**, 13–24.
- Selman, P. J., Mol, J. A., Rutteman, G. R., and Rijnberk, A. (1994). *Eur. J. Endocrinol.* **131**, 422.
- Shutt, D. A., and Fell, L. R. (1985). *J. Dairy Sci.* **68**, 1832.
- Siegel, E. T. (1965). *Am. J. Vet. Res.* **26**, 1152.
- Siegel, E. T. (1967). *Am. J. Vet. Res.* **28**, 287.
- Siegel, E. T. (1968). *Am. J. Vet. Res.* **29**, 173.
- Sloet van Oldruitenborgh-Oosterbaan, M. M., Blok, M. B., Begeman, L., Kamphuis, M. C. D., Lameris, M. C., Spierenburg, A. J., and Lashley, M. J. J. O. (2006). *Tijdsch. Diergeneeskd.* **131**, 114.
- Smiley, L. E., and Peterson, M. E. (1993). *J. Vet. Int. Med.* **7**, 163.
- Smith, M. C., and Feldman, E. C. (1987). *Am. J. Vet. Res.* **48**, 1719.
- Spat, A., and Hunyady, L. (2004). *Physiol. Rev.* **84**, 489–539.
- Stellato, C. (2004). *Proc. Am. Thorac. Soc.* **1**, 255–263.
- Stephens, D. B. (1980). *Adv. Vet. Sci. Comp. Med.* **24**, 179.
- Stolp, R., Rijnberk, A., Meijer, J. C., and Croughs, R. J. M. (1983). *Res. Vet. Sci.* **34**, 141.
- Sutherland, M. A., Niekamp, S. R., Rodriguez-Zas, S. L., and Salak-Johnson, J. L. (2006). *J. Anim. Sci.* **84**, 588–596.
- Taylor, W. (1971). *Vitam. Horm.* **29**, 201.
- Teske, E., Rothuizen, J., de Bruijne, J. J., and Mol, J. A. (1986). *J. Chromatogr.* **369**, 349.
- Teske, E., Rothuizen, J., de Bruijne, J. J., Rijnberk, A., (1989). **125**, 12.
- Thun, R., Eggenberger, E., Zerobin, K., Lüscher, T., and Vetter, W. (1981). *Endocrinology* **109**, 2208.
- Toutain, P. L., and Brandon, R. A. (1983). In “Veterinary Pharmacology and Toxicology” (Y. Ruckebush, P. L. Toutain, and G. D. Kovitz, Eds.). MIT Press, Boston.
- Turner, A. I., Canny, B. J., Hobbs, R. J., Bond, J. D., Clarke, I. J., and Tilbrook, A. J. (2002). *J. Endocrinol.* **173**, 113–122.
- van der Kolk, J. H., Kalsbeek, H. C., van Garderen, E., Wensing, T., and Breukink, H. J. (1993). *Vet. Rec.* **133**, 594.
- van der Kolk, J. H., Nachreiner, R. F., Schott, H. C., Refsal, K. R., and Zanella, A. J. (2001). *Equine Vet. J.* **33**, 211–213.
- Van Sluijs, F. J., Sjollem, B. E., Voorhout, G., Van den Ingh, T. S. G. A. M., and Rijnberk, A. (1995). *Vet. Quart.* **17**, 113.
- Van Vonderen, I. K., Kooistra, H. S., and Rijnberk, A. (1998). *J. Vet. Intern. Med.* **12**, 431.
- Van Wijk, P. A., Rijnberk, A., Croughs, R. J. M., Wolfswinkel, J., Selman, P. J., and Mol, J. A. (1994). *Eur. J. Endocrinol.* **130**, 410.
- Vincent, I. C., and Michell, A. R. (1992). *Res. Vet. Sci.* **53**, 342.
- Viswanathan, M., John, T. M., George, J. C., and Etcher, R. J. (1987). *Horm. Metab. Res.* **19**, 400.
- Walsh, M. T., Beldegreen, R. A., Clubb, S. L., and Chen, C. L. (1985). *Am. J. Vet. Res.* **46**, 1584.
- Westerhof, I., Mol, J. A., Van den Brom, W. E., Lumeij, J. T., and Rijnberk, A. (1994). *Avian Dis.* **38**, 428.
- Williams, G. H. (2005). *Heart Fail. Rev.* **10**, 7–13.
- Woloski, B. M. R. N. J., Smith, E. M., Meyer, W. J., Fuller, G. M., and Blalock, J. E. (1985). *Science* **230**, 1035.
- Woltz, H. H., Thompson, F. N., Kempainen, R. J., Munnell, J. F., and Lorenz, M. D. (1983). *Am. J. Vet. Res.* **44**, 2000.
- Zenoble, R. D., Kempainen, R. J., Young, D. W., and Carpenter, J. W. (1985). *J. Am. Vet. Med. Assoc.* **187**, 1119.
- Zolovick, A., Upson, D. W., and Eleftherion, B. E. (1966). *J. Endocrinol.* **35**, 249.

# Thyroid Function

J. Jerry Kaneko

*Department of Pathology, Microbiology, and Immunology*

*School of Veterinary Medicine*

*University of California, Davis*

*Davis, California*

- 
- I. INTRODUCTION**
  - II. ANATOMICAL CONSIDERATIONS**
  - III. NUTRITIONAL REQUIREMENTS**
  - IV. IODINE METABOLISM**
  - V. FUNCTIONS OF THE THYROID GLAND**
    - A. Thyroid Hormones
    - B. Hormonogenesis and Release
  - VI. TRANSPORT OF HORMONE: PROTEIN BINDING**
  - VII. MECHANISM OF THYROID HORMONE ACTION**
    - A. General Effects of Thyroid Hormones
    - B. Molecular Basis of Thyroid Hormone Action
  - VIII. CATABOLISM AND EXCRETION OF THYROID HORMONES**
  - IX. REGULATION OF THE THYROID GLAND**
    - A. Production and Regulation of Thyroid-Stimulating Hormone
    - B. Action of the Thyroid-Stimulating Hormone on the Thyroid Gland
    - C. Action of the Thyroid-Stimulating Hormone on Hormonogenesis
    - D. Long-Acting Thyroid Stimulators
  - X. THYROID FUNCTION TESTS**
    - A. Indirect Tests of Thyroid Function
    - B. Direct Tests of Thyroid Function
    - C. Radionuclide Uptake Tests
    - D. Thyroid Ultrasonography
    - E. Tropic Hormone Response Tests
  - XI. DISEASES OF THE THYROID**
    - A. Goiter
    - B. Hypothyroidism
    - C. Hyperthyroidism
    - D. Tumors of the Thyroid Gland

## REFERENCES

---

## I. INTRODUCTION

Disorders of the thyroid gland are the most common endocrine disorders in humans, and extensive historical and scientific literature is available. Among the domestic animals, thyroid function and its diseases are well known in companion animals but less so in other animals, domestic or wild. In livestock, nutritional iodine deficiencies have been of greater importance than thyroid gland diseases, particularly in the iodine-deficient areas of the world. The importance of thyroid function and its diseases has also become progressively more important as the longevity of companion animals such as the dog and the cat has increased.

Advances in thyroid physiology, pathogenesis of its diseases, and the continued development and refinement of methods of testing thyroid function have added impetus to the study of thyroid disease in all animals. This chapter reviews the anatomy and physiology of the thyroid gland and its diseases as a corollary to the understanding of the pathophysiology of the thyroid gland in disease. Emphasis is placed on the physiological bases of a variety of thyroid function tests, most of which are now readily available to the veterinary clinician.

## II. ANATOMICAL CONSIDERATIONS

The thyroid gland of animals is a bilobed structure that overlays the trachea at a point just below the larynx. Anatomical variations of the gland are marked between species and, to some extent, within a given species. The isthmus connecting the two lobes of the thyroid is the region that varies most markedly between species. Humans and pig have a large discrete isthmus, which forms a pyramidal lobe connecting the two lateral lobes. The cow has



a fairly wide band of glandular tissue, which forms the connecting isthmus. In the horse, sheep, goat, cat, and dog, the isthmus is a narrow remnant of tissue and may be nonexistent. The size of the gland relative to body weight is extremely small in all animals, approximating 0.20% of body weight. The size of the gland varies and may be enlarged when iodine deficiency, ingestion of goitrogenic toxins, tumors, or hyperactivity is present. In primary hypothyroidism, the gland may be reduced to fibrotic and inactive remnants of thyroid tissue.

Accessory or extrathyroidal tissue is commonly observed in the dog, particularly near the thoracic inlet though they may be found anywhere along the esophagus. This accessory tissue is fully functional physiologically, synthesizes hormone, and can be located by its uptake of radionuclides. This is a particularly important consideration for the dog when thinking about surgical intervention for treatment of hyperthyroidism resulting from a thyroid tumor.

The thyroid gland is a highly vascularized tissue with a large blood flow. The functional unit of the thyroid gland is the thyroid follicle, which can be envisioned as a spherical structure composed of an outer monolayer of follicular cells surrounding an inner core of colloid. Colloid is a thyroglobulin-hormone complex that is the storage reservoir of thyroid hormone in the thyroid gland. The colloid stored in the lumen is a clear, viscous fluid. The individual follicular cells vary from 5 to 10  $\mu\text{m}$  in height, and the entire follicle may vary from 25 to 250  $\mu\text{m}$  in diameter. The size of the follicles and the height of their follicular cells vary according to the functional state of the gland. The cells may vary from an inactive squamous cell to the highly active, tall columnar cell. Interspersed between the follicles are the thyroid "C" cells, the source of calcitonin, the hypocalcemic hormone associated with calcium metabolism. A third type of hormonal tissue, the parathyroid, is imbedded within the thyroid or located in close proximity to it. The parathyroids are the source of parathormone, the hypercalcemic hormone. Removal of the parathyroids is virtually unavoidable during surgical thyroidectomies so that post-surgical hypocalcemia is an important consequence to be considered.

### III. NUTRITIONAL REQUIREMENTS

The thyroid gland is unique among the endocrine glands in that an integral part of its hormone, L-thyroxine ( $T_4$ ), is a trace mineral, iodine, which is available to the animal in only limited amounts. Marine plants are known to be good sources of iodine, but on land, iodine is limited and many regions of the world are known to be iodine deficient. The recommended daily requirement is 35  $\mu\text{g}/\text{kg}$  bw (276 nmol/kg bw) for the adult dog and 70  $\mu\text{g}/\text{kg}$  bw (551.6 nmol/kg bw) for the growing puppy. For most animals, nutrient requirements are given in mg/Kg dry diet or ppm and range from

0.1 to 1.0 mg, including cats and horses. Milk is a poor source of hormonal iodide contributing only about 4% to 7% of the maintenance requirements for hormone (Akasha and Anderson, 1984).

The small requirements are compensated for by an efficient intestinal absorption mechanism and conservation and recycling of internal iodine. Little iodine is lost from the body by the various excretory routes such as urine, saliva, tears, milk, sweat, and feces. Also, whereas most endocrine glands store little of their hormones, the thyroid manages to store large quantities of hormone sufficient for 1 to 3 weeks depending on the species. The thyroid gland contains about 20% of the total body iodine. Its iodine content and size vary with iodine intake and the state of thyroid function, but it usually contains 10 to 40 mg (78.8 to 315.2  $\mu\text{mol}$ ) iodine/100 gm tissue or 4 to 16 mg (31.5 to 126.1  $\mu\text{mol}$ ) iodine in a 20-kg dog.

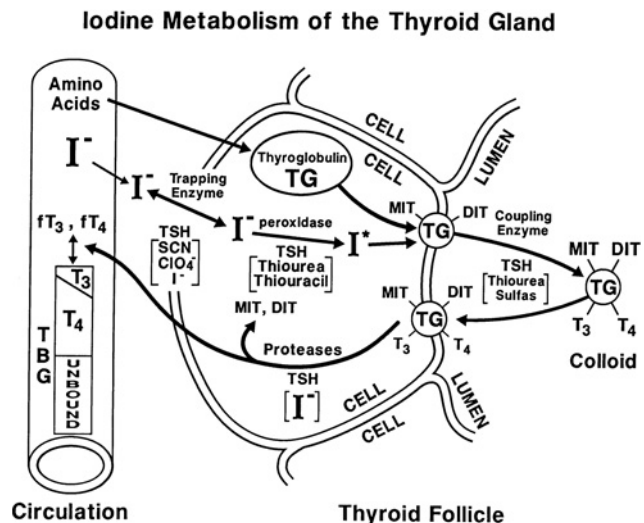
### IV. IODINE METABOLISM

Iodine can be absorbed in any of its soluble chemical forms, but in the intestines it is usually absorbed in the form of iodides ( $\text{I}^-$ ), iodates ( $\text{IO}_4^-$ ), or as the hormonal forms. Iodides may be absorbed from any moist body surface, including the mucus membranes, and it is absorbed easily through broken epithelia. Normally, the chief route of entry into the general circulation is by absorption through the mucosal cells of the small intestine. The  $\text{I}^-$  in the circulation is trapped almost exclusively by the thyroid gland, with small amounts being trapped by the salivary gland and minimal amounts by the gastric mucosa, placenta, and mammary gland. In the ruminant, 70% to 80% of an oral dose is absorbed in the rumen and 10% in the omasum.

The main route of excretion of  $\text{I}^-$  is by the kidneys through which almost all the  $\text{I}^-$  that was not trapped by the thyroid is lost in the urine. A small but significant amount is lost in the saliva, and minimal amounts are lost in tears, feces, sweat, and milk. A minute amount of free hormone, that fraction not bound to serum proteins, is also lost in the urine. These routes of excretion are especially important considerations when patients are being treated with radioiodine.

### V. FUNCTIONS OF THE THYROID GLAND

The main functions of the thyroid gland are the trapping of  $\text{I}^-$  and the synthesis, storage, and release of thyroid hormones (Fig. 20-1), and these activities are under the control of the thyrotropin or the thyroid-stimulating hormone (TSH). Although TSH stimulates all steps in hormonogenesis, the trapping of  $\text{I}^-$  and the release of hormone are the two major sites of its action.



**FIGURE 20-1** Pathways of iodine metabolism and thyroid hormone synthesis. Goitrogenic blocking agents are shown in brackets.

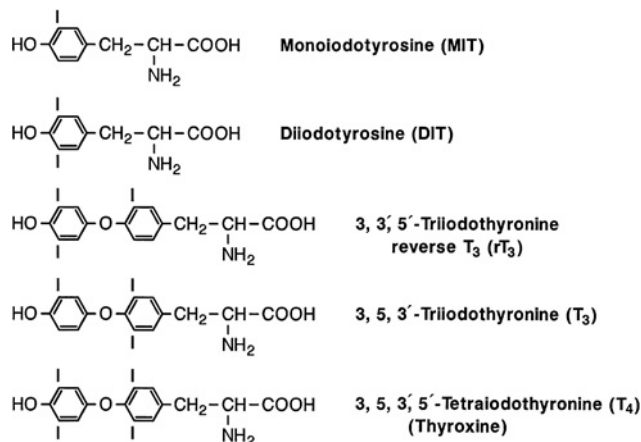
**A. Thyroid Hormones**

The principal thyroid hormones elaborated by the thyroid are the two active hormones, 3,5,3',5'-tetraiodothyronine (T<sub>4</sub>) and 3,5,3'-triiodothyronine (T<sub>3</sub>), and the inactive hormone, 3,3',5'-triiodothyronine (reverse T<sub>3</sub> or rT<sub>3</sub>). The rT<sub>3</sub> is the inner deiodination product of the T<sub>4</sub>. The structures of the individual hormones are given in Figure 20-2. The T<sub>4</sub> molecule contains 65.3% iodine, and the T<sub>3</sub> molecule contains 58.5% iodine. The T<sub>3</sub> is the active hormone in the target cell. The T<sub>4</sub> functions as the transport form and as the feedback regulator of the thyroid gland.

**B. Hormonogenesis and Release**

**1. Trapping of Iodide**

The I<sup>-</sup> in the general circulation is taken up by the thyroid follicular cells by a highly efficient trapping and concentrating mechanism. It does this against a large concentration gradient, which can be from 1:20- to 1:500-fold across the thyroid cell membrane and is stimulated by TSH. The trapping process is catalyzed by a trapping enzyme, requires oxygen, and is an active transport or "pump" mechanism catalyzed by a Na<sup>+</sup>K<sup>+</sup>-ATPase and dependent on ATP. The transport process is mediated by a sodium iodide symporter (NIS) protein located on the plasma membrane (Riesco-Eizaguirre and Santisteban, 2006). It is the high efficiency of this trapping system that concentrates virtually all of the body iodine in the thyroid gland. It also accounts for the microgram nutrient requirement for iodine. In addition, the thyroid follicular cells have a high capability for compensatory hypertrophy when there is a scarcity of iodine, hence the development of iodine



**FIGURE 20-2** Chemical structures of the major iodinated compounds of the thyroid gland.

deficiency goiters. The efficiency of I<sup>-</sup> trapping is also the basis for the radioactive iodine uptake (<sup>131</sup>I Uptake) test of thyroid function, <sup>131</sup>I thyroid imaging, and <sup>131</sup>I thyroid therapy. The trapping of I<sup>-</sup> is stimulated by TSH and blocked by the goitrogenic agents such as thiocyanate (SCN<sup>-</sup>), perchlorate (ClO<sub>4</sub><sup>-</sup>) and by large amounts of I<sup>-</sup>. Figure 20-1 also shows the sites of these and other blocks in the thyroxine biosynthetic pathway. Other compounds are trapped by the thyroid gland, and the most widely clinically used one is <sup>99m</sup>Tc-pertechnetate, which is used for thyroid tissue imaging.

**2. Synthesis of Thyroid Hormones**

After trapping, there is an oxidation of I<sup>-</sup> catalyzed by a peroxidase and the product is a highly active form of iodine, most likely a free radical, I<sup>\*</sup>. This reaction is inhibited by thyrotoxic agents such as the thiouracils or thioureas and stimulated by TSH. Propylthiouracil is commonly used in the treatment of hyperthyroidism. The I<sup>\*</sup> almost instantaneously binds to the phenyl groups of the tyrosine moieties of thyroglobulin at the 3 or 5 position to form a monoiodotyrosine (MIT) or a diiodotyrosine (DIT). This iodination occurs while the tyrosines remain in polypeptide linkage within the thyroglobulin molecule. Next, the iodinated phenyl groups of the tyrosines are coupled by the oxidative condensation of an iodinated phenyl group of one DIT to another DIT to form T<sub>4</sub> or of an MIT group to a DIT to form T<sub>3</sub>. These iodination reactions occur mainly at the follicular cell membrane-colloid interface. These iodination reactions are energy requiring and sensitive to blocking by sulfa drugs, thioureas, and paraaminobenzoic acid (PABA).

**3. Storage of Hormone**

Thyroglobulin is the thyroidal glycoprotein of high molecular weight (660,000 daltons) synthesized exclusively by

the thyroidal follicular cells. After synthesis, it moves to the cell membrane where the iodinations occur and the iodinated thyroglobulin, or colloid, is released into the lumen of the follicle where it is stored. The amount stored can be quite large as evidenced by the mass of protein contained within a normal follicle.

#### 4. Release of Hormone

TSH stimulation of the release of hormones is the second of its two principal sites of action. Within a few minutes after giving TSH, small packets of colloid are taken up by the follicular cell membrane, and vesicles are formed and taken into the follicular cell by endocytosis. The vesicles merge with lysosomes within the cell, and the lysosomal proteases hydrolyze the colloid and release their MIT, DIT,  $T_3$ , and  $T_4$ . The released MIT and DIT are enzymatically degraded by microsomal tyrosine deiodinases, and their iodine is recycled within the follicular cell. The  $T_4$  and  $T_3$  are released into the circulation by a simple diffusion process. Of the total hormone released, about 90% is  $T_4$  and 10% is  $T_3$ . Within the gland, there is also some deiodination of the  $T_4$  of the inner phenyl group to form  $rT_3$ , but most of this deiodination occurs in the peripheral tissues.

This  $rT_3$  is the inactive form of thyroid hormone and is on a degradation pathway.

## VI. TRANSPORT OF HORMONE: PROTEIN BINDING

The thyroid hormones in the circulation are  $T_4$ ,  $T_3$ , and  $rT_3$ . Immediately upon entering the circulation, these hormones are bound to transport proteins, mainly to thyroxine-binding globulin (TBG), and with lesser amounts to thyroxine binding prealbumin (TBPA) and to albumin. There is a wide spectrum of species variation in hormone binding by serum proteins (Table 20-1). TBPA is present in all the species in contrast to earlier reports indicating that TBPA was present only in humans, rhesus monkey, horse, cat, rabbit, pigeon, and chicken. The early work was based on electrophoretic migration, but later work based on chemical properties identified TBPA or its analogues at different migration sites (Larsson *et al.*, 1985). The differences in migration are likely due to differences in the amino acid composition of these proteins among the various species. Using chemical criteria, all species have TBPA.

**TABLE 20-1** Thyroxine-Binding Proteins of Various Species, Their Electrophoretic Migration, and Their Relative Thyroxine Binding<sup>a</sup>

Species	Electrophoretic Migration Position		
	Alpha-Globulin	Albumin	Prealbumin
Human	TBG (73)	ALB (10)	TBPA (17)
Rhesus monkey	TBG (59)	ALB (8)	TBPA (33)
Cattle*	TBG (60)	TBPA (20)	ALB (20)
Sheep	TBG (86)	TBPA (14)	
Goat	TBG (63)	TBPA (37)	
Water buffalo	TBG (78)	TBPA (22)	
Horse	TBG (61)	ALB (17)	TBPA (22)
Pig	TBPA (0)	TBG (93)	ALB (7)
Dog	TBG (60)	TBPA (17) $\alpha$ -G (11)	ALB (12)
Cat*	TBPA (39)	ALB (61)	
Rabbit*	TBPA (73)	ALB (27)	
Rat*		ALB (80)	TBPA (20)
Mouse*		ALB (80)	TBPA (20)
Guinea pig*		ALB (81)	TBPA (19)
Chicken	TBPA (10)	ALB (75)	TBPA (15)
Pigeon*		ALB (50)	TBPA (50)

<sup>a</sup> TBG, thyroxine-binding globulin; ALB, albumin; TBPA, thyroxine-binding prealbumin;  $\alpha$ -G,  $\alpha$ -globulin; positioned as shown relative to the albumin position in each species. Numbers in parentheses specify the percentage of thyroxine binding. Constructed from the data of Tanabe *et al.* (1969), Refetoff *et al.* (1970), and Larsson *et al.* (1985). The \* indicates approximations.

TBG is the major binding protein for hormone, but not all species have TBG. In those species without TBG, albumin serves as the major binding protein. The binding constant of TBG for  $T_4$  is about  $10^{10}$  liter/mole so that some 99.97% of the plasma  $T_4$  is bound to TBG and only 0.03% is free or unbound ( $fT_4$ ). The binding constant for  $T_3$  is about  $10^9$  liter/mole so that about 99.7% of the plasma  $T_3$  is bound to TBG and 0.3% is free. Therefore, TBG or albumin transports most of the hormones.

In the cat, rabbit, rat, mouse, guinea pig, pigeon, or chicken, TBG is absent and most of the hormone is transported by albumin. The albumin binding constant is about  $10^5$  liter/mole for  $T_4$  or  $T_3$  but with an unlimited binding capacity. In these species without TBG, albumin transports between 50% and 80% of the hormones.  $T_3$  (and likely  $rT_3$ ) appears to bind to these transport proteins in parallel with  $T_4$  binding.

Protein binding has several functions. Protein binding solubilizes these lipid soluble hormones for transport in the aqueous plasma. The bound forms also do not readily pass through the renal glomerular membrane, so they minimize urinary loss of hormones, whereas the free hormones pass and are lost. The bound forms also serve as a large and readily accessible reservoir of the active hormones for delivery to the target organs and cells. Finally, the protein binding equilibrium is the fundamental basis for protein or immunoprotein binding assays of hormone and the indirect assay of TBG.

## VII. MECHANISM OF THYROID HORMONE ACTION

### A. General Effects of Thyroid Hormones

After the administration of thyroid extracts or  $T_4$ , its first physiological effects are noted in 24 to 28h and its maximal effects are noted in 7 to 10 days (Table 20-2). The  $T_4$  requirements for these effects vary. The requirement for  $T_3$  also varies, and less is required for equivalent activity and it acts more quickly.  $T_3$  is now recognized as the active form of the thyroid hormone within the target cell. The  $T_4$  that is transported into the target cell is rapidly deiodinated to the active  $T_3$ . However,  $rT_3$ , which is also produced in the cell in the deiodination process, is an inactive form of thyroid hormone and is simply degraded.

### B. Molecular Basis of Thyroid Hormone Action

The molecular basis of thyroid hormone action at the cellular level has been frequently reviewed, and a multifaceted concept of its action has evolved. For many years, the mitochondrion was considered to be the site of thyroid hormone action. Uncoupling of oxidative phosphorylation

(ox-phos) in the mitochondria was a viable hypothesis for many years. Under normal conditions, 3 moles of ATP (P) are synthesized per atom of oxygen ( $\frac{1}{2} O_2 = O$ ) used in the cytochrome oxidase system; hence, P:O ratio equals 3. If less than 3 moles of ATP are formed per unit O in a system in the presence of a compound such as the thyroid hormone, the system is said to be uncoupled (i.e., P:O ratio is less than 3). In this event, more  $O_2$  would be needed to generate an equivalent amount of ATP, and  $O_2$  consumption would increase.  $T_4$  has repeatedly been shown to uncouple oxidative phosphorylation in *in vitro* systems, but it does so only in large, unphysiological amounts. These findings were extended to the whole animal to explain the increased oxygen consumption by  $T_4$ . The large amounts of oxidative energy not incorporated into ATP increased body temperature and were dissipated as heat. Thus,  $T_4$  action was theorized to be the result of the uncoupling of oxidative phosphorylation.

Another now well-known effect of thyroid hormone is the stimulation of cellular protein synthesis (Tapley, 1964; Tata *et al.*, 1963), and this occurs during the latent period when the calorogenic effect of thyroid hormone occurs.  $T_3$  is now known to stimulate messenger RNA (mRNA) transcription, increasing translation and protein synthesis and accounting for the anabolic effects of thyroid hormones. This also means that the site of action is at the cell nucleus.

Another action of thyroid hormone is to stimulate the "sodium pump" (Na-K-ATPase) at the cell membrane, an action that would increase  $O_2$  consumption (Edelman, 1974). Ouabain, an inhibitor of Na-K-ATPase, also inhibits the increased  $O_2$  consumption induced by  $T_4$  or  $T_3$ . Thus, stimulation of the sodium pump is an important way in which thyroid hormones stimulate increased oxygen consumption and accounts for almost half of the increase.

**TABLE 20-2** Effects of Thyroid Hormone

Category	Effect
Clinical	Tremors, nervousness, exophthalmos, hyperactivity, weight loss
Physiological	Increased temperature, heart function
Calorogenic	Increased basal metabolic rate ( $O_2$ consumption)
Carbohydrate metabolism	Increased glucose turnover, absorption
Protein metabolism	Anabolic, positive N balance
Lipid metabolism	Decrease in blood cholesterol
Development	Stimulation of growth and maturation
Reproductive	Fertility, pregnancy, ovulation
Hematological	Erythropoiesis

A direct effect of thyroid hormones on cell membrane transport has also been suggested from studies on 2-deoxyglucose uptake (Segal *et al.*, 1977). Pliam and Goldfine (1977) proposed that  $T_3$  binds to receptors on the cell membrane and is transported by carriers into the cell.

A combination of the aforementioned mechanisms is the most likely explanation of the mechanism of action of thyroid hormone. A viable model patterned after the generalized steroid hormone model is one in which (1)  $T_3$  is bound to a receptor site on the plasma membrane, (2)  $T_3$  is transported across the membrane into the cell by the carrier protein, (3)  $T_3$  in the cell is again bound to a carrier protein, (4)  $T_3$  rapidly exchanges between receptor sites on the mitochondrion or nucleus, and (5)  $T_3$  interacts in metabolic processes and protein synthesis.

## VIII. CATABOLISM AND EXCRETION OF THYROID HORMONES

The thyroid hormones undergo deiodination, conjugation, or oxidative reactions. The deiodination reaction occurs widely in peripheral tissues and is catalyzed by deiodinases specific for each iodine position, and the released iodine is returned to the iodine pool. The details of the specific reactions, however, are not yet known. The deiodinase that catalyzes the deiodination of  $T_4$  to  $T_3$  in target cells is actually participating in an activation reaction. Deiodination at the 3 position of  $T_4$  gives  $rT_3$ , the inactive form on the degradation pathway. Within a cell, therefore, some of the  $T_4$  is converted to its active form, and some is converted to its inactive form for degradation. Some of the thyroid hormones are conjugated in the liver and excreted in the bile either as glucuronides or as sulfates. Also, the thyroid hormones, being amino acids, are deaminated and decarboxylated in the liver to form corresponding tetraiodoacetic acid and tri-iodoacetic acid, which are excreted by the kidney. Finally, the kidney also excretes the small amounts of free hormones in the blood.

## IX. REGULATION OF THE THYROID GLAND

### A. Production and Regulation of Thyroid-Stimulating Hormone

The thyroid gland is under the control of the thyroid-stimulating hormone (TSH), which is secreted by the anterior pituitary gland, which in turn is mediated through the hypothalamus and its thyrotropin-releasing hormone (TRH). The TRH is synthesized in the anterior hypothalamus by neurosecretory cells and then transported down axonic processes to the anterior pituitary. There, TRH stimulates the thyrotrophic cells to synthesize TSH. The secretion of TSH is regulated by a classic negative feedback control system based on the product of the target gland, thyroxine. A high

plasma concentration of free hormone,  $fT_4$ , depresses TSH secretion by the pituitary and, to some extent, the TRH from the hypothalamus. The direct inhibition of the pituitary by increased  $fT_4$  is the faster responding of the two tissues. At low concentrations of  $fT_4$ , however, the hypothalamus responds quickly by increasing its synthesis and release of TRH, which in turn increases the synthesis and release of pituitary TSH. In consequence, this regulatory mechanism, which is sensitive to either high or low concentrations of  $fT_4$ , maintains the circulatory hormone concentrations at the normal homeostatic level for that species.

### B. Action of the Thyroid-Stimulating Hormone on the Thyroid Gland

TSH has a number of direct effects on the thyroid gland: the gland increases in size, the height of the follicular cell increases, and there is a loss of colloid. The response of the thyroid gland to TSH is modified by the intake of stable iodine. When iodine intake is high, the action of TSH is suppressed and the height, size, and activity of the follicular cells decrease. When iodine intake is low, there is a compensatory hypertrophy of the gland with an increase in number, height, and size of the follicular cells. This is characteristic of the iodine deficiency goiters or the nontoxic goiters.

### C. Action of the Thyroid-Stimulating Hormone on Hormonogenesis

The effects of TSH on hormone synthesis by the thyroid follicle are outlined in Figure 20-1 and discussed in Section V. TSH affects every reaction in the hormone synthetic pathway beginning with the uptake of iodine, its activation, tyrosine iodination, coupling of the iodinated phenyls, and hydrolysis of colloid. The two most important sites of TSH action are the initial uptake of iodine and the final hydrolysis of colloid to release hormones into the circulation.

### D. Long-Acting Thyroid Stimulators

A second thyroid stimulatory factor has been identified in the serum of human patients with Graves' disease and appears to be closely involved in the mechanism of thyrotoxicosis (Adams, 1958). It differs from TSH in that it is cleared from the blood more slowly and produces its thyroid-stimulating effects many hours (8 to 24) after that of TSH. It is therefore referred to as long-acting thyroid stimulator, or LATS. Studies of LATS have been largely in humans where it has been closely correlated with hyperthyroidism (Lipman *et al.*, 1967). Since the initial observations, many other forms of delayed-acting thyroid stimulators have been found, and all, including LATS, are now known to be immunoglobulins of the IgG class. These

thyroid-stimulating immunoglobulins or thyroid-stimulating antibodies (TSAbs) do not appear to have a role in normal thyroid physiology, nor have corresponding stimulators been found in animals.

## X. THYROID FUNCTION TESTS

The diagnosis of thyroid disease is usually obscured by the nonspecific nature and variety of clinical signs. A thorough physical examination is essential for the detection of a potential thyroid disease and as a rationale for laboratory tests of thyroid function. Initial routine laboratory tests such as hematology or urinalysis are of limited value except for a moderate to slight normocytic normochromic anemia, which may sometimes be observed. The initial biochemical screen is also limited except for a hypercholesterolemia, which may be observed. In consequence, the specific tests of thyroid function are of great importance in the diagnosis of thyroid disease. Fortunately, improvements of standard tests and the development of new tests have made several specific and direct tests of thyroid function readily available to the veterinary clinician.

### A. Indirect Tests of Thyroid Function

#### 1. Hematology

A moderate normocytic normochromic anemia is sometimes associated with clinical hypothyroidism in the dog. This anemia has also been observed in human hypothyroidism and in experimental animals and is known to be of a depression type or the anemia of chronic disease. The stained blood smear characteristically has little or no evidence of active erythropoiesis such as anisocytosis, polychromasia, or nucleated red cells. Leptocytosis may be prominent in some cases. The hemogram, therefore, is characteristic of the nonresponsive anemia of chronic diseases such as neoplasia, chronic infection, and so on. This anemia is not diagnostic for hypothyroidism, but conversely, in cases of unexplained hypoplastic or nonresponsive anemia, hypothyroidism is an important differential diagnosis that should be pursued.

#### 2. Cholesterol

The serum cholesterol generally varies inversely with thyroid activity. The net effect of thyroid hormone on cholesterol metabolism is to increase the rate of its catabolism by the liver (Koppers and Palumbo, 1972), thereby lowering the cholesterol. In hypothyroidism, the net effect is a decrease in cholesterol catabolism and an increase in cholesterol.

The cholesterol is carried in dog plasma equally by the low-density lipoproteins (LDL-Chol) and the high-density

lipoproteins (HDL-Chol) (Mahley and Weisgrober, 1974). In humans, cholesterol is carried mainly by the LDL-Chol and only about 20% by the HDL-Chol. This partitioning of cholesterol is important because increased LDL-Chol is associated with atherosclerosis, whereas increased HDL-Chol is associated with a reduced risk for heart disease, hence it is commonly known as "good" cholesterol.

Total cholesterol alone is of limited value because hypercholesterolemia is seen in a variety of conditions unrelated to thyroid activity. These include the diet, nephrotic syndrome, hepatic function, biliary obstruction, and diabetes mellitus. The diagnostic accuracy of serum cholesterol for hypothyroidism in the dog is about 66%. However, when the concentrations are very high, >500 mg/dl (>12.9 mmol/l), and diabetes mellitus is eliminated, its diagnostic accuracy increases greatly. Therefore, increased cholesterol again is simply a signal to further investigate thyroid disease.

Similarly, hypocholesterolemia has little value as an index of hyperthyroidism. On the other hand, cholesterol decreases consistently in response to thyroxine replacement therapy, so it has value as a guide to therapeutic response. In thyroidectomized horses with clinical evidence of hypothyroidism, Lowe *et al.* (1974) found a 50% decrease in serum cholesterol shortly after feeding iodinated casein. Feeding of iodinated casein to these horses also resulted in a rapid rise of  $T_4$  to above normal. Iodinated casein contains about 2.5  $\mu\text{g}$  (3.85 nmol)  $T_4$  and 1.25  $\mu\text{g}$  (1.61 nmol)  $T_3$  per gram.

### B. Direct Tests of Thyroid Function

Direct approaches to thyroid evaluation are (1) to measure the amount of the hormones in the blood, (2) to assess the response of the thyroid to stimulation by the thyroid-stimulating hormone (TSH), or (3) to assess the response of the pituitary gland to stimulation by the thyrotropin-releasing hormone (TRH). Because there are thyroid inhibitory effects among a wide variety of iodine containing compounds, it is critical that any form of iodine-containing medication, including thyroid hormones, be ascertained in the history of the patient. As a general rule, any iodine-containing medication or thyroid hormones being given to the patient should be withdrawn for at least 2 weeks before any thyroid function tests are undertaken.

#### 1. Thyroxine by Radioimmunoassay

The principle of competitive protein binding ( $T_4$ -CPB) is the basis for the now standard radioimmunoassay for all hormones including  $T_4$  and  $T_3$ . The method is based on the competitive binding of TBG for patient  $T_4$  and  $^{131}\text{I}$ -labeled  $T_4$ . The  $^{131}\text{T}_4$  and patient  $T_4$  bind to the TBG in proportion to their concentrations so that labeled  $T_4$  binding is inversely proportional to patient  $T_4$  concentration.

Specific antibodies have replaced the use of TBG so that there is high specificity for the assay of proteins, polypeptides, haptens, and most of the hormones. Polyclonal antibodies give accurate results and are usually used for these hormone assays. The mean normal  $T_4$ -RIA in dogs is  $2.3 \pm 0.8 \mu\text{g/dl}$  ( $29.6 \pm 10.3 \text{ nmol/l}$ ) with an observed range of 0.6 to  $3.6 \mu\text{g/dl}$  (7.7 to  $46.3 \text{ nmol/l}$ ), which is comparable to the 1.5 to  $3.6 \mu\text{g/dl}$  (19.3 to  $46.3 \text{ nmol/l}$ ) of Sims *et al.* (1977).  $T_4$ -RIA is also widely used in cats because of the high prevalence of hyperthyroidism in this species. The reference range for cats is 0.1 to  $2.5 \mu\text{g/dl}$  (1.3 to  $32.3 \text{ nmol/l}$ ). In the horse,  $T_4$ -RIA is also quite low, 0.9 to  $2.8 \mu\text{g/dl}$  (11.6 to  $36.0 \text{ nmol/l}$ ). Messer *et al.* (1995) reported a mean  $T_4$ -RIA of  $21.42 \pm 3.46 \text{ nmol/l}$  in 12 adult horses.

## 2. Thyroxine by Enzyme-Labeled Immunoassay

An important advance in hormone assay is the development of an enzyme-labeled immunoassay (EIA) test comparable in every way to radioimmunoassay except that the labeling is by an enzyme rather than radioiodine. This method has some obvious advantages in that there is no need to use radioactivity and the enzyme can be assayed in any laboratory. One system labels  $T_4$  with malate dehydrogenase (MD), which in competition with unlabeled  $T_4$ , binds to antibody. This method has the acronym EMIT for enzyme multiplied immunosorbent test. This method has another advantage in that the labeled and unlabeled fractions need not be separated. The MD when bound to  $T_4$  is inactive, and when it binds to the immunoglobulin, it is activated. The activity of malate dehydrogenase is assayed by standard enzyme methodology, and the  $T_4$  is read from a standard curve as in a radioimmunoassay.

Another system uses two separate recombinant fragments of the enzyme  $\beta$ -galactosidase (Horn *et al.*, 1991). The individual fragments, enzyme donor (ED) and enzyme acceptor (EA), are inactive but when they recombine, they form the active enzyme. Thyroxine is bound to ED. In the presence of thyroxine antibody, the thyroxine-ED-antibody complex inhibits recombination with EA, and no active  $\beta$ -galactosidase is formed. When sample thyroxine and a standard amount of thyroxine-ED are mixed, they compete for a standard amount of antibodies. Thus, unbound thyroxine-ED accumulates in direct proportion to the amount of sample thyroxine. The unbound thyroxine-ED is free to bind with EA to form the active  $\beta$ -galactosidase. In this case, enzyme activity is directly proportional to the amount of thyroxine. This method had a very high correlation coefficient when compared to an RIA ( $r = 0.969$ ), EIA ( $r = 0.966$ ) and a fluorescence polarization immunoassay (FPIA,  $r = 0.939$ ).

Another variation of the nonisotopic immunoassay is the fluorescence immunoassay in which a fluorochrome is tagged to the  $T_4$ . The  $T_4$  concentration is inversely proportional to the fluorescence as in the RIA. This is also a

sensitive test, but it requires a sensitive spectrofluorometer for the assay.

Chemiluminescence is another nonisotopic method with comparable accuracy (Wilkinson *et al.*, 1993). Enzyme immunoassays have not replaced radioimmunoassays for hormones, but the principle is now widely used for antigen or antibody assays using horseradish peroxidase (HRP) as the enzyme label. The procedure is popularly known as the enzyme-linked immunosorbent assay or by its acronym, ELISA. This procedure has been adapted for  $T_4$  by labeling  $T_4$  with HRP, coupling the HRP to a dye that indicates enzyme activity and hence  $T_4$  concentration.

## 3. Triiodothyronine by Radioimmunoassay

Triiodothyronine is also commonly assayed by radioimmunoassay ( $T_3$ -RIA). In the dog, the mean normal  $T_3$ -RIA is  $107 \pm 18 \text{ ng/dl}$  ( $1.6 \pm 0.3 \text{ nmol/l}$ ) with an observed range of 82 to  $138 \text{ ng/dl}$  (1.26 to  $2.12 \text{ nmol/l}$ ) (Kaneko, 1997). It closely parallels  $T_4$ -RIA in the dog so that the simultaneous determination of  $T_4$ -RIA and  $T_3$ -RIA will increase the diagnostic accuracy of either one alone. In cats,  $T_3$ -RIA is less widely used in comparison to  $T_4$ -RIA. The reference range for cats is 15 to  $50 \text{ ng/dl}$  (0.23 to  $0.77 \text{ nmol/l}$ ). In the horse, Messer *et al.* (1995) reported a mean  $T_3$ -RIA of  $0.85 \pm 0.52 \text{ nmol/l}$ .

## 4. "Free" Thyroxine and "Free" Triiodothyronine

"Free" thyroxine ( $ft_4$ ) is the unbound fraction of the total circulating  $T_4$ , and its concentration is controlled by the equilibrium between TBG and TBG- $T_4$  (Section III). Equilibrium dialysis is now considered the best method for determining the free hormones, but it is often too labor-intensive for use in many clinical laboratories. An equilibrium dialysis method for free thyroxine is commercially available so that this method is now widely used.

The  $ft_4$  concentration for dogs is 0.52 to  $2.7 \text{ ng/dl}$  (6.7 to  $34.7 \text{ pmol/l}$ ). In the hyperthyroid cat, Hays *et al.* (1988) found no differences in dialyzable  $T_4$  from the normal. They inferred that the total  $T_4$  is sufficient for diagnosis and that the free hormone is not needed in the cat. In the horse, Messer *et al.* (1995) reported a mean  $ft_4$ -RIA of  $14.0 \pm 1.16 \text{ pmol/l}$ .

The  $ft_3$ -RIA parallels  $ft_4$ -RIA in its binding characteristics. Because  $ft_3$  is the physiologically active form of the hormone, it is potentially the single most reliable test of thyroid function. In the horse, Messer *et al.* (1995) reported a mean  $ft_3$ -RIA of  $0.89 \pm 0.53 \text{ pmol/l}$ .

## 5. Thyroid-Binding Globulin, Thyroglobulin, and Thyroid Autoantibodies

Thyroid-binding globulin (TBG) and thyroglobulin (Tg) or colloid are measured by RIA. The standard technique for

thyroglobulin antibodies (TgAA) is the ELISA method. Haines *et al.* (1984), using ELISA, detected TgAA in a high percentage of dogs with hypothyroidism, in dogs with other endocrine diseases, and in those dogs that were closely related to the TgAA-positive dogs but found a low percentage in healthy unrelated dogs. They concluded that thyroid autoimmunity is strongly genetically influenced in the dog. An enzyme immunoassay (EIA) method has also been developed for the detection of autoantibodies to thyroxine and triiodothyronine (Patzl and Mostl, 2003).

### 6. Thyroid-Stimulating Hormone

Serum TSH is measured by radioimmunoassay (TSH-RIA) using an anticanine TSH antibody, which is commercially available for use in dogs. The human assay method, which is not suitable for dogs (Larsson, 1981), has been used in monkeys (*M. mulatta*) with 0.2 to 2.6  $\mu\text{U}/\text{ml}$  (1.53  $\mu\text{U}/\text{ml}$ ) (Belchetz *et al.*, 1978). Marca *et al.* (2001) compared three assay methods for canine serum: RIA, EIA, and chemiluminescent. They found that the chemiluminescent assay had the best within- and between-run precision, and that all three had satisfactory correlations to serum TSH concentrations.

### 7. Thyrotrophin-Releasing Hormone

Although as yet no reliable thyrotrophin-releasing factor (TRH) assay has been developed for use in domestic animals, a highly purified TRH is available and is used in the TRH response test.

## C. Radionuclide Uptake Tests

### 1. Radionuclide Scintigraphy

Radioiodine is taken up by the thyroid gland in exactly the same manner as the nonradioactive isotope, and its uptake remains as one of the most definitive tests for thyroid function. Radioactive  $^{99\text{m}}\text{Tc}$ -pertechnetate is also taken up in the same manner and is now widely used for scintigraphy. Pertechnetate scintigraphy is used for detecting asymmetry of the thyroids, for localizing of active thyroid nodules and "hot spots" (Scrivani *et al.*, 2007). Quantitative pertechnetate uptake was found to have the highest discriminatory power between primary hypothyroidism and nonthyroidal illness when compared to other methods of evaluating thyroid function (Diaz-Espineira *et al.*, 2007).

## D. Thyroid Ultrasonography

Ultrasonographic evaluation of the thyroid gland has been proposed as a means to differentiate between hypothyroid and euthyroid dogs. Two studies have reached essentially

the same conclusion that the estimated thyroid volume by ultrasound has a highly specific predictive value for canine hypothyroidism (Bromel *et al.*, 2005; Reese *et al.*, 2005).

## E. Trophic Hormone Response Tests

### 1. Thyroid-Stimulating Hormone Response Test

The response of the thyroid to TSH injection is a means of evaluating thyroid activity as well as to differentiate a primary hypothyroidism because of a thyroid lesion from a hypothyroidism secondary to a pituitary lesion. The responsiveness of the thyroid to the TSH injection is evaluated by an increase (or failure to increase) as evidence of thyroid activity (or inactivity). In the general procedure, thyroidal activity (or lack of activity) is first established by the measurement of serum hormones, and this is followed by the injection of TSH. In a primary hypothyroidism where the lesion is localized in the thyroid, there is no response to the exogenous TSH. If the hypothyroidism is due to a pituitary hypofunction with a deficiency of TSH or a hypothalamic lesion with a lack of TRH, there will be a response of the thyroid to the exogenous TSH as seen by a significant increase in serum hormone concentrations. Glucocorticoids and phenylbutazone are also well known to depress thyroid activity so that the TSH response test is useful in detecting low hormone concentrations due to thyroid disease. Useful procedure for the TSH response test is to first to obtain a serum sample for baseline  $T_4$  or  $T_3$ , then inject 10IU of bovine TSH intravenously. Held and Oliver (1984) and Oliver and Waldrop (1983) have recommended a minimum of 5IU for the dog and horse, respectively. After 4h, a second serum sample is taken and hormone again measured. The normal response in dogs is a doubling or more of the hormone above baseline level. In the primary hypothyroid individual, there is a virtual absence of a response. In the drug-induced or Cushing's patient with low hormone, there will be a response to well within the normal hormone concentrations. The secondary (TSH) or tertiary (TRH) hypothyroid patient will have a response similar to the drug-induced or Cushing's patient. In cats, Peterson *et al.* (1983) found  $T_4$  to increase almost three-fold above the baseline at 4h post TSH. In the baboon, the TSH response test had peaks of more than double the baseline at 8 and 12h for  $T_3$  and  $T_4$ , respectively (Maul *et al.*, 1982). In horses, Messer *et al.* (1995), at 6h after TSH administration, found significant increases in  $T_4$ ,  $T_3$ , and  $fT_4$  but not in  $fT_3$ . They suggested that the TSH response test may not be as valuable for thyroid disease diagnostics in the horse as it is in the dog and cat.

### 2. Thyrotrophin-Releasing Hormone Response

The response to thyrotrophin-releasing hormone (TRH) has been used in dogs and cats. Lothrop *et al.* (1984) found



a doubling of  $T_4$ -RIA at 6h postinjection in dogs and cats. Scott-Montcrieff and Nelson (1998) measured TSH at 30min after TRH injection and found a small increase in TSH in hypothyroid as compared to euthyroid dogs. They concluded that the test had little advantage over using the baseline TSH, total  $T_4$ , or  $fT_4$ .

## XI. DISEASES OF THE THYROID

Thyroid disease has been most extensively studied in the dog, whereas in the cat, the number of studies is increasing as the incidence of hyperthyroidism has increased. Hyperthyroidism is now the most frequently encountered endocrinopathy in this species. In the horse, Lowe *et al.* (1974) described the clinical effects of experimental thyroidectomy in mares and stallions, and hypothyroidism remains as a frequent consideration in breeding problems. In ruminants, a congenital goiter has been described in Merino sheep and in Afrikaner cattle. Local enlargements or nodules are also observed in all animals, and these are usually benign tumors.

### A. Goiter

Goiter may be defined as an enlargement of the thyroid gland, which is not due to inflammation or malignancy. There are two general types of goiters: (1) nontoxic goiters, which produce either (a) normal amounts of hormone (simple goiter) or (b) below normal amounts of hormone (hypothyroid), and (2) the toxic goiters, which produce excess amounts of hormone (hypertrophy). Furthermore, a defect or deficiency at any trophic step can also result in thyroid disease. Iodine deficiency (endemic goiter) is well known in iodine-deficient areas of the world. Goitrogenic materials, either natural substances or drugs, induce goiters by their blocking effects on steps in the hormonogenic pathways. There are also rare types of familial goiters associated with defects in hormone synthesis (dys-hormonogenesis) in humans, which find their counterparts in Merino sheep (Rac *et al.*, 1968) and in Afrikaner cattle (Van Zyl *et al.*, 1965). The congenital goiter in the Merino sheep is fundamentally a failure of thyroglobulin synthesis. The goiter is inherited as an autosomal recessive and is frequently seen in Australia. The similar congenital goiter in the Afrikaner cattle (Ricketts *et al.*, 1985) is also inherited as an autosomal recessive. These cattle have a thyroglobulin synthesis defect involving defective gene splicing of the thyroglobulin gene transcript. In Bongo antelopes, goiter was observed in a group of adults, which was associated with synthesis of an abnormal 19S thyroglobulin (Schiller *et al.*, 1995). The goitrous antelopes were hormonally euthyroid but had other manifestations of hypothyroidism (e.g., reproductive difficulties). Iodine deficiency goiter was observed in seven Thoroughbred foals in the northern

island of Hokkaido, Japan (Osame and Ichijo, 1994), which was attributed to iodine deficiency in the soil of the region. All foals had readily detectable thyroid enlargements, and four of the seven had clinical signs of thyroid deficiency as well. The goiters receded after iodine supplementation of the feed.

Simple goiter is a compensatory increase in thyroid glandular mass (hyperplasia and hypertrophy) so that the gland maximizes iodine uptake and is able to synthesize and release a normal amount of  $T_4$ . At this time, the patient is physiologically normal, but the gland can become quite large. Ultimately in iodine deficiency, the goitrous gland fails to synthesize sufficient  $T_4$  and hypothyroidism occurs.

### B. Hypothyroidism

Hypothyroidism may be the result of a variety of causative factors. Thyroiditis, with similarities to Hashimoto's thyroiditis in humans, has been reported in about 12% of beagle dogs (Beierwaltes and Nishiyama, 1968). Antithyroglobulin antibodies were found in these dogs. In the adult dog, follicular atrophy is probably the most common cause of hypothyroidism. Finally, hypothyroidism may be secondary to a pituitary insufficiency.

The hypothyroid dog is typically obese, lethargic, has myxedema, a dry skin, and a sparse hair coat. Hypothyroidism is therefore an important differential in the diagnoses of dermatoses. The requirement of  $T_4$  for normal reproduction, growth, and development is well known, so hypothyroidism is an important differential in reproductive failures. Experimentally, thyroidectomized mares and stallions failed to grow; were lethargic, had coarse, dull hair coats; and had increased serum cholesterol (Lowe *et al.*, 1974). Hypothyroid horses tend toward obesity and crestiness.

In the initial screen, an increased cholesterol is often the first clue to hypothyroidism. Definitive laboratory findings in the hypothyroidism of animals are a low  $T_4$  or  $T_3$  with little or no response to the TSH response test. Therefore, the recommended algorithm is to first obtain the total  $T_4$  and  $T_3$  (and the  $fT_4$  and  $fT_3$  if available). If the results are equivocal, this is followed by the TSH response test. Other definitive studies such as the  $^{99m}Tc$ -pertchnetate scans can be used in specialized hospital settings for the identification of isolated thyroid nodules.

In human thyroid disease diagnostics, TSH is now considered to be the single best test of thyroid status and more cost effective than  $T_4$ . TSH can now be readily assayed with a functional sensitivity of 0.01 to 0.02 mU/l. Because of this sensitivity, human thyroidologists now recommend that TSH be used as the initial test and that  $T_4$  or preferably  $fT_4$  be used only on a selected basis. In the dog, however, Kooistra *et al.* (2000) found that TSH in hypothyroid dogs was secreted in a pulsatile pattern. This may explain

the variations in TSH found in hypothyroid dogs, which detract from its usefulness canine hypothyroidism.

### C. Hyperthyroidism

Hyperthyroidism or toxic goiter is characterized by weight loss, hyperactivity, a voracious appetite, and increased thyroid hormones. Hyperthyroidism is rarely observed in dogs, but in the cat, the high incidence of hyperthyroidism has been recognized as a common endocrinopathy (Peterson *et al.*, 1983). The most common form of hyperthyroidism in the cat is a functional thyroid adenoma.

Increases in  $T_4$  or  $T_3$  are virtually pathognomonic signs of hyperthyroidism in the cat. In 131 cases,  $T_4$  was increased to between 4.0 and 54.1  $\mu\text{g}/\text{dl}$  (51.5 to 696.3  $\text{nmol}/\text{l}$ ) in all cats, and  $T_3$  was between 54 and 1000  $\text{ng}/\text{dl}$  (0.83 to 15.36  $\text{nmol}/\text{l}$ ) in 97% of the cats (Peterson *et al.*, 1983). Hays *et al.* (1988) suggested that  $T_4$  and  $T_3$  are sufficient for diagnosis and that the free hormones are not needed for the diagnosis. In the 131 cases, the mean 24-h  $^{131}\text{I}$  uptake was 39.1% as compared to 9.2% in normal cats. There was no increment of response above the baseline value to the TSH response test in these cats as would be expected of a tumor.  $^{99}\text{Tm}$ -pertechnetate scans demonstrated increased uptake and size in one or both lobes of the thyroid.

### D. Tumors of the Thyroid Gland

Except for the dog and cat, tumors of the thyroid occur infrequently in animals. About 20% of canine thyroid tumors are functional. Scintigraphic imaging is now used to identify functional thyroid tumors and their metastases. In feline hyperthyroidism, a functional thyroid adenoma is the most common finding.

## REFERENCES

- Adams, D. D. (1958). Presence of an abnormal thyroid-stimulating hormone in serum of some thyrotoxic patients. *J. Clin. Endocrinol. Metab.* **18**, 699–712.
- Akasha, M., and Anderson, R. R. (1984). Thyroxine and triiodothyronine in milk of cows, goats, sheep and guinea pigs. *Proc. Soc. Exp. Biol. Med.* **177**, 360–371.
- Beierwaltes, W. H., and Nishiyama, R. H. (1968). Dog thyroiditis: occurrence and similarity to Hashimoto's stroma. *Endocrinology* **83**, 501–508.
- Belchetz, P. E., Gredley, G., and Himsworth, R. (1978). Pituitary-thyroid function in the rhesus monkey (*Macaca mulatta*). *J. Endocrinol.* **76**, 427–438.
- Bromel, C., Pollard, R. E., Kass, P. H., Samii, V. P., Davidson, A. P., and Nelson, R. W. (2005). Ultrasonographic evaluation of the thyroid gland in healthy, hypothyroid, and euthyroid golden retrievers with nonthyroidal illness. *J. Vet. Intern. Med.* **19**, 499–506.
- Diaz-Espineira, M. M., Mol, J. A., Peeters, M. E., Pollak, Y. W., Iverson, L., van Dijk, J. E., Rijnberk, A., and Kooistra, H. S. (2007). Assessment of thyroid function in dogs with low plasma thyroxine concentration. *J. Vet. Intern. Med.* **21**, 25–32.
- Edelman, I. S. (1974). Thyroid thermogenesis. *N. Engl. J. Med.* **290**, 1303–1308.
- Haines, D. M., Lording, P. M., and Penhale, W. J. (1984). Survey of thyroid autoantibodies in dog. *Am. J. Vet. Res.* **45**, 1493–1497.
- Hays, M. T., Turrel, J. M., and Broome, M. R. (1988). Assessing degree of hyperthyroidism in cats. *J. Am. Vet. Med. Assoc.* **192**, 1–7.
- Held, J. P., and Oliver, J. W. (1984). A sampling protocol for the thyrotropin stimulation test in the horse. *J. Am. Vet. Med. Assoc.* **184**, 326–327.
- Horn, K., Castineiras, M. J., Ortola, J., Kock, R., Perriard, F. C., Bittner, S., Pairet, J. V., Ers, P., Boulanger, J., Zeidner, S., Maier, R., Boege, F., Dubois, H., McGovern, M., and Opitz, I. (1991). The determination of thyroxine and thyroxine uptake with new homogeneous enzyme immunoassays using Boehringer Mannheim Hitachi analysis systems. *Eur. J. Clin. Chem. Clin. Biochem.* **29**, 697–703.
- Kaneko, J. J. (1997). Thyroid function. In "Clinical Biochemistry of Domestic Animals" (J. J. Kaneko, J. W. Harvey, and M. L. Bruss, Eds.), 5th ed., pp. 571–588. Academic Press, San Diego.
- Kooistra, H. S., Diaz-Espineira, M., Mol, J. A., van den Brom, W. E., and Rijnberk, A. (2000). Secretion pattern of thyroid-stimulating hormone in dogs during euthyroidism and hypothyroidism. *Domest. Anim. Endocrinol.* **18**, 19–29.
- Koppers, L. E., and Palumbo, P. J. (1972). Lipid disturbances in endocrine disorders. *Med. Clin. North Am.* **56**, 1013–1020.
- Larsson, M. (1981). Evaluation of human TSH radioimmunoassay as a diagnostic tool for primary canine hypothyroidism. *Acta Vet. Scand.* **22**, 589–591.
- Larsson, M., Pettersson, T., and Carlstrom, A. (1985). Thyroid hormone binding in serum of 15 vertebrate species: isolation of thyroid binding globulin and prealbumin analogs. *Gen. Comp. Endocrinol.* **58**, 360–375.
- Lipman, L. M., Green, D. E., Snyder, N. J., Nelson, J. C., and Solomon, D. H. (1967). Relationship of long-acting thyroid stimulator to the clinical features and course of Graves disease. *Am. J. Med.* **43**, 486–498.
- Lothrop, C. D., Jr., Tamas, P. M., and Fadok, V. A. (1984). Canine and feline thyroid function assessment with the thyrotropin releasing hormone response test. *Am. J. Vet. Res.* **45**, 2310–2313.
- Lowe, J. E., Baldwin, B. H., Foote, R. H., Hillman, R. B., and Kallfelz, F. A. (1974). Equine hypothyroidism: the long term effects of thyroidectomy on metabolism and growth in mares and stallions. *Cornell Vet.* **64**, 276–295.
- Mahley, R. W., and Weisgraber, K. H. (1974). Canine lipoproteins and atherosclerosis. I. Isolation and characterization of plasma lipoproteins from control dogs. *Circ. Res.* **35**, 713–721.
- Marca, M. C., Loste, A., Orden, I., Gonzalez, J. M., and Marsella, J. A. (2001). Evaluation of canine serum thyrotropin (TSH) concentration: comparison of three analytical procedures. *J. Vet. Diagn. Invest.* **13**, 106–110.
- Maul, D. H., Rosenberg, D. P., Henrickson, R. V., and Kaneko, J. J. (1982). Response of thyroxine and triiodothyronine to thyroid stimulating hormone in adult female baboons (*Papio cynocephalus*). *Lab. Anim. Sci.* **32**, 267–268.
- Messer, M. T., Ganjam, V. K., Nachreiner, R. F., and Krause, G. F. (1995). Effect of dexamethasone administration on serum thyroid hormone concentrations in clinically normal horses. *J. Am. Vet. Med. Assoc.* **206**, 63–66.
- Oliver, J. W., and Waldrop, V. (1983). Sampling protocol for thyrotropin stimulating test in the dog. *J. Am. Vet. Med. Assoc.* **182**, 486–489.

- Osame, S., and Ichijo, S. (1994). Clinicopathologic observations in Thoroughbred foals with enlarged thyroid gland. *J. Vet. Med. Sci.* **56**, 771–772.
- Patzi, M., and Mostl, E. (2003). Determination of autoantibodies to thyroglobulin, thyroxine and triiodothyronine in canine serum. *J. Vet. Med. A Physio. Pathol. Clin. Med.* **50**, 72–78.
- Peterson, M. E., Kintzer, P. P., Cavanagh, P. G., Fox, P. R., Ferguson, D. C., Johnson, G. F., and Becker, D. V. (1983). Feline hyperthyroidism: pretreatment clinical and laboratory evaluation of 131 cases. *J. Am. Vet. Med. Assoc.* **183**, 103–110.
- Pliam, N. B., and Goldfine, I. D. (1977). High affinity thyroid hormone binding sites on purified rat liver plasma membrane. *Biochem. Biophys. Res. Commun.* **79**, 166–172.
- Rac, R., Hill, G. N., Pain, R. W., and Mulhearn, C. J. (1968). Congenital goiter in Merino sheep due to an inherited defect in biosynthesis of thyroid hormone. *Res. Vet. Sci.* **9**, 209–223.
- Reese, S., Breyer, U., Deeg, C., Kraft, W., and Kaspers, B. (2005). Thyroid sonography as an effective tool to discriminate between euthyroid sick and hypothyroid dogs. *J. Vet. Intern. Med.* **19**, 491–498.
- Refetoff, S., Robin, N. I., and Fang, V. S. (1970). Parameters of thyroid function in serum of 16 selected vertebrate species: a study of PBI, Serum T4, Free T4, and the pattern of T4 and T3 binding to serum proteins. *Endocrinology* **86**, 793–805.
- Ricketts, M. H., Pohl, V., de Martynoff, G., Boyd, C. D., Bester, A. J., Van Jaarsveld, P. P., and Vassart, G. (1985). Defective splicing of thyroglobulin gene transcripts in the congenital goiter of the Afrikander cattle. *EMBO J.* **4**, 731–737.
- Riesco-Eizaguirre, G., and Santisteban, P. (2006). A perspective view of sodium iodide symporter research and its clinical implications. *Eur. J. Endocrinol.* **155**, 495–512.
- Schiller, C. A., Montali, R. J., and Grollman, E. F. (1995). Clinical and morphological findings of familial goiter in bongo antelope. *Vet. Pathol.* **32**, 242–249.
- Scott-Montcrieff, J. C., and Nelson, R. W. (1998). Change in serum thyroid-stimulating hormone concentration in response to administration of thyrotropin-releasing hormone in healthy dogs, hypothyroid dogs, and euthyroid dogs with concurrent disease. *J. Am. Vet. Med. Assoc.* **213**, 1435–1438.
- Scrivani, P. V., Dykes, N. L., Page, R. B., and Erb, H. N. (2007). Investigation of two methods for assessing thyroid-lobe asymmetry during pertechnetate scintigraphy in suspected hyperthyroid cats. *Vet. Radiol. Ultrasound* **48**, 383–387.
- Segal, J., Schwartz, H., and Gordon, A. (1977). The effect of triiodothyronine on 2-deoxy-(1-3H)glucose uptake in cultured chick embryo heart cells. *Endocrinology* **101**, 143–149.
- Sims, M. H., Redding, R. W., and Nachreiner, R. F. (1977). Depressed thyroid function in two tetraplegic dogs. *J. Am. Vet. Med. Assoc.* **171**, 178–180.
- Tanabe, Y., Ishii, T., and Tamaki, Y. (1969). Comparison of thyroxine-binding plasma proteins of various vertebrates and their evolutionary aspects. *Gen. Comp. Endocrinol.* **13**, 14–21.
- Tapley, D. F. (1964). Mode and site of action of thyroxine. *Mayo Clinic Proc.* **39**, 626–636.
- Tata, J. R., Ernster, L., Lindberg, O., Arrhenius, E., Pederson, S., and Hedman, R. (1963). The action of thyroid hormones at the cell level. *Biochem. J.* **86**, 408–428.
- Van Zyl, A., Schulz, K., Wilson, B., and Pansegrouw, D. (1965). Thyroidal iodine and enzymatic defects in cattle with congenital goiter. *Endocrinology* **76**, 353–361.
- Wilkinson, E., Rae, P. W., Thomson, K. J., Toft, A. D., Spencer, C. A., and Beckett, G. J. (1993). Chemiluminescent third generation assay (Amberlite TSH-30) of thyroid stimulating hormone in serum and plasma assessed. *Clin. Chem.* **10**, 2167–2173.

# Clinical Reproductive Endocrinology

Håkan Andersson<sup>1</sup>

Department of Integrative Biology  
Umea University  
Umea, Sweden

## I. Introduction

- A. Definition of Hormones
- B. Chemical Classes of Reproductive Hormones
- C. Hormone Receptors
- D. Local Conversion of Steroids in Target Tissues
- E. Synthesis and Clearance of Hormones

## II. Assay Methods

- A. Immunoassay

## III. Physiology of Reproductive Hormones in the Female

- A. Estrus Cycle
- B. Control of the Corpus Luteum
- C. Early Pregnancy
- D. Pregnancy and Parturition

## IV. Clinical Aspects of Reproductive Endocrinology

- A. Cattle
- B. Sheep
- C. Pig
- D. Horse
- E. Dog
- F. Cat

## V. General Comments

- A. Hormone Concentrations
- B. Analysis and Storage Effects

## REFERENCES

## I. INTRODUCTION

Clinical reproductive endocrinology includes the study of diseases and secretory status of the endocrine glands involved in reproduction and their secretory products, the reproductive hormones. To obtain a satisfactory understanding of the complex endocrinological events that occur during normal and abnormal reproductive function, it is necessary to quantify specific hormones.

Major progress in hormone analytical techniques occurred as the result of the development of immunoassay

and related systems. The first of the assays, radioimmunoassay, was developed in the late 1950s (Berson and Yalow, 1959) with the competitive protein binding assay following a few years later (Murphy, 1964). Nonradiometric assays (e.g., enzyme immunoassay) were developed in the 1970s (Engvall and Perlmann, 1971; van Weemen and Schuurs, 1971). These assay systems have the characteristics of being sensitive, specific, relatively inexpensive, and requiring small amounts of assay material. They have been of special value for studying endocrinological reproductive function in domestic animals in that they have made possible the study of dynamic endocrine changes through the assay of serial blood samples from the same animal. The immunoassay systems have also been useful as diagnostic aids for identifying and elucidating clinical reproductive problems. In clinical practice, these methods are important from both a diagnostic and therapy-monitoring point of view.

Because this book deals with clinical biochemistry in domestic animals, this chapter emphasizes the determination of hormones and the use of the data as diagnostic aids. General reproductive endocrinology in domestic species is broadly covered. Readers specifically interested in this subject are referred to specialized books dealing with this matter.

## A. Definition of Hormones

The best understood humoral control system in the body is the endocrine system. This system uses specific messengers, termed *hormones*, to regulate important body functions. By the classical definition, hormones are chemical substances synthesized and secreted by ductless endocrine glands in minute quantities directly into the blood vascular system and are transported to a remote target organ where they regulate the rates of specific biochemical processes. The classic endocrine glands include the pituitary, thyroid, parathyroid, adrenal, pancreas, ovary, testis, placenta, and pineal gland.

In the case of reproduction, the pituitary and pineal glands, the gonads, and the placenta play a primary role in controlling the system. Other endocrine glands such as the adrenal and thyroid glands also have some influence

<sup>1</sup>Revised and updated by Lars-Erik Edqvist and Mats Forsberg

on reproductive function. It has also been shown that other organs like the uterus and the hypothalamus, although they may not fulfill the strict requirement of being defined as endocrine glands, can synthesize and secrete hormones that have a profound influence on reproductive function.

## B. Chemical Classes of Reproductive Hormones

### 1. Peptide and Protein Hormones

#### a. Releasing Hormones

Several types of hormones are involved in the regulation of reproduction. Releasing hormones are peptide hormones, which are produced within the hypothalamus and transferred via the hypothalamo-hypophyseal portal veins to the adenohypophysis, where they regulate the synthesis or release of adenohypophyseal hormones. Gonadotropin-releasing hormone I (GnRH), a decapeptide with the sequence pGlu-His-Trp-Ser-Tyr-Gly-Leu-Arg-Pro-Gly-NH<sub>2</sub>, regulates the release of two important reproductive hormones, luteinizing hormone (LH) and follicle-stimulating hormone (FSH). A conserved second GnRH (GnRH-II) form exists in some mammals but appears not to have importance for gonadotropin release (Millar, 2005). Thyrotropin-releasing hormone, a tripeptide (pGlu-His-Pro-NH<sub>2</sub>), which regulates the synthesis and release of thyroid-stimulating hormone (TSH), also causes the release of prolactin in several species.

GnRH is released in a pulsatile fashion, where the frequency of peaks varies according to reproductive status (see Clarke and Pompolo, 2005). Recently discovered neuropeptides have shed some light on the central regulation of GnRH release. Kisspeptin (or mestatin) and its receptor (G protein-coupled receptor 54) are expressed in the hypothalamus in close connection with GnRH-neurons. Kisspeptin is regulated by sex steroids and can directly activate GnRH neurons and induce GnRH secretion; thus it may be an important regulator of the reproductive axis and puberty (Seminara, 2005). First discovered in birds (Tsutsui *et al.*, 2000), gonadotropin-inhibiting hormone (GnIH) has also been demonstrated in mammals, where its hypothalamic localization, association with steroid receptors, and inhibiting effect on gonadotropin secretion suggest an important role in the reproductive axis (Kriegsfeld *et al.*, 2006).

#### b. Hypophyseal Hormones

Luteinizing hormone (LH) and follicle-stimulating hormone (FSH) are glycoproteins containing 13% to 25% carbohydrate. The molecular weight of LH in domestic animals (bovine, ovine, porcine, equine) is about 30,000. Ovine and equine FSH have molecular weights of about 32,000. Prolactin is a protein with a molecular weight of approximately 23,000 (bovine, ovine, porcine). Luteinizing hormone and FSH, as well as TSH, consist of two nonidentical subunits designated  $\alpha$  and  $\beta$ . Within a species, the  $\alpha$ -subunit

is identical for these glycoprotein hormones, whereas the  $\beta$ -subunit is unique for each hormone and determines the biological activity. Individual subunits by themselves possess little or no biological activity and are probably not released into the circulatory system under normal physiological conditions.

The cells of the adenohypophysis can be divided into basophiles (affinity for basic stains) and acidophiles (affinity for acid stains). Luteinizing hormone and FSH are produced within basophilic cells; it has been demonstrated that LH and FSH can be present within the same cell (the gonadotrope). Prolactin, on the other hand, has been localized in acidophilic cells. Gonadotropes have G protein-coupled GnRH-receptors on their surface, and the secretion of LH and FSH during the ovarian cycle is controlled by changes in the frequency of GnRH pulses. Except during the preovulatory LH surge in the estrus cycle, there is a clear difference in the patterns of FSH and LH secretion, as measured in the peripheral circulation, and only LH is released in a clear pulsatile manner reflecting GnRH secretion (see Pawson and McNeilly, 2005).

#### c. Neurohypophyseal Hormones

The posterior pituitary is responsible for storage and release of oxytocin, an important reproductive hormone, and antidiuretic hormone (vasopressin). These two hormones are synthesized primarily in the regions of the paraventricular nucleus and supraoptic nucleus of the hypothalamus. The hormones are transported to the posterior pituitary by axoplasmic fluid. Release of these hormones occurs as a result of stimulation of the nerve cell bodies in the nuclei. Oxytocin is an octapeptide with a molecular weight of 1000.

#### d. Gonadal Activins and Inhibins

Activins and inhibins are structurally related proteins belonging to the transforming growth-factor- $\beta$  (TGF- $\beta$ ) superfamily and have impact on the endocrine reproductive axis. Inhibins and activins are made up of two peptide chains. Inhibins form  $\alpha$ - $\beta$  dimers and activins  $\beta$ - $\beta$  dimers. There are two varieties of the  $\beta$ -unit (called A and B) producing two forms of inhibin, inhibin A ( $\alpha$ - $\beta$ A), and inhibin B ( $\alpha$ - $\beta$ B), and three forms of activin, activin A ( $\beta$ A- $\beta$ A), activin B ( $\beta$ B- $\beta$ B), and activin C ( $\beta$ A- $\beta$ B). Activins and inhibins secreted from the gonads act antagonistically on the gonadotropes to regulate FSH release. In the female, activins have several autocrine/paracrine functions in reproductive tissues and ovary activin A has been indicated as an endocrine stimulator of FSH release. In the male, inhibin is produced by Sertoli cells and function as a negative feedback regulator of pituitary FSH, probably in synergy with testosterone. In most species (e.g., bull, boar, and stallion), the dominant testicular form is inhibin B, whereas in the ram, inhibin A appears to be the dominant inhibin of the testicles of adult males (McNeilly *et al.*, 2002).

e. Placental Gonadotropin

A gonadotropin, renamed equine chorionic gonadotropin (eCG) because of its close relationship with human chorionic gonadotropin (hCG) (Farmer and Papkoff, 1979), was formerly called pregnant mares' serum gonadotropin (PMSG) and is produced by mares during early pregnancy (day 40 to 140) by fetal trophoblastic cells of the chorionic girdle, which attach to, invade, and phagocytose the maternal epithelium and become embedded within the uterus as specialized endometrial cups. This process begins on day 36 of pregnancy. No specific placental gonadotropins have been demonstrated in other domestic species.

2. Steroid Hormones

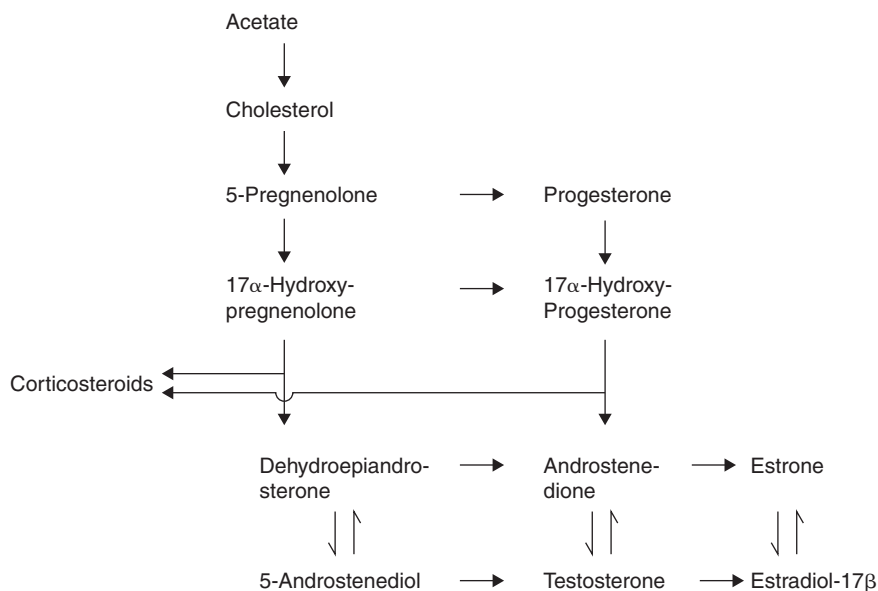
Steroid hormones are derived from a common precursor molecule, cholesterol, via the metabolic pathway schematically outlined in Figure 21-1. More than 1500 biologically active steroids have been isolated from biological material or have been produced synthetically. The molecular weight of steroid hormones is low, usually below 500 (Table 21-1). Examples of steroids that play an important role in reproductive processes are estrogens, androgens, and progestagens, with the main source being the gonads. The structure of the most important sex steroids is presented in Figure 21-2. The most common steroid hormones are usually designated by a trivial name (e.g., estradiol, testosterone, or progesterone). The International Union of Pure and Applied Chemistry (IUPAC; www.iupac.org) has recommended systemic names for steroid hormones. These systemic names describe the chemical and stereoisomeric characteristics of the particular steroid hormone (Table 21-1).

3. Prostaglandins

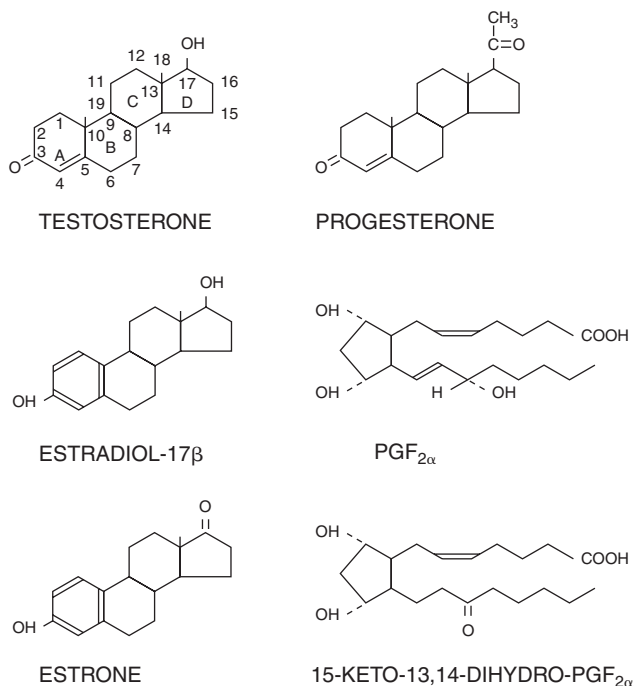
Prostaglandins constitute a group of 20-carbon unsaturated fatty acids with molecular weights usually between 300 and 400 (Table 21-1). Prostaglandins are not hormones

**TABLE 21-1** Nomenclature and Molecular Weights of Some Biologically Important Steroids and Prostaglandins

Trivial Name	Systematic Name	Molecular Weight
Androstenedione	4-Androstene-3, 17-dione	286
17β-Estradiol	1,3,5(10)-Estratriene-3, 17β-diol	272
Estrone	3-Hydroxy-1,3,5(10)-estatrien-17-one	270
17α-Hydroxyprogesterone	17α-Hydroxy-4-pregnene-3,20-dione	331
Pregnenolone	3β-Hydroxy-5-pregnen-20-one	317
Progesterone	4-Pregnene-3,20-dione	315
Testosterone	17β-Hydroxy-4-androsten-3-one	288
PGF <sub>2α</sub>	9α,11α,15-Trihydroxyprosta-5, 13-dienoic acid	354
15-Keto-13, 14-dihydro-PGF <sub>2α</sub>	9α,11α,Dihydroxy-15-ketoprost-5-enoic acid	354



**FIGURE 21-1** Pathway for the synthesis of biologically active steroids from acetate. The steroids secreted from the gonads and the adrenals are formed from acetate and cholesterol.



**FIGURE 21-2** The number of sequence for the carbon atoms of the steroid skeleton and lettering sequence for the four rings are shown for testosterone. The structures of three other important sex steroid hormones, estrone, estradiol-17 $\beta$ , and progesterone, as well as the structure of prostaglandin F $_{2\alpha}$  and its blood plasma metabolite 15-keto-13,14-dihydroprostaglandin F $_{2\alpha}$  are also depicted.

in the strictest sense, and the expressions “paracrine factor” or “local hormones” have been used to describe these substances. This is because prostaglandins are not secreted from any particular gland and the biological half-life of prostaglandins is usually extremely short, allowing, in most cases, only a local action. Several different prostaglandins are found in a number of types of mammalian tissues. One prostaglandin released from the uterus, prostaglandin F $_{2\alpha}$  (PGF $_{2\alpha}$ ), plays an important role in regulating reproductive cycles in domestic species through the control of luteal activity in nonpregnant animals and the initiation of delivery in pregnant animals. The structures of prostaglandin F $_{2\alpha}$  and its main metabolite, 15-keto-13,14-dihydroprostaglandin F $_{2\alpha}$ , are presented in Figure 21-2.

### C. Hormone Receptors

Because steroid hormones are fat soluble, they are able to enter all cells of the body as the lipid cellular boundaries present no barrier. Steroid hormone concentrations in plasma are very low as compared to many compounds including their important precursor, cholesterol. For example, plasma estrogens in nonpregnant domestic animals range from as low as 10pmol/l to as high as 150pmol/l. In this situation, most cells within the body have very low concentrations of estrogen. The specificity of tissue response occurs because cells of tissues that have need of estrogen stimulation should have receptors that enable those particular cells to concentrate the

hormone within the cell and, more important, to elicit particular cellular responses. This explains the important generalization that specific tissue response requires specific receptors to be present within the cell, in this case for a particular steroid hormone.

Binding of a hormone to a receptor in a target cell can be considered to be the primary event and the hormone receptor interaction will cause a measurable biological response that differs for different hormones. Receptors have a limited binding capacity (receptors are saturable thus limiting number of hormone molecules that can enter a target cell), they bind specific hormones (e.g., estrogen receptors are specific for estrogenic compounds), and upon binding a biological response will be created.

Steroid hormones enter cells by passive diffusion and bind to receptors inside the cell. It is assumed that only nonprotein bound or free hormone can enter target cells. Traditionally, the steroid bound irreversibly to the carrier protein have been considered to be virtually biologically inactive and only the minute quantity of free (nonprotein bound) steroid can enter the cell. However, studies suggest that sex steroids bound to the sex hormone-binding globulin can be internalized and as the carrier is degraded by lysosomes, the steroids are released to induce steroid-responsive genes (Hammes *et al.*, 2005). When the steroid interacts with its receptor, a steroid-receptor complex is formed. The hormone-receptor complex is then activated and alters gene expression. The target cell responds by increased RNA synthesis with the transcription of specific mRNAs, which enters cytoplasm and stimulates protein synthesis. The specific effect of steroid hormones on target cells is an altered cell function related to a change in the pattern of protein synthesis. In addition to this classical genomic steroid action, rapid effects (within minutes) of steroid have also been described (see Bramely 2003; Kelly and Wagner, 1999).

Protein hormones like GnRH, LH, and FSH do not enter the target cell to exert their effects but interact with their receptors, which are located on the plasma membranes of the cell, s.c. G protein-coupled receptors. The binding of the hormone to the cell surface receptor activates second messenger(s), for example, cyclic AMP (3',5'-AMP). The second messenger(s) is the intracellular mediator of many actions of LH and FSH in the ovary and the testis. The second messenger(s) is thought to activate another intracellular enzyme, protein kinase, which will influence the transport of cholesterol into the mitochondrion and the conversion of cholesterol to pregnenolone, which is the rate-limiting step in the biosynthetic pathway for the steroids that play a significant role in reproductive processes.

### D. Local Conversion of Steroids in Target Tissues

The effects of steroid hormones on cells can be accentuated or modulated by the conversion of the entering hormone

to another form. For example, many of the tissues that are particularly responsive to androgens have the enzyme  $5\alpha$ -reductase that converts testosterone to  $5\alpha$ -dihydrotestosterone ( $5\alpha$ -DHT);  $5\alpha$ -DHT has a much higher affinity for the androgen receptor within the target cell, which makes  $5\alpha$ -DHT more biologically active than testosterone as to its androgenic effects. The androgenic potency of  $5\alpha$ -DHT is twice that of testosterone.

Another important interconversion of steroid hormones is the one resulting from the increase in circulating cortisol concentrations that occur in the fetal lamb before parturition. The elevated fetal cortisol concentrations stimulate  $17\alpha$ -hydroxylase, C17-C20 lyase activity, and probably aromatase activity in the placenta. This makes it possible for progesterone to be converted to estrogen synthesis in the placenta. Estrogens then affect the synthesis of prostaglandin  $F_{2\alpha}$ , which precipitates delivery. The interconversion of progesterone to estrogen is well documented in the sheep and probably also occurs in a similar way in the goat and the cow.

### E. Synthesis and Clearance of Hormones

The determination of concentrations of hormones in biological fluids including plasma, urine, saliva, milk, and feces has been useful in determining the reproductive status of animals. Although a number of factors can influence hormone concentrations, the overriding factors are synthesis and clearance. We are usually concerned about the rate of synthesis of a hormone from a particular endocrine gland because factors that govern clearance are usually stable, and the concentration of the hormone usually reflects the rate of synthesis or secretion.

The synthesis of steroid hormones of the reproductive system is under the control of gonadotropins, which are released in pulsatile fashion. This has a profound influence on the secretion of testosterone in the male in that changes in pulsatile rate can occur a number of times a day with increases in pulse rate resulting in greatly increased concentrations of testosterone. For example, in males of many domestic species, testosterone values can range from 3.5 to 20 nmol/l within a period of a few hours with the extremes still representing normal production of testosterone by the testes. The usual judgment as to normalcy is based on an animal having at least the minimal or basal concentration. In the female, estrogen and progesterone synthesis by the ovary is also under the control of a pulsatile mode of gonadotropin secretion. The pulse rate usually remains relatively stable over certain periods of time so that fluctuations in concentration of these hormones are not as acute as for androgens.

In the female, synthesis rates for ovarian steroid hormones are obviously related to ovarian function. Progesterone concentrations, relatively stable during the luteal phase of the estrus cycle, decline rapidly over a 24- to 36-h period during luteolysis. Estrogen values continually

increase during the follicular phase of the cycle, declining with the onset of the gonadotropin preovulatory surge as the granulosa is converted from estrogen to progesterone production. Even though secretion rates can change for both progesterone and estrogen, analysis of these hormones usually brings useful information as to luteal or follicular activity, respectively. One other factor must be considered if one wishes to use hormone values (in blood, for example) as an indication for secretory activity of an endocrine organ (i.e., the conversion of steroid hormones by peripheral tissues). For example, in primates, estrone concentrations are derived mainly from the conversion of ovarian estradiol- $17\beta$  and adrenal androstenedione by tissues such as the liver.

Steroids are eliminated via conjugation with glucuronic acid or sulfates to form inactive mono- or diglucosiduronates or sulfates. These conjugates are all water soluble with excretion occurring via urine or bile (feces). The conjugation occurs mainly in the liver, and the conjugates formed lack steroidal activity. Steroids are also rendered inactive by their metabolism to compounds that have greatly reduced biological activity. In this way, steroids are rapidly cleared from the bloodstream. Clearance is defined as the volume of blood that would be totally cleared of a particular steroid per unit time. Clearance can thus be expressed as liters/minute, and the clearance for most steroid hormones is around 1 liter/minute. In most situations, the clearance rate of steroids is relatively constant, so that blood concentrations are a fairly good measure of fluctuations in production rates.

Placental gonadotropic hormones like hCG and eCG are produced in high concentrations and have much longer half-lives than the pituitary gonadotropins and prolactin. The latter have half-lives that are around 10 to 30 min, whereas the corresponding figures for the placental hormones are from 1.5 days for hCG to 6 days for eCG. One exception is equine LH, which shows structural similarities to eCG and also has a much longer half-life (days) than LH from other species. The increased half-lives are due to the fact that the molecules are composed of a larger portion of carbohydrate moiety as compared to FSH and LH of most species.

In the blood circulation, prostaglandins are rapidly metabolized to their respective 15-keto-13,14-dihydro compounds (Fig. 21-2). Primary prostaglandins like  $PGF_{2\alpha}$  have a half-life in the peripheral circulation that is less than 20sec, whereas the 15-keto-13,14-dihydro- $PGF_{2\alpha}$  have a somewhat longer half-life of about 8min; 90% or more of  $PGF_{2\alpha}$  is metabolized by one passage through the lungs. The 15-keto metabolites are biologically inactive, and before being excreted into urine they are degraded into short dicarboxylic acids (Neff *et al.*, 1981).

## II. ASSAY METHODS

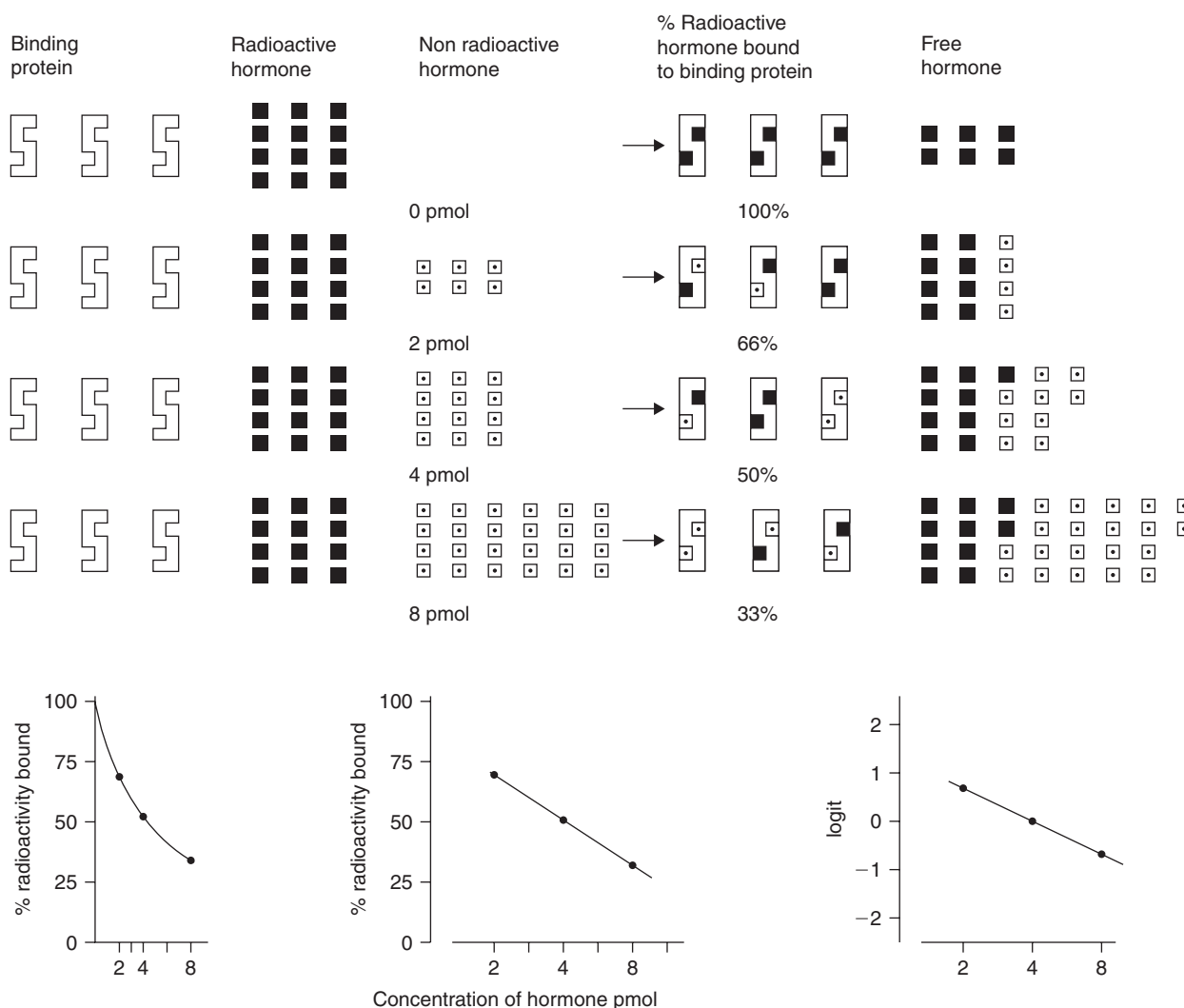
The radioimmunoassay (RIA) technique was originally introduced for the measurement of plasma insulin (Berson and Yalow, 1959) and the enzyme immunoassay (EIA)



techniques for the quantitative determination of immunoglobulin G (Engvall and Perlmann, 1971). The techniques are competitive and utilize the same basic principle, which is based on the ability of nonlabeled hormone to compete with a fixed amount of labeled (radioactive isotope or enzyme) hormone for the binding sites on a fixed amount of protein. The nonlabeled hormone reduces the number of free binding sites on the protein, thus decreasing the availability of the binding sites to the labeled hormone. At equilibrium, the free hormone is separated from the protein-bound hormone, and the reaction is quantified by the determination of the amount of labeled hormone

that is antibody bound or free (Fig. 21-3). The degree of inhibition of binding of the labeled hormone to the binding protein is a function of the concentration of nonlabeled hormone present in the solution. As a basis for the quantification, a standard curve is developed with fixed amounts of labeled hormone and binding protein incubated together in the presence of a known and graded concentration of unlabelled hormone (Fig. 21-3).

Certain disadvantages exist to the use of radioisotopes as labels in immunoassays. Among those are limited shelf life and stability of radiolabel compounds, need for relatively expensive counting equipment (especially for tritium-labeled



**FIGURE 21-3** The principle of an immunoassay technique is based on the ability of the binding protein to bind the labeled hormone. Excess-labeled hormone is added to ensure saturation of the hormone-binding sites on the binding protein. The addition of increasing amounts of nonlabeled hormone (2, 4, and 8 pmol) results in a proportional decrease in the quantity of labeled hormone bound to the binding protein. Separation of labeled hormone bound to the binding protein from free hormone must be achieved before quantification can be done. In the lower part of the figure, this reaction is depicted in three different ways. In the panel on the left and in the middle, the percentage-labeled hormone bound to the binding protein is on the ordinate, and the amount of hormone on a linear scale (left) and log scale (middle) is on the abscissa. In the panel on the right, the logit of the response variable is on the ordinate, and the amount of hormone is plotted on a log scale. The method depicted in the middle and to the right can be used for determination of parallelism. The logit/log transformation (right) is frequently used when computers analyze immunoassay data.

compounds), need for well-trained personnel and specialized laboratory, and problems in disposal of radioactive waste. Consequently, great progress has been made to develop assays that use nonisotopic labels such as enzymes, fluorogens, and chemiluminescent precursors. Enzyme immunoassays can be as sensitive, accurate, and precise as radioimmunoassays; the specificity depends on the quality of the antibody as is true for radioimmunoassay systems (Munro and Stabenfeldt, 1984). Of particular interest in domestic animals has been their use in the determination of progesterone in blood (Lopate and Threlfall, 1991; Meyers *et al.*, 1988; Munro and Stabenfeldt, 1984) and in milk (Allen and Foote, 1988; Arnstadt and Cleere, 1981; Etherington *et al.*, 1991; Sauer *et al.*, 1981). Enzyme immunoassay in the laboratory setting is very efficient, particularly as concerns the time required for the assay reaction (2h or less), ease of separation of bound from free hormone when using microtiter plate system (30sec to wash 96 wells on a microtiter plate), and speed of end point analysis (optical densities can be determined in 1min for a 96 well microtiter plate).

Among the various approaches to enzyme immunoassay, the double antibody sandwich method for determination of larger hormones is frequently used. In this assay system, the plastic wells are coated with antibody. The sample to be processed is then added, and its hormone binds to the antibody-coated plastic well. A second enzyme-labeled antibody directed against another epitope of the hormone is then added. The amount of enzyme-labeled antibody bound is directly proportional to the amount of hormone in the sample. There are two advantages with this methodology: (1) the hormone does not need to be isolated for labeling, and (2) the same general technique can be used to label different antibodies. The method can only be used to assay hormones with at least two binding sites, and it is thus unsuitable for measurement of low-molecular-weight hormones like steroid hormones.

The analytical equipment used for enzyme immunoassay can be used for a variety of determinations including those involved in disease surveillance and drug analysis. This allows for the sharing of one specialized spectrophotometer among several disciplines at a great reduction in cost. Another benefit is that the analytical equipment needs little maintenance. The elimination of the problems engendered by use of radioisotopes is a major advantage for enzyme immunoassay. This and the fact that color change is fundamental to enzyme immunoassay means that the assay can be used visually to determine the presence or absence of a corpus luteum (CL) in domestic and other species. Enzyme immunoassay-based analytical systems for progesterone in blood or milk can be used on the farm beside the animal to directly assess the functional ovarian status of an animal (Herrler *et al.*, 1990; Matsas *et al.*, 1992; Nebel *et al.*, 1989; Romagnolo and Nebel, 1991).

Automatized immunoassay instrumentation has been developed mainly for the human medical market, but some

systems have specific veterinary applications (e.g., chemiluminescent-labeled immunoassays by DPC), and as some hormones (e.g., steroids) cross-react between species, these automatized immunoassay instruments can be useful in a veterinary diagnostic lab with high throughput.

## A. Immunoassay

### 1. Production of Antibodies

Immunoassay techniques utilize antibodies as binding proteins. Hormones such as LH and FSH, which are glycoproteins with molecular weights of around 30,000, are antigenic because of their size and chemical composition. In general, a lower level of purity is required of the polypeptide hormones for antibody production as compared to the hormone used in the labeling procedure.

If an assay for bovine LH utilizes an antibody to bovine LH, radio- or enzyme-labeled bovine LH as tracer, and bovine LH as the standard, the assay system is completely species specific and is said to be of the homologous type. Such a system represents the ideal immunoassay system for measuring a polypeptide hormone. Because of the limited availability or lack of suitable purity of polypeptide hormone preparations, heterologous assay systems have been developed. In these cases, an antiserum to a polypeptide hormone of one species has been used to determine the same polypeptide hormone in another species. The standard hormone used for quantification of the assay should, however, originate from the same species for which the measurements are performed.

Polypeptide hormone antisera are available that show a high degree of cross-reactivity. One such antiserum of special interest in the field of reproductive hormones in domestic species is a polyclonal LH antiserum raised against ovine LH (Niswender *et al.*, 1969). This antiserum reacts specifically with LH from other species and has been used to determine LH in approximately 45 species including the cow, sheep, pig, cat, and dog (Madej and Lindforsberg, 1991; Millar and Aehnelt, 1977). A monoclonal antibody generated against bovine LH has been reported to have high cross-reactivity between species (Bravo *et al.*, 1992; Forsberg *et al.*, 1993b; Matteri *et al.*, 1987).

Steroid hormones and prostaglandins have considerably lower molecular weights and thus are not immunogenic per se. However, these structures can be rendered immunogenic if covalently linked to large carrier molecules such as bovine serum albumin, and specific antibodies can be elicited. For such a hormone-protein conjugate to be immunogenic, approximately 10 to 20 hormone molecules should be present per molecule of protein. In the case of bovine serum albumin, about 30% of the sites available for conjugation should be occupied.

Most naturally occurring steroid hormones and prostaglandins contain hydroxyl or ketone groups, which are used

to prepare derivatives containing active groups such as carboxyl or amino groups. These groups are then activated so that they react with amino or carboxyl groups of the protein molecule. The specificity of the antisera obtained by immunization with a steroid-protein conjugate depends on the site used for conjugating the steroid to the protein. More specific antisera are obtained if the hapten (steroid) is attached to the protein at a site remote from the characteristic functional groups of the hormone (Lindner *et al.*, 1972).

The species most frequently used to produce polyclonal antibodies are sheep and rabbits. One of the most popular and efficient schedules for immunization involves multiple injections in the back and neck of the animal of the antigen emulsified in complete Freund's adjuvant (Vaitakaitis *et al.*, 1971). During immunization, the developing antibody titer is monitored, and a relatively large number of milliliters of serum can be obtained when a suitable titer has been achieved. A few milliliters of a high titer antiserum are usually sufficient for millions of immunoassay determinations. Antisera seem to be stable when stored at  $-20^{\circ}\text{C}$ , although the usual preferred temperature is  $-70^{\circ}\text{C}$ .

The discovery that hybridomas could be used to produce an endless supply of antibodies with certain specificity (Köhler and Milstein, 1975) led to a new development in the technology of antibody production. The procedure involves the fusion of two cell lines: B lymphocytes selected for the production of a specific antibody and myeloma cells that have the capacity for permanent growth. Antibody production occurs by injection of the cell lines into mice; permanency is assured by maintaining a supply of cells in the frozen state. Monoclonal antibodies are useful for the quantitative immunoassay of hormones. They have the advantages of specificity, unlimited supply over time, and the possibility to standardize assay methods between laboratories; disadvantages are that they have lower affinities as compared to polyclonal antibodies and they do not always form precipitates with antigens. Mixing of monoclonal antibodies may increase affinity (Ehrlich *et al.*, 1982).

## 2. Labeled Hormone

In radioimmunoassay techniques for polypeptide hormones, the antigen (hormone) is most commonly used for preparing the radioactive tracer. Usually, radioactive iodine,  $^{125}\text{I}$ , is used for radioiodination of the antigen. The two most frequently used techniques for iodination are the chloramine-T (Hunter and Greenwood, 1962), immobilized chloramine-T (Iodobeads; Markwell, 1982), and the lactoperoxidase procedures (Thorell and Johansson, 1971). Peptide hormones containing tyrosyl or histidyl residues can also be iodinated with these techniques.

Many RIA systems for steroid hormones and prostaglandins utilize tritiated forms of these molecules, which are available commercially. Because tritium has a considerably longer half-life than iodine, tritium tracers can be

used in many cases over several years, whereas the iodinated tracers often have to be prepared monthly. There are, however, certain advantages in using iodinated tracers for steroid hormones and prostaglandins in that simpler and cheaper counting systems can be used (i.e., gamma counting as opposed to liquid scintillation counting). Another advantage of radioiodine over tritium is its higher specific activity, which increases the sensitivity of the assay. Direct incorporation of iodine in the skeleton of steroid hormones results in a loss of the immunoreactivity. Thus, the approach taken for radioiodination of steroid hormones has been to link a tyrosyl or histidyl molecule to the steroid molecule, making direct radioiodination possible (Niswender, 1973), or to iodinate a compound such as tyramine and conjugate the iodinated compound to the steroid molecule (Lindberg and Edqvist, 1974).

Most EIA systems for steroid hormones use horseradish peroxidase, alkaline phosphatase, or  $\beta$ -galactosidase as labels. The enzyme-labeled steroid is produced the same way as has been described for the synthesis of steroid protein conjugates for the production of antibodies.

## 3. Separation of Antibody-Bound and Free Hormone

An essential part of any immunoassay system is an efficient procedure for the separation of antibody-bound and free hormone. Several different approaches have been taken to achieve a rapid and efficient separation. Frequently used separation procedures are based on antibodies coupled to an insoluble polymer, precipitation of antibody-bound hormone, or adsorption of free hormone.

Antibodies coupled to an insoluble polymer can be used for separating antibody-bound and free hormone in RIA procedures (Abraham, 1969). One procedure involves the decanting of polystyrene tubes in which antibodies have been adsorbed to the surface of the tube, which is followed by determination of radioactivity in the antibody-bound (contained in the tube) or free (contained in the eluent) form. In most EIA systems designed for low-molecular-weight hormones, antibody-bound hormone is measured after free hormone has been removed by washing the wells of the microtiter plate that have been previously coated with antibody.

Another common procedure for RIA utilizes antibodies covalently coupled to an insoluble polymer granule. In this case, free and antibody-bound hormones are separated through centrifugation. After removal of the supernatant containing the free hormone, the antibody-bound radioactivity can be determined. Antibody-coated glass beads have been used in both RIA and EIA (Schmidt *et al.*, 1993). Separation is achieved by washing the bead and then the radio or enzyme activity is determined.

Precipitation of the antibody-bound hormone has been achieved through the addition of ammonium sulfate (Mayes

and Nugent, 1970) or polyethylene glycol (Desbuquois and Aurbach, 1971), leaving the free hormone in the solution. The latter precipitation procedure has been found advantageous for the precipitation of prostaglandin antibody complexes (Van Orden and Farley, 1973). Precipitation of the antibody-bound hormone complexes can also be achieved through the addition of a second antibody prepared against the first antibody. Thus, in an RIA technique for bovine LH that utilizes an antiserum to bovine LH raised in a rabbit (first antibody), the second antibody will be an antibody prepared against rabbit gammaglobulin. The addition of the second antibody will result in a precipitate containing the antibody-bound LH, which can be separated from the supernatant by centrifugation. The time required for the separation can be decreased by the addition of polyethylene glycol (Eisenman and Chew, 1983). Systems using a second antibody coupled to insoluble particles are efficient and commonly used (Dericks-Tan and Taubert, 1975; Forsberg *et al.*, 1993b).

For steroid hormones, a traditional separation procedure is the adsorption of free hormone to dextran-coated charcoal. After the addition of the charcoal, the separation of free and antibody-bound steroids is achieved through centrifugation. This method is rapid and efficient in separating free and bound steroid hormones. However, the charcoal can also adsorb some of the antibody-bound steroid, which is called "stripping." To control this, timing of the reaction is important.

#### 4. Reliability Criteria

The reliability of immunoassay analyses depends on its specificity, sensitivity, accuracy, and precision.

##### a. Specificity

The specificity of an immunoassay, or freedom from interference by substances other than the one to be measured, depends on several different factors, the most important being the specificity of the antiserum used. Demonstration of specificity for the immunoassay of hormones that cannot easily be synthesized is relatively difficult and relies on indirect criteria because these molecules have to be isolated and purified from biological material with variable purity.

A relatively common finding is the cross-reaction of TSH with antibodies to LH, and vice versa. Antibody specificity is usually demonstrated by testing the binding of hormones, other than the one intended to be measured, to the antibody. If, for example, bovine TSH significantly inhibits the binding of bovine LH to an antibody to bovine LH, this indicates that the antiserum used is nonspecific or that the TSH preparation contains LH. If the inhibition curves are parallel, the latter explanation is likely because the parallelism indicates the same binding kinetics. It should be noted that parallelism, in itself, is not adequate proof of specificity. As indicated previously, both LH and TSH are composed of two subunits, an  $\alpha$ -subunit that

is identical for the two hormones and a  $\beta$ -subunit that is unique for each hormone. It is possible that an antiserum could contain binding sites, which will react only with the  $\alpha$ -subunit. In such a case, the dose-response curve of LH and TSH utilizing such an antiserum will be parallel, the assay system will not be hormone specific, and thus the system will be invalid for the measurement of LH. Double antibody sandwich methods utilizing monoclonal or polyclonal antisera can partly reduce the problem.

In the case of immunoassay techniques for steroid hormones and prostaglandins, the same proof of specificity has to be undertaken. Here the situation is simpler, because small-molecular-weight hormones can easily be purified and, in most cases, produced synthetically more easily.

Some idea as to the specificity of an antiserum to a steroid hormone can be gained from the position of the steroid molecule that is used as the anchoring point to the protein (Fig. 21-2). If an antiserum to estradiol-17 $\beta$  is produced through the use of an antigen conjugated via the hydroxyl group at carbon 17 of the steroid, the resulting antiserum will react almost equally well with estrone and thus would have relatively poor specificity. This is because the only structural difference between the estradiol-17 $\beta$  and estrone molecules is the configuration at position 17 (Fig. 21-2). In general, steroid antibodies are more specific for the portion of the steroid molecule that protrudes from the carrier protein and less specific for the portion of the steroid used for linkage to the protein. Thus, in the case of estradiol-17 $\beta$ , highly specific antibodies have been developed after immunization with conjugates when carbon 6 of the B ring has been used as the site of attachment to the protein (Exley *et al.*, 1971).

Protein hormone determination by immunoassay is often performed in blood serum or plasma. The influence of serum or plasma on the binding of the tracer to the antibody must be investigated. The assay of different amounts of serum or plasma should result in curves parallel to those obtained with protein hormone standard. In some steroid hormone immunoassays, an organic solvent from a blood plasma sample extracts the hormone. Organic solvents can also be used as a means to selectively remove steroids from biological fluids. For example, many immunoassay procedures designed to measure progesterone utilize antisera developed against a progesterone-11 protein conjugate, which results in a minor cross-reaction with corticosteroids (Thorneycroft and Stone, 1972). By using a nonpolar solvent such as petroleum ether for the extraction of progesterone from serum or plasma samples, about 80% to 90% of progesterone is extracted leaving the more polar corticosteroids in the plasma (Johansson, 1969). The use of such a selective extraction system increases the overall assay specificity. Direct analytical systems for steroid hormones omitting the extraction step are also employed. Because steroid hormones in a blood sample to be analyzed are bound to carrier proteins, direct assay systems have to secure that all steroid molecules, both free and protein-bound

steroids in the sample, are given equal opportunities to interact with the antibody used in the assay. The synthetic steroid danazol ( $17\alpha,2,4$ -pregnandien-20-yno(2,3-d)isoxazol-17ol) can be used to displace progesterone from the binding proteins (Carrière and Lee, 1994).

Certain immunoassay systems may require purification of the plasma extract to achieve an acceptable specificity.

The main problem in the immunoassay of primary prostaglandins is that they can continue to be formed in large amounts by platelets after the blood sample has been obtained (Samuelsson *et al.*, 1975), thus the concentrations of  $\text{PGF}_{2\alpha}$  reported in blood serum or plasma can appear much higher than the actual values. The primary prostaglandins have a very short half-life in the circulation (Hamberg and Samuelsson, 1971) and are rapidly converted to their corresponding 15-keto-13,14-dihydro derivatives. The latter have considerably longer half-lives and occur in higher concentrations than the parent compounds (Beguin *et al.*, 1972). Analysis of metabolites of prostaglandin  $\text{F}_{2\alpha}$  avoids the problem of the overestimation observed for the parent compound in that the metabolites are formed only within the body and values thus remain stable once a blood sample has been obtained. Radioimmunoassay systems utilizing antibodies to  $9\alpha,11\alpha$ -dihydroxy-15-ketoprost-5-enoic acid and  $5\alpha,7\alpha$ -dihydroxy-11-ketotetranorprosta-1,16-dioic acid have been developed (Granström and Samuelsson, 1972). Most problems involved in the determination of the primary prostaglandins are avoided if their main metabolites, the 15-keto-13,14-dihydro compounds, are measured.

#### b. Sensitivity

The sensitivity of immunoassays is defined as the smallest quantity of hormone that the assay can reliably distinguish from a zero amount of the hormone. Usually two kinds of sensitivity are evaluated. The sensitivity of the standard curve is defined as the smallest amount of hormone that is significantly different from zero at the 95% confidence limit. However, the most meaningful sensitivity to establish is the smallest amount of hormone that can be measured per unit of biological fluid (e.g., per milliliter of blood plasma).

#### c. Accuracy

The accuracy of an assay is defined as the extent to which the measurement of a hormone agrees with the exact amount of the hormone. Accuracy is often determined by comparing immunoassay data with values determined by other procedures such as gravimetry, gas liquid chromatography, and mass spectrometry. For steroid hormones and prostaglandins, accuracy is also often determined by recovery experiments in which different amounts of hormones are added to a biological fluid (e.g., blood plasma), which contains low concentrations of the hormone; the amount of hormone measured in the assay is then compared with the amount of hormone added.

#### d. Precision

Two types of precision are usually evaluated. The within-assay precision is determined from duplicate measurements of the same sample within the same assay. The between-assay precision is determined from replicate analyses of the same sample in different assays. Usually the between-assay variance is greater than the within-assay variance. Assay variance should be checked continuously with each assay of a certain hormone by use of plasma pools containing set amounts of the hormone. Usually three different plasma sets containing low, medium, and high hormone concentrations are used. Within- and between-assay variations in immunoassay procedures are usually greater than for ordinary routine procedures used in clinical chemistry.

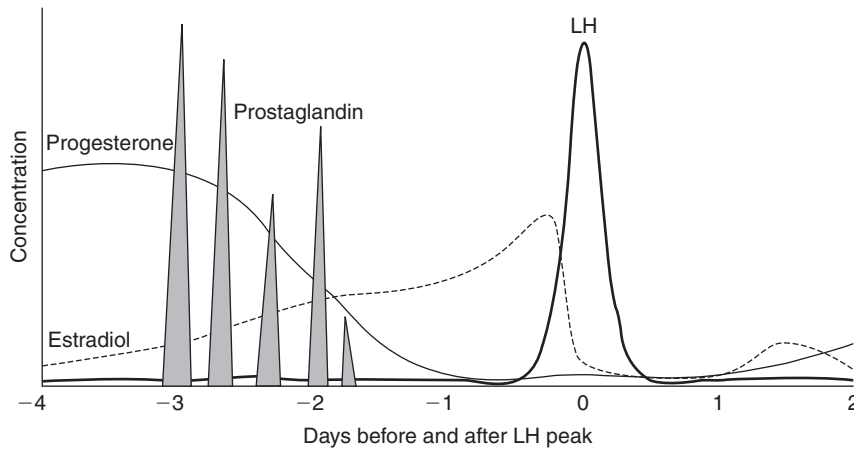
### III. PHYSIOLOGY OF REPRODUCTIVE HORMONES IN THE FEMALE

This presentation is relatively brief as to its coverage of endocrinological events during the reproductive cycle. Readers interested in a more complete presentation of hormonal events involved in reproduction are referred to texts dealing specifically with the subject. Also, some hormones with some influence on reproductive processes, such as those of the thyroid, adrenal, and pineal glands, are not covered in this presentation.

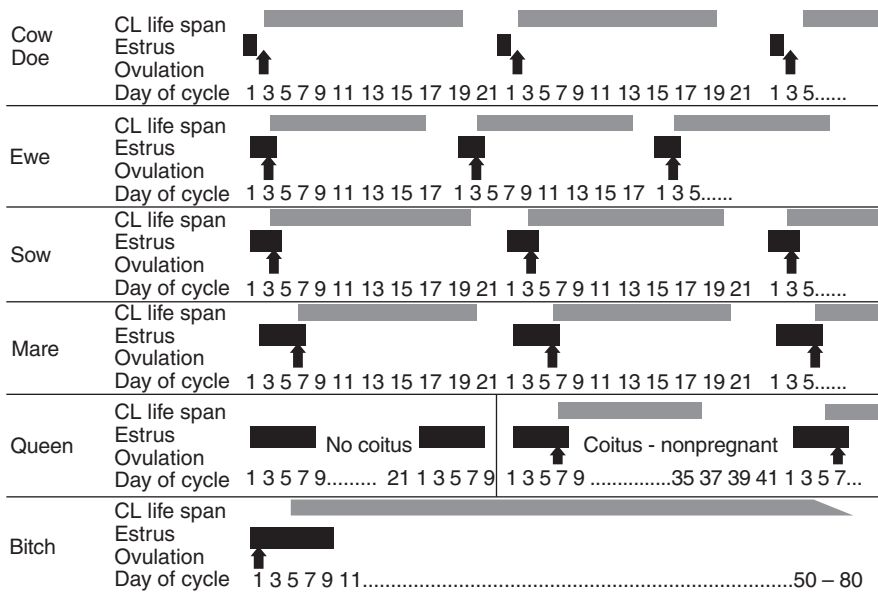
#### A. Estrus Cycle

The major endocrine events that precede ovulation have been well documented in the cow (Chenault *et al.*, 1975), ewe (Nett *et al.*, 1974), sow (Shearer *et al.*, 1972), mare (Evans and Irvine, 1975; Palmer and Jousset, 1975; Stabenfeldt *et al.*, 1975), dog (Concannon *et al.*, 1975), and cat (Shille *et al.*, 1979b). In large domestic animals (cattle, horse, pig, sheep, and goat), follicle growth occurs during the luteal phase in spite of the inhibitory nature of progesterone, the main secretory product of the CL. Although follicles are usually not ovulated during the luteal phase in most species, the mare occasionally ovulates during the luteal phase.

With regression of the CL, follicles grow rapidly before ovulation because of gonadotropin stimulation. The follicles secrete increasing amounts of estrogen during development, which is important for the onset of sexual receptivity as well as for the initiation of the surge release of gonadotropins that is essential for the ovulatory process (Fig. 21-4). Estrogens initiate the surge of LH and FSH through the release of GnRH (Moenter *et al.*, 1990). In most species, the preovulatory surge of gonadotropins begins approximately 24h before ovulation and is usually of short duration, (e.g., 8 to 10h in the cow). The mare is an exception in that large amounts of LH are released during an 8- to 9-day period with ovulation occurring on the third day (Geschwind *et al.*, 1975). Another important



**FIGURE 21-4** Schematic presentation of the preovulatory events in general applicable to the cow, doe, ewe, and sow. These endocrine events also occur in the mare, but in this species, the release of LH occurs over a considerably longer time period.



**FIGURE 21-5** Comparative data on the duration of estrus, time of ovulation, and duration of corpus luteum function in the cow, ewe, sow, mare, queen, and bitch. Modified from Stabenfeldt (1974).

function of GnRH is to elicit sexual receptivity. Thus, the onset of the preovulatory LH surge and sexual receptivity is coordinated via GnRH synthesis and release.

Following ovulation, a CL is formed under the influence of pituitary gonadotropins. In most species, LH is the major luteotropin, though prolactin is thought to play a role in sheep and in rodents. If pregnancy does not ensue, the CL regresses, which permits the estrus cycle to be repeated. This well-timed sequence occurs repetitively at set intervals if not interrupted by pregnancy.

A summary of estrus cycle activity in common domestic animal species is given in Figure 21-5. Most of the domestic species have evolved from seasonally breeding ancestors. In mammals, photoperiod, via the circadian melatonin profile, synchronizes endogenous circannual rhythms (Lincoln *et al.*, 2003). The mare, ewe, doe, and queen undergo cyclic ovarian activity only during the breeding season in response to seasonal changes in photoperiod. In contrast, cattle, pigs, and dogs can reproduce the entire year, although vestiges of seasonality have been demonstrated (e.g., Andersson *et al.*, 1998).

Estrus cycle length is approximately 21 days in the cow, doe, mare, and sow and 17 days in the ewe. The bitch has a much longer estrus cycle, the luteal phase often being between 50 to 80 days in duration. The interval between cyclic ovarian activities in the bitch is extended even further by the occurrence of a 4- to 5-month anestrus period following regression of the CL. The cat is an induced ovulator requiring coital stimulation for ovulation and thus for CL formation. In the absence of coitus, follicles develop every 15 to 20 days, with follicular growth and regression occupying 5 to 7 days of each period. An ovulatory, non-fertile mating results in the formation of CL that persists for approximately 35 days and a syndrome termed pseudo-pregnancy in the cat.

### B. Control of the Corpus Luteum

The regression of the CL (luteolysis) is a key event that is responsible for the well-timed estrus cyclicity seen in most domestic species. The importance of the uterus in the control of the life span of the CL has been documented

through hysterectomy (Stabenfeldt *et al.*, 1974b). Removal of the uterus from these species during the luteal phase prolongs luteal activity. It is well established that the uterus in these species synthesizes and releases  $\text{PGF}_{2\alpha}$ , which causes the CL to regress (McCracken *et al.*, 1972).

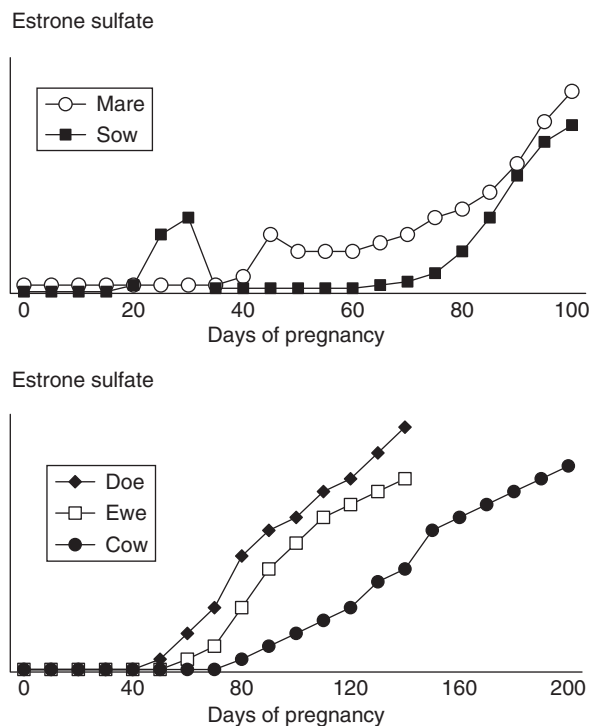
The temporal release patterns of  $\text{PGF}_{2\alpha}$  (Fig. 21-4), usually in a pulsatile mode lasting a few hours, have been described in the ewe (Barcikowski *et al.*, 1974; Harrison *et al.*, 1972), sow (Gleeson *et al.*, 1974), doe (Fredriksson *et al.*, 1984), and cow (Nancarrow *et al.*, 1973). Some of the problems involved in determining  $\text{PGF}_{2\alpha}$  (e.g., a short half-life and formation by platelets at collection) can be avoided if the main blood plasma metabolite, 15-keto-13,14-dihydro- $\text{PGF}_{2\alpha}$ , is determined. Data are available on the patterns of the metabolite during luteolysis in the cow (Kindahl *et al.*, 1976), ewe (Peterson *et al.*, 1976), mare (Neely *et al.*, 1979), doe (Fredriksson *et al.*, 1984), and sow (Shille *et al.*, 1979a).

Regression of CL is usually accomplished within 48h following the onset of the prostaglandin release. It is likely that estrogens, presumably of ovarian follicle origin, initiate  $\text{PGF}_{2\alpha}$  release. Estrogen also initiates the formation of endometrial oxytocin receptors (McCracken *et al.*, 1984), which in sheep are important for pulsatile synthesis and release of  $\text{PGF}_{2\alpha}$  in that oxytocin can initiate the release of  $\text{PGF}_{2\alpha}$  (Sharma and Fitzpatrick, 1974). In ruminants, the CL is able to synthesize oxytocin and oxytocin release from the CL in response to  $\text{PGF}_{2\alpha}$ , which, in turn, initiates the synthesis and release of  $\text{PGF}_{2\alpha}$  by the uterus; this is the basis for the pulsatile secretion of  $\text{PGF}_{2\alpha}$  (for a review, see Flint *et al.* [1992], and Whates and Denning-Kendall [1992]). In the dog and cat,  $\text{PGF}_{2\alpha}$  does not appear to be involved in luteolysis, although its precise role is still uncertain.

### C. Early Pregnancy

Modification of  $\text{PGF}_{2\alpha}$  release is essential for the establishment of pregnancy in the species (cow, ewe, mare, and sow) in which this compound serves as the luteolysin (Kindahl *et al.*, 1976; Nett *et al.*, 1976; Shille *et al.*, 1979a). The rapid elongation of fetal membranes, which precedes the critical time of the initiation of luteal regression by about 3 days in the nonpregnant animal, appears to be important for modifying prostaglandin release. Fredriksson *et al.* (1984) in goats and Zarco *et al.* (1988) in sheep have shown that the main change in  $\text{PGF}_{2\alpha}$  synthesis and release, nonpregnant versus pregnant animal, involves a continuous mode of secretion, not pulsatile. In fact,  $\text{PGF}_{2\alpha}$  concentrations increase at the onset of pregnancy, but the release is continuous, which prolongs luteal activity.

Maternal recognition of pregnancy in the cow, ewe, doe, and sow involves mechanisms that alter the prostaglandin release to protect the CL from luteolysis. In the cow, ewe, and doe, embryonic interferon tau ( $\text{IFN-}\tau$ ), which is secreted between days 10 and 21 to 24 of pregnancy



**FIGURE 21-6** Blood levels of conjugated estrogens (mainly estrone sulfate) during early pregnancy in the mare, sow, doe, ewe, and cow. Data derived from Kindahl *et al.* (1982) (mare); Robertson and King (1974) (sow); Chaplin and Holdsworth (1982) (doe); Tsang (1978) (ewe); and Gaiani *et al.* (1982) (cow).

by trophoblast cells of the blastocysts (Roberts *et al.*, 1990), inhibits uterine  $\text{PGF}_{2\alpha}$  pulses (Spencer *et al.*, 1999; Thatcher *et al.*, 2001).  $\text{IFN-}\tau$  is secreted into the uterine lumen and inhibits the expression of estrogen and oxytocin receptors, thus blocking the episodic uterine  $\text{PGF}_{2\alpha}$  secretion and luteolysis (for a review, see Spencer *et al.* [2004]). In the sow, the maternal recognition of pregnancy is controlled by conceptus-derived estrogens (Geisert *et al.*, 1982; Perry *et al.*, 1976) (Fig. 21-6).

Modification of the release pattern of  $\text{PGF}_{2\alpha}$  (pulsatile to continuous) by the luteotropic products from the conceptus and uterus is probably the most important factor that allows luteal activity to continue. The net result is that luteal activity is extended in the cow, ewe, mare, and sow beginning at about 14 days following ovulation. Modification of  $\text{PGF}_{2\alpha}$  release appears not to be important for the establishment of pregnancy in the dog and cat.

### D. Pregnancy and Parturition

The presence of a CL is necessary for the maintenance of pregnancy in a vast majority of cows (Estergreen *et al.*, 1967). The pig also requires luteal support throughout gestation (see Bazer *et al.*, 1979). In the ewe, the presence of CL is required for the first 50 to 60 days of gestation

(Linzell and Heap, 1968). After this time period, the fetoplacental unit secretes significant amounts of progesterone. The dog requires the presence of CL for all of gestation. Sokolowski (1971) found that ovariectomy even as late as day 56 postbreeding resulted in premature delivery.

The necessity of secondary CL, which are formed in the mare between days 40 and 60 of gestation, has been discussed over the years. The secondary CL are the result of eCG secretion by the endometrial cups, which are formed from a circular band of cells of placental origin (chorionic girdle cells) that invade the endometrium and form isolated endocrine organs of temporary function (Allen, 1969). Although secondary CL are not essential for the maintenance of pregnancy in the mare in that the primary CL continues to function for up to 150 days, they do add extra progestational support for the pregnancy during the time placental production of progesterone is being established. Progesterone support of pregnancy in the mare begins to be taken over by the placenta as early as day 50 of gestation but is not complete for all mares until approximately 100 days or later, a time that coincides with the beginning demise of both primary and secondary CL (Holtan *et al.*, 1979).

It has been demonstrated that eCG has a close immunological relationship with equine LH (Farmer and Papkoff, 1979); further, incubation studies of CL have shown a luteotropic effect of eCG (Squires *et al.*, 1979). If fetal loss occurs after the formation of endometrial cups, continuing eCG production supports luteal activity, even to the point of making lysis of these CL difficult in conjunction with the pharmacological administration of prostaglandin  $F_{2\alpha}$ .

The endocrine activity of the fetoplacental unit can be monitored through the measurement of conjugated estrogens, especially estrone sulfate in peripheral blood plasma or urine (Fig. 21-6). In the pregnant sow, concentrations of estrone sulfate become detectable at day 17 of pregnancy, increase until about day 28, then decline to low or undetectable values and then increase again beginning around day 75 to 80 of pregnancy and remain high until parturition (Robertson and King, 1974). In the mare, estrone sulfate values begin to increase around day 35 to 40 of pregnancy with accentuated production at 80 to 90 days and with highest values obtained from day 150 to parturition (Kindahl *et al.*, 1982; Terqui and Palmer, 1979). In the ewe (Tsang, 1978), estrone sulfate levels can be detected from around day 70 to 80 after conception and in the goat concentrations start to increase around day 50 of pregnancy (Chaplin and Holdsworth, 1982). In the pregnant cow, estrone sulfate concentrations in milk start to increase between days 100 to 120 (Hatzidakis *et al.*, 1993; Henderson *et al.*, 1994). In all species, high values of estrone sulfate in the peripheral blood, milk, or urine are strong evidence for the presence of a viable fetus.

The mare produces two estrogens during pregnancy that are unique to equids, equilin, and equilenin, both of which have unsaturated B rings. Pashen and Allen (1979)

have shown through fetal gonadectomy in the horse the importance of fetal gonads in the production of estrogen in cooperation with the placenta. Little evidence of estrogen production during pregnancy has been reported for the dog (Hadley, 1975). Estrogen production by the fetoplacental unit in the cat also appears to be minimal during gestation (Verhage *et al.*, 1976).

An important endocrine change, which occurs before parturition in the cow, ewe, and sow, involves an increase in the synthesis and release of unconjugated estrogens by the fetoplacental unit. This increased estrogen synthesis is reflected in elevated plasma estrone concentrations in the pregnant cow beginning between 30 and 20 days prepartum (Edqvist *et al.*, 1973), in the ewe about 2 days before parturition (Challis *et al.*, 1971), and in the pig about 1 week before delivery (Robertson and King, 1974). In the cow (Edqvist *et al.*, 1973; Stabenfeldt *et al.*, 1970) and bitch (Smith and McDonald, 1974), parturition is preceded by an abrupt fall in progesterone concentrations between 48 and 24h before delivery. In the ewe (Stabenfeldt *et al.*, 1972), mare (Noden *et al.*, 1978), and sow (Baldwin and Stabenfeldt, 1975), partial withdrawal of progesterone occurs before delivery. In the cow (Edqvist *et al.*, 1978; Fairclough *et al.*, 1975), ewe (Liggins *et al.*, 1972), and bitch (Concannon *et al.*, 1988), it has been demonstrated that prostaglandin release initiates regression of the CL and thus is responsible for the withdrawal of progesterone.

High estrogen and prostaglandin concentrations combined with low progesterone concentrations increase the contractile state of the uterus. Prostaglandins may also initiate cellular changes within the cervix, in addition to the effect of relaxin, which result in cervical softening and dilation. Cervical stimulation, the result of the initial entry of the fetus into the pelvic canal, causes the reflex release of oxytocin from the posterior pituitary. This increases the intensity of uterine contractions and thus aids the final delivery process.

#### IV. CLINICAL ASPECTS OF REPRODUCTIVE ENDOCRINOLOGY

Important differences exist between humans and animals as concerns endocrine analysis. For example, steroid hormone concentrations are much lower (10-fold less as concerns estrogens) in animals, which produces a requirement for more rigorous assay systems for animals. In animals, the most useful information comes from assessing gonadal or fetoplacental activity (versus pituitary activity) and thus emphasizes the determination of steroid hormones. Besides the fact that gonadotropin values are less useful for the assessment of clinical situations, variations in amino acid composition among species as concern specific hormones mean that multiple systems have to be developed to determine the content of one protein hormone



across species lines. Antibodies such as the one developed for LH by Professor Gordon Niswender (Niswender *et al.*, 1969), which are able to detect LH in many species, are the exception.

For hormone analyses to be useful as a diagnostic tool, certain criteria have to be fulfilled. The concentration of the hormone at the sampling site (usually a peripheral vein) should closely correlate with the amount of the hormone being released from the endocrine gland. It is preferable that the release pattern of the hormone be steady, which allows valid information to be obtained on the secretory status of the endocrine gland from one sample. Several reproductive hormones do not fulfill the latter criteria, and thus their determination is not useful from a routine diagnostic view. For example, the duration of the LH surge observed in conjunction with ovulation is short in most domestic species except the horse. In the cow, the preovulatory LH peak has a duration of 8 to 10h, requiring samples to be obtained every 4h in order to detect the peak. In the mare, the duration of the peak is considerably longer, 8 to 9 days, which allows a less frequent sampling interval (Geschwind *et al.*, 1975). However, the long duration of LH peak in the mare prevents the determination from being useful in predicting ovulation.

One reproductive hormone, progesterone, has been found to be of significant clinical value in females of most domestic species and, in fact, overall its analysis gives the most useful information as to the reproductive status of animals. Other hormones with established or potential clinical use will be discussed further for each species. As a percentage of total number of clinical assays, the highest number has been utilized as pregnancy diagnostic tests. It is worth keeping in mind that the analysis of hormones as a diagnostic aid in solving clinical problems only supplements, but does not replace, the information gained by a careful clinical examination.

Although blood has been the usual medium for hormone analysis, milk, urine, saliva, and even feces are also sources for gaining useful endocrine information. The latter tissues have the advantage in certain situations of being easier to collect and, at the very least, they allow one to avoid the use of venipuncture. It has been shown that the determination of estrogens conjugates in urine is much more effective in revealing ovarian follicle production of estrogens as compared to the analysis of either free or conjugated estrogen in plasma.

## A. Cattle

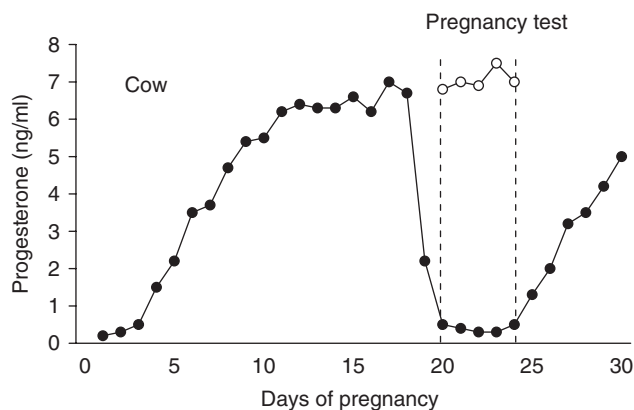
### 1. Progesterone

Several reports are available on progesterone concentrations in blood during early pregnancy in cattle (Pope *et al.*, 1969). A finding of importance is that progesterone can be measured in the milk of lactating cows and, further, that

its concentration accurately reflects the concurrent blood plasma concentration of progesterone (Laing and Heap, 1971).

The difference that exists in both blood plasma and milk progesterone concentrations 19 to 24 days after a fertile breeding as compared to a nonfertile breeding has been used as an early pregnancy test (Robertson and Sarda, 1971; Shemesh *et al.*, 1968) (Fig. 21-7). The plasma progesterone concentration in blood of pregnant cows at 21 days postbreeding is almost always at least 2ng/ml (6nmol/liter) and usually 4 to 8ng/ml (13 to 26nmol/liter), as compared to less than 0.5ng/ml (1.6nmol/liter) in the nonpregnant animal at the same time. Elevated progesterone concentrations, however, only reflect the presence of luteal tissue and do not directly indicate the presence of a fetus *in utero*. Furthermore, a slight prolongation of luteal activity in a nonpregnant animal can occur, which results in elevated progesterone concentrations at day 21, a situation in which the analytical progesterone result would be positive and the animal would be falsely considered pregnant. The accuracy of the forecast for pregnancy (positive forecast) thus is often lower than desirable, in most cases ranging between 75% and 90%. The negative forecast, however, is more accurate because cows having low progesterone concentrations in milk or blood 21 days postbreeding will almost always not be pregnant. The accuracy of the positive forecast increases if progesterone analyses are also carried out on samples obtained at the time of insemination in order to eliminate animals inseminated during the luteal phase of the estrus cycle. Cows inseminated during the luteal phase will be in the luteal phase 21 days later with the animal being falsely considered pregnant.

It should be recognized that the main focus of early pregnancy diagnosis is for the more efficient management of breeding. In most cases involving early pregnancy



**FIGURE 21-7** Time after breeding for utilizing progesterone analysis as a means of pregnancy diagnosis. Progesterone content in nonpregnant (●) cows compared with progesterone content of pregnant animals (○) (Stabenfeldt *et al.*, 1969b).

diagnosis, pregnancy status needs to be verified again at about 40 days postbreeding. In spite of the limitations of progesterone analysis as concerns pregnancy diagnosis, this is the most common clinical use of any of the reproductive hormones. Progesterone analysis can also be used for the retrospective confirmation of the absence (or presence) of a CL at the time of insemination in cattle. Because inadequate detection of estrus is the most common cause of low fertility in herds utilizing artificial insemination, the determination of progesterone concentrations at the time of insemination can be a useful tool when herds with fertility problems are encountered. The use of progesterone determinations in milk obtained at the time of insemination in cows with questionable heat signs and inconclusive genital tract findings can serve as a valuable tool for educating the staff responsible for insemination (Garcia and Edqvist, 1990).

A potential important area for the diagnostic use of progesterone analysis concerns the elucidation of clinical syndromes in the postpartum period in which cows fail to show sexual receptivity for extended periods of time. Animals that have reestablished ovarian activity can often be distinguished from those that have ovarian inactivity; elevated progesterone values indicate that significant ovarian activity is present. Cows that have luteal activity can be manipulated through PGF<sub>2α</sub> treatment with a reasonable expectation of response as concerns the initiation of a new cycle. Progesterone determinations could also be used to verify the presence of luteal tissue in conjunction with endometritis/pyometra (Pepper and Dobson, 1987) and ovarian cysts (Booth, 1988; Sprecher *et al.*, 1990). Both conditions should respond to prostaglandin therapy. As concerns ovarian cysts in cattle, differentiation of luteal versus follicular cysts is usually not done because it is technically difficult by palpation *per rectum* and because the same gonadotropin treatment can be used in both situations; luteinization of the structure with a luteotropin is followed in 10 to 14 days with prostaglandin treatment. In both cases though, the use of progesterone analysis would be useful in establishing the therapeutic response.

## 2. Estrone Sulfate

High concentrations of estrone sulfate are found in blood beginning at about day 80 of pregnancy and in milk from about day 100 (Fig. 21-6). In a study measuring estrone sulfate concentrations in milk samples as an indicator for pregnancy status, an overall accuracy rate of 95% in milk samples collected at 120 days or later was found (Henderson *et al.*, 1994). When comparing peripheral blood concentrations of estrone sulfate between three breeds of cattle, it was found that the breed giving birth to the lightest calves had lower estrone sulfate concentrations in the interval 101 to 200 days of gestation (Abdo *et al.*, 1991). Estrone sulfate measurements cannot be used to predict time of calving (Shah *et al.*, 2006).

## 3. Other Substances

Proteins of placental origin, bovine pregnancy-specific protein B (bPSBP), and bovine pregnancy-associated glyco-protein 1 (bPAG-1) have been observed in the blood of pregnant cows beginning between days 16 and 21 of gestation (Sasser and Ruder, 1987). The existence of proteins that are present only if an embryo is present opens the way for an early and definitive pregnancy diagnosis in cattle by blood analysis. Humblot *et al.* (1988) compared diagnosis of pregnancy in Frisian cattle by determination of progesterone and bPSBP in blood. The study revealed the accuracy (number positive and pregnant/number of positive diagnoses) of the positive forecast to be 67% (82/122) for progesterone on day 24 after insemination. The accuracy of the negative forecast for progesterone was 98% (52/53). The accuracy of the positive forecast for bPSPB increased with gestation age from 86% (50/58) on day 24 to 99% (83/84) on day 70. The accuracy of the negative diagnoses by bPSPB increased from 72% (84/117) on day 24 to 100% (83/83) on days 30 to 35. The authors concluded measurement of bPSPB 30 days after insemination to be an efficient test both for the positive and the negative pregnancy diagnoses. A cardinal principle of pregnancy detection is that the test should be effective by the time the estrus cycle would end if the animal was not pregnant. This reemphasizes the main point of early pregnancy detection (i.e., it is done so the animal can be rebred if not pregnant). The test fulfilling this criterion has yet to be found.

A comparison of ultrasonography with bPSBP and bPAG-1 RIA assays showed no difference in accuracy diagnosis of pregnant cows compared to calving results. However, the accuracy of detection of nonpregnant cows by the bPSBP and bPAG-1 measurements was limited by the relatively long half-life of these proteins after calving and early embryonic death (Szenci *et al.*, 1998). On-farm tests to detect bPAG-1 (early conception factor) have been developed to be used within 48 h of conception. Although the test appears to function well, it also has been criticized for not being reliable for determine nonpregnancy in cattle (Cordoba *et al.*, 2001).

## B. Sheep

### 1. Progesterone

Progesterone analysis as an early test for pregnancy has been used in sheep (Robertson and Sarda, 1971). In the ewe, the progesterone analysis has to be carried out on blood samples, as most breeds of sheep are not lactating at the time of breeding. Maximal luteal phase progesterone concentrations in the ewe are approximately 2 to 4 ng/ml (6 to 13 nmol/liter), whereas the concentrations at estrus range from 0.15 to 0.25 ng/ml (0.5 to 0.8 nmol/liter) (Stabenfeldt *et al.*, 1969c). Using an amplified enzyme

immunoassay technique for plasma progesterone an accuracy of 100% to diagnose pregnancy in samples taken between days 15 to 16 from a flock of 130 ewes (107 diagnosed pregnant and 24 diagnosed nonpregnant) was reported (McPhee and Tiberghen, 1987).

A relatively marked increase in progesterone values from 2 to 4 ng/ml (6 to 13 nmol/liter) to 12 to 20 ng/ml (38 to 64 nmol/liter) occurs between days 60 and 125 of pregnancy (Stabenfeldt *et al.*, 1972). This increase is due to increased progesterone production from the fetoplacental unit. The contribution of the CL to progesterone concentrations remains constant throughout pregnancy, thus the relatively large difference in progesterone concentrations between nonpregnant ewes with a CL present and ewes with fetus(es) present could be used to minimize the relatively high false-positive forecasts observed for sheep at 17 days postbreeding. The limitations are the same for the use of progesterone analysis as a pregnancy test in sheep as discussed for cattle.

## 2. Estrone Sulfate

In the pregnant ewe estrone sulfate produced from the fetoplacental unit is detected in elevated concentrations beginning at around day 70 after conception (Tsang, 1978) (Fig. 21-6). Worsfold *et al.* (1986) determined estrone sulfate concentrations in blood from ewes bred 85 days previously and found the accuracy of the nonpregnant versus pregnant interpretations was 44% and 88%, respectively. A considerable overlap in estrone sulfate values between ewes with single and multiple fetuses was found and even at day 116 of pregnancy, estrone sulfate concentrations overlapped between groups of ewes with single and multiple fetuses. Because of this the authors conclude that estrone sulfate concentrations could not be used as a predictive tool for litter size (Fletcher and Worsfold, 1988).

## 3. Other Substances

Circulating pregnancy-associated glycoprotein 1 (ovPAG-1) has been reported in sheep. A heat labile protein with a molecular weight of around 8000 was found in sera of sheep as early as day 6 of gestation (Cerini *et al.*, 1976). It has been demonstrated that the bovine pregnancy-specific protein B (bPSPB) assay can be used for early detection of pregnancy also in the ewe, as pregnant ewes have a blood antigen that cross-reacts with antibodies to bPSPB (ovPSPB, Ruder *et al.*, 1988). In a study comparing the accuracy of detecting pregnancy with an ultrasonic device, a real-time scanning instrument and a RIA for bPSPB in ewes, it was concluded that the RIA for bPSPB detected pregnancy earlier and more accurately than the ultrasonic device and equally accurate as the real-time scanning instrument (Ruder *et al.*, 1988).

Ovine placental lactogen (oPL) has been demonstrated in the peripheral blood of pregnant ewes (Kelly *et al.*,

1974). Increase in maternal oPL concentrations occurs between 40 and 50 days of pregnancy, reaches maximum concentrations between days 120 and 140, and declines as parturition approaches (Chan *et al.*, 1978). The determination of oPL concentrations might be used as a basis for a specific pregnancy test in the ewe.

## C. Pig

### 1. Progesterone

Luteal phase progesterone concentrations in the pig are considerably higher than in cattle and sheep, namely, 20 to 50 ng/ml (64 to 159 nmol/liter), whereas concentrations at estrus are below 0.5 ng/ml (<1.6 nmol/liter) (Stabenfeldt *et al.*, 1969a). The difference in progesterone values between nonpregnant and pregnant animals 19 to 24 days after service has been used as an early pregnancy test (Robertson and Sarda, 1971). In the pig, progesterone determination is usually performed on blood. Because of the sensitivity of the assay systems and the concentration of progesterone in blood in pigs during the luteal phase, analyses can be performed on a small volume of blood (about 10 drops), allowing the sample to be obtained through a small incision in an ear vein. The limitations associated with using progesterone determinations as a pregnancy test in the pig are similar to those previously discussed for cattle. Progesterone analyses can be used to determine ovarian activity in clinically anestrous gilts as well as to establish the stage of the estrus cycle in gilts and subsequent response to treatment. It is also possible to monitor luteal phase activity in the sow through measurement of fecal gestagens (Hultén *et al.*, 1995; Moriyoshi *et al.*, 1997).

### 2. Estrone Sulfate

Previous studies of estrogen concentrations in urine revealed a marked increase in estrogen between day 20 and 30 of pregnancy in pigs (Velle, 1958). Studies of blood concentrations of estrone sulfate in pigs during pregnancy showed patterns similar to those determined in urine (Robertson and King, 1974) (Fig. 21-6). In early pregnancy in the pig, it has been hypothesized that estrogen synthesized by the early preimplantation embryo may be the messenger for the maternal recognition of pregnancy (Perry *et al.*, 1976) and that the elevated estrone sulfate concentrations in the maternal circulation during early pregnancy reflect fetal synthesis. The determination of estrone sulfate in early pregnancy in the pig is thus a specific pregnancy test (Cunningham *et al.*, 1983). The index of discrimination between estrone sulfate concentrations in blood of pregnant versus nonpregnant pigs around 25 days after breeding is very high as concerns pregnancy diagnosis. Sugiyama *et al.* (1986) reported an accuracy rate of 98% in pigs between

days 20 and 26 of pregnancy. Horne *et al.* (1983) found litter size on days 20 to 26 of pregnancy to be positively correlated with estrone sulfate values but such a relationship was not found later in pregnancy. During the latter part of pregnancy, the maternal blood concentrations of estrogens (estrone sulfate, estrone, and estradiol-17 $\beta$ ) are very high and can thus be used to confirm pregnancy at this stage of gestation (Fig. 21-6).

In the pregnant sow, the concentration of estrogen in urine and feces follows the same pattern as in blood (Choi *et al.*, 1987). Szenci *et al.* (1993) compared ultrasonography and the determination of unconjugated estrogen in feces, 25 to 30 days after insemination, for the diagnosis of pregnancy in pigs. Based on farrowing data the positive and negative predictive values for the ultrasound were 93% and 100%, respectively. For the determination of unconjugated estrogens, the corresponding predictive values were 94% and 55%, respectively.

## D. Horse

### 1. Equine Chorionic Gonadotropin

Although pregnancy diagnosis has been done in mares through the measurement of equine chorionic gonadotropin (eCG) formerly named pregnant mare serum gonadotropin (PMSG), the main drawback to its use is that the presence of eCG does not guarantee the presence of a fetus but indicates that a viable fetus was present at the time of endometrial cups formation. This is because endometrial cups have autonomy of function and continue to secrete PMSG for a period of time in spite of loss of the fetus (Allen, 1969). This means that both mares with normal pregnancies and mares that experience embryonic mortality after day 40 of gestation will have elevated eCG concentrations in blood. The use of eCG determinations as a positive pregnancy diagnosis test will consequently yield some mares to have been diagnosed pregnant but not delivering a foal (Fig. 21-8; Jeffcott *et al.*, 1987; Mitchell, 1971). Complementation with estrone-sulfate measurements after 100 days of pregnancy can compensate for this shortcoming.

### 2. Progesterone

Progesterone analysis is useful for establishing the presence or absence of ovarian activity in animals with puzzling behavioral patterns. Agitated or aggressive behavior, often interpreted as sexual in orientation, occurs without regard to luteal status. Progesterone analysis can be helpful because elevated values directly indicate the presence of a CL and, additionally, are evidence that folliculogenesis and ovulation are normal. Relatively low luteal phase values for progesterone (1 to 3 ng/ml; 3 to 10 nmol/liter) versus normal luteal phase values (>3 ng/ml; >10 nmol/liter) are often associated with the presence of a persistent CL

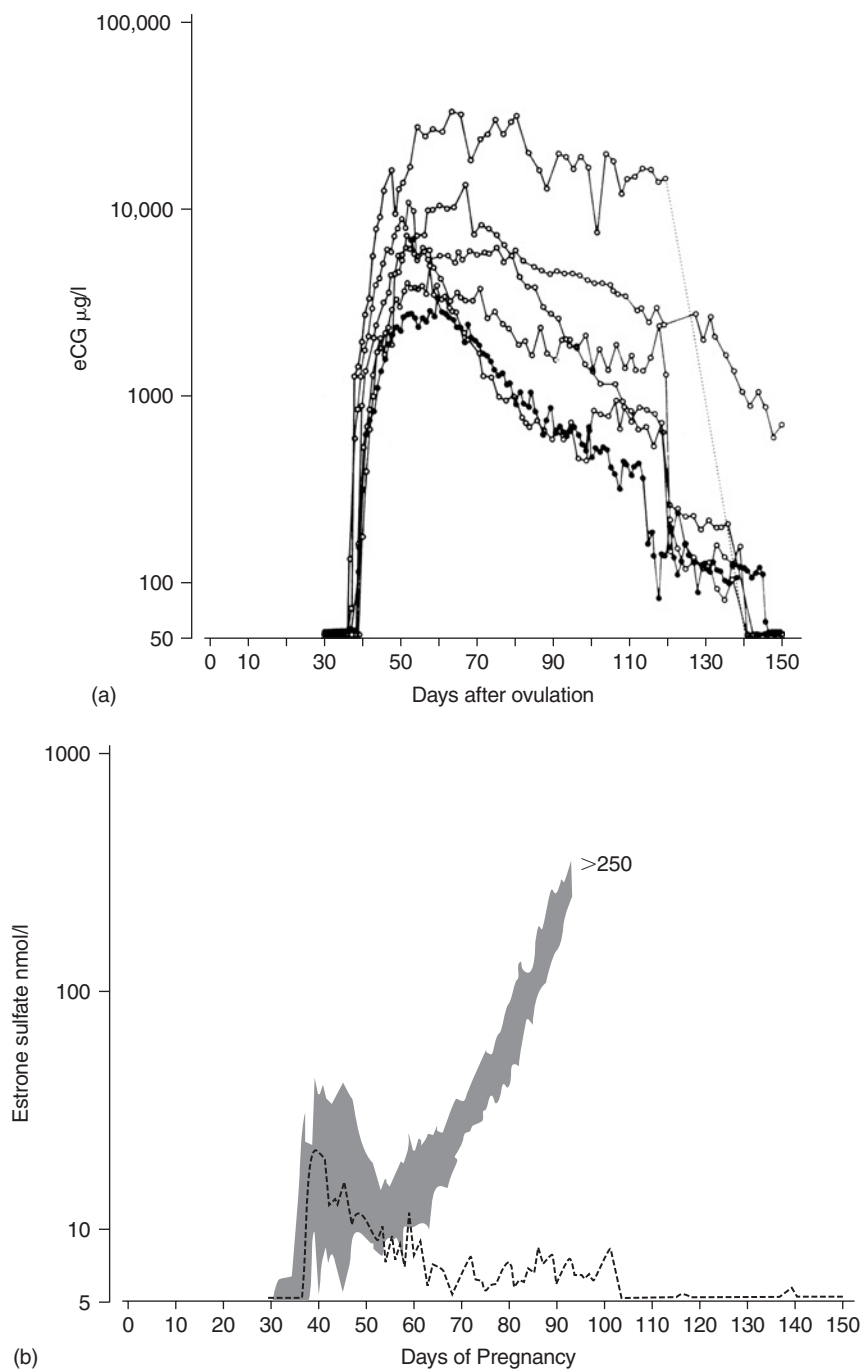
(Stabenfeldt *et al.*, 1974a). Progesterone values of mares with persistent luteal activity are low because some PGF<sub>2 $\alpha$</sub>  synthesis and release often occurs about 14 days postovulation, albeit insufficient to cause complete luteolysis (Neely *et al.*, 1979).

Progesterone analyses can also be useful in mares that fail to manifest sexual receptivity yet have cyclic ovarian activity. Progesterone analysis at 5-day intervals over 20 days (approximately one estrus cycle length) can verify the presence or absence of cyclic ovarian activity. The time of ovulation can also be predicted within a 2- to 3-day interval, a prediction that can be helpful to the veterinary practitioner anticipating the next time of ovulation. Breeding may have to occur by artificial means in these situations. Hinrichs *et al.* (1988) compared the accuracy of determining day of ovulation  $\pm 1$  day using three different methods: (1) an immediate, qualitative ELISA for progesterone in blood; (2) a quantitative ELISA for progesterone in blood; and (3) daily teasing to detect estrus. Ovulation was detected by ultrasound examination per rectum. The accuracy in determining day of ovulation  $\pm 1$  day using the three methods was 72% for the qualitative progesterone assay, 88% for the quantitative progesterone assay, and 86% for teasing.

### 3. Conjugated Estrogens

Estrone in its unconjugated form (free estrogen) reflects important physiological events in the mare beginning at about day 75 of gestation when the fetoplacental unit begins to produce estrone in rapidly increasing amounts (Nett *et al.*, 1975). More important, it has been shown that estrone is rapidly conjugated after secretion to water-soluble estrogen conjugates and the ratio between free and conjugated forms is 1:100 (Terqui and Palmer, 1979). Terqui and Palmer (1979) and Kindahl *et al.* (1982) have both shown that significant increases in estrone conjugate concentrations occur between days 35 and 40 of gestation (Fig. 21-8). Kindahl *et al.* showed the increase to be 10- to 20-fold between days 35 and 40. Concentrations then decline slightly with a further increase noted at the same time that free estrone concentrations begin to increase. The initial source of increased estrone production during gestation days 20 and 70 is the ovaries (Daels *et al.*, 1990); later on its occurrence is likely driven by the attachment of the embryo and the production of eCG (PMSG). A study in miniature mares showed that the determination of estrone sulfate concentrations in blood after day 100 of pregnancy is a reliable method for determining pregnancy status, as well as eliminating "false-positive" diagnosis by eCG measurements between day 40 to 100 (Henderson *et al.*, 1998).

Also estrone conjugate concentrations in urine can be used to document pregnancy in the mare and, in fact, may be more accurate than plasma analysis because of the concentrating aspects associated with urine formation (Daels *et al.*, 1991). Increased amounts of fecal estrogens and



**FIGURE 21-8** (a) Blood plasma concentrations of eCG in five normal pregnant mares ( $\circ$ ) and in one mare in which the fetus died around day 50 of pregnancy ( $\bullet$ ). (b) Geometric means of blood plasma concentrations of estrone sulfate in the five normal mares (shaded area) and the estrone sulfate concentration in the mare in which the fetus died around day 50 and was aborted on day 113 of pregnancy (Darenius *et al.*, 1988).

gestagens have also been reported in the pregnant mare (Schwarzenberger *et al.*, 1991), and fecal estrone sulfate may be a noninvasive alternative from day 150 (Henderson *et al.*, 1998).

In addition to being a means of confirmation of pregnancy, estrone conjugate analysis also allows the soundness of the pregnancy to be assessed because estrogen concentrations reflect the dynamics of a growing fetus.

Thus, it is possible not only to indicate that pregnancy is in progress by estrone conjugate analysis but also to indicate whether the pregnancy is proceeding well or that it is in some state of compromise. Analysis of estrone conjugates is an important aid for the verification of pregnancy in the mare and does not suffer the drawback with false-positive diagnosis as is the case for eCG (Fig. 21-8). Estrone conjugate analysis also has been used to assess follicle growth

patterns in nonpregnant mares, an approach that was difficult to do with the determination of free estradiol-17 $\beta$  (Daels *et al.*, 1991; Makawiti *et al.*, 1983).

#### 4. Other Pregnancy-Associated Substances

A test (a lateral flow assay using antibodies with colloid gold as the indicator) for equine early conception factor (a pregnancy-associated immunosuppressive protein) is suggested to be a quick, easy, and noninvasive method for detecting nonpregnant mares. However, a controlled study shows that a large proportion (60%) of animals give a positive test result even before breeding (Horteloup *et al.*, 2005).

#### 5. Testosterone

Testosterone values vary in the mare according to the reproductive state. Values, usually less than 15 pg/ml (>52 pmol/liter) during anestrus, range between 20 and 40 pg/ml (69 to 139 pmol/liter) during cyclic ovarian activity with the higher values being observed during the follicular phase of the cycle immediately before ovulation. Testosterone determinations have been used to aid the diagnosis of granulosa-theca cell tumors in the mare (Stabenfeldt *et al.*, 1979) and to differentiate granulosa-theca cell tumors from ovarian teratoma (Panciera *et al.*, 1991). Leydig-like cells in the theca appear to be the source of testosterone. In cases of granulosa-theca cell tumors, testosterone values vary with values ranging from 40 pg (139 pmol/liter). Values over 100 pg/ml (347 pmol/liter) are considered diagnostic of granulosa-theca cell tumors in mares. These tumors are generally slow in development, and it is not known whether this slow development also reflects a slowly developing capacity for testosterone production or whether there is variability as to the number of testosterone secreting cells among tumors. Aggressive stallion-like behavior is associated with high values of testosterone (Stabenfeldt *et al.*, 1979). Inhibin is usually elevated in granulosa-theca cell tumors in mares and thus suppresses pituitary FSH release (Bailey *et al.*, 2002).

Testosterone determinations in the male horse have been used as an aid in the diagnosis of cryptorchidism. Cox (1975) reported that horses with <40 pg/ml (<139 pmol/liter) plasma should be considered castrated, whereas animals with concentrations >100 pg/ml (>347 pmol/liter) should be considered as having testicular tissue present. Although some cryptorchid animals have testosterone concentrations <100 pg/ml (<347 pmol/liter), most have values ranging from 200 to 1000 pg/ml (693 to 3467 pmol/liter) (Cox, 1975). Testosterone concentrations in intact males usually range from 1000 to 2000 pg/ml (3467 to 6934 pmol/liter) (Berndtson *et al.*, 1974; Cox *et al.*, 1973). HCG administration for the purpose of stimulating testosterone production by the testes has been suggested as a means of resolving cases in which values are between 40 and 100 pg/ml (139 to 347 pmol/liter). Dosages of injected hCG have been 6000 to

12,000 IU. (Cox *et al.*, 1986; Silberzahn *et al.*, 1989) and the second sample for analysis of testosterone obtained after 30 to 120 min (Cox *et al.*, 1986) or after 3 days (Silberzahn *et al.*, 1989). The responses to hCG may be lower in horses less than 18 months of age and during the nonbreeding season (winter).

It has been suggested that the analysis for estrone sulfate conjugates for the diagnosis of cryptorchidism is preferred over testosterone on the basis that it requires only one analysis and that the accuracy is slightly improved (Cox *et al.*, 1986). It should be noted, however, that estrone sulfate analysis for cryptorchidism cannot be used in horses less than 3 years of age or in donkeys because little estrone sulfate is produced in either of these situations. Androstenedione is the precursor hormone of androgens and estrogens and can also be used for the diagnosis of cryptorchidism (Illera *et al.*, 2003).

Castration and thus withdrawal of androgens causes increased levels of gonadotropins, which thus can be measured as a complement to testosterone.

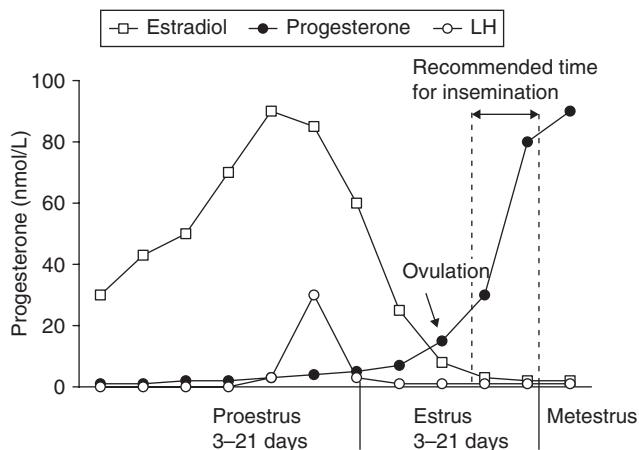
The presence of sexual behavior in suspected cases of cryptorchidism is not necessarily dependent on elevated testosterone concentrations in that many patients (about one-third) referred because of behavioral problems are, in fact, castrated. In essence, some animals can maintain normal libido with low circulating concentrations of testosterone. In this situation, testosterone analysis is helpful from the point of view of either eliminating unnecessary surgery or indicating to the surgeon that testicular tissue is present and should be found on surgical entry.

### E. Dog

#### 1. Progesterone

In the bitch, there is little difference between the progesterone pattern of the pregnant and nonpregnant luteal phase. Plasma concentrations of progesterone are elevated throughout the luteal phase. However, although mean concentrations of progesterone are higher during the latter part of the pregnant luteal phase compared with the nonpregnant luteal phase, these differences are not significant to allow progesterone determinations to be used as a pregnancy diagnosis test.

Bitches usually ovulate at the onset of sexual receptivity, remain sexually receptive for about the first week of luteal activity, and, in fact, are fertile during this period of time (Holst and Phemister, 1974). Progesterone analysis can be used to confirm the occurrence of ovulation with concentrations usually increasing slightly above baseline in the periovulatory period reaching about 15 nmol/liter at ovulation followed by a sustained increase beginning 24 h following ovulation (Fig. 21-9) (Concannon *et al.*, 1975). This approach may be used in a retrospective analysis of a breeding cycle in an attempt to correlate the time of ovulation with other criteria such as vaginal cytological changes. The determination of



**FIGURE 21-9** Schematic representation of the temporal relationship among estradiol, progesterone, peak of luteinizing hormone (LH), and ovulation in the bitch. The recommended time of mating or artificial insemination is based on the progesterone concentration.

progesterone in daily samples of blood obtained during the perioovulatory period gives a more precise timing of ovulation than can be obtained by vaginal cytology.

In situations wherein a particular pairing of animals does not result in a mutual sexual attraction and where artificial insemination must be used, progesterone analysis is a useful tool to verify ovulation. Artificial insemination with frozen-thawed semen usually results in lower pregnancy rates than artificial inseminations using fresh semen. Using progesterone determinations to pinpoint ovulation it was found that the pregnancy rate following insemination with frozen-thawed semen could be improved when the insemination was performed at progesterone concentrations  $>30$  nmol/liter (Fig. 21-9) (Linde-Forsberg and Forsberg, 1989, 1993).

Progesterone analysis can also be useful in cases of short estrus cycle intervals to determine if ovulatory failure has occurred, a situation in which progesterone concentrations are low following the termination of estrus.

Analysis of progesterone (alone or in combination with estrogen) is also useful in cases when there is some question as to the completeness of removal of ovarian tissue during an ovariohysterectomy (ovarian remnant syndrome). Stimulation by hCG/eCG or GnRH can improve the possibility of finding any remnant ovarian tissue. An important distinction as concerns the dog is that, unlike other domestic species, the bitch is keyed into sexual receptivity at the end of the follicular phase by progesterone. Dogs may be sexually attractive because of odors arising from the vagina because of factors such as infection, but bitches will only accept males in the presence of increased progesterone concentrations, a situation that is almost always associated with luteal tissue as part of a remaining ovarian remnant.

## 2. Testosterone

The most common endocrine test in male dogs is testosterone for the purpose of checking the secretory status of the Leydig cells. Testosterone values in normal dogs range from about 1 ng/ml (3.5 nmol/liter) to about 10 ng/ml (35 nmol/liter) because of the pulsatile release pattern of testosterone. Testosterone concentrations in castrated dogs are less than 0.5 nmol/liter.

Assays of basal testosterone concentration may allow the diagnosis of the absence of testicular tissue in the same manner as described previously for the male horse. Sometimes the positive confirmation of presence of testicular tissue may require the use of hCG or GnRH to stimulate testosterone production. In this situation, a resting blood plasma sample is collected immediately before the administration of the stimulating hormone, and a second blood sample is collected an hour later. A significant increase in plasma testosterone concentration is diagnostic of testicular tissue.

Testosterone analysis is done in conjunction with fertility examinations, often in stud animals that are presented as infertility cases following a prolonged show tour. Most of these animals have testosterone concentrations that are compatible with normal spermatogenesis, although sperm counts are often very low. The management of this syndrome is still uncertain.

Feminizing syndromes in intact male dogs have been observed, in which concentrations of testosterone are greatly decreased below normal (to 100 pg/ml or less;  $<350$  pmol/liter) and estradiol values are two to three times normal (30 to 45 pg/ml versus the normal 15 pg/ml; 110 to 165 pmol/liter and 55 pmol/liter). It is thought that a majority of these cases involve Sertoli cell tumors. Dogs with confirmed Sertoli cell tumors have high peripheral blood plasma levels of inhibin and suppressed levels of LH and testosterone (Grootenhuus *et al.*, 1990). These authors were, however, unable to detect differences in blood concentrations of estradiol between dogs with Sertoli cell tumors and control dogs.

## 3. Relaxin

Relaxin in the pregnant dog is first detected at day 18 to 25 of gestation but is undetectable during anestrus, throughout nonpregnant ovarian cycles, and in male dogs (Steinetz *et al.*, 1987, 1996). Maximal concentrations are attained by days 40 to 50 of pregnancy and are followed by slight declines before parturition. Relaxin is produced predominantly by syncytiotrophoblasts in the placenta (Klonisch *et al.*, 1999) but also by the ovary, and it is the closest thing to a pregnancy-specific canine hormone (Tsutsui and Stewart, 1991). Commercial available assays for canine relaxin can be used to diagnose pregnancy as early as 21 days after breeding, although negative results should be rechecked after a week. However, relaxin cannot be used to estimate litter size and remains elevated after pregnancy loss.



## F. Cat

### 1. Progesterone

Progesterone analysis can be used to verify the occurrence of ovulation in the cat following coitus. Ovulation usually occurs 24 to 36h after coital contact with a male at the appropriate time of the follicular phase of the estrus cycle (Shille *et al.*, 1983). If the breeding schedule is very limited in time, it is possible for a cat to be bred too early in the follicular phase with coitus failing to elicit LH release. Or more rarely, females may allow copulation at times other than the follicular phase. In both these situations, ovulatory failure would be documented by the finding of low progesterone values 10 days postbreeding. In one study, progesterone concentration  $>1.87$  ng/ml;  $>6$  nmol/liter was consistently associated with luteal-phase ovaries, and values  $<0.15$  ng/ml;  $<0.5$  nmol/liter were associated with follicular phase ovaries (Lawler *et al.*, 1991).

### 2. Estrogen

As the cat is an induced ovulator (requires coitus), estradiol analysis can be used to assess the presence of ovarian follicle activity with values ranging from 10 pg/ml (37 pmol/liter) in the interfollicular phase to 60 pg/ml (220 pmol/liter) during folliculogenesis. As indicated previously, queens have ovarian follicle growth patterns that last 5 to 7 days followed by a slightly longer interval before the next growth phase (Shille *et al.*, 1979b). Estrogen analysis could document the presence or absence of ovarian follicular activity in animals that fail to manifest sexual activity. It also could be used to assess the completeness of an ovariectomy in cats that are spayed but who present signs suggestive of sexual receptivity. The usual finding is that of low estrogen concentrations, which indicates the behavior is not sexual in orientation.

In the domestic cat, estrogen metabolites are primarily excreted in the feces (Möstl *et al.*, 1993; Shille *et al.*, 1990). Analysis of fecal steroids is a useful noninvasive approach of monitoring ovarian function in exotic Felidae (Graham *et al.*, 1993).

### 3. Testosterone

Testosterone analyses can be used to evaluate Leydig cell function in the testis of the male cat. The range of values is usually between 1 and 10 ng/ml (3.5 to 35 nmol/liter).

### 4. Relaxin

Relaxin is produced by the fetoplacental unit beginning about day 20 of gestation; maximal concentrations are achieved by day 30 to 35 (Addiego *et al.*, 1987). Relaxin concentrations thus can be used to assess pregnancy status in the cat and even to assess its normalcy based on the fact that fetoplacental units in jeopardy produce less relaxin.

## V. GENERAL COMMENTS

### A. Hormone Concentrations

The foregoing presentation did not emphasize hormone concentrations. This is because there is still some variability as to the values reported by various laboratories. It is important that clinical endocrinology laboratories understand and have experience with their assay systems in relation to particular clinical syndromes. For example, the actual concentration of progesterone during the follicular phase of the estrus cycle of domestic animals is approximately 100 pg/ml (318 pmol/liter), certainly no greater than 200 pg/ml (636 pmol/liter) plasma. Some laboratories, however, report basal values of 1 to 2 ng/ml (3.2 to 6.4 nmol/liter) for progesterone. The reference values developed by laboratories depend on the type of assay used.

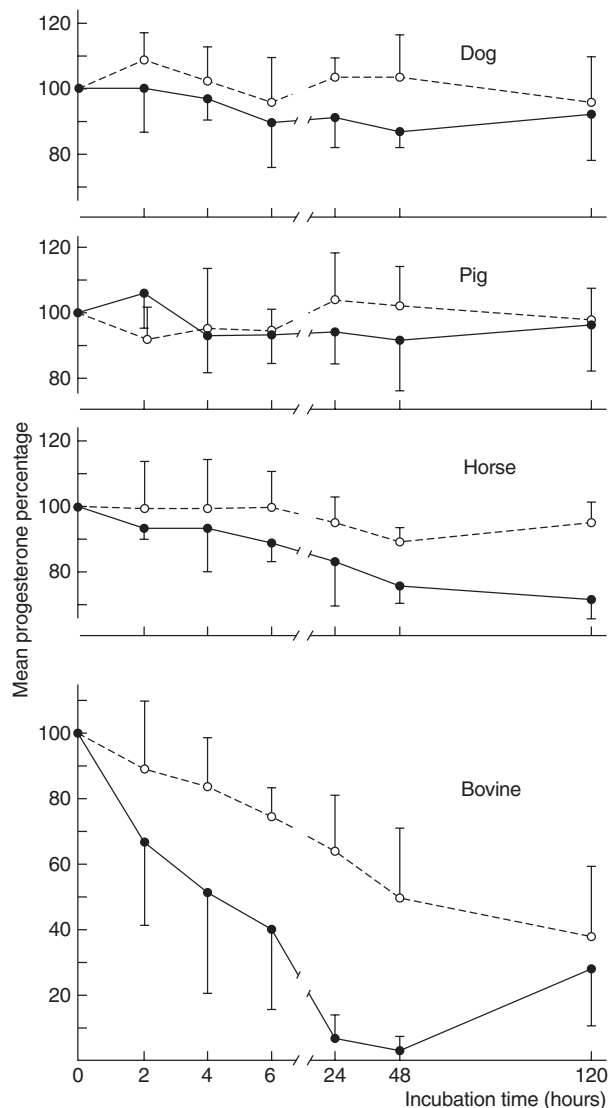
It is possible to have a wide range of values for a particular hormone and still have normal physiological conditions. Luteal phase progesterone concentrations in the cow, for example, range between 2 and 12 ng/ml (6 to 38 nmol/liter) because of pulsatile gonadotropin secretion (Walters *et al.*, 1984) with no adverse effect on the preparation of the animal for the nurture of a potential embryo. Hormone values can also depend on the type of material used in the assay. Luteal phase progesterone values are approximately 4 ng/ml (13 nmol/liter) in fat-free milk, between 5 and 35 ng/ml (16 to 111 nmol/liter) in whole milk, and approximately 250 ng/ml (795 nmol/liter) in milk fat.

### B. Analysis and Storage Effects

#### 1. Blood

The treatment and storage of samples before analysis can influence the hormone value obtained for a blood sample. It has been known that red blood cells from cow have the capacity to metabolize progesterone to other steroids (Short, 1958; Fig. 21-10). The rapid decrease, about 10% to 20% reduction/hour, in the progesterone content in heparinized bovine blood samples appears to be due to the conversion of progesterone to 20 $\beta$ -hydroxylated gestagens. Also other 20-keto-gestagens like pregnenolone and 17 $\alpha$ -hydroxyprogesterone undergo a similar conversion to 20 $\beta$ -hydroxylated gestagens and reduce their blood concentration during storage (Choi *et al.*, 1989). The drop in progesterone concentration in heparinized whole blood follows glycolysis, and when glucose concentrations are low the enzymatic degradation of progesterone in heparinized cow blood is to some degree reversed (Oltner and Edqvist, 1982; Fig. 21-10). The use of anticoagulants blocking or preventing glycolysis like sodium fluoride much reduces the rate of decline in whole blood progesterone concentrations (Pulido *et al.*, 1991; Vahdat *et al.*, 1979). Temperature also plays a significant role in regulating the rate of decline





**FIGURE 21-10** Mean (and SD) plasma progesterone percentage after storage of heparinized whole blood from four dogs, four pigs, four horses, and eight cows at 20°C (●) and at 4°C (○). The initial progesterone value at time 0 has arbitrarily been set as 100% (Oltner and Edqvist, 1982).

in progesterone, the lower the temperature of storage, the slower is the rate of progesterone decline (Fig. 21-10).

The enzymes responsible for the progesterone conversion are present in the red blood cells; harvesting serum or plasma as soon as possible after the collection of the sample prevents the metabolism of progesterone (Vahdat *et al.*, 1979). If this cannot be done within half an hour, the sample should be put on ice to retard the enzymatic processes.

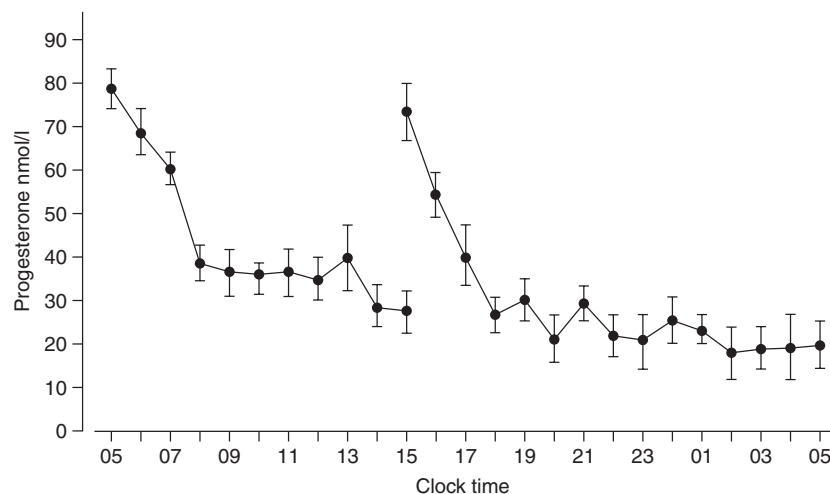
A decline in progesterone concentrations also occurs in stored whole blood from the ewe (Van der Molen and Groen, 1968; Wiseman *et al.*, 1983), although the decline is not as rapid and pronounced as in the cow. In the female goat, on the other hand, no significant decrease in whole blood progesterone was found during storage at room temperature for 24 h (Navarro *et al.*, 1990). Some decline in progesterone also seems to occur during storage of equine whole blood (Fig. 21-10). For other domestic animals dealt with here, no major effects of storage on progesterone concentrations have been reported.

Storage of bovine whole blood also results in significant decreases of 17-keto-androgens (e.g., androstenedione, dehydroepiandrosterone) and 17-keto-estrogens (e.g., estrone) because 17 $\alpha$ -hydroxysteroid dehydrogenase present in red blood cells converts the steroids to epitestosterone and estradiol-17 $\alpha$ , respectively (Choi *et al.*, 1989). Concentrations of testosterone and estradiol-17 $\beta$  are not influenced when storing whole bovine blood over 24 h at 20°C (Choi *et al.*, 1989).

Plasma or serum samples can be stored frozen for long periods of time without a significant loss in reproductive hormone concentration. Sample handling procedures from blood collection to the freezing of serum or plasma should be standardized for each species and hormone determined.

## 2. Milk

Milk samples for progesterone analysis can be preserved with sodium azide, potassium dichromate, or thimerosal



**FIGURE 21-11** Hourly changes in whole-milk concentrations of progesterone due to the variation in fat content during 24 h, mean and SE of 12 cows (Garcia and Edqvist, 1990).

for storage at room temperature for about 3 weeks and for several months if the milk is stored at 4 to 5°C (Nachreiner *et al.*, 1992). There is a difference in progesterone content among fore milk, composite milk, and strippings because of the variation in milk fat content (Fig. 21-11) (Garcia and Edqvist, 1990). This difference is less obvious when using skim milk for the immunoassay of progesterone, but the temperature must be controlled at centrifugation because warm butterfat will absorb progesterone more readily than cold butterfat (Nachreiner *et al.*, 1992). A common recommendation for sampling of milk for analyses of progesterone is to obtain strippings after milking.

## REFERENCES

- Abdo, G. A., Njuguna, O. M., Fredriksson, G., and Madej, A. (1991). Levels of oestrone sulphate during pregnancy in different breeds of cows and its possible association with retained foetal membranes. *Acta Vet. Scand.* **32**, 183–188.
- Abraham, G. E. (1969). Solid-phase immunoassay of estradiol-17 beta. *J. Clin. Endocrinol. Metab.* **29**, 866–870.
- Addiego, L. A., Tsutsui, T., Sewart, D. R., and Stabenfeldt, G. H. (1987). Determination of the source of immunoreactive relaxin in the cat. *Biol. Reprod.* **34**, 1165–1169.
- Allen, S. E., and Foote, R. H. (1988). An enzyme-linked immunoassay of milk progesterone as a diagnostic aid in embryo transfer programs. *Theriogenology* **29**, 893.
- Allen, W. R. (1969). The immunological measurement of pregnant mare serum gonadotrophin. *J. Endocrinol.* **43**, 593–598.
- Andersson, H., Wallgren, M., Rydhmer, L., Lundstrom, K., Andersson, K., and Forsberg, M. (1998). Photoperiodic effects on pubertal maturation of spermatogenesis, pituitary responsiveness to exogenous GnRH, and expression of boar taint in crossbred boars. *Anim. Reprod. Sci.* **54**, 121–137.
- Arnstadt, K. I., and Cleere, W. F. (1981). Enzyme-immunoassay for determination of progesterone in milk from cows. *J. Reprod. Fert.* **62**, 173–180.
- Bailey, M. T., Troedsson, M. H. T., and Wheatson, J. E. (2002). Inhibin concentrations in mares with granulosa cell tumors. *Theriogenology* **57**, 1885–1895.
- Baldwin, D. M., and Stabenfeldt, G. H. (1975). Endocrine changes in the pig during late pregnancy, parturition and lactation. *Biol. Reprod.* **12**, 508–515.
- Barcikowski, B., Carlson, J. C., Wilson, L., and McCracken, J. A. (1974). The effect of endogenous and exogenous estradiol-17beta on the release of prostaglandin F<sub>2</sub>alpha from the ovine uterus. *Endocrinology* **95**, 1340–1349.
- Bazer, F. W., Roberts, R. M., and Thatcher, W. W. (1979). Actions of hormones on the uterus and effect on conceptus development. *J. Anim. Sci.* **49**, 35–45.
- Beguín, F., Bygdeman, M., Green, K., Samuelsson, B., Topozada, M., and Wiquist, N. (1972). Analysis of prostaglandin F<sub>2</sub> and metabolites in blood during constant intravenous infusion of prostaglandin F<sub>2</sub> in the human female. *Acta Physiol. Scand.* **86**, 430–432.
- Berndtson, W. E., Pickett, B. W., and Nett, T. M. (1974). Reproductive physiology of the stallion. IV. Seasonal changes in the testosterone concentration of peripheral plasma. *J. Reprod. Fert.* **39**, 115–118.
- Berson, S. A., and Yalow, R. S. (1959). Assay of plasma insulin in human subjects by immunological methods. *Nature* **184**, 1648–1649.
- Booth, J. M. (1988). The milk progesterone test as an aid to the diagnosis of cystic ovaries in dairy cows. *Vet. Rec.* **123**, 437–439.
- Bramley, T. (2003). Non-genomic progesterone receptors in the mammalian ovary: some unresolved issues. *Reproduction* **125**, 3–15.
- Bravo, P. W., Stabenfeldt, G. H., Fowler, M. E., and Lasley, B. L. (1992). Pituitary response to repeated copulation and/or gonadotropin-releasing hormone administration in llamas and alpacas. *Biol. Reprod.* **47**, 884–888.
- Carrière, P. D., and Lee, B. (1994). Direct radioimmunoassay of progesterone in bovine plasma using danazol (17-alpha-2,4-pregnadien-20-yno(2,3-d)isoxazol-17-ol) as a displacing agent. *Can. J. Vet. Res.* **58**, 230–233.
- Cerini, M., Findley, J. K., and Lawson, R. A. S. (1976). Pregnancy-specific antigens in the sheep: application to the diagnosis of pregnancy. *J. Reprod. Fert.* **46**, 65–69.
- Challis, J. R. G., Harrison, F. A., and Heap, R. B. (1971). Uterine production of oestrogens and progesterone at parturition in the sheep. *J. Reprod. Fert.* **25**, 306–307.
- Chan, J. S. D., Robertson, H. A., and Friesen, H. G. (1978). Maternal and foetal concentrations of ovine placental lactogen measured by radioimmunoassay. *Endocrinology* **102**, 1606–1613.
- Chaplin, V. M., and Holdsworth, R. J. (1982). Oestrone sulphate in goats' milk. *Vet. Rec.* **111**, 224.
- Chenault, J. R., Thatcher, W. W., Kalra, P. S., Abrams, R. M., and Wilcox, C. J. (1975). Transitory changes in plasma progestins, estradiol, and luteinizing hormone approaching ovulation in the bovine. *J. Dairy Sci.* **58**, 709–717.
- Choi, H. S., Keisenhofer, E., Gantner, H., Hois, J., and Bamberg, E. (1987). Pregnancy diagnosis in sows by estimation of oestrogens in blood, urine or faeces. *Anim. Reprod. Sci.* **15**, 209–216.
- Choi, H. S., Möstl, E., and Bamberg, E. (1989). Conversion of steroids in bovine blood in vitro. *Theriogenology* **31**, 571.
- Clarke, I. J., and Pompolo, S. (2005). Synthesis and secretion of GnRH. *Anim. Reprod. Sci.* **88**, 29–55.
- Concannon, P. W., Hansel, W., and Visek, W. J. (1975). The ovarian cycle of the bitch: plasma estrogen, LH and progesterone. *Biol. Reprod.* **13**, 112–121.
- Concannon, P. W., Isaman, L., Frank, D. A., Michel, F. J., and Currie, W. B. (1988). Elevated concentrations of 13,14-dihydro-15-keto-prostaglandin F<sub>2</sub> alpha in maternal plasma during parturition luteolysis and parturition in dogs (*Canis familiaris*). *J. Reprod. Fert.* **84**, 71–77.
- Cordoba, M. C., Sartori, R., and Fricke, P. M. (2001). Assessment of a commercially available early conception factor (ECF) test for determining pregnancy status of dairy cattle. *J. Dairy Sci.* **24**, 1884–1889.
- Cox, J. E. (1975). Experiences with a diagnostic test for equine cryptorchidism. *Equine Vet. J.* **7**, 179–183.
- Cox, J. E., Redhead, P. H., and Dawson, I. E. (1986). Comparison of the measurement of plasma testosterone and plasma oestrogens for the diagnosis of cryptorchidism in the horse. *Equine Vet. J.* **18**, 179–192.
- Cox, J. E., Williams, J. H., Rowe, P. H., and Smith, J. A. (1973). Testosterone in normal, cryptorchid and castrated male horses. *Equine Vet. J.* **5**, 85–90.
- Cunningham, N. F., Hattersley, J. J. P., and Wrathall, A. E. (1983). Pregnancy diagnosis in sows based on serum oestrone sulphate concentration. *Vet. Rec.* **113**, 229–233.
- Daels, P. F., Ammon, D. C., Stabenfeldt, G. H., Liu, I. K. M., Hughes, J. P., and Lasley, B. L. (1991). Urinary and plasma estrogen conjugates, estradiol and estrone concentrations in nonpregnant and early pregnant mares. *Theriogenology* **35**, 1001–1017.

- Daels, P. F., Shideler, S., Lasley, B. L., Hughes, J. P., and Stabenfeldt, G. H. (1990). Source of oestrogen in early pregnancy in the mare. *J. Reprod. Fert.* **90**, 55–61.
- Darenius, K., Kindahl, H., and Madej, A. (1988). Clinical and endocrine studies in mares with known history of repeated conceptus losses. *Theriogenology* **29**, 1215–1232.
- Dericks-Tan, J. S. E., and Taubert, H. D. (1975). Measurement of rat LH with a double-antibody solid-phase radioimmunoassay: effect of LH-RH and of testosterone oenanthate in castrated animals. *Acta Endocrinol. (Copenhagen)* **78**, 451–460.
- Desbuquois, B., and Aurbach, G. D. (1971). Use of polyethylene glycol to separate free and antibody-bound peptide hormones in radioimmunoassays. *J. Clin. Endocrinol. Metab.* **33**, 732–738.
- Edqvist, L.-E., Ekman, L., Gustafsson, B., and Johansson, E. D. B. (1973). Peripheral plasma levels of oestrogens and progesterone during late bovine pregnancy. *Acta Endocrinol. (Copenhagen)* **72**, 81–88.
- Edqvist, L.-E., Kindahl, H., and Stabenfeldt, G. H. (1978). Release of prostaglandin F<sub>2</sub>α during the bovine periparturition period. *Prostaglandins* **16**, 111–119.
- Ehrlich, P. H., Moyle, W. R., Moustafa, Z. A., and Canfield, R. E. (1982). Mixing two monoclonal antibodies yields enhanced affinity for antigen. *J. Immunol.* **128**, 2709–2713.
- Eisenman, J. R., and Chew, B. P. (1983). Polyethylene glycol in conjunction with a second antibody for 24-hour radioimmunoassays of bovine prolactin and growth hormone. *J. Dairy Sci.* **66**, 1174–1179.
- Engvall, E., and Perlmann, P. (1971). Enzyme-linked immunosorbent assay (ELISA). Quantitative assay of immunoglobulin G. *Immunochemistry* **8**, 871–874.
- Estergreen, V. L., Jr., Frost, O. L., Gomes, W. R., Erb, R. E., and Bullard, J. F. (1967). Effect of ovariectomy on pregnancy maintenance and parturition in dairy cows. *J. Dairy Sci.* **50**, 1293–1295.
- Etherington, W. G., Christie, K. A., Walton, J. S., Leslie, K. E., Wickstrom, S., and Johnson, W. H. (1991). Progesterone profiles in postpartum Holstein dairy cows as an aid in the study of retained fetal membranes, pyometra and anestrus. *Theriogenology* **35**, 731–746.
- Evans, M., and Irvine, C. (1975). Serum concentrations of FSH, LH and progesterone during the oestrous cycle and early pregnancy in the mare. *J. Reprod. Fert.* **23(suppl)**, 193–200.
- Exley, D., Johnson, M. W., and Dean, P. D. G. (1971). Antisera highly specific for 17β-oestradiol. *Steroids* **18**, 605–620.
- Fairclough, R. J., Hunter, J. T., and Welch, R. A. S. (1975). Peripheral plasma progesterone and utero-ovarian prostaglandin F concentrations in the cow around parturition. *Prostaglandins* **9**, 901–914.
- Farmer, S. W., and Papkoff, H. (1979). Immunochemical studies with pregnant mare serum gonadotropin. *Biol. Reprod.* **21**, 425–431.
- Fletcher, N. A., and Worsfold, A. I. (1988). A direct radioimmunoassay for oestrone sulphate in serum. *Br. Vet. J.* **144**, 269–272.
- Flint, A. P. F., Stewart, H. J., Lamming, G. E., and Payne, J. H. (1992). Role of the oxytocin receptor in the choice between cyclicity and gestation in ruminants. *J. Reprod. Fert.* **45(suppl)**, 53–58.
- Forsberg, M., Tagle, R., Madej, A., Molina, J. R., and Carlsson, M.-A. (1993b). Radioimmunoassay of bovine, ovine and porcine luteinizing hormone with a monoclonal antibody and a human tracer. *Acta Vet. Scand.* **34**, 255–262.
- Fredriksson, G., Kindahl, H., and Edqvist, L.-E. (1984). 11-Ketotetranor PGF metabolites, a suitable indicator for measuring prostaglandin release during the normal oestrous cycle and early pregnancy in the goat. *Anim. Reprod. Sci.* **7**, 537–545.
- Gaiani, R., Mattioli, M., Galeati, G., and Chiesa, F. (1982). The relationship between oestrone and oestrone sulphate in the plasma and milk of cows during pregnancy. *Arch. Vet. Ital.* **33**, 86–91.
- Garcia, M., and Edqvist, L.-E. (1990). Progesterone determinations and clinical examinations of reproductive organs in purebred and crossbred female Zebu cattle. *Theriogenology* **33**, 1091–1103.
- Geisert, R. D., Renegar, R. H., Thatcher, W. W., Roberts, R. M., and Bazer, F. W. (1982). Establishment of pregnancy in the pig. I. Interrelationships between preimplantation development of the pig blastocyst and uterine endometrial secretions. *Biol. Reprod.* **27**, 925–939.
- Geschwind, I. I., Dewey, R., Hughes, J. P., Evans, J. W., and Stabenfeldt, G. H. (1975). Plasma LH levels in the mare during the oestrous cycle. *J. Reprod. Fert.* **23(suppl)**, 207–212.
- Gleeson, A. R., Thorburn, G. D., and Cox, R. I. (1974). Prostaglandin F concentrations in the utero-ovarian venous plasma of the sow during the late luteal phase of the oestrous cycle. *Prostaglandins* **5**, 521–529.
- Graham, L. H., Raeside, J. I., Goodrowe, K. L., and Liptrap, R. M. (1993). Measurements of faecal oestradiol and progesterone in non-pregnant and pregnant domestic and exotic cats. *J. Reprod. Fert.* **47(suppl)**, 119–120.
- Granström, E., and Samuelsson, B. (1972). Development and mass spectrometric evaluation of a radioimmunoassay for 9,11-dihydroxy-15-ketoprost-5-enoic acid. *FEBS Lett.* **26**, 211–214.
- Grootenhuys, A. J., van Sluijs, F. J., Klaij, I. A., Steenbergen, J., Timmerman, M. A., Bevers, M. M., Deleman, S. J., and de Jong, F. H. (1990). Inhibin, gonadotrophins and sex steroids in dogs with Sertoli cell tumours. *J. Endocr.* **127**, 235–242.
- Hadley, J. C. (1975). Total unconjugated oestrogen and progesterone concentrations in peripheral blood during pregnancy in the dog. *J. Reprod. Fert.* **44**, 453–460.
- Hamberg, M., and Samuelsson, B. (1971). On the metabolism of prostaglandins E<sub>1</sub> and E<sub>2</sub> in man. *J. Biol. Chem.* **246**, 6713–6721.
- Hammes, A., Andreassen, T. K., Spoelgen, R., Raila, J., Hubner, N., Schulz, H., Metzger, J., Schweigert, F. J., Lupp, P. B., Nykjaer, A., and Willnow, T. E. (2005). Role of endocytosis in cellular uptake of sex steroids. *Cell* **122**, 751–762.
- Harrison, F. A., Heap, R. B., Horton, E. W., and Poyser, N. L. (1972). Identification of prostaglandin F<sub>2</sub> in uterine fluid from the non-pregnant sheep with an autotransplanted ovary. *J. Endocr.* **53**, 215–222.
- Hatzidakis, G., Katrakili, K., and Krambovitis, E. (1993). Development of a direct and specific enzymeimmunoassay for the measurement of oestrone sulphate in bovine milk. *J. Reprod. Fert.* **98**, 235–240.
- Henderson, K. M., Camberis, M., Simmons, M. H., Starrs, W. J., and Hardie, A. H. M. (1994). Application of enzymeimmunoassay to measure oestrone sulphate concentrations in cow's milk during pregnancy. *J. Steroid Biochem. Molec. Biol.* **50**, 189–196.
- Henderson, K., Stevens, S., Bailey, C., Hall, G., Stewart, J., and Wards, R. (1998). Comparison of the merits of measuring equine chorionic gonadotrophin (eCG) and blood and faecal concentrations of oestrone sulphate for determining the pregnancy status of miniature horses. *Reprod. Fertil. Dev.* **10**, 441–444.
- Herrler, A., Elsaesses, F., and Niemann, H. (1990). Rapid milk progesterone assay as a tool for the selection of potential donor cows prior to superovulation. *Theriogenology* **33**, 415–422.
- Hinrichs, K., Sertich, P. L., Solorzano, N. M., and Caldwell, L. A. (1988). Use of an immediate, qualitative progesterone assay for determination of day of ovulation in an equine embryo transfer program. *Theriogenology* **29**, 1123–1130.
- Holst, P. A., and Phemister, R. D. (1974). Onset of diestrus in the beagle bitch: definition and significance. *Am. J. Vet. Res.* **35**, 401–406.

- Holtan, D. W., Squires, E. L., Lapin, D. R., and Ginther, O. J. (1979). Effect of ovariectomy on pregnancy in mares. *J. Reprod. Fert.* **27(suppl)**, 457–463.
- Horne, C., Chew, B. P., Wiseman, B. S., and Dziuk, P. J. (1983). Relationship between the level of estrone sulphate in the plasma and the number of fetuses during pregnancy in the gilt. *Biol. Reprod.* **29**, 56–62.
- Horteloup, M. P., Threlfall, W. R., and Funk, J. A. (2005). The early conception factor (ECF) lateral flow assay for non-pregnancy determination in the mare. *Theriogenology* **64**, 1061–1071.
- Hultén, F., Zhang, B. R., Forsberg, M., and Dalin, A.-M. (1995). Applying a progesterone assay to faecal samples collected from sows during the oestrous cycle. *Reprod. Dom. Anim.* **30**, 101–105.
- Humblot, P., Camous, S., Martal, J., Charlerly, J., Jeanguyot, N., Thibier, M., and Sasser, G. (1988). Diagnosis of pregnancy by radioimmunoassay of a pregnancy-specific protein in the plasma of dairy cows. *Theriogenology* **30**, 257–267.
- Hunter, W. M., and Greenwood, F. C. (1962). Preparation of iodine-131 labelled human growth hormone of high specific activity. *Nature* **194**, 495–496.
- Illera, J. C., Silván, G., Munro, C. J., Lorenzo, P. L., Illera, M. J., Liu, I. K. M., and Illera, M. (2003). Amplified androstenedione enzymeimmunoassay for the diagnosis of cryptorchidism in the male horse: comparison with testosterone and estrone sulphate methods. *J. Steroid Biochemistry* **84**, 377–382.
- Jeffcott, L. B., Hyland, J. H., MacLean, A. A., Dyke, T., and Robertson-Smith, G. (1987). Changes in maternal hormone concentrations associated with induction of fetal death at day 45 of gestation in mares. *J. Reprod. Fert.* **35(suppl)**, 461–467.
- Johansson, E. D. B. (1969). Progesterone levels in peripheral plasma during the luteal phase of the normal human menstrual cycle measured by a rapid competitive protein binding technique. *Acta Endocrinol. (Copenhagen)* **61**, 592–606.
- Kelly, M. J., and Wagner, E. J. (1999). Estrogen modulation of G-protein-coupled receptors. *Trends Endocrinol. Metab.* **10**, 369–374.
- Kelly, P. A., Robertson, H. A., and Friesen, H. G. (1974). Temporal pattern of placental lactogen and progesterone secretion in sheep. *Nature* **248**, 435–437.
- Kindahl, H., Edqvist, L.-E., Granström, E., and Bane, A. (1976). The release of prostaglandin F<sub>2</sub>α as reflected by 15-keto-13,14-dihydroprostaglandin F<sub>2</sub>α in the peripheral circulation during normal luteolysis in heifers. *Prostaglandins* **11**, 871–878.
- Kindahl, H., Knudsen, O., Madej, A., and Edqvist, L.-E. (1982). Progesterone, prostaglandin F-2 alpha, PMSG and oestrone sulphate during early pregnancy in the mare. *J. Reprod. Fert.* **32(suppl)**, 353–359.
- Klonisch, T., Hombach-Klonisch, S., Froehlich, C., Kauffold, J., Steger, K., Steinetz, B. G., and Fischer, B. (1999). Canine preprorelaxin: nucleic acid sequence and localization within the canine placenta. *Biol. Reprod.* **60**, 551–557.
- Köhler, G., and Milstein, C. (1975). Continuous cultures of fused cells secreting antibody of predefined specificity. *Nature* **256**, 495–497.
- Kriegsfeld, L. J., Mei, D. F., Bentley, G. E., Ubuka, T., Mason, A. O., Inoue, K., Ukena, K., Tsutsui, K., and Silver, R. (2006). Identification and characterization of a gonadotropin-inhibitory system in the brains of mammals. *Proc. Natl. Acad. Sci. USA* **103**, 2410–2415.
- Laing, J. A., and Heap, R. B. (1971). The concentration of progesterone in the milk of cows during the reproductive cycle. *Br. Vet. J.* **127**, XIX–XXII.
- Lawler, D. F., Evans, R. H., Reimers, T. J., Colby, E. D., and Monti, K. L. (1991). Histopathologic features, environmental factors, and serum estrogen, progesterone, and prolactin values associated with ovarian phase and inflammatory uterine disease in cats. *Am. J. Vet. Res.* **52**, 1747–1753.
- Liggins, G. C., Grieves, S. A., Kendall, J. Z., and Knox, B. S. (1972). The physiological roles of progesterone, oestradiol-17 and prostaglandin F 2 in the control of ovine parturition. *J. Reprod. Fert.* **16(suppl)**, 10–85.
- Lincoln, G. A., Andersson, H., and Loudon, A. (2003). Clock genes in calendar cells as the basis of annual timekeeping in mammals: a unifying hypothesis. *J. Endocrinol.* **179**, 1–13.
- Lindberg, P., and Edqvist, L.-E. (1974). The use of 17β-oestradiol-6-(O-carboxymethyl)oxime-(125I)tyramine as tracer for the radioimmunoassay of 17β-oestradiol. *Clin. Chim. Acta* **53**, 169–174.
- Linde-Forsberg, C., and Forsberg, M. (1989). Fertility in dogs in relation to semen quality and the time and site of insemination with fresh and frozen semen. *J. Reprod. Fert.* **39(suppl)**, 299–310.
- Linde-Forsberg, C., and Forsberg, M. (1993). Results of 527 controlled artificial inseminations in dogs. *J. Reprod. Fert.* **47(suppl)**, 313–323.
- Lidner, H. R., Perel, E., Frielander, A., and Zeitlin, A. (1972). Specificity of antibodies to ovarian hormones in relation to the steroid hapten to the peptide carrier. *Steroids* **19**, 357–375.
- Linzell, J. L., and Heap, R. B. (1968). A comparison of progesterone metabolism in the pregnant sheep and goat: sources of production and an estimation of uptake by some target organs. *J. Endocrinol.* **41**, 433–438.
- Lopate, C., and Threlfall, W. R. (1991). Assessment of luteal function with progesterone enzyme immunoassays in the horse mare. *Theriogenology* **35**, 583–590.
- McCracken, J. A., Carlson, J. C., Glew, M. E., Goding, J. R., Baird, D. T., Green, K., and Samuelsson, B. (1972). Prostaglandin F 2 identified as a luteolytic hormone in sheep. *Nature New Biol.* **238**, 129–134.
- McCracken, J. A., Schramm, W., and Okulicz, W. C. (1984). Hormone receptor control of pulsatile secretion of PGF<sub>2α</sub> from the ovine uterus during luteolysis and its abrogation in early pregnancy. *Anim. Reprod. Sci.* **7**, 31–55.
- McNeilly, A. S., Souza, C. J., Baird, D. T., Swanston, I. A., McVerry, J., Crawford, J., Cranefield, M., and Lincoln, G. A. (2002). Production of inhibin A not B in rams: changes in plasma inhibin A during testis growth, and expression of inhibin/activin subunit mRNA and protein in adult testis. *Reproduction* **123**, 827–835.
- McPhee, I. M., and Tiberghien, M. P. (1987). Assessment of pregnancy in sheep by analysis of plasma progesterone using an amplified enzyme immunoassay technique. *Vet. Rec.* **121**, 63–65.
- Madej, A., and Linde-Forsberg, C. (1991). A rapid radioimmunoassay for determining plasma concentrations of LH in dogs. *J. Reprod. Fert.* **91**, 463–468.
- Makawiti, D. W., Allen, W. E., and Kilpatrick, H. J. (1983). Changes in oestrone sulphate concentrations in peripheral plasma of pony mares associated with follicular growth, ovulation and early pregnancy. *J. Reprod. Fert.* **68**, 481–487.
- Markwell, M. A. K. (1982). A new solid-state reagent to iodinate proteins. I. Conditions for the efficient labeling of antiserum. *Anal. Biochem.* **125**, 427–432.
- Matsas, D. J., Nebel, R. L., and Pelzer, K. D. (1992). Evaluation of an on-farm blood progesterone test for predicting the day of parturition in cattle. *Theriogenology* **37**, 859–868.
- Matteri, R. L., Roser, J. F., Baldwin, D. M., Lipovetsky, V., and Papkoff, H. (1987). Characterization of a monoclonal antibody which detects luteinizing hormone from diverse mammalian species. *Domest. Anim. Endocr.* **4**, 157–165.

- Meyers, P. J., Elmore, R. G., Varner, D. D., Blanchard, T. L., Shull, J. W., and Todd, J. (1988). Use of a rapid progesterone assay in a beef cattle oestrus synchronization program. *Theriogenology* **29**, 1285–1294.
- Mayes, D., and Nugent, C. A. (1970). Plasma estradiol determined with a competitive protein binding method. *Steroids* **15**, 389–403.
- Millar, R. P. (2005). GnRHs and GnRH receptors. *Anim. Reprod. Sci.* **88**, 5–28.
- Millar, R. P., and Aehnelt, C. (1977). Application of ovine luteinizing hormone (LH) radioimmunoassay in the quantitation of LH in different mammalian species. *Endocrinology* **101**, 760–768.
- Mitchell, D. (1971). Early fetal death and a serum gonadotrophin test for pregnancy in the mare. *Can. Vet. J.* **12**, 41–44.
- Moenter, S. M., Caraty, A., and Karsch, F. J. (1990). The estradiol-induced surge of gonadotropin-releasing hormone in the ewe. *Endocrinology* **127**, 1375–1384.
- Moriyoshi, M., Nozoki, K., Ohtaki, T., Nakada, K., Nakao, T., and Kawata, K. (1997). Measurement of gestagen concentration in feces using a bovine milk progesterone quantitative test EIA kit and its application to early pregnancy diagnosis in the sow. *J. Vet. Med. Sci.* **59**, 695–701.
- Möstl, E., Lehmann, H., and Wenzel, U. (1993). Gestagens in the faeces of mink and cats for monitoring corpus luteum activity. *J. Reprod. Fert.* **47(suppl)**, 540–541.
- Munro, C., and Stabenfeldt, G. (1984). Development of a microtitre plate enzyme immunoassay for the determination of progesterone. *J. Endocrinol.* **10**, 41–49.
- Murphy, B. E. (1964). Application of the property of protein-binding to the assay of minute quantities of hormones and other substances. *Nature* **201**, 679–682.
- Nachreiner, R. F., Oschmann, S. J., Edqvist, L.-E., and Richards, J. I. (1992). Factors affecting skim milk progesterone assay results. *Am. J. Vet. Res.* **53**, 1085–1089.
- Nancarrow, C. W., Buckmaster, J., Chamley, W., Cox, R. I., Cumming, I. A., Cummins, L., Drinan, J. P., Findlay, J. K., Goding, J. R., Restall, B. J., Schneider, B. J., and Thorburn, G. D. (1973). Hormonal changes around oestrus in the cow. *J. Reprod. Fert.* **32**, 320–321.
- Navarro, H., Zarco, L., Ducoing, A., Flores, G., and Valencia, J. (1990). Effect of time and temperature of incubation of heparinized caprine blood on concentrations of progesterone detected in plasma. *Theriogenology* **33**, 749–755.
- Nebel, R. L., Altemose, D. L., Munkittrick, T. W., Sprecher, D. J., and McGilliard, M. L. (1989). Comparisons of eight commercial on-farm milk progesterone tests. *Theriogenology* **31**, 753–764.
- Neely, D. P., Kindahl, H., Stabenfeldt, G. H., Edqvist, L.-E., and Hughes, J. P. (1979). Prostaglandin release patterns in the mare: physiological, pathophysiological, and therapeutic responses. *J. Reprod. Fert.* **27(suppl)**, 181–189.
- Neff, A. W., Ruppel, C. C., Gosline, R. E., Jaglan, P. S., and McGrath, J. P. (1981). PGF<sub>2</sub> alpha residue studies in beef and dairy cattle. *Acta Vet. Scand.* **77(suppl)**, 11–27.
- Nett, T. M., Akbar, A. M., and Niswender, G. D. (1974). Serum levels of luteinizing hormone and gonadotropin-releasing hormone in cycling, castrated and anestrous ewes. *Endocrinology* **94**, 713–718.
- Nett, T. M., Akbar, A. M., Phemister, R. D., Holst, P. A., Reichert, L. E., Jr., and Niswender, G. D. (1975). Levels of luteinizing hormone, estradiol and progesterone in serum during the oestrous cycle and pregnancy in the beagle bitch. *Proc. Soc. Exp. Biol. Med.* **148**, 134–139.
- Nett, T. M., Staigmiller, R. B., Akbar, A. M., Diekman, M. A., Ellinwood, W. E., and Niswender, G. D. (1976). Secretion of prostaglandin F<sub>2</sub>alpha in cycling and pregnant ewes. *J. Anim. Sci.* **42**, 876–880.
- Niswender, G. D. (1973). Influence of the site of conjugation on the specificity of antibodies to progesterone. *Steroids* **22**, 413–424.
- Niswender, G. D., Reichert, L. E., Midgley, A. R., and Nalbandov, A. V. (1969). Radioimmunoassay for bovine and ovine luteinizing hormone. *Endocrinology* **84**, 1166–1173.
- Noden, P. A., Oxender, W. D., and Hafs, H. D. (1978). Plasma luteinizing hormone, progestogens, and estrogens in mares during gestation, parturition, and first postpartum oestrus (foal oestrus). *Am. J. Vet. Res.* **39**, 1965–1967.
- Oltner, R., and Edqvist, L.-E. (1982). Changes in plasma progesterone levels during storage of heparinized whole blood from cow, horse, dog and pig. *Acta Vet. Scand.* **23**, 1–8.
- Palmer, E., and Jousset, B. (1975). Urinary oestrogen and plasma progesterone levels in non-pregnant mares. *J. Reprod. Fert.* **23(suppl)**, 213–221.
- Pancieria, R. J., Slusher, S. A., and Hayes, K. E. N. (1991). Ovarian teratoma and granulosa cell tumor in two mares. *Cornell Vet.* **81**, 43–50.
- Pashen, R. L., and Allen, W. R. (1979). The role of the fetal gonads and placenta in steroid production, maintenance of pregnancy and parturition in the mare. *J. Reprod. Fert.* **27(suppl)**, 499–509.
- Pawson, A. J., and McNeilly, A. S. (2005). The pituitary effects of GnRH. *Anim. Reprod. Sci.* **88**, 75–94.
- Pepper, R. T., and Dobson, H. (1987). Preliminary results of treatment and endocrinology of chronic endometritis in the dairy cow. *Vet. Rec.* **120**, 53–56.
- Perry, J. S., Heap, R. B., Burton, R. D., and Gadsby, J. E. (1976). Endocrinology of the blastocyst and its role in the establishment of pregnancy. *J. Reprod. Fert.* **25(suppl)**, 85–104.
- Peterson, A. J., Tervit, H. R., Fairclough, R. J., Havik, P. G., and Smith, J. F. (1976). Jugular levels of 13, 14-dihydro-15-keto-prostaglandin F and progesterone around luteolysis and early pregnancy in the ewe. *Prostaglandins* **12**, 551–558.
- Pope, G. S., Gupta, S. K., and Munro, I. B. (1969). Progesterone levels in the systemic plasma of pregnant, cycling and ovariectomized cows. *J. Reprod. Fert.* **20**, 369–381.
- Pulido, A., Zarco, L., Galina, C. S., Murcia, C., Flores, G., and Posadas, E. (1991). Progesterone metabolism during storage of blood samples from Gyr cattle: effects of anticoagulant, time and temperature of incubation. *Theriogenology* **35**, 965.
- Roberts, R. M., Cross, J. C., Farin, C. E., Hansen, T. R., Klemann, S. W., and Imakawa, K. (1990). Interferons at the placental interface. *J. Reprod. Fert.* **41(suppl)**, 63–74.
- Robertson, H. A., and King, G. J. (1974). Plasma concentrations of progesterone, oestrone, oestradiol-17beta and of oestrone sulphate in the pig at implantation, during pregnancy and at parturition. *J. Reprod. Fert.* **40**, 133–141.
- Robertson, H. A., and Sarda, I. R. (1971). A very early pregnancy test for mammals: its application to the cow, ewe and sow. *J. Endocrinol.* **49**, 407–419.
- Romagnolo, D., and Nebel, R. L. (1991). The accuracy of enzyme-linked immunosorbent assay and latex agglutination progesterone test for the validation of oestrus and early pregnancy diagnosis in dairy cattle. *Theriogenology* **39**, 1121–1128.
- Ruder, C. A., Stelflug, J. N., Dahmen, J. J., and Sasser, R. G. (1988). Detection of pregnancy in sheep by radioimmunoassay of sera for pregnancy-specific protein B. *Theriogenology* **29**, 905–912.
- Samuelsson, B., Granström, E., Green, K., Hamberg, M., and Hammarström, S. (1975). Prostaglandins. *Annu. Rev. Biochem.* **44**, 669–695.

- Sauer, M. J., Foulkes, J. A., and Cookson, A. D. (1981). Direct enzyme immunoassay of progesterone in bovine milk. *Steroids* **38**, 45–53.
- Sasser, R. G., and Ruder, C. A. (1987). Detection of early pregnancy in domestic ruminants. *J. Reprod. Fert.* **34(suppl)**, 261–671.
- Schmidt, D. E., Brooks, T. L., Mhatre, S., Junghans, R. P., and Khazaeli, M. B. (1993). An advanced solid support for immunoassays and other affinity applications. *BioTechniques* **14**, 1020–1025.
- Schwarzenberger, F., Möstl, E., Bamberg, E., Pammer, J., and Schmechlik, O. (1991). Concentrations of progestagens and oestrogens in the faeces of pregnant Lipizzan, trotter and thoroughbred mares. *J. Reprod. Fert.* **44(suppl)**, 489–499.
- Seminara, S. B. (2005). Metastin and its G protein-coupled receptor, GPR54: critical pathway modulating GnRH secretion. *Front. Neuroendocr.* **26**, 131–138.
- Shah, K. D., Nakao, T., and Kubota, H. (2006). Plasma estrone sulphate (E<sub>1</sub>S) and estradiol-17 $\beta$  (E<sub>2</sub> $\beta$ ) profiles during pregnancy and their relationship with the relaxation of sacrospinal ligament, and prediction of calving time in Holstein-Friesian cattle. *Anim. Reprod. Sci.* **95**, 38–53.
- Sharma, S. C., and Fitzpatrick, R. J. (1974). Effect of oestradiol-17 $\beta$  and oxytocin treatment on prostaglandin F $\alpha$  release in the anoestrous ewe. *Prostaglandins* **6**, 97–105.
- Shearer, I. J., Purvis, K., Jenkin, G., and Haynes, N. B. (1972). Peripheral plasma progesterone and oestradiol-17 levels before and after puberty in gilts. *J. Reprod. Fert.* **30**, 347–360.
- Shemesh, M., Ayalon, N., and Lindner, H. R. (1968). Early effect of conceptus on plasma progesterone level in the cow. *J. Reprod. Fert.* **15**, 161–164.
- Shille, V., Karlblom, I., Einarsson, S., Larsson, K., Kindahl, H., and Edqvist, L.-E. (1979a). Concentrations of progesterone and 15-keto-13,14-dihydroprostaglandin F $\alpha$  in peripheral plasma during the oestrous cycle and early pregnancy in gilts. *Zentralbl. Veterinärmed., Reihe A* **26**, 169–181.
- Shille, V. M., Haggerty, M. A., Shackleton, C., and Lasley, B. L. (1990). Metabolites of estradiol in serum, bile, intestine and feces of the domestic cat (*Felis catus*). *Theriogenology* **34**, 779–794.
- Shille, V. M., Lundström, K. E., and Stabenfeldt, G. H. (1979b). Follicular function in the domestic cat as determined by estradiol-17 $\beta$  concentrations in plasma: relation to oestrous behavior and cornification of exfoliated vaginal epithelium. *Biol. Reprod.* **21**, 953–963.
- Shille, V. M., Munro, C., Farmer, S. W., and Papkoff, H. (1983). Ovarian and endocrine responses in the cat after coitus. *J. Reprod. Fert.* **69**, 29–39.
- Short, R. V. (1958). Progesterone in blood. I. The chemical determination of progesterone in peripheral blood. *J. Endocr.* **16**, 415–425.
- Silberzahn, P., Pouret, E. J. M., and Zwain, I. (1989). Androgen and oestrogen response to a single injection of hCG in cryptorchid horses. *Equine Vet. J.* **21**, 126–129.
- Smith, M. S., and McDonald, L. E. (1974). Serum levels of luteinizing hormone and progesterone during the oestrous cycle, pseudopregnancy and pregnancy in the dog. *Endocrinology* **94**, 404–412.
- Sokolowski, J. H. (1971). The effects of ovariectomy on pregnancy maintenance in the bitch. *Lab. Anim. Sci.* **21**, 696–699.
- Spencer, T. E., Johnson, G. A., Burghardt, R. C., and Bazer, F. W. (2004). Progesterone and placental hormone actions on the uterus: insights from domestic animals. *Biol. Reprod.* **71**, 2–10.
- Spencer, T. E., Stagg, A. G., Ott, T. L., Johnson, G. A., Ramsey, W. S., and Bazer, F. W. (1999). Differential effects of intrauterine and subcutaneous administration of recombinant ovine interferon tau on the endometrium of cyclic ewes. *Biol. Reprod.* **61**, 464–470.
- Sprecher, D. J., Strelow, L. W., and Nebel, R. L. (1990). The response of cows with cystic ovarian degeneration to luteotropic or luteolytic therapy as assigned by latex agglutination milk progesterone assay. *Theriogenology* **34**, 1149–1158.
- Squires, E. L., Stevens, W. B., Pickett, B. W., and Nett, T. M. (1979). Role of pregnant mare serum gonadotropin in luteal function of pregnant mares. *Am. J. Vet. Res.* **40**, 889–891.
- Stabenfeldt, G. H. (1974). Physiologic, pathologic, and therapeutic roles of progestins in domestic animals. *J. Am. Vet. Med. Assoc.* **164**, 311–317.
- Stabenfeldt, G. H., Akins, E., Ewing, L. L., and Morrisette, M. C. (1969a). Peripheral plasma progesterone levels in pigs during the oestrous cycle. *J. Reprod. Fert.* **20**, 443–449.
- Stabenfeldt, G. H., Drost, M., and Franti, C. E. (1972). Peripheral plasma progesterone levels in the ewe during pregnancy and parturition. *Endocrinology* **90**, 144–150.
- Stabenfeldt, G. H., Ewing, L. L., and McDonald, L. E. (1969b). Peripheral plasma progesterone levels during the bovine oestrous cycle. *J. Reprod. Fert.* **19**, 433–442.
- Stabenfeldt, G. H., Holt, J. A., and Ewing, L. L. (1969c). Peripheral plasma progesterone levels during the ovine oestrous cycle. *Endocrinology* **85**, 11–15.
- Stabenfeldt, G. H., Hughes, J. P., Evans, J. W., and Geschwind, I. I. (1975). Unique aspects of the reproductive cycle of the mare. *J. Reprod. Fert.* **23(suppl)**, 155–160.
- Stabenfeldt, G. H., Hughes, J. P., Evans, J. W., and Neely, D. P. (1974a). Spontaneous prolongation of luteal activity in the mare. *Equine Vet. J.* **6**, 158–163.
- Stabenfeldt, G. H., Hughes, J. P., Kennedy, P. C., Meagher, D. M., and Neely, D. P. (1979). Clinical findings, pathological changes and endocrinological secretory patterns in mares with ovarian tumours. *J. Reprod. Fert.* **27(suppl)**, 277–285.
- Stabenfeldt, G. H., Hughes, J. P., Wheat, J. D., Evans, J. W., Kennedy, P. C., and Cupps, P. T. (1974b). The role of the uterus in ovarian control in the mare. *J. Reprod. Fert.* **37**, 343–351.
- Stabenfeldt, G. H., Osburn, B. I., and Ewing, L. L. (1970). Peripheral plasma progesterone levels in the cow during pregnancy and parturition. *Am. J. Physiol.* **218**, 571–575.
- Steinetz, B., Goldsmith, L., and Lust, G. (1987). Plasma relaxin levels in pregnant and lactating dogs. *Biol. Reprod.* **37**, 719–725.
- Steinetz, B. G., Bullesbach, E. E., Goldsmith, L. T., Schwabe, C., and Lust, G. (1996). Use of synthetic canine relaxin to develop a rapid homologous radioimmunoassay. *Biol. Reprod.* **54**, 1252–1260.
- Sugiyama, S., Nakao, T., Tsunoda, N., and Kawata, K. (1985). An enzymeimmunoassay of serum estrone sulphate and its application to early pregnancy diagnosis in pigs. *Br. Vet. J.* **141**, 60–68.
- Szenci, O., Beckers, J. F., Humblot, P., Sulon, J., Sasser, G., Taverne, M. A. M., Varga, J., Baltussen, R., and Schekk, G. (1998). Comparison of ultrasonography, bovine pregnancy-specific protein B, and bovine pregnancy-associated glycoprotein 1 tests for pregnancy detection in dairy cows. *Theriogenology* **50**, 77–88.
- Szenci, O., Taverne, M. A. M., Palme, R., Bertoti, B., and Merics, I. (1993). Evaluation of ultrasonography and the determination of unconjugated oestrogen in faeces for the diagnosis of pregnancy in pigs. *Vet. Rec.* **132**, 510–512.
- Terqui, M., and Palmer, E. (1979). Oestrogen pattern during early pregnancy in the mare. *J. Reprod. Fert.* **27(suppl)**, 441–446.
- Thatcher, W. W., Guzeloglu, A., Mattos, R., Binelli, M., Hansen, T. R., and Pru, J. K. (2001). Uterine-conceptus interactions and reproductive failure in cattle. *Theriogenology* **56**, 1435–1450.
- Thorell, J. I., and Johansson, B. G. (1971). Enzymatic iodination of polypeptides with 125I to high specific activity. *Biochim. Biophys. Acta* **251**, 363–369.

- Thornycroft, I. H., and Stone, S. C. (1972). Radioimmunoassay of serum progesterone in women receiving oral contraceptive steroids. *Contraception* **5**, 129–146.
- Tsang, C. P. W. (1978). Plasma levels of estrone sulphate, free estrogens and progesterone in the pregnant ewe throughout gestation. *Theriogenology* **10**, 97–110.
- Tsutsui, T., and Stewart, D. R. (1991). Determination of the source of relaxin immunoreactivity during pregnancy in the dog. *J. Vet. Med. Sci.* **53**, 1025–1029.
- Tsutsui, K., Saigoh, E., Ukena, K., Teranishi, H., Fujisawa, Y., Kikuchi, M., Ishii, S., and Sharp, P. J. (2000). A novel avian hypothalamic peptide inhibiting gonadotropin release. *Biochem. Biophys. Res. Commun.* **275**, 661–667.
- Vahdat, F., Hurtgen, J. P., Whitmore, H. L., Johnston, S. D., and Ketelson, C. L. (1979). Effect of time and temperature on bovine serum and plasma progesterone concentration. *Theriogenology* **12**, 371–374.
- Vaitakaitis, J., Robbins, J. B., Nieschlag, E., and Ross, G. T. (1971). A method for producing specific antisera with small doses of immunogen. *J. Clin. Endocrinol. Metab.* **33**, 988–991.
- Van der Molen, H. J., and Groen, D. (1968). Interconversion of progesterone and 20-alpha-dihydroprogesterone and of androstenedione and testosterone in vitro by blood and erythrocytes. *Acta Endocrinol. (Copenhagen)* **58**, 419–444.
- Van Orden, D. E., and Farley, D. B. (1973). Prostaglandin F<sub>2</sub> radioimmunoassay utilizing polyethylene glycol separation technique. *Prostaglandins* **4**, 215–233.
- Van Weemen, B. K., and Schuurs, A. H. W. H. (1971). Immunoassay using antigen-enzyme conjugates. *FEBS Lett.* **15**, 232–236.
- Velle, W. (1958). Urinary estrogens of the pregnant sow. *Am. J. Vet. Res.* **19**, 405–408.
- Verhage, H. G., Beamer, N. B., and Brenner, R. M. (1976). Plasma levels of estradiol and progesterone in the cat during polyestrus, pregnancy and pseudopregnancy. *Biol. Reprod.* **14**, 579–585.
- Walters, D. L., Schams, D., and Schallenberger, E. (1984). Pulsatile secretion of gonadotrophins, ovarian steroids and ovarian oxytocin during the luteal phase of the oestrous cycle in the cow. *J. Reprod. Fert.* **71**, 479–491.
- Whates, D. C., and Denning-Kendall, P. A. (1992). Control of synthesis and secretion of ovarian oxytocin in ruminants. *J. Reprod. Fert.* **45(suppl)**, 39–52.
- Wiseman, B. S., Vincent, D. L., Thomford, P. J., Scaffrahn, N. S., Sargent, G. F., and Kesler, D. J. (1983). Changes in porcine, ovine, bovine and equine blood progesterone concentrations between collection and centrifugation. *Anim. Reprod. Sci.* **5**, 157.
- Worsfold, A. I., Chamings, R. J., and Booth, J. H. (1986). Measurement of oestrone sulphate in sheep plasma as a possible indicator of pregnancy and the number of viable foetuses present. *Br. Vet. J.* **142**, 195–197.
- Zarco, L., Stabenfeldt, G. H., Basu, S., Bradford, G. E., and Kindahl, H. (1988). Modification of prostaglandin F<sub>2</sub> alpha synthesis and release in the ewe during the initial establishment of pregnancy. *J. Reprod. Fert.* **83**, 527–536.

# Trace Minerals

Robert B. Rucker

Department of Nutrition  
College of Agriculture and Environmental  
Sciences, University of California, Davis  
Davis, California

Andrea J. Fascetti

Department of Molecular Biosciences  
School of Veterinary Medicine  
University of California, Davis  
Davis, California

Carl L. Keen

Department of Nutrition  
College of Agriculture and Environmental  
Sciences, University of California, Davis  
Davis, California

## I. INTRODUCTION

- A. General Properties of Minerals
- B. Typical Configurations of Metal Complexes
- C. Biological Perspectives

## II. COBALT

- A. Cobalt Function
- B. Absorption and Transport
- C. Disorders of Cobalt Metabolism

## III. COPPER

- A. Copper Distribution
- B. Copper Functions
- C. Dietary Copper
- D. Copper Metabolism, Absorption, and Transport
- E. Evaluation of Cu Status

## IV. MANGANESE

- A. Manganese Distribution
- B. Manganese Function
- C. Dietary Manganese
- D. Manganese Metabolism, Absorption, and Transport
- E. Deficiency and Excesses
- F. Evaluation of Manganese Status

## V. MOLYBDENUM

- A. Molybdenum Distribution
- B. Molybdenum Functions
- C. Molybdenum Metabolism, Absorption, and Transport
- D. Other Disorders

## VI. SELENIUM

- A. Dietary Selenium
- B. Selenium Functions
- C. Selenium Metabolism, Absorption, and Transport
- D. Disorders of Selenium Metabolism
- E. Evaluation of Selenium Status

## VII. ZINC

- A. Zinc Distribution
- B. Functions of Zinc
- C. Dietary Zinc
- D. Zinc Metabolism, Absorption, and Transport
- E. Zinc Deficiency
- F. Zinc Toxicity
- G. Evaluation of Zinc Status

## VIII. CONCLUDING COMMENTS

## REFERENCES

## I. INTRODUCTION

Of the 103 elements in the periodic table, about 30 are presently considered essential or important for the normal health and growth of animals. Of these, 16 are often designated as essential trace elements, a classification initially based on the difficulty of measuring such elements with precision in biological tissues. Although the development of new instrumentation has greatly facilitated measurement, the term *trace elements* has been retained and is still commonly applied to those elements that occur in the body at concentrations in the submicromolar to micromolar range (Fraga, 2005; O'Dell and Sunde, 1997; Reilly, 2004; Ullrey, 2002).

This chapter focuses on six elements—cobalt (Co), copper (Cu), manganese (Mn), molybdenum (Mo), selenium (Se), and zinc (Zn)—to illustrate the concepts important to trace element metabolism and disease (Reilly, 2004). These elements have been chosen because there is evidence that perturbations in their metabolism are relatively common. Other biologically active trace elements, although potentially important, often require special conditions or long periods of deprivation before signs of deficiency are recognized, and exposures at 10 to 100 times normal intakes are required before toxic signs are observed (Subcommittee on Dairy Cattle, National Research Council [NRC], 2001; Subcommittee on Mineral Toxicity in Animals, NRC, 1980). In conventional settings, deficiencies of elements such as vanadium, chromium, silicon, nickel, and tin are rarely encountered. Further, arguments for their nutritional essentiality remain controversial. If there is a nutritional need, it is likely to be in the microgram per kilogram of diet range, whereas the relative need for Co, Cu, Zn, Mn, Mo, and Se approaches, or exceeds, amounts in the milligram per kilogram of diet range (Tables 22-1 and 22-2).

### A. General Properties of Minerals

Most elements accumulate in tissues to some extent. The essential elements, however, are distinguished in that



they are intimately associated with the functions of specific organic molecules, mostly proteins with enzymatic properties. When metals function to facilitate enzymatic catalysis, they typically fall into two categories, metalloenzymes and metal-enzyme complexes. Stability constants that define metal binding dictate whether metalloenzyme or metal-enzyme complex is the best designation (Reedijk and Bouwman, 1999; Taylor, 2002). For metalloenzymes there is often good stoichiometry between the moles of metal bound per mole of protein or protein subunit following purification. Metalloenzymes have metal-binding constants of  $10^8$  to  $10^9$  or greater. Metal protein complexes have constants of  $10^5$  or less. Metals in such complexes are easily dissociated upon dialysis of the complex (Reedijk and Bouwman, 1999).

**TABLE 22-1** Trace Elements Essential for the Development and Health of Mammals and Birds

Subject to Natural Deficiencies	Experimentally Produced <sup>a</sup>
Cobalt	Arsenic
Copper	Chromium
Iodine	Fluoride
Iron	Nickel
Manganese	Silicon
Molybdenum	Vanadium
Selenium	Lithium
Zinc	Boron

<sup>a</sup>Deficiency induced experimentally using purified diets in a rigidly controlled environment; "deficiency" is often dependent on and a function of the controlled environment.

Trace elements that are nutritionally essential are localized to the fourth and fifth rows of the periodic table. All have incompletely filled d orbitals, except for Cu and Zn. How a given metal facilitates catalytic functions is related in part to its ability to engage in redox (the loss or gain of an electron[s]) or modulate an energy excitable transition state during a catalytic event. Such modulations in protein transition states are sometimes referred as entasis. The entasis (structural dictating) domains of most proteins utilize O, S, or N as electron donors (Riordan and Valle, 1974). When associated with given complexes, if one or two outer shell valence electrons are involved, the result is one oxidation state (e.g.,  $\text{Na}^{+1}$ ,  $\text{Ca}^{+2}$ , or  $\text{Mg}^{+2}$ ); two or more valence electrons can result in two oxidation states ( $\text{Fe}^{+2}$  or  $\text{Fe}^{+3}$ ). The use of electrons in orbitals other than the outermost valence orbitals (e.g., transition metals), however, can have a variety of oxidation states. Some metals can also function as a Lewis acid (i.e., can accept electrons from a base). Enzymes that utilize this property act as acid catalysis (e.g., Zn and the hydrolysis of phosphate esters by alkaline phosphatase (Taylor, 2002).

## B. Typical Configurations of Metal Complexes

In simple metal complexes, the basicity of the electron donating group and the ability to approach the metal ion (steric effects) are the primary factors that influence stability. However, when the electron donor groups are bound together into a single molecule capable of binding a given metal, the importance of steric effects is greatly increased and stability depends on a number of other factors including the size and number of rings formed. Five- or six-membered rings have more stability; usually five-membered rings are more stable than six-membered rings. Four-membered rings are rare. Rings larger than six members are less unstable.

**TABLE 22-2** Cobalt, Copper, Manganese, Molybdenum, Selenium, and Zinc Requirements for Young and Adult Dogs, Swine, Sheep, and Beef and Dairy Cattle Expressed as Mg per Kg of Ration for Adequate Intakes<sup>a</sup>

	Dogs	Swine	Sheep	Beef Cattle	Dairy Cattle
Co	30–60mg as vitamin B <sub>12</sub>	30–60mg as vitamin B <sub>12</sub>	0.1–0.3mg as Co	0.1–0.3mg as Co	0.1–0.3mg as Co
Cu	5–10	5–10	5–10	5–10	5–10
Mn	3–20	3–20	20–40	20–40	20–40
Mo <sup>b</sup>	1–2	1–2	1–2	1–2	1–2
Se	0.25–0.3	0.25–0.3	0.15–0.40	0.15–0.4	0.15–0.4
Zn	80–100	80–100	30–60	30–60	30–60

<sup>a</sup>Values were taken from several industrial and NRC sources (Committee on Animal Nutrition, NRC, 1985; Subcommittee on Dairy Cattle Nutrition, NRC, 2001; Subcommittee on Laboratory Animal Nutrition, NRC, 1995; Subcommittee on Mineral Toxicity in Animals, NRC, 1980; Subcommittee on Swine Nutrition, NRC, 1998; The Salt Institute, [www.saltinstitute.org/index.html](http://www.saltinstitute.org/index.html)).

<sup>b</sup>For ruminant animals, the Cu:Mo ratio should exceed 5 or more given the interactions and negative effects Mo has on Cu availability (see text).

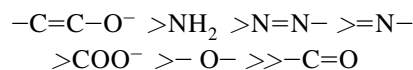
The stability of calcium complexes of ethylenediamine tetraacetic acid (EDTA) and its homologues with increasing number of C atoms in the bridge between N atoms is as follows:

N	Atom in Bridge Carbon	Log K <sub>a</sub>
2	5	10.5
3	6	7.1
4	7	5.2
5	8	4.6

Such complexes are called chelates. Note that the stability also increases as the number of rings increases:

Ligand	Number of Rings	Log K <sub>a</sub>
H <sub>2</sub> NCH <sub>2</sub> COOH	1	5.2
CH <sub>2</sub> COOH		
NHCH <sub>2</sub> COOH	2	7.0
CH <sub>2</sub> COOH		
NCH <sub>2</sub> COOH		
CH <sub>2</sub> COOH	3	10.6

Although a further discussion of ligand basicity and steric effects is beyond the scope of this chapter, knowledge of the following relationship can be useful where various coordinating groups are compared in order of decreasing affinity for given metal ions:



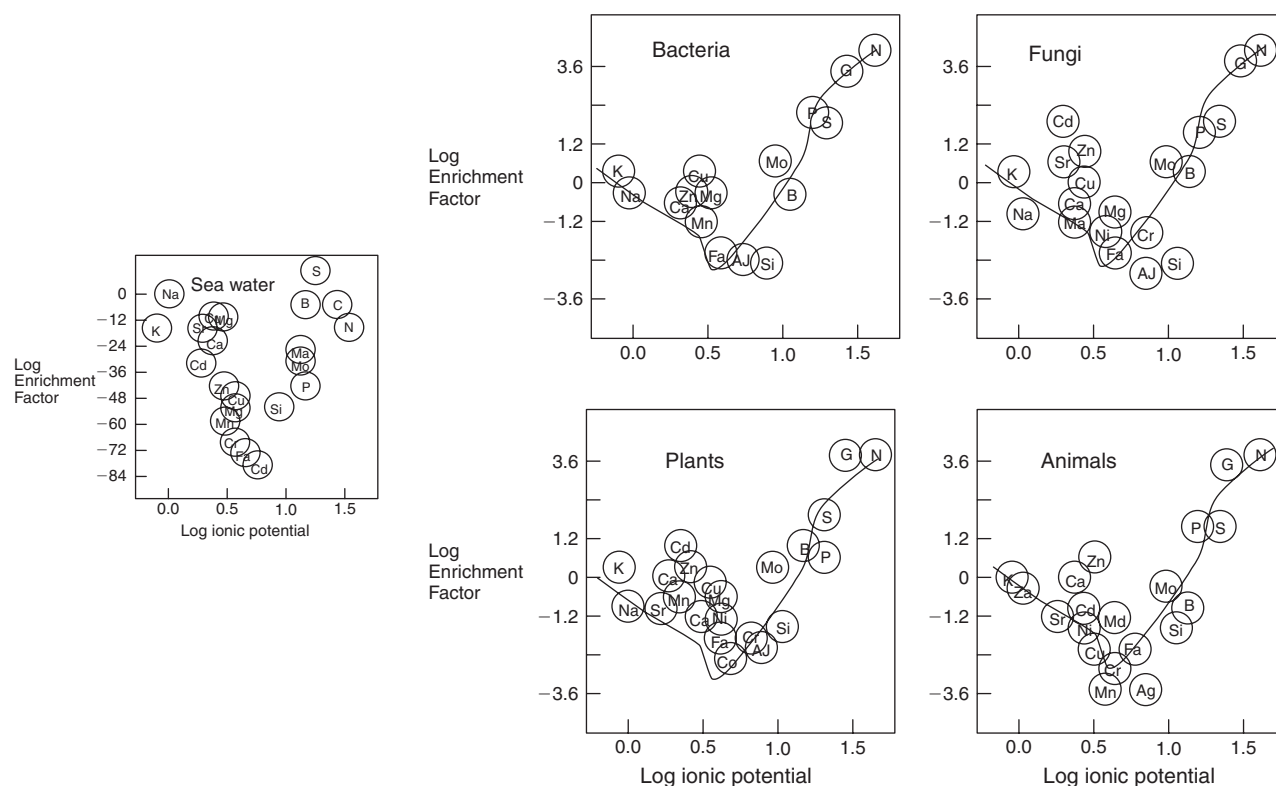
Enolates > Amino > Azo > Ring N > Carboxylate  
> Ether >> Carbonyl

These relationships are important to the types and shapes of complexes that metal ions form, their stabilities, and their redox potentials.

## C. Biological Perspectives

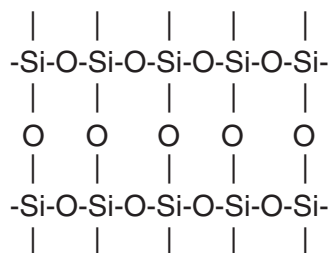
### 1. Trace Elements as Essential Components in Evolution and Animal Diversity

A reasonable question to ask is why are certain elements more nutritionally important than others? From an evolutionary perspective, relative abundance and, in many cases, the ability to form complexes with catalytic (redox) potential are among the most important reasons. Figure 22-1 shows the distribution of elements in seawater, bacteria, fungi, plants, and animals (Banin and Navrot, 1975). That



**FIGURE 22-1** Distribution of elements in seawater, bacteria, fungi, plants, and animals relative to the earth's crust plotted as a function of the ionic potential (see text).

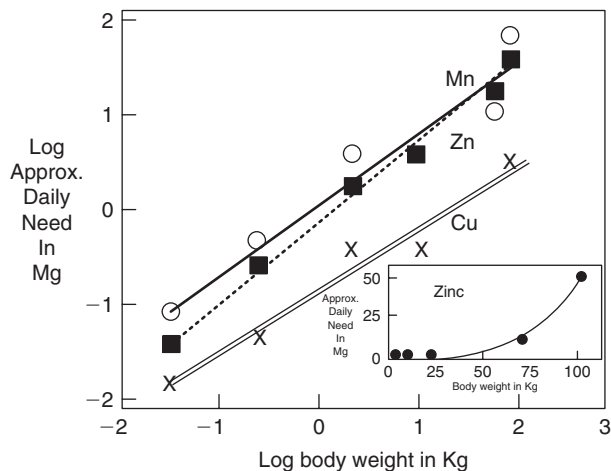
the patterns are similar suggests common chemical principles have persisted as a part of natural selection. To the extent that the ionic potential of an element is related to its relative abundance in seawater, one can argue that evolutionary choice as it relates to metal utilization is based in part on chemical properties that dictate its interaction with water. For example, when the ionic potential is high ( $>10$ ), the positive ion appropriates one or more oxygen ions, freeing the hydrogen and forming an oxyanion. Oxyanions are generally soluble; thus, relative to the earth's crust, the log enrichment is high. This is a characteristic of the nonmetals in the upper right corner of the periodic table (e.g., C, N, O, S, P). Such elements are also the smallest in size to form stable multiple bonds. With time carbon can become a carbonate ion in water and eventually  $\text{CO}_2$  ( $\text{O}=\text{C}=\text{O}$ , a gas) when oxidized further. Contrast that with silicon, carbon's tetravalent homologue in period 4 of the periodic table. Silicon in water forms silicates, which easily polymerize and are oxidized to the end product silicon dioxide or quartz, a solid, because of the inability to form stable multiple bonds:



For elements with low to intermediate ionic potential values, such as silicon ( $\text{IP} < \log 0.5$ ), the log of the enrichment factor is often in the range of  $-1$  to  $+1$ , indicating small enrichment or even depletion relative to the crust. Metals with low, but positive, intermediate, or slightly negative ionic potentials tend to form hydroxides in water, most with low solubility. Many of the essential trace elements fall in this category. Finally, elements with negative ionic potentials tend to form hydrated shells and interact by organizing water structure, a role that is important to understanding the functions of Na, K, Mg, and Ca in cells.

## 2. Utilization of Trace Elements and Metabolic Regulation and Metabolism

As an additional perspective, it can be generalized that dietary requirements across species (Table 22-2 and Fig. 22-2) are more similar than dissimilar (Rucker, 2007). This is particularly the case when given requirements are expressed per unit of energy consumed or per unit weight of ration. Figure 22-2 shows the relationship for selected mineral requirements and metabolic body size. The requirements of trace elements scale allometrically in a manner that is similar in principle to scaling algorithms (e.g.,  $\text{kWt}^{3/4}$ ) for basal metabolism. If a set of common principles was involved in



**FIGURE 22-2** Relationship of mineral requirements and metabolic body size. Log plots of the daily intake of selected minerals for mice, rats, chickens, dogs, humans, and pigs versus their respective body weights in kilograms. The data for individual minerals plotted in this fashion result in reasonably linear plots with slopes that range from 0.6 to 0.8. For any given mineral, plots of daily intake versus units of body weight are not linear and require polynomial equations to describe the function (insert).

the selection of the elements important to life, it follows that nutrition requirements would be influenced by the same principles (e.g., all cells utilize in principle the same metabolic strategies). Indeed, a strong case can be made that when expressed per unit of food-derived energy or relative to metabolic body size, requirements for essential elements are similar for a diverse array of species. As substances important to catalyst and entasis, it follows consequently that their relative nutritional needs are also driven by factors and principles important to energy utilization.

Why do deficiencies or excess occur? Nutritional deficiencies obviously result when the intake of essential nutrients consistently falls below the minimal requirement (i.e., a primary deficiency). In animal nutrition this is regrettably common given the tendency to feed monotonous diets or foods common to a given region. Secondary mineral deficiencies can also arise through a variety of mechanisms that include poor bioavailability, interactions with other competing substances, and genetic influences (e.g., polymorphisms that dictate an increased need for given nutrients; Keen, 1996). Table 22-3 provides a list of several mechanisms underlying the development of deficiencies and common interactions that will be amplified in each of the sections that follow.

## II. COBALT

A large animal (50 to 100 kg) can contain 1 to 2 mg of Co with liver containing about 0.1 mg ( $1.7 \mu\text{mol}$ ), skeletal muscle 0.2 mg ( $3.4 \mu\text{mol}$ ), bone and hair 0.3 mg ( $5.1 \mu\text{mol}$ ) each, and adipose tissue 0.4 mg ( $6.8 \mu\text{mol}$ ) (Smith *et al.*, 1987).

**TABLE 22-3** Potential Causes of Trace Element Deficiencies

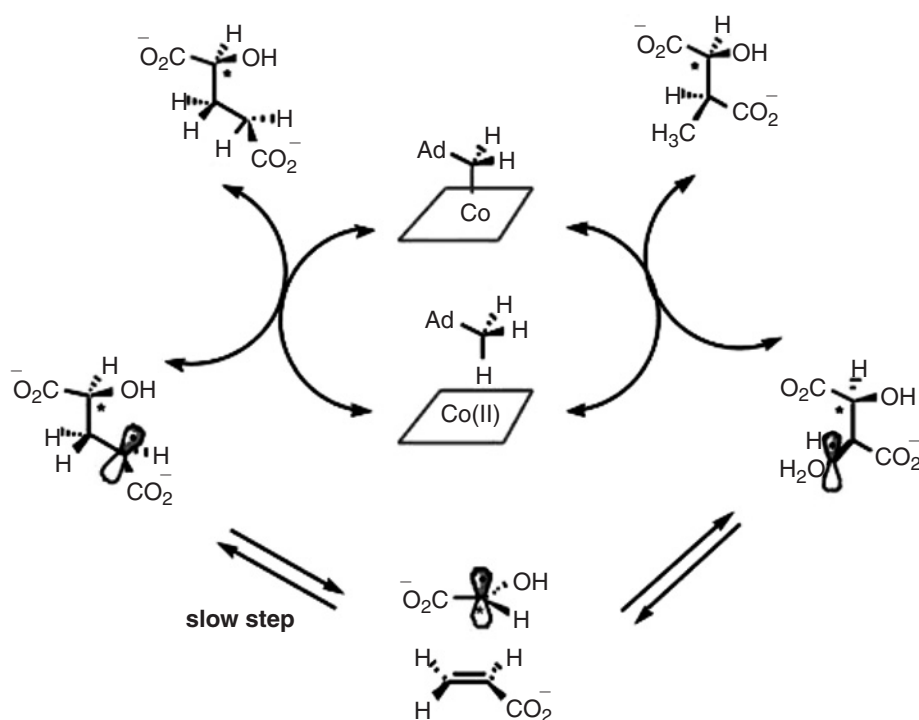
Cause	Mechanism
Food processing	Loss of elements because of refining
Dietary interactions	Competitive interactions between elements
Drug interactions	Impaired absorption or increased excretion; redistribution of elements among tissue pools; decreased absorption (chelators, laxatives); increased excretion (diuretics)
Disease or genetic	Increased requirement because of a block in the normal metabolism of the element (primary); increased requirement because of decreased absorption or increased excretion secondary to the disorder (secondary)

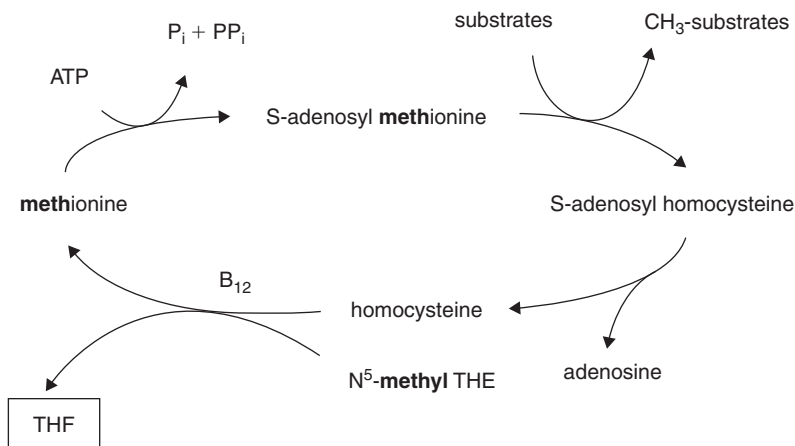
In tissues, Co is normally found associated with vitamin B<sub>12</sub> or cobalamin in all animals that require preformed vitamin B<sub>12</sub>. Cobalt in most tissues is low (picomolar concentrations), with liver, heart, and bone containing the highest tissue levels. Low normal serum cobalamin is approximately 2 to 3 ng cobalamin/ml (1.5 to 2.3 nmol/liter). In contrast to Zn, Cu, and Fe, Co does not accumulate with fetal age and it is not stored to any appreciable degree in the adult animal (Ammerman and Goodrich, 1983; Keen, 1996). With toxicity, tissue Co can increase over 10-fold in cattle (Barceloux, 1999; Domingo, 1989; Lauwerys and Lison, 1994).

## A. Cobalt Function

Cobalt is novel because there is no evidence that any organism needs the cobalt ion, either in the free form or as a simple protein complex. Cobalt in the form of a specific complex, vitamin B<sub>12</sub> or one of the cobalamides, is essential for animals and many bacteria. Plants contain cobalt, but there is no evidence that it occurs as a cobalamide. Vitamin B<sub>12</sub> is also unique among vitamins in that plants do not produce it.

The role of rumen microflora in the economy of ruminant animals makes ionic cobalt of particular significance to this group of animals. Although one cannot dismiss the possibility that some organisms require cobalt other than that in a corrinoid (B<sub>12</sub>-related) complex, there is no such evidence at present and this discussion will hinge primarily around the metabolism and metabolic function of cobalt as it exists in the cobalamides. In aqueous solution, Co is generally in the +2 or +3 oxidation state. Cobaltous ion forms complexes with both octahedral and tetrahedral geometry (Burgess, 1999; Kerber and Goldberg, 2006). All Co complexes are octahedral and most involve nitrogen as the electron donor. The skeletal structure of the cobalamides can be visualized by representing the corrin ring of cobalamides with a planar ring and the ligands by X and Y (see Chapter 23). Both the cobalamides and cobaloximes (simpler cobalt corrin-like structures) act as the catalytic site for intramolecular mutations and single carbon transfer reactions (Frausto da Silva and Williams, 1991). Such reactions are important to tissue and cellular growth; as such, Co is primarily associated with erythropoiesis, granulopoiesis, and glucose homeostasis. Two important enzymes that require vitamin B<sub>12</sub> as a cofactor are (1) methylmalonyl-CoA mutase, which catalyzes the molecular rearrangement of methylmalonyl-CoA to succinyl-CoA:





and (2) 5'-methyltetrahydrofolate-homocysteine methyltransferase, which demethylates 5'-methyltetrahydrofolate and regenerates methionine and tetrahydrofolate.

The former reaction is critical for glucose homeostasis in ruminants because a primary gluconeogenic precursor for these animals is propionic acid. Because propionic acid has three carbons, propionyl-CoA cannot enter  $\beta$ -oxidation nor the citric acid cycle; thus, in most vertebrates it is carboxylated to D-methylmalonyl-CoA, isomerized to L-methylmalonyl-CoA, and rearranged to yield succinyl-CoA via the vitamin B<sub>12</sub>-dependent step shown previously. Succinyl-CoA is an intermediate of the citric acid cycle and can be readily incorporated there.

Another aspect of Co in mammalian systems is the potential pharmacological effect of high doses of Co on erythropoietin production (Katsuoka *et al.*, 1983). Whether physiological concentrations of Co influence erythropoietin production is not known. Dietary requirements (as B<sub>12</sub>) in most animals are usually met either by ingestion of animal tissues or products or by coprophagy. Because of the rumen microflora, ruminants can be fed ionic Co, and the microbes will synthesize cobalamin for absorption. Nevertheless, the relative inefficiency of vitamin B<sub>12</sub> production in the rumen and poor absorption of B<sub>12</sub> predispose ruminants to deficiency. Between 2 and 5 mg/day (1.5 to 3.9  $\mu$ mol/day) of CoCl for sheep and 20 to 30 mg/day (15.4 to 23.1  $\mu$ mol/day) for cattle are required for normal B<sub>12</sub> production (Kennedy *et al.*, 1995; Kincaid *et al.*, 2003).

## B. Absorption and Transport

In rats, 80% of orally administered Co appeared in the feces. High amounts of iron in the diet can depress Co absorption and vice versa. Co absorption is enhanced in iron deficiency (Domingo, 1989). Excretion of Co is primarily via the kidneys and is linearly related to the ingested dose. Additional sites of excretion have been reported to be

the large intestine in chicks and the bile and small intestine in mammals.

Absorption of vitamin B<sub>12</sub> depends on normal gastric parietal cell synthesis of intrinsic factor and a healthy ileal mucosa for the binding and transport of the vitamin B<sub>12</sub>. Response to therapy and a ration containing less than 0.08 mg Co/g (1.4  $\mu$ mol/g) of diet is diagnostic of Co deficiency in ruminants. In sheep, hepatic vitamin B<sub>12</sub> levels of less than 0.1  $\mu$ g/g (0.07 nmol/g), or serum levels of less than 0.3 ng/ml (0.2 nmol/liter), are associated with impending or frank deficiency. Thus, vitamin B<sub>12</sub> status can be used to assess Co adequacy in sheep. Although measurement of plasma cobalamin levels has been considered sufficient for assessment of Co status in sheep, it has been suggested that liver cobalamin should also be included in assessment studies as plasma levels do not always reflect soft tissue levels (Mills, 1987). In this regard, it should be considered that the measurement of plasma cobalamin is complicated by the presence of cobalamin analogues that interfere with the assay (Halpin *et al.*, 1984). Therefore, the measurement of plasma methylmalonate levels is used as an indirect indicator of the functional cobalamin status of the animal. The increase in methylmalonate is due to a reduction in the activity of methylmalonyl-CoA mutase, for which adenosylcobalamin is a cofactor (discussed earlier).

## C. Disorders of Cobalt Metabolism

The signs and biochemical lesions that are manifested in Co deficiency are referable to a deficiency of vitamin B<sub>12</sub>. The pathways that are most severely impaired are those of purine biosynthesis and gluconeogenesis. Deficiencies of Co have been correlated with a reduction in blood glucose and an increase in methylmalonic acid excretion. A primary defect in Co deficiency underlying the previous discussion has been attributed to a reduction in the activity of

methylmalonyl CoA mutase in ruminants. The hepatic lipodosis observed in Co-deficient animals has been attributed to a reduction in choline biosynthesis caused by a reduction in the activity of homocysteine methyltransferase. Vitamin B<sub>12</sub> deficiency reduces the regeneration of methionine, which can impair choline biosynthesis. With a reduction in the activity of this enzyme, Co deficiency can result in a reduction in the regeneration of tetrahydrofolic acid, which can then result in the development of megaloblastic anemia and pancytopenia secondary to impaired purine biosynthesis. A reduction in tetrahydrofolate reduces the available methyl donors and therefore reduces purine biosynthesis (see Chapter 23). The primary signs of Co deficiency are referable to pernicious anemia, granulocytopenia, and chronic wasting, which is secondary to aberrations in amino acid, nucleic acid, carbohydrate, and potentially, lipid metabolism. Another disorder, white liver disease, is a Co-responsive disease of sheep that is characterized by unthriftiness, listlessness, weight loss, ocular discharge, anemia, pale liver, and occasionally, photosensitivity and neurological dysfunction (Kennedy *et al.*, 1997; Mitchell *et al.*, 2007; Smith *et al.*, 1987).

Toxicity in animals under natural conditions has not been reported. Toxic levels appear to be at least 300 to 1000 times the requirement in most species. Cases of toxicity are invariably the result of accidental oversupplementation to prevent deficiency or inhalation of Co sources. Doses in excess of 4-mg/kg body weight (68  $\mu\text{mol/kg}$ ) can be toxic for sheep and ingestion of greater than 1.1 mg/kg (18.7  $\mu\text{mol/kg}$ ) in cattle can be toxic. The major clinical signs include polycythemia, anorexia, fatty infiltration of the liver, pulmonary edema, and depressed growth. Noteworthy, cases of Co intoxication from ingestion of beer have been reported in humans (Barceloux, 1999; Lauwerys and Lison, 1994). In humans, signs of Co toxicity are hyperthyroidism, thyroid hyperplasia, cardiomegaly, and heart failure. Symptoms related to inhalation toxicosis are mostly referable to the lungs and skin with hypersensitivity, dermatitis, and pulmonary fibrosis being the major lesions (Mitchell *et al.*, 2007; Watson, 1998).

### III. COPPER

#### A. Copper Distribution

A large animal can contain 50 to 120 mg (780 to 1889  $\mu\text{mol}$ ) of Cu. In the adult, about one-third of the total body Cu is found in the liver and brain. Most nonruminant species have liver Cu concentrations that are between 2 and 10  $\mu\text{g/g}$  (0.032 to 0.16  $\mu\text{mol/g}$ ). Skeletal muscle, although considered low in Cu, represents about one-third of the total body Cu because of its mass. The remainder of the Cu is fairly evenly distributed throughout the body. The highest concentrations of Cu (>5  $\mu\text{g/g}$ ; >0.079  $\mu\text{mol/g}$ ) are normally present in liver, brain, heart, and hair. Tissues with intermediate

levels of Cu (1.5 to 5  $\mu\text{g/g}$ ; 0.024 to 0.078  $\mu\text{mol/g}$ ) include kidney, pancreas, skin, muscle, and bone. Tissues with low concentrations of Cu (<1.5  $\mu\text{g/g}$ ; <0.024  $\mu\text{mol/g}$ ) include pituitary, thyroid, thymus, ovary, and testis (Keen *et al.*, 2003; Mason, 1979; Smart *et al.*, 1981; Stern *et al.*, 2007). The normal range of Cu in the blood of most healthy animals is between 0.5 and 1.5  $\mu\text{g/ml}$  (7.9 to 23.6  $\mu\text{mol/liter}$ ). In most species, plasma/serum and whole blood Cu concentrations are similar. Birds, fish, and marsupials are characterized by blood Cu concentrations that are about half that of other species (Mason, 1979).

Ruminants have a high storage capacity for Cu in their livers, often exceeding two-thirds of the total body pool. Typical liver Cu concentrations in sheep and cattle range from 20 to 150  $\mu\text{g/g}$  (0.315 to 2 to 36  $\mu\text{mol/g}$ ). Similarly high liver Cu levels have been reported for ducks and some fish. The high liver Cu in ruminants compared to nonruminants is thought to reflect a higher retention rather than a difference in dietary intake of Cu or absorption. Copper concentrations in other ruminant tissues are similar to those reported for nonruminants. For most species, the newborn is characterized by liver Cu concentrations that are markedly higher than those found in adults. However, the Cu in most other tissues tends to be higher in the adult than in the newborn (Stern *et al.*, 2007).

It has been suggested that the high liver Cu in the newborn can represent a reserve pool of Cu for the rapidly growing neonate. Several cases of Cu deficiency have been reported in premature infants. In sheep, liver Cu in the newborn is lower than in adults, and in cattle, newborn and adult liver Cu is similar (Keen, 1996).

For all species studied, the pigmented tissues of the eye are particularly high in Cu, with very high levels associated with the melanins. The function of this Cu in the eye is not known. Except in certain disease states and in deficiency, the body Cu content is homeostatically controlled, and there is little accumulation of Cu in the eye (Krajacic *et al.*, 2006).

#### B. Copper Functions

Copper has two major functions. It can be a structural component in macromolecules acting as a coordination center. It is also a common redox cofactor for a number of oxidases and monooxygenases that are essential for life, owing to its ability to cycle between reduced and oxidized states.

Perturbations in the activity of these enzymes because of poor Cu dietary status can be linked to specific biochemical steps and lesions. For example, poor growth, reproduction, skeletal, and vascular formation can result from a lack of lysyl oxidase and cytochrome C oxidase. Impaired immunity, neurological function, oxidant defense, and depigmentation resulting from Cu deprivation can also

be linked to specific enzymes such as Cu-Zn superoxide dismutase (CuZnSOD), which catalyzes the dismutation of the superoxide anion; dopamine  $\beta$ -hydroxylase, responsible for noradrenalin and adrenalin production; and melaninase, responsible for melanin production (Keen *et al.*, 2003; Rucker *et al.*, 1998; Stites *et al.*, 2000; Tinker and Rucker, 1985).

A diverse array of physiological symptoms, particularly during the perinatal period, can occur including hypotension, muscle hypotonia, hypothermia, and hypoglycemia. Moreover, elastin and collagen from Cu-deficient animals have an elevated content of lysine and a low content of various cross-linking amino acids. Loss of cross-linking results in defects in the elastic properties of arteries and decreases in bone strength and the tensile strength of various connective tissues. A reduction in CuZnSOD can increase hydrogen peroxide and superoxide radicals that can irreversibly oxidize proteins, nucleic acids, lipids, and carbohydrate components within cytoskeletal structures and the cell wall.

Changes in Cu status, particularly in the fetus and neonates, have been associated with perturbations in nitric oxide (NO) metabolism, a key signaling molecule to endothelial cell responsiveness (e.g., contraction and relaxation). Moreover, when an increase in hydroxyl radical occurs, because of a reduction in CuZnSOD activity, the reaction of peroxide radicals with NO can produce peroxynitrite. Peroxynitrite, another potent oxidant, can cause ATP depletion and peroxynitrite-induced nitration of tyrosine residues on proteins. Many of the neurological signs and endothelial changes associated with Cu deficiency are thought to be the result of altered NO metabolism (Schuscha, 1997; Yang *et al.*, 2007) and peroxynitrite-induced lesions (Fig. 22-3).

Other Cu-containing enzymes include tryptophan oxygenase, ascorbate oxidase, tyrosinase, amine oxidases, peptidyl-glycine- $\alpha$ -amidating monooxygenase, and possibly some fatty acid desaturase enzymes such as C18  $\Delta^6$ -desaturase. It has been suggested that Cu can also be involved in a nonenzymatic manner in neuropeptide release from the brain.

### C. Dietary Copper

Copper absorption from diets is relatively efficient, although some dietary constituents can affect bioavailability. Copper hydroxides, iodides, glutamates, and citrates are more easily absorbed than molybdates, sulfates, and phytates. High intakes (100 or more mg/kg of diet) of Ag and Zn can interfere with intestinal copper transport. Moreover, the extended use of supplements that contain iron can negatively affect copper status. Cu absorption is greater in neonates than in adults (Committee on Copper in Drinking Water, 2000; Stern *et al.*, 2007).

Another interaction that has attracted attention involves Cu, Mo, and sulfate. Particularly in ruminants, dietary sulfate

intensifies the harmful effects of Mo on Cu absorption.  $\text{CuSO}_4$  and  $\text{Na}_2\text{MoO}_4$  react to form an insoluble complex referred to as a thiomolybdate, which renders Cu biologically less active and less bioavailable (see Section V).

Nutritional Cu deficiency occurring outside of the laboratory has been well documented in a variety of species including humans, cattle, sheep, pigs, and horses. The recommended minimal daily requirements for Cu for a number of species are presented in Table 22-2. Given that the uptake of Cu from a diet can be influenced by other dietary factors as well as the physiological state of the animal, under some conditions, a diet cannot contain sufficient Cu for the animal even though the level of Cu in the diet is at the level suggested in the NRC tables.

Food items that are high in Cu include nuts, dried legumes, dried vine, and dried stone foods (300 to 400  $\mu\text{g/g}$ ; 4.72 to 6.30  $\mu\text{mol/g}$ ). Food items considered low in Cu content ( $<1 \mu\text{g/g}$ ; 0.016  $\mu\text{mol/g}$ ) include dairy products and sugar, refined cereals, fresh fruits, and nonleafy vegetables contain about 7  $\mu\text{g}$  Cu/g (0.11  $\mu\text{mol/g}$ ). Copper in typical animal feeds can range from 20  $\mu\text{g/g}$  (0.315  $\mu\text{mol/g}$ ) (cottonseed meal) to 2 (0.032  $\mu\text{mol/g}$ ) (corn), with the concentration being highly dependent on soil conditions and fertilizer practices.

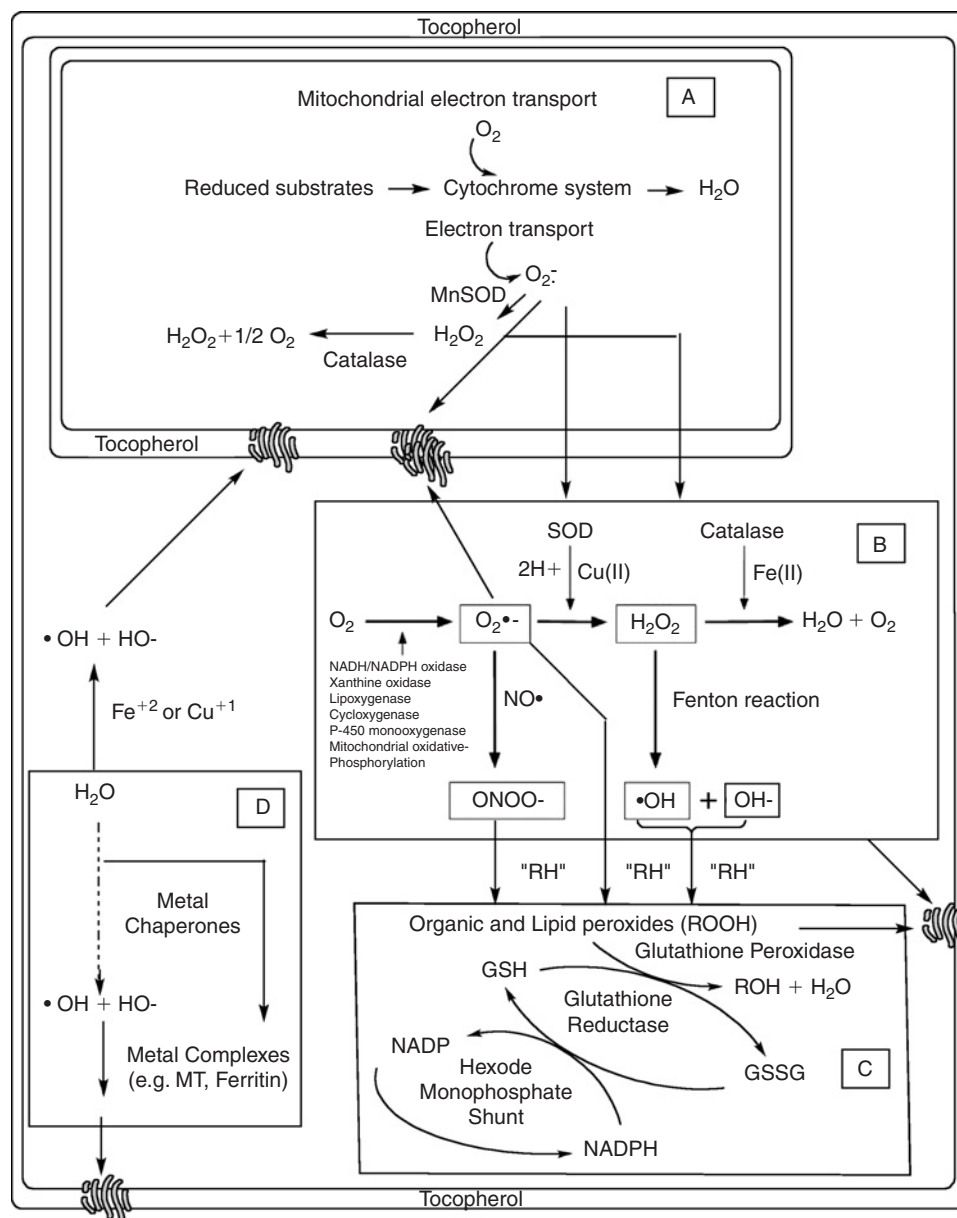
## D. Copper Metabolism, Absorption, and Transport

### 1. Cellular Transport and Regulation

Copper is absorbed in all segments of the gastrointestinal tract. For most species, absorption occurs in the upper small intestine, but in sheep considerable absorption also occurs in the large intestine. Absorption of Cu is about 30% to 60% with a net absorption of about 5% to 10% owing to the rapid excretion of newly absorbed Cu into the bile. A delicate balance between Cu uptake and efflux maintains copper homeostasis (Cromwell *et al.*, 1989; Gooneratne *et al.*, 1989; O'Dell and Sunde, 1997; Reilly, 2004; Stern *et al.*, 2007; Theile, 2003).

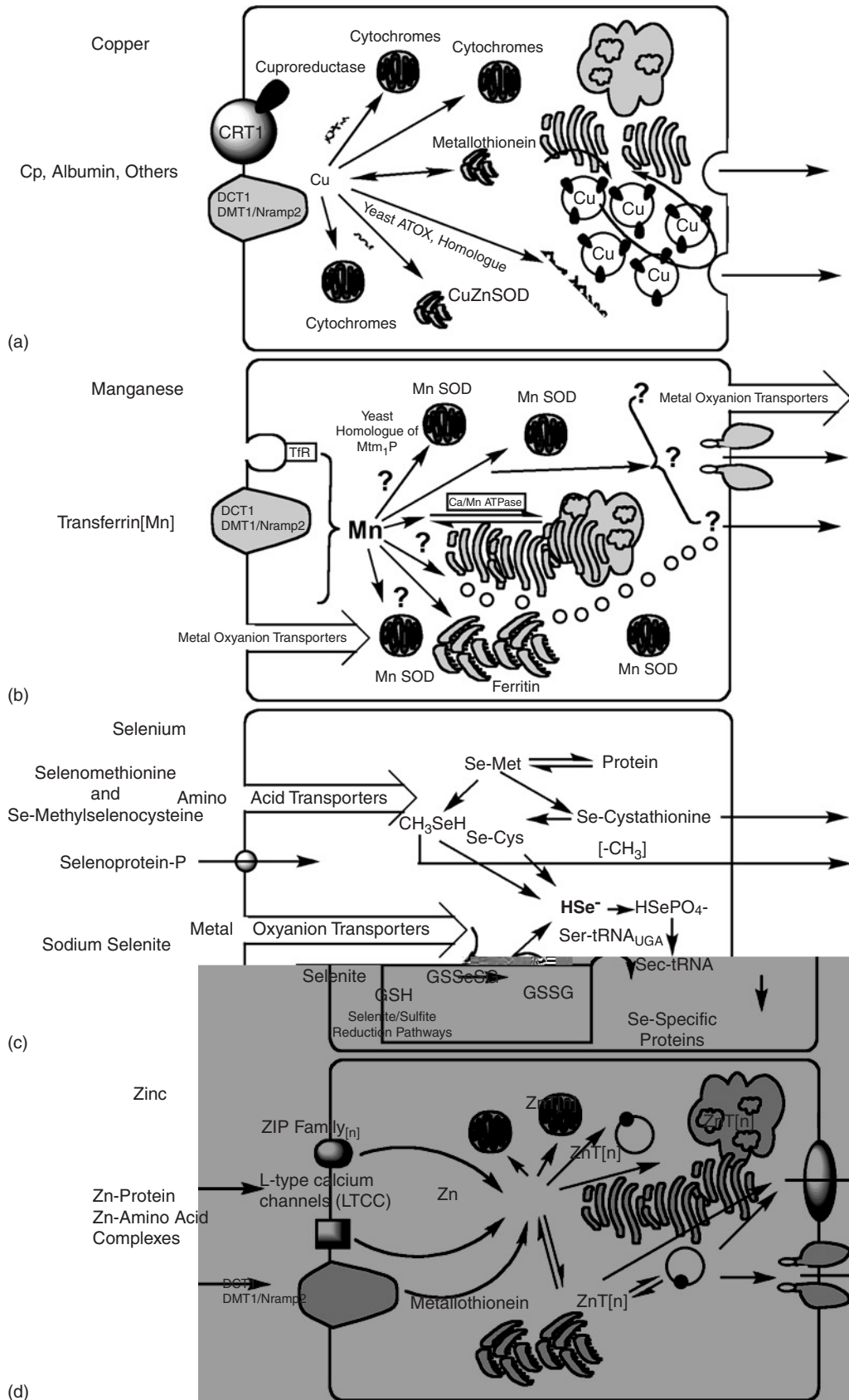
Cu uptake occurs through both high- and low-affinity transport systems (Fig. 22-4). Environmental factors can influence the response to transporters. Most important are factors that influence solubility and redox state. Cu exists in two different valence states; the cupric ion ( $\text{Cu}^{+1}$ ) is the primary substrate for the transport systems that take Cu across plasma membranes. Reduction ( $\text{Cu}^{+2} \rightarrow \text{Cu}^{+1}$ ) is catalyzed by plasma membrane reductases (Theile, 2003). However, the cuprous ion ( $\text{Cu}^{+2}$ ) in the intestinal lumen is more soluble than the cupric ion ( $\text{Cu}^{+1}$ ). Chemical reduction of luminal contents (e.g., by reducing agents such as ascorbic acid) can decrease the amount of Cu that is bioavailable (i.e., affectively delivered to the surface of intestinal cells). It is important, however, to note several caveats. Observations in humans suggest that the effects of ascorbic





**FIGURE 22-3** Major sources and regulation of reactive oxidant species (ROS) in cells. Depending on the stage of development and condition, on a per mole basis ROSs are normally generated at rates of 1% to 4% of the oxygen consumed or greater when ROS regulation is disrupted. A major source of ROS is derived from superoxide anion ( $O_2^{\cdot-}$ ) generated in the mitochondrion (A) because of uncoupling from the cytochrome oxidase system during mitochondrial electron transport. In addition to water and oxidized metabolites as products, superoxide anion and  $H_2O_2$  are produced. Enzymes, such as catalase and MnSOD (localized in the mitochondria) control excess production of  $O_2^{\cdot-}$  and  $H_2O_2$ . When there is subsequent leakage from mitochondria, an increase in the cellular pool of ROS occurs owing both to ROSs from mitochondria and production from other organelles and cytosol (B). Sources of ROSs from other organelles and cytosol are the products from reactions catalyzed by NADH and NAPH oxidases, xanthine oxidase (activated during ischemic injury), lipoxygenase, and P450 monooxygenase enzymes (localized mainly in the smooth endoplasmic reticulum and responsible for the metabolism of xenobiotics, drugs, and secondary metabolites). In addition, excess ROS can potentially alter nitric oxide metabolism (e.g., formation of peroxynitrites) and cause the generation of organic and lipid peroxides and so-called Fenton products (C). For example, "RH," used to depict numerous aromatic and lipid-derived possibilities as potential reactants, can be converted to ROOH, potential organic peroxide-containing products. Excess superoxide anion, ROOH,  $OH^-$ ,  $OH\cdot$ , and other ROSs can then damage proteins, nucleic acids, and lipids, particularly lipid structures in cell and organelle membranes. Important to this discussion, metals can act as both catalysts for ROS formation and cofactors for antioxidant enzymes that modulate influence ROS metabolism. For example, (1) MnSOD and CuZn SOD (superoxide dismutases) cause the dismutation of excess superoxide anion to peroxide, (2) catalase (contains Fe) and glutathione peroxidase (contains Se) can control excess of both hydrogen and organic peroxides. As an additional defense, metal chaperones (see text), metallothionein (MT), or ferritin control "free" metal ion concentrations in cells that are capable of redox (D). Redox metals (Fe or Cu) can act as Fenton catalysts and promote the homolytic cleavage of  $H_2O_2$  to  $OH\cdot$  and  $OH^-$ , which are highly damaging oxidants. Reduction in the concentration or sequestration of metals (depicted by the dashed line) markedly reduces potential Fenton products. As a final line of defense, tocopherols and polyphenolic and related phytochemicals, which localize to lipid membranes, provide additional ROS defense.





**FIGURE 22-4** Cellular transport. Features important to the transport of copper, manganese, selenium, and zinc are summarized. For features related to cobalt (and vitamin B<sub>12</sub>), refer to the vitamin chapter and for molybdate see Figure 22-5. (a) Dietary copper is presented to intestinal cells in the form of protein and amino acid complexes, and in plasma, Cu is bound to a number of proteins; however, it is most often associated with albumin and ceruloplasmin. The transport and cellular metabolism of Cu depend on a series of membrane proteins and smaller soluble peptides that constitute a functionally integrated system for maintaining cellular Cu homeostasis. The high-affinity copper transporter (CTR1) of the plasma membrane mediates

acid on Cu absorption are modest and probably occur only at the extremes of ascorbate intake (Jacob *et al.*, 1987; Lonnerdal, 1998; Stern *et al.*, 2007).

From a conceptual perspective, studies in yeast have shed light on proteins involved in the process of Cu transport. For example, in *S. cerevisiae*, high-affinity Cu ion uptake has been characterized as temperature and ATP dependent. Cu ion uptake appears to be coupled with  $K^+$  efflux with a 1:2 stoichiometry, suggesting that the process takes place via a  $Cu^+/2K^+$  antiport mechanism. In yeast, the gene for Cu reductase activity, designated *FRE1*, is regulated by activation of a transcription factor in response to cellular Cu levels (Pena *et al.*, 1999; Puig and Theile, 2002; Stern *et al.*, 2007; Theile, 2003). In mammalian cells, the entry of Cu into cells is first orchestrated by the action of a reductase and then contact with a high-affinity Cu transporter, currently designated as Ctr1 and Ctr3 (Ctr2 is a low-affinity transporter). High-affinity Cu uptake is saturable with a  $K_m$  of  $1-4 \mu\text{mol/l}$ . Under Cu-limiting conditions, there is evidence that the transporters and proteins involved in Cu redox are up-regulated, whereas under Cu-replete conditions, they are down-regulated (Theile, 2003). Of some significance, Ag and Zn ions can compete for Cu by using the Ctr transporters. Zn and Ag ions have similar chemical characteristics as  $Cu^{+1}$ . Effective competition does not occur except at intakes 5 to 10 or more fold the Zn requirement and when Cu intake is marginal (Committee on Cu in Drinking Water, 2000; Stern *et al.*, 2007).

In addition to the transporters, cellular chaperones specific for Cu deliver Cu to specific cellular proteins (Fig. 22-4). Other important features of Cu regulation include the role of metallothionein, a divalent metal-binding protein for Cu, Zn, Hg, and Cd, which acts to buffer shifts in the cellular concentrations of Cu (and Zn). Cu egress or transport out of cells is controlled by P-ATPase Cu-transporters that are located on the surface of vesicles that arise from Golgi processing. Although a change in Cu status does not appear to alter Cu-transporting P-ATPase gene expression, it can affect the movement of copper-containing vesicles to and from that outer cell membrane. Cu homeostasis must be coordinated, as the release of free Cu ions can cause damage to cellular components by catalyzing the generation of reactive oxidant species (ROS).

Free cuprous ions (and ferric) react readily with hydrogen peroxide to yield deleterious hydroxyl radicals. Accordingly, Cu homeostasis is regulated tightly, and unbound Cu is extremely low in concentration ( $\sim$ one atom/cell). For example, Atox1, a chaperone that delivers Cu into egress or efflux pathways, docks with a Cu-transporting ATPase (ATP7B in the liver or ATP7A in other cells). ATP7B directs Cu to plasma ceruloplasmin or to biliary excretion in concert with another chaperone, Murr1, the protein missing in certain types of canine Cu toxicosis. ATP7A directs Cu within the trans Golgi network to the proteins dopamine  $\beta$ -monooxygenase, peptidylglycine  $\alpha$ -amidating monooxygenase, lysyl oxidase, and tyrosinase, depending on the cell type (Stern *et al.*, 2007; Theile, 2003).

**FIGURE 22-4** (Continued) nearly all Cu uptake under low copper conditions. It is one of a family of proteins involved in Cu transport that is transcriptionally induced at low copper levels and degraded at high copper levels. Associated with this transporter is a copper reductase that maintains Cu in the +1 state (its most soluble form) while in the vicinity of the transporter. Next, Cu is transferred to chaperones whose functions are to carry copper to specific proteins within the cell (e.g., COX-17  $\rightarrow$  cytochromes, ATOX  $\rightarrow$  vesicular P-ATPases, CCS  $\rightarrow$  SOD). Copper egress (efflux) is accomplished by a novel process, the transport of copper into secretory vesicles via post-Golgi processing. This occurs coincidentally with efflux of specific apocuproproteins (see text) that are localized to the same vesicles. On the membrane of the vesicles, two membrane-bound Cu-transporting ATPase enzymes, ATP7A and ATP7B, catalyze an ATP-dependent transfer of Cu to intracellular compartments or expel Cu from the cell (from the Golgi to and from the cell membrane). In response to a high level of cellular Cu, there is recycling of the vesicles at higher rates to more effectively remove copper. Within the vesicles, apocuproproteins can also become activated. Consequently, secreted cuproproteins with enzyme activity, such as lysyl oxidase or ceruloplasmin, often reflect Cu status or dietary intake. Some evidence also suggests DMT or Nramp transporters important to iron transport can play a minor role in copper uptake. (b) Intestinal and systemic cellular manganese transport is mediated mostly by divalent metal transporter 1 (DMT1) and is up-regulated in iron deficiency. Within the body, Mn bound to transferrin is taken up by transferrin receptors. Unlike other transition metals, which are not found in "free" ion forms in cells, the behavior of Mn is analogous to Mg (i.e., dissociable ion exists). Less is known currently about specific chaperones than for copper or zinc. Excess Mn in cells is sequestered on ferritin. A Golgi-derived ATPase has been described to facilitate the movement of Mn from and to the nucleus and cis- and trans-Golgi compartments. Although the evidence is indirect that other types of ion channels and vesicular egress play a role in Mn cellular transport, given that  $MnO_4^-$  anion can be transported in addition to  $Mn^{+2}$  and  $Mn^{+3}$ , a role for oxyanion transport is indicated. (c) Selenium is delivered to cells via amino acid and oxyanion transporters and when present in plasma via processes that recognize selenoprotein P. The selenite and selenate forms must first be reduced (via a glutathione reduction system) to HSe- before Se can be utilized as a cofactor. Selenomethionine, if not incorporated into protein, can also be eventually converted to HSe-. Next, for incorporation into specific Se-proteins (e.g., GPx, 5'-ID, or Se-protein P), HSe- is phosphorylated (requires ATP). Then following transfer to Ser-tRNA<sub>UGA</sub> to form Se-Cys-tRNA<sub>UGA</sub>, the stage is set for translation of Se-containing proteins. Regarding cellular efflux, Se is lost from cells as secreted Se-proteins, such as selenoprotein P, Se-cystathionine, or as volatile forms of methylated Se (e.g.,  $CH_3-Se-CH_3$ ). (d) Zinc uptake and cellular translocation are controlled by two large families of metal transporters for which there more than two dozen variants. More specifically, the two solute-linked carrier (SLC) gene families encode the zinc transporters: ZnT (SLC30) and Zip (SLC39). The ZnT transporters reduce intracellular zinc availability by promoting zinc efflux from cells or into intracellular vesicles, whereas Zip transporters increase intracellular zinc and promote extracellular zinc uptake. The ZnT and Zip transporter families exhibit unique tissue-specific expression and differential responsiveness to dietary Zn intake and to physiological stimuli. Temporary influxes of Zn are buffered by the induction of metallothionein. DMT1 and over-ion channels can play minor roles in Zn transport.

## 2. Systemic Regulation of Cu

From the intestine, a case can be made for the transport of Cu on albumin and in the form of low-molecular-weight complexes (e.g., histidine) to target tissues, particularly the liver. From the liver, ceruloplasmin seems to aid in the transport of Cu to other tissues. Ceruloplasmin is the predominant Cu-containing protein in mammalian serum, a glycosylated multi-Cu ferroxidase that carries >95% of total serum Cu. Surprisingly, whereas ceruloplasmin can function in Cu transport, the absence of ceruloplasmin has not been shown to alter Cu levels in the peripheral tissues. Such observations come from what is known about individuals and animal models that have aceruloplasminemia, a genetic disorder of ceruloplasmin deficiency. Moreover, analbumemic rats do not have significantly impaired Cu metabolism. Apparently Cu movement from serum proteins to the cell surface reductase-Ctr transporters is not highly specific (Hellman and Gitlin, 2002).

## 3. Disorders of Cu Metabolism-Cu Deficiency

A number of pathologies are associated with Cu deficiency that represent perturbations in the functions of Cu outlined earlier. For example, anemia (microcytic hypochromic or normocytic hypochromic) is probably the most frequent sign associated with chronic Cu deficiency. Cu deficiency results in impaired normal iron absorption (O'Dell and Sunde, 1997), mobilization, and utilization, partly because of Cu's role as a redox cofactor in various membrane associated ferroxidases that oxidize  $\text{Fe}^{+2}$  and  $\text{Fe}^{+3}$ , thereby promoting the transfer of iron to transferrin. Reduced aminolevulinic acid dehydrase, important to the first step in heme synthesis, is also decreased in Cu deficiency. Heinz body anemia caused by ROS can also develop with a significant depression of CuZnSOD activity (O'Dell and Sunde, 1997).

Cardiovascular defects have been associated with Cu deficiency since the 1950s. In cattle, Cu deficiency can result in severe degeneration of the myocardium with fibrosis ("falling disease"). Sudden death is a frequent observation and is thought to be due to acute heart failure. Cardiac failure associated with cardiac hypertrophy has also been reported in Cu-deficient rats. A number of biochemical lesions can underlie the changes in the heart observed with Cu deficiency (e.g., decreased cytochrome oxidase activity, abnormalities in cardiac and vessel wall elastin and collagen structure because of lysyl oxidase, and low cardiac norepinephrine levels, which can decrease coronary resistance and reduce systolic pressure) (Tinker and Rucker, 1985). In experimental Cu deficiency in young animals, such as turkey poults, aortic aneurysms can occur (Savage *et al.*, 1966). This is the result of poor biomechanical properties of elastic fibers (constitutes as much as 50% of the total protein in aorta) that are weakened as a result

of defective and reduced cross-linking. Such elastin is also susceptible to degradation and lost. Contrast this condition with normal elastin that normally has a biological half-life best measured in months to years (Tinker and Rucker, 1985).

In addition, skeletal defects have been reported in Cu-deficient dogs, sheep, chicks, cattle, foals, and humans. The primary biochemical lesion underlying development of bony lesions in Cu-deficient animals is again a reduction in the activity of lysyl oxidase leading to a reduction in the cross-linking of bone collagen, thus reducing bone stability and strength analogous to the situation with elastin (Tinker and Rucker, 1985).

An increased rate of tissue lipid peroxidation is another mechanism by which Cu deficiency can contribute to a wide variety of lesions. In addition to the depression in CuZnSOD activity, Cu deficiency can reduce the activity of selenium(Se)-dependent glutathione peroxidase (GPx). Thus, two major components of the cells' antioxidant defense system can be affected by Cu deficiency. Another lipid alteration is hypercholesterolemia (Engel *et al.*, 2000; Gooneratne *et al.*, 1989; Keen *et al.*, 2003; Mills, 1987; Schuscha, 1997). In Cu-deficient animals, total cholesterol and free cholesterol levels are elevated and are associated with high concentrations of high- and low-density lipoproteins (HDL and LDL). The lipid composition of HDL isolated from Cu-deficient animals has been reported to be similar to that of Cu-supplemented animals, but the HDL has been shown to be enriched in apo F. A primary biochemical lesion underlying the hypercholesterolemia is a reduction in hepatic HDL binding that results in a slower turnover of HDL and leads to an accumulation of apo E-rich HDL. Both of these phenomena, lipid peroxidation and abnormal lipid transport, are important features that underlie abnormal membrane function.

Important to Cu's role in oxidative defense are observations that link Cu status to NO metabolism, an important mediator of cellular regulation. NO can be synthesized in both the cytosol and mitochondria (Wu and Meininger, 2002). Among its major functions as a signaling molecule, NO modulates oxidative phosphorylation and protects mitochondria from oxygen radicals. This process, however, depends on optimal cytochrome oxidase and CuZnSOD activities. Cu deficiency limits NO availability, because in the presence of ROS, NO is converted to products, such as peroxynitrite, thus altering NO-dependent signaling and contributing to processes that can range from abnormal development to aging to neurological and cardiovascular disorders. Indeed, many neurological signs can be associated with Cu deficiency, owing to Cu's role as a cofactor in dopamine  $\beta$ -monoxygenase and in influencing NO metabolism (Wu and Meininger, 2002). A classical example of a neurological disorder is neonatal ataxia.

Neonatal ataxia has been shown to be a consequence of perinatal Cu deficiency in lambs, goats, swine, guinea

pigs, deer, camels, and rats. Originally described in lambs, the disorder, which is often referred to as enzootic ataxia or swayback, is characterized by spastic paralysis, especially of the hind limbs, severe incoordination of movement, blindness in some cases, and anemia. The brains of affected animals are smaller than normal with collapsed cerebral hemispheres and shallow convolutions and are characterized by a paucity of myelin. It has been suggested that the neural lesions associated with enzootic ataxia are in part the result of a Cu deficiency-induced reduction in brain cytochrome oxidase activity and impairment in phospholipid synthesis with a subsequent block in myelin synthesis. Motor incoordination and tremors have been ascribed to the effects of perinatal Cu deficiency on brain catecholamine metabolism. Norepinephrine levels are decreased in the whole brain and brainstem. The reduction in norepinephrine levels is most likely due to a decreased activity of dopamine beta-hydroxylase (monoxygenase), which catalyzes the hydroxylation of dopamine to norepinephrine (Engel *et al.*, 2000; Gambling and McArdle, 2004; Gooneratne *et al.*, 1989; Keen *et al.*, 1998).

Additional consequences of Cu deficiency, particularly during early development, are alterations in the immune system and systemic metabolism. Regarding immune function, effects of Cu deficiency include impaired neutrophil function, increased susceptibility to bacterial infections, decreased resistance to tumor challenge, reduced cell-mediated and humoral immunity, and alterations in lymphocyte subpopulations. Arthur and Boyne (Arthur and Boyne 1985; Boyne and Arthur, 1986, 1990) reported that the loss of neutrophil microbicidal activity associated with Cu deficiency in cattle is secondary to a failure to produce superoxide within the neutrophil phagosome. A primary biochemical defect can also be a reduction in lymphopoiesis secondary to a decrease in erythropoiesis. Cu deficiency also reduces splenocyte production of interleukin-1 and T cell replacing factor. Thus, it is possible that some of the immune defects observed in Cu-deficient animals are the result of reductions in hormonal signals (Arthur and Boyne, 1985; Boyne and Arthur, 1986, 1998; Gooneratne *et al.*, 1989; Keen *et al.*, 1998; Milanino and Buchner, 2006).

Regarding metabolism, abnormal pancreatic function is associated with marginal Cu deficiency.

Histological lesions suggest that the basic biochemical defect is one of excessive membrane lipid peroxidation or serum protease infiltration (Tosh *et al.*, 2007). Altered insulin secretion and glucose regulation can also be disturbed.

#### 4. Cu Excesses

Acute Cu toxicity is rarely a serious problem in domestic animals, probably because of the strong emetic effect of the element. In contrast, chronic Cu toxicosis is a frequent occurrence in some species, particularly sheep. In sheep,

there are two phases associated with Cu toxicosis. In the first phase, there is a gradual accumulation of Cu in tissues and a rise in serum aspartate aminotransferase, lactate dehydrogenase, sorbitol dehydrogenase, arginase, and glutamic dehydrogenase. As liver Cu accumulates, there is swelling and necrosis of the hepatic parenchymal cells and Kupffer cells resulting in a focal necrosis of liver tissue. The primary biochemical lesion arising from Cu toxicosis is thought to be Cu-initiated free radical damage. The hemolysis can also occur with Cu toxicity and is thought to be a result of changes within the erythrocyte rather than a direct effect of Cu on the erythrocyte membrane. During the hemolytic crisis, sheep have swollen, partially cirrhotic livers and dark, hemoglobin stained kidneys. Renal and hepatic tissues from Cu intoxicated sheep with hemolytic crises have cytoplasmic lipofuscin granules in the renal tubular epithelium and hepatic parenchyma, suggesting lysosomal rupture. Additional pathology can occur in the white matter of the cerebrum, pons, and cerebellum.

Liver Cu has also been shown to be markedly elevated in animal models for diabetes, but it is not clear if similar increases occur in spontaneous diabetes or whether the increased liver Cu represents increased risk of liver disease. Kidney Cu concentrations can also be markedly increased with diabetes. However, similar to other metabolic and inflammatory-induced elevations in hepatic Cu levels, it is not known if the diabetes-associated changes in renal Cu represent a threat (Keen and Uriu-Adams, 2005).

#### 5. Cu-Related Genetic Models and Other Conditions (e.g., Prions)

Genetic defects mimicking Cu deficiency have been reported for humans (Menkes' disease) and mice (mottled mutants). Menkes' disease is X-linked and is characterized by progressive degeneration of the brain and spinal cord, hypothermia, connective tissue defects, and failure to thrive (Keen *et al.*, 1998; Pena *et al.*, 1999; Puig and Thiele, 2002; Stern *et al.*, 2007; Thiele, 2003). Death often occurs before 3 years of age. The mottled mutants have been developed as animal models for Menkes' disease. It is now appreciated that the major defect is gene deletions and transpositions associated with Cu-ATPase-7A. There is a lack of normal copper egress from cells. Cu is not directed to lysyl oxidase and some cases other proteins (dopamine beta-monoxygenase, peptidylglycine a-amidating monoxygenase, or tyrosinase depending on the cell type). Thus, lesions arise associated with defects in collagen and elastin metabolism and Cu catalyzed oxidative damage.

Similarly, genetic defects mimicking Cu toxicity have been reported in humans (Wilson's disease) as well (Theile, 2003). Wilson's disease is an autosomal recessive inherited disorder of Cu metabolism in which there is a failure to excrete Cu through the biliary system because of a mutation in the gene coding for an ATPase Cu pump.

Corresponding defects in the Cu-transporting ATPase, P-ATPase-7B, in the liver also occur. Recall that this ATPase directs Cu to plasma ceruloplasmin or to biliary excretion. Patients with Wilson's disease frequently present with one of three major clinical problems, liver disease (liver failure, hepatitis, or chronic cirrhosis), neurological signs (slurred speech, difficulty controlling facial muscle, or dystonia), or psychiatric problems. Unlike Menkes' disease, Wilson's disease is treatable if diagnosed early with Zn, Cu chelators (e.g., penicillamine).

A proposed analogue of this disorder in animals is Cu toxicosis in Bedlington terriers, which affects up to 60% of the breed (Haywood, 2006). Dogs homozygous for the gene are characterized by extremely high liver Cu concentrations often exceeding 500 micrograms/g (7.87 micromol/g) compared to controls of less than 75 micrograms/g (1.180 micromol/g). The associated hepatic injury is thought to be due to a Cu-initiated, free radical damage and lysosomal rupture. Several other breeds, including West Highland white terriers, Skye terriers, Dobermans, Dalmatians, and Keeshounds, have been identified as having Cu-associated liver disease as well (Haywood, 2006).

The mechanism by which Cu toxicosis occurs in Bedlington terriers, however, adds another dimension to Cu regulation and the P-ATPase relationship. Although eleven polymorphisms, two in the coding region, have been identified in the Bedlington terrier ATP7B gene, another gene, COMMD1 (Cu metabolism gene MURR1), has been identified that seems to function as a Cu chaperone. COOMD1 belongs to a family of multifunctional proteins whose functions have been linked to inhibition of nuclear factor NF- $\kappa$ B to Cu transport (Forman *et al.*, 2005; Haywood, 2006; Spee *et al.*, 2006). COMMD1 was implicated as a regulator of Cu metabolism by its proposed role in Cu delivery to P-ATPase-7B (see Fig. 22-4). Without P-ATPase-7B or the chaperone, Cu is sequestered in liver and promotes ROS-related lesions (Haywood, 2006).

With regard to Cu toxicity, chelation therapy can be effective for the treatment. The chelating drugs with worldwide application are dimercaprol, succimer, unithiol, D-penicillamine, N-acetyl-D-penicillamine, calcium disodium ethylenediaminetetraacetate, calcium trisodium or zinc trisodium diethylenetriaminepentaacetate, deferiprone, triethylenetetraamine (trientine), N-acetylcysteine (NAC), and Prussian blue. Penicillamine and diethylenetriaminepentaacetate derivatives are often used first when there are clear indications that an excess of Cu is the problem. Monitoring Cu status, however, is important with the use of any chelating agent or dietary approach (increasing the Zn intake) to diminish the prospects of a secondary Cu deficiency (Seguin and Bundy, 2001; Willis *et al.*, 2005).

As a final comment, transmissible spongiform encephalopathies (TSEs) are a family of neurodegenerative diseases characterized by their long incubation periods, progressive neurological changes, and spongiform appearance in

the brain. There is now evidence that TSEs are caused by an isoform of the normal cellular surface prion protein PrPC. The normal function of PrPC is still unknown, but it exhibits properties of a cuproprotein, capable of binding Cu ions.

There are two differing views on Cu's role in prion diseases. Whereas one view looks at the PrPC Cu binding as the trigger for conversion to PrPSc, the opposing viewpoint sees a lack of PrPC Cu binding resulting in the conformational change into the disease-causing isoform. Manganese and Zn have also been shown to interact with PrPC (Leach *et al.*, 2006).

## E. Evaluation of Cu Status

Measurement of plasma/serum Cu concentrations can be useful in suspected cases of Cu deficiency as low levels are diagnostic. Similarly, measurement of plasma/serum ceruloplasmin levels in suspected cases of deficiency can be useful, as 90% of the Cu present in plasma/serum is associated with this protein. Another possibility is the analysis of diamine oxidase (Legleiter and Spears, 2007). However, it should be noted that because synthesis of ceruloplasmin (an acute phase protein) can increase in acute or chronic infections; thus, a normal or elevated plasma or serum ceruloplasmin level does not rule out a deficiency. Increased synthesis of ceruloplasmin is thought to be in part mediated by a leukocyte endogenous mediator, and excessive production of ceruloplasmin is a consequence of a number of diseases that can result in marked redistribution of hepatocyte Cu pools into plasma. Elevated plasma or serum Cu concentrations have been reported to occur as a result of excessive Cu feeding in rats, sheep, and pigs, however, given that high plasma/serum Cu levels can also reflect a number of stress syndromes, a finding of high whole blood or plasma Cu levels should not be the sole criterion for diagnosis of Cu toxicosis (Stern *et al.*, 2007).

In sheep and cattle, Cu concentrations below 0.5  $\mu$ g/ml are considered diagnostic for Cu deficiency. Although measurement of whole blood Cu has been widely used in diagnosing Cu deficiency, it is currently thought that measurement of erythrocyte CuZnSOD is preferable as it better reflects the functional Cu status of the animal. Complementary measurements of Cu chaperones, such as CCS, may also be eventually used for assessment (Keen and Uriu-Adams, 2006).

Liver Cu concentrations have been used as an indicator of Cu status in animals. The effect of low Cu diets on liver Cu levels can be dramatic. Ataxic lambs suffering from Cu deficiency can have levels below 5  $\mu$ g/g (0.079  $\mu$ mol/g) compared to control levels of 25 to 75  $\mu$ g/g (0.394 to 1.181  $\mu$ mol/g). Similarly, high levels of dietary Cu elevate hepatic Cu content. Levels in excess of 500  $\mu$ g/g (7.87  $\mu$ mol/g) in adult sheep have been reported.

## IV. MANGANESE

### A. Manganese Distribution

A large animal can contain from 10 to 20 mg (182 to 364 micromole) of Mn, which is fairly uniformly distributed throughout the body. There is relatively little variation among species with regard to tissue Mn concentrations (O'Dell and Sunde, 1997). Bone, liver, and kidney tend to have higher concentrations (1 to 3 microgram/g; 18 to 2 to 54.6 micromole/g) than other tissues. Manganese in brain, heart, lung, and muscle is typically less than 1 microgram/g (18.2 micromole/g); blood and serum Mn levels are about 0.01 microgram/ml (0.182 micromol/l) and 0.001 microgram/ml (0.0182 micromol/l), respectively.

Expressed as a percentage of the total, skeletal Mn can account for up to 25% of the total body pool. Bone Mn can be raised or lowered by substantially varying dietary Mn, but skeletal pools of Mn exchange slowly; thus, they are not thought to constitute an important pool for rapid mobilization (Reilly, 2004). Regarding development features of Mn metabolism, the fetus does not normally accumulate liver Mn before birth, and the levels of Mn in fetal liver are lower than in adult liver. This appears to be due to the expression of Mn enzymes such as arginase, pyruvate carboxylase, and MnSOD that occurs predominantly after birth (Bourre, 2006; Keen *et al.*, 1999).

### B. Manganese Function

Mn functions both as an enzyme activator and as a constituent of metalloenzymes. For Mn-activated reactions, it can act by binding either to a substrate (such as ATP) or to the protein directly, to facilitate subsequent conformational changes. Whereas there are relatively few Mn metalloenzymes, there are a large number of enzymes that can be activated upon Mn additions (e.g., various hydrolases, kinases, decarboxylases, and transferases). Although the extent to which such activation is specifically related to Mn can be questioned (e.g., Mg can replace Mn), some appear Mn specific (e.g., several glycosyltransferases). Other divalent cations do not readily activate glycosyltransferases, and some of the pathological defects associated with Mn deficiency can be ascribed to a low activity of enzymes in this classification (Bourre, 2006; Keen *et al.*, 1999). For example, it has been suggested that xylosyl transferase is specifically activated by Mn. Cartilage isolated from Mn-deficient chicks is xylose poor, and fetuses born of Mn-deficient rats have limb deformities that can be related to reduced glycosylation (Lui *et al.*, 1994). In addition, Mn can activate phosphoenolpyruvate carboxykinase *in vivo*; low activity of phosphoenolpyruvate carboxykinase has been reported in Mn-deficient rats. Other Mn-containing and sensitive enzymes include arginase, pyruvate carboxylase, MnSOD, and glutamine synthase. All except glutamine synthase have

been reported to be low in Mn-deficient animals (Aschner and Aschner, 2005; Crossgrove and Zheng, 2004; Ensunsa *et al.*, 2004; Spears, 2003).

### C. Dietary Manganese

Nutritional Mn deficiency occurring outside the laboratory has been documented in a number of species including cattle, chickens, and rats. In humans, abnormal Mn metabolism has been reported to be a potential problem in epilepsy, Down's syndrome, osteoporosis, and diabetes (Aschner and Aschner, 2005; Crossgrove and Zheng, 2004; Spears, 2003). The recommended daily requirements for Mn for a number of species are shown in Table 22-2. Diets containing less than 1 micrograms Mn/g (0.018 micromol/g) are unable to support normal reproduction in several species (i.e., sheep, goats, cattle, pigs, mice, rats, and rabbits). For perspective, the maximum reproductive performance in cattle does not occur until diets contain more than 20 micrograms Mn (0.31 micromol) per gram diet on a dry weight basis. The minimum dietary Mn requirement for poultry for growth and normal egg production and hatchability is about 40 micrograms/g (0.73 micromol/g) under normal dietary conditions. Excess dietary fiber, calcium, and phosphorus can markedly increase Mn requirements by reducing Mn bioavailability. The higher Mn requirements of birds compared to mammals can be due to a lower efficiency of absorption (Hansen *et al.*, 2006; Miranda *et al.*, 2006; Nocek *et al.*, 2006; Subcommittee on Mineral Toxicity in Animals, 1980; Subcommittee on Poultry Nutrition, 1994; Weis and Socha, 2005). Food items considered high in Mn include nuts, whole cereals, dried fruits, and leafy vegetables. Meats, dairy products, poultry, and seafood are considered to be poor sources of Mn. Manganese in typical animal feeds can range from 10 microgram/g (0.18 micromol/g) in corn to 105 microgram/g (2.73 micromol/g) in ryegrass and red clover, with the concentration highly dependent on soil conditions and fertilizer practice.

### D. Manganese Metabolism, Absorption, and Transport

Absorption of Mn is thought to occur throughout the small intestine. The efficiency of Mn absorption is relatively low and is not thought to be under homeostatic control (Keen *et al.*, 2000; Sandstrom, 2001). It has been reported that adult humans typically absorb approximately 3% to 4% of dietary Mn, although absorption is increased in those with iron deficiency. High dietary intakes of dietary calcium, phosphorus, and phytate can increase requirements for Mn. Mn absorption and retention are higher in neonates than in adults, and it has been suggested for this reason neonates can be particularly susceptible to Mn toxicosis (Keen *et al.*, 2000). The overall health status of the animal can also

influence absorption and its susceptibility to Mn toxicity. Studies in poultry have demonstrated that under conditions of duodenal coccidiosis Mn is utilized more efficiently. Coccidial infection exacerbated Mn toxicity as evidenced by depressed hematological parameters and increased bone and bile Mn concentrations (Southern and Baker, 1983).

In contrast to other essential trace elements, Mn absorption does not appear to be increased under conditions of Mn deficiency (Keen *et al.*, 2000). Mn absorption is increased under conditions of Fe deficiency. Because of the connection between the transport of iron and Mn, the transferrin receptor (TfR) and the divalent metal transporter-1 (DMT-1) seem to play a role in Mn transport, which could be the basis for the connection (Aschner and Aschner, 2005; Culotta *et al.*, 2005; Keen *et al.*, 2000). Mn from the gastrointestinal tract entering the portal blood can either remain free or rapidly becomes bound to alpha-2-macroglobulin and transferrin, particularly as  $Mn^{+3}$ . Mn uptake by cells is usually unidirectional and saturable.

The metabolic fate of newly absorbed Mn entering the hepatocyte has not been well defined, although several cellular pools of Mn can be identified. The first represents Mn taken up by the lysosomes. Lysosomal uptake of Mn is also considered to be an essential step to egress as it is thought that lysosomes concentrate Mn for delivery to the bile canaliculus (i.e., whole body homeostatic regulation of Mn is maintained through biliary excretion). In this regard, up to 50% of Mn injected intravenously can be recovered in the feces within 24h. Another pool of Mn is associated with the mitochondria. Mitochondria have a large capacity for  $Mn^{+2}$  uptake, and it has been suggested that mitochondrial  $Mn^{+2}$  and  $Ca^{+2}$  uptake can be linked. Nuclear, cytoskeletal (microsomal), and cytosolic pools of  $Mn^{+2}$  also exist. In contrast to Zn, Cu, and Fe for which only a few atoms per cell exist in free form, a portion of Mn can be viewed as dissociable, somewhat analogous to  $Ca^{+2}$  and  $Mg^{+2}$  (Keen *et al.*, 2000).

## E. Deficiency and Excesses

### 1. Deficiency

Manifestations of Mn deficiency in domestic animals include impaired growth, skeletal abnormalities, disturbed or depressed reproductive function, ataxia of the newborn, and defects in lipid and carbohydrate metabolism (Keen *et al.*, 2000). Biochemical lesions associated with these defects are discussed later.

The effects of Mn deficiency on skeletal development have been reported extensively. Mn deficiency results in limbs that are shortened and thickened and joints, which are swollen and enlarged (Lui *et al.*, 1994). Multiple reports of Mn deficiency in cattle are also present in the literature. One interesting case describes 47 Holstein calves with dwarfism, joint laxity, superior brachygnathism, and

domed foreheads that were born to heifers grazing naturally on one farm in South Africa. Seepage from seawater evaporation pans on an adjacent farm was believed to cause Mn deficiency in the dams by leaching Mn from the soil. The seawater contained high levels of strontium, calcium, and iron, which likely further inhibited Mn absorption (Staley *et al.*, 1994). As noted earlier, a basic biochemical lesion underlying the development of bone defects with Mn deficiency is a reduction in proteoglycan biosynthesis, which is secondary to a reduction in the activities of glycosyltransferases. These enzymes are specifically activated by Mn and are needed for the synthesis of chondroitin sulfate side chains of proteoglycan molecules (Hansen *et al.*, 2006).

Ataxia in the offspring of Mn-deficient animals was first observed in the chick and in rats in the 1940s. Ataxia is the result of impaired vestibular function caused by impaired otolith development in utricular and secular maculae. The precise biochemical lesion underlying the block in otolith development has not been identified, although it is thought to involve a defect in proteoglycan biosynthesis. Further, defects in carbohydrate metabolism, in addition to those known to arise from impairment of the activities of glycosyltransferases, have been observed in Mn-deficient rats and guinea pigs. In the guinea pig, Mn deficiency results in severe pancreatic pathology with aplasia or marked hypoplasia of all cellular components including fewer and less intensely granulated islet cells than controls. When glucose is given either orally or intravenously to Mn-deficient guinea pigs, they display diabetic-like glucose tolerance curves. Mn supplementation completely reverses the abnormal glucose tolerance. Mn deficiency can also affect carbohydrate metabolism through an effect on insulin metabolism (Keen *et al.*, 2000; O'Dell and Sunde, 1997).

Mn associated with the islet cell exists in two pools: a readily exchangeable pool associated with the cell surface and an intracellular pool. Mn fluxes between these pools can affect insulin release. Accumulation of Mn associated with the islet cell membrane inhibits insulin release, whereas increases in the intracellular concentration of Mn are associated with a stimulation of insulin synthesis or release, consistent with the idea that Mn has a regulatory role in insulin synthesis/release. In rats, Mn deficiency depresses pancreatic insulin synthesis and secretion, and it enhances intracellular insulin degradation (Keen *et al.*, 2000).

Regarding lipid metabolism, Mn-deficient pigs, rats, and mice are characterized by deposition of excess fat in the liver. Abnormal lipid metabolism has been suggested as a cause of some of the ultrastructural abnormalities seen in tissues of Mn-deficient animals, which include alterations in the integrity of cell membranes, swollen and irregular endoplasmic reticulum, and elongated mitochondria with stacked cristae. The effect of Mn deficiency on cell membrane integrity could be due to changes in membrane

lipid composition or an increased rate of lipid peroxidation in cell membranes, as the activity of MnSOD is lower in Mn-deficient animals than in controls (Keen *et al.*, 2000).

Another step at which Mn can be critical for lipid metabolism is as a cofactor in steroid biosynthesis (O'Dell and Sunde, 1997). Enhancement by Mn of cholesterol synthesis from acetate in liver preparations has been demonstrated, and hypocholesterolemia has been reported in a human case of Mn deficiency. The metabolic site in cholesterol synthesis wherein Mn is thought to be required is farnesyl pyrophosphate synthase, which catalyzes geranyl and isopentyl pyrophosphate condensation to form farnesyl pyrophosphate. Defects in subsequent steroid synthesis can also underlie some of the observed reproductive dysfunctions in Mn-deficient animals. Mn deficient females have absent or irregular estrous cycles, whereas Mn-deficient males have sterility associated with degenerating cells in the epididymis (O'Dell and Sunde, 1997). In addition, lipoprotein metabolism is affected in Mn deficiency. Mn-deficient rats have low plasma cholesterol and low HDL. In addition, Mn-deficient rats have a shift to a smaller plasma HDL particle, lower HDL apo E levels, and higher apo C levels. High levels of dietary Mn have also been reported to affect lipid metabolism when animals are fed high-fat diets. Repletion with Mn increases the activity of several key glycolytic enzymes including hexokinase, glyceraldehydes-3-phosphate dehydrogenase, enolase, lactate dehydrogenase, and glycerol-3-phosphate dehydrogenase. Increases are also found for enzymes of the pentose phosphate pathway and of lipogenesis. Thus, the supplementation of Mn to the high-fat diet can increase the potential for glucose oxidation and for lipogenesis thereby enhancing carbohydrate conversion to fat. The mechanism(s) by which excess Mn induces the enzyme changes is not known, but it is suggested that an effect on insulin metabolism could be involved (Keen *et al.*, 2000). Mn can activate guanylate cyclase and phosphodiesterase, so another possibility is that Mn might change levels of cyclic nucleotides, which then act as second messengers.

## 2. Manganese Toxicity

Although Mn excess can produce toxic effects, it is often considered to be among the less toxic of the essential trace elements to birds and mammals (Subcommittee on Mineral Toxicity in Animals, 1980). For example, chicks, calves, pigs, and sheep have been reported to tolerate diets up to 3000, 1000, 500, and 200 micrograms Mn/g (54.6, 18.2, 9.1, and 3.6 micromol/g), respectively (Failla, 1999; Subcommittee on Mineral Toxicity in Animals, 1980).

In domestic animals, the major reported biochemical lesion associated with dietary Mn toxicosis is an induction of iron deficiency, which is thought to be the result of an inhibitory effect of Mn on iron absorption. In humans, incidents of Mn toxicity mainly occur as a result of chronic

inhalation of massive amounts of airborne Mn (>5 mg/m; >91 micromol) with particle sizes less than 5-micrometer diameter, a situation that can occur in Mn mining. In individuals working in environments contaminated with Mn, overt signs of toxicity normally occur after months or several years of chronic exposure. The initial expression of Mn toxicity is often characterized by severe psychiatric disorders that include signs of memory impairment, disorientation, hallucination, speech disturbances, and compulsive behavior. If the person is removed from the high Mn environment, some improvement of the psychiatric signs can occur. With progression of toxicity, there can be extrapyramidal signs that are remarkably similar to Parkinson's disease (Crossgrove and Zheng, 2004). Removal of a person or animal from the high Mn area at this time may not lead to an improvement in clinical condition, even though tissue Mn levels can return to normal. Secondary conditions that exacerbate Mn toxicity, such as liver failure, can be the underlying cause. The mechanisms underlying the cellular toxicity of Mn have not been clearly identified, although evidence has been provided that Mn-initiated tissue lipid peroxidation can be a primary biochemical lesion.

A second lesion that can underlie some of the pathologies is a disturbance in carbohydrate metabolism (Crossgrove and Zheng, 2004; Keen *et al.*, 2000). With acute Mn toxicity, there is a rapid uptake of Mn by the pancreas, a sharp reduction in circulating insulin, and an increase in plasma glucose. Thus, similar to Mn deficiency, Mn toxicity can affect insulin production or release from the pancreas (Aschner *et al.*, 2007; Keen *et al.*, 2000).

## 3. Other Disorders

Abnormal Mn metabolism occurs in experimental animal models for diabetes (Failla, 1999). It has been shown that the high Mn concentrations in the liver of diabetics are associated with arginase (Failla, 1999; Keen *et al.*, 2000). Although an increase in arginase activity seems reasonable in light of the increased gluconeogenic demands of the diabetic, the functional necessity of this increase has not been shown. It has been reported that Mn metabolism can also be abnormal in some forms of epilepsy. The significance of this observation is underscored by the observation that Mn-deficient animals have a reduced threshold to drug-induced and electroshock-induced seizures. Finally, whole blood Mn levels are often low in humans with osteoporosis and have been proposed to be important to the development of osteopenic bone disease in aging humans and animals (Gonzalez-Reyers *et al.*, 2007; Keen *et al.*, 2000).

## F. Evaluation of Manganese Status

Measurement of whole blood Mn concentrations can be useful in suspected cases of Mn deficiency because low whole blood Mn levels have been found to reflect low soft



tissue Mn concentration. Caution must be exercised in interpreting serum Mn values, however, because they can reflect recent dietary history rather than the long-term Mn status of the animal (O'Dell and Sunde, 1997). Although measurement of hair Mn has been used as an indicator of Mn status, most investigators agree that the value of this analyte is limited owing to excessive environmental contamination with Mn (Bouchard *et al.*, 2007). Liver Mn concentrations have been used as an indicator of Mn status in animals, but their main value is in the identification of Mn deficiency conditions. Currently there are no satisfactory laboratory tests for the identification of Mn toxicity (Reilly, 2004), although high levels of tissue Mn can be assessed with imaging techniques, such as MRI (Jiang *et al.*, 2007).

## V. MOLYBDENUM

### A. Molybdenum Distribution

The highest concentrations of Mo are in the liver (0.5 to 0.7  $\mu\text{g/g}$ ) and kidney (0.3  $\mu\text{g/g}$ ). In sheep, whole blood Mo is about 0.02  $\mu\text{g/ml}$  (0.21  $\mu\text{mol/liter}$ ) but is sensitive to changes in dietary intake (Spears, 2003; Suttle, 1991). The most important function is as a cofactor for xanthine dehydrogenase/oxidase, aldehyde oxidase, and sulfite oxidase. Mo is present in these enzymes as molybdopterin or a molybdenum cofactor (Fig. 22-5). Xanthine oxidase was first characterized as a Mo enzyme in the early 1950s (Mendel and Bittner, 2006; Schwarz and Mendel, 2006).

### B. Molybdenum Functions

In its usual form as xanthine dehydrogenase, the reaction,  $\text{XH} + \text{H}_2\text{O} + \text{NAD}^+ \rightarrow \text{X}=\text{O} + \text{NADH}$ , is catalyzed. The most common substrates are purines. Uric acid forms the metabolic endpoint of purine degradation. The last metabolic steps in the process (from hypoxanthine to xanthine and from xanthine to uric acid) are promoted by xanthine dehydrogenase (oxidoreductase, EC1.1.3.22). The overall mechanism is complex. Xanthine dehydrogenase is a flavoprotein that contains both iron and Mo and uses  $\text{NAD}^+$  as electron acceptor (Mendel and Bittner, 2006; Schwarz and Mendel, 2006).

Moreover, xanthine dehydrogenase exists in two interconvertible forms, xanthine dehydrogenase and xanthine oxidase. In its oxidase form, the enzyme transfers the reducing equivalent generated by oxidation of substrates to molecular oxygen with the resultant production of superoxide anion and hydrogen peroxide (Fig. 22-3). Hydrogen peroxide can be converted to free hydroxyl radicals. For example, during ischemia, reperfusion, or reoxygenation of an injured tissue can occur, and xanthine dehydrogenase can be converted to xanthine oxidase (Mendel and Bittner, 2006; Scharz, 2005). In this latter form, the reaction sequence is  $\text{XH} + \text{H}_2\text{O} + \text{O}_2 \rightarrow \text{X}=\text{O} + \text{H}_2\text{O}_2$ .

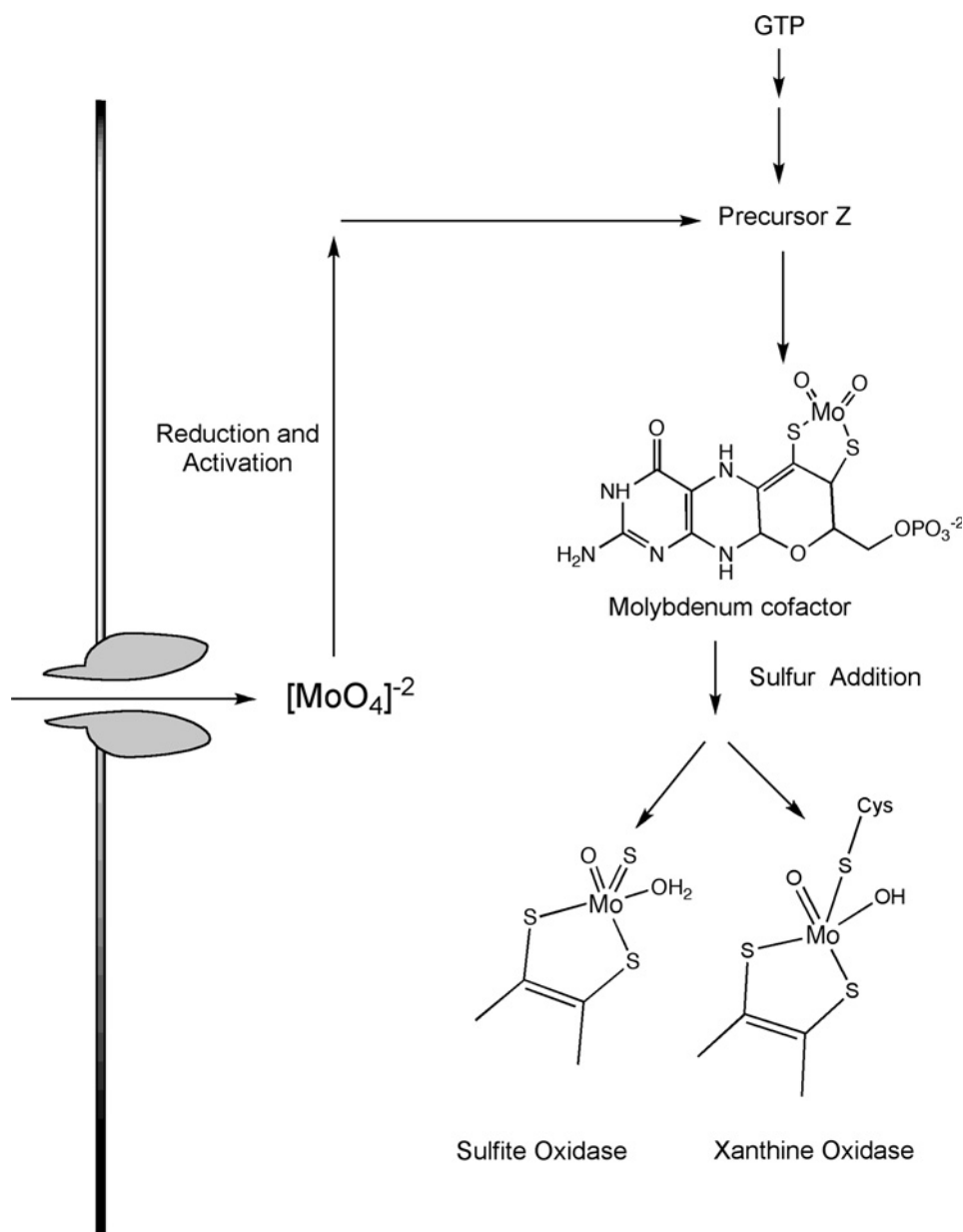
Given that in such conditions ATP is depleted and there is an increase in the purine pool, such available substrate promotes production of large quantities of superoxide radicals are released, which can be a major source of tissue peroxidation. Aldehyde oxidase is a related Mo enzyme that catalyzes many of the same reactions as xanthine dehydrogenase. Both of these enzymes are needed in ruminants to catabolize exogenous pyrimidines. The third known Mo enzyme is sulfite oxidase, a mitochondrial enzyme that catalyzes the oxidation of sulfite to sulfate during the degradation of sulfur amino acid (Mendel and Bittner, 2006; Schwarz and Mendel, 2006).

### C. Molybdenum Metabolism, Absorption, and Transport

Other than thiomolybdates, Mo is well absorbed by all species. It has been proposed that Mo is transported by a carrier-mediated process and that sulfate and Mo can compete for the same carrier or inhibit membrane transport in the intestine and renal tubules (Brondino *et al.*, 2006; Failla, 1999; Spears, 2003), hence impairing Mo absorption and retention. An alternate postulate is that formation of insoluble thiomolybdates precludes absorption. Cu and sulfur influence Mo absorption. High dietary levels of vitamins E and C, zinc, iron, tungsten, and dietary protein levels can also affect optimal status. Cu or sulfur reduces Mo availability via a mechanism whereby reactive sulfides or hydrogen sulfide ions displace oxygen in molybdate to form thio- and oxythiomolybdates (see Section III) (Spears, 2003; Suttle, 1991). This complex can in turn react with Cu to form an insoluble complex. This is primarily applicable to the strong reducing environment of the rumen. Because of this interaction, excess Mo will induce a secondary Cu deficiency (e.g., dietary Mo in excess of 10  $\mu\text{g/g}$ ; 0.104  $\mu\text{mol/l}$ ; Johnson *et al.*, 2007; Spears, 2003; Suttle, 1991).

Excretion in nonruminants appears to be mostly through the urine, but in ruminants fecal and milk losses can represent significant losses. Although Mo deficiency does occur, it is apparently relatively rare. In animals, growth and production have been reported to be impaired in poultry and sheep (Suttle, 1991). In the case of birds, the high flux of metabolites through purine-related pathways accounts in part for the need for Mo (e.g., as a cofactor for xanthine oxidase). For the ruminant, one postulate has been a depression in microbial Mo enzyme activities.

The clinical syndrome of Mo toxicity can be characterized by achromotrichia, anemia, cartilaginous dysplasia, abnormal endochondrial ossification, subperiosteal ossification, and abnormal fibrogenesis (Spears, 2003; Suttle, 1991). These lesions are characteristic signs of an induced Cu deficiency. Additionally, Mo has been suggested to specifically induce mandibular exostosis, aberrations in phosphorus metabolism that can contribute to bone and joint lesions, testicular degeneration, and central nervous system changes.



**FIGURE 22-5** Molybdenum cofactor. Mo as molybdates enter cells by way of oxyanion transporters. A series of complex condensation and reductive steps (e.g., formation of the pterin precursor from guanine triphosphate [GTP] and condensation with molybdenum) result in the formation of the molybdenum cofactor. The cofactor is essential for the activities of sulfite oxidase, xanthine dehydrogenase, and aldehyde oxidase (see text).

The clinical signs of molybdenosis also include lameness; weight loss; anorexia; loss of color and quality of the wool or hair; and in cattle, diarrhea. Thiomolybdates are used to treat chronic Cu toxicosis, to help mobilize stored Cu and reduce the high oxidizing of free Cu (Brewer *et al.*, 2006; Spears, 2003; Suttle, 1991).

#### D. Other Disorders

In human animals, combined deficiencies of xanthine dehydrogenase/oxidase and sulfite oxidase have been reported

in humans. The cause of the decreased enzyme activities is thought to be the loss of Mo cofactor that results in a functional Mo deficiency. Single enzyme deficiencies of xanthine dehydrogenase/oxidase and sulfite oxidase have also been described (Mendel and Bittner, 2006; Schartz, 2005). Xanthinuria and elevated serum uric acid have been reported in patients with xanthine dehydrogenase deficiency. A severely debilitating condition in children is sulfite oxidase deficiency that leads to severe aberrations in sulfur and sulfur amino acid metabolism (Mendel and Bittner, 2006; Schartz, 2005).

## VI. SELENIUM

### A. Dietary Selenium

A large animal (50 to 100kg) contains 10 to 20 mg (126 to 253 micromol) of Se. Se is found throughout the body with highest concentrations normally in the kidney and liver (0.5 to 1.5 and 0.2 to 0.8 micrograms/g [0.0063 to 0.019 and 0.0025 to 0.010 micromol/g], respectively). Skeletal muscle has a mean Se concentration of about 0.2 microgram/g (0.0025 micromol/g), and muscle contains about 50% of the total body pool. Blood Se concentrations are highly responsive to diet, with values in humans ranging from 0.02 to 7.0 microgram/ml (0.25 to 0.88 micromol/liter) in low Se and high Se areas, respectively (Ammerman *et al.*, 1995; Finley, 2006; Hostetler and Kincaid, 2004; O'Dell and Sunde, 1997; Spears, 2002).

Plant foods are the major dietary sources of Se in most countries throughout the world. The amount of Se in soil, which varies by region, can determine the amount of Se in the food chain, wherein Se is found as selenomethionine and selenocysteine. Se is one of the few mineral elements in which the soil concentration can influence the relative amounts found in food. Because Se bioavailability varies markedly with the form of Se ingested and other competing factors, it has been difficult to define what constitutes either deficient or toxic amounts. Various dietary forms of Se are given in Figure 22-6. Each can accumulate to some degree in tissue proteins. Accordingly, whole body and tissue concentrations of Se tend to correlate with environmental exposure (Ammerman *et al.*, 1995; Finley, 2006; Gunther *et al.*, 2002; Hostetler *et al.*, 2003; O'Dell and Sunde, 1997; Spears, 2002). Suggested Se intakes for a number of species are given in Table 22-2. Foods that contain Se include nuts (0.5 to 10.0  $\mu\text{g/g}$ ), fish, poultry and beef (0.5 to 0.8  $\mu\text{g/g}$ ), grains (0.2 to 0.4  $\mu\text{g/g}$  can vary with high Se soils), whole eggs (0.1 to 0.3  $\mu\text{g/g}$ ), and cheese (0.1 to 0.2  $\mu\text{g/g}$ ). Se-accumulating plants can have concentrations that exceed 5mg/g (63.3 micromol/g), whereas pastures and forages in areas without Se deficiency syndromes can be as low as 0.1  $\mu\text{g/g}$  (0.0013 micromol/g). In grazing animals, deficiency signs occur when feed concentrations are below 0.05  $\mu\text{g/g}$  (0.0063 micromol/g), and adverse effects can occur when dietary levels exceed 3  $\mu\text{g/g}$  (0.038 micromol/g) (Ammerman *et al.*, 1995; Finley, 2006; Gunther *et al.*, 2002; Hostetler and Kincaid, 2004; O'Dell and Sunde, 1997; Spears, 2002).

### B. Selenium Functions

Perspectives regarding the nutritional importance of Se have changed markedly. In the 1930s, Se was identified as the toxic agent causing so-called alkali disease in animals (O'Dell and Sunde, 1997). In the 1940s and early 1950s, research was conducted to identify the specific seleno-compounds causing toxicity. Throughout the 1960s, concerns

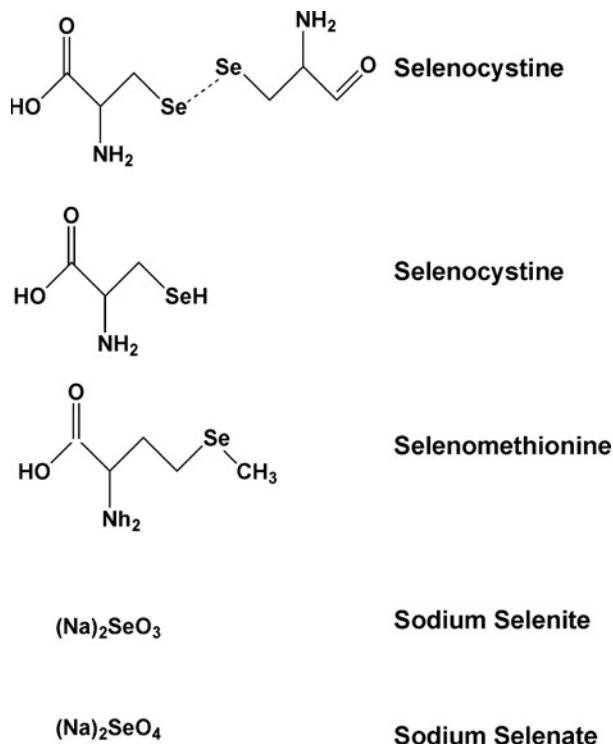


FIGURE 22-6 Common forms of dietary selenium.

regarding Se focused on its putative procarcinogenic potential. However, following the demonstration that Se was an essential nutrient for laboratory animals, the scope of work quickly shifted to identifying deficiency syndromes and signs. Se deficiency was soon identified as a cause of white muscle disease. However, it was not until 1979 that the U.S. Food and Drug Administration published regulations that legalized Se supplementation of diets for dairy cattle and eventually humans and other animals (Subcommittee on Mineral Toxicity in Animals, 1980).

#### 1. Glutathione Peroxidase

The best-defined function of Se is as a component of glutathione peroxidase (GPx). GPx catalyzes the reduction of hydrogen and organic peroxides (ROOH) to their respective alcohols and water (Herbette *et al.*, 2007). It is now recognized that there are two different GPx activities in tissues, one that is Se dependent and a second that is not. The non-Se-dependent GPx enzymes are referred to as GSH S-transferases, and their activities can increase under conditions of severe Se deficiency.

Regarding the Se-containing GPx, there are several isozymes encoded by different genes that vary in cellular location and substrate specificity. GPx1 is the most abundant and is found in the cytoplasm. Although  $\text{H}_2\text{O}_2$  is the preferred substrate ( $2\text{GSH} + \text{H}_2\text{O}_2 \rightarrow \text{GS} - \text{SG} + 2\text{H}_2\text{O}$ , where GSH represents reduced monomeric glutathione, and GS - SG represents glutathione disulfide), fatty acid

and other lipid peroxides (ROOH) also function as substrates. The product is an acyl moiety wherein the [–OOH] group is converted to an [=OH] group. Mice genetically designed to lack GPx1 are in many respects phenotypically normal, indicating that the enzyme is not critical for life. However, other variants (e.g., GPx4) are lethal and die during early embryonic development (Burk and Hill, 2005; Stadtman, 2000).

## 2. Iodothyronine Deiodinase

In addition, another family of selenoproteins is the 1,5'-iodothyronine deiodinase (EC 3.8.1.4) (5'-ID). The enzyme, 5'-ID, catalyzes the 5'-monodeiodination of thyroxine, the major secretory product of the thyroid gland, to its active form 3,3',5-triiodothyronine (Koenig, 2005). Deiodination by 5'-ID occurs in peripheral tissues (e.g., liver, kidney, and muscle). In Se deficiency, activity of type 1,5'-iodothyronine deiodinase is decreased along with the concentration of thyroxine.

## 3. Other Proteins

A number of proteins have been identified that are presumably important to Se transport and delivery to organelles and tissues (e.g., the plasma protein, selenoprotein P) (Burk and Hill, 2005). Selenocysteine is also found in thioredoxin reductases, formate dehydrogenases, and glycine reductases. In addition, Waschulewski and Sunde (1988) demonstrated that in dietary methionine deficiency, selenomethionine could be incorporated into proteins in place of methionine. This important observation indicates that several identified “selenoproteins” cannot be dependent on Se per se for their structure or function, but rather might arise from the incorporation of the methionine.

## 4. Se and Viruses

Recent work has also demonstrated that deficiencies in either Se or vitamin E can in certain cases increase viral pathogenicity by changing relatively benign viruses into virulent ones, an example wherein host nutritional status should be considered a driving force for the emergence of new viral strains or newly pathogenic strains of known viruses (Beck, 2007).

## C. Selenium Metabolism, Absorption, and Transport

Absorption of Se occurs mainly in the duodenum with little evidence of uptake by the rumen, abomasums, stomach, jejunum, or ileum. In monogastric animals, absorption of soluble forms of Se (selenite, selenocysteine, selenomethionine) is very high (>80%) and does not appear to be

homeostatically controlled (Finley, 2006). Absorption of Se in ruminants is lower than in nonruminants (about 40%), presumably because of the reduction of selenite to insoluble forms of Se in the rumen. Elemental Se and Se sulfide are not absorbed to any appreciable degree (Ammerman *et al.*, 1995; Spears, 2000, 2003). After absorption, there appears to be a rapid distribution of water-soluble Se compounds to most organs.

Transport in plasma to various organs seems to involve selenoprotein P (Burk and Hill, 2005). Selenoprotein P is an abundant extracellular glycoprotein that is rich in selenocysteine. Four isoforms of selenoprotein P have been identified. They share the same N terminus and amino acid sequence. One isoform is full length and the three others terminate at the positions of the second, third, and seventh selenocysteine residues normally present in the full-length protein. In rats, it has been estimated that 25% of whole-body Se passes through this protein each day. Selenoprotein P knockout mice have low Se concentrations in the brain, testis, and fetus. Measurement of selenoprotein P in human plasma has shown that it is depressed by Se deficiency and by cirrhosis. Of potential importance, Se supplementation optimizes glutathione peroxidase activity before Se in selenoprotein P is optimized, indicating that plasma selenoprotein P can be a better index for assessing Se nutritional status.

Although the intracellular processing of Se remains poorly understood, it is known that before the incorporation of inorganic Se (selenite or selenate) into amino acids, it must be reduced to selenide (–SeH), a process requiring glutathione. Se is excreted primarily through the urine and appears to be dependent on a renal threshold. Fecal and respiratory losses are important routes, depending on species. Ruminants have relatively higher fecal Se losses than nonruminants, because of reduction or the complexing of Se in the rumen making it unavailable for absorption.

Concentrations in the diet of sulfur (inorganic and as sulfur-containing amino acids), proteins containing high amounts of sulfur amino acids, and phosphates can affect Se absorption/excretion. The order of uptake in Caco cells is  $\text{SeO}_3 < \text{or} = \text{selenocysteine} < \text{selenomethionine} < \text{SeO}_4$ . Both amino acid-related and anion transporters are involved in Se transport. Many of the details, however, have yet to be resolved. For example, the transport of selenomethionine is inhibited by its sulfur analogue, methionine, whereas inhibition of the transport of selenocysteine by cysteine is not observed. The transport of  $\text{SeO}_4$  is inhibited by thiosulfate, but not sulfate (Burk and Hill, 2005; Finley, 2006; Spears, 2003). A number of intestinal inflammatory diseases and short-bowel syndrome can lead to Se deficiency (Burk and Hill, 2005; Finley, 2006; Spears, 2003).

In other cells, common Se compounds (selenate, selenite, selenomethionine, and selenocysteine), are taken up rapidly through anion-exchange transporter systems. Uptake through anion-exchange carriers is followed by

reduction by glutathione-requiring steps. Important is that some oxyanions, such as chromate, can inhibit uptake, which GPx activity and activation and subsequently, glutathione depletion. As a final point, respiratory losses (as methyl selenides) increase as Se intake increases, although respiratory losses of Se are thought to be minimal under most circumstances (Burk and Hill, 2005; Finley, 2006; Spears, 2003).

### 1. Novel Aspects of Se Metabolism

Unlike other amino acids, selenocysteine, which is at the active site of selenoproteins, is not coded using a conventional codon. Selenocysteine is encoded in a special way by a UGA codon that normally acts as a stop codon in transcription (Stadman, 2002). The UGA codon is made to encode selenocysteine by the presence of a SECIS element (the selenocysteine insertion sequence) in selenoprotein mRNAs. SECIS elements are stem-loop structures located in the 3' untranslated regions (UTRs) of eukaryotic selenoprotein mRNAs that are required for directing cotranslational selenocysteine incorporation at UGA codons. Previous characterization studies of the mammalian SECIS elements indicate these elements are highly conserved in type 1 deiodinase, GPx, and selenoprotein P (Burk and Hill, 2005).

When cells are grown in the absence of Se, translation of selenoproteins terminates at the UGA codon, resulting in a truncated, nonfunctional enzyme. The primary and secondary structures of selenocysteine tRNA also differ from those of standard tRNAs, most notably, a long variable region arm, and substitutions at several well-conserved base positions (Stadman, 2002).

The selenocysteine tRNAs are initially charged with serine by seryl-tRNA ligase, but the resulting Ser-tRNA is not used for translation because it is not recognized by other translation factors. Rather, the tRNA-bound seryl residue is converted to a selenocysteyl-residue by the pyridoxal phosphate-containing enzyme selenocysteine synthase. The resulting selenocysteyl-containing tRNA (Sec-tRNA) is recognized and is next specifically bound to a translational elongation factor that delivers Sec-tRNA in a targeted manner to the ribosomes translating mRNAs for selenoproteins. Other details regarding this process are beyond the scope of this chapter. Suffice to say that Se metabolism from translation to cellular delivery is novel in keeping with its sulfur-like electronegative chemical properties (Stadman, 2002).

## D. Disorders of Selenium Metabolism

### 1. Se Deficiency

The major biochemical lesions that are associated with Se deficiency are low GPx and 5'-ID activities (Beck,

2007; Koenig, 2005). Excess cellular free-radical damage can be the initial lesion underlying the widespread pathologies. Consistent with this idea are the observations that simultaneous deficiencies of other antioxidants (i.e., hypovitaminosis E and A) amplify the signs of Se deficiency when they occur.

Signs of Se deficiency in humans and domestic animals have been well described and include degenerative changes of several tissues, reproductive and growth defects, immune defects, increased susceptibility to cardiovascular disease, and some cancers. The interplay of many nutrients will greatly influence expression of disease (Fig. 22-3).

Se status, either toxicity or deficiency, will directly affect the free-radical scavenging system, which can be expressed as clinical disease. For example, nutritional muscular dystrophy is a Se-responsive disorder that principally affects young farm animals (sheep, cattle, pigs, horses, poultry). This myopathy is typically associated with excessive peroxidation of lipids, particularly the mitochondrial lipids, resulting in degeneration, necrosis, and subsequent fibrosis of myofibers. Often this is associated with cardiac involvement and, depending on the species, hepatic necrosis (Arthur, 1998).

Poultry and swine can be affected by exudative diathesis and edematous conditions that respond to supplemental Se. In poultry, the condition typically affects the pectoral muscles but can also involve the gizzard and other skeletal muscles. In mammalian species, the muscles of locomotion are usually more severely affected (dorsal spinous and appendicular muscles). Nutritional pancreatic atrophy is a specific Se-responsive condition in chicks. Deficiency of Se alone will induce the condition, and it is apparently related to a severe alteration of the endoplasmic reticulum and not mitochondria as previously thought. This condition results in a loss of functional pancreatic acinar cells.

In swine and cattle, mastitis has been shown to be Se responsive (Arthur, 1998; Koenig *et al.*, 1997; Smith *et al.*, 1987; Spears, 2000). Testicular degeneration and impaired sperm production, infertility, abortion, weak and stillborn young and retained placentas have all been shown to be responsive to Se supplementation. A reduction in testicular selenoprotein can underlie the reduced spermatogenesis or maturation leading to the testicular atrophy associated with Se. The mechanisms involved in Se deficiency-induced infertility and retained placenta have not been defined (Arthur, 1998; Koenig *et al.*, 1997; Smith *et al.*, 1987; Spears, 2000).

As might be expected given the links to mitochondrial function and ROS defense, altered immunocompetence has been linked to Se deficiency. Mastitis, diarrhea, metritic, and "unthriftness" can be envisioned as being precipitated by a reduced ability to respond to invading pathogens. Reduction in mitogen responsiveness, phagocytotic killing of pathogens, and antibody production have all been associated with Se deficiency. Although the negative effects

of Se deficiency on immunocompetence are recognized, the biochemical lesions underlying these effects have not been delineated. Anemia appears to involve a depression in GPx activity and subsequent Heinz body formation (Arthur, 1998; Koenig *et al.*, 1997; Smith *et al.*, 1987; Spears, 2000).

In humans, Keshan disease is an endemic congestive cardiomyopathy affecting primarily children and women of childbearing age with lesions that are very similar to the characteristic lesions of nutritional cardiomyopathy associated with white muscle disease (Burk and Hill, 2005). The disease derives its name from a serious outbreak of the disorder in the Keshan province of Northern China in 1935. That Se supplementation improves many of the clinical signs of Keshan's disease identifies it as a Se-responsive disorder. The soils of the Keshan area are low in Se as well as locally produced produce. Another human disorder is Keshan-Beck disease, an endemic osteoarthropathy that occurs in several regions of eastern Asia. The disease is characterized by chronic, disabling, degenerative osteoarthrosis and frequently occurs in young children. In the initial phase, the patient complains of general limb weakness and joint stiffness. With progression, the disease results in shortening of the fingers and long bones with severe enlargement and dysfunction of the joints. Although other aspects of the etiology of the disease have not been defined, it has been suggested that Se deficiency can be a principal underlying cause.

## 2. Se and Viral Infections

The study of Keshan disease also has led to an association between Se and increased susceptibility to infection with certain enteroviruses. The discovery that the cardiomyopathy of Keshan disease likely had a dual etiology (nutritional and infectious) provided impetus for additional studies of relationships between nutritional Se status and viral infection. Observed was that an amyocarditic strain of coxsackievirus B3, CVB3/0, was converted to a highly virulent strain when it was inoculated into Se-deficient mice. This conversion was accompanied by changes in the genetic structure of the virus so that its genome closely resembled that of other known virulent CVB3 strains. Similar alterations in virulence and genomic composition of CVB3/0 could be observed in mice fed normal diets but genetically deprived of GPx (e.g., the use of knockout mouse models; Beck, 2007). In addition, more recent observations have shown that two strains of influenza virus exhibit increased virulence when given to Se-deficient mice. Again, this increased virulence is accompanied by multiple changes in the viral genome in a segment previously thought to be relatively stable. Ongoing research should resolve many of the mechanistic details. Important herein is the concept that there is a basis for linking the expression of viral diseases to nutrition (Beck, 2007).

## 3. Se Toxicity

Three types of Se toxicity have been identified in livestock: acute and chronic blind staggers and chronic alkali disease (Subcommittee on Mineral Toxicity in Animals, 1980). Abnormal movement and posture, breathing difficulties, diarrhea, and rapid death characterize acute Se toxicity. Chronic Se toxicity of the blind staggers type occurs when animals consume Se toxic accumulator plants (usually over a period of weeks or months). They develop blindness, severe abdominal pain, and paralysis. Death often results from respiratory failure.

Se toxicity of the alkali disease type occurs when animals consume high Se diets (5 to 50 microgram/m; 0.063 to 0.63 micromol/g) for prolonged periods of time. Alkali disease is characterized by emaciation, a lack of vitality, cardiac atrophy, erosions of the joints of the long bones, hepatic cirrhosis, and anemia (Subcommittee on Mineral Toxicity in Animals, 1980). Se has also been reported to affect normal development of the embryo and fetus in cattle, pigs, and sheep following consumption of seleniferous diets, and Se toxicity has been shown to induce malformations and reduce hatching success, growth, and survival of young in poultry, quail, and mallards (Hamilton, 2004).

In the high Se areas of Wyoming, South Dakota, and Nebraska in the United States, human Se toxicosis was suggested to be a problem, but this has not been substantiated and is less of concern now that foods are available from around the world rather than a local region. Endemic Se toxicity has also been reported in the Hubei province of China. The selenosis has been linked to high Se contamination of the soil. It has been estimated that affected individuals can have consumed 5mg Se/day (63.3 micromol/day) or more for several years. Signs of toxicity included hair loss in the early stages and, in the later stages, convulsions, paralysis, and motor disturbances. Human intakes throughout most of the world are between 20 and 300 microgram Se/day (0.25 to 3.80 micromol/day) and other large animals perhaps two to three times that amount (Burk and Hill, 2005).

## E. Evaluation of Selenium Status

Because deficiency-related disorders are more common than selenosis (Se toxicity), most laboratories assess Se adequacy indirectly by measurement of erythrocyte GPx activity or selenoprotein P (Reilly, 2004). Plasma GPx measurements can also be used as an index of Se status. Plasma GPx levels, however, can be affected by erythrocyte GPx leakage. Erythrocyte GPx activity is 25 to 100 times higher than plasma GPx activity so that even minor hemolysis negates the value of plasma GPx.

Although most commonly used, the sole use of GPx is often questioned given the wide tissue variation in GPx activity that is storage dependent, reflecting the adequacy

of the animal at the time of incorporation of selenocysteine into GPx, and that at higher Se concentrations there is an increase in activity as compared to tissue Se levels, which can plateau (Reilly, 2004). Few of these criticisms apply to selenoprotein P, which reflects current history and directly responds to recent Se intake (Burk and Hill, 2005). Also, it is important when measuring GPx activity that hydrogen peroxide be used as the substrate and azide used to inhibit catalase activity if the purpose of the assay is to determine Se-dependent GPx activity. For diagnosis of Se toxicosis, whole blood, hepatic, or renal tissue Se concentrations can be of value. Urinary excretion of trimethyl Se can also be of value in severe Se toxicosis (Subcommittee on Mineral Toxicity in Animals, 1980).

## VII. ZINC

### A. Zinc Distribution

A large animal can contain as much as 1.4 to 2.3g (0.024 to 0.035mmol) of Zn. Next to calcium and magnesium, Zn, is the most abundant intracellular cation. A large amount of Zn is presented in bone and muscle (>70%), but Zn is not easily mobilizable in response to Zn deficiency (Keen *et al.*, 2003; Park *et al.*, 2004; Watson, 1998). Thus, a Zn-deficient diet can significantly reduce certain tissue pools, such as plasma. In the rat, for example, consumption of a Zn-deficient diet can result in a 50% reduction in plasma Zn within 24h. Eventually, muscle catabolism can result in a significant release of Zn into the circulation. Moreover, very high Zn concentrations are found in integumental tissues (skin, hair, wool, and nails), retina, and male reproductive organs. Typical plasma or serum Zn concentrations for most species range between 0.5 and 1.5 microgram/ml (7.6 to 22.9 micromol/liter), with whole blood concentrations being about 10 times higher (Keen *et al.*, 2003; Park *et al.*, 2004; Watson, 1998).

### B. Functions of Zinc

Zn is essential for the function of more than 200 enzymes. Zn-containing enzymes are found in all of the major metabolic pathways involved in carbohydrate, lipid, protein, and nucleic acid metabolism (Keen *et al.*, 2003; O'Dell and Sunde, 1997). Zn can function as a structural component of an enzyme (entasis), as a proton donor at the active site of an enzyme, and as a bridging atom between the substrate and the enzyme. Mammalian Zn enzymes include carboxypeptidases, alkaline phosphatase, alcohol dehydrogenase, carbonic anhydrase, and superoxide dismutase. Given the variety of enzymes that contain Zn, a cellular deficiency of Zn would be expected to have profound consequences.

In addition to its enzymatic roles, Zn is also thought to be involved in stabilizing the structures of RNA, DNA, and ribosomes (Keen *et al.*, 2003). Zn has been shown to promote conformational transformations of DNA from the beta to the Z form. A large family of nuclear binding proteins has Zn binding domains (Zn-binding fingers). The structure of each individual finger is highly conserved and consists of about 30 amino acid residues, constructed as a  $\beta\beta\alpha$  fold and held together by the Zn ion. Many transcription factors, regulatory proteins, and other proteins that interact with DNA contain Zn fingers (e.g., at the major groove along the double helix of DNA in which case the Zn fingers are arranged around the DNA strand). In young developing animals, even a short-term Zn deficiency can have a profound effect on transcriptional regulation important to development.

In addition to its roles in enzymes and nucleic acids, Zn is also important to the stabilization of biomembranes. Membrane-bound Zn alters the fluidity and stabilization of membranes (O'Dell and Sunde, 1997). Zn deficiency contributes to oxidative stress to membranes, because of structural strains, altered activities of membrane-bound enzymes, and changes in membrane receptors. An example is the increase in the sensitivity of erythrocytes from Zn-deficient animals to osmotic shock that quickly reverses upon Zn repletion. Membrane lipid damage can also be an important component in the teratogenic pathology of Zn deficiency (Keen *et al.*, 2003). In addition to membrane proteins, Zn has also been shown to specifically bind to cytoskeletal proteins, such as tubulin, and cause polymerization. Such interactions have been linked to abnormal cell signaling (Mackenzie *et al.*, 2002).

### C. Dietary Zinc

Nutritional Zn deficiency has been well documented in a number of species including humans, cattle, dogs, and sheep. Similar to Cu, the uptake of dietary Zn is influenced by a variety of dietary factors, and conditioned Zn deficiencies are common. Foods that are high in Zn include shellfish (>200 microgram/g; >3.0 micromol/g), other seafood and meat (20 to 50 microgram/g; 0.31 to 0.76 micromol/gram), and whole grains, legumes, and nuts (20 to 30 microgram/g; 0.31 to 0.46 micromol/g) (Ammerman *et al.*, 1995; Spears, 2003). Food items considered low in Zn (<1 microgram/g; 0.015 micromol/g) include dairy products, fruits, and vegetables. Typical Zn concentrations in pastures in nonindustrial areas range from 20 to 50 microgram/g (0.31 to 0.76 micromol/g). Cereal grains of pig and poultry rations typically contain 20 to 40 microgram/g (0.31 to 0.61 micromol/g). Soybean, peanut, and linseed meals contain 50 to 70 microgram/g (0.76 to 1.15 micromol/g), and fish and meal can contain up to 100 microgram/g (1.53 micromol/g) (Ammerman *et al.*, 1995; Spears, 2003).

## D. Zinc Metabolism, Absorption, and Transport

### 1. Absorption

In monogastric animals, Zn is mainly absorbed from the duodenum, jejunum, and ileum, with little being absorbed from the stomach. In cattle, about one-third of the Zn is absorbed from the abomasums. In most species, the initial absorption of Zn is about 10% to 20% (Cousins, 1998; Liuzzi and Cousins, 2004; Cousins *et al.*, 2006; Sekler *et al.*, 2007). Phytate (myoinositol hexaphosphate), which is found in all plant seeds and most roots and tubers, can significantly inhibit Zn absorption in many species and in humans by forming insoluble complexes. The consumption of high phytate diets has been linked to the induction of Zn deficiency, but usually in situations wherein the diets are marginal in Zn content.

Similar to other trace elements, a number of dietary constituents can influence Zn availability. High dietary iron decreases Zn absorption, although its significance with regard to overall Zn balance can be questioned. Several amino acids form Zn complexes with high stability constants, and it has been suggested that such complex formation facilitates Zn uptake (Cousins *et al.*, 2006; Liuzzi and Cousins, 2004; Sekler *et al.*, 2007). Zn absorption is higher in neonates than in adults and is increased in Zn deficiency in rats and cattle.

### 2. Transport

Zn travels across the brush border via carrier-mediated processes (Fig. 22-4). Active transport dominates at low or normal intake, whereas passive diffusion contributes more significantly at high intake. The mechanisms underlying the regulation of Zn absorption have long remained elusive. Low-molecular-weight cellular proteins, such as metallothionein (MT), bind Zn, Cu, and cadmium. Zn induces MT, but only at very high intakes. The Zn transporter 1 (ZnT-1) appears to be involved in the export of Zn across the enterocyte basolateral membrane, whereas ZnT-2 and ZnT-4 are involved in the flux of Zn in the endosomes, possibly regulating intracellular trafficking of Zn. ZnT-1 is localized to the basolateral membrane, and ZnT-2 is found in acidic vesicles that accumulate Zn (Cousins, 1998; Liuzzi and Cousins, 2004; Cousins *et al.*, 2006; Sekler *et al.*, 2007). These transporters are found primarily in villus cells and much less frequently in crypt cells. The ileum is the major site for ZnT-1. ZnT-2 is found in the duodenum and jejunum, and ZnT-4 in all parts of the small intestine.

Regarding cellular uptake, in contrast to cellular egress and intracellular organelle transport, a superfamily of human Zn transport proteins has been identified (Zn importer proteins, ZIP1 and ZIP2, plus others that constitute a large family of proteins). These proteins are localized in the plasma membrane and have structural characteristics

typical of other transport proteins (e.g., permeable membrane domains, a transport channel, high-affinity binding domains).

## E. Zinc Deficiency

An early effect of severe Zn deficiency in many species is anorexia and cyclic feeding. Regardless of the direct biochemical explanation for the anorexia, the cyclical food intake patterns of Zn-deficient animals can represent an adaptation of the animal to the Zn-deficient diet, because during the periods of low food intake there will be substantial muscle catabolism and release of Zn into the plasma pool (Keen *et al.*, 2003; Park *et al.*, 2004; Watson, 1998). Hepatic and extrahepatic tissues for Zn-requiring processes can then use this released Zn.

If the period of Zn deficiency is prolonged, additional hallmarks of Zn deficiency are decreased efficiency of food utilization, impaired growth, and severe dermatitis. The dermatological lesions are frequently characterized histopathologically as parakeratosis. The biochemical lesions that underlie these pathologies have not been firmly identified, although it is recognized that a reduction in cell division is an early event with Zn deficiency. The reduction in cell replication in Zn deficiency has been related to the role of Zn in nucleic acid synthesis, protein synthesis, nucleotide transport, chromatin condensation, and assembly of mitotic spindle via condensation, and assembly, in addition to affecting cell cycle-related regulation and oxidative stress (Clegg *et al.*, 2006; Oteiza and Mackenzie, 2005).

Zn responsive dermatosis is a well-documented disease in dogs and can be manifested as two syndromes (White *et al.*, 2001). Syndrome I occurs primarily in northern-breed dogs (Alaskan malamute, Samoyed, and Siberian husky), but it has been documented in other breeds as well. Although these dogs are generally consuming Zn-adequate diets, they frequently require Zn supplementation, either orally or parenterally, in some cases, for life (White *et al.*, 2001). Syndrome II occurs in young dogs consuming diets that are not adequate in Zn or contain high concentrations of calcium or phytates. Changing the dog to a Zn-adequate diet is the only treatment necessary in most cases, along with transient Zn supplementation.

Because of the diverse roles of Zn in nucleic acid and protein synthesis and in gene expression, a Zn deficiency during early development is teratogenic in mammals. Typical malformations associated with Zn deficiency include cleft lip and palate, brain and eye malformations, and numerous abnormalities of the heart, lung, skeletal, and urogenital systems (Keen *et al.*, 2003).

In addition to a high incidence of early postnatal death, marginal Zn deficiency has been associated with altered skeletal development and behavioral abnormalities (Ganes and Jheon, 2004; Keen *et al.*, 2003).



Perhaps the most striking effect of a marginal prenatal Zn deficiency is on the ontogeny of the immune system. In both mice and rhesus monkeys, marginal prenatal Zn deficiency impairs immunoglobulin M production and decreases sensitivity to a number of mitogens. Of particular interest are the observations that these immune defects can persist well into adulthood despite the introduction of Zn-replete diets at birth. Immune defects associated with postnatal Zn deficiency include reduced thymic hormone production and activity, impaired lymphocyte, natural killer cell and neutrophil function, and impaired antibody-dependent cell mediated cytotoxicity. Postulated defects include impaired cell replication, gene expression, and cell motility and alterations in cell surface recognition sites (Cousins, 1998; Fraker and King, 2004).

There can also be a reduction in glucose utilization in Zn deficiency that has been linked to increased lipid metabolism. It is secondary to reduced insulin release, increased insulin degradation via glutathione insulin transhydrogenase, and an increase in peripheral insulin resistance. As with Cu and Mn, Zn deficiency can result in marked alterations in lipoprotein metabolism. A Zn deficiency-induced hypercholesterolemia has been demonstrated in rat models. This hypercholesterolemia is primarily due to a decrease in HDL cholesterol; the HDL isolated from Zn-deficient animals is enriched in apo E and low in apo C content (Fekete and Brown, 2007; Hughes and Samman, 2006).

In addition to lipoprotein metabolism, Zn deficiency has been shown to affect essential fatty acid metabolism, and many of the signs of Zn deficiency mimic essential fatty acid deficiency. For example, the delta-desaturation of linoleic acid is markedly elevated in Zn-deficient rats, and Zn deficiency has consistently been shown to increase tissue arachidonic acid levels (Fekete and Brown, 2007; Hughes and Samman, 2006). In addition, Zn deficiency is associated with a reduction in growth hormone production and output. This defect can be secondary to the Zn deficiency-induced reduction in food intake rather than resulting from a direct role in growth hormone synthesis and release. The growth retardation associated with Zn deficiency is refractory to growth hormone therapy, however, unless Zn therapy is also instituted, suggesting that Zn is required for growth hormone uptake, or that reduction is required for growth hormone uptake, or that reduction in cellular Zn is the rate-limiting step with regard to cell growth (O'Dell and Sunde, 1997). A classic sign of Zn deficiency in humans is hypogonadism. In Zn-deficient animals, the testes are significantly reduced in size with atrophy of the seminiferous epithelium. The resulting testicular hypofunction affects both spermatogenesis and output of testosterone by Leydig cells. Current evidence suggests a primary defect in Leydig cell function with a secondary effect of Zn deficiency per se. There are also specific effects of Zn deficiency on prostate, epididymal, and seminal vesicle size that are independent of the reduction

in food intake, suggesting a defect in testosterone's target cell response. Tissue and circulating levels of hypothalamic pituitary hormones are consistent with a primary failure of Leydig cell function. Levels of LHRH, FSH, and LH have all been reported to be normal or elevated with Zn deficiency. Prolactin, thyroid hormone, and corticosterone metabolism have all been reported to be either unaffected or affected by Zn deficiency.

At least five genetic errors in Zn metabolism that mimic Zn deficiency have been identified in mammals. They are Adema disease (inherited parakeratosis) of cattle, chondrodysplasia, congenital Zn deficiency (lethal acrodermatitis) in bull terriers, acrodermatitis enteropathica (AE) in humans, and lethal milk syndrome in mice. Bovine hereditary Zn deficiency, Adema disease, is an autosomal recessive disorder that results in inadequate amounts of Zn being absorbed from the gastrointestinal tract and leads to a number of clinical abnormalities. The first clinical manifestation is diarrhea, followed by skin lesions, poliosis, and a decreased ability to sustain a suckle reflex (Watson, 1998). It is similar in many respects to acrodermatitis enteropathica in humans. The oral administration of Zn acetate caused a reversal of all clinical, biochemical, and histological abnormalities in affected calves. Adema disease occurs predominantly in black pied cattle of Frisian descent. Affected calves are born "normal," but the signs of the disease usually appear 30 to 60 days after birth; in addition to diarrhea, other signs include dry scaly coat, alopecia, hyperkeratotic conjunctivitis, diarrhea, poor weight gain, immunological dysfunction (in particular severe thymic atrophy), and death at 3 to 4 months of age. An additional sign of the disease is delayed sexual maturation. Mature dwarfs produce spermatozoa with 45% acrosomal defects compared to 5% in controls. Significantly, this defect in spermatozoa can be corrected by dietary Zn supplementation. Of interest, many of these same signs occur in humans with acrodermatitis enteropathica (O'Dell and Sunde, 1997). Lethal milk syndrome is an autosomal recessive disorder caused by a mutant gene in the C57BL/6J(B6) mouse strain. Phenotypic characteristics of this genotype are similar to some signs observed in AE and Adema diseases. Offspring, which suckle from affected dams, exhibit stunted growth, alopecia, dermatitis, immune incompetence, and rarely survive past weaning (Keen *et al.*, 2003).

Lethal acrodermatitis (congenital Zn deficiency) is an autosomal recessive disorder in bull terriers (Colombini, 1999; McEwan *et al.*, 2000). The syndrome is clinically characterized by growth retardation, progressive acrodermatitis, chronic pyoderma, diarrhea, pneumonia, and abnormal behavior. Laboratory findings include nonregenerative anemia, neutrophilia, low serum alkaline phosphatase, and hypercholesterolemia. Pathological findings include parakeratosis, hyperkeratosis, and a reduction in lymphocytes in the T-lymphocyte areas of lymphoid tissue.

Overall, the expression of lethal acrodermatitis in bull terriers is similar to experimental Zn deficiency in dogs.

Although the syndrome described for bull terriers is similar to cattle with Adema disease and humans with AE, two significant differences should be noted. Serum Zn is not consistently low in affected pups, and the syndrome is not responsive to Zn therapy. These observations suggest that the genetic lesion in Zn metabolism in bull terriers is quite different from that in previously described disorders.

Chondrodysplasia (short-limbed dwarfism) in Alaskan malamutes causes several deformities, but it is not life threatening. Malamutes have been reported to have a decreased ability to absorb Zn from the gastrointestinal tract (Brown *et al.*, 1978). Mutant dogs have severe bowing of the forelimbs with gross changes in size and shape of the humerus, radius, and ulna. There is no difference between dwarf and normal dogs in mineral content of the long bones and forelimbs, but in some regions calcium is more soluble than normal. In addition to the apparent abnormality of calcium binding, the dwarfs have high levels of urinary acid mucopolysaccharides, suggesting a disturbance in normal bone maturation. Dogs with this genetic lesion can also have hemolytic anemia. In anemic dwarfs, red cells are macrocytic, hypochromic, and without reticulocytosis. Erythrocytes are fragile and have higher than normal intracellular cadmium and potassium and lower than normal glutathione. The specific defect that predisposes the cells to premature destruction is not known.

## **F. Zinc Toxicity**

The risk for Zn toxicity and the likelihood of achieving excessive dietary intakes of Zn are both low. Zn has been characterized as a relatively nontoxic element with a wide margin of safety. However, given the diversity of enzymes

In addition to plasma Zn analysis, whole blood or erythrocyte Zn has been used to assess Zn status; however, whereas low erythrocyte Zn indicates a Zn deficiency, it is often too insensitive for accurate diagnosis. Neutrophil Zn has been reported to be more sensitive to Zn status than erythrocyte Zn, but its usefulness is limited, as an assay requires about 10 to 20 ml of blood for conventional assays. In experimental settings, liver Zn has been useful in diagnosing Zn toxicity, but it is of little value in diagnosing Zn deficiency as values rarely decrease by more than 20% even in severe deficiencies. Liver metallothionein has been used to gauge Zn deficiency in nonhuman primates. The use of Zn transporter measurements to assess status has also been proposed (Keen and Uriu-Adams, 2006).

## VIII. CONCLUDING COMMENTS

Metal ions in combination with numerous organic accessory and catalytic factors (e.g., various vitamins) play important roles in enhancing specificity and providing additional properties that allow complementary forces and arrangements to improve the orientation and efficiency of catalysis. In enzyme transition states, metals influence the entropic components of enzymatic reactions. Metals allow the formation of metastable bonds and play roles in entasis (enzyme shape and configuration). Some minerals are important to organizing water structure; others act as Lewis acids and bases.

Appropriate intake levels of certain chemical elements are required to maintain optimal health. On a per food energy basis (e.g., kcal or joules), the requirements of most animals are similar. Most commonly, a conventional diet will meet the requirements. However, most deficiency situations occur when the diet is simple and monotonous in terms of composition. The extensive range of supplements, such as for Se, Fe, and Zn, reflect the success of research in ways that were unimaginable even a decade ago.

## REFERENCES

- Ammerman, C. B., and Goodrich, R. D. (1983). Advances in mineral nutrition in ruminants. *J. Animal Sci.* **57**(suppl 2), 519–533.
- Ammerman, C. L., Baker, D. P., and Lewis, A. J. (1995). "Bioavailability of Nutrient for Animals: Amino Acids, Minerals, and Vitamins." Academic Press, New York.
- Arthur, J. R. (1998). Free radicals and diseases of animal muscle. In "Oxidative Stress in Skeletal Muscle" (A. Z. Reznick, Ed.). Birkhauser Verlag, Basel.
- Arthur, J. R., and Boyne, R. (1985). Superoxide dismutase and glutathione peroxidase activities in neutrophils from selenium deficient and Cu deficient cattle. *Life Sci.* **36**, 1569–1575.
- Aschner, J. L., and Aschner, M. (2005). Nutritional aspects of manganese homeostasis. *Mol. Aspects Med.* **26**, 353–362.
- Aschner, M., Guilarte, T. R., Schneider, J. S., and Zheng, W. (2007). Manganese: recent advances in understanding its transport and neurotoxicity. *Toxicol. Appl. Pharmacol.* **221**, 131–147.
- Banin, A., and Navrot, J. (1975). Origin of life: clues from relations between chemical compositions of living organisms and natural environments. *Science* **189**, 550–551.
- Barceloux, D. G. (1999). Cobalt. *J. Toxicol. Clin. Toxicol.* **37**, 201–206.
- Beck, M. A. (2007). Selenium and vitamin E status: impact on viral pathogenicity. *J. Nutr.* **137**, 1338–1340.
- Bouchard, M., Laforest, F., Vandelay, L., Bellinger, D., and Mergler, D. (2007). Hair manganese and hyperactive behaviors: pilot study of school-age children exposed through tap water. *Environ. Health Perspect.* **115**, 122–127.
- Bourre, J. M. (2006). Effects of nutrients (in food) on the structure and function of the nervous system: update on dietary requirements for brain, part 1: micronutrients. *J. Nutr. Health Aging* **10**, 377–385.
- Boyne, R., and Arthur, J. R. (1986). Effects of molybdenum or iron induced Cu deficiency on the viability and function of neutrophils from cattle. *Res. Vet. Sci.* **41**, 417–419.
- Brewer, G. J., Askari, F., Lorincz, M. T., Carlson, M., Schilsky, M., Kluin, K. J., Hedera, P., Moretti, P., Fink, J. K., Tankanow, R., Dick, R. B., and Sitterly, J. (2006). Treatment of Wilson disease with ammonium tetrathiomolybdate: IV. Comparison of tetrathiomolybdate and trientine in a double-blind study of treatment of the neurologic presentation of Wilson disease. *Arch. Neurol.* **63**, 521–527.
- Brondino, C. D., Romao, M. J., Moura, I., and Moura, J. J. (2006). Molybdenum and tungsten enzymes: the xanthine oxidase family. *Curr. Opin. Chem. Biol.* **10**, 109–114.
- Brown, R. G., Hoag, G. N., Smart, M. E., and Mitchell, L. H. (1978). Alaskan Malamute chondrodysplasia. V. Decreased gut Zn absorption. *Growth* **42**, 1–6.
- Burgess, J. (1999). "Ions in Solution: Basic Principles of Chemical Interactions." Horwood Publishing Limited, Westergate.
- Burk, R. F., and Hill, K. E. (2005). Selenoprotein P: an extracellular protein with unique physical characteristics and a role in selenium homeostasis. *Annu. Rev. Nutr.* **25**, 215–235.
- Clegg, M. S., Hanna, L. A., Niles, B. J., Momma, T. Y., and Keen, C. L. (2005). Zinc deficiency-induced cell death. *IUBMB Life* **57**, 661–669.
- Colombini, S. (1999). Canine zinc-responsive dermatosis. *Vet. Clin. North Am. Small Anim. Pract.* **29**, 1373–1383.
- Committee on Animal Nutrition (1985). "Nutrient Requirements of Sheep," 6th rev. ed. National Research Council, National Academy of Sciences, Washington, DC.
- Committee on Cu in Drinking Water (2000). "Copper in Drinking Water 2000." National Research Council, National Academy of Sciences, Washington, DC.
- Cousins, R. J. (1998). A role of zinc in the regulation of gene expression. *Proc. Nutr. Soc.* **57**, 307–311.
- Cousins, R. J., Liuzzi, J. P., and Lichten, L. A. (2006). Mammalian zinc transport, trafficking, and signals. *J. Biol. Chem.* **281**, 24085–24089.
- Cromwell, G. L., Stahly, T. S., and Monegue, H. J. (1989). Effects of source and level of copper in performance and liver copper stores in weanling pigs. *J. Anim. Sci.* **67**, 2996–3000.
- Crossgrove, J., and Zheng, W. (2004). Manganese toxicity upon overexposure. *NMR Biomed.* **17**, 544–553.
- Culotta, V. C., Yang, M., and Hall, M. D. (2005). Manganese transport and trafficking: lessons learned from *Saccharomyces cerevisiae*. *Eukaryotic Cell* **4**, 1159–1165.
- Domingo, J. L. (1989). Cobalt in the environment and its toxicological implications. *Rev. Environ. Contam. Toxicol.* **108**, 105–132.
- Engle, T. E., Spears, J. W., Xi, L., and Edens, W. F. (2000). Dietary copper effects on lipid metabolism and circulating catecholamine concentrations in finishing steers. *J. Anim. Sci.* **78**, 2737–2742.

- Ensuna, J. L., Symons, J. D., Lanoue, L., Schrader, H. R., and Keen, C. L. (2004). Reducing arginase activity via dietary manganese deficiency enhances endothelium-dependent vasorelaxation of rat aorta. *Exp. Biol. Med.* **229**, 1143–1153.
- Failla, M. L. (1999). Considerations for determining “optimal nutrition” for copper, zinc, manganese and molybdenum. *Proc. Nutr. Soc.* **58**, 497–505.
- Fekete, S. G., and Brown, D. L. (2007). Veterinary aspects and perspectives of nutrigenomics: a critical review. *Acta Vet. Hung.* **55**, 229–239.
- Finley, J. W. (2006). Bioavailability of selenium from foods. *Nutr. Rev.* **64**, 146–151.
- Forman, O. P., Boursnell, M. E., Cunmore, B. J., Stendall, N., van den Sluis, B., Fretwell, N., Jones, C., Wijmenga, C., Rothuizen, J., van Oost, B. A., Holmes, N. G., Binns, M. M., and Jones, P. (2005). Characterization of the COMMD1 (MURR1) mutation causing copper toxicosis in Bedlington terriers. *Anim. Genet.* **36**, 497–501.
- Fraga, C. G. (2005). Relevance, essentiality and toxicity of trace elements in human health. *Mol. Aspects Med.* **26**, 235–244.
- Fraker, P. J., and King, L. E. (2004). Reprogramming of the immune system during zinc deficiency. *Annu. Rev. Nutr.* **24**, 277–298.
- Frausto da Silva, J. J. R., and Williams, R. J. P. (1991). “The Inorganic Chemistry of Life.” Clarendon Press, Oxford.
- Gambling, L., and McArdle, H. J. (2004). Iron, copper and fetal development. *Proc. Nutr. Soc.* **63**, 553–563.
- Gonzalez-Reyes, R. E., Gutierrez-Alvarez, A. M., and Moreno, C. B. (2007). Manganese and epilepsy: a systematic review of the literature. *Brain Res. Rev.* **53**, 332–336.
- Gooneratne, S. R., Cuckley, W. T., and Christensen, D. A. (1989). Review of copper deficiency and metabolism in ruminants. *Can. J. Anim. Sci.* **69**, 819–825.
- Gurnee, C. M., and Drobatz, K. J. (2007). Zinc intoxication in dogs: 19 cases (1991–2003). *J. Am. Vet. Med. Assoc.* **230**, 1174–1179.
- Halpin, C. G., Harris, D. J., Caple, I. W., and Petterson, D. S. (1984). Contribution of cobalamin analogues to plasma vitamin B12 concentrations in cattle. *Res. Vet. Sci.* **37**, 249–251.
- Hamilton, S. J. (2004). Review of selenium toxicity in the aquatic food chain. *Sci. Total Environ.* **326**, 1–31.
- Hansen, S. L., Spears, J. W., Lloyd, K. E., and Whisnant, C. S. (2006). Growth, reproductive performance, and manganese status of heifers fed varying concentrations of manganese. *J. Anim. Sci.* **84**, 3375–3380.
- Haywood, S. (2006). Copper toxicosis in Bedlington terriers. *Vet. Rec.* **159**, 687–689.
- Hellman, N. E., and Gitlin, J. D. (2002). Ceruloplasmin metabolism and function. *Annu. Rev. Nutr.* **22**, 439–458.
- Herbette, S., Roeckel-Drevet, P., and Drevet, J. R. (2007). Selenium-independent glutathione peroxidases. More than simple antioxidant scavengers. *FEBS J.* **274**, 2163–2180.
- Hotstetler, C. E., and Kincaid, R. L. (2004). Gestational changes in concentrations of selenium and zinc in the porcine fetus and the effects of maternal intake of selenium. *Biol. Trace Elem. Res.* **97**, 57–70.
- Hughes, S., and Samman, S. (2006). The effect of zinc supplementation in humans on plasma lipids, antioxidant status and thrombogenesis. *J. Am. Coll. Nutr.* **25**, 285–291.
- Jacob, R. A., Skala, J. H., Ocan, S. T., and Turnlund, J. R. (1987). Effect of varying ascorbic acid intakes on copper absorption and ceruloplasmin levels of young men. *J. Nutr.* **117**, 2109–2115.
- Jiang, Y., Zheng, W., Long, L., Zhao, W., Li, X., Mo, X., Lu, J., Fu, X., Li, W., Liu, S., Long, Q., Huang, J., and Pira, E. (2007). Brain magnetic resonance imaging and manganese concentrations in red blood cells of smelting workers: search for biomarkers of manganese exposure. *Neurotoxicology* **28**, 126–135.
- Johnson, H. E., Bleich, V. C., and Krausman, P. R. (2007). Mineral deficiencies in tule elk, Owens Valley, California. *J. Wildl. Dis.* **43**, 61–74.
- Katsuoka, Y., Beckman, B., George, W. J., and Fisher, J. W. (1983). Increased levels of erythropoietin in kidney extracts of rats treated with cobalt and hypoxia. *Am. J. Physiol.* **244**, F129–F133.
- Keen, C. L. (1996). Teratogenic effects of essential trace metals: deficiency and excesses. In “Toxicology of Metals” (L. W. Chang, L. Magos, and T. Suzuki, Eds.), pp. 977–1001. CRC Press, New York.
- Keen, C. L., Ensuna, J. L., and Clegg, M. S. (2000). Manganese metabolism in animals and humans including the toxicity of manganese. *Met. Ions. Biol. Syst.* **37**, 89–121.
- Keen, C. L., Ensuna, J. L., Watson, M. H., Baly, D. L., Donovan, S. M., Monaco, M. H., and Clegg, M. S. (1999). Nutritional aspects of manganese from experimental studies. *Neurotoxicology* **20**, 213–223.
- Keen, C. L., Hanna, L. A., Lanoue, L., Uriu-Adams, J. Y., Rucker, R. B., and Clegg, M. S. (2003). Developmental consequences of trace mineral deficiencies in rodents: acute and long-term effects. *J. Nutr.* **133**, 1477S–1480S.
- Keen, C. L., and Uriu-Adams, J. Y. (2006). Assessment of Zn, Cu, and Mg status: current approaches and promising new directions. In “Mineral Requirements for Military Personnel,” pp. 304–315. Committee on Military Nutrition Research, Food Nutrition Board, Institute of Medicine, National Academies Press, Washington, DC.
- Keen, C. L., Uriu-Hare, J. Y., Hawk, S. N., Jankowski, M. A., Daston, G. P., Kwik-Urbe, C. L., and Rucker, R. B. (1998). Effect of copper deficiency on prenatal development and pregnancy outcome. *Am. J. Clin. Nutr.* **67**, 1003S–1011S.
- Kennedy, D. G., Young, P. B., Kennedy, S., Scott, J. M., Molloy, A. M., Weir, D. G., and Price, J. (1995). Cobalt-vitamin B<sub>12</sub> deficiency and the activity of methylmalonyl CoA mutase and methionine synthase in cattle. *Int. J. Vitam. Nutr. Res.* **65**, 241–247.
- Kennedy, S., McConnell, S., Anderson, H., Kennedy, D. G., Young, P. B., and Blanchflower, W. J. (1997). Histopathologic and ultrastructural alterations of white liver disease in sheep experimentally depleted of cobalt. *Vet. Pathol.* **34**, 575–584.
- Kerber, W. D., and Goldberg, D. P. (2006). High-valent transition metal corrolazines. *J. Inorg. Biochem.* **100**, 838–857.
- Kincaid, R. L., Lefebvre, L. E., Cronrath, J. D., Socha, M. T., and Johnson, A. B. (2003). Effect of dietary cobalt supplementation on cobalt metabolism and performance of dairy cattle. *J. Dairy Sci.* **86**, 1405–1414.
- Koenig, K. M., Rode, L. M., Cohen, R. D., and Buckley, W. T. (1997). Effects of diet and chemical form of selenium on selenium metabolism in sheep. *J. Anim. Sci.* **75**, 817–820.
- Koenig, R. J. (2005). Regulation of type 1 iodothyronine deiodinase in health and disease. *Thyroid* **15**, 835–840.
- Krajacic, P., Qian, Y., Hahn, P., Dentchev, T., Lukinova, N., and Dunaief, J. L. (2006). Retinal localization and copper-dependent relocalization of the Wilson and Menkes disease proteins. *Invest. Ophthalmol. Vis. Sci.* **47**, 3129–3134.
- Lauwerys, R., and Lison, D. (1994). Health risks associated with cobalt exposure: an overview. *Sci. Total Environ.* **150**, 1–6.
- Leach, S. P., Salman, M. D., and Hamar, D. (2006). Trace elements and prion diseases: a review of the interactions of copper, manganese and zinc with the prion protein. *Anim. Health Res. Rev.* **7**, 97–105.
- Legleiter, L. R., and Spears, J. W. (2007). Plasma diamine oxidase: a biomarker of copper deficiency in the bovine. *J. Anim. Sci.* **85**, 2198–2204.

- Liu, A. C., Heinrichs, B. S., and Leach, R. M., Jr. (1994). Influence of manganese deficiency on the characteristics of proteoglycans of avian epiphyseal growth plate cartilage. *Poultry Sci.* **73**, 663–667.
- Liuzzi, J. P., and Cousins, R. J. (2004). Mammalian zinc transporters. *Annu. Rev. Nutr.* **24**, 151–172.
- Lonnerdal, B. (1998). Copper nutrition during infancy and childhood. *Am. J. Clin. Nutr.* **67**, 1046S–1053S.
- Mackenzie, G. G., Zago, M. P., Keen, C. L., and Oteiza, P. I. (2002). Low intracellular zinc impairs the translocation of activated NF-kappa B to the nuclei in human neuroblastoma IMR-32 cells. *J. Biol. Chem.* **277**, 34610–34617.
- Mason, K. E. (1979). A conspectus of research on copper metabolism and requirements of man. *J. Nutr.* **109**, 1979–2066.
- McEwan, N. A., McNeil, P. E., Thompson, H., and McCandlish, I. A. (2000). Diagnostic features, confirmation and disease progression in 28 cases of lethal acrodermatitis of bull terriers. *J. Small Anim. Pract.* **41**, 501–507.
- Mendel, R. R., and Bittner, F. (2006). Cell biology of molybdenum. *Biochim. Biophys. Acta* **1763**, 621–635.
- Milanino, R., and Buchner, V. (2006). Copper: role of the “endogenous” and “exogenous” metal on the development and control of inflammatory processes. *Rev. Environ. Health* **21**, 153–215.
- Mills, C. F. (1987). Biochemical and physiological indicators of mineral status in animals: copper, cobalt and zinc. *J. Anim. Sci.* **65**, 1702–1711.
- Miranda, M., Alonso, M. L., and Benedito, J. L. (2006). Copper, zinc, iron, and manganese accumulation in cattle from Asturias (northern Spain). *Biol. Trace Elem. Res.* **109**, 135–143.
- Mitchell, L. M., Robinson, J. J., Watt, R. G., McEvoy, T. G., Ashworth, C. J., Rooke, J. A., and Dwyer, C. M. (2007). Effects of cobalt/vitamin B<sub>12</sub> status in ewes on ovum development and lamb viability at birth. *Reprod. Fertil. Dev.* **19**, 553–562.
- Nocek, J. E., Socha, M. T., and Tomlinson, D. J. (2006). The effect of trace mineral fortification level and source on performance of dairy cattle. *J. Dairy Sci.* **89**, 2679–2693.
- O'Dell, B. L., and Sunde, R. A., Eds. (1997). “Handbook of Nutritionally Essential Mineral Elements.” Dekker, New York.
- Oteiza, P. I., and Mackenzie, G. G. (2005). Zinc, oxidant-triggered cell signaling, and human health. *Mol. Aspects Med.* **26**, 245–255.
- Park, S. Y., Birkhold, S. G., Kubena, L. F., Nisbet, D. J., and Ricke, S. C. (2004). Review on the role of dietary zinc in poultry nutrition, immunity, and reproduction. *Biol. Trace Elem. Res.* **101**, 147–163.
- Pena, M. M., Lee, J., and Thiele, D. J. (1999). A delicate balance: homeostatic control of copper uptake and distribution. *J. Nutr.* **129**, 1251–1260.
- Puig, S., and Thiele, D. J. (2002). Molecular mechanisms of copper uptake and distribution. *Curr. Opin. Chem. Biol.* **6**, 171–180.
- Reedijk, J., and Bouwman, E. (1999). “Bioinorganic Catalysis,” 2nd ed. Marcel Dekker, New York.
- Reilly, C. (2004). “The Nutritional Trace Elements.” Blackwell, Oxford.
- Riordan, J. F., and Vallee, B. L. (1974). The functional roles of metals in metalloenzymes. *Adv. Exp. Med. Biol.* **48**, 33–57.
- Rucker, R. B. (2007). Allometric scaling, metabolic body size and interspecies comparisons of basal nutritional requirements. *J. Anim. Physiol. Anim. Nutr. (Berl.)* **91**, 148–156.
- Rucker, R. B., Kosonen, T., Clegg, M. S., Mitchell, A. E., Rucker, B. R., Uriu-Hare, J. Y., and Keen, C. L. (1998). Copper, lysyl oxidase, and extracellular matrix protein cross-linking. *Am. J. Clin. Nutr.* **67**, 996S–1002S.
- Sandstrom, B. (2001). Micronutrient interactions: effects on absorption and bioavailability. *Br. J. Nutr.* **85**, S181–S185.
- Savage, J. E., Bird, D. W., Reynolds, G., and O'Dell, B. L. (1966). Comparison of copper deficiency and lathyrism in turkey poults. *J. Nutr.* **88**, 15–25.
- Schuscha, D. A. (1997). Dietary copper in the physiology of the microcirculation. *J. Nutr.* **127**, 2274–2281.
- Schwarz, G., and Mendel, R. R. (2006). Molybdenum cofactor biosynthesis and molybdenum enzymes. *Annu. Rev. Plant Biol.* **57**, 623–647.
- Seguin, M. A., and Bunch, S. E. (2001). Iatrogenic copper deficiency associated with long-term copper chelation for treatment of copper storage disease in a Bedlington terrier. *J. Am. Vet. Med. Assoc.* **218**, 1593–1597.
- Sekler, I., Sensi, S. L., Hershinkel, M., and Silverman, W. F. (2007). Mechanism and regulation of cellular zinc transport. *Mol. Med.* **13**, 337–343.
- Smart, M. E., Gudmundson, J., and Christensen, D. A. (1981). Trace mineral deficiencies in cattle: a review. *Can. Vet. J.* **22**, 372–376.
- Smith, T. J., Drummond, G. S., and Kappas, A. (1987). Cobalt-protoporphyrin suppresses thyroid and testicular hormone concentrations in rat serum: a novel action of this synthetic heme analogue. *Pharmacology* **34**, 9–16.
- Spears, J. W. (2000). Micronutrients and immune function in cattle. *Proc. Nutr. Soc.* **59**, 587–594.
- Spears, J. W. (2003). Trace mineral bioavailability in ruminants. *J. Nutr.* **133**, 1506S–1509S.
- Spee, B., Arends, B., van Wees, A. M., Bode, P., Penning, L. C., and Rothuizen, J. (2007). Functional consequences of RNA interference targeting COMMD1 in a canine hepatic cell line in relation to copper toxicosis. *Anim. Genet.* **38**, 168–170.
- Stadtman, T. C. (2002). Discoveries of vitamin B<sub>12</sub> and selenium enzymes. *Annu. Rev. Biochem.* **71**, 1–16.
- Staley, P., Van Der Lugt, J. J., Axsell, G., and Loock, A. H. (1994). Congenital skeletal malformations in Holstein calves associated with putative manganese deficiency. *J. So. African Vet. Assoc.* **65**, 73–78.
- Stern, B. R., Solioz, M., Krewski, D., Aggett, P., Aw, T. C., Baker, S., Crump, K., Dourson, M., Haber, L., Hertzberg, R., Keen, C., Meek, B., Rudenko, L., Schoeny, R., Slob, W., and Starr, T. (2007). Copper and human health: biochemistry, genetics, and strategies for modeling dose-response relationships. *J. Toxicol. Environ. Health B Crit. Rev.* **10**, 157–222.
- Stites, T. E., Mitchell, A. E., and Rucker, R. B. (2000). Physiological importance of quinoenzymes and the O-quinone family of cofactors. *J. Nutr.* **130**, 719–727.
- Subcommittee on Dairy Cattle Nutrition, Committee on Animal Nutrition, & National Research Council (2001); Subcommittee on Dairy Cattle Nutrition, Committee on Animal Nutrition, National Research Council (2001). “Mineral Tolerance of Domestic Animals.” National Research Council, National Academy of Sciences, Washington, DC.
- Subcommittee on Laboratory Animal Nutrition, Committee on Animal Nutrition, Board on Agriculture (1995). “Nutrient Requirements of Laboratory Animals,” 4th rev. ed. National Research Council, National Academy of Sciences, Washington, DC.
- Subcommittee on Mineral Toxicity in Animals, Committee on Animal Nutrition, Board on Agriculture and Renewable Resources (1980). “Mineral Tolerance of Domestic Animals.” National Research Council, National Academy of Sciences, Washington, DC.

- Subcommittee on Poultry Nutrition, National Research Council Subcommittee on Poultry Nutrition (1994). "Nutrient Requirements of Poultry," 9th rev. ed. National Research Council, National Academy of Sciences, Washington, DC.
- Subcommittee on Swine Nutrition, Committee on Animal Nutrition, National Research Council (1998). "Nutrient Requirements of Swine," 10th rev. ed. National Research Council, National Academy of Sciences, Washington, DC.
- Suttle, N. F. (1991). The interactions between copper, molybdenum, and sulphur in ruminant nutrition. *Annu. Rev. Nutr.* **11**, 121–140.
- Taylor, K. B. (2002). "Enzyme Kinetics and Mechanisms." Dordrecht, Kluwer Academic, Boston.
- Tinker, D., and Rucker, R. B. (1985). Role of selected nutrients in synthesis, accumulation, and chemical modification of connective tissue proteins. *Physiol. Rev.* **65**, 607–657.
- Thiele, D. J. (2003). Integrating trace element metabolism from the cell to the whole organism. *J. Nutr.* **133**, 1579S–1580S.
- Tosh, D., Shen, C. N., Alison, M. R., Sarraf, C. E., and Slack, J. M. (2007). Copper deprivation in rats induces islet hyperplasia and hepatic metaplasia in the pancreas. *Biol. Cell* **99**, 37–44.
- Ullrey, D. E., Ed. (2002). "Scientific Advances in Animal Nutrition: Promise for the New Century, Proceedings of a Symposium," pp. 1–87. National Research Council, National Academy of Sciences, Washington, DC.
- Waschulewski, I. H., and Sunde, R. A. (1988). Effect of dietary methionine on tissue selenium and glutathione peroxidase (EC1.11.1.9) activity in rats given selenomethionine. *Br. J. Nutr.* **60**, 57–68.
- Watson, T. D. (1998). Diet and skin disease in dogs and cats. *J. Nutr.* **128**, 2783S–2789S.
- Weiss, W. P., and Socha, M. T. (2005). Dietary manganese for dry and lactating Holstein cows. *J. Dairy Sci.* **88**, 2517–2523.
- Wu, G., and Meininger, C. J. (2002). Regulation of nitric oxide synthesis by dietary factors. *Annu. Rev. Nutr.* **22**, 61–86.
- White, S. D., Bourdeau, P., Rosychuk, R. A., Cohen, B., Bonenberger, T., Fieseler, K. V., Ihrke, P., Chapman, P. L., Schultheiss, P., Zur, G., Cannon, A., and Outerbridge, C. (2001). Zinc-responsive dermatosis in dogs: 41 cases and literature review. *Vet. Dermatol.* **12**, 101–109.
- Willis, M. S., Monaghan, S. A., Miller, M. L., McKenna, R. W., Perkins, W. D., Levinson, B. S., Bhushan, V., and Kroft, S. H. (2005). Zinc-induced copper deficiency: a report of three cases initially recognized on bone marrow examination. *Am. J. Clin. Pathol.* **123**, 125–131.
- Yang, S. J., Uriu-Adams, J. Y., Lanoue, L., Rucker, R. B., and Keen, C. L. (2007). Low nitric oxide: a key factor underlying copper deficiency teratogenicity. *Free Radical Biology Medicine*, **43**, 1639–1648.

# Vitamins

**Robert B. Rucker**

*Department of Nutrition  
College of Agriculture and Environmental  
Sciences  
University of California, Davis  
Davis, California*

**James Morris**

*Department of Molecular Bioscience  
School of Veterinary Medicine  
University of California, Davis  
Davis, California*

**Andrea J. Fascetti**

*Department of Molecular Bioscience  
School of Veterinary Medicine  
University of California, Davis  
Davis, California*

- 
- I. INTRODUCTION AND BRIEF HISTORY**
  - II. DEFINITION, GENERAL PROPERTIES, AND OVERVIEW OF FUNCTIONS**
  - III. FAT-SOLUBLE VITAMINS**
    - A. Vitamin A
    - B. Vitamin D
    - C. Vitamin E
    - D. Vitamin K
  - IV. WATER-SOLUBLE VITAMINS**
    - A. Vitamins Important to Redox: Ascorbic Acid, Niacin, and Riboflavin
    - B. Vitamins Directed at Specific Features of Carbohydrate, Protein, or Lipid Metabolism: Thiamin, Pyridoxine, and Pantothenic Acid
    - C. Vitamins Involved in Single-Carbon Metabolism: Biotin, Folic Acid, and B<sub>12</sub>
  - V. VITAMIN-LIKE COMPOUNDS**
    - A. Lipotropic Factors
    - B. Other Vitamin-Like Compounds
  - VI. CONCLUDING REMARKS**
  - REFERENCES**
- 

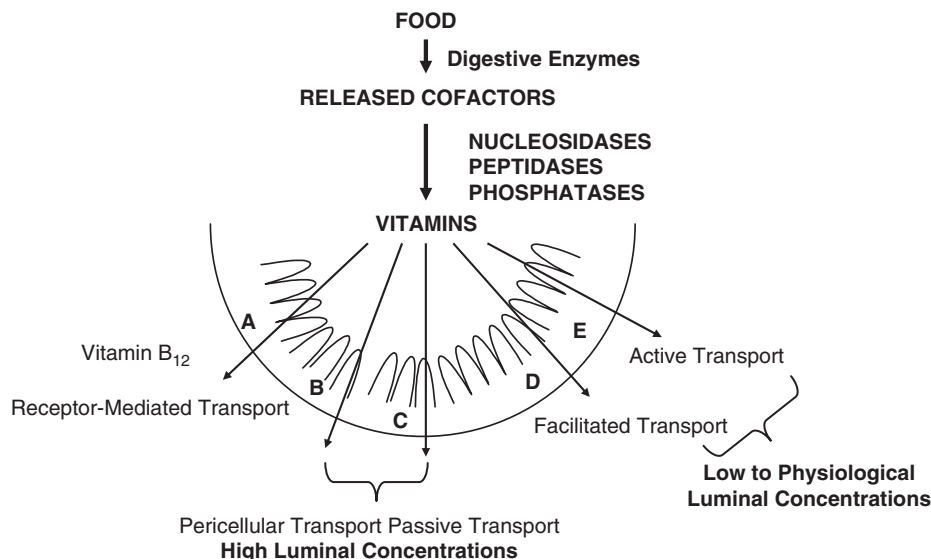
## I. INTRODUCTION AND BRIEF HISTORY

The concept that food components are linked to tissue growth and repair was evident in the writings of Greek philosophers as early as the fifth century B.C. In human medicine, nutrition is a topic found in the Hippocratic collection. The first disease to be recognized as nutrition related may have been night blindness. An ancient Egyptian medical text, the *Papyrusebers* (written about 1550–1570 B.C.), prescribed “beef liver, roasted, squeezed,

placed against the eye” for various eye diseases, including night blindness. In China, liver applied topically to the eye was also used as a treatment for night blindness.

By the mid-1700s, the curative effects of certain foods had been linked to a number of diseases. James Lynn, a physician in England, assembled his classic treatise that fresh fruits and vegetables seemed effective in curing scurvy. By the 1800s, the association of corn to pellagra (niacin deficiency) was made; by the 1900s, Eijkman, a Dutch physician working in Java, reported that consumption of polished rice was related to polyneuritis, associated with the nutrition disease beriberi. These studies are also noteworthy because they are among the first to utilize experimental animals to produce a vitamin deficiency in a controlled setting. However, the concept that specific diseases could be caused by the lack of a dietary component did not evolve until the beginning of the 20th century. Because of the success of Pasteur and the “germ theory,” many diseases now recognized as nutritional in origin were initially attributed to infectious agents. It was widely held that only the gross constituents of the diet (i.e., carbohydrates, protein, fat, and minerals) were needed for complete nourishment. As F. G. Hopkins, one of the founders of nutrition as a science, noted in his 1929 Nobel lecture, “the quantitative character of the data obtained and the attractive circumstance that such data appeared to supply . . . induced a feeling that knowledge concerning these needs had become highly adequate and was approximating even to finality . . . and a feeling that knowledge concerning nutrition was adequate and complete” (Hopkins, 1930). Nevertheless, the concept that a small amount of certain factors seemed necessary for optimal growth and development soon evolved (Goldblith and Joslyn, 1964).

The pursuit to define the nature of vitamins was first directed at lipid substances that were demonstrated to



**FIGURE 23-1** Vitamin absorption. Vitamins in foods are often present as cofactors or in highly modified forms. Pancreatic and intestinal cell-derived enzymes are required to initiate normal uptake in absorption. Nucleosidases, phosphatases, and peptidases are key factors in processing cofactors to vitamins. Transport of given vitamins can be receptor mediated and occur via pericellular-related processes, passive transport (usually at high luminal concentrations), active transport (requires energy), or facilitated processes (requiring a transporter or chaperone).

be essential in the diet of animals. McCollum and Davis at Wisconsin confirmed that butter or egg yolk, but not lard, supplied a lipid soluble factor that was necessary for growth in rats. As a consequence, the first fat-soluble substance with growth promoting properties (designated as vitamin A) was reported in the early 1900s, a time that most considered the beginning of the “age” of vitamin exploration (Goldblith and Joslyn, 1964).

Now there is constant awareness and sensitivity to the possibility of dietary vitamin deficiencies (and excesses). Nutritional deficiencies are not uncommon in animals, particularly animals fed diets of a limited (or restricted) number of dietary ingredients. A number of subsidiary and contributory factors may also lead to vitamin-related diseases. These factors include interference with normal food intake, loss of appetite (anorexia), impaired absorption or utilization, increased excretion, and the presence of antagonists. Stressful physiological states that increase nutrient demands (e.g., lactation) may also perturb the vitamin status of animals.

## II. DEFINITION, GENERAL PROPERTIES, AND OVERVIEW OF FUNCTIONS

No definition for vitamins is totally satisfactory. Vitamins have been defined as organic substances present in minute amounts in natural foodstuffs that are essential to normal metabolism, the lack of which causes deficiency diseases. This definition, however, is not specific and can apply to a number of compounds derived from the secondary

metabolism of amino acids, simple sugars, and fatty acids. Suffice to say that in most mammals they represent essential organic compounds, not easily classified with the macronutrients. Some may be synthesized, but in insufficient amounts to meet normal needs during critical developmental periods.

Vitamins can be further classified according to chemical and physical properties, such as whether they are soluble in aqueous solution or lipid solvents. Those vitamins that are soluble in lipid solvents (vitamins A, D, E, and K) are absorbed and transported by conventional lipid transport processes. For water-soluble vitamins, respective solubility coefficients are major factors that dictate the availability and ease of absorption. Within physiological ranges of intake, active processes are usually involved in the absorption of water-soluble vitamins. Although for some, at high concentrations (10 times or more the typical requirements), passive processes may also be involved. In this regard, the diversity and complexity of vitamin metabolism and processing should be appreciated at the onset. Vitamins in foods are often present as cofactors or in highly modified forms. Pancreatic and intestinal cell-derived enzymes are required to initiate normal uptake in absorption. Nucleosidases, phosphatases, and peptidases are key factors in processing cofactors to vitamins (Fig. 23-1).

Vitamins serve a broad range of functions. For example, some of the actions of vitamin A and vitamin D are consistent with the actions of steroid hormones; derivatives of vitamin A and also vitamin E can act as signal transduction mediators; vitamin K acts principally as an enzymatic



**TABLE 23-1** Requirements for Selected Water Soluble Vitamins Expressed as mg/1000kcal or 4.2Mjoules<sup>a</sup>

Vitamin	Animal				
	Cat	Rat	Mouse	Chick	Human
Thiamin	2–3	2	2	1	1–2
Riboflavin	1–2	1	1	0.5	1
Niacin <sup>b</sup>	20–30	8	8	6–8	5
Pyridoxine <sup>b</sup>	2–4	2	2	1–2	1
Folate	3–4	0.5	0.5	0.5	0.3

<sup>a</sup>Taken from the National Research Council publications dealing with requirements for animals or humans. Values were obtained by dividing the recommended safe and adequate intake by the recommended energy intake.

<sup>b</sup>Cats do not effectively convert tryptophan to niacin; thus, there is absolute need for niacin. In this regard, ~10 mg of niacin is produced per 4.2MJ of typical diets containing high-quality protein when utilized by the rat, mouse, chick, or human. The higher pyridoxine need in the cat is due to the higher protein requirements of carnivores and higher concentrations of enzymes dedicated to nitrogen metabolism. If expressed on a unit protein basis rather than energy basis, the pyridoxine requirements of most homeothermic animals are similar.

cofactor; vitamin E can act as an agent that scavenges free-radical containing lipids and oxidants, independent of a direct association with an enzyme, although recent information indicates possible roles in cell signaling. Regarding the water-soluble vitamins, most serve as cofactors or co-substrates for enzymes or in cell signaling.

These varied functions of vitamins have also complicated the development of a simple system of classification or nomenclature. When the vitamins were originally discovered, they were isolated as fractions from selected foods, and as their exact chemical composition was seldom known, a system of letter designations was developed. However, this system became complicated when it was discovered that some functions originally ascribed to vitamins were due to other substances, such as one of the essential amino acids. Consequently, the designation of vitamins by letters was not systematically pursued. Similarly, the lack of chemical composition data resulted in a complex system of expressing dosages as arbitrarily defined units. Regarding requirements, when expressed on an energy basis, vitamin requirements are often of the same order from one species to the next. Some examples are given in Table 23-1. Differences in dietary requirements between species for given vitamins (in contrast to physiological or metabolic requirements) are usually due to presence of unique pathways for their production, degradation, or disposal. Good examples are ascorbic acid and niacin, which cannot be made in some animals and therefore are true vitamins for such animals. Taurine is another example of a nutrient (although not a true vitamin as classically defined) where continual disposal or loss from the body results in a nutritional need, even though taurine can be synthesized. Further, young and growing animals may have a relatively higher nutritional need for some nutrients. Many species during neonatal periods have requirements for certain compounds, which later in life may be

sufficiently produced (e.g., choline, carnitine, or inositol). There are also numerous possibilities for deleterious interactions that can have physiological consequences and affect given requirements (Committee on Animal Nutrition, 2001a, 2001b; McDonell, 2001; Rucker and Steinberg, 2002; Subcommittee on Laboratory Animal Nutrition, Board on Agriculture, National Research Council, 1995).

### III. FAT-SOLUBLE VITAMINS

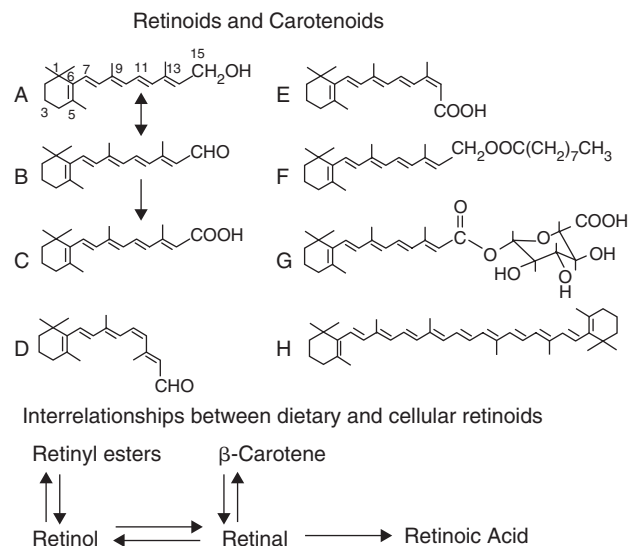
#### A. Vitamin A

##### 1. Introduction

Observations by Hopkins, Stepp, and others that a growth-stimulating factor could be extracted from milk by means of lipid solvents, concentrated, and tested in experimental animal models were seminal steps that eventually led to the identification of vitamin A (Goldblith and Joslyn, 1964). This growth-promoting factor was also described as being present in egg yolk, butter, and cod liver oil. In later studies, “Factor A” or vitamin A was shown to be present as lipid esters in animal tissues and in the form of a “provitamin A” in plants (e.g., compounds in the carotenoid family). The structures and recommended names of naturally occurring and commercial forms of vitamin A and carotenoids are shown in Figure 23-2. Once chemical features for the carotenoids and retinoids were resolved in the 1940s and 1950s, studies of their biological function were undertaken and commercial synthesis of vitamin A and vitamin A-like molecules proceeded rapidly.

##### 2. Proforms of Vitamin A: The Carotenoids

Carotenoids comprise a group of more than 700 compounds (most often red, yellow, and orange pigments in



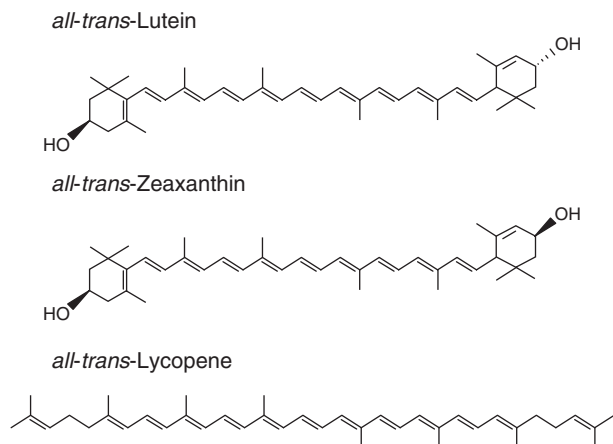
**FIGURE 23-2** Structures of retinoids and carotenoids related to vitamin A. The structures are for (A) retinol, (B) retinal or retinaldehyde, (C) retinoic acid [all-trans], (D) retinoic acid [11-cis], (E) retinoic acid [13-cis], (F) retinyl ester [palmitate], (G) retinoyl  $\beta$ -glucuronide, and (H)  $\beta$ -carotene.  $\beta$ -Carotene is a precursor to retinal, which in turn may be reduced to retinol or irreversibly oxidized to retinoic acid. In animal cells, retinol is “stored” as retinyl ester.

their isolated states) found in many fruits and vegetables (Stahl and Sies, 2005). To act as a provitamin A, a carotenoid must contain a  $\beta$ -ionone structure (i.e., the ring structure shown in Figure 23-2 containing a single double bond and three methyl groups). The carotenoids represent an unusual class of biological pigments. Carotenoids are rich in conjugated double bonds and are designed to interact with light. Green plants are the main sources of carotenoids in the diet of most animals.

In plants and prokaryotes, carotenoids serve as mediators of photo-energy-related processes by capturing energy from light (Stahl and Sies, 2005). Carotenoids are also readily destroyed by intense light, particularly UV light. From a chemical perspective, this is important given the wide range of functions involving carotenoids and vitamin A. Carotenoids can also quench singlet oxygen and may act as both antioxidants and prooxidants. The resulting products of such reactions may also have unwanted side effects, a problem that is not often appreciated.

When hays are stored for long periods (e.g., a year or more), the carotenoid content may be markedly reduced or modified because of chemical or physical (UV light) oxidation. Moreover, in plants, carotenoids occur in association with chloroplasts complexed with protein and other lipids and provide the main source of provitamin A for animals. In nonruminant animals, poor digestion of complex organelle structures, such as chloroplasts, in turn may lead to poor digestibility of carotenoid components.

Grains, with some exceptions (e.g., corn) are minor sources of provitamin A. Among the legume grains,

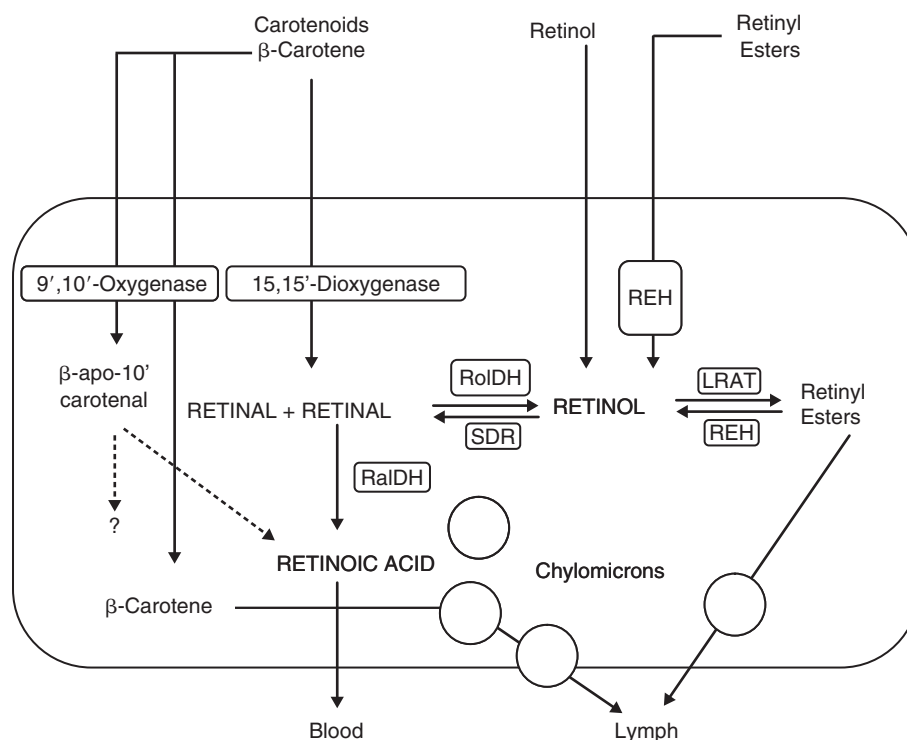


**FIGURE 23-3** Structures of carotenoids without vitamin A activity. Lutein is found in green leafy vegetables and is employed as an antioxidant and for blue light absorption. Lutein covalently bound to one or more fatty acids is present in some fruits and flowers, notably marigolds. As a pigment, lutein and other xanthophylls (e.g., zeaxanthin) are used as natural colorants (e.g., in chicken feed to provide the yellow skin color). Lutein is also found to be present in a concentrated area of the macula, a small area of the retina responsible for central vision. As a consequence, there is interest in lutein and diseases of the eye, such as age-related macular degeneration. Lycopene is a bright red carotenoid pigment found in tomatoes and other red fruits.

chickpeas, green and black grams are the best sources of provitamin A. The richest source of carotenoid is red palm oil, which contains 500 g of mixed  $\alpha$ - and  $\beta$ -carotene per milliliter. Of the carotenoids, six are known to be biologically important:  $\alpha$ -carotene, lycopene, lutein, zeaxanthin, cryptoxanthin, and  $\beta$ -carotene (e.g., because of its role as a precursor to vitamin A). The structures of lycopene, lutein, and zeaxanthin are shown in Figure 23-3. The following sections focus mostly on  $\beta$ -carotene and vitamin A followed by short descriptions for the other carotenoids, which serve as important biofactors, although with no specific or known vitamin functions.

### 3. Metabolism

Following ingestion, retinyl esters in animal products are hydrolyzed to retinol by pancreatic hydrolases (esterases) or lipid hydrolases localized on the surface of the brush border of intestinal cells (Harrison, 2005). Bile and dietary lipids facilitate the absorption process, as retinyl esters must be a part of a lipid micelle to be absorbed. The micellar structures enhance fusion into the microvillus of intestinal cells. Similarly, lipid micelles enhance the uptake of carotenoids into intestinal cells. The bioavailability and digestion of vitamin A and carotenoids are affected by the overall nutritional status and the integrity of the intestinal microvillus. Absorption of physiological doses of vitamin A in most animals is 70% to 90%, but the efficiency of absorption for carotenoids added to diets is 40% to 60%, depending on the type of carotenoid. Carotenoids contained in plant chloroplasts, however, are often poorly



**FIGURE 23-4** Absorption and cellular metabolism of carotenoids and retinoids. In the intestinal mucosal cell, some carotenoids are oxidized to both carotenals and retinals. Retinal can be reduced by alcohol dehydrogenases (RoIDH) to retinol and re-esterified by lecithin retinol acyl transferase (LRAT). Retinol and associated esters are then incorporated into chylomicra, which are released into the lymph. Retinol can also be released from retinyl esters by action of retinyl ester hydrolase (REH). Moreover, retinol can be oxidized to retinal by short-chain dehydrogenases/reductases (SDR). Retinoic acid is formed from retinal by the action of retinal dehydrogenase (RalDH). Retinoic acid is sufficiently polar so that movement is directed to plasma. In contrast, owing to their nonpolar nature, given carotenoid pigments and retinyl esters are partitioned into chylomicrons for delivery into lymph. Retinol transport and carotenoid transport differ. RET enters intestinal cells by diffusion and effluxes in part by a basolateral transporter in the ABCA1 transport family of protein transporters. Carotenoid uptake is mediated by the apical transporter SR-B1, and carotenoid efflux occurs exclusively via secretion in CM.

absorbed (less than 10%), because of the low digestibility of chloroplasts and release of carotenoids.

In the intestinal mucosal cell, some carotenoids are oxidized to both carotenals and retinals (Fig. 23-4). Most of the retinal is next reduced by alcohol dehydrogenases to retinol and re-esterified. Retinol and associated esters are then incorporated into chylomicra, which are released into the lymph.

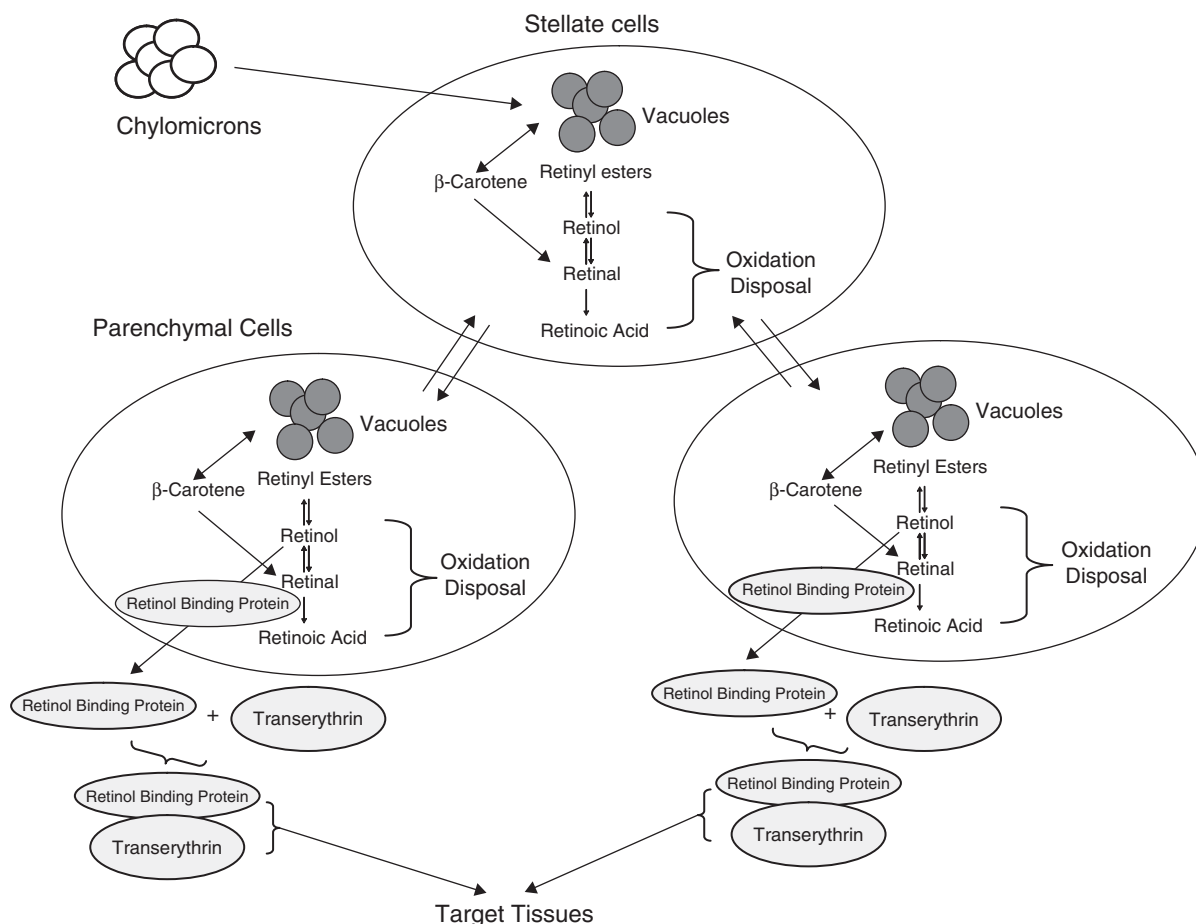
Chylomicra particles in lymph are carried to the liver where about 75% of the retinol-derived products are cleared in most animals. In liver, there is active exchange of retinyl and other retinoids between stellate (also known as Ito cells) and parenchyma cells. To buffer such cells from an excess of vitamin A, it may be “stored” in lipid vacuoles. The storage form is as retinyl esters, where retinyl palmitate is usually the most predominant form.

As the body needs vitamin A, retinyl ester in the liver is hydrolyzed and released as retinol bound to retinol-binding protein (RBP), which binds one molecule of vitamin A as retinol per molecule of RBP (Fig. 23-5). When released into circulation, RBP exists as a complex not only with vitamin A, but also with another protein, transthyretin, which binds thyroxine. The RBP and the transthyretin

complex transport not only vitamin A, but also thyroxine to targeted cells. The primary target cells for vitamin A are epithelial in nature (e.g., fetal epidermal cells, the cells of the gastrointestinal mucosa, the reproductive tract, pulmonary secretory cells, and the salivary gland) (Debiec and Larondelle, 2005; Harrison, 2005).

In regard to uptake and entry into targeted cells, such as epithelial cells, the exact role of RBP at the cell surface is unclear. The association constant ( $K_a$ ) between retinol and the transthyretin-RBP complex is relatively low, approximately  $10^6$  M/l. For example, this association constant is about the same as that for the binding of retinol to other proteins (e.g., albumin), which does not imply a high degree of specificity. In cell cultures, RBP is not essential for retinol uptake. However, the interaction of retinol within RBP’s hydrophobic binding domain protects retinol from oxidation. The complex is also not cleared by the kidney, which helps to sustain retinol levels in circulation (Harrison, 2005).

Inside the targeted cells, vitamin A, as retinol, interacts with cellular-binding proteins that function to control its subsequent metabolism (e.g., oxidation to retinal and to retinoic acid). Retinal metabolites do not exist “free” in



**FIGURE 23-5** Steps in vitamin A processing in liver Stellate and parenchymal cells. Retinoids and carotenoids are transported from the intestine in chylomicron particles and are cleared primarily by the liver. The stellate cell is designed to sequester lipid-like compounds until needed. Fluids in the liver sinusoids derived from blood and lymph bathe stellate cells. The stellate cells are in communication with liver parenchymal cells. As the body needs vitamin A, retinyl esters and  $\beta$ -carotene sequestered in lipid vacuoles are released and eventually converted to retinol. The next steps involve the binding of vitamin A to retinol-binding protein (RBP). When released into circulation, RBP exists as a complex not only with vitamin A but also with another protein, transthyretin, which binds thyroxine. The RBP and the transthyretin complex transport not only vitamin A but also thyroxines to targeted cells. The primary target cells for vitamin A are epithelial in nature (e.g., fetal epidermal cells, the cells of the gastrointestinal mucosa, reproductive tract, pulmonary secretory cells, and salivary gland).

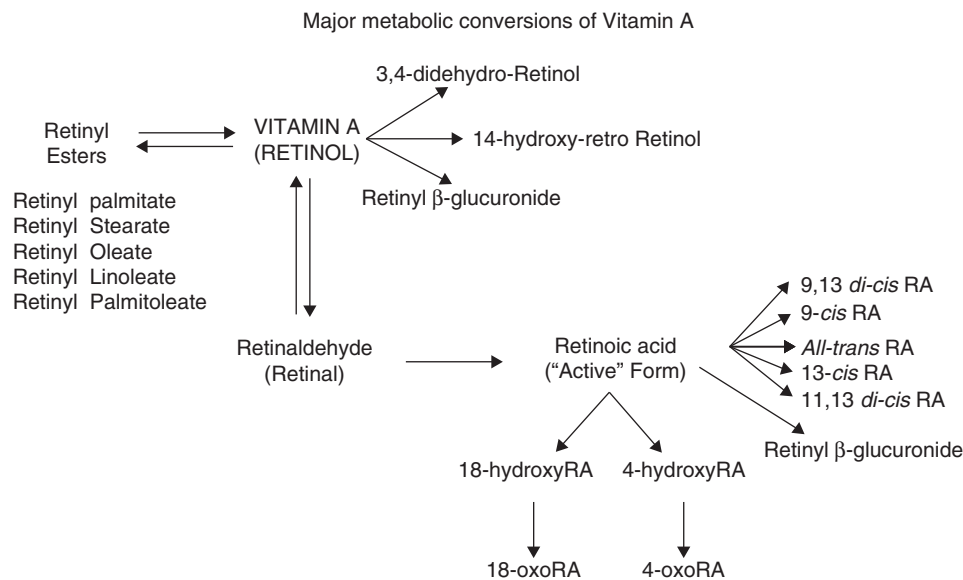
cells but are associated with specific binding proteins. The binding to and release from such proteins is rapid. Because the binding proteins are contiguously associated as a part of the cellular scaffolding, it is possible for given retinoid metabolites to move vectorially along given paths to specific locations in the cell.

Regarding the retinoid metabolites, retinoic acid is the most important, serving as a ligand for nuclear receptors (Velazquez and Fernandez-Mejia, 2004; Velazquez *et al.*, 2005). These receptors are a part of a family of transcription factors that include nuclear receptors that also interact with glucocorticoids, thyroxine, and the so-called peroxisomal proliferation activator agonists or ligands. Retinoic acid influences the transcriptional regulation of at least 600 known genes. Both excesses and deficiencies of vitamin A can markedly influence the expression.

The catabolism of excess retinal may be initiated by one of several alcohol dehydrogenase isozymes with subsequent oxidation via peroxisomal enzymes. Microsomal enzymes (cytochrome P450 hydroxylases) are also involved. Examples of some of the events and products are given in Figure 23-6. Important interactions involve agents that can induce cytochrome P450 hydroxylases (or monooxygenases). For example, phenobarbital can cause depletion of liver retinol by induction of a microsomal oxidase system that promotes retinoid oxidation.

#### 4. Functions

The major roles of vitamin A are in cellular differentiation, tissue growth, and vision. In vision, vitamin A, as a component of rhodopsin, facilitates the efficient transfer of energy



**FIGURE 23-6** Steps in the metabolic conversion of vitamin A. The catabolism of excess retinol/retinal may be initiated by one of several alcohol dehydrogenase isozymes with subsequent oxidation via peroxisomal enzymes. Microsomal enzymes (cytochrome P450 hydroxylases) are also involved. Shown are some of the events and products. Some of these products may become sufficiently oxidized so that they are excreted by the kidney. Others, such as the glucuronide, are deposited by transport and eventual delivery into bile.

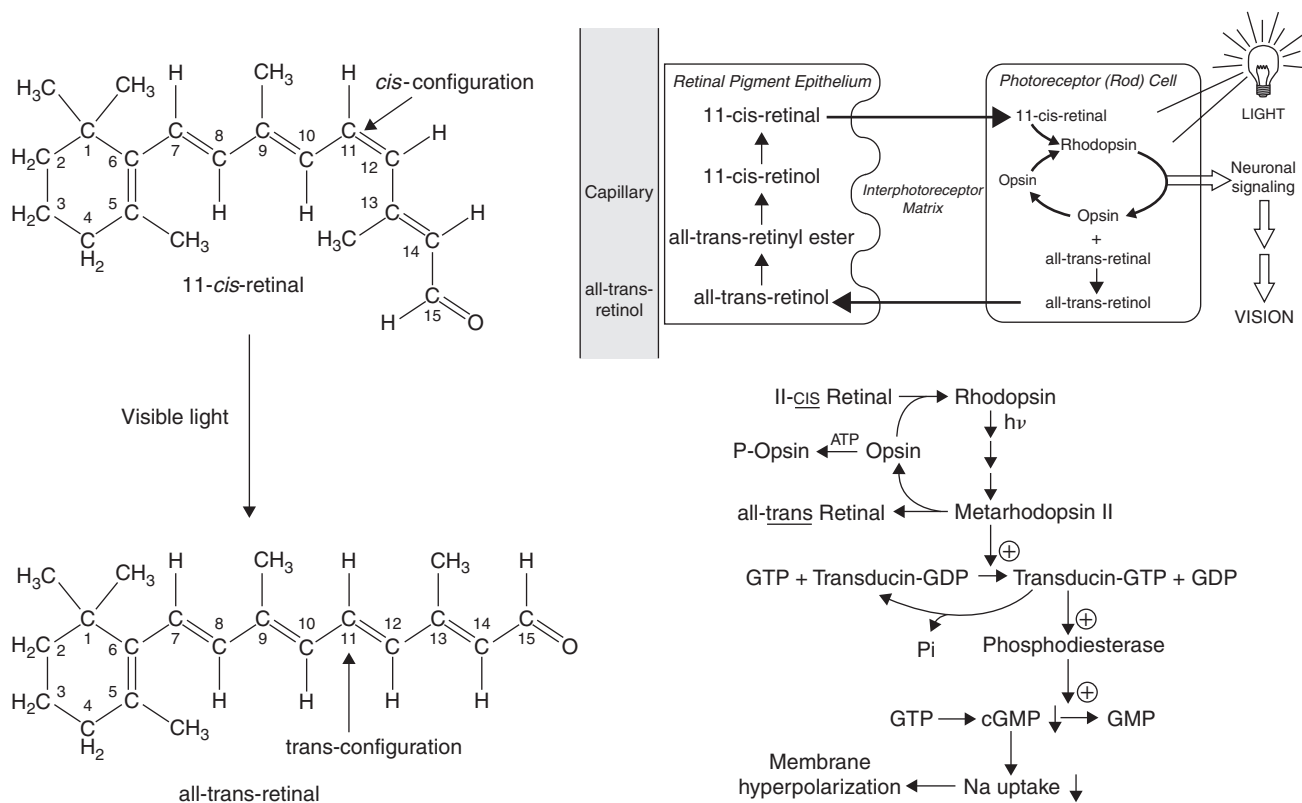
from photons of light to electrochemical signals. The series of events leading up the propagation of this signal are as follows: vitamin A as 11-*cis* retinal, forms a protonated Schiff base by binding to a lysine residue in the protein opsin to yield the visual pigment, rhodopsin (Lamb and Pugh, 2004). When a photon of light strikes rhodopsin, *cis-trans* isomerization occurs and the process results in a highly strained form of rhodopsin, bathorhodopsin, which is converted to metarhodopsin with subsequent deprotonation (Jang *et al.*, 2000). The deprotonated metarhodopsin interacts with transducin, one of the proteins in the transmembrane G-protein family. This interaction causes a subunit of transducin to bind GTP and stimulate cGMP phosphodiesterase activity. This results in a decrease in cGMP, which constitutes a significant amplification of the initiating event, the conversion of light-derived energy through 11-*cis* to transisomerization of retinal and specific changes in protein conformation (Fig. 23-7). Next, the local change in cGMP concentration results in changes in cation flux (Na and Ca ions) across rod cell membranes (Lamb and Pugh, 2004; McCabe *et al.*, 2004). This initiates an electrochemical event, the firing of cells of the optic nerve. Further, metarhodopsin is phosphorylated during these final steps and interacts with a protein designated as arrestin. The metarhodopsin-arrestin complex inhibits the transducin response and causes the release of all-*trans* retinal and the return to rhodopsin (opsin), thus completing the cycle.

In quantitative terms, only a small fraction of the total vitamin A requirement is involved in the visual process because of extensive recycling of retinal. With vitamin A deficiency, there is an inability to appropriately saturate

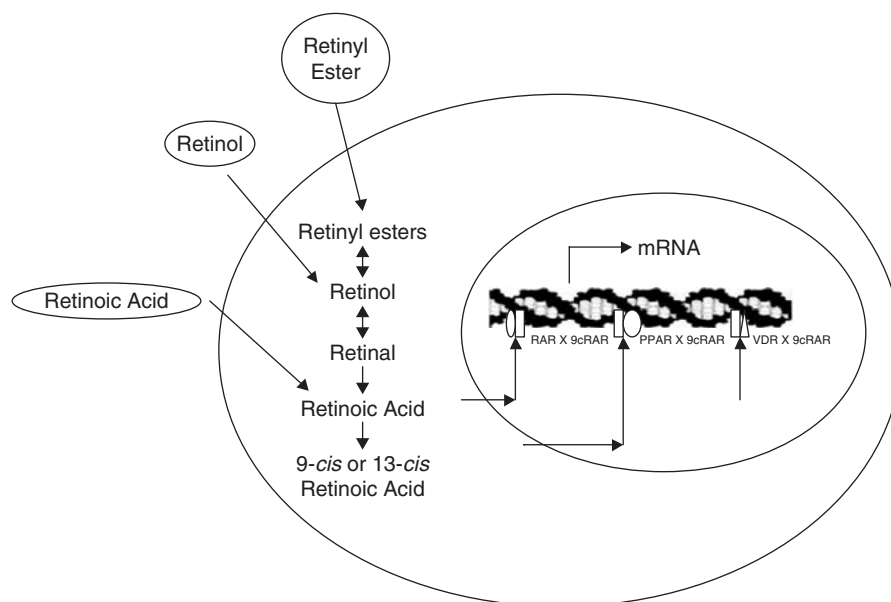
opsin with 11-*cis* retinal to form rhodopsin and its subsequent complexes. This decreases the sensitivity of the visual apparatus, so that light of low intensity is not perceived leading to nyctalopia or night blindness. An important note, which underscores the importance of having some knowledge of vitamin A chemistry and physiology, is that night blindness is not uncommon in cattle or sheep that have been grazing on dry weathered pasture for long periods such as during prolonged drought (Barnett *et al.*, 1970; Booth *et al.*, 1987). Although most cattle in feedlots are supplemented with vitamin A, if vitamin A is accidentally left out of the ration and stored hay is fed that has lost its carotene content or grain (other than yellow corn), night blindness can occur.

### 5. Growth and Cell Differentiation

As work on vitamin A progressed, it became appreciated that although retinol and retinal were important to vision, the retinoic acid would not correct night blindness but was essential to growth and normal development (Debiec and Larondelle, 2005). Within cells all-*trans* retinol associates with cytosolic retinol-specific binding proteins, and the resulting complex become vehicles for subsequent processing. For example, all-*trans* retinol may be oxidized and isomerized to all-*trans*, 9-*cis*, or 13-*cis* retinoic acid, which subsequently binds to retinoic acid-specific binding proteins that act as transcription factors in protein regulation and cellular differentiation (Fig. 23-8). The details of such interactions are beyond the scope of this chapter. However, it is important to appreciate that in response to very low



**FIGURE 23-7** Vitamin A and vision. Retinal, as a component of rhodopsin, facilitates the transfer of energy from photons of light to electrochemical signals. The series of events includes the *cis-trans* isomerization, which results in a highly strained form of rhodopsin that is converted to metarhodopsin with subsequent deprotonation. The deprotonated metarhodopsin interacts with transducin, one of the proteins in the transmembrane G-protein family. This interaction stimulates cGMP phosphodiesterase activity, which results in a decrease in cGMP and signal amplification. The local changes in cGMP concentration result in turn in changes in cation flux (Na and Ca ions) across rod cell membranes to initiate firing of cells of the optic nerve.



**FIGURE 23-8** Vitamin A and cell regulation. Within cells all-*trans* retinol associates with cytosolic retinol-specific binding proteins, and the resulting complex become vehicles for subsequent processing. For example, all-*trans* retinol may be oxidized and isomerized to all-*trans*, 9-*cis*, or 13-*cis* retinoic acid, which subsequently binds to retinoic acid-specific binding proteins that act as transcription factors in protein regulation and cellular differentiation. The nature of the metabolic control has many facets including the regulation of specific receptor concentrations and their combination to form specific signaling complexes. The figure shows duplexes for the retinoic acid receptor (RAR) with (1) an isomeric form, (2) complexes with peroxisomal receptors, and (3) receptors under the control of vitamin D derivatives.

doses of retinoids, epithelial cells undergo a “terminal differentiation.” Epithelial cells lose their normal columnar shape, become flattened or squamous, and increase their cytosolic content of keratin (stabilized by transglutaminase catalyzed cross-links).

In dermis, this process normally results in a protective outer layer, scales, and other specialized surfaces. With a deficiency, however, the skin can thicken and become hyperkeratinized. If the primary function of the epithelial cell is the provision of a moist surface or absorption (e.g., an enterocyte or lung secretory cell), squamous hyperkeratinization leads to loss of functional integrity. Lack of protective mucus secretions sets the stage for infections of the lungs and other tissues that depend on a mucus barrier. In the intestine, hyperkeratinization induces premature sloughing of enterocytes and malabsorption. The gradient delivery of retinoids to epithelial cells helps to explain why some epithelial cells undergo terminal differentiation, whereas others undergo cell cycling and periodic turnover, although important details need to be resolved. Other cells that are responsive to retinoids include phagocytic cells and cells associated with the immune response (e.g., the normal proliferation of the B cells and T cells requires vitamin A) (Ross *et al.*, 2000).

## 6. Requirements

For any given animal, the requirement for vitamin A depends on age, sex, rate of growth, and reproductive status. For optimal maintenance, the allowance for many animals ranges from 100 to 200 international units per kilogram of body weight per day (one international unit is equal to 0.3 g of retinol). In young growing animals, a more precise method of expressing the vitamin A requirement is on an energetic basis. In animal feeds, 4000 to 10,000 international units per kilogram of feed is considered adequate in the United States to provide vitamin A requirements for most animals.

Pathological conditions that influence vitamin A status include malabsorption, including pancreatic insufficiency and cholestatic disease, cystic fibrosis, liver disease, and kidney disease. Many forms of liver disease interfere with the production or release of RBP, which results in a lower plasma level of vitamin A. Renal failure can result in loss of RBP in urine. Factors that impair lipid absorption and transport might also be expected to influence vitamin A status.

## 7. Evaluation of Vitamin A Status of Animals

The vitamin A status of animals may be evaluated on the basis of physiological, clinical, and biochemical procedures. Clinical testing for night blindness and the elevation of CSF pressure has been used to indicate vitamin A status. The concentration of retinol and its esters is readily measured in biological samples by HPLC using various detectors and indicates the vitamin A status. As the concentration

of retinol in plasma is well maintained until liver reserves are depleted, plasma retinol is not an index of vitamin A reserves. The latter is best provided by analysis of liver biopsy samples. In many carnivores, the plasma contains, in addition to retinol, equal or greater concentrations of retinyl palmitate and retinyl stearate bound to albumin, the immunoglobulin fraction, or to VLDL. Plasma retinol concentrations in excess of 30 g/dl generally indicate that vitamin A is not limiting. In most species, liver concentrations of 100 g of retinol/g liver are generally adequate.

## 8. Pharmacology and Toxicity

Vitamin A and various retinoids are used increasingly to treat skin disorders (acne and psoriasis) and certain forms of cancer. A vitamin A responsive dermatosis in cocker spaniels is well recognized and has been previously described (Scott, 1986). Retinyl- $\beta$ -glucuronide and hydroxyethyl retinamide are commercial preparations of retinoids that have such activity but are less toxic than retinoic acid. The mechanisms by which these agents function most probably relate to the complex pathways involved in epithelial and epidermal cell differentiation.

Vitamin toxicities may be classified under three broad categories: acute, chronic, and teratogenic. When a single dose of vitamin A (greater than 100mg) is injected into animals (20 to 50-kg weight range), symptoms such as nausea, vomiting, increased cerebral spinal fluid pressure, and impaired muscular coordination result. A lethal dose of vitamin A (100mg) given to young monkeys has been reported to cause coma, convulsions, and eventual respiratory failure.

Chronic toxicity may be induced by intakes of vitamin A in amounts 10 times the normal requirements. Doses of vitamin A in this range can lead to alopecia, ataxia, bone and muscle pain, and purities. Although cats have a high tolerance to excessive intakes of vitamin A, hypervitaminosis A occurs in cats that are given a diet largely of liver. Affected cats exhibit skeletal deformations, particularly exostoses of the cervical vertebra, which precludes effective grooming. Vitamin A is also a powerful teratogen. A single large dose during pregnancy (in the 50- to 100-mg range) for an animal weighing 20 to 50kg can result in fetal malformations. Chronic intakes (exceeding 10 times the requirements for given animals) can also be teratogenic. Carotenoids, unlike retinoids, are generally non-toxic, and many animals routinely ingest gram amounts of carotenoids on a daily basis with no deleterious effects (old world primates, herbivores, etc.).

## 9. Other Carotenoids

In addition to  $\beta$ -carotene, of the other carotenoids, the most information is available for  $\alpha$ -carotene, lycopene, lutein, zeaxanthin, and cryptoxanthin. To reiterate, these carotenoids along with hundreds of others are the natural pigments in



plant tissues and give them color (Fig. 23-3). Carotenoid pigments attach themselves to proteins or fats and can produce blue, green, purple, or brown pigments in addition to yellow, orange, and red. If an animal's skin or feather color comes from carotenoids and it is not available in food, some or all of the color fades. For example, many birds develop bright red, orange, or yellow carotenoid pigmentation that they use presumably to attract mates. Because animals often obtain several different carotenoids from plant and animal food sources, it is possible that these pigments are accumulated at different levels, which results in the ultimate color expression of individual animals. As an example, when finches are fed a lutein-zeaxanthin mix, proportionally more zeaxanthin was found than lutein than occurred in the diet (i.e., there is preferential accumulation in the body). In fish, pigmentation is influenced by diet and sex. Presumably, males absorb/retain more pigments than females. Often consumers of various products (notably egg yolk, eggshell, broiler skin, and salmon flesh) prefer a specific type and degree of coloration. Although some birds can be sexed by visual inspection of their genitalia, mating resulting in sex-associated color phenotypes is becoming more in use. The genetic markers involved affect the color of the plumage and the cloning of genes involved in pigmentation offers the prospect of deciphering the genetic control of animal pigmentation and modifying it to meet specific pigmentation needs (Castaneda *et al.*, 2005; Johnson *et al.*, 2000).

Regarding specific carotenoids,  $\alpha$ -carotene is one of the most abundant carotenoids in the diet and can be converted to vitamin A, but with only one-half the activity as  $\beta$ -carotene (contains only one  $\beta$ -ionone ring in contrast to two for  $\beta$ -carotene). Other differences in biological activity have also been reported. The  $\alpha$ -carotene is a better inhibitor toward certain growth factors (e.g., N-myc activity) than  $\beta$ -carotene. N-myc is in the oncogene family of growth factors. Because of its abundance,  $\alpha$ -carotene is also an excellent biomarker of intake of fruits and vegetables (Stahl and Sies, 2005). Another carotenoid, lycopene, is a red pigment found in fruits and vegetables. In human epidemiological studies, its consumption in modest amounts is weakly associated with a reduced risk of certain cancers. Lutein and zeaxanthin are carotenoids found in green, leafy vegetables and algae and have been considered recently for potential benefits to sight and vision, particularly a decrease in the risk of cataracts. Cryptoxanthin has even been reported to decrease bone loss in ovariectomized rodents. Thus, there are a wide range of health effects, which may have nutritionally and pharmacological potential (Stahl and Sies, 2005).

## B. Vitamin D

### 1. Introduction

Sir Edward Mellanby in 1921 reported the induction of rickets in dogs through dietary manipulation. He discovered that

the disease could be corrected with cod liver oil. McCollum in 1922 reported the curative factor in cod liver oil was not vitamin A and appeared to be another fat-soluble substance. This substance was later identified as vitamin D, based on the ability to inactivate the vitamin A factor in cod liver by mild oxidation with the retention of antirachitic activity (Goldblith and Joslyn, 1964).

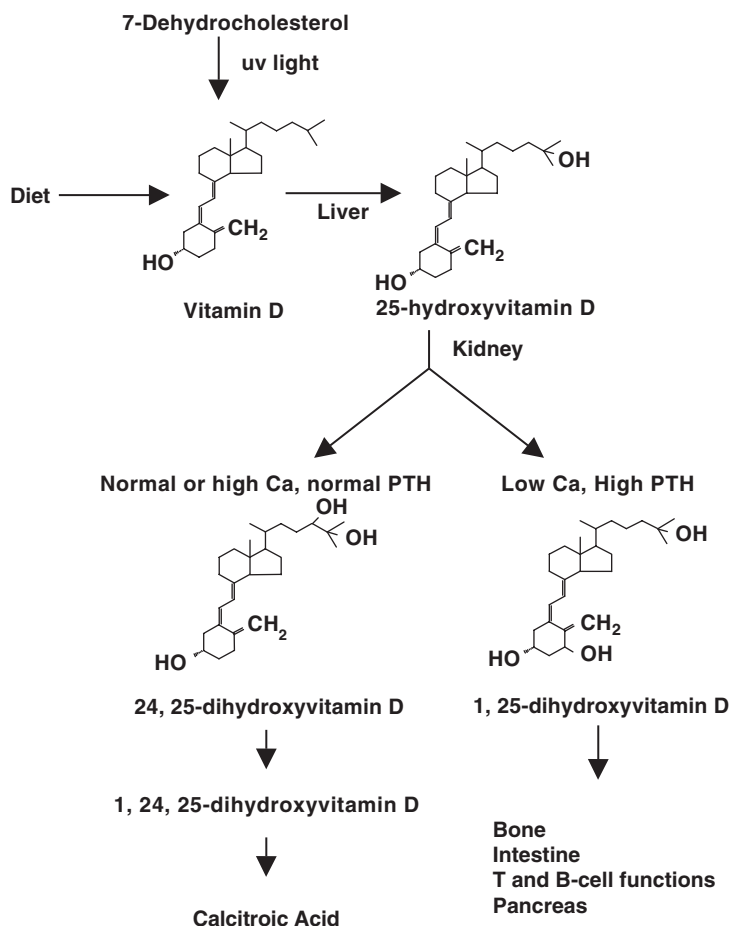
### 2. Sources, Functions, and Metabolism of Vitamin D

The D vitamins are a family of 9,10-secosteroids that differ only in the structure of the side chain attached to carbon-17. The two forms of vitamin D significant in veterinary medicine are ergocalciferol (vitamin D<sub>2</sub>) and cholecalciferol (vitamin D<sub>3</sub>). The differences in the side chain result in the vitamins having disparate potencies with some species of animal and differing in toxicity when consumed in large amounts. These two forms of vitamin D are produced in a two-step reaction when their respective sterols ergocalciferol and 7-dehydrocholesterol absorb ultraviolet radiation and undergo photolysis, which is then followed by thermal isomerization (Fig. 23-9). Excessive ultraviolet radiation of the sterols produces inactive compounds. Under most instances, animals can synthesize sufficient quantities of cholecalciferol if they receive adequate exposure to ultraviolet light of wavelength 280 to 320 nm (Hendy and Goltzman, 2005; Hendy *et al.*, 2006; Xue *et al.*, 2005). This is particularly true when the calcium and phosphorus requirements of the animal are met. As vitamin D is produced at one site and acts at other sites including bone and intestine, it fulfills the definition of a prohormone.

In most animals, 7-dehydrocholesterol is abundant in skin, being the ultimate precursor for cholesterol, which is synthesized from acetate. However, the skin of cats and dogs and possibly other carnivores contains only small quantities of 7-dehydrocholesterol, which does not permit adequate synthesis of vitamin D. These animals are solely dependent on the diet for this vitamin. With the exception of animal products, most natural foods contain low vitamin D activity. Fish, in particular saltwater fish, such as sardines, salmon and herring, and fish liver oils contain significant to large quantities of vitamin D. Many plants also contain hydroxylated ergosterol derivatives, some of which have potent vitamin D activities (Wasserman, 1975).

Initially, it was speculated that vitamin D might serve as an enzymatic cofactor for reactions that served to maintain calcium and phosphorus (as phosphate). When isotopes of calcium became available, it was soon appreciated that there was considerable lag between the administration of vitamin D and its effect on calcium-related metabolism. This lag was shown to be due to the conversion of vitamin D to an active form. Investigations throughout the 1960s and 1970s led to the sequence of events that is outlined in Figure 23-9. For example, the kidneys were identified





**FIGURE 23-9** Vitamin D metabolism. Vitamin D is formed in the skin of most animals after exposure to ultraviolet radiation. Vitamin D can also come from the diet. It is hydroxylated in the liver to 25-hydroxyvitamin D, and in the kidney to 1,25-dihydroxyvitamin D, which is the active form. The production of 1,25-dihydroxyvitamin D is normally regulated through feedback control and the influence of parathyroid hormone (PTH) on the activities of the  $1\alpha$ -OH or 25-OH-vitamin D hydroxylase. A fall in plasma calcium triggers the release of PTH from the parathyroid gland, which stimulates  $1\alpha$ -hydroxylase production and leads to an increase in output. A separate hydroxylase, which catalyzes 24,25-(OH)<sub>2</sub>-vitamin D<sub>3</sub> production, is activated under eucalcemic and hypercalcemic states. The major sites of action in relation to calcium homeostasis are bone and intestine. The immune system and the pancreas are also sensitive to changes in vitamin D status.

as the site of 1,25-dihydroxycholecalciferol (calcitriol or 1,25-(OH)<sub>2</sub>-D<sub>3</sub>) production. This discovery, together with the finding that 1,25-(OH)<sub>2</sub>-D<sub>3</sub> was in the nuclei of intestinal cells, suggested that vitamin D was functioning in a manner analogous to that for steroid hormones. The production of calcitriol is normally closely regulated through feedback control and the influence of parathyroid hormone (PTH) on the activities of the  $1\alpha$ - and 24-OH-hydroxylases. A fall in plasma calcium triggers the release of PTH from the parathyroid gland, which stimulates  $1\alpha$ -hydroxylase production and leads to an increase output of calcitriol from the kidney. A separate hydroxylase, which catalyzes 24,25-(OH)<sub>2</sub>-D<sub>3</sub> production, is activated under eucalcemic and hypercalcemic states. Whether 24,25-(OH)<sub>2</sub>-D<sub>3</sub> serves an essential function is controversial. However, there is evidence that 24,25-(OH)<sub>2</sub>-D<sub>3</sub> is required for some of the biological responses attributed to vitamin D (Dusso *et al.*, 2005; Norman *et al.*, 2002). Norman and coworkers (Norman *et al.*, 2002) have shown that hatchability in chickens markedly improves if both 1,25-(OH)<sub>2</sub>-D<sub>3</sub> and 24,25-(OH)<sub>2</sub>-D<sub>3</sub> are administered into eggs containing viable embryos from hens rendered rachitic (vitamin D deficient) before egg production. The two major sites of action of calcitriol in relation to calcium homeostasis are bone,

where it acts rapidly in concert with PTH in response to hypocalcemia, and at the intestine, where the response time is longer. In addition to 1,25-(OH)<sub>2</sub>-D<sub>3</sub> and 24,25-(OH)<sub>2</sub>-D<sub>3</sub>, more than 20 other hydroxylated intermediates and end products have been identified. Most of these are probably routed into elimination pathways, although some may be potentially functional (e.g., 1,24,25-trihydroxycholecalciferol, which has some vitamin D activity).

Calbindin, a calcium binding protein, is a major product synthesized in intestinal cells in response to calcitriol. Calbindin influences the movement of calcium across the intestinal cell. Binding of calcium to this protein allows the intracellular concentration of calcium to be elevated. The hormone forms of cholecalciferol also stimulate the production of the calcium, sodium-dependent ATPases, which reside on the luminal surface of the intestinal cell. This facilitates the vectorial movement of calcium out of the cell into circulation. In addition, evidence also indicates that 1,25-(OH)<sub>2</sub>-D<sub>3</sub> can stimulate secondary messenger systems (e.g., protein kinase and adenylyl cyclase-controlled dependent messenger systems) (Dusso *et al.*, 2005).

In addition to intestinal cells, the osteoblasts of bone are another target of vitamin D metabolites and play a major role in short-term calcium homeostasis. In addition,

1,25-(OH)<sub>2</sub>-D<sub>3</sub> is required for normal bone mineralization during skeletal growth and remodeling of bone. Vitamin D receptors (VDR) in bone are located in osteoblasts and progenitor cells of bone and control the synthesis and secretion of a number of bone-specific proteins in osteoblasts such as osteocalcin, osteopontin, collagen, and alkaline phosphatase. The actions of vitamin D metabolites are both direct (e.g., transcriptional regulation via VDR interactions) and indirect (modulation of secondary signaling pathways, e.g., protein kinase C regulated pathways). Although osteocalcin and osteopontin synthesis have been shown to be regulated at the transcriptional level of their respective genes, for the most part vitamin D metabolites attenuate the action of polypeptide hormones, such as PTH or calcitonin, which stimulates bone resorption and accretion, respectively. Of these two processes, maintaining bone resorption is the most important, because under normal conditions, the serum calcium and phosphate ion concentrations are at levels that favor bone apposition or accretion (Dusso *et al.*, 2005).

Naturally occurring deficiencies of vitamin D occur in lambs born to ewes not supplemented prepartum with D<sub>3</sub> in northern latitudes during the winter months. Vitamin D deficiency also occurs in lambs reared indoors on grain diets (often barley), which do not supply an adequate amount of vitamin D<sub>2</sub>. Deficiency is frequently manifested as skeletal limb abnormalities. As an unusual and specific example, there are also published reports of vitamin D deficiency in llama offspring (crias) in Oregon during the winter months (Judson and Feakes, 1999; Murray *et al.*, 2001; Van Saun *et al.*, 1996).

### 3. Other Functions of Vitamin D

Vitamin D receptors (VDR) have been found in a large number of cell types, ranging from skeletal muscle to cells important to immune and phagocytic functions (e.g., macrophages). In pancreatic  $\beta$ -cells, 1,25-(OH)<sub>2</sub>-D<sub>3</sub> has also been observed to be important to normal insulin secretion. Vitamin D increases insulin release from isolated perfused pancreatic cells. Moreover, vitamin D metabolites can suppress immunoglobulin production by activated B-lymphocytes. T cells are also affected by vitamin D metabolites; 1,25-(OH)<sub>2</sub>-D<sub>3</sub> exhibits permissive or enhancing effects on T cell suppressor activity.

A specific transport protein delivers 1,25-(OH)<sub>2</sub>-D<sub>3</sub> and other active forms of vitamin D to targeted cells. The active form of vitamin D then interacts with receptor proteins, which in turn signals enhanced expression of selected proteins. The vitamin D-binding protein (DBP), also known as group-specific component or Gc-globulin, is a multifunctional plasma protein. DBP is expressed as a single polypeptide chain with a molecular mass of ~56 kDa and circulates in plasma at 6 to 7 M. Because of its extensive polymorphism, DBP initially was named the group-specific component of serum, later shortened to Gc-globulin. DBP is a member of the albumin,

$\alpha$ -fetoprotein, and  $\alpha$ -albumin/afamin gene family. In addition to functioning as a circulating vitamin D transport protein, it has been demonstrated to scavenge G-actin released at sites of necrotic cell death and prevents polymerization of actin in the circulation (Dusso *et al.*, 2005).

### 4. Requirements and Toxicity

Most animals require about five micrograms cholecalciferol per 1000 kcal of diet. When intake exceeds five to ten times this amount, there is a risk of toxicity, characterized by hypercalcemia and soft tissue calcification, in particularly the blood vessels of the lung, kidney, and heart. Acute doses of vitamin D (>100 times the requirement) can eventually result in a negative calcium balance, because bone resorption is accelerated. As noted, some plants (e.g., *Solanum malacoxylon*, *Cestrum diurnum*, and *Trisetum flavescens*) contain compounds with vitamin D activity (mostly glycosylated forms of ergocalciferols) and vitamin D intoxication can follow their ingestion. Rodenticides containing cholecalciferol as the active ingredient have resulted in toxicity in companion animals that ingest the bait directly, or carcasses of rodents that have ingested the bait. Naturally occurring toxicity has occurred in cats in Japan given a commercial diet containing large amounts of tuna viscera. Tuna viscera contains extremely high amounts of vitamin D, most of it in the liver.

### 5. Assessment of Vitamin D Status

Reliable assays for the measurement of vitamin D, calcidiol, and calcitriol in plasma are available. Calcitriol occurs in picomolar concentrations (normal values 40 to 150 pmol/l or 16 to 60 pg/ml) and has a half-life of about 4 to 6 h in a large (50 to 100 kg) animal. Concentrations of vitamin D in plasma after oral administration are in the nanomolar range ("normal" values range from 0 to 310 nmol/l or 0 to 120 ng/ml). Vitamin D has a half-life of 24 h, so the plasma concentration reflects immediate intake, rather than overall status. In contrast, 25-OH vitamin D has a half-life of about 3 weeks, provides the useful index of vitamin D status, and is the measurement of choice. Plasma concentrations of 25-OH vitamin D of 20 to 150 nmol/l or 8 to 60 ng/ml cover the normal range for most animals. Much higher levels than these have been observed in cats given diets containing high levels of cholecalciferol without apparent deleterious effects (Committee on Animal Nutrition, 2001a, 2001b; Subcommittee on Laboratory Animal Nutrition, Board on Agriculture, National Research Council, 1995).

## C. Vitamin E

### 1. Introduction

In the early 1920s, Herbert Evans and Kathryn Bishop observed that rats failed to reproduce when fed diets

containing rancid lard, unless they were supplemented with lettuce or whole wheat. Later it was found that germ oils, particularly wheat germ oil, contained an active principle that seemed responsible for improving reproductive performance. These early studies provided yet another function for a fat-soluble substance. By the early 1930s, it was recognized that this substance was a factor that differed from vitamin A or vitamin D. The compound was designated as vitamin E by Barnett Sure and later as  $\alpha$ -tocopherol from the Greek word "tokos" meaning childbirth or reproduction. By 1940, a number of compounds in the tocopherol family were identified and purified. With elucidation of tocopherol structures and eventual chemical synthesis (Fig. 23-10), studies quickly followed that demonstrated embryonic failure resulted from vitamin E deficiency. Pappenheimer, Olcott, Martill, and others observed that muscle degeneration was also a common deficiency symptom and that vitamin E seemed to function as an antioxidant. Next, other signs and symptoms were identified, including oxidative diathesis and encephalomalacia in chickens. In addition to these signs, liver necrosis and hemolytic anemias were observed in vitamin E-deficient animals (Traber, 2007).

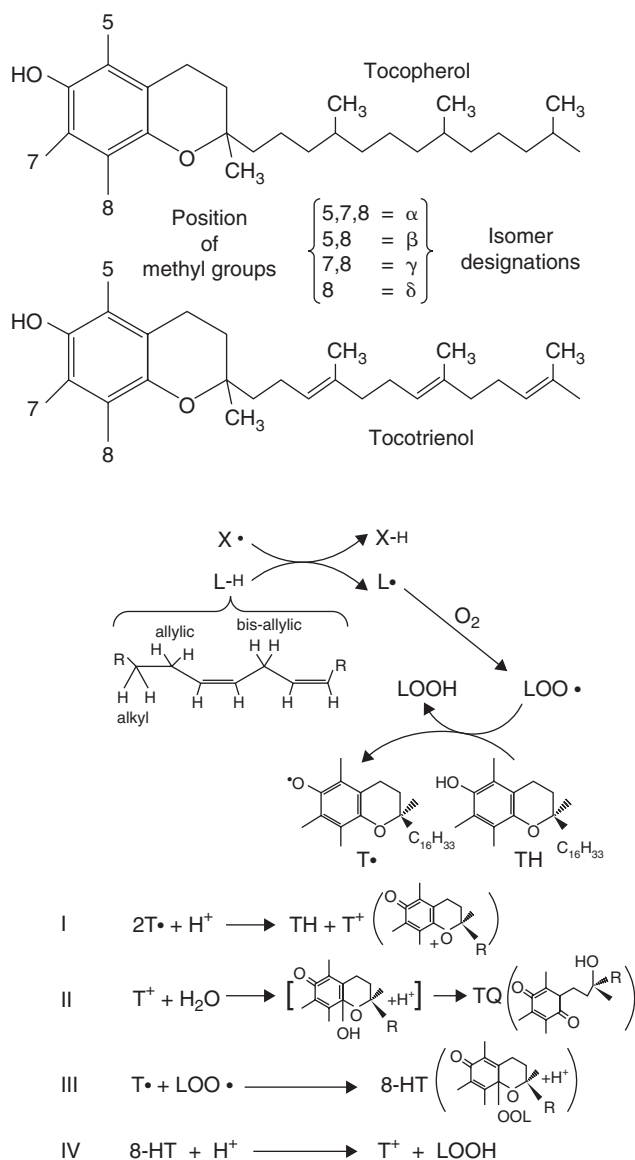
## 2. Chemistry, Metabolism, and Sources

The principal sources of tocopherols are plant oils. Tocopherols are unique because they act primarily at a chemical level as antioxidants, although other possible roles in cell signaling have been described. Primarily, vitamin E protects unsaturated fatty acids found in the phospholipids of cell membranes. The quinone moiety of tocopherols is capable of quenching free radicals, such as the free radical of hydrogen ( $H^\bullet$ ), superoxide radicals ( $O_2^{\bullet-}$ ), hydroxyl radicals ( $OH^\bullet$ ), and other lipid-derived radical species ( $LOO^\bullet$ ). Vitamin E in the course of its action is sacrificed in acting as a free-radical scavenger. Vitamin E is very reactive and is in effect sacrificed thus inhibiting the formation of lipid-derived oxidation products (Traber, 2007).

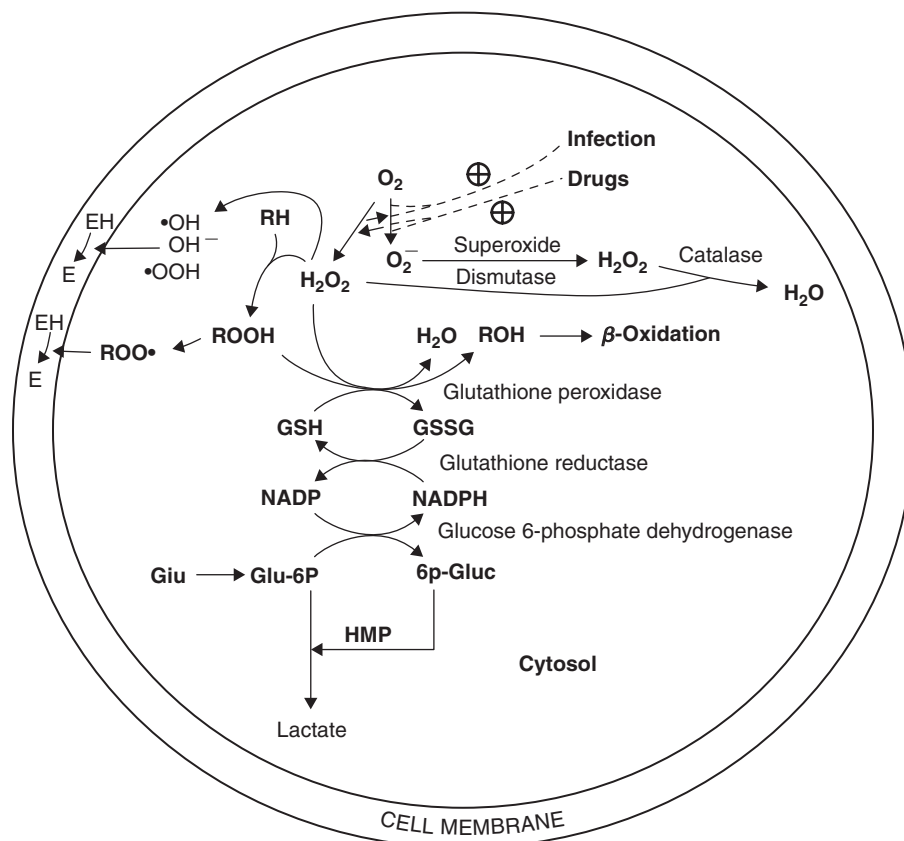
Cell membranes contain vitamin E at a concentration of approximately 1mg per 5 to 10g of lipid membrane; a concentration sufficient to retard membrane lipid oxidation. Membrane lipids are constantly engaged in the process of turnover and repair. By prolonging the initiation time before a free-radical chain reactions occurs, vitamin E gives cells time to replace damaged membrane lipids through the process of normal cell turnover.

With regard to absorption and transport, tocopherols first must partition into the intestinal micelles and are absorbed with other dietary lipids. Following absorption, vitamin E is transferred into the lymph associated with chylomicrons and intestinally derived VLDL particles, similar to other fat-soluble vitamins. Vitamin E is cleared from chylomicrons and VLDL by the lung and the liver. From the liver, most of the vitamin E is found in association with

VLDL and LDL particles. For example, there is preference for the  $\alpha$ -tocopherol form of vitamin E. More specifically, tocopherol-binding proteins favor the retention of the most potent vitamin E homologue, RRR- $\alpha$ -tocopherol. The LDL particles contain the highest concentration of vitamin E. This is important in that high concentrations of vitamin E protect the LDL particle from oxidation. It is currently proposed that oxidized LDL particles are important mediators of vascular disease.



**FIGURE 23-10** Vitamin E metabolism. The two principal forms of vitamin E are shown, tocopherol and tocotrienol. Methyl groups are found at the 5, 6, and/or 8 position, which may modulate antioxidant potency. Tocopherol is the most potent of the various forms of vitamin E in biological systems. Some of the mechanisms involving free-radical quenching are also shown. Vitamin E is particularly important in quenching free radicals that are generated from allylic and bis-allylic nonconjugated bonds found in membrane polyunsaturated lipids. Resolutions of the vitamin radical and other intermediates are shown in steps I and IV.



**FIGURE 23-11** Vitamin E and antioxidant defense. A number of factors can influence the need for tocopherols in cells and subsequently their utilization at a cellular level. Vitamin E acts as the last line of defense for lipid oxidation, primarily residing in lipid membranes. Enzymes such as superoxide dismutases (catalyzes superoxide radicals to hydrogen peroxide), catalase (catalyzes hydrogen peroxide to water and oxygen), glutathione peroxidase (catalyzes lipid and hydrogen peroxides to water or hydroxy-fatty acids), and related systems for oxidant defense (generation of reductants, such as NADPH and reduced glutathione) also aid in providing additional oxidant defense. Without intracellular control of reactive oxygen species, such as hydrogen peroxide or hydroxide radicals, polyunsaturated lipids are targets for oxidation.

Vitamin E enters cells by processes similar to those for LDL uptake (Aguie, 1995; Traber *et al.*, 1993, 1994a, 1994b, 1994c). LDL membrane receptors, through receptor-mediated endocytosis, appear responsible for vitamin E uptake by scavenger receptor B type I and LDL receptors. Efflux from cells is less well understood but appears to be dependent on transporters in the ABCA1 transporter family (ATP-requiring transporters associated with cholesterol transport). Once in cells, vitamin E is incorporated into liquid membranes. About 40% of vitamin E is found in nuclear membranes; the remaining 60% is divided between lysosomal, mitochondrial and the outer cell wall membranes (Traber, 2007).

### 3. Requirements and Functions

The nutritional status of vitamin E is often difficult to assess. A number of factors can influence the concentration of tocopherols in cells. As noted, vitamin E acts as the last line of defense for lipid oxidation, primarily residing in lipid membranes. Consequently, enzymes such as

superoxide dismutases, catalase, glutathione peroxidase, and related systems for oxidant defense can moderate the absolute need for vitamin E (Fig. 23-11). Further high dietary intakes of polyunsaturated dietary fats may increase the vitamin E requirement, because of their eventual deposition in cell membranes. Naturally occurring deficiencies of vitamin E occur in cats given human-grade canned tuna (which is not fortified with vitamin E). Deficiencies can also occur in cats given fish-based diets unless they are highly fortified with vitamin E. Proper handling of fish is essential to prevent the PUFAs in fish oil from readily oxidizing following their harvesting and processing. The requirement of most animals is on the order of 25 to 50 mg per kilogram dry diet or 4 to 8 mg per 1000 kcal or 4.2 MJ.

At the cellular level, vitamin E deficiency promotes increased lipid peroxidation, making cells more vulnerable to oxidative injury. Fortunately clinical manifestations of chronic vitamin E deficiency are rare and are usually seen only when fat malabsorption is present. In these cases, the neuromuscular, vascular, and reproductive systems may be affected. Vitamin E deficiency signs include

immunodeficiency, dermatosis, anorexia, myopathy, steatitis, focal interstitial, focal myositis of skeletal muscle, and periportal mononuclear infiltration in the liver. Signs of vitamin E deficiency are mostly attributed to membrane dysfunction as a result of the oxidative degradation of polyunsaturated membrane phospholipids and disruption of other critical cellular processes.

Vitamin E can also influence two major signal transduction pathways centered on protein kinase C and phosphatidylinositol 3-kinase (Singh and Jialal, 2005). Changes in the activity of these key kinases are associated with changes in cell proliferation, platelet aggregation, and NADPH-oxidase activation. Vitamin E status also influences genes that are involved in the uptake and degradation of tocopherols and antioxidant defense (e.g.,  $\alpha$ -tocopherol transfer protein, cytochrome P450-3A,  $\gamma$ -glutamyl-cysteine synthetase heavy subunit, and glutathione-S-transferase), genes that are involved in the modulation of extracellular matrix proteins (e.g., collagen- $\alpha$ -1 chains and connective tissue growth factor), genes that are connected to cell adhesion and inflammation (ICAM-1 integrins and TGF- $\beta$ ), and genes in the steroid superfamily (e.g., PPAR- $\gamma$ ) (Azzi *et al.*, 2004).

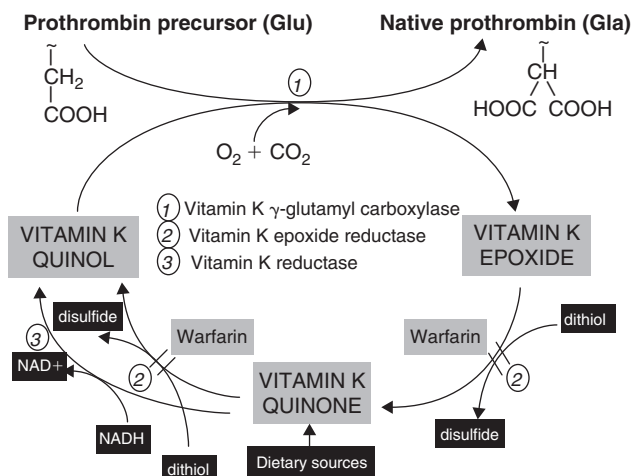
#### 4. Evaluation of Vitamin E Status

Tocopherols in biological tissues can be measured by HPLC. Although the  $\alpha$ -tocopherol can readily be separated from other tocopherols, the separation of the  $\beta$ - and  $\gamma$ -isomers is difficult. For nutritional assessment of vitamin E, the current indices are based on changes in total tocopherol concentrations in plasma and serum. Measurement of tocopherol concentration in erythrocytes may be an even better indicator for tissue vitamin E than plasma or serum levels. The platelet concentration of vitamin E is also a sensitive measure of vitamin E intake. Moreover, in the experimental setting the measurement of adipose levels of tocopherols seems to be a reliable index for assessing long-term vitamin E status. As in other cells, vitamin E partitions primarily into the membrane lipid compartments. Thus, the concentration of vitamin E per adipose tissue mass may even increase when there is loss of nonmembrane stored triglycerides. As plasma tocopherol concentration is affected by lipid concentration, an  $\alpha$ -tocopherol/total lipid ratio of 0.6 to 0.8 mg/g of total lipids has been suggested as indicating adequate nutritional status. Functional tests such as the erythrocyte hemolysis in the presence of 2% peroxide have also been used to indicate status (Traber, 2007).

### D. Vitamin K

#### 1. Introduction

In 1929, Henrik Dam reported what was thought first to be an essential role for cholesterol in the diet of chickens. He noted that chicks fed diets that had been extracted with



**FIGURE 23-12** Major components in vitamins K's role in  $\gamma$ -carboxyglutamyl residue formation.

nonpolar solvents to remove sterols developed subdural and muscular hemorrhages and that blood seemed to clot at a slower rate. Edward Doisy in the United States did much of the work that led to the discovery of the structure and chemical nature of vitamin K. Dam and Doisy shared the 1943 Nobel Prize for medicine for this work. For several decades, the vitamin K-deficient chick model was the only method of quantitation of vitamin K in various foods: the chicks were made vitamin K deficient and subsequently fed diets with known amounts of vitamin K-containing food. The extent to which blood coagulation was restored by the diet was taken as a measure for its vitamin K content. As this work progressed, it was soon demonstrated that hemorrhagic disease in chicks could be reversed by extracts of alfalfa. In the 1940s, it became clear that substances synthesized by bacteria also could reverse hemorrhagic symptoms. In addition, it was discovered that compounds in spoiled clover and grasses seemed to cause hemorrhagic disorders in animals and serve as antagonist to vitamin K (Fig. 23-12).

#### 2. Function and Metabolism

With the isolation and identification of vitamin K, work toward an understanding of mechanisms proceeded, although not without controversy. At first there was the problem of reconciling how compounds present in the sweet clover acted as vitamin K antagonists. A number of questions were also raised regarding the structural requirements for vitamin K activity (Stafford, 2005; Suttie, 2007).

Now it is appreciated that a number of compounds in the 1,4-naphthaquinone series possess vitamin K activity. For example, even relatively simple compounds, such as menadione, possess vitamin K activity. An active phyloquinone can be synthesized from menadione when combined with isoprenoids from the cholesterol synthesis pathway. Dietary

phylloquinones are transported to the liver by chylomicrons and intestinal VLDL particles and from liver by VLDL and LDL. From studies of vitamin K clearance, it was appreciated that the total pool of vitamin K in the body is replaced rapidly, within hours to days in contrast to the slower turnover of the other fat-soluble vitamins (weeks to months).

The mechanism of action for vitamin K became much clearer after it was demonstrated that the formation of  $\gamma$ -carboxyglutamic acid residues (GLA) in thrombin and other proteinases associated with the blood-clotting cascade was vitamin K dependent. The formation of GLA residues is a key in that they serve as calcium-binding sites in the proforms of proteinases associated with blood coagulation. Calcium binding is a requisite for their eventual activation. In this regard, vitamin K serves as cofactor for microsomal carboxylases, which are responsible for GLA formation. The vitamin K-dependent carboxylase utilizes oxygen and bicarbonate as substrates. The reaction only occurs if glutamic acid is a part of a polypeptide with the correct sequence for specificity. Only the reduced form of vitamin K serves as a cofactor, which led to an appreciation that a reductase system was necessary for vitamin K regeneration and that one of the intermediate forms was a vitamin K epoxide. As this pathway was resolved, it next was apparent that many of the vitamin K antagonists functioned as inhibitors of reductases important for vitamin K generation (Suttie, 2007). The rate of carboxylation is mainly controlled by the level of reduced vitamin K available for the reactions, whereas the dissociation rate constant depends on both the propeptide and the Gla domain of the substrate. In addition, there are allosteric effects that increase the rate of dissociation of the fully carboxylated substrates. Carboxylation requires the abstraction of a proton from the 4-carbon of glutamate by reduced vitamin K and results in the conversion of vitamin K to vitamin K epoxide. The vitamin K epoxide must be recycled to vitamin K before it can be reused, a reaction catalyzed by the enzyme vitamin K epoxide reductase.

Specifically, vitamin K provides important control of blood coagulation by regulating the activities of factor VIIIa (FVIIIa) and factor Va (FVa), cofactors in the activation of factor X and prothrombin, respectively. The system comprises membrane-bound and circulating proteins that assemble into multimolecular complexes on cell surfaces. Vitamin K-dependent protein C, the key component of the system, circulates in blood as zymogen to an anticoagulant serine protease. It is activated on the surface of endothelial cells by thrombin bound to the membrane protein thrombomodulin. An endothelial protein C receptor further stimulates the protein C activation. Moreover, activated protein C together with another protein, cofactor protein S, can also slow coagulation by degrading FVIIIa and FVa on the surface of negatively charged phospholipid membranes providing a level of reversible control (Suttie, 2007).

GLA residues are also found in bone proteins. The GLA-containing proteins in bone (osteocalcins) appear

to be involved in the regulation of new bone growth and formation. The presence of GLA protein in bone helps to explain why administration of the vitamin K antagonist at levels that cause hemorrhagic diseases also may result in bone defects, particularly in neonates. The mineralization disorders are characterized by complete fusion of the proximal tibia growth plate and cessation of longitudinal bone growth (Suttie, 2007).

### 3. Nutritional Requirements

The establishment of the dietary requirement for many animals has been difficult, in part because of (1) the short half-life of vitamin K, (2) the fact that large amounts of vitamin K may be synthesized by intestinal bacteria, and (3) the extent to which different animal species practice coprophagy. Birds tend to have relatively high requirements for vitamin K; thus, chickens are often used as experimental animals in vitamin K studies (Stafford, 2005; Suttie, 2007). Recent work suggests that the vitamin K requirement depends on the relative content of vitamin K epoxide reductase activity. A low level of epoxide reductase activity can increase the requirement for vitamin K. Ruminant microorganisms synthesize large amounts of vitamin K; thus, ruminants do not need an external source for this reason.

Assessments of nutritional requirements suggest that small animals should obtain approximately 500 to 1000 g of phylloquinone per kilogram diet. Oxidized squalene and high intakes of vitamin E may act as vitamin K antagonists. Insufficient vitamin K can also occur with antibiotic treatment, treatment with coccidiostatic drugs, or long-term parenteral hyperalimentation without vitamin K supplements. Poultry and swine diets are regularly supplemented with menadione, but the need to supplement the diet of other species is questionable. Few hazards have been attributed to long-term ingestion of vitamin K in amounts of 1 to 10mg per kilogram diet of phylloquinone. However, menadione in amounts corresponding to 10 to 100mg per kilogram of diet may act as a prooxidant, and high dietary concentrations produce hemolysis. Phylloquinone (vitamin K<sub>1</sub>) rather than menadione should be used parenterally to treat animals that have ingested warfarin or other anticoagulants. Menadione being water soluble, at high concentrations it can promote hemolysis. Like many quinones it may act as a prooxidant and initiate free-radical formation.

## IV. WATER-SOLUBLE VITAMINS

We have chosen to organize the discussion of water-soluble vitamins based on physiological function. Most vitamins serve eventually as enzymatic cofactors. For example, niacin, riboflavin, and ascorbic acid serve primarily as redox cofactors. The roles of thiamin, pyridoxine (vitamin B<sub>6</sub>), and pantothenic acid (as a component of coenzyme A)



are distinguished because of their importance to carbohydrate, amino acid, and acyl and acetyl transport, respectively. Biotin, folic acid, and vitamin B<sub>12</sub> (cobalamin) will be discussed in relationship to their roles in single carbon metabolism. Several vitamin-like compounds will also be described. These compounds are products derived from carbohydrate, amino acid, or fatty acid metabolic pathways and primarily perform specialized transport functions or are associated with signal transduction mediators in cells. A nutritional case can be made that in some animal species, these compounds have important "conditional" requirements, and developmental periods may be identified in which a dietary source is required to maintain balance.

## A. Vitamins Important to Redox: Ascorbic Acid, Niacin, and Riboflavin

### 1. Ascorbic Acid

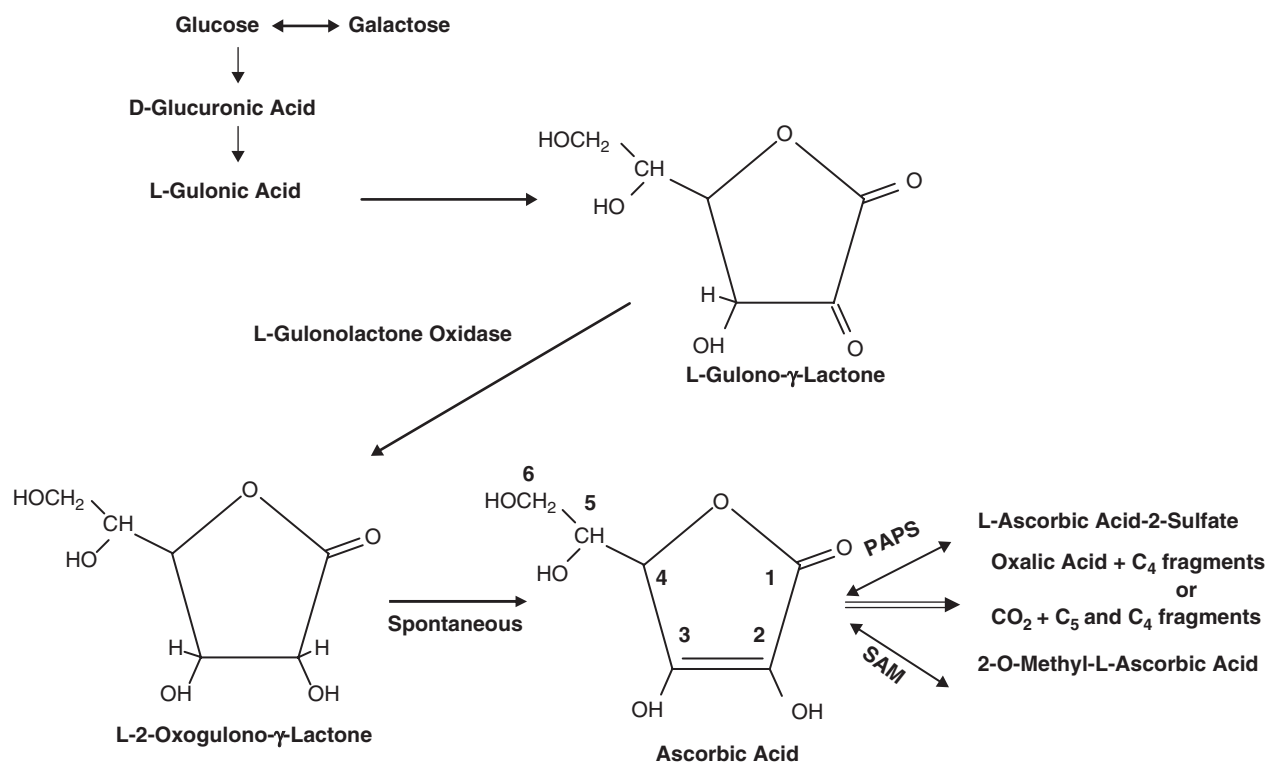
#### a. Introduction

Ascorbic acid functions primarily as a cofactor for microsomal monooxygenases (hydroxylases) and oxidases. In most animals, ascorbic acid is synthesized from glucose in the liver or kidney (Fig. 23-13). In some animals, however,

a deficiency of gulonolactone oxidase, a last step in ascorbic acid synthesis, results in the need for a dietary source. The enzymes for ascorbic acid production in the cold-blooded vertebrates (fishes, amphibians, and reptiles) are located in the kidneys. Present-day birds, whose ancestors appeared about the same time as the mammals, have a kidney-liver transition. The older order of present-day birds, such as the ducks, pigeons, and hawks, synthesize ascorbic acid in their kidneys, whereas in the more recent order they produce ascorbic acid both in their kidneys and livers (e.g., of the perching and song birds). Mammals produce ascorbic acid in the liver. Of the mammals that do not produce ascorbic acid (e.g., primates and guinea pigs), so-called pseudogenes for L-gulonolactone oxidase exist. The 164-nucleotide sequence of exon X of this gene contains nucleotide substitutions throughout its sequence with a single nucleotide deletion, a typical example of a pseudogene.

#### b. Chemistry

Ascorbic acid is of general importance as an antioxidant, because of its high reducing potential. However, under some conditions ascorbic acid can also act as a prooxidant. Ascorbic acid is a 2,3-enediol-L-gulonic acid. Both of the hydrogens of the enediol group can dissociate, which



**FIGURE 23-13** Ascorbic acid synthesis. The direct oxidative pathway for glucose is utilized in those animals that make ascorbic acid. Major metabolites are the 2-sulfate and 2-methyl derivatives of ascorbic acid, which require phosphoadenosyl phosphosulfate (PAPS) and S-adenosyl methionine (SAM) as sulfate and methyl donors, respectively. When ascorbate is in excess, catabolic enzymes can effectively decarboxylase or cleave ascorbic acid (between C-2 and C-3).

results in the strong acidity of ascorbic acid. Enediols are excellent reducing agents; the reaction usually occurs in a stepwise fashion with a semiquinone intermediate (Johnston *et al.*, 2007).

For ascorbic acid, this intermediate with monodehydroascorbic acid disproportionates to ascorbic acid, and dehydroascorbic acid is not as hydrophilic as ascorbic acid, because it exists in a deprotonated form. As such, dehydro of ascorbic acid can move easily across cell membranes. The dehydro form, however, is easily cleaved by alkali (e.g., to oxalic acid and threonic acid).

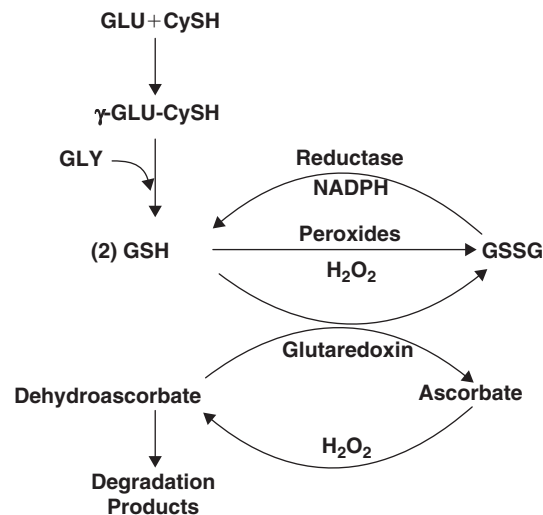
### c. Absorption, Tissue Distribution, and Metabolic Functions

Dietary ascorbic acid is absorbed from the duodenum and proximal jejunum. Measurable amounts can also cross the membranes of the mouth and gastric mucosa. Although some controversy exists regarding the relationship between ascorbic acid intake and the intestinal absorption of ascorbic acid, most careful studies indicate that within the physiological ranges of intake (20 to 400 mg per kilogram of dry food), 80% to 90% of the vitamin may be absorbed.

With respect to tissue distribution, the highest concentration of ascorbic acid is found in the adrenal and pituitary glands followed by the liver, thymus, brain, and pancreas. In diabetic animals, the ascorbic acid content of tissue is often depressed, which suggests that factors responding to hyperglycemic states can compromise ascorbic acid status. This may be because dehydroascorbic acid uptake is facilitated by hexose transporters (Johnston *et al.*, 2007; Said, 2004). Uptake of reduced ascorbic acid involves a specialized Na<sup>+</sup>-dependent, carrier-mediated system; egress of ascorbic acid from enterocytes also utilizes a Na<sup>+</sup>-dependent carrier system. Regarding cellular retention, ascorbic acid is maintained in cells by several mechanisms. Ascorbate reductases maintain L-ascorbic acid in the reduced form, which prevents passive leakage from the cell as dehydroascorbic acid. Significant amounts of ascorbic acid, particularly in fish, may also exist as the 2-sulfate derivative. In rats, about 5% of a labeled dose of ascorbic acid is recovered in urine as 2-O-methyl ascorbic acid. Cellular modification of ascorbic acid is important for compartmentalization or modulation of functional ascorbic acid levels (Johnston *et al.*, 2007; Wilson 2005).

In the neonate, glutathione is important to ascorbate recycling and regeneration (Fig. 23-14). An argument can be made for a dietary need for ascorbic acid in some neonates of species not normally showing a requirement for ascorbate. For example, the levels of glutathione are relatively low in neonate rat and mouse tissue. Ascorbate is oxidized to dehydroascorbic acid, which is easily catabolized, thus the need for continual replacement.

As a cellular reducing agent, ascorbic acid plays a number of important roles. It serves as a cofactor for mixed-function oxidations that result in the incorporation



**FIGURE 23-14** Interaction between ascorbic acid and glutathione. The most important reductant in the cell is glutathione L-( $\gamma$ -glutamyl-L-cysteinylglycine, GSH), which is synthesized by a two-step reaction involving L-glutamyl cysteine synthetase and GSH synthetase. In addition to reducing equivalents derived from the pentose shunt or hexose monophosphate shunt pathway via NADPH, reduced ascorbic acid can transfer reducing equivalents to oxidized glutathione (GSSG) catalyzed by glutaredoxin.

of molecular oxygen into various substrates. Examples include the hydroxylation of proline in collagen, elastin, C1q complement, and acetylcholine esterase. Hydroxylases (monooxygenases) and some P450-dependent hydroxylases that carry out the hydroxylation of steroids, drugs, and other xenobiotics utilize ascorbic acid as a reductant. Moreover, the hydroxylation steps in the biosynthesis of carnitine, hydroxylation of tyrosine in the formation of catecholamines, and hydroxylation of proline in collagen represent other important and essential catalytic functions of ascorbic acid. Most of the enzymes involved in these processes are metal-requiring enzymes in which ascorbic acid's role is to maintain the metal (usually Cu or Fe) in its reduced state (Johnston *et al.*, 2007).

### d. Requirements and Toxicity

Ascorbate is synthesized by most animals with the exception of primates, guinea pigs, some snakes, fruit-eating bats, birds (passerines), and salmonid fish. For these animals, impaired collagen synthesis is a principal feature of ascorbate deficiency. Scurvy is characterized by poor wound healing, impaired bone formation in higher animals, and kyphosis and scoliosis in fish (Committee on Animal Nutrition, 2001a, 2001b; Subcommittee on Laboratory Animal Nutrition, Board on Agriculture, National Research Council, 1995). Connective tissue lesions are primarily a result of underhydroxylated collagen (at specific prolyl and lysyl residues) being abnormally susceptible to degradation. In addition, the inability to deal with metabolic stress requiring normal adrenal gland function and the reduced



ability to metabolize fatty acids (carnitine synthesis) contribute signs of scurvy.

To maintain these functions, most animals generate 10 to 60mg of ascorbic acid per 1000kcal utilized in the course of normal metabolism. Similarly, requirements for ascorbic acid, when required in the diet, range from 50 to 250mg per kilogram of diet (i.e., about 50mgs per 1000kcal), which correspond to the amount in mammalian milk (Rucker and Steinberg, 2002). It is noteworthy that when fed in excess of metabolic need, tissue levels of ascorbic acid are homeostatically maintained. Homeostasis occurs by the induction of ascorbic acid decarboxylases and cleavage enzymatic activity, which results in CO<sub>2</sub> plus ribulose or oxalic acid plus threonic acid. These conversions are probably to protect cells against nonspecific and oxidative reactions resulting from excesses of reduced metals, such as iron and copper (Johnston *et al.*, 2007).

## 2. Niacin

### a. Introduction

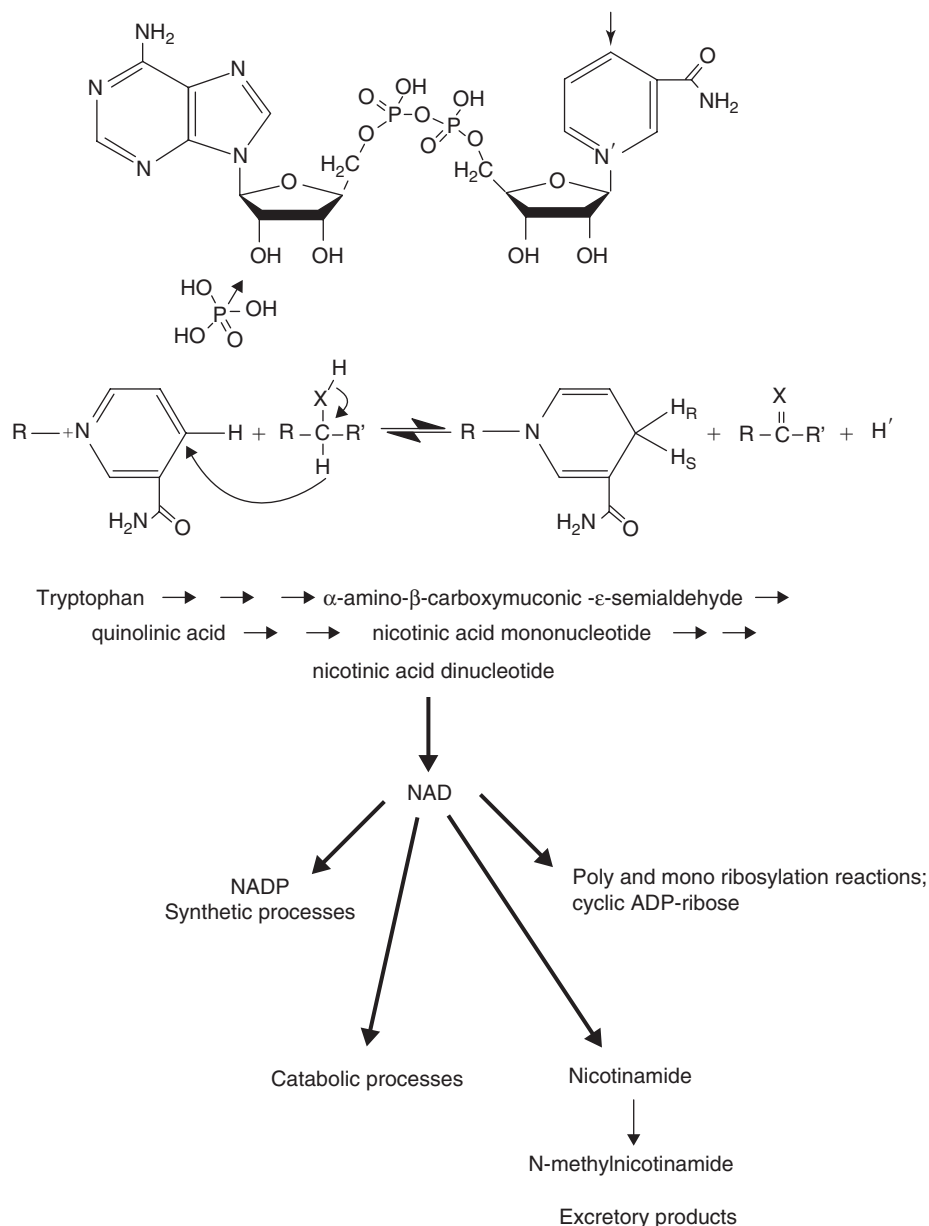
Through the elegant work of Goldberger and others, pellagra was identified as a nutritional deficiency in the 1900s. Commonly known as the “disease of the four D’s—dermatitis, diarrhea, dementia, and death”—it was first recognized in Spain and Italy as a specific disease in the late 1700s, as *mal de la Rosa* and pellagra, respectively, from *pelle* (skin) and *agra* (rough). In 1810, another Italian, Giovanni Battista Marzari, proposed that the disease was caused by overreliance on corn as the main dietary staple. Indeed, there were two schools of thought: the *Zeists*, who supported the corn theory, and the *anti-Zeists*, who discredited it (Goldblith and Joslyn, 1964). Niacin deficiency comes about when foodstuffs (e.g., corn) are consumed that are low in bioavailable niacin and the amino acid tryptophan. Tryptophan is important to niacin status (Bender, 1996), because niacin can be generated upon tryptophan degradation (Fig. 23-15). Although niacin deficiency is observed infrequently in free-ranging animals, it nevertheless is a good example of a vitamin-related disease that occurs from consuming a monotonous diet. In this regard, dogs played an important role as models for pellagra, as they exhibited a condition called “black tongue,” when given a diet similar to that which produces pellagra in humans. Black tongue is characterized by initial reddening of the mucosa of the lips and mouth that progresses to necrosis of the mucosa accompanied by ropy saliva, a fetid odor, and diarrhea. In 1937, Elvehjem discovered that dogs with “black tongue” responded dramatically both to nicotinic acid and to nicotinamide, which was isolated from liver extracts that had previously been found to have relatively high antipellagra activity. The acid and the amide were tested with human pellagrins and gave relief of the irritation of the mucous membrane of the mouth and digestive tract and the disappearance of acute mental symptoms within a few days (Bender, 1996; Kirkland, 2007).

With regard to pellagra and corn, niacin is not highly bioavailable unless the corn is finely ground or processed under alkaline conditions (e.g., ground in the presence of limestone). In human populations, this was not the practice in Western Europe and the southern United States, although it was the practice in Central and South America. Normally, niacin is derived from food by hydrolysis of nicotinamide adenosyl dinucleotide (NAD) and nicotinamide adenosyl phosphodinucleotide (NADP) to niacin by the action of pancreatic or intestinal nucleosides and phosphatases. Facilitating NAD and NADP hydrolysis by alkali treatment of corn or increasing surface area is important to increasing the bioavailability of niacin. Given that most animals consume diets that contain adequate tryptophan, and available NAD and NADP, niacin deficiency is usually not a problem. An exception to this generalization is cats. In this species, the degradation of tryptophan does not proceed along a pathway that leads to nicotinic acid, even though all the enzymes for the pathway are present. High activity of the enzyme picolinic carboxylase, at a branch point in the pathway, results in diversion from eventual NAD production. For cats and probably all other felids, available niacin is an obligatory dietary factor.

### b. Functions

NAD and its phosphorylated form, NADP, are two coenzymes derived from niacin (Fig. 23-15). Both contain an unsubstituted pyridine 3-carboxamide that is essential to function in redox reactions with a chemical potential near  $-0.32V$ . Virtually all cells are capable of converting niacin to NAD (Kirkland, 2007). Most enzymes requiring NAD are oxidoreductases (dehydrogenases) that aid the catalysis of a diverse array of reactions, such as the conversion of alcohols and polyols to aldehydes or ketones. The most common mechanisms involve the stereospecific abstraction of a hydride ion (H<sup>-</sup>) from the substrate with subsequent transfer. Further, cells utilize NAD in catabolic pathways, whereas NADP is utilized in synthetic pathways. An additional and equally important function of NAD is its role as a substrate in poly- and monoribosylation reactions. Mono- and polyribosylations are important to many cellular regulatory functions. Enzymes that undergo monoribosylation can become activated or deactivated upon addition of ADP-ribose. Somewhat analogous to phosphorylation, ribosylation represents another example of covalent modification as a regulatory control.

In the nuclei of cells, polyribosylation of histone precedes the normal process of DNA repair (Hageman and Stierum, 2001). This later phenomenon is important in that pellagra-related lesions often involve the skin, following exposure to UV light. UV damage of epidermal cell DNA is an underlying mechanism for the dark pigmented lesions associated with pellagra. Lack of niacin and therefore NAD is thought to be a contributing factor to the skin lesions because of the inability of cells to carry out polyribosylation reactions. It is this nonredox function of NAD



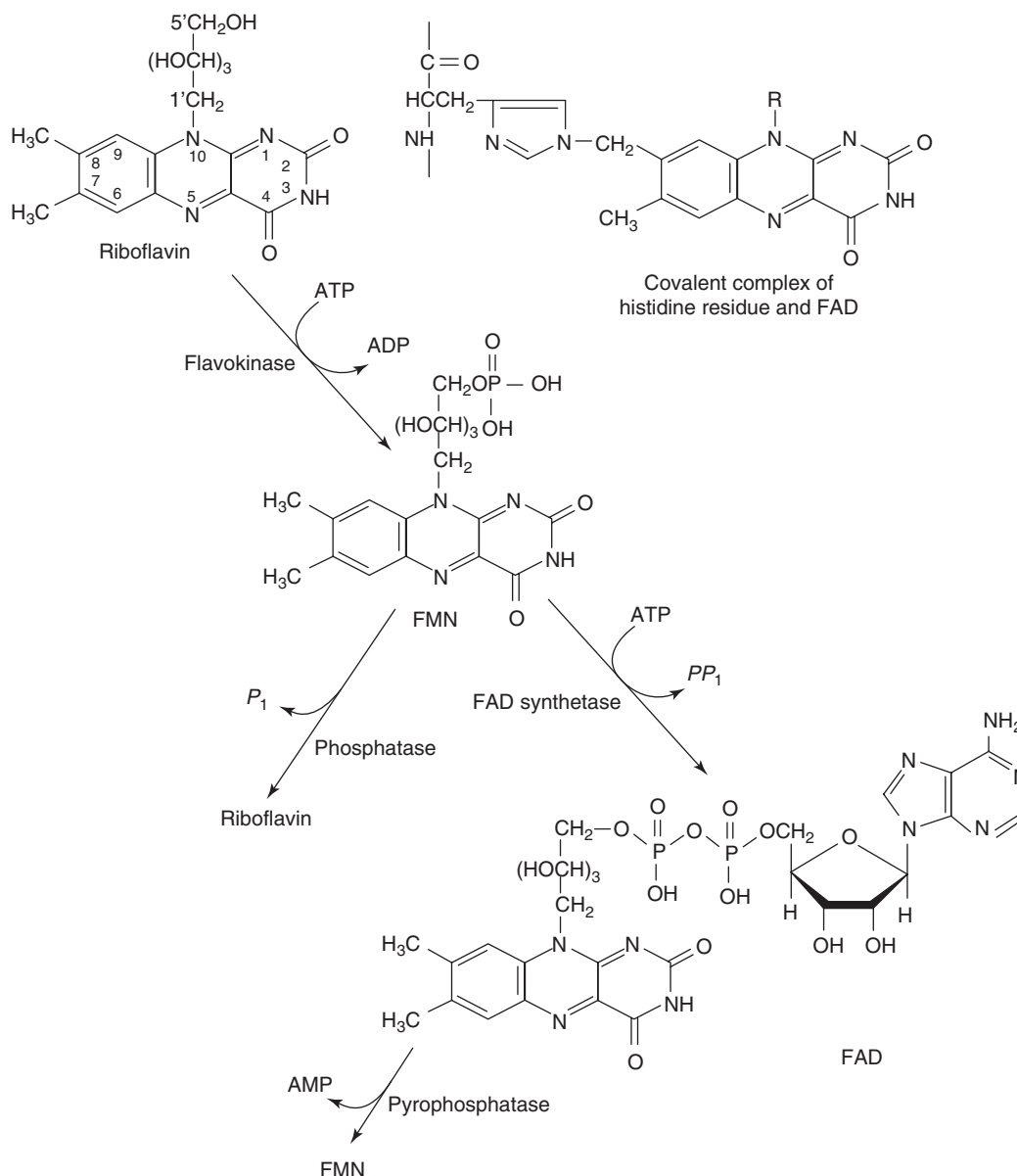
**FIGURE 23-15** Niacin and NAD(P). Niacin can be derived from tryptophan degradation or the diet. In cells, niacin is eventually converted to NAD(P). Most enzymes requiring NAD are oxidoreductases (dehydrogenases). The most common mechanisms involve the stereospecific abstraction of a hydride ion (H<sup>-</sup>) from the substrate with subsequent transfer. NAD is usually associated with catabolic pathways, whereas NADP is utilized in synthetic pathways. An additional and equally important function of NAD is its role as a substrate in poly- and monoribosylation reactions. Mono- and polyribosylations are important to many cellular regulatory functions (e.g., DNA repair); cyclic-ADP ribose is important in calcium-related cell signaling pathways.

that accounts for the rapid turnover of NAD in cells. Some estimates suggest that as much as 40% to 60% of the NAD in cells is involved in mono- or polyribosylation reactions.

NAD is also the substrate for cyclic ADP-ribose (cADPR), which is a Ca<sup>2+</sup> mobilizing second messenger found in various cell types, tissues, and organisms. Receptor-mediated formation of cADPR involves ADP-ribosyl cyclases located within the cytosol or in internal membranes of cells. cADPR activates intracellular Ca<sup>2+</sup> release (Jacobson *et al.*, 1995).

### c. Requirements and Pharmacology

Niacin is needed in amounts corresponding to 10 to 25mg/kg of diet. Depending on species, the conversion of tryptophan to niacin produces about 1mg of niacin for every 60mg of tryptophan degraded. Niacin (nicotinamide) is relatively nontoxic, although nicotinic acid can cause vasodilatation when consumed in excess of 100mg per kilogram of diet. Consequently, there are a number of therapeutic uses for pharmacological doses of niacin-derived compounds, when increased blood flow is desirable.



**FIGURE 23-16** Riboflavin. The major forms of riboflavin found in cells are flavin adenine mononucleotide (FMN) and flavin dinucleotide (FAD). In some enzymes, riboflavin may also be covalently bound to the enzymes that it serves, for example, succinic dehydrogenase.

#### d. Determination of Niacin Status

A nicotinamide loading test has been used to determine niacin status of patients. The patient is given an oral dose of nicotinamide, and the urinary excretion products, which are species dependent, are measured. For humans, monkeys, dogs, rats, and swine largely methylated products are produced. Analytical approaches in measuring nicotinic acid and niacin now involve hydrophilic interaction chromatography or capillary electrophoresis using UV, fluorescence, or mass spectrophotometry for detection (Kirkland, 2007).

### 3. Riboflavin

#### a. Introduction

Riboflavin was one of the first of the B vitamins identified. Riboflavin is present in tissue and cells as flavin adenine dinucleotide (FAD) and flavin adenine mononucleotide (FMN). FAD and FMN are cofactors in aerobic processes, usually as cofactors for oxidases, although FAD also can function in an anaerobic environment as a dehydrogenase cofactor. Many flavin-containing proteins are also found in the smooth endoplasmic reticulum of cells associated with microsomal enzymes (Fig. 23-16).

### b. Functions

Enzymes containing flavins are distinguished, because they are capable of transferring hydrogen directly to molecular oxygen with the formation of hydrogen peroxide as a product (Powers, 2003; Rivlin, 2007). Oxygen prefers to participate in reactions involving one electron, one hydrogen transfers proceeding in a stepwise manner. The chemical characteristics of riboflavin are ideally suited for such reactions. Thus, with the addition of riboflavin containing cofactors to biological systems, it is possible for the system to carry out a range of redox reactions utilizing mechanisms that involve ion hydride transfers (via NAD or NADP), radical hydrogen ion transfers (via FMN, FAD) or ascorbic acid, and one electron plus one proton transfer (via FMN or FAD).

### c. Metabolism and Requirements

FMN and FAD in foods are hydrolyzed in the upper gut to free riboflavin. Riboflavin is absorbed by active processes and is transported in blood to target tissues in association with albumin (Said, 2004). Once in cells, riboflavin is phosphorylated to FMN. FMN is also released from cells and may bind to albumin for reutilization by other cells. Active transfer mechanisms are responsible for the uptake of FMN. In this regard certain drugs (e.g., penicillin and theophylline) can displace riboflavin from binding proteins that are important to its transport. Urine is the major route of excretion for riboflavin, although some FAD is excreted in bile (Rivlin, 2007).

Requirements for riboflavin are lower than those for niacin or ascorbic acid. This is primarily because riboflavin is tightly associated with the oxidases and dehydrogenases it serves as cofactor; thus, riboflavin turnover is dependent on the turnover of the proteins to which it is associated. In some cases, FMN is even covalently bound (e.g., as in succinic dehydrogenase). Because of the high affinity with the enzymes that it serves as a cofactor, in most animals the half-life of riboflavin is several weeks. Two to six milligrams of riboflavin per kilogram of diet is required (Committee on Animal Nutrition, 2001a, 2001b; Rivlin, 2007; Subcommittee on Laboratory Animal Nutrition, Board on Agriculture, National Research Council, 1995).

When signs of riboflavin deficiency are observed they usually include lesions of the oral cavity, around the periphery of the lips, and particularly the angle of the mouth (cheilosis). There can also be inflammation of the tongue (glossitis) and accompanying seborrheic dermatitis. In severe cases of riboflavin deficiency, the filiform papillae of the tongue are lost and the tongue changes color from its usual pink to magenta. Anemia and increased vascularization of the eye are other common signs of riboflavin deficiency in some animals. Ariboflavinosis is the clinical name for riboflavin deficiency. Riboflavin deficiency is rarely found in isolation; it occurs frequently in combination with deficiencies of other water-soluble vitamins. In addition to anemia,

severe riboflavin deficiency may result in decreased conversion of vitamin B<sub>6</sub> to its coenzyme form and decreased conversion of tryptophan to niacin.

Lean meats, eggs, legumes, nuts, green leafy vegetables, dairy products, and milk provide riboflavin in the diet. Because riboflavin is destroyed by exposure to light, foods with riboflavin should not be stored in glass containers that are exposed to light. Moreover, as grains are a poor source of riboflavin, deficiencies frequently occur in animals given diets based on cereal grains. One of the more striking and specific signs of riboflavin deficiency in birds is “curled toe syndrome.” Curled toe paralysis has been of economic significance to the broiler industry. In young animals, growth failure, lost of feathers, or alopecia may be observed (Rivlin, 2007).

### d. Determination of Riboflavin Status

The erythrocyte glutathione reductase activity coefficient (EGRAC) is the preferred clinical test of riboflavin adequacy. This enzyme stimulation test measures the reduction of oxidized glutathione by the enzyme glutathione reductase with and without the addition of exogenous FAD. In dogs, a ratio of greater than 1.3 has been taken as deficient. Similar to the other B-vitamins, analytical approaches involve hydrophilic interaction chromatography or capillary electrophoresis using UV, fluorescence, or mass spectrophotometry for detection (Rivlin, 2007).

## B. Vitamins Directed at Specific Features of Carbohydrate, Protein, or Lipid Metabolism: Thiamin, Pyridoxine, and Pantothenic Acid

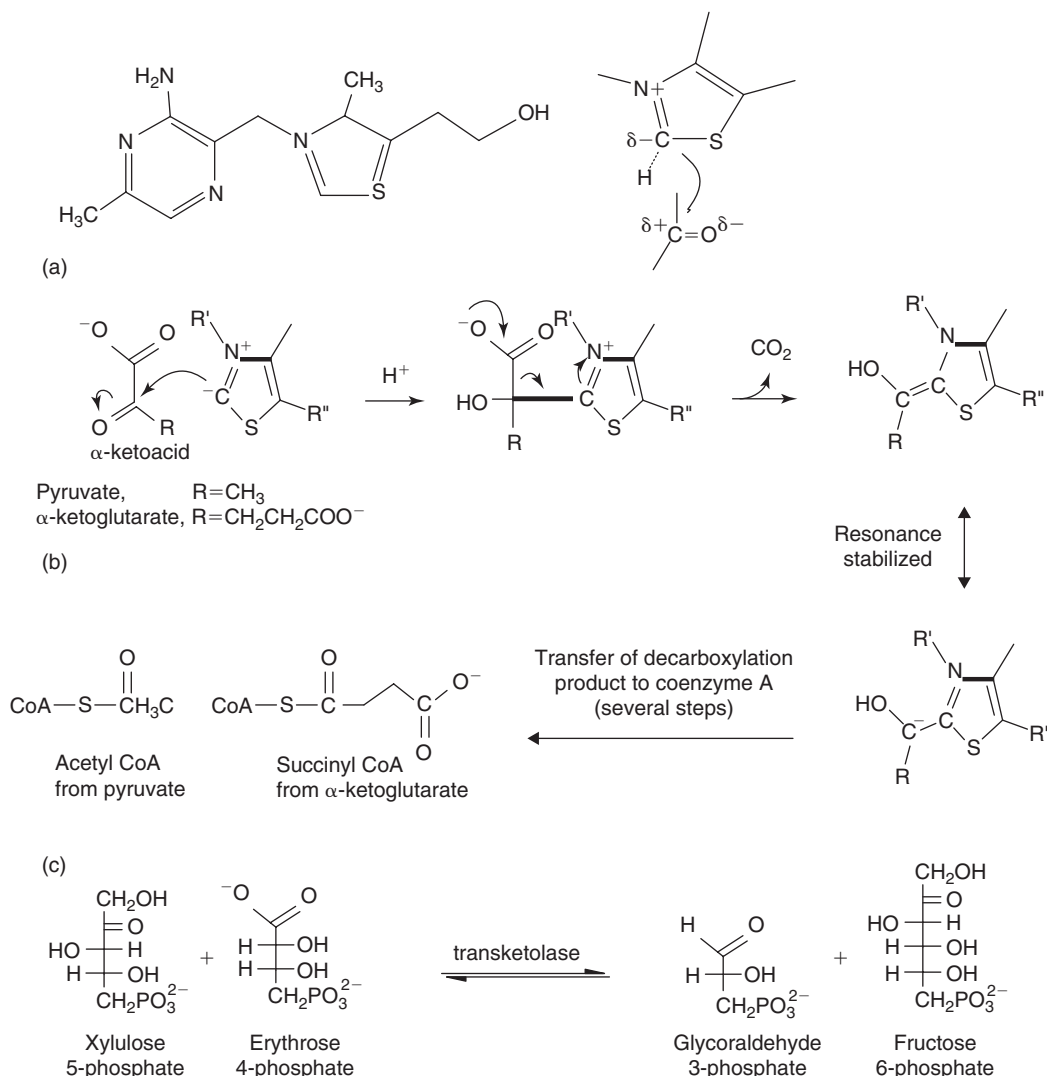
### 1. Thiamin

#### a. Introduction

Studies related to thiamin were important to the development of early concepts associated with the role and importance of vitamins. Another aspect of this work, particularly efforts by the Dutch medical officer Christian Eijkman, was that the polyneuritis associated with human beriberi could also be produced in an experiment animal model by dietary manipulation. Eijkman and his colleagues fed a diet of polished rice, presumably low in thiamin, to chickens and observed a characteristic feature—head retraction. The focus on rice and the observation that there appeared to be a curative principle in rice bran led to the eventual isolation of thiamin. This sequence of discovery provided the underpinnings that led to the discovery of vitamins as precursors to cofactors and their roles as regulators (Goldblith and Joslyn, 1964).

#### b. General Functions

Thiamin is found in cells either as the pyrophosphate (TPP) or the triphosphate (TPPP) (Fig. 23-17). TPPP predominates in neural tissue and in the brain (Davis, 1983). There



**FIGURE 23-17** Thiamin. The structure of thiamine (a) is shown in its vitamin form. Along with magnesium, thiamin as thiamin pyrophosphate is designed to interact with C=O moieties to initiate active aldehyde transfer reactions. One example is the decarboxylation of  $\alpha$ -keto acids or transketolase reactions (b). Thiamin also facilitates the transformation of “ketols” (ketose phosphates) in the pentose phosphate pathway (c).

are two general types of reactions wherein TPP functions. TPP is a coenzyme for active aldehyde transfer reactions, most often coordinated with magnesium. One example is the decarboxylation of  $\alpha$ -keto acids. This type of reaction is called the transketolase reaction. TPP also facilitates the transformation of “ketols” (ketose phosphates) in the pentose phosphate pathway. The importance of these reactions cannot be overstated. The first type of reaction, decarboxylation of “keto acids, is essential to the flux of substrates through the TCA cycle (i.e., the conversion of pyruvic acid to acetyl CoA and the conversion of  $\alpha$ -ketoglutarate to succinyl CoA). In the pentose phosphate pathway, NADP is also reduced to NADPH, an essential reducing agent for synthetic reactions (see niacin). Consequently, with a deficiency of thiamin there is impaired metabolism of carbohydrates, because of defective TCA cycle regulation. Further, if there are perturbations in the pentose phosphate-related

carbohydrates pathway, there can be decreased production of NADPH, which may impact other synthetic processes, such as fatty acid biosynthesis.

Another function that may be ascribed to thiamin occurs in brain and neural tissue. In the brain, TPPP is proposed to be involved in sodium-gating processes (i.e., the flux of sodium ions, across neuronal cell membranes) (Bettendorff, 1996). This aspect of thiamin metabolism may be related to the psychosis and impairment of neuromuscular control that is observed in thiamin deficiency.

### c. Requirements

Thiamin status should be routinely considered in disease assessment, because a number of factors influence thiamin availability and may induce deficiency. Thiamin is heat and alkali unstable, so extensive destruction of thiamin can

occur in the various steps of food processing and preservation. Canning, with its elevated temperatures and often alkaline conditions, can result in very low recoveries of thiamin. Thiamin can also be destroyed enzymatically by thiaminases, which are abundant in the flesh of some fish, particularly spoiled fish, and bacteria associated with fermentation processes. Thiamin deficiency has been observed in fish-eating birds, seals, dolphins, even other fish (Ceh *et al.*, 1964; Cowey *et al.*, 1975; Evans, 1975; Geraci, 1972, 1974; Murai and Andrews, 1978; Rigdon and Drager, 1955; Vimokesant *et al.*, 1982; White, 1970), when spoiled or uncooked fish has been routinely fed. Thiaminase activity is strikingly high, particularly in tuna and sardines (i.e., the destruction of mg quantities of thiamin per hour per gram of fish muscle). Thiamin deficiency has also been reported in foxes fed uncooked fish products and in cats given both fresh fish and canned cat food that has suffered excessive processing losses. Naturally occurring thiamin deficiency has also been reported in cats given diets that have been preserved by sodium metabisulfite that degrades the thiamin in the diet (Donoghue and Langenberg, 1994). A novel case of thiamin deficiency in fish has reported for which consumption of shad was proposed as the mechanism. Shad contain high concentrations of thiaminase, which was inferred to be the mechanism. So-called early mortality syndrome is a noninfectious disease affecting lake trout and other salmonids associated with thiamin deficiency. It is characterized by loss of equilibrium, hyperexcitability, anorexia, and eventually death.

In herbivores, thiamin deficiency can occur from the ingestion of bracken fern (*Pteridium aquilinum*) or nardoo (*Marsilea drummen*). In both herbivores and monogastric animals, the most predominant characteristic of thiamin deficiency is polioencephalomalacia, primarily of the deep cordial gray matter, periventricular gray matter, and alteration in the vestibular and lateral geniculate nuclei (Frye *et al.*, 1991). A relationship between excessive production of hydrogen sulfide in the rumen of cattle and sheep and polioencephalomalacia has recently been demonstrated. The availability of thiamin in foodstuffs is comprised of high levels of tannins. As a general requirement, animals should receive from 4 to 10mg of thiamin per kilogram of dry food (Committee on Animal Nutrition, 2001a; Donoghue and Langenberg, 1994).

#### d. Determination of Thiamin Status

Traditionally the erythrocyte transketolase saturation test, which is a measure of the stimulation of the transketolase reaction, has been used to assess thiamin status. A stimulation of greater than 16% has been taken as a thiamin deficiency. A more sensitive test, however, is the measurement of thiamin-phosphorylated esters in plasma; the level of phosphate esters declines in plasma before any change occurs in erythrocyte transketolase values. A thiamin loading test, which measures the urinary excretion of thiamin

following an oral dose of thiamin, has also been used. However, this test lacks sensitivity compared to measuring metabolites in plasma.

## 2. Pyridoxine

### a. Introduction

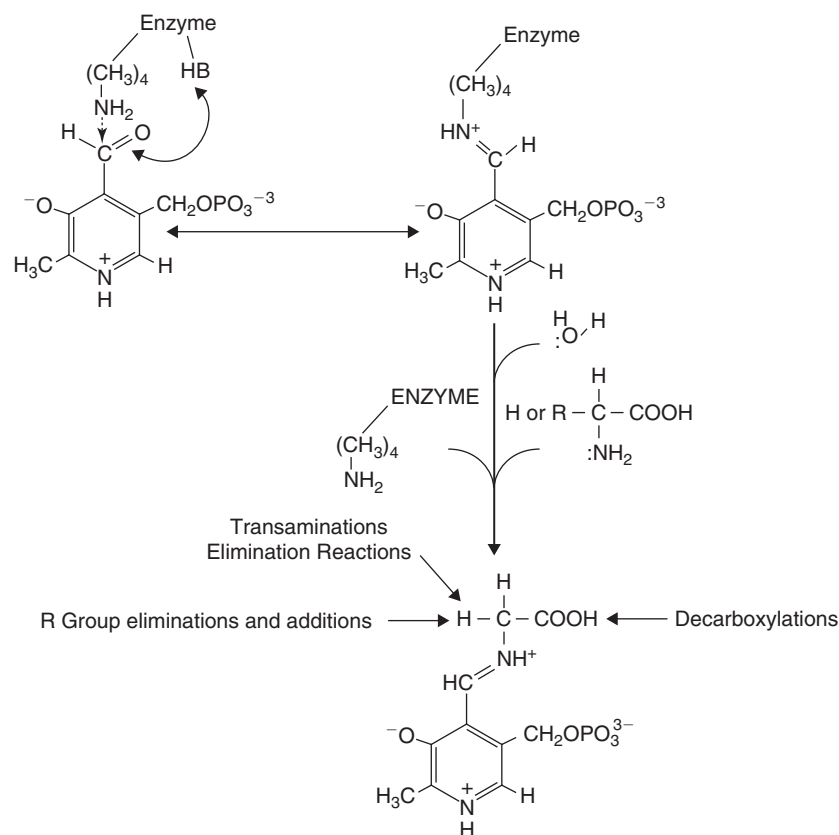
Vitamin B<sub>6</sub> is a collective term for pyridoxine, pyridoxal, and pyridoxamine (Fig. 23-18). Pyridoxine is most abundant in plants, and pyridoxal and pyridoxamine are most abundant in animal tissues (Coburn, 1996). Each can be converted to the other. The active form pyridoxal (B<sub>6</sub> cofactor form) is phosphorylated. When pyridoxal-5-phosphate is in excess, it is converted to pyridoxic acid (-CHO→-COOH), which is then excreted.

Vitamin B<sub>6</sub> is essential in reactions important to amino acid metabolism and glycogen hydrolysis. The major types of reactions involving amino acids fall into three general categories. The most common of these is the transaminase reaction. Transaminations are essential to the interconversion of amino acids to corresponding WA  $\alpha$ -keto acids. The transamination mechanism also applies for reactions important to producing racemic amino acid mixtures, for example, the conversion of L-alanine to D-alanine, and  $\alpha,\beta$ -additions or elimination reactions. Examples of  $\alpha,\beta$ -elimination reactions are the conversion of serine to pyruvic acid and the conversion of homocysteine plus serine to cystathionine. The basic feature of a transamination-type mechanism involves electron withdrawal from the  $\alpha$ -carbon resulting in a proton liberation that sets the stage for substitution and additions reactions (Fig. 23-18).

The second most common reaction involves electron withdrawal from the  $\alpha$ -carbon and carboxylic acid group carbon. This facilitates decarboxylation. Examples of decarboxylation reactions include the conversion of tyrosine to tyramine, 5-hydroxytryptophan to serotonin, histidine to histamine, and glutamate to gamma-aminobutyric acid (GABA). The convulsions associated with vitamin B<sub>6</sub> deficiency are attributed to insufficient activity of PLP-dependent L-glutamate decarboxylase leading to a deficit of the inhibitory neurotransmitter GABA.

A third type of reaction involves electron withdrawal from the  $\alpha,\beta$ -carbons of amino acids. This sets the stage for hydride condensations or aldol reactions. A good example of an aldol reaction is the conversion of serine to glycine with the transfer of the  $\beta$ -carbon (as formaldehyde) to another vitamin cofactor, tetrahydrofolic acid. An excellent example of a hydride condensation is the formation of  $\alpha$ -aminolevulinic acid, the first step in heme biosynthesis (Bender, 1994; Coburn, 1996).

Regarding glycogen, vitamin B<sub>6</sub> (as pyridoxal 5'-phosphate) is a cofactor for glycogen phosphorylase (Helmreich, 1992). Glycogen phosphorylase catalyzes the hydrolysis of ether bonds in glycogen to form 6-phosphoglucose. Ether bonds are best catalyzed through acid-mediated mechanisms.



**FIGURE 23-18** Pyridoxine. Vitamin B<sub>6</sub> is a collective term for pyridoxine (-CH<sub>2</sub>OH), pyridoxal (-CHO), and pyridoxamine (-CH<sub>2</sub>-NH<sub>2</sub>). The active form pyridoxal (B<sub>6</sub> cofactor form) is phosphorylated. The type of reactions carried out by vitamin B<sub>6</sub> fall into three general categories. These are mainly reactions that apply to the metabolism and interconversion of amino acids. The most common of these is the transaminase reaction. Transaminations are essential to the interconversion of amino acids to corresponding  $\alpha$ -keto acids. The transamination mechanism also applies for reactions important to producing racemic amino acid mixtures. Examples of  $\alpha,\beta$ -elimination reactions are the conversion of serine to pyruvate or the conversion of homocysteine plus serine to cystathionine. The second most common reaction involves electron withdrawal from the  $\alpha$ -carbon and carboxylic acid group carbon. This facilitates decarboxylation reactions. A third type of reaction involves electron withdrawal from the  $\alpha,\beta$ -carbons of amino acids. This sets the stage for hydride condensations or aldol reactions (e.g., the formation of  $\alpha$ -aminolevulinic acid), the first step in heme biosynthesis.

The acid proton in this instance is derived from the phosphate group of pyridoxal 5'-phosphate. Before the elucidation of this important function, it was speculated that the association of vitamin B<sub>6</sub> with glycogen phosphorylase was primarily some type of storage mechanism. Indeed, muscle is a good source of vitamin B<sub>6</sub>, but its presence in muscle relates mostly to its role as a catalyst in glycogen hydrolysis.

#### b. Metabolism and Requirements

The requirement of vitamin B<sub>6</sub> by animals is positively related to their intake of protein and amino acids; however, vitamin B<sub>6</sub> deficiency is rarely seen in animals as most diets provide adequate amounts. Normally, B<sub>6</sub> is needed in amounts that range from 2 to 6 mg/kg diet. Ruminants and many herbivores meet a substantial part of their vitamin B<sub>6</sub> requirement from intestinal microbes. Administration of the tuberculostatic drug isoniazid induces a metabolic deficiency of vitamin B<sub>6</sub>.

As might be expected, the most important signs of B<sub>6</sub> deficiency relate to the inability to carry out normal amino acid metabolism. Neurological signs occur as a result of

the inability to synthesize important biogenic amines from amino acid precursors and anemia results from decreased heme synthesis. Under experimental conditions, some animals may show signs of oxaluria with long-term deficiencies in vitamin B<sub>6</sub> (Committee on Animal Nutrition, 2001b).

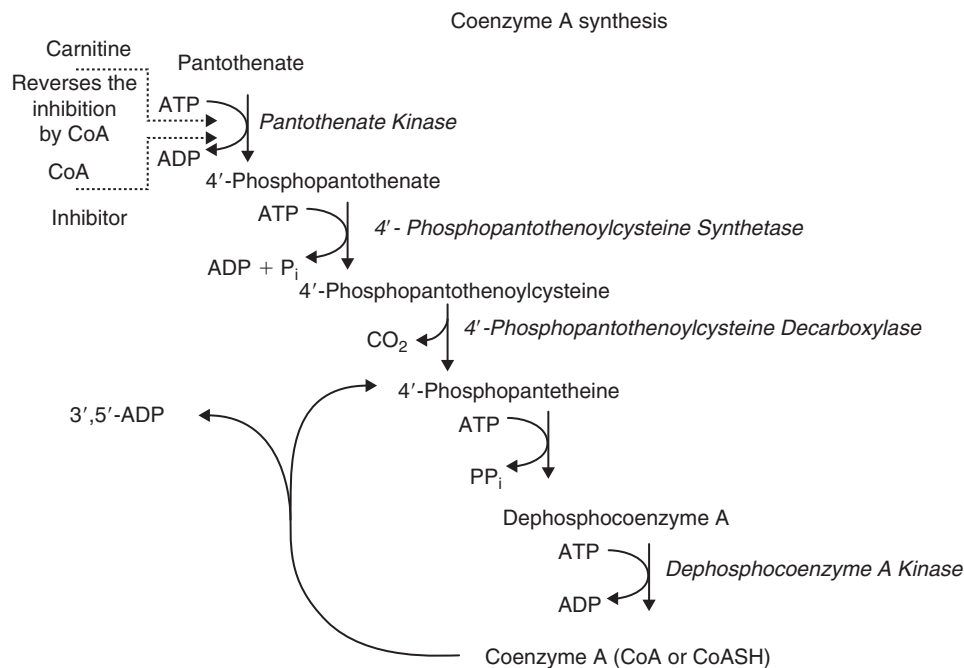
#### c. Determination of Vitamin B<sub>6</sub> Status

A number of tests have been used as an index of vitamin B<sub>6</sub> status. These include measurement of the activities of enzymes that require pyridoxal phosphate such as kynureninase and aminotransferases. However, the most sensitive methods involve the measurement of pyridoxal and pyridoxal phosphate in blood plasma. The relative ratio of these two forms and their response to dietary intake of pyridoxine depends on the species of animal.

### 3. Pantothenic Acid

#### a. Introduction

Pantothenic acid was first recognized as a growth factor for yeast and lactic acid bacteria in the 1930s. Later,



**FIGURE 23-19** Pantothenic acid and coenzyme A. The most important control step in CoA synthesis is the phosphorylation of pantothenic acid to 4'-phosphopantothenic acid by pantothenic acid kinase. There is feedback regulation from CoA and carnitine reverses that inhibition. Most cells are able to conserve pantothenic acid by reutilizing 4'-phosphopantothenic acid.

Elvehjem, Jukes, and others demonstrated pantothenic acid to be essential for animals. Pantothenic acid is a component of coenzyme A (Fig. 23-19). Pantothenic acid (as a part of phosphopantetheine) is also present at the active site of acyl carrier protein (ACP), a component of the fatty acid synthesis complex. Both forms are present in foods. Consequently, absorbed pantothenic acid must first be released from coenzyme A and ACP, steps that involve the actions of peptidases and nucleosidases.

#### b. Absorption and Regulation

Intestinal phosphatases and nucleosidases are capable of very efficient hydrolysis of coenzyme A so that near quantitative release of pantothenic acid occurs as a normal part of digestion. In rats, pantothenic acid was initially found to be absorbed in all sections of the small intestine by simple diffusion (Rucker and Bauerly, 2007). However, subsequent work in rats and chicks indicated that at low concentrations, the vitamin is absorbed by a saturable, sodium-dependent transport mechanism (Rucker and Bauerly, 2007; Said, 2004). Further, the overall  $K_m$  for pantothenic acid intestinal uptake is 10 to 20  $\mu\text{M}$ . At an intake of  $\sim 20/30\text{mg/kg}$  diet as coenzyme A or pantotheine, a concentration typical of many foodstuffs, the pantothenic acid concentration in luminal fluid would be  $\sim 1$  to 2  $\mu\text{M}$ . At this concentration, pantothenic acid does not saturate the transport system, and should be efficiently and actively absorbed. Pantothenic acid shares a common membrane transport system in the small intestine with

another vitamin, biotin (Said, 2004). Following uptake, the maintenance of pantothenic acid cellular concentration depends on its incorporation into cellular CoASH and pantotheine. The most important control step in this process is the phosphorylation of pantothenic acid to 4'-phosphopantothenic acid by pantothenic acid kinase. At least four known enzyme isoforms serve as pantothenic acid kinases. They possess a broad pH optimum (between pH 6 and 9). The  $K_m$  for pantothenic acid in the liver enzyme of most animals is  $\sim 20 \mu\text{M}$ . Mg-ATP is the nucleotide substrate for the phosphorylation reaction.

#### c. Metabolism Functions and Requirements

CoA is the principal moiety for the vectorial transport of acyl and acetyl groups in synthetic and catabolic reactions, and a deficiency is characterized by impaired acetyl and acyl metabolism. The ability to utilize fatty acids as fuels is compromised. There is also an increased production of short chain fatty acids and ketone bodies, which can lead to severe metabolic acidosis.

CoA is involved in a broad array of acetyl and acyl transfer reactions, which also includes carbohydrates and amino acids as cosubstrates, as well as processes related primarily to lipid oxidative metabolism and catabolism, whereas ACP is involved in mostly synthetic reactions involving primarily lipids and possibly amino acids. Protein acetylations and acylations are also key functions catalyzed with CoA as a cosubstrate in reactions. Aminoterminal acetylations occur cotranslationally and posttranslationally



on processed eukaryotic regulatory peptides. Proteins with serine and alanine termini are the most frequently acetylated, although methionine, glycine, and threonine may also be targets. This type of acetylation is usually irreversible and occurs shortly after the initiation of translation. The biological significance of aminoterminal modification varies in that some proteins require acetylation for function, whereas others do not have an absolute requirement. Lysine residues are also targets for acetylations. The acetylation of histones, transcription factors, co-transcriptional activators, nuclear receptors, and  $\alpha$ -tubulin is proteins in which acetylation modulates or alters function (Rucker and Bauerly, 2007). The acylation of proteins with fatty acids (e.g., palmitic acid) or isoprene moieties in the cholesterol synthesis pathway imparts lipid character to proteins, which is often essential to lipid transport and docking at specific locations in cells.

For most animals the need for pantothenic acid is 10 to 20mg per kilogram of diet, which is easily met, because of the ubiquitous presence of pantothenic acid. In animals, the classical signs of deficiency include growth retardation and dermatitis as a secondary consequence of altered lipid metabolism. Neurological, immunological, hematological, reproductive, and gastrointestinal pathologies have also been reported.

### C. Vitamins Involved in Single-Carbon Metabolism: Biotin, Folic Acid, and B<sub>12</sub>

#### 1. Biotin

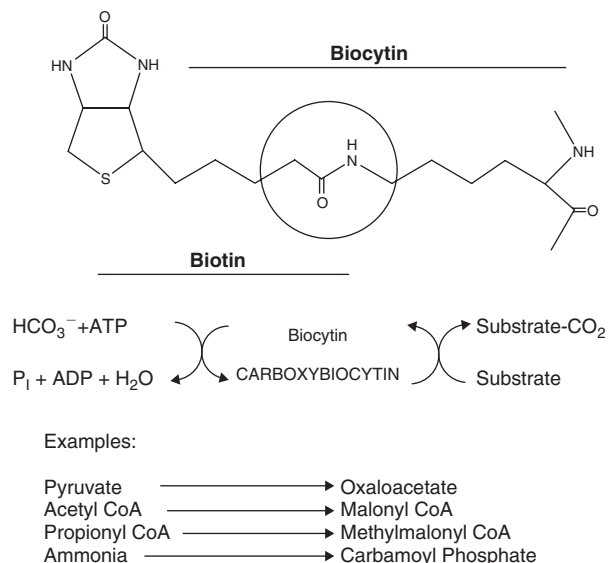
##### a. Introduction

Biotin functions in enzymatic carboxylations as a cofactor for three CO<sub>2</sub>-fixing enzymes: acetyl CoA carboxylase, which is essential for fatty acid synthesis; propionyl CoA carboxylase, which participates in odd chain fatty acid metabolism; and pyruvate carboxylase, which is involved in the formation of oxaloacetate, an important obligatory step in reverse glycolysis and gluconeogenesis (Fig. 23-20).

##### b. Metabolism and Requirements

Biotin is found in highest concentrations in the liver. In food, biotin is present in relatively high concentrations in cereals including soybeans, rice, barley, oats, corn, and wheat. However, the bioavailability of biotin from cereals varies widely. Biotin is covalently bound to the enzymes that it serves as cofactor; the chemical linkage is to a peptide bond between the carboxylic acid moiety on biotin and the  $\epsilon$ -amino function of peptidyl lysine in the enzyme. The biotin-enzyme peptide bond requires an ATP-dependent step (Zempleni, 2005).

Biotin is the coenzyme for four carboxylases: (1) acetyl coenzyme A carboxylase, found in both the mitochondria and cytosol, catalyzes the carboxylation of acetyl-CoA to



**FIGURE 23-20** Biotin. Biotin is covalently bound in carboxylases and transcarboxylases by peptidyl linkage between the carboxylic acid moiety of biotin and the  $\epsilon$ -amino group of peptide bound lysine. The biotin-lysine adduct is called biocytin and can be released from carboxylases after proteolysis and cleavage of peptides containing biocytin by biocytinase. Three major carboxylation reactions that use biotin as a cofactor are shown. All involve the transfer of CO<sub>2</sub> to the respective substrate. Not shown is 3-methylcrotonyl-CoA conversion to 3 methyl glutaconyl-CoA, a reaction important to leucine degradation. Carbamoyl phosphate also requires biotin. Carbamoyl phosphate is a substrate for urea synthesis and purine synthesis.

malonyl-CoA. Malonyl-CoA is the immediate precursor for fatty acid synthesis. (2) Pyruvate carboxylase, which is located in the mitochondria, catalyzes the carboxylation of pyruvate to form oxaloacetate. Oxaloacetate can be metabolized in the tricarboxylic acid cycle or it can be converted to glucose in the liver and kidney and other tissues that are involved in gluconeogenesis. Pyruvate carboxylase is the principal enzyme that replenishes tricarboxylic acid cycle intermediates. (3) Methylcrotonyl-CoA carboxylase, also located in the mitochondria, is involved in the metabolism of L-leucine. (4) Propionyl-CoA carboxylase, also found in mitochondria, is involved in the metabolism of L-isoleucine and L-valine, and L-threonine and L-methionine. All four of the carboxylase enzymes using bicarbonate as their one-carbon substrate share a common biochemical mechanism.

Evidence is also emerging that biotin participates in processes other than classical carboxylation reactions. Specifically, novel roles for biotin in cell signaling, gene expression, and chromatin structure have been identified in recent years. Biotinylation of histones appears to play a role in cell proliferation, gene silencing, and the cellular response to DNA repair. Roles for biotin in cell signaling and chromatin structure are consistent with the notion that biotin has a unique significance in cell biology (Gravel and Narang, 2005; Zempleni, 2005).

When biotin-containing carboxylases are degraded, biotin is released as biocytin (Fig. 23-20). Biocytinase is an important liver enzyme that catalyzes the cleavage of the peptide linkage between biotin and lysine to release free biotin for reutilization. The biotin requirement in animals is relatively low (i.e., in the microgram per kilogram of diet range). Furthermore, biotin can also be produced by gut microflora and the biotin that is covalently attached to enzymes is reutilized.

Nevertheless, there can be nutritional problems associated with biotin status. Biotin and biocytin have affinity for certain proteins, particularly avidin in egg white. The use of raw eggs can cause biotin deficiency because of the association of biotin with avidin in uncooked eggs. The response in fur-bearing animals to ingestion of significant quantities of raw egg white has been described as “egg white injury.” Native (nondenatured) avidin in eggs causes egg white injury because it binds tightly to biotin, preventing its absorption.

The relationship of biotin to avidin is important, particularly to industries that utilize fur-bearing animals for profit. It was subsequently found that egg white injury could be cured by a liver factor that was first called protective factor X and later determined to be biotin. Because biotin cured the skin disorder of egg white injury, it was called vitamin H (for *haut*, the German word for skin). Conditions that may increase biotin requirements in pregnancy, lactation, and therapies are the use of anticonvulsants or exposure to high concentrations of lipoic acid. Spontaneous biotin deficiency occurs rarely in animals because biotin is well distributed among foodstuffs, and a good part, if not all, of the requirement for the vitamin is met by microbial synthesis in the gut. As noted, the deficiency can, however, be induced by the inclusion of unheated (raw) egg white in the diet (Zempleni, 2005). For most monogastric animals, 50 to 100 g of biotin per 1000kcal or ~0.2 to 0.4 mg per kilogram of diet is probably sufficient.

Biotin deficiency leads to impaired gluconeogenesis and impaired fat metabolism. Alopecia and dermatitis are characteristics of biotin deficiency in most animals and birds. Biotin deficiencies can also cause severe metabolic acidosis. The inability to carry out fat metabolism markedly affects the dermis in biotin-deficient animals. Unless there is an inborn error or genetic polymorphism involving one of the carboxylase enzymes, the likelihood of a biotin-related metabolic compromise or deficiency is low, except when uncooked egg white is the major protein source.

Biotin turnover and requirements can be estimated on the basis of (1) concentrations of biotin and metabolites in body fluids, (2) activities of biotin-dependent carboxylases, and (3) the urinary excretion of organic acids that are formed at increased rates if carboxylase activities are reduced. Urinary excretion of biotin and its metabolite, bisnorbiotin, activities of propionyl-CoA carboxylase and beta-methylcrotonyl-CoA carboxylase in lymphocytes,

and urinary excretion of 3-hydroxyisovaleric acid are good indicators of marginal biotin deficiency.

## 2. Folic Acid and Vitamin B<sub>12</sub>

### a. Introduction

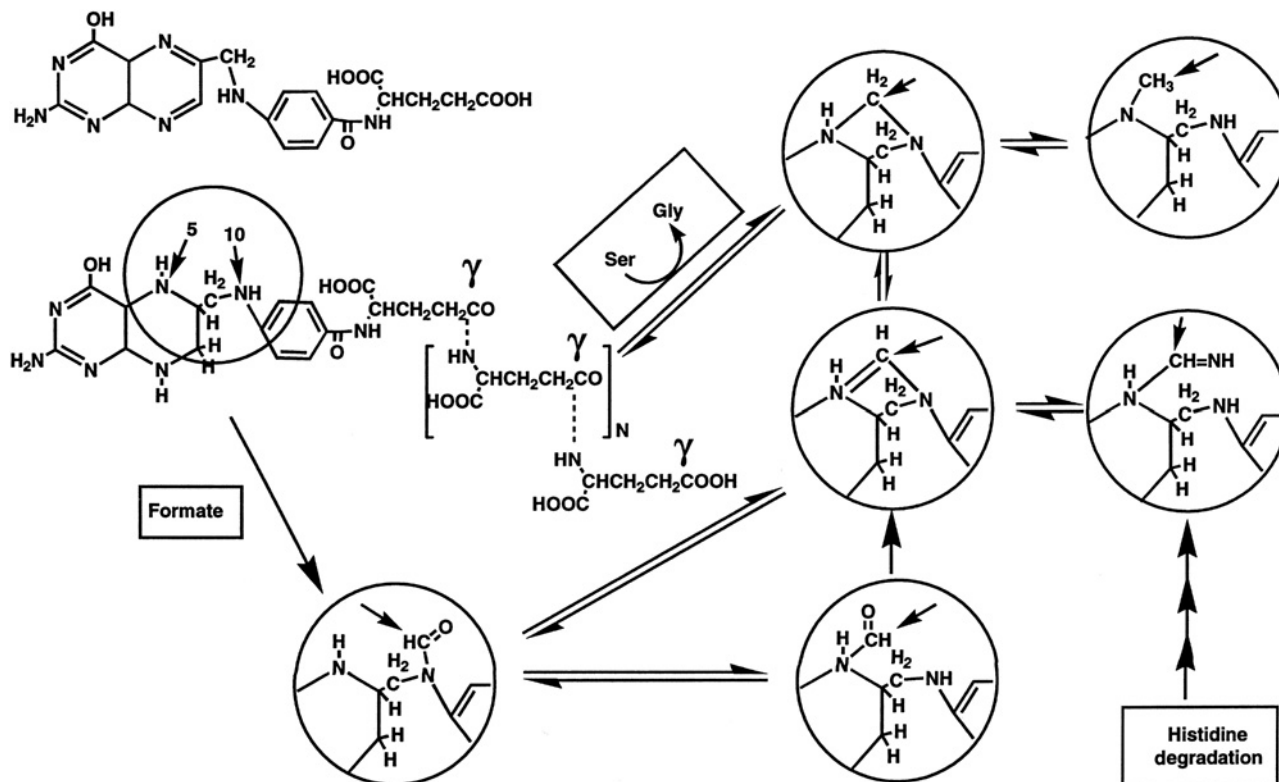
Knowledge regarding folic acid and B<sub>12</sub> evolved from efforts to better understand macrocytic anemias and certain degenerative neurological disorders (Scott, 1994). Combe, the Scottish physician, recognized in the early 1800s that a certain form of macrocytic anemia appears related to a disorder of the digestive organs. In classic studies by Minot and Murphy, Castle, and others, it became clearer that the disorder was associated with gastric secretions and in some cases could be reversed by consuming raw or lightly cooked liver. Through careful clinical investigations and inferences, Castle postulated the existence of an intrinsic factor in gastric juice, which appeared to combine with a dietary extrinsic factor to modulate the severity of the anemia (Goldblith and Joslyn, 1964).

In parallel studies, folic acid was also associated with macrocytic anemia. Large-scale efforts by a number of pharmaceutical companies throughout the 1940s and 1950s and careful clinical and basic studies at academic institutions eventually led to the isolation of folic acid and vitamin B<sub>12</sub>.

### b. Chemistry and Functions

The structures for folic acid and vitamin B<sub>12</sub> are given in Figures 23-21 and 23-22. Folic acid is part of a family of compounds with a pteridine moiety. In the case of folic acid, the pteridine moiety is associated with aminobenzoic acid and glutamyl residues conjugated by a methylene bridge to para-aminobenzoic acid, which in turn is joined to glutamyl residues by a peptide linkage. Figure 23-21 presents an overview of one-carbon transfers involving tetrahydrofolate (THF) coenzymes and their metabolic origins. The reactions include the generation and utilization of formaldehyde and formimino groups in the synthesis of pyridine nucleotides, interconversion of some amino acids, and eventual reduction of the methylene form of THF to methyl THF to facilitate the conversion of homocysteine to methionine (Goldblith and Joslyn, 1964; Scott, 1994).

To set the stage for these conversions, folic acid must be in its completely reduced state. The reductions occur at positions 5, 6, 7, and 8 to form a tetrahydrofolic acid (THFA) (Fig. 23-21). The reduction brings the nitrogen at positions 5 and 10 closer together and changes electrochemical properties of both nitrogens, which facilitates the formation of the various THFA single carbon derivatives that are involved in the metabolic conversions shown in Figure 23-21. The formyl, methanyl, and methylene forms are utilized for purine synthesis and important steps in thymidylate (i.e., DNA-related) synthesis. These reactions are therefore of obvious importance and are essential to cell



**FIGURE 23-21** Folic acid. Structures of oxidized and reduced tetrahydrofolic acid (THFA) are shown. The 5 and 10 positions of the molecule are highlighted because these sites are important to single-carbon transfer. Folic acid is found in foods as  $\gamma$ -linked polyglutamyl folic acid ( $n$  ranges from 3 to 5 units). In the intestine,  $\gamma$ -peptidases (also referred to as conjugases) cleave the polyglutamyl residues to the single glutamate (as shown for the oxidized structure of folic acid). Single carbon units can enter into THFA by a number of routes. Formimino groups can arise from glycine and histidine degradation. Cylation results in  $N^5,N^{10}$ -methenyl THFA. Reduction of this product results in  $N^5,N^{10}$ -methylene THFA. This product can also be derived directly from an aldol-type condensation reaction arising from the conversion of serine to glycine (see Fig. 24-17). This step represents a major source of single carbon units. Subsequently, all of the forms of methylated THFA may be ultimately reduced to  $N^5$ -methyl THFA.

division and proliferation. As a final step, when 5-methyl THFA transfers its methyl moiety to vitamin B<sub>12</sub>, one of the resulting products is the oxidized form of folic acid, which must be reduced to THFA to reinitiate the cycle.

With regard to vitamin B<sub>12</sub>, the methylated form is also shown in Figure 23-22 and is the B<sub>12</sub> cofactor utilized in the THFA-homocysteine transmethylase system. The other reactions involving vitamin B<sub>12</sub> utilize B<sub>12</sub> as deoxyadenosylcobalamin (Fig. 23-22). An example is methylmalonyl-CoA mutase. Without B<sub>12</sub>, methylmalonic acid accumulates. Otherwise, methylmalonic acid is converted to succinyl-CoA for ultimate use as a metabolic fuel, a reaction that is essential for the eventual delivery of carbon from odd-chained fatty acids into the TCA cycle. This is an important process for animals, such as some herbivores and ruminants, which depend in part on odd-chain fatty acids as a source of gluconeogenic precursors.

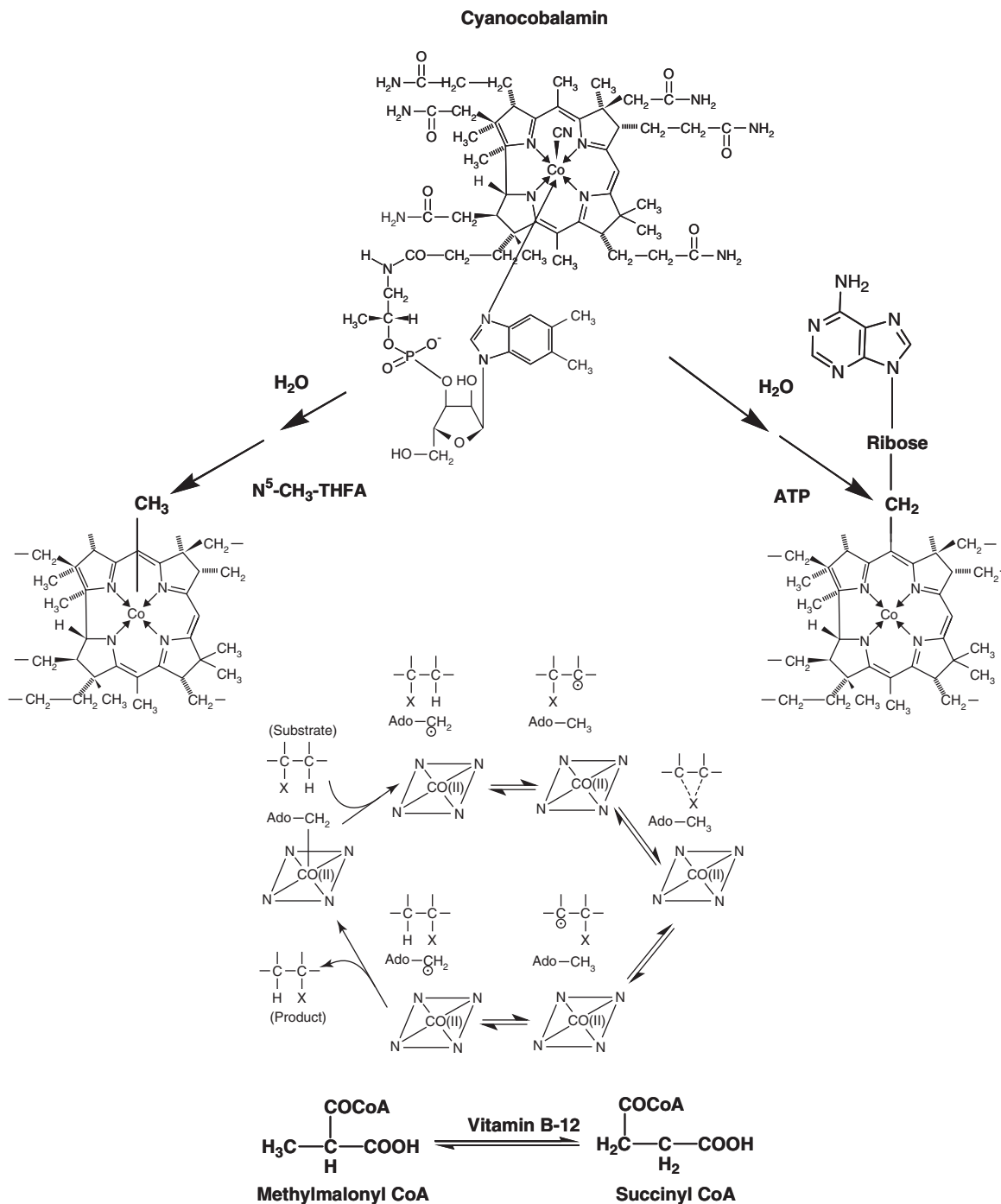
### c. Metabolism

The steps in absorption, transport, and the utilization of folic acid and vitamin B<sub>12</sub> are more complex than for other

water-soluble vitamins (Said, 2004). In the case of the folic acid, the conjugated glutamyl residues must be removed for effective absorption (e.g., to monoglutamyl tetrahydrofolate) in the jejunum where it is absorbed. Next, folates enter plasma and are rapidly cleared by the liver and other organs. Biliary drainage results in a large enterohepatic circulation of folate (Scott, 1994).

Folic acid is found in circulation primarily as methyl-tetrahydrofolate. Thus, it may be assumed that reduction and methylation are essential steps in the eventual transfer of folic acid across cellular barriers and membranes. The enzymes found in the intestinal cells that carry out the hydrolysis of conjugated glutamyl residues are commonly referred to as conjugases. Specific serum transport proteins exist for folic acid and cellular uptake is by active processes (Said, 2004).

For B<sub>12</sub>, the steps important to processing (Fig. 23-22) involve first the release of B<sub>12</sub> from foods under acidic conditions; vitamin B<sub>12</sub> then binds to proteins produced by cells of the gastric fundus (and also the pancreas and salivary gland in some species). Two proteins have been identified, which have been designated as R protein



**FIGURE 23-22** Cyanocobalamin. Commercial preparations of vitamin B<sub>12</sub> usually have a cyano group coordinated with the cobalt (associated with the corrin ring of vitamin B<sub>12</sub>). In an aqueous environment, the cyano group can be displaced by water for the eventual transfer of a methyl group (donated by N<sup>5</sup>-methyl-THFA) or an adenosyl moiety (from ATP). Methylated vitamin B<sub>12</sub> serves as a cofactor for methionine synthetase (see Fig. 23-7). Adenosylated vitamin B<sub>12</sub> serves as a cofactor for unusual isomerase reactions, such as the conversion of methylmalonyl CoA to succinyl CoA. A mechanism for this process is shown, which involves the redox of cobalt in the corrin ring of cobalamin (Co<sup>+3</sup> ↔ Co<sup>+2</sup>).

(and more recently as small-molecular-weight haptocorin) and intrinsic factor (IF). Vitamin B<sub>12</sub> first binds to R proteins and is apparently released in the intestinal lumen by the action of pancreatic and intestinal proteinases and

peptidases. Next, vitamin B<sub>12</sub> associates with an intrinsic factor, a binding protein made in the stomach. The vitamin B<sub>12</sub>-intrinsic factor complex then interacts with receptors on the intestinal brush border localized in the midgut

(i.e., ileum). In the small intestine, following uptake via the IF receptor, there is subsequent proteolytic release of B<sub>12</sub> and binding to intracellular transcobalamin II (TcII). The TcII receptor then transports the TcII-VB<sub>12</sub> complex across the cell, whence it is released into the circulation. Vitamin B<sub>12</sub> is transported in plasma by one of at least three known transport proteins: transcobalamin I, II, or III. The transcobalamins transport vitamin B<sub>12</sub> to cells, where it is again transferred into targeted cells by endocytotic mechanisms (Selhub, 2002).

Interference with R protein or intrinsic factor production (e.g., as caused by inflammatory diseases affecting the ileum, or overproduction of intestinal microflora) can influence availability of vitamin B<sub>12</sub>. With bacterial overproduction, there is competition between the host and bacteria for vitamin B<sub>12</sub> and production of bacterial proteins that bind B<sub>12</sub> and interact with its uptake. Gut bacteria can also be a source of B<sub>12</sub>. Many animals obtain vitamin B<sub>12</sub> through coprophagy. In ruminants, vitamin B<sub>12</sub> is synthesized in ample quantities by ruminal bacteria.

#### d. Requirements and Deficiency

The requirements for folic acid range from 1 to 10mg per kilogram of diet for most animals. There are some conditions in which the folic acid requirements are conditionally high (e.g., when either natural or pharmacological folic acid agonists are present in the diet). With the discovery that THFA is required for DNA synthesis, a number of antimetabolites were developed starting in the 1950s and 1960s that function as inhibitors of folic acid reductase. The best example is methotrexate, which ultimately inhibits the proliferation and regeneration of rapidly replicating cells. Cell division is blocked in the S phase, because of impaired DNA synthesis. As a consequence, drugs such as methotrexate are widely used in cancer chemotherapy particularly for tumors of the lymphoreticular system (Baily, 2007; Scott, 1994; Selhub, 2002).

The requirement for vitamin B<sub>12</sub> for most animals is in the 2 to 15 g per kilogram of diet range. Although deficiencies of folic acid and vitamin B<sub>12</sub> are uncommon in free-ranging animals, diseases of the proximal duodenum or stomach and ileum and pancreatic insufficiency can affect folic acid and vitamin B<sub>12</sub> absorption, respectively. Moreover, cobalt deficiency can result in vitamin B<sub>12</sub> deficiency in ruminants because of the need for cobalt to vitamin B<sub>12</sub> synthesis by rumen microorganisms.

Deficiencies of both vitamin B<sub>12</sub> and folic acid include macrocytic anemia and dyssynchronies in growth and development owing to the importance of folic acid to purine and DNA synthesis (Bohnsack, 2004). Chronic deficiencies of either folic acid or B<sub>12</sub> can also promote fatty liver disease and indirectly influence extracellular matrix maturation stability by causing abnormal elevations in homocysteine. Such signs and symptoms are attributable to both THFA

and B<sub>12</sub> deficiencies, because of the integral relationship of vitamin B<sub>12</sub> to THFA regeneration. Dietary intakes of folic acid, sufficient to maintain functional THFA levels, can mask the initial signs of vitamin B<sub>12</sub> deficiency (e.g., macrocytic and megaloblastic anemia). Prolonged vitamin B<sub>12</sub> deficiency can result in serious neurological disorders (e.g., degeneration of the myelin sheath). A number of environmental conditions can alter folate concentrations in foodstuffs (excessive heat, UV light). Storage of eggs for more than several weeks may depress hatchability and increase hematological abnormalities characteristic of mild macrocytic anemia. Such changes can result from deficiencies of folic acid. Regarding aging animals, malabsorption of B<sub>12</sub> can be a problem. Analogous to pernicious anemia in humans, an autoimmune disease that affects the gastric parietal cells, destruction of these cells also can occur in old animals. This curtails the production of intrinsic factor and subsequently limits vitamin B<sub>12</sub> absorption. This should be explored in aging animals with signs of macrocytic or megaloblastic anemia (Baily, 2007; Scott, 1994; Selhub, 2002).

In humans, it is also becoming clear that periconceptional folic acid at the suggested optimal levels of intake reduce the risk of neural tube and related developmental defects (NTDs). This has led to fortification of foods in many countries and policies for supplementation in others. However, some potential adverse effects, such as masking vitamin B<sub>12</sub> deficiency, increasing twinning rates, or accelerating preexisting malignant neoplasms, have also been reported (Scott, 1994; Selhub, 2002).

#### e. Assessment of Vitamin B<sub>12</sub> and Folate Status of Animals

An independent role of vitamin B<sub>12</sub> involvement in propionate metabolism and folate in histidine metabolism provides the basis for classical methods of assessment of clinical adequacy, independent of their mutual roles in methyl transfer. Vitamin B<sub>12</sub> is a component of the coenzyme for methylmalonyl-CoA mutase, which catalyses the conversion of L-methylmalonyl-CoA to succinyl-CoA. Although assays based on B<sub>12</sub> absorption (e.g., the Schilling's test) are utilized to assess the potential for B<sub>12</sub> deficiency in humans, B<sub>12</sub> assessments in animals most often involve administration of a loading dose of valine (1g/kg body weight). L-valine is a precursor of methylmalonyl-CoA, which is excreted in excess the urine of a vitamin B<sub>12</sub>-efficient animal in that it is not converted to succinyl-CoA. Similarly in histidine metabolism THF is required for the removal of the formimino group from formimino glutamic acid. In the folate-deficient animal given a loading dose of histidine (0.2g/kg body weight), there is enhanced urinary excretion of unchanged formiminoglutamic acid.

Serum folate and cobalamin concentrations are also commonly used to assess status in clinical practice.

## V. VITAMIN-LIKE COMPOUNDS

### A. Lipotropic Factors

Nutritional requirements exist for a number of compounds at specific periods in development, particularly neonatal development, and periods of rapid growth. These compounds typically perform specialized transport functions particularly in relation to fatty acids. Apart from specific amino acids such as methionine and glycine in feathered animals, examples include choline, inositol, and carnitine.

#### 1. Choline

Choline is particularly noteworthy because it plays a key role in methyl group metabolism, carcinogenesis, and lipid transport as a component of lecithin (Garrow, 2007). Choline is normally produced in sufficient amounts; however, in young growing animals, a positive growth response can occur upon addition of choline, commercially available as trimethyl hydroxyethyl ammonium chloride or as the bitartrate. Choline is generally added to diets to reduce the need for activated methyl groups supplied by methionine. It is more economical to add choline for these methyl groups than to add methionine.

Choline is one of the precursors of acetylcholine. Choline is also a component of sphingomyelin and lecithin. Formation of betaine from choline provides important sources of labile methyl groups for transmethylation reactions. Choline can also be synthesized *de novo* from ethanolamine, when methionine or dimethylcysteine, or betaine is in adequate supply. The most abundant source of choline in the diet is lecithin. The primary sign of choline deficiency is fatty liver. In monkeys, dogs, cats, and rats, it has also been shown that prolonged choline deficiency results in cirrhosis. In mice and rats, prolonged deficiency ultimately results in hepatocellular cancer, a unique example of nutrition deficiency resulting in neoplasm. Five hundred to 1000 mg of choline are often added per kilogram of diet (Garrow, 2007).

#### 2. Inositol

Inositol is also a component of phospholipids and, similar to choline, results in a fatty liver, if insufficient in supply (Holub, 1986, 1992). Inositol is synthesized from glucose-6-phosphate after cyclization. In some animals, particularly gerbils and hamsters, there is a nutritional need for inositol when they are given diets containing coconut oil. Myoinositol is plentiful in foodstuffs. The estimated daily intake for large animals can be as high as 1 or 2 g per day. Inositol is particularly important in cellular signal transduction and phospholipid assembly. Plasma levels of inositol are increased during renal disease and nephrectomy. The presence of myoinositol hexabisphosphate (InsP6) in biological fluids (blood, urine, saliva, interstitial fluid) of animals has

been clearly demonstrated. The existence of intracellular InsP6 in mammalian cells has also been established. A relationship between InsP6 ingestion and the InsP6 distribution in various tissues exists. Whereas intracellular inositol depends on endogenous synthesis, depletion of extracellular InsP6 occurs at high rates when InsP6-poor diets are consumed. Consequently, there are probably health benefits that are linked to dietary inositol and InsP6 intake. The suggestion that inositol is important in young animals came from studies carried out throughout the 1970s and 1980s. In particular, it was noted that female gerbils fed a diet containing high coconut oil (relatively saturated) develop an intestinal lipodystrophy that is not seen in animals fed a diet containing 20% safflower oil (relatively unsaturated) or a diet of 20% coconut oil supplemented with 0.1% inositol. The level of inositol in the intestinal tissue of animals fed the coconut oil diet not supplemented with inositol has been shown to decrease. Clearance of lipid (i.e., resolution of the lipodystrophy) was dependent on inositol (Holub, 1986, 1992).

#### 3. Carnitine

Oxidation of fatty acids requires their transportation from the cytosol into the mitochondrial matrix where they undergo  $\beta$ -oxidation. Carnitine plays a major role in this transport process by accepting activated fatty acids at the outer mitochondrial membrane. Carnitine comes both from the diet and synthesis from lysine by a process that is ascorbic acid dependent. These steps are not carried out efficiently in some newborns. Given the importance of carnitine to  $\beta$ -oxidation of long-chain fatty acids, carnitine deficiency can have profound effects on lipid utilization. An inherited carnitine deficiency has been recognized in some dogs such as the boxer (Keene, 1991; Keene *et al.*, 1991; Kittleson *et al.*, 1997; Mc Entee *et al.*, 2001). Moreover, American cocker spaniels that are taurine deficient have been shown to be responsive to a combination of taurine and carnitine supplementation (Kittleson *et al.*, 1997).

Meats and dairy products in contrast to plant foods are good sources of carnitine. Cereal grains besides being low in carnitine are also generally low in the precursors of carnitine: lysine and methionine. Drugs, such as mildronate (3-(2,2,2-trimethylhydrazinium)propionate) can also lower carnitine levels and inhibit synthesis. Mildronate is a butyrobetaine analogue that is known to inhibit gamma-butyrobetaine hydroxylase, the enzyme catalyzing the last step of carnitine biosynthesis. In humans, mildronate is used to ameliorate cardiac function during ischemia by modulating myocardial fatty acid oxidation to the more favorable glucose oxidation. When given to pregnant animals, carnitine levels increase in the milk. Correspondingly, an increase in triglyceride levels is observed in liver, heart, and muscle of mildronate pups (i.e., biochemical modifications compatible with a carnitine deficiency status).

#### 4. Taurine

Although taurine is not generally considered a vitamin, the requirement for taurine by some animals is of the similar order as choline. Taurine, 2-aminoethanesulfonic acid, is present in all animal tissues and is one of the principal free amino acids. Some tissues such as the retina, olfactory bulb, and granulocytes have particularly high concentrations of taurine. Many animals use taurine or glycine as a conjugate for the bile acids. Some of the taurine excreted in the bile is returned to the liver in the enterohepatic circulation (MacDonald *et al.*, 1984). Most animals can synthesize adequate amounts of taurine from the oxidation of cysteine; however, some animals, particularly domesticated and wild felids, and human infants do not synthesize adequate amounts of taurine. Dogs normally synthesize adequate amounts of taurine; however, when they are given low-sulfur amino acid diets, taurine may become limiting. Taurine deficiency occurs in cats when the diet does not contain adequate amounts of the amino acid. Defective synthesis in cats is a result of low activity of two enzymes in the synthetic pathway: cysteine dioxygenase and cysteine sulfinic acid decarboxylase and an obligatory requirement for taurine to conjugate bile acids. A wide array of clinical signs has been described in taurine-deficient cats including central retinal degeneration, reversible dilated cardiomyopathy, reproductive failure in queens, teratogenic defects, and abnormal brain development in kittens (MacDonald *et al.*, 1984).

Dietary concentrations of taurine required to maintain adequate levels in plasma and whole blood of cats are a function of type of diet, which affects the degree of microbial degradation that occurs in the enterohepatic circulation. For most expanded diets 1g taurine/kg is adequate, but canned diets may require concentrations up to 2.5g taurine/kg dry matter.

Plasma and whole blood concentrations of 40 and 300 M of taurine appear to be adequate in cats for reproduction, which is the most demanding physiological state for taurine (MacDonald *et al.*, 1984).

### B. Other Vitamin-Like Compounds

The following compounds are highlighted because of their known role as coenzymes in prokaryotes and potential role as probiotics (growth-promoting substances) in higher animals. These compounds include queuosine coenzyme Q, pteridines (other than folic acid), such as biopterin and the pteridine cofactor for the Mo-Fe flavoproteins, lipoic acid, and pyrroloquinoline quinone (PQQ).

#### 1. Queuosine

Queuosine is included because it represents a known and novel product arising from a microbe-host interaction. Queuine is the nucleoside base, which is modified to queuosine.

Queuosine resembles guanidine and is preferably utilized in some t-RNAs. The importance of this interaction has yet to be fully understood. Germ-free animals survive without a source of queuine or queuosine (Farkas, 1980).

#### 2. Coenzyme Q

Although claims have been made for a nutrition requirement for coenzyme Q, more work is needed to fully clarify a true nutritional role for this compound. Ubiquinone or coenzyme Q is found in mitochondria. Coenzyme Q is structurally similar to vitamins E and K. As a quinone, coenzyme Q is ideally suited to interact with cytochromes to affect the flow of electrons in the mitochondrial respiratory chain. Coenzyme Q can be synthesized and is easily absorbed from the intestine by the same route as other fat-soluble vitamins. However, there is no known requirement for coenzyme Q in higher animals.

Of the lipophilic substances with redox cycling capacity, the ubiquinones (coenzyme Q) are a group of ubiquitous 2,3-dimethoxy-5-methyl benzoquinones substituted at the position 6 with terpenoid chains of varying lengths. In mitochondria, coenzyme Q causes two electron processes and helps initiate two single electron transfers through semiquinone intermediates. Coenzyme Q is found mainly in the mitochondrial intermembrane. Although there is no apparent dietary requirement, coenzyme Q is present in food and promoted for various putative health benefits. Coenzyme Q that is absorbed from the intestine is transported by the same transport system as vitamin E and vitamin K.

#### 3. Pteridines

In animals, tetrahydrobiopterin (commonly abbreviated BH<sub>4</sub>) is an important redox cofactor, best known for its role at the catalytic site for phenylalanine and tyrosine hydroxylases. Tetrahydrobiopterin is made in sufficient quantities from pathways related to guanine synthesis. A related cofactor is the molybdenum cofactor, also in the pterin family, a cofactor for xanthine oxidase and aldehyde oxidase (important to purine metabolism) and sulfite oxidase (important in sulfur amino acid metabolism; see the Molybdenum section in Chapter 22).

#### 4. Lipoic Acid

Lipoic acid (LA) is made in the liver of most animals. This coenzyme is linked by amide linkage to lysyl residues within transacetylases (Fuchs and Zimmer, 1997). Lipoyl moieties function in the transfer of electrons and activated acyl groups from the thiazole-moiety of thiamin pyrophosphate to CoASH. In this process, the disulfide bond is broken and dihydrolipoyl transiently generated. Reoxidation is required to reinitiate this cycle. Although most reactions in biological systems may be described as nucleophilic in

nature, reactions involving oxidized lipoic acid involve electrophilic mechanisms owing to the oxidized state of the two sulfurs in lipoic acids.

Reduction of oxidative stress by LA supplementation has been demonstrated in animal models (Fuchs and Zimmer, 1997). To determine how normal development or pathological conditions are affected by genetic alterations in the ability of mammalian cells to synthesize LA and whether dietary LA can circumvent its endogenous absence, mice deficient in lipoic acid synthase (Lias) have been generated. Mice heterozygous for disruption of the Lias gene develop normally, and their plasma levels of thiobarbituric acid-reactive substances do not differ from those of wild-type mice. However, the heterozygotes have significantly reduced erythrocyte glutathione levels, indicating that their endogenous antioxidant capacity is lower than those of wild-type mice. Homozygous embryos die by day 8 to 12 of gestation. Of nutritional interest, supplementing the diet of heterozygous mothers with LA (1.65 g/kg of body weight) during pregnancy fails to prevent the prenatal deaths of homozygous embryos. Apparently, an endogenous LA synthesis is essential for developmental survival and cannot be replaced by LA in maternal tissues and blood via the diet (Fuchs and Zimmer, 1997).

### 5. Pyrroloquinoline Quinone

Pyrroloquinoline quinone (PQQ) is a cofactor that was originally isolated from methylotrophic bacteria. PQQ is utilized in bacteria as a redox cycling cofactor. It has been shown to be present in mammalian tissue; however, its primary function is still not clear, although recent evidence suggests that gestational deficiency affects mitochondriogenesis (Steinberg *et al.*, 1994, 2003; Stites *et al.*, 2000a, 2000b, 2006). PQQ is a growth stimulant in mammals fed chemically defined diets, particularly in mice. If there is a requirement for PQQ, however, it is yet to be established. The growth response in neonates is most obvious in offspring from dams that have been nutritionally deprived of PQQ throughout their adult lives.

## VI. CONCLUDING REMARKS

Vitamins evolved to serve unique and complex roles: as cofactors, as signaling agents in cells, as regulators of gene expression, and as redox and free-radical quenching agents. All natural vitamins are organic food substances found only in living things. With few exceptions, the body cannot manufacture or synthesize vitamins. They must be supplied in the diet. As is the case for any substance that is essential to a given function, all vitamins at some point in development can be viewed as limiting nutrients, the absence of which results in specific deficiency signs and symptoms.

## REFERENCES

- Aguie, G. A., Rader, D. J., Clavey, V., Traber, M. G., Torpier, G., *et al.* (1995). Lipoproteins containing apolipoprotein B isolated from patients with abetalipoproteinemia and homozygous hypobetalipoproteinemia: identification and characterization. *Atherosclerosis* **118**, 183–191.
- Azzi, A., Kempna, G. R., Munteanu, P., Negis, A., Villacorta, Y., *et al.* (2004). Vitamin E mediates cell signaling and regulation of gene expression. *Ann. NY Acad. Sci.* **1031X**, 86–95.
- Barnett, K. C., Palmer, A. C., Abrams, J. T., Bridge, P. S., Spratling, F. R., and Sharman, I. M. (1970). Ocular changes associated with hypovitaminosis A in cattle. *Br. Vet. J.* **126**, 561–573.
- Baily, L. (2007). Folic acid. In “Handbooks of Vitamins” (J. Zempleni, R. B. Rucker, J. Suttie, and D. McCormick, Eds.), 4th ed., pp. 385–419. Taylor & Francis, New York.
- Bender, D. A. (1994). Novel functions of vitamin B<sub>6</sub>. *Proc. Nutr. Soc.* **53**, 625–630.
- Bender, D. A. (1996). Tryptophan and niacin nutrition: is there a problem? *Adv. Exp. Med. Biol.* **398**, 565–569.
- Bettendorff, L. (1996). A non-cofactor role of thiamine derivatives in excitable cells? *Arch. Physiol. Biochem.* **104**, 745–751.
- Bohnsack, B. L., and Hirschi, K. (2004). Nutrient regulation of cell cycle progression. *Annu. Rev. Nutr.* **24**, 433–453.
- Booth, A., Reid, M., and Clark, T. (1987). Hypovitaminosis A in feedlot cattle. *J. Am. Vet. Med. Assoc.* **190**, 1305–1308.
- Castaneda, M. P., Hirschler, E. M., and Sams, A. R. (2005). Skin pigmentation evaluation in broilers fed natural and synthetic pigments. *Poult. Sci.* **84**, 143–147.
- Ceh, L., Helgebostad, A., and Ender, F. (1964). Thiaminase in capelin (*Mallotus villosus*): an arctic fish of the *Salmonidae* family. *Int. Z. Vitaminforsch.* **34**, 189–196.
- Coburn, S. P. (1996). Modeling vitamin B6 metabolism. *Adv. Food Nutr. Res.* **40**, 107–132.
- Committee on Animal Nutrition. (2001a). “Nutrient Requirements of Dairy Cattle,” 7th rev. ed. National Research Council, National Academy of Sciences, Washington, DC.
- Committee on Animal Nutrition. (2001b). “Requirements of Dogs and Cats.” National Academy of Sciences, Washington, DC.
- Cowey, C. B., Adron, J. W., Knox, D., and Ball, G. T. (1975). Studies on the nutrition of marine flatfish: the thiamin requirement of turbot (*Scophthalmus maximus*). *Br. J. Nutr.* **34**, 383–390.
- Davis, R. E. (1983). Clinical chemistry of thiamin. *Adv. Clin. Chem.* **23**, 93–140.
- Debier, C., and Larondelle, Y. (2005). Vitamins A and E: metabolism, roles and transfer to offspring. *Br. J. Nutr.* **93**, 153–174.
- Donoghue, S., and Langenberg, J. (1994). Clinical nutrition of exotic pets. *Aust. Vet. J.* **71**, 337–341.
- Dusso, A. S., Brown, A. J., and Slatopolsky, E. (2005). Vitamin D. *Am. J. Physiol. Renal. Physiol.* **289**, F8–F28.
- Evans, W. C. (1975). Thiaminases and their effects on animals. *Vitam. Horm.* **33**, 467–504.
- Farkas, W. R. (1980). Effect of diet on the queuosine family of tRNAs of germ-free mice. *J. Biol. Chem.* **255**, 6832–6835.
- Frye, T. M., Williams, S. N., and Graham, T. W. (1991). Vitamin deficiencies in cattle. *Vet. Clin. North Am. Food Anim. Pract.* **7**, 217–275.
- Fuchs, J. P. L., and Zimmer, G. Eds., (1997). “Lipoic Acid in Health and Disease.” Marcel Dekker, New York.
- Geraci, J. R. (1972). Experimental thiamine deficiency in captive harp seals, *Phoca groenlandica*, induced by eating herring, *Clupea harengus*, and smelts, *Osmerus mordax*. *Can. J. Zool.* **50**, 179–195.



- Geraci, J. R. (1974). Thiamine deficiency in seals and recommendations for its prevention. *J. Am. Vet. Med. Assoc.* **165**, 801–803.
- Garrow, T. A. (2007). Choline. In “Handbooks of Vitamins” (J. Zempleni, R. B. Rucker, J. Suttie, and D. McCormick, Eds.), 4th ed., pp. 459–488. Taylor & Francis, New York.
- Goldblith, S. A., and Joslyn, M. A. (1964). “Milestones in Nutrition,” pp. 331–446. Avi, Westport, CT.
- Gravel, R. A., and Narang, M. A. (2005). Molecular genetics of biotin metabolism: old vitamin, new science. *J. Nutr. Biochem.* **16**, 428–431.
- Hageman, G. J., and S. R. (2001). Niacin, poly(ADP-ribose) polymerase-1 and genomic stability. *Mutat. Res.* **475**, 45–56.
- Harrison, E. H. (2005). Mechanisms of digestion and absorption of dietary vitamin A. *Annu. Rev. Nutr.* **25**, 87–103.
- Helmreich, E. J. (1992). How pyridoxal 5'-phosphate could function in glycogen phosphorylase catalysis. *Biofactors* **3**, 159–172.
- Hendy, G. N., and Goltzman, D. (2005). Does calcitriol have actions independent from the vitamin D receptor in maintaining skeletal and mineral homeostasis? *Curr. Opin. Nephrol. Hypertens.* **14**, 344–350.
- Hendy, G. N., Hruska, K. A., Mathew, S., and Goltzman, D. (2006). New insights into mineral and skeletal regulation by active forms of vitamin D. *Kidney Int.* **69**, 218–223.
- Holub, B. J. (1986). Metabolism and function of myo-inositol and inositol phospholipids. *Annu. Rev. Nutr.* **6**, 563–597.
- Holub, B. J. (1992). The nutritional importance of inositol and the phosphoinositides. *N. Engl. J. Med.* **326**, 1285–1287.
- Hopkins, F. G. (1930). The earlier history of vitamin research. Nobel lectures delivered on Dec. 19, 1929. Les Prix Nobel, Stockholm, Sweden.
- Jacobson, M. K., Ame, J., Lin, W., Coyle, D. L., and Jacobson, E. L. (1995). Cyclic ADP-ribose. A new component of calcium signaling. *Receptor* **5**, 43–49.
- Jang, G. F., McBee, J. K., Alekseev, A. M., Haeseleer, F., and Palczewski, K. (2000). Stereoisomeric specificity of the retinoid cycle in the vertebrate retina. *J. Biol. Chem.* **275**, 28128–28138.
- Johnson, E. J., Hammond, B. R., Yeum, K. J., Qin, J., Wang, X. D., et al. (2000). Relation among serum and tissue concentrations of lutein and zeaxanthin and macular pigment density. *Am. J. Clin. Nutr.* **71**, 1555–1562.
- Johnston, C. S., and Steinberg, F., Rucker, R. B. (2007). Ascorbic acid. In “Handbooks of Vitamins” (J. Zempleni, R. B. Rucker, J. Suttie, D. McCormick, Eds.), 4th ed., pp. 489–520. Taylor & Francis, New York.
- Judson, G. J., and Feakes, A. (1999). Vitamin D doses for alpacas (*Lama pacos*). *Aust. Vet. J.* **77**, 310–315.
- Keene, B. W. (1991). L-carnitine supplementation in the therapy of canine dilated cardiomyopathy. *Vet. Clin. North Am. Small Anim. Pract.* **21**, 1005–1009.
- Keene, B. W., Panciera, D. P., Atkins, C. E., Regitz, V., Schmidt, M. J., and Shug, A. L. (1991). Myocardial L-carnitine deficiency in a family of dogs with dilated cardiomyopathy. *J. Am. Vet. Med. Assoc.* **198**, 647–650.
- Kirkland, J. B. (2007). Niacin. In “Handbooks of Vitamins” (J. Zempleni, R. B. Rucker, J. Suttie, and D. McCormick, Eds.), 4th ed., pp. 191–232. Taylor & Francis, New York.
- Kittleson, M. D., Keene, B., Pion, P. D., and Loyer, C. G. (1997). Results of the multicenter spaniel trial (MUST): taurine- and carnitine-responsive dilated cardiomyopathy in American cocker spaniels with decreased plasma taurine concentration. *J. Vet. Intern. Med.* **11**, 204–211.
- Lamb, T. D., and Pugh, E. N., Jr. (2004). Dark adaptation and the retinoid cycle of vision. *Prog. Retin. Eye Res.* **23**, 307–380.
- MacDonald, M. L., Rogers, Q. R., and Morris, J. G. (1984). Nutrition of the domestic cat, a mammalian carnivore. *Annu. Rev. Nutr.* **4**, 521–562.
- McEntee, E. K., Flandre, T., Dessy, C., Desmecht, D., Clercx, C., et al. (2001). Metabolic and structural abnormalities in dogs with early left ventricular dysfunction induced by incessant tachycardia. *Am. J. Vet. Res.* **62**, 889–894.
- McCabe, S. L., Pelosi, D. M., Tetreault, M., Miri, A., Nguitragool, W., et al. (2004). All-trans-retinal is a closed-state inhibitor of rod cyclic nucleotide-gated ion channels. *J. Gen. Physiol.* **123**, 521–531.
- McDonnell, L. R. (2001). “Vitamins in Animal and Human Nutrition,” 2nd ed. Iowa State Press, Ames, IA.
- Murai, T., and Andrews, J. W. (1978). Thiamin requirement of channel catfish fingerlings. *J. Nutr.* **108**, 176–180.
- Murray, S. L., Lau, K. W., Begg, A., and Jacobs, K. (2001). Myelodysplasia, hypophosphataemia, vitamin D and iron deficiency in an alpaca. *Aust. Vet. J.* **79**, 328–331.
- Norman, A. W., Okamura, W. H., Bishop, J. E., and Henry, H. L. (2002). Update on biological actions of 1 $\alpha$ ,25(OH)<sub>2</sub>-vitamin D<sub>3</sub> (rapid effects) and 24R,25(OH)<sub>2</sub>-vitamin D<sub>3</sub>. *Mol. Cell Endocrinol.* **197**, 1–13.
- Powers, H. J. (2003). Riboflavin (vitamin B<sub>2</sub>) and health. *Am. J. Clin. Nutr.* **77**, 1352–1360.
- Rigdon, R. H., and Drager, G. A. (1955). Thiamine deficiency in sea lions (*otaria californiana*) fed only frozen fish. *J. Am. Vet. Med. Assoc.* **127**, 453–455.
- Rivlin, R. S. (2007). Riboflavin. In “Handbooks of Vitamins” (J. Zempleni, R. B. Rucker, J. Suttie, and D. McCormick, Eds.), 4th ed., pp. 233–252. Taylor & Francis, New York.
- Ross, S. A., McCaffery, P. J., Drager, U. C., and De Luca, L. M. (2000). Retinoids in embryonal development. *Physiol. Rev.* **80**, 1021–1054.
- Rucker, R. B., and Bauerly, K. (2007). Pantothenic acid. In “Handbooks of Vitamins” (J. Zempleni, R. B. Rucker, J. Suttie, and D. McCormick, Eds.), 4th ed., pp. 289–314. Taylor & Francis, New York.
- Rucker, R. B., and Steinberg, F. M. (2002). Vitamin requirements. *Biochem. Mol. Biol. Education* **30**, 86–89.
- Said, H. M. (2004). Recent advances in carrier-mediated intestinal absorption of water-soluble vitamins. *Annu. Rev. Physiol.* **66**, 419–446.
- Scott, D. W. (1986). Vitamin A-responsive dermatosis in the cocker spaniel. *J. Am. Animal Hosp. Assoc.* **22**, 125–130.
- Scott, J. W. D. (1994). Folate/vitamin B<sub>12</sub> inter-relationships. *Essays Biochem.* **28**, 63–72.
- Selhub, J. (2002). Folate, vitamin B<sub>12</sub> and vitamin B<sub>6</sub> and one carbon metabolism. *J. Nutr. Health Aging* **6**, 39–42.
- Singh, U., Devaraj, S., and Jialal, I. (2005). Vitamin E, oxidative stress, and inflammation. *Annu. Rev. Nutr.* **25**, 151–174.
- Stafford, D. W. (2005). The vitamin K cycle. *J. Thromb. Haemost.* **3**, 1873–1878.
- Stahl, W., and Sies, H. (2005). Bioactivity and protective effects of natural carotenoids. *Biochim. Biophys. Acta* **1740**, 101–107.
- Steinberg, F., Stites, T. E., Anderson, P., Storms, D., Chan, I., et al. (2003). Pyrroloquinoline quinone improves growth and reproductive performance in mice fed chemically defined diets. *Exp. Biol. Med. (Maywood)* **228**, 160–166.
- Steinberg, F. M., Gershwin, M. E., and Rucker, R. B. (1994). Dietary pyrroloquinoline quinone: growth and immune response in BALB/c mice. *J. Nutr.* **124**, 744–753.
- Stites, T., Storms, D., Bauerly, K., Mah, J., Harris, C., et al. (2006). Pyrroloquinoline quinone modulates mitochondrial quantity and function in mice. *J. Nutr.* **136**, 390–396.
- Stites, T. E., Mitchell, A. E., and Rucker, R. B. (2000a). Physiological importance of quinoenzymes and the O-quinone family of cofactors. *J. Nutr.* **130**, 719–727.

- Stites, T. E., Sih, T. R., and Rucker, R. B. (2000b). Synthesis of [(14)C]pyrroloquinoline quinone (PQQ) in *E. coli* using genes for PQQ synthesis from *K. pneumoniae*. *Biochim. Biophys. Acta* **1524**, 247–252.
- Subcommittee on Laboratory Animal Nutrition, Board on Agriculture, National Research Council (1995). “Nutrient Requirements of Laboratory Animals.” National Research Council, National Academy of Sciences, Washington, DC.
- Suttie, J. W. (2007). Vitamin K. In “Handbooks of Vitamins” (J. Zempleni, R. B. Rucker, J. Suttie, and D. McCormick, Eds.), 4th ed., pp. 111–152. Taylor & Francis, New York.
- Traber, M. (2007). Vitamin E. In “Handbooks of Vitamins” (J. Zempleni, R. B. Rucker, J. Suttie, and D. McCormick, Eds.), 4th ed., pp. 153–174. Taylor & Francis, New York.
- Traber, M. G., Diamond, S. R., Lane, J. C., Brody, R. I., and Kayden, H. J. (1994a). Beta-carotene transport in human lipoproteins: comparisons with a-tocopherol. *Lipids* **29**, 665–669.
- Traber, M. G., Pillai, S. R., Kayden, H. J., and Steiss, J. E. (1993). Vitamin E deficiency in dogs does not alter preferential incorporation of RRR-alpha-tocopherol compared with all rac-alpha-tocopherol into plasma. *Lipids* **28**, 1107–1112.
- Traber, M. G., Rader, D., Acuff, R. V., Brewer, H. B., Jr., and Kayden, H. J. (1994b). Discrimination between RRR- and all-racemic-alpha-tocopherols labeled with deuterium by patients with abetalipoproteinemia. *Atherosclerosis* **108**, 27–37.
- Traber, M. G., Ramakrishnan, R., and Kayden, H. J. (1994c). Human plasma vitamin E kinetics demonstrate rapid recycling of plasma RRR-alpha-tocopherol. *Proc. Natl. Acad. Sci. USA* **91**, 10005–10008.
- Van Saun, R. J., Smith, B. B., and Watrous, B. J. (1996). Evaluation of vitamin D status of llamas and alpacas with hypophosphatemic rickets. *J. Am. Vet. Med. Assoc.* **209**, 1128–1133.
- Velazquez, A., and Fernandez-Mejia, C. (2004). Vitamin metabolism, genetics and the environment. *World Rev. Nutr. Diet* **93**, 164–187.
- Velazquez, A. L. P., Martin, P. J., Flajollet, S., Dedieu, S., Billaut, X., and Lefebvre, B. (2005). Transcriptional activities of retinoic acid receptors. *Vitam. Horm.* **70**, 199–264.
- Vimokesant, S., Kunjara, S., Rungruangsak, K., Nakornchai, S., and Panijpan, B. (1982). Beriberi caused by antithiamin factors in food and its prevention. *Ann. NY Acad. Sci.* **378**, 123–136.
- Wasserman, R. H. (1975). Active vitamin D-like substances in Solanum malacoxylon and other calcinogenic plants. *Nutr. Rev.* **33**, 1–5.
- White, J. R. (1970). Thiamine deficiency in an Atlantic bottle-nosed dolphin (*Tursiops truncatus*) on a diet of raw fish. *J. Am. Vet. Med. Assoc.* **157**, 559–562.
- Wilson, J. X. (2005). Regulation of vitamin C transport. *Annu. Rev. Nutr.* **25**, 105–125.
- Xue, Y., Karaplis, A. C., Hendy, G. N., Goltzman, D., and Miao, D. (2005). Genetic models show that parathyroid hormone and 1,25-dihydroxyvitamin D3 play distinct and synergistic roles in postnatal mineral ion homeostasis and skeletal development. *Hum. Mol. Genet.* **14**, 1515–1528.
- Zempleni, J. (2005). Uptake, localization, and noncarboxylase roles of biotin. *Annu. Rev. Nutr.* **25**, 175–196.

# Lysosomal Storage Diseases

Mark Haskins

*Department of Pathology  
School of Veterinary Medicine  
University of Pennsylvania  
Philadelphia, Pennsylvania*

Urs Giger

*School of Veterinary Medicine  
University of Pennsylvania  
Philadelphia, Pennsylvania*

- 
- I. LYSOSOMAL BIOLOGY**
  - II. LYSOSOMAL STORAGE DISEASES (LSDs)**
  - III. PATHOGENESIS**
  - IV. CLINICAL SIGNS**
  - V. DIAGNOSIS**
  - VI. THERAPY**
    - A. ERT
    - B. BMT
    - C. Gene Therapy

---

## REFERENCES

---

### I. LYSOSOMAL BIOLOGY

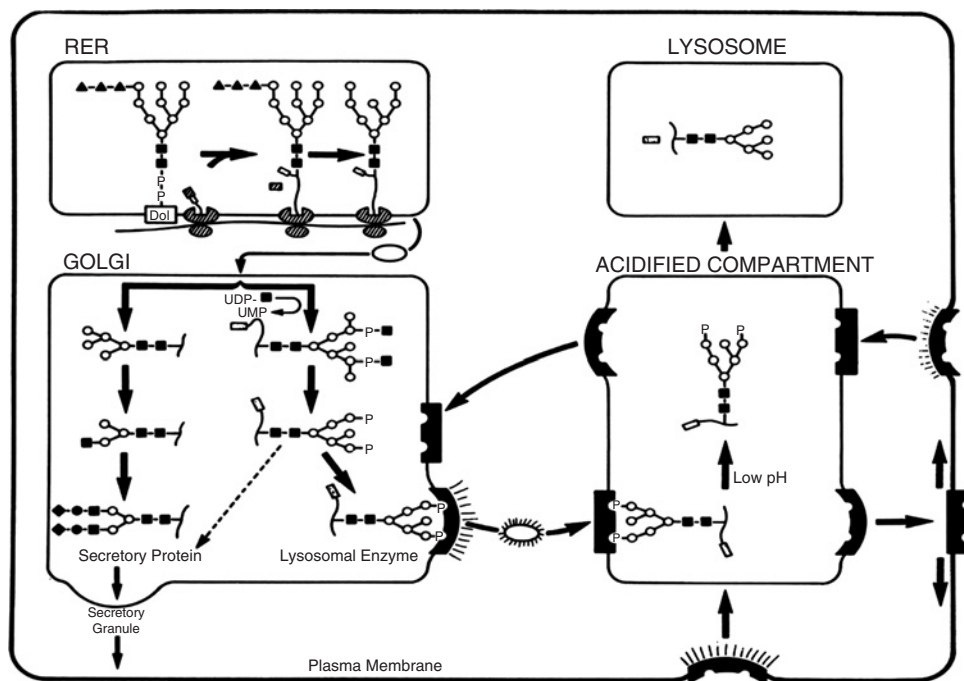
In 1955, de Duve *et al.* named the cytoplasmic particles that contain a series of hydrolytic enzymes lytic bodies, or “lysosomes.” These organelles have a single lipoprotein membrane and contain several dozen different acid hydrolase enzymes (Holtzman, 1989), which typically catalyze catabolic reactions  $A-B + H_2O \rightarrow A-H + B-OH$ , optimally at acid pH. Lysosomes and their “housekeeping” enzymes degrade many substrates that are found in all nucleated mammalian cells. Deficiencies of these enzymes lead to lysosomal accumulation of their substrates, thereby causing lysosomal storage disease (LSDs), many of which have been discovered and characterized in domestic animals.

In normal cells, most lysosomal hydrolases are synthesized as preproenzymes on rough endoplasmic reticulum (ER) ribosomes. Through a signal-recognition particle complex, the enzymes are translocated into the lumen of the ER where high mannose oligosaccharides are added (Fig. 24-1; reviewed in Kornfeld and Sly [2001]). These oligosaccharides are trimmed, and the glycoprotein moves to the Golgi apparatus where further shortening occurs. Further posttranslational modification results from the action of two enzymes that add a mannose 6-phosphate

(M6P) marker. Deficiency in activity of these transferases can result in unique forms of LSD (e.g., mucopolipidosis II in domestic shorthair cats). The M6P moiety can be recognized by two similar integral membrane glycoprotein receptors, which transfer the enzyme to the lysosome. These two receptors are (1) small and cation dependent for binding and (2) large and cation independent, which in some species also bind insulin-like growth factor II. Both receptors appear responsible for the transport of the enzymes from the Golgi apparatus via clathrin-coated vesicles to the prelysosomal/endosomal compartment. Once the lysosomal enzymes dissociate, the receptors recycle to the Golgi apparatus.

A proportion of the M6P modified enzyme in the Golgi may also leave the cell via secretory granules (Fig. 24-1). The secreted enzymes can then move from the extracellular space into the circulation. Different enzymes appear to be secreted from cells in varied amounts (Dobrenis *et al.*, 1994). Thus, the level of activity in serum of any particular enzyme is related to how much is secreted and its stability at plasma pH. Secreted enzymes can ultimately reach the lysosome of other cells because the cation-independent receptor is present in the plasma membrane on many cells (Distler *et al.*, 1979; Kaplan *et al.*, 1977; Natowicz *et al.*, 1979). Thus, enzymes that connect with this receptor can be internalized and transferred to lysosomes. This pathway provides the mechanism for therapy for lysosomal storage diseases discussed later.

Although posttranslational glycosylation is common to most lysosomal enzymes, other modifications or activator proteins are necessary for the function of a subset of the hydrolases. For example, the lysosomal sulfatases (17 in humans; 14 in rodents) undergo an additional posttranslational modification by sulfatase modifying factor 1 (SUMF-1), which converts a cysteine residue into C (alpha)-formylglycine (FGly) at the active site (Dierks *et al.*, 2005; Preusser-Kunze *et al.*, 2005). The absence



**FIGURE 24-1** Schematic diagram of how lysosomal enzymes are processed and delivered to the lysosome. From Kornfeld, 1987, with permission.

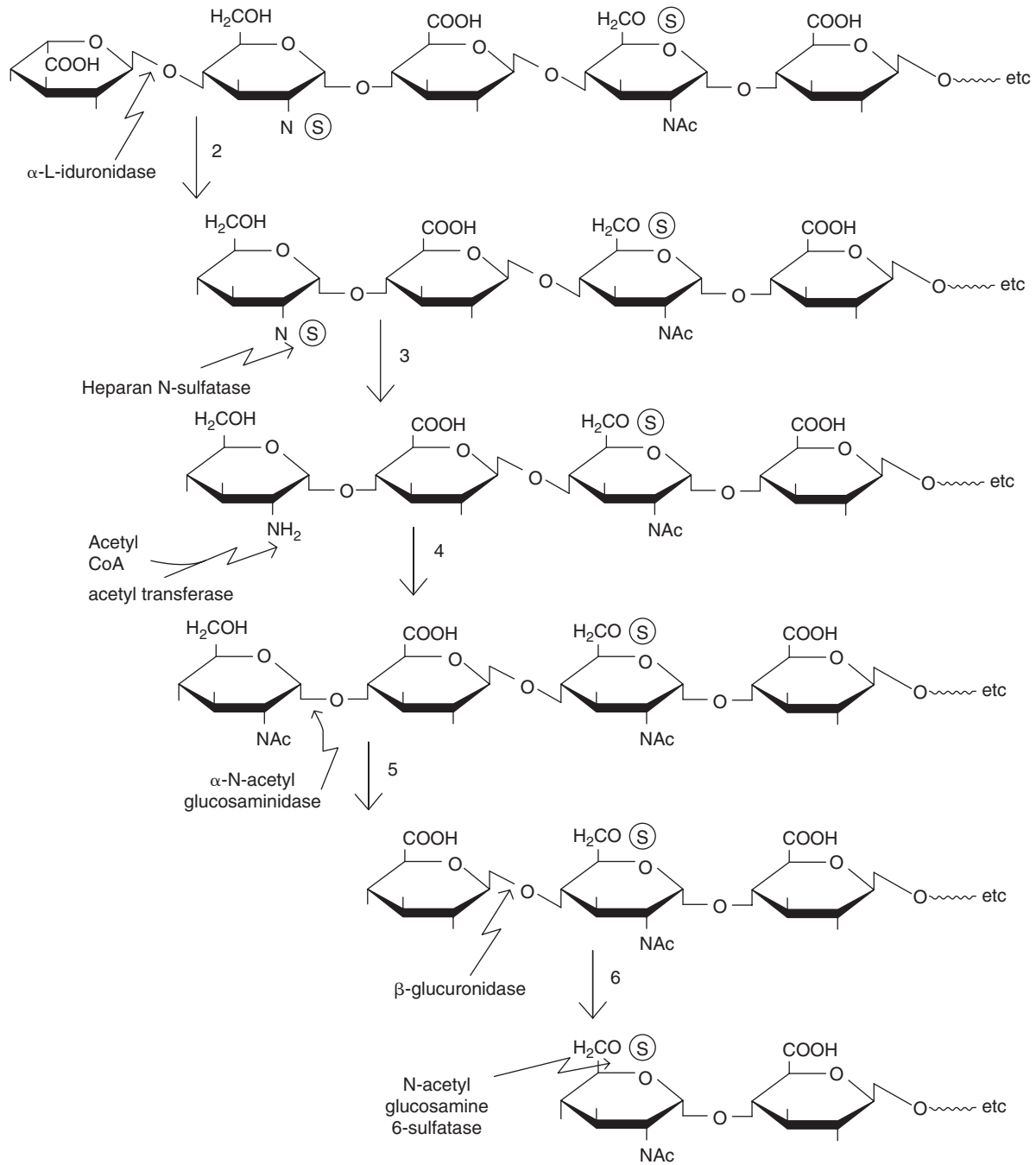
of this conversion results in multiple sulfatase deficiency. A second factor, SUMF-2, which is also part of this system, apparently down-regulates SUMF-1 activity (Zito *et al.*, 2005). The degradation of sphingolipids with short hydrophilic head groups requires sphingolipid activator proteins (SAPs), which are small, nonenzymatic glycoproteins (reviewed in Sandhoff *et al.*, 2001). Deficiency in activity of SAPs is also known to cause lysosomal storage diseases.

Lysosomes degrade large complex substrates that have been taken into a cell by endocytosis or autophagy (the degradation/turnover of a cell's own molecules). The endosome containing the substrates fuses with a primary lysosome, producing a secondary lysosome, which contains the mixture of hydrolases and substrates. Degradation of most substrates occurs by the activity of a cascade of hydrolases, each step requiring the action of the previous hydrolase to modify the substrate, thereby permitting catabolism to proceed to the next enzyme step in the pathway. If one step in the process fails, further degradation ceases. For example, the glycosaminoglycans (GAGs), formerly known as mucopolysaccharides, are long molecules of repeating subunits and are, as part of proteoglycans, a component of the ground substance of the extracellular matrix. Figure 24-2 illustrates the series of hydrolases that are responsible for the sequential stepwise degradation of one of the glycosaminoglycans, dermatan sulfate. Each of the enzymes in this pathway has been described as deficient in a domestic animal causing different mucopolysaccharidosis.

## II. LYSOSOMAL STORAGE DISEASES (LSDs)

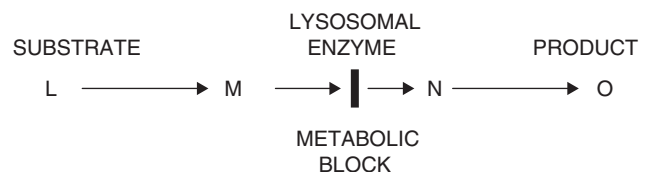
The LSDs are defined as a group of individually rare genetic disorders of cellular catabolism involving the lysosome. The earliest detailed clinical reports of an LSD were in humans by Tay (1881) and Sachs (1887). Eight decades later, the stored material in "Tay-Sachs disease" was defined as GM2 ganglioside (Svennerholm, 1962); 7 years later, the enzyme that is deficient in activity (beta-hexosaminidase A) was identified (Okada and O'Brien, 1969; Sandhoff, 1969). Isolation and sequencing of the cDNA coding for the alpha subunit of beta-hexosaminidase A was reported 15 years later (Korneluk *et al.*, 1986; Myerowitz and Proia, 1984) and was quickly followed by the identification of the first of more than 50 mutations responsible for Tay-Sachs disease (Myerowitz and Hogikyan, 1986, 1987) and sequencing of the entire gene (Proia and Soravia, 1987). Similar rapid progress has been made in identifying and characterizing the molecular bases of all lysosomal diseases since the 1980s.

LSDs are inherited as autosomal recessive traits (except MPS II, which is X-linked) and result from mutations in the coding sequence of one of the acid hydrolases located in the lysosome. Point mutations, deletions, insertions, and other alterations in sequence may occur anywhere along the length of DNA coding the enzyme protein. Each individual alteration will produce a unique change in the protein affecting structure, stability, and function. Thus, these



**FIGURE 24-2** The stepwise degradation of the glycosaminoglycan dermatan sulfate by a series of lysosomal enzymes, all of which have been determined to be deficient in activity in domestic animals. From Neufeld and Muenzer (1995), with permission.

genetic abnormalities result in the reduction or elimination of the catalytic activity of the particular enzyme. This, in turn, results in the accumulation within the lysosome of the substrate of that enzyme (Fig. 24-3), hence the name LSD. In many LSDs, the reduction in the amount of product of the metabolic pathway does not appear to produce disease. However, the storage of cholesterol in Niemann-Pick type C disease may result in a downstream deficiency



**FIGURE 24-3** The reduction in catalytic activity of the enzyme, which converts M to N, results in the accumulation of M within the lysosome.

**TABLE 24-1** Naturally Occurring Lysosomal Storage Diseases in Animals

Disease	Deficient enzyme	Species & selected References
Ceroid lipofuscinosis	Cathepsin D CLN2 (TTP1) CLN5 CLN6  CLN8 Undefined	American bulldogs (Awano <i>et al.</i> , 2006b), sheep (Tynnela <i>et al.</i> , 2000) Dachshund (Awano <i>et al.</i> , 2006a) Border collie (Melville <i>et al.</i> , 2005) Mice (Wheeler <i>et al.</i> , 2002), Merino and Hampshire sheep (Broom <i>et al.</i> , 1998; Cook <i>et al.</i> , 2002) English setter dog (Katz <i>et al.</i> , 2005) 18 breeds of dog including Labrador retriever (Rossmeis <i>et al.</i> , 2003), cocker spaniel (Minatel <i>et al.</i> , 2000), miniature schnauzer (Jolly <i>et al.</i> , 1997), Polish Owczarek Nizinny (Narfstrom and Wrigstad, 1995), Tibetan terrier (Riis <i>et al.</i> , 1992), Australian cattle (Sisk <i>et al.</i> , 1990), dalmatian (Goebel <i>et al.</i> , 1988), blue heeler (Cho <i>et al.</i> , 1986), Saluki (Appleby <i>et al.</i> , 1982); Holstein cattle (Hafner <i>et al.</i> , 2005); domestic cat (Weissenbock and Rossel, 1997)
Fucosidosis	Alpha-fucosidase	English springer spaniel dog (Friend <i>et al.</i> , 1985; Healy <i>et al.</i> , 1984; Kelly <i>et al.</i> , 1983; Skelly <i>et al.</i> , 1996, 1999; Smith <i>et al.</i> , 1996)
Galactosylceramide lipidosi (globoid cell leukodystrophy; Krabbe disease)	Galactosylceramidase (galactocerebrosidase beta-galactosidase)	Cairn terrier dog (Austin <i>et al.</i> , 1968; Fankhauser <i>et al.</i> , 1963; Fletcher and Kurtz, 1972; Fletcher <i>et al.</i> , 1966, 1971; Hirth and Nielsen, 1967; Howell and Palmer, 1971; McGrath <i>et al.</i> , 1968; Suzuki <i>et al.</i> , 1970, 1974) West Highland white terrier dog (Fankhauser <i>et al.</i> , 1963; Fletcher and Kurtz, 1972; Fletcher <i>et al.</i> , 1971; Jortner and Jonas, 1968) Dorset sheep (Pritchard <i>et al.</i> , 1980) Twitcher mouse (Duchen <i>et al.</i> , 1980; Kobayashi <i>et al.</i> , 1980) Domestic shorthair cat (Johnson, 1970) Miniature poodle dog (Suzuki <i>et al.</i> , 1974) Beagle dog (Johnson <i>et al.</i> , 1975) Blue tick hound dog (Boysen <i>et al.</i> , 1974) Irish setter dog (Wenger <i>et al.</i> , 2001) Rhesus monkey (Luzi <i>et al.</i> , 1997)
Glucocerebrosidosis (Gaucher disease)	Acid beta-glucosidase (Glucocerebrosidase)	Sydney silky terrier dog (Farrow <i>et al.</i> , 1982; Hartley and Blakemore, 1973; Van De Water <i>et al.</i> , 1979) Sheep (Laws and Saal, 1968) Pig (Sandison and Anderson, 1970)
Glycogen storage disease II (Pompe disease)	Acid alpha-glucosidase	Lapland dog (Mostafa, 1970; Walvoort <i>et al.</i> , 1982, 1984, 1985) Domestic shorthair cat (Sandstrom <i>et al.</i> , 1969) Corriedale sheep (Manktelow and Hartley, 1975) Shorthorn cattle (Howell <i>et al.</i> , 1981; Jolly <i>et al.</i> , 1977) Brahman cattle (O'Sullivan <i>et al.</i> , 1981; Wisselaar <i>et al.</i> , 1993) Japanese quail (Fujita <i>et al.</i> , 1991; Higuchi <i>et al.</i> , 1987; Nunoya <i>et al.</i> , 1983; Sahara <i>et al.</i> , 1989)
G <sub>M1</sub> Gangliosidosis	Beta-galactosidase	Siamese cat (Baker <i>et al.</i> , 1971; Farrell <i>et al.</i> , 1973; Handa and Yamakawa, 1971; Holmes and O'Brien, 1978a, 1978b) Domestic shorthair cat (Blakemore, 1972; Purpura and Baker, 1976, 1978; Purpura <i>et al.</i> , 1978) Korat cat (Baker <i>et al.</i> , 1976; Martin <i>et al.</i> , 2004) Beagle mix dog (Alroy <i>et al.</i> , 1985; Read <i>et al.</i> , 1976; Rittmann <i>et al.</i> , 1980; Rodriguez <i>et al.</i> , 1982) Springer spaniel dog (Alroy <i>et al.</i> , 1985, 1992; Kaye <i>et al.</i> , 1992) Portuguese water dog (Alroy <i>et al.</i> , 1992; Saunders <i>et al.</i> , 1988; Shell <i>et al.</i> , 1989) Frisian cattle (Donnelly <i>et al.</i> , 1973a, 1973b) Suffolk sheep (Murnane <i>et al.</i> , 1991a, 1991b, 1994) Sheep (Ahern-Rindell <i>et al.</i> , 1988a, 1988b, 1989)
G <sub>M2</sub> gangliosidosis (Tay-Sachs disease)	Beta-hexosaminidase A	American flamingo (Kolodny <i>et al.</i> , 2006)
G <sub>M2</sub> gangliosidosis (Sandhoff disease)	Beta-hexosaminidase A and B	Domestic cat (Cork <i>et al.</i> , 1977, 1978; Walkley <i>et al.</i> , 1990) Korat cat (Muldoon <i>et al.</i> , 1994; Neuwelt <i>et al.</i> , 1985) Japanese spaniel dog (Cummings <i>et al.</i> , 1985; Ishikawa <i>et al.</i> , 1987) Yorkshire pig (Kosanke <i>et al.</i> , 1978, 1979; Pierce <i>et al.</i> , 1976; Read and Bridges, 1968) German short-haired pointer dog (Bernheimer and Karbe, 1970; Gambetti <i>et al.</i> , 1970; Karbe, 1973; Karbe and Schiefer, 1967; McGrath <i>et al.</i> , 1968; Singer and Cork, 1989) Muntjak deer (Fox <i>et al.</i> , 1999)

(Continued)

TABLE 24-1 (Continued)

Mucopolipidosis II (I-cell disease)	N-acetylglucosamine-1-phosphotransferase	Domestic shorthair cat (Bosshard <i>et al.</i> , 1996; Giger <i>et al.</i> , 2006; Hubler <i>et al.</i> , 1996)
Alpha-mannosidosis	Alpha-mannosidase	Persian cat (Burditt <i>et al.</i> , 1980; Castagnaro, 1990; Cummings <i>et al.</i> , 1988; Jezyk <i>et al.</i> , 1986; Maenhout <i>et al.</i> , 1988; Raghavan <i>et al.</i> , 1988; Warren <i>et al.</i> , 1986) Angus and Murray gray cattle (Hocking <i>et al.</i> , 1972; Jolly, 1971, 1974, 1975, 1978; Jolly <i>et al.</i> , 1973, 1974; Phillips <i>et al.</i> , 1974) Galloway cattle (Embury and Jerrett, 1985) Guinea pig (Crawley <i>et al.</i> , 1999)
Beta-mannosidosis	Beta-mannosidase	Anglo-Nubian goat (Jones <i>et al.</i> , 1983; Jones and Dawson, 1981; Kumar <i>et al.</i> , 1986; Lovell and Jones, 1983) Saler cattle (Abbitt <i>et al.</i> , 1991; Bryan <i>et al.</i> , 1993; Healy <i>et al.</i> , 1992; Patterson <i>et al.</i> , 1991)
Mucopolysaccharidosis I (Hurler, Scheie, and Hurler/Scheie syndromes)	Alpha-L-iduronidase	Domestic shorthair cat (Abbitt <i>et al.</i> , 1991; Bryan <i>et al.</i> , 1993; Haskins <i>et al.</i> , 1979a, 1979b; Haskins and McGrath, 1983; Healy <i>et al.</i> , 1992; Patterson <i>et al.</i> , 1991) Plott hound dog (Menon <i>et al.</i> , 1992; Shull and Hastings, 1985; Shull <i>et al.</i> , 1982, 1984; Spellacy <i>et al.</i> , 1983; Stoltzfus <i>et al.</i> , 1992) Rottweiler dog (Giger, personal communication)
Mucopolysaccharidosis II (Hunter Syndrome)	Iduronate sulfatase	Labrador retriever dog (Prieur <i>et al.</i> , 1995)
Mucopolysaccharidosis III A (Sanfilippo A syndrome)	Heparan N-sulfatase	Wirehaired dachshund dog (Aronovich <i>et al.</i> , 2001; Fischer <i>et al.</i> , 1998) New Zealand huntaway dog (Jolly <i>et al.</i> , 2000; Yogalingam <i>et al.</i> , 2002) Mouse (Bhaumik <i>et al.</i> , 1999)
Mucopolysaccharidosis III B (Sanfilippo B syndrome)	Alpha-N-acetylglucosaminidase	Skipperke dog (Ellinwood <i>et al.</i> , 2001, 2002, 2003) Emu (Giger <i>et al.</i> , 1997)
Mucopolysaccharidosis III D (Sanfilippo D syndrome)	N-acetylglucosamine 6-sulfatase	Nubian goat (Friderici <i>et al.</i> , 1995; Thompson <i>et al.</i> , 1992)
Mucopolysaccharidosis VI (Maroteaux-Lamy syndrome)	N-acetylglucosamine 4-sulfatase (arylsulfatase B)	Siamese cat (Cowell <i>et al.</i> , 1976; Di Natale <i>et al.</i> , 1992; Haskins <i>et al.</i> , 1979c, 1981; Jezyk <i>et al.</i> , 1977) Domestic short-haired cat (Giger, personal communication) Miniature pinscher dog (Berman <i>et al.</i> , 2004; Foureman <i>et al.</i> , 2004; Neer <i>et al.</i> , 1992, 1995) Welsh corgi dog (Giger, personal communication) Miniature schnauzer dog (Berman <i>et al.</i> , 2004), Chesapeake Bay retriever dog and dachshund (Giger, personal communication) Rat (Yoshida <i>et al.</i> , 1993, 1994)
Mucopolysaccharidosis VII (Sly disease)	Beta-glucuronidase	German shepherd (Haskins <i>et al.</i> , 1984; Schuchman <i>et al.</i> , 1989; Silverstein Domrowski <i>et al.</i> , 2004) GUS mouse (Birkenmeier <i>et al.</i> , 1989; Sands and Birkenmeier, 1993; Vogler <i>et al.</i> , 1990) Domestic shorthair cat (Fyfe <i>et al.</i> , 1999; Gitzelmann <i>et al.</i> , 1994)
Sphingomyelinosis A and B (Niemann-Pick A and B diseases)	Acid sphingomyelinase	Siamese cat (Chrisp <i>et al.</i> , 1970; Snyder <i>et al.</i> , 1982; Wenger <i>et al.</i> , 1980; Yamagami <i>et al.</i> , 1989) Miniature poodle dog (Bundza <i>et al.</i> , 1979)
Sphingomyelinosis C (Niemann-Pick C disease)	NPCI	Domestic cat (Bundza <i>et al.</i> , 1979) Mouse (Loftus <i>et al.</i> , 1997)

of neurosteroids (Griffin *et al.*, 2004; Mellon *et al.*, 2004). LSDs are classified by the primary substrates that accumulate and are defined by the individual enzyme that is deficient in activity. For example, the mucopolysaccharidoses (MPSSs) are a group of diseases resulting from defective catabolism of GAGs (previously mucopolysaccharides). Each of the MPSSs is caused by impaired function of one of 12 enzymes required for normal GAG degradation. In humans, these disorders were initially defined by clinical phenotype then by the particular GAGs (heparan, dermatan,

chondroitin, keratan sulfates) present in the patient's urine. Now, in addition to defining the diseases by the specific enzyme deficiency, many are subdivided by the particular mutation in the coding sequence of the gene responsible for the defect.

Different mutations of the same gene may produce similar diseases or somewhat varied degrees of disease as is seen in humans with MPS IH (Hurler) and MPS IS (Scheie), with and without CNS disease, respectively (Neufeld and Meunzer, 2001), and in cats with MPS VI

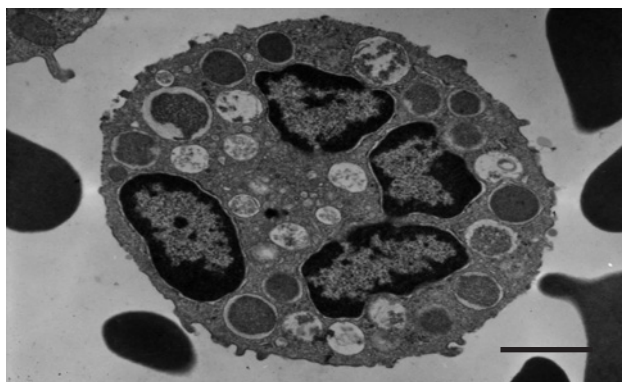
(Crawley *et al.*, 1998). Affected individuals can be either homozygous for the same mutation in both alleles (typical of most LSDs in animals) or heteroallelic (having one mutation in the allele on one chromosome and a different mutation in the allele on the other chromosome [Crawley *et al.*, 1998], common in humans with LSDs). In addition, if the substrates being stored in different diseases have similar pathological effects, defects in different lysosomal enzymes may produce similar diseases, as has been described in humans and animals with MPS III A-D (Aronovich *et al.*, 2001; Bhaumik *et al.*, 1999; Ellinwood *et al.*, 2003; Fischer *et al.*, 1998; Jones *et al.*, 1998; Neufeld and Meunzer, 2001; Yogalingam *et al.*, 2002). Furthermore, it is now recognized that the expression of lysosomal genes, similar to other inborn errors of metabolism, is also influenced by other (modifying) genes and the environment, which explains the phenotypic variation in animals homozygous for the same mutation. Finally, the clinical features and disease course of animals with all types of LSDs closely resemble their human counterparts.

Animals of several species were diagnosed clinically and pathologically as having an LSD before recognizing that the group of diseases were caused by deficiencies in hydrolase activity. Because of the distinctive central and peripheral nervous system lesions, the first of these diseases to be described was globoid cell leukodystrophy in Cairn and West highland white terriers (Fankhauser *et al.*, 1963). These two related dog breeds (primarily a color variation) are now known to have the same mutation in the gene coding for galactosylceramidase (Victoria *et al.*, 1996), which apparently originated in the 19th century from an ancestor common to these two breeds that diverged around the beginning of the 20th century. The first definitive discovery of an enzyme deficiency in a nonhuman mammal was GM1 gangliosidosis in a Siamese cat by Baker and colleagues in 1971 (Baker *et al.*, 1971). Since then, naturally occurring LSDs defined by a deficiency in lysosomal enzyme activity have been recognized in cats, cattle, dogs, goats, mice, pigs, rats, horses, sheep, and two avian species, emus and flamingos (Table 24-1).

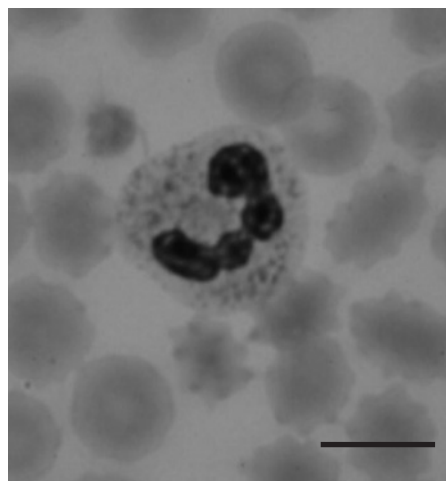
Additional storage diseases do not involve lysosomal enzymes and, thus, are not strictly LSDs, but some have been included in Table 24-1. These include glycogen storage disease IV Niemann-Pick disease C, and ceroid lipofuscinoses. Many mouse models of LSDs have been created by gene knockout technology, but have not been included in Table 24-1. In creating murine knockouts, the phenotype has ranged from essentially the same as in humans, to no disease, to being fatal soon after birth. New knockout models of LSDs will continue to be created in mice to learn more about the pathogenesis of these debilitating disorders and to evaluate therapy. However, companion animals appear often to be better disease homologues and are important to translating novel therapies to humans.

### III. PATHOGENESIS

In LSDs, the continued presentation of substrates to the cell and their lack of degradation result in their storage and swelling of the lysosomes. By electron microscopy, lysosomes within the cytoplasm can be seen as membrane-bound inclusions containing the stored substrate (Fig. 24-4). As the lysosomes become larger, they can be seen with light microscopy (Fig. 24-5). However, in some LSDs, the accumulated substrate may be lost during tissue processing, leaving empty vacuolar artifacts. The accumulation of the primary substrate for a particular enzyme pathway may also interfere with other lysosomal hydrolases necessary for different catabolic pathways (Kint *et al.*, 1973), thereby leading to the secondary accumulation of additional substrates. As more substrates accumulate, the lysosomes occupy more of the cytoplasm (Fig. 24-6). This increase in the number and size of lysosomes may obscure the other



**FIGURE 24-4** An electron micrograph of a polymorphonuclear leukocyte from a cat with MPS VI showing the enlarged lysosomes containing granular material (dermatan sulfate). Bar = 1  $\mu$ .

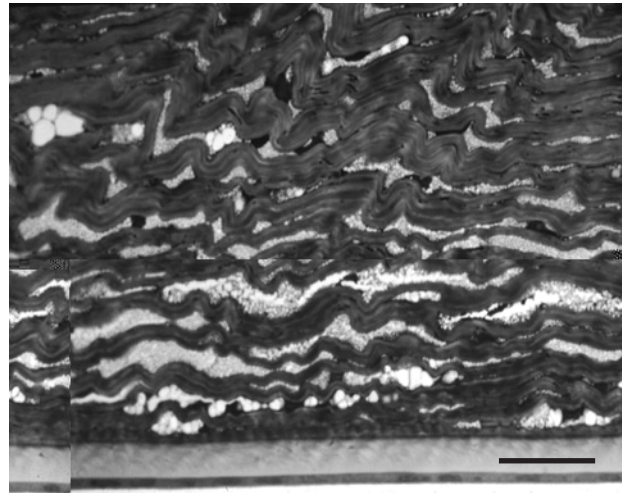


**FIGURE 24-5** A light micrograph of a polymorphonuclear leukocyte from a dog with MPS VII showing the cytoplasmic granules, which represent the lysosomes containing GAG, which stain metachromatically with toluidine blue. Bar = 10  $\mu$ m.

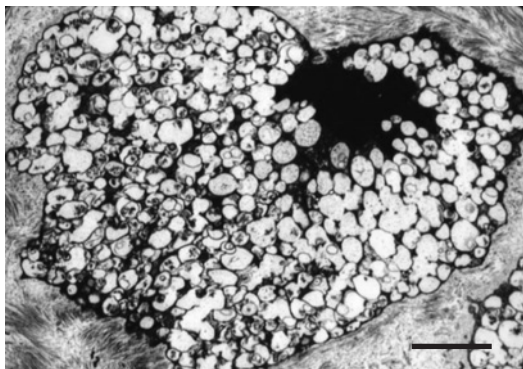


cellular organelles and may deform the nuclear outline. As the process continues, the affected cells enlarge, which is one cause of organomegaly. Just as with the CNS, cartilage, and bone, pathophysiology is probably not solely related to the increase in the cell, tissue, or organ size. The storage of GAGs within the mitral heart valve causes the normally fusiform cells to become rounded (Fig. 24-6). This, in turn, causes the valve leaflet and cordae tendineae to become thick (Fig. 24-7), interfering with normal valve function and producing mitral regurgitation. Similarly, storage within the cells of the cornea (Fig. 24-8) results in reflection and refraction of light, producing the cloudiness observed grossly and by ophthalmoscopy (Fig. 24-9). However, in the cornea there is also an abnormality in collagen biosynthesis resulting in larger fibrils that are more widely spaced than normal (Alroy *et al.*, 1999), and the cornea of the MPS VI cat, rather than being thicker because of increased cell size, is thinner than normal (Aguirre *et al.*, 1992).

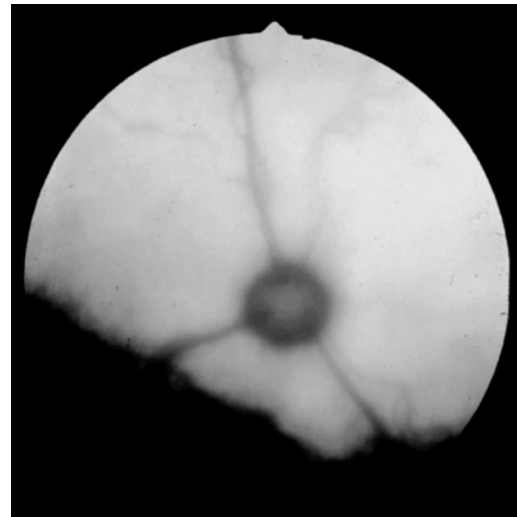
In many LSDs, the CNS contains swollen neurons (Fig. 24-10) with lysosomes that contain lamellar substrate



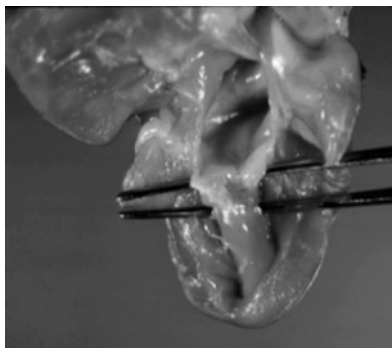
**FIGURE 24-8** A light micrograph of the posterior cornea from a cat with MPS VI illustrating the highly vacuolated keratocytes. Bar = 25u.



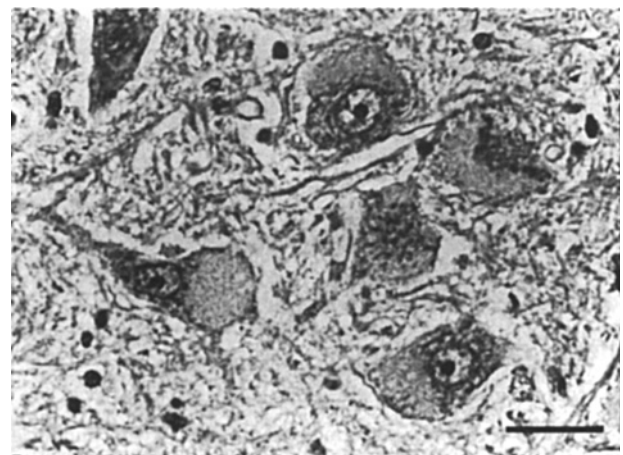
**FIGURE 24-6** An electron micrograph of a cell from the mitral heart valve from a cat with MPS I. Note the extreme number of cytoplasmic vacuoles, the loss of recognition of other organelles, and the deformed nuclear outline. Bar = 3u.



**FIGURE 24-9** The appearance of the retina with indistinct optic disc and vessels of an MPS I cat as seen through the cloudy cornea.



**FIGURE 24-7** The mitral valve from a cat with MPS I illustrating the thickened valve leaflets and cordae tendineae.



**FIGURE 24-10** A light micrograph of swollen neurons in the facial nucleus in the brain of a cat with MPS I. Bar = 25u.



**FIGURE 24-11** An electron micrograph of the lysosomes in a neuron from a cat with MPS I showing the lamellar inclusions. These inclusions are not typical of glycosaminoglycans but rather may represent glycolipids, which accumulate secondary to the primary substrate storage. Bar = 0.5 $\mu$ .

(Fig. 24-11). The pathogenesis of the CNS lesions includes the development of meganeurites and neurite sprouting, which appear correlated to alterations in ganglioside metabolism (Purpura and Baker, 1977, 1978; Purpura *et al.*, 1978; Siegel and Walkley, 1994; Walkley, 1988; Walkley *et al.*, 1988, 1990, 1991). Gangliosides, whether stored as a primary substrate (in  $G_{M1}$  and  $G_{M2}$  gangliosidosis) or secondarily (in MPS I and III), appear to stimulate the development of neurite sprouts with synapses. The presence of new neurites and their synapses apparently plays a role in the CNS dysfunction of these diseases (Walkley, 2003).

Mucopolipidosis II, also known as I-cell disease (named for the inclusions seen in cultured fibroblasts (Tondeur *et al.*, 1971), is an exception to the usual pathogenesis of LSDs (reviewed in Kornfeld and Sly [2001]). Studies of fibroblasts from patients with this disease were seminal in providing insight into the M6P transport system (Hickman and Neufeld, 1972). This disorder results from a failure in the first enzyme in the pathway responsible for the post-translational phosphorylation of the mannose moiety of most lysosomal hydrolases (Hasilik *et al.*, 1981; Reitman *et al.*, 1981). The consequence of a defect in this phosphotransferase enzyme is to produce lysosomal enzymes that lack the signal responsible for efficiently directing the enzymes to the lysosome by the M6P receptor-mediated pathway. Thus, little amounts of the enzymes reach the lysosomes, whereas large amounts are secreted extracellularly into the plasma. Because the phosphotransferase activity has been difficult to measure, the diagnosis of I-cell disease has usually been reached by demonstrating the low intracellular activity of most lysosomal enzymes and consequent high enzyme activity in serum. The gene for this phosphotransferase has been cloned for both humans and cats, and mutations have been identified (Giger *et al.*,

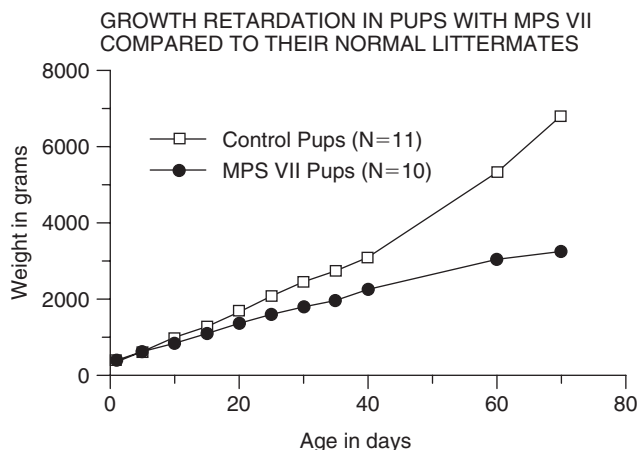
2006; Kudo *et al.*, 2006). Although a clinical and pathological phenotype that combines all of the lysosomal storage diseases would be expected in I-cell disease, this does not occur. Although I-cell is a severe disease in children and cats, most of the pathology is found in mesenchymally derived cells; Kupffer cells and hepatocytes are essentially normal (Martin *et al.*, 1975, 1984; Mazrier *et al.*, 2003). Although mental retardation is present in children, and death occurs before adulthood, there is relatively little CNS pathology (Martin *et al.*, 1984; Nagashima *et al.*, 1977). All cell types examined to date have been deficient in phosphotransferase activity, yet many organs (including liver, spleen, kidney, and brain) still have near normal intracellular lysosomal enzyme activities. This observation indicates that there is either an intracellular M6P-independent pathway to lysosomes, or that secreted enzymes are internalized by cell surface receptors that recognize other carbohydrates on enzymes, such as nonphosphorylated mannose (Waheed *et al.*, 1982). An M6P-independent pathway to the lysosome has been demonstrated for beta-glucocerebrosidase and acid phosphatase (Peters *et al.*, 1990; Williams and Fukuda, 1990).

#### IV. CLINICAL SIGNS

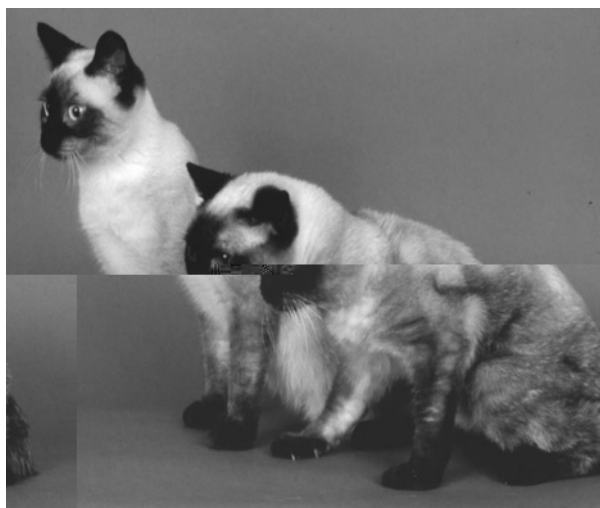
As a group, LSDs are chronic, progressive disorders generally with an early age of onset and characteristic clinical signs. The predominant clinical signs are related to the CNS, skeleton, joints, eye, cardiovascular system, and organomegaly. Most LSDs can be divided clinically into those with or without CNS involvement. Head and limb tremors that progress to gait abnormalities, spastic quadriplegia, seizures, and death are commonly observed. The disorders in animals with marked CNS signs include fucosidosis, galactosylceramide lipidosis, gangliosidosis, mannosidosis, MPS III, and sphingomyelinosis.

Non-CNS clinical signs associated with lysosomal storage disorders include failure to thrive, growth retardation (Fig. 24-12), umbilical hernia, corneal clouding, hepatosplenomegaly, cardiac murmurs, renal dysfunction, and skeletal abnormalities including facial dysmorphism and vertebral, rib, and long bone deformities (Fig. 24-13). The MPS disorders, in general, have more organ systems affected than the other diseases. The age of onset and severity of clinical signs are usually relatively consistent for a particular disease in animals; however, some variability can exist even in a family having the same disease-causing mutation. In research colonies of dogs and cats with LSDs kept in a relatively consistent environment, the explanation for variation in clinical signs rests with the variable genetic background (modifying genes) on which the mutation is expressed.

Most LSDs are manifest within a few months after birth, with some evident at birth or before weaning and fewer with adult onset (canine MPS IIIA and B). In severely



**FIGURE 24-12** This graph illustrates the growth retardation often seen in animals with lysosomal storage disorders.



**FIGURE 24-13** A normal Siamese cat next to a littermate with MPS VI. Note the outward manifestations of the skeletal abnormalities: flattened facies, small size, low posture associated with fusion of the cervical and lumbar spine.

affected animals, death often occurs at birth or before weaning.

In humans with LSDs, although frequently no consistent, specific mutations in some diseases have been associated with a particular pattern of clinical severity and progression (genotype-phenotype correlations). Null mutations that produce little RNA or unstable RNA resulting in no enzyme protein synthesis (cross-reacting material [CRM] negative) usually have a severe phenotype. Although specific mutations have been identified for several LSDs in animals, there is still not enough information to be useful in prognosis.

## V. DIAGNOSIS

The approach to a diagnosis of an LSD includes a complete history and physical examination with evaluation of the

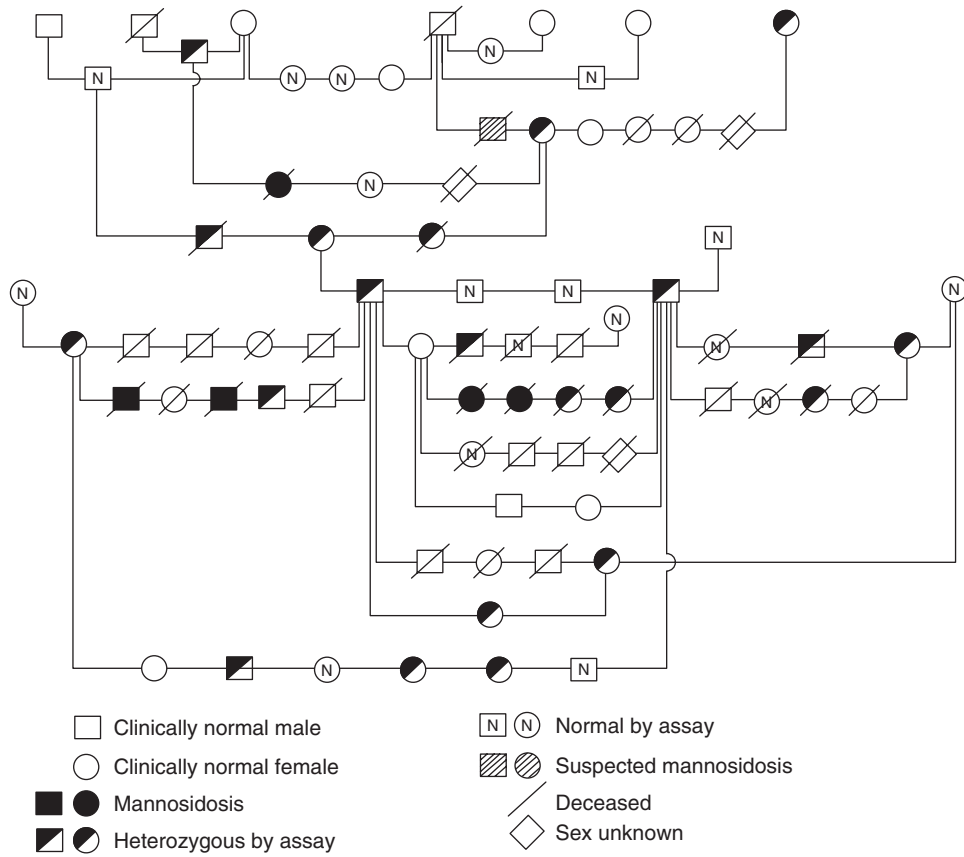
chest, abdomen, CNS, skeleton, and eyes. Laboratory tests should include a complete blood count with evaluation of granulocyte and lymphocyte morphology (cytoplasmic inclusions), skeletal radiographs, and urine screening for abnormal metabolites, particularly GAGs and oligosaccharides. Fresh EDTA blood or fresh-frozen serum can be used to assess lysosomal enzyme activities. Establishing a fibroblast culture from a skin biopsy and a fresh-frozen liver biopsy may be helpful for further biochemical analyses. The disease may progress quickly, and the diagnosis may only follow a complete postmortem examination.

A pedigree analysis should be performed as part of the history to determine information about the inbreeding of the parents and the presence of other family members with similar clinical signs or that died early. As most LSDs are inherited as autosomal recessive traits, parents are often related and are carriers (heterozygotes) but are clinically (phenotypically) normal. On average, one-fourth of the offspring of heterozygous parents are affected, two-thirds of unaffected offspring are carriers, and other relatives may also be affected (Fig. 24-14).

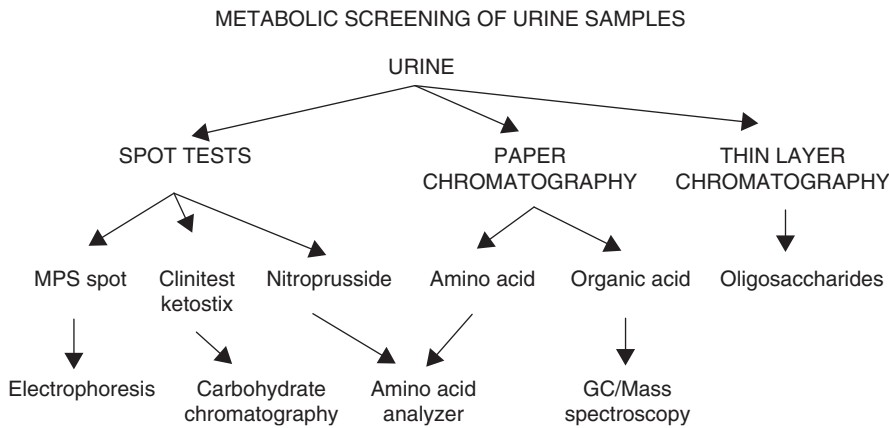
Abnormal metabolites may be found in urine and their presence points toward specific metabolic pathways that warrant further evaluation. A metabolic screen of urine (Fig. 24-15) (Giger and Jezyk, 1992; Jezyk *et al.*, 1982) for GAGs is a relatively simple and inexpensive approach to identify the mucopolysaccharidoses and some cases of gangliosidosis (toluidine blue or MPS spot test; Fig. 24-16). Thin layer chromatography of urinary oligosaccharides is helpful to identify mannosidosis. Urine samples to be evaluated should be kept refrigerated or frozen and sent to an appropriate laboratory.<sup>1</sup>

A final diagnosis for LSDs requires the demonstration of a particular enzyme deficiency by either determining the lack of enzyme activity or a disease-causing mutation in an enzyme gene; these tests do not only identify affected animals but are also helpful in identifying carriers. Enzyme assays using artificial substrates can usually be performed on serum, white blood cells, cultured fibroblasts, or liver. Generally, there is a profound deficiency in activity of the enzyme, making the diagnosis straightforward. In addition, the activities of other lysosomal enzymes in the cells or tissues are frequently higher than normal. The biochemical status of the clinically normal parents should be evaluated when possible. In an autosomal recessive disease, heterozygous parents are expected to have half-normal activity of the enzyme in question because each parent carries one normal and one mutant allele. Although in a population, heterozygotes (carriers) have on average half-normal

<sup>1</sup>One such laboratory is the Metabolic Screening Laboratory, Section of Medical Genetics, Veterinary Hospital of the University of Pennsylvania, 3900 Delancey Street, Philadelphia, PA 19104-6010. A complete history including signalment of the animal should be included with the samples (<http://www.upenn.edu/research/pennngen>).



**FIGURE 24-14** The pedigree of a family of cats with alpha-mannosidosis.



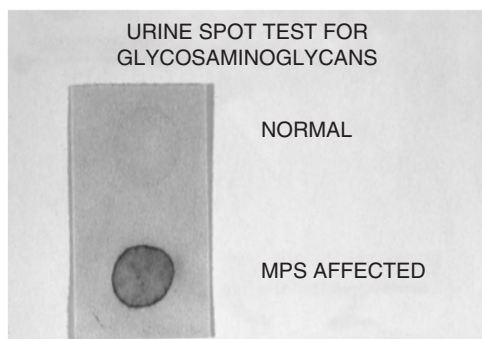
**FIGURE 24-15** The scheme used to detect metabolic diseases, including some lysosomal storage disorders, by examining compounds present in urine.

activity, there is overlap between the ranges for enzyme activity values from normal and obligate heterozygous animals (Fig. 24-17). Thus, accurate determination of an asymptomatic individual as normal or a carrier may be difficult with an enzyme assay alone but can best be achieved by molecular DNA tests for the specific mutation in those diseases and families where the mutation has been identified.<sup>2</sup>

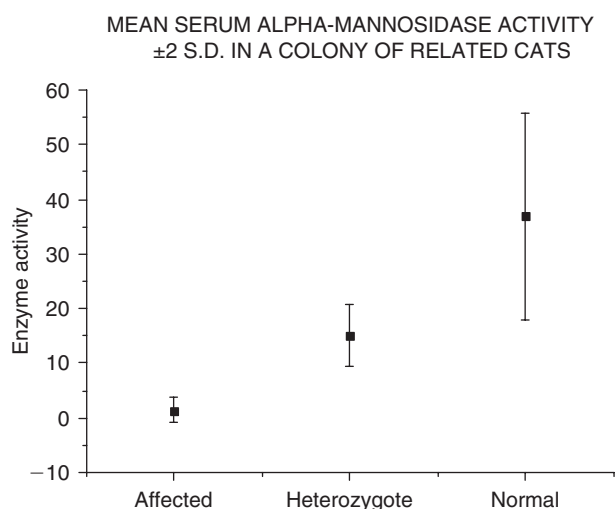
An animal with clinical signs suspected of having an LSD that dies or requires euthanasia should have a complete post-mortem examination, including the CNS, skeletal, and ocular

<sup>2</sup>One such laboratory is the Josephine Deubler Genetic Disease Testing Laboratory, Section of Medical Genetics, Veterinary Hospital of the University of Pennsylvania, 3900 Delancy Street, Philadelphia, PA 19104-6010 (<http://w3.vet.upenn.edu/research/centers/pennngen/services>).





**FIGURE 24-16** The results of a urine spot test detecting abnormal amounts of glycosaminoglycans in the urine of animals with MPS.



**FIGURE 24-17** Serum alpha-mannosidase activity of a colony of cats illustrating the overlap that exists between normal and heterozygous animals. Although heterozygote detection is possible in a population, detection is difficult for an individual. Molecular techniques overcome these difficulties in carrier detection when the mutation is known.

systems. Liver should be frozen as quickly as possible for subsequent determination of accumulated substrate, enzyme activities, and RNA and DNA analyses. Fibroblast cultures can be established from skin, linea alba, or pericardium (using sterile technique) for future studies that may require living cells. Liver, brain, and other tissues should be preserved in formalin, and samples should be taken for thin section and electron microscopy (in glutaraldehyde-paraformaldehyde), particularly from the liver and CNS.

## VI. THERAPY

The combination of secretion of lysosomal enzymes by cells and uptake of enzymes by diseased cells via the M6P receptor system forms the basis for the present approaches to therapy for the LSDs. Providing a source of normal enzyme to abnormal cells will permit that enzyme to be taken up by the plasma membrane receptor, resulting in

delivery of the normal enzyme to the lysosome where it can catabolize stored substrate (except for mucopolysaccharides). Fortunately, the amount of enzyme needed in the lysosome for sufficient function and, thus, phenotypic correction of an individual cell is only a small proportion of normal. The three approaches to providing normal enzyme to a patient's cells are (1) enzyme replacement therapy (ERT), (2) bone marrow transplantation (BMT), and (3) gene therapy. In general, the most difficult target tissue in the LSDs is correction of the CNS lesions. Approximately 60% of LSDs have a CNS component, for which systemic therapy is limited by the blood-brain barrier. Successful treatment of the neuropathic LSDs will require direct therapy to the CNS or systemic therapy that crosses the blood-brain barrier. Animal models have been used extensively to evaluate these approaches to therapy for LSDs in humans. Although these novel therapies could be adapted for domestic animals, supportive care is generally used in clinical practice and emphasis is placed on prevention of the production of affected animals in future generations.

### A. Enzyme Replacement Therapy (ERT)

The efficacy of the parenteral injection of purified recombinant enzyme has been tested in various animal models of LSDs, including MPS VII mice, MPS I dogs and cats, MPS VI cats, and glycogen storage disease in Japanese quail (Ellinwood *et al.*, 2004; Haskins *et al.*, 2002). In knockout mice, enzyme derived from rabbit milk or from Chinese hamster ovary cells has been shown to be useful (Ioannou, 2000; Kakkis *et al.*, 1996, 2001; Wraith, 2001). Today, ERT by intravenous infusion is the standard therapy for non-neuropathic Gaucher disease in human patients and is available or under evaluation for the treatment of Fabry disease, Pompe disease, MPS I, MPS II, and MPS VI.

### B. Bone Marrow Transplant (BMT)

Heterologous BMT as therapy for LSDs has been performed for decades (reviewed in Brochstein [1992], Haskins *et al.* [1991], Hoogerbrugge and Valerio [1998], Krivit *et al.* [1999], and O'Marcaigh and Cowan [1997]). This approach provides both normal bone marrow and bone marrow-derived cells, which are available to release enzyme continuously for uptake by other deficient cells. In addition, some monocyte-derived cells can cross the blood-brain barrier, becoming microglia and secreting an enzyme that can be available to neurons. BMT in animal models of LSDs has been carried out in MPS VII mice, mannosidosis, and mucopolysaccharides II cats, GM2 gangliosidosis mice, MPS VI cats, and the MPS VII dog, among others (Haskins, 1996; Haskins *et al.*, 1991). A combination of neonatal ERT followed by BMT at 5 weeks of age in MPS VII mice had positive long-term effects (Sands *et al.*, 1997).

## C. Gene Therapy

The most striking clinical results of gene therapy involving an LSD have been those seen in a series of neonatal gene transfer studies conducted using viral vectors in the murine and canine models of MPS VII documenting significant improvement of cornea, joint, and cardiac disease (Daly *et al.*, 1999, 2001; Ponder *et al.*, 2002; Xu *et al.*, 2002a, 2002b). In spite of the rarity of MPS VII (1/250,000 live births in humans), these disease models have become a paradigm for LSDs in general because of the ability to detect the normal enzyme ( $\beta$ -glucuronidase) activity directly using a histochemical technique. Intracranial injection of vector carrying the feline alpha mannosidase gene has produced remarkable clinical improvement in affected cats (Vite *et al.*, 2005).

## ACKNOWLEDGMENTS

The authors wish to thank Dr. Donald F. Patterson for his vision and for establishing the first Section of Medical Genetics in a veterinary school; Dr. Peter Jczyk for developing a metabolic screening laboratory for animals; Mr. James Hayden for the illustrations; Ms. Ping Wang, Ms. Marisa Van Hoeven, and Ms. Angie Huff for metabolic and enzyme analyses; Drs. Cathy Just and Meg Weil; Ms. Patricia O'Donnell; many Medical Genetics residents; and a cadre of veterinary students for animal care. Supported by NIH grants RR02512, DK25795, and DK54481.

## REFERENCES

- Abbitt, B., Jones, M. Z., Kasari, T. R., Storts, R. W., Templeton, J. W., Holland, P. S., and Castenson, P. E. (1991). Beta-mannosidosis in twelve Salers calves. *J. Am. Vet. Med. Assoc.* **198**, 109–113.
- Aguirre, G., Raber, I., Yanoff, M., and Haskins, M. (1992). Reciprocal corneal transplantation fails to correct mucopolysaccharidosis VI corneal storage. *Invest. Ophthalmol. Vis. Sci.* **33**, 2702–2713.
- Ahern-Rindell, A. J., Murnane, R. D., and Prieur, D. J. (1988a). Beta-galactosidase activity in fibroblasts and tissues from sheep with a lysosomal storage disease. *Biochem. Genet.* **26**, 733–746.
- Ahern-Rindell, A. J., Murnane, R. D., and Prieur, D. J. (1989). Interspecific genetic complementation analysis of human and sheep fibroblasts with beta-galactosidase deficiency. *Somat. Cell. Mol. Genet.* **15**, 525–533.
- Ahern-Rindell, A. J., Prieur, D. J., Murnane, R. D., Raghavan, S. S., Daniel, P. F., McCluer, R. H., Walkley, S. U., and Parish, S. M. (1988b). Inherited lysosomal storage disease associated with deficiencies of beta-galactosidase and alpha-neuraminidase in sheep. *Am. J. Med. Genet.* **31**, 39–56.
- Alroy, J., Haskins, M., and Birk, D. E. (1999). Altered corneal stromal matrix organization is associated with mucopolysaccharidosis I, III and VI. *Exp. Eye. Res.* **68**, 523–530.
- Alroy, J., Orgad, U., DeGasperi, R., Richard, R., Warren, C. D., Knowles, K., Thalhammer, J. G., and Raghavan, S. S. (1992). Canine GM1-gangliosidosis: a clinical, morphologic, histochemical, and biochemical comparison of two different models. *Am. J. Pathol.* **140**, 675–689.
- Alroy, J., Orgad, U., Ucci, A. A., Schelling, S. H., Schunk, K. L., Warren, C. D., Raghavan, S. S., and Kolodny, E. H. (1985). Neurovisceral and skeletal GM1-gangliosidosis in dogs with beta-galactosidase deficiency. *Science* **229**, 470–472.
- Appleby, E. C., Longstaffe, J. A., and Bell, F. R. (1982). Ceroid-lipofuscinosis in two Saluki dogs. *J. Comp. Pathol.* **92**, 375–380.
- Aronovich, E. L., Johnston, J. M., Wang, P., Giger, U., and Whitley, C. B. (2001). Molecular basis of mucopolysaccharidosis type IIIB in emu (*Dromaius novaehollandiae*): an avian model of Sanfilippo syndrome type B. *Genomics* **74**, 299–305.
- Austin, J., Armstrong, D., and Margolis, G. (1968). Studies of globoid leukodystrophy in dogs. *Neurology* **18**, 300.
- Awano, T., Katz, M. L., O'Brien, D. P., Sohar, I., Lobel, P., Coates, J. R., Khan, S., Johnson, G. C., Giger, U., and Johnson, G. S. (2006a). A frame shift mutation in canine TPP1 (the ortholog of human CLN2) in a juvenile Dachshund with neuronal ceroid lipofuscinosis. *Mol. Genet. Metab.* **89**, 254–260.
- Awano, T., Katz, M. L., O'Brien, D. P., Taylor, J. F., Evans, J., Khan, S., Sohar, I., Lobel, P., and Johnson, G. S. (2006b). A mutation in the cathepsin D gene (CTSD) in American Bulldogs with neuronal ceroid lipofuscinosis. *Mol. Genet. Metab.* **87**, 341–348.
- Baker, H. J., Jr., Lindsey, J. R., McKhann, G. M., and Farrell, D. F. (1971). Neuronal GM1 gangliosidosis in a Siamese cat with beta-galactosidase deficiency. *Science* **174**, 838–839.
- Baker, H. J., Mole, J. A., Lindsey, J. R., and Creel, R. M. (1976). Animal models of human ganglioside storage diseases. *Fed. Proc.* **35**, 1193–1201.
- Berman, L., Foureman, P., Stieger, K., Van Hoeven, M., Ellinwood, N. M., Henthorn, P. S., Thrall, M. A., Kirkness, E., Haskins, M. E., and Giger, U. (2004). Mucopolysaccharidosis type VI caused by a point mutation in the miniature pinscher and deletion in the miniature schnauzer. In “2nd International Conference: Advances in Canine and Feline Genomics,” p. 60. Utrecht, The Netherlands.
- Bernheimer, H., and Karbe, E. (1970). [Morphological and neurochemical investigations of 2 types of amaurotic idiocy in the dog: evidence of a GM2-gangliosidosis]. *Acta Neuropathol. (Berl.)* **16**, 243–261.
- Bhaumik, M., Muller, V. J., Rozaklis, T., Johnson, L., Dobrenis, K., Bhattacharyya, R., Wurzelmann, S., Finamore, P., Hopwood, J. J., Walkley, S. U., and Stanley, P. (1999). A mouse model for mucopolysaccharidosis type III A (Sanfilippo syndrome). *Glycobiology* **9**, 1389–1396.
- Birkenmeier, E. H., Davisson, M. T., Beamer, W. G., Ganschow, R. E., Vogler, C. A., Gwynn, B., Lyford, K. A., Maltais, L. M., and Wawrzyniak, C. J. (1989). Murine mucopolysaccharidosis type VII: characterization of a mouse with beta-glucuronidase deficiency. *J. Clin. Invest.* **83**, 1256–1258.
- Blakemore, W. F. (1972). GM-1 gangliosidosis in a cat. *J. Comp. Pathol.* **82**, 179–185.
- Bosshard, N. U., Hubler, M., Arnold, S., Briner, J., Spycher, M. A., Sommerlade, H. J., von Figura, K., and Gitzelmann, R. (1996). Spontaneous mucopolipidosis in a cat: an animal model of human I-cell disease. *Vet. Pathol.* **33**, 1–13.
- Boysen, B. G., Tryphonas, L., and Harries, N. W. (1974). Globoid cell leukodystrophy in the bluetick hound dog. I. Clinical manifestations. *Can. Vet. J.* **15**, 303–308.
- Brochstein, J. A. (1992). Bone marrow transplantation for genetic disorders. *Oncology (Huntingt.)* **6**, 51–58.

- Broom, M. F., Zhou, C., Broom, J. E., Barwell, K. J., Jolly, R. D., and Hill, D. F. (1998). Ovine neuronal ceroid lipofuscinosis: a large animal model syntenic with the human neuronal ceroid lipofuscinosis variant CLN6. *J. Med. Genet.* **35**, 717–721.
- Bryan, L., Schmutz, S., Hodges, S. D., and Snyder, F. F. (1993). Bovine beta-mannosidosis: pathologic and genetic findings in Salers calves. *Vet. Pathol.* **30**, 130–139.
- Bundza, A., Lowden, J. A., and Charlton, K. M. (1979). Niemann-Pick disease in a poodle dog. *Vet. Pathol.* **16**, 530–538.
- Burditt, L. J., Chotai, K., Hirani, S., Nugent, P. G., Winchester, B. G., and Blakemore, W. F. (1980). Biochemical studies on a case of feline mannosidosis. *Biochem. J.* **189**, 467–473.
- Castagnaro, M. (1990). Lectin histochemistry of the central nervous system in a case of feline alpha-mannosidosis. *Res. Vet. Sci.* **49**, 375–377.
- Cho, D. Y., Leipold, H. W., and Rudolph, R. (1986). Neuronal ceroidosis (ceroid-lipofuscinosis) in a Blue Heeler dog. *Acta Neuropathol.* **69**, 161–164.
- Chrisp, C. E., Ringler, D. H., Abrams, G. D., Radin, N. S., and Brenkert, A. (1970). Lipid storage disease in a Siamese cat. *J. Am. Vet. Med. Assoc.* **156**, 616–622.
- Cook, R. W., Jolly, R. D., Palmer, D. N., Tammen, I., Broom, M. F., and McKinnon, R. (2002). Neuronal ceroid lipofuscinosis in Merino sheep. *Aust. Vet. J.* **80**, 292–297.
- Cork, L. C., Munnell, J. F., and Lorenz, M. D. (1978). The pathology of feline GM2 gangliosidosis. *Am. J. Pathol.* **90**, 723–734.
- Cork, L. C., Munnell, J. F., Lorenz, M. D., Murphy, J. V., Baker, H. J., and Rattazzi, M. C. (1977). GM2 ganglioside lysosomal storage disease in cats with beta-hexosaminidase deficiency. *Science* **196**, 1014–1017.
- Cowell, K. R., Jezyk, P. F., Haskins, M. E., and Patterson, D. F. (1976). Mucopolysaccharidosis in a cat. *J. Am. Vet. Med. Assoc.* **169**, 334–339.
- Crawley, A. C., Jones, M. Z., Bonning, L. E., Finnie, J. W., and Hopwood, J. J. (1999). Alpha-mannosidosis in the guinea pig: a new animal model for lysosomal storage disorders. *Pediatr. Res.* **46**, 501–509.
- Crawley, A. C., Yogalingam, G., Muller, V. J., and Hopwood, J. J. (1998). Two mutations within a feline mucopolysaccharidosis type VI colony cause three different clinical phenotypes. *J. Clin. Invest.* **101**, 109–119.
- Cummings, J. F., Wood, P. A., de Lahunta, A., Walkley, S. U., and Le Boeuf, L. (1988). The clinical and pathologic heterogeneity of feline alpha-mannosidosis. *J. Vet. Intern. Med.* **2**, 163–170.
- Cummings, J. F., Wood, P. A., Walkley, S. U., de Lahunta, A., and DeForest, M. E. (1985). GM2 gangliosidosis in a Japanese spaniel. *Acta Neuropathol.* **67**, 247–253.
- Daly, T. M., Ohlemiller, K. K., Roberts, M. S., Vogler, C. A., and Sands, M. S. (2001). Prevention of systemic clinical disease in MPS VII mice following AAV-mediated neonatal gene transfer. *Gene Ther.* **8**, 1291–1298.
- Daly, T. M., Vogler, C., Levy, B., Haskins, M. E., and Sands, M. S. (1999). Neonatal gene transfer leads to widespread correction of pathology in a murine model of lysosomal storage disease. *Proc. Natl. Acad. Sci. USA* **96**, 2296–2300.
- Di Natale, P., Annella, T., Daniele, A., Spagnuolo, G., Cerundolo, R., de Caprariis, D., and Gravino, A. E. (1992). Animal models for lysosomal storage diseases: a new case of feline mucopolysaccharidosis VI. *J. Inherit. Metab. Dis.* **15**, 17–24.
- Dierks, T., Dickmanns, A., Preusser-Kunze, A., Schmidt, B., Mariappan, M., von Figura, K., Ficner, R., and Rudolph, M. G. (2005). Molecular basis for multiple sulfatase deficiency and mechanism for formylglycine generation of the human formylglycine-generating enzyme. *Cell* **121**, 541–552.
- Distler, J., Hieber, V., Sahagian, G., Schmickel, R., and Jourdan, G. W. (1979). Identification of mannose 6-phosphate in glycoproteins that inhibit the assimilation of beta-galactosidase by fibroblasts. *Proc. Natl. Acad. Sci. USA* **76**, 4235–4239.
- Dobrenis, K., Wenger, D. A., and Walkley, S. U. (1994). Extracellular release of lysosomal glycosidases in cultures of cat microglia. *Molec. Biol. Cell* **5**, 113a.
- Donnelly, W. J., Sheahan, B. J., and Kelly, M. (1973a). Beta-galactosidase deficiency in GM1 gangliosidosis of Friesian calves. *Res. Vet. Sci.* **15**, 139–141.
- Donnelly, W. J., Sheahan, B. J., and Rogers, T. A. (1973b). GM1 gangliosidosis in Friesian calves. *J. Pathol.* **111**, 173–179.
- Duchen, L. W., Eicher, E. M., Jacobs, J. M., Scaravilli, F., and Teixeira, F. (1980). Hereditary leucodystrophy in the mouse: the new mutant twitcher. *Brain* **103**, 695–710.
- Ellinwood, N. M., Henthorn, P. S., Giger, U., and Haskins, M. E. (2002). Characterization of the normal cDNA for the canine N-acetyl- $\alpha$ -D-glucosaminidase gene, the gene defective in mucopolysaccharidosis IIIB. *Am. J. Hum. Genet.* **71**(suppl), 420.
- Ellinwood, N. M., Vite, C. H., and Haskins, M. E. (2004). Gene therapy for lysosomal storage diseases: the lessons and promise of animal models. *J. Gene. Med.* **6**, 481–506.
- Ellinwood, N. M., Wang, P., Skeen, T., Sharp, N., Cesta, M., Bush, W., Hardam, E., Haskins, M. E., and Giger, U. (2001). Characterization of a canine model of mucopolysaccharidosis IIIB. *Am. J. Hum. Genet.* **69**, 1760.
- Ellinwood, N. M., Wang, P., Skeen, T., Sharp, N. J., Cesta, M., Decker, S., Edwards, N. J., Bublot, I., Thompson, J. N., Bush, W., Hardam, E., Haskins, M. E., and Giger, U. (2003). A model of mucopolysaccharidosis IIIB (Sanfilippo syndrome type IIIB): N-acetyl-alpha-D-glucosaminidase deficiency in Schipperke dogs. *J. Inherit. Metab. Dis.* **26**, 489–504.
- Embury, D. H., and Jerrett, I. V. (1985). Mannosidosis in Galloway calves. *Vet. Pathol.* **22**, 548–551.
- Fankhauser, R., Luginbuhl, H., and Hartley, W. J. (1963). Leukodystrophie vom Typus Krabbe beim Hund. *Schweiz. Arch. Tierheilk.* **105**, 198–207.
- Farrell, D. F., Baker, H. J., Herndon, R. M., Lindsey, J. R., and McKhann, G. M. (1973). Feline GM 1 gangliosidosis: biochemical and ultrastructural comparisons with the disease in man. *J. Neuropathol. Exp. Neurol.* **32**, 1–18.
- Farrow, B. R., Hartley, W. J., Pollard, A. C., Fabbro, D., Grabowski, G. A., and Desnick, R. J. (1982). Gaucher disease in the dog. *Prog. Clin. Biol. Res.* **95**, 645–653.
- Fischer, A., Carmichael, K. P., Munnell, J. F., Jhabvala, P., Thompson, J. N., Matalon, R., Jezyk, P. F., Wang, P., and Giger, U. (1998). Sulfamidase deficiency in a family of dachshunds: a canine model of mucopolysaccharidosis IIIA (Sanfilippo A). *Pediatr. Res.* **44**, 74–82.
- Fletcher, T. F., and Kurtz, H. J. (1972). Animal model: globoid cell leukodystrophy in the dog. *Am. J. Pathol.* **66**, 375–378.
- Fletcher, T. F., Kurtz, H. J., and Low, D. G. (1966). Globoid cell leukodystrophy (Krabbe type) in the dog. *J. Am. Vet. Med. Assoc.* **149**, 165–172.
- Fletcher, T. F., Lee, D. G., and Hammer, R. F. (1971). Ultrastructural features of globoid-cell leukodystrophy in the dog. *Am. J. Vet. Res.* **32**, 177–178.
- Fouremant, P., Berman, L., Stieger, K., Van Hoesven, M., Ellinwood, N. M., Haskins, M. E., Kirkness, E., and Giger, U. (2004).

- Mucopolysaccharidosis type VI in miniature pinschers: screening for the mutation. *J. Vet. Intern. Med.* **18**, 408–409.
- Fox, J., Li, Y. T., Dawson, G., Alleman, A., Johnsrude, J., Schumacher, J., and Homer, B. (1999). Naturally occurring GM2 gangliosidosis in two Muntjak deer with pathological and biochemical features of human classical Tay-Sachs disease (type B GM2 gangliosidosis). *Acta Neuropathol. (Berl.)* **97**, 57–62.
- Federici, K., Cavanagh, K. T., Leipprandt, J. R., Traviss, C. E., Anson, D. S., Hopwood, J. J., and Jones, M. Z. (1995). Cloning and sequence analysis of caprine N-acetylglucosamine 6-sulfatase cDNA. *Biochim. Biophys. Acta* **1271**, 369–373.
- Friend, S. C., Barr, S. C., and Embury, D. (1985). Fucosidosis in an English springer spaniel presenting as a malabsorption syndrome. *Aust. Vet. J.* **62**, 415–420.
- Fujita, T., Nonaka, I., and Sugita, H. (1991). Japanese quail and human acid maltase deficiency: a comparative study. *Brain Dev.* **13**, 247–255.
- Fyfe, J. C., Kurzhals, R. L., Lassaline, M. E., Henthorn, P. S., Alur, P. R., Wang, P., Wolfe, J. H., Giger, U., Haskins, M. E., Patterson, D. F., Sun, H., Jain, S., and Yuhki, N. (1999). Molecular basis of feline beta-glucuronidase deficiency: an animal model of mucopolysaccharidosis VII. *Genomics* **58**, 121–128.
- Gambetti, L. A., Kelly, A. M., and McGrath, J. T. (1970). Biochemical studies in a canine gangliosidosis. *J. Neuropath. Exp. Neurol.* **29**, 137.
- Giger, U., and Jezyk, P. F. (1992). “Diagnosis of Inherited Diseases in Small Animals.” Saunders, Philadelphia.
- Giger, U., Shivaprasad, H., Wang, P., Jezyk, P., Patterson, D., and Bradley, G. (1997). Mucopolysaccharidosis type IIIB (Sanfilippo B syndrome) in emus. *Vet. Pathol.* **34**, 473.
- Giger, U., Tcherneva, E., Caverly, J., Seng, A., Huff, A. M., Cullen, K., Van Hoeven, M., Mazrier, H., Haskins, M. E. (2006). A missense point mutation in N-acetylglucosamine-1-phosphotransferase causes mucopolipidosis II in domestic shorthair cats. *J. Vet. Intern. Med.* **20**, 781.
- Gitzelmann, R., Bosshard, N. U., Superti-Furga, A., Spycher, M. A., Briner, J., Wiesmann, U., Lutz, H., and Litschi, B. (1994). Feline mucopolysaccharidosis VII due to beta-glucuronidase deficiency. *Vet. Pathol.* **31**, 435–443.
- Goebel, H. H., Bilzer, T., Dahme, E., and Malkusch, F. (1988). Morphological studies in canine (Dalmatian) neuronal ceroid-lipofuscinosis. *Am. J. Med. Genet. Suppl.* **5**, 127–139.
- Griffin, L. D., Gong, W., Verot, L., and Mellon, S. H. (2004). Niemann-Pick type C disease involves disrupted neurosteroidogenesis and responds to allopregnanolone. *Nat. Med.* **10**, 704–711.
- Hafner, S., Flynn, T. E., Harmon, B. G., and Hill, J. E. (2005). Neuronal ceroid-lipofuscinosis in a Holstein steer. *J. Vet. Diagn. Invest.* **17**, 194–197.
- Handa, S., and Yamakawa, T. (1971). Biochemical studies in cat and human gangliosidosis. *J. Neurochem.* **18**, 1275–1280.
- Hartley, W. J., and Blakemore, W. F. (1973). Neurovisceral glucocerebroside storage (Gaucher’s disease) in a dog. *Vet. Pathol.* **10**, 191–201.
- Hasilik, A., Waheed, A., and von Figura, K. (1981). Enzymatic phosphorylation of lysosomal enzymes in the presence of UDP-N-acetylglucosamine. Absence of the activity in I-cell fibroblasts. *Biochem. Biophys. Res. Commun.* **98**, 761–767.
- Haskins, M. (1996). Bone marrow transplantation therapy for metabolic disease: animal models as predictors of success and in utero approaches. *Bone Marrow Transpl.* **18**, S25–S27.
- Haskins, M., Casal, M., Ellinwood, N. M., Melniczek, J., Mazrier, H., and Giger, U. (2002). Animal models for mucopolysaccharidoses and their clinical relevance. *Acta Paediatr. Suppl.* **91**, 88–97.
- Haskins, M. E., Baker, H. J., Birkenmeier, E., Hoogerbrugge, P. M., Poorthuis, B. J. H. M., Sakiyama, T., Shull, R. M., Taylor, R. M., Thrall, M. A., and Walkley, S. U. (1991). Transplantation in animal model systems. In “Treatment of Genetic Diseases” (R. Desnick, Ed.), pp. 183–201. Churchill Livingstone, New York.
- Haskins, M. E., Desnick, R. J., DiFerrante, N., Jezyk, P. F., and Patterson, D. F. (1984). Beta-glucuronidase deficiency in a dog: a model of human mucopolysaccharidosis VII. *Pediatr. Res.* **18**, 980–984.
- Haskins, M. E., Jezyk, P. F., Desnick, R. J., McDonough, S. K., and Patterson, D. F. (1979a). Alpha-L-iduronidase deficiency in a cat: a model of mucopolysaccharidosis I. *Pediatr. Res.* **13**, 1294–1297.
- Haskins, M. E., Jezyk, P. F., Desnick, R. J., McDonough, S. K., and Patterson, D. F. (1979b). Mucopolysaccharidosis in a domestic short-haired cat: a disease distinct from that seen in the Siamese cat. *J. Am. Vet. Med. Assoc.* **175**, 384–387.
- Haskins, M. E., Jezyk, P. F., Desnick, R. J., and Patterson, D. F. (1981). Animal model of human disease: mucopolysaccharidosis VI Maroteaux-Lamy syndrome, arylsulfatase B-deficient mucopolysaccharidosis in the Siamese cat. *Am. J. Pathol.* **105**, 191–193.
- Haskins, M. E., Jezyk, P. F., and Patterson, D. F. (1979c). Mucopolysaccharide storage disease in three families of cats with arylsulfatase B deficiency: leukocyte studies and carrier identification. *Pediatr. Res.* **13**, 1203–1210.
- Haskins, M. E., and McGrath, J. T. (1983). Meningiomas in young cats with mucopolysaccharidosis I. *J. Neuropathol. Exp. Neurol.* **42**, 664–670.
- Healy, P. J., Farrow, B. R., Nicholas, F. W., Hedberg, K., and Ratcliffe, R. (1984). Canine fucosidosis: a biochemical and genetic investigation. *Res. Vet. Sci.* **36**, 354–359.
- Healy, P. J., Kidd, G. N., Reuter, R. E., Bunce, C., Hosie, I., and Stapleton, T. (1992). Beta-mannosidosis in Salers calves in Australia. *Aust. Vet. J.* **69**, 145.
- Hickman, S., and Neufeld, E. F. (1972). A hypothesis for I-cell disease: defective hydrolases that do not enter lysosomes. *Biochem. Biophys. Res. Commun.* **49**, 992–999.
- Higuchi, I., Nonaka, I., Usuki, F., Ishiura, S., and Sugita, H. (1987). Acid maltase deficiency in the Japanese quail; early morphological event in skeletal muscle. *Acta Neuropathol.* **73**, 32–37.
- Hirth, R. S., and Nielsen, S. W. (1967). A familial canine globoid cell leukodystrophy (“Krabbe type”). *J. Small Anim. Pract.* **8**, 569–575.
- Hocking, J. D., Jolly, R. D., and Batt, R. D. (1972). Deficiency of -mannosidase in Angus cattle: an inherited lysosomal storage disease. *Biochem. J.* **128**, 69–78.
- Holmes, E. W., and O’Brien, J. S. (1978a). Feline GM1 gangliosidosis: characterization of the residual liver acid beta-galactosidase. *Am. J. Hum. Genet.* **30**, 505–515.
- Holmes, E. W., and O’Brien, J. S. (1978b). Hepatic storage of oligosaccharides and glycolipids in a cat affected with GM1 gangliosidosis. *Biochem. J.* **175**, 945–953.
- Holtzman, E. (1989). Historical fragments; methods; source terminology. In “Lysosomes” (P. Siekevitz, Ed.), pp. 1–24. Plenum Press, New York.
- Hoogerbrugge, P. M., and Valerio, D. (1998). Bone marrow transplantation and gene therapy for lysosomal storage diseases. *Bone Marrow Transplant.* **21(suppl 2)**, S34–S36.
- Howell, J. M., Dorling, P. R., Cook, R. D., Robinson, W. F., Bradley, S., and Gawthorne, J. M. (1981). Infantile and late onset form of generalised glycogenosis type II in cattle. *J. Pathol.* **134**, 267–277.
- Howell, J. M., and Palmer, A. C. (1971). Globoid cell leukodystrophy in two dogs. *J. Small Anim. Pract.* **12**, 633–642.



- Hubler, M., Haskins, M. E., Arnold, S., Kaser-Hotz, B., Bosshard, N. U., Briner, J., Spycher, M. A., Gitzelmann, R., Sommerlade, H. J., and von Figura, K. (1996). Mucopolipidosis type II in a domestic shorthair cat. *J. Small Anim. Pract.* **37**, 435–441.
- Ioannou, Y. A. (2000). Gene therapy for lysosomal storage disorders with neuropathology. *J. Am. Soc. Nephrol.* **11**, 1542–1547.
- Ishikawa, Y., Li, S. C., Wood, P. A., and Li, Y. T. (1987). Biochemical basis of type AB GM2 gangliosidosis in a Japanese spaniel. *J. Neurochem.* **48**, 860–864.
- Jezyk, P. F., Haskins, M. E., and Newman, L. R. (1986). Alpha-mannosidosis in a Persian cat. *J. Am. Vet. Med. Assoc.* **189**, 1483–1485.
- Jezyk, P. F., Haskins, M. E., and Patterson, D. F. (1982). Screening for inborn errors of metabolism in dogs and cats. *Prog. Clin. Biol. Res.* **94**, 93–116.
- Jezyk, P. F., Haskins, M. E., Patterson, D. F., Mellman, W. J., and Greenstein, M. (1977). Mucopolysaccharidosis in a cat with arylsulfatase B deficiency: a model of Maroteaux-Lamy syndrome. *Science* **198**, 834–836.
- Johnson, G. R., Oliver, J. E., Jr., and Selcer, R. (1975). Globoid cell leukodystrophy in a beagle. *J. Am. Vet. Med. Assoc.* **167**, 380–384.
- Johnson, K. H. (1970). Globoid leukodystrophy in the cat. *J. Am. Vet. Med. Assoc.* **157**, 2057–2064.
- Jolly, R. D. (1971). The pathology of the central nervous system in pseudolipidosis of Angus calves. *J. Pathol.* **103**, 113–121.
- Jolly, R. D. (1974). Animal model of human disease: mannosidosis of children, other inherited lysosomal storage diseases. *Am. J. Pathol.* **74**, 211–214.
- Jolly, R. D. (1975). Mannosidosis of Angus cattle: a prototype control program for some genetic diseases. *Adv. Vet. Sci. Comp. Med.* **19**, 1–21.
- Jolly, R. D. (1978). Mannosidosis and its control in Angus and Murray Grey cattle. *N. Z. Vet. J.* **26**, 194–198.
- Jolly, R. D., Allan, F. J., Collett, M. G., Rozaklis, T., Muller, V. J., and Hopwood, J. J. (2000). Mucopolysaccharidosis IIIA (Sanfilippo syndrome) in a New Zealand Huntaway dog with ataxia. *N. Z. Vet. J.* **48**, 144–148.
- Jolly, R. D., Digby, J. G., and Rammell, C. G. (1974). A mass screening programme of Angus cattle for the mannosidosis genotype: a prototype programme for control of inherited diseases in animals. *N. Z. Vet. J.* **22**, 218–222.
- Jolly, R. D., Sutton, R. H., Smith, R. I., and Palmer, D. N. (1997). Ceroid-lipofuscinosis in miniature Schnauzer dogs. *Aust. Vet. J.* **75**, 67.
- Jolly, R. D., Tse, C. A., and Greenway, R. M. (1973). Plasma mannosidase activity as a means of detecting mannosidosis heterozygotes. *N. Z. Vet. J.* **21**, 64–69.
- Jolly, R. D., Van-de-Water, N. S., Richards, R. B., and Dorling, P. R. (1977). Generalized glycogenosis in beef shorthorn cattle: heterozygote detection. *Aust. J. Exp. Biol. Med. Sci.* **55**, 14U–50U.
- Jones, M. Z., Alroy, J., Boyer, P. J., Cavanagh, K. T., Johnson, K., Gage, D., Vorro, J., Render, J. A., Common, R. S., Leedle, R. A., Lowrie, C., Sharp, P., Liour, S. S., Levene, B., Hoard, H., Lucas, R., and Hopwood, J. J. (1998). Caprine mucopolysaccharidosis-IIID: clinical, biochemical, morphological and immunohistochemical characteristics. *J. Neuropathol. Exp. Neurol.* **57**, 148–157.
- Jones, M. Z., Cunningham, J. G., Dade, A. W., Alessi, D. M., Mostosky, U. V., Vorro, J. R., Benitez, J. T., and Lovell, K. L. (1983). Caprine beta-mannosidosis: clinical and pathological features. *J. Neuropathol. Exp. Neurol.* **42**, 268–285.
- Jones, M. Z., and Dawson, G. (1981). Caprine beta-mannosidosis: inherited deficiency of beta-D-mannosidase. *J. Biol. Chem.* **256**, 5185–5188.
- Jortner, B. S., and Jonas, A. M. (1968). The neuropathology of globoid-cell leukodystrophy in the dog. A report of two cases. *Acta Neuropathol. (Berl.)* **10**, 171–182.
- Kakkis, E. D., McEntee, M. F., Schmidtchen, A., Neufeld, E. F., Ward, D. A., Gompf, R. E., Kania, S., Bedolla, C., Chien, S. L., and Shull, R. M. (1996). Long-term and high-dose trials of enzyme replacement therapy in the canine model of mucopolysaccharidosis I. *Biochem. Mol. Med.* **58**, 156–167.
- Kakkis, E. D., Schuchman, E., He, X., Wan, Q., Kania, S., Wiemelt, S., Hasson, C. W., O'Malley, T., Weil, M. A., Aguirre, G. A., Brown, D. E., and Haskins, M. E. (2001). Enzyme replacement therapy in feline mucopolysaccharidosis I. *Mol. Genet. Metab.* **72**, 199–208.
- Kaplan, A., Fischer, D., Achord, D., and Sly, W. (1977). Phosphohexosyl recognition is a general characteristic of pinocytosis of lysosomal glycosidases by human fibroblasts. *J. Clin. Invest.* **60**, 1088–1093.
- Karbe, E. (1973). Animal model of human disease Gm2-gangliosidosis (amaurotic idiocies) types I, II, and III. *Am. J. Pathol.* **71**, 151–154.
- Karbe, E., and Schiefer, B. (1967). Familial amaurotic idiocy in male German shorthair pointers. *Pathol. Vet.* **4**, 223–232.
- Katz, M. L., Khan, S., Awano, T., Shahid, S. A., Siakotos, A. N., and Johnson, G. S. (2005). A mutation in the CLN8 gene in English setter dogs with neuronal ceroid-lipofuscinosis. *Biochem. Biophys. Res. Commun.* **327**, 541–547.
- Kaye, E. M., Alroy, J., Raghavan, S. S., Schwarting, G. A., Adelman, L. S., Runge, V., Gelblum, D., Thalhammer, J. G., and Zuniga, G. (1992). Dysmyelinogenesis in animal model of GM1 gangliosidosis. *Pediatr. Neurol.* **8**, 255–261.
- Kelly, W. R., Clague, A. E., Barns, R. J., Bate, M. J., and MacKay, B. M. (1983). Canine alpha-L-fucosidosis: a storage disease of springer spaniels. *Acta Neuropathol.* **60**, 9–13.
- Kint, J. A., Dacremont, G., Carton, D., Orye, E., and Hooft, C. (1973). Mucopolysaccharidosis: secondarily induced abnormal distribution of lysosomal isoenzymes. *Science* **181**, 352–354.
- Kobayashi, T., Yamanaka, T., Jacobs, J. M., Teixeira, F., and Suzuki, K. (1980). The Twitcher mouse: an enzymatically authentic model of human globoid cell leukodystrophy (Krabbe disease). *Brain. Res.* **202**, 479–483.
- Kolodny, E. H., Zeng, B., Viner, T. C., Torres, P. A., Wang, Z. H., and Raghavan, S. S. (2006). Spontaneous appearance of Tay-Sachs disease in American flamingo birds. In “6th International Symposium on Lysosomal Storage Diseases,” p. G9. Stockholm, Sweden.
- Korneluk, R. G., Mahuran, D. J., Neote, K., Klavins, M. H., O'Dowd, B. F., Tropak, M., Willard, H. F., Anderson, M. J., Lowden, J. A., and Gravel, R. A. (1986). Isolation of cDNA clones coding for the alpha-subunit of human beta-hexosaminidase: extensive homology between the alpha- and beta-subunits and studies on Tay-Sachs disease. *J. Biol. Chem.* **261**, 8407–8413.
- Kornfeld, S. (1987). Trafficking of lysosomal enzymes. *Faseb. J.* **1**, 462–468.
- Kornfeld, S., and Sly, W. (2001). I-cell disease and pseudo-hurler polydystrophy: disorders of lysosomal enzyme phosphorylation and localization. In “The Metabolic & Molecular Bases of Inherited Disease” (C. R. Scriver, A. L. Beaudet, W. S. Sly, and D. Valle, Eds.), pp. 3469–3482. McGraw-Hill, New York.
- Kosanke, S. D., Pierce, K. R., and Bay, W. W. (1978). Clinical and biochemical abnormalities in porcine GM2-gangliosidosis. *Vet. Pathol.* **15**, 685–699.
- Kosanke, S. D., Pierce, K. R., and Read, W. K. (1979). Morphogenesis of light and electron microscopic lesions in porcine GM2-gangliosidosis. *Vet. Pathol.* **16**, 6–17.
- Krivit, W., Aubourg, P., Shapiro, E., and Peters, C. (1999). Bone marrow transplantation for globoid cell leukodystrophy, adrenoleukodystrophy,

- metachromatic leukodystrophy, and Hurler syndrome. *Curr. Opin. Hematol.* **6**, 377–382.
- Kudo, M., Brem, M. S., and Canfield, W. M. (2006). Mucopolipidosis II (I-cell disease) and mucopolipidosis IIIA (classical pseudo-hurler polydystrophy) are caused by mutations in the GlcNAc-phosphotransferase alpha/beta-subunits precursor gene. *Am. J. Hum. Genet.* **78**, 451–463.
- Kumar, K., Jones, M. Z., Cunningham, J. G., Kelley, J. A., and Lovell, K. L. (1986). Caprine beta-mannosidosis: phenotypic features. *Vet. Rec.* **118**, 325–327.
- Laws, L., and Saal, J. R. (1968). Lipidosis of the hepatic reticuloendothelial cells in a sheep. *Aust. Vet. J.* **44**, 416–417.
- Loftus, S. K., Morris, J. A., Carstea, E. D., Gu, J. Z., Cummings, C., Brown, A., Ellison, J., Ohno, K., Rosenfeld, M. A., Tagle, D. A., Pentchev, P. G., and Pavan, W. J. (1997). Murine model of Niemann-Pick C disease: mutation in a cholesterol homeostasis gene. *Science* **277**, 232–235.
- Lovell, K. L., and Jones, M. Z. (1983). Distribution of central nervous system lesions in beta-mannosidosis. *Acta Neuropathol.* **62**, 121–126.
- Luzi, P., Rafi, M. A., Victoria, T., Baskin, G. B., and Wenger, D. A. (1997). Characterization of the rhesus monkey galactocerebrosidase (GALC) cDNA and gene and identification of the mutation causing globoid cell leukodystrophy (Krabbe disease) in this primate. *Genomics* **42**, 319–324.
- Maenhout, T., Kint, J. A., Dacremont, G., Ducatelle, R., Leroy, J. G., and Hoorens, J. K. (1988). Mannosidosis in a litter of Persian cats. *Vet. Rec.* **122**, 351–354.
- Manktelow, B. W., and Hartley, W. J. (1975). Generalized glycogen storage disease in sheep. *J. Comp. Pathol.* **85**, 139–145.
- Martin, D. R., Krum, B. K., Varadarajan, G. S., Hathcock, T. L., Smith, B. F., and Baker, H. J. (2004). An inversion of 25 base pairs causes feline GM2 gangliosidosis variant. *Exp. Neurol.* **187**, 30–37.
- Martin, J. J., Leroy, J. G., Farriaux, J. P., Fontaine, G., Desnick, R. J., and Cabello, A. (1975). I-cell disease (mucopolipidosis II): a report on its pathology. *Acta Neuropathol. (Berl.)* **33**, 285–305.
- Martin, J. J., Leroy, J. G., van Eygen, M., and Ceuterick, C. (1984). I-cell disease: a further report on its pathology. *Acta Neuropathol.* **64**, 234–242.
- Mazrier, H., Van Hoeven, M., Wang, P., Knox, V. W., Aguirre, G. D., Holt, E., Wiemelt, S. P., Sleeper, M. M., Hubler, M., Haskins, M. E., and Giger, U. (2003). Inheritance, biochemical abnormalities, and clinical features of feline mucopolipidosis II: the first animal model of human I-Cell disease. *J. Hered.* **94**, 363–373.
- McGrath, J. T., Kelly, A. M., and Steinberg, S. A. (1968). Cerebral lipidosis in the dog. *J. Neuropathol. Exp. Neurol.* **27**, 141.
- Mellon, S., Gong, W., and Griffin, L. D. (2004). Niemann Pick type C disease as a model for defects in neurosteroidogenesis. *Endocr. Res.* **30**, 727–735.
- Melville, S. A., Wilson, C. L., Chiang, C. S., Studdert, V. P., Lingaas, F., and Wilton, A. N. (2005). A mutation in canine CLN5 causes neuronal ceroid lipofuscinosis in border collie dogs. *Genomics* **86**, 287–294.
- Menon, K. P., Tieu, P. T., and Neufeld, E. F. (1992). Architecture of the canine IDUA gene and mutation underlying canine mucopolysaccharidosis I. *Genomics* **14**, 763–768.
- Minatel, L., Underwood, S. C., and Carfagnini, J. C. (2000). Ceroid-lipofuscinosis in a cocker spaniel dog. *Vet. Pathol.* **37**, 488–490.
- Mostafa, I. E. (1970). A case of glycogenic cardiomegaly in a dog. *Acta Vet. Scand.* **11**, 197–208.
- Muldoon, L. L., Neuwelt, E. A., Pagel, M. A., and Weiss, D. L. (1994). Characterization of the molecular defect in a feline model for type II GM2-gangliosidosis (Sandhoff disease). *Am. J. Pathol.* **144**, 1109–1118.
- Murnane, R. D., Hartley, W. J., and Prieur, D. J. (1991a). Similarity of lectin histochemistry of a lysosomal storage disease in a New Zealand lamb to that of ovine GM1 gangliosidosis. *Vet. Pathol.* **28**, 332–335.
- Murnane, R. D., Prieur, D. J., Ahern-Rindell, A. J., Holler, L. D., and Parish, S. M. (1994). Clinical and clinicopathologic characteristics of ovine GM-1 gangliosidosis. *J. Vet. Intern. Med.* **8**, 221–223.
- Murnane, R. D., Wright, R. W., Jr., Ahern-Rindell, A. J., and Prieur, D. J. (1991b). Prenatal lesions in an ovine fetus with GM1 gangliosidosis. *Am. J. Med. Genet.* **39**, 106–111.
- Myerowitz, R., and Hogikyan, N. D. (1986). Different mutations in Ashkenazi Jewish and non-Jewish French Canadians with Tay-Sachs disease. *Science* **232**, 1646–1648.
- Myerowitz, R., and Hogikyan, N. D. (1987). A deletion involving Alu sequences in the beta-hexosaminidase alpha-chain gene of French Canadians with Tay-Sachs disease. *J. Biol. Chem.* **262**, 15396–15399.
- Myerowitz, R., and Proia, R. L. (1984). cDNA clone for the alpha-chain of human beta-hexosaminidase: deficiency of alpha-chain mRNA in Ashkenazi Tay-Sachs fibroblasts. *Proc. Natl. Acad. Sci. USA* **81**, 5394–5398.
- Nagashima, K., Sakakibara, K., Endo, H., Konishi, Y., Nakamura, N., Suzuki, Y., and Abe, T. (1977). I-cell disease (mucopolipidosis 11): pathological and biochemical studies of an autopsy case. *Acta Pathol. Jpn.* **27**, 251–264.
- Narfstrom, K., and Wrigstad, A. (1995). Clinical, electrophysiological, and morphological findings in a case of neuronal ceroid lipofuscinosis in the Polish Owczarek Nizinny (PON) dog. *Vet. Q.* **17(suppl 1)**, S46.
- Natowicz, M. R., Chi, M. M., Lowry, O. H., and Sly, W. S. (1979). Enzymatic identification of mannose 6-phosphate on the recognition marker for receptor-mediated pinocytosis of beta-glucuronidase by human fibroblasts. *Proc. Natl. Acad. Sci. USA* **76**, 4322–4326.
- Neer, T. M., Dial, S. M., Pechman, R., Wang, P., and Giger, U. (1992). Mucopolysaccharidosis VI (Maroteaux-Lamy syndrome) in a miniature pinscher. *J. Vet. Intern. Med.* **6**, 124.
- Neer, T. M., Dial, S. M., Pechman, R., Wang, P., Oliver, J. L., and Giger, U. (1995). Clinical vignette: mucopolysaccharidosis VI in a miniature pinscher. *J. Vet. Intern. Med.* **9**, 429–433.
- Neufeld, E. B., and Muenzer, J. (1995). The mucopolysaccharidoses. In “The Metabolic and Molecular Bases of Inherited Disease” (C. R. Scriver, A. L. Beaudet, W. Sly, and D. Valle, Eds.), vol. 7, p. 2467. McGraw-Hill, New York.
- Neufeld, E. F., and Meunzer, J. (2001). The mucopolysaccharidoses. In “Metabolic and Molecular Basis of Inherited Disease” (C. R. Scriver, A. L. Beaudet, W. S. Sly, and D. Valle, Eds.), pp. 3421–3452. McGraw Hill, New York.
- Neuwelt, E. A., Johnson, W. G., Blank, N. K., Pagel, M. A., Maslen-McClure, C., McClure, M. J., and Wu, P. M. (1985). Characterization of a new model of GM2-gangliosidosis (Sandhoff’s disease) in Korat cats. *J. Clin. Invest.* **76**, 482–490.
- Nunoya, T., Tajima, M., and Mizutani, M. (1983). A new mutant of Japanese quail (*Coturnix coturnix japonica*) characterized by generalized glycogenosis. *Lab. Anim.* **17**, 138–142.
- O’Marcaigh, A. S., and Cowan, M. J. (1997). Bone marrow transplantation for inherited diseases. *Curr. Opin. Oncol.* **9**, 126–130.
- O’Sullivan, B. M., Healy, P. J., Fraser, I. R., Nieper, R. E., Whittle, R. J., and Sewell, C. A. (1981). Generalised glycogenosis in Brahman cattle. *Aust. Vet. J.* **57**, 227–229.
- Okada, S., and O’Brien, J. S. (1969). Tay-Sachs disease: generalized absence of a beta-D-N-acetylhexosaminidase component. *Science* **165**, 698–700.

- Patterson, J. S., Jones, M. Z., Lovell, K. L., and Abbitt, B. (1991). Neuropathology of bovine beta-mannosidosis. *J. Neuropathol. Exp. Neurol.* **50**, 538–546.
- Peters, C., Braun, M., Weber, B., Wendland, M., Schmidt, B., Pohlmann, R., Waheed, A., and von Figura, K. (1990). Targeting of a lysosomal membrane protein: a tyrosine-containing endocytosis signal in the cytoplasmic tail of lysosomal acid phosphatase is necessary and sufficient for targeting to lysosomes. *Embo. J.* **9**, 3497–3506.
- Phillips, N. C., Robinson, D., Winchester, B. G., and Jolly, R. D. (1974). Mannosidosis in Angus cattle: the enzymic defect. *Biochem. J.* **137**, 363–371.
- Pierce, K. R., Kosanke, S. D., Bay, W. W., and Bridges, C. H. (1976). Animal model of human disease: GM2 gangliosidosis. *Am. J. Pathol.* **83**, 419–422.
- Ponder, K. P., Melniczek, J. R., Xu, L., Weil, M. A., O'Malley, T. M., O'Donnell, P. A., Knox, V. W., Aguirre, G. D., Mazrier, H., Ellinwood, N. M., Sleeper, M., Maguire, A. M., Volk, S. W., Mango, R. L., Zweigle, J., Wolfe, J. H., and Haskins, M. E. (2002). Therapeutic neonatal hepatic gene therapy in mucopolysaccharidosis VII dogs. *Proc. Natl. Acad. Sci. USA* **99**, 13102–13107.
- Preusser-Kunze, A., Mariappan, M., Schmidt, B., Gande, S. L., Mutenda, K., Wenzel, D., von Figura, K., and Dierks, T. (2005). Molecular characterization of the human Calpha-formylglycine-generating enzyme. *J. Biol. Chem.* **280**, 14810–14900.
- Prieur, D. J., Wilkerson, M. J., Lewis, D. C., Kennaway, N. G., Toone, J. R., Applegarth, D. A., Vallance, H., Marks, S. L., and Wood, R. K. (1995). Iduronate-2-sulfatase deficiency in a dog: Canine Hunter syndrome. *Am. J. Hum. Genet.* **57**, A182.
- Pritchard, D. H., Naphtine, D. V., and Sinclair, A. J. (1980). Globoid cell leucodystrophy in polled Dorset sheep. *Vet. Pathol.* **17**, 399–405.
- Proia, R. L., and Soravia, E. (1987). Organization of the gene encoding the human beta-hexosaminidase alpha-chain. *J. Biol. Chem.* **262**, 5677–5681.
- Purpura, D. P., and Baker, H. J. (1978). Meganeurites and other aberrant processes of neurons in feline GM1-gangliosidosis: a Golgi study. *Brain. Res.* **143**, 13–26.
- Purpura, D. P., Pappas, G. D., and Baker, H. J. (1978). Fine structure of meganeurites and secondary growth processes in feline GM1-gangliosidosis. *Brain. Res.* **143**, 1–12.
- Purpura, D. P., and Baker, H. J. (1977). Neurite induction in mature cortical neurones in feline GM1-ganglioside storage disease. *Nature* **266**, 553–554.
- Raghavan, S., Stuer, G., Riviere, L., Alroy, J., and Kolodny, E. H., (1988). Characterization of alpha-mannosidase in feline mannosidosis. *J. Inherit. Metab. Dis.* **11**, 3–16.
- Read, D. H., Harrington, D. D., Keenana, T. W., and Hinsman, E. J. (1976). Neuronal-visceral GM1 gangliosidosis in a dog with beta-galactosidase deficiency. *Science* **194**, 442–445.
- Read, W. K., and Bridges, C. H. (1968). Cerebrospinal lipodystrophy in swine: a new disease model in comparative pathology. *Pathol. Vet.* **5**, 67–74.
- Reitman, M. L., Varki, A., and Kornfeld, S. (1981). Fibroblasts from patients with I-cell disease and pseudo-hurler polydystrophy are deficient in uridine 5'-diphosphate-N-acetylglucosamine: glycoprotein N-acetylglucosaminylphosphotransferase activity. *J. Clin. Invest.* **67**, 1574–1579.
- Riis, R. C., Cummings, J. F., Loew, E. R., and de Lahunta, A. (1992). Tibetan terrier model of canine ceroid lipofuscinosis. *Am. J. Med. Genet.* **42**, 615–621.
- Rittmann, L. S., Tennant, L. L., and O'Brien, J. S. (1980). Dog GM1 gangliosidosis: characterization of the residual liver acid beta-galactosidase. *Am. J. Hum. Genet.* **32**, 880–889.
- Rodriguez, M., O'Brien, J. S., Garrett, R. S., and Powell, H. C. (1982). Canine GM1 gangliosidosis. An ultrastructural and biochemical study. *J. Neuropathol. Exp. Neurol.* **41**, 618–629.
- Rossmesl, J. H., Jr., Duncan, R., Fox, J., Herring, E. S., and Inzana, K. D. (2003). Neuronal ceroid-lipofuscinosis in a Labrador Retriever. *J. Vet. Diagn. Invest.* **15**, 457–460.
- Sachs, B. (1887). Ib arrested cerebral development with special reference to its cortical pathology. *J. Nerv. Ment. Dis.* **14**, 541–553.
- Sandhoff, K. (1969). Variation of beta-N-acetylhexosaminidase-patter in Tay-Sachs disease. *FEBS Letters* **4**, 351–354.
- Sandhoff, K., Kolter, T., Hartzler, K., Schepers, U., and Rimmel, N. (2001). Sphingolipid activator proteins. In "The Metabolic and Molecular Basis of Inherited Disease" (C. R. Scriver, A. L. Beaudet, D. Valle, W. S. Sly, B. Childs, K. W. Kinzler, and B. Vogelstein, Eds.), vol. 8, pp. 3371–3388. McGraw-Hill, New York.
- Sandison, A. T., and Anderson, L. J. (1970). Histiocytosis in two pigs and a cow: conditions resembling lipid storage disorders in man. *J. Pathol.* **100**, 207–210.
- Sands, M. S., and Birkenmeier, E. H. (1993). A single-base-pair deletion in the beta-glucuronidase gene accounts for the phenotype of murine mucopolysaccharidosis type VII. *Proc. Natl. Acad. Sci. USA* **90**, 6567–6571.
- Sands, M. S., Vogler, C., Torrey, A., Levy, B., Gwynn, B., Grubb, J., Sly, W. S., and Birkenmeier, E. H. (1997). Murine mucopolysaccharidosis type VII: long term therapeutic effects of enzyme replacement and enzyme replacement followed by bone marrow transplantation. *J. Clin. Invest.* **99**, 1596–1605.
- Sandstrom, B., Westman, J., and Ockerman, P. A. (1969). Glycogenesis of the central nervous system in the cat. *Acta Neuropathol.* **14**, 194–200.
- Saunders, G. K., Wood, P. A., Myers, R. K., Shell, L. G., and Carithers, R. (1988). GM1 gangliosidosis in Portuguese water dogs: pathologic and biochemical findings. *Vet. Pathol.* **25**, 265–269.
- Schuchman, E. H., Toroyan, T. K., Haskins, M. E., and Desnick, R. J. (1989). Characterization of the defective beta-glucuronidase activity in canine mucopolysaccharidosis type VII. *Enzyme* **42**, 174–180.
- Shell, L. G., Potthoff, A. I., Carithers, R., Katherman, A., Saunders, G. K., Wood, P. A., and Giger, U. (1989). Neuronal-visceral GM1 gangliosidosis in Portuguese water dogs. *J. Vet. Intern. Med.* **3**, 1–7.
- Shull, R. M., and Hastings, N. E. (1985). Fluorometric assay of alpha-L-iduronidase in serum for detection of affected and carrier animals in a canine model of I. *Clin. Chem.* **31**, 826–827.
- Shull, R. M., Helman, R. G., Spellacy, E., Constantopoulos, G., Munger, R. J., and Neufeld, E. F. (1984). Morphologic and biochemical studies of canine mucopolysaccharidosis I. *Am. J. Pathol.* **114**, 487–495.
- Shull, R. M., Munger, R. J., Spellacy, E., Hall, C. W., Constantopoulos, G., and Neufeld, E. F. (1982). Canine alpha-L-iduronidase deficiency. A model of mucopolysaccharidosis I. *Am. J. Pathol.* **109**, 228–244.
- Siegel, D. A., and Walkley, S. U. (1994). Growth of ectopic dendrites on cortical pyramidal neurons in neuronal storage diseases correlates with abnormal accumulation of GM2 ganglioside. *J. Neurochem.* **62**, 1852–1862.
- Silverstein Domrowski, D. C., Carmichael, K. P., Wang, P., O'Malley, T., Haskins, M. E., and Giger, U. (2004). Mucopolysaccharidosis type VII in a German shepherd dog. *J. Am. Vet. Med. Assoc.* **224**, 553–557.
- Singer, H. S., and Cork, L. C. (1989). Canine GM2 gangliosidosis: morphological and biochemical analysis. *Vet. Pathol.* **26**, 114–120.

- Sisk, D. B., Levesque, D. C., Wood, P. A., and Styer, E. L. (1990). Clinical and pathologic features of ceroid lipofuscinosis in two Australian cattle dogs. *J. Am. Vet. Med. Assoc.* **197**, 361–364.
- Skelly, B. J., Sargan, D. R., Herrtage, M. E., and Winchester, B. G. (1996). The molecular defect underlying canine fucosidosis. *J. Med. Genet.* **33**, 284–288.
- Skelly, B. J., Sargan, D. R., Winchester, B. G., Smith, M. O., Herrtage, M. E., and Giger, U. (1999). Genomic screening for fucosidosis in English springer spaniels. *Am. J. Vet. Res.* **60**, 726–779.
- Smith, M. O., Wenger, D. A., Hill, S. L., and Matthews, J. (1996). Fucosidosis in a family of American-bred English springer spaniels. *J. Am. Vet. Med. Assoc.* **209**, 2088–2090.
- Snyder, S. P., Kingston, R. S., and Wenger, D. A. (1982). Niemann-Pick disease: sphingomyelinosis of Siamese cats. *Am. J. Pathol.* **108**, 252–254.
- Spellacy, E., Shull, R. M., Constantopoulos, G., and Neufeld, E. F. (1983). A canine model of human alpha-L-iduronidase deficiency. *Proc. Natl. Acad. Sci. USA* **80**, 6091–6095.
- Stoltzfus, L. J., Sosa-Pineda, B., Moskowitz, S. M., Menon, K. P., Dlott, B., Hooper, L., Teplow, D. B., Shull, R. M., and Neufeld, E. F. (1992). Cloning and characterization of cDNA encoding canine alpha-L-iduronidase: mRNA deficiency in mucopolysaccharidosis I dog. *J. Biol. Chem.* **267**, 6570–6575.
- Suhara, Y., Ishiura, S., Tsukahara, T., and Sugita, H. (1989). Mature 98,000-dalton acid alpha-glucosidase is deficient in Japanese quails with acid maltase deficiency. *Muscle Nerve* **12**, 670–678.
- Suzuki, Y., Austin, J., Armstrong, D., Suzuki, K., Schlenker, J., and Fletcher, T. (1970). Studies in globoid leukodystrophy: enzymatic and lipid findings in the canine form. *Exp. Neurol.* **29**, 65–75.
- Suzuki, Y., Miyatake, T., Fletcher, T. F., and Suzuki, K. (1974). Glycosphingolipid beta-galactosidases. 3. Canine form of globoid cell leukodystrophy: comparison with the human disease. *J. Biol. Chem.* **249**, 2109–2112.
- Svennerholm, L. (1962). The chemical structure of normal human and Tay-Sachs gangliosides. *Biochem. Biophys. Res. Commun.* **9**, 436–446.
- Tay, W. (1881). Symmetrical changes in the region of the yellow spot in each eye of an infant. *Trans. Ophthalmol. Soc. UK* **1**, 155–157.
- Thompson, J. N., Jones, M. Z., Dawson, G., and Huffman, P. S. (1992). N-acetylglucosamine 6-sulphatase deficiency in a Nubian goat: a model of Sanfilippo syndrome type D (mucopolysaccharidosis IIID). *J. Inher. Metab. Dis.* **15**, 760–768.
- Tondeur, M., Vamos-Hurwitz, E., Mockel-Pohl, S., Dereume, J. P., Cremer, N., and Loeb, H. (1971). Clinical, biochemical, and ultrastructural studies in a case of chondrodystrophy presenting the I-cell phenotype in tissue culture. *J. Pediatr.* **79**, 366–378.
- Tyynela, J., Sohar, I., Sleat, D. E., Gin, R. M., Donnelly, R. J., Baumann, M., Haltia, M., and Lobel, P. (2000). A mutation in the ovine cathepsin D gene causes a congenital lysosomal storage disease with profound neurodegeneration. *EMBO J.* **19**, 2786–2792.
- Van De Water, N. S., Jolly, R. D., and Farrow, B. R. (1979). Canine Gaucher disease: the enzymic defect. *Aust. J. Exp. Biol. Med. Sci.* **57**, 551–554.
- Victoria, T., Rafi, M. A., and Wenger, D. A. (1996). Cloning of the canine GALC cDNA and identification of the mutation causing globoid cell leukodystrophy in West Highland White and Cairn terriers. *Genomics* **33**, 457–462.
- Vite, C. H., McGowan, J. C., Niogi, S. N., Passini, M. A., Drobatz, K. J., Haskins, M. E., and Wolfe, J. H. (2005). Effective gene therapy for an inherited CNS disease in a large animal model. *Ann. Neurol.* **57**, 355–364.
- Vogler, C., Birkenmeier, E. H., Sly, W. S., Levy, B., Pegors, C., Kyle, J. W., and Beamer, W. G. (1990). A murine model of mucopolysaccharidosis VII. Gross and microscopic findings in beta-glucuronidase-deficient mice. *Am. J. Pathol.* **136**, 207–217.
- Waheed, A., Pohlmann, R., Hasilik, A., von Figura, K., van Elsen, A., and Leroy, J. G. (1982). Deficiency of UDP-N-acetylglucosamine: lysosomal enzyme N-acetylglucosamine-1-phosphotransferase in organs of I-cell patients. *Biochem. Biophys. Res. Commun.* **105**, 1052–1058.
- Walkley, S. U. (1988). Pathobiology of neuronal storage disease. *Int. Rev. Neurobiol.* **29**, 191–244.
- Walkley, S. U. (2003). Neurobiology and cellular pathogenesis of glycolipid storage diseases. *Philos. Trans. R. Soc. Lond. B. Biol. Sci.* **358**, 893–904.
- Walkley, S. U., Baker, H. J., Rattazzi, M. C., Haskins, M. E., and Wu, J. Y. (1991). Neuroaxonal dystrophy in neuronal storage disorders: evidence for major GABAergic neuron involvement. *J. Neurol. Sci.* **104**, 1–8.
- Walkley, S. U., Haskins, M. E., and Shull, R. M. (1988). Alterations in neuron morphology in mucopolysaccharidosis type I: a Golgi study. *Acta Neuropathol.* **75**, 611–620.
- Walkley, S. U., Wurzelmann, S., Rattazzi, M. C., and Baker, H. J. (1990). Distribution of ectopic neurite growth and other geometrical distortions of CNS neurons in feline GM2 gangliosidosis. *Brain Res.* **510**, 63–73.
- Walvoort, H. C., Dormans, J. A., and van den Ingh, T. S. (1985). Comparative pathology of the canine model of glycogen storage disease type II (Pompe's disease). *J. Inher. Metab. Dis.* **8**, 38–46.
- Walvoort, H. C., Slee, R. G., and Koster, J. F. (1982). Canine glycogen storage disease type II: a biochemical study of an acid alpha-glucosidase-deficient Lapland dog. *Biochim. Biophys. Acta* **715**, 63–69.
- Walvoort, H. C., Slee, R. G., Sluis, K. J., Koster, J. F., and Reuser, A. J. (1984). Biochemical genetics of the Lapland dog model of glycogen storage disease type II (acid alpha-glucosidase deficiency). *Am. J. Med. Genet.* **19**, 589–598.
- Warren, C. D., Alroy, J., Bugge, B., Daniel, P. F., Raghavan, S. S., Kolodny, E. H., Lamar, J. J., and Jeanloz, R. W. (1986). Oligosaccharides from placenta: early diagnosis of feline mannosidosis. *FEBS Lett.* **195**, 247–252.
- Weissenbock, H., and Rossel, C. (1997). Neuronal ceroid-lipofuscinosis in a domestic cat: clinical, morphological and immunohistochemical findings. *J. Comp. Pathol.* **117**, 17–24.
- Wenger, D. A., Sattler, M., Kudoh, T., Snyder, S. P., and Kingston, R. S. (1980). Niemann-Pick disease: a genetic model in Siamese cats. *Science* **208**, 1471–1473.
- Wenger, D. A., Suzuki, K., Suzuki, Y., and Suzuki, K. (2001). Galactosylceramide lipidosis. Globoid cell leukodystrophy (Krabbe disease). In "The Metabolic & Molecular Bases of Inherited Disease" (C. R. Scriver, A. L. Beaudet, W. S. Sly, and V. D., Eds.), pp. 3669–3694. McGraw-Hill, New York.
- Wheeler, R. B., Sharp, J. D., Schultz, R. A., Joslin, J. M., Williams, R. E., and Mole, S. E. (2002). The gene mutated in variant late-infantile neuronal ceroid lipofuscinosis (CLN6) and in nclf mutant mice encodes a novel predicted transmembrane protein. *Am. J. Hum. Genet.* **70**, 537–542.
- Williams, M. A., and Fukuda, M. (1990). Accumulation of membrane glycoproteins in lysosomes requires a tyrosine residue at a particular position in the cytoplasmic tail. *J. Cell. Biol.* **111**, 955–966.
- Wisselaar, H. A., Hermans, M. M., Visser, W. J., Kroos, M. A., Oostra, B. A., Aspden, W., Harrison, B., Hetzel, D. J., Reuser, A. J.,

- and Drinkwater, R. D. (1993). Biochemical genetics of glycogenosis type II in Brahman cattle. *Biochem. Biophys. Res. Commun.* **190**, 941–947.
- Wraith, J. E. (2001). Enzyme replacement therapy in mucopolysaccharidosis type I: progress and emerging difficulties. *J. Inherit. Metab. Dis.* **24**, 245–250.
- Xu, L., Haskins, M. E., Melniczek, J. R., Gao, C., Weil, M. A., O'Malley, T. M., O'Donnell, P. A., Mazrier, H., Ellinwood, N. M., Zweigle, J., Wolfe, J. H., and Ponder, K. P. (2002a). Transduction of hepatocytes after neonatal delivery of a Moloney murine leukemia virus based retroviral vector results in long-term expression of beta-glucuronidase in mucopolysaccharidosis VII dogs. *Mol. Ther.* **5**, 141–153.
- Xu, L., Mango, R. L., Sands, M. S., Haskins, M. E., Ellinwood, N. M., and Ponder, K. P. (2002b). Evaluation of pathological manifestations of disease in mucopolysaccharidosis VII mice after neonatal hepatic gene therapy. *Mol. Ther.* **6**, 745–758.
- Yamagami, T., Umeda, M., Kamiya, S., and Sugiyama, K. (1989). Neurovisceral sphingomyelinosis in a Siamese cat. *Acta Neuropathol.* **79**, 330–332.
- Yogalingam, G., Pollard, T., Gliddon, B., Jolly, R. D., and Hopwood, J. J. (2002). Identification of a mutation causing mucopolysaccharidosis type IIIA in New Zealand Huntaway dogs. *Genomics* **79**, 150–153.
- Yoshida, M., Noguchi, J., Ikadai, H., Takahashi, M., and Nagase, S. (1993). Arylsulfatase B-deficient mucopolysaccharidosis in rats. *J. Clin. Invest.* **91**, 1099–1104.
- Yoshida, M., Tachibana, M., Kobayashi, E., Ikadai, H., and Kunieda, T. (1994). The locus responsible for mucopolysaccharidosis VI (Maroteaux-Lamy syndrome) is located on rat chromosome 2. *Genomics* **20**, 145–146.
- Zito, E., Fraldi, A., Pepe, S., Annunziata, I., Kobinger, G., Di Natale, P., Ballabio, A., and Cosma, M. P. (2005). Sulphatase activities are regulated by the interaction of sulphatase-modifying factor 1 with SUMF2. *EMBO Rep.* **6**, 655–660.

# Tumor Markers

Michael D. Lucroy  
VCA Veterinary Specialty Center  
Indianapolis, Indiana

- 
- I. INTRODUCTION**
  - II. SERUM TUMOR MARKERS**
    - A. Oncofetal Proteins
    - B. Hormones and Ectopic Hormones
    - C. Enzymes
    - D. Immunoglobulins
    - E. Tumor-Associated Antigens
    - F. Miscellaneous Serum Tumor Markers
  - III. FLOW CYTOMETRY**
    - A. DNA Ploidy
    - B. Cell Surface Determinants
  - IV. PROLIFERATION MARKERS/APOPTOSIS**
    - A. Mitotic Counts
    - B. Thymidine Labeling Index and BrdU Incorporation
    - C. Nucleolar Organizing Regions
    - D. Proliferation Markers
    - E. Image Analysis
    - F. Apoptosis
  - V. IMMUNOHISTOCHEMISTRY/  
IMMUNOCYTOCHEMISTRY**
    - A. Epithelium
    - B. Mesenchyme
    - C. Drug Resistance
    - D. Proliferation
    - E. Leukocyte Markers
    - F. Other Markers
  - VI. CYTOCHEMISTRY**
  - VII. CYTOGENETICS**
  - VIII. MOLECULAR ONCOLOGY**
  - IX. PROTEOMICS, GENOMICS, METABOLOMICS**
  - REFERENCES**
- 

## I. INTRODUCTION

Biomarkers, particularly tumor markers, represent an exciting tool for the clinical discipline of oncology. However, as various markers of disease, including physiological, biochemical, and genetic changes, are identified, they may become more

than useful diagnostic tests. These biomarkers may also play a role in drug discovery and development and become useful tools for predicting the response to therapy and prognosis.

To help address the issues surrounding biomarkers and their application to various disciplines of clinical medicine and biomedical research, the National Institutes of Health (NIH) formed a working group on definitions to develop a set of preferred terms and descriptions, along with a conceptual model, that could be broadly applied to the increasing use of biomarkers. The working group defined a biomarker as an objectively measured and evaluated characteristic that is an indicator of a normal biological processes, a pathogenic process, or a response to a therapeutic intervention (Downing, 2000). The NIH Working Group on Definitions also characterized several important applications for biomarkers including their use for diagnosis, for staging disease, as indicators of disease risk, and as tools to predict and monitor clinical responses to therapy (Downing, 2000).

This chapter focuses on how various biomarkers have an application to cancer management in veterinary medicine. Ideally, in addition to the attributes listed in the introduction, tumor markers should be both sensitive and specific for the detection of cancer, to minimize both false-positive and false-negative test findings, and they should use methodology that is minimally invasive to increase acceptance and compliance by animal owners. Tumor markers should also reflect the total tumor burden, identify tumor recurrence after treatment, and be unaffected by cancer treatment or adverse events associated with cancer treatment. Tumor markers should be reproducible among laboratories and have a well-defined reference range to distinguish between health and disease. In human medicine, testing for tumor markers is recommended only in situations where it is demonstrated to result in a better patient outcome, increased quality of life, or reduced overall cost of care (Duffy, 2004).

The rapid technological advances in immunology, biochemistry, and cell and molecular biology will continue to offer new opportunities to evaluate candidate tumor markers. However, few tumor markers, including those that are

commonly used in veterinary medicine, have been rigorously tested. To determine whether a candidate tumor marker has clinical utility, it is vital that it undergo critical evaluation. In evidence-based medicine, there are several criteria for interpreting the usefulness of a diagnostic test (Jaeschke *et al.*, 2002). First, it should be useful for situations or cases where clinicians routinely face diagnostic uncertainty. For example, the diagnostic evaluation of hematuria in an older dog is one situation in which an effective tumor marker would be highly useful. Second, candidate tumor markers should be blindly evaluated against an independent “gold standard” diagnostic test in cancer patients, sick noncancer patients, and healthy patients. Only after the usefulness of a tumor marker has been established can clinicians begin to determine how effectively the test result and its interpretation will improve patient management. The likelihood ratio (Letelier *et al.*, 2002) is one tool that can help clinicians interpret and apply test results, and it may be useful to apply to veterinary tumor markers. Briefly, the clinician must have an idea about the patient’s probability for having cancer based on signalment, history, physical findings, and other factors before tumor marker testing. Given knowledge of the likelihood of a high test value occurring in a patient with cancer compared to the likelihood of a high test value occurring in a patient suspected of cancer that was later ruled out, it is possible to calculate the posttest probability for the patient having cancer given a high, low, or intermediate test result. For the interested reader, the Evidence-Based Medicine Working Group has detailed the critical evaluation of diagnostic tests, results interpretation, and application to clinical patients (*Users’ Guide to the Medical Literature: A Manual for Evidence-Based Clinical Practice*, 2002).

Historically, using a broad definition, veterinary tumor markers have included various molecules found in serum, flow cytometry, proliferation and apoptosis markers, immunohistochemistry, cytochemistry, and cytogenetics. With the advent of new technologies, molecular markers of cancer will become more important in human and veterinary oncology. Likewise, the explosion of the “-omics,” including genomics, proteomics, and metabolomics, may also be important to the diagnosis and management of cancer in the future. Each of these issues will be considered in turn.

## II. SERUM TUMOR MARKERS

### A. Oncofetal Proteins

Oncofetal proteins originate within tumor cells and enter the bloodstream either by secretion from the tumor or as a breakdown product of tumor cells. Normally oncofetal proteins are present during embryogenesis and may increase with certain cancers, making them potentially useful tumor markers. *Carcinoembryonic antigen (CEA)* and *alpha-fetoprotein (AFP)* are the most widely used oncofetal protein tumor markers (Garrett and Kurtz, 1986). CEA has been well

studied in human medicine, and since the 1970s it has been recognized as a useful marker for cancers of the lung, colon-rectum, breast, ovary, and prostate gland (Go, 1976). CEA is the most useful tumor marker to distinguish benign from malignant pleural effusions (Shirit *et al.*, 2005). Preoperative serum CEA levels may also predict survival in human colorectal cancer patients (Park *et al.*, 2005). In veterinary medicine, CEA has received little attention, and its role as a tumor marker in domestic animal species remains undefined.

In humans, AFP is commonly used to diagnose hepatocellular carcinoma and predict its prognosis (Zhou *et al.*, 2006). AFP has been measured in the serum of cancer-bearing dogs (Hahn and Richardson, 1995). However, in this report, the mean serum concentration of AFP in dogs with various malignancies was not significantly different from the mean serum AFP concentration of the 16 dogs without cancer. A single dog with hepatic involvement with lymphoma had a serum AFP concentration >225 ng/ml, suggesting AFP may have a role for diagnosing primary or secondary hepatic cancer in the absence of other serum biochemical abnormalities. Indeed high serum concentrations (>250 ng/ml) of AFP have been detected in a small number of dogs with primary liver tumors (Lowseth *et al.*, 1991). Because serum AFP concentration is higher in canine hepatocellular carcinoma compared to other hepatic diseases, it may be a useful tool for diagnosing hepatocellular carcinoma in dogs (Yamada *et al.*, 1999).

In a study of serum AFP concentrations in healthy dogs and dogs with multicentric lymphoma (Lechowski *et al.*, 2002), the mean serum AFP concentration was higher in dogs with lymphoma compared to the healthy dogs. Serum AFP concentration was also found to increase with advancing clinical stage of lymphoma, and decrease to levels similar to normal dogs as the lymphoma went into remission with chemotherapy. These observations suggest serum AFP may be a useful biomarker for determining lymphoma remission in the dog and potentially an early indicator of relapse. Serum AFP has not been carefully evaluated as a tumor marker in other domestic species.

### B. Hormones and Ectopic Hormones

#### 1. Inhibin

Inhibin is a nonsteroidal hormone that is involved in the follicular phase of the human menstrual cycle (Groome *et al.*, 1996). Inhibin has also been identified as a regulatory hormone in the follicular phase of the equine estrous cycle (Medan *et al.*, 2004). Serum inhibin concentrations have been shown to be elevated in mares with granulosa theca cell tumors (GTCT) (Christman *et al.*, 1999). Measuring inhibin concentrations can be helpful in diagnosing equine GTCT, especially if serum testosterone concentrations are not elevated, and distinguishing GTCT from other diseases of the ovary. Increased serum inhibin concentrations have

also been identified in dogs with Sertoli cell tumors, making it a potentially useful marker for identifying testicular tumors (Grootenhuis *et al.*, 1990).

## 2. Serum Parathyroid Hormone

Increased serum parathyroid hormone (PTH) in the presence of hypercalcemia has been considered sufficient for the diagnosis of primary hyperparathyroidism. However, a retrospective case-control study suggests that normal PTH concentrations in the presence of hypercalcemia are an inappropriate physiological response by the parathyroid gland and are also consistent with primary hyperparathyroidism (Feldman *et al.*, 2005). Although primary hyperparathyroidism is an uncommon disease of dogs and cats, both adenomas and carcinomas of the parathyroid glands are reported in the literature and should be considered among the differential diagnoses.

## 3. Parathyroid Hormone-Related Protein

Hypercalcemia of malignancy is a well-recognized paraneoplastic syndrome in animals. Hypercalcemia of malignancy may arise from local bone resorption stimulated by metastatic bone lesions or through endocrine factors that disrupt normal calcium homeostasis (Clines and Guise, 2005). Ectopic production of PTH by tumors is a rare phenomenon, and most humoral hypercalcemia of malignancy may be explained by the inappropriate production of parathyroid hormone-related protein (PTHrP) by a variety of tumors. Canine PTHrP is similar in structure and function to PTH (Rosol *et al.*, 1995). In dogs, PTHrP has been implicated in hypercalcemia associated with apocrine gland adenocarcinoma of the anal sac and lymphoma (Rosol *et al.*, 1992), melanoma (Pressler *et al.*, 2002), thymoma (Foley *et al.*, 2000), and poorly differentiated carcinoma. Increased serum PTHrP concentration has been identified in a small number of cats with humoral hypercalcemia of malignancy associated with a variety of carcinomas and lymphoma (Bolliger *et al.*, 2002). Increased serum PTHrP has also been described in a horse with hypercalcemia and multiple myeloma (Barton *et al.*, 2004).

## 4. Thyroxine/Thyroglobulin

Estimates of the proportion of dogs with thyroid masses that are revealed to be carcinoma range from 51% to 100% (Scarlett, 1994). It is reported that 70% of dogs with thyroid carcinomas have increased concentrations of serum thyroglobulin, although these findings were not strongly correlated with serum thyroxine ( $T_4$ ) concentrations (Verschuere *et al.*, 1991). It is generally accepted that most dogs with thyroid carcinomas are euthyroid, but the contemporary peer-reviewed literature is sparse with respect to the prevalence of functional thyroid tumors in dogs.

In cats elevated serum total or free  $T_4$  is generally diagnostic for hyperthyroidism, although some cats with

nonthyroidal disease may have elevated free  $T_4$  (Peterson *et al.*, 2001). Cats with equivocal results may require additional evaluation with the triiodothyronine ( $T_3$ ) suppression test to confirm the diagnosis of hyperthyroidism (Graves and Peterson, 1994). Unlike dogs, most cats with hyperthyroidism have a functional adenoma or adenomatous hyperplasia rather than an underlying thyroid carcinoma. Serial  $T_4$  determinations are useful to monitor response to therapy and detect a relapse following radioiodine treatment (Peterson and Becker, 1995).

## 5. Adrenocorticotropin Hormone/Cortisol

Hyperfunctioning adrenocortical tumors can be diagnosed by measuring basal plasma cortisol concentration or changes in plasma cortisol concentration from a variety of provocative tests using natural or synthetic adrenocorticotropin hormone (ACTH) stimulation or dexamethasone suppression. The measurement of endogenous ACTH may help distinguish primary adrenal disorders from those secondary to pituitary gland dysfunction. The ratio of the precursor hormones pro-opiomelanocortin and proadrenocorticotropin has been recently correlated to the size of pituitary tumors in dogs with hyperadrenocorticism (Granger *et al.*, 2005). Measurement of basal ACTH and the use of provocative testing with ACTH have been reported for the diagnosis of equine pituitary pars intermedia adenomas (van der Kolk *et al.*, 1995).

## 6. Sex Steroid Hormones

Measurement of plasma sex steroid hormones is useful for characterization of equine GTCT in mares with clinical signs attributable to high plasma concentrations of testosterone or estrogen (Meinecke and Gips, 1987; Stabenfeldt *et al.*, 1979). Occasionally plasma progestins are elevated. Considerable variation in sex steroid hormone profiles exists among affected horses and may be due to the presence of abnormal ovarian follicles, defects in aromatase activity, or possible feedback inhibition affecting gonadotropin secretion (Hoque *et al.*, 2003).

Determination of plasma concentrations of androstenedione, 17-hydroxyprogesterone, and estradiol may be useful in diagnosing adrenocortical neoplasia in ferrets (Rosenthal and Peterson, 1996). Likewise, increased plasma concentrations of these adrenal sex hormones have been observed in dogs with adrenal gland adenocarcinoma with provocative testing using ACTH (Hill *et al.*, 2005). Elevated plasma progesterone has been described in a cat with a well-differentiated adrenocortical adenocarcinoma (Boord and Griffin, 1999).

Much literature exists surrounding the presence of estrogen and progesterone receptors in mammary gland tumors of the dog. Recent findings reveal that dogs with biologically aggressive inflammatory mammary carcinomas had increased serum and tissue concentrations of androgens



when compared to dogs with noninflammatory malignant mammary tumors (Illera *et al.*, 2006).

The presence of progesterone receptors has been described in lymphomas of the horse (Henson *et al.*, 2000). A case report describing the regression of a cutaneous lymphoma in a mare after removal of GTCT hints at the biological significance of progesterone receptors in equine lymphomas (Henson *et al.*, 1998).

## 7. Insulin

Increased secretion of insulin from the beta cells of the pancreas is the hallmark of insulinoma (beta cell tumor, pancreatic islet cell tumor). Although several variations on the insulin-glucose ratio appear in the literature, documentation of the abnormal physiological condition of fasting hypoglycemia and measurable serum insulin is sufficient for the diagnosis of insulinoma. Measuring serum fructosamine and glycated hemoglobin may also be helpful in the diagnosis of insulinoma. In a few small series of dogs with insulinoma, decreased serum fructosamine concentrations (Loste *et al.*, 2001; Mellanby and Herrtage, 2002) and decreased serum glycated hemoglobin concentrations (Elliott *et al.*, 1997; Marca *et al.*, 2000) have been observed. Low serum fructosamine may indicate the presence of insulinoma despite normoglycemia (Mellanby and Herrtage, 2002).

## C. Enzymes

### 1. Lactate Dehydrogenase, Serum Alkaline Phosphatase, Prostatic Acid Phosphatase, Thymidine Kinase

Lactate dehydrogenase (LDH), an enzyme that catalyzes the interconversion of pyruvate and lactate, has been studied in humans with a variety of malignancies, but it is best validated as a marker for evaluating prognosis in patients with nonseminomatous germ cell tumors (Duffy, 2004). LDH activity, along with activity of several of its isoenzymes, is increased in dogs with lymphoma; dogs with lower serum LDH activity had overall longer survival times compared to dogs with increased LDH activity, suggesting this may be a useful marker for canine lymphoma (Zanatta *et al.*, 2003). Increased plasma and urine LDH activity have been observed in cows with urinary bladder cancer (Dawra *et al.*, 1991).

Elevated serum alkaline phosphatase (ALP) activity is a prognostic factor in humans with a variety of advanced cancers (Hauser *et al.*, 2006) and may predict outcome in a variety of cancers including prostate cancer (Cho *et al.*, 2003) and advanced uveal melanoma (Eskelin *et al.*, 2003). Serum ALP activity has apparently no value as a tumor marker for canine lymphoma or canine mammary tumors (Karayannopoulou *et al.*, 2003; Wiedemann *et al.*, 2005). Pretreatment elevated serum ALP activity and failure to

return to normal ALP activity after treatment correlate with poor survival of dogs with appendicular osteosarcoma (Ehrhart *et al.*, 1998; Garzotto *et al.*, 2000).

Prostatic acid phosphatase (PAP), a neutral protein tyrosine phosphatase, was widely used as a tumor marker before the discovery of prostate-specific antigen. Serum PAP activity is increased in men with prostate cancer and has important cellular functions in carcinogenesis of the prostate (Veeramani *et al.*, 2005). However, this increase does not appear to occur in dogs with prostate cancer (Bell *et al.*, 1995).

Thymidine kinase (TK), a phosphotransferase enzyme found in most living cells, has been evaluated as a tumor marker in women with breast cancer, showing a decrease in serum activity after surgical treatment of the primary tumor (He *et al.*, 2000). It may also provide prognostic information in humans with non-Hodgkin's lymphoma and multiple myeloma (Diem *et al.*, 1993; Hallek *et al.*, 1992). In dogs with lymphoma, serum TK activity appears to be a predictor of survival (von Euler *et al.*, 2004). TK can now be measured with nonradiometric methods, making it more appealing for routine laboratory use (von Euler *et al.*, 2006).

## D. Immunoglobulins

A long-standing use of a serum tumor marker in veterinary medicine is the measurement of serum immunoglobulins. In diseases of B cells, including multiple myeloma and Waldenström's macroglobulinemia, hyperglobulinemia is often present. Electrophoresis of the serum proteins reveals a typical monoclonal gammopathy, and immunoelectrophoresis is used to further characterize the antibody class of the immunoglobulins. The hyperglobulinemia resolves with successful treatment and therefore makes a convenient measure to assess response and recurrence. IgM, IgG, and IgA gammopathies have been described in the dog (Giraudel *et al.*, 2002; Lautzenhiser *et al.*, 2003; Ramaiah *et al.*, 2002). It should be noted that hypergammaglobulinemia does not occur with all cases of myeloma, and there may be hypogammaglobulinemia with a normal electrophoretic pattern. Canine ehrlichiosis infection can also cause a monoclonal gammopathy and should be considered among the differential diagnoses for increased serum immunoglobulins (Breitschwerdt *et al.*, 1987).

## E. Tumor-Associated Antigens

### 1. CA-125

Cancer antigen 125 (CA-125) is a product of the MUC16 gene and has found use in human medicine as a tumor marker for epithelial ovarian cancers, although the sensitivity and specificity are poor (Moss *et al.*, 2005). Serum CA-125 may be elevated in other cancers, such as endometrial cancer, cancer of the fallopian tubes, lung cancer, breast cancer, and

cancer of the gastrointestinal tract and nonneoplastic diseases such as endometriosis. CA-125 has not found application in veterinary medicine.

## 2. Prostate-Specific Antigen

Prostate-specific antigen (PSA) is a tumor-associated antigen identifiable in the serum of men with prostate cancer, and it has become a widely used tumor marker for prostate cancer screening programs. Evidence suggests it may not adequately discriminate between cancer and benign enlargement of the prostate gland (Constantinou and Feneley, 2006). One study failed to identify PSA in canine serum, although weak immunoreactivity was noted on immunohistochemistry of canine prostatic adenocarcinoma specimens (Bell *et al.*, 1995).

## 3. Other Tumor-Associated Antigens

Tumor-associated antigens, 1A10 and SB2, have been identified in the serum of dogs with a variety of cancers with the use of murine monoclonal antibodies developed against a canine mammary carcinoma cell line (Wang *et al.*, 1995). However, the clinical importance of these antibodies has not been defined.

## F. Miscellaneous Serum Tumor Markers

### 1. Fibronectin

Fibronectin (FN) is a large glycoprotein that is a component of the extracellular matrix and occurs in its soluble form in plasma. A study of plasma FN concentrations in dogs with malignancies documented both increased and decreased plasma FN (Feldman *et al.*, 1988). A study of canine and feline pleural and abdominal effusions revealed no useful distinction in FN concentrations between malignant and nonmalignant effusions, although the FN/albumin ratio was higher in dogs with malignant effusions compared to those with congestive heart failure (Hirschberger and Pusch, 1996).

### 2. Sialic Acid

Sialic acid describes derivatives of neuraminic acid, which are potentially useful tumor markers because of the aberrant glycosylation in cancer cell membranes. Although the cancer specificity of sialic acid is reported to be high, its sensitivity is low because sialic acid-rich glycoproteins are present in inflammatory diseases (Narayanan, 1994). Increased serum sialic acid concentration has been observed in cancer-bearing dogs (Poli *et al.*, 1986); however, further studies suggest the increase is not specific for cancer (Thougaard *et al.*, 1998).

## 3. Acute-Phase Proteins

The acute-phase proteins (APP) are those plasma proteins, made primarily by hepatocytes, whose concentrations change after tissue injury or infection. Their relationship with cancer has long been recognized in human medicine (Cooper and Stone, 1979). An increase in APP at the time of diagnosis is a negative prognostic indicator in human cancer patients, and increases may also occur with advancing disease (Cooper, 1988). APP that may have use as tumor markers include ceruloplasmin (Cp), complement components C3 and C4,  $\alpha$ 1-acid glycoprotein (AGP),  $\alpha$ 1-proteinase inhibitor ( $\alpha$ 1-antitrypsin),  $\alpha$ 1-antichymotrypsin, haptoglobin (Hp), fibrinogen (Fbn), C-reactive protein (CRP), and serum amyloid A (SAA). As an example, increased serum CRP has been shown to be a poor prognostic indicator in people with multiple myeloma, melanoma, lymphoma, and ovarian, renal, pancreatic, and gastrointestinal tumors (Mahmoud and Rivera, 2002). Because interleukin 6 (IL-6) and tumor necrosis factor alpha (TNF- $\alpha$ ) induce synthesis of CRP and potentially other APP, they are also receiving attention as potential biomarkers and therapeutic targets.

APP have been studied in veterinary medicine. In a recent study of APP in diseased dogs, significant increases in Cp, Hp, and CRP were observed in dogs with cancer and other inflammatory diseases, and decreases with treatment were associated with more favorable outcomes (Tecles *et al.*, 2005). Increased serum concentrations of AGP at diagnosis have been observed to decrease with cancer treatment and onset of clinical remission in dogs with lymphoma, suggesting its potential as a biomarker (Hahn *et al.*, 1999).

## III. FLOW CYTOMETRY

### A. DNA Ploidy

The flow cytometer is frequently employed to determine the DNA content of cancer cells in various veterinary tumors (Culmsee and Nolte, 2002). Most normal tissues, reactive tissues, and benign tumors have diploid (2N) DNA values. The different DNA content of tumor cells compared to normal tissues may be the result of abnormal DNA (aneuploidy) or due to increased DNA content with cell division. Although aneuploidy has been identified in a wide variety of veterinary tumors, it has not been studied carefully as a prognostic indicator. Aneuploidy may predict aggressive tumor behavior in canine hemangiopericytoma (Kang *et al.*, 2006), canine mammary tumors (Hellmen *et al.*, 1993), canine melanoma (Bolon *et al.*, 1990), and possibly canine mast cell tumors (Ayl *et al.*, 1992). However, aneuploidy does not seem to predict biological behavior or prognosis in equine melanomas (Roels *et al.*, 2000a) or canine lymphomas (Teske *et al.*, 1993).

## B. Cell Surface Determinants

With the use of specific monoclonal antibodies, the flow cytometer can be used to characterize cell populations based on their cell surface determinants. Although particularly well suited for the study of leukemias, this technique may also be adapted to the study of solid tumors. Aberrant expression of cluster differentiation (CD) molecules has been identified as a common, and distinguishing, feature of canine lymphomas (Wilkerson *et al.*, 2005). The flow cytometer also allows rapid immunophenotyping of lymphomas using an aspirate specimen (Culmsee *et al.*, 2001). Further work is needed to determine how these findings may correlate with prognosis.

## IV. PROLIFERATION MARKERS/APOPTOSIS

### A. Mitotic Counts

Determining the frequency of mitotic figures visible in histological sections of biopsy specimens is a long-standing method for assessing cell proliferation. Cells in the mitotic phase are easily recognizable on routinely prepared specimens. There are various methods for reporting the mitotic activity, including number of mitoses visible per certain number of high, dry microscopic fields or the number of mitoses present in a certain number of cells (mitotic index). It has been shown that the mitotic index correlates better to other indices of proliferation and tumor grade compared to mitoses per area (Sarli *et al.*, 1999). Although determining mitotic counts is technically simple, it is limited in its usefulness because of lack of reproducibility, and errors in interpretation may be introduced by delays in tissue fixation, variation in section thickness or size of microscopic field of view, and in difficulty recognizing mitoses.

High mitotic index has been reported as a negative prognostic indicator of various tumors, including canine ocular melanoma (Wilcock and Peiffer, 1986), feline fibrosarcoma (Bostock and Dye, 1979), and canine soft tissue sarcomas (Kuntz *et al.*, 1997). However, the mitotic index may have limited value for predicting the behavior of canine melanoma (Spangler and Kass, 2006), canine skin cancers (Martin De Las Mulas *et al.*, 1999), or canine lymphoma (Kiupel *et al.*, 1999).

### B. Thymidine-Labeling Index and BrdU Incorporation

The synthesis of DNA occurring in the S phase of the cell cycle can be measured by labeled DNA precursor incorporation. Although there are radiometric methods using tritiated thymidine, bromodeoxyuridine (BrdU), a halogenated thymidine analogue, is more commonly used for direct

estimation of DNA synthesis. The use of specific monoclonal antibodies to BrdU allows immunohistochemical detection in paraffin-embedded sections with simultaneous morphological examination of the tissues. The thymidine labeling index is defined as the ratio of the number of positively stained cells to the total number of cells. The S-phase fraction of the cell cycle can be determined by counting nuclei labeled with BrdU providing an accurate assessment of the proliferative capacity of the tumor. One drawback to this technique is that it requires infusing patients with BrdU before surgery to permit its incorporation into tumor DNA.

BrdU incorporation and calculation of tumor potential doubling time has been associated with biological behavior and prognosis in canine chondrosarcoma, osteosarcoma, epulides, and lymphoma (Ohta *et al.*, 2004; Schwyn *et al.*, 1998; Vail *et al.*, 1996; Yoshida *et al.*, 1999).

### C. Nucleolar Organizing Regions

Quantifying the proteins associated with nucleolar organizing regions (NORs) of interphase chromosomes is another method to assess the proliferation rates of tumors. The NORs are visualized microscopically with a simple silver-staining method that is effective because of the argyrophilia of their nonhistone acidic proteins. The staining procedure can be done on both histological and cytological specimens. These argyrophilic nucleolar organizing regions (AgNORs) are representative of actual or potential transcriptional activity of ribosomal DNA and may be used as a marker for cell proliferation. AgNOR counts may be expressed as the mean number of AgNORs per nuclei or as the percentage of tumor cells with >5 AgNORs per nucleus. It is believed that the mean AgNOR count reflects DNA ploidy, whereas the percentage of tumor cells with >5 AgNORs per nucleus represents the proliferative activity.

Increasing AgNOR scores have been shown to be predictive of poor outcome in canine soft tissue sarcoma (Ettinger *et al.*, 2006), canine mast cell tumors (Bostock *et al.*, 1989; Scase *et al.*, 2006; Simoes *et al.*, 1994), canine mammary gland tumors (Sarli *et al.*, 2002), canine lymphoma (Kiupel *et al.*, 1998, 1999; Vail *et al.*, 1996), transmissible venereal tumors (Harmelin *et al.*, 1995), and feline mammary carcinoma (Preziosi *et al.*, 2002). However, AgNOR scores do not seem to be predictive of outcome in feline lymphoma (Rassnick *et al.*, 1999; Vail *et al.*, 1998), and other studies suggest that AgNOR scores do not predict outcome in canine mammary gland tumors (Lohr *et al.*, 1997).

### D. Proliferation Markers

Methods for detection of cell cycle-related antigens are described in Section V.D.

## E. Image Analysis

Obtaining morphometric and densitometric measurements from individual nuclei and providing information about ploidy, S-phase fraction, and nuclear area, are possible with image analysis of cytocentrifuge preparations of Feulgen-stained nuclei extracted from formalin-fixed, paraffin-embedded tissues. Morphometric measurements can also be obtained from hematoxylin and eosin (H&E) and panoptic-stained cytology specimens. Nuclear morphometry and ploidy may aid in the classification of canine mast cell tumors (Strefezzi Rde *et al.*, 2003), distinguish benign from malignant melanocytic tumors in dogs and cats (Roels *et al.*, 2000b), and predict the outcome of feline mammary carcinomas (De Vico and Maiolino, 1997).

## F. Apoptosis

Apoptosis is an energy-dependent process that may be considered a “programmed” form of cell death, distinct from the “accidental” cell death of necrosis. During apoptosis, there is activation of endogenous nucleases, which create oligonucleosomal fragments that have a characteristic orderly ladder appearance when separated by electrophoresis, compared with the smeared appearance of DNA degraded during necrosis. Cells undergoing apoptosis have characteristic morphological features including condensation of nuclear heterochromatin and resultant crescent apposed to the nuclear membrane, cell shrinkage, cytoplasmic condensation, and bud formation at the cell membrane, which may condense into “apoptotic bodies.” Another characteristic of apoptosis is the absence of inflammation, which is typically present with necrosis.

Although features of apoptosis may be identified with light microscopy of H&E-stained cells, electron microscopy or fluorescence microscopy with dyes such as propidium iodine or acridine orange may also be useful.

The apoptotic index predicts the initial relapse-free survival in dogs with lymphoma, but not its overall survival (Phillips *et al.*, 2000). However, the apoptotic index does not appear to correlate with survival in feline mammary tumors (Sarli *et al.*, 2003).

## V. IMMUNOHISTOCHEMISTRY/ IMMUNOCYTOCHEMISTRY

Immunohistochemistry is now a well-accepted and routinely applied method in most every veterinary diagnostic laboratory. Similar techniques have been applied to cytology specimens with good result. These methods involve the use of antibodies, which bind specific cellular components representing specific markers of the cell type of origin. By linking the antibodies to a dye, the immunoreactivity between the tissue specimens and antibodies can be visualized with the light microscope.

The use of immunohistochemistry and immunocytochemistry has advanced the understanding of tumor differentiation and allowed for improved tumor typing. Immunohistochemistry facilitates the determination of histogenesis of many tumors that might otherwise be classified as undifferentiated on the basis of light microscopy of routine H&E stained tissues. Although the antibodies used for immunohistochemical staining do not recognize unique attributes of the tumor nor do they differentiate benign from malignant cells per se, the accurate determination of histogenesis may allow the clinician to choose appropriate treatment and formulate an accurate estimate of the prognosis. It is beyond the scope of this chapter to exhaustively review all immunohistochemical and immunocytochemical markers useful for veterinary cancer diagnosis. What follows are examples of those markers that well illustrate the use of these techniques as tumor markers.

### A. Epithelium

It is often difficult to distinguish carcinoma for other poorly differentiated or undifferentiated neoplasms. The immunohistochemistry (IHC) markers that are commonly used to characterize tumors of epithelial origin are antibodies directed against the cytokeratin intermediate filaments. The cytokeratin proteins are unique among the intermediate filaments of the cytoskeleton because of their high degree of diversity in polypeptide units and the fact that cytokeratin intermediate filaments are highly correlated with the degree of tissue differentiation. Therefore, identification of specific cytokeratins can be useful for confirming epithelial histogenesis and distinguishing glandular from squamous differentiation independent of other morphological features. As epithelial tumors progress from dysplastic epithelium to carcinoma *in situ* to invasive squamous cell carcinoma, there is a concurrent decrease in expression of both high- and low-molecular-weight cytokeratins. Although a majority of canine and feline carcinomas will have immunoreactivity of at least some neoplastic cells for cytokeratins, the use of a panel of anticytokeratin antibodies, to include both high- and low-molecular-weight keratins, may improve the sensitivity of the immunohistochemistry. It is noteworthy that many studies of cytokeratin intermediate filaments in domestic animal tumors have used antibodies directed against human cytokeratins, and there are clear differences in the observed immunoreactivity among species for many of these antibodies.

Specific cytokeratins have been proposed as diagnostic markers for some tumors owing to a change in cytokeratin expression as a consequence of tumorigenesis. For example, poorly differentiated prostatic carcinoma in dogs has positive immunoreactivity for cytokeratin AE1/AE3 (Grieco *et al.*, 2003), yet cytokeratin 7 is not sufficient to distinguish prostatic from transition cell carcinomas in dogs (LeRoy *et al.*, 2004). Various canine skin tumors may

be distinguished based on the observed immunoreactivity to a cytokeratin panel (Walter, 2000). Cytokeratin 6 is present in all epithelial skin tumors with the exception of pilomatrixoma. Cytokeratin 14 reactivity occurs in basal cell-derived neoplasms and in sebaceous and perianal gland tumors, whereas reactivity to cytokeratin 10/11 is limited to spinous cell-derived tumors and cytokeratin 8/18 immunoreactivity occurs only in tumors of sweat gland origin. Cytokeratin immunostaining has also been used to detect micrometastases in lymph nodes of dogs with mammary gland carcinoma that were considered negative on routine evaluation of H&E stained specimens (Matos *et al.*, 2006).

## B. Mesenchyme

### 1. Vimentin

Vimentin intermediate filaments are used to mark non-muscle sarcomas (Fox *et al.*, 2002; Mazzei *et al.*, 2002). Vimentin expression is lost during the process of differentiation of skeletal muscle and is absent in normal mature myofibrils. Vimentin intermediate filaments have been reported, however, in poorly differentiated rhabdomyosarcomas (Brockus and Myers, 2004).

### 2. Desmin

Desmin is the cytoskeletal component that holds myofibrils in place, and it has found use as a marker for canine leiomyomas and leiomyosarcomas (Sato *et al.*, 2003). Canine skeletal muscle tumors are also reactive to desmin antibodies (Illanes, 2002). Canine hemangiopericytoma may also express desmin (Mazzei *et al.*, 2002).

### 3. Fibrillary Acid Protein

Glial fibrillary acid protein (GFAP) is found in glial cells in the central nervous system, in Schwann cells and schwannomas, and other tissues. In dogs, GFAP reactivity occurs in glial cells, including fibrous astrocytes, Schwann cells, axons, and cell bodies of peripheral ganglia. It has also been identified in glioblastoma multiforme of dogs (Lipsitz *et al.*, 2003).

## C. Drug Resistance

An important mechanism for cellular resistance to anticancer drugs involves the overexpression of the product of the MDR-1 gene, P-glycoprotein (Pgp). Pgp is an ATP-dependent transmembrane efflux pump that reduces the intracellular concentration of a variety of chemotherapy drugs. The presence of Pgp can be detected with immunohistochemistry, and Pgp expression is associated with a poor clinical outcome in dogs with lymphoma (Lee *et al.*, 1996).

## D. Proliferation

### 1. Ki-67

The monoclonal antibody (MIB-1) directed against Ki-67 recognizes a nonhistone nuclear protein expressed in proliferating cells during G1-, S-, G2-, and M-phases of the cell cycle, but it is not present in quiescent (G0) cells. Immunostaining for the Ki-67 antigen offers an efficient method for estimating the proliferative fraction of a tumor and correlates well with other measures of proliferation. Ki-67 labeling index may have prognostic significance in canine mammary gland tumors (De Matos *et al.*, 2006; Zuccari *et al.*, 2004), soft tissue sarcomas (Ettinger *et al.*, 2006), and melanoma (Laprie *et al.*, 2001; Millanta *et al.*, 2002). The Ki-67 labeling index is of limited value in predicting outcome in canine lymphoma (Phillips *et al.*, 2000). Low Ki-67 labeling of feline squamous cell carcinoma was predictive of a poor response to radiation therapy (Melzer *et al.*, 2006).

### 2. Proliferating Cell Nuclear Antigen

Cyclin, also known as proliferating cell nuclear antigen (PCNA), is a nonhistone nuclear protein that is present throughout the cell cycle in proliferating cells, reaching its maximum during S phase. Use of PCNA to estimate tumor proliferation rate has value in predicting response to treatment in dogs undergoing radiation therapy for meningioma (Theon *et al.*, 2000). PCNA immunoreactivity does not correlate with survival canine mast cell tumors (Scase *et al.*, 2006), canine or feline lymphoma (Kiupel *et al.*, 1998; Phillips *et al.*, 2000; Vail *et al.*, 1998), canine or feline melanoma (Roels *et al.*, 1999), or canine soft tissue sarcomas (Ettinger *et al.*, 2006).

## E. Leukocyte Markers

The study of immune system malignancies has been advanced by the development of monoclonal antibodies with specific reactivity to canine and feline leukocyte antigens. At present, leukocyte antigens are defined by cluster-differentiation (CD) numbers assigned by international workshops. Panels of antibodies against leukocyte antigens are useful for classifying round cell malignancies and may provide prognostic information (Fernandez *et al.*, 2005). Commonly used antibodies to identify various cell types of origin include CD3 (T cells), CD79a (B cells), CD18 (leukocytes), canine CD11d (macrophages and T cells), factor VIII-related antigen (megakaryocytes), and CD45RA (leukocytes). T cells can be further characterized as T cell helpers (CD4 reactive) or cytotoxic T cells (CD8 reactive). Peripheral T cells (thymocytes) can be identified by their reactivity to Thy-1. B cells can also be identified with CD20 (Jubala *et al.*, 2005). MCH-II may also be used to identify antigen-presenting cells. Plasma cells may be identified by their immunoreactivity to canine immunoglobulin antibodies (Day, 1995).

The immunophenotyping of canine lymphoma has received considerable attention as a potential prognostic indicator. Several studies suggest that dogs with B cell lymphoma may have longer survival than those with T cell lymphoma (Dobson *et al.*, 2001; Kiupel *et al.*, 1999; Ponce *et al.*, 2004; Teske *et al.*, 1994). It is unclear if immunophenotype is an important prognostic factor in feline lymphoma (Patterson-Kane *et al.*, 2004).

Different anatomic forms of lymphoma have also been associated with specific cell types of origin. For example, in the dog, cutaneous lymphoma is primarily of T cell origin, and epitheliotropic lymphoma is exclusively of T cell origin (Day, 1995). There also appears to be breed differences in lymphoma. In one study, 82% of boxer dogs had T cell lymphoma, whereas other only 50% of the golden retrievers and rottweilers studied had T cell lymphoma (Lurie *et al.*, 2004). In cats, mediastinal and intestinal lymphoma appear to be predominantly T cell in origin (Gabor *et al.*, 1999; Zwahlen *et al.*, 1998); however, there may be some worldwide geographic differences in the distribution of B cell lymphomas among cats.

Similar immunophenotyping techniques have been successfully applied to fine needle aspirate samples of lymph nodes using flow cytometry (Gibson *et al.*, 2004) and cytospin cytology preparations (Caniatti *et al.*, 1996). Immunophenotyping of leukocyte tumors has also been applied in other species including the horse (Kelley and Mahaffey, 1998), cow (Vernau *et al.*, 1997), and ferret (Coleman *et al.*, 1998).

## F. Other Markers

### 1. Von Willebrand's Factor (Factor VIII-Related Antigen)

Von Willebrand's factor, part of the factor VIII complex, is restricted to endothelial cells, megakaryocytes, and platelets. Positive immunoreactivity to factor VIII-related antigen is useful in diagnosing vascular neoplasia in a variety of species. Factor VIII-related antigen has also been used to identify tumor microvessels, and various determinations of microvessel density may carry prognostic significance. In one study of malignant canine mammary tumors, a high tumor vascular density was associated with an increased likelihood of local tumor recurrence (Griffey *et al.*, 1998). Intratumoral vascular density has also been shown to predict survival in dogs with mast cell tumors (Preziosi *et al.*, 2004).

### 2. Actin Microfilaments

Vertebrates have at least six tissue-specific forms of actin. There are actins specific for skeletal muscle, cardiac muscle, vascular smooth muscle, and enteric smooth muscle. Alpha-smooth muscle actin may be a useful marker to distinguish canine hemangiopericytomas from other peripheral nerve sheath tumors (Chijiwa *et al.*, 2004).

### 3. Skeletal Myosin

Antibodies that distinguish between smooth muscle and sarcomeric myosin found in skeletal and cardiac muscle may be helpful in determining the cell of origin for muscle tumors.

### 4. S-100 Proteins

S-100 was originally isolated from brain and thought to be specific for glial cells; however, S-100 proteins have subsequently been identified in a variety of non-neuroectodermal tissues. In dogs, S-100 immunoreactivity has been identified in melanoma and amelanotic melanoma, gastrointestinal stromal tumors, and schwannomas, making it nonspecific for melanoma (Choi and Kusewitt, 2003). Because the diagnosis of canine melanoma is often challenging, having positive immunoreactivity for S-100, vimentin, and neuron-specific enolase and negative immunoreactivity for cytokeratins supports a tentative diagnosis of melanoma. However, other immunohistochemical markers, such as tyrosinase-related protein-2 (TRP-2), have apparently greater specificity for melanocytic tumors and may be more useful than S-100 (Choi and Kusewitt, 2003).

### 5. Neuron-Specific Enolase

Neuron-specific enolase (NSE) is the  $\gamma$ -subunit of the enolase enzyme involved in the glycolytic pathway and is characteristic of neural cells. Several tumors have been shown to be immunoreactive with NSE including medullary thyroid (C-cell) tumors, chordomas, and ganglioneuroblastomas. Meningiomas and melanomas may also have positive immunoreactivity with NSE (Barnhart *et al.*, 2002; Koenig *et al.*, 2001).

### 6. Chromogranin A

The diagnosis of cancers arising from neuroendocrine cells, those with neurotransmitter, neuromodulator, or neuropeptide hormone production; dense-core secretory granules; and the absence of axons and synapses, is aided by the use of neuroendocrine markers, particularly chromogranin A (Barakat *et al.*, 2004). Chromogranin A is present in the secretory granules of endocrine cells and has been a useful immunohistochemical marker for diagnosing a variety of neuroendocrine tumors of animals, including carcinoid, pheochromocytoma, insulinoma, and neuroendocrine carcinoma (Barthez *et al.*, 1997; Doss *et al.*, 1998; Morrell *et al.*, 2002; Myers *et al.*, 1997; Sako *et al.*, 2003, 2005).

### 7. Type IV Collagen and Laminin

Type IV collagen and laminin make up basement membranes and can be visualized with light microscopy through

the periodic acid Schiff reaction. However, immunohistochemical staining allows specific and sensitive evaluation of the integrity of the basement membrane, facilitating the distinction between benign tumors with intact basement membranes and invasive cancers with degraded basement membranes (Peña *et al.*, 1995). Fragmentation, loss, or absence of the basement membrane is associated with tumor invasion and metastasis in human colorectal cancer (Ogawa *et al.*, 2005). Immunostaining with antibodies directed against matrix metalloproteinase enzymes (e.g., MMP-9), which degrade basement membrane proteins, may also be important for understanding the relationship between the extracellular matrix and cancer progression (Yokota *et al.*, 2001).

### 8. Integrins

The integrins mediate cell-to-cell adhesions and play a role in interactions between cells and the extracellular matrix proteins including fibronectin, collagens, and laminin. Decreased expression of integrins correlates with the metastatic potential of the tumor (Kawaguchi, 2005). Expression of other integrins, such as alpha(v)beta3, may reflect the angiogenic activity of the tumor, as has been observed in canine melanoma (Rawlings *et al.*, 2003).

### 9. Amyloid

Antibodies, directed against amyloid of immunoglobulin lambda light-chain origin and amyloid-A, have been used to confirm that the amyloid associated with plasma cell tumors is of immunoglobulin origin (Cangul *et al.*, 2002). These immunoreactivity patterns have also been useful to show plasmacytoid differentiation in some tumors.

### 10. Oncoproteins

Antibodies directed against proteins of oncogenes or tumor suppressor genes may serve as biomarkers for cancer. Antibodies have been developed against human p53, Rb, PTEN, Bcl-2, BCRA1, *c-myc*, *c-ras*, and *c-erbB-2*, among others; reports in the veterinary literature suggest cross-reactivity with some of them to domestic animal tissues. In canine lymphoma, expression of the p53 protein is associated with high-grade histology and the T cell immunophenotype (Sueiro *et al.*, 2004), both of which suggest a poor prognosis. Likewise, overexpression of the p53 protein was associated with a poor prognosis for dogs with mammary gland tumors (Lee *et al.*, 2004). Changes in expression of PTEN and p53 proteins have been associated with canine melanoma (Koenig *et al.*, 2002). The expression Bcl-2, a regulator of apoptosis, did not predict survival in a study of feline lymphoma (Dank *et al.*, 2002). Overexpression of *c-ras* has been associated with the development of feline hyperthyroidism (Merryman *et al.*, 1999).

## VI. CYTOCHEMISTRY

Light microscopy of blood films and bone marrow aspirate specimens has been aided by cytochemistry to distinguish various hematological disorders, most notably the acute leukemias. Although various new techniques, including immunophenotyping, various molecular methods (Grindem, 1996), and flow cytometry (Fernandes *et al.*, 2002), are improving the classification of these diseases, cytological evaluation remains an integral part of diagnosis. The myeloperoxidase reaction and Sudan black C stain are useful for identifying neutrophilic differentiation, along with chloroacetate esterase. In the dog and cat, acute myeloid leukemia can be diagnosed on the basis of alkaline phosphatase reactivity because their normal neutrophils lack alkaline phosphatase reactivity. The “nonspecific” esterase reactions, including  $\alpha$ -naphthyl acetate esterase, are useful for identifying monocytic differentiation. The lipase stain can also be a marker for monocytic differentiation. Acute monoblastic leukemia has been diagnosed in the dog based on reactivity with N-butyrate esterase and the lack of chloroacetate esterase or leukocyte peroxidase reactivity (Modiano *et al.*, 1998). Myelomonocytic leukemias can be recognized by simultaneous cytochemical reactivity, often alkaline phosphatase and nonspecific esterase (Jain *et al.*, 1981). Basophilic leukemia has been reported to be negative for peroxidase and naphthol AS-D chloroacetate esterase reactivity (Mahaffey *et al.*, 1987). Cytochemical evaluation of acute megakaryoblastic leukemia may be of limited diagnostic value (Colbatzky and Hermanns, 1993). Similar cytochemical techniques have also been applied to lymph node samples, both imprint and aspirate, to distinguish B and T cell regions and cell types (Raskin and Nipper, 1992).

## VII. CYTOGENETICS

Cytogenetics refers to both the study of the structure of chromosome material and the study of diseases caused by structural and numerical abnormalities of chromosomes. It includes the routine analysis of G-banded chromosomes, other cytogenetic banding techniques, and molecular cytogenetics such as fluorescent *in situ* hybridization (FISH) and comparative genomic hybridization (CGH). In human medicine, cytogenetics has played an important role in the diagnosis and clinical management of lymphomas, leukemias, and various solid tumors (Campbell, 2005; Gebhart, 2004; Mundle and Sokolova, 2004). Breakthroughs in karyotype analysis have overcome the impediments presented by the complexity of the canine karyotype ( $2N = 78$ ) in identifying rearranged chromosomes (Milne *et al.*, 2004). Both numerical and structural chromosome abnormalities have been identified in canine soft tissue sarcomas (Milne *et al.*, 2004). Although many of the cytogenetic studies of animal tumors have been small case series, the advent and development of microarrays for canine CGH

analysis will facilitate future studies (Thomas *et al.*, 2003, 2005).

In a small study of canine leukemia, cytogenetic abnormalities did not correlate with survival (Grindem and Buoen, 1986). Similarly, a small study of feline leukemia found no relationship between cytogenetic abnormalities and prognosis (Grindem and Buoen, 1989). In a study of the cytogenetics of canine lymphoma, dogs with tumors having trisomy 13 had a significantly longer median survival time compared to dogs with tumors having other chromosomal aberrations (Hahn *et al.*, 1994). Further studies are needed to determine the prognostic importance of chromosomal aberrations in veterinary oncology.

## VIII. MOLECULAR ONCOLOGY

The literature detailing the application of molecular biology techniques in human clinical oncology is vast. Not only have methods studying alterations in gene expression and DNA mutations contributed greatly to the understanding of cancer biology, they also are useful for defining subgroups of patients with similar histology yet different prognoses, identifying patients that will benefit from targeted therapy, and predicting the risk for toxicity from treatment (Khanna and Helman, 2006). A complete review of molecular biology applications in oncology is beyond the scope of this chapter, and they are reviewed elsewhere (Costa and Lizardi, 2005). Canine mast cell tumors illustrate the potential of molecular techniques to advance veterinary oncology. Mutations, notably tandem duplications in exons 11 and 12, have been discovered in the protooncogene *c-kit* of malignant canine mast cells (London *et al.*, 1999). These changes can lead to the constitutive activation of Kit, a type 3 receptor tyrosine kinase, in the absence of its ligand, stem cell factor. Dysregulation of Kit may play a role in the uncontrolled growth or inappropriate survival of canine mast cells, potentially leading to mast cell tumor formation. These observations led to *in vitro* studies of tyrosine kinase inhibitors in canine mast cell tumors, which showed promise as targeted therapeutic agents for tumors with Kit dysregulation (Liao *et al.*, 2002). These targeted inhibitors then entered clinical trials in veterinary medicine (London *et al.*, 2003; Pryer *et al.*, 2003). Although the presence of *c-kit* mutations does not predict biological behavior of canine mast cell tumors (Downing *et al.*, 2002), cytoplasmic immunoreactivity with anti-Kit (CD 117) antibodies does appear to predict local recurrence and survival time (Preziosi *et al.*, 2004; Webster *et al.*, 2004).

## IX. PROTEOMICS, GENOMICS, METABOLOMICS

The advent of sophisticated methods for protein separation and rapid identification has provided the ability for researchers to study global patterns of protein and gene

expression or activity in metabolic pathways, in emerging disciplines known as proteomics, genomics, and metabolomics. The applications of proteomics to veterinary medicine have revealed a series of fucosylated proteins, including CD44 and E-selectin, that are elevated in dogs with lymphoma and decrease during the course of chemotherapy treatment (Xiong *et al.*, 2003). With the completion of the sequencing of the canine genome, a microarray is being developed to study the changes in tumor gene expression in canine tumors (Thomas *et al.*, 2003), which may lead to improved early diagnosis methods and targeted therapeutic strategies. These technologies are not yet ready for widespread clinical use, in part because of the challenges of analyzing the massive amounts of data generated and the persistent concerns about reproducibility of results. Despite these challenges, the “-omics” have tremendous potential to become rapid, high-throughput systems for identifying candidate tumor markers for more careful study. See Chapter 5 for more detailed information about proteomics.

## REFERENCES

- Ayl, R. D., Couto, C. G., Hammer, A. S., Weisbrode, S., Ericson, J. G., and Mathes, L. (1992). Correlation of DNA ploidy to tumor histologic grade, clinical variables, and survival in dogs with mast cell tumors. *Vet. Pathol.* **29**, 386–390.
- Barakat, M. T., Meeran, K., and Bloom, S. R. (2004). Neuroendocrine tumours. *Endocr. Relat. Cancer* **11**, 1–18.
- Barnhart, K. F., Wojcieszyn, J., and Storts, R. W. (2002). Immunohistochemical staining patterns of canine meningiomas and correlation with published immunophenotypes. *Vet. Pathol.* **39**, 311–321.
- Barthez, P. Y., Marks, S. L., Woo, J., Feldman, E. C., and Matteucci, M. (1997). Pheochromocytoma in dogs: 61 cases (1984–1995). *J. Vet. Int. Med.* **11**, 272–278.
- Barton, M. H., Sharma, P., LeRoy, B. E., and Howerth, E. W. (2004). Hypercalcemia and high serum parathyroid hormone-related protein concentration in a horse with multiple myeloma. *J. Am. Vet. Med. Assoc.* **225**(376), 409–413.
- Bell, F. W., Klausner, J. S., Hayden, D. W., Lund, E. M., Liebenstein, B. B., Feeney, D. A., Johnston, S. D., Shivers, J. L., Ewing, C. M., and Isaacs, W. B. (1995). Evaluation of serum and seminal plasma markers in the diagnosis of canine prostatic disorders. *J. Vet. Intern. Med.* **9**, 149–153.
- Bolliger, A. P., Graham, P. A., Richard, V., Rosol, T. J., Nachreiner, R. F., and Refsal, K. R. (2002). Detection of parathyroid hormone-related protein in cats with humoral hypercalcemia of malignancy. *Vet. Clin. Pathol.* **31**, 3–8.
- Bolon, B., Calderwood Mays, M. B., and Hall, B. J. (1990). Characteristics of canine melanomas and comparison of histology and DNA ploidy to their biologic behavior. *Vet. Pathol.* **27**, 96–102.
- Boord, M., and Griffin, C. (1999). Progesterone secreting adrenal mass in a cat with clinical signs of hyperadrenocorticism. *J. Am. Vet. Med. Assoc.* **214**, 666–669.
- Bostock, D. E., Crocker, J., Harris, K., and Smith, P. (1989). Nucleolar organiser regions as indicators of post-surgical prognosis in canine spontaneous mast cell tumours. *Br. J. Cancer* **59**, 915–918.



- Bostock, D. E., and Dye, M. T. (1979). Prognosis after surgical excision of fibrosarcomas in cats. *J. Am. Vet. Med. Assoc.* **175**, 727–728.
- Breitschwerdt, E. B., Woody, B. J., Zerbe, C. A., De Buysscher, E. V., and Barta, O. (1987). Monoclonal gammopathy associated with naturally occurring canine ehrlichiosis. *J. Vet. Intern. Med.* **1**, 2–9.
- Brockus, C. W., and Myers, R. K. (2004). Multifocal rhabdomyosarcomas within the tongue and oral cavity of a dog. *Vet. Pathol.* **41**, 273–274.
- Campbell, L. J. (2005). Cytogenetics of lymphomas. *Pathology* **37**, 493–507.
- Cangul, I. T., Wijnen, M., Van Garderen, E., and van den Ingh, T. S. (2002). Clinico-pathological aspects of canine cutaneous and mucocutaneous plasmacytomas. *J. Vet. Med. A Physiol. Pathol. Clin. Med.* **49**, 307–312.
- Caniatti, M., Roccabianca, P., Scanziani, E., Paltrinieri, S., and Moore, P. F. (1996). Canine lymphoma: immunocytochemical analysis of fine-needle aspiration biopsy. *Vet. Pathol.* **33**, 204–212.
- Chijiwa, K., Uchida, K., and Tateyama, S. (2004). Immunohistochemical evaluation of canine peripheral nerve sheath tumors and other soft tissue sarcomas. *Vet. Pathol.* **41**, 307–318.
- Cho, D., Di Blasio, C. J., Rhee, A. C., and Kattan, M. W. (2003). Prognostic factors for survival in patients with hormone-refractory prostate cancer (HRPC) after initial androgen deprivation therapy (ADT). *Urol. Oncol.* **21**, 282–291.
- Choi, C., and Kusewitt, D. F. (2003). Comparison of tyrosinase-related protein-2, S-100, and melan A immunoreactivity in canine amelanotic melanomas. *Vet. Pathol.* **40**, 713–718.
- Christman, S. A., Bailey, M. T., Wheaton, J. E., Troedsson, M. H., Ababneh, M. M., and Santschi, E. M. (1999). Dimeric inhibin concentrations in mares with granulosa-theca cell tumors. *Am. J. Vet. Res.* **60**, 1407–1410.
- Clines, G. A., and Guise, T. A. (2005). Hypercalcemia of malignancy and basic research on mechanism responsible for osteolytic and osteoblastic metastasis to bone. *Endocr. Relat. Cancer* **12**, 549–583.
- Colbatzky, F., and Hermanns, W. (1993). Acute megakaryoblastic leukemia in one cat and two dogs. *Vet. Pathol.* **30**, 186–194.
- Coleman, L. A., Erdman, S. E., Schrenzel, M. D., and Fox, J. G. (1998). Immunophenotypic characterization of lymphomas from the mediastinum of young ferrets. *Am. J. Vet. Res.* **59**, 1281–1286.
- Constantinou, J., and Feneley, M. R. (2006). PSA testing: an evolving relationship with prostate cancer screening. *Prostate Cancer Prostatic Dis.* **9**, 6–13.
- Cooper, E. H. (1988). Acute phase reactant proteins as prognostic indicators in cancer. *Tokai. J. Exp. Clin. Med.* **13**, 361–364.
- Cooper, E. H., and Stone, J. (1979). Acute phase reactant proteins in cancer. *Adv. Cancer Res.* **30**, 1–44.
- Costa, J. C., and Lizardi, P. M. (2005). Advanced molecular diagnostics. In “Cancer: Principles & Practice of Oncology” (V. T. DeVita, S. Hellman, and S. A. Rosenberg, Eds.), pp. 581–587. Lippincott Williams and Wilkins, Philadelphia.
- Culmsee, K., and Nolte, I. (2002). Flow cytometry and its application in small animal oncology. *Methods Cell Sci.* **24**, 49–54.
- Culmsee, K., Simon, D., Mischke, R., and Nolte, I. (2001). Possibilities of flow cytometric analysis for immunophenotypic characterization of canine lymphoma. *J. Vet. Med. A Physiol. Pathol. Clin. Med.* **48**, 199–206.
- Dank, G., Lucroy, M. D., Griffey, S. M., Gandour-Edwards, R., and Madewell, B. R. (2002). bcl-2 and MIB-1 labeling indexes in cats with lymphoma. *J. Vet. Intern. Med.* **16**, 720–725.
- Dawra, R. K., Sharma, O. P., Krishna, L., and Vaid, J. (1991). The enzymatic profile of urine and plasma in bovine urinary bladder cancer (enzootic bovine haematuria). *Vet. Res. Commun.* **15**, 416–421.
- Day, M. J. (1995). Immunophenotypic characterization of cutaneous lymphoid neoplasia in the dog and cat. *J. Comp. Pathol.* **112**, 79–96.
- De Matos, A. J., Lopes, C. C., Faustino, A. M., Carvalheira, J. G., Dos Santos, M. S., Rutteman, G. R., and Gartner Mde, F. (2006). MIB-1 labelling indices according to clinico-pathological variables in canine mammary tumours: a multivariate study. *Anticancer Res.* **26**, 1821–1826.
- De Vico, G., and Maiolino, P. (1997). Prognostic value of nuclear morphometry in feline mammary carcinomas. *J. Comp. Pathol.* **117**, 99–105.
- Diem, H., Fateh-Moghadam, A., and Lamerz, R. (1993). Prognostic factors in multiple myeloma: role of beta 2-microglobulin and thymidine kinase. *Clin. Investig.* **71**, 918–923.
- Dobson, J. M., Blackwood, L. B., McInnes, E. F., Bostock, D. E., Nicholls, P., Hoather, T. M., and Tom, B. D. (2001). Prognostic variables in canine multicentric lymphosarcoma. *J. Small. Anim. Pract.* **42**, 377–384.
- Doss, J. C., Grone, A., Cappen, C. C., and Rosol, T. J. (1998). Immunohistochemical localization of chromogranin A in endocrine tissues and endocrine tumors of dogs. *Vet. Pathol.* **35**, 312–315.
- Downing, G. J. (2000). Biomarkers and surrogate endpoints in clinical research: definitions and conceptual models. In “Biomarkers and Surrogate Endpoints: Clinical Research and Applications” (G. J. Downing, Ed.), pp. 1–9. Elsevier, New York.
- Downing, S., Chien, M. B., Kass, P. H., Moore, P. E., and London, C. A. (2002). Prevalence and importance of internal tandem duplications in exons 11 and 12 of c-kit in mast cell tumors of dogs. *Am. J. Vet. Res.* **63**, 1718–1723.
- Duffy, M. J. (2004). Evidence for the clinical use of tumour markers. *Ann. Clin. Biochem.* **41**, 370–377.
- Ehrhart, N., Dernell, W. S., Hoffmann, W. E., Weigel, R. M., Powers, B. E., and Withrow, S. J. (1998). Prognostic importance of alkaline phosphatase activity in serum from dogs with appendicular osteosarcoma: 75 cases (1990–1996). *J. Am. Vet. Med. Assoc.* **213**, 1002–1006.
- Elliott, D. A., Nelson, R. W., Feldman, E. C., and Neal, L. A. (1997). Glycosylated hemoglobin concentrations in the blood of healthy dogs and dogs with naturally developing diabetes mellitus, pancreatic beta-cell neoplasia, hyperadrenocorticism, and anemia. *J. Am. Vet. Med. Assoc.* **211**, 723–727.
- Eskelin, S., Pyrhonen, S., Hahka-Kemppinen, M., Tuomaala, S., and Kivela, T. (2003). A prognostic model and staging for metastatic uveal melanoma. *Cancer* **97**, 4654–4675.
- Etinger, S. N., Scase, T. J., Oberthaler, K. T., Craft, D. M., McKnight, J. A., Leibman, N. F., Charney, S. C., and Bergman, P. J. (2006). Association of argyrophilic nucleolar organizing regions, Ki-67, and proliferating cell nuclear antigen scores with histologic grade and survival in dogs with soft tissue sarcomas: 60 cases (1996–2002). *J. Am. Vet. Med. Assoc.* **228**, 1053–1062.
- Feldman, B. F., Brummerstedt, E., Larsen, L. S., and Larsen, S. (1988). Plasma fibronectin concentration associated with various types of canine neoplasia. *Am. J. Vet. Res.* **49**, 1017–1019.
- Feldman, E. C., Hoar, B., Pollard, R., and Nelson, R. W. (2005). Pretreatment clinical and laboratory findings in dogs with primary hyperparathyroidism: 210 cases (1987–2004). *J. Am. Vet. Med. Assoc.* **227**, 756–761.
- Fernandes, P. J., Modiano, J. F., Wojcieszyn, J., Thomas, J. S., Benson, P. A., Smith, R., 3rd, Avery, A. C., Burnett, R. C., Boone, L. I., Johnson, M. C., and Pierce, K. R. (2002). Use of the Cell-Dyn 3500 to predict leukemic cell lineage in peripheral blood of dogs and cats. *Vet. Clin. Pathol.* **31**, 167–182.

- Fernandez, N. J., West, K. H., Jackson, M. L., and Kidney, B. A. (2005). Immunohistochemical and histochemical stains for differentiating canine cutaneous round cell tumors. *Vet. Pathol.* **42**, 437–445.
- Foley, P., Shaw, D., Runyon, C., McConkey, S., and Ikede, B. (2000). Serum parathyroid hormone-related protein concentration in a dog with a thymoma and persistent hypercalcemia. *Can. Vet. J.* **41**, 867–870.
- Fox, D. B., Cook, J. L., Kreeger, J. M., Beissenherz, M., and Henry, C. J. (2002). Canine synovial sarcoma: a retrospective assessment of described prognostic criteria in 16 cases (1994–1999). *J. Am. Anim. Hosp. Assoc.* **38**, 347–355.
- Gabor, L. J., Canfield, P. J., and Malik, R. (1999). Immunophenotypic and histological characterisation of 109 cases of feline lymphosarcoma. *Aust. Vet. J.* **77**, 436–441.
- Garrett, P. E., and Kurtz, S. R. (1986). Clinical utility of oncofetal proteins and hormones as tumor markers. *Med. Clin. North Am.* **70**, 1295–1306.
- Garzotto, C. K., Berg, J., Hoffmann, W. E., and Rand, W. M. (2000). Prognostic significance of serum alkaline phosphatase activity in canine appendicular osteosarcoma. *J. Vet. Intern. Med.* **14**, 587–592.
- Gebhart, E. (2004). Comparative genomic hybridization (CGH): ten years of substantial progress in human solid tumor molecular cytogenetics. *Cytogenet. Genome Res.* **104**, 352–358.
- Gibson, D., Aubert, I., Woods, J. P., Abrams-Ogg, A., Kruth, S., Wood, R. D., and Bienzle, D. (2004). Flow cytometric immunophenotype of canine lymph node aspirates. *J. Vet. Intern. Med.* **18**, 710–717.
- Giraudel, J. M., Pages, J. P., and Guelfi, J. F. (2002). Monoclonal gammopathies in the dog: a retrospective study of 18 cases (1986–1999) and literature review. *J. Am. Anim. Hosp. Assoc.* **38**, 135–147.
- Go, V. L. (1976). Carcinoembryonic antigen: clinical application. *Cancer* **31**, 562–566.
- Granger, N., de Fornel, P., Devauchelle, P., Segond, S., Delisle, F., and Rosenberg, D. (2005). Plasma pro-opiomelanocortin, pro-adrenocorticotropin hormone, and pituitary adenoma size in dogs with Cushing's disease. *J. Vet. Intern. Med.* **19**, 23–28.
- Graves, T. K., and Peterson, M. E. (1994). Diagnostic tests for feline hyperthyroidism. *Vet. Clin. North Am. Small Anim. Pract.* **24**, 567–576.
- Grieco, V., Patton, V., Romussi, S., and Finazzi, M. (2003). Cytokeratin and vimentin expression in normal and neoplastic canine prostate. *J. Comp. Pathol.* **129**, 78–84.
- Grieffy, S. M., Verstrataete, F., Kraegel, S. A., Lucroy, M. D., and Madewell, B. R. (1998). Computer-assisted image analysis of intratumoral vessel density in mammary tumors from dogs. *Am. J. Vet. Res.* **59**, 1238–1242.
- Grindem, C. B. (1996). Blood cell markers. *Vet. Clin. North Am. Small Anim. Pract.* **26**, 1043–1064.
- Grindem, C. B., and Buoen, L. C. (1986). Cytogenetic analysis of leukemic cells in the dog. A report of 10 cases and a review of the literature. *J. Comp. Pathol.* **96**, 623–635.
- Grindem, C. B., and Buoen, L. C. (1989). Cytogenetic analysis in nine leukaemic cats. *J. Comp. Pathol.* **101**, 21–30.
- Groome, N. P., Illingworth, P. J., O'Brien, M., Pai, R., Rodger, F. E., Mather, J. P., and McNeilly, A. S. (1996). Measurement of dimeric inhibin B throughout the human menstrual cycle. *J. Clin. Endocrinol. Metab.* **81**, 1401–1405.
- Grootenhuys, A. J., van Sluijs, F. J., Klaij, I. A., Steenbergen, J., Timmerman, M. A., Bevers, M. M., Dieleman, S. J., and de Jong, F. H. (1990). Inhibin, gonadotrophins and sex steroids in dogs with Sertoli cell tumours. *J. Endocrinol.* **127**, 235–242.
- Hahn, K. A., Freeman, K. P., Barnhill, M. A., and Stephen, E. L. (1999). Serum alpha 1-acid glycoprotein concentrations before and after relapse in dogs with lymphoma treated with doxorubicin. *J. Am. Vet. Med. Assoc.* **214**, 1023–1025.
- Hahn, K. A., and Richardson, R. C. (1995). Detection of serum alpha-fetoprotein in dogs with naturally occurring malignant neoplasia. *Vet. Clin. Pathol.* **24**, 18–21.
- Hahn, K. A., Richardson, R. C., Hahn, E. A., and Chrisman, C. L. (1994). Diagnostic and prognostic importance of chromosomal aberrations identified in 61 dogs with lymphosarcoma. *Vet. Pathol.* **31**, 528–540.
- Hallek, M., Wanders, L., Strohmeyer, S., and Emmerich, B. (1992). Thymidine kinase: a tumor marker with prognostic value for non-Hodgkin's lymphoma and a broad range of potential clinical applications. *Ann. Hematol.* **65**, 1–5.
- Harmelin, A., Zuckerman, A., and Nyska, A. (1995). Correlation of Ag-NOR protein measurements with prognosis in canine transmissible venereal tumour. *J. Comp. Pathol.* **112**, 429–433.
- Hauser, C. A., Stockler, M. R., and Tattersall, M. H. (2006). Prognostic factors in patients with recently diagnosed incurable cancer: a systematic review. *Support Care Cancer.*
- He, Q., Zou, L., Zhang, P. A., Lui, J. X., Skog, S., and Fornander, T. (2000). The clinical significance of thymidine kinase 1 measurement in serum of breast cancer patients using anti-TK1 antibody. *Int. J. Biol. Markers* **15**, 139–146.
- Hellmen, E., Bergstrom, R., Holmberg, L., Spangberg, I. B., Hansson, K., and Lindgren, A. (1993). Prognostic factors in canine mammary tumors: a multivariate study of 202 consecutive cases. *Vet. Pathol.* **30**, 20–27.
- Henson, K. L., Alleman, A. R., Cutler, T. J., Ginn, P. E., and Kelley, L. C. (1998). Regression of subcutaneous lymphoma following removal of an ovarian granulosa cell tumor in a horse. *J. Am. Vet. Med. Assoc.* **212**, 1419–1422.
- Henson, K. L., Alleman, A. R., Kelley, L. C., and Mahaffey, E. A. (2000). Immunohistochemical characterization of estrogen and progesterone receptors in lymphoma of horses. *Vet. Clin. Pathol.* **29**, 40–46.
- Hill, K. E., Scott-Moncrieff, J. C., Koshko, M. A., Glickman, L. T., Glickman, N. W., Nelson, R. W., Blevins, W. E., and Oliver, J. W. (2005). Secretion of sex hormones in dogs with adrenal dysfunction. *J. Am. Vet. Med. Assoc.* **226**, 556–561.
- Hirschberger, J., and Pusch, S. (1996). Fibronectin concentrations in pleural and abdominal effusions in dogs and cats. *J. Vet. Intern. Med.* **10**, 321–325.
- Hoque, S., Senba, H., Tsunoda, N., Derar, R. I., Watanabe, G., Taya, K., Osawa, T., and Miyake, Y. (2003). Endocrinological changes before and after removal of the granulosa theca cell tumor (GTCT) affected ovary in 6 mares. *J. Vet. Med. Sci.* **65**, 887–891.
- Illanes, O. G. (2002). Juvenile parameningeal rhabdomyosarcoma in a dog causing unilateral denervation atrophy of masticatory muscles. *J. Comp. Pathol.* **126**, 303–337.
- Illera, J. C., Perez-Alenza, M. D., Nieto, A., Jimenez, M. A., Silvan, G., Dunner, S., and Pena, L. (2006). Steroids and receptors in canine mammary cancer. *Steroids* **71**, 541–548.
- Jaeschke, R., Guyatt, G., and Lijmer, J. (2002). Diagnostic tests. In "Users' Guide to the Medical Literature: A Manual for Evidence-Based Practice" (G. Guyatt and D. Rennie, Eds.), pp. 121–140. AMA Press, Chicago.
- Jain, N. C., Madewell, B. R., Weller, R. E., and Geissler, M. C. (1981). Clinical-pathological findings and cytochemical characterization of myelomonocytic leukaemia in 5 dogs. *J. Comp. Pathol.* **91**, 17–31.

- Jubala, C. M., Wojcieszyn, J. W., Valli, V. E., Getzy, D. M., Fosmire, S. P., Coffey, D., Bellgrau, D., and Modiano, J. F. (2005). CD20 expression in normal canine B cells and in canine non-Hodgkin lymphoma. *Vet. Pathol.* **42**, 468–476.
- Kang, S. K., Park, N. Y., Cho, H. S., Shin, S. S., Kang, M. I., Kim, S. K., Hyun, C., Park, I. C., Kim, J. T., Jeong, C., Park, S. H., Park, S. J., Jeong, J. H., Kim, Y. J., Ochiai, K., Umemura, T., and Cho, K. O. (2006). Relationship between DNA ploidy and proliferative cell nuclear antigen index in canine hemangiopericytoma. *J. Vet. Diagn. Invest.* **18**, 211–214.
- Karayannopoulou, M., Koutinas, A. F., Polizopoulou, Z. S., Roubies, N., Fytianou, A., Saridomichelakis, M. N., and Kaldrymidou, E. (2003). Total serum alkaline phosphatase activity in dogs with mammary neoplasms: a prospective study on 79 natural cases. *J. Vet. Med. A Physiol. Pathol. Clin. Med.* **50**, 501–505.
- Kawaguchi, T. (2005). Cancer metastasis: characterization and identification of the behavior of metastatic tumor cells and the cell adhesion molecules, including carbohydrates. *Curr. Drug Targets Cardiovasc. Haematol. Disord.* **5**, 39–64.
- Kelley, L. C., and Mahaffey, E. A. (1998). Equine malignant lymphomas: morphologic and immunohistochemical classification. *Vet. Pathol.* **35**, 241–252.
- Khanna, C., and Helman, L. J. (2006). Molecular approaches in pediatric oncology. *Annu. Rev. Med.* **57**, 83–97.
- Kiupel, M., Bostock, D., and Bergmann, V. (1998). The prognostic significance of AgNOR counts and PCNA-positive cell counts in canine malignant lymphomas. *J. Comp. Pathol.* **119**, 407–418.
- Kiupel, M., Teske, E., and Bostock, D. (1999). Prognostic factors for treated canine malignant lymphoma. *Vet. Pathol.* **36**, 292–300.
- Koenig, A., Wojcieszyn, J., Weeks, B. R., and Modiano, J. F. (2001). Expression of S100a, vimentin, NSE, and melan A/MART-1 in seven canine melanoma cell lines and twenty-nine retrospective cases of canine melanoma. *Vet. Pathol.* **38**, 427–435.
- Koenig, A., Bianco, S. R., Fosmire, S., Wojcieszyn, J., and Modiano, J. F. (2002). Expression and significance of p53, rb, p21/waf-1, p16/ink-4a, and PTEN tumor suppressors in canine melanoma. *Vet. Pathol.* **39**, 458–472.
- Kuntz, C. A., Dernell, W. S., Powers, B. E., Devitt, C., Straw, R. C., and Withrow, S. J. (1997). Prognostic factors for surgical treatment of soft-tissue sarcomas in dogs: 75 cases (1986–1996). *J. Am. Vet. Med. Assoc.* **211**, 1147–1151.
- Laprie, C., Abadie, J., Amardeilh, M. F., Net, J. L., Lagadic, M., and Delverdier, M. (2001). MIB-1 immunoreactivity correlates with biologic behaviour in canine cutaneous melanoma. *Vet. Dermatol.* **12**, 139–147.
- Lautzenhiser, S. J., Walker, M. C., and Goring, R. L. (2003). Unusual IgM-secreting multiple myeloma in a dog. *J. Am. Vet. Med. Assoc.* **223**(636), 645–648.
- Lechowski, R., Jagielski, D., Moffmann-Jagielska, M., Zmudzka, M., and Winnicka, A. (2002). Alpha-fetoprotein in canine multicentric lymphoma. *Vet. Res. Comm.* **26**, 285–296.
- Lee, C. H., Kim, W. H., Lim, J. H., Kang, M. S., Kim, D. Y., and Kweon, O. K. (2004). Mutation and overexpression of p53 as a prognostic factor in canine mammary tumors. *J. Vet. Sci.* **5**, 63–69.
- Lee, J. J., Hughes, C. S., Fine, R. L., and Page, R. L. (1996). P-glycoprotein expression in canine lymphoma: a relevant, intermediate model of multidrug resistance. *Cancer* **77**, 1892–1898.
- LeRoy, B. E., Nadella, M. V., Toribio, R. E., Leav, I., and Rosol, T. J. (2004). Canine prostate carcinomas express markers of urothelial and prostatic differentiation. *Vet. Pathol.* **41**, 131–140.
- Letelier, L. M., Weaver, B., and Montori, V. (2002). Diagnosis: examples of likelihood ratios. In “Users’ Guide to the Medical Literature: A Manual for Evidence-Based Practice” (G. Guyatt and D. Rennie, Eds.), pp. 485–515. AMA Press, Chicago.
- Liao, A. T., Chien, M. B., Shenoy, N., Mendel, D. B., McMahon, G., Cherrington, J. M., and London, C. A. (2002). Inhibition of constitutively active forms of mutant kit by multitargeted indolinone tyrosine kinase inhibitors. *Blood* **100**, 585–593.
- Lipsitz, D., Higgins, R. J., Kortz, G. D., Dickinson, P. J., Bollen, A. W., Naydan, D. K., and LeCouteur, R. A. (2003). Glioblastoma multiforme: clinical findings, magnetic resonance imaging, and pathology in five dogs. *Vet. Pathol.* **40**, 659–669.
- Lohr, C. V., Teifke, J. P., Failing, K., and Weiss, E. (1997). Characterization of the proliferation state in canine mammary tumors by the standardized AgNOR method with postfixation and immunohistologic detection of Ki-67 and PCNA. *Vet. Pathol.* **34**, 212–221.
- London, C. A., Galli, S. J., Yuuki, T., Hu, Z.-Q., Helfand, S. C., and Geissler, E. N. (1999). Spontaneous canine mast cell tumors express tandem duplications in the proto-oncogene c-kit. *Exp. Hematol.* **27**, 689–697.
- London, C. A., Hannah, A. L., Zadovskaya, R., Chien, M. B., Kollias-Baker, C., Rosenberg, M., Downing, S., Post, G., Boucher, J., Shenoy, N., Mendel, D. B., McMahon, G., and Cherrington, J. M. (2003). Phase I dose-escalating study of SU11654, a small molecule receptor tyrosine kinase inhibitor, in dogs with spontaneous malignancies. *Clin. Cancer Res.* **9**, 2755–2768.
- Loste, A., Marca, M. C., Perez, M., and Unzueta, A. (2001). Clinical value of fructosamine measurements in non-healthy dogs. *Vet. Res. Commun.* **25**, 109–115.
- Lowseth, L. A., Gillett, N. A., Chang, I. Y., Muggenburg, B. A., and Boecker, B. B. (1991). Detection of serum alpha-fetoprotein in dogs with hepatic tumors. *J. Am. Vet. Med. Assoc.* **199**, 735–741.
- Lurie, D. M., Lucroy, M. D., Griffey, S. M., Simonson, E., and Madewell, B. R. (2004). T-cell-derived malignant lymphoma in the boxer breed. *Vet. Comp. Oncol.* **2**, 171–175.
- Mahaffey, E. A., Brown, T. P., Duncan, J. R., Latimer, K. S., and Brown, S. A. (1987). Basophilic leukaemia in a dog. *J. Comp. Pathol.* **97**, 393–399.
- Mahmoud, F. A., and Rivera, N. I. (2002). The role of C-reactive protein as a prognostic indicator in advanced cancer. *Curr. Oncol. Rep.* **4**, 245–250.
- Marca, M. C., Loste, A., Unzueta, A., and Perez, M. (2000). Blood glycosylated hemoglobin evaluation in sick dogs. *Can. J. Vet. Res.* **64**, 141–144.
- Martin De Las Mulas, J., Millan, Y., Ruiz-Villamor, E., Bautista, M. J., Rollon, E., and Espinosa De Los Monteros, A. (1999). Apoptosis and mitosis in tumours of the skin and subcutaneous tissues of the dog. *Res. Vet. Sci.* **66**, 139–146.
- Matos, A. J., Faustino, A. M., Lopes, C., Rutteman, G. R., and Gartner, F. (2006). Detection of lymph node micrometastases in malignant mammary tumours in dogs by cytokeratin immunostaining. *Vet. Rec.* **158**, 626–630.
- Mazzei, M., Millanta, F., Citi, S., Lorenzi, D., and Poli, A. (2002). Haemangiopericytoma: histological spectrum, immunohistochemical characterization and prognosis. *Vet. Dermatol.* **13**, 15–21.
- Medan, M. S., Nambo, Y., Nagamine, N., Shinbo, H., Watanabe, G., Groome, N., and Taya, K. (2004). Plasma concentrations of ir-inhibin, inhibin A, inhibin pro-alphaC, FSH, and estradiol-17beta during estrous cycle in mares and their relationship with follicular growth. *Endocrine* **25**, 7–14.

- Meinecke, B., and Gips, H. (1987). Steroid hormone secretory patterns in mares with granulosa cell tumours. *Zentralbl. Veterinarmed. A* **34**, 545–560.
- Mellanby, R. J., and Herrtage, M. E. (2002). Insulinoma in a normoglycaemic dog with low serum fructosamine. *J. Small. Anim. Pract.* **43**, 506–508.
- Melzer, K., Guscetti, F., Rohrer Bley, C., Sumova, A., Roos, M., and Kaser-Hotz, B. (2006). Ki67 reactivity in nasal and periocular squamous cell carcinomas in cats treated with electron beam radiation therapy. *J. Vet. Intern. Med.* **20**, 676–681.
- Merryman, J. I., Buckles, E. L., Bowers, G., and Neilsen, N. R. (1999). Overexpression of c-Ras in hyperplasia and adenomas of the feline thyroid gland: an immunohistochemical analysis of 34 cases. *Vet. Pathol.* **36**, 117–124.
- Meyers, N. C., Andrews, G. A., and Chard-Bergstrom, C. (1997). Chromogranin A plasma concentration and expression in pancreatic islet cell tumors of dogs and cats. *Am. J. Vet. Res.* **58**, 615–620.
- Millanta, F., Fratini, F., Corazza, M., Castagnaro, M., Zappulli, V., and Poli, A. (2002). Proliferation activity in oral and cutaneous canine melanocytic tumours: correlation with histological parameters, location, and clinical behaviour. *Res. Vet. Sci.* **73**, 45–51.
- Milne, B. S., Hoather, T., O'Brien, P. C., Yang, F., Ferguson-Smith, M. A., Dobson, J., and Sargan, D. (2004). Karyotype of canine soft tissue sarcomas: a multi-colour, multi-species approach to canine chromosome painting. *Chromosome Res.* **12**, 825–835.
- Modiano, J. F., Smith, R., 3rd, Wojcieszyn, J., Thomas, J. S., Rosenbaum, B. A., Ball, C., Nicholds, E. A., Anthony, M. A., and Barton, C. L. (1998). The use of cytochemistry, immunophenotyping, flow cytometry, and in vitro differentiation to determine the ontogeny of a canine monoblastic leukemia. *Vet. Clin. Pathol.* **27**, 40–49.
- Morrell, C. N., Volk, M. V., and Mankowski, J. L. (2002). A carcinoid tumor in the gallbladder of a dog. *Vet. Pathol.* **39**, 756–758.
- Moss, E. L., Hollingworth, J., and Reynolds, T. M. (2005). The role of CA125 in clinical practice. *J. Clin. Pathol.* **58**, 308–312.
- Mundle, S. D., and Sokolova, I. (2004). Clinical implications of advanced molecular cytogenetics in cancer. *Expert Rev. Mol. Diagn.* **4**, 71–81.
- Narayanan, S. (1994). Sialic acid as a tumor marker. *Ann. Clin. Lab. Sci.* **24**, 376–384.
- Ogawa, M., Ikeuchi, K., Watanabe, M., Etoh, K., Kobayashi, T., Takao, Y., Anazawa, S., and Yamazaki, Y. (2005). Expression of matrix metalloproteinase 7, laminin and type IV collagen-associated liver metastasis in human colorectal cancer: immunohistochemical approach. *Hepatogastroenterology* **52**, 875–880.
- Ohta, G., Sakai, H., Kachi, S., Hirata, A., Yonemaru, K., Kitajima, A., Yanai, T., and Masegi, T. (2004). Assessment of proliferative potentials of canine osteosarcomas and chondrosarcomas by MIB-1 immunohistochemistry and bromodeoxyuridine incorporation. *J. Comp. Pathol.* **131**, 18–27.
- Park, I. J., Kim, H. C., Yu, C. S., Yoo, J. H., and Kim, J. C. (2005). Cutoff values of preoperative s-CEA levels for predicting survivals after curative resection of colorectal cancer. *J. Korean Med. Sci.* **20**, 624–627.
- Patterson-Kane, J. C., Kugler, B. P., and Francis, K. (2004). The possible prognostic significance of immunophenotype in feline alimentary lymphoma: a pilot study. *J. Comp. Pathol.* **130**, 220–222.
- Peterson, M. E., and Becker, D. V. (1995). Radioiodine treatment of 524 cats with hyperthyroidism. *J. Am. Vet. Med. Assoc.* **207**, 1422–1428.
- Peterson, M. E., Melian, C., and Nichols, R. (2001). Measurement of serum concentrations of free thyroxine, total thyroxine, and total triiodothyronine in cats with hyperthyroidism and cats with nonthyroidal disease. *J. Am. Vet. Med. Assoc.* **218**, 529–536.
- Peña, L., Casaña, M., Sanchez, M. A., Rodriguez, A., and Flores, J. M. (1995). Immunocytochemical study of type IV collage and laminin in canine mammary tumours. *Zentralbl. Veterinarmed. A* **42**, 50–61.
- Phillips, B. S., Kass, P. H., Naydan, D. K., Winthrop, M. D., Griffey, S. M., and Madewell, B. R. (2000). Apoptotic and proliferation indexes in canine lymphoma. *J. Vet. Diagn. Invest* **12**, 111–117.
- Poli, A., Arispici, M., Camillo, F., and Corazza, M. (1986). Increase of serum lipid-associated sialic acid concentration in dogs with neoplasms. *Am. J. Vet. Res.* **47**, 607–609.
- Ponce, F., Magnol, J. P., Ledieu, D., Marchal, T., Turinelli, V., Chalvet-Monfray, K., and Fournel-Fleury, C. (2004). Prognostic significance of morphological subtypes in canine malignant lymphomas during chemotherapy. *Vet. J.* **167**, 158–166.
- Pressler, B. M., Rotstein, D. S., Law, J. M., Rosol, T. J., LeRoy, B., Keene, B. W., and Jackson, M. W. (2002). Hypercalcemia and high parathyroid hormone-related protein concentration associated with malignant melanoma in a dog. *J. Am. Vet. Med. Assoc.* **221**(240), 263–265.
- Preziosi, R., Morini, M., and Sarli, G. (2004). Expression of the KIT protein (CD117) in primary cutaneous mast cell tumors of the dog. *J. Vet. Diagn. Invest.* **16**, 554–561.
- Preziosi, R., Sarli, G., Benazzi, C., Mandrioli, L., and Marcato, P. S. (2002). Multiparametric survival analysis of histological stage and proliferative activity in feline mammary carcinomas. *Res. Vet. Sci.* **73**, 53–60.
- Pryer, N. K., Lee, L. B., Zadovaskaya, R., Yu, X., Sukbuntherng, J., Cherrington, J. M., and London, C. A. (2003). Proof of target for SU11654: inhibition of KIT phosphorylation in canine mast cell tumors. *Clin. Cancer Res.* **9**, 5729–5734.
- Ramaiah, S. K., Seguin, M. A., Carwile, H. F., and Raskin, R. E. (2002). Biclonal gammopathy associated with immunoglobulin A in a dog with multiple myeloma. *Vet. Clin. Pathol.* **31**, 83–89.
- Raskin, R. E., and Nipper, M. N. (1992). Cytochemical staining characteristics of lymph nodes from normal and lymphoma-affected dogs. *Vet. Clin. Pathol.* **21**, 62–67.
- Rassnick, K. M., Mauldin, G. N., Moroff, S. D., Mauldin, G. E., McEntee, M. C., and Mooney, S. C. (1999). Prognostic value of argyrophilic nucleolar organizer region (AgNOR) staining in feline intestinal lymphoma. *J. Vet. Intern. Med.* **13**, 187–190.
- Rawlings, N. G., Simko, E., Bechuk, T., Caldwell, S. J., and Singh, B. (2003). Localization of integrin alpha(v)beta3 and vascular endothelial growth factor receptor-2 (KDR/Flk-1) in cutaneous and oral melanomas of dogs. *Histol. Histopathol.* **18**, 819–826.
- Roels, S., Tilmant, K., and Ducatelle, R. (1999). PCNA and Ki67 proliferation markers as criteria for prediction of clinical behaviour of melanocytic tumours in cats and dogs. *J. Comp. Pathol.* **121**, 13–24.
- Roels, S., Tilmant, K., Van Daele, A., Van Marck, E., and Ducatelle, R. (2000a). Proliferation, DNA ploidy, p53 overexpression and nuclear DNA fragmentation in six equine melanocytic tumours. *J. Vet. Med. A. Physiol. Pathol. Clin. Med.* **47**, 439–448.
- Roels, S. L., Van Daele, A. J., Van Marck, E. A., and Ducatelle, R. V. (2000b). DNA ploidy and nuclear morphometric variables for the evaluation of melanocytic tumors in dogs and cats. *Am. J. Vet. Res.* **61**, 1074–1109.
- Rosenthal, K. L., and Peterson, M. E. (1996). Evaluation of plasma androgen and estrogen concentrations in ferrets with hyperadrenocorticism. *J. Am. Vet. Med. Assoc.* **209**, 1097–1102.
- Rosol, T. J., Nagode, L. A., Couto, C. G., Hammer, A. S., Chew, D. J., Peterson, J. L., Ayl, R. D., Steinmeyer, C. L., and Capen, C. C. (1992). Parathyroid hormone (PTH)-related protein, PTH, and

- 1,25-dihydroxyvitamin D in dogs with cancer-associated hypercalcemia. *Endocrinology* **131**, 1157–1164.
- Rosol, T. J., Steinmeyer, C. L., McCauley, L. K., Grone, A., DeWille, J. W., and Capen, C. C. (1995). Sequences of the cDNAs encoding canine parathyroid hormone-related protein and parathyroid hormone. *Gene* **160**, 241–243.
- Sako, T., Uchida, E., Okamoto, M., Yamamoto, E., Kagawa, Y., Yoshino, T., Hirayama, K., and Taniyama, H. (2003). Immunohistochemical evaluation of a malignant intestinal carcinoid in a dog. *Vet. Pathol.* **40**, 212–215.
- Sako, T., Shimoyama, Y., Akihara, Y., Ohmachi, T., Yamashita, K., Kadosawa, T., Nakade, T., Uchida, E., Okamoto, M., Hirayama, K., and Taniyama, H. (2005). Neuroendocrine carcinoma in the nasal cavity of ten dogs. *J. Comp. Pathol.* **133**, 155–163.
- Sarli, G., Benazzi, C., Preziosi, R., Della Salda, L., Bettini, G., and Marcato, P. S. (1999). Evaluating mitotic activity in canine and feline solid tumors: standardizing the parameter. *Biotech. Histochem.* **74**, 64–76.
- Sarli, G., Preziosi, R., Benazzi, C., Bazzo, R., Mandrioli, L., and Marcato, P. S. (2003). Rate of apoptosis in feline mammary tumors is not predictive of postsurgical survival. *J. Vet. Diagn. Invest.* **15**, 115–122.
- Sarli, G., Preziosi, R., Benazzi, C., Castellani, G., and Marcato, P. S. (2002). Prognostic value of histologic stage and proliferative activity in canine malignant mammary tumors. *J. Vet. Diagn. Invest.* **14**, 25–34.
- Sato, T., Aoki, K., Shibuya, H., Machida, T., and Watari, T. (2003). Leiomyosarcoma of the kidney in a dog. *J. Vet. Med. A Physiol. Pathol. Clin. Med.* **50**, 366–369.
- Scarlett, J. M. (1994). Epidemiology of thyroid diseases of dogs and cats. *Vet. Clin. North Am. Small Anim. Pract.* **24**, 477–486.
- Scase, T. J., Edwards, D., Miller, J., Henley, W., Smith, K., Blunden, A., and Murphy, S. (2006). Canine mast cell tumors: correlation of apoptosis and proliferation markers with prognosis. *J. Vet. Intern. Med.* **20**, 151–158.
- Schwyn, U., Crompton, N. E., Blattmann, H., Hauser, B., Klink, B., Parvis, A., Ruslander, D., and Kaser-Hotz, B. (1998). Potential tumour doubling time: determination of Tpot for various canine and feline tumours. *Vet. Res. Commun.* **22**, 233–247.
- Shirit, D., Zingerman, B., Shirit, A. B., Shlomi, D., and Kramer, M. R. (2005). Diagnostic value of CYFRA 21-1, CEA, CA 19-9, CA 15-3, and CA 125 assays in pleural effusions: analysis of 116 cases and review of the literature. *Oncologist* **10**, 501–507.
- Simoes, J. P., Schoning, P., and Butine, M. (1994). Prognosis of canine mast cell tumors: a comparison of three methods. *Vet. Pathol.* **31**, 637–647.
- Spangler, W. L., and Kass, P. H. (2006). The histologic and epidemiologic bases for prognostic considerations in canine melanocytic neoplasia. *Vet. Pathol.* **43**, 136–149.
- Stabenfeldt, G. H., Hughes, J. P., Kennedy, P. C., Meagher, D. M., and Neely, D. P. (1979). Clinical findings, pathological changes and endocrinological secretory patterns in mares with ovarian tumours. *J. Reprod. Fertil. Suppl.* 277–285.
- Strefezzi Rde, F., Xavier, J. G., and Catao-Dias, J. L. (2003). Morphometry of canine cutaneous mast cell tumors. *Vet. Pathol.* **40**, 268–275.
- Sueiro, F. A., Alessi, A. C., and Vassallo, J. (2004). Canine lymphomas: a morphological and immunohistochemical study of 55 cases, with observations on p53 immunopositivity. *J. Comp. Pathol.* **131**, 207–213.
- Tecles, F., Spiranelli, E., Bonfanti, U., Ceron, J. J., and Paltrinieri, S. (2005). Preliminary studies of serum acute-phase protein concentrations in hematologic and neoplastic diseases of the dog. *J. Vet. Intern. Med.* **19**, 865–870.
- Teske, E., Rutteman, G. R., Kuipers-Dijkshoorn, N. J., van Dierendonck, J. H., van Heerde, P., and Cornelisse, C. J. (1993). DNA ploidy and cell kinetic characteristics in canine non-Hodgkin's lymphoma. *Exp. Hematol.* **21**, 579–584.
- Teske, E., van Heerde, P., Rutteman, G. R., Kurzman, I. D., Moore, P. F., and MacEwen, E. G. (1994). Prognostic factors for treatment of malignant lymphoma in dogs. *J. Am. Vet. Med. Assoc.* **205**, 1722–1728.
- Theon, A. P., Lecouteur, R. A., Carr, E. A., and Griffey, S. M. (2000). Influence of tumor cell proliferation and sex-hormone receptors on effectiveness of radiation therapy for dogs with incompletely resected meningiomas. *J. Am. Vet. Med. Assoc.* **216**, 684–685, 701–707.
- Thomas, R., Fiegler, H., Ostrander, E. A., Galibert, F., Carter, N. P., and Breen, M. (2003). A canine cancer-gene microarray for CGH analysis of tumors. *Cytogenet. Genome Res.* **102**, 254–260.
- Thomas, R., Scott, A., Langford, C. F., Fosmire, S. P., Jubala, C. M., Lorentzen, T. D., Hitte, C., Karlsson, E. K., Kirkness, E., Ostrander, E. A., Galibert, F., Lindblad-Toh, K., Modiano, J. F., and Breen, M. (2005). Construction of a 2-Mb resolution BAC microarray for CGH analysis of canine tumors. *Genome Res.* **15**, 1831–1837.
- Thougaard, A. V., Hellmen, E., and Jensen, A. L. (1998). Total serum sialic acid is a general disease marker rather than a specific tumour marker in dogs. *Zentralbl. Veterinarmed. A* **45**, 471–479.
- “Users’ Guide to the Medical Literature: A Manual for Evidence-Based Clinical Practice.” (2002). AMA Press, Chicago.
- Vail, D. M., Kisseberth, W. C., Obradovich, J. E., Moore, F. M., London, C. A., MacEwen, E. G., and Ritter, M. A. (1996). Assessment of potential doubling time (Tpot), argyrophilic nucleolar organizer regions (AgNOR), and proliferating cell nuclear antigen (PCNA) as predictors of therapy response in canine non-Hodgkin's lymphoma. *Exp. Hematol.* **24**, 807–815.
- Vail, D. M., Moore, A. S., Ogilvie, G. K., and Volk, L. M. (1998). Feline lymphoma (145 cases): proliferation indices, cluster of differentiation 3 immunoreactivity, and their association with prognosis in 90 cats. *J. Vet. Intern. Med.* **12**, 349–354.
- van der Kolk, J. H., Wensing, T., Kalsbeek, H. C., and Breukink, H. J. (1995). Laboratory diagnosis of equine pituitary pars intermedia adenoma. *Domest. Anim. Endocrinol.* **12**, 35–39.
- Veeramani, S., Yuan, T. C., Chen, S. J., Lin, F. F., Petersen, J. E., Shaheduzzaman, S., Srivastava, S., MacDonald, R. G., and Lin, M. F. (2005). Cellular prostatic acid phosphatase: a protein tyrosine phosphatase involved in androgen-independent proliferation of prostate cancer. *Endocr. Relat. Cancer* **12**, 805–822.
- Vernau, W., Jacobs, R. M., Valli, V. E., and Heeney, J. L. (1997). The immunophenotypic characterization of bovine lymphomas. *Vet. Pathol.* **34**, 222–225.
- Verschuere, C. P., Selman, P. J., Mol, J. A., Vos, J. H., van Dijk, J. E., Sjollem, B. E., and de Vijlder, J. J. (1991). Circulating thyroglobulin measurements by homologous radioimmunoassay in dogs with thyroid carcinoma. *Acta Endocrinol. (Copenh.)* **125**, 291–298.
- von Euler, H., Einarsson, R., Olsson, U., Lagerstedt, A. S., and Eriksson, S. (2004). Serum thymidine kinase activity in dogs with malignant lymphoma: a potent marker for prognosis and monitoring the disease. *J. Vet. Intern. Med.* **18**, 696–702.
- von Euler, H. P., Ohrvik, A. B., and Eriksson, S. K. (2006). A non-radiometric method for measuring serum thymidine kinase activity in malignant lymphoma in dogs. *Res. Vet. Sci.* **80**, 17–24.

- Walter, J. (2000). A cytokeratin profile of canine epithelial skin tumours. *J. Comp. Pathol.* **122**, 278–287.
- Wang, J., Brunner, C. J., Gangopadhyay, A., Bird, A. C., and Wolfe, L. G. (1995). Detection of tumor-associated antigens in sera of canine cancer patients by monoclonal antibodies generated against canine mammary carcinoma cells. *Vet. Immunol. Immunopathol.* **48**, 193–207.
- Webster, J. D., Kiupel, M., Kaneene, J. B., Miller, R., and Yuzbasiyan-Gurkan, V. (2004). The use of KIT and tryptase expression patterns as prognostic tools for canine cutaneous mast cell tumors. *Vet. Pathol.* **41**, 371–377.
- Wiedemann, A. L., Charney, S. C., Barger, A. M., Schaeffer, D. J., and Kitchell, B. E. (2005). Assessment of corticosteroid-induced alkaline phosphatase as a prognostic indicator in canine lymphoma. *J. Small Anim. Pract.* **46**, 185–190.
- Wilcock, B. P., and Peiffer, R. L., Jr. (1986). Morphology and behavior of primary ocular melanomas in 91 dogs. *Vet. Pathol.* **23**, 418–424.
- Wilkerson, M. J., Dolce, K., Koopman, T., Shuman, W., Chun, R., Garrett, L., Barber, L., and Avery, A. (2005). Lineage differentiation of canine lymphoma/leukemias and aberrant expression of CD molecules. *Vet. Immunol. Immunopathol.* **106**, 179–196.
- Xiong, L., Andrews, D., and Regnier, F. (2003). Comparative proteomics of glycoproteins based on lectin selection and isotope coding. *J. Proteome. Res.* **2**, 618–625.
- Yamada, T., Fujita, M., Kitao, S., Ashida, Y., Nishizono, K., Tsuchiya, R., Shida, T., and Kobayashi, K. (1999). Serum alpha-fetoprotein values in dogs with various hepatic diseases. *J. Vet. Med. Sci.* **61**, 657–659.
- Yokota, H., Kumata, T., Taketaba, S., Kobayashi, T., Moue, H., Taniyama, H., Hirayama, K., Kagawa, Y., Itoh, N., Fujita, O., Nakade, T., and Yuasa, A. (2001). High expression of 92 kDa type IV collagenase (matrix metalloproteinase-9) in canine mammary adenocarcinoma. *Biochim. Biophys. Acta.* **1568**, 7–12.
- Yoshida, K., Yanai, T., Iwasaki, T., Sakai, H., Ohta, J., Kati, S., Ishikawa, K., Lackner, A. A., and Masegi, T. (1999). Proliferative potential of canine oral epulides and malignant neoplasms assessed by bromodeoxyuridine labeling. *Vet. Pathol.* **36**, 35–41.
- Zanatta, R., Abate, O., D'Angelo, A., Miniscalco, B., and Mannelli, A. (2003). Diagnostic and prognostic value of serum lactate dehydrogenase (LDH) and LDH isoenzymes in canine lymphoma. *Vet. Res. Commun.* **27(suppl 1)**, 449–452.
- Zhou, L., Liu, J., and Luo, F. (2006). Serum tumor markers for detection of hepatocellular carcinoma. *World J. Gastroenterol.* **12**, 1175–1181.
- Zuccari, D. A., Santana, A. E., Cury, P. M., and Cordeiro, J. A. (2004). Immunocytochemical study of Ki-67 as a prognostic marker in canine mammary neoplasia. *Vet. Clin. Pathol.* **33**, 23–28.
- Zwahlen, C. H., Lucroy, M. D., Kraegel, S. A., and Madewell, B. R. (1998). Results of chemotherapy for cats with alimentary malignant lymphoma: 21 cases (1993–1997). *J. Am. Vet. Med. Assoc.* **213**, 1144–1149.

# Cerebrospinal Fluid

William Vernau

*Department of Pathology, Microbiology, and Immunology  
School of Veterinary Medicine  
University of California, Davis  
Davis, California*

Karen A. Vernau

*Department of Surgical and Radiological Sciences  
School of Veterinary Medicine  
University of California, Davis  
Davis, California*

Cleta Sue Bailey

*Department of Surgical and Radiological Sciences  
School of Veterinary Medicine  
University of California, Davis  
Davis, California*

## I. INTRODUCTION

## II. FUNCTIONS OF CEREBROSPINAL FLUID

## III. CSF FORMATION, CIRCULATION, AND ABSORPTION

- A. Anatomy of Brain-Fluid Interfaces
- B. CSF Formation
- C. CSF Circulation
- D. CSF Absorption

## IV. CELLULAR COMPOSITION OF NORMAL CSF

- A. Total Erythrocyte and Nucleated Cell Count
- B. Differential Cell Count

## V. BIOCHEMICAL CONSTITUENTS OF NORMAL CSF

- A. Ontogeny of CSF
- B. Proteins in the Cerebrospinal Fluid
- C. Glucose
- D. Enzymes
- E. Neurotransmitters
- F. Other CSF Constituents
- G. Concentration Gradient along the Neuraxis

## VI. CSF COLLECTION AND ANALYTICAL TECHNIQUES

- A. Collection
- B. Physical Examination: Clarity, Color, and Viscosity
- C. Cytological Analysis
- D. Protein Analysis
- E. Antibody/Antigen Tests
- F. Microbial Tests
- G. Blood Contamination

## VII. GENERAL CHARACTERISTICS OF CSF IN DISEASE

- A. Physical Characteristics: Clarity, Color, and Viscosity
- B. Cytology
- C. Protein
- D. Antibody Titers
- E. Glucose
- F. Enzymes
- G. Other Constituents

## VIII. CHARACTERISTICS OF CSF ASSOCIATED WITH SPECIFIC DISEASES

- A. Degenerative Disorders
- B. Idiopathic Diseases
- C. Immune-Mediated Diseases
- D. Infectious Diseases
- E. Ischemic Disorders
- F. Malformations of Neural Structures
- G. Metabolic/Nutritional Disorders
- H. Miscellaneous Conditions
- I. Neoplasia
- J. Parasitic Diseases
- K. Toxicity
- L. Trauma/Compression of Neural Tissue

## REFERENCES

## I. INTRODUCTION

The analysis of cerebrospinal fluid (CSF) has been described as the central nervous system (CNS) equivalent of the complete blood count (Jamison and Lumsden, 1988), and the analogy is appropriate. CSF analysis is a general index of neurological health and often provides evidence of the presence of disease. Similar to a complete blood count, CSF analysis has reasonable sensitivity but low specificity. The possible alterations of CSF are relatively limited compared to the varieties of neurological diseases that exist (particularly if the analysis is restricted to total cell counts and total protein determination). Additionally, the type and degree of CSF abnormality seem to be related as much to the location of disease as to the cause or the severity of lesion; meningeal and paraventricular diseases generally produce greater abnormalities than deep parenchymal diseases. Previous therapy may affect the type, degree, and duration of CSF (Jamison and Lumsden, 1988) abnormalities as well. The CSF abnormalities identified are also dependent on the CSF collection site with respect to lesion location

(Thomson *et al.*, 1989, 1990). Lastly, the CSF of animals with neurological disease is not always abnormal (Tipold *et al.*, 1995). Only occasionally does CSF analysis provide a specific diagnosis (Kjeldsberg and Knight, 1993)—for example, if infectious agents (bacteria or fungi) or neoplastic cells are observed. In most situations, the chief utility of CSF analysis is to assist in the diagnostic process by excluding the likelihood of certain disease processes being present. As is the case with all tests of relatively low specificity, examination of CSF is most useful when the results are correlated with the history, clinical findings, imaging studies, and ancillary laboratory studies. As stated by Fankhauser (1962), “It is futile to make a diagnosis based solely on the CSF findings and particularly on single alterations of it. Only the entire picture of all findings linked with the other clinical symptoms is of value in reaching a diagnosis.”

## II. FUNCTIONS OF CEREBROSPINAL FLUID

Cerebrospinal fluid has four major functions: (1) physical support of neural structures, (2) excretion and “sink” action, (3) intracerebral transport, and (4) control of the chemical environment of the central nervous system. Cerebrospinal fluid provides a “water jacket” of physical support and buoyancy. When suspended in CSF, a 1500-gm brain weighs only about 50 gm. The CSF is also protective because its volume changes reciprocally with changes in the volume of intracranial contents, particularly blood. Thus, the CSF protects the brain from changes in arterial and central venous pressure associated with posture, respiration, and exertion. Acute or chronic pathological changes in intracranial contents can also be accommodated, to a point, by changes in the CSF volume (Fishman, 1992; Milhorat, 1987; Rosenberg, 1990).

The direct transfer of brain metabolites into the CSF provides excretory function. This capacity is particularly important because the brain lacks a lymphatic system. The lymphatic function of the CSF is also manifested in the removal of large proteins and cells, such as bacteria or blood cells, by bulk CSF absorption (see Section II.D). The “sink” action of the CSF arises from the restricted access of water-soluble substances to the CSF and the low concentration of these solutes in the CSF. Therefore, solutes entering the brain, as well as those synthesized by the brain, diffuse freely from the brain interstitial fluid into the CSF. Removal may then occur by bulk CSF absorption or, in some cases, by transport across the choroid plexus into the capillaries (Davson and Segal, 1996; Fishman, 1992; Milhorat, 1987; Rosenberg, 1990).

Because CSF bathes and irrigates the brain, including those regions known to participate in endocrine functions, the suggestion has been made that CSF may serve as a vehicle for intracerebral transport of biologically active substances. For example, hormone releasing factors, formed in the hypothalamus and discharged into the CSF of the third ventricle, may be carried in the CSF to their effective sites in the median eminence. The CSF may

**TABLE 26-1** Composition of the Brain–Fluid Interfaces

Interface	Cell Type	Junction Type
Blood-brain	Brain capillary endothelium	Tight junction
Blood-CSF Blood-CSF CSF-blood	Choroid plexus epithelium Arachnoid cells Arachnoid villi	Apical tight junction Tight junction Valve
CSF-brain	Ependyma Pia mater	Gap junction Gap junction

*Modified from Rosenberg (1990).*

also be the vehicle for intracerebral transport of opiates and other neuroactive substances (Davson and Segal, 1996; Fishman, 1992; Milhorat, 1987; Rosenberg, 1990).

An essential function of CSF is the provision and maintenance of an appropriate chemical environment for neural tissue. Anatomically, the interstitial fluid of the central nervous system and the CSF are in continuity (see Section II.A); therefore, the chemical composition of the CSF reflects and affects the cellular environment. The composition of the CSF (and the interstitial fluid) is controlled by cells forming the interfaces, or barriers, between the “body” and the neural tissue. These semipermeable interfaces, the blood-brain barrier, the blood-CSF barrier, and the CSF-brain barrier, control the production and absorption of CSF and provide a fluid environment that is relatively stable despite changes in the composition of blood (Davson and Segal, 1996; Fishman, 1992; Milhorat, 1987; Rosenberg, 1990).

## III. CSF FORMATION, CIRCULATION, AND ABSORPTION

The brain (and the spinal cord) as an organ is isolated in many ways from the body and the systemic circulation. This isolation is accomplished anatomically by several interfaces between brain tissue and systemic fluids (Table 26-1). At these interfaces, selective carriers and ion pumps transport electrolytes and essential nutrients and thereby control the brain’s microenvironment. A substantial portion of this control is achieved through the formation, circulation, and absorption of CSF at these brain-fluid interfaces (Davson and Segal, 1996; Fishman, 1992; Milhorat, 1987; Rosenberg, 1990).

### A. Anatomy of Brain-Fluid Interfaces

#### 1. Blood-Brain Barrier

The important blood-brain (and blood-spinal cord) interface is formed by the endothelial cells of the intraparenchymal capillaries. In most areas of the brain and spinal cord,



the capillary endothelium differs from that of other body tissues in the following ways: (1) the absence of fenestrae, (2) the presence of tight junctions between adjacent cells, (3) a lower number of pinocytotic pits and vesicles, (4) a higher number of mitochondria, and (5) closely applied, perivascular, astrocytic foot processes. These features result in the capillary endothelium being a selective barrier—the blood-brain barrier—that regulates the entry, and probably the exit, of biologically important substances and aids in the maintenance of a precise, stable environment for the neural tissues (Davson and Segal, 1996; Fishman, 1992; Milhorat, 1987; Rosenberg, 1990).

## 2. Blood-CSF Barrier

The epithelial cells of the circumventricular organs form one part of the blood-CSF interface. The circumventricular organs, which include the four choroid plexuses, the median eminence, the neural lobe of the hypophysis, and other specialized areas, border the brain ventricles and are involved with specific secretory activities that appear to require a direct contact with plasma. The capillaries within these organs are fenestrated, similar to capillaries in other organs of the body. Overlying each of the organs are specialized epithelial cells joined by intercellular tight junctions at their apical (ventricular) borders. These epithelial cells also are characterized by an abundance of intracellular organelles and lysosomes. These organelles are probably an important aspect of the barrier and secretory functions of these cells (Davson and Segal, 1996; Fishman, 1992; Milhorat, 1987; Rosenberg, 1990). The choroid plexuses are the major source of CSF. They are formed by evaginations of the ependyma and the pial blood vessels into the ventricles, and they consist of a single row of cuboidal, specialized epithelial cells thrown into villi around a core of blood vessels and connective tissue. The apical (ventricular) surface of the epithelial cells has a brush border of microvilli with occasional cilia. The basal and lateral cell surfaces have numerous infoldings. Overall, the structure of these cells resembles other epithelia specialized for fluid transport, such as proximal renal tubular epithelium (Davson and Segal, 1996; Fishman, 1992; Milhorat, 1987; Rosenberg, 1990). Autonomic nerve terminals have also been identified in the choroid plexus, but their function is unclear (Fishman, 1992; Nilsson *et al.*, 1992).

The second part of the blood-CSF interface is formed by the arachnoid membrane at the arachnoid villi. These villi are microscopic evaginations of the arachnoid membrane into the lumen of the dural sinuses. The barrier function of these arachnoid cells is demonstrated by their tight junctions. Their transport function is indicated by giant intracellular vacuoles, some of which have both basal and apical openings, and pinocytotic vesicles. The sinus surface of a villus is covered by sinus endothelium (Milhorat, 1987; Rosenberg, 1990). Endothelium-lined channels may link directly with the subarachnoid space (Bell, 1995; Davson and Segal, 1996).

Arachnoid villi are not limited to intracranial venous sinuses but also are present at the spinal nerve roots penetrating into the spinal veins (Bell, 1995; Milhorat, 1987).

## 3. CSF-Brain Interface

The extensive CSF-brain (and spinal cord) interface consists of the ependyma within the cavities of the central nervous system and the pia mater covering the central nervous system. These two layers are each composed of a single layer of cells joined by gap junctions. The ependyma and the pia mater are not important permeability barriers; the CSF (ventricular and subarachnoid) and the brain interstitial fluid are directly continuous (Davson and Segal, 1996; Milhorat, 1987).

## B. CSF Formation

### 1. Choroidal and Extrachoroidal Formation

Cerebrospinal fluid is formed principally by the choroid plexuses, with a smaller amount formed extrachoroidally (Davson and Segal, 1996; Milhorat, 1987). Choroidal formation involves two processes that occur in series; first is filtration across the choroidal capillary wall, and second is secretion by the choroidal epithelium. Within the choroid plexus, hydrostatic pressure of the choroidal capillaries initiates the transfer of water and ions to the interstitial fluid and then to the choroidal epithelium. Water and ions are then transferred into the ventricles either by (1) intracellular movement across the epithelial membranes, or (2) intercellular movement across the apical tight junctions between epithelial cells. Both of these processes probably depend on ion pumps. Secretion of CSF results from the active transport of sodium, which is dependent on the membrane-bound, sodium-potassium activated ATPase present at the apical (ventricular) surface of the choroidal epithelium (Davson and Segal, 1996; Rosenberg, 1990). The presence of autonomic nerve terminals in the choroid plexus suggests a neural control of CSF secretion. However, the functional role of this innervation in normal and pathological conditions is unknown (Fishman, 1992; Nilsson *et al.*, 1992).

Spurred primarily by clinical evidence that excision of the choroid plexus did not benefit human patients with hydrocephalus, experimental evidence now supports the existence of an extrachoroidal source of CSF. The diffusion of brain interstitial fluid across the ependyma or pia mater is the apparent source of this extrachoroidal CSF component. Formation of the interstitial fluid is thought to occur by active transport processes (secretion) at the cerebral capillaries, but an alternative theory proposes passive permeability of the capillary endothelium and active transport by the surrounding astrocytes (Milhorat, 1987; Rosenberg, 1990). The relative contributions of choroidal and extrachoroidal sources to CSF in normal and pathological conditions are not certain. Some investigators report the choroid plexus to be the major if not the sole source of CSF; whereas others conclude

**TABLE 26-2** Rate of CSF Formation in Various Species<sup>a</sup>

Species	Rate ( $\mu\text{l}/\text{min}$ )
Mouse	0.325
Rat	2.1–5.4
Guinea pig	3.5
Rabbit	10
Cat	20–22
Dog	47–66
Sheep	118
Goat	164
Calf <sup>b</sup>	290
Monkey	28.6–41
Human being	350–370

Modified from Davson and Segal (1996).

<sup>a</sup> Estimated by ventriculo-cisternal perfusion.

<sup>b</sup> Calhoun et al. (1967).

that at least one-third of newly formed CSF is extrachoroidal (Davson and Segal, 1996; Milhorat, 1987).

## 2. Rate of CSF Formation

Regardless of the amount of extrachoroidal formation, the rate of CSF formation is closely correlated to the weight of the choroid plexus and varies among species (Table 26-2) (Cserr, 1971; Welch, 1975). Increases and decreases in formation rate have been achieved experimentally, but the general tendency is for the formation rate to remain relatively constant. The formation rate directly parallels the rate of sodium exchange, which is linked to the bicarbonate ion. The enzyme carbonic anhydrase plays an important role because it provides the bicarbonate. Inhibition of carbonic anhydrase slows (but does not abolish) sodium, bicarbonate, and chloride flow, resulting in a reduction of CSF secretion (Maren, 1992). Several drugs and conditions inhibit CSF production (Table 26-3), but their clinical utility is limited either by their time frame of action or toxicity (Davson and Segal, 1996; Pollay, 1992; Rosenberg, 1990).

Moderate variations in intracranial pressure probably do not affect CSF formation. However, studies of chronically hydrocephalic animals have shown a reduction of CSF formation with increasing intraventricular pressure. The secretion process may also be affected by chronically increased intracranial pressure (Fishman, 1992).

## C. CSF Circulation

Cerebrospinal fluid flows in bulk from sites of production to sites of absorption. Fluid formed in the lateral ventricles

**TABLE 26-3** Factors Influencing CSF Formation

Effect	Substance or Condition	Site of Action
Increase	Cholera toxin	cAMP
	Phenylephrine <sup>b</sup>	Cholinergic pathways
Decrease	Acetazolamide, furosemide	Carbonic anhydrase
	Atrial natriuretic hormone	cGMP
	Diazepam analogue <sup>c</sup>	Choroidal benzodiazepine receptor
	Dopamine D <sub>1</sub> receptor agonist	Choroidal dopamine receptor
	Hyperosmolarity	Choroidal capillaries
	Hypothermia	Metabolism (decreased)
	Noradrenaline <sup>a</sup>	cAMP/choroidal Na <sup>+</sup> -K <sup>+</sup> ATPase
	Omeprazole <sup>b</sup>	H <sup>+</sup> -K <sup>+</sup> ATPase?
	Ouabain	Na <sup>+</sup> -K <sup>+</sup> ATPase
	Serotonin receptor agonist	Choroidal serotonin receptor
	Steroids <sup>b</sup>	Choroidal Na <sup>+</sup> -K <sup>+</sup> ATPase
Vasopressin	Choroidal vasopressin (V <sub>1</sub> ) receptor	

Modified from Fishman (1992).

<sup>a</sup> Nilsson et al. (1992).

<sup>b</sup> Davson and Segal (1996).

flows through the paired interventricular foramina (foramen of Monro) into the third ventricle, then through the mesencephalic aqueduct (aqueduct of Sylvius) into the fourth ventricle. The majority of CSF exits from the fourth ventricle into the subarachnoid space; a small amount may enter the central canal of the spinal cord. In people, CSF enters the subarachnoid space through the lateral apertures (foramina of Luschka) and the median aperture (foramen of Magendie) of the fourth ventricle. Animals below the anthropoid apes do not have a median aperture (Fankhauser, 1962; Fletcher, 1993). Cerebrospinal fluid has also been shown to flow from the spinal subarachnoid space into the spinal perivascular spaces, across the interstitial space, then into the central canal (Stoodley *et al.*, 1996). Mechanisms for propelling the CSF along its route probably include (1) the continuous outpouring of newly formed ventricular fluid, (2) the ciliary action of the ventricular ependyma, (3) respiratory and vascular pulsations, and (4) the pressure gradient across the arachnoid villi (Milhorat, 1987).

## D. CSF Absorption

Absorption of CSF occurs by bulk absorption of the fluid and by absorption or exchange of individual constituents of the fluid (i.e., ions, proteins, and drugs). Bulk absorption occurs directly into the venous system and depends primarily

**TABLE 26-4** Total White Blood Cell Count of Normal CSF in Domestic Animals

Species	Collection Site <sup>a</sup>	N <sup>b</sup>	Cells/ $\mu$ L <sup>c</sup>	Reference
Dog	C	50	0–2	Jamison and Lumsden, 1988
Dog	C, L	31	0–4	Bailey and Higgins, 1985
Cat	C	33	0–2	Rand <i>et al.</i> , 1990b
Horse	Pooled C & L	44	0–6	Mayhew, 1977
Horse	C	14	0–5	Furr and Bender, 1994
Cow	L	16	0.85–3.52 <sup>d</sup>	Welles <i>et al.</i> , 1992
Llama	L	17	0–3	Welles <i>et al.</i> , 1994
Sheep	L	NS	0–5	Fankhauser, 1962
Goat	NS	NS	0–4	Brewer, 1983
Pig	NS	NS	0–7	Fankhauser, 1962
Ferret	C	42	0–8	Platt <i>et al.</i> , 2004
Holsten calf, 8 weeks old	C	10	0–10	St. Jean <i>et al.</i> , 1995

<sup>a</sup> C = cerebellomedullary cistern. L = lumbar subarachnoid space.

<sup>b</sup> N = number of animals.

<sup>c</sup> Range.

<sup>d</sup> 95% confidence interval.

NS = not stated.

on the CSF hydrostatic pressure; as the pressure rises, the absorption rate increases (Davson and Segal, 1996). If intracranial pressure falls below a critical point, bulk absorption decreases, a homeostatic response to stabilize the intracranial pressure and the CSF volume. The primary site of bulk absorption, at least in people, is the arachnoid villi that project into the dural sinuses. Two other routes are through lymphatic channels in the dura and through the perineural sheaths of cranial nerves (particularly the olfactory nerves) and spinal nerves. Perineural absorption may be through arachnoid villi projecting into perineural veins, lymphatics, or connective tissue (Davson and Segal, 1996; Milhorat, 1987). The importance of these various absorption routes varies with the species (Bell, 1995).

Absorption through the arachnoid villi occurs transcellularly through micropinocytotic vesicles and giant intracellular vesicles, but it may also occur through endothelium-lined, intercellular clefts. The mechanisms appear to vary among species (Bell, 1995). Absorption is unidirectional from the CSF into the venous blood—the villi act like one-way valves. The basis for the valve-like mechanism appears to be transport by the giant vesicles (see Section II.A.2). Particles ranging in size from colloidal gold (0.2  $\mu$ m) to erythrocytes (7.5  $\mu$ m) can be transported across the villi. In disease conditions, accumulations of larger size particles (e.g., protein molecules, erythrocytes, leukocytes) within the villi may impair absorption leading to hydrocephalus (Fishman, 1992; Milhorat, 1987). The choroid plexus also has an absorptive function, acting

on specific substances in the CSF rather than by bulk fluid absorption. A variety of compounds are actively transported from the CSF, in a fashion reminiscent of the proximal renal tubule. Solutes may also be cleared from the CSF by diffusion into adjacent brain cells or capillaries (Fishman, 1992; Milhorat, 1987).

#### IV. CELLULAR COMPOSITION OF NORMAL CSF

##### A. Total Erythrocyte and Nucleated Cell Count

Cerebrospinal fluid normally does not contain erythrocytes (Chrisman, 1992; Cook and DeNicola, 1988; Rand *et al.*, 1990b; Wilson and Stevens, 1977). Erythrocytes in a CSF sample are most commonly iatrogenic, because of trauma associated with the needle placement. However, CSF erythrocytes may also originate from pathological hemorrhage. The normal nucleated cell count of CSF in domestic animals is in Table 26-4. The most widely accepted reference ranges for the numbers of leukocytes in the CSF of dogs and cats is 0 to 5 cells/ $\mu$ L (de Lahunta, 1983; Oliver and Lorenz, 1993) to 0 to 8 cells/ $\mu$ L (Duncan, 1994). However, these ranges are too broad in our experience and other studies confirm this (Jamison and Lumsden, 1988). Jamison examined 50 clinically and histopathologically normal dogs and derived cerebellomedullary CSF reference limits of 0 to 2 cells/ $\mu$ L (Jamison and Lumsden, 1988). In fact,

all except one of these dogs had counts of 0 to 1 cells/ $\mu\text{L}$  (personal communication). Bailey and Higgins examined 31 dogs that were clinically and histopathologically normal. For cerebellomedullary CSF, the mean nucleated cell count was 1.45 cells/ $\mu\text{L}$  with the 95% confidence intervals 1.04 to 1.86, and the observed range 0 to 4 cells/ $\mu\text{L}$ . Twenty-six of 31 dogs had counts between 0 to 2 cells/ $\mu\text{L}$ . They also found that lumbar CSF had a significantly lower nucleated cell count, with a mean of 0.55 cells/ $\mu\text{L}$ , a 95% confidence interval of 0.22 to 0.88 and an observed range of 0 to 4 cells/ $\mu\text{L}$ , although 30/31 dogs had counts of 0 to 2 cells/ $\mu\text{L}$  (Bailey and Higgins, 1985). In our opinion, a normal nucleated count for cerebellomedullary CSF in dogs is 0 to 2 cells/ $\mu\text{L}$ , with 3 cells/ $\mu\text{L}$  being questionably abnormal and 4 cells/ $\mu\text{L}$  definitely abnormal.

Rand and colleagues (1990b) derived reference limits for cerebellomedullary CSF from 33 cats that were clinically and histopathologically normal. The samples did not have blood contamination. The mean  $\pm 1$  SD for the white blood cell count was  $0.1 \pm 0.4$  with an observed range of 0 to 2 cells/ $\mu\text{L}$ . Thirty of 33 cats had counts of 0 cells/ $\mu\text{L}$ . Three cells or more per microliter is therefore abnormal in feline cerebellomedullary CSF.

## B. Differential Cell Count

### 1. Leukocytes

Excellent morphological descriptions of the cell types normally found in the CSF of domestic animals can be found elsewhere (Cook and DeNicola, 1988; Jamison and Lumsden, 1988; Rand *et al.*, 1990b). Normal CSF consists of varying proportions of small lymphocytes and monocytes. The proportions are species and age dependent (Kjeldsberg and Knight, 1993). In dogs, monocytic type cells predominate (Jamison and Lumsden, 1988), although there is individual variation. In cats (Jamison and Lumsden, 1988; Rand *et al.*, 1990b), (unreactive) macrophages also predominate, with a mean of 87%, whereas small lymphocytes have a mean of 9%. This same trend is observed in horses, with 73.6% monocytes (macrophages) and 26.2% lymphocytes (Furr and Bender, 1994). However, small lymphocytes predominate in cattle (Welles *et al.*, 1992) and llamas (Welles *et al.*, 1994). In the literature published before 1975 that focused on humans, any neutrophils present in the CSF were thought to be indicative of disease (Kjeldsberg and Knight, 1993). However, with the advent of techniques for concentrating CSF specimens, such as cytocentrifugation, it became clear that a very small number of neutrophils may be found in normal human CSF (Fishman, 1992; Kjeldsberg and Knight, 1993). Similar observations have been made in many veterinary species, and rare neutrophils may be a normal finding in the CSF of all domestic species. Eosinophils are not present in normal CSF, although a single cell is occasionally seen on cytocentrifuge slides in animals with

normal total nucleated cell counts. Large foamy activated macrophages or phagocytes are not seen in normal CSF (Christopher *et al.*, 1988; Fishman, 1992), and their presence is nonspecific evidence of an inflammatory disorder. Plasma cells are not seen in normal CSF (Fishman, 1992; Kjeldsberg and Knight, 1993; Pelc *et al.*, 1981). Their presence indicates underlying inflammatory disease. In people, plasma cells are seen particularly in acute viral disease and various chronic inflammatory conditions including tuberculous meningitis, syphilis, multiple sclerosis, and the Guillain-Barré syndrome (Kjeldsberg and Knight, 1993; Pelc *et al.*, 1981). In animals, plasma cells have been observed in various conditions including distemper (Vandeveld and Spano, 1977), other viral meningitis (Bichsel *et al.*, 1984a; Vandeveld and Spano, 1977), rabies (Green *et al.*, 1992), granulomatous meningoencephalomyelitis (Bailey and Higgins, 1986a; Vandeveld and Spano, 1977), neoplasia, and abscesses (W. Vernau, personal observations). Therefore, although they are abnormal, no specificity is associated with their presence in CSF. Similarly, reactive lymphocytes are not found in normal CSF, but their presence has no specificity. They can be seen in active or resolving infectious disease, immune mediated diseases, and neoplasia (Cook and DeNicola, 1988).

### 2. Other Cells

Cells other than leukocytes can be seen in both normal and abnormal CSF. Cells lining the leptomeninges, choroid plexus cells, and ependymal cells can be seen as single cells or, more often, as small papillary clusters or sheets. Cytologically, choroid plexus cells and ependymal cells are indistinguishable (Cook and DeNicola, 1988; Garma-Avina, 2004; Kjeldsberg and Knight, 1993). The majority of lining cells seen in normal CSF is choroid plexus cells (Kjeldsberg and Knight, 1993). Excellent descriptions and illustrations of these cell types can be found elsewhere (Cook and DeNicola, 1988; Garma-Avina, 2004; Kjeldsberg and Knight, 1993; Rand *et al.*, 1990b). Chondrocytes are occasionally observed in CSF sampled by lumbar puncture, likely resulting from the spinal needle puncturing the intervertebral disk (Bigner and Jonston, 1981). Squamous cells can be observed in CSF and may be due to skin contamination or an underlying pathological process such as epidermoid cysts (Kornegay and Gorgacz, 1982) or metastatic carcinomas. Bone marrow cells (immature hematopoietic precursors) have been described in the CSF of people (Kjeldsberg and Knight, 1993) and dogs (Christopher, 1992). In people, bone marrow cells in the CSF are usually associated with lumbar puncture, usually in infants or in patients with vertebral bone abnormalities that create difficulties during the sampling process. The cells are present because of sampling from the vertebral body or articular process bone marrow. Christopher (1992) observed hematopoietic cells in the lumbar CSF of two dogs and speculated that it was due either to marrow penetration or to dural extramedullary hematopoiesis (Christopher, 1992).

Extramedullary hematopoiesis was observed in the choroid plexus of five dogs that did not have underlying hematological abnormalities or the presence of extramedullary hematopoiesis elsewhere (Bienzle *et al.*, 1995). Although the CSF was normal in these dogs and hematopoietic cells were not observed, this site could provide another potential source for the presence of these cells in CSF. Metastatic myeloid leukemia could conceivably produce similar findings, but peripheral blood and marrow examination would clarify the origin of the cells in question. Neurons, astrocytes, glial cells, and neural tissue may be observed in the CSF of people (Bigner and Jonston, 1981) and also in cerebellomedullary cisternal samples associated with traumatic CSF taps in animals (Fallin *et al.*, 1996). White matter in CSF is more common in lumbar versus cisternal CSF samples in dogs, most likely because of the sampling method,<sup>1</sup> although the presence of underlying malacia is another potential cause (Mesher *et al.*, 1996). White matter in the CSF is not correlated with a negative prognosis when compared to dogs without white matter in the CSF.<sup>1</sup>

## V. BIOCHEMICAL CONSTITUENTS OF NORMAL CSF

Because CSF is a product of plasma filtration and membrane secretion, its composition is different from plasma. In general, CSF is a clear, colorless, nearly acellular, low protein fluid. Various ions, enzymes, and other substances are also found in normal CSF. In health, the CSF composition is maintained relatively constant by the various membrane interfaces, although some fluctuations occur with fluctuations in plasma composition. The chemical composition of the CSF of various animal species is summarized in Tables 26-5 through 26-8. These values should serve only as a guide; normal values must be established for individual laboratories.

### A. Ontogeny of CSF

In people and animals, differences in CSF appearance and composition exist between neonates and adults. Human neonatal CSF is usually xanthochromic, probably because of a greater protein and bilirubin content than adult CSF. Glucose content is also increased, more closely approximating the blood glucose level. Many of these differences (e.g., protein content) are attributed to immaturity of the blood-brain barrier. Immaturity of the blood-brain barrier may be due to an increased number of fenestrae in the brain capillaries or inadequate closure of their endothelial tight junctions. Other factors that may contribute to age differences in CSF composition are the integrity of the blood-CSF barrier, the rate of CSF secretion and efficiency of absorption, the volume

of the extracellular space of the brain, and the lipid-solubility of the substances (Davson and Segal, 1996; Fishman, 1992). Protein also decreases with age in foals and puppies (Furr and Bender, 1994; Meeks *et al.*, 1994; Rossdale *et al.*, 1982). In contrast, two studies of calves found that CSF protein increased with age (Binkhorst, 1982; St. Jean *et al.*, 1995). Foals also had xanthochromia and a higher CSF glucose and creatine kinase level than adults (Furr and Bender, 1994; Rossdale *et al.*, 1982). The white blood count (WBC) decreased with age in puppies and calves (Binkhorst, 1982; Meeks *et al.*, 1994).

Studies done in prenatal, neonatal, and adult laboratory animals (including rats, rabbits, pigs, sheep, cats, dogs, and monkeys) and people have shown that, in general, the CSF/plasma concentration ratios ( $R_{CSF}$ ) of  $Na^+$ ,  $Mg^{2+}$ , and  $Cl^-$  increase with age. The  $R_{CSF}$  of  $K^+$ ,  $HCO_3^-$ , and urea decrease. In some instances, however (e.g.,  $Cl^-$  and  $K^+$ ), changing plasma levels of these substances contribute to the change in the  $R_{CSF}$ . The  $R_{CSF}$  of total protein, as well as the individual proteins, decreases with age. The decreasing concentration of proteins in the CSF compared to plasma protein is an indication of the maturation of the blood-brain and blood-CSF barriers. In rats, the  $R_{CSF}$  of amino acids also falls quickly with age, although large individual variations exist. Taurine, for example, has a higher level in the adult than the newborn. This fact, as well as the species-specific transport of some proteins (e.g., albumin) into the CSF, indicates a special mechanism of transport based on factors other than molecular weight (Davson and Segal, 1996).

### B. Proteins in the Cerebrospinal Fluid

Proteins identified in the CSF are given in Tables 26-9 and 26-10. In general, the concentration of a CSF protein is inversely related to its molecular weight. If the blood-brain barrier is normal, serum proteins with a molecular weight greater than 160,000 daltons are largely excluded. However, Felgenhaur (1974) reported CSF:serum protein distribution ratios to be better correlated with the hydrodynamic radii than with the molecular weight of the proteins. Almost all the proteins normally present in CSF are derived from the serum. The exceptions are transthyretin (prealbumin) and transferrin, which are also synthesized by the choroid plexus, and beta and gamma trace proteins, tau protein (tau fraction, modified transferrin), glial fibrillary acidic protein, and myelin basic protein, which appear to be synthesized intrathecally (Thompson, 1988).

#### 1. Albumin

With electrophoretic techniques, protein in the CSF can be separated into prealbumin, albumin, and alpha, beta, and gamma globulins. The major protein in CSF is albumin, which is synthesized only in the liver. The limited entry of albumin into the CSF is dependent on the blood-brain/CSF

<sup>1</sup>Zabolotzky, S., Vernau, W., Vernau, K. M., *et al.*, manuscript in preparation.

**TABLE 26-5** Biochemical Constituents of CSF of the Dog<sup>d</sup>

Constituent	Tipold <i>et al.</i> , 1994	Sorjonen, 1987	Bailey and Higgins, 1985	Bichsel <i>et al.</i> , 1984b	Sorjonen <i>et al.</i> , 1991	Krakowka <i>et al.</i> , 1981	Coles, 1980	Bleich, 1964	Fankhauser, 1962
Methods									
# RBC/ $\mu$ l	NS	$\leq 10$	<1500	0	$\leq 10$	0	NS	NS	NS
Necropsy	NS	Yes	Yes	NS	NS	Yes	NS	NS	NS
Total protein (mg/dl)									
Cerebellomedullary		$27 \pm 4.2$ (23–35)	$13.97 \pm 4.54$ (3–23)		$29.9 \pm 1.57$ (23–38.5)	$27.6 \pm 1.15E$ (15.5–42)			$27.5$ (11–55)
Lumbar			$28.68 \pm 5.52$ (18–44)						
Method		Coomassie brilliant blue	Coomassie brilliant blue		Micro-Lowry	Coomassie brilliant blue			NS
Albumin (mg/dl)		$37 \pm 4.29\%$ (31–44%)		$17.1 \pm 6.7$ (7.5–27.6)	$12.43 \pm 0.96^f$ (10.5–17.4) $11.27 \pm 1.0^e$ (7.8–19.0)	$10.28 \pm 0.85E$ (5.8–18.9)			$27$ (16.5–37.5)
Albumin quotient		$0.22 \pm 0.05$ (0.17–0.3)							
Globulin (mg/dl)					$17.45 \pm 0.83$ (14.0–21.1)				$9.0$ (5.5–16.5)
IgG (mg/dl)				$0.85 \pm 0.14$ (0.71–1.09)	$4.68 \pm 0.68$ (2.5–8.5)	$1.16 \pm 0.15E$			
IgG index	$0.7 \pm 0.3$ (0.2–1.3)		$0.38 \pm 0.24$ (0.15–0.9)						
IgM ( $\mu$ g/ml)	1.7 (0–5.8)				0	0			
IgA ( $\mu$ g/ml)	$0.08(0–0.2)$				0	0			

Alanine transferase (Reitman-Frankel units)	13.7 ± 1.35SE (2-32)
Aspartate transferase (Reitman-Frankel units)	20.1 ± 1.64SE (9-46)
Creatine kinase (SU)	<1
Bicarbonate (mEq/L)	23.5 ± 0.19SE
Calcium (mg/dl)	6.56 (5.13-7.40)
Chloride (mEq/L)	130 ± 0.5SE 808 (761-883) mg/dl 667 (602-783) mg/dl
Magnesium (mg/dl)	3.09 (2.58-3.81)
Phosphorus (mg/dl)	3.09 (2.82-3.47)
Potassium (mEq/L)	3.3 ± 0.04SE
Sodium (mEq/L)	153 ± 0.5SE
Glucose (mg/dl)	74 (61-116)
pH	7.36
Urea (mg/dl)	10-11
Specific gravity	1.005 (1.003-1.012)

<sup>a</sup> Mean ± 1 SD, observed range in parentheses, unless otherwise noted. Values are for cerebrospinal fluid unless otherwise noted.

<sup>b</sup> By electrophoresis.

<sup>c</sup> By radial immunodiffusion.

NS = not stated.

**TABLE 26-6** Biochemical Constituents of CSF of the Cat<sup>a</sup>

Constituent	Rand <i>et al.</i> , 1990b	Hochwald <i>et al.</i> , 1969	Ames, 1964	Fankhauser, 1962
Methods				
# RBC/ $\mu$ l	<30	NS		NS
Necropsy	Yes	No		NS
Total protein (mg/dl)				
Cerebellomedullary	18 $\pm$ 7 <sup>b</sup>	27.0 $\pm$ 8.8		<20
Reference range	6–36			
Lumbar		44.0 $\pm$ 1.7		
Method	Ponceau S	Biuret		NS
Albumin (mg/dl)				
Cerebellomedullary		6.5 $\pm$ 2.1		
Lumbar		10.1 $\pm$ 2.9		
$\gamma$ -Globulin (mg/dl $\pm$ SD)				
Cerebellomedullary		1.2 $\pm$ 0.27		
Lumbar		1.6 $\pm$ 0.30		
IgG (mg/dl)	1.4 $\pm$ 1.7			
Reference range	0–5.3			
IgG–Total protein index	0.321 $\pm$ 0.210 (0.086–1.297)			
Aspartate transferase (U/L)	17 $\pm$ 7			
Reference range	0–34			
Creatine kinase (U/L)	47 $\pm$ 51 <sup>b</sup>			
Reference range	2–236			
Lactate dehydrogenase (U/L)	12 $\pm$ 5 <sup>b</sup>			
Reference range	0–24			
Calcium (mEq/kg H <sub>2</sub> O $\pm$ SE)			1.50 $\pm$ 0.06	5.2 mg/dl
Chloride (mEq/kg H <sub>2</sub> O $\pm$ SE)			144 $\pm$ 2	900 mg/dl
Magnesium (mEq/kg H <sub>2</sub> O $\pm$ SE))			1.33 $\pm$ 0.02	
Potassium (mEq/kg H <sub>2</sub> O $\pm$ SE)			2.69 $\pm$ 0.09	
Sodium (mEq/kg H <sub>2</sub> O $\pm$ SE)			158 $\pm$ 4	
Glucose (mg/dl)	74.54 $\pm$ 23.6			85
Reference range	18.2–130.9			
pH				Slightly alkaline

<sup>a</sup> Mean  $\pm$  1 SD, observed range in parentheses, unless otherwise noted. Values are for cerebellomedullary fluid unless otherwise noted.

<sup>b</sup> Significantly correlated with CSF RBC count.

NS = not stated.

barrier to macromolecules. When total CSF protein increases, the albumin concentration increases disproportionately. This phenomenon illustrates the role of molecular size in determining the distribution of serum proteins into the CSF (Felgenhauer, 1974).

## 2. Alpha and Beta Globulins

Immunoelectrophoresis can separate the alpha and beta globulins into several proteins (Table 26.9). The origin of tau protein (beta<sub>2</sub> transferrin) is uncertain. This protein may be modified serum transferrin (beta<sub>1</sub> transferrin) or it may be a unique protein, “tau protein,” in the CSF (Fishman, 1992). In veterinary and human medicine, no correlation

has been made between changes in the concentrations of these globulins and specific neurological disease (Fishman, 1992; Sorjonen *et al.*, 1991). Thus, their measurement has limited clinical use at this time.

## 3. Gamma Globulins

Because of the changes found in association with multiple sclerosis and other inflammatory diseases, the gamma globulins have received a great deal of attention. Electrophoretic techniques define the gamma globulins as a heterogeneous group of proteins with migrations at similar rates (see Table 26.9). The gamma globulin fraction contains immunoglobulins. Immunological assays identify three major immunoglobulins



**TABLE 26-7** Biochemical Constituents of CSF of Foals and Horses<sup>a</sup>

Constituent	Rossdale <i>et al.</i> , 1982	Andrews <i>et al.</i> , 1994	Andrews <i>et al.</i> , 1990a	Andrews <i>et al.</i> , 1990b	Rossdale <i>et al.</i> , 1982	Mayhew, 1977 <sup>b</sup>	Fankhauser, 1962
Age	<40 hrs <sup>c</sup>	= 10 days	4-9 years	NS	Adult	0.75-15 years	Adult?
Methods							
#RBC/ $\mu$ l	NS	<2000	<600	NS	NS	195.15 $\pm$ 511.96	NS
Necropsy	NS	No	2 of 12	NS	NS	No	NS
Total protein (mg/dl)							
Cerebellomedullary	138 $\pm$ 50 (70-210)	82.8 $\pm$ 19.2 (56.7-115)	87.0 $\pm$ 17.0 (59-118)		105 $\pm$ 38 (40-170)	37.23 $\pm$ 28.4 <sup>d</sup> 5-100 <sup>e</sup> -0.46 $\pm$ 13.7 (LS-CM difference)	47.58 (28.75-71.75)
Lumbosacral		83.6 $\pm$ 16.1 (60.5-116)	93 $\pm$ 16 (65-124)			TCA	
Method	Biuret	Coomassie brilliant blue	Coomassie brilliant blue		Biuret		NS
Albumin (mg/dl $\pm$ SD)							
Cerebellomedullary		52.0 $\pm$ 8.6 (34-64)	35.8 $\pm$ 9.7 (24-51)				38.64 (22.62-67.94)
Lumbosacral		53.8 $\pm$ 15.7 (30-92)	37.8 $\pm$ 11.2 (24-56)				
Albumin quotient ( $\pm$ SD)							
Cerebellomedullary		1.86 $\pm$ 0.29 (1.55-2.33)	1.4 $\pm$ 0.4 (1-2.1)				
Lumbosacral		1.85 $\pm$ 0.51 (1.07-2.88)	1.5 $\pm$ 0.4 (1-2.4)				
Globulin (mg/dl)							9.34(3.37-18.37)
IgG (mg/dl $\pm$ SD)							
Cerebellomedullary		10.2 $\pm$ 5.5 (3-22)	5.6 $\pm$ 1.4 (3-8)				
Lumbosacral		9.9 $\pm$ 5.7 (3-22.5)	6.0 $\pm$ 2.1 (3-10)				
IgG index ( $\pm$ SD)							
Cerebellomedullary		0.519 $\pm$ 0.284 (0.095-0.942)	0.19 $\pm$ 0.046 (0.12-0.27)				
Lumbosacral		0.482 $\pm$ 0.27 (0.091-2.089)	0.194 $\pm$ 0.05 (0.12-0.26)				
Alkaline phosphatase (IU)							
						0.83 $\pm$ 0.95 0-8 <sup>e</sup>	
Aspartate transferase (IU)							
Cerebellomedullary	16.6 $\pm$ 7.6 (6-26)			4-16 <sup>e</sup>	18.27 $\pm$ 10.8 (7.5-30)	30.74 $\pm$ 6.31 SFU 15-50 <sup>e</sup>	
Lumbosacral				0-16 <sup>e</sup>			

(continued)

**TABLE 26-7** Continued

Constituent	Rossdale <i>et al.</i> , 1982	Andrews <i>et al.</i> , 1994	Andrews <i>et al.</i> , 1990a	Andrews <i>et al.</i> , 1990b	Rossdale <i>et al.</i> , 1982	Mayhew, 1977 <sup>b</sup>	Fankhauser, 1962
Creatine kinase (IU) Cerebellomedullary	15.2 ± 9.2 (4-33)			0-8 <sup>e</sup>	5.78 ± 3.7 (3.2-11)	1.08 ± 3.13 0-8 <sup>e</sup>	
Lumbosacral				0-8 <sup>e</sup>			
γ glutamyl transferase (IU)	1.5 ± 1.5 (0.9-2.3)				2.45 ± 1.9 (0.8-4.2)		
Lactate dehydrogenase (IU)	23.2-10.7 (10-40)			0-8 <sup>e</sup>	27.7 ± 8.0 (12-34)	1.54 ± 1.75 0-8 <sup>e</sup>	
Calcium (mg/dl)						4.18 ± 0.87 2.5-6.0 <sup>e</sup>	6.26 (5.55-6.98)
Chloride (mEq/L)	109 ± 3.4 (104-113)				103.3 ± 13.5 (92-116)	109.22 ± 6.90 95-123 <sup>e</sup>	737 mg/dl (690-792)
Magnesium (mg/dl)							1.98 (1.06-2.95)
Phosphorus (mg/dl)						0.83 ± 0.20 0.5-1.5 <sup>e</sup>	1.44 (0.87-2.20)
Potassium (mEq/L)	3.6 ± 2.1 (1.3-4.6)				2.9 ± 0.6 (1.9-3.9)	2.95 ± 0.05 2.5-3.5 <sup>e</sup>	12.66 mg/dl (10.65-14.20)
Sodium (mEq/L)	142.6 ± 2.8 (139-147)				143.9 ± 2.6 (139-147)	144.58 ± 1.86 140-150 <sup>e</sup>	
Cholesterol (mg/dl)						4.76 ± 5.7 20-20 <sup>e</sup>	0.36-0.55
Glucose (mg/dl) Cerebellomedullary				35-70% of blood glucose <sup>e</sup>		48.0 ± 9.92 30-70 <sup>e</sup>	57.2 (40-78)
Lumbosacral				35-70% of blood glucose <sup>e</sup>		55.13 ± 8.22 40-75 <sup>e</sup>	
Lactic acid (mg/dl) Cerebellomedullary				1.92 ± 0.12			
Lumbosacral				2.3 ± 0.21			
pH							7.13-7.36
Specific gravity				1.003-1.005 <sup>e</sup>			1.004-1.008
Urea nitrogen (mg/dl)						11.82 ± 3.26 0-20 <sup>e</sup>	

LS = lumbar subarachnoid space CSF, CM = cerebellomedullary cistern CSF.

<sup>a</sup> Mean ± 1 SD, observed range in parentheses, unless otherwise noted. Values are for cerebellomedullary fluid unless otherwise noted.

<sup>b</sup> Except where noted, values are for pooled cerebellomedullary and lumbosacral fluid.

<sup>c</sup> Spontaneously delivered.

<sup>d</sup> Total protein for ponies - 60.48 ± 20.45, reference range 20-105 (significantly different from horses).

<sup>e</sup> Reference range.

NS = not stated.

**TABLE 26-8** Biochemical Constituents of CSF of the Cow, Sheep, Goat, Pig, and Llama<sup>a</sup>

Constituent	Cow Welles <i>et al.</i> , 1992 <sup>b</sup>	Sheep Altman and Dittmer, 1974 <sup>c</sup>	Goat Altman and Dittmer, 1974 <sup>c</sup>	Pig Altman and Dittmer, 1974 <sup>c</sup>	Llama Welles <i>et al.</i> , 1994 <sup>d</sup>
Methods					
# RBC/ $\mu$ l	(5–1,930)	NS	NS	NS	(0–1,360)
Necropsy	No	NS	NS	NS	No
Total protein (mg/dl)					
Cerebellomedullary		(8–70)	12	(24–29)	
Lumbosacral	39.16 $\pm$ 3.39 (23.4–66.3)				43.1 $\pm$ 9.0 (31.2–66.8)
Method	Coomassie brilliant blue	NS	NS	NS	Coomassie brilliant blue
Albumin (mg/dl)					
Cerebellomedullary				(17–24)	
Lumbosacral	15.75 $\pm$ 1.53% (8.21–28.71)				17.9 $\pm$ 4.45 (11.8–27.1)
Albumin quotient					0.523 $\pm$ 0.114 (0.38–0.75)
Globulin (mg/dl)				(5–10)	
$\gamma$ -Globulin (mg/dl)	4.84 $\pm$ 0.44% (2.46–8.85)				6.4 $\pm$ 2.50 (3.4–13.8)
IgG (mg/dl)	9.49 $\pm$ 1.03i (4.88–16.57)				
Creatine kinase (U/L)	11.44 $\pm$ 3.43 (2–48)				4.6 $\pm$ 4.69 (0.0–15.0)
Lactate dehydrogenase (U/L)	13.94 $\pm$ 1.318 (2–25)				13 $\pm$ 5.6 (7–24)
Calcium (mg/dl)		5.6 $\pm$ 0.3			
Chloride (mEq/L)		832 mg/dl (750–868)	681 mg/dl		134 $\pm$ 6.5 (116–143)
Magnesium (mg/dl)	1.99 $\pm$ 0.03 mEq/L (1.8–2.1)	2.88			
Potassium (mEq/L)	2.96 $\pm$ 0.03 (2.7–3.2)				3.19 $\pm$ 0.10 (2.9–3.3)
Sodium (mEq/L)	140 $\pm$ 0.78 (132–142)				154 $\pm$ 5.8 (134–160)
Glucose (mg/dl)	42.88 $\pm$ 0.99 (37–51)	(48–109)	71	(45–87)	69.3 $\pm$ 7.35 (59–86)
pH		7.35(7.3–7.4)			

<sup>a</sup> Mean  $\pm$  1 SD, observed range in parentheses, unless otherwise noted.<sup>b</sup> Lumbosacral fluid. Mean  $\pm$  SEM.<sup>c</sup> Cerebellomedullary fluid.<sup>d</sup> Lumbosacral fluid.1

NS = not stated.

**TABLE 26-9** Cerebrospinal Fluid Proteins Identified by Electrophoresis (Top Row) and Immunoelectrophoresis (Underlying Columns)

Transthyretin (Prealbumin)	Albumin	Alpha <sub>1</sub> Globulin	Alpha <sub>2</sub> Globulin	Beta Globulin	Gamma Globulin
Transthyretin	Albumin	Alpha <sub>1</sub> antitrypsin	Alpha <sub>2</sub> macroglobulin	Beta lipoprotein	IgG
		Alpha <sub>1</sub> lipoprotein	Alpha <sub>2</sub> lipoprotein	Transferrin	IgA
		Alpha <sub>1</sub> glycoprotein	Haptoglobulin	Tau protein (modified transferrin)	IgM
			Ceruloplasmin	Plasminogen	
			Erythropoietin	Complement	IgD
				Hemopexin	IgF
				Beta-trace	Gamma-trace

Modified from Fishman (1992).

**TABLE 26-10** Protein Content of Cerebellomedullary Cisternal CSF of Healthy Dogs, Cats, and Horses as Identified by Electrophoresis<sup>a</sup>

Protein fraction	Dog Sorjonen, 1987	Cat Rand <i>et al.</i> , 1990a	Horse, Kristensen and Firth, 1977
Prealbumin			2.0 ± 0.9
Albumin	37 ± 4.29 (31–44)	11 ± 15 (1–53)	43.4 ± 6.8
Alpha globulin	28 ± 5.27 (24–31)	21 ± 11 (0–48)	
Alpha <sub>1</sub>			5.3 ± 1.3
Alpha <sub>2a</sub>			3.3 ± 0.8
Alpha <sub>2bc</sub>			6.4 ± 1.8
Beta globulin	25 ± 5.31 (19–30)	57 ± 15 (37–91)	
Beta <sub>1</sub>			17.0 ± 3.2
Beta <sub>2</sub>			7.8 ± 2.3
Gamma globulin	7.75 ± 1.84 (6–9)	12 ± 7 (0–29)	14.8 ± 3.3

<sup>a</sup> Mean ± SD percentage of total CSF protein; range in parentheses.

in normal CSF: IgG, IgM, and IgA. Minute amounts of other immunoglobulins have also been detected in normal CSF (Fishman, 1992; Kjeldsberg and Knight, 1993).

#### a. IgG

The major immunoglobulin in normal CSF is IgG, which normally originates from the serum. An increased level of CSF gamma globulin is reported in a number of inflammatory central nervous system disorders. In disease conditions,

gamma globulin may enter the CSF through dysfunctional blood-brain/CSF barriers, or it may be synthesized intrathecally by cells that have migrated into the brain or CSF and are participating in the disease process (Fishman, 1992; Kjeldsberg and Knight, 1993).

#### b. IgM and IgA

Cerebrospinal fluid IgM and IgA also originate normally from the serum. However, in certain diseases, particularly

inflammatory diseases, these immunoglobulins are produced within the central nervous system as well (Fishman, 1992; Kjeldsberg and Knight, 1993). IgM is ontogenetically and phylogenetically the most primitive immunoglobulin and is therefore detected at an earlier stage of the general immune response of the body. IgM is also the first immunoglobulin to return to normal when the offending antigen disappears. The characteristics of IgM and IgA participation in the intrathecal immune response still need to be resolved, however (Felgenhauer, 1982; Tipold and Jaggy, 1994).

#### 4. Other Proteins

Many other proteins have been identified in CSF including myelin basic protein, S-100 protein, C-reactive protein, interferon, embryonic proteins, fibronectin, and glial fibrillary acidic protein. In general, the CSF concentrations of these proteins may be altered by a number of neurological disease processes. The utility of assaying these proteins in clinical veterinary or human medicine has yet to be established (Fishman, 1992; Kjeldsberg and Knight, 1993).

### C. Glucose

CSF glucose is derived solely from the plasma by facilitated diffusion. The concentration of CSF glucose depends on the blood glucose concentration, the rate of glucose transport into the CSF, and the metabolic rate of the central nervous system. The normal CSF glucose level is about 60% to 80% of the blood glucose concentration, reflecting at least in part the high metabolic rate of the central nervous system. Equilibration with plasma glucose requires about 1 to 2 h; thus, ideally, plasma glucose should be determined about 1 h before CSF aspiration and analysis. In people, a glucose gradient exists along the neuraxis; the concentration decreases from ventricular to lumbar fluid (Fishman, 1992; Kjeldsberg and Knight, 1993). In people, a CSF:serum glucose ratio less than 0.4 to 0.5 is abnormal and associated with bacterial and fungal infections, as well as metastasis to the leptomeninges (Deisenhammer *et al.*, 2006). CSF glucose and serum CSF:glucose ratio is not routinely used in veterinary medicine, possibly because of the lack of specificity and availability of more specific tests in most instances.

### D. Enzymes

Numerous enzymes have been assayed in the CSF of animals (see Tables 26.5 to 26.8) (Jackson *et al.*, 1996; Lobert *et al.*, 2003; Rand *et al.*, 1990a; Wilson, 1977) and people (Banik, 1983). These enzymes have three possible sources: (1) blood, (2) neural tissue or neural tumors, and (3) cells within the CSF (Fishman, 1992; Kjeldsberg and Knight, 1993). The blood enzyme levels are usually higher than the CSF levels. Unfortunately, many studies of CSF levels in disease fail to report the concurrent blood level and a

measure of blood-brain/CSF barrier integrity. However, studies of CSF creatine kinase (CK) in dogs and horses did not find a relationship between WBC counts, serum CK, or CSF total protein and CSF CK (Furr and Tyler, 1990; Jackson *et al.*, 1996). Regarding correlation of CSF red blood count (RBC) with CSF CK, one study reported a significant correlation (Indrieri *et al.*, 1980), whereas another study did not find a statistical association between the two parameters (Jackson *et al.*, 1996). CSF lactate is independent of blood glucose, and it may be measured in people and animals (Deisenhammer *et al.*, 2006; Lobert *et al.*, 2003). In people, blood:CSF lactate ratio may be elevated with mitochondrial disease and correlates inversely with the blood:CSF glucose ratio. To date, none of the enzyme assays is sufficiently sensitive or specific to warrant routine use in clinical practice (Fishman, 1992; Indrieri *et al.*, 1980; Jackson *et al.*, 1996; Kjeldsberg and Knight, 1993; Rand *et al.*, 1994a).

### E. Neurotransmitters

Because they are produced by neurons, neurotransmitters and their metabolites have been extensively studied in people for their potential use as markers of neuronal activity and neurological and psychiatric disease (Davis, 1990). The concentrations of several neurotransmitters (e.g.,  $\gamma$ -aminobutyric acid [GABA], glutamate, aspartate and dopamine) and their metabolites (e.g., 5-hydroxyindolacetic acid, homovanillic acid, and dihydroxyphenylacetic acid) have been measured in the CSF from various sites in dogs, sheep, goats, cattle, and horses (Bardon and Ruckebusch, 1984; Ellenberger *et al.*, 2004; Faull *et al.*, 1982; Holt *et al.*, 2002; Loscher and Schwartz-Porsche, 1986; Podell and Hadjiconstantinou, 1997; Ruckebusch and Costes, 1988; Ruckebusch and Sutra, 1984; Sisk *et al.*, 1990; Vaughn *et al.*, 1988a, 1989). Some metabolite concentrations have a gradient along the neuraxis (Ruckebusch and Costes, 1988; Ruckebusch and Sutra, 1984; Vaughn *et al.*, 1988b; Vaughn and Smyth, 1989), and some are age-related (Ruckebusch and Costes, 1988; Smyth *et al.*, 1994; Vaughn and Smyth, 1989).

Despite intense interest, more research is needed to verify the clinical utility of assay of these substances in the CSF (Fishman, 1992; Kjeldsberg and Knight, 1993).

### F. Other CSF Constituents

Many other substances have been measured in CSF in experimental and clinical situations. These include electrolytes, gases, organic and amino acids, ammonia, urea, creatinine, prostaglandins, cytokines, and hormones. Assay of these substances is not particularly helpful in the diagnosis of neurological disease in people because the substances are not generally associated with specific disease (Fishman, 1992; Kjeldsberg and Knight, 1993). Some substances, such as S-100B, a calcium-binding protein, have been used as a marker protein in

people with brain injury, but its utility in veterinary medicine is unproven (Shimada *et al.*, 2005). The usefulness of these substances in veterinary medicine has yet to be established.

## G. Concentration Gradient along the Neuraxis

In cats (Hochwald *et al.*, 1969), dogs (Bailey and Higgins, 1985; Vaughn *et al.*, 1988b), horses (Andrews *et al.*, 1990a; Vaughn and Smyth, 1989), rhesus macaques (Smith and Lackner, 1993), and people (Davson and Segal, 1996; Fishman, 1992), the total protein concentration increases along the neuraxis from rostral to caudal. For example, in people the total protein concentration of ventricular, cerebellomedullary cistern, and lumbar subarachnoid fluid is about 26, 32, and 42 mg/dl, respectively (Weisner and Bernhardt, 1978). Total protein, albumin, and globulin content of cerebellomedullary cistern and lumbar subarachnoid CSF for dogs, cats, and horses is given in Tables 26.5, 26.6, and 26.7, respectively. The concentration of the albumin and globulin fractions also increases from ventricular to lumbar fluid. The increased protein content may be the result of a greater permeability of the spinal blood-CSF barrier than of the ventricular barrier to albumin (Fishman, 1992), additions of protein from adjacent nervous tissue (e.g., IgG from lymphocytes located in or near the CSF pathway (Weisner and Bernhardt, 1978), progressive equilibration of CSF with plasma through the capillary walls (Weisner and Bernhardt, 1978), and low flow rates of lumbar CSF (Davson and Segal, 1996).

A study of healthy dogs also identified a small but significant gradient for the CSF WBCs; lumbar fluid contained significantly fewer cells than cerebellomedullary fluid (Bailey and Higgins, 1985). Another study did not find a difference in WBC counts between fluids from the two sites (Vaughn *et al.*, 1988b). However, 4 of the 10 dogs in this study had CSF total WBC counts  $>3/\mu\text{l}$ , and none of the dogs was necropsied to verify its health. Therefore, some of these dogs may have had subclinical neurological disease, disguising a small cellular gradient. The small number of WBCs in normal fluid may make a cellular gradient more of a theoretical issue than a practical issue, however. If a cellular gradient exists, it may be due to fewer cells entering the lumbar CSF than the cerebellomedullary CSF, a greater rate of cell lysis in the lumbar CSF, a greater migration rate of WBCs from lumbar CSF back into the blood, or loss of WBCs that entered the CSF rostrally and lysed as CSF circulated to the caudal subarachnoid space.

A gradient has also been reported for CSF neurotransmitter metabolites in the dog (Vaughn *et al.*, 1988b) and the horse (Vaughn and Smyth, 1989). In each species, the neurotransmitter metabolite content of cerebellomedullary CSF was greater than that of lumbar subarachnoid CSF. This gradient probably reflects the major source of the neurotransmitter (brain) and transport of the metabolite from the CSF into the blood along the spinal axis (Vaughn *et al.*, 1988a).

## VI. CSF COLLECTION AND ANALYTICAL TECHNIQUES

### A. Collection

#### 1. General Techniques

Specific details about the collection of CSF from the various species are covered in many excellent articles and textbooks (Boogerd and Peters, 1986; Brewer, 1983, 1987, de Lahunta, 1983; Fowler, 1989; Holbrook and White, 1992; Kornegay, 1981; Mayhew, 1989) and will not be covered here except for the authors' preferred technique for collection from the cerebellomedullary cistern of dogs and cats (discussed later). Considerations that apply regardless of species are sterility, use of a specialized spinal needle, and collection from animals with increased intracranial pressure. To prevent iatrogenic central nervous system infection, sterility during the collection procedure is essential. A generous area around the puncture site should be clipped and surgically prepared. Preparation of too small an area can lead to contamination if any difficulty in palpating landmarks or entering the subarachnoid site is encountered. Additionally, the use of a fenestrated drape is highly recommended. Spinal puncture is contraindicated in an area of severe pyoderma/furunculosis or cellulitis. A needle with a stylet (spinal needle) should be used to prevent implantation of a plug of epidermis in the subarachnoid space that not only could lead to infection but also could seed an epidermoid tumor. Replacement of the stylet upon withdrawal is controversial, either preventing or causing entrapment and severance or dislocation of nerve root filaments (Fishman, 1992). Collection of CSF from animals with increased intracranial pressure may result in brain herniation. Appropriate anesthetic agents, hyperventilation, and mannitol (to treat intracranial hypertension) may decrease the probability of herniation. Use of the smallest gauge needle possible may also help prevent herniation by decreasing CSF leakage through the puncture hole in the meninges. Only the minimal amount of CSF necessary to perform the desired tests should be withdrawn. Brain herniation can occur following lumbar taps as well as cerebellomedullary cistern taps.

#### 2. Collection Site

Cerebellomedullary puncture should be done under general anesthesia. In most instances, lumbar puncture can be done with sedation and local anesthesia. Therefore, if general anesthesia is contraindicated, a lumbar puncture should be done.

The choice of collection site is influenced by the species and breed of animal, the location of the neurological lesion, and anesthetic considerations. The size of some animals may make lumbar subarachnoid puncture difficult, if not impossible. However, cerebellomedullary puncture usually can be accomplished even in large or obese animals. Because of differences in anatomy, the type or breed influences the exact site for lumbar puncture in the dog; L4-5 is

recommended for large breed, nonchondrodystrophic dogs (e.g., German shepherd dogs), whereas L5 to 6 is recommended for small, chondrodystrophic dogs (e.g., dachshunds) (Morgan *et al.*, 1987). The puncture site chosen should be as close to the lesion as possible without penetrating the lesion, or the site should be caudal to the lesion. In animals with spinal disease, cerebellomedullary fluid is abnormal more frequently with cervical disease than it is with thoracolumbar disease, but overall lumbar fluid is abnormal more often than cerebellomedullary fluid. With intracranial disease, CSF from both sites is usually abnormal, perhaps because both sites are caudal to the lesion (Scott, 1992; Thomson *et al.*, 1989, 1990). Occasionally, CSF is collected from both sites. Although the order of collection (cerebellomedullary or lumbar CSF collected first) appears not to influence significantly the analytical results (Bailey and Higgins, 1985), aspiration from the relatively small lumbar subarachnoid space is easier if the CSF pressure has not just been lowered by cerebellomedullary CSF collection.

### 3. CSF Collection from the Cerebellomedullary Cistern

The authors' preferred technique for CSF collection from the cerebellomedullary cistern is to utilize the palpable bony landmarks that are the closest to the puncture site. These structures are the vertebral arch of C1 and the external occipital protuberance. After anesthetic induction and intubation, the animal is placed in right lateral recumbency, and padding is placed under the neck to align the dorsal cervical and cranial midline parallel to the tabletop. The assistant is instructed to tuck in the animal's chin (flex the neck) and push the external occipital protuberance toward the operator. This procedure flexes the atlantooccipital joint and maximizes the space between the occipital bone and C1. Asking the assistant to simply flex the neck seems to produce flexion of the midcervical area more than the atlantooccipital area.

The clinician faces the dorsal aspect of the patient's neck, kneeling on a pad. The external occipital protuberance, the C2 spinous process, and the C1 vertebral arch are palpated. The latter structure is located by rolling a fingertip off the cranial edge of the C2 spinous process and palpating firmly, feeling for a transverse bony ridge (the C1 vertebral arch). The C1 vertebral arch can usually be palpated, and if so, the puncture is made on the midline just in front of the fingertip palpating the vertebral arch. If C1 is not palpable, the distance between the cranial edge of the C2 spinous process and the occipital protuberance is noted, and the puncture is made on the midline about one-third of that distance cranial to the cranial edge of the C2 spinous process. In rare cases, neither C1 nor C2 can be palpated. In this situation, the lateral edge of each C1 transverse process is palpated and a triangle from each edge to the occipital protuberance is constructed visually. The puncture is made on the midline in the center of that triangle. The needle should be advanced slowly

and the stylet removed regularly. A "pop" may be palpated when the dura mater is punctured with the needle. The clinician should hold the spinal needle with one hand (to hold it steady) and remove the stylet with the other hand. The CSF should be allowed to drip out of the spinal needle into a tube. A volume of at least 0.5 mLs should be collected for a full CSF analysis (partial analysis may be done with smaller volumes). Larger volumes may be collected for other tests such as culture and sensitivity, polymerase chain reaction for infectious agents, antigen/antibody testing, immunophenotyping, and clonality assessment. To collect CSF for culture and sensitivity testing, aspirate CSF directly from the spinal needle hub using a needle and syringe.

## B. Physical Examination: Clarity, Color, and Viscosity

After collection, the CSF is examined visually and the color, clarity, and viscosity are recorded. Normal CSF is clear and colorless and has essentially the same viscosity as water. For accurate assessment, the CSF can be compared to the same amount of distilled water in the same type of container. The containers can be held against a white, typewritten page to judge color and clarity, and gently shaken to assess viscosity. If the CSF appears abnormal, the color and clarity of the supernatant after centrifugation should be noted.

## C. Cytological Analysis

### 1. General Techniques

Collection of CSF in a plastic or silicon coated glass tube is preferred because monocytes will adhere to glass and can activate in the process (Fishman, 1992). This can result in erroneous cell counts and also alter morphology. In practical terms, this is of little consequence in those specimens that are rapidly processed, but it becomes important as the delay between collection and processing increases. A complete cytological examination includes both a total and differential cell count, as well as thorough morphological assessment. A differential and thorough morphological assessment should be done routinely, even on those samples that have cell counts within normal limits. In our experience, very low cell counts alone cannot be used as an indicator of normality. In one study utilizing cytocentrifugation, about 25% of canine CSF samples with cell counts in the normal range had abnormalities in cell type or morphology (Christopher *et al.*, 1988). Abnormalities included the presence of phagocytic macrophages, increased percentage of neutrophils in the differential, and the presence of reactive lymphocytes and plasma cells. Malignant cells have been observed in samples with normal nucleated cell counts (Bichsel *et al.*, 1984b; Grevel and Machus, 1990). CSF samples should be processed as soon as possible after collection. Cells degenerate quickly in CSF (Chrisman, 1992; Fishman, 1992; Fry

*et al.*, 2006; Kjeldsberg and Knight, 1993; Steele *et al.*, 1986), likely secondary to the CSF hypotonicity and very low protein content (in nonpathological specimens). Proteins and lipids tend to have a membrane stabilizing effect (Fry *et al.*, 2006; Steele *et al.*, 1986). A multitude of veterinary references state that CSF must be processed within 30 min of collection (Chrisman, 1983; Cook and DeNicola, 1988; Oliver and Lorenz, 1993; Thomson *et al.*, 1990). However, these references do not cite scientific data to support this statement. One study systematically evaluated the effects of time, initial composition and stabilizing agents on the results of abnormal (TNCC  $\geq 5$  cells/ul) canine CSF evaluation (Fry *et al.*, 2006). Statistically significant changes ( $p = <0.05$ ) in the total nucleated cell count were not noted at any time point (0, 2h, 4h, 8h, 12h, 24h, and 48h) in unaltered (refrigerated) CSF, CSF with added fetal calf serum, or CSF with added hetastarch. However, differential cell percentages deteriorated in a time dependent fashion and macrophages were the most labile cell type in this study with their differential percentage being significantly decreased by 2h. Concurrently, the percentage of unrecognizable cells was significantly increased at 2h. At 12 and 24h, the percentages of lymphocytes and neutrophils, respectively, were significantly decreased. Samples with a higher protein concentration ( $\geq 50$  mg/dl) were less susceptible to deterioration than those with a lower protein concentration ( $<50$  mg/dl). The addition of fetal calf serum or hetastarch improved the stability of the CSF. Ultimately, the authors supported the contention that CSF should be analyzed as soon as possible post collection but that delays of 4 to 8h were unlikely to alter the overall clinical interpretation (Fry *et al.*, 2006). If the protein concentration is  $>50$  mg/dL, the analysis may be delayed up to 12h without altering the overall clinical interpretation as the mean percentage of unrecognizable cells was only 6% at this time point (versus 33% in samples with protein concentration  $<50$  mg/dl) (Fry *et al.*, 2006). Several reports recommend altering CSF processing when it is not analyzed within 1h of collection (Bienzle *et al.*, 2000; Fry *et al.*, 2006). If there is a delay in processing, CSF samples should be divided into two aliquots. The unaltered aliquot should be submitted for TNCC and protein concentration. The second aliquot should be treated by the addition of either 20% fetal calf serum or 10% autologous serum, and the differential cell counts and morphology should be assessed on the second altered aliquot.

In a study of feline CSF, there was excellent correlation between the total numbers of cells on the slides and the differential cell count between sediment slides processed immediately and those preserved with fetal bovine serum (200  $\mu$ l of CSF and 200  $\mu$ l of fetal bovine serum) and cyto-centrifuged 2 to 4h later (Rand *et al.*, 1990b).

There have also been several human studies performed on the effects of time and temperature on CSF (Kjeldsberg and Knight, 1993; Steele *et al.*, 1986; Stokes *et al.*, 1975). Interestingly, in these studies, and in contrast to the above study assessing canine CSF, neutrophils and

not large mononuclear cells were the most labile cell type. Refrigeration at 4°C markedly reduced the rate of lysis of all cell types in the human CSF studies. Therefore, the recommendation that analysis be performed within 30 min is reasonable, but it is predicated by the conditions that the sample is exposed to. Refrigeration obviously slows lysis, likely long enough for transport to reference laboratories in some instances. Addition of protein to the sample helps preserve cells and therefore attenuates the temporal effects involved in transport of samples to more remote facilities.

## 2. Total Leukocyte and Erythrocyte Counts

Electronic cell or particle counters are typically not sensitive enough to be used for enumeration of cells in CSF. The level of background counts with these counters is frequently in excess of the counts present in the majority of CSF samples that are analyzed. Therefore, cells are usually counted with a standard hemacytometer chamber with Neubauer ruling (Brobst, 1989; Cook and DeNicola, 1988; Jamison and Lumsden, 1988). The chamber is charged with undiluted fluid. Ideally, the cells are allowed to settle for 10 min in a humidified environment. This allows all the cells to be visible in the same plane of focus. The cells in the nine largest squares on both sides of the chamber are counted (18 squares in total) and the result multiplied by 0.55 to obtain the number of cells per microliter. Alternatively, the cells in nine large squares are counted and the number multiplied by 1.1 to determine the count per microliter. To the untrained observer, unstained leukocytes and erythrocytes may be difficult to differentiate. Leukocytes are larger, and the presence of nuclei gives them a more granular appearance than erythrocytes. With experience, nuclear morphology can often be appreciated (Cook and DeNicola, 1988). The cytoplasmic border is usually slightly irregular. In contrast, erythrocytes are usually smaller, smooth, and refractile, although they may become crenated upon standing (Jamison and Lumsden, 1988). Differentiating nucleated cells and erythrocytes in a hemacytometer chamber can be expedited by staining with New Methylene Blue before counting (Fry *et al.*, 2006). This latter technique can be used without significant dilutional effects.

A laser based cell counter and dedicated software are used to count and differentiate cells in human CSF (Aune *et al.*, 2004; Mahieu *et al.*, 2004). This technique has the advantage of markedly superior precision and accuracy. The same methodology has been used to assess canine CSF (Ruotsalo *et al.*, 2005). Although there was good correlation between the leukocyte and erythrocyte concentrations when compared with standard hemacytometer methods, the current software algorithms were not suitable for determining an accurate differential count in canine CSF. Additionally, it is likely that the cost and logistics of this methodology will preclude routine use in veterinary medicine.



### 3. Cytological Examination

There are a variety of methods to facilitate cytological examination of CSF (Barrett and King, 1976; Ducos *et al.*, 1979; Grevel, 1991; Hansen *et al.*, 1974; Jamison and Lumsden, 1988; Kolmel, 1977; Roszel, 1972; Sornas, 1967; Steinberg and Vandeveld, 1974; Woodruff, 1973). There is controversy as to which method is optimal, and all have their strengths and weaknesses. Methods include simple centrifugation, sedimentation, and variations thereof; membrane filtration; and cyto centrifugation (Jamison and Lumsden, 1988). Consult these references for specific methodological details. Simple centrifugation usually produces slides that are unsatisfactory for cytological examination. The chief advantage of membrane filtration techniques is excellent cellular recovery with yields approaching 90% to 100% (Barrett and King, 1976). However, the methodology is laborious and time consuming, the cellular morphology relatively poor, many cells are partly hidden in the filter substance, which itself stains variably, and the technique requires specialized, nonroutine staining techniques that most veterinary clinical pathologists do not have experience or expertise in interpreting. For these reasons, they are not recommended. Cyto centrifugation (Hansen *et al.*, 1974; Woodruff, 1973) is the method of choice in both human (Fishman, 1992; Kjeldsberg and Knight, 1993) and veterinary medicine (Christopher *et al.*, 1988; Jamison and Lumsden, 1988). It is rapid, simple, and produces slides with good cytological detail. The technique is enhanced by the addition of protein to the CSF sample before centrifugation, which helps to preserve cell morphology. Conditions of cyto centrifugation vary from laboratory to laboratory. We prefer the method described by Rand and colleagues (Rand *et al.*, 1990b). The disadvantages of cyto centrifugation are the expense of the instrument and the relatively low cell yield. In one comparative study (Barrett and King, 1976), the following cell yields were determined: millipore filtration  $81 \pm 3\%$  (SEM), nucleopore filtration  $69 \pm 3\%$ , and cyto centrifugation  $11 \pm 1\%$ . The Sornas method of centrifugation results in a cell yield, after staining, of approximately 20% (Sornas, 1967). The sedimentation technique of Sayk, modified by Kölmel (Grevel, 1991; Grevel and Machus, 1990; Kolmel, 1977), results in a yield of approximately 30% (Kolmel, 1977), although this can be increased to almost 90% if a membrane filter is substituted for direct sedimentation onto a slide. We have some experience with the Kölmel apparatus and technique and have found the cell morphology to be at least as good as cyto centrifugation with an apparently superior cell yield, although this needs to be confirmed with controlled comparative studies. Therefore, most studies suggest that sedimentation techniques result in greater cell yields than does cyto centrifugation. However, there is at least one study that found the yield of cyto centrifugation to be marginally higher than sedimentation (Ducos *et al.*, 1979). Standard Romanowsky stains are recommended for staining of slides. They provide good cellular detail on air-dried CSF preparations and are familiar to most observers. These stains include

the Wright's and Wright-Giemsa staining methods as well as a variety of rapid staining methods including Diff-quick and Camco-quick (Jamison and Lumsden, 1988).

### 4. Immunocytochemistry

In people, the value of cytological diagnosis of CSF can be improved if morphological studies are appropriately supplemented by immunocytochemistry (Kjeldsberg and Knight, 1993). Immunophenotypic studies of cyto centrifuge slides are useful in the differential diagnosis of leukemia, lymphosarcoma, primary brain tumors, and metastatic tumors (Bigner, 1992; Bigner and Jonston, 1981; Jorda *et al.*, 1998; Kjeldsberg and Knight, 1993; Tosaka *et al.*, 2001). Few veterinary studies document CSF immunocytochemistry. In dogs, immunophenotyping is useful in the diagnosis of lymphoma and infiltrative leukemia<sup>2</sup> and histiocytic sarcoma, both postmortem (Zimmerman *et al.*, 2006) and antemortem.<sup>3</sup>

Panels of monoclonal antibodies are typically used for the immunocytochemical assessment of CSF. The greatest limitation is therefore the volume and cellularity of the specimen available for the marker studies. Undifferentiated tumor panels frequently include leukocyte common antigen and cytokeratin antibodies. These can be helpful in distinguishing single carcinoma cells from lymphocytes or monocytes (Bigner, 1992; Bigner and Jonston, 1981; Kjeldsberg and Knight, 1993). Glial fibrillary acidic protein has proven to be helpful in distinguishing a glial origin, but there are currently no specific markers to distinguish primary brain tumors. Immunocytochemistry can be used also to characterize the lymphocyte subpopulations present in CSF. Seventy-five to 95% of the lymphocytes found in normal human CSF are T cells, with a mean of approximately 85% (Kjeldsberg and Knight, 1993). Within the population of T cells, T-helper cells predominate and account for up to 88% of T cells. Alterations of these percentages have been shown to have significant associations with disease in people (Kjeldsberg and Knight, 1993). Similar studies assessing CSF lymphocyte subset alterations in disease are lacking in domestic animals but may be useful. Lymphocyte subset distribution has been assessed in the brains of dogs with different types of diseases (Tipold *et al.*, 1999). T cells predominated in viral encephalitides, whereas B cells predominated in bacterial and protozoal diseases and in steroid responsive meningitis-arteritis (Tipold *et al.*, 1999). However, it has not been determined if similar changes are reflected in the CSF. Lymphocyte subset distribution has been assessed in normal dogs and horses (Duque *et al.*, 2002; Furr *et al.*, 2001; Tipold *et al.*, 1998). Similar to people, T lymphocytes predominate in canine CSF but are present as a lower percentage than in people, accounting for approximately 50% to 60% of lymphocytes (Duque *et al.*, 2002; Tipold *et al.*, 1998). However, there appears to be

<sup>2</sup>Vernau, W., unpublished observations.

<sup>3</sup>Tzipory, Vernau, Moore, in preparation.

much individual variation that may complicate use of this type of assessment clinically (Tipold *et al.*, 1998). Horses appear to be more similar to people, with T cells accounting for approximately 80% of lymphocytes in the CSF (Furr *et al.*, 2001). However, in contrast to people, CD8+ T cells in normal equine CSF may constitute a greater subset of T cells, accounting for approximately 30% of CSF T cells in one study (Furr *et al.*, 2001). In people, most central nervous system lymphomas are B cell in origin; immunocytochemistry assessing immunoglobulin light chain expression can be used to document monoclonality (Bigner, 1992; Bigner and Jonston, 1981). This is strong evidence (but not definitive proof) of malignancy. This assessment cannot be made in most domestic animals because of the marked light chain skewing that exists normally in these species (Arun *et al.*, 1996; Butler, 1998, #387). The B cell origin of the lymphocytes can also be confirmed with demonstration of immunoglobulin light chain expression. For patients with T cell lymphomas, marker studies can be more difficult to interpret as T cells predominate in normal and inflammatory CSF (Kjeldsberg and Knight, 1993). If there is systemic involvement, then comparison with the peripheral phenotype is useful to confirm presence in the CSF. Immunocytochemistry has also been utilized to detect infectious agents such as cytomegalovirus and mycobacterium tuberculosis in human patients (Stark *et al.*, 1993; Sumi *et al.*, 2002) and distemper virus in dogs (Abate *et al.*, 1998).

### 5. Polymerase Chain Reaction

Polymerase chain reaction (PCR) technology is a powerful adjunct to routine cytological assessment of CSF that may increase both the sensitivity and specificity of diagnosis. Because PCR exponentially increases *in vitro* the number of original DNA copies to a final number dependent on the number of cycles programmed, it is uniquely suited to the low volumes and small cell numbers frequently found in CSF samples. In people, one of the most useful applications of PCR methodology is the confirmation of malignancy and detection of minimal residual disease in lymphomatous meningitis (Rhodes *et al.*, 1996). This is accomplished via detection of clonal immunoglobulin or T cell receptor gene rearrangements and the detection of clone specific rearrangements, respectively. However, the exquisite sensitivity may result in false positive results because of either contamination or very low initial numbers of cells producing an artifactual clonal band. Tumor specific quantitative reverse transcriptase PCR (qRT-PCR) has been used for the sensitive detection of (neoplastic) neuroblastoma cells in the CSF of a human patient (Rosanda *et al.*, 2006). Other applications in people include detection of a wide variety of infectious agents, such as toxoplasma, borrelia, tuberculosis, human immunodeficiency virus, rabies virus, herpes simplex virus, and various amebas (Christen *et al.*, 1995; Guffond *et al.*, 1994; Lin *et al.*, 1995; Novati *et al.*, 1994; Qvarnstrom *et al.*, 2006). In the majority of these studies, PCR results in a

more rapid diagnosis with superior sensitivity and specificity when compared to standard culture and serological diagnostic techniques (Deisenhammer *et al.*, 2006).

In veterinary medicine, PCR is used to detect several infectious agents in CSF samples, such as bacteria (*listeria monocytogenes* and *Streptococcus equi*), protozoa (*sarcocystis neurona*, *toxoplasma gondii*, *neospora caninum*), and viruses (canine distemper virus, West Nile virus, and equine herpesvirus-1) (Amude *et al.*, 2006a, 2006b; Cannon *et al.*, 2006; Fenger, 1994; Finno *et al.*, 2006; Frisk *et al.*, 1999; Goehring *et al.*, 2006; Kim *et al.*, 2006; Peters *et al.*, 1995; Schatzberg *et al.*, 2003; Stiles *et al.*, 1996). Some agents such as listeria, encysted neospora or toxoplasma bradyzoites in the CNS parenchyma may not gain access to the meningoventricular system. This may result in negative CSF PCR results in confirmed positive cases (Peters *et al.*, 1995). A combination of diagnostic information (clinical information, CSF assessment, serology, PCR, biopsy, and immunohistochemistry) is the most practical way to make a clinical diagnosis, rather than the use of a single test result, such as PCR (Schatzberg *et al.*, 2003). PCR assays for the detection of clonal immunoglobulin or T-cell receptor gene rearrangements in dogs and cats have now been developed (Burnett *et al.*, 2003; Moore *et al.*, 2005; Vernau and Moore, 1999; Werner *et al.*, 2005). These assays have been used for the confirmation of malignancy in the CSF of dogs with suspected CNS lymphoma (W. Vernau, unpublished data). Recently, qRT-PCR was used to assess the cytokine profiles present in the CSF of horses with different neurological disorders (Pusterla *et al.*, 2006b). Some differences were noted between the different types of diseases but significant overlap of values also occurred. Further developmental work in conjunction with additional prospective studies will be required before the true utility of PCR based CSF diagnostics can be accurately assessed in domestic animals.

## D. Protein Analysis

### 1. Measurement of CSF Total Protein

An increase in the concentration of CSF total protein was recognized as an indicator of neurological disease soon after the introduction of lumbar puncture in human medicine. A number of tests were developed to assess qualitative changes in CSF protein, such as Lange's colloidal gold test, the Nonne-Appelt test, the Pandy test, and others. These qualitative tests have largely been replaced by quantitative methods. Urinary dipsticks have been used to determine CSF protein concentration, but false negative and false positive test results occur using this methodology, which preclude recommendation for routine use (Behr *et al.*, 2003; Jacobs *et al.*, 1990). Techniques for quantitative measurement of CSF total protein include turbidimetric methods, biuret procedures, and Lowry's method. The accuracy of these methods in many clinical laboratories is no better than  $\pm 5\%$  (Fishman, 1992). Dye binding microprotein assays such as Coomassie Brilliant Blue, Ponceau

S red, and Pyrogallol red (Marshall and Williams, 2000; Pesce and Strande, 1973) are more accurate and are now the methods of choice for measurement of CSF protein concentration. Total CSF protein values are reported in numerous articles and vary noticeably with the methodology and the laboratory performing the assay. Therefore, clinicians must use laboratory-specific normal values when assessing CSF protein concentration.

## 2. CSF Protein Fractionation

A number of techniques for fractionation of CSF proteins have been developed. These include electrophoresis using paper or cellulose acetate, agar, agarose, polyacrylamide, and starch gels. Immunoelectrophoresis, electroimmunodiffusion, radioimmunoassay, isoelectric focusing, and high-resolution protein electrophoresis are more recent techniques (Behr *et al.*, 2006; Fishman, 1992; Kjeldsberg and Knight, 1993). Because of the normally low protein content, most of these methods require concentration of the CSF, which can create technical artifacts in the measured protein content. Techniques that do not require CSF concentration, such as electroimmunodiffusion, are therefore advantageous (Fishman, 1992).

## 3. Albumin and the CSF/Serum Albumin Index

Because albumin is synthesized only extrathecally, increased CSF albumin indicates damage to the blood-brain/CSF barriers, intrathecal hemorrhage, or a traumatic CSF tap. In these conditions, albumin will leak into the CSF in general proportion to its serum concentration. Therefore, in the absence of intrathecal hemorrhage (pathological or iatrogenic), the ratio of CSF albumin to serum albumin can be used as an indicator of barrier dysfunction (Link and Tibbling, 1977; Tibbling *et al.*, 1977). This ratio is also called the albumin index (a.k.a. albumin quota, albumin quotient) and is calculated as follows (Kjeldsberg and Knight, 1993):

$$\text{Albumin Index} = \frac{\text{CSF albumin (mg/dl)}}{\text{serum albumin (g/dl)}}$$

Values above the normal range indicate increased barrier permeability. The use of this index is potentially limited, however, because the large variability of CSF albumin in normal animals (at least in dogs and horses) (Andrews *et al.*, 1990a, 1994; Bichsel *et al.*, 1984b; Krakowka *et al.*, 1981) results in a large variability in the values for this index (Davson and Segal, 1996). In people, the albumin index is age dependent, being highest in newborns, and lowest in childhood. The albumin index increases with age (Deisenhammer *et al.*, 2006).

## 4. Quantitative Measurement of Immunoglobulins

### a. IgG and the IgG/Albumin Index

The identification of intrathecal production of immunoglobulin is helpful in the diagnosis of neurological disease.

Immunoglobulin G is the dominant CSF immunoglobulin. However, the IgG content of CSF is not a particularly useful measurement by itself because the IgG present in CSF may be of serum-origin (via a dysfunctional blood-brain/CSF barrier, intrathecal hemorrhage, or traumatic puncture) or intrathecally produced (as in various neural diseases). Varied opinions exist regarding the best way to calculate the contribution of IgG from each source (Thompson, 1988; Trotter, 1989). To determine the probable origin of CSF IgG, it can be related mathematically to a protein of purely extrathecal origin. Because albumin is synthesized entirely extrathecally, it is the preferred comparison protein and is the most widely used (Fishman, 1992). Transferrin and alpha<sub>2</sub> macroglobulin have also been recommended because of their extrathecal origin (Schliep and Felgenhauer, 1974).

The simplest formula for correction of the CSF IgG level for extrathecal "contamination" (Zimmerman *et al.*, 2006), and thereby demonstration of intrathecal IgG synthesis, is the IgG/albumin index (Link and Tibbling, 1977; Tibbling *et al.*, 1977). This index is calculated using the CSF and serum concentrations of albumin and IgG as follows (Kjeldsberg and Knight, 1993):

$$\text{IgG Index} = \frac{\frac{\text{CSF IgG (mg/dl)}}{\text{serum IgG (g/dl)}}}{\frac{\text{CSF albumin (mg/dl)}}{\text{serum albumin (g/dl)}}}$$

The denominator of this index (CSF albumin/serum albumin) is the albumin index. Because albumin is synthesized only extrathecally, the albumin index assesses the amount of albumin crossing the blood-brain/CSF barriers and therefore is a measure of barrier integrity. Blood contamination of the CSF with as little as 0.2% serum (equivalent to about 5000 to 10,000 RBC/ $\mu$ l) by a traumatic puncture falsely elevates the IgG index in people (Peter and Tourtellotte, 1986). Also, the IgG index loses reliability when CSF protein levels are less than 25 mg/dl or greater than 150 mg/dl (Boerman *et al.*, 1991).

An additional problem with the IgG index is its basic premise that the selectivity of the protein transfer at the blood-CSF barrier is independent of the actual permeability condition. This concept has been shown to be incorrect and the IgG index, as well as the IgA and IgM indices, vary in a nonlinear fashion with progressive impairment of the barrier (Reiber and Felgenhauer, 1987). Therefore, Reiber and Felgenhauer (1987) developed a formula to calculate the intrathecally synthesized fractions of IgG, IgM, and IgA in the CSF.

### b. IgM and IgA Indices

As with IgG, CSF IgM and IgA may be of serum origin or intrathecally produced. Indices for IgM and IgA can be calculated in the same fashion as for IgG (Fryden *et al.*, 1978). However, because of high variability in normal IgM and IgA levels and the biological variation of these large molecules, the application of the same formula for IgM and IgA indices as used for the IgG index may only

provide rough estimates (Reiber and Felgenhauer, 1987; Tipold *et al.*, 1994).

### 5. Qualitative Immunoglobulin Assays

Qualitative assays of CSF immunoglobulins include agarose-gel electrophoresis, acrylamide immunoelectrophoresis, isoelectric focusing, and immunofixation. These tests separate the proteins into “bands” and provide information regarding the CSF protein composition. Although abnormal band patterns are not specific for a particular disease, they do indicate pathology and may indicate a type of disease. Abnormal band patterns may be detected even in patients with a normal IgG index. Thus, both quantitative and qualitative immunoglobulin assays are useful in the assessment of central nervous system disorders in both people and animals, particularly immunological or inflammatory diseases (Bichsel *et al.*, 1984b; Deisenhammer *et al.*, 2006; Fishman, 1992; Kjeldsberg and Knight, 1993).

### E. Antibody/Antigen Tests

A variety of CSF antibody and antigen tests are available for viruses, fungi, rickettsia, protozoa, parasites, and other organisms (Berthelin *et al.*, 1994a; Duarte *et al.*, 2006; Dubey, 1990b; Jacobs and Medleau, 1998; Lunn *et al.*, 2003; Madhusudana *et al.*, 2004; Porter *et al.*, 2004; Rossano *et al.*, 2003). For antibody titers, two samples taken 2 weeks apart should be assayed. Because of inter-run variability, the samples should be assayed at the same time in the same analytical run. Interpretation of CSF antibody titers must take into account the possibility of passage of serum antibodies through a defective blood-brain/CSF barrier. Serum antibodies could be present because of disease, previous exposure to antigen, or vaccination. Ideally, the CSF/serum albumin index and IgG index are also determined (see Sections V.D.3 and V.D.4) to identify blood-CSF barrier dysfunction and intrathecal production of immunoglobulin. Intrathecal production of antigen-specific antibody (specific Ig) can be determined with an antibody index in the same fashion as intrathecal IgG production is detected with the IgG index. The formula is (Reiber and Lange, 1991):

$$\text{Antibody Index} = \frac{\frac{\text{CSF specific Ig}}{\text{serum specific Ig}}}{\frac{\text{CSF total Ig}}{\text{serum total Ig}}}$$

A modification of this formula accounting for large local synthesis of polyclonal IgG in the central nervous system may be necessary (Reiber and Lange, 1991). An antibody index >1 suggests intrathecal production of the specific antibody (Munana *et al.*, 1995; Reiber and Lange, 1991). Antibody indices have been calculated in human patients

with a variety of diseases (Reiber and Lange, 1991). The diagnostic reliability of these indices and application to clinical veterinary medicine need further study.

Antigen detection tests include immunoelectrophoretic techniques, agglutination tests, and enzyme-linked immunosorbent assay (ELISA) for bacterial antigens and latex agglutination for cryptococcal antigens. The polymerase chain reaction (PCR) procedures detect the presence of specific antigen DNA (or RNA) in CSF and can be highly sensitive, specific, and rapid (see Section V.C.5).

### F. Microbial Tests

The Gram stain, the Ziehl-Neelson acid-fast stain, and both aerobic and anaerobic cultures of CSF are time-honored methods for diagnosis of bacterial central nervous system infections. Bacteriological tests must be performed as soon as possible after CSF acquisition because some bacteria undergo rapid autolysis in the test tube. Additional tests such as the acridine orange stain for bacteria, tests for microbial antigens by counterimmunoelectrophoresis or agglutination techniques, and the G test for the broad spectrum detection of fungi (tests for (1,3)- $\beta$ -D-glucan in most fungal cell walls) (Stevens, 2002) may also be useful (Fishman, 1992). PCR may be used to detect microbes in CSF (Finno *et al.*, 2006; Peters *et al.*, 1995; Stevens, 2002).

### G. Blood Contamination

Erythrocytes may be present in CSF samples because of subarachnoid hemorrhage or, more commonly, because of traumatic puncture. Blood contamination resulting from traumatic puncture is a common problem during CSF collection and, depending on its degree, can interfere with cytological interpretation. Blood contamination is more likely to occur with lumbar puncture as opposed to cerebellomedullary cisternal puncture (Bailey and Higgins, 1985; Oliver and Lorenz, 1993; Thomson *et al.*, 1990). Blood contamination is a source of leukocytes and hence can affect both the leukocyte count and the differential. In one study of CSF analysis in cats (Rand *et al.*, 1990b), the total leukocyte count, the neutrophil percentage and the eosinophil percentage were positively correlated with the CSF erythrocyte count once this count exceeded 500 erythrocytes per microliter. However, there was no significant increase in total white blood cell count or alteration in the differential percentages with up to 500 RBC/ $\mu$ l of CSF. Numerous correction factors have been used to correct leukocyte counts for the effect of blood contamination and include the following: in people, 1 white blood cell per 700 red blood cells is subtracted from the total white blood cell count (Fishman, 1992); in dogs, 1 white blood cell per 500 red blood cells is subtracted from the total count (Bailey and Higgins, 1985); in cats, a maximum of

one white blood cell per 100 red blood cells is subtracted (Rand *et al.*, 1990b). A more accurate formula takes into account the actual white blood cell and red blood cells counts of the patient and hence compensates for any significant alterations in these counts (Fishman, 1992):

$$W = WBC_F - \frac{WBC_B \times RBC_F}{RBC_B}$$

where  $W$  is the white blood cell count of the fluid before blood was added (i.e., the corrected count),  $WBC_F$  is the total white blood cell count in the bloody fluid,  $WBC_B$  is the white blood cell count in the peripheral blood per microliter, and  $RBC_F$  and  $RBC_B$  are the numbers of red blood cells per microliter in the CSF and blood, respectively. Despite all of these elaborate corrections, our own experience is that many thousands of red blood cells in contaminated samples of CSF will frequently be observed without any accompanying white blood cells, suggesting that these correction factors may not be valid. This empirical observation has been made by others (de Lahunta, 1983). This lack of validity has been proven by several studies (Novak, 1984; Wilson and Stevens, 1977). In one article, blood contamination appeared to have little effect on white blood cell numbers, and the above correction formula was considered unreliable. The authors evaluated 91 samples from both normal and diseased animals where there were numerous red blood cells but no white blood cells. Some of the red blood cell counts exceeded 15,000 RBC/ $\mu$ L, but white blood cells were still absent (Wilson and Stevens, 1977). In another article, the authors concluded that the standard computations frequently overcorrect white blood cell counts in blood contaminated CSF, and the magnitude of the overcorrection may obscure disease in some instances—in eight infants with marked blood contamination but proven bacterial meningitis, correction computations normalized or overcorrected the white blood cell counts (Novak, 1984). The mechanism of this overcorrection was not defined, but it is clear that the presence of low numbers of neutrophils should not be immediately discounted when red cells are concurrently found (Christopher *et al.*, 1988).

A study of feline CSF (Rand *et al.*, 1990a) also found that values for CSF total protein, lactate dehydrogenase, creatine kinase, IgG ratio, and  $\gamma$ -globulin percentage were affected by blood contamination. The CSF total protein value of blood-contaminated CSF may be corrected using the formula for white blood cell correction given previously but substituting the total protein levels of the bloody CSF and the serum for the corresponding white blood cell counts (Kjeldsberg and Knight, 1993). In people, bloody contamination of CSF with as little as 0.2% serum (equivalent to about 5000 to 10,000 RBC/ml) elevates the IgG index (Fishman, 1992).

## VII. GENERAL CHARACTERISTICS OF CSF IN DISEASE

### A. Physical Characteristics: Clarity, Color, and Viscosity

Normal CSF is clear and colorless, and has the consistency of water. In pathological conditions the clarity, color, or consistency may change.

#### 1. Clarity

Cloudy or turbid CSF is usually due to pleocytosis; about 200 WBC/ $\mu$ l or 400 RBC/ $\mu$ l will produce a visible change. With these low levels of cellularity, the CSF may appear opalescent or slightly hazy. Microorganisms, epidural fat, or myelographic contrast agent may also produce hazy or turbid CSF.

#### 2. Color

Although the term xanthochromia means yellow color, it has often been used to describe pink CSF as well. The color of CSF is most usefully described as (1) pink or orange, (2) yellow, or (3) brown. These colors correspond to the major pigments derived from red cells: oxyhemoglobin, bilirubin, and methemoglobin. Oxyhemoglobin is red in color, but after dilution in the CSF it appears pink or orange. Oxyhemoglobin is released from lysed red cells and may be detected in the CSF supernatant about 2h after red cells enter the CSF. The level of oxyhemoglobin reaches its peak about 36h later and disappears over the next 4 to 10 days. Bilirubin is yellow in color. Bilirubin is derived from hemoglobin and is formed by macrophages and other leptomeningeal cells that degrade the hemoglobin from lysed red blood cells. Bilirubin is detected about 10h after red cells enter the CSF, reaches a maximum at about 48h, and may persist for 2 to 4 weeks. Bilirubin is also the major pigment responsible for the abnormal color of CSF with a high protein content. Methemoglobin in CSF is dark yellow-brown. Methemoglobin is a reduction product of hemoglobin characteristically found in encapsulated subdural hematomas and in old, loculated intracerebral hemorrhages (Fishman, 1992; Kjeldsberg and Knight, 1993). Occasionally the CSF may be black tinged CSF in animals with melanin-producing tumors in the nervous system.

Causes of a CSF color change other than red cell contamination include icterus resulting from liver disease or hemolytic disease, markedly increased CSF total protein level, and drug effects. Both free and conjugated bilirubin may be present in the CSF, although the amount of bilirubin in the CSF does not correlate well with the degree of hyperbilirubinemia. If the CSF protein level is increased, the color change will be greater because of increased amounts of the albumin-bound bilirubin. High CSF protein content alone can impart a yellow color to the CSF (Fishman, 1992; Kjeldsberg and Knight, 1993). The drug rifampin imparts an

orange-red color to body fluids. Rifampin is 90% bound to protein; hypoproteinemia may result in rifampin staining of CSF in patients receiving this drug (Fishman, 1992).

### 3. Viscosity

Increased viscosity is usually due to a very high CSF protein content, particularly fibrinogen. If pleocytosis is present, a surface pellicle or a clot may form. In this situation, collection of the CSF in a heparinized or EDTA tube may be necessary to obtain an accurate cell count. Cryptococcosis may increase CSF viscosity because of the polysaccharide capsule of the yeast. Epidural fat or nucleus pulposus in the CSF may also increase viscosity or result in globules within the fluid (Fishman, 1992; Kjeldsberg and Knight, 1993).

## B. Cytology

An increase in the cellularity of CSF is termed pleocytosis. In general terms, the degree of pleocytosis depends on several factors, including the nature of the inciting cause and the severity and location of the lesion with respect to the subarachnoid space or ventricular system (Cook and DeNicola, 1988). A normal CSF analysis does not exclude the presence of disease (Fishman, 1992; Kjeldsberg and Knight, 1993). This is especially true with deep parenchymal lesions that do not communicate with the leptomeninges, and hence the subarachnoid space, or the ependymal surfaces. In these cases, despite the presence of neurological disease that is often severe, the lesion may not affect the CSF cellularity (Cook and DeNicola, 1988). Abnormal CSF findings always indicate the presence of pathology.

### 1. Neutrophilia

A marked pleocytosis with neutrophil predominance suggests either bacterial meningitis (Kjeldsberg and Knight, 1993; Kornegay *et al.*, 1978) or suppurative, nonseptic (corticosteroid responsive) meningitis (Meric, 1988, 1992a; Tipold and Jaggy, 1994). Total leukocyte counts in excess of 2000 cells per microliter are frequently encountered in these diseases and may even exceed 10,000 cells per microliter (Meric, 1992a). Observation of bacteria or a positive culture confirms septic meningitis. In our experience, bacteria are more commonly observed in the CSF of large animals afflicted with septic meningitis than in dogs or cats with septic meningitis. Neutrophil nuclear morphology is often used as criteria for determining the likelihood of sepsis with nuclear degenerative changes or karyolysis interpreted as evidence of bacterial disease. However, the neutrophils in confirmed cases of septic meningitis in dogs and cats are frequently well preserved, especially if there has been prior therapy. Therefore, absence of bacteria or degenerative nuclear changes in neutrophils cannot be used to unequivocally exclude a diagnosis of septic meningitis, although it does make it less likely. In people, acute viral meningoencephalitis initially causes a neutrophilic pleocytosis (Converse *et al.*, 1973; Fishman, 1992; Kjeldsberg

and Knight, 1993) that may persist from a few hours to several days before the development of the more typical mononuclear reaction. A similar phenomenon is documented in animals (Green *et al.*, 1993). Occasionally, distemper virus infection causes massive encephalomalacia (Vandeveldel and Spano, 1977) resulting in a neutrophilic pleocytosis, in contrast to the more typical moderate mononuclear pleocytosis. Central nervous system neoplasia may result in a neutrophil predominance in the CSF, especially if there is significant necrosis and inflammation associated with the tumor. Moderate to marked pleocytosis with neutrophil predominance may be noted in dogs with meningioma (Bailey and Higgins, 1986b). However, in another study of dogs with meningioma, about 30% of dogs had a normal CSF analysis (Dickinson *et al.*, 2006). In this study, a significant association between meningiomas in the caudal portion of the cranial fossa and an elevated CSF nucleated cell count was found; but only 19% of the dogs had an elevated total nucleated white cell count with a predominance of neutrophils (Dickinson *et al.*, 2006).

Canine intervertebral disk disease is associated with variable alterations in CSF that depend on factors such as disease severity and chronicity (Thomson *et al.*, 1989). Acute severe disease may result in counts greater than 50 cells per microliter with more than 50% neutrophils (Thomson *et al.*, 1989). This finding may be a reflection of acute inflammation secondary to trauma that may be exacerbated by myelomalacia in some instances. The authors have seen a similar phenomenon associated with fibrocartilaginous embolic myelopathy in dogs. A neutrophilic pleocytosis of varying severity often occurs following myelography with iodinated contrast agents (Carakostas *et al.*, 1983; Johnson *et al.*, 1985; Widmer *et al.*, 1992). These changes usually peak at 24 h postmyelogram (see Section VII for further details). Similarly, a neutrophilic pleocytosis has been observed postictally in people. We have occasionally observed similar findings in dogs (see Section VII).

### 2. Lymphocytosis

Alterations in both numbers and morphology of lymphocytes (see Section III.B) in the CSF occur in a variety of diseases. Central nervous system viral infections often result in a predominantly lymphocytic pleocytosis, documented in dogs (Vandeveldel and Spano, 1977), cats (Dow *et al.*, 1990; Rand *et al.*, 1994b), horses (Green *et al.*, 1992; Hamir *et al.*, 1992; Wamsley *et al.*, 2002), sheep, goats (Brewer, 1983), and numerous other species. In people, CSF lymphocytosis has been observed in bacterial meningitis following antibiotic therapy (Cargill, 1975; Converse *et al.*, 1973; Fishman, 1992; Kjeldsberg and Knight, 1993), indicating that therapy and chronicity can alter the CSF findings. A similar finding has been reported in dogs (Sarfaty *et al.*, 1986; Tipold and Jaggy, 1994) and calves (Green and Smith, 1992). We have noted that dogs with chronic or acute on chronic type I intervertebral disk disease have a pleocytosis that is more commonly lymphocytic than neutrophilic (Windsor *et al.*, 2007). The CSF

findings with granulomatous meningoencephalitis (GME) are somewhat variable, but a marked lymphocytic pleocytosis is common (Bailey and Higgins, 1986a; Thomas and Eger, 1989). Similarly, dogs with necrotizing meningoencephalitis (small breed dogs including pug dogs, Yorkshire terriers, and Maltese terriers) frequently have a marked lymphocytic pleocytosis (Cordy and Holliday, 1989; Stalis *et al.*, 1995; Tipold *et al.*, 1993a).

### 3. Eosinophilia

Eosinophils are not present in normal, uncontaminated (by blood) CSF. Single eosinophils are occasionally noted on cytocentrifuge slides from animals with normal CSF (normal nucleated counts and protein concentration). Although the presence of eosinophils in CSF is abnormal and evidence of underlying disease, no diagnostic specificity is associated with their presence in human CSF, as they can be found in a variety of diseases (Bosch and Oehmichen, 1978). Additionally, CSF eosinophilia and peripheral blood eosinophilia do not necessarily occur together and if they do, no positive correlation exists between the magnitude of peripheral blood eosinophilia and the severity of the CSF eosinophilia (Bosch and Oehmichen, 1978; Smith-Maxie *et al.*, 1989). In one case series of eight dogs with eosinophilic meningoencephalitis, five of eight had concurrent peripheral eosinophilia, but no correlation was present between the peripheral and CSF eosinophil counts. The two dogs with the highest CSF eosinophil counts had peripheral eosinophil counts within normal reference limits. In people, central nervous system invasion by parasites, especially *Angiostrongylus cantonensis*, is the most frequent cause of eosinophilic pleocytosis; in many of these cases eosinophils predominate in the CSF differential cell count (Bosch and Oehmichen, 1978; Kuberski, 1979). A marked eosinophilic pleocytosis is also reported in dogs with neural angiostrongylosis (Lunn *et al.*, 2003; Mason, 1989). CSF eosinophilia can also occur in association with bacterial, fungal, and viral infections and hence can be seen concurrently with suppurative, granulomatous, and lymphocytic inflammatory processes of the central nervous system (Jamison and Lumsden, 1988; Smith-Maxie *et al.*, 1989). However, in many of these cases, eosinophils represent less than 5% of the total cell count in CSF (Bosch and Oehmichen, 1978; Smith-Maxie *et al.*, 1989). Other documented causes in people include neurosyphilis, tuberculosis, rickettsial disease, foreign body reactions to shunt tubes, intrathecal penicillin or contrast agents, hypereosinophilic syndrome, multiple sclerosis, lymphoma, Hodgkin's disease, leukemia, melanoma, disseminated glioblastoma, idiopathic, and systemic allergic reactions (Bell *et al.*, 2006; Fishman, 1992; Kjeldsberg and Knight, 1993; Kuberski, 1979; Smith-Maxie *et al.*, 1989). In animals, CSF pleocytosis that consists predominantly, or almost exclusively, of eosinophils is rare. We have personally seen CSF eosinophilia with marked eosinophil predominance in association with idiopathic or steroid

responsive eosinophilic meningoencephalitis (Smith-Maxie *et al.*, 1989), canine neural angiostrongylosis (Mason, 1989), and histopathologically confirmed canine CNS neosporosis.<sup>4</sup> Golden retriever dogs and rottweilers may be predisposed to idiopathic or steroid responsive eosinophilic meningoencephalitis (Bennett *et al.*, 1997; Smith-Maxie *et al.*, 1989). Pleocytosis with eosinophil predominance has also been described in central nervous system cryptococcosis (Vandeveld and Spano, 1977), although this finding is not common in our experience. Other documented causes of CSF eosinophilia (though not necessarily predominance) in animals include bacterial encephalitis, distemper, rabies, toxoplasmosis, neosporosis, cuterebral encephalitis, central nervous system nematodiasis and cestodiasis, protothecosis, granulomatous meningoencephalomyelitis, lymphoma, astrocytoma, cerebral infarction, canine neural angiostrongylosis, and salt poisoning (Chrisman, 1992; Darien *et al.*, 1988; Jamison and Lumsden, 1988; Lester, 1992; Mac Donald *et al.*, 1976; Mason, 1989; Oruc and Uslu, 2006; Smith, 1957; Tyler *et al.*, 1980; Vandeveld and Spano, 1977).

### 4. Neoplastic Cells

Lymphoma has been diagnosed on the basis of CSF assessment in both small and large animals (Lane *et al.*, 1994; Pusterla *et al.*, 2006a; Vandeveld and Spano, 1977). However, the observation of neoplastic cells in CSF samples from animals with central nervous system neoplasia other than lymphoma is uncommon in our experience. Few veterinary studies have investigated the prevalence of positive CSF cytology in animals with confirmed central nervous system neoplasia. In one study involving 77 histopathologically confirmed cases of primary central nervous system neoplasia in dogs, neoplastic cells were not observed in any sample (Bailey and Higgins, 1986b). However, in this study, cytological assessment was done only on those samples with an elevated cell count and these only accounted for 41.3% of cases. Tumor cells have been observed in the CSF when the CSF cell counts were within normal limits (Grevel and Machus, 1990; Grevel *et al.*, 1992). Additionally, in the study assessing primary brain tumors in 77 dogs (Bailey and Higgins, 1986b), CSF differential and cytology were done on cytopspin samples. The cell yield with cytopspin slide preparation is low, approximating 10% (Barrett and King, 1976) in some studies, and this may partly explain the failure to observe neoplastic cells in the above study. Other veterinary studies utilizing different techniques report a higher prevalence of neoplastic cells in the CSF from confirmed cases of central nervous system neoplasia. In two studies utilizing a K lmeel sedimentation apparatus, tumor cells were seen in the CSF in five of eight dogs (Grevel and Machus, 1990) and four of nine dogs (Grevel *et al.*, 1992). In the former study, two of the five cytologically

<sup>4</sup>W. Vernau, unpublished data.

positive cases had normal cell counts. The Kölmel technique results in a higher cell yield than cytocentrifugation, which may be partly responsible for the increased incidence of neoplastic cell observation in the CSF. Despite the low yield of cytospin slides, the presence of neoplastic cells in cytospin CSF slides from animals with CNS tumors other than lymphoma has been reported in cats with intracranial oligodendroglioma, dogs with CNS histiocytic sarcoma, and dogs with choroid plexus carcinoma (Dickinson *et al.*, 2000; Zimmerman *et al.*, 2006).<sup>3,5</sup>

A large number of studies assess the prevalence of neoplastic cells in the CSF of people with central nervous system neoplasia. Overall sensitivities that are frequently quoted are 70% for CNS leukemia, 20% to 60% for metastatic meningeal carcinoma, and approximately 30% for primary CNS tumors (Kjeldsberg and Knight, 1993), regardless of the technique utilized. The detection rate of malignant cells in the CSF is improved by the collection of multiple samples (Olson *et al.*, 1974). These figures are supported by one study utilizing cytocentrifugation in 117 cases of histopathologically confirmed central nervous system neoplasia (Glass *et al.*, 1979). Overall, 26% (31/117) were positive. However, if only those people with leptomeningeal involvement were considered, the prevalence increased to 59%. Conversely, of 66 cases in which the tumor did not reach the leptomeninges, only a single sample was positive. In another study, only 13.9% of all gliomas had a positive CSF cytology (Balhuizen *et al.*, 1978). This low prevalence is likely because the majority of gliomas does not extend into the subarachnoid space (Balhuizen *et al.*, 1978). As a result of these studies, the following generalizations are frequently made in human medicine: (1) a positive CSF cytology is a reliable indicator of central nervous system malignancy and almost always reflects a leptomeningeal tumor (or one involving the ventricular system), and (2) a negative cytology does not exclude the presence of an intracerebral tumor, particularly a deep parenchymal mass that does not breach the pia or the ventricular system. Controlled studies are required in veterinary medicine to determine the prevalence of positive CSF cytology in confirmed cases of different types of central nervous system neoplasias, and also to compare the sensitivities of different preparative methods. These studies may be hampered by the general lack of experience at identifying cells derived from central nervous system neoplasms. Tumor cells can be erroneously identified as normal ependymal or choroid plexus cells. Solitary tumor cells from metastatic carcinomas can be mistaken for lymphocytes or monocytes (Kjeldsberg and Knight, 1993). The need for the above type of study has been somewhat decreased by the advent of more routine access to advanced imaging and biopsy techniques (Koblik *et al.*, 1999; Vernau *et al.*, 2001).

<sup>5</sup>Westworth, D., in preparation.

## C. Protein

### 1. Changes in CSF Total Protein Content

An increase in the total protein content of CSF is the single most useful alteration in the chemical composition of the fluid (Fishman, 1992). However, this alteration accompanies many diseases and is therefore nonspecific. Increased total protein may be caused by (1) increased permeability of the blood-brain/spinal cord/CSF barriers allowing passage of serum proteins into the CSF, (2) intrathecal globulin production, and (3) interruption of CSF flow or absorption. Particular emphasis has been put on CSF flow rate as a major factor in CSF protein content (Reiber, 1994). In many diseases, two or all three of these mechanisms are at work. In complete spinal subarachnoid space blockage (e.g., by a compressive lesion or arachnoiditis), CSF withdrawn caudal to the block may clot when aspirated. In people, this phenomenon is called Froin's syndrome and results from very high CSF protein levels caused by the defective flow and absorption and blood-spinal cord barrier breakdown (Fishman, 1992; Kjeldsberg and Knight, 1993).

Decreased total protein is much less common. Theoretically, low levels of CSF protein could result from decreased entry of protein into the CSF or increased removal. No evidence exists to support the first mechanism. Increased removal can occur, however, if intracranial pressure is increased while the barriers to serum protein remain normal. In this situation, bulk flow absorption of CSF is increased, whereas entrance of protein into the CSF remains normal. Protein content of fluid collected from the lumbar site could be decreased if large volumes are removed or if ongoing leakage of CSF from the lumbar area is occurring. In these situations, lumbar CSF is replaced more quickly than normal by ventricular CSF, which has a lower protein content than lumbar CSF (Fishman, 1992; Kjeldsberg and Knight, 1993). Low CSF protein has also occurred in people with hyperthyroidism, leukemia, or water intoxication (Fishman, 1992; Kjeldsberg and Knight, 1993).

### 2. Albuminocytological Dissociation

In many disease processes, the CSF cell count and CSF total protein increase in rough parallel. In some disorders, the cell count remains normal, whereas the total protein is notably increased, a phenomenon termed albuminocytological dissociation. Some degenerative disorders, ischemia/infarction, immune-mediated diseases (e.g., polyradiculoneuritis), tumors, and neural compression produce albuminocytological dissociation (Laterre, 1996).

### 3. Increased CSF Albumin and Albumin Index

Elevation of CSF albumin (which originates in the serum), and consequently an increased albumin index, indicates dysfunction of the blood-brain/spinal cord/CSF barriers or



contamination of the CSF by blood (from intrathecal hemorrhage or traumatic spinal tap). Barrier damage occurs in most types of neurological disorders, including inflammatory diseases, neoplasia, trauma, compression, and occasionally metabolic diseases (Bichsel *et al.*, 1984b; Krakowka *et al.*, 1981; Sorjonen, 1987; Sorjonen *et al.*, 1991).

#### 4. Increased CSF IgG and IgG Index

The CSF IgG can be increased by movement of protein across damaged blood-brain/CSF barriers, intrathecal hemorrhage (pathological or iatrogenic), or intrathecal IgG synthesis. An elevated CSF IgG content and increased IgG index, indicating intrathecal IgG synthesis, are typical for infectious inflammatory diseases (Tipold *et al.*, 1993b, 1994). In contrast, animals with noninflammatory diseases usually have normal IgG indices (Tipold *et al.*, 1993b). In a few animals with noninfectious disorders mild intrathecal IgG synthesis occurs, reflecting the presence of inflammatory infiltrates around the lesion (Tipold *et al.*, 1993b). Therefore, the IgG index is often useful for distinguishing between inflammatory and noninflammatory lesions, which is not always possible on the basis of CSF cell counts alone (Bichsel *et al.*, 1984b). In one study (Tipold *et al.*, 1993b), 7 of 66 dogs with inflammatory lesions had no pleocytosis but had an elevated IgG index; in contrast, 17 of 32 dogs with noninflammatory disease had pleocytotic CSF and a normal IgG index. The authors of this study consider an IgG index  $\geq 2.8$  as proof of intrathecal synthesis allowing a diagnosis of meningoencephalomyelitis, and an IgG index between 1.3 and 2.8 as suggestive of inflammatory disease. In a few dogs with marked inflammatory lesions and intrathecal IgG production, the IgG index may not be elevated because of marked IgG exudation against which the local IgG synthesis is undetectable (Bichsel *et al.*, 1984b). Traumatic puncture and red blood cell contamination of the CSF can artifactually increase the IgG index. Additionally, the normal IgG index of cerebellomedullary fluid and lumbar fluid are likely to be different because of the different protein concentrations of these fluids.

#### 5. Classification of Disease Based on Albumin Index and IgG Index

Alterations of the albumin index and the IgG index can be grouped into three pathogenetical categories: (1) blood-brain/CSF barrier disturbance (increased albumin index), (2) intrathecal IgG synthesis (increased IgG index), and (3) barrier disturbance combined with intrathecal IgG production (both indices increased). These categories correlate somewhat with certain types of diseases. Barrier disturbance may be seen in degenerative, inflammatory, metabolic, space-occupying, vascular, and traumatic conditions (Bichsel *et al.*, 1984b; Sorjonen, 1987; Sorjonen *et al.*, 1991). Intrathecal IgG synthesis is typical of inflammatory conditions (Tipold *et al.*, 1994) but also occurs in noninfectious

disorders that have secondary inflammation such as some tumors (Tipold *et al.*, 1993b). Barrier disturbance coupled with intrathecal IgG production is typical of infectious-inflammatory diseases (Bichsel *et al.*, 1984b).

#### 6. Increased CSF IgM, IgA, and IgM and IgA Indices

The immunoglobulins IgM and IgA may be increased in the CSF of animals with inflammatory neurological disease. A study of 69 dogs with inflammatory disease detected IgM elevations in 16 dogs and IgA elevations in 40 (Tipold *et al.*, 1994). An increased CSF IgM index is considered by some investigators to be a good indication of recent or persistent immunological stimulation in people (Sharief and Thompson, 1989). In contrast, one study reported that IgM was present through all stages of human herpes and bacterial meningitis, and increased and decreased with IgG (Felgenhauer, 1982). Perhaps a transition from IgM to IgG production does not occur in the central nervous system (Tipold *et al.*, 1994), or perhaps, in the presence of a normal or near-normal blood-CSF barrier, IgM accumulates in the CSF (Felgenhauer, 1982). In people with *Borrelia* infection, CSF IgM is persistently produced and the IgM index is a better indicator of this disease than is the IgG index (Fishman, 1992). Anti-West Nile Virus (WNV) IgM antibody production appears to occur intrathecally in horses and detection of CSF anti-WNV IgM may be used to differentiate previously vaccinated horses versus infected horses (Porter *et al.*, 2004). Further studies need to be done in animals to determine the sensitivity and specificity of the various immunoglobulin alterations occurring in disease.

#### 7. Electrophoretic Patterns of CSF Protein in Disease

Abnormalities in the CSF electrophoretic pattern can suggest categories of diseases (Sorjonen, 1987; Sorjonen *et al.*, 1991). In one study, dogs with inflammatory diseases had one of three patterns: (1) little or no blood-brain barrier disturbance (as determined by CSF albumin concentration and the albumin quota) with decreased gamma globulin, (2) mild blood-brain barrier disturbance with markedly increased gamma globulin, and (3) moderate or marked blood-brain barrier disturbance with increased gamma globulin. Dogs with intervertebral disk protrusion or cervical spondylomyelopathy had a pattern of normal barrier function or severe barrier disturbance with decreased alpha globulin. Dogs with brain neoplasia had marked barrier disturbance and normal or mildly increased alpha and beta globulins (Sorjonen *et al.*, 1991). However, a more recent study using high-resolution agarose electrophoresis was unable to differentiate various categories of neurological disease in dogs using this technique (Behr *et al.*, 2006).

In the gamma globulin region, three patterns of protein bands can occur: monoclonal, oligoclonal, and polyclonal.

Oligoclonal bands are associated with disease and are seen in a high percentage of people with multiple sclerosis or encephalitis. These bands, readily identifiable against the low background of normal polyclonal IgG in the CSF, are thought to represent the products of a limited number of plasma cell clones. Oligoclonal bands unique to CSF (i.e., not present in serum) indicate intrathecal synthesis of immunoglobulin and may be more sensitive than the IgG index in detecting this synthesis. People with multiple sclerosis may have a normal IgG index yet have CSF oligoclonal banding; thus, the demonstration of these bands is considered by some to be the single most useful test in the diagnosis of multiple sclerosis (Kjeldsberg and Knight, 1993). Oligoclonal bands are also seen in patients with inflammatory diseases and in some patients with neoplasia (Fishman, 1992). Occasionally, a single (monoclonal) band is identified in the CSF electrophoretic pattern of people. Monoclonal bands have been seen in neurologically normal people as well as in patients with neurological disease (Kjeldsberg and Knight, 1993).

#### 8. Other CSF Proteins

Numerous attempts have been made to correlate specific CSF proteins, particularly “brain-specific” proteins, with specific diseases. Proteins such as C-reactive protein, interferon, myelin basic protein, and S-100 are increased in the CSF associated with neurological disease, but these increases are found in many heterogeneous conditions. This nonspecificity limits the clinical utility of many of these specific protein assays. However, the measurement of some of these proteins is thought to be useful as a screening procedure for neurological disease or as an indication of prognosis (Fishman, 1992; Kjeldsberg and Knight, 1993; Lowenthal *et al.*, 1984). Immunoassay detection in the CSF of the brain-derived protein 14-3-3 appears to be helpful for the diagnosis of transmissible spongiform encephalopathies in both animals and people (Hsich *et al.*, 1996; Sanchez-Juan *et al.*, 2006). An autoantibody against canine glial fibrillary acidic protein present in astrocytes has been detected in the CSF of two pug dogs affected with necrotizing encephalitis (Uchida *et al.*, 1999). However, it is unknown if the presence of this antibody is a primary or secondary phenomenon.

#### 9. Plasma Proteins in the CSF

Alterations in plasma proteins may be reflected in the CSF. For example, in people, the serum protein monoclonal gammopathy of multiple myeloma may be evident in the CSF. Bence Jones proteins are also readily seen in the CSF. The high molecular weight paraproteins do not cross the normal blood-brain barrier, however. Serum protein electrophoresis is indicated in patients with elevated CSF globulins to clarify the source of the globulins (Fishman, 1992).

#### D. Antibody Titers

The CSF antibody titer can be measured for a number of diseases (Dubey, 1990b; Greene, 1990). Interpretation of the results is confounded by the need to differentiate among titers caused by vaccination, exposure to the antigen without development of the disease, and actual disease. Interpretation of CSF antibody titers could be aided by an accurate vaccination history, comparison of CSF and serum titers, assessment of blood-brain/CSF barrier function, and intrathecal immunoglobulin production by determination of albumin and immunoglobulin indices, determination of CSF IgM levels, and analysis of acute and convalescent samples (Chrisman, 1992; Green *et al.*, 1993; Porter *et al.*, 2004).

#### E. Glucose

Increased CSF glucose usually reflects hyperglycemia. Decreased CSF glucose occurs with several disorders of the nervous system, particularly acute, bacterial, fungal, amebic, or tuberculous meningitis. In people, low CSF glucose is also characteristic of diffuse carcinomatous meningitis, meningeal cysticercosis or trichinosis, and syphilitic meningitis. The major factors responsible for low CSF glucose levels are inhibition of the entry of glucose because of the alteration of membrane glucose transport and increased anaerobic glycolysis by neural tissue. As noted previously, hyperglycemia elevates the CSF glucose, which may mask a decreased CSF level. Therefore, calculation of a CSF/serum glucose ratio has been recommended to identify pathologically low CSF glucose levels (Deisenhammer *et al.*, 2006; Kjeldsberg and Knight, 1993). A CSF/serum glucose ratio less than 0.4 to 0.5 is considered to be pathological in people (Deisenhammer *et al.*, 2006). A low CSF glucose level in the absence of hypoglycemia indicates a diffuse, meningeal disorder, rather than focal disease (Fishman, 1992; Kjeldsberg and Knight, 1993). Decreased CSF glucose classically has been associated with bacterial meningitis, but many human patients with bacterial meningitis have normal CSF glucose levels. Therefore, the recommendation has been made that CSF glucose need be measured only if the opening CSF pressure, cell count, cyto-spin differential, and protein are inconclusive (Hayward *et al.*, 1987). CSF glucose concentration and CSF/serum glucose ratio are not routinely measured in veterinary medicine, possibly because of the lack of specificity and availability of more specific tests in most instances.

#### F. Enzymes

Numerous enzymes have been assayed in the CSF of animals (Furr and Tyler, 1990; Jackson *et al.*, 1996; Rand *et al.*, 1994b; Wilson, 1977). Of these, creatine kinase has received the most attention, and opinions of its usefulness are conflicting. Although Furr and Tyler confirmed previous observations that CSF creatine kinase activity was elevated in

several neurological diseases, they concluded that the greater frequency of elevation in the CSF of horses with protozoal myelitis versus horses with cervical compressive myelopathy indicated this enzyme assay was useful in differentiating these two diseases (Furr and Tyler, 1990). This conclusion was disputed by Jackson *et al.* (1996), who did not find the sensitivity or specificity of creatine kinase measurement sufficient for diagnosis of a specific disease. Jackson *et al.* (1996) also concluded that contamination of the CSF sample with epidural fat or dura mater may contribute to previously unexplained elevations in CSF creatine kinase activity. Their conclusion regarding this enzyme's lack of sensitivity and specificity reflects the current situation with all of the enzymes in CSF studied to date—none has sufficient specificity to warrant its routine use as diagnostic test (Fishman, 1992; Indrieri *et al.*, 1980; Jackson *et al.*, 1996; Kjeldsberg and Knight, 1993; Rand *et al.*, 1994b). The site of CSF collection with respect to the location of the lesion may be responsible for some of the lack of diagnostic significance in CSF enzyme analysis. Cerebellomedullary fluid may be less affected than lumbar fluid in animals with spinal disease (Indrieri *et al.*, 1980). Measurement of enzyme isomers may increase the specificity (Kjeldsberg and Knight, 1993).

To date, none of the enzyme assays are sufficiently sensitive or specific to warrant routine use in clinical practice (Fishman, 1992; Indrieri *et al.*, 1980; Jackson *et al.*, 1996; Kjeldsberg and Knight, 1993; Rand *et al.*, 1994a).

## G. Other Constituents

### 1. Interferon

Interferon is increased in the CSF in a large percentage of people with viral encephalitis-meningitis. This finding is not specific, however, as increases are also found in patients with bacterial meningitis (Glimaker *et al.*, 1994) or multiple sclerosis and occasionally in patients with noninflammatory neurological disease (Brooks *et al.*, 1983). In an experimental study of canine distemper, interferon appeared to be a valid marker for persistence of the virus in the central nervous system (Tsai *et al.*, 1982).

### 2. Neurotransmitters

Gamma-aminobutyric acid (GABA) is a major inhibitory neurotransmitter, whose dysfunction has been suggested to play a role in experimental (Griffith *et al.*, 1991) and clinical seizure disorders. Conversely, glutamate (GLU) is a major excitatory neurotransmitter in the CNS that plays an important role in the initiation, spread, and maintenance of epileptic activity in people (Meldrum, 1994). Increased extracellular concentrations of glutamate in the CNS may also mediate secondary tissue damage and cell death (Meldrum, 2000). A study of epileptic dogs found the average CSF

concentration of GABA to be significantly reduced, a situation similar to that in people (Loscher and Schwartz-Porsche, 1986). Inhibitory and excitatory neurotransmitters have been assayed in the CSF of epileptic dogs (Ellenberger *et al.*, 2004; Podell and Hadjiconstantinou, 1997). In one study, epileptic dogs were found to have lower levels of CSF GABA and higher levels of CSF glutamate than normal dogs (Podell and Hadjiconstantinou, 1997). In another study, CSF GABA was also found to be decreased in epileptic Labradors, but in contrast to the former report, these dogs had lower levels of CSF glutamate than normal dogs or epileptic non-Labradors (Ellenberger *et al.*, 2004). CSF neurotransmitters have also been assayed in dogs with portosystemic shunts (PSS) and clinical signs of hepatic encephalopathy (Holt *et al.*, 2002). Dogs with PSS had significantly higher levels of glutamine, tryptophan, and 5-hydroxyindoleacetic acid. These alterations may play a role in the neurological abnormalities associated with hepatic encephalopathy (Holt *et al.*, 2002). Because of its potential role in secondary tissue damage, glutamate concentrations in lumbar CSF have been measured in dogs with intervertebral disk herniation and acute and chronic compressive spinal cord lesions (Olby *et al.*, 1999). Dogs with severe, acute thoracolumbar disk herniations have two- to ten-fold increases in their lumbar CSF 12h or more after injury. The severity of the clinical signs appeared to be related to the lumbar CSF glutamate concentration (Olby *et al.*, 1999). Dogs with chronic compressive thoracolumbar lesions have a two-fold elevation of lumbar CSF glutamate concentration. However, focal spinal cord injuries did not alter glutamate concentrations in cisternal CSF (Olby *et al.*, 1999).

Increased CSF levels of the biogenic amine neurotransmitter metabolites homovanillic acid and 5-hydroxyindoleacetic acid were found in 2 of 10 collies experimentally given ivermectin (Vaughn *et al.*, 1989). Both of these collies had severe neurological deficits. Neurotransmitter metabolite concentrations were also elevated in the CSF of goats demonstrating neurological abnormalities after experimental boron toxicosis (Sisk *et al.*, 1990). Significant differences in neurotransmitter concentrations were found between the CSF of normal dogs and narcoleptic dogs (Faull *et al.*, 1982). Hypocretins are neuropeptides that bind to the G-protein coupled hypocretin receptors Hcrtr 1 and Hcrtr 2. Hypocretins are undetectable in the CSF of sporadic narcoleptic dogs but are normal in familial narcoleptic dogs that have mutations in the hypocretin receptor 2 gene (Ripley *et al.*, 2001).

### 3. Quinolinic Acid

Quinolinic acid is a neuroexcitotoxic metabolite of L-tryptophan and an agonist of N-methyl-D-aspartate receptors. Increased levels have been found in people with a variety of neurological diseases including AIDS (Heyes *et al.*, 1992) and macaques infected with simian immunodeficiency virus (Smith, 1995). Quinolinic acid levels

may be elevated in the CSF of animals with inflammatory nervous system disease. Therefore, they may be useful as a marker of inflammation and perhaps also as an indicator of prognosis (Smith, 1995). Increased CSF quinolinic acid concentrations were also found in dogs with portosystemic shunts (PSS) and signs of hepatic encephalopathy (HE) (Holt *et al.*, 2002); it was speculated in this study that quinolinic acid and other tryptophan metabolites may contribute to the neurological abnormalities present in dogs with PSS and HE.

#### 4. Lactic Acid

In people, the measurement of CSF lactic acid has been advocated in differentiating bacterial from viral meningitis. CSF lactate concentration is also increased in CNS fungal infections and leptomenigeal metastatic disease (Deisenhammer *et al.*, 2006). CSF lactate concentration is independent of blood lactate concentration (Deisenhammer *et al.*, 2006). In people, CSF lactate concentration may be elevated in diseases resulting in severe or global brain ischemia and anaerobic glycolysis or mitochondrial disease. It correlates inversely with the CSF: blood glucose ratio. However, because many diseases may elevate CSF lactic acid, the overlapping CSF lactate levels limit the value of CSF lactate assay (Fishman, 1992; Kjeldsberg and Knight, 1993). In a study of dogs with a variety of CNS diseases, blood and CSF pyruvate and lactate levels were measured. Levels of pyruvate were variable. Lactate levels were significantly elevated only in dogs with disk disease over CSF lactate levels in normal dogs (Lobert *et al.*, 2003). A study of CSF lactate levels in horses with neurological disease found elevated lactate levels in several types of central nervous system diseases (Green and Green, 1990). Therefore, as with people, increased CSF lactic acid in the horse appears to be a nonspecific indicator of central nervous system disease. Interestingly, in the horses studied, elevated lactic acid was the only CSF abnormality associated with brain abscess (Green and Green, 1990).

#### 5. 3-OH Butyrate

The measurement of serum 3-OH butyrate concentration is useful in the feeding management of pregnant ewes and in the diagnosis of pregnancy toxemia. Following death, however, rapid autolytic change renders serum biochemical analysis useless. Scott *et al.* (1995) compared the 3-OH butyrate concentrations of serum collected antemortem and aqueous humor and CSF collected within 6 h of death. Their results indicated either fluid was suitable for post-mortem determination of 3-OH butyrate levels and that such data could be extrapolated to indicate antemortem serum 3-OH butyrate concentration and the possibility that pregnancy toxemia contributed to the death of the animal.

## VIII. CHARACTERISTICS OF CSF ASSOCIATED WITH SPECIFIC DISEASES

### A. Degenerative Disorders

This group of disorders includes a variety of diseases such as the inherited, breed-specific polyradiculoneuropathies, myelopathies, and encephalopathies; motor neuron diseases; and cerebellar abiotrophies. The storage diseases can also be included in this group. The inclusion of canine degenerative myelopathy is arguable, awaiting further clarification of its pathogenesis. The CSF in animals with degenerative disorders is characteristically normal, reflecting the lack of inflammation in the disease process (Braund, 1994; Oliver and Lorenz, 1993). A mild to moderate increase of CSF total protein may occur in several of these disorders, however. Increased total protein is also found in people with motor neuron disease, Parkinson's disease, and with various hereditary neuropathies and myelopathies. The mechanism of the protein increase is unknown. Electrophoretic studies of CSF associated with some human neurodegenerative disorders have shown a transudative pattern. Intrathecal immunoglobulin production has also been found in people with motor neuron disease (Fishman, 1992). In storage diseases such as globoid cell leukodystrophy, mucopolysaccharidosis, and fucosidosis, accumulated metabolic material may be seen in the white blood cells in the CSF (Keller and Lamarre, 1992; Roszel, 1972; Silverstein Dombrowski *et al.*, 2004).

#### 1. Canine Degenerative Myelopathy

Although the CSF of dogs with degenerative myelopathy may be normal, a mild elevation of the white blood cell count is present occasionally (Bichsel *et al.*, 1984b). More common is a normal cell count coupled with a mild to moderate elevation of total protein (approximately 40 to 70 mg/dl). This albuminocytological dissociation may support the theory that this disorder is an immune-mediated disease (Waxman *et al.*, 1980). However, concurrent, chronic, spinal cord compression by type II disk protrusion in many of these dogs complicates the situation, because chronic cord compression may also produce an increase in total protein. The elevated total protein concentration in canine degenerative myelopathy is probably the result of increased CSF albumin (Bichsel *et al.*, 1984b). The CSF IgG index is usually normal (Bichsel *et al.*, 1984b; Tipold *et al.*, 1993b), indicating a lack of intrathecal IgG production.

#### 2. Degenerative Myeloencephalopathy of Llamas

A degenerative myeloencephalopathy has been identified in two adult llamas. Lesions consist of bilateral white matter degeneration in all spinal cord segments and degenerate

neurons in the brain stem nuclei or degeneration of brain stem white matter tracts. Inflammation is not evident. Lumbosacral CSF from both animals was normal (Morin *et al.*, 1994).

### 3. Equine Motor Neuron Disease

The CSF of horses with this (Loscher and Schwartz-Porsche, 1986) disorder is either normal or has albuminocytological dissociation (Cummings *et al.*, 1990; Divers *et al.*, 1994; Morin *et al.*, 1994). In a study of 28 cases (Divers *et al.*, 1994), 9 of 26 horses had elevated CSF protein. The albumin quotient was abnormal in only 2 of 19 horses. The IgG index was increased in 8 of 16 horses. The abnormalities in total protein and IgG index did not appear to be associated with the duration or severity of clinical signs. The increased protein and IgG index in these horses suggest that intrathecal immunoglobulin production occurs. Blood-brain barrier damage and intrathecal IgG production also occur in people with motor neuron disease (Apostolski *et al.*, 1991).

## B. Idiopathic Diseases

### 1. Granulomatous Meningoencephalomyelitis

The CSF associated with granulomatous meningoencephalomyelitis (GME) is usually abnormal. The fluid may be clear or hazy and is generally colorless. The total white blood cell count is moderately to markedly elevated, as is the total protein. The white blood cell differential is variable, but typically lymphocytes predominate, with monocytes/macrophages and neutrophils comprising the remainder in about equal percentages (Bailey and Higgins, 1986a; Braund, 1994; Sarfaty *et al.*, 1986; Thomas and Eger, 1989; Tipold, 1995). A 15% to 30% neutrophilic component suggests GME, but the white blood cell differential can range from 95% neutrophils (Sorjonen, 1990) to 100% mononuclear cells. Plasma cells, cells undergoing mitosis, and large, mononuclear cells with abundant foamy cytoplasm are occasionally present (Bailey and Higgins, 1986a; Braund, 1994). Lumbar fluid is also abnormal, although it generally has fewer cells and less protein than cerebellomedullary fluid (Bailey and Higgins, 1986a). Electrophoresis of CSF suggests blood-brain barrier dysfunction is present in the acute stage of disease; intrathecal IgG production with resolution of the barrier dysfunction occurs in chronic disease (Sorjonen, 1990). The albumin quota is elevated (Sorjonen, 1987), and the IgG index is usually elevated (Bichsel *et al.*, 1984b; Tipold *et al.*, 1993b, 1994). If barrier dysfunction is severe, with marked transudation of protein, the IgG index may be normal because the amount of intrathecally produced IgG is small in comparison to the amount of transudated serum IgG (Bichsel *et al.*, 1984b; Fishman, 1992).

### 2. Necrotizing Encephalitis of Pug Dogs, Maltese Dogs, and Yorkshire Terriers

A necrotizing encephalitis (NE) of unknown cause is recognized in pug dogs (Cordy and Holliday, 1989; de Lahunta, 1983), Maltese dogs (Stalis *et al.*, 1995), and Yorkshire terriers (Ducote *et al.*, 1999; Jull *et al.*, 1997; Kuwamura *et al.*, 2002; Tipold *et al.*, 1993a). The lesions are similar in each breed, although the distribution of lesions in the pug and Maltese dogs (large, diffuse, cerebral) is different from that in the Yorkshire terriers (well-defined multifocal brain stem). The CSF associated with the pug and Maltese dog diseases has a moderate to marked, predominantly lymphocytic, increased white blood cell count (although one Maltese had 62% neutrophils) and moderate to marked elevation in total protein (Bradley, 1991; Cordy and Holliday, 1989; Stalis *et al.*, 1995). The CSF of the Yorkshire terriers has mild to moderate increases in white blood cells and protein, with a predominantly mononuclear differential count (Ducote *et al.*, 1999; Tipold, 1995; Tipold *et al.*, 1993a). Seizures are a consistent clinical sign for the pugs and the Maltese dogs but not the Yorkshire terriers.

An autoantibody against canine astrocytes has been detected in the CSF of dogs with NE (Matsuki *et al.*, 2004; Uchida *et al.*, 1999). This autoantibody, which recognizes glial fibrillary acidic protein, has also been detected in the CSF of dogs with GME and with intracranial tumors (Matsuki *et al.*, 2004); therefore, it is not a specific finding in dogs with NE. It is unknown if the presence of this antibody is a primary or secondary phenomenon. Further research is necessary to determine the clinical utility of the presence of this autoantibody in CSF.

## C. Immune-Mediated Diseases

### 1. Acute Idiopathic Polyradiculoneuritis/Coonhound Paralysis

Acute idiopathic polyradiculoneuritis is one of the most common canine polyneuropathies, and coonhound paralysis is the most common form. The disorder resembles Guillain-Barre syndrome of people. In affected dogs, the classical CSF abnormality is albuminocytological dissociation. The abnormality is more obvious in lumbar CSF than in cerebellomedullary CSF (Cuddon, 1990; Cummings *et al.*, 1982). The CSF IgG level and IgG index may also be increased, indicating intrathecal immunoglobulin production (Cuddon, 1990; Tipold *et al.*, 1993b).

### 2. Equine Cauda Equina Neuritis

This disease is thought to be an autoimmune polyneuritis. The CSF of affected horses may be xanthochromic and typically has a prominent, usually lymphocytic pleocytosis (at least in the chronic stage) and moderately elevated

protein. The CSF can also be normal (Mayhew, 1989; Yvorchuk, 1992).

### 3. Steroid-Responsive Meningitis/Arteritis

Steroid-responsive meningitis/arteritis is a common, suppurative meningitis of dogs. The CSF has a marked, often extreme, neutrophilic pleocytosis, and moderately to markedly increased protein. Occasionally a single sample collected early in the disease is normal (de Lahunta, 1983; Meric, 1988; Tipold *et al.*, 1995). The IgG index is typically elevated (Tipold and Jaggy, 1994; Tipold *et al.*, 1993b), and IgM and IgA levels are often elevated as well (Tipold and Jaggy, 1994; Tipold *et al.*, 1995). Microbial cultures are negative. In protracted or inadequately treated cases, the pleocytosis is mild to moderate with a mixed population or even a mononuclear cell predominance; the protein level may be normal or slightly elevated. The CSF may even be normal (Tipold and Jaggy, 1994). A polyarteritis/vasculitis reported in beagles, Bernese mountain dogs, German short-haired pointers, and sporadically in other breeds (Meric, 1988) has similar CSF abnormalities and pathological changes and may be the same disease as steroid-responsive meningitis/arteritis (Tipold and Jaggy, 1994). Boxer dogs may also be predisposed to this disease (Behr and Cauzinille, 2006).

## D. Infectious Diseases

The variety of CSF abnormalities associated with infectious disease reflects the variety of infectious diseases affecting the central nervous system. If the infection causes inflammation, the total white blood cell count and protein usually will be elevated, but the degree and type of abnormality depend on the infectious agent, the immune status of the animal, the location of the infectious process (e.g., surface-related versus parenchymal), the duration of the infection, and previous treatment. The general rules of inflammation resulting from infection apply (i.e., bacterial infections result in suppurative inflammation whereas viral infections result in nonsuppurative inflammation). Several important exceptions exist, however.

### 1. Bacterial Diseases

In central nervous system aerobic or anaerobic bacterial infections, the CSF may be clear, hazy, or turbid (depending on the cell count), and colorless or amber with moderate to marked elevations of total white blood cell count and total protein concentration. Because of the elevated protein concentration, the CSF may clot or foam when shaken. The white blood cell differential count characteristically has a high percentage of neutrophils (>75%), which may be degenerate (Baum, 1994; Dow *et al.*, 1988; Foreman and Santschi, 1989; Green and Smith, 1992; Kornegay, 1981; Meric, 1988; Rand *et al.*, 1994b; Santschi and Foreman,

1989; Scott, 1995; Sturges *et al.*, 2006; Tipold, 1995). The protein is composed of albumin that has crossed the diseased blood-brain/CSF barrier and immunoglobulin produced intrathecally; therefore, the IgG index is usually elevated (Tipold *et al.*, 1993b, 1994). The IgM and IgA levels may be normal or increased (Tipold *et al.*, 1994). The CSF of animals with chronic or treated bacterial infections may be non-suppurative with mild to moderate elevations of total white blood cell count and total protein concentration (Green and Smith, 1992; Sturges *et al.*, 2006). Occasionally extracellular or intracellular bacteria may be seen, either on a routine Wright's stain or a Gram stain (Foreman and Santschi, 1989; Green and Smith, 1992; Kornegay, 1981). Because prior antibiotic therapy is common, and some bacteria undergo rapid autolysis in the test tube, bacterial culture of these infections is often unrewarding. Nonetheless, culture should be attempted. Polymerase chain reaction techniques may be used to detect the presence of bacterial DNA (Finno *et al.*, 2006; Peters *et al.*, 1995).

#### a. Listeriosis

Despite being a bacterial infection, the CSF of cattle with meningoencephalitis caused by *Listeria monocytogenes* typically has mild to moderate elevations in total white blood cell count and total protein, with the white cells mostly mononuclear cells (Rebhun and deLahunta, 1982). These mild (to moderate) changes probably reflect the characteristic lesions of this disease, which are mononuclear vascular cuffing and parenchymal microabscesses. The disease in sheep may produce a CSF similar to that of infected cattle (Scarratt, 1987). However, two studies reported ovine CSF with moderate to marked elevations in white blood cell count and protein, with a neutrophilic pleocytosis (53% to 100% neutrophils) (Scott, 1992, 1993). The mononuclear CSF reported in cattle likely reflects a more chronic stage or resolution of the disease (Green and Smith, 1992; Kjeldsberg and Knight, 1993). A study of bacterial culture and polymerase chain reaction (PCR) for the detection of *L. monocytogenes* in the CSF of 14 infected ruminants yielded no positive cultures and only one positive PCR. Direct culture of brain tissue was more frequently positive. The authors concluded that *L. monocytogenes* only occasionally gains access to the meningoventricular system in the course of the disease, and that reliable, *in vivo* diagnosis of listeric encephalitis generally cannot be based on the detection of the organism in the CSF (Peters *et al.*, 1995).

#### b. Neuroborreliosis (Lyme Disease)

Although neuroborreliosis caused by the Lyme disease spirochete, *Borrelia burgdorferi*, has been suspected in dogs (Feder *et al.*, 1991; Mandel *et al.*, 1993) and horses (Burgess and Mattison, 1987; Hahn *et al.*, 1996), the actual incidence in animals is unknown. The diagnostic difficulties arise from a delay or repression of seroconversion

after infection; the high number of seropositive, clinically normal animals; the persistence of infection and seropositivity despite resolution of clinical disease; antibody cross-reactivity; and difficulty in culturing the organism from tissue or fluid samples (Appel *et al.*, 1993; Levy *et al.*, 1993; Madigan, 1993; Parker and White, 1992). The CSF associated with neuroborreliosis in animals has not been characterized. In people, CSF abnormalities are related to the stage of the disease. When present, typical abnormalities are a mononuclear pleocytosis (T lymphocytes, plasma cells, and IgM-positive B cells (Sindern and Malin, 1995) with a moderately elevated total protein and normal or decreased CSF glucose (Fishman, 1992). Persistent CSF oligoclonal bands and intrathecal synthesis of IgG, IgM, and IgA occur (Henriksson *et al.*, 1986). Diagnosis is enhanced by the determination of intrathecal synthesis of specific *B. burgdorferi* antibodies (Kaiser and Lucking, 1993), but cross-reactivity is a problem (Fishman, 1992). *Borrelia burgdorferi* antibodies have also been detected in the CSF of dogs (Feder *et al.*, 1991; Mandel *et al.*, 1993). Polymerase chain reaction (PCR) techniques for CSF have been developed, but the diagnostic success rate is variable (Lebech, 1994). The CSF of a horse was reported PCR positive for *B. burgdorferi* (Hahn *et al.*, 1996).

### c. Ehrlichial and Rickettsial Diseases

Ehrlichiosis, usually caused by *Ehrlichia canis*, and Rocky Mountain spotted fever, caused by *Rickettsia rickettsii*, sporadically involve the central nervous system of animals. In dogs with neural ehrlichiosis, the CSF resembles that of viral diseases (i.e., the white blood cell count and protein may be normal or slightly to moderately elevated with a predominantly mononuclear pleocytosis) (Buoro *et al.*, 1990; Firneisz *et al.*, 1990; Greene *et al.*, 1985; Marezki *et al.*, 1994; Meinkoth *et al.*, 1989). The albumin quotient is reported to be elevated (Sorjonen *et al.*, 1991). Occasionally, *Ehrlichia morulae* may be observed in CSF mononuclear cells or neutrophils (Marezki *et al.*, 1994; Meinkoth *et al.*, 1989). The few reports of CSF associated with Rocky Mountain spotted fever suggest a difference from ehrlichiosis in that the CSF pleocytosis of Rocky Mountain spotted fever may be predominantly neutrophilic, particularly early in the disease (Breitschwerdt, 1995; Breitschwerdt *et al.*, 1985; Greene *et al.*, 1985; Rutgers *et al.*, 1985). A predominantly neutrophilic pleocytosis has also been reported in dogs experimentally infected with *R. rickettsii* (Breitschwerdt *et al.*, 1990). In this same study, IgG or IgM antibodies were not detected in the CSF of experimentally infected dogs, but they were detected in the CSF of one naturally infected dog that also had a high serum titer (Breitschwerdt *et al.*, 1990).

### d. Thromboembolic Meningoencephalitis

In cattle, *Hemophilus somnus* causes bacteremia and thromboembolism, with some preference for neural tissue.

The vascular lesion results in multifocal hemorrhages. Consequently, the CSF is characteristically yellow with a high red blood cell count (not iatrogenic in origin), and moderately to markedly increased white blood cell count (predominantly neutrophils) and protein (Ames, 1987; George, 1996; Little and Sorensen, 1969; Mayhew, 1989). The bacterium can be cultured only occasionally from CSF and more easily from septicemic animals (Little, 1984; Nayar *et al.*, 1977)

## 2. Viral Diseases

The CSF associated with viral diseases is characterized by nonsuppurative inflammatory changes. The total white blood cell count and total protein are generally mildly to moderately elevated. The white cell population may be mixed with a majority of mononuclear cells or may be entirely mononuclear cells. Occasionally, neutrophils predominate, particularly in the early stages of disease or in certain diseases (discussed later). The IgG index is commonly elevated (Bichsel *et al.*, 1984b; Tipold *et al.*, 1994). The IgA and IgM levels may also be elevated. The CSF of viral infections may also be normal, particularly if the meninges or ependyma is not involved (Fankhauser, 1962; Fishman, 1992; Rand *et al.*, 1994b; Tipold, 1995; Tipold *et al.*, 1994).

### a. Canine Distemper

The CSF abnormalities associated with canine distemper (CDV) vary strikingly with the stage of the disease. Dogs with acute, demyelinating, noninflammatory distemper encephalitis may have normal or near normal CSF (mild elevations of total cell count and total protein) (Johnson *et al.*, 1988; Tipold, 1995). Protein elevation is most likely the result of blood-brain barrier dysfunction (Bichsel *et al.*, 1984b). The IgG index may also be normal or occasionally mildly elevated, which correlates with the histological findings of multifocal demyelination with few or no infiltration of inflammatory cells (Bichsel *et al.*, 1984b; Johnson *et al.*, 1988; Tipold *et al.*, 1993b, Vandeveld *et al.*, 1986). The acute form of nervous canine distemper is an exception to the usual association of an elevated IgG index with infectious neurological diseases because infiltration with inflammatory cells occurs only in the chronic stage of distemper encephalitis (Vandeveld *et al.*, 1986). The CSF IgM and IgA content is also usually normal (Johnson *et al.*, 1988; Tipold *et al.*, 1994). The CSF of subacute/chronic, inflammatory distemper usually has a moderately elevated total white blood cell count, primarily mononuclear, and moderately elevated protein (Bichsel *et al.*, 1984b; Tipold, 1995). The IgG index is typically elevated (Bichsel *et al.*, 1984b; Vandeveld *et al.*, 1986), and IgA levels are commonly increased. Interestingly, IgM levels are increased more often in the dogs in the chronic stage than in the dogs with acute, noninflammatory distemper (Tipold *et al.*, 1993b, 1994). The IgM and IgA are presumably of intrathecal origin (Tipold *et al.*, 1994), although blood-brain barrier dysfunction is also present in some dogs and

therefore protein could be of serum origin (Bichsel *et al.*, 1984b; Sorjonen, 1987; Sorjonen *et al.*, 1991). Occasionally the CSF is normal or has only mild changes in cell count or total protein content (Bichsel *et al.*, 1984b; Sorjonen *et al.*, 1991; Tipold, 1995; Tipold *et al.*, 1993b, 1994; Vandeveld *et al.*, 1986). Antimyelin antibody and antiviral antibody have also been identified in the CSF of inflammatory distemper (Vandeveld *et al.*, 1986). Canine distemper virus antibody is normally absent from CSF; when present it is diagnostic of infection. False-positive results can occur, however, if the CSF is contaminated by serum distemper virus antibody by either iatrogenic or pathological blood-brain barrier disturbance. The CSF of delayed-onset canine distemper (a.k.a. old dog encephalitis) has an elevated protein and nonsuppurative, inflammatory cytology. The IgG index is elevated, and much of the CSF IgG is virus-specific, suggesting an intrathecal antiviral immune response. The IgM and IgA concentrations are normal (Johnson *et al.*, 1988). Occasionally, distemper virus infection causes massive encephalomalacia (Vandeveld and Spano, 1977), resulting in a neutrophilic pleocytosis. Because of the variable presentations and CSF findings associated with CDV infection, definitive antemortem diagnosis can be difficult. Fluorescent antibody testing (IFA) for the detection of viral antigen in conjunctival, tonsillar, and respiratory epithelium has proven useful but only in the acute phases of illness (Greene and Appel, 2006). In subacute and chronic disease, antibody coating of viral antigen may interfere with diagnostic immunofluorescence (Amude *et al.*, 2006a; Andrews *et al.*, 1994; Greene and Appel, 2006). RT-PCR for the detection of viral RNA is likely the most sensitive method for detecting CDV infection; however, sensitivity may be higher in urine than in CSF (Amude *et al.*, 2006a; Frisk *et al.*, 1999; Kim *et al.*, 2006).

#### b. Equine Herpesvirus Myeloencephalitis

With its predilection for endothelial cells, the equine herpes virus 1 (EHV-1) may cause vasculitis and perivascular hemorrhage in the brain and spinal cord. As a result, the CSF is often xanthochromic. The total white blood cell count may be normal, whereas the total protein level is moderately to markedly elevated (albuminocytological dissociation). The CSF/serum albumin ratio is increased (Klingeborn *et al.*, 1983). In some cases, the total protein is normal, perhaps because the CSF is analyzed early in the course of the disease before the protein level has risen or late in the disease after the level has subsided (Kohn and Fenner, 1987). Antibodies to the virus may be identified in the CSF (Blythe *et al.*, 1985; Jackson *et al.*, 1977; Klingeborn *et al.*, 1983). Antiviral CSF antibodies are not present routinely in neurologically normal horses, horses vaccinated with modified live EHV-1, or horses with other neurological diseases (Blythe *et al.*, 1985). However, because of destruction of the blood-brain barrier, serum antiviral antibodies may pass into the CSF and confound

the interpretation of the CSF titers (Blythe *et al.*, 1985; Jackson *et al.*, 1977; Klingeborn *et al.*, 1983; Kohn and Fenner, 1987). Determining the CSF IgG index may help to assess the relevance of a positive CSF EHV-1 titer.

#### c. Feline Infectious Peritonitis

The feline infectious peritonitis (FIP) coronavirus may cause a multifocal, pyogranulomatous meningitis, choroid pleinitis, and ependymitis characterized by perivascular granulomas around small blood vessels. The CSF associated with these lesions consistently has a moderate to marked elevation of white blood cell count and protein concentration. In one study, the CSF of cats with FIP was distinctive compared to that of cats with other inflammatory central nervous system diseases in having greater than 200 mg/dl total protein (Rand *et al.*, 1994b). Despite being a viral disease, the white cell population is dominated by neutrophils, commonly greater than 70% (Baroni and Heinold, 1995; Kline *et al.*, 1994; Rand *et al.*, 1994b). Prolonged glucocorticosteroid therapy may result in a normal CSF in rare instances; the authors have observed this on at least one occasion.

#### d. Feline Immunodeficiency Virus

The CSF associated with feline immunodeficiency virus (FIV) neurological disease typically has a mild, primarily lymphocytic, pleocytosis (Dow *et al.*, 1990; Phillips *et al.*, 1994). In experimentally infected cats, the pleocytosis appears related to the duration, and perhaps route, of infection, as well as the age of the cat. In one study, pleocytosis appeared within 2 to 8 weeks of inoculation of adult cats, then disappeared by 20 weeks (Dow *et al.*, 1990). In a study of kittens, the total and differential cell counts were normal at 3 and 12 to 16 months postinoculation (Podell *et al.*, 1993). The total protein content is typically normal, although the albumin quotient and IgG index may be elevated (Dow *et al.*, 1990; Podell *et al.*, 1993). Antibodies to the virus may be detected in the CSF, and their presence in CSF that has not been contaminated by peripheral blood is presumptive evidence of FIV neural infection (Dow *et al.*, 1990; Phillips *et al.*, 1994). In experimentally inoculated cats, FIV antibodies developed in the CSF 4 to 8 weeks after the appearance of CSF pleocytosis (Dow *et al.*, 1990). The virus can be recovered from the CSF of most cats that have intrathecal antibodies (Dow *et al.*, 1990; Phillips *et al.*, 1994). In the immunodeficient, chronic stage of FIV infection, the effect of possible opportunistic neural infections on CSF must be considered.

#### e. Rabies

Because rabies is an overwhelmingly fatal, zoonotic disease, there is a paucity of information regarding its CSF abnormalities. In people, the total white blood cell count is normal or has a mild, lymphocytic pleocytosis, and total protein is mildly increased. Occasionally, the pleocytosis is marked



(Fishman, 1992). The CSF of animals with rabies may be normal or abnormal. Typical abnormalities include a mild to moderate mononuclear pleocytosis and mild to moderate elevations in total protein. The white cells may be predominantly lymphocytes, with macrophages, neutrophils, and occasionally plasma cells and eosinophils (Braund, 1994; Coles, 1980; Green *et al.*, 1992; Hamir *et al.*, 1992; Hanlon *et al.*, 1989). A neutrophilic pleocytosis reported for one horse was thought to reflect an early stage of the disease (Green, 1993). Xanthochromia was detected in the CSF of three of five horses in one study (Green *et al.*, 1992), perhaps because of antemortem head trauma. The CSF IgM titer increases in 2 to 3 weeks or more after the onset of clinical rabies (Murphy *et al.*, 1980). Because of this delay, a negative titer result does not eliminate rabies infection as a possibility (Greene, 1998). Infective virus may be isolated from the CSF before clinical signs of the disease appear, and neutralizing antibodies in the CSF may not be identified until after clinical signs develop (Fekadu and Shaddock, 1984). Because of the human health hazard, CSF collection should be avoided if rabies is suspected.

#### f. West Nile Virus

West Nile virus (WNV) is a mosquito-borne flavivirus that is endemic in Africa, Europe, and Asia and emerged as a pathogen in the United States in 1999 (Cannon *et al.*, 2006; Davis *et al.*, 2006; Long *et al.*, 2006; Porter *et al.*, 2004). Disease occurs most commonly in birds, horses, and humans and in several other animal species, and rarely in dogs. Clinical signs frequently include fever and neurological disease most often manifest by ataxia, weakness, and muscle tremors (Cannon *et al.*, 2006). Nonsuppurative (lymphoplasmacytic and histiocytic) poliomyelitis is seen histopathologically in the CNS of animals (Cannon *et al.*, 2006; Cantile *et al.*, 2000, 2001; Kiupel *et al.*, 2003; Wunschmann *et al.*, 2005). CSF is usually abnormal in horses (Wamsley *et al.*, 2002). A mild to moderate mononuclear pleocytosis with lymphocyte predominance and mildly increased protein concentration are the most common CSF findings (Wamsley *et al.*, 2002). However, macrophages may predominate, and occasionally only elevated protein concentration is present (albuminocytological dissociation). The albumin quotient is usually normal and the IgG index is elevated in lumbar (but not in cisternal) samples, perhaps reflecting spinal cord involvement, intrathecal IgG production in this location, and the tendency for pelvic limb weakness in many horses with clinical WNV disease (Porter *et al.*, 2004). In one study of horses with neurological disease attributable to WNV infection, all measured CSF parameters were within reference limits in 27% (8/30) of horses (Wamsley *et al.*, 2002). The current gold standard for diagnosis of active WNV infection in horses is the IgM capture ELISA (MAC-ELISA) for the detection of WNV-specific IgM antibodies. This test appears capable of distinguishing infected horses from vaccinated

horses (Porter *et al.*, 2004). Additionally, use of the MAC-ELISA in CSF may be slightly more sensitive than application of the same test in serum for horses with WNV infection (Porter *et al.*, 2004).

### 3. Fungal Diseases

Fungal infection of nervous tissue is relatively uncommon, although *Cryptococcus neoformans* has a predilection for the central nervous system. The CSF associated with neural cryptococcosis is quite variable. The total white blood cell count can be near normal or markedly increased. The white blood cell differential count is typically mixed with a majority of neutrophils (Berthelin *et al.*, 1994b; Steckel *et al.*, 1982). However, mononuclear CSF has been reported (Berthelin *et al.*, 1994b; de Lahunta, 1983), as has eosinophilic fluid (de Lahunta, 1983; Vandeveld and Spano, 1977). The total protein is typically elevated, although sometimes only marginally so. The albumin quotient and IgG index are mildly to markedly elevated (Sorjonen *et al.*, 1991). Cryptococcal organisms are commonly seen in the CSF (93% in one report/review) (Berthelin *et al.*, 1994b), and cultures are often, but not invariably, positive. Latex agglutination for cryptococcal antigen in the CSF may also be positive (Berthelin *et al.*, 1994b; Jacobs and Medleau, 1998).

There are only a few reports of the CSF abnormalities associated with CNS aspergillosis, blastomycosis, coccidioidomycosis, or histoplasmosis. The CSF abnormalities are variable; but a mixed pleocytosis and elevated protein are typical (Coates, 1995; Gelatt *et al.*, 1991; Kornegay, 1981; Mullaney *et al.*, 1983; Nafe *et al.*, 1983; Schaer *et al.*, 1983; Vandeveld and Spano, 1977). In a case of aspergillosis of the brain of a dog, the CSF had a normal total nucleated cell count (differential count was not done) and a normal protein (Parker and Cunningham, 1971). The tropism of some fungi for CNS white matter might result in failure to access the meninges or ventricular system and hence result in normal CSF.

### 4. Prion Disorders

The transmissible spongiform encephalopathies (TSEs) are a group of neurodegenerative diseases of people and animals caused by prions (proteinaceous infectious particles). The diseases in this group include Kuru and Creutzfeldt-Jakob disease of people, bovine spongiform encephalopathy, scrapie of sheep and goats, transmissible mink encephalopathy, and spongiform encephalopathies in deer, captive ungulates, and domestic cats (Schreuder, 1994a, 1994b). The CSF associated with the spongiform encephalopathies in animals has normal cytology, protein content, and electrophoretic pattern. Thus, these diseases, although apparently infectious, do not appear to damage the blood-brain barrier or elicit an immune response in the central nervous system (Green *et al.*, 2007; Lowenthal and Karcher, 1994;

Millson *et al.*, 1960; Scott *et al.*, 1990; Strain *et al.*, 1984). However, immunoassay detection in the CSF of the brain derived protein 14-3-3 appears to be useful for the diagnosis of TSE in both animals and people (Hsich *et al.*, 1996; Sanchez-Juan *et al.*, 2006).

## E. Ischemic Disorders

In general, neural ischemia causes blood-brain/CSF barrier dysfunction resulting in increased CSF protein. If infarction occurs, the tissue destruction and cellular response may result in CSF pleocytosis. With extensive, particularly acute, infarction the pleocytosis may be substantially neutrophilic (Fishman, 1992). In animals, CSF abnormalities are reported for fibrocartilaginous embolism and cerebral ischemia/infarction.

### 1. Fibrocartilaginous Embolism

The CSF characteristics associated with fibrocartilaginous embolism (FCE) are reported for dogs and horses. About one-third of the reported canine cases have normal CSF, about one-third have a mononuclear pleocytosis and increased protein, and about one-third have albuminocytological dissociation (Bichsel *et al.*, 1984a, 1984b; Cauzinille and Kornegay, 1996; Gandini *et al.*, 2003; Grunfelder *et al.*, 2005). Similar findings are reported for two horses (Jackson *et al.*, 1995; Taylor *et al.*, 1977). However, we have seen marked neutrophilic pleocytoses associated with (histopathologically confirmed) severe, acute FCE in dogs (unpublished observation). The type of pleocytosis, neutrophilic or mononuclear, probably depends on the size, location, and age of the infarct. The CSF albumin is reported to be normal, and the IgG index either normal or slightly elevated, the latter possibly reflecting the subsequent inflammation around the lesion (Bichsel *et al.*, 1984b; Tipold *et al.*, 1993b). Dogs with normal CSF may have a better prognosis for recovery (Cauzinille and Kornegay, 1996; Gandini *et al.*, 2003).

### 2. Cerebral Ischemia/Infarction

Cerebral infarction (ischemic encephalopathy) is reported primarily in cats, but also in a few dogs. In cats within the first week of onset, the CSF white blood cell count is normal or mildly elevated with a mixed, predominantly mononuclear, pleocytosis, and protein is mildly to markedly elevated (de Lahunta, 1983; Rand *et al.*, 1994a). Dogs with cerebral infarction have similar CSF characteristics (Bichsel *et al.*, 1984b; de Lahunta, 1983; Joseph *et al.*, 1988; Vandeveld and Spano, 1977), although two dogs in one report had a mixed, but predominantly neutrophilic, pleocytosis and normal protein (Vandeveld and Spano, 1977). The neutrophilic pleocytosis reflected the acute encephalomalacia noted on histopathological examination (Vandeveld and Spano, 1977). In one dog of another report, the CSF albumin and IgG

index were normal (Bichsel *et al.*, 1984b). Another dog with a deep, parenchymal, hemorrhagic infarct in the basal nuclear region had normal CSF (Norton, 1992).

## F. Malformations of Neural Structures

Although reports with CSF analysis are relatively few, the CSF of animals with neural malformations is generally normal (Greene *et al.*, 1976; Meric, 1992b; Milner *et al.*, 1996; Rand *et al.*, 1994a; Shell *et al.*, 1988; Vandeveld and Spano, 1977; Wilson *et al.*, 1979). However, if the malformation interferes with CSF circulation or absorption, abnormalities in protein and even cell count may be present. The CSF may also be altered by secondary or additional unrelated processes (Rishniw *et al.*, 1994). For example, intraventricular hemorrhage can occur in hydrocephalic animals, producing xanthochromic CSF with an increased white blood cell count and protein content.

### 1. Intracranial Intra-Arachnoid Cysts

Although several reports describe intracranial intra-arachnoid cysts (ICIACs) in dogs (Duque *et al.*, 2005; Kitagawa *et al.*, 2003; Saito *et al.*, 2001; Vernau *et al.*, 1997, 2002; Von Kurnatowski *et al.*, 2006), most do not report the CSF findings present with this condition. Several dogs with ICIACs are diagnosed with concurrent inflammatory brain disease (Duque *et al.*, 2005; Kitagawa *et al.*, 2003; Vernau *et al.*, 1997; Von Kurnatowski *et al.*, 2006), and some authors believe that ICIACs may therefore be incidental in some animals. One report describes two dogs with ICIACs with intracystic hemorrhage. One of these dogs had a normal CSF nucleated cell count but had some degenerate red blood cells and a moderate elevation of protein. The other dog had a mild mononuclear pleocytosis, a mild elevation of protein, and there was evidence of erythrocytrophagia (Vernau *et al.*, 2002).

### 2. Spinal Arachnoid Cysts

Most dogs with spinal arachnoid cysts have normal CSF analysis (Gnirs *et al.*, 2003; Hashizume, 2000; Jurina and Grevel, 2004; Rylander *et al.*, 2002; Sessums and Ducote, 2006; Skeen *et al.*, 2003). In dogs with a spinal arachnoid cyst that have abnormal CSF, the most common abnormality is an albuminocytological dissociation (Gnirs *et al.*, 2003; Rylander *et al.*, 2002) with protein concentrations that may exceed 100 mg/dl. Less commonly, dogs may have a mild mononuclear pleocytosis and increased protein concentration as high as 216 mg/dl (Rylander *et al.*, 2002).

## G. Metabolic/Nutritional Disorders

Cerebrospinal fluid analysis is not done commonly in animals with metabolic or nutritional neurological disorders

because most of these disorders are diagnosed from historical and physical findings and laboratory tests of blood and urine. When other procedures are nondiagnostic, or when therapy does not eliminate or perhaps worsens the neurological dysfunction, CSF analysis is indicated to investigate other causes of the neurological signs. In most cases, routine analysis of CSF associated with metabolic or nutritional disorders does not detect abnormalities (Bichsel *et al.*, 1984b; Fishman, 1992; Scott, 1995; Vandeveld and Spano, 1977). Although brain edema is relatively common with some of these disorders (e.g., hypoxia, hyponatremia, or the osmotic dysequilibrium syndromes of hemodialysis or diabetic ketoacidosis), the edema is usually cytotoxic rather than vasogenic. Therefore, the blood-brain/CSF barrier is usually intact and CSF protein is normal. If edema is severe enough to result in brain ischemia, infarction, or herniation, the blood-brain/CSF barrier becomes dysfunctional, vasogenic edema occurs, and CSF protein rises. If neural necrosis ensues, the white blood cell count may also increase. Even in the (apparent) absence of vasogenic edema, blood-brain barrier leakage may occur, perhaps because of the biochemical effects of the disorder on the barrier cells. Animals and people with uremic or hepatic encephalopathies or hypothyroidism may have increased total protein with a normal IgG index (Bichsel *et al.*, 1984b, 1988; Fishman, 1992). People with diabetic neuropathy may also have increased CSF protein (Fishman, 1992). Animals with severe metabolic encephalopathies often suffer seizures and the effect of seizures on the CSF must also be considered (see Section VII.H). Disorders in which neural necrosis is a primary feature, such as the polioencephalomalacia of thiamine deficiency, typically have a pleocytosis and increased total protein (Bichsel *et al.*, 1984b; de Lahunta, 1983; George, 1996). Specific biochemical analysis of CSF may show abnormalities, such as abnormalities in osmolality or electrolyte content with salt or water intoxication (Kopcha, 1987; Mayhew, 1989), abnormalities in amino acid levels (such as glutamine) with hepatic encephalopathy (Grabner and Goldberg, 1991; Schaeffer *et al.*, 1991), and elevated citrulline in bovine citrullinemia (Healy *et al.*, 1990).

## H. Miscellaneous Conditions

### 1. Alterations in CSF Following Myelography

Changes in the composition of CSF following myelography have been reported in people (Fishman, 1992) and animals (Burbidge *et al.*, 1989; Widmer and Blevins, 1991). Many contrast agents are low-grade leptomeningeal irritants, resulting in leptomeningeal inflammation that is reflected in the CSF. By 90 min after myelography, the total white blood cell count and total protein can be elevated and the white blood cell differential count altered. The pleocytosis is typically a mixed mononuclear/neutrophilic response, with the proportion of mononuclear cells to neutrophils varying with the contrast agent used and the time interval

after myelography. The pleocytosis may resolve within 10 days (Johnson *et al.*, 1985), although individual animals may have a slightly increased total white blood cell count up to 14 days following contrast injection (Spencer *et al.*, 1982; Wood *et al.*, 1985). In contrast, one study of the contrast agents iohexol and iotrolan did not detect any alteration of total white blood cell count in CSF taken between 1 and 14 days following myelography (van Bree *et al.*, 1991). The CSF specific gravity and Pandy test score can also be elevated, presumably partly because of the presence of the contrast media (Widmer *et al.*, 1992). Increased CSF albumin and immunoglobulin levels may be due predominantly to blood-brain/CSF barrier leakage, and may return to normal levels within 5 days (Johnson *et al.*, 1985). In summary, any alteration of CSF within the first week or two following myelography must be assessed cautiously.

### 2. Seizures: Interictal and Postictal CSF Characteristics

Patients with seizures resulting from progressive intracranial or some extracranial disorders typically have CSF changes reflecting the disorder. In contrast, the interictal CSF of patients with nonprogressive, intracranial disease should be normal. Postictal CSF is often abnormal, however. Pleocytosis of postictal CSF has been well documented in people (Barry and Hauser, 1994; Fishman, 1992; Rider *et al.*, 1995). The white blood cell counts may be up to 80/ $\mu$ l with a neutrophilic component from 5% to 92%. The cell counts are highest at about 24 h after the seizure. The mechanism of the pleocytosis is obscure (Fishman, 1992). Convulsive seizures, regardless of cause, may also induce a reversible increase in blood-brain/CSF barrier permeability, resulting in a transient elevation of CSF protein. Brain metabolism is also stimulated during the seizure, resulting in an increase in brain lactate production and a decrease in brain pH (Fishman, 1992). However, differentiating the effects of the local (brain) phenomena from the effects of systemic phenomena that occur during seizures (hypertension, acidosis, hypoxia, etc.) is difficult. For example, severe, experimental hyperthermia in dogs (core body temperature > 41.2°C) results in increased CSF enzymes, calcium, and chloride, probably because of increased blood-brain/CSF barrier permeability (Deswal and Chohan, 1981). Interpretation of postictal CSF must be done cautiously because of the potential confusion of a postictal, "idiopathic epileptic" condition with a progressive disease that alters the CSF primarily. For children with seizures, the recommendation has been made that CSF with >20 white blood cell/ $\mu$ l or >10 polymorphonuclear cells/ $\mu$ l not be attributed to the seizures (Rider *et al.*, 1995).

### I. Neoplasia

The CSF associated with neoplastic conditions affecting the central nervous is variable, reflecting the variety of tumors,

locations, and tissue reactions to the disease. The CSF is usually clear and colorless, although xanthochromia may be present if hemorrhage has occurred. The total white cell count is often normal, but pleocytosis may occur, particularly with meningiomas and choroid plexus tumors (and occasionally other tumors) (Bailey and Higgins, 1986b; Carrillo *et al.*, 1986). Pleocytosis is usually mononuclear, although meningiomas may have > 50% neutrophils (Bailey and Higgins, 1986b). However, in another study of dogs with meningioma, about 30% of dogs had a normal CSF analysis (Dickinson *et al.*, 2006). In this study, a significant association between meningiomas in the caudal portion of the cranial fossa and an elevated CSF nucleated cell count was found; but only 19% of the dogs had an elevated total nucleated white cell count with a predominance of neutrophils (Dickinson *et al.*, 2006). Neural lymphosarcoma often has a lymphocytic/lymphoblastic pleocytosis (Couto and Kallet, 1984; Lane *et al.*, 1994; Williams *et al.*, 1992), except in cattle in which the tumor is usually extradural (Sherman, 1987). One study of brain tumors in dogs found that pleocytotic CSF is associated with a significantly shorter survival time than is normal or albuminocytological CSF (Heidner *et al.*, 1991). The most common CSF abnormality present with CNS neoplasia is increased total protein, with choroid plexus tumors producing the most marked elevations (Bailey and Higgins, 1986b; Brehm *et al.*, 1995; Heidner *et al.*, 1991; Mayhew, 1989; Moore *et al.*, 1994; Rand *et al.*, 1994a; Roeder *et al.*, 1990; Sarfaty *et al.*, 1988; Waters and Hayden, 1990). Dogs with neural neoplasia, particularly of the meninges or choroid plexus, commonly have blood-brain/spinal cord barrier disturbance and subsequently an increased albumin quotient (Bichsel *et al.*, 1984b; Moore *et al.*, 1994; Sorjonen, 1987; Sorjonen *et al.*, 1991). In one study, this abnormality was most common with choroid plexus tumors and least common with astrocytomas (Moore *et al.*, 1994). Alpha and beta globulin levels are usually normal; gamma globulins are normal or mildly increased (Moore *et al.*, 1994; Sorjonen, 1987; Sorjonen *et al.*, 1991). The IgG index may be elevated, reflecting the presence of inflammatory infiltrates around the lesion (Bichsel *et al.*, 1984b; Tipold *et al.*, 1993b).

The CSF associated with spinal neoplasia is reported to be normal more often than is the CSF of brain tumors (Fingerroth *et al.*, 1987; Luttgen *et al.*, 1980; Schott *et al.*, 1990). This finding may reflect the fact that most spinal neoplasia is extradural or that most spinal tumors are relatively small at the time of diagnosis. It may also reflect the site of CSF collection—that most of the samples are cerebellomedullary rather than lumbar, although many reports do not state the puncture site. Cerebrospinal fluid collected caudal to the lesion is abnormal more often than is CSF collected cranial to the lesion (Thomson *et al.*, 1990). Neoplastic cells can also be observed in CSF, facilitating a definitive diagnosis. Lymphoma has been diagnosed on the basis of CSF assessment in both small and large animals (Lane *et al.*, 1994; Pusterla *et al.*, 2006a; Vandeveld and

Spano, 1977). However, the observation of neoplastic cells in CSF samples from animals with central nervous system neoplasia other than lymphoma is more uncommon in our experience. This may be partly because cytocentrifugation has been the most common technique employed for the cytological assessment of CSF. Although cytopspin slides produce excellent morphology, the cell yield is low (Barrett and King, 1976), which may increase the incidence of false negative results in confirmed cases of CNS neoplasia. Additionally, the general lack of experience of veterinary clinical pathologists at identifying cells derived from central nervous system neoplasms may also result in false negative results. Despite these limitations, the presence of neoplastic cells in cytopspin CSF slides from animals with CNS tumors other than lymphoma has been reported in cats with intracranial oligodendroglioma, dogs with CNS histiocytic sarcoma, and dogs with choroid plexus carcinoma (Dickinson *et al.*, 2000; Zimmerman *et al.*, 2006)<sup>3,5</sup>

## J. Parasitic Diseases

### 1. Equine Protozoal Encephalomyelitis

Equine protozoal encephalomyelitis (EPM), caused by *Sarcocystis neurona* (*S. falcatula*) (Dame *et al.*, 1995), is characterized by multifocal areas of mononuclear, perivascular inflammation and necrosis; severe lesions may be hemorrhagic and have neutrophilic infiltration (Madigan and Higgins, 1987; Mayhew *et al.*, 1978). The CSF may be normal or have mild to moderate mononuclear pleocytosis and increase in total protein (Mayhew, 1989). Xanthochromia is occasionally present, as well as neutrophils and eosinophils (Mayhew, 1989). The CSF albumin concentration and albumin quotient are reported to be normal and the IgG index elevated, indicating intrathecal IgG production (Andrews and Provenza, 1995). IgG antibodies to *S. neurona* can be identified in the CSF by immunoblot analysis (Granstrom, 1993). The test is very sensitive and specific for the diagnosis of EPM; however, its accuracy depends on an intact blood-brain/CSF barrier because many infected and previously infected horses have serum antibodies to *S. neurona* but do not have clinical disease (Andrews and Provenza, 1995; Fenger, 1995). Therefore, it may be useful to also measure the albumin quotient and IgG index in CSF that is submitted for *S. neurona* immunoblotting. However, some have questioned the utility of doing this and recommend a CSF RBC count instead, with RBC counts >50 RBCs/ $\mu$ L invalidating interpretation of a positive CSF immunoblot result (Furr *et al.*, 2002). Conversely, a negative CSF result, even when concurrent with RBC counts >50 RBCs/ $\mu$ L, would indicate that EPM is highly unlikely. The development of a *Sarcocystis neurona* specific IgM capture ELISA, similar to that developed for WNV infection, may further improve EPM clinical diagnostics (Murphy *et al.*, 2006). Detection of *S. neurona* in the CSF

by polymerase chain reaction provides definitive evidence of the presence of the parasite in the central nervous system. The results of polymerase chain reaction assay are independent of serum leakage across the blood-brain/CSF barrier (Fenger, 1994). However, although a powerful and highly specific test, the PCR test for detection of parasite antigen has not been found to be clinically useful because of the high incidence of false negative results (Furr *et al.*, 2002). The reasons for this are unclear but may be due to rarity of the parasite in CSF or rapid destruction of parasite DNA in the CSF environment or both (Furr *et al.*, 2002).

## 2. Neosporosis, Toxoplasmosis

Both *Neospora* and *Toxoplasma* can invade the central nervous system causing necrosis, vasculitis and a multifocal, granulomatous meningoencephalomyelitis. *Neospora* seems to have more of a predilection for the central nervous system than *Toxoplasma*, particularly in young dogs (Dubey *et al.*, 1988, 1989). The CSF associated with neural protozoal infections generally has a mild to moderate increase in white blood cell count and total protein. Typically, the white blood cell differential count shows a mixed pleocytosis with monocytes, lymphocytes, neutrophils, and eosinophils in order of decreasing percentage (Averill and DeLahunta, 1971; Cuddon *et al.*, 1992; Dubey, 1990a; Hass *et al.*, 1989; Kornegay, 1981; Rand *et al.*, 1994b; Tipold, 1995; Vandeveld and Spano, 1977). However, we have also seen marked pleocytosis with marked eosinophil predominance in histopathologically confirmed canine CNS neosporosis (W. Vernau, unpublished observation). Occasionally the white blood cell count and protein are normal (Parish *et al.*, 1987; Tipold, 1995). The CSF IgG index was elevated in three of three dogs studied; in two of two dogs, the IgM was normal and the IgA was elevated (Tipold *et al.*, 1993b, 1994). In a study of experimentally infected cats, *T. gondii*-specific IgG was intrathecally produced, but *T. gondii*-specific IgM was not detected (Munana *et al.*, 1995). Antiprotozoal antibodies in the CSF may be detected by a variety of methods (Cole *et al.*, 1993; Patton *et al.*, 1991; Ruehlmann *et al.*, 1995). However, the presence of antibodies does not necessarily indicate clinical disease (Dubey and Lindsay, 1993; Munana *et al.*, 1995). Polymerase chain reaction techniques have been developed to identify the protozoa in tissue and fluids, including CSF (Novati *et al.*, 1994; Parmley *et al.*, 1992; Schatzberg *et al.*, 2003; Stiles *et al.*, 1996). Occasionally the organisms themselves may be seen in CSF cells (Dubey, 1990a; Gaitero *et al.*, 2006; McGlennon *et al.*, 1990).

In considering the CSF abnormalities of toxoplasmosis and neosporosis, two issues must be kept in mind. First, reports of toxoplasmosis before 1988 (when *Neospora* was identified) must be carefully scrutinized because many of these cases were actually neosporosis. Second, because *T. gondii* is not a primary pathogen, clinical toxoplasmosis is relatively rare and is seen mostly in conjunction with a

second disease, particularly canine distemper, which may itself alter the CSF (Dubey *et al.*, 1989).

## 3. Migratory Parasites

Neural invasion by migratory parasites is relatively common in large and exotic animals, yet rare in dogs and cats. The CSF may reflect the physical trauma and consequent inflammatory response, and in some cases an immune reaction, to the parasite tissue. The CSF abnormalities are variable and probably depend to some degree on the specific parasite as well as its location and the type of incited response. For example, *H. bovis* larvae in the cow normally lodge in the lumbar epidural space and their effect on the spinal cord may be primarily compression. The CSF in such a case could be normal or have only mildly to moderately elevated protein. Parasites that actually invade neural tissue may leave the CSF unchanged or produce CSF with mild to marked pleocytosis and protein elevation, as well as xanthochromia. An eosinophilic pleocytosis suggests parasitism and is typical of some parasites such *Parelaphostrongylus* (Baum, 1994; George, 1996; Mason, 1989; Pugh *et al.*, 1995) and *Angiostrongylus cantonensis* (Lunn *et al.*, 2003; Mason, 1989). However, eosinophilic pleocytosis is not pathognomonic for parasitism, nor does a lack of eosinophils in the CSF rule out neural parasitism (Braund, 1994; de Lahunta, 1983; Lester, 1992). The *Parelaphostrongylus*-specific ELISA may be useful to detect parasite antigen in the CSF (Dew *et al.*, 1992). *Angiostrongylus cantonensis*-specific antibodies can be detected in the CSF via ELISA (Lunn *et al.*, 2003).

## K. Toxicity

Even though neurological signs may occur, the CSF associated with toxicity is usually normal (e.g., cows with lead poisoning, tetanus or botulism) (Fankhauser, 1962; Feldman, 1989). Mild elevations of the white blood cell count and protein may occur if the toxin causes breakdown of blood-brain/CSF barrier or neural degeneration or necrosis, such as in some cases of lead poisoning (Dorman *et al.*, 1990; Dow *et al.*, 1989; Fankhauser, 1962; George, 1996; Little and Sorensen, 1969; Mayhew, 1989; Swarup and Maiti, 1991). Lead has been shown to selectively poison capillary endothelial cells (Goldstein *et al.*, 1977), as well as cause cerebral cortical necrosis (Christian and Tryphonas, 1970). If necrosis is severe, the white blood cell count and the total protein can be markedly increased with a predominance of neutrophils, as with leukoencephalomalacia caused by moldy corn poisoning in horses. Xanthochromia is also a characteristic of moldy corn poisoning, reflecting the perivascular hemorrhages in the central nervous system (Masri *et al.*, 1987; McCue, 1989). With toxicities, biochemical alterations of the CSF may occur more commonly than alterations of CSF cell counts or protein. At the onset of fatal signs of lead poisoning, CSF glucose, urea, creatinine, and creatine

kinase levels are increased (Swarup and Maiti, 1991). Neurostimulatory toxins may result in elevated monoamine metabolites in the CSF (Sisk *et al.*, 1990). Ivermectin toxicity producing recumbency in dogs elevates the CSF concentrations of homovanillic acid and 5-hydroxyindoleacetic acid (Vaughn *et al.*, 1989). Interestingly, copper poisoning in sheep does not produce significant increases in CSF copper, zinc, or iron levels (Gooneratne and Howell, 1979).

## L. Trauma/Compression of Neural Tissue

The CSF abnormalities associated with trauma or compression are variable depending on the rate at which the neural insult developed, the degree of neural damage, the location of the lesion (particularly with respect to the CSF collection site), the elapsed time since the onset of the neural insult, and the maintenance or progression of the insult. With acute trauma, the CSF may be pink and hazy or turbid, or actually bloody. After centrifugation, the supernatant can be clear. If hemorrhage occurred more than 48h before CSF collection, the supernatant may be yellow because of bilirubin. The total red blood cell count may be markedly elevated. The white blood cell count may be mildly to moderately elevated, reflecting either hemorrhage into the subarachnoid space or inflammation instigated by the trauma. Erythrophagocytosis may be present. The pleocytosis is usually a mixed cell population, and a substantial proportion of neutrophils (40% to 50%) is possible; acute severe disease may result in counts greater than 50 cells per microliter with more than 50% neutrophils (Thomson *et al.*, 1989). In another larger study of canine intervertebral disk disease, mixed pleocytoses as high as 428 cells/ $\mu$ L were noted (Windsor *et al.*, 2007). Total protein may be moderately to markedly elevated because of the disruption of blood vessels, interruption of CSF flow and absorption, and necrosis (Green *et al.*, 1993; Thomson *et al.*, 1989). Thus, the CSF of acute trauma may have a distinct, inflammatory character. With spinal cord trauma/compression, lumbar CSF is more consistently abnormal than cerebellomedullary CSF (Thomson *et al.*, 1990). The CSF abnormalities of chronic trauma or sustained compression tend to be milder than the abnormalities of acute damage. The white blood cell count may be normal or mildly elevated with generally a mixed or mononuclear pleocytosis. We have noted that dogs with chronic or acute on chronic type I intervertebral disk disease have a pleocytosis that is more commonly lymphocytic than neutrophilic (Windsor *et al.*, 2007); white blood cell counts in these instances may be as high as 180 cells/ $\mu$ L. The cerebellomedullary CSF of horses with cervical stenotic myelopathy is reported to be hypocellular with a reduced number of lymphocytes (Grant *et al.*, 1993). The CSF protein associated with chronic trauma or sustained neural compression may be normal to moderately elevated (Mayhew, 1989; Thomson *et al.*, 1989). The albumin content and the albumin

quotient of CSF associated with trauma/compression may be normal or increased, the latter reflecting the vascular damage and edema (Andrews and Provenza, 1995; Bichsel *et al.*, 1984b; Sorjonen, 1987; Sorjonen *et al.*, 1991). The gamma globulin percentage and the IgG index are usually normal. Occasional elevations probably reflect the presence of inflammatory cells in the lesion (Andrews and Provenza, 1995; Bichsel *et al.*, 1984b; Tipold *et al.*, 1993b).

## REFERENCES

- Abate, O., Bollo, E., Lotti, D., and Bo, S. (1998). Cytological, immunocytochemical and biochemical cerebrospinal fluid investigations in selected central nervous system disorders of dogs. *Zentralbl. Veterinarmed. B.* **45**, 73–85.
- Altman, P. L., and Dittmer, D. S. (1974). "Biology Data Book," 2nd ed.. Federation of American Societies for Experimental Biology, Bethesda, MD. vol. III, pp. 1978
- Ames, A., III, Sakanoue, M., and Endo, S. (1964). Na, K, Ca, Mg, and Cl concentrations in choroid plexus fluid and cisternal fluid compared with plasma ultrafiltrate. *J. Neurophysiol.* **27**, 672–681.
- Ames, T. R. (1987). Neurologic disease caused by *Haemophilus somnus*. *Vet. Clin. North Am. Food. Anim. Pract.* **3**, 61–73.
- Amude, A. M., Alfieri, A. A., and Alfieri, A. F. (2006a). Antemortem diagnosis of CDV infection by RT-PCR in distemper dogs with neurological deficits without the typical clinical presentation. *Vet. Res. Commun.* **30**, 679–687.
- Amude, A. M., Alfieri, A. A., Balarin, M. R., dos Reis, A. C., and Alfieri, A. F. (2006b). Cerebrospinal fluid from a 7-month-old dog with seizure-like episodes. *Vet. Clin. Pathol.* **35**, 119–122.
- Andrews, F. M., Geiser, D. R., Sommarahl, C. S., Green, E. M., and Provenza, M. (1994). Albumin quotient, IgG concentration, and IgG index determinations in cerebrospinal fluid of neonatal foals. *Am. J. Vet. Res.* **55**, 741–745.
- Andrews, F. M., Maddux, J. M., and Faulk, D. (1990a). Total protein, albumin quotient, IgG and IgG index determinations for horse cerebrospinal fluid. *Prog. Vet. Neurol.* **1**, 197–204.
- Andrews, F. M., Matthews, H. K., and Reed, S. M. (1990b). The ancillary techniques and test for diagnosing equine neurological disease. *Veterinary Medicine* **85**, 1325–1330.
- Andrews, F. M., and Provenza, M. (1995). Differentiating neurologic disease in the horse using albumin quotient and IgG index determination. In "Thirteenth Annual ACVIM Medical Forum," vol. 13, pp. 600–603. Lake Buena Vista, FL.
- Apostolski, S., Nikolic, J., Bugarski-Prokopljevic, C., Miletic, V., Pavlovic, S., and Filipovic, S. (1991). Serum and CSF immunological findings in ALS. *Acta Neurol. Scand.* **83**, 96–98.
- Appel, M. J., Allan, S., Jacobson, R. H., Lauderdale, T. L., Chang, Y. F., Shin, S. J., Thomford, J. W., Todhunter, R. J., and Summers, B. A. (1993). Experimental Lyme disease in dogs produces arthritis and persistent infection. *J. Infect. Dis.* **167**, 651–664.
- Arun, S. S., Breuer, W., and Hermanns, W. (1996). Immunohistochemical examination of light-chain expression (lambda/kappa ratio) in canine, feline, equine, bovine and porcine plasma cells. *Zentralbl. Veterinarmed. A.* **43**, 573–576.
- Aune, M. W., Becker, J. L., Brugnara, C., Canfield, W., Dorfman, D. M., Fiehn, W., Fischer, G., Fitzpatrick, P., Flaming, T. H., Henriksen, H. K., Kunicka, J. E., Lackner, K. J., Minchello, E., Mullenix, P. A., Myers,

- M., Petersen, A., Ternstrom, W., and Wilson, S. J. (2004). Automated flow cytometric analysis of blood cells in cerebrospinal fluid: analytic performance. *Am. J. Clin. Pathol.* **121**, 690–700.
- Averill, D. R., Jr., and DeLahunta, A. (1971). Toxoplasmosis of the canine nervous system: clinicopathologic findings in four cases. *J. Am. Vet. Med. Assoc.* **159**, 1134–1141.
- Bailey, C. S., and Higgins, R. J. (1985). Comparison of total white blood cell count and total protein content of lumbar and cisternal cerebrospinal fluid of healthy dogs. *Am. J. Vet. Res.* **46**, 1162–1165.
- Bailey, C. S., and Higgins, R. J. (1986a). Characteristics of cerebrospinal fluid associated with canine granulomatous meningoencephalomyelitis: a retrospective study. *J. Am. Vet. Med. Assoc.* **188**, 418–421.
- Bailey, C. S., and Higgins, R. J. (1986b). Characteristics of cisternal cerebrospinal fluid associated with primary brain tumors in the dog: a retrospective study. *J. Am. Vet. Med. Assoc.* **188**, 414–417.
- Balhuizen, J. C., Bots, G. T., Schaberg, A., and Bosman, F. T. (1978). Value of cerebrospinal fluid cytology for the diagnosis of malignancies in the central nervous system. *J. Neurosurg.* **48**, 747–753.
- Banik, N. L., and Hogan, E.L. (1983). "Neurobiology of Cerebrospinal Fluid" (J. H. Wood, Ed.), vol. 2, pp. 205–231. Plenum Press, New York.
- Bardon, T., and Ruckebusch, M. (1984). Changes in 5-HIAA and 5-HT levels in lumbar CSF following morphine administration to conscious dogs. *Neurosci. Lett.* **49**, 147–151.
- Baroni, M., and Heinold, Y. (1995). A review of the clinical diagnosis of feline infectious peritonitis viral meningoencephalomyelitis. *Prog. Vet. Neurol.* **6**, 88–94.
- Barrett, D. L., and King, E. B. (1976). Comparison of cellular recovery rates and morphologic detail obtained using membrane filter and cytocentrifuge techniques. *Acta Cytol.* **20**, 174–180.
- Barry, E., and Hauser, W. A. (1994). Pleocytosis after status epilepticus. *Arch. Neurol.* **51**, 190–193.
- Baum, K. H. (1994). Neurologic diseases of llamas. *Vet. Clin. North Am. Food Anim. Pract.* **10**, 383–390.
- Behr, S., and Cauzinille, L. (2006). Aseptic suppurative meningitis in juvenile boxer dogs: retrospective study of 12 cases. *J. Am. Anim. Hosp. Assoc.* **42**, 277–282.
- Behr, S., Trumel, C., Cauzinille, L., Palenche, F., and Braun, J. P. (2006). High resolution protein electrophoresis of 100 paired canine cerebrospinal fluid and serum. *J. Vet. Intern. Med.* **20**, 657–662.
- Behr, S., Trumel, C., Palanche, F., and Braun, J. P. (2003). Assessment of a pyrogallol red technique for total protein measurement in the cerebrospinal fluid of dogs. *J. Small Anim. Pract.* **44**, 530–533.
- Bell, R. S., Vo, A. H., Cooper, P. B., Schmitt, C. L., and Rosner, M. K. (2006). Eosinophilic meningitis after implantation of a rifampin and minocycline-impregnated ventriculostomy catheter in a child. Case report. *J. Neurosurg.* **104**, 50–54.
- Bell, W. O. (1995). Cerebrospinal fluid reabsorption: a critical appraisal. 1990. *Pediatr. Neurosurg.* **23**, 42–53.
- Bennett, P. F., Allan, F. J., Guilford, W. G., Julian, A. F., and Johnston, C. G. (1997). Idiopathic eosinophilic meningoencephalitis in rottweiler dogs: three cases (1992–1997). *Aust. Vet. J.* **75**, 786–789.
- Berthelin, C. F., Bailey, C. S., Kass, P. H., Legendre, A. M., and Wolf, A. M. (1994a). Cryptococcosis of the nervous system in dogs. Part 1. Epidemiologic, clinical, and neuropathological features. *Prog. Vet. Neurol.* **5**, 88–97.
- Berthelin, C. F., Legendre, A. M., Bailey, C. S., Kass, P. H., and Wolf, A. M. (1994b). Cryptococcosis of the nervous system in dogs. Part 2. Diagnosis, treatment, monitoring, and prognosis. *Prog. Vet. Neurol.* **5**, 136–145.
- Bichsel, P., Jacobs, G., and Oliver, J. E., Jr. (1988). Neurologic manifestations associated with hypothyroidism in four dogs. *J. Am. Vet. Med. Assoc.* **192**, 1745–1747.
- Bichsel, P., Vandeveld, M., and Lang, J. (1984a). [Spinal cord infarction following fibrocartilaginous embolism in the dog and cat]. *Schweiz. Arch. Tierheilkd.* **126**, 387–397.
- Bichsel, P., Vandeveld, M., Vandeveld, E., Affolter, U., and Pfister, H. (1984b). Immunoelectrophoretic determination of albumin and IgG in serum and cerebrospinal fluid in dogs with neurological diseases. *Res. Vet. Sci.* **37**, 101–107.
- Bienzle, D., Kwiczen, J. M., and Parent, J. M. (1995). Extramedullary hematopoiesis in the choroid plexus of five dogs. *Vet. Pathol.* **32**, 437–440.
- Bienzle, D., McDonnell, J. J., and Stanton, J. B. (2000). Analysis of cerebrospinal fluid from dogs and cats after 24 and 48 hours of storage. *J. Am. Vet. Med. Assoc.* **216**, 1761–1764.
- Bigner, S. H. (1992). Cerebrospinal fluid (CSF) cytology: current status and diagnostic applications. *J. Neuropathol. Exp. Neurol.* **51**, 235–245.
- Bigner, S. H., and Jonston, W. W. (1981). The cytopathology of cerebrospinal fluid. I. Nonneoplastic conditions, lymphoma and leukemia. *Acta Cytol.* **25**, 345–353.
- Binkhorst, G. J. (1982). Cerebrospinal fluid as an aid in the differential diagnosis of nervous diseases. In "XIIth World Congress on Diseases of Cattle," vol. II, pp. 864–867. International Congressentrum RAI, Amsterdam, The Netherlands.
- Blythe, L. L., Mattson, D. E., Lassen, E. D., and Craig, A. M. (1985). Antibodies against equine herpesvirus 1 in the cerebrospinal fluid in the horse. *Can. Vet. J.* **26**, 218–220.
- Boerman, R. H., Arnoldus, E. P., Peters, A. C., Bloem, B. R., Raap, A. K., and van der Ploeg, M. (1991). Polymerase chain reaction for early detection of HSV-DNA in cerebrospinal fluid: an experimental mouse encephalitis study. *J. Med. Virol.* **33**, 83–88.
- Boogerd, W., and Peters, A. C. (1986). A simple method for obtaining cerebrospinal fluid from a pig model of herpes encephalitis. *Lab. Anim. Sci.* **36**, 386–388.
- Bosch, I., and Oehmichen, M. (1978). Eosinophilic granulocytes in cerebrospinal fluid: analysis of 94 cerebrospinal fluid specimens and review of the literature. *J. Neurol.* **219**, 93–105.
- Bradley, G. A. (1991). Myocardial necrosis in a pug dog with necrotizing meningoencephalitis. *Vet. Pathol.* **28**, 91–93.
- Braund, K. G. (1994). "Clinical Syndromes in Veterinary Neurology." Mosby, St. Louis, MO.
- Brehm, D. M., Vite, C. H., Steinberg, H. S., Havilan, J., and Van Winkle, T. (1995). A retrospective evaluation of 51 cases of peripheral sheath tumors in the dog. *J. Am. Anim. Hosp. Assoc.* **31**, 349–359.
- Breitschwerdt, E. B. (1995). "Textbook of Veterinary Internal Medicine." Saunders, Philadelphia.
- Breitschwerdt, E. B., Levy, M. G., Davidson, M. G., Walker, D. H., Burgdorfer, W., Curtis, B. C., and Babineau, C. A. (1990). Kinetics of IgM and IgG responses to experimental and naturally acquired *Rickettsia rickettsii* infection in dogs. *Am. J. Vet. Res.* **51**, 1312–1316.
- Breitschwerdt, E. B., Meuten, D. J., Walker, D. H., Levy, M., Kennedy, K., King, M., and Curtis, B. (1985). Canine Rocky Mountain spotted fever: a kennel epizootic. *Am. J. Vet. Res.* **46**, 2124–2128.
- Brewer, B. D. (1983). Neurologic disease of sheep and goats. *Vet. Clin. North Am. Large Anim. Pract.* **5**, 677–700.
- Brewer, B. D. (1987). Examination of the bovine nervous system. *Vet. Clin. North Am. Food Anim. Pract.* **3**, 13–24.
- Brobst, D., and Bryan, G. (1989). "Diagnostic Cytology of the Dog and Cat" (R. L. C. a. R. D. Tyler, Ed.), pp. 141–149. American Veterinary, Goleta, CA.

- Brooks, B. R., Hirsch, R. L., and Coyle, P. K. (1983). In "Neurobiology of Cerebrospinal Fluid" (J. H. Wood, Ed.), pp. 263–329. Plenum Press, New York.
- Buoro, I. B. J., Kanui, T. I., Atwell, R. B., Njenga, K. M., and Gathumbi, P. K. (1990). Polymyositis associated with *Ehrlichia canis* infection in two dogs. *J. Small Anim. Pract.* **31**, 624–627.
- Burbidge, H. M., Kannegieter, N., Dickson, L. R., Goulden, B. E., and Badcoe, L. (1989). Iohexol myelography in the horse. *Equine. Vet. J.* **21**, 347–350.
- Burgess, E. C., and Mattison, M. (1987). Encephalitis associated with *Borrelia burgdorferi* infection in a horse. *J. Am. Vet. Med. Assoc.* **191**, 1457–1458.
- Burnett, R. C., Vernau, W., Modiano, J. F., Olver, C. S., Moore, P. F., and Avery, A. C. (2003). Diagnosis of canine lymphoid neoplasia using clonal rearrangements of antigen receptor genes. *Vet. Pathol.* **40**, 32–41.
- Butler, J. E. (1998). Immunoglobulin diversity, B-cell and antibody repertoire development in large farm animals. *Rev. Sci. Tech.* **17**, 43–70.
- Calhoun, M. C., Hurt, H. D., Rousseau, J. E., and Hall, R. C. (1967). "Rates of Formation and Absorption of Cerebrospinal Fluid in Holstein Male Calves." Storrs Agricultural Experiment Station, University of Connecticut.
- Cannon, A. B., Luff, J. A., Brault, A. C., MacLachlan, N. J., Case, J. B., Green, E. N., and Sykes, J. E. (2006). Acute encephalitis, polyarthritis, and myocarditis associated with West Nile virus infection in a dog. *J. Vet. Intern. Med.* **20**, 1219–1223.
- Cantile, C., Del Piero, F., Di Guardo, G., and Arispici, M. (2001). Pathologic and immunohistochemical findings in naturally occurring West Nile virus infection in horses. *Vet. Pathol.* **38**, 414–421.
- Cantile, C., Di Guardo, G., Eleni, C., and Arispici, M. (2000). Clinical and neuropathological features of West Nile virus equine encephalomyelitis in Italy. *Equine. Vet. J.* **32**, 31–35.
- Carakostas, M. C., Gossett, K. A., Watters, J. W., and MacWilliams, P. S. (1983). Effects of metrizamide myelography on cerebrospinal fluid analysis in the dog. *Vet. Radiol.* **24**, 267–270.
- Cargill, J. S. (1975). Letter: previous antibiotic treatment and meningitis diagnosis. *Lancet* **2**, 665–666.
- Carrillo, J. M., Sarfaty, D., and Greenlee, P. (1986). Intracranial Neoplasm and Associated Inflammatory Response from the Central Nervous System. *J. Am. Anim. Hosp. Assoc.* **22**, 367–373.
- Cauzinille, L., and Kornegay, J. N. (1996). Fibrocartilaginous embolism of the spinal cord in dogs: review of 36 histologically confirmed cases and retrospective study of 26 suspected cases. *J. Vet. Intern. Med.* **10**, 241–245.
- Chrisman, C. L. (1983). In "Current Veterinary Therapy VIII: Small Animal Practice" (R. W. Kirk, Ed.), pp. 676–681. Saunders, Philadelphia.
- Chrisman, C. L. (1992). Cerebrospinal fluid analysis. *Vet. Clin. North Am. Small Anim. Pract.* **22**, 781–810.
- Christen, H. J., Eiffert, H., Ohlenbusch, A., and Hanefeld, F. (1995). Evaluation of the polymerase chain reaction for the detection of *Borrelia burgdorferi* in cerebrospinal fluid of children with acute peripheral facial palsy. *Eur. J. Pediatr.* **154**, 374–377.
- Christian, R. G., and Tryphonas, L. (1970). Lead poisoning in cattle: brain lesions and hematologic changes. *Am. J. Vet. Res.* **32**, 203–216.
- Christopher, M. M. (1992). Bone marrow contamination of canine cerebrospinal fluid. *Vet. Clin. Pathol.* **21**, 95–98.
- Christopher, M. M., Perman, V., and Hardy, R. M. (1988). Reassessment of cytologic values in canine cerebrospinal fluid by use of cytocentrifugation. *J. Am. Vet. Med. Assoc.* **192**, 1726–1729.
- Coates, J. R. (1995). What is your neurologic diagnosis? An atypical case of diskospondylitis caused by *Aspergillus* spp. *J. Am. Vet. Med. Assoc.* **206**, 1333–1335.
- Cole, R. A., Lindsay, D. S., Dubey, J. P., and Blagburn, B. L. (1993). Detection of *Neospora caninum* in tissue sections using a murine monoclonal antibody. *J. Vet. Diagn. Invest.* **5**, 579–584.
- Coles, E. H. (1980). "Clinical Biochemistry of Domestic Animals," 3rd ed. (J. J. Kaneko, Ed.), pp. 719–748. Academic Press, New York.
- Converse, G. M., Gwaltney, J. M., Jr., Strassburg, D. A., and Hendley, J. O. (1973). Alteration of cerebrospinal fluid findings by partial treatment of bacterial meningitis. *J. Pediatr.* **83**, 220–225.
- Cook, J. R., Jr., and DeNicola, D. B. (1988). Cerebrospinal fluid. *Vet. Clin. North Am. Small Anim. Pract.* **18**, 475–499.
- Cordy, D. R., and Holliday, T. A. (1989). A necrotizing meningoencephalitis of pug dogs. *Vet. Pathol.* **26**, 191–194.
- Couto, C. G., and Kallet, A. J. (1984). Preleukemic syndrome in a dog. *J. Am. Vet. Med. Assoc.* **184**, 1389–1392.
- Cserr, H. F. (1971). Physiology of the choroid plexus. *Physiol. Rev.* **51**, 273–311.
- Cuddon, P., Lin, D. S., Bowman, D. D., Lindsay, D. S., Miller, T. K., Duncan, I. D., deLahunta, A., Cummings, J., Suter, M., Cooper, B., et al. (1992). *Neospora caninum* infection in English Springer Spaniel littermates. Diagnostic evaluation and organism isolation. *J. Vet. Intern. Med.* **6**, 325–332.
- Cuddon, P. A. (1990). Electrophysiological and immunological evaluation in coonhound paralysis. In "8th Annual ACVIM Forum," pp. 1009–1012, Washington, DC.
- Cummings, J. F., de Lahunta, A., George, C., Fuhrer, L., Valentine, B. A., Cooper, B. J., Summers, B. A., Huxtable, C. R., and Mohammed, H. O. (1990). Equine motor neuron disease; a preliminary report. *Cornell. Vet.* **80**, 357–379.
- Cummings, J. F., de Lahunta, A., Holmes, D. F., and Schultz, R. D. (1982). Coonhound paralysis. Further clinical studies and electron microscopic observations. *Acta Neuropathol. (Berl.)* **56**, 167–178.
- Dame, J. B., MacKay, R. J., Yowell, C. A., Cutler, T. J., Marsh, A., and Greiner, E. C. (1995). *Sarcocystis falcatula* from passerine and psittacine birds: synonymy with *Sarcocystis neurona*, agent of equine protozoal myeloencephalitis. *J. Parasitol.* **81**, 930–935.
- Darien, B. J., Belknap, J., and Niefeld, J. (1988). Cerebrospinal fluid changes in two horses with central nervous system nematodiasis (*Micronema deletrix*). *J. Vet. Intern. Med.* **2**, 201–205.
- Davis, B. A. (1990). "Biogenic Monoamines and Their Metabolites in the Urine, Plasma, and Cerebrospinal Fluid of Normal, Psychiatric, and Neurological Subjects." CRC Press, Boca Raton, FL.
- Davis, L. E., DeBiasi, R., Goade, D. E., Haaland, K. Y., Harrington, J. A., Harnar, J. B., Pergam, S. A., King, M. K., DeMasters, B. K., and Tyler, K. L. (2006). West Nile virus neuroinvasive disease. *Ann. Neurol.* **60**, 286–300.
- Davson, H., and Segal, M. B. (1996). "Physiology of the CSF and Blood-Brain Barriers." CRC Press, Boca Raton, FL.
- de Lahunta, A. (1983). "Veterinary Neuroanatomy and Clinical Neurology." Saunders, Philadelphia.
- Deisenhammer, F., Bartos, A., Egg, R., Gilhus, N. E., Giovannoni, G., Rauer, S., and Sellebjerg, F. (2006). Guidelines on routine cerebrospinal fluid analysis: report from an EFNS task force. *Eur. J. Neurol.* **13**, 913–922.
- Deswal, K., and Chohan, I. S. (1981). Effects of hyperthermia on enzymes and electrolytes in blood and cerebrospinal fluid in dogs. *Int. J. Biometeorol.* **25**, 227–233.
- Dew, T. L., Bowman, D. D., and Grieve, R. B. (1992). Parasite-specific immunoglobulin in the serum and cerebrospinal fluid of white-tailed



- deer (*Odocoileus virginianus*) and goats (*Capra hircus*) with experimentally induced parelaphostrongylosis. *J. Zoo Wildlife Med.* **23**, 281–287.
- Dickinson, P. J., Keel, M. K., Higgins, R. J., Koblik, P. D., LeCouteur, R. A., Naydan, D. K., Bollen, A. W., and Vernau, W. (2000). Clinical and pathologic features of oligodendrogliomas in two cats. *Vet. Pathol.* **37**, 160–167.
- Dickinson, P. J., Sturges, B. K., Kass, P. H., and LeCouteur, R. A. (2006). Characteristics of cisternal cerebrospinal fluid associated with intracranial meningiomas in dogs: 56 cases (1985–2004). *J. Am. Vet. Med. Assoc.* **228**, 564–567.
- Divers, T. J., Mohammed, H. O., Cummings, J. F., Valentine, B. A., De Lahunta, A., Jackson, C. A., and Summers, B. A. (1994). Equine motor neuron disease: findings in 28 horses and proposal of a pathophysiological mechanism for the disease. *Equine. Vet. J.* **26**, 409–415.
- Dorman, D. C., Parker, A. J., and Buck, W. B. (1990). Bromethalin toxicosis in the dog. part I: clinical effects. *J. Am. Anim. Hosp. Assoc.* **26**, 589–594.
- Dow, S. W., LeCouteur, R. A., Henik, R. A., Jones, R. L., and Poss, M. L. (1988). Central nervous system infection associated with anaerobic bacteria in two dogs and two cats. *J. Vet. Intern. Med.* **2**, 171–176.
- Dow, S. W., LeCouteur, R. A., Poss, M. L., and Beadleston, D. (1989). Central nervous system toxicosis associated with metronidazole treatment of dogs: five cases (1984–1987). *J. Am. Vet. Med. Assoc.* **195**, 365–368.
- Dow, S. W., Poss, M. L., and Hoover, E. A. (1990). Feline immunodeficiency virus: a neurotropic lentivirus. *J. Acquir. Immune Defic. Syndr.* **3**, 658–668.
- Duarte, P. C., Ebel, E. D., Traub-Dargatz, J., Wilson, W. D., Conrad, P. A., and Gardner, I. A. (2006). Indirect fluorescent antibody testing of cerebrospinal fluid for diagnosis of equine protozoal myeloencephalitis. *Am. J. Vet. Res.* **67**, 869–876.
- Dubey, J. P. (1990a). *Neospora caninum*: a look at a new toxoplasma-like parasite of dogs and other animals. *Compendium on Continuing Education for the Practicing Veterinarian* **12**, 653–663.
- Dubey, J. P., Carpenter, J. L., Speer, C. A., Topper, M. J., and Uggla, A. (1988). Newly recognized fatal protozoan disease of dogs. *J. Am. Vet. Med. Assoc.* **192**, 1269–1285.
- Dubey, J. P., Carpenter, J. L., Topper, M. J., and Uggla, A. (1989). Fatal toxoplasmosis in dogs. *J. Am. Vet. Med. Assoc.* **25**, 659–664.
- Dubey, J. P., Greene, C. E., and Lappin, M. R. (1990b). In “Infectious Diseases of the Dog and Cat” (C. E. Greene, Ed.), pp. 818–834. Saunders, Philadelphia.
- Dubey, J. P., and Lindsay, D. S. (1993). Neosporosis. *Parasitol. Today* **9**, 452–458.
- Ducos, R., Donoso, J., Weickhardt, U., and Vietti, T. J. (1979). Sedimentation versus cytocentrifugation in the cytologic study of craniospinal fluid. *Cancer* **43**, 1479–1482.
- Ducote, J. M., Johnson, K. E., Dewey, C. W., Walker, M. A., Coates, J. R., and Berridge, B. R. (1999). Computed tomography of necrotizing meningoencephalitis in 3 Yorkshire Terriers. *Vet. Radiol. Ultrasound* **40**, 617–621.
- Duncan, J. R., Prasse, K. W., Mahaffey, E. A. (1994). “Veterinary Laboratory Medicine. Clinical Pathology.” Iowa State University Press, Ames.
- Duque, C., Parent, J., and Bienzle, D. (2002). The immunophenotype of blood and cerebrospinal fluid mononuclear cells in dogs. *J. Vet. Intern. Med.* **16**, 714–719.
- Duque, C., Parent, J., Brisson, B., Da Costa, R., and Poma, R. (2005). Intracranial arachnoid cysts: are they clinically significant? *J. Vet. Intern. Med.* **19**, 772–774.
- Ellenberger, C., Mevissen, M., Doherr, M., Scholtysik, G., and Jaggy, A. (2004). Inhibitory and excitatory neurotransmitters in the cerebrospinal fluid of epileptic dogs. *Am. J. Vet. Res.* **65**, 1108–1113.
- Fallin, C. W., Raskin, R. E., and Harvey, J. W. (1996). Cytologic identification of neural tissue in the cerebrospinal fluid of two dogs. *Vet. Clin. Pathol.* **25**, 127–129.
- Fankhauser, R. (1962). *Comparative Neuropathology* (J. R. M. I. a. L. Z. Saunders, Ed.), pp. 21–54. Academic Press, New York.
- Faull, K. F., Barchas, J. D., Foutz, A. S., Dement, W. C., and Holman, R. B. (1982). Monoamine metabolite concentrations in the cerebrospinal fluid of normal and narcoleptic dogs. *Brain. Res.* **242**, 137–143.
- Feder, B. M., Joseph, R. J., Moroff, S. D., Schneider, E. M., and Bosler, E. M. (1991). *Borrelia burgdorferi* in canine cerebrospinal fluid. In “The 9th Annual ACVIM Forum,” vol. 5, p. 137. New Orleans, LA.
- Fekadu, M., and Shaddock, J. H. (1984). Peripheral distribution of virus in dogs inoculated with two strains of rabies virus. *Am. J. Vet. Res.* **45**, 724–729.
- Feldman, B. F. (1989). Cerebrospinal Fluid. In “Clinical Biochemistry of Domestic Animals” (J. J. Kaneko, Ed.), pp. 835–865. Academic Press, San Diego, CA.
- Felgenhauer, K. (1974). Protein size and cerebrospinal fluid composition. *Klin. Wochenschr.* **52**, 1158–1164.
- Felgenhauer, K. (1982). Differentiation of the humoral immune response in inflammatory diseases of the central nervous system. *J. Neurol.* **228**, 223–237.
- Fenger, C. K. (1994). PCR-based detection of sarcocystis neurona: implications for diagnosis and research. In “12th Annual ACVIM Forum,” p. 550. San Francisco.
- Fenger, C. K. (1995). Update on the diagnosis and treatment of equine protozoal myeloencephalitis (EPM). In “Thirteenth Annual ACVIM Form,” pp. 597–599. Lake Buena Vista, FL.
- Fingerroth, J. M., Prata, R. G., and Patnaik, A. K. (1987). Spinal meningiomas in dogs: 13 cases (1972–1987). *J. Am. Vet. Med. Assoc.* **191**, 720–726.
- Finno, C., Pusterla, N., Aleman, M., Mohr, F. C., Price, T., George, J., and Holmberg, T. (2006). Streptococcus equi meningoencephalomyelitis in a foal. *J. Am. Vet. Med. Assoc.* **229**, 721–724.
- Finneis, G. D., Cochrane, S. M., Parent, J., and Houston, D. M. (1990). Canine ehrlichiosis in Ontario. *Can. Vet. J.* **31**, 652–653.
- Fishman, R. A. (1992). “Cerebrospinal Fluid in Diseases of the Nervous System.” Saunders, Philadelphia.
- Fletcher, T. F. (1993). In “Miller’s Anatomy of the Dog” (H. E. Evans, Ed.), 3rd ed., pp. 800–828. Saunders, Philadelphia.
- Foreman, J. H., and Santschi, E. M. (1989). Equine bacterial meningitis: part II. *Compend. Contin. Educ. Pract. Vet.* **11**, 640–644.
- Fowler, M. E. (1989). “Medicine and Surgery of South American Camelids.” Iowa State University Press, Ames.
- Frisk, A. L., Konig, M., Moritz, A., and Baumgartner, W. (1999). Detection of canine distemper virus nucleoprotein RNA by reverse transcription-PCR using serum, whole blood, and cerebrospinal fluid from dogs with distemper. *J. Clin. Microbiol.* **37**, 3634–3643.
- Fry, M. M., Vernau, W., Kass, P. H., and Vernau, K. M. (2006). Effects of time, initial composition, and stabilizing agents on the results of canine cerebrospinal fluid analysis. *Vet. Clin. Pathol.* **35**, 72–77.
- Fryden, A., Link, H., and Norrby, E. (1978). Cerebrospinal fluid and serum immunoglobulins and antibody titers in mumps meningitis and aseptic meningitis of other etiology. *Infect. Immun.* **21**, 852–861.
- Furr, M., MacKay, R., Granstrom, D., Schott, H., 2nd, and Andrews, F. (2002). Clinical diagnosis of equine protozoal myeloencephalitis (EPM). *J. Vet. Intern. Med.* **16**, 618–621.

- Furr, M., Pontzer, C., and Gasper, P. (2001). Lymphocyte phenotype subsets in the cerebrospinal fluid of normal horses and horses with equine protozoal myeloencephalitis. *Vet. Therapeut.* **2**, 317–324.
- Furr, M. O., and Bender, H. (1994). Cerebrospinal fluid variables in clinically normal foals from birth to 42 days of age. *Am. J. Vet. Res.* **55**, 781–784.
- Furr, M. O., and Tyler, R. D. (1990). Cerebrospinal fluid creatine kinase activity in horses with central nervous system disease: 69 cases (1984–1989). *J. Am. Vet. Med. Assoc.* **197**, 245–248.
- Gaitero, L., Anor, S., Montoliu, P., Zamora, A., and Pumarola, M. (2006). Detection of *Neospora caninum* tachyzoites in canine cerebrospinal fluid. *J. Vet. Intern. Med.* **20**, 410–414.
- Gandini, G., Cizinauskas, S., Lang, J., Fatzer, R., and Jaggy, A. (2003). Fibrocartilaginous embolism in 75 dogs: clinical findings and factors influencing the recovery rate. *J. Small Anim. Pract.* **44**, 76–80.
- Garma-Avina, A. (2004). Cytology of the normal and abnormal choroid plexi in selected domestic mammals, wildlife species, and man. *J. Vet. Diagn. Invest.* **16**, 283–292.
- Gelatt, K. N., Chrisman, C. L., Samuelson, D. A., and Buergelt, C. D. (1991). Ocular and systemic aspergillosis in a dog. *J. Am. Anim. Hosp. Assoc.* **27**, 427–431.
- George, L. W. (1996). In “Large Animal Internal Medicine” (B. P. Smith, Ed.), pp. 1001–1175. Mosby, St. Louis, MO.
- Glass, J. P., Melamed, M., Chernik, N. L., and Posner, J. B. (1979). Malignant cells in cerebrospinal fluid (CSF): the meaning of a positive CSF cytology. *Neurology* **29**, 1369–1375.
- Glimaker, M., Olcen, P., and Andersson, B. (1994). Interferon-gamma in cerebrospinal fluid from patients with viral and bacterial meningitis. *Scand. J. Infect. Dis.* **26**, 141–147.
- Gnirs, K., Ruel, Y., Blot, S., Begon, D., Rault, D., Delisle, F., Boulouha, L., Colle, M. A., Carozzo, C., and Moissonnier, P. (2003). Spinal sub-arachnoid cysts in 13 dogs. *Vet. Radiol. Ultrasound* **44**, 402–408.
- Goehring, L. S., van Winden, S. C., van Maanen, C., and Sloet van Oldruitenborgh-Oosterbaan, M. M. (2006). Equine herpesvirus type 1-associated myeloencephalopathy in The Netherlands: a four-year retrospective study (1999–2003). *J. Vet. Intern. Med.* **20**, 601–607.
- Goldstein, G. W., Wolinsky, J. S., and Csejtey, J. (1977). Isolated brain capillaries: a model for the study of lead encephalopathy. *Ann. Neurol.* **1**, 235–239.
- Gooneratne, S. R., and Howell, J. M. (1979). Copper, zinc and iron levels in the cerebrospinal fluid of copper poisoned sheep. *Res. Vet. Sci.* **27**, 384–385.
- Grabner, A., and Goldberg, M. (1991). [Pilot study of the relationship of free amino acids in serum and in the cerebrospinal fluid of horses]. *Tierarztl. Praxis* **19**, 271–275.
- Granstrom, D. E. (1993). Diagnosis of equine protozoal myeloencephalitis: Western Blot analysis. In “11th Annual ACVIM Forum,” pp. 587–590, Washington, DC.
- Grant, B., Roszel, J., Peterson, R., and Perris, E. (1993). Cerebrospinal fluid cytological examination as an aid in the diagnosis and prognosis of cervical cord myelopathy. *Proc. Ann. Conv. Am. Assoc. Equine Pract.* **38**, 737–742.
- Green, A., Sanchez-Juan, P., Ladogana, A., Cuadrado-Corrales, N., Sanchez-Valle, R., Mitrova, E., Stoeck, K., Sklaviadis, T., Kulczycki, J., Heinemann, U., Hess, K., Slivarichova, D., Saiz, A., Calero, M., Mellina, V., Knight, R., van Duijn, C. M., and Zerr, I. (2007). CSF analysis in patients with sporadic CJD and other transmissible spongiform encephalopathies. *Eur. J. Neurol.* **14**, 121–124.
- Green, E. M., Constantinescu, G. M., and Kroll, R. A. (1993). Equine Cerebrospinal Fluid: Analysis. *Comp. Continuing Edu. Pract. Vet.* **15**, 288–301.
- Green, E. M., and Green, S. (1990). Cerebrospinal fluid lactic acid concentrations: reference values and diagnostic implications of abnormal concentrations in adult horses. In “8th Annual ACVIM Forum,” pp. 495–499. Blacksburg, VA.
- Green, S. L. (1993). Equine rabies. *Vet. Clin. North Am. Equine. Pract.* **9**, 337–347.
- Green, S. L., and Smith, L. L. (1992). Meningitis in neonatal calves: 32 cases (1983–1990). *J. Am. Vet. Med. Assoc.* **201**, 125–128.
- Green, S. L., Smith, L. L., Vernau, W., and Beacock, S. M. (1992). Rabies in horses: 21 cases (1970–1990). *J. Am. Vet. Med. Assoc.* **200**, 1133–1137.
- Greene, C. E. (1990). In “Infectious Diseases of the Dog and Cat” (C. E. Greene, Ed.), pp. 891–904. Saunders, Philadelphia.
- Greene, C. E., and Appel, M. J. (2006). Canine distemper. In “Infectious Diseases of the Dog and Cat” (C. E. Greene, Ed.), pp. 25–41. Elsevier, St. Louis, MO.
- Greene, C. E., Burgdorfer, W., Cavagnolo, R., Philip, R. N., and Peacock, M. G. (1985). Rocky Mountain spotted fever in dogs and its differentiation from canine ehrlichiosis. *J. Am. Vet. Med. Assoc.* **186**, 465–472.
- Greene, C. E., Vandeveld, M., and Braund, K. (1976). Lissencephaly in two Lhasa Apso dogs. *J. Am. Vet. Med. Assoc.* **169**, 405–410.
- Greene, C. E. a. D., D. W. (1998). Rabies. In “Infectious Diseases of the Dog and Cat” (C. E. Greene, Ed.), pp. 114–126. Saunders, Philadelphia.
- Grevel, V. (1991). [Experiences with a sedimentation technique for the enrichment of cerebrospinal fluid cells in the dog and cat. Part 1.]. *Tierarztl. Praxis* **19**, 553–560.
- Grevel, V., and Machus, B. (1990). Diagnosing brain tumors with a CSF sedimentation technique. *Vet. Med. Rpt.* **2**, 403–408.
- Grevel, V., Machus, B., and Steeb, C. (1992). [Cytology of the cerebrospinal fluid in dogs with brain tumors and spinal cord compression. Part 4]. *Tierarztl. Praxis* **20**, 419–428.
- Griffith, N. C., Cunningham, A. M., Goldsmith, R., and Bandler, R. (1991). Interictal behavioral alterations and cerebrospinal fluid amino acid changes in a chronic seizure model of temporal lobe epilepsy. *Epilepsia* **32**, 767–777.
- Grunenfelder, F. I., Weishaupt, D., Green, R., and Steffen, F. (2005). Magnetic resonance imaging findings in spinal cord infarction in three small breed dogs. *Vet. Radiol. Ultrasound* **46**, 91–96.
- Guffond, T., Dewilde, A., Lobert, P. E., Caparros-Lefebvre, D., Hober, D., and Wattre, P. (1994). Significance and clinical relevance of the detection of herpes simplex virus DNA by the polymerase chain reaction in cerebrospinal fluid from patients with presumed encephalitis. *Clin. Infect. Dis.* **18**, 744–749.
- Hahn, C. N., Mayhew, I. G., Whitwell, K. E., Smith, K. C., Carey, D., Carter, S. D., and Read, R. A. (1996). A possible case of Lyme borreliosis in a horse in the UK. *Equine Vet. J.* **28**, 84–88.
- Hamir, A. N., Moser, G., and Rupprecht, C. E. (1992). A five year (1985–1989) retrospective study of equine neurological diseases with special reference to rabies. *J. Comp. Pathol.* **106**, 411–421.
- Hanlon, C. A., Ziemer, E. L., Hamir, A. N., and Rupprecht, C. E. (1989). Cerebrospinal fluid analysis of rabid and vaccinia-rabies glycoprotein recombinant, orally vaccinated raccoons (*Procyon lotor*). *Am. J. Vet. Res.* **50**, 364–367.
- Hansen, H. H., Bender, R. A., and Shelton, B. J. (1974). The cyto-centrifuge and cerebrospinal fluid cytology. *Acta Cytol.* **18**, 259–262.
- Hashizume, C. T. (2000). Cervical spinal arachnoid cyst in a dog. *Can. Vet. J.* **41**, 225–227.
- Hass, J. A., Shell, L., and Saunders, G. (1989). Neurological manifestation of toxoplasmosis: a literature review and case summary. *J. Am. Anim. Hosp. Assoc.* **25**, 253–260.

- Hayward, R. A., Shapiro, M. F., and Oye, R. K. (1987). Laboratory testing on cerebrospinal fluid A reappraisal. *Lancet* **1**, 1–4.
- Healy, P. J., Harper, P. A., and Dennis, J. A. (1990). Bovine citrullinemia: a clinical, pathological, biochemical and genetic study. *Aust. Vet. J.* **67**, 255–258.
- Heidner, G. L., Kornegay, J. N., Page, R. L., Dodge, R. K., and Thrall, D. E. (1991). Analysis of survival in a retrospective study of 86 dogs with brain tumors. *J. Vet. Intern. Med.* **5**, 219–226.
- Henriksson, A., Link, H., Cruz, M., and Stiernstedt, G. (1986). Immunoglobulin abnormalities in cerebrospinal fluid and blood over the course of lymphocytic meningoradiculitis (Bannwarth's syndrome). *Ann. Neurol.* **20**, 337–345.
- Heyes, M. P., Saito, K., Crowley, J. S., Davis, L. E., Demitrack, M. A., Der, M., Dilling, L. A., Elia, J., Kruesi, M. J., Lackner, A., et al. (1992). Quinolinic acid and kynurenine pathway metabolism in inflammatory and non-inflammatory neurological disease. *Brain* **115** (Pt 5), 1249–1273.
- Hochwald, G. M., Wallenstein, M. C., and Mathews, E. S. (1969). Exchange of proteins between blood and spinal subarachnoid fluid. *Am. J. Physiol.* **217**, 348–353.
- Holbrook, T. C., and White, S. L. (1992). Ancillary tests for assessment of the nervous system. *Vet. Clin. North Am. Food Anim. Pract.* **8**, 305–316.
- Holt, D. E., Washabau, R. J., Djali, S., Dayrell-Hart, B., Drobatz, K. J., Heyes, M. P., and Robinson, M. B. (2002). Cerebrospinal fluid glutamine, tryptophan, and tryptophan metabolite concentrations in dogs with portosystemic shunts. *Am. J. Vet. Res.* **63**, 1167–1171.
- Hsich, G., Kenney, K., Gibbs, C. J., Lee, K. H., and Harrington, M. G. (1996). The 14-3-3 brain protein in cerebrospinal fluid as a marker for transmissible spongiform encephalopathies. *N. Engl. J. Med.* **335**, 924–930.
- Indrieri, R. J., Holliday, T. A., and Keen, C. L. (1980). Critical evaluation of creatine phosphokinase in cerebrospinal fluid of dogs with neurologic disease. *Am. J. Vet. Res.* **41**, 1299–1303.
- Jackson, C., de Lahunta, A., Divers, T., and Ainsworth, D. (1996). The diagnostic utility of cerebrospinal fluid creatine kinase activity in the horse. *J. Vet. Intern. Med.* **10**, 246–251.
- Jackson, T. A., Osburn, B. I., Cordy, D. R., and Kendrick, J. W. (1977). Equine herpesvirus 1 infection of horses: studies on the experimentally induced neurologic disease. *Am. J. Vet. Res.* **38**, 709–719.
- Jackson, W., deLahunta, A., Adaska, A., and Divers, T. J. (1995). Fibrocartilagenous embolic myelopathy in an adult Belgian horse. *Prog. Vet. Neurol.* **6**, 16–19.
- Jacobs, G. J., and Medleau, L. (1998). Cryptococcosis. In "Infectious Diseases of the Dog and Cat" (C. E. Green, Ed.), pp. 383–390. Saunders, Philadelphia.
- Jacobs, R. M., Cochrane, S. M., Lumsden, J. H., and Norris, A. M. (1990). Relationship of cerebrospinal fluid protein concentration determined by dye-binding and urinary dipstick methodologies. *Can. Vet. J.* **31**, 587–588.
- Jamison, E. M., and Lumsden, J. H. (1988). Cerebrospinal fluid analysis in the dog: methodology and interpretation. *Semin. Vet. Med. Surg. (Small Anim.)* **3**, 122–132.
- Johnson, G. C., Fenner, W. R., and Krakowka, S. (1988). Production of immunoglobulin G and increased antiviral antibody in cerebrospinal fluid of dogs with delayed-onset canine distemper viral encephalitis. *J. Neuroimmunol.* **17**, 237–251.
- Johnson, G. C., Fuciu, D. M., Fenner, W. R., and Krakowka, S. (1985). Transient leakage across the blood-cerebrospinal fluid barrier after intrathecal metrizamide administration to dogs. *Am. J. Vet. Res.* **46**, 1303–1308.
- Jorda, M., Ganjei-Azar, P., and Nadji, M. (1998). Cytologic characteristics of meningeal carcinomatosis: increased diagnostic accuracy using carcinoembryonic antigen and epithelial membrane antigen immunocytochemistry. *Arch. Neurol.* **55**, 181–184.
- Joseph, R. J., Greenlee, P. G., Carrillo, J. M., and Kay, W. J. (1988). Canine cerebrovascular disease: clinical and pathological findings in 17 cases. *J. Am. Anim. Hosp. Assoc.* **24**, 569–576.
- Jull, B. A., Merryman, J. I., Thomas, W. B., and McArthur, A. (1997). Necrotizing encephalitis in a Yorkshire terrier. *J. Am. Vet. Med. Assoc.* **211**, 1005–1007.
- Jurina, K., and Grevel, V. (2004). Spinal arachnoid pseudocysts in 10 rottweilers. *J. Small Anim. Pract.* **45**, 9–15.
- Kaiser, R., and Lucking, C. H. (1993). Intrathecal synthesis of specific antibodies in neuroborreliosis: comparison of different ELISA techniques and calculation methods. *J. Neurol. Sci.* **118**, 64–72.
- Keller, C. B., and Lamarre, J. (1992). Inherited lysosomal storage disease in an English springer spaniel. *J. Am. Vet. Med. Assoc.* **200**, 194–195.
- Kim, D., Jeoung, S. Y., Ahn, S. J., Lee, J. H., Pak, S. I., and Kwon, H. M. (2006). Comparison of tissue and fluid samples for the early detection of canine distemper virus in experimentally infected dogs. *J. Vet. Med. Sci.* **68**, 877–879.
- Kitagawa, M., Kanayama, K., and Sakai, T. (2003). Quadrigeminal cisterna arachnoid cyst diagnosed by MRI in five dogs. *Aust. Vet. J.* **81**, 340–343.
- Kiupel, M., Simmons, H. A., Fitzgerald, S. D., Wise, A., Sikarskie, J. G., Cooley, T. M., Hollamby, S. R., and Maes, R. (2003). West Nile virus infection in Eastern fox squirrels (*Sciurus niger*). *Vet. Pathol.* **40**, 703–707.
- Kjeldsberg, C. R., and Knight, J. A. (1993). "Body Fluids: Laboratory Examination of Amniotic, Cerebrospinal, Seminal, Serous & Synovial Fluids." American Society of Clinical Pathologists, Chicago.
- Kline, K. L., Joseph, R. J., and Averill, D. R. (1994). Feline infectious peritonitis with neurological involvement: clinical and pathological findings in 24 cats. *J. Am. Anim. Hosp. Assoc.* **30**, 111–118.
- Klingeborn, B., Dinter, Z., and Hughes, R. A. (1983). Antibody to neurotogenic myelin protein P2 in equine paresis due to equine herpesvirus 1. *Zentralbl. Veterinarmed. B.* **30**, 137–140.
- Koblik, P. D., LeCouteur, R. A., Higgins, R. J., Bollen, A. W., Vernau, K. M., Kortz, G. D., and Ilkiw, J. E. (1999). CT-guided brain biopsy using a modified Pelorus Mark III stereotactic system: experience with 50 dogs. *Vet. Radiol. Ultrasound* **40**, 434–440.
- Kohn, C. W., and Fenner, W. R. (1987). Equine herpes myeloencephalopathy. *Vet. Clin. North Am. Equine Pract.* **3**, 405–419.
- Kolmel, H. W. (1977). A method for concentrating cerebrospinal fluid cells. *Acta Cytol.* **21**, 154–157.
- Kopcha, M. (1987). Nutritional and metabolic diseases involving the nervous system. *Vet. Clin. North Am. Food Anim. Pract.* **3**, 119–135.
- Kornegay, J. N. (1981). Cerebrospinal fluid collection, examination, and interpretation in dogs and cats. *Compendium on Continuing Education for the Practicing Veterinarian* **3**, 85–90.
- Kornegay, J. N., and Gorgacz, E. J. (1982). Intracranial epidermoid cysts in three dogs. *Vet. Pathol.* **19**, 646–650.
- Kornegay, J. N., Lorenz, M. D., and Zenoble, R. D. (1978). Bacterial meningoencephalitis in two dogs. *J. Am. Vet. Med. Assoc.* **173**, 1334–1336.
- Krakowka, S., Fenner, W., and Miele, J. A. (1981). Quantitative determination of serum origin cerebrospinal fluid proteins in the dog. *Am. J. Vet. Res.* **42**, 1975–1977.
- Kristensen, F., and Firth, E. C. (1977). Analysis of serum proteins and cerebrospinal fluid in clinically normal horses, using agarose electrophoresis. *Am. J. Vet. Res.* **38**, 1089–1092.
- Kuberski, T. (1979). Eosinophils in the cerebrospinal fluid. *Ann. Intern. Med.* **91**, 70–75.

- Kuwamura, M., Adachi, T., Yamate, J., Kotani, T., Ohashi, F., and Summers, B. A. (2002). Necrotising encephalitis in the Yorkshire terrier: a case report and literature review. *J. Small Anim. Pract.* **43**, 459–463.
- Lane, S. B., Kornegay, J. N., Duncan, J. R., and Oliver, J. E., Jr. (1994). Feline spinal lymphosarcoma: a retrospective evaluation of 23 cats. *J. Vet. Intern. Med.* **8**, 99–104.
- Laterre, D. C. (1996). "Handbook of Clinical Neurology: Tumors of the Spine and Spinal Cord," Part I (P. J. Vinken and G. W. Bruyn, Eds.), pp. 125–138. American Elsevier, New York.
- Lebech, A.-M. (1994). "Lyme Borreliosis" (J. S. Axford and D. E. H. Rees, Ed.), pp. 303–305. Plenum Press, New York.
- Lester, G. (1992). Parasitic Encephalomyelitis in Horses. *Compendium on Continuing Education for the Practicing Veterinarian* **14**, 1624–1630.
- Levy, S. A., Dombach, D. M., Barthold, S. W., and Wasmoen, T. L. (1993). Canine lyme borreliosis. *Compendium on Continuing Education for the Practicing Veterinarian* **15**, 833–846.
- Lin, J. J., Harn, H. J., Hsu, Y. D., Tsao, W. L., Lee, H. S., and Lee, W. H. (1995). Rapid diagnosis of tuberculous meningitis by polymerase chain reaction assay of cerebrospinal fluid. *J. Neurol.* **242**, 147–152.
- Link, H., and Tibbling, G. (1977). Principles of albumin and IgG analyses in neurological disorders. II. Relation of the concentration of the proteins in serum and cerebrospinal fluid. *Scand. J. Clin. Lab. Invest.* **37**, 391–396.
- Little, P. B. (1984). *Haemophilus somnus* complex: pathogenesis of the septicemic thrombotic meningoencephalitis. *Can. Vet. J.* **27**, 94–96.
- Little, P. B., and Sorensen, D. K. (1969). Bovine polioencephalomalacia, infectious embolic meningoencephalitis, and acute lead poisoning in feedlot cattle. *J. Am. Vet. Med. Assoc.* **155**, 1892–1903.
- Lobert, V., Mischke, R., and Tipold, A. (2003). Laktat- und pyruvatbestimmung in plasmata und liquor cerebrospinalis beim hund. *Kleintierpraxis* **48**, 725–792.
- Long, M. T., Jeter, W., Hernandez, J., Sellon, D. C., Gosche, D., Gillis, K., Bille, E., and Gibbs, E. P. (2006). Diagnostic performance of the equine IgM capture ELISA for serodiagnosis of West Nile virus infection. *J. Vet. Intern. Med.* **20**, 608–613.
- Loscher, W., and Schwartz-Porsche, D. (1986). Low levels of gamma-aminobutyric acid in cerebrospinal fluid of dogs with epilepsy. *J. Neurochem.* **46**, 1322–1325.
- Lowenthal, A., Crols, R., De Schutter, E., Gheuens, J., Karcher, D., Noppe, M., and Tasnier, A. (1984). Cerebrospinal fluid proteins in neurology. *Int. Rev. Neurobiol.* **25**, 95–138.
- Lowenthal, A., and Karcher, D. (1994). The value of studying the cerebrospinal fluid in slow viral and related diseases. *Ann. NY Acad. Sci.* **724**, 68–74.
- Lunn, J., Lee, R., Martin, P., and Malik, R. (2003). Antemortem diagnosis of canine neural angiostrongylosis using ELISA. *Aust. Vet. J.* **81**, 128–131.
- Luttgen, P. J., Braund, K. G., Brawner, W. R., Jr, and Vandeveld, M. (1980). A retrospective study of twenty-nine spinal tumours in the dog and cat. *J. Small Anim. Pract.* **21**, 213–226.
- Mac Donald, J. M., Delahunta, A., and Georgi, J. (1976). Cuterebra encephalitis in a dog. *Cornell. Vet.* **66**, 372–380.
- Madhusudana, S. N., Paul, J. P., Abhilash, V. K., and Suja, M. S. (2004). Rapid diagnosis of rabies in humans and animals by a dot blot enzyme immunoassay. *Int. J. Infect. Dis.* **8**, 339–345.
- Madigan, J. E. (1993). Lyme disease (Lyme borreliosis) in horses. *Vet. Clin. North Am. Equine. Pract.* **9**, 429–434.
- Madigan, J. E., and Higgins, R. J. (1987). Equine protozoal myeloencephalitis. *Vet. Clin. North Am. Equine. Pract.* **3**, 397–403.
- Mahieu, S., Vertessen, F., and Van der Planken, M. (2004). Evaluation of ADVIA 120 CSF assay (Bayer) vs. chamber counting of cerebrospinal fluid specimens. *Clin. Lab. Haematol.* **26**, 195–199.
- Mandel, N. S., Senker, E. G., Bosler, E. M., and Schneider, E. M. (1993). Intrathecal production of *Borrelia burgdorferi*-specific antibodies in a dog with central nervous system Lyme borreliosis. *Compendium on Continuing Education for the Practicing Veterinarian* **15**, 581–585.
- Maren, T. H. (1992). In "Barriers and Fluids of the Eye and Brain" (M. B. Segal, Ed.), pp. 37–48. CRC Press, Boca Raton, FL.
- Maretzki, C. H., Fisher, D. J., and Greene, C. E. (1994). Granulocytic ehrlichiosis and meningitis in a dog. *J. Am. Vet. Med. Assoc.* **205**, 1554–1556.
- Marshall, T., and Williams, K. M. (2000). Protein determination in cerebrospinal fluid by protein dye-binding assay. *Br. J. Biomed. Sci.* **57**, 281–286.
- Mason, K. V. (1989). Haematological and cerebrospinal fluid findings in canine neural angiostrongylosis. *Aust. Vet. J.* **66**, 152–154.
- Masri, M. D., Olcott, B. M., Nicholson, S. S., McClure, J. J., Schmidt, S. P., Freestone, J. F., and Kornegay, W. R. (1987). *Am. Assoc. Eq. Pract. Proc.* **33**, 367.
- Matsuki, N., Fujiwara, K., Tamahara, S., Uchida, K., Matsunaga, S., Nakayama, H., Doi, K., Ogawa, H., and Ono, K. (2004). Prevalence of autoantibody in cerebrospinal fluids from dogs with various CNS diseases. *J. Vet. Med. Sci.* **66**, 295–297.
- Mayhew, I. G. (1989). "Large Animal Neurology." Lea & Febiger, Philadelphia.
- Mayhew, I. G., deLahunta, A., Whitlock, R. H., Krook, L., and Tasker, J. B. (1978). Spinal cord disease in the horse. *Cornell. Vet.* **68** (suppl. 6), 1–207.
- Mayhew, I. G., Whitlock, R. H., and Tasker, J. B. (1977). Equine cerebrospinal fluid: reference values of normal horses. *Am. J. Vet. Res.* **38**, 1271–1274.
- McCue, P. M. (1989). Equine Leukoencephalomalacia. *Compendium on Continuing Education for the Practicing Veterinarian*, **11**, 646–650.
- McGlennon, N. J., Jeffries, A. R., and Casas, A. (1990). Polyradiculoneuritis and polymyositis due to a toxoplasma-like protozoan: diagnosis and treatment. *J. Small Anim. Pract.* **31**, 102–104.
- Meeks, J. C., Christopher, M. L., Chrisman, C. L., Hopkins, A. L., and Homer, B. H. (1994). The maturation of canine cerebrospinal fluid. In "12th Annual ACVIM Forum," p. 1008, San Francisco, CA.
- Meinkoth, J. H., Hoover, J. P., Cowell, R. L., Tyler, R. D., and Link, J. (1989). Ehrlichiosis in a dog with seizures and nonregenerative anemia. *J. Am. Vet. Med. Assoc.* **195**, 1754–1755.
- Meldrum, B. S. (1994). The role of glutamate in epilepsy and other CNS disorders. *Neurology* **44**, S14–S23.
- Meldrum, B. S. (2000). Glutamate as a neurotransmitter in the brain: review of physiology and pathology. *J. Nutr.* **130**, 1007S–1015S.
- Meric, S. M. (1988). Canine meningitis: a changing emphasis. *J. Vet. Intern. Med.* **2**, 26–35.
- Meric, S. M. (1992a). In "Current Veterinary Therapy XI- Small Animal Practice" (R. W. Kirk and J. D. Bonagura, Eds.), pp. 1007–1009. Saunders, Philadelphia.
- Meric, S. M. (1992b). In "Essentials of Small Animal Internal Medicine" (R. W. Nelson and C. G. Couto, Eds.), pp. 732–739. Mosby, St. Louis, MO.
- Meshner, C. I., Blue, J. T., Guffroy, M. R., and De Lahunta, A. (1996). Intracellular myelin in cerebrospinal fluid from a dog with myelomalacia. *Vet. Clin. Pathol.* **25**, 124–126.

- Milhorat, T. H. (1987). "Cerebrospinal Fluid and the Brain Edemas." Neuroscience Society of New York, New York.
- Millson, G. C., West, L. C., and Dew, S. M. (1960). Biochemical and haematological observation on the blood and cerebrospinal fluid of clinically healthy and scrapie-affected goats. *J. Comp. Pathol.* **70**, 194–198.
- Milner, R. J., Engela, J., and Kirberger, R. M. (1996). Arachnoid cyst in cerebellar pontine area of a cat—diagnosis by magnetic resonance imaging. *Vet. Radiol. Ultrasound* **37**, 34–36.
- Moore, M. P., Gavin, P. R., Bagley, R. S., and Harrington, M. L. (1994). Cerebrospinal fluid analysis in dog with intracranial tumors. In "12th Annual ACVIM Forum," p. 917, San Francisco, CA.
- Moore, P. F., Woo, J. C., Vernau, W., Kosten, S., and Graham, P. S. (2005). Characterization of feline T cell receptor gamma (TCRG) variable region genes for the molecular diagnosis of feline intestinal T cell lymphoma. *Vet. Immunol. Immunopathol.* **106**, 167–178.
- Morgan, J. P., Atilola, M., and Bailey, C. S. (1987). Vertebral canal and spinal cord mensuration: a comparative study of its effect on lumbosacral myelography in the dachshund and German shepherd dog. *J. Am. Vet. Med. Assoc.* **191**, 951–957.
- Morin, D. E., Toenniessen, J. G., French, R. A., Knight, B. L., and Zachary, J. F. (1994). Degenerative myeloencephalopathy in two llamas. *J. Am. Vet. Med. Assoc.* **204**, 938–943.
- Mullaney, T. P., Levin, S., and Indrieri, R. J. (1983). Disseminated aspergillosis in a dog. *J. Am. Vet. Med. Assoc.* **182**, 516–518.
- Munana, K. R., Lappin, M. R., Powell, C. C., Cooper, C. M., and Chavkin, M. J. (1995). Sequential measurement of *Toxoplasma gondii*-specific antibodies in the cerebrospinal fluid of cats with experimentally induced toxoplasmosis. *Prog. Vet. Neurol.* **6**, 27–31.
- Murphy, F. A., Bell, J. F., Bauer, S. P., Gardner, J. J., Moore, G. J., Harrison, A. K., and Coe, J. E. (1980). Experimental chronic rabies in the cat. *Lab. Invest.* **43**, 231–241.
- Murphy, J. E., Marsh, A. E., Reed, S. M., Meadows, C., Bolten, K., and Saville, W. J. (2006). Development and evaluation of a *Sarcocystis neurona*-specific IgM capture enzyme-linked immunosorbent assay. *J. Vet. Intern. Med.* **20**, 322–328.
- Nafe, L. A., Turk, J. R., and Carter, J. D. (1983). Central Nervous System Involvement of Blastomycosis in the Dog. *J. Am. Anim. Hosp. Assoc.* **19**, 933–945.
- Nayar, P. S., Ward, G. E., Saunders, J. R., and MacWilliams, P. (1977). Diagnostic procedures in experimental *Hemophilus somnus* infection in cattle. *Can. Vet. J.* **18**, 159–163.
- Nilsson, C., Lindvall-Axelsson, M., and Owman, C. (1992). Neuroendocrine regulatory mechanisms in the choroid plexus-cerebrospinal fluid system. *Brain. Res. Brain. Res. Rev.* **17**, 109–138.
- Norton, F. (1992). Cerebral Infarction in a Dog. *Prog. Vet. Neurol.* **3**, 120–125.
- Novak, R. W. (1984). Lack of validity of standard corrections for white blood cell counts of blood-contaminated cerebrospinal fluid in infants. *Am. J. Clin. Pathol.* **82**, 95–97.
- Novati, R., Castagna, A., Morsica, G., Vago, L., Tambussi, G., Ghezzi, S., Gervasoni, C., Bisson, C., d'Arminio Monforte, A., and Lazzarin, A. (1994). Polymerase chain reaction for *Toxoplasma gondii* DNA in the cerebrospinal fluid of AIDS patients with focal brain lesions. *Aids* **8**, 1691–1694.
- Olby, N. J., Sharp, N. J., Munana, K. R., and Papich, M. G. (1999). Chronic and acute compressive spinal cord lesions in dogs due to intervertebral disc herniation are associated with elevation in lumbar cerebrospinal fluid glutamate concentration. *J. Neurotrauma* **16**, 1215–1224.
- Oliver, J. E., and Lorenz, M. D. (1993). "Handbook of Veterinary Neurology." Saunders, Philadelphia.
- Olson, M. E., Chernik, N. L., and Posner, J. B. (1974). Infiltration of the leptomeninges by systemic cancer: a clinical and pathologic study. *Arch. Neurol.* **30**, 122–137.
- Oruc, E., and Uslu, U. (2006). [Comparative cytopathological and histopathological studies of sheep with suspected *Coenurus cerebralis* infection]. *Turkiye. Parazitol. Derg.* **30**, 285–288.
- Parish, S. M., Maag-Miller, L., Besser, T. E., Weidner, J. P., McElwain, T., Knowles, D. P., and Leathers, C. W. (1987). Myelitis associated with protozoal infection in newborn calves. *J. Am. Vet. Med. Assoc.* **191**, 1599–1600.
- Parker, A. J., and Cunningham, J. G. (1971). Successful surgical removal of an epileptogenic focus in a dog. *J. Small Anim. Pract.* **12**, 513–521.
- Parker, J. L., and White, K. K. (1992). Lyme borreliosis in cattle and horses: a review of the literature. *Cornell. Vet.* **82**, 253–274.
- Parmley, S. F., Goebel, F. D., and Remington, J. S. (1992). Detection of *Toxoplasma gondii* in cerebrospinal fluid from AIDS patients by polymerase chain reaction. *J. Clin. Microbiol.* **30**, 3000–3002.
- Patton, S., Legendre, A. M., McGavin, M. D., and Pelletier, D. (1991). Concurrent infection with *Toxoplasma gondii* and feline leukemia virus: antibody response and oocyst production. *J. Vet. Intern. Med.* **5**, 199–201.
- Pelc, S., De Maertelaere, E., and Denolin-Reubens, R. (1981). CSF cytology of acute viral meningitis and meningoencephalitis. *Eur. Neurol.* **20**, 95–102.
- Pesce, M. A., and Strande, C. S. (1973). A new micromethod for determination of protein in cerebrospinal fluid and urine. *Clin. Chem.* **19**, 1265–1267.
- Peter, J. B., and Tourtellotte, W. W. (1986). Modest serum contamination of cerebrospinal fluid (CSF) invalidates the calculation of intra-BBB albumin formation but not unique CSF oligoclonal IgG bands. In "11th Annual Meeting of the American Neurological Association," vol. 20, p. 167. Annals of Neurology, Boston.
- Peters, M., Pohlenz, J., Jatou, K., Ninet, B., and Bille, J. (1995). Studies of the detection of *Listeria monocytogenes* by culture and PCR in cerebrospinal fluid samples from ruminants with listeric encephalitis. *Zentralbl. Veterinarmed. B.* **42**, 84–98.
- Phillips, T. R., Prospero-Garcia, O., Puaoli, D. L., Lerner, D. L., Fox, H. S., Olmsted, R. A., Bloom, F. E., Henriksen, S. J., and Elder, J. H. (1994). Neurological abnormalities associated with feline immunodeficiency virus infection. *J. Gen. Virol.* **75** (Pt 5), 979–987.
- Platt, S. R., Dennis, P. M., McSherry, L. J., Chrisman, C. L., and Bennett, R. A. (2004). Composition of cerebrospinal fluid in clinically normal adult ferrets. *Am. J. Vet. Res.* **65**, 758–760.
- Podell, M., and Hadjiconstantinou, M. (1997). Cerebrospinal fluid gamma-aminobutyric acid and glutamate values in dogs with epilepsy. *Am. J. Vet. Res.* **58**, 451–456.
- Podell, M., Oglesbee, M., Mathes, L., Krakowka, S., Olmstead, R., and Lafrado, L. (1993). AIDS-associated encephalopathy with experimental feline immunodeficiency virus infection. *J. Acquir. Immune Defic. Syndr.* **6**, 758–771.
- Pollay, M. (1992). "Barriers and Fluids of the Eye and Brain" (M. B. Segal, Ed.), pp. 49–58. CRC Press, Boca Raton, FL.
- Porter, M. B., Long, M., Gosche, D. G., Schott, H. M., 2nd, Hines, M. T., Rossano, M., and Sellon, D. C. (2004). Immunoglobulin M-capture enzyme-linked immunosorbent assay testing of cerebrospinal fluid and serum from horses exposed to West Nile virus by vaccination or natural infection. *J. Vet. Intern. Med.* **18**, 866–870.

- Pugh, D. G., Causey, M. K., Blagburn, B. L., and Wolfe, D. F. (1995). Clinical parelaphostromylosis in llamas. *Compendium on Continuing Education for the Practicing Veterinarian* **17**, 600–605.
- Pusterla, N., Colegrove, K. M., Moore, P. F., Magdesian, K. G., and Vernau, W. (2006a). Multicentric T-cell lymphosarcoma in an alpaca. *Vet. J.* **171**, 181–185.
- Pusterla, N., Wilson, W. D., Conrad, P. A., Mapes, S., and Leutenegger, C. M. (2006b). Comparative analysis of cytokine gene expression in cerebrospinal fluid of horses without neurologic signs or with selected neurologic disorders. *Am. J. Vet. Res.* **67**, 1433–1437.
- Qvarnstrom, Y., Visvesvara, G. S., Sriram, R., and da Silva, A. J. (2006). Multiplex real-time PCR assay for simultaneous detection of *Acanthamoeba* spp. *Balamuthia mandrillaris*, and *Naegleria fowleri*. *J. Clin. Microbiol.* **44**, 3589–3595.
- Rand, J. S., Parent, J., Jacobs, R., and Johnson, R. (1990a). Reference intervals for feline cerebrospinal fluid: biochemical and serologic variables, IgG concentration, and electrophoretic fractionation. *Am. J. Vet. Res.* **51**, 1049–1054.
- Rand, J. S., Parent, J., Jacobs, R., and Percy, D. (1990b). Reference intervals for feline cerebrospinal fluid: cell counts and cytologic features. *Am. J. Vet. Res.* **51**, 1044–1048.
- Rand, J. S., Parent, J., Percy, D., and Jacobs, R. (1994a). Clinical, cerebrospinal fluid, and histological data from thirty-four cats with primary noninflammatory disease of the central nervous system. *Can. Vet. J.* **35**, 174–181.
- Rand, J. S., Parent, J., Percy, D., and Jacobs, R. (1994b). Clinical, cerebrospinal fluid, and histological data from twenty-seven cats with primary inflammatory disease of the central nervous system. *Can. Vet. J.* **35**, 103–110.
- Rebhun, W. C., and deLahunta, A. (1982). Diagnosis and treatment of bovine listeriosis. *J. Am. Vet. Med. Assoc.* **180**, 395–398.
- Reiber, H. (1994). Flow rate of cerebrospinal fluid (CSF)—a concept common to normal blood-CSF barrier function and to dysfunction in neurological diseases. *J. Neurol. Sci.* **122**, 189–203.
- Reiber, H., and Felgenhauer, K. (1987). Protein transfer at the blood cerebrospinal fluid barrier and the quantitation of the humoral immune response within the central nervous system. *Clin. Chim. Acta* **163**, 319–328.
- Reiber, H., and Lange, P. (1991). Quantification of virus-specific antibodies in cerebrospinal fluid and serum: sensitive and specific detection of antibody synthesis in brain. *Clin. Chem.* **37**, 1153–1160.
- Rhodes, C. H., Glantz, M. J., Glantz, L., Lekos, A., Sorenson, G. D., Honsinger, C., and Levy, N. B. (1996). A comparison of polymerase chain reaction examination of cerebrospinal fluid and conventional cytology in the diagnosis of lymphomatous meningitis. *Cancer* **77**, 543–548.
- Rider, L. G., Thapa, P. B., Del Beccaro, M. A., Gale, J. L., Foy, H. M., Farwell, J. R., and Mendelman, P. M. (1995). Cerebrospinal fluid analysis in children with seizures. *Pediatr. Emerg. Care* **11**, 226–229.
- Ripley, B., Fujiki, N., Okura, M., Mignot, E., and Nishino, S. (2001). Hypocretin levels in sporadic and familial cases of canine narcolepsy. *Neurobiol. Dis.* **8**, 525–534.
- Rishniw, M., Wilkerson, M. J., and de Lahunta, A. (1994). Myelodysplasia in an Alaskan malamute dog with adult onset of clinical signs. *Prog. Vet. Neurol.* **5**, 35–38.
- Roeder, B. L., Johnson, J. W., and Cash, W. C. (1990). Paradoxical vestibular syndrome in a cow with a metastatic brain tumor. *Compendium on Continuing Education for the Practicing Veterinarian* **12**, 1175–1181.
- Rosanda, C., Gambini, C., Carlini, B., Conte, M., De Bernardi, B., Garaventa, A., and Corrias, M. V. (2006). Diagnostic identification of malignant cells in the cerebrospinal fluid by tumor-specific qRT-PCR. *Clin. Exp. Metastasis* **23**, 223–226.
- Rosenberg, G. A. (1990). “Brain Fluids and Metabolism.” Oxford University Press, New York.
- Rossano, M. G., Kaneene, J. B., Schott, H. C., 2nd, Sheline, K. D., and Mansfield, L. S. (2003). Assessing the agreement of Western blot test results for paired serum and cerebrospinal fluid samples from horses tested for antibodies to *Sarcocystis neuronaf*. *Vet. Parasitol.* **115**, 233–238.
- Rossdale, P. D., Cash, R. S., Leadon, D. P., and Jeffcott, L. B. (1982). Biochemical constituents of cerebrospinal fluid in premature and full term foals. *Equine. Vet. J.* **14**, 134–138.
- Roszel, J. F. (1972). Membrane filtration of canine and feline cerebrospinal fluid for cytologic evaluation. *J. Am. Vet. Med. Assoc.* **160**, 720–725.
- Ruckebusch, M., and Costes, G. (1988). Metabolites Terminaux de la Dopamine et de la Serotonine dans le Liquide Céphalorachidien Lombaire che la Vache. *Revue De Medecine Veterinaire* **139**, 1125–1131.
- Ruckebusch, M., and Sutra, J. F. (1984). On the significance of monoamines and their metabolites in the cerebrospinal fluid of the sheep. *J. Physiol.* **348**, 457–469.
- Ruehlmann, D., Podell, M., Oglesbee, M., and Dubey, J. P. (1995). Canine neosporosis: a case report and literature review. *J. Am. Anim. Hosp. Assoc.* **31**, 174–183.
- Ruotsalo, K., Poma, R., and Bienzle, D. (2005). Evaluation of the Advia 120 CSF assay for analysis of canine cerebrospinal fluid. *Vet. Clin. Pathol.* **34**, 282.
- Rutgers, C., Kowalski, J., Cole, C. R., Sherding, R. G., Chew, D. J., Davenport, D., O’Grady, M., and Murtaugh, R. J. (1985). Severe Rocky Mountain spotted fever in five dogs. *J. Am. Anim. Hosp. Assoc.* **21**, 361–369.
- Rylander, H., Lipsitz, D., Berry, W. L., Sturges, B. K., Vernau, K. M., Dickinson, P. J., Anor, S. A., Higgins, R. J., and LeCouteur, R. A. (2002). Retrospective analysis of spinal arachnoid cysts in 14 dogs. *J. Vet. Intern. Med.* **16**, 690–696.
- Saito, M., Olby, N. J., and Spaulding, K. (2001). Identification of arachnoid cysts in the quadrigeminal cistern using ultrasonography. *Vet. Radiol. Ultrasound* **42**, 435–439.
- Sanchez-Juan, P., Green, A., Ladogana, A., Cuadrado-Corrales, N., Sanchez-Valle, R., Mitrova, E., Stoek, K., Sklaviadis, T., Kulczycki, J., Hess, K., Bodemer, M., Slivarichova, D., Saiz, A., Calero, M., Ingrosso, L., Knight, R., Janssens, A. C., van Duijn, C. M., and Zerr, I. (2006). CSF tests in the differential diagnosis of Creutzfeldt-Jakob disease. *Neurology* **67**, 637–643.
- Santschi, E. M., and Foreman, J. H. (1989). Equine bacterial meningitis: part I. *Compendium on Continuing Education for the Practicing Veterinarian* **11**, 479–483.
- Sarfaty, D., Carrillo, J. M., and Greenlee, P. G. (1986). Differential diagnosis of granulomatous meningoencephalomyelitis, distemper, and suppurative meningoencephalitis in the dog. *J. Am. Vet. Med. Assoc.* **188**, 387–392.
- Sarfaty, D., Carrillo, J. M., and Peterson, M. E. (1988). Neurologic, endocrinologic, and pathologic findings associated with large pituitary tumors in dogs: eight cases (1976–1984). *J. Am. Vet. Med. Assoc.* **193**, 854–856.
- Scarratt, W. K. (1987). Ovine Listeric Encephalitis. *Compendium on Continuing Education for the Practicing Veterinarian* **9**, F28–F33.
- Schaeffer, M. C., Rogers, Q. R., Leung, P. M., Wolfe, B. M., and Strombeck, D. R. (1991). Changes in cerebrospinal fluid and plasma

- amino acid concentrations with elevated dietary protein concentration in dogs with portacaval shunts. *Life Sci.* **48**, 2215–2223.
- Schaer, M., Johnson, K. E., and Nicholson, A. C. (1983). Central nervous system disease due to histoplasmosis in a dog: a case report. *J. Am. Anim. Hosp. Assoc.* **19**, 311–316.
- Schatzberg, S. J., Haley, N. J., Barr, S. C., deLahunta, A., Olby, N., Munana, K., and Sharp, N. J. (2003). Use of a multiplex polymerase chain reaction assay in the antemortem diagnosis of toxoplasmosis and neosporosis in the central nervous system of cats and dogs. *Am. J. Vet. Res.* **64**, 1507–1513.
- Schliep, G., and Felgenhauer, K. (1974). The alpha2-macroglobulin level in cerebrospinal fluid; a parameter for the condition of the blood-CSF barrier. *J. Neurol.* **207**, 171–181.
- Schott, H. C., Major, M. D., Grant, B. D., and Bayly, W. M. (1990). Melanoma as a cause of spinal cord compression in two horses. *J. Am. Vet. Med. Assoc.* **196**, 1820–1822.
- Schreuder, B. E. (1994a). Animal spongiform encephalopathies: an update. Part I. Scrapie and lesser known animal spongiform encephalopathies. *Vet. Q.* **16**, 174–181.
- Schreuder, B. E. (1994b). Animal spongiform encephalopathies: an update. Part II. Bovine spongiform encephalopathy (BSE). *Vet. Q.* **16**, 182–192.
- Scott, P. R. (1992). Analysis of cerebrospinal fluid from field cases of some common ovine neurological diseases. *Br. Vet. J.* **148**, 15–22.
- Scott, P. R. (1993). A field study of ovine listerial meningo-encephalitis with particular reference to cerebrospinal fluid analysis as an aid to diagnosis and prognosis. *Br. Vet. J.* **149**, 165–170.
- Scott, P. R. (1995). The collection and analysis of cerebrospinal fluid as an aid to diagnosis in ruminant neurological disease. *Br. Vet. J.* **151**, 603–614.
- Scott, P. R., Aldridge, B. M., Clarke, M., and Will, R. G. (1990). Cerebrospinal fluid studies in normal cows and cases of bovine spongiform encephalopathy. *Br. Vet. J.* **146**, 88–90.
- Scott, P. R., Sargison, N. D., Penny, C. D., and Strachan, W. D. (1995). Aqueous humour and cerebrospinal fluid collected at necropsy as indicators of ante mortem serum 3-OH butyrate concentration in pregnant sheep. *Br. Vet. J.* **151**, 459–461.
- Sessums, K. B., and Ducote, J. M. (2006). What is your diagnosis? Spinal arachnoid cysts. *J. Am. Vet. Med. Assoc.* **228**, 1019–1020.
- Sharief, M. K., and Thompson, E. J. (1989). Immunoglobulin M in the cerebrospinal fluid: an indicator of recent immunological stimulation. *J. Neurol. Neurosurg. Psychiatry* **52**, 949–953.
- Shell, L. G., Carrig, C. B., Sponenberg, D. P., and Jortner, B. S. (1988). Spinal dysraphism, hemivertebrae, and stenosis of the spinal canal in a rottweiler puppy. *J. Am. Anim. Hosp. Assoc.* **24**, 341–344.
- Sherman, D. M. (1987). Localized diseases of the bovine brain and spinal cord. *Vet. Clin. North Am. Food. Anim. Pract.* **3**, 179–191.
- Shimada, N., Inoue, T., and Murata, H. (2005). Cerebrospinal fluid S-100B concentrations in normal and diseased cattle. *J. Vet. Med. Sci.* **67**, 621–623.
- Silverstein Dombrowski, D. C., Carmichael, K. P., Wang, P., O'Malley, T. M., Haskins, M. E., and Giger, U. (2004). Mucopolysaccharidosis type VII in a German shepherd dog. *J. Am. Vet. Med. Assoc.* **224**, 532–533. 553–557.
- Sindern, E., and Malin, J. P. (1995). Phenotypic analysis of cerebrospinal fluid cells over the course of Lyme meningoradiculitis. *Acta Cytol.* **39**, 73–75.
- Sisk, D. B., Colvin, B. M., Merrill, A., Bondari, K., and Bowen, J. M. (1990). Experimental acute inorganic boron toxicosis in the goat: effects on serum chemistry and CSF biogenic amines. *Vet. Hum. Toxicol.* **32**, 205–211.
- Skeen, T. M., Olby, N. J., Munana, K. R., and Sharp, N. J. (2003). Spinal arachnoid cysts in 17 dogs. *J. Am. Anim. Hosp. Assoc.* **39**, 271–282.
- Smith, D. L. (1957). Poisoning by sodium salt; a cause of eosinophilic meningoencephalitis in swine. *Am. J. Vet. Res.* **18**, 825–850.
- Smith, M. O. (1995). Quinolinic acid: merely a marker or major mediator? In "Thirteenth Annual ACVIM Forum," pp. 929–931, Lake Buena Vista, FA.
- Smith, M. O., and Lackner, A. A. (1993). Effects of sex, age, puncture site, and blood contamination on the clinical chemistry of cerebrospinal fluid in rhesus macaques (*Macaca mulatta*). *Am. J. Vet. Res.* **54**, 1845–1850.
- Smith-Maxie, L. L., Parent, J. P., Rand, J., Wilcock, B. P., and Norris, A. M. (1989). Cerebrospinal fluid analysis and clinical outcome of eight dogs with eosinophilic meningoencephalomyelitis. *J. Vet. Intern. Med.* **3**, 167–174.
- Smyth, G. B., Vaughn, D. M., and Frischmeyer, K. J. (1994). Neurotransmitters in atlanto-occipital cerebrospinal fluid of normal foals. *Prog. Vet. Neurol.* **5**, 13–17.
- Sorjonen, D. C. (1987). Total protein, albumin quota, and electrophoretic patterns in cerebrospinal fluid of dogs with central nervous system disorders. *Am. J. Vet. Res.* **48**, 301–305.
- Sorjonen, D. C. (1990). Clinical and histopathological features of granulomatous meningoencephalitis in dogs. *J. Am. Anim. Hosp. Assoc.* **26**, 141–147.
- Sorjonen, D. C., Golden, D. L., Levesque, D. C., Shores, A., and Moore, M. P. (1991). Cerebrospinal fluid protein electrophoresis: a clinical evaluation of a previously reported diagnostic technique. *Prog. Vet. Neurol.* **2**, 261–268.
- Sornas, R. (1967). A new method for the cytological examination of the cerebrospinal fluid. *J. Neurol. Neurosurg. Psychiatry* **30**, 568–577.
- Spencer, C. P., Chrisman, C. L., Mayhew, I. G., and Kaude, J. V. (1982). Neurotoxicologic effects of the nonionic contrast agent iopamidol on the leptomeninges of the dog. *Am. J. Vet. Res.* **43**, 1958–1962.
- St. Jean, G., Yvorchuk-St. Jean, K., Anderson, D. E., and Moore, W. E. (1995). *Proc. ACVIM* 13, 1008.
- Stalis, I. H., Chadwick, B., Dayrell-Hart, B., Summers, B. A., and Van Winkle, T. J. (1995). Necrotizing meningoencephalitis of Maltese dogs. *Vet. Pathol.* **32**, 230–235.
- Stark, E., Haas, J., and Schedel, I. (1993). Diagnosis of cytomegalovirus infections of the nervous system by immunocytochemical demonstration of infected cells in cerebrospinal fluid. *Eur. J. Med.* **2**, 223–226.
- Steckel, R. R., Adams, S. B., Long, G. G., and Rebar, A. H. (1982). Antemortem diagnosis and treatment of cryptococcal meningitis in a horse. *J. Am. Vet. Med. Assoc.* **180**, 1085–1089.
- Steele, R. W., Marmer, D. J., O'Brien, M. D., Tyson, S. T., and Steele, C. R. (1986). Leukocyte survival in cerebrospinal fluid. *J. Clin. Microbiol.* **23**, 965–966.
- Steinberg, S. A., and Vandeveld, M. (1974). [A comparative study of two methods of cytological evaluation of spinal fluid in domestic animals]. *Folia. Vet. Lat.* **4**, 235–250.
- Stevens, D. A. (2002). Diagnosis of fungal infections: current status. *J. Antimicrob. Chemother.* **49**(suppl. 1), 11–19.
- Stiles, J., Prade, R., and Greene, C. (1996). Detection of toxoplasma gondii in feline and canine biological samples by use of the polymerase chain reaction. *Am. J. Vet. Res.* **57**, 264–267.
- Stokes, H. B., O'Hara, C. M., Buchanan, R. D., and Olson, W. H. (1975). An improved method for examination of cerebrospinal fluid cells. *Neurology* **25**, 901–906.
- Stoodley, M. A., Jones, N. R., and Brown, C. J. (1996). Evidence for rapid fluid flow from the subarachnoid space into the spinal cord central canal in the rat. *Brain Res.* **707**, 155–164.

- Strain, G. M., Barta, O., Olcott, B. M., and Braun, W. F., Jr (1984). Serum and cerebrospinal fluid concentrations of immunoglobulin G in Suffolk sheep with scrapie. *Am. J. Vet. Res.* **45**, 1812–1813.
- Sturges, B. K., Dickinson, P. J., Kortz, G. D., Berry, W. L., Vernau, K. M., Wisner, E. R., and LeCouteur, R. A. (2006). Clinical signs, magnetic resonance imaging features, and outcome after surgical and medical treatment of otogenic intracranial infection in 11 cats and 4 dogs. *J. Vet. Intern. Med.* **20**, 648–656.
- Sumi, M. G., Mathai, A., Reuben, S., Sarada, C., and Radhakrishnan, V. V. (2002). Immunocytochemical method for early laboratory diagnosis of tuberculous meningitis. *Clin. Diagn. Lab. Immunol.* **9**, 344–347.
- Swarup, D., and Maiti, S. K. (1991). Changes in some biochemical constituents in blood and cerebrospinal fluid of lead intoxicated calves. *Indian J. Anim. Sci.* **61**, 942–945.
- Taylor, H. W., Vandeveld, M., and Firth, E. C. (1977). Ischemic myelopathy caused by fibrocartilaginous emboli in a horse. *Vet. Pathol.* **14**, 479–481.
- Thomas, J. B., and Eger, C. (1989). Granulomatous meningoencephalomyelitis in 21 dogs. *J. Small Anim. Pract.* **30**, 287–293.
- Thompson, E. J. (1988). “The CSF Proteins: A Biochemical Approach.” Elsevier Science, New York.
- Thomson, C. E., Kornegay, J. N., and Stevens, J. B. (1989). Canine intervertebral disc disease: changes in the cerebrospinal fluid. *J. Small Anim. Pract.* **30**, 685–688.
- Thomson, C. E., Kornegay, J. N., and Stevens, J. B. (1990). Analysis of cerebrospinal fluid from the cerebellomedullary and lumbar cisterns of dogs with focal neurologic disease: 145 cases (1985–1987). *J. Am. Vet. Med. Assoc.* **196**, 1841–1844.
- Tibbling, G., Link, H., and Ohman, S. (1977). Principles of albumin and IgG analyses in neurological disorders. I. Establishment of reference values. *Scand. J. Clin. Lab. Invest.* **37**, 385–390.
- Tipold, A. (1995). Diagnosis of inflammatory and infectious diseases of the central nervous system in dogs: a retrospective study. *J. Vet. Intern. Med.* **9**, 304–314.
- Tipold, A., Fatzner, R., Jaggy, A., Surbruggen, A., and Vandeveld, M. (1993a). Necrotizing encephalitis in Yorkshire terriers. *J. Small Anim. Pract.* **34**, 623–627.
- Tipold, A., and Jaggy, A. (1994). Steroid responsive meningitis-arteritis in dogs: long-term study of 32 cases. *J. Small Anim. Pract.* **35**, 311–316.
- Tipold, A., Moore, P., Jungi, T. W., Sager, H., and Vandeveld, M. (1998). Lymphocyte subsets and CD45RA positive T-cells in normal canine cerebrospinal fluid. *J. Neuroimmunol.* **82**, 90–95.
- Tipold, A., Moore, P., Zurbruggen, A., and Vandeveld, M. (1999). Lymphocyte subset distribution in steroid responsive meningitis-arteriitis in comparison to different canine encephalitis. *Zentralbl. Veterinarmed. A.* **46**, 75–85.
- Tipold, A., Pfister, H., and Vandeveld, M. (1993b). Determination of the IgG index for the detection of intrathecal immunoglobulin synthesis in dogs using an ELISA. *Res. Vet. Sci.* **54**, 40–44.
- Tipold, A., Pfister, H., Zurbruggen, A., and Vandeveld, M. (1994). Intrathecal synthesis of major immunoglobulin classes in inflammatory diseases of the canine CNS. *Vet. Immunol. Immunopathol.* **42**, 149–159.
- Tipold, A., Vandeveld, M., and Zurbruggen, A. (1995). Neuroimmunological studies in steroid-responsive meningitis-arteritis in dogs. *Res. Vet. Sci.* **58**, 103–108.
- Tosaka, M., Tamura, M., Oriuchi, N., Horikoshi, M., Joshita, T., Sugawara, K., Kobayashi, S., Kohga, H., Yoshida, T., and Sasaki, T. (2001). Cerebrospinal fluid immunocytochemical analysis and neuroimaging in the diagnosis of primary leptomeningeal melanoma. *Case report. J. Neurosurg.* **94**, 528–532.
- Trotter, J. L. a. R., R. S. (1989). “The Cerebrospinal Fluid” (R. M. Hendon and R. A. Brunback, Eds.), pp. 179–226. Kluwer Academic, Boston.
- Tsai, S. C., Summers, B. A., and Appel, M. J. (1982). Interferon in cerebrospinal fluid: a marker for viral persistence of canine distemper encephalomyelitis. *Arch. Virol.* **72**, 257–265.
- Tyler, D. E., Lorenz, M. D., Blue, J. L., Munnell, J. F., and Chandler, F. W. (1980). Disseminated protothecosis with central nervous system involvement in a dog. *J. Am. Vet. Med. Assoc.* **176**, 987–993.
- Uchida, K., Hasegawa, T., Ikeda, M., Yamaguchi, R., and Tateyama, S. (1999). Detection of an autoantibody from pug dogs with necrotizing encephalitis (pug dog encephalitis). *Vet. Pathol.* **36**, 301–307.
- van Bree, H., Van Rijssen, B., and Van Ham, L. (1991). Comparison of nonionic contrast agents iohexol and iotrolan for cisternal myelography in dogs. *Am. J. Vet. Res.* **52**, 926–933.
- Vandeveld, M., and Spano, J. S. (1977). Cerebrospinal fluid cytology in canine neurologic disease. *Am. J. Vet. Res.* **38**, 1827–1832.
- Vandeveld, M., Zurbruggen, A., Steck, A., and Bichsel, P. (1986). Studies on the intrathecal humoral immune response in canine distemper encephalitis. *J. Neuroimmunol.* **11**, 41–51.
- Vaughn, D. M., Coleman, E., Simpson, S. T., and Satjawatcharaphong, C. (1988a). Analysis of neurotransmitter metabolite concentrations in canine cerebrospinal fluid. *Am. J. Vet. Res.* **49**, 1302–1306.
- Vaughn, D. M., Coleman, E., Simpson, S. T., Whitmer, B., and Satjawatcharaphong, C. (1988b). A rostrocaudal gradient for neurotransmitter metabolites and a caudorostral gradient for protein in canine cerebrospinal fluid. *Am. J. Vet. Res.* **49**, 2134–2137.
- Vaughn, D. M., Simpson, S. T., Blagburn, B. L., Whitmer, W. L., Heddens-Mysinger, R., and Hendrix, C. M. (1989). Determination of homovanillic acid, 5-hydroxyindoleacetic acid and pressure in the cerebrospinal fluid of collie dogs following administration of ivermectin. *Vet. Res. Commun.* **13**, 47–55.
- Vaughn, D. M., and Smyth, G. B. (1989). Different gradients for neurotransmitter metabolites and protein in horse cerebrospinal fluid. *Vet. Res. Commun.* **13**, 413–419.
- Vernau, K. M., Higgins, R. J., Bollen, A. W., Jimenez, D. F., Anderson, J. V., Koblik, P. D., and LeCouteur, R. A. (2001). Primary canine and feline nervous system tumors: intraoperative diagnosis using the smear technique. *Vet. Pathol.* **38**, 47–57.
- Vernau, K. M., Kortz, G. D., Koblik, P. D., LeCouteur, R. A., Bailey, C. S., and Pedroia, V. (1997). Magnetic resonance imaging and computed tomography characteristics of intracranial intra-arachnoid cysts in 6 dogs. *Vet. Radiol. Ultrasound* **38**, 171–176.
- Vernau, K. M., LeCouteur, R. A., Sturges, B. K., Samii, V., Higgins, R. J., Koblik, P. D., and Vernau, W. (2002). Intracranial intra-arachnoid cyst with intracystic hemorrhage in two dogs. *Vet. Radiol. Ultrasound* **43**, 449–454.
- Vernau, W., and Moore, P. F. (1999). An immunophenotypic study of canine leukemias and preliminary assessment of clonality by polymerase chain reaction. *Vet. Immunol. Immunopathol.* **69**, 145–164.
- Von Kurnatowski, J., Stein, V. M., Moller, C., and Tipold, A. (2006). Meningoenzephalitis und Arachnoidalzyste des dritten Ventrikels bei einer Shit-Tzu-Hundin. *Kleintierpraxis* **51**, 586–592.
- Wamsley, H. L., Alleman, A. R., Porter, M. B., and Long, M. T. (2002). Findings in cerebrospinal fluids of horses infected with West Nile virus: 30 cases (2001). *J. Am. Vet. Med. Assoc.* **221**, 1303–1305.
- Waters, D. J., and Hayden, D. W. (1990). Intramedullary spinal cord metastasis in the dog. *J. Vet. Intern. Med.* **4**, 207–215.



- Waxman, F. J., Clemmons, R. M., and Hinrichs, D. J. (1980). Progressive myelopathy in older German shepherd dogs II. Presence of circulating suppressor cells. *J. Immunol.* **124**, 1216–1222.
- Weisner, B., and Bernhardt, W. (1978). Protein fractions of lumbar, cisternal, and ventricular cerebrospinal fluid: separate areas of reference. *J. Neurol. Sci.* **37**, 205–214.
- Welch, K. (1975). "Advances in Neurology: Current Reviews" (W. J. Friedlander, Ed.), pp. 247–332. Raven Press, New York.
- Welles, E. G., Pugh, D. G., Wenzel, J. G., and Sorjonen, D. C. (1994). Composition of cerebrospinal fluid in healthy adult llamas. *Am. J. Vet. Res.* **55**, 1075–1079.
- Welles, E. G., Tyler, J. W., Sorjonen, D. C., and Whatley, E. M. (1992). Composition and analysis of cerebrospinal fluid in clinically normal adult cattle. *Am. J. Vet. Res.* **53**, 2050–2057.
- Werner, J. A., Woo, J. C., Vernau, W., Graham, P. S., Grahn, R. A., Lyons, L. A., and Moore, P. F. (2005). Characterization of feline immunoglobulin heavy chain variable region genes for the molecular diagnosis of B-cell neoplasia. *Vet. Pathol.* **42**, 596–607.
- Widmer, W. R., and Blevins, W. E. (1991). Veterinary myelography: a review of contrast media, adverse effects and technique. *J. Am. Anim. Hosp. Assoc.* **27**, 163–177.
- Widmer, W. R., DeNicola, D. B., Blevins, W. E., Cook, J. R., Jr., Cantwell, H. D., and Teclaw, R. F. (1992). Cerebrospinal fluid changes after iopamidol and metrizamide myelography in clinically normal dogs. *Am. J. Vet. Res.* **53**, 396–401.
- Williams, M. A., Welles, E. G., Gailor, R. J., Ewart, S. L., Humburg, J. M., Mullaney, T. P., Stickle, J., Chang, C. D., and Walter, G. L. (1992). Lymphosarcoma associated with neurological signs and abnormal cerebrospinal fluid in two horses. *Prog. Vet. Neurol.* **3**, 51–56.
- Wilson, J. W. (1977). Clinical application of cerebrospinal fluid creatine phosphokinase determination. *J. Am. Vet. Med. Assoc.* **171**, 200–202.
- Wilson, J. W., Kurtz, H. J., Leipold, H. W., and Lees, G. E. (1979). Spina bifida in the dog. *Vet. Pathol.* **16**, 165–179.
- Wilson, J. W., and Stevens, J. B. (1977). Effects of blood contamination on cerebrospinal fluid analysis. *J. Am. Vet. Med. Assoc.* **171**, 256–258.
- Windsor, R. C., Vernau, K. M., Sturges, B. K., Dickinson, P. J., Knipe, M. F., LeCouteur, R. A., Kass, P. H., and Vernau, W. (2007). Characterization of inflammatory cerebrospinal fluid in dogs with type 1 intervertebral disc disease: 213 cases. In "25th ACVIM Forum," pp. 641, abstract 25. Seattle, WA.
- Wood, A. K., Farrow, B. R., and Fairburn, A. J. (1985). Cervical myelography in dogs using iohexol. *Acta Radiol. Diagn. (Stockh.)* **26**, 767–770.
- Woodruff, K. H. (1973). Cerebrospinal fluid cytomorphology using cyto-centrifugation. *Am. J. Clin. Pathol.* **60**, 621–627.
- Wunschmann, A., Shivers, J., Bender, J., Carroll, L., Fuller, S., Saggese, M., van Wettere, A., and Redig, P. (2005). Pathologic and immunohistochemical findings in goshawks (*Accipiter gentilis*) and great horned owls (*Bubo virginianus*) naturally infected with West Nile virus. *Avian Dis.* **49**, 252–259.
- Yvorchuk, K. (1992). In "Current Therapy in Equine Medicine" (N. E. Robinson, Ed.), pp. 569–570. Saunders, Philadelphia.
- Zimmerman, K., Almy, F., Carter, L., Higgins, M., Rossmeisl, J., Inzana, K., and Duncan, R. (2006). Cerebrospinal fluid from a 10-year-old dog with a single seizure episode. *Vet. Clin. Pathol.* **35**, 127–131.

# Clinical Biochemistry in Toxicology

Kurt V. Kreutzer

Department of Biomedical Sciences  
College of Veterinary Medicine  
University of Missouri  
Columbia, Missouri

James R. Turk

Department of Biomedical Sciences  
College of Veterinary Medicine  
University of Missouri  
Columbia, Missouri

Stan W. Casteel

Medical Diagnostic Laboratory  
College of Veterinary Medicine  
University of Missouri  
Columbia, Missouri

- 
- I. INTRODUCTION
  - II. HEPATOTOXICITY
  - III. NEPHRO TOXICITY
  - IV. TOXINS AFFECTING SKELETAL AND CARDIAC MUSCLE
  - V. TOXINS AFFECTING THE LUNG AND RESPIRATORY TRACT
  - VI. TOXINS AFFECTING THE GASTROINTESTINAL TRACT
  - VII. TOXINS AFFECTING ERYTHROCYTES AND THE HEMATOPOIETIC SYSTEM
  - VIII. TOXINS AFFECTING HEMOGLOBIN AND OXIDATIVE METABOLISM
  - IX. TOXINS AFFECTING THE ENDOCRINE SYSTEM
  - X. TOXINS AFFECTING THE NERVOUS SYSTEM
  - XI. TOXINS AFFECTING THE INTEGUMENT
- REFERENCES
- 

## I. INTRODUCTION

The availability of accurate historical information including a list of the animal species affected, clinical signs, toxins suspected, potential route of exposure, vehicle, relative amount, and timing of exposure is often a limiting factor in the diagnosis of toxic disease. This information permits the diagnostician to make a rational selection of samples and tests to be performed by considering the known target organs of the toxins suspected. Unfortunately, this information is often unavailable during the initial stages of an intoxication. In the absence of such detailed history, the identification of target organs using clinical biochemistry may help clinicians to create a list of potential toxins retrospectively.

There are species differences in the most useful biochemical markers of organ-specific cellular injury and in the susceptibility to various toxins (Kramer and Hoffmann, 1997). For this reason, the following discussion is organized on an organ system and species basis. Neither bacterial toxins nor hereditary disease predisposing to intoxication will be discussed.

## II. HEPATOTOXICITY

Many toxins induce hepatic injury (Table 27-1). The susceptibility of the liver to toxic insult is in part a consequence of its location between the digestive tract and the rest of the body and the central role it plays in biotransformation and disposition of xenobiotics (Miyai, 1991; Snyder, 1979). Extrahepatic metabolism of toxins by mixed function oxidases may affect the target organ and potential hepatotoxicity of a given xenobiotic (Gram *et al.*, 1986). A variety of factors including the induction of these enzyme systems by drugs (Snyder, 1979) and suppression of enzyme activity by infectious agents and cytokines (Monshouwer *et al.*, 1995) may modify the response to a given toxin. Lipophilic compounds tend to be more hepatotoxic than hydrophilic ones because the latter are eliminated by the kidney (Kelly, 1993). Many toxins are hepatotoxic and nephrotoxic, however, and most toxins have multiple target organs.

The cytosolic enzyme alanine aminotransferase (ALT) is found in both hepatocytes and skeletal muscle of animals. The dog and cat have high levels of ALT in hepatocytes, making it a useful marker for hepatocellular injury in these species (Stockham and Scott, 2002). The plasma half-life of this enzyme in the dog is estimated to be approximately 60h. Increased serum levels parallel the magnitude of hepatocellular injury in acute disease. Several days following injury, ALT levels may be spuriously low.

**TABLE 27.1** Hepatotoxins

Hepatotoxin	Disease Onset	Geography	Species Affected
Aflatoxin B <sub>1</sub> ( <i>Aspergillus flavus</i> )	Acute to chronic	Worldwide	All
<i>Agave lecheguilla</i>	Acute	US, MEX	Cp, O
Blue-green algae (Cyanobacteria)	Acute	Worldwide	All
Chlorinated hydrocarbons	Acute to chronic	Worldwide	All
Copper	Acute to chronic	Worldwide	O, all
Compositae	Acute	AFR, AUS	B, O, P
Corticosteroids	Chronic	Worldwide	Cn
Cresols (pitch)	Acute	Worldwide	P
Cycadales	Acute to chronic	AUS, FL, PRDOM REP	B, O
Cyclopiazonic acid ( <i>Penicillium cyclopium</i> )	Acute to chronic	UK	B, E, O
Dimethylnitrosamine	Acute to chronic	Worldwide	B, Cn, F, O
Ethanol	Acute to chronic	Worldwide	All
Fumonisin ( <i>Fusarium moniliforme</i> )	Chronic	Worldwide	B, E, O, P
Gossypol (cottonseed)	Acute to chronic	Worldwide	B, Cp, E, O, P
<i>Hymenoxys odorata</i> (bitterweed)	Acute to chronic	US	O
Indospicine ( <i>Indigofera</i> spp.)	Acute to chronic	AUS	B, Cn, E
Iron	Acute	Worldwide	P, E
<i>Karwinskia humboldtiana</i> (coyotillo)	Acute to chronic	MEX, TX	B, Cp, O
<i>Kochia scoparia</i> (fireweed)	Chronic	US	B
<i>Lantana camara</i>	Chronic	AUS, AFR, MEX, US	B, O, E
Mebendazole	Acute	Worldwide	Cn
Moldy hay	Chronic	US	B
Myoporaceae	Acute to chronic	AUS, NZ	B, O
<i>Nolina texana</i> (sacahuiste)	Chronic	US	B, Cp, O
Petroleum	Acute	Worldwide	All
Phalloidin ( <i>Amanita</i> )	Acute	Worldwide	All
Phomopsin (mycotoxin on lupines)	Acute to chronic	AUS, US	B, O
Phenytoin/primidone	Chronic	Worldwide	Cn
Phosphorus	Acute	Worldwide	All
Pyrrolizidine alkaloids	Chronic	Worldwide	B, Cp, E, O, P
<i>Ricinus communis</i> (castor bean)	Acute	Worldwide	All
Rubratoxins ( <i>Penicillium rubrum</i> )	Acute to chronic	Worldwide	B, CN, E, F
Sawfly larvae	Acute	AUS, DENMARK	B, Cp, O
Solanaceae	Acute	AFR, AUS S AM, US	B, Cp, O
Sporidesmin ( <i>Pithomyces chartarum</i> )	Chronic	AUS, AFR, NZ	B, O
Tannic acid ( <i>Quercus</i> spp., oaks)	Acute	Worldwide	B, Cp, E, O
<i>Terminalia oblongata</i> (yellowwood)	Acute to chronic	AUS	B, O
<i>Tetradymia</i> spp. (rabbit/horsebrush)	Chronic	US	B, Cp, O
<i>Trema aspera</i> (poison peach)	Acute	AUS	B
<i>Trifolium hybridum</i> (Alsike clover)	Chronic	Worldwide	B, E, O
<i>Xanthium strumarium</i> (Cocklebur)	Acute	US	B, P

Abbreviations: B, bovine; Cn, canine; Cp, caprine; E, equine; F, feline; O, ovine; P, porcine.

Therefore, ALT is not helpful in evaluating chronic liver disease. ALT levels also may be elevated by corticosteroid treatment and some anticonvulsant medications. ALT is not useful in evaluating hepatic disease in the horse and cow because of relatively low levels of ALT in hepatocytes relative to muscle (Lassen, 2004).

Aspartate aminotransferase (AST) is found in several different cell types including hepatocytes, erythrocytes, and cardiac and skeletal myocytes. However, it is most useful in evaluating hepatocellular and muscular injury because of its high activity in the cells of these tissues. AST is commonly used as a marker of hepatocyte damage in the equine and bovine, though muscle damage and hemolysis can also increase serum activity. AST is less specific for hepatocyte damage in the dog as compared to ALT (Stockham and Scott, 2002). As with ALT, AST may not be useful in detecting chronic liver disease (Lassen, 2004).

Alkaline phosphatase (ALP) activity is found in the cell membranes of many tissues including liver, bone, intestine, kidney, and placenta. Serum ALP is primarily of hepatic origin in the dog, cat, and horse, though bone isoenzyme can also be detected. Also dogs can have measurable levels of corticosteroid induced ALP in serum when the animal is subjected to increased levels of endogenous corticosteroids or with administration of glucocorticoids (Stockham and Scott, 2002). Hepatic isoenzymes have a longer half-life (days) than intestinal, renal, or placental (minutes) isoenzymes. Cholestasis induces hepatic ALP. An increase in serum ALP can precede hyperbilirubinemia. Corticosteroids, phenobarbital, dieldrin, and other compounds may induce hepatic ALP. Increased osteoblastic activity in hyperparathyroidism, bone healing, or osteosarcoma may elevate ALP. Horses and ruminants have wide reference intervals for ALP; therefore, this enzyme has decreased sensitivity for the detection of cholestatic disease in these animals (Lassen, 2004; Stockham and Scott, 2002).

Gamma glutamyltransferase (GGT) is found in many cells, but specifically the renal tubular epithelium, canalicular surfaces of hepatocytes, pancreas, and bile duct epithelium. The mammary gland is another source of GGT in cattle, sheep, and dogs, which can result in high serum levels in neonates of these species after nursing (Lassen, 2004). In renal disease, GGT is excreted in the urine (see nephrotoxicity). Serum GGT is generally of hepatic origin and is elevated by cholestasis. GGT has narrower reference intervals than ALP in horses and ruminants, which makes it more useful for detecting cholestatic disease in these species (Lassen, 2004; Stockham and Scott, 2002). Increased serum GGT activity proved to be a sensitive and long-lived indicator of liver insult in cattle exposed to moldy hay (Casteel *et al.*, 1995). Like alkaline phosphatase, GGT appears in serum as a result of increased synthesis, rather than as a result of leakage from cells (Pearson, 1990). In dogs, the increase of GGT tends to parallel that of ALP.

A high activity of sorbitol dehydrogenase (SDH) is found in hepatocellular cytoplasm of dogs, cats, horses, and ruminants (Lassen, 2004). The plasma half-life of this enzyme is very short, and serum activities may return to normal within 5 days of hepatocellular insult. Though this enzyme is more specific for hepatocellular damage than other enzymes in the horse and ruminant, the relatively low *in vitro* stability makes it less commonly used in the dog and cat compared to ALT.

Lactate dehydrogenase (LDH) is a tetrameric enzyme with five isoenzymes that catalyze the reversible conversion of L-lactate to pyruvate in all tissues. All LDH isoenzymes are found in varying concentrations in all tissues. LDH<sub>1</sub> is the principal isoenzyme in cardiac muscle and kidney of most species. It is also found in the liver of cattle and sheep. Unlike the other isoenzymes, it is heat stable at 65°C for 30 min. LDH<sub>5</sub> is the principal isoenzyme in skeletal muscle and erythrocytes. Serum LDH activity is tissue nonspecific; however, necroses of muscle, liver, and hemolysis are the major causes sources of elevations. Isoenzyme analysis would improve the specificity of LDH analysis for hepatocellular damage, but this is not commonly performed in most veterinary laboratories (Lassen, 2004; Stockham and Scott, 2002).

Bilirubin is derived from destruction of damaged or senescent erythrocytes by macrophages of the spleen, liver, and bone marrow. It is noteworthy that bilirubin at physiological levels is an antioxidant (Stocker *et al.*, 1987). Bilirubin is transported in plasma bound to proteins (albumin, globulin). Hepatic uptake and glucuronide conjugation render it water soluble. Conjugated bilirubin is secreted into bile canaliculi and transported to the intestine where the majority is transformed into urobilinogen by intestinal flora and excreted. Direct diazo assay for bilirubin detects conjugated bilirubin. Total bilirubin is measured after addition of alcohol, which allows additional color development. Unconjugated bilirubin is determined by the difference in direct and total bilirubin. Cholestasis results in conjugated hyperbilirubinemia. Bilirubinuria may occur as a result of "regurgitation" of conjugated bilirubin. Increased ALP or GGT can precede hyperbilirubinemia in most species. Hemolysis may result in unconjugated hyperbilirubinemia and elevations of LDH<sub>5</sub>.

Sulfobromophthalein (BSP) injected intravenously is removed rapidly from the blood, conjugated by hepatocytes, and excreted in bile. The rate of hepatic blood flow, functional hepatic mass, and patency of the biliary system affect the hepatic clearance of this compound. Altered blood flow secondary to cardiotoxicity discussed later may increase BSP retention. The use of this test is limited as BSP is no longer commercially available, and similar information can be obtained by assessment of bile acids and total bilirubin (Stockham and Scott, 2002).

Bile acids are secreted from the liver into the bile and are subsequently reabsorbed in the intestine. The portal

blood flow delivers the bile acids to the liver where, in healthy animals, they are efficiently cleared by the hepatocytes. Increased serum bile acids in fasting animals are a result of decreased biliary excretion or decreased clearance by hepatocytes. Increased serum bile acids are highly sensitive for hepatobiliary dysfunction; however, there are many diseases that may cause hepatobiliary dysfunction (Stockham and Scott, 2002). Bile acids may be useful for detecting hepatic dysfunction in instances where enzyme levels or clinical signs are equivocal (Lassen, 2004). Acute toxic hepatic necrosis increases serum bile acids (cholic and chenodeoxycholic) in the dog, horse, sheep, and cow (Bain, 2003). Some studies have recommended tests for urine bile acids as a possible alternative to serum bile acids to detect hepatic dysfunction in the dog and cat (Balkman *et al.*, 2003; Trainor *et al.*, 2003).

Ammonia is generated by microbial activity and digestion of protein within the intestinal tract. It is absorbed from the intestine and transported to the liver by the portal venous system where it is converted to urea by the healthy liver. Elevations of plasma ammonia during fasting or following ammonia challenge suggest reduction in clearance from the blood, frequently resulting from a decrease in functional hepatic mass. Urea toxicosis in cattle and consumption of ammoniated forages by cattle can result in high plasma ammonia levels because of increased production and consumption of ammonia, respectively (Stockham and Scott, 2002).

Severe hepatic insufficiency may result in hypoproteinemia (Kaneko, 1997a) with reduction of plasma oncotic pressure that promotes tissue edema and effusions that mimic the effects of cardiotoxins (Table 27-3).

The clinical signs of acute submassive or massive hepatic necrosis may include anorexia, vomiting, icterus, hepatic encephalopathy, disseminated intravascular coagulopathy, edema, and effusions. Surprisingly, there may be few or no clinical signs in some cases. The activity of ALT and SDH with short half-lives may be elevated but often fall rapidly. Inducible enzymes such as ALP and GGT may increase gradually. All enzymes may return to normal in the presence of chronic severe liver disease. Hyperbilirubinemia may follow if lesions progress to chronicity and fibrosis.

Chronic hepatotoxicity has sequelae for most organ systems, but especially the nervous (hepatic encephalopathy), integumentary (secondary photosensitization in herbivores), and cardiovascular systems. Cardiotoxins and pneumotoxins may produce enzyme elevations suggestive of hepatic or renal disease as a result of ischemia/hypoxia.

Ingestion of toxic plants (Table 27-1) tends to be more common in herbivores than carnivores; however, nonherbivorous species are often susceptible if they are willing to ingest them. In addition to hepatotoxins, the blue-green algae (actually classified as cyanobacteria), which contaminate water (Carmichael, 1994), possess neurotoxins that may induce sudden death that precedes alterations of clinical

biochemistry and morphological changes. However, one report documents marked elevations of ALT and AST in a dog 12h post ingestion of a blue-green algae (DeVries *et al.*, 1993).

Therapeutic drugs can also occasionally have hepatotoxic effects in animals. Nonsteroidal anti-inflammatory drugs, barbiturates, antineoplastic agents, and antiparasitic compounds have all been found to have hepatotoxic effects (Kristal *et al.*, 2004; Macphail *et al.*, 1998; Roder, 2003). Carprofen, a nonsteroidal anti-inflammatory drug, has been reported to cause acute hepatocellular necrosis and cholestasis in some dogs. This adverse reaction is associated with marked increases in serum ALT, AST, ALP, and total bilirubin (Macphail *et al.*, 1998). The antineoplastic drug 1-(2-chloroethyl)-3-cyclohexyl-1-nitrosourea (CCNU) is reported to occasionally cause hepatotoxicity in dogs with increases in ALT, AST, ALP, GGT, and bilirubin noted in the affected dogs (Kristal *et al.*, 2004).

Hepatotoxic plants of the order Compositae include *Asaemia axillaris*, *Athanasia trifurcata*, *Helichrysum blandowskianum*, *Lasiospermum bipinatum*, and *Xanthium* spp. The toxin in these plants has been identified as carboxyatractyloside. Profound hypoglycemia is reported as a finding in carboxyatractyloside poisoned animals (Barr and Reager, 2001).

Cycadales contain methylazoxymethanol, which is converted by hepatic microsomal activity to potent alkylating agents. A report of dogs ingesting cycads indicates bilirubin, ALT, and ALP are most commonly elevated values on the chemistry panel (Albretsen *et al.*, 1998).

Hepatotoxic plants of the order Myoporaceae include *Myosporum deserti*, *M. acuminatum*, *M. insulare*, *M. tetrandum*, and *M. laetum*. These plants contain furanosesquiterpenoid oils, the best characterized of which is ngaione.

Chronic intoxication of swine with fumonisins, mycotoxins produced by *Fusarium moniliforme*, is associated with elevations of serum total bilirubin, ALP, AST, GGT, and cholesterol (Casteel *et al.*, 1994). In addition, fumonisins inhibit N-acetyl transferase resulting in loss of complex sphingolipids and accumulation of sphinganine and sphingosine in tissues and serum (Riley *et al.*, 1993).

Iron toxicity from nutritional supplements may produce hepatic necrosis in foals (Acland *et al.*, 1984) and pigs (Kelly, 1993). Excessive dietary copper may be associated with elevation of GGT in goats (Solaimen *et al.*, 2001) and llamas (Weaver *et al.*, 1999).

Hepatotoxic pyrrolizidine alkaloids are found in the plant species *Amsinckia intermedia*, *Crotolaria* spp., *Cynoglossum officinale*, *Echium plantagineum*, *Heliotropium europeum*, *Senecio jacobea*, *S. vulgaris*, and *S. longilobus*. Acute intoxications with these plants result in large increases in AST, ALP, GGT, and SDH (Stegelmeier, 2003). Chronic exposure to small amounts of the plant is more difficult to detect, though serum GGT levels have been

suggested as a screening test for subclinical hepatic damage in horses exposed to *Crotolaria* spp. (Curran et al., 1996).

Hepatotoxic solanaceae include *Cestrum parqui*, *C. laevigatum*, and *C. aurantiacum*. The toxin in these plants has been identified as atractyloside.

Sawfly larvae (*Lophyrotoma interruptus* and *Arge pul-lata*) infesting eucalyptus and birch trees in Australia and Denmark, respectively, have been reported to induce hepatic necrosis in cattle, sheep, and goats browsing foliage.

*Terminalia oblongata*, the yellowwood tree of Australia, contains hepatotoxic tannins and pucicalagin, which induces acute hepatic necrosis (Kelly, 1993).

### III. NEPHROTOXICITY

Acute nephrotoxicity (Table 27-2) may initially induce polyuria that is followed by oliguria or anuria.

Nephrotoxins affecting approximately 66% of the nephrons will result in inability to concentrate urine to a specific gravity greater than 1.030 in the dog, 1.035 in the cat, and 1.025 in the horse and cow. Chronic toxicity may result in isosthenuria (constant urine osmolality in the range of glomerular filtrate, 1.008 to 1.012).

The majority of urea is synthesized in the liver from ammonia formed by protein catabolism or intestinal absorption. Urea enters the vascular system and is distributed throughout the total body water compartment by passive diffusion. The urea concentration of blood and glomerular filtrate is approximately equal. Urea passively diffuses from the tubular lumen back to the blood. Urine flow rate is inversely related to urea reabsorption. Gastrointestinal secretion is inconsequential in monogastrics; however, in ruminants up to 90% of urea in glomerular filtrate may be reabsorbed and enter the rumen via saliva for utilization in amino acid synthesis.

**TABLE 27-2** Nephrotoxins

Nephrotoxin	Disease Onset	Geography	Species Affected
<i>Amaranthus retroflexus</i> (pigweed)	Subacute	US	B, P
Antibiotics	Acute to chronic	Worldwide	All
Cantharidin (blister beetle)	Acute	US	B, Cp, E, O
Chlorinated hydrocarbons	Acute	Worldwide	All
Ethylene glycol	Acute	Worldwide	B, Cn, F, P
Fumonisin ( <i>Fusarium moniliforme</i> )	Acute to chronic	Worldwide	E, O, P
Gossypol (cottonseed)	Chronic	Worldwide	B
Hemoglobin	Acute		All
Hypercalcemia	Chronic	Worldwide	All
<i>Isotropis</i> spp.	Acute	AUS	B, O
<i>Lantana camara</i>	Chronic	US, MEX, AUS, AFR	B, E, O
Menadione	Acute	Worldwide	E
Metals (Cd, Hg, Pb, Tl)	Acute to chronic	Worldwide	All
Myoglobin	Acute		All
Ochratoxin ( <i>Penicillium ochraceus</i> )	Chronic	Worldwide	P
Oxalates	Acute to chronic	Worldwide	B, Cp, O, P
Paraquat/diquat	Acute	Worldwide	All
Petroleum	Acute	Worldwide	All
Phenothiazine	Acute	Worldwide	E
Phenylbutazone	Acute	Worldwide	E
Phosphorus	Acute	Worldwide	All
Pyrrrolizidine alkaloids	Chronic	Worldwide	B, Cp, E, O, P
Tannins ( <i>Quercus</i> spp., oaks)	Acute	Worldwide	B, Cp, E, O
<i>Terminalia oblongata</i> (yellowwood)	Acute to chronic	AUS	B, O

Abbreviations: B, bovine; Cn, canine; Cp, caprine; E, equine; F, feline; O, ovine; P, porcine.

Azotemia, elevation in blood urea nitrogen (BUN) or creatinine, may occur as prerenal, renal, or postrenal. Prerenal azotemia may result from dehydration or decreased renal perfusion (e.g., cardiotoxins). Renal azotemia occurs only after approximately 75% of the nephrons have lost function.

Renal disease also results in elevation of serum creatinine. The majority of serum creatinine originates from the endogenous conversion of phosphocreatine in muscle, which occurs at a relatively constant rate. Creatinine is not reutilized. The creatine pool is modified by conditioning and muscle disease. Creatinine also is distributed throughout the compartment of total body water. It diffuses more slowly than urea, however, and is not reabsorbed within the tubules after leaving as glomerular filtrate. Creatinine concentration is not affected significantly by diet, protein catabolism, or urinary flow. Reduced renal perfusion affects BUN and creatinine similarly (Finco, 1997). Elevations of BUN and creatinine are not proportional in renal disease of ruminants because of reutilization of urea by the rumen. Ingestion of the plant *Nolletia gariiepina* has been reported to cause renal failure in ruminants with a measurable increase in urinary GGT along with azotemia (Meintjes *et al.*, 2005).

Hyperkalemia may occur in renal failure with oliguria or anuria and acidosis. Hypercalcemia is common in equines as a result of decreased renal clearance of calcium. Hypocalcemia is more common in dogs, cats, and cattle with chronic renal disease. Cattle also tend to have hypokalemia, hyponatremia, and hypochloridemia with renal disease. Mild to moderate increases of amylase and lipase may also be seen in dogs with renal disease as these enzymes are inactivated in the kidney (Stockham and Scott, 2002).

Proteinuria in the absence of occult blood and cellular sediment suggests renal disease. Glomerular lesions typically result in high protein levels in which albumin is the major constituent. Acute tubular damage observed with many nephrotoxins generally results in lower protein levels containing higher levels of smaller globulins and some albumin (Stockham and Scott, 2002). Analysis of enzymes in the urine can potentially determine the primary site of renal damage because of the characteristic localization of enzymes within the nephron. Increases in the brush border enzymes, GGT and ALP, in the urine have been associated with renal proximal tubular damage in dogs, whereas increases in N-acetyl-beta-D-glucosaminidase have been observed in the early stage of renal papillary necrosis. However, evaluation of several enzymes at multiple time points is needed to compensate for normal enzyme variation and to identify potential anatomic site selectivity of the toxin (Clemon, 1998).

Hypoproteinemia secondary to chronic urinary loss (Kaneko, 1997a) promotes tissue edema and effusions that may mimic cardiotoxicity and hepatotoxicity, as discussed previously.

Bilirubin is considered to be mildly nephrotoxic. Bilirubinuria may occur because of "regurgitation" of conjugated bilirubin resulting from cholestatic hepatotoxins. Myoglobin is also nephrotoxic. Myoglobinuria may occur with toxic necrosis of skeletal and cardiac muscle. Hemoglobin appears to be nephrotoxic in the presence of concurrent dehydration or hypovolemia. Hemoglobinuria may occur with hemolytic toxins.

Dehydration exacerbates the nephrotoxicity of many agents, especially antibiotics in all species and nonsteroidal anti-inflammatory drugs (phenylbutazone) in the horse. Nephrotoxic antibiotics include the aminoglycosides (amikacin, gentamicin, kanamycin, neomycin, streptomycin, and tobramycin), amphotericin B, cephalosporins, polymyxins, sulfonamides, and tetracyclines (Maxie, 1993). Elevation of GGT in urine is a sensitive indicator of aminoglycoside toxicity (Gossett *et al.*, 1987).

Hypercalcemia and hyperphosphatemia may result in nephrocalcinosis following iatrogenic hypervitaminosis D or ingestion of cholecalciferol rodenticide (Fooshee and Forrester, 1990) by any species. Ingestion of the toxic plants containing vitamin D-like analogues including *Cestrum diurnum*, *Dactylis glomerata*, some *Solanum* spp., and *Trisetum flavescens* by herbivores also may produce hypercalcemia with calcification of soft tissues including the kidney.

Nephrotoxic metals include arsenic, bismuth, cadmium, lead, mercury, and thallium (Maxie, 1993).

Plants containing toxic concentrations of soluble oxalates include the species *Amaranthus retroflexus* (pigweed), *Halogeton glomeratus*, *Oxalis* spp., *Rheum rhaponticum* (rhubarb), and *Sarcobatus vermiculatus* (greasewood). Intoxication with ethylene glycol from antifreeze is one of the more common accidental or malicious poisonings encountered in dogs and cats. Birefringent hippurate and oxalate crystals may be observed in urine sediments (Kramer *et al.*, 1984). An increased anion gap and decreased blood bicarbonate can be observed in animals with ethylene glycol intoxication (Dalefield, 2003). Blood calcium is lowered in animals intoxicated with oxalate containing plants that also have low calcium content. Blood calcium is also decreased in animals with ethylene glycol toxicosis (Stockham and Scott, 2002).

Nephrotoxic pyrrolizidine alkaloids include the plant species listed under hepatotoxicity.

Trees of the genus *Quercus* (oaks) and *Terminalia oblongata* (yellow-wood tree) contain tannins that induce acute tubular necrosis when leaves, buds, or acorns are ingested. *Amaranthus retroflexus* (pigweed), via an unidentified toxic principle, also induces similar renal disease in cattle (Casteel *et al.*, 1994) and pigs (Osweiler *et al.*, 1969) in the absence of oxalate nephrosis. At postmortem examination, there were consistent elevations of urea and creatinine concentrations in ocular fluid and serum.

#### IV. TOXINS AFFECTING SKELETAL AND CARDIAC MUSCLE

The clinical signs of weakness, dysmetria, and incoordination suggest not only the possibility of neurological disease but also skeletal muscular or cardiovascular disease. Acute toxicity of skeletal or cardiac muscle (Table 27-3) can be detected by elevations in serum creatine kinase (CK) (Cardinet, 1997). This dimeric enzyme catalyzes the reversible reaction, phosphocreatine + ADP  $\rightleftharpoons$  creatine + ATP, and has three isoenzyme types: CK<sub>1</sub>, CK<sub>2</sub>, and CK<sub>3</sub>. CK<sub>1</sub> is found in brain, peripheral nerves, cerebrospinal fluid, and viscera, but it is not found in serum during neurological disease. CK<sub>2</sub> is found in cardiac muscle and minute amounts in skeletal muscle. CK<sub>3</sub> is found in cardiac and skeletal muscle. CK plasma half-life is short and is considered to be specific for muscle when hemolysis, elevated bilirubin, muscle fluid contamination during venipuncture, and dilution of CK inhibitors during sample processing can be excluded. When injury is not progressive,

CK elevations maximize within 6 to 12h and return to normal within 24 to 48h. Continuing necrosis can result in persistent elevation.

Cardiac troponin T and I have been demonstrated to be sensitive and specific biomarkers of cardiac injury in dogs and laboratory animals (O'Brien, 2006; O'Brien *et al.*, 2006). Cardiac troponins have been demonstrated to correlate with myocardial injury in the dog, cat, and horse and may provide a more specific antemortem method of detecting myocardial compromise secondary to toxicosis in these species (Herndon, 2002; Oyama and Sisson, 2004; Schwarzald *et al.*, 2003).

As discussed previously, LDH<sub>5</sub> is the principal isoenzyme in skeletal muscle and erythrocytes. LDH activity is tissue nonspecific, but necroses of muscle, liver, and hemolysis are the major sources for elevations of serum activity. Necrosis of skeletal muscle may result in release of myoglobin and potassium resulting in myoglobinemia and hyperkalemia. Myoglobinuria, detectable by urinalysis, may induce secondary nephrotoxicity.

**TABLE 27-3** Toxins Affecting Cardiac and Skeletal Muscle

Toxins	Disease Onset	Geography	Species Affected
Cardiac glycosides	Acute	Worldwide	All
<i>Cassia occidentalis</i> (Coffee senna)	Acute	Worldwide	B, Cp, O, P
Cantharidin (blister beetle)	Acute	US	E
Catecholamines	Acute		All
<i>Eupatorium rugosum</i> (white snakeroot)	Chronic	US	B, E
Fluoroacetate	Acute	AUS, S AFR	All
Gossypol (cottonseed)	Chronic	Worldwide	P, B, Cn
Hypercalcemia	Chronic	Worldwide	All
Iron	Acute	Worldwide	P
<i>Karwinskia humboldtiana</i> (coyotillo)	Acute to chronic	MEX, TX	Cp, O
<i>Lantana camara</i>	Chronic	AFR, AUS, MEX, US	B, E, O
Metals (As, Bi, Cd, Hg, Pb, Tl)	Acute to chronic	Worldwide	All
Methylxanthines (caffeine, theophyl-line, theobromine)	Acute	Worldwide	Cn
Monensin	Acute to chronic	Worldwide	B, E, Cp, O, P
Nephrotoxins (uremia, see text)	Chronic		All
<i>Persea americana</i> (avocado)	Acute	Worldwide	B, Cp, E, O
<i>Phalaris</i>	Acute	Worldwide	B, E, O
Phosphorus	Acute	Worldwide	All
Potassium	Acute to chronic	Worldwide	All
<i>Pteridium aquilinum</i> (Bracken fern)	Acute to chronic	Worldwide	B, Cp, E, O, P
Quinolizidine alkaloids ( <i>Lupinus</i> spp.)	Chronic	Worldwide	B, O
<i>Vicia villosa</i> (hairy vetch)	Chronic	Worldwide	B, E

Abbreviations: B, bovine; Cn, canine; Cp, caprine; E, equine; F, feline; O, ovine; P, porcine.



Cardiac glycosides disrupt cardiac ion channels producing sudden dysrhythmias and often death (Cheville, 1988). Plants containing cardiac glycosides include *Bryophyllum tubiflorum*, *Digitalis* spp. (foxglove), *Homeria* spp. (cape tulip), *Nerium oleander* (oleander), *Thevetia peruviana* (yellow oleander), and *Tylecodon* spp. (Robinson and Maxie, 1993). Most intoxications occur in herbivores, although the cat is reported to have increased CK levels after ingestion of Easter lily plant. (Rumbeihha *et al.*, 2005). Amphibians producing cardiac glycosides include *Bufo alvarius*, *B. marinus*, and *Dendrobates* spp. (poison dart frog). Most intoxications occur in cats and dogs that become curious about these animals. Neurological signs may be the presenting complaint in intoxication from *B. marinus* (Roberts *et al.*, 2000).

Fluoroacetate containing plants include *Acacia georginae*, *Dichapetalum cymosum*, *Gastrolobium* spp., and *Oxylobium* spp. Fluoroacetate (compound 1080) also has been utilized as a rodenticide. It is not directly toxic, but combines with oxaloacetic acid to form fluorocitrate that inhibits *cis*-aconitase and succinic dehydrogenase of the citric acid cycle thus reducing ATP generation. Animals intoxicated with fluoroacetate are reported to have hyperglycemia and hypocalcemia, along with increased serum citrate levels (Parton, 2003).

Glycosides and fluoroacetate may produce sudden death that precedes alterations of clinical chemistry or morphological changes. Hypercalcemia may induce cardiac calcinosis and nephrotoxicity as discussed earlier.

Hyperkalemia from myotoxicity (especially gossypol) (Albrecht *et al.*, 1969), nephrotoxicity, or adrenal necrosis (hypoadosteronism) may exert a dysrhythmogenic (Q-T prolongation and high amplitude T waves) effect on the heart. Potassium chloride injection also has been used for lethal poisoning by individuals attempting to circumvent detection by insurance adjusters (Casteel *et al.*, 1989).

Cardiotoxic metals include lithium, cadmium, nickel, barium, lanthanum, manganese, vanadium, lead, and cobalt (Van Vleet and Ferrans, 1986). Iron-dextran toxicity in pigs may produce necrosis of skeletal muscle and hyperkalemia, sparing the myocardium (Kelly, 1993).

Quinolizidine alkaloids in *Lupinus* spp., *Laburnum anagyroides*, and *Thermopsis montana* have been shown to produce skeletal muscle necrosis in cattle with elevations of serum CK and AST in the absence of myoglobinuria (Keeler and Baker, 1990). Quinolizidine alkaloids are also teratogenic.

Elevations in serum creatine kinase have been reported in association with viper envenomation in dogs (Aroch *et al.*, 2004).

The numerous chemotherapeutic agents that have been associated with cardiotoxicity have been reviewed elsewhere (Van Vleet and Ferrans, 1986).

Cardiotoxins may produce serum enzyme elevations suggestive of hepatic or renal disease secondary to ischemia/hypoxia.

## V. TOXINS AFFECTING THE LUNG AND RESPIRATORY TRACT

Disease affecting the respiratory tract is often clinically apparent on the basis of dyspnea. Dyspnea in veterinary medicine is more often the result of pneumonia rather than intoxication. However, when body temperature is normal, the possibility of pulmonary edema induced by toxins affecting the lung and respiratory tract (Table 27-4) or cardiovascular system should be considered. Because, with the exception of the horse, domestic mammals remove excess heat by panting, reduced respiratory capacity secondary to intoxication also may result in elevated body temperature.

**TABLE 27-4** Toxins Affecting the Lung and Respiratory Tract

Toxins	Disease Onset	Geography	Species Affected
<i>Eupatorium adenophorum</i>	Chronic	AUS	E
Fumonisin ( <i>Fusarium moniliforme</i> )	Acute to chronic	Worldwide	P
4-ipomeanol ( <i>Fusarium solanii</i> )	Acute	Worldwide	B
Kerosene/Petroleum	Acute	Worldwide	All
3-methylindole	Acute	Worldwide	B
Myoporaceae	Acute	AUS, NZ	B, O
Organobromines/organochlorines	Chronic	Worldwide	All
O <sub>2</sub>	Acute to chronic	Worldwide	All
Paraquat	Acute to chronic	Worldwide	All
<i>Perilla frutescens</i>	Acute	US	B, E, O
Pyrrolizidine alkaloids	Chronic	Worldwide	B, Cp, E, O, P

Abbreviations: B, bovine; Cn, canine; Cp, caprine; E, equine; F, feline; O, ovine; P, porcine.

Angiotensin converting enzyme (ACE) is concentrated on the luminal surface of pulmonary endothelial cells. Most circulating ACE originates from the lung; however, many tissues including tubular epithelial and endocrine cells contain this enzyme (Erdos, 1987). Serum ACE activity is altered in chronic and acute pulmonary disease (Hollinger, 1983). Unfortunately, assay for this enzyme is not readily available in most veterinary clinical biochemistry laboratories, and ACE remains primarily a research tool.

Acute pulmonary edema is the typical lesion resulting from toxins affecting the epithelial-endothelial interface of the alveolus. Because  $\text{CO}_2$  is approximately 20 times more diffusible than  $\text{O}_2$ , early pulmonary edema typically results in decreased  $\text{P}_a\text{O}_2$ , whereas  $\text{P}_a\text{CO}_2$  remains normal or may decrease with hyperventilation producing respiratory alkalosis. Severe pulmonary edema may result in elevated  $\text{P}_a\text{CO}_2$  (hypercapnia and respiratory acidosis) (Carlson, 1997).

Chronic insult to the alveolar epithelial-endothelial interface may progress to pulmonary fibrosis (e.g., paraquat intoxication) and be associated with low  $\text{PaO}_2$  and elevated  $\text{PaCO}_2$ . Pulmonary fibrosis impinging on the pulmonary vasculature may induce pulmonary hypertension and *cor pulmonale* associated with enzymological alterations suggestive of hepatotoxicity resulting from passive hepatic congestion.

Cattle are susceptible to several toxins that induce acute pulmonary edema including ingestion of perilla ketone in *Perilla frutescens*, 4-ipomeanol in sweet potatoes (*Ipomoea batatas*) infected with *Fusarium solani* (Doster et al., 1978), and the generation of 3-methylindole by ruminal *Lactobacillus skatoli* from tryptophan in lush pasture grasses (Breeze and Carlson, 1982).

Some of the pyrrolizidine alkaloids, notably monocrotaline from *Crotalaria spectabilis*, may induce chronic pulmonary arteriopathy resulting in pulmonary hypertension that progresses to right heart failure and elevation of enzymes suggestive of cardiotoxicity or hepatotoxicity. Similar pulmonary arteriopathy occurs in pigs with chronic fumonisin intoxication (Casteel et al., 1994).

Organochlorines and organobromines include chlorinated naphthalenes, polychlorinated biphenyls (PCBs), polybrominated biphenyls (PBBs), and dibenzofurans. These industrial toxins are cumulative and result in hypovitaminosis A that is associated with squamous metaplasia of columnar epithelium of the respiratory tract and hyperkeratosis as discussed under integumentary toxins.

The numerous chemotherapeutic agents that have been associated with pulmonary toxicity or hypersensitivity have been reviewed elsewhere (Myers, 1993).

## VI. TOXINS AFFECTING THE GASTROINTESTINAL TRACT

Disease affecting the gastrointestinal tract is often clinically apparent on the basis of vomiting or diarrhea. In

veterinary medicine, these are more often the result of infectious disease rather than intoxication. However, the possibility of gastrointestinal toxins (Table 27-5) should be considered, especially in acute outbreaks affecting several animals sharing the same environment.

Vomiting and diarrhea may produce dehydration that results in mild to moderate elevations of BUN, plasma protein, packed cell volume (PCV), and urine specific gravity.

Metabolic alkalosis (increased pH, normal or increased  $\text{PCO}_2$ , increased  $\text{HCO}_3^-$  and  $\text{HCO}_3^-/\text{H}_2\text{CO}_3$ ) and hypochloridemia may result from chloride loss associated with vomiting (Tennant and Hornbuckle, 1997).

Metabolic acidosis (decreased pH, normal or decreased  $\text{PCO}_2$ , decreased  $\text{HCO}_3^-$  and  $\text{HCO}_3^-/\text{H}_2\text{CO}_3$ ) may result from secretory loss of bicarbonate in diarrhea.

In the absence of evidence of malnutrition or hepatic or renal disease, chronic gastrointestinal malabsorption or protein loss should be considered as a potential cause of hypoproteinemia (Kaneko, 1997a).

Ingestion of strong acids or alkalis may induce immediate and severe damage to the gastrointestinal mucosa.

The seleniferous plants, which may be associated with acute gastroenteritis in herbivores, are discussed under the integumentary system.

Trichothecenes, especially T-2, produced by *Fusarium* spp. and the macrocyclic trichothecene produced by *Stachybotrys alternans* are highly irritant and produce acute ulceration and hemorrhage of the gastrointestinal tract. These mycotoxins also produce acute ulcerative and necrotizing lesions of the skin and chronic pancytopenia with hemorrhage.

The estrogenic mycotoxin, zearalenone, may induce rectal prolapse in pigs in addition to affecting reproductive performance.

## VII. TOXINS AFFECTING ERYTHROCYTES AND THE HEMATOPOIETIC SYSTEM

Toxins inducing hemolysis (Table 27-6) may produce elevations of serum LDH, anemia, icterus, hemoglobinemia, hemoglobinuria with secondary nephrotoxicity, and unconjugated bilirubinemia.

Chronic, drug-induced, immune-mediated hemolysis has been associated with para-aminosalicylic acid, chlorpromazine, dipyrine, insecticides, penicillin, phenacetin, quinine, quinidine, and sulfonamides (Valli, 1993).

Mellitin is a hemolyzing component of Hymenopterous toxins and comprises approximately 50% of bee venom (Cheville, 1988). One report also attributes a case of immune-mediated hemolytic anemia in a young dog to exposure to bee venom (Noble and Armstrong, 1999).

Chronic nephrotoxicosis leading to uremia may decrease erythrocyte life span because products normally eliminated by the kidney are retained. This mechanism

**TABLE 27-5** Toxins Affecting the Gastrointestinal Tract

Toxins	Disease Onset	Geography	Species Affected
Acids/alkalis	Acute	Worldwide	All
<i>Aleurites fordii</i> (tung oil tree)	Acute	AUS, US	B
Arsenic	Acute	Worldwide	All
<i>Asclepias</i> spp. (milkweed)	Acute	N AM	B, E, Cp, O
Cantharidin (blister beetle)	Acute	US	All
Copper	Acute	Worldwide	All
Fluoroacetate	Acute	AUS, MEX, S AFR	All
<i>Fluorensia cernua</i> (blackbush/tarbush)	Acute	MEX, US	Cp, O
<i>Hymenoxys odorata</i> (bitterweed)	Acute	US	O
<i>Isotropis</i> spp.	Acute	AUS	B, O
Kerosene/petroleum	Acute	Worldwide	All
<i>Nerium oleander</i> (oleander)	Acute	Worldwide	B, Cp, E, O
Pyrrrolizidine alkaloids	Acute	Worldwide	B, Cp, E, O, P
<i>Ricinus communis</i> (castor bean)	Acute	Worldwide	B, E
<i>Robinia pseudoacacia</i> (Black locust)	Acute	N AM	B, E
Solanaceae	Acute	Worldwide	All
Selenium	Acute	Worldwide	B, Cp, E, O, P
Tannins ( <i>Quercus</i> spp., oaks)	Acute	Worldwide	B, Cp, O
Tricothecenes	Acute	Worldwide	All
<i>Urginea maritima</i> (sea onion)	Acute	Worldwide	Cn, F, P
Zearalenone ( <i>Fusarium roseum</i> )	Chronic	Worldwide	P
Zinc	Acute	Worldwide	B, Cn, O

Abbreviations: B, bovine; Cn, canine; Cp, caprine; E, equine; F, feline; O, ovine; P, porcine.

**TABLE 27-6** Toxins Inducing Hemolysis

Toxins	Disease Onset	Geography	Species Affected
<i>Allium</i> spp. (onion)	Acute	Worldwide	B, Cn, E, O
<i>Acer rubrum</i> (red maple)	Acute	US	E
Brassicaceae	Acute	Worldwide	B, O
Copper	Acute	Worldwide	Cn, O
Drug-induced immune mediated anemia	Chronic	Worldwide	All
Mellitin	Acute	Worldwide	All
Methylene blue	Acute	Worldwide	F
Molybdenum	Chronic	Worldwide	B, Cp, O
Naphthalene	Acute	Worldwide	Cn
Nephrotoxins	Chronic		All
Phenothiazine	Acute	Worldwide	E, O
Snake venoms	Acute	Worldwide	All
Zinc	Acute to chronic	Worldwide	B, Cn, O, P

Abbreviations: B, bovine; Cn, canine; Cp, caprine; E, equine; F, feline; O, ovine; P, porcine.

**TABLE 27-7** Toxins Inducing Hemorrhage/Coagulopathy

Toxins	Disease Onset	Geography	Species Affected
Anticoagulant rodenticides	Chronic	Worldwide	All
Dicoumarol (moldy <i>Melilotus alba</i> )	Chronic	Worldwide	B, E, P
Drugs	Chronic	Worldwide	All
Estrogen	Chronic	Worldwide	All
Hepatotoxins	Chronic	Worldwide	All
<i>Pteridium aquilinum</i> (bracken fern)	Chronic	Worldwide	B, Cp, E, O, P
Trichothecenes	Acute	Worldwide	All
Venoms	Acute	Worldwide	All

Abbreviations: B, bovine; Cn, canine; Cp, caprine; E, equine; F, feline; O, ovine; P, porcine.

is usually insufficient to produce acute hemolytic crises, and other factors, including decreased erythropoietin production, likely play a larger role in the anemia seen with chronic renal disease (Stockham and Scott, 2002). The anthelmintic, phenothiazine, may be acutely hemolytic in sheep and horses. It also may induce primary photosensitization as discussed under integumentary toxins. Zinc intoxication in dogs can produce a severe intravascular hemolysis (Dziwenka and Coppock, 2003).

The venom of various snakes including Crotalidae, Elapidae, Hydrophidae, and Viperidae, contains a mixture of toxins of which phospholipase A<sub>2</sub> (PLA<sub>2</sub>) is an important component. PLA<sub>2</sub> is directly lytic for erythrocytes and may induce hemolysis, and for platelets and it may induce hemorrhage and coagulopathy (Cheville, 1988).

Basophilic stippling and inappropriate rubricytosis have been associated with lead intoxication in dogs (Stockham and Scott, 2002).

Additional toxins inducing hemorrhage (Table 27-7) include dicoumarol derived from moldy sweet clover (*Melilotus* spp.) and the synthetic derivatives used as anticoagulant rodenticides such as brodifacoum, bromadiolone, diphacinone, fumarin, pindone, and warfarin. These agents are vitamin K antagonists. Prothrombin (factor II), and factors VII, IX, and X require vitamin K for their production. The half-life of factor VII is approximately 4 to 6 h, whereas, half-lives of factors IX and X are approximately 14 to 18 h, and for prothrombin the half-life is 40 h. Therefore, prolongation of the one-stage prothrombin time (PT) is thought to occur earliest, followed by prolongation of the activated partial thromboplastin test (PTT). Vitamin K antagonists do not affect fibrinogen or platelet numbers initially but may eventually exhaust their supplies. Excessive hemorrhage following slight trauma, epistaxis, melena, and hematuria may occur with these intoxications (Dodds, 1997). Testing for products of vitamin K antagonism or absence (PIVKAs) may help to detect this intoxication. This test is a modified PT assay, which detects

decreased activity of factors II, VII, and X. Though anticoagulant rodenticide intoxication decreases the activity of these factors, other diseases may also prolong this test; thus this test is not specific for rodenticide intoxication (Stockham and Scott, 2002).

Chronic hepatotoxicity in which hepatic mass is reduced by 70% or more may result in sufficiently inadequate synthesis of both clotting factors and their inhibitors to prolong PT and PTT. Chronic cholestasis with interruption of the enterohepatic circulation of bile salts also may result in malabsorption of fat-soluble vitamin K producing a syndrome similar to anticoagulant intoxication.

Toxins inducing pancytopenia include estrogen, *Pteridium aquilinum* (bracken fern), and the trichothecene mycotoxins. Insufficient numbers of platelets promote hemorrhage and consumption coagulopathy (Valli, 1993).

## VIII. TOXINS AFFECTING HEMOGLOBIN AND OXIDATIVE METABOLISM

Lead poisoning interrupts heme synthesis at the level of formation of protoporphyrin and causes accumulation of delta-aminolevulinic acid. Increased urinary excretion of this metabolite indicates lead intoxication.

Toxins inducing oxidation of ferrous iron in hemoglobin to ferric iron in methemoglobin (Harvey, 1989) include the herbicide sodium chlorate, the stalk parts of nitrate-accumulating plants such as corn and wheat, hay grown on heavily fertilized soils under drought conditions, fertilizer, or water contaminated by fertilizers or organic material. Wilted red maple leaves have also been reported to cause methemoglobinemia, in addition to hemolysis, in horses (Barr and Reagor, 2001). Ruminants are most susceptible to the nitrate-accumulating plants *Amaranthus* spp. (pigweed), *Avena sativa* (oats), *Chenopodium* spp. (lambsquarter), *Sorghum* spp., and *Triticum aestivum* (wheat) because of the ability of rumen microbes to reduce nitrate to the proximate

toxicant, nitrite. Monogastrics and ruminants are equally susceptible to nitrite-based fertilizers (Osweiler *et al.*, 1985). Nitrate/nitrite intoxication produces a brown discoloration of the blood caused by methemoglobinemia.

Carbon monoxide (CO) competes with oxygen binding to the heme moiety in hemoglobin and myoglobin. CO affinity for the hemoglobin binding site is approximately 200 times that of O<sub>2</sub>, resulting in tightly bound carboxyhemoglobin and decreased blood oxygen transport. Because continuous delivery of O<sub>2</sub> is critical to the heart and brain, carbon monoxide may induce signs of cardiotoxicity or neurotoxicity. Anoxia of the liver, kidney, and muscle may elevate serum enzymes referable to these systems.

Acetaminophen, propylene glycol, and zinc intoxication in small animals and copper intoxication in ruminants have been associated with Heinz body anemia (Thrall, 2004).

CO, cyanide, and H<sub>2</sub>S are potent inhibitors of cytochrome oxidase and may produce sudden death because of a failure of oxidative metabolism, which precedes alterations in clinical biochemistry or morphology.

Numerous plants contain cyanogenic glycosides that may affect herbivores, especially ruminants. The most common cultivated species include *Cynodon* spp., *Sorghum* spp., and *Prunus* spp. (Jubb and Huxtable, 1993).

## IX. TOXINS AFFECTING THE ENDOCRINE SYSTEM

Carbadox/Mecadox is an antibacterial agent that, with prolonged exposure at levels greater than 25 ppm, induces degeneration of the zona glomerulosa of the adrenal gland associated with reduced plasma aldosterone, hyperkalemia, and hyponatremia (Capen, 1993).

The drug ortho,-para'2,2-bis(2-chlorophenyl-4-chlorophenyl)-1,1-dichloroethane (o,p'DDD) is toxic to the zona fasciculata and reticularis of the adrenal gland and is used as therapy for canine hyperadrenocorticism. This toxin reduces circulating cortisol levels.

Goitrogenic substances induce iodine deficiency or inhibit organification of iodine (Kaneko, 1997b). Thiocyanates, produced by ruminal digestion of cyanogenic glycosides from the toxic plants *Cynodon* spp. and *Trifolium repens*, and goitrin, derived from *Brassica* spp., are goitrogenic. Mimosine (discussed later under integumentary toxins) is metabolized in the rumen to a compound that inhibits organic binding of iodine by the thyroid gland. Thioamides (sulfonamides) inhibit thyroperoxidase. All of these substances may reduce serum T<sub>4</sub> and T<sub>3</sub>. Iodine toxicity producing hyperplastic goiter in horses has been associated with feeding kelp.

Hepatic glucuronidation is the rate-limiting step for biliary excretion of T<sub>4</sub>. Sulfation by phenol sulfotransferase is the rate-limiting step for excretion of T<sub>3</sub>. Induction of hepatic microsomal enzymes may increase T<sub>4</sub>/T<sub>3</sub> elimination

and disrupt the hypothalamic-pituitary-thyroid axis resulting in excessive thyroid stimulating hormone (TSH). Xenobiotics that induce hepatic microsomal enzymes include benzodiazepines, calcium channel blockers, chlorinated hydrocarbons, phenobarbital, PCBs, PBBs, retinoids, and steroids (Capen, 1993).

Toxins inducing hypercalcemia are discussed in Section II. Certain species of the Solanaceous produce toxins that may induce chronic atrophy of parathyroid chief cells. Chronic nephrotoxicity, especially in the dog, may result in hypocalcemia and hyperphosphatemia, which stimulates excessive production of parathyroid hormone. Impaired intestinal absorption of calcium and increased mobilization from the skeleton also may occur secondary to insufficient renal production of 1,25-dihydroxycholecalciferol by the kidney (Capen, 1993).

*Vicia villosa* (hairy vetch) produces angiocentric eosinophilic granulomatous inflammation of the skin, myocardium, kidney, lymph nodes, thyroid, and adrenal glands. The mechanism is unknown. Biochemical alterations suggest cardiotoxicity, nephrotoxicity, and depression of serum thyroxine and cortisol levels may occur.

Ingestion of Xylitol, a sugar substitute used in cooking and in sugar-free chewing gum, can cause a severe hypoglycemia in dogs by inducing an exaggerated elevation of plasma insulin levels (Dunayer, 2004).

## X. TOXINS AFFECTING THE NERVOUS SYSTEM

Many acute and chronic neurotoxins (Table 27-8) produce illness or death without alterations detectable by routine clinical biochemistry performed on blood or serum. The cerebrospinal fluid (CSF) is usually normal in neurotoxicity; however, mild elevations in protein and leukocyte count may occur with lead poisoning (Bailey and Vernau, 1997). Also, CSF sodium levels may be compared to serum sodium levels to assist in the diagnosis of sodium toxicosis. Sodium levels in serum may decline if the animal acquires access to water or is administered IV fluids, but the CSF sodium levels may remain elevated (Niles, 2003). Elevation of myelin basic protein has been reported in CSF in experimental fumonisin-induced leukoencephalomalacia in ponies (Brownie and Cullen, 1987).

Accumulations of endogenous toxins secondary to hepatotoxicity and nephrotoxicity may produce neurological dysfunction. Conversely, alterations that mimic hepatotoxicity, nephrotoxicity, muscle toxicity, respiratory, and gastrointestinal toxicity may occur secondary to ischemia/anoxia from depression of cardiopulmonary centers or by affecting sympathetic/parasympathetic balance.

Increased urinary excretion of delta-aminolevulinic acid is a potential indicator of lead intoxication. Organophosphates induce cholinesterase inhibition, which can be

**TABLE 27-8** Toxins Affecting the Nervous System

Toxins	Disease Onset	Geography	Species Affected
<i>Asclepias</i> spp. (milkweed)	Acute	N AM	All
<i>Aspergillus clavatus</i>	Acute	UK, S AFR	B, O
CO	Acute	Worldwide	All
<i>Centaurea</i> spp.	Chronic	US	E
Cyanide	Acute	Worldwide	All
Cycadales	Chronic	AUS, DOM REP, US	B
<i>Eupatorium rugosum</i> (white snakeroot)	Acute to chronic	US	B
Fluoroacetate	Acute	AUS, S AFR	B, Cn, Cp, F, O
Fumonisin ( <i>Fusarium moniliforme</i> )	Chronic	Worldwide	E
Hepatic encephalopathy	Chronic		All
Hexachlorophene	Chronic	Worldwide	All
Halogenated salicylanilide	Chronic	Worldwide	Cp, O
<i>Helichrysum</i> spp.	Acute to chronic	AUS, S AFR	B, Cp, O
<i>Karwinskia humboldtiana</i> (coyotillo)	Chronic	US	All
<i>Kochia scoparia</i> (fireweed)	Chronic	US	B
Lead	Chronic	Worldwide	All
<i>Lolium perenne</i> (perennial ryegrass)	Acute	Worldwide	B, E, O
Nitrate/nitrite	Acute	Worldwide	B, Cp, O
Organophosphates	Acute to chronic	Worldwide	All
<i>Phalaris</i>	Chronic	AUS, NZ, S AFR, US	B, O
Renal encephalopathy	Chronic		All
Selenium	Acute to chronic	Worldwide	P
<i>Solanum</i> spp.	Chronic	Worldwide	B
Strychnine	Acute	Worldwide	All
Styphandrol	Acute to chronic	ASIA, AUS	B, Cp, O
Swainsonine	Chronic	AUS, N AM	B, Cp, E, O
Thiaminase	Chronic	Worldwide	B, Cn, E, F, O,
<i>Trachyandra</i> spp.	Chronic	AUS, S AFR	Cp, E, O, P

Abbreviations: B, bovine; Cn, canine; Cp, caprine; E, equine; F, feline; O, ovine; P, porcine.

detected as reduction of plasma or whole blood cholinesterase activity.

Subacute selenium intoxication in pigs exposed to complete rations containing 9.7 to 27 ppm selenium for 45 days is manifested as a central nervous system disorder characterized initially by hind limb ataxia progressing to posterior paralysis. The clinical syndrome is associated with focal symmetrical poliomyelomalacia of the ventral horns of the cervical and lumbosacral intumescences (Casteel *et al.*, 1985). Hoof separation at the coronary band also occurs. The clinical pathological alterations were consistent with dehydration from inability to reach water sources. Iatrogenic disease in the dog may result from parenteral administration of selenium preparations (Turk, 1980).

*Solanum kwebense*, *S. dimidiatum*, and *S. fastigiatum* produce neuronal vacuolation resembling a lysosomal storage disease. The biochemical basis of this lesion is unknown.

Swainsonine is an indolizidine alkaloid produced by certain species of the plants genera *Astragalus*, *Oxytropis*, and *Swainsona*. This toxin inhibits lysosomal alpha-mannosidase resulting in a lysosomal storage alteration that affects cells in many organs but is often lethal because of its neurological effect.

Thiaminases that may induce polioencephalomalacia in herbivores are present in *Equisetum arvense* and *Pteridium aquilinum*. Many uncooked fish species also contain thiaminase, which may produce encephalopathy affecting

primarily carnivores. The coccidiostat, amprolium, is a thiamine antagonist that produces polioencephalomalacia in ruminants. Calves early in the course of polioencephalomalacia may have reduced blood transketolase (which requires thiamine pyrophosphate as a cofactor) and increased pyruvate (Jubb and Huxtable, 1993).

## XI. TOXINS AFFECTING THE INTEGUMENT

Most toxins affecting the skin (Table 27-9) will induce no or nonspecific alterations in clinical biochemistry. Fortunately lesions are usually readily visible by physical examination. Topical exposure to strong acids or alkalis may induce immediate and severe damage of the stratum corneum and epidermis.

Ergot and ergot-like syndromes are produced by the fungi *Claviceps purpurea* in infected rye and other cereal grains, and *Acremonium coenophilaum* in fescue and other pasture grasses. These fungi produce vasoconstrictive alkaloids, which are derivatives of lysergic acid including ergotamine, ergometrine, ergotamine (*C. purpurea*), and ergovaline (*A. coenophilaum*). Skin lesions are the result of ischemic necrosis that is usually most impressive in the distal extremities.

Dermatotoxic heavy metals include thallium and arsenic (Yager and Scott, 1993). Thallium is still used as a rodenticide in some countries, but it is mainly of historical interest in many developed countries in which it has been banned. Thallium induces parakeratosis and alopecia. The mechanism is unknown, but it is speculated to center around alteration of sulfhydryl groups in keratin resulting in parakeratosis and alopecia. Arsenic toxicity exerts similar influences.

Mimosine is a toxic amino acid occurring in *Mimosa pudica* and *Leucaena leucocephala*. This toxin produces alopecia by mechanisms that are incompletely understood but may involve metal chelation that inhibits metalloenzymes.

Organochlorines and organobromines include chlorinated naphthalenes, polychlorinated biphenyls (PCBs), polybrominated biphenyls (PBBs), and dibenzofurans. These industrial toxins are cumulative and result in alopecia, hyperkeratosis, and squamous metaplasia of columnar epithelium of the respiratory tract. Molybdenum toxicosis results in a relative copper deficiency in cattle and sheep that produces depigmentation as a consequence of the decreased activity of tyrosinase.

Toxic photosensitization, enhanced susceptibility of the skin to actinic radiation, occurs primarily in lightly pigmented skin of herbivores and may be primary or secondary to chronic hepatotoxicity (Yager and Scott, 1993). Primary disease is due to exogenous photodynamic agents that include treatment with the anthelmintic phenothiazine and grazing of toxic plants such as *Ammi majus* (Bishop's weed, furocoumarin), *Cymopterus watsoni* (spring parsley, furocoumarin) *Fagopyrum* spp. (buckwheat, fagopyrin), *Hypericum perforatum* (St. John's wort, hypericin), and *Thamnosma texana* (Dutchmen's britches, furocoumarin).

Secondary, or hepatogenous, photosensitization occurs in herbivores with diffuse liver damage that reduces the ability to excrete phylloerythrin. This photodynamic agent is formed from chlorophyll by gastrointestinal flora and is transported by the portal system to the liver where it is normally conjugated and excreted in the bile. When phylloerythrin escapes into the systemic circulation, it is poorly excreted by the kidneys and accumulates in tissues including the skin.

**TABLE 27-9** Toxins Affecting the Integumentary System

Toxins	Disease Onset	Geography	Species Affected
Acids/alkalis	Acute	Worldwide	All
Ergotism	Acute to Chronic	Worldwide	All
Kerosene	Chronic	Worldwide	B
Metals (As, Tl)	Chronic	Worldwide	All
Mimosine	Chronic	Worldwide	B, E, O, P
Organobromines/organochlorines	Chronic	Worldwide	All
Photosensitization, primary	Acute to chronic	Worldwide	All
Photosensitization, secondary	Acute to chronic	Worldwide	B, O
Selenium	Chronic	Worldwide	All
Tricothecenes	Acute	Worldwide	All
<i>Vicia villosa</i> (hairy vetch)	Chronic	Worldwide	B, E

Abbreviations: B, bovine; Cn, canine; Cp, caprine; E, equine; F, feline; O, ovine; P, porcine.

Plants classified as seleniferous actively concentrate Se. Seleniferous plants can be subclassified as obligate (requiring Se) and facultative (Se not required). *Astragalus* spp. (locoweed), *Machaeranthera* spp., *Oenopsis* spp. (goldenweed), *Stanleya* spp., and *Xylorrhiza* spp. (wood aster) are obligate accumulators of selenium. These species are generally nonpalatable and are consumed only by herbivores with little other available forage. Several plants are facultative accumulators of selenium including the genera *Asters*, *Atriplex*, *Catilleja*, *Gutierrezia*, and *Sideranthus*, which are more often associated with forage-associated selenium intoxication. In addition, various grasses and crops may accumulate from 1 to 25 ppm selenium when grown on seleniferous soils. The differences in selenium accumulation by these three groups are rather indistinct. Grasses are by far the most important group from the standpoint of sheer numbers of livestock affected.

Grazing of seleniferous plants may result in acute gastroenteritis, but it also induces what has historically been called "alkali disease" that manifests as alopecia and dystrophic growth of the hooves primarily in horses, cattle, and goats. There are conflicting reports regarding the hepatotoxicity, nephrotoxicity, and cardiotoxicity of selenium.

*Vicia villosa* (hairy vetch) produces angiocentric eosinophilic granulomatous inflammation of the skin, myocardium, kidney, lymph nodes, thyroid, and adrenal glands. The mechanism is unknown. The skin lesions are pruritic.

## REFERENCES

- Acland, H. M., Mann, P. C., Robertson, J. L., Divers, T. J., Lichensteiger, C. A., and Whitlock, R. H. (1984). Toxic hepatopathy in foals. *Vet. Pathol.* **21**, 3–9.
- Albrecht, J. E., Clawson, A. J., Ulberg, L. C., and Smith, F. H. (1969). Effects of high gossypol cottonseed meal on the electrocardiogram of swine. *J. Anim. Sci.* **27**, 976–980.
- Albretsen, J. C., Khan, S. A., and Richardson, J. A. (1998). Cycad palm toxicosis in dogs: 60 cases (1987–1997). *J. Am. Vet. Med. Assoc.* **213**, 99–101.
- Aroch, I., Segev, G., Klement, E., Shipov, A., and Harrus, S. (2004). Fatal *Vipera xanthina palestinae* envenomation in 16 dogs. *Vet. Hum. Toxicol.* **46**, 268–272.
- Bain, P. J. (2003). In "Duncan & Prasse's Veterinary Laboratory Medicine. Clinical Pathology" (K. S. Lattimer, E. A. Mahaffey and K. W. Prasse, Eds.), pp. 193–214. Iowa State University Press, Ames.
- Bailey, C. S., and Vernau, W. (1997). Cerebrospinal fluid. In "Clinical Biochemistry of Domestic Animals" (J. J. Kaneko, J. W. Harvey, and M. L. Bruss, Eds.), pp. 785–827. Academic Press, San Diego, CA.
- Balkman, C. E., Center, S. A., Randolph, J. F., Trainor, D., Warner, K. L., Crawford, M. A., Adachi, K., and Erb, H. N. (2003). Evaluation of urine sulfated and nonsulfated bile acids as a diagnostic test for liver disease in dogs. *J. Am. Vet. Med. Assoc.* **222**, 1368–1375.
- Barr, A. C., and Reagor, J. C. (2001). Toxic plants, what the practitioner needs to know. In "The Veterinary Clinics of North America; Equine Practice; Toxicology" (F. D. Galey, Ed.), vol. 17(3), pp. 529–546. W. B. Saunders, Philadelphia, PA.
- Breeze, R. G., and Carlson, J. R. (1982). Chemical-induced lung disease in domestic animals. *Adv. Vet. Sci. Comp. Med.* **26**, 201–232.
- Brownie, C. F., and Cullen, J. (1987). Characterization of experimentally induced equine leukoencephalomalacia (ELEM) in ponies (*Equus caballus*): preliminary report. *Vet. Hum. Toxicol.* **29**, 34–38.
- Capen, C. C. (1993). The endocrine glands. In "Pathology of Domestic Animals" (K. V. F. Jubb, P. C. Kennedy, and N. Palmer, Eds.), vol. 3, pp. 267–347. Academic Press, San Diego, CA.
- Cardinet, G. H., III (1997). Skeletal muscle function. In "Clinical Biochemistry of Domestic Animals" (J. J. Kaneko, J. W. Harvey, and M. L. Bruss, Eds.), pp. 407–440. Academic Press, San Diego, CA.
- Carlson, G. W. (1997). Fluid, electrolyte, and acid-base balance. In "Clinical Biochemistry of Domestic Animals" (J. J. Kaneko, J. W. Harvey, and M. L. Bruss, Eds.), pp. 485–516. Academic Press, San Diego, CA.
- Carmichael, W. W. (1994). The toxins of cyanobacteria. *Scientific. Amer.* **270**, 78–86.
- Casteel, S. W., Johnson, G. C., Miller, M. A., Chudomelka, H. J., Cupps, D. E., Haskins, H. E., and Gosser, H. S. (1994). *Amaranthus retroflexus* (redroot pigweed) poisoning in cattle. *J. Am. Vet. Med. Assoc.* **204**, 1068–1070.
- Casteel, S. W., Osweiler, G. D., Cook, W. O., Daniels, G., and Kadlec, R. (1985). Selenium toxicosis in swine. *J. Am. Vet. Med. Assoc.* **186**, 1084–1085.
- Casteel, S. W., Rottinghaus, G. E., Johnson, G. C., and Wicklow, D. T. (1995). Liver disease in cattle induced by consumption of moldy hay. *Vet. Human. Toxicol.* **37**, 248–251.
- Casteel, S. W., Thomas, B. R., and South, P. J. (1989). Postmortem diagnosis of potassium poisoning. *J. Eq. Vet. Sci.* **9**, 247–249.
- Casteel, S. W., Turk, J. R., and Rottinghaus, G. E. (1994). Chronic effects of dietary fumonisin on the heart and pulmonary vasculature of swine. *Fundam. Appl. Toxicol.* **23**, 518–524.
- Cheville, N. F. (1988). Chemical causes of disease. In "Introduction to Veterinary Pathology" (N.F. Cheville, Ed.), pp. 432–454. Iowa State University Press, Ames. pp. 432–454.
- Clemo, F. A. (1998). Urinary enzyme evaluation of nephrotoxicity in the dog. *Toxicol. Pathol.* **26**, 29–32.
- Curran, J. M., Sutherland, R. J., and Peet, R. L. (1996). A screening test for subclinical liver disease in horses affected by pyrrolizidine alkaloid toxicosis. *Aust. Vet. J.* **74**, 236–240.
- Dalefield, R. (2003). In "Clinical Veterinary Toxicology" (K. H. Plumlee, Ed.), pp. 150–154. Mosby, St. Louis, MO.
- DeVries, S. E., Galey, F. D., Namikoshi, M., and Woo, J. C. (1993). Clinical and pathological findings of blue-green algae (*Microcystis aeruginosa*) intoxication in a dog. *J. Vet. Diagn. Invest.* **5**, 403–408.
- Dodds, W. J. (1997). Fluid, electrolyte, and acid-base balance. In "Clinical Biochemistry of Domestic Animals" (J. J. Kaneko, J. W. Harvey, and M. L. Bruss, Eds.), pp. 241–283. Academic Press, San Diego, CA.
- Doster, A. R., Mitchell, F. E., Farrell, R. L., and Wilson, B. J. (1978). Effects of 4-ipomeanol, a produce from mold-damage sweet potatoes, on the bovine lung. *Vet. Pathol.* **15**, 367–375.
- Dunayer, E. K. (2004). Hypoglycemia following canine ingestion of xylitol-containing gum. *Vet. Hum. Toxicol.* **46**, 87–88.
- Dziwenka, M. M., and Coppock, R. (2003). In "Clinical Veterinary Toxicology" (K. H. Plumlee, Ed.), pp. 221–226. Mosby, St. Louis, MO.
- Erdos, E. G. (1987). The angiotensin I-converting enzyme. *Lab Invest.* **56**, 345–348.
- Fenco, D. R. (1997). Skeletal muscle function. In "Clinical Biochemistry of Domestic Animals" (J. J. Kaneko, J. W. Harvey, and M. L. Bruss, Eds.), pp. 441–484. Academic Press, San Diego, CA.



- Fooshee, S. K., and Forrester, S. D. (1990). Hypercalcemia secondary to cholecalciferol rodenticide toxicosis in two dogs. *J. Am. Vet. Med. Assoc.* **196**, 1265–1268.
- Gossett, K. A., Turnwald, G. H., Kearney, M. T., Greco, D. S., and Cleghorn, G. (1987). Evaluation of gamma-glutamyl transpeptidase-to-creatinine ratio from spot samples of urine supernatant, as an indicator of urinary enzyme excretion. *Am. J. Vet. Res.* **48**, 455–457.
- Gram, T. E., Okine, L. K., and Gram, R. A. (1986). The metabolism of xenobiotics by certain extrahepatic organs and its relation to toxicity. *Ann. Rev. Pharmacol. Toxicol.* **26**, 259–291.
- Harvey, J. W. (1989). Erythrocyte metabolism. In “Clinical Biochemistry of Domestic Animals” (J. J. Kaneko, Ed.), pp. 185–234. Academic Press, San Diego, CA.
- Herdon, W. E., Kittleson, M. D., Sanderson, K., Drobatz, K. J., Clifford, C. A., Gelzer, A., Summerfield, N. J., Linde, A., and Sleeper, M. M. (2002). Cardiac troponins I in feline hypertrophic cardiomyopathy. *J. Vet. Intern. Med.* **16**, 558–564.
- Hollinger, M. A. (1983). Serum angiotensin-converting enzyme. Status report on its diagnostic significance in pulmonary disease. *Chest* **83**, 589–590.
- Jubb, K. V. F., and Huxtable, C. R. (1993). VII. Degeneration in the nervous system. In “Pathology of Domestic Animals” (K. V. F. Jubb, P. C. Kennedy, and N. Palmer, Eds.), vol. 1, pp. 334–383. Academic Press, San Diego, CA.
- Kaneko, J. J. (1997a). Serum proteins and dysproteinemias. In “Clinical Biochemistry of Domestic Animals” (J. J. Kaneko, J. W. Harvey, and M. L. Bruss, Eds.), pp. 117–138. Academic Press, San Diego, CA.
- Kaneko, J. J. (1997b). Thyroid function. In “Clinical Biochemistry of Domestic Animals” (J. J. Kaneko, J. W. Harvey, and M. L. Bruss, Eds.), pp. 571–588. Academic Press, San Diego, CA.
- Keeler, R. F., and Baker, D. C. (1990). Myopathy in cattle induced by alkaloid extracts from *Thermopsis montana*, *Laburnum anagyroides*, and a *Lupinus* spp. *J. Comp. Pathol.* **103**, 169–182.
- Kelly, W. R. (1993). XI. Toxic liver disease. In “Pathology of Domestic Animals” (K. V. F. Jubb, P. C. Kennedy, and N. Palmer, Eds.), vol. 2, pp. 382–400. Academic Press, San Diego, CA.
- Kramer, J. W., Bistline, D., Sheridan, P., and Emerson, C. (1984). Identification of hippuric acid crystals in the urine of ethylene glycol-intoxicated dogs and rats. *J. Am. Vet. Med. Assoc.* **184**, 584–585.
- Kramer, J. W., and Hoffmann, W. E. (1997). Clinical enzymology. In “Clinical Biochemistry of Domestic Animals” (J. J. Kaneko, J. W. Harvey, and M. L. Bruss, Eds.), pp. 338–363. Academic Press, San Diego, CA.
- Kristal, O., Rassnick, K. M., Gliatto, J. M., Northrup, N. C., Chretien, J. D., Morrison-Collister, K., Cotter, S. M., and Moore, A. S. (2004). Hepatotoxicity associated with CCNU (lomustine) chemotherapy in dogs. *J. Vet. Intern. Med.* **18**, 75–80.
- Lassen, E. D. (2004). Laboratory evaluation of the liver. In “Veterinary Hematology and Clinical Chemistry” (M. A. Thrall, Ed.), pp. 355–376. Lippincott Williams & Wilkins, Philadelphia.
- MacPhail, C. M., Lappin, M. R., Meyer, D. J., Smith, S. G., Webster, C. R., and Armstrong, P. J. (1998). Hepatocellular toxicosis associated with administration of carprofen in 21 dogs. *J. Am. Vet. Med. Assoc.* **212**, 1895–1901.
- Maxie, M. G. (1993). The kidney. In “Pathology of Domestic Animals” (K. V. F. Jubb, P. C. Kennedy, and N. Palmer, Eds.), vol. 2, pp. 447–522. Academic Press, San Diego, CA.
- Meintjes, R. A., Botha, C. J., and Prozesky, L. (2005). Toxicity, pathophysiology and pathology in sheep following dosing of the nephrotoxic plant *Nolletia gariepina* (DC) Matf. *Onderstepoort. J. Vet. Res.* **72**, 39–53.
- Miyai, K. (1991). Structural organization of the liver. In “Hepatotoxicology” (R. G. Meeks, S. D. Harrison, and R. J. Bull, Eds.), pp. 1–66. CRC Press, Boca Raton, FL.
- Monshouwer, M., Witkamp, R. F., Nijmeijer, S. M., van Leengoed, L. A. M. G., Verheijden, J. H. M., and van Miert, A. S. J. P. A. M. (1995). Infection (*Actinobacillus pleuropneumoniae*)-mediated suppression of oxidative hepatic drug metabolism and cytochrome P<sub>450</sub><sub>3a</sub> mRNA levels in pigs. *Drug. Metab. Dispos.* **23**, 44–47.
- Myers, J. L. (1993). Diagnosis of drug reactions in the lung. In “The Lung: Current Concepts” (A. Churg and A. A. Katzenstein, Eds.), pp. 32–53. Williams & Wilkins, Baltimore.
- Niles, G. (2003). In “Clinical Veterinary Toxicology” (K. H. Plumlee, Ed.), pp. 218–221. Mosby, St. Louis, MO.
- Noble, S. J., and Armstrong, P. J. (1999). Bee sting envenomation resulting in secondary immune-mediated hemolytic anemia in two dogs. *J. Am. Vet. Med. Assoc.* **214**, 1026–1027.
- O’Brien, P. J. (2006). Blood cardiac troponin in toxic myocardial injury: archetype of a translational safety biomarker. *Expert. Rev. Mol. Diagn.* **6**, 685–702.
- O’Brien, P. J., Smith, D. E., Knechtel, T. J., Marchak, M. A., Pruijboom-Brees, I., Brees, D. J., Spratt, D. P., Archer, F. J., Butler, P., Potter, A. N., Provost, J. P., Richard, J., Snyder, P. A., and Reagan, W. J. (2006). Cardiac troponin I is a sensitive, specific biomarker of cardiac injury in laboratory animals. *Lab. Anim.* **40**, 153–171.
- Osweller, G. D., Buck, W. B., and Bicknell, E. J. (1969). Production of perirenal edema in swine with *Amaranthus retroflexus*. *Am. J. Vet. Res.* **30**, 557–566.
- Osweller, G. D., Carson, T. L., Buck, W. B., and van Gelder, G. A. (1985). Nitrates, nitrites, and related problems. In “Clinical and Diagnostic Veterinary Toxicology,” pp. 460–466. Kendall/Hunt, Dubuque, IA.
- Oyama, M. A., and Sisson, D. D. (2004). Cardiac troponins-I concentration in dogs with cardiac disease. *J. Vet. Intern. Med.* **18**, 831–839.
- Parton, K. H. (2003). In “Clinical Veterinary Toxicology” (K. H. Plumlee, Ed.), pp. 451–454. Mosby, St. Louis, MO.
- Pearson, E. G. (1990). Diseases of the hepatobiliary system. In “Large Animal Internal Medicine” (B. P. Smith, Ed.), pp. 837–843. Mosby, St. Louis, MO.
- Riley, R. T., An, N. H., Showker, J. L., Yoo, H.-S., Norred, W. P., Chamberlain, W. J., Wang, E., Merrill, A. H., Motelin, G., Beasley, V. R., and Haschek, W. M. (1993). Alteration of tissue and serum sphinganine to sphingosine ratio: an early biomarker of exposure to fumonisin-containing feeds. *Toxicol. Appl Pharmacol.* **118**, 105–112.
- Roberts, B. K., Aronsohn, M. G., Moses, B. L., Burk, R. L., Toll, J., and Weeren, F. R. (2000). *Bufo marinus* intoxication in dogs: 94 cases (1997–1998). *J. Am. Vet. Med. Assoc.* **216**, 1941–1944.
- Robinson, W. F., and Maxie, M. G. (1993). VII. Myocardium. In “Pathology of Domestic Animals” (K. V. F. Jubb, P. C. Kennedy, and N. Palmer, Eds.), vol. 2, pp. 27–36. Academic Press, San Diego, CA.
- Roder, J. D. (2003). In “Clinical Veterinary Toxicology” (K. H. Plumlee, Ed.), pp. 284–286. 302–305 Mosby, St. Louis, MO.
- Rumbeiha, W. K., Francis, J. A., Fitzgerald, S. D., Nair, M. G., Holan, K., Bugyei, K. A., and Simmons, H. A. (2005). Comprehensive study of Easter lily poisoning in cats. *J. Vet. Diagn. Invest.* **16**, 527–541.
- Schwarzald, C. C., Hardy, J., and Buccellato, M. (2003). High cardiac troponin I serum concentration in a horse with multifocal ventricular tachycardia and myocardial necrosis. *J. Vet. Intern. Med.* **17**, 364–368.
- Snyder, R. (1979). Classes of hepatic microsomal mixed function oxidase inducers. *Pharmacol. Therap.* **7**, 203–244.

- Solaiman, S. G., Maloney, M. A., Qureshi, M. A., Davis, G., and D'Andrea, G. (2001). Effects of high copper supplements on performance, health, plasma copper and enzymes in goats. *Small Rumin. Res.* **41**, 127–139.
- Stegelmeier, B. (2003). In "Clinical Veterinary Toxicology" (K. H. Plumlee, Ed.), pp. 370–377. Mosby, St. Louis, MO.
- Stocker, R., Yamamoto, Y., McDonagh, A. F., Glazer, A. N., and Ames, B. N. (1987). Bilirubin is an antioxidant of possible physiological importance. *Science* **235**, 1043–1046.
- Stockham, S. L., and Scott, M. A. (2002). "Fundamentals of Veterinary Clinical Pathology." Iowa State, Ames.
- Tennant, B. C., and Hornbuckle, W. E. (1997). Gastrointestinal function. In "Clinical Biochemistry of Domestic Animals" (J. J. Kaneko, J. W. Harvey, and M. L. Bruss, Eds.), pp. 417–461. Academic Press, San Diego, CA.
- Thrall, M. A. (2004). Regenerative Anemia. In "Veterinary Hematology and Clinical Chemistry," pp. 95–120. Lippincott Williams & Wilkins, Philadelphia.
- Trainor, D., Center, S. A., Randolph, F., Balkman, C. E., Warner, K. L., Crawford, M. A., Adachi, K., and Erb, H. N. (2003). Urine sulfated and nonsulfated bile acids as a diagnostic test for liver disease in cats. *J. Vet. Intern. Med.* **17**, 145–153.
- Turk, J. R. (1980). Chronic parenteral selenium administration in a dog. *Vet. Pathol.* **17**, 493–496.
- Valli, V. E. O. (1993). The erythron. In "Pathology of Domestic Animals" (K. V. F. Jubb, P. C. Kennedy, and N. Palmer, Eds.), vol. 3, pp. 157–265. Academic Press, San Diego, CA.
- Van Vleet, J. F., and Ferrans, V. J. (1986). Myocardial diseases of animals. *Am. J. Pathol.* **124**, 98–174.
- Yager, J. A., and Scott, D. W. (1993). VI. Physicochemical diseases of the skin, and VII. Actinic diseases of the skin. In "Pathology of Domestic Animals" (K. V. F. Jubb, P. C. Kennedy, and N. Palmer, Eds.), vol. 1, pp. 579–597. Academic Press, San Diego, CA.
- Weaver, D. M., Tyler, J. W., Marion, R. S., Casteel, S. W., Loiacono, C. M., and Turk, J. R. (1999). Subclinical copper accumulation in llamas. *Can. Vet. J.* **40**, 422–424.

# Avian Clinical Biochemistry

J. T. Lumeij

*Department of Clinical Sciences of Companion Animals*

*Faculty of Veterinary Medicine*

*Utrecht, University*

*Utrecht, The Netherlands*

---

## I. INTRODUCTION

## II. COLLECTION OF BLOOD SAMPLES

- A. Size of Blood Samples
- B. Handling of Blood Samples
- C. Sampling Procedure

## III. STARVATION, FLIGHT, AND POSTPRANDIAL EFFECTS: CIRCADIAN AND CIRCANNAL RHYTHMS

- A. Introduction
- B. Biochemistry of Long-Term Starvation
- C. Biochemistry of Endurance Flight

## IV. PLASMA PROTEINS

- A. Introduction
- B. Plasma versus Serum
- C. Physiological Variation in Female Birds
- D. Refractometry versus the Biuret Method
- E. Effect of Protein Standards
- F. Plasma Protein Electrophoresis: Albumin/Globulin Ratio
- G. Albumin Methodology
- H. Prealbumin

## V. RENAL FUNCTION

- A. End Products of Protein Metabolism: Hyperuricemia and Gout
- B. Articular and Visceral Gout
- C. Acute versus Chronic Renal Failure
- D. Prerenal Azotemia
- E. Urea versus BUN
- F. Postprandial Effects
- G. Other Changes Associated with Renal Failure
- H. Murexide Test
- I. Birefringent Crystals

## VI. HEPATOBILIARY DISEASE

- A. Clinical Enzymology
- B. Enzyme Activities in Avian Tissues
- C. Clearance of Enzymes from Plasma
- D. Experimentally Induced Liver and Muscle Disease
- E. Bile Pigments
- F. Bile Acids

- G. Postprandial Effects
- H. Plasma Ammonia: Hepatoencephalopathy
- I. Exogenous Markers
- J. Iron Storage Disease
- K. Clinical Diagnosis of Liver Disease

## VII. MUSCLE DISEASE

## VIII. CALCIUM AND PHOSPHORUS: METABOLIC BONE DISEASE

- A. Relation between Calcium and Protein in Avian Plasma
- B. Hypercalcemia
- C. Physiological Marrow Ossification
- D. Hypocalcemia Syndrome in African Grey Parrots
- E. Alkaline Phosphatase in Bone Disease

## IX. DIABETES MELLITUS AND PLASMA GLUCOSE

## X. EXOCRINE PANCREATIC DISEASE

## XI. TOXICOLOGY

- A. Lead
- B. Zinc
- C. Organophosphate and Carbamate

## XII. BLOOD COAGULATION

- A. Introduction
- B. Normal Hemostasis in Birds
- C. Diagnostic Tests
- D. Hemostatic Disorders

## ACKNOWLEDGMENTS

## REFERENCES

---

## I. INTRODUCTION

Avian medicine and surgery have been recognized as an official specialty in veterinary medicine on three continents (Europe, Australia, and North America). The increasing demand for veterinary care for individual birds with a high sentimental or economical value and efforts to conserve endangered species facilitated this awareness. The commercial poultry flock approach to diagnosis, utilizing necropsy as

a primary diagnostic tool combined with comparatively fewer testing procedures on living birds, which had been practiced for decades, had only limited applicability for individual pet birds. As a result, alternative diagnostic and therapeutic techniques were developed. Clinical signs in birds are often nonspecific, and the information gained by physical examination is limited in regard to specific and detailed diagnosis. Earlier demands for large blood sample volumes and limited veterinary involvement in the diagnosis and management of individual and pet bird disease were major obstacles to the development of clinical biochemistry in avian medicine. The introduction of micromethods in clinical laboratories and the public demand for veterinary care for individual birds have removed these obstacles. The scientific and clinical work in avian clinical biochemistry since the 1980s has led to its widespread application in avian medicine.

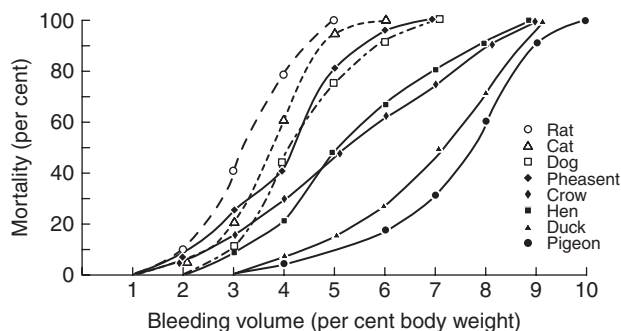
Reference values are dependent on the methodology used. Factors such as type of coagulant, amount of blood, and analytical method may all influence the results. Therefore, values from clinical cases should be compared with reference values from the same species established with the same method in the same laboratory. Published reference values for many blood chemical variables can only be used as a rough guideline.

All efforts should be made to obtain a blood sample before any treatment is given. Treatments that have been administered before samples have been collected may severely affect plasma chemical values (see Fig. 28-16), which will jeopardize a correct diagnosis at a later stage. The time interval between restraint and blood sampling should be kept to a minimum to prevent stress-associated changes in clinical chemistry parameters (see Section VII). Paradoxically, blood samples should be obtained before an extensive clinical examination has been performed to avoid iatrogenic changes in the samples. In one study with pigeons, the percentage of heterophils more than doubled whereas the percentage of lymphocytes decreased after extensive handling for 3h. Creatine kinase and glucose both increased, whereas uric acid decreased (Scope *et al.*, 2002b). Although the changes associated with a short clinical examination might be negligible, the clinician should keep these iatrogenic effects in mind when performing more extensive procedures.

## II. COLLECTION OF BLOOD SAMPLES

### A. Size of Blood Samples

An important consideration when taking blood samples from small birds is response to blood loss. Kovách *et al.* (1969) studied the mortality of various avian and mammalian species following blood loss and showed that birds can better tolerate severe blood loss than mammals (Fig. 28-1). This is because of their greater capacity for extravascular fluid mobilization (Djojogugito *et al.*, 1968; Wyse and Nickerson, 1971). Kovách *et al.* (1969) found that in healthy individuals, the amount of blood that can be removed without



**FIGURE 28-1** Mortality after identical blood losses in various avian and mammalian species (abscissa). Every hour, 1% of body weight blood was withdrawn from every animal (ordinate). The percentage of animals lost during the hour following bleeding has been recorded and plotted (see Kovách *et al.*, 1969). Reprinted with permission from Lumeij (1987a).

deleterious effects is 3% of body weight in ducks and pigeons, 2% in chickens, and 1% in crows and pheasants (Fig. 28-1). Unless birds are severely debilitated, a maximum of 1% seems a safe limit for the amount of blood that can be collected for diagnostic purposes.

### B. Handling of Blood Samples

Nearly all routine hematological and biochemical investigations can be performed when lithium heparin is used. The use of one single sample limits unnecessary blood spillage, which is an important consideration when dealing with small birds. When plasma is used instead of serum, more plasma can be harvested than serum from the collecting tube. Another reason for not using serum in avian samples is the risk of clotting of the supernatant when serum and cells are separated within a couple of hours after collection.

In mammals, EDTA is regarded as the best anticoagulant for preservation of cellular morphology and good staining characteristics (Schmidt *et al.*, 1963), but this is not necessarily true in hematology of all avian species. There are various avian species where EDTA causes disruption of the red blood cells. Hawkey *et al.* (1983) found that EDTA produced progressive hemolysis in blood samples from crowned cranes. Dein (1986a, 1986b) reported a similar reaction in crows, jays, brush turkey, and hornbills. Similar reactions to EDTA are observed in blood from crows and magpies (Lumeij, unpublished). Fourie (1977) found heparin to be the most suitable anticoagulant for hematology in pigeons. Good quality smears can also be obtained from whole blood without anticoagulants. Whatever method is used, blood smears should be made immediately after collection of the sample to prevent changes in blood cell morphology.

The normal time lag of up to 60min between collection of a blood sample and separation of plasma from cells, which is common in human medicine (Laessig *et al.*, 1976), is not acceptable in avian clinical biochemistry. Immediately after collection, plasma and cells should be separated by centrifuging. In pigeon blood at room temperature, a rapid

decline (10% in 10 min, 30% in 30 min, up to 65% in 2 h) of plasma potassium concentrations occurs, because of a shift of potassium ions from the plasma into the red blood cells. In chickens, decreases were smaller overall with a 29% decrease being noted after 2 h (Lumeij, 1985a). In ostriches, significant increases in plasma potassium concentrations were observed when blood was stored at 20°C (up to 20% in 2 h), whereas at 0°C significant decreases were observed (Verstappen *et al.*, 2002). Many reports on blood chemistry in birds are based on determinations in serum instead of plasma or plasma from blood samples that were not centrifuged immediately. Plasma potassium concentrations reported herein are often too low.

In suspected lead poisoning, heparinized whole blood samples should be sent to the laboratory, because the majority of lead is associated with the red blood cells (see Section XI.A).

### C. Sampling Procedure

In most species, the right jugular vein is the preferred site for blood sampling. This thick walled vein is less prone to hematoma formation (Law, 1960; McClure and Cedeno, 1955; Stevens and Ridgeway 1966). The medial metatarsal vein is especially useful for multiple sampling of small blood volumes in larger birds such as pigeons. Blood can be collected using a needle and syringe or a blood lancet. In the pigeon, the jugular vein is not readily visible.

The basilic vein, which is readily visible as it crosses the ventral aspect of the elbow of all avian species, is the vein that is traditionally used in poultry. The vein is punctured with a blood lancet after being swabbed with alcohol (Gratzl und Koehler 1968). These authors warn against the use of the comb for blood collection in poultry because the high risk of exsanguination, especially during cold weather. In pet birds, the use of a blood lancet for blood collection from the basilic vein cannot be recommended because this site is prone to hematoma formation, often even when a needle is used. The advantage of the basilic vein, on the other hand, is that it can be located in all avian species.

In ostriches the operator should be aware of the risk of being kicked. Blood can be collected from the basilic vein using a sideways approach to the standing animal after it has been hooded and the wing has been lifted upward by two assistants (Fowler, 1978c). The jugular vein can also be approached in the same manner.

In ducks and geese, the venous occipital sinus is a good site for blood sampling (Vuillaume, 1983). It is located at the junction of the base of the skull and the first cervical vertebra. Although this site is especially useful for obtaining large samples, many clinicians will feel more comfortable using the easily accessible basilic and metatarsal veins in these species.

Cardiac puncture carries the risk of cardiac tamponade, and therefore this technique is not recommended for use in avian clinical practice.

Some individuals choose to clip a toenail to obtain a blood sample. Disadvantages of this method are that it is painful to the bird, the sample may become contaminated with tissue fluids, it may cause damage to the nail bed, and the amount of blood that can be obtained is limited. Furthermore, contamination of the sample with urates from the droppings may give false high readings (Ekstrom and Degernes, 1989; Roskopf *et al.*, 1982). For the aforementioned reasons, this method should only be regarded as a last resort, and the nail should be thoroughly cleaned before obtaining a sample.

Different bleeding sites (e.g., venous blood versus blood collected by cardiac puncture) may cause variation in hematological or biochemical values (Kern and De Graw, 1978).

A vacuum system greatly facilitates blood sampling from the jugular and basilic veins and from the venous occipital sinus in Anseriformes. A 3-ml vacuum tube is sufficient for most cases (Venoject, Omnilabo, Breda, The Netherlands). For smaller birds, and thus smaller sample sizes, it is best to use small volume (e.g., 0.5 ml) Vacutainers (Veterinary Lab Supply, 315 E. Madison, Winterset, Iowa 50273, United States).

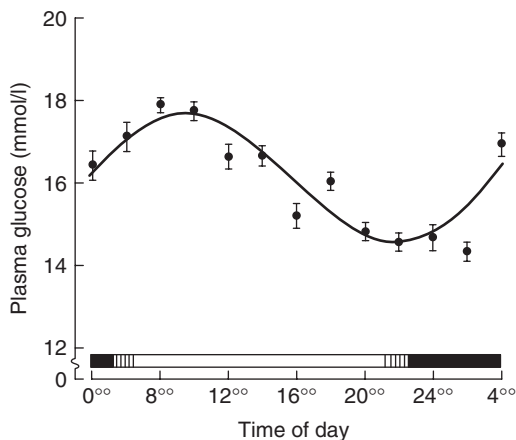
## III. STARVATION, FLIGHT, AND POSTPRANDIAL EFFECTS: CIRCADIAN AND CIRCANNUAL RHYTHMS

### A. Introduction

Some plasma chemical variables are influenced by starvation or food consumption. Up to 4 days of starvation in pigeons did not result in hypoglycemia, but rather a starvation hyperglycemia occurred after 3 days (Lumeij, 1987b). Variables that may have markedly increased values postprandially are uric acid and total bile acid concentrations. See Sections V.F. and VI.G (Lumeij, 1991; Lumeij and Remple, 1991, 1992). Furthermore, daily or yearly fluctuations have also been reported for some chemical variables. In fasted pigeons maintained on a natural daily 17-h photoperiod a circadian rhythm was found in plasma glucose concentrations (Lumeij *et al.*, 1987b) with high values early during the photophase (Fig. 28-2). Basal plasma thyroxine concentrations in racing pigeons were significantly higher in July than in September and December (Lumeij and Westerhof, 1988a). Age, sex, altitude, nutritional status, and egg laying may also cause variation (Driver, 1981; Kocan, 1972; Kocan and Pits, 1976; McGrath, 1971; Mori and George, 1978; Simkiss, 1967). Effects of long-term starvation and endurance flight are discussed in Sections III.B. and III.C, respectively.

### B. Biochemistry of Long-Term Starvation

Many avian species depend on catabolism of lipid depots for survival through the night or winter to enable migratory

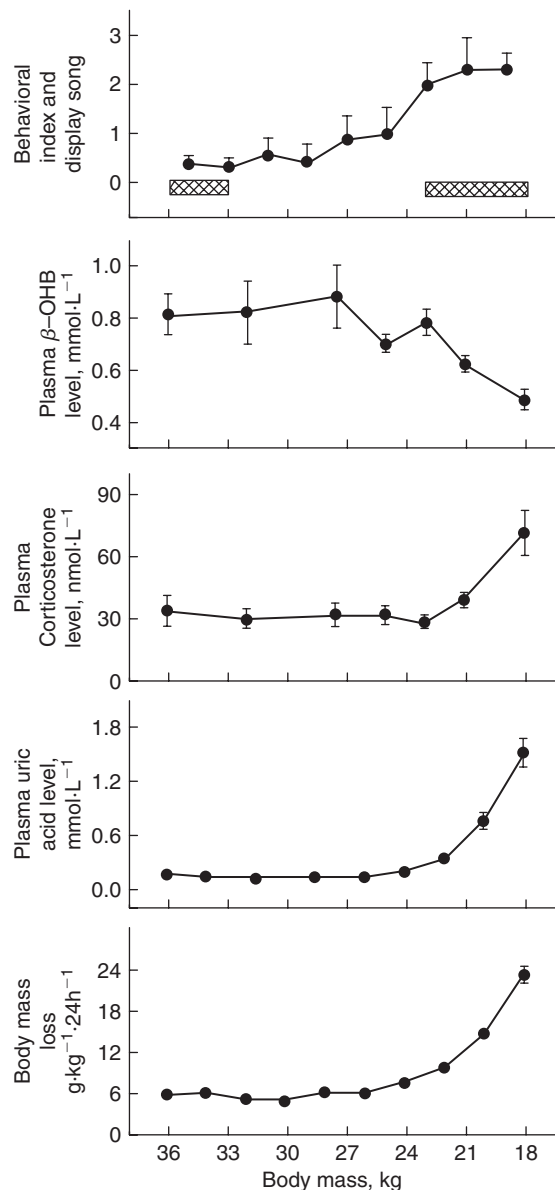


**FIGURE 28-2** Mean ( $\pm$ SEM) plasma glucose concentration as a function of time in fasted racing pigeons. A cosine function  $y(t)$  is fitted to the data:  $y(t) = 16.26 + 1.55 \cdot \cos(0.2618t \text{ to } 2.4646)$ . The relevance of the fit as judged by means of the multiple correlation coefficient was significant ( $R = 0.892$ ,  $p < 0.01$ ). Reprinted with permission from Lumeij *et al.* (1987b).

flights or to incubate eggs (Blem, 2000). During migratory flights, energy expenditure may be more than seven times the basic metabolic rate for 3 to 5 days (Battley, 2003). Lipid reserves in birds are stored as triglycerides, which have a high caloric density and do not require water. Storage of fat reserves may double the body mass in some cases.

Starved birds go through three phases. The total duration of the various phases depends on the size of the bird and the amount of lipid reserves and may vary from a few hours in hummingbirds to 5 months in emperor penguins (Robin *et al.*, 1998).

In phase 1, food in the digestive tract and glycogen reserves are used; in phase 2, lipids are metabolized; and in phase 3, protein is used as a substrate for glucose synthesis. Phase 2 of starvation is characterized by an almost constant rate of body mass loss, a low respiratory quotient, and steady plasma concentrations of uric acid and  $\beta$  hydroxybutyrate. Although fatty acids provide the main energy source, about 5% of the energy is provided by protein breakdown, to generate citric acid intermediates, to act as substrate for gluconeogenesis, and for production of antioxidants (Battley, 2003). When critical depletion of fat stores is imminent, phase 3 of starvation is heralded by lowering of plasma concentrations of  $\beta$ -hydroxybutyrate and increased uric acid concentrations, reflecting a decreased contribution of lipids to energy metabolism and increased protein catabolism, respectively (Fig. 28-3). The refeeding drive is related to the attainment to a given energy status rather than to a given duration of fasting or body mass loss (Robin *et al.*, 1998). The metabolic shift to an increased protein breakdown is regulated by an endocrine



**FIGURE 28-3** Changes in specific daily body mass, plasma uric acid, corticosterone, and  $\beta$ -hydroxybutyrate ( $\beta$ -OHB), and behavior versus body mass in spontaneously fasted emperor penguins ( $X \pm SE$ ;  $n = 6$ ). Crosshatched bars represent periods of display songs. The behavioral index was calculated as number of days an animal was active during successive periods of fasting corresponding to a 2-kg loss in body mass. Reprinted with permission from Robin *et al.* (1998).

shift (elevated corticosterone concentration), after which a further adrenocortical response to an acute stressor is inhibited. The adrenocortical response typical for an emergency situation is only reached when muscle protein is dangerously low (Jenni *et al.*, 2000).

Mortality resulting from hepatic lipidosis has been described in a wide variety of avian species (James *et al.*, 2000; Wadsworth *et al.*, 1984) including, among others, chickens (Butler, 1976), turkeys (Gazdinski *et al.*, 1994),

parrots (Baker, 1980; Murphey, 1992a), raptors (Cooper and Forbes, 1983; Forbes and Cooper, 1993), and bustards (Nichols *et al.*, 1997) and is known as fatty liver syndrome. Although the exact mechanism has not been elucidated, it seems that deficiencies of other nutrients, which are essential in lipid metabolism, like the amino acids methionine and cysteine and the vitamin biotin, may play a crucial role in the pathophysiology of this syndrome (Butler, 1976). Because of the lack of these essential components for lipid metabolism, a buildup of lipids occurs in the liver, which eventually leads to liver failure. The need to conserve body protein during starvation has been stressed in extremely obese persons who were treated by starvation, because slow loss of protein during complete starvation may lead to sudden death because of a cumulative protein loss (Le Maho *et al.*, 1988).

From a physiological point of view, birds thus seem to be well equipped to deal with prolonged periods of starvation through prolonged metabolism of fat as the major energy source, provided they have sufficient fat stores and sufficient essential amino acid and vitamin stores to facilitate lipid catabolism. When clinically monitoring obese birds during a forced starvation period, plasma concentrations of corticosterone,  $\beta$ -hydroxybutyrate and uric acid can be used to pinpoint the critical transition from phase 2 to phase 3 of starvation.

When starving obese birds, which have a history of malnutrition, to force them to change over to a balanced diet, it seems prudent to give a multivitamin injection and small amounts of a mixture of essential amino acids to avoid a deficiency of lipotropic factors and starvation-related hepatic lipidosis.

### C. Biochemistry of Endurance Flight

After a 90- to 160-min flight of 48 km, homing pigeons show marked changes in plasma chemistry, which include increased glucagon like immunoreactivity (GLI), increased concentrations of free fatty acids (FFA) and triglyceride (TG), decreased thyroxine (T<sub>4</sub>), triiodothyronine (T<sub>3</sub>), and T<sub>3</sub>/T<sub>4</sub> ratio (George *et al.*, 1989). Viswanathan *et al.* (1987, 1988) observed significant increases in plasma glucose and lactate, FFA, and growth hormone (GH), but not corticosterone after a 80- to 90-min flight of 48 km. In contrast to George *et al.* (1989), they did not see changes in T<sub>4</sub> and T<sub>3</sub>. George *et al.* (1992) documented under similar conditions a significant increase of plasma arginine vasotocine (AVT) without change in plasma osmolality. However, in free-flying tipler pigeons trained to fly continuously for up to 5 h, Giladi *et al.* (1997) found three- to eightfold increased plasma AVT (up to 100 pg/ml), increased plasma osmolality and decreased hematocrit values.

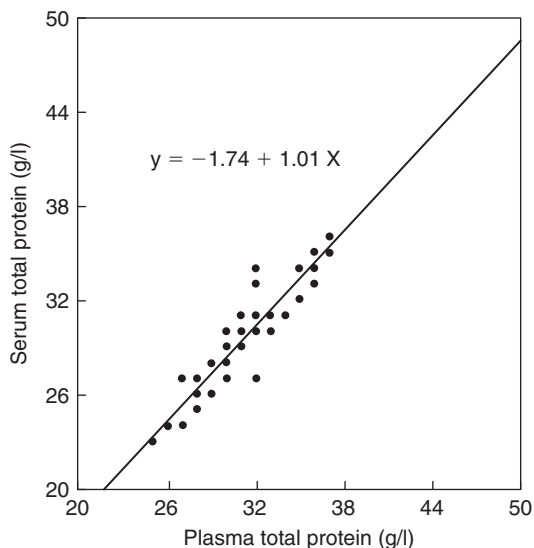
Bordel and Haase (1993, 2000) studied the influence of flight duration on blood parameters in homing pigeons that

returned after 2 to 22 h from release sites 113 to 620 km away. Hematocrit values decreased from 54% in controls to 51% in flown birds. Plasma FFA levels increased significantly during flight, and TG concentrations gradually decreased with progressive flight duration. Plasma concentrations of glucose and lactate did not differ between experimental and control birds. Immediately after takeoff and up to  $\approx$  5 h of flight, plasma uric acid (UA) increased in a linear manner and reached values of 1500  $\mu$ mol/after flight duration  $>$ 5 h to 22 h (two to fourfold increase of control values), whereas urea (UR) levels gradually rose with flight duration to 400% of control values. Plasma protein decreased in flown pigeons. The excretion of UR, uric acid and N<sup>7</sup>-methylhistidine was significantly higher in flown birds compared to controls during 1 to 3 days immediately following return, but immediately after flight N<sup>7</sup>-methylhistidine did not elevate.

These findings support the view that lipids are the main energy source during flight. The increase in lactate during short flights is compatible with the idea that carbohydrates are utilized as fuel mainly in the initial phase of flight and are used for the activity of the white glycolytic fibers in the flight muscles. Furthermore, protein catabolism increases during endurance flights. Because UR formation in pigeons occurs mainly through arginolysis (Bordel and Haase, 1998) and increased protein breakdown raises the availability of arginine (Robin *et al.*, 1987), the elevated plasma concentrations of UR and UA can be attributed to an accelerated protein breakdown during flight. The increased availability of free amino acids and their conversion into metabolites of the citric acid cycle could enhance the capacity of the tricarboxylic acid cycle and thereupon the oxidation of acetyl-CoA derived from lipolysis (Dohm *et al.*, 1985). In addition, protein degradation contributes to the prevention of dehydration during flight because the catabolism of a mixture of 70% lipids and 30% protein yields  $\approx$ 20% more water than the catabolism of pure fat (Klaasen, 1996). Because the methylated amino acid N<sup>7</sup>-methylhistidine occurs almost exclusively in actin and myosin filaments and is excreted after myofibrillar breakdown, the findings suggest an increased breakdown of myofibrillar proteins in the immediate period after the flight, probably as a result of repair processes of contractile elements in the muscles as a reaction to protein breakdown during flight (Bordel and Haase, 2000).

The AVT increase can be regarded as an overall homeostatic mechanism during homing flights, whereby (1) lipid is mobilized, (2) water is conserved, and (3) temperature is regulated. There is a significant correlation between postflight AVT and body mass loss (which in flying birds represents mainly water loss). Water loss is related to the duration of flight and the environmental temperature.

Despite substantial water loss, the hematocrit of flying pigeons significantly decreases. This probably results from expansion of plasma volume through a shift of water from the interstitial fluid. The expanded plasma volume



**FIGURE 28-4** Relation between plasma and serum total protein by biuret method in racing pigeons ( $n = 50$ ; g/l). From Lumeij and McLean (1996).

and reduced hematocrit may contribute to the maintenance of blood pressure, whereas the decreased hematocrit may enhance blood flow to metabolically active tissues.

The absence of changes in plasma corticosterone concentrations during the shorter flights can be considered as an absence of stress under the circumstances studied.

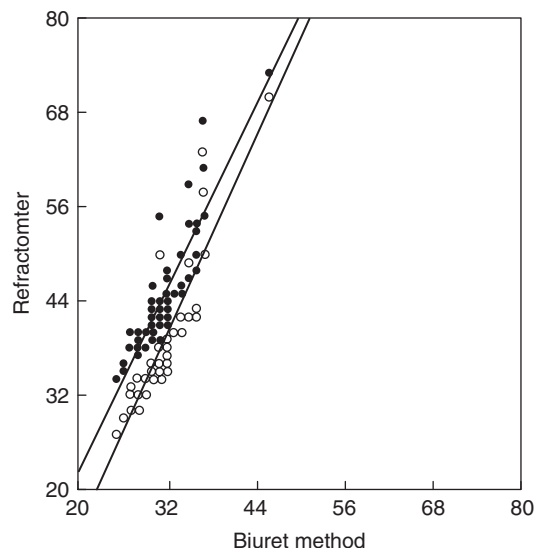
## IV. PLASMA PROTEINS

### A. Introduction

Plasma proteins are important complementary constituents in the diagnosis of gastrointestinal, hepatic, renal, or infectious diseases. Determination of plasma proteins seldom leads to a specific diagnosis (e.g., monoclonal gammopathies) but will help the clinician to evaluate the nature, severity, and progress of a disease.

### B. Plasma versus Serum

In pigeons, the concentration of total protein (TP) in plasma is about 1.5 g/L higher than in serum, because the former also contains fibrinogen:  $TP_{\text{serum}} = -1.7 + 1.01 TP_{\text{plasma}}$  (Fig. 28-4). According to Lumeij and McLean (1996), the correlation is highly significant ( $p < 0.000001$ ;  $R = 0.99$ ;  $n = 50$ ). Differences between plasma and serum were discussed in Section II.B. When plasma rather than serum is used, recognition of elevated fibrinogen concentration can be seen in the protein electrophoresis and is reflected by elevation of the acute phase ( $\alpha$  or  $\beta$ ) proteins (Roman *et al.*, 2005). See also Section XII.C.6.



**FIGURE 28-5** Relation between plasma total protein concentration by biuret method and two types of refractometers in pigeons (g/L;  $n = 58$ ). Symbols: ●, temperature compensated refractometer ( $y = -16.38 + 1.93 X$ ;  $r = 0.89$ ); ○, nontemperature compensated refractometer ( $y = -25.88 + 2.06 X$ ;  $r = 0.89$ ). From Lumeij and McLean (1996).

### C. Physiological Variation in Female Birds

In female birds, a considerable increase in plasma total protein concentration occurs just before egg laying because of an estrogen-induced increase in the globulin fractions (Griminger, 1976). The proteins are the yolk precursors (e.g., vitellogenin and lipoproteins), which are synthesized in the liver and transported to the ovary, where they are incorporated in the oocyte (Griffin *et al.*, 1984).

### D. Refractometry versus the Biuret Method

Lumeij and De Bruijne (1985b) demonstrated that the refractometric method is unreliable for use in avian blood and therefore this method should not be used in avian practice. The refractometric method consistently yields higher values when compared to total protein concentrations determined with the biuret method, and the correlation coefficient between these two methods is low. One study suggested that only temperature compensated refractometers are reliable (Andreasen *et al.*, 1989). In another study in our laboratory (Lumeij and McLean, 1996), using plasma and serum of 58 pigeons, two types of refractometers were compared with the biuret method. Neither instrument proved to give an accurate measurement of plasma total protein. Both refractometers gave considerably higher values than the biuret method, with the temperature compensated instrument being consistently higher in readings than the nontemperature compensated one (Fig. 28-5). It was concluded that a species- and refractometer-specific conversion factor must be applied before refractometric



values can be used, and then only as a rough estimate of the TP. Another important consideration is that TP determinations (refractometric or by biuret method) without information on plasma protein electrophoresis have limited value (see later discussion). For avian clinical practice, it is advised that the clinician establish TP values using the biuret method.

### E. Effect of Protein Standards

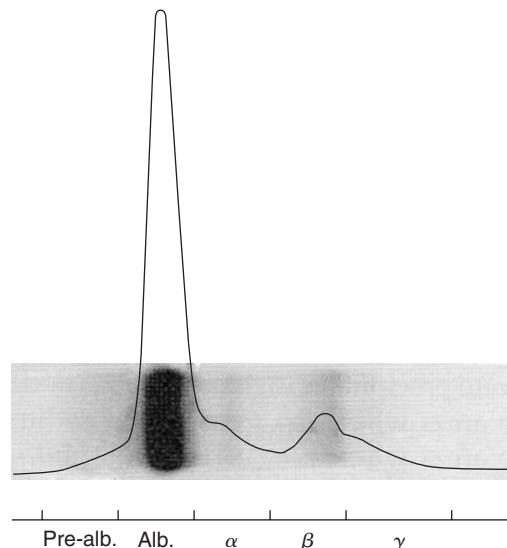
Most commercial laboratories use a human standard for TP and albumin (Alb) determinations, without validating the method for the species of which the blood sample is submitted. There are significant differences between TP concentrations when different standards are used (e.g., human, bovine, pigeon, and chicken standards), although there is a high correlation between the results obtained with the various standards (Lumeij *et al.*, 1990; Spano *et al.*, 1987,1988). When a pigeon standard was used to determine serum TP concentration (TP<sub>p</sub>) with the biuret method, values found were significantly higher compared to values found determined with the biuret method using the human standard (TP<sub>h</sub>), but there was a high correlation (Lumeij *et al.*, 1990):

$$TP_h = 2.94 + 0.83 TP_p \quad (P < 0.0001; r = 0.93)$$

Spano *et al.* (1987, 1988) found consistently lower TP values in chicken serum using a chicken standard compared with a bovine standard. Because the use of a species-specific standard for all species presented to the avian practitioner is unrealistic and because a high correlation exists between the results obtained with the various standards, it is recommended that clinicians establish reference values for the various species using the standard that is most commonly used in commercial laboratories (i.e., the human standard).

### F. Plasma Protein Electrophoresis: Albumin/Globulin Ratio

Plasma protein electrophoresis (PPE) on cellulose acetate membranes has been widely used in avian patients (Lumeij, 1987e; Lumeij and De Bruijne, 1985a). In many laboratories, agarose gel films are replacing cellulose acetate membranes. A good correlation ( $r = 0.998$ ) exists between these methods in human serum (Archer and Battison, 1997). Protein fractions that can be observed include Alb,  $\alpha$ ,  $\beta$ , and  $\gamma$  globulin. The  $\alpha$  and  $\beta$  globulins (including fibrinogen) are considered acute phase proteins, whereas the  $\gamma$  fraction is elevated in chronic conditions and includes the immunoglobulins. Often a prealbumin fraction can also be observed (Fig. 28-6). In healthy birds, the Alb fraction is the largest protein fraction. In acute or chronic inflammatory conditions, a rise in total protein caused by elevated globulin fractions may occur. Often Alb concentrations are

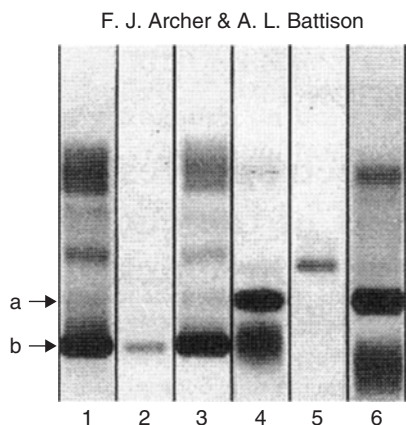


**FIGURE 28-6** Densitometer scan and electrophoretic pattern on a cellulose acetate membrane from a representative pigeon serum. Prealbumin, albumin,  $\alpha$ ,  $\beta$ , and  $\gamma$  globulin. Reprinted with permission from Lumeij and De Bruijne (1985a).

decreased in these situations. The combined effect of these changes is a decrease in the Alb/Globulin (A/G) ratio. Often the total protein concentration is within the reference range, whereas the A/G ratio is decreased, therefore the A/G ratio is of greater clinical significance than the total protein concentration. Examples of diseases with a decrease in the A/G ratio are egg related peritonitis and chronic infectious diseases such as aspergillosis, psittacosis, and tuberculosis. In ducks, Liu *et al.* (1984) found that serum globulin increased with the severity of pathological changes of amyloidosis and that the globulin was also found in the amyloidotic tissue. Protein electrophoresis can also be used to monitor response to treatment. In liver failure, extremely low plasma protein concentrations can occur in combination with a decreased A/G ratio. Gastrointestinal and renal diseases can also lead to severe hypoproteinemia. In birds, protein malnutrition may lead to hypoproteinemia (Leveille and Sauberlich, 1961). Increased TP concentrations with a normal A/G ratio can be expected in dehydrated birds if the primary disease did not cause hypoproteinemia. To calculate the A/G ratio, prealbumin and Alb as determined by plasma protein electrophoresis are combined as “A” and all globulin fractions as “G” (Figs 28-8 through 28-11; Lumeij, 1987e).

In plasma of some species, the mobility of Alb in cellulose acetate and agarose gels is less compared to the usual patterns, as seen, for example, in chickens and pigeons. In the cockatiel, for example, prealbumin migrates to a position equivalent to chicken albumin, and albumin to a position equivalent to chicken  $\alpha$  globulins (Fig. 28-7). Tatum *et al.* (2000) has confirmed the diagnostic value of PPE for a wide variety of raptor species.

Rosenthal *et al.* (2005a) questioned the reliability of PPE in birds. However, they limited their study to healthy



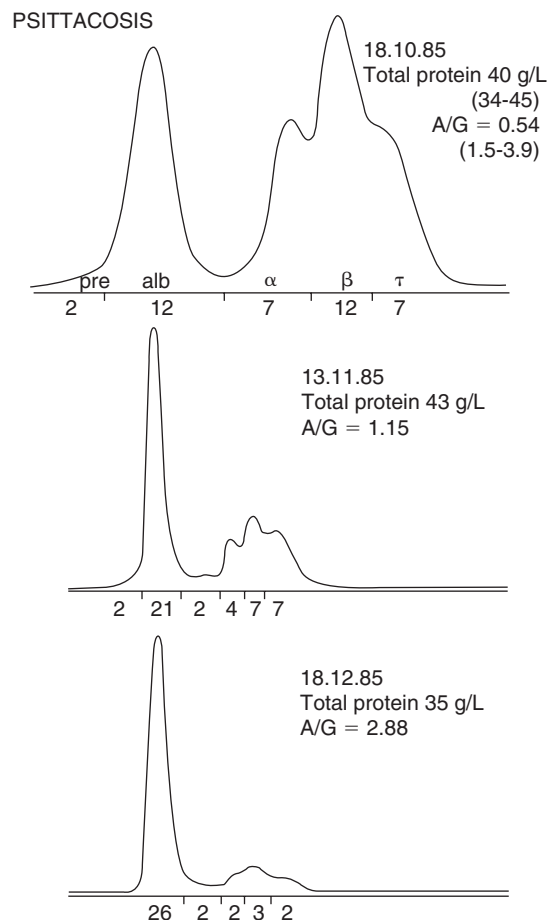
**FIGURE 28-7** Agarose gel electrophoresis. From left to right, chicken (*Gallus gallus domesticus*) serum (lane 1), purified chicken albumin (lane 2), chicken plasma (lane 3), cockatiel (*Nymphicus hollandicus*) plasma (lane 4), purified cockatiel albumin (lane 5), and cockatiel serum (lane 6). Chicken albumin (lanes 1, 2, and 3, band b) migrated further than cockatiel albumin (lanes 4 and 6, band a). Cockatiel albumin migration was similar to that of chicken  $\alpha$  globulins (lanes 1 and 3, band a), whereas cockatiel prealbumin migration (lanes 4 and 6, broad bands b) was similar to that of chicken albumin. Purification of cockatiel albumin (lane 5, single band) altered its migration pattern, whereas purification of chicken albumin (lane 2, single band b) did not have this effect. Reprinted with permission from Archer and Battison (1997).

birds, and their data did not span the full range of clinical values. Because values of individual globulin fractions in healthy birds are low and boundaries between the various globulin fractions are not clear, it is to be expected that large bias is introduced when an arbitrary (manual) distinction between the various globulin fractions has to be made (Cray, 2005; Rosenthal *et al.*, 2005b). Their study did, however, confirm the high reliability of determinations of TP and Alb, whereas measurement of  $\gamma$ -globulins had fair to good agreement. Determination of the A/G ratio as described earlier and visual inspection of the globulin fractions in case of abnormal values will leave no doubt on the fractions responsible for the abnormalities, as, for example, in the hyperglobulinemia reported by De Wit *et al.* (2003).

### G. Albumin Methodology

The labor-intensive PPE is not available in every laboratory, and Alb is commonly determined chemically by the brom-cresol green (BCG) dye-binding method. The BCG method is unreliable in avian blood. Discrepancies between values obtained by dye-binding techniques and those obtained by electrophoresis have been demonstrated for chicken, duck, turkey, and pigeon (Lumeij *et al.*, 1990; Spano *et al.*, 1987, 1988). In general, Alb determinations performed with dry methods have not been validated for use in birds.

Furthermore, various Alb standards can be used in different laboratories, although most commercial laboratories will use a human standard for TP and Alb determinations. The method used should have been validated for the species

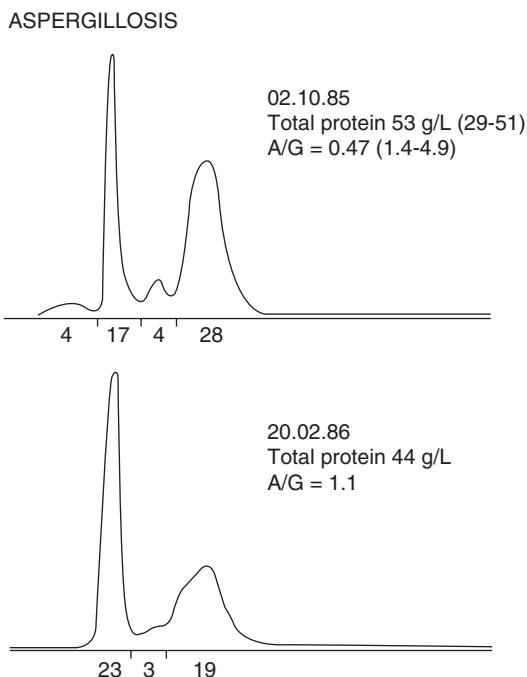


**FIGURE 28-8** Plasma protein electrophoresis and the albumin:globulin ratio (A/G) in an African grey parrot (*Psittacus erithacus erithacus*) with psittacosis, before, during, and after treatment with doxycycline. Symbols: Pre, prealbumin; alb, albumin;  $\alpha$ ,  $\beta$ ,  $\gamma$ , globulin fractions (reference values in parentheses). Reprinted with permission from Lumeij (1987e).

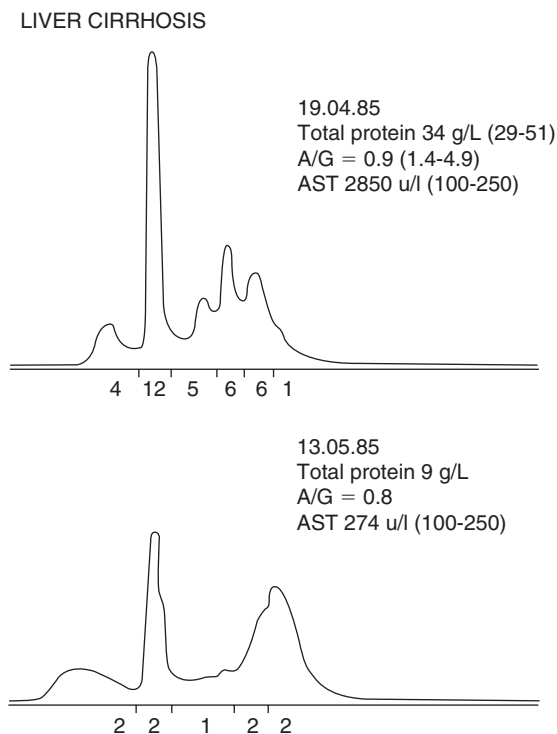
in question and compared with reference values established in the same laboratory.

### H. Prealbumin

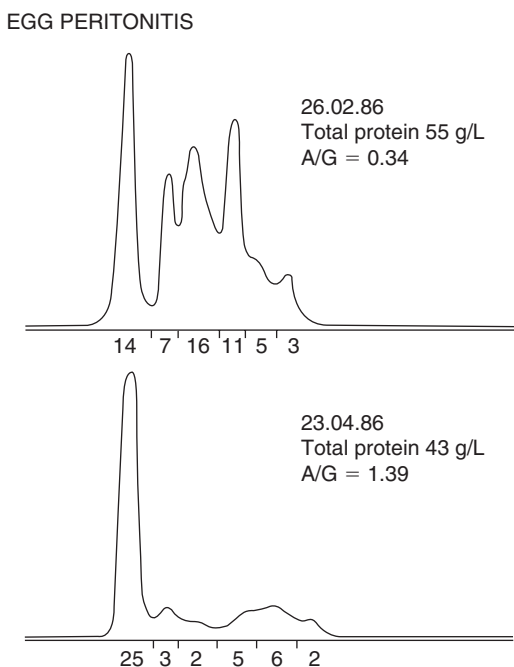
Prealbumin is the most rapidly migrating fraction in avian plasma and has been associated with binding thyroxine and retinol (thyroxine binding prealbumin-TBPA; transthyretin). Although the protein travels anodal to albumin in birds, primates, and the horse, it is usually not visualized in the last. In other species transthyretin travels cathodal to albumin or has the same motility to albumin, which explains the absence of a “prealbumin” fraction in these species using routine electrophoresis techniques (Chang *et al.*, 1999; Larsson *et al.*, 1985). Seasonally high concentrations of plasma transthyretin concentrations (150 to 200mg/L in May through July versus 80 to 100mg/L in September through January) have been associated with molting in storks (Cookson *et al.*, 1988).



**FIGURE 28-9** Plasma protein electrophoresis in an Amazon parrot (*Amazona* sp.) with aspergillosis. At 4½ months after a diagnosis was made and despite treatment with ketoconazole and 5-fluorocytosine, the globulin fraction was still elevated, causing the A/G ratio to decrease (reference values in parentheses). Reprinted with permission from Lumeij (1987e).



**FIGURE 28-11** Total protein concentration, plasma protein electrophoresis, albumin:globulin ratio (A/G), and plasma aspartate aminotransferase (AST) activity in an Amazon parrot (*Amazona* sp.). At the first examination there was a marked elevation of AST and decreased A/G. Liver cirrhosis was diagnosed by means of histological examination of a liver biopsy. The second protein electrophoresis was made from a plasma sample collected just before the bird was euthanized 1 month later. Reference values in parentheses. Reprinted with permission from Lumeij (1987e).



**FIGURE 28-10** Serum protein electrophoresis and albumin:globulin (A/G) ratio in an Emu (*Dromiceius novaehollandiae*) with an egg-related peritonitis. Two months after surgical treatment and remission of clinical signs, a marked increase in the albumin fraction and decrease of the globulin fraction was observed. Reprinted with permission from Lumeij (1987e).

## V. RENAL FUNCTION

### A. End Products of Protein Metabolism: Hyperuricemia and Gout

Uric acid (UA) is the major end product of nitrogen (N) metabolism in birds. It constitutes approximately 60% to 80% of the total excreted N in avian urine (Skadhauge, 1981). The formation of urea (UR) in pigeons occurs mainly through arginolysis (Bordel and Haase, 1998). Uricotelism permits excretion or storage of N waste in a small volume of water. UA is relatively nontoxic when compared to UR or ammonia (NH<sub>3</sub>), which is essential for the development of the embryo in the egg of reptiles and birds. UA is synthesized in the liver, and 90% is excreted via tubular secretion, largely independent of urine flow rate (Skadhauge, 1981). The clearance of UA exceeds the glomerular filtration rate by a factor 8 to 16. The rate of secretion is largely independent of the state of hydration. Very high concentrations of UA can be found in ureteral urine in dehydrated birds. Renal function disorders can eventually lead to elevated plasma UA concentrations. Nonprotein nitrogen (NPN) substances in plasma such as UA, creatinine (Cr), and UR will only

be elevated when renal function is below 30% of its original capacity. For elevated UA and UR during starvation and endurance flight see Sections III.B and III.C.

## B. Articular and Visceral Gout

Hyperuricemia can result in precipitation of monosodium urate monohydrate (MSUM) crystals in joints (articular gout) and on visceral surfaces (visceral gout). The exact mechanism of deposition or the predilection for certain sites is unknown, although lower temperatures at predilection sites have been suggested. Gout should not be regarded as a disease but as a clinical sign of any severe renal function disorder.

When birds are provided with dietary protein in excess of their requirements, the surplus protein is catabolized and the N released converted to UA. The total amount of UA formed may surpass the clearing capacity of this substance from the body and hyperuricemia, and articular gout may result. The use of high-protein poultry pellets as the bulk food in psittacines may result in an increased incidence of gout.

There is no consensus on the different etiologies of articular and visceral gout in birds. The following hypothesis, however, seems to explain all known facts about avian gout. A plasma UA concentration that is slightly above the solubility of MSUM will lead to UA precipitates in the body. Predilection sites are those areas where the solubility of MSUM is lower than in other areas. The joints and synovial sheaths may be predilection sites because of a comparatively low temperature. Articular gout is a sign of chronic moderate hyperuricemia. MSUM deposits grow with time with chronic hyperuricemia and form the typical tophi of articular gout.

If urates precipitate in the tubules or collecting ducts of the kidney or the ureters (e.g., severe dehydration of long duration, vitamin A deficiency), this will lead to an acute obstructive uropathy (postrenal obstruction). Anuria or gross oliguria and tubular secretion of UA are severely compromised. This leads to a rapid and severe increase in plasma UA with precipitation of urate crystals on many visceral surfaces and those predilection sites for articular gout. This condition of visceral gout will rapidly lead to death of the affected animal. This hypothesis is based on the fact that no inflammation or tophi are seen in typical predilection sites for articular gout, because the condition has a rapidly fatal course. There is no time for an inflammatory reaction or tophi to develop. In this situation, the kidney tubules, collecting ducts, and ureters may contain UA deposits. An alternative situation could occur in acute tubular failure. In this condition, visceral gout could develop without UA deposits in the tubules, collecting ducts, and ureters.

## C. Acute versus Chronic Renal Failure

Renal function disorders may result from any progressive destructive condition affecting both kidneys (chronic renal

failure), or from conditions wherein the function of the kidneys is rapidly and severely, but often reversibly, compromised (acute renal failure). In the latter condition, oliguria is usual, whereas in the former situation, polyuria is normally observed. It is important to differentiate between reversible conditions (e.g., prerenal renal failure caused by dehydration or shock of any cause, urolithiasis [postrenal renal failure] and acute nephritis) and chronic irreversible renal failure. Appropriate and timely treatment of acute renal failure can often prevent further damage and in some cases result in improved function. Extrarenal factors such as infection, gastrointestinal hemorrhage, and hypovolemia can disturb an otherwise stable, well-compensated asymptomatic chronic renal patient and precipitate a desperately dangerous condition.

## D. Prerenal Azotemia

Prerenal azotemia can be defined as the clinical condition associated with reduced renal arterial tension leading to oliguria and retention of nitrogenous waste products in the blood. It is often seen during shock or severe dehydration. No increased plasma UA concentrations were observed in 4-day dehydrated racing pigeons, whereas plasma UR concentration had a significant 6.5- to 15.3-fold increase. Plasma UR appeared to be the single most useful variable for early detection of prerenal causes of renal failure (Lumeij, 1987c). This is because UR is excreted by glomerular filtration, whereas tubular reabsorption is dependent on urine flow, which in turn depends on the state of hydration. During hydration, almost all of the filtered UR is excreted and during dehydration nearly all of the filtered UR is reabsorbed. The active tubular secretion of UA, on the other hand, is not dependent on arterial pressure, because the tubules of the reptilian type nephrons are supplied by venous blood through the renal portal system. The tubular reabsorption of UR in conditions of renal failure accompanied by a low urine flow (e.g., dehydration) in combination with a nearly unchanged tubular secretion of UA causes a disproportionate increase in plasma UR concentration, resulting in an elevated UR/uric acid ratio. Although potentially useful for judging the hydration status of a bird, UR is normally present in low concentration in avian plasma and has traditionally been considered an inappropriate variable to evaluate renal function in birds.

When the dehydration becomes more severe, this may eventually lead to hyperuricemia. This might be caused by reduced tubular blood supply which leads to reduced uric acid secretion. Urates may also precipitate in the tubules when there is active tubular secretion of UA in the absence of urine flow. The latter condition looks much like acute uric acid nephropathy in humans (Watts, 1978).

## E. Urea versus BUN

There is a great deal of confusion with respect to the conversion of urea ( $\text{CH}_4\text{N}_2\text{O}$ ) to blood UR nitrogen or "BUN." Apart

from the fact that BUN only refers to the nitrogen part of the UR molecule, in the United States it is often expressed in mg/dl, whereas in Europe UR is usually expressed in SI units (mmol/L). It is sad to see how reference values that were presented in the previous edition of this book were erroneously converted to American units in the *Journal of Veterinary Clinical Pathology* (Harr, 2002).

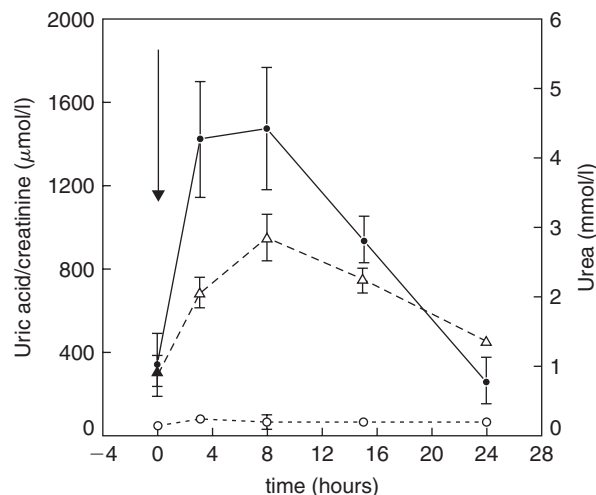
To convert BUN in mg/dl to urea in mmol/L, the following steps must be performed:

1. Convert BUN (mg/dl) to urea (mg/dl) by multiplying BUN with the quotient of the molecular mass of urea and the molecular mass of nitrogen in the urea molecule  $(12 + 4 \times 1 + 2 \times 14 + 16)/(2 \times 14)$ .
2. Convert urea (mg/dl) to urea (mmol/L) by dividing urea (mg/dl) by the molecular mass of urea (60).
3. Convert mg/dl to mg/L by multiplying the result by 10.

Or more simply: to convert BUN (mg/dl) to urea (mmol/L), divide BUN with total mass of nitrogen in urea molecule and multiply by 10  $(10/28) = 0.357$ . The conversion from UR (mmol/L) to BUN (mg/dl) is  $1/0.357 = 2.8$ .

## F. Postprandial Effects

In raptors, a significant postprandial increase in plasma UA and UR concentrations occurs (Lumeij and Remple, 1991, 1992). Postprandial UA was similar to that in birds with hyperuricemia and gout and was well above the theoretical limit of solubility of urate in plasma. It is not clear why under physiological conditions, no urate deposits occur in raptors, which have hyperuricemia for at least 12h after ingesting a natural meal (Fig. 28-12). A similar



**FIGURE 28-12** Fasting and postprandial nonprotein nitrogen substances in plasma of peregrine falcons, *Falco peregrinus* (mean  $\pm$  SD). Symbols: ●, [uric acid] ( $\mu\text{mol/L}$ );  $\Delta$ , [urea] (mmol/L); O, [creatinine] ( $\mu\text{mol/L}$ ); ↓, feeding quail. Reprinted with permission from Lumeij and Remple (1991).

effect was noted in the piscivorous blackfooted penguin (*Spheniscus demersus*) (Kolmstetter and Ramsay, 2000). To avoid physiological food-induced elevations in UA and UR that can complicate interpretation of plasma chemistry results in raptorial or piscivorous birds, blood samples should ideally be collected after a 24-h fasting period. In small passerines, this is obviously not an option!

## G. Other Changes Associated with Renal Failure

Hyperkalemia is a particular problem in acute renal failure that may lead to severe electrocardiographic changes and eventually to cardiac arrest. Hypocalcemia and hyperphosphatemia are usual in humans with renal failure. The former may lead to hypocalcemic tetany, especially with rapid correction of acidosis. In birds, special attention should be paid to these variables for further documentation of changes in renal disease because these changes may have therapeutic implications. Anemia has been documented in birds with chronic renal failure.

## H. Murexide Test

Macroscopically, the aspirated urates from articular gout look like toothpaste. The presence of urate can be confirmed by performing the murexide test or by microscopic examination of aspirates of tophi or joint accumulations. The murexide test is performed by mixing a drop of nitric acid with a small amount of the suspected material on a slide. The material is evaporated to dryness in a Bunsen flame and allowed to cool. Then one drop of concentrated ammonia is added. If urates are present, a mauve color will develop.

## I. Birefringent Crystals

Microscopically sharp needle-shaped crystals about the size of a leukocyte can be seen in smears of joint fluid from patients with articular gout. A polarizing microscope is helpful in identifying the typical birefringent crystals. Birefringent literally means splitting a ray of light in two. Crystals bend light and become visible in joint fluid when viewed through a microscope with crossed polarizing filters. When a compensator plate is used on the microscope, monosodium urate crystals parallel to the axis of the compensator appear yellow (negatively birefringent). In humans, pseudo-gout is diagnosed by finding positively birefringent calcium pyrophosphate dihydrate crystals that appear blue when parallel to the axis of the compensator. Calcium pyrophosphate dihydrate crystals are smaller and are rhomboid shaped.

## VI. HEPATOBILIARY DISEASE

### A. Clinical Enzymology

Clinical enzymology is described more fully in a separate chapter in this book, so only a brief synopsis is given here. Enzymes occur normally in the cytoplasm (e.g., aspartate aminotransferase [AST], alanine aminotransferase [ALT], lactic dehydrogenase [LDH]), mitochondria (glutamate dehydrogenase [GLDH] and AST), nucleus, or membranes (alkaline phosphatase [AP], gamma glutamyl transferase [GGT,  $\gamma$ GT]) of body cells, where they catalyze specific reactions. The distribution of various enzymes is markedly different among organs and animal species, which explains the variation in organ and tissue specificities among animal species. Generally, increased plasma enzyme concentrations indicate recent organ damage rather than decreased organ function. Increased enzyme production has been reported in cholestatic liver disease in mammals (AP and GGT). Sometimes a decreased activity is of diagnostic value (e.g., decreased cholinesterase activity in organophosphate toxicity). Baseline activity of an enzyme in plasma is generally a reflection of the amount and turnover of the tissue that contains this enzyme. For example, the creatine kinase (CK) activity in plasma increases in direct proportion to the increase of skeletal muscle mass as a result of training. Increases in CK may also be observed simply as a result of the muscle cellular damage associated with capture and restraint. Conversely, in chronic liver diseases with severe fibrosis and a reduction in the number of functional hepatocytes, plasma activities of liver enzymes may be within normal limits. The increase of a particular enzyme also depends on factors such as its rate of release, rate of production, and rate of clearance from plasma. Cytoplasmatic enzymes will be released early in cell degeneration, whereas mitochondrial enzymes will be released after advanced cell damage (necrosis). Enzymes with high tissue concentrations but with short elimination half-lives are of limited value in clinical enzymology because of their rapid disappearance from plasma.

Generally, EDTA samples are not appropriate for enzyme assays, because this anticoagulant may chelate metal ions, which are required for maximal enzyme activity. Plasma and cells should be separated immediately after sampling to prevent leakage of intracellular enzymes into the plasma. Even if the cellular elements are separated from the plasma, freezing/thawing and refrigeration of plasma samples for several days may severely decrease enzyme activity and therefore should be avoided unless the effects of the storage procedure used is known.

### B. Enzyme Activities in Avian Tissues

Enzyme profiles of the various organs have been studied in chickens, mallards, turkeys, racing pigeons, budgerigars

and African grey parrots (Lumeij 1994d; Figs. 28-13 through 28-15).

### C. Clearance of Enzymes from Plasma

The half-life of an enzyme is defined as the time required for its concentration to be reduced by half. When an enzyme is injected into plasma, its clearance from the plasma generally follows a biphasic exponential decline. Initially, there is a rapid decline, which is the primary mixing or distribution phase, followed by a slower secondary decline phase, which is the actual clearance of the enzyme from the plasma. During this secondary phase, a constant fraction of enzyme present is cleared per unit of time; hence, the decline is linear on a semilogarithmic scale. The  $(t_{1/2})_{\beta}$  half-life of the enzyme can be calculated from the regression function of the secondary linear phase of the semilogarithmic concentration-time curve and is independent of plasma enzyme activity.

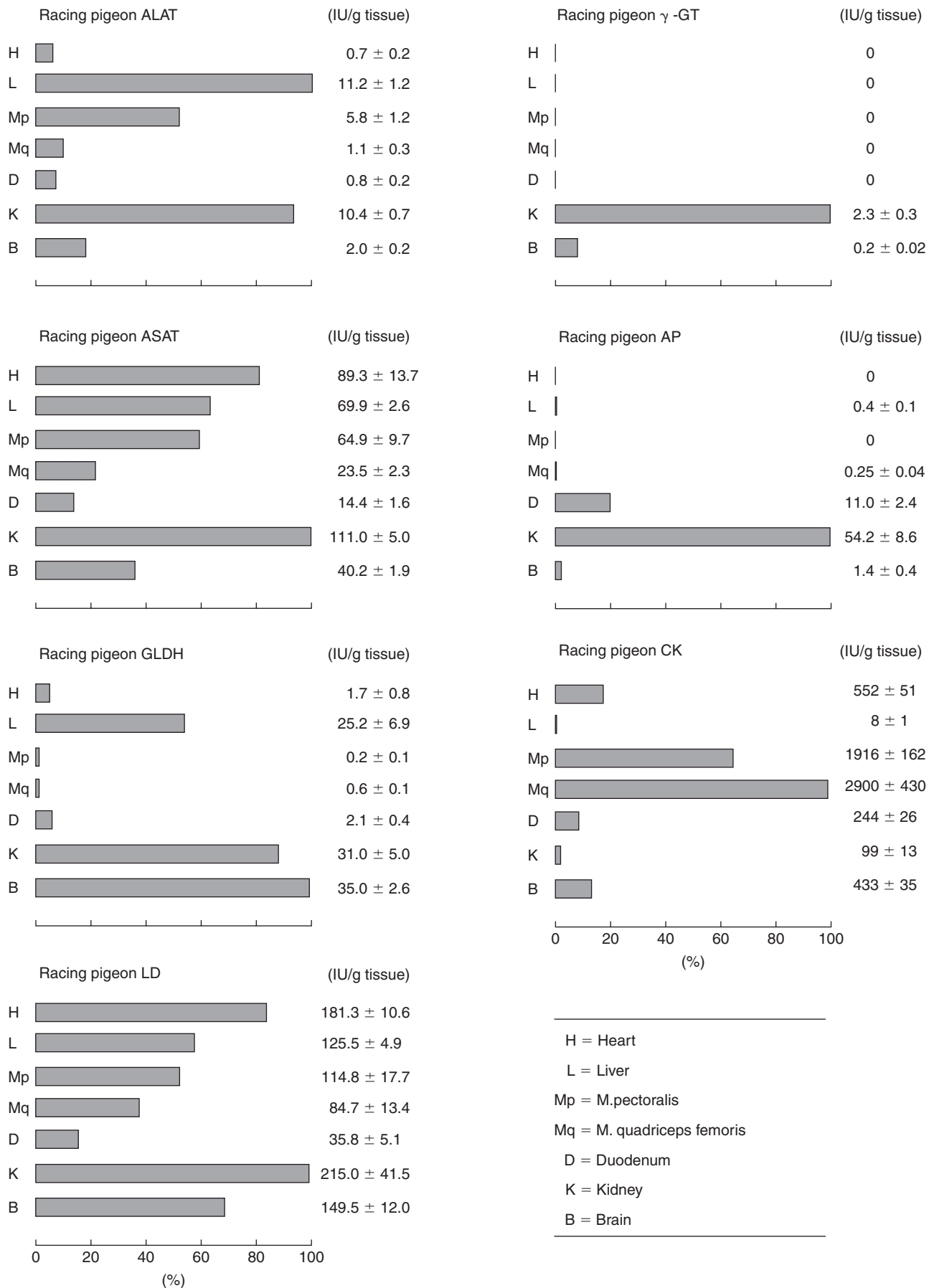
Clearance half-lives of various enzymes considered to be of use for the differential diagnosis of liver and muscle disease in pigeons have been established by studying the disappearance rates of enzymes from plasma after IV injections of supernatants of homologous liver and muscle homogenates (Lumeij *et al.*, 1988a). For AST, ALT, and LD, the half-lives of the respective enzymes from liver and muscle were compared, whereas for GLDH and CK, only liver and muscle were used, respectively (Table 28-1).

### D. Experimentally Induced Liver and Muscle Disease

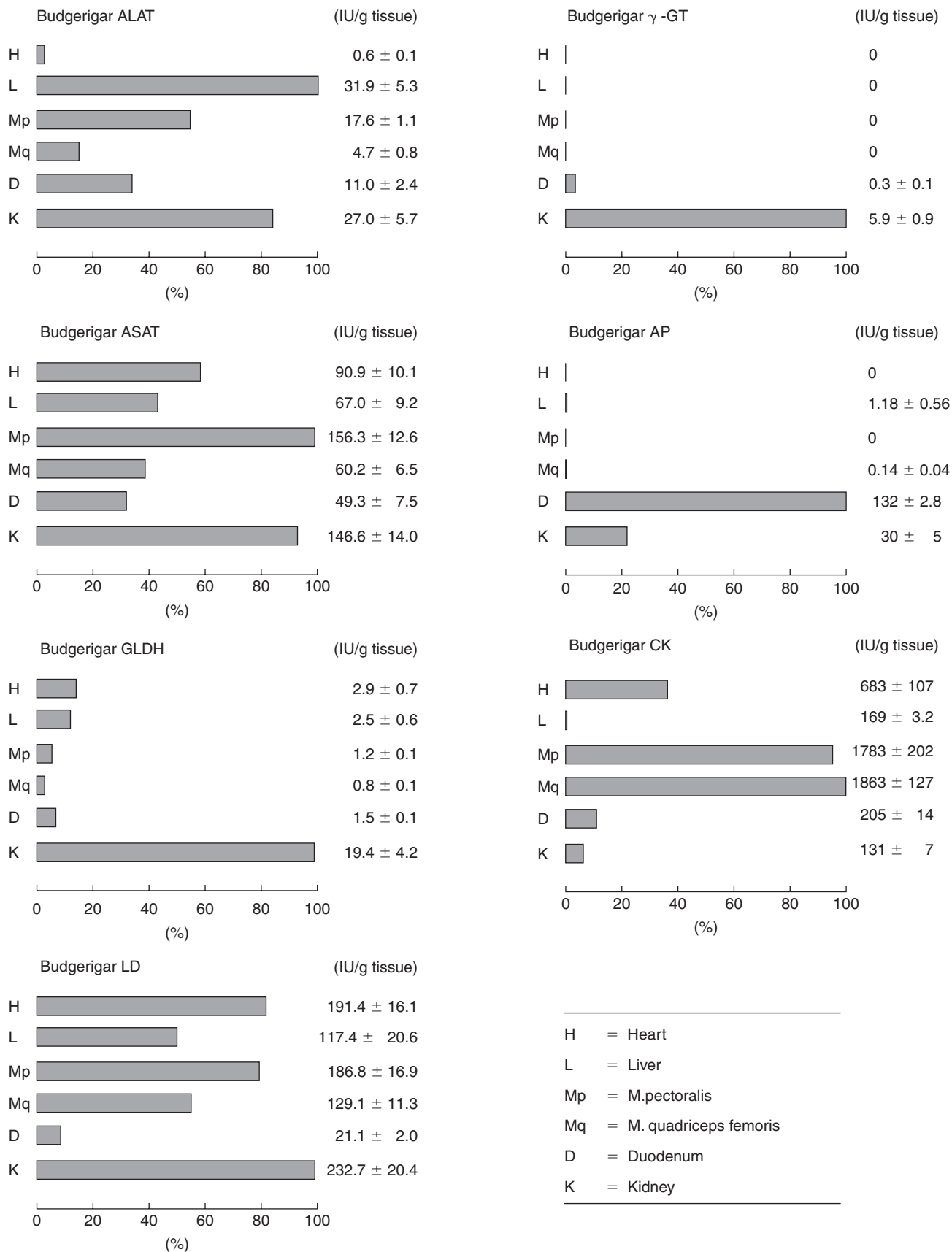
Plasma enzyme profiles after experimentally or spontaneously occurring liver disease have been studied in a number of avian species. The results of studies in racing pigeons (Lumeij *et al.*, 1988a, 1988b) with two different types of liver disease were compared to plasma chemistry changes after muscle injury. Liver disease was induced by ethylene glycol or D-galactosamine, and muscle injury was induced by an intramuscular injection of doxycycline in three groups of six pigeons each. Plasma chemical changes were correlated with histological findings from organ samples taken just after the last blood collection (Fig. 28-16, Table 28-2).

Plasma AST activity and bile acid (BA) concentration were the most sensitive indicators of liver disease in the racing pigeon, followed by ALT, GGT, and LD. Although all pigeons with histological proven ethylene glycol- or galactosamine-induced liver damage had increased AST activity and BA concentrations in their plasmas, these constituents were not raised at every sampling time. Increased plasma GLDH activities were associated with large necrotic areas in the liver. Moderate necrosis of liver cells resulted in slightly elevated GLDH activities. Degeneration



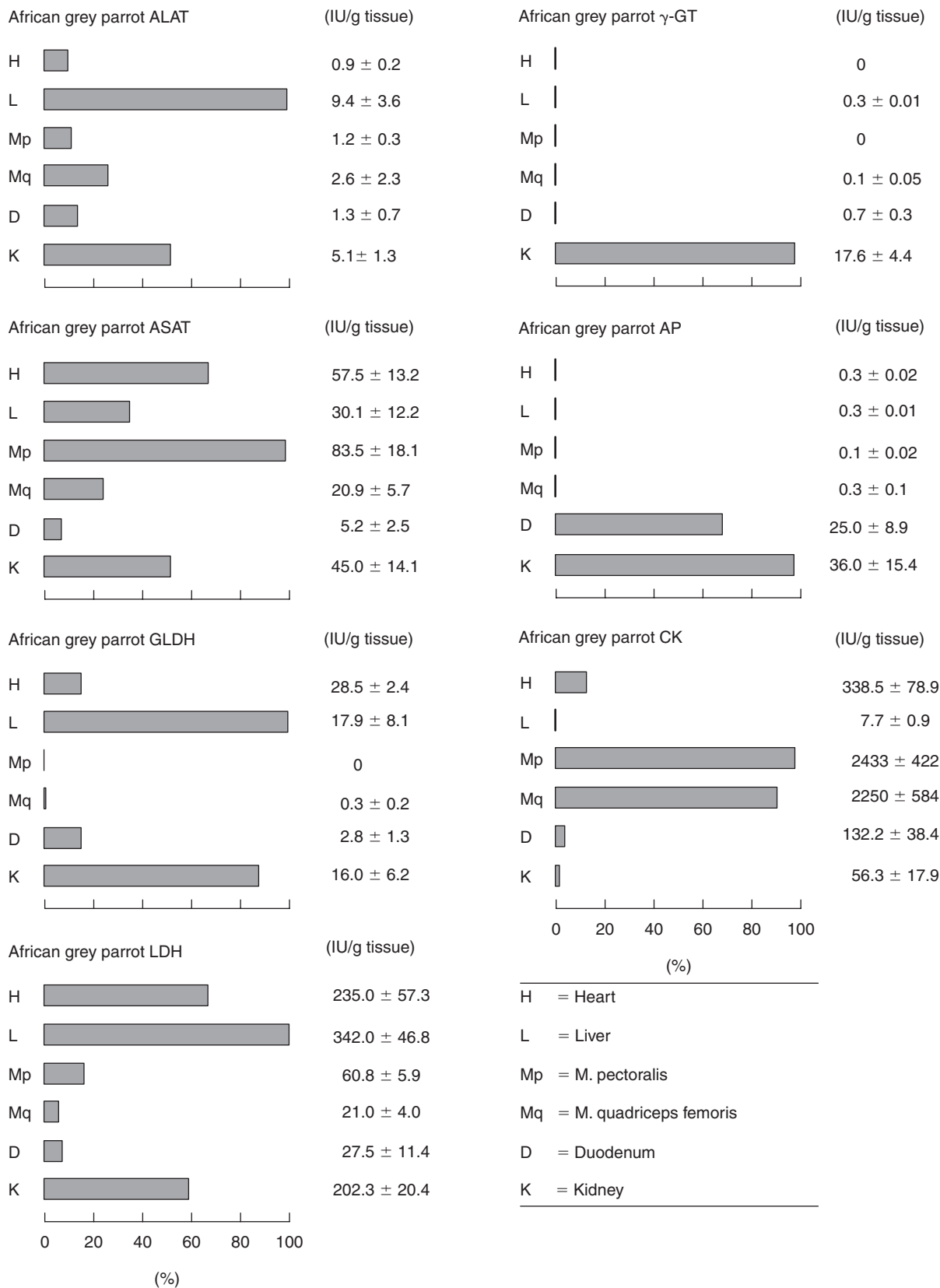


**FIGURE 28-13** Relative distribution of various tissue enzymes in supernatants of pigeon tissue homogenates. Mean ± SEM, U/g wet tissue, n = 6. Reprinted with permission from Lumeij *et al.* (1988a).



**FIGURE 28-14** Relative distribution of various tissue enzymes in supernatants of tissue homogenates from the budgerigar, *Melopsittacus undulatus*. Mean ± SEM, n = 7, U/g wet tissue. Reprinted with permission from Lumeij and Wolfswinkel (1987).



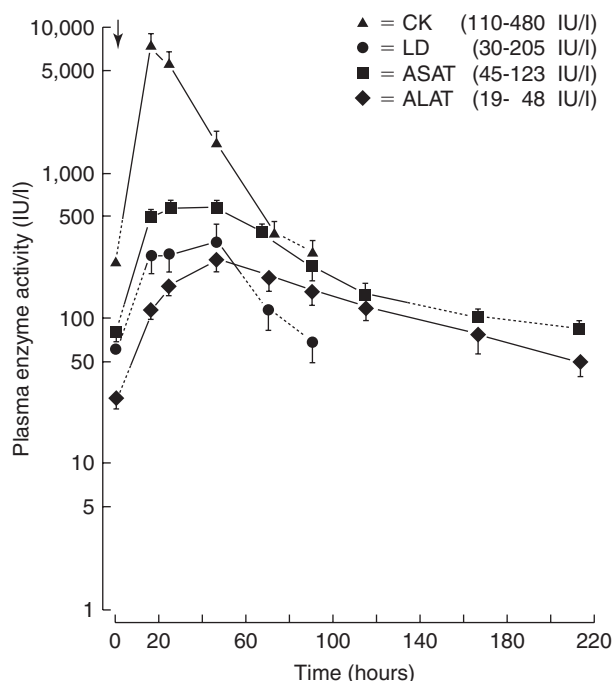


**FIGURE 28-15** Relative distribution of various tissue enzymes in supernatants of tissue homogenates from the African grey parrot, *Psittacus erithacus*. Mean ± SEM, U/g wet tissue. Reprinted with permission from Lumeij (1994d).

**TABLE 28-1** Mean ( $\pm$ SD)  $t_{1/2\beta}$  in Plasma of IV Injected Homologous Enzymes in the Racing Pigeon (n = 6)

Source	Enzyme	$t_{1/2\beta}$ (hours)	Regression Function	SD of Slope	r
Liver	AST	7.66 $\pm$ 1.55	$\log y = 2.6 - 0.04 x$	0.008	0.9711
	ALT	15.69 $\pm$ 1.70	$\log y = 2.1 - 0.02 x$	0.002	0.9455
	LD	0.71 $\pm$ 0.10	$\log y = 3.5 - 0.44 x$	0.065	0.9901
	GLDH	0.68 $\pm$ 0.17	$\log y = 2.3 - 0.46 x$	0.150	0.9964
Muscle	AST	6.51 $\pm$ 0.83	$\log y = 2.7 - 0.05 x$	0.007	0.9652
	ALT	11.99 $\pm$ 1.32	$\log y = 2.7 - 0.03 x$	0.003	0.9712
	LD	0.48 $\pm$ 0.07	$\log y = 4.0 - 0.60 x$	0.119	0.9882
	CK	3.07 $\pm$ 0.59	$\log y = 3.7 - 0.10 x$	0.019	0.9652

Reprinted with permission from Lumeij *et al.* (1988a).



**FIGURE 28-16** Mean ( $\pm$ SEM) plasma enzyme activities after intramuscular injection of 75 mg/kg doxycycline (Vibramycin<sup>®</sup>-Pfizer, New York) in six racing pigeons. The parts of the curves that are above the reference range are indicated with continuous lines. Variables that did not show elevations above the reference range during the entire experiment (GLDH, AP, and bile acids) are not indicated. On histological examination at  $t = 215$ h, degeneration and necrosis of muscle cells was observed. Reprinted with permission from Lumeij *et al.* (1988b).

of liver cells and hepatitis with single-cell necrosis did not give rise to elevated plasma GLDH activities. Plasma CK activity was never increased because of liver damage, whereas GLDH, GGT, and BA were never elevated during muscle damage. Thus, these four constituents are useful for differentiating between liver and muscle disease. GLDH is the most liver-specific enzyme in the racing pigeon. Because GLDH is localized within the mitochondria of the liver cells, increased plasma GLDH activities, however, are only observed after liver cell necrosis.

The enzymes that are the most specific indicators of muscle and liver cell damage (CK and GLDH, respectively)

have shorter half-lives than AST and ALT, which are not specific indicators of damage to either organ. Thus, after muscle or liver cell damage, AST and ALT activities in plasma can be increased, even though CK or GLDH activities have returned to baseline values. The fact that LDH has a shorter half-life than CK makes this enzyme valuable for differentiating between muscle and liver disease in the pigeon. When plasma LDH activity is increased in the absence of elevated CK activity, muscle damage is unlikely. Enzyme profiles can only serve as rough guides to interpretation of elevated plasma enzyme activity and are not characteristic for a particular organ. The most important reason is that the enzyme profile alters after enzymes have entered the circulation resulting from different removal rates for the various components.

Based on the tissue enzyme studies, it seemed that LD was the most sensitive indicator of liver cell damage, whereas ALT, because of its low activity in liver, would be of limited value. It also seemed that LDH would be a more sensitive indicator of muscle cell damage than ALT. Experimentally induced liver and muscle damage, however, demonstrated that ALT activity in plasma is increased sooner than LDH activity. The relative increase of ALT was also larger than that of LDH, except in severe liver cell damage accompanied by large areas of necrosis. Plasma ALT activities were increased for a longer period after organ damage compared to LDH. These findings can be explained by differences between their clearance half-lives. The clearance half-life of LDH is 15 to 30 times less than that of ALT.

Campbell (1986) reported increased AST and ALT activities in 75% of pigeons with aflatoxin B1-induced liver damage and increased LDH activities in 33%. In addition, AP and GGT were not sensitive indicators of liver disease in pigeons, cockatiels, red-tailed hawks, and great horned owls. With the exception of GGT, these findings were confirmed by Lumeij *et al.* (1988a, 1988b). The discrepancy might reflect the difference in the hepatotoxic agents used. In the study of Lumeij *et al.* (1988a, 1988b), GGT activities were increased in the majority of pigeons with experimentally induced liver disease, though

**TABLE 28-2** Summary of Specificity and Sensitivity of Plasma Chemical Variables in Liver and Muscle Disease Based on Experimental Studies in Pigeons by Lumeij *et al.* (1988a, 1988b)

Variable	Liver disease		Muscle disease	
	Specificity	Sensitivity	Specificity	Sensitivity
Bile acids	+++	+++	—	—
GGT	+++	+	—	—
AST	—	+++	—	+++
ALT	—	++	—	+++
AP	—	—	—	—
CK	—	—	+++	+++
LD	—	+	—	+
GLDH	+++	(+) <sup>a</sup>	—	—

<sup>a</sup>Elevated GLDH activity is a sign of extensive liver cell necrosis, as GLDH is a mitochondrial and not a cytoplasmic enzyme. Liver cell degeneration will not cause elevated GLDH activities. In the budgerigar (*Melopsittacus undulatus*), GLDH activity in liver tissue is relatively low when compared to humans and most of the domestic animals including cockerel, duck, turkey, and pigeon (Lumeij and Wolfswinkel, 1987). However, in Amazon parrots with extensive liver necrosis as a result of Pacheco's disease, elevated GLDH activities were observed in plasma, which indicates that this variable is also useful in at least some of the psittacine species (Lumeij, unpublished observations).

no GGT activity could be detected in supernatants of liver tissue homogenates. This might be explained by synthesis of GGT during (cholestatic) liver diseases, as has been reported in mammalian species (Kaplan and Righetti, 1969; Kryszewski *et al.*, 1973). Phalen *et al.* (1997) found that 5/5 Amazon parrots with bile duct carcinoma showed increased GGT activities and suggested that GGT may prove a valuable tool for early detection and staging of bile duct carcinomas.

In birds, increased AP activities are predominantly associated with increased osteoblastic activity, such as skeletal growth, nutritional secondary hyperparathyroidism, rickets, fracture repair osteomyelitis, as well as impending ovulation (Lumeij and Westerhof, 1987) (see Section VIII.E). Increased plasma AP associated with liver disease in birds is rare (Ahmed *et al.*, 1974). In the experimental studies from Lumeij *et al.* (1988a, 1988b), AP and CK were never elevated after liver cell damage, whereas activities of these enzymes in liver tissue were negligible. Increased activities of liver enzymes in plasma may indicate recent damage to liver cells but do not give information on liver function. In end-stage liver disease (cirrhosis), it is possible to have normal activities of liver enzymes in the plasma, because active damage to liver cells has ceased (e.g., Fig. 28-11).

In psittacine birds, the use of a good anamnesis and plasma AST is sufficient to make a tentative diagnosis of liver disease. When birds are known to have been recently injected intramuscularly, elevated AST (and ALT) activity should be interpreted with caution. Including a plasma constituent that specifically gives information on liver function, for example, total bile acids, has proven to be of great value. When liver disease is suspected, a biopsy of this organ is essential to establish a definite diagnosis.

## E. Bile Pigments

The excretion of green urates suggests liver disease in birds (Galvin, 1980; Lothrop *et al.*, 1986; Steiner and Davis, 1981). This discoloration is caused by biliverdin, which is the most important bile pigment in birds (biliverdinuria). Icterus or jaundice, which is caused by a hyperbilirubinemia, is seen infrequently in birds. When in chickens both bile ducts are ligated the concentration of plasma bile pigments rises immediately but stabilizes after 2 weeks at about 85  $\mu\text{mol/L}$ , which is a much lower concentration than in mammals with total biliary obstruction. In sera of healthy ducks, low levels of bilirubin may be detected and significantly elevated levels have been reported after experimental duck virus hepatitis infection. However, the observed levels of about 17  $\mu\text{mol/L}$  were well below the serum concentration of 34 to 51  $\mu\text{mol/L}$ , which has been mentioned as the level above which jaundice becomes apparent in humans. The infrequent occurrence of icterus in birds is explained by the absence of biliverdin reductase, which converts biliverdin to bilirubin (Lin *et al.*, 1974; Lind *et al.*, 1967; Tenhunen, 1971). It has been suggested that in birds biliverdin may be converted to bilirubin by bacteria or nonspecific reducing enzymes (Lewandowski *et al.*, 1986). A yellow discoloration of avian plasma is often caused by the presence of carotenoids, which is often misinterpreted as being icteric.

## F. Bile Acids

Plasma bile acids (BA) and their salts are formed in the liver from cholesterol and are excreted in the intestine, where they assist in digestion of lipids. There is a continuous secretion of bile in both birds with and without a gallbladder.

This is slightly increased postprandially because of the intrahepatic effects of intestinal hormones like secretin, avian vasoactive intestinal peptide (VIP), or cholecystokinin (CCK). The sites of the increased bile secretion and the regulatory mechanism are unknown (Lumeij, 1991). Via the enterohepatic recirculation, over 90% is reabsorbed in the jejunum and ileum (Hill, 1983). Plasma BA concentrations including their salts and corresponding glycine and taurine conjugates are a reflection of the clearing capacity for BA of the liver. All liver functions such as extraction, conjugation, and excretion are involved in this process, and the BA provides information on the combined effects of these functions. The plasma concentration of BA is a sensitive and a specific indicator of liver function, and it is widely used in humans and domestic animals, including birds (De Bruijne and Rothuizen, 1988; Hoffmann *et al.*, 1987; Lumeij, 1988; Rutgers *et al.*, 1988). Reference values for BA have been established for the racing pigeon, the most commonly kept psittacine species (Lumeij and Overduin, 1990; Lumeij and Wolfswinkel, 1988), ostriches, and peregrine falcons (Table 28-3). Lumeij (1987f) found that BA was the single most useful plasma constituent for detecting liver function disorders in the racing pigeon, where it is both specific and sensitive, the main advantage over AST being that the latter is not liver specific. In experimental liver disease, a 5- to 10-fold increase of BA over the upper limit of the reference range is common.

### G. Postprandial Effects

There is a significant postprandial increase in BA in granivorous birds, with and without a gallbladder (Lumeij, 1991), as well as in carnivorous birds (Fig. 28-17; Lumeij and Remple, 1992). Although up to a 4.5-fold postprandial increase of BA was observed in individual birds, the concentrations were never increased more than 1.65 fold over the upper limit of the reference range, whereas in hepatobiliary disease 5- to 10-fold increases are common (Lumeij *et al.*, 1988a). Even though postprandial increases might complicate interpretation of BA, differentiation between postprandial increases and increases that result from hepatobiliary disease is possible. Experimental findings suggest that values  $>70 \mu\text{mol/L}$  in fasted racing pigeons and values  $>100 \mu\text{mol/L}$  postprandially should be considered increased and suggestive for hepatobiliary disease.

### H. Plasma Ammonia: Hepatoencephalopathy

A tentative diagnosis of hepatoencephalopathy is often made when neurological signs are observed in birds with liver disease. The syndrome, however, has not been well documented in birds. In mammals, hepatoencephalopathy and hepatic coma are most often observed in portosystemic

shunting in which portal blood and its ammonia are shunted away from the liver. Hepatoencephalopathy is not a disease in itself, except for the anatomical anomaly, but a medical condition characterized by neurological symptoms caused by intoxication of the brain by products of protein digestion, namely ammonia ( $\text{NH}_3$ ). Most likely, degradation products from protein act as false neurotransmitters. Protein-rich foods often trigger neurological symptoms in these patients. Fasting plasma  $\text{NH}_3$  levels and plasma  $\text{NH}_3$  levels 30min after oral loading with  $\text{NH}_4\text{Cl}$  in the form of the  $\text{NH}_3$  tolerance test (ATT) can be used to establish the ability of the liver to convert  $\text{NH}_3$  into UR. Fasting plasma  $\text{NH}_3$  in healthy psittacines ranged from 36 to  $274 \mu\text{mol/L}$ , which is well above the fasting concentrations reported in dogs (Lumeij and Peccati, 1993). Furthermore, some avian species will normally have up to an 8-fold increase of plasma  $\text{NH}_3$  concentration on the ATT using the canine protocol. Therefore, an abnormal ATT is not diagnostic for portosystemic shunting in birds (Lumeij and Peccati, 1993).

### I. Exogenous Markers

The hepatic clearance of exogenous drugs or compounds plays a central role in the diagnosis and monitoring of hepatic disease in humans, but so far it has received little attention in avian diagnostics. Jaensch *et al.* (2000a) performed galactose and indocyanine green clearance assays in normal chickens and following celiotomy and compared values with those after 13% hepatectomy. Partial hepatectomy resulted in elevation of galactose single point concentrations, but, paradoxically, galactose clearance values did not alter significantly. Partial hepatectomy did not alter clearance values of indocyanine green.

In galahs (*Eolopus roseicapillus*) a significant reduction in galactose clearance and galactose clearance as a function of body surface area (GEC-SA) was observed after 18% hepatectomy, compared to no reduction after celiotomy alone or 6% hepatectomy. Although galactose single-point concentrations did not elevate significantly, they were strongly correlated with galactose clearance and GEC-SA values (Jaensch *et al.*, 2000b).

Further work is needed in birds to explore the potential of galactose clearance for use as a noninvasive method to monitor hepatic function.

### J. Iron Storage Disease

A distinction should be made between hemosiderosis, which includes a range of disorders that lead to a buildup of iron pigment in hepatic tissue, and hemochromatosis, which is a genetic disorder in humans and possibly other species. There is no conclusive evidence that hemosiderosis has any clinical significance in birds, with the possible exception of the hemochromatosis syndrome in the Indian hill mynah

**TABLE 28-3** Plasma Chemistry Reference Values (Inner Limits of P<sub>2.5</sub> to P<sub>97.5</sub> with a Probability of 90%, Unless Specified Otherwise in Footnotes ) for Pigeons, Some Psittacine Species, Peregrine Falcon, and Ostrich as Established by the Division of Avian and Exotic Animal Medicine, Utrecht University Department of Clinical Sciences of Companion Animals<sup>a,g</sup>

Variable	Ostrich (n = 60)	Peregrine falcon (n = 79)	Pigeon (n = 50)	African grey (n = 71)	Amazon (n = 99)	Cockatoo (n = 27)	Macaw <sup>f</sup> (n = 15)
Urea (mmol/L)	0.5–0.8	0.8–2.9	0.4–0.7	0.7–2.4	0.9–4.6	0.8–2.1	0.3–3.3
Creatinine (μmol/L)	/	24–64	23–36	23–40	19–33	21–36	20–59
Uric acid (μmol/L)	351–649	253–996	150–765	93–414	72–312	190–327	109–231
Urea/uric acid ratio	0.9–1.8	1.7–6.4	1.8 ± 1.8 <sup>b</sup>	2.4–15.6	4.4–33	2.7–8.9	5–28
Osmolality (mOsmol/kg)	305–328	322–356	297–317	320–347	316–373	317–347	319–378
Sodium (mmol/L)	147–157	150–170	141–149	154–164	149–164	152–164	150–175
Potassium (mmol/L)	3.7–5.1	/	3.9–4.7	2.5–3.9	2.3–4.2	3.2–4.9	1.9–4.1
Chloride (mmol/L)	94–105	114–131	101–113	/	/	/	/
Total calcium (mmol/L) <sup>d</sup>	2.4–4.8 <sup>d</sup>	1.9–2.4 <sup>d</sup>	1.9–2.6 <sup>d</sup>	2.1–2.6 <sup>d</sup>	2.0–2.8 <sup>d</sup>	2.2–2.7 <sup>d</sup>	2.2–2.8 <sup>d</sup>
Ionized calcium <sup>d</sup> (mmol/L)			1.32–1.39 <sup>d</sup>	1.35–1.68 <sup>d</sup>			
Phosphorous (mmol/L)	1.3–2.3	0.55–1.53	0.57–1.33	/	/	/	/
Glucose (mmol/L)	10.3–13.7	16.5–22.0	12.9–20.5	11.4–16.1	12.6–16.9	12.8–17.6	12.0–17.9
LDH (IU/L) EC 1.1.1.27	860–2236	1008–2650	30–205	147–384	46–208	203–442	66–166
GLDH (IU/L) EC 1.4.1.3	<8	<8	<8	<8	<8	<8	<8
GGT (IU/L) EC 2.3.2.2	<1–1	<1–3	<1–3	1–4	1–10	2–5	<1–5
AST (IU/L) EC 2.6.1.1	243–418	34–116	45–123	54–155	57–194	52–203	58–206
ALT (IU/L) EC 2.6.1.2	/	29–90	19–48	12–59	19–98	12–37	22–105
CK (IU/L) EC 2.7.3.2	1648–4246	120–442	110–480	123–875	45–265	34–204	61–531
α-amylase (IU/L) EC 3.2.1.1	/	/	382–556 <sup>f</sup>	571–1987 <sup>d</sup>	/	/	/
Lipase (IU/L) EC 3.1.1.3	/	/	0–5 <sup>f</sup>	268–1161 <sup>d</sup>	/	/	/
Bile acids (μmol/L)	8–33	5–69	22–60	18–71	19–144	23–70	25–71
Total protein (g/L)	39–56	24–39	21–35	32–44	33–50	35–44	33–53
Albumin/globulin ratio	0.9–1.4	0.8–2.4	1.5–3.6	1.4–4.7	2.6–7.0	1.5–4.3	1.4–3.9
Thyroxine (nmol/L) before and 16 h after stimulation with 2 IU/kg TSH			6–35 100–300	/	/	/	/
Corticosterone (nmol/L) before and 90 min after stimulation with 250 μg/kg ACTH			6–36 <sup>e</sup> 64–324 <sup>e</sup>	/	16–39 <sup>e</sup> 108–506 <sup>e</sup>	/	/
AVT (pg/ml) before and after 24-h water deprivation			1.7 ± 1.4 <sup>b</sup> 6.3 ± 2.2 <sup>b</sup>	/	/	/	/

<sup>a</sup> Lumeij 1987f; Lumeij & Overduin 1990; Lumeij & Westerhof 1988a; Lumeij et al., 1987a; Verstappen et al., 2002; unpublished results from Lumeij, Remple, Riddle, 1995; Van der Horst 1995; Westerhof 1995.

<sup>b</sup> Mean ± standard deviation (n = 6).

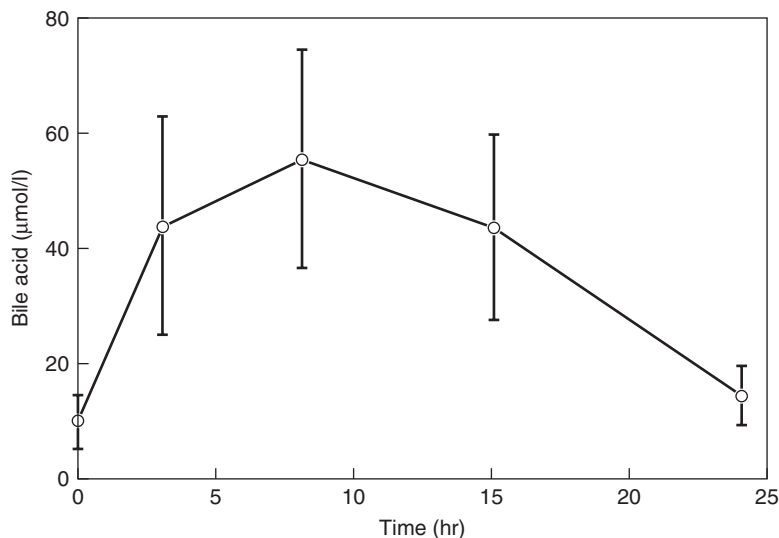
<sup>c</sup> Range

<sup>d</sup> These Ca values might be too low because they were established in nonbalanced heparin tubes; see Section VIII.A. Preliminary data from our clinic from a group of 20 pellet-fed African grey parrots established in blood samples collected with balanced Pico syringes (Radiometer, Copenhagen) suggest that the reference values for tCa values in this species are 2.6 to 3.4 mmol/L and those for iCa are 1.35–1.68 mmol/L. Histological changes in the parathyroid gland consistent with nutritional secondary hyperparathyroidism were observed in individuals with tCa values between 2.1 and 2.6 mmol/L.

<sup>e</sup> Range (n = 6).

<sup>f</sup> Amann et al. (2006).

<sup>g</sup> It is recommended that clinicians use reference values established in the same laboratory and with the same methods as used for the patient under investigation. Furthermore, reference values based on the individual patient may help to improve diagnostic interpretation of clinical chemistry values because clinical chemistry values in birds have a high degree of individuality, measured by the index of individuality (Scope et al. 2002a).



**FIGURE 28-17** Plasma bile acid concentrations (mean  $\pm$  SD) in peregrine falcons, *Falco peregrinus* ( $n = 6$ ) after a 42-h fasting period and 3, 8, 15, and 24 h after birds were fed a complete skinned quail, *Coturnix coturnix*, at 0 h. Values at 3, 8, and 15 h are significantly different from values at 0 and 24 h ( $p < 0.05$ ). Reprinted with permission from Lumeij and Remple (1992).

(*Gracula religiosa*) and toucans (*Rhamphastos* spp.). In these species, hemochromatosis is often associated with hepatic fibrosis, but the causal relation has not been confirmed.

Hemosiderosis should be considered in the differential diagnosis of avian hepatopathy. Diagnostically, determination of blood iron concentrations is not reliable. There is, however, a positive correlation between the concentration of stainable iron determined by image analysis of histological sections and biochemically determined liver iron concentration. For a review, see Cork (2000).

### K. Clinical Diagnosis of Liver Disease

The index of suspicion of liver disease can be raised by the use of physical examination, plasma chemistry (enzymes, BA, TP, and PPE, galactose clearance test, and ultrasonography). However, to make a specific diagnosis, liver biopsy is the only method currently available (Lumeij, 1994a).

## VII. MUSCLE DISEASE

Muscle enzyme profiles, half-lives of these enzymes in plasma, and plasma chemistry changes after experimentally induced muscle damage have been reported for racing pigeons (see Section VI.B). Enzyme profiles were studied for pectoral muscle, quadriceps muscle, and heart in pigeons and parrots (Fig. 28-13). Creatine kinase (CK) was the most important enzyme in these three muscles, followed by LDH, AST, and ALT. Muscle damage was induced by injection of doxycycline in the pectoral muscle in pigeons (Fig. 28-16). Creatine kinase activity in plasma was markedly elevated (about 20-fold) 16 h after injection. However, within 66 h plasma activities of CK had returned to the maximum value of the reference range. LD activities were only slightly elevated (about twofold) and only for about 40 h. AST activities showed a marked increase (about fourfold) for about 140 h, whereas ALT showed a

marked increase (about fivefold) for about 214 h. Despite the fact that ALT activities in individual muscles are low, elevated plasma activities of this enzyme can be seen until 9 days after muscle damage. Plasma CK activities, on the other hand, return to within the reference range within 3 days after muscle damage, despite high tissue activities. LDH appeared to be a relatively poor indicator of muscle cell damage, despite relatively high activity of this enzyme in muscle (Fig. 28-16). These findings can be explained by the differences in elimination half-lives of the respective enzymes (LDH 50 min, CK 3 h, AST 7 h, ALT 12 h; Tables 28-1 and 28-2).

Not all elevated concentrations of muscle enzymes in plasma are an indication for muscle disease. Extreme muscular activity in the period preceding blood sampling is an important cause of elevated enzyme activities in plasma. In dogs, plasma CK activities increase approximately twofold with exercise (Heffron *et al.*, 1976). Trained persons have plasma CK activities that are twice those of more sedentary people (Okinaka *et al.*, 1964). In humans, elevated activities of plasma CK can persist for about 1 week after exercise (Newham *et al.*, 1983). Chronic elevated plasma CK activities have been reported in certain occupational workers as a result of local muscular strain (Brewster and De Visser, 1988; Hagberg *et al.*, 1982). In healthy turkeys, plasma CK activity is extremely sensitive to physical exercise and stress. With controlled conditions of minimal exercise, stress, and time of handling, however, iatrogenic elevations of plasma CK activities can be prevented (Tripp and Schmitz, 1982). Limited handling of penned mallards resulted in mean  $\pm$  SD serum CK activities of  $1325 \pm 1212$  IU/L, whereas capture of wild mallards in entanglement nets resulted in serum CK activities of  $12035 \pm 8125$  IU/L, compared to  $225 \pm 52$  IU/L in control animals with minimal handling (Dabbert and Powll, 1993). Elevated plasma CK activities can be expected in birds with large muscle mass after capture stress (e.g., ostrich). Intramuscular injections in birds are a well-known

cause of elevated activities of plasma enzymes from muscle origin (Fig. 28-16). When physiological or iatrogenic causes of hyperCKemia can be ruled out, primary neuromuscular disease should be considered.

In birds, several causes of degenerative myopathy have been reported. In poultry, furazolidone and ionophore coccidiostats are well-known causes of myocyte degeneration (Julian, 1991). Ingestion of the beans of coffee senna (*Cassia* spp.) has been suggested as a possible cause of acute myocyte degeneration in birds (Rae, 1992). Two important causes of degenerative myopathy in birds are exertional rhabdomyolysis (capture myopathy) and nutritional myopathy.

One of the signs of a deficiency of selenium or vitamin E in birds is muscular degeneration. Some authors believe that exertional rhabdomyolysis is an acute manifestation of nutritional myopathy although it has been recorded in species with apparently normal vitamin E levels (Spraker, 1980).

Capture myopathy has been reported in flamingos (Fowler, 1978a, 1978b; Young, 1967), cranes (Brannian *et al.*, 1987; Carpenter *et al.*, 1991; Windingstad, 1983), Canada geese (Chalmers and Barrett, 1982), turkeys (Spraker *et al.*, 1987), and ratites (Dolensek and Bruning, 1978; Phalen *et al.*, 1990; Rae, 1992).

Nutritional related myopathies have been reported in piscivorous birds after feeding an unsupplemented diet of previously frozen fish, primarily smelt (Campbell and Montali, 1980; Carpenter *et al.*, 1979; Nichols and Montali, 1987; Nichols *et al.*, 1986). Vitamin E deficiency has also been associated with muscle lesions in raptors (Calle *et al.*, 1989; Dierenfeld *et al.*, 1989). Rae (1992) reported that a large percentage of young ratites submitted for necropsy exhibited evidence of degenerative myopathy and considered nutritional deficiency of vitamin E and possibly selenium as the most probable cause.

The muscle lesions produced by the various causes cannot be distinguished from each other and the clinical history is important to establish a diagnosis (Rae, 1992). The use of serum or plasma vitamin E concentrations has been advocated to enable a clinical diagnosis of nutritional myopathy in birds (Rae, 1992). Mean ( $\pm$ SE) plasma concentrations of vitamin E (quantified as  $\alpha$ -tocopherol) established in 274 captive cranes were  $6.57 \pm 0.82 \mu\text{g/ml}$ . Cranes species that evolved in temperate habitats had higher circulating levels of  $\alpha$ -tocopherol than tropical or subtropical species: for example, Black crowned crane (*Balearica pavonina*) ( $n = 10$ )  $2.77 \pm 0.23 \mu\text{g/ml}$  and Siberian crane (*Grus leucogeranus*) ( $n = 51$ )  $9.41 \pm 0.64 \mu\text{g/ml}$  (Dierenfeld *et al.*, 1993). In peregrine falcons (*Falco peregrinus*), circulating  $\alpha$ -tocopherol concentrations  $<10 \mu\text{g/ml}$  were considered a reflection of a marginal vitamin E status, whereas plasma concentrations  $<5 \mu\text{g/ml}$  were considered deficient (Dierenfeld *et al.*, 1989). Only limited data are available on normal plasma concentrations of  $\alpha$ -tocopherol in ratites. In apparently healthy rheas, circulating  $\alpha$ -tocopherol concentrations ranged between 9.0 and 14.5  $\mu\text{g/ml}$ , whereas two rheas with muscular problems exhibited mean plasma concentrations of 1.34  $\mu\text{g/ml}$  (Dierenfeld, 1989).

For the diagnosis of cardiac diseases in birds plasma chemistry has also been used. Enzymes that have been used include AST, LDH, and CPK. CPK activity in plasma from cardiac muscle origin (CPK-MB isoenzyme) was significantly higher in ducklings with furazolidone-induced cardiotoxicosis when compared to controls (Webb *et al.*, 1991).

Cardiac troponin T (c TnT), a cardiac specific protein that forms part of the contractile apparatus of striated muscle, is a specific and sensitive serological indicator of acute myocardial infarction in human patients. Elevated serum c TnT concentrations have also been used as a marker for early myocardial damage in broiler chicks (Maxwell *et al.*, 1995). Whether plasma or serum is used seems not to be critical, according to Dominici *et al.* (2004). In Siamese fighting fowl, sex-specific differences have been demonstrated in plasma c TnT concentrations (Sribhen *et al.*, 2006).

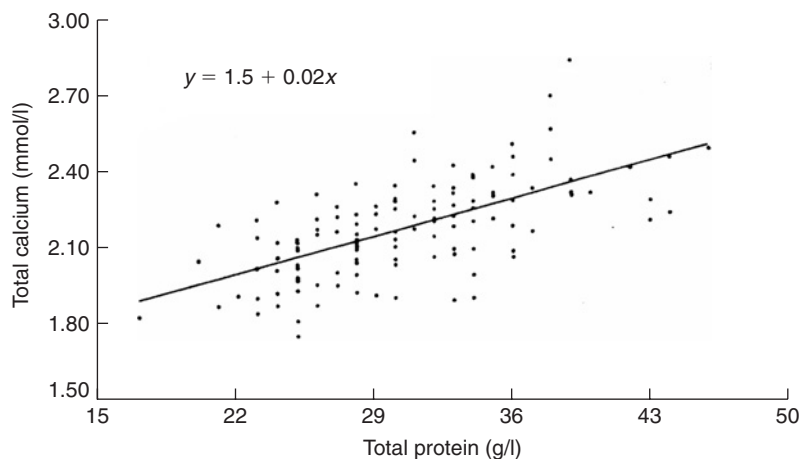
## VIII. CALCIUM AND PHOSPHORUS: METABOLIC BONE DISEASE

### A. Relation between Calcium and Protein in Avian Plasma

Between 50% and 80% of plasma calcium is biologically inactive and consists of protein-bound calcium and complexed calcium. Total calcium (tCa) concentration is influenced by plasma protein concentrations. Ionized calcium (iCa) is important with regard to deposition of calcium salts and excitability of nervous tissues. In most laboratories, for technical reasons, only tCa is measured. Hence, when tCa is measured it is also important to measure plasma protein concentrations and to make allowances for any deviations from the normal in the latter. A significant linear correlation was found between tCa and Alb in the plasma of 70 healthy African grey parrots ( $r = 0.37$ ;  $p < 0.05$ ), and a correction formula was derived on the basis of the concentration of Alb: Adjusted tCa (mmol/L) = measured tCa (mmol/L)  $-0.015 \text{ Alb (g/L)} + 0.4$ . Approximately 14% of the variability of tCa was attributable to the change in the concentration of plasma Alb ( $R^2 = 0.137$ ) (Lumeij, 1990).

A significant correlation was also found between tCa and TP in 124 plasma samples of peregrine falcons ( $r = 0.65$ ;  $p < 0.01$ ). About 42% of the variability in tCa was attributable to the change in the plasma TP ( $R^2 = 0.417$ ). The correlation between tCa and Alb was significant ( $r = 0.33$ ;  $p < 0.01$ ), but it was significantly smaller than the correlation between tCa and TP ( $p < 0.01$ ). Only 11% of the tCa was attributable to difference in concentration of Alb ( $R^2 = 0.108$ ). An adjustment formula for tCa concentration in the peregrine falcon was derived on the basis of TP: Adj.tCa (mmol/L) = measured tCa (mmol/L)  $-0.02 \text{ TP (g/L)} + 0.67$  (Fig. 28-18; Lumeij *et al.*, 1993a).

In ostriches a significant correlation was found between tCa and TP ( $R^2 = 0.55$ ;  $p < 0.001$ ). The adjustment



**FIGURE 28-18** Significant relationship ( $r = 0.65$ ;  $p < 0.01$ ) between total protein and calcium in plasma of 124 peregrine falcons (*Falco peregrinus*). The least square regression line is indicated. As the concentration of total protein decreases, there is a concurrent decrease in plasma total calcium. About 42% of the variability in calcium was attributable to the changes in the plasma total protein concentration ( $R^2 = 0.417$ ). Reprinted with permission from Lumeij *et al.* (1993a).

formula for tCa was: adjusted tCa (mmol/L) = measured tCa (mmol/L)  $- 0.09$  TP (g/L) + 4.4.

Application of a correction formula in African grey parrots, peregrine falcons, ostriches, and most likely other species is indicated when extremely low or extremely high plasma protein concentrations are found. The aforementioned correction formulas are based on TP and Alb determinations with the methods as outlined before (Section IV).

Application of a correction formula based on TP or Alb, however, does not take into account the fraction of complexed calcium, which can vary in different conditions. With the development of ion selective electrodes, it is now possible to measure iCa. It is to be expected that direct measurement of iCa in avian blood will provide a more accurate assessment of Ca status, compared to adjusted tCa, as was the case in a canine study (Schenk and Chew, 2005). One study (Stanford, 2003a, 2003b) yielded reference values for serum [sic] iCa based on heparinized plasma samples from 80 “healthy” seed-fed African grey parrots of 0.96 to 1.22 mmol/L (3.84 to .88 mg/dl). Preliminary reference values for iCa in blood of racing pigeons as established in our clinic ( $n = 20$ ; inner limits of percentiles  $P_{2.5}$  and  $P_{97.5}$  with 90% certainty) were 1.32 to 1.39 mmol/L when blood was sampled in electrolyte-balanced, 80 IU heparin, 2 ml syringes (Pico 50 Arterial Blood Sampler; Radiometer Medical A/S Denmark-2700 Brønshøj – Ref 956–552) and 1.21 to 1.38 mmol/L when sampled in 3 ml heparinized vacuum tubes (Venoject, Terumo Europe N.V., 3001 Leuven, Belgium). Preliminary data from our clinic from pellet-fed African grey parrots established in blood samples collected with balanced Pico syringes (Radiometer, Copenhagen) suggest that the reference values for tCa values in this species are 2.6 to 3.4 mmol/L and those for iCa are 1.35 to 1.68 mmol/L. Histological changes in the parathyroid gland consistent with nutritional secondary hyperparathyroidism were observed in individuals with tCa values between 2.1 and 2.6 mmol/L ( $n = 20$ ; inner limits of percentiles  $P_{2.5}$  and  $P_{97.5}$  with 90% certainty). These reference values for iCa were significantly higher when compared to values established by Stanford (2003a, 2003b). It is

most likely that the seed-fed parrots from Stanford (2003a, 2003b) were Ca-deficient, because Stanford (2003b) himself showed that after 1 year of pelleted diet, iCa values increased significantly in his experimental group of 20 parrots. Furthermore, our findings in pigeon blood have shown that the containers in which the blood is collected may affect iCa values. The guidelines of the International Federation of Clinical Chemistry specify that Ca can be bound by heparine and that plasma binding sites in the anticoagulant should be titrated in such a way that a maximum concentration of 15 IU/ml of heparine remains in the collecting tubes. In unbalanced heparine tubes about 0.1 mmol/L of Ca will be bound by 80 IU of heparine (Boink *et al.*, 1991). For this reason, tCa values as reported in Table 28.3 of this chapter, which were determined in nonbalanced heparine tubes are likely too low. Howard *et al.* (2004) established reference values (“95% frequency intervals”) for iCa in thick-billed parrots (*Rhynchopsitta pachyrhyncha*) from 0.82 to 1.3 mmol/L and for tCa from 1.37 to 2.06 mmol/L. These values were lower than those reported for other psittacine species.

## B. Hypercalcemia

### 1. Introduction

Based on pathophysiological principles, the differential diagnosis for hypercalcemia in birds includes hyperproteinemia, estrogen-induced hypercalcemia, primary hyperparathyroidism, pseudo-hyperparathyroidism, tertiary hyperparathyroidism, metastatic, osteolytic skeletal tumors, and excess of dietary calcium or vitamin D<sub>3</sub> (Lumeij, 1994c), but actual clinical cases, apart from protein-induced (pseudo)hypercalcemia and vitamin D<sub>3</sub> toxicity, are poorly documented.

Clinical signs in true hypercalcemic states may include hypercalcemia, anorexia, polyuria, and polydipsia (PU/PD), delayed crop emptying, regurgitation, weight loss, depression, and renomegaly (Machlin, 1984). Gout has been associated with hypervitaminosis D-induced hypercalcemia (Brue, 1994; Ekstrom and Degernes, 1989; Flammer and Clubb,



1994; Phalen *et al.*, 1990; Takeshita *et al.*, 1986). PU/PD can be explained by the fact that in a hypercalcemic state, the ability of the renal tubules to respond to antidiuretic hormone decreases, thus inhibiting the reabsorption of water (Meric, 1995). The calcifications found in the kidneys may also contribute to the polyuria. Other clinical signs include muscle weakness, painful joints, demineralization of the bone and disorientation, the abnormalities eventually leading to death. Calcium is regulated within narrow limits and slight elevations above the reference range should be taken seriously.

At *postmortem* examination, metastatic calcifications in the liver, kidney, gastrointestinal tract, heart, and blood vessels can be found (Dumoncaux and Harrison, 1994; Lumeij, 1994b; Macwhirter, 1994; Phalen *et al.*, 1990; Takeshita *et al.*, 1986).

## 2. Estrogen-Induced Hypercalcemia

Estrogen-induced (pseudo)hypercalcemia may be seen in various avian species related to egg laying. About 4 days before female pigeons are due to ovulate, tCa rises from a normal value of about 2.2 mmol/L to a value of over 5.0 mmol/L at the time of ovulation. This rise in Ca is caused by an increase in the protein-bound Ca resulting from the estrogen-induced transport of yolk proteins to the ovary as Ca complexes, whereby the concentration of iCa remains constant (Simkiss, 1967). Because tCa is the sum of biologically active iCa, protein-bound Ca, and Ca chelated to anions, tCa should always be interpreted in conjunction with plasma proteins. When reference values for iCa are available for the species under consideration, determination of iCa is the method of choice (see Section VIII.A).

## 3. Primary Hyperparathyroidism

Primary hyperparathyroidism may result from hyperplasia, adenoma, or carcinoma of the parathyroid gland (Lumeij, 1994c). Although tumors of the parathyroid gland do occur in avian species, primary hyperparathyroidism has not been documented.

## 4. Pseudohyperparathyroidism

Pseudohyperparathyroidism occurs when nonendocrine tumors secrete hormone-like substances that cause hypercalcemia. This phenomenon may be seen, for instance, in malignant lymphoma. Hypercalcemia was reported in two Amazon parrots (*Amazona spp.*) associated with lymphocytic leucosis (de Wit *et al.*, 2003). Although a paraneoplastic syndrome was suggested, this was not convincingly demonstrated, and hyperproteinemia may have been the reason for elevated tCa in these cases.

## 5. Tertiary Hyperparathyroidism

Tertiary hyperparathyroidism might develop after prolonged nutritionally secondary hyperparathyroidism, where

the chronically stimulated hyperplastic gland may develop an adenoma (Lumeij, 1994c). In contrast to secondary hyperparathyroidism, where the increased activity of the parathyroid is a consequence of hypocalcemia, tertiary hyperparathyroidism is associated with hypercalcemia.

## 6. Calcium and Vitamin D<sub>3</sub> Toxicity

Oversupplementation of the diet with calcium and vitamin D<sub>3</sub> is the most common cause of true hypercalcemia in birds.

Vitamin D<sub>3</sub> (1,25-dihydroxycholecalciferol) regulates the absorption of calcium by the gut (Lumeij, 1994c). Birds can synthesize vitamin D in their skin from 7-dehydrocholesterol and therefore only need dietary vitamin D<sub>3</sub> when they lack ultraviolet light (Lumeij, 1994c; Nott and Taylor, 1993). One can easily oversupplement a bird's diet because most commercial diets contain abundant vitamin D<sub>3</sub> (Dumoncaux and Harrison, 1994; Macwhirter, 1994). Vitamin D<sub>3</sub> is considered to be in the toxic range at 4 to 10 times the recommended dose (Brue, 1994). Avian species that have been reported to be susceptible to hypervitaminosis D<sub>3</sub> are the macaw, cockatoo, African grey parrot, toucan, dove, and cardinal (Phalen *et al.*, 1990; Takeshita *et al.*, 1986; Dumoncaux and Harrison, 1994; Lumeij, 1994b). In literature on hypervitaminosis D in birds, there seldom is discrimination between vitamin D<sub>3</sub> and D<sub>2</sub>. Because vitamin D<sub>2</sub> (ergocalciferol) is 30 times less active than vitamin D<sub>3</sub> (Nott and Taylor, 1993), an excess of vitamin D<sub>3</sub> occurs most easily. When amounts of vitamin D are expressed in international chicken units (ICU), they refer to vitamin D<sub>3</sub>. The baby macaws described by Takeshita *et al.* (1986) showed symptoms when fed a diet containing 1000 to 4000 ICU vitamin D<sub>3</sub>/kg. Other workers reported that toxic effects will appear when the birds are fed a diet containing more than 2500 ICU vitamin D<sub>3</sub>/kg diet (Brue, 1994; Harrison, 1991). The diet of the two birds reported by De Wit *et al.* (2003) contained more than 25,000 ICU vitamin D<sub>3</sub>/kg.

Recommended calcium concentrations for maintenance in avian diets are 5 to 10 g/kg. A level of 30 g calcium/kg diet will result in toxicity (Shane *et al.*, 1969). A high calcium intake alone can cause calcifications in the kidneys (Macwhirter, 1994). Nutritional errors can be prevented by the use of balanced commercial diets.

## C. Physiological Marrow Ossification

Physiological marrow ossification is induced by the combined effects of estrogens and androgens and can be observed at about the same time as the estrogen-induced hypercalcemia in female birds (Simkiss, 1967). There is a large increase in the quantities of Ca and P, which are retained from the diet and laid down as medullary bone. This medullary bone may completely fill the marrow spaces of the long bones. It is most clearly seen in the limb bones but occurs in most parts of the skeleton. This period of bone

deposition coincides with increased osteoblastic activity. When the bird starts to secrete the eggshell the medullary bone is resorbed by osteoclastic activity. Ca is deposited in the eggshell as Ca-carbonate and the P is excreted from the body. Medullary bone might be mistaken for a pathological condition when radiographs are being evaluated.

#### D. Hypocalcemia Syndrome in African Grey Parrots

In birds of prey and African grey parrots a hypocalcemia syndrome is known, characterized by hypocalcemic seizures. A striking feature of this syndrome in African grey parrots, which is not known in other birds, is that demineralization of the skeleton is not obvious at the moment the seizures occur. The hypocalcemia syndrome is an important differential diagnosis in an African grey parrot that repeatedly falls off its perch. Reference values for tCa concentrations in African grey parrots range from 2.0 to 3.25 mmol/L (Roskopf *et al.*, 1982). Lumeij (1990), studying a population of 72 African grey parrots found reference values of 2.1 to 2.6 mmol/L (inner limits of the percentiles P<sub>2.5</sub> to P<sub>97.5</sub>, with a probability of 90%) and a range from 2.0 to 3.4 mmol/L. Hochleithner (1989b), studying 68 African grey parrots and using a dry chemistry system (Kodak Ektachem), reported reference values for Ca of 1.75 to 2.38 mmol/L (inner limits of the percentiles P<sub>2.5</sub> to P<sub>97.5</sub>). Hochleithner (1989a) reported five cases of hypocalcemia in African grey parrots with plasma calcium concentrations ranging from 0.75 to 1.5 mmol/L. Roskopf *et al.* (1985) stated that the one consistent finding of the hypocalcemia syndrome is a "blood calcium level" below 1.5 mmol/L. Values as low as 0.6 mmol/L have been reported (Roskopf *et al.*, 1985). When borderline calcium concentrations are found, the correction formula reported in Section VIII.A should be used. Stanford (2005) reported that 5/19 cases of hypocalcaemia in African grey parrots as diagnosed by low iCa concentrations had normal tCa concentrations and therefore concluded that measurement of iCa concentration is vital to diagnose hypocalcaemia. This conclusion, however, was not supported by data on corrected tCa. With the current availability of ion selective electrodes, however, measurement of iCa seems to be the practical way of evaluating Ca status in birds. When timely treatment with parenteral Ca and vitamin D<sub>3</sub> preparations starts and sufficient dietary uptake of Ca is taken care of, clinical signs will regress in a short time. It is therefore likely that the disease is caused by Ca and vitamin D<sub>3</sub> deficiency. The higher incidence of the hypocalcaemia syndrome in African grey parrots might be related to the relatively higher dependence on ultraviolet light in this species (Stanford, 2005, p. 136).

#### E. Alkaline Phosphatase in Bone Disease

Alkaline phosphatases (APs) form a group of membrane-bound glycoproteins that hydrolyze monophosphate esters

at alkaline pH. Three different isoenzymes have been identified. Although there is a significant activity of AP in various tissues, the physiological role is unclear, except for AP in bone tissue. AP activity in bone reflects the activity of osteoblasts, and this enzyme is involved in the formation and mineralization of the bone matrix. In humans, increased AP activity is observed during growth and in osteoproliferative disorders (Savova and Kirev, 1992).

Different techniques have been used to identify fractions responsible for increased plasma activities. The heat inactivation test has been developed to distinguish AP activity of bone origin from that of liver origin (Johnson *et al.*, 1972; Posen *et al.*, 1965). In humans, residual activities after heat inactivation at 56°C higher than 35% indicate hepatic disease, whereas residual values lower than 25% indicate bone disease with increased osteoblastic activity (Fennely *et al.*, 1969; Fitzgerald *et al.*, 1969; Stolbach, 1969). Using a guinea fowl model with bone tumors induced by osteopetrosis virus, Savova and Kirev (1992) were able to confirm these findings also for an avian species. They showed, by comparing the findings with the more sensitive wheat germ lectin method (Brixen *et al.*, 1989; Rosalki and Foo, 1984), that for guinea fowl the AP activity of bone origin can be inactivated at 58°C rather than 56°C. Savova and Kirev (1992) found that AP activity of bone origin in 15-week-old guinea fowl was twice as high as that of 1-year-old birds. They also confirmed the positive correlation between the intensity of virus-induced excessive bone growth and serum AP activity reported previously by Sanger *et al.* (1986) and Barnes and Smith (1977). The presumed high proportion of AP of bone origin was supported by the low values of residual activity after heat inactivation at 58°C (14.7±3.7%) and after precipitation with wheat germ lectin (13±1.2%) during the period of active bone tumor formation (Savova and Kirev, 1992).

### IX. DIABETES MELLITUS AND PLASMA GLUCOSE

The basic metabolic regulation of glucose metabolism in birds is identical to that in mammals, but there is a quantitative difference. Reference values for plasma glucose in birds range somewhere between 11 and 25 mmol/L (Lumeij and Overduin, 1990; Roskopf *et al.*, 1982). Physiological values up to 33 mmol/L have been observed postprandially in pigeons (Lumeij, 1987b). As a result of stress, plasma glucose concentrations up to 33 mmol/L may also be observed (Jenkins, 1994). The insulin content of the pancreas of granivorous birds is about one-sixth that of mammalian pancreata, whereas the glucagon content is about two to five times greater. Circulating plasma concentrations of glucagon (1 to 4 ng/ml) are 10 to 50 times higher in birds than in mammals. Insulin is synthesized in the B cells of the pancreas, whereas glucagon is synthesized in the A cells.

Spontaneous diabetes mellitus, as characterized by polyuria/polydipsia (PU/PD), glucosuria, persistent hyperglycemia, and loss of weight despite good appetite, has been reported in a number of avian species, including budgerigars, cockatiels, an Amazon parrot, an African grey parrot, toco toucans, a red-tailed hawk, and the pigeon (Altman and Kirmayer 1976; Candeletta *et al.*, 1993; Lothrop *et al.*, 1986; Lumeij 1994c; Murphey, 1992b; Schlumberger 1956; Spira, 1981; Wallner-Pendleton *et al.*, 1993; Wiesner, 1971; Woerpel *et al.*, 1987).

The species that will be most commonly encountered in clinical avian practice are budgerigars, cockatiels, and toco toucans. A tentative diagnosis can be made by finding glucose in the urine using a test strip (Testape, Eli-Lilly Benelux NV, Amsterdam), whereas a definitive diagnosis can be made by finding an elevated plasma glucose concentration. PU/PD accompanied by glucosuria does not always indicate diabetes mellitus. Diabetes mellitus can only be diagnosed if elevated plasma glucose concentrations have been demonstrated.

In mammals, Fanconi's syndrome is known, characterized by renal glucosuria, hyperaminoaciduria, and hyperphosphaturia, as well as renal loss of potassium, bicarbonate and water, and other substances conserved by the proximal tubule. Fanconi's syndrome should be considered as the final result of any one of many possible primary insults to proximal tubular function. The patient's symptoms reflect the disturbance of tubular function, in addition to the primary cause of the syndrome. The syndrome may be inherited or acquired.

There are some striking differences between birds and mammals with regard to pancreatic control of carbohydrate metabolism. In mammals, pancreatectomy results in diabetes mellitus. Reported effects of pancreatectomy in birds are controversial. However, the more recent experiments performed on granivorous birds indicate that surgical extirpation or destruction of the pancreas with cytotoxic agents leads to hypoglycemic crisis and death. The few reported pancreatectomies performed on carnivorous birds have always led to diabetes mellitus. It is generally accepted that glucagon is more effective in granivorous birds, which exhibit a marked insulin insensitivity. The limited data available on spontaneous diabetes mellitus in granivorous birds suggest that in these species diabetes mellitus is not caused by an insulin deficiency. Birds of prey may be much more insulin dependent.

Spontaneous diabetes mellitus in birds has been reported to be successfully treated with daily injections of insulin in dosages comparable to doses used in dogs. These successful treatments of diabetic birds (disappearance of clinical signs) are surprising, considering the relative insulin insensitivity that has been reported to occur in a variety of avian species.

Plasma insulin and glucagon concentrations have been established in three birds with hyperglycemia (Lothrop

*et al.*, 1986). In all cases, insulin concentrations were similar to those of controls, whereas glucagon concentrations, on the other hand, were extremely high or extremely low. In another case of diabetes mellitus (DM) in an African grey parrot, Candeletta *et al.* (1993) reported extremely low insulin concentrations. It is not clear whether these determinations were accurate. The findings, however, suggest that different etiologies were likely to be involved.

Speculations on possible etiologies of diabetes mellitus in birds have been discussed (Lumeij, 1994c).

## X. EXOCRINE PANCREATIC DISEASE

Exocrine pancreatic hormones that are present in the duodenum of birds include amylase, lipase, trypsin, and chymotrypsin. They facilitate degradation of carbohydrates, fats, and proteins, respectively. The inactive precursors of trypsin and chymotrypsin, trypsinogen, and chymotrypsinogen enter the duodenum, where they are activated by intestinal enterokinase. This mechanism prevents autodigestion of pancreatic tissue (Duke, 1986).

There are two basic manifestations of exocrine pancreatic hormone disorders: (1) acute pancreatitis or acute pancreatic necrosis, and (2) chronic pancreatitis resulting in pancreatic fibrosis and pancreatic exocrine insufficiency.

The pathogenesis of acute pancreatitis involves the activation of pancreatic enzymes in and around the pancreas and bloodstream, resulting in coagulation necrosis of the pancreas and necrosis and hemorrhage of peripancreatic and peritoneal adipose tissue. Increased amylase and lipase activities in plasma have been reported from birds with active pancreatitis.

Reference values for plasma lipase and amylase have been established in a population of 87 African grey parrots (Van der Horst and Lumeij, unpublished observations).  $\alpha$ -Amylase activity in plasma was determined with a kinetic *p*-nitrophenylmaltoheptaoside method (Sopachem  $\alpha$ -Amylase kit # 003-0311-00 Sopar-biochem, 1080 Brussels) at 30°C. Values ranged from 571 to 1987 U/L (inner limits of  $P_{2.5}$  to  $P_{97.5}$  with a probability of 90%).

Lipase activity was measured at 30°C using a test based on the conversion of triolein by lipase to monoglyceride and oleic acid. The associated decreased turbidity was measured in the UV range (Boehringer Mannheim kit # MPR 3-1442651). Reference values ranged from 268 to 1161 U/L.

Hochleithner (1989b) reported reference values for plasma amylase in four different psittacine species using a dry chemistry system (Kodak Ektachem, Amylopectin, 25°C; Kodak Company, 1986). The values were considerably lower as compared to the ones just discussed: budgerigar ( $n = 50$ ) 187 to 585 U/L, African grey parrot ( $n = 68$ ) 211 to 519 U/L, Amazon parrot ( $n = 30$ ) 106 to 524 U/L, and macaw 276 to 594 U/L.

In racing pigeons ( $n = 24$ ), plasma amylase and lipase activities were determined with a Synchron CX chemistry analyzer (Beckman Coulter, Mijdrecht, The Netherlands) with reagents provided by the manufacturer. Lipase was measured by a time enzymatic rate method. Briefly, 1–2 diglyceride substrate is hydrolyzed by pancreatic lipase to 2-monoglyceride and fatty acid. The change of absorbance at 560 nm because of formation of the red quinone dimine dye after four consecutive chemical reactions is directly proportional to lipase activity. Amylase was measured by the rate of formation of maltose from maltotetraose through three coupled reactions. The change of absorbance at 340 nm is directly proportional to amylase activity. Reference values (inner limits of  $P_{2.5}$  and  $P_{97.5}$  with a probability of 90%) for plasma amylase and lipase activities in pigeons were 382 to 556 IU/L and 0 to 5 IU/L, respectively (Amann *et al.*, 2006).

Chronic pancreatitis may result in fibrosis and decreased production of pancreatic hormones. When insufficient pancreatic enzymes are available in the duodenum, maldigestion and passing of feces with excessive amylum and fat will occur. Affected animals have voluminous, pale, or tan greasy feces. Fat can be demonstrated by Sudan staining.

Fecal amylase and proteolytic activity were determined in African grey parrots ( $n = 87$ ) by Van der Horst and Lumeij (unpublished observations), using radial enzyme diffusion as reported by Westermarck and Sandholm (1980). Reference values (inner limits of  $P_{2.5}$  to  $P_{97.5}$  with a probability of 90%) for fecal amylase were 6 to 18 mm and for fecal trypsin 14 to 19 mm. In racing pigeons ( $n = 24$ ), these values were 13 to 16 mm and 11 to 14 mm, respectively (Amann *et al.*, 2006). In a clinical case of exocrine pancreatic insufficiency in a racing pigeon, which was histologically confirmed at postmortem examination, values for fecal amylase and proteolytic activity were 0 and 2 mm, respectively, whereas plasma amylase and lipase activities were within the reference limits (Amann *et al.*, 2006).

## XI. TOXICOLOGY

### A. Lead

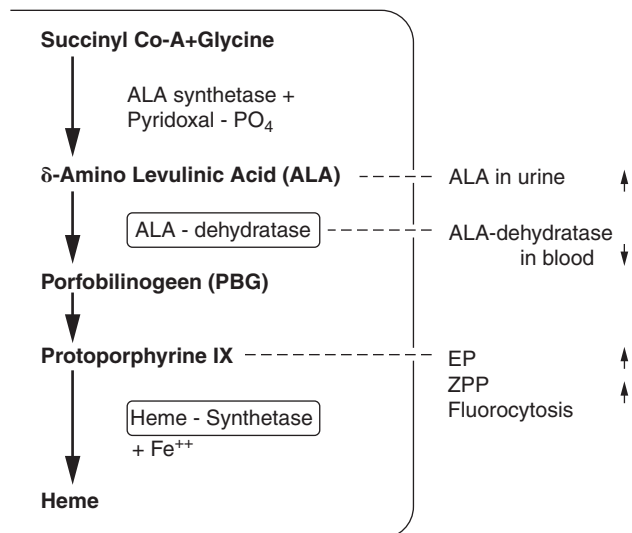
Lead (Pb) poisoning is common in birds (Dumonceaux and Harrison, 1994; Lumeij 1985b). A clinical diagnosis can be made by demonstrating elevated Pb concentrations in whole blood or by demonstrating secondary effects of Pb on various enzymes involved in heme synthesis. Blood Pb concentrations in clinically normal birds and in birds with signs of Pb poisoning can be much higher than in mammals (Lumeij, 1985b). Blood Pb in birds without clinical signs and without known exposure to Pb ranged between 2.5 and 180  $\mu\text{g}/\text{dl}$  (100  $\mu\text{g}/\text{dl} = 4.8 \mu\text{mmol}/\text{L}$ ). Birds that had been exposed to Pb but showed no clinical signs had Pb concentrations ranging between 40 and 2000  $\mu\text{g}/\text{dl}$ , whereas birds with clinical signs had blood Pb concentrations ranging from 52 to 5840  $\mu\text{g}/\text{dl}$ . Dieter (1979) proposed that a blood Pb

concentration of 20  $\mu\text{g}/\text{dl}$  was physiologically detrimental in canvasback ducks, *Aythya valisineria*, because a significant inhibition of  $\delta$ -aminolevulinic acid dehydratase (ALA-D) activity, was observed at these Pb concentrations. The U.S. Fish and Wildlife Service (1986) accepted that blood Pb concentrations  $>20 \mu\text{g}/\text{dl}$  in 5% of hunter-killed or live-trapped waterfowl indicate that some type of Pb has been assimilated in tissues (U.S. Federal Register 29673, August 20, 1986). Draury *et al.* (1993) used the terms “detrimental” and “deleterious” in association with blood Pb of 20  $\mu\text{g}/\text{dl}$ . Although a blood Pb of 20  $\mu\text{g}/\text{dl}$  indicates increased exposure to Pb these values are not considered harmful to animals. The current clinical view is that blood Pb  $> 50 \mu\text{g}/\text{dl}$  ( $>2.4 \mu\text{mol}/\text{L}$ ) is generally not associated with clinical signs and has a good prognosis, even without treatment. Lead between 50 and 100  $\mu\text{g}/\text{dl}$  is associated with mild clinical signs and carries a good prognosis for recovery with treatment. Clinical signs and prognosis worsen when blood Pb exceeds 100  $\mu\text{g}/\text{dl}$ . When concentrations exceed 200  $\mu\text{g}/\text{dl}$ , the prognosis is guarded to poor (Degernes, 1995). When clinical signs are present, blood Pb  $> 35 \mu\text{g}/\text{dl}$  suggests of Pb toxicosis (Klein and Galey, 1989). In psittacines, blood Pb levels as low as 20  $\mu\text{g}/\text{dl}$  are considered suggestive for Pb exposure (Dumonceaux and Harrison, 1994).

Most of the Pb in whole blood is associated with the red blood cells (Buggiani and Rindi, 1980). The nuclear inclusions which have been observed by electron microscopy in nucleated erythrocytes of pigeons with high blood Pb concentrations have led to the assumption that these could serve as storage sites, just like the Pb inclusion bodies that have been described in kidneys from Pb-poisoned rats. The capacity of birds to survive high blood Pb concentrations without overt toxicosis might be associated with these erythrocytic inclusion bodies (Barthalmus *et al.*, 1977).

Lead interferes with two enzymes in the hemoglobin biosynthetic pathway:  $\delta$ -aminolevulinic acid dehydratase (ALA-D) and heme synthetase (Fig. 28-19). In humans, ALA-D inhibition occurs even at normal blood Pb levels (McIntire *et al.*, 1973). When there is an increase in Pb, ALA-D is uniformly low. A level  $> 600 \text{ IU}/\text{dl}$  excludes Pb poisoning (Beeson *et al.*, 1979). A significant negative correlation exists between blood Pb and ALA-D in pigeons, urban-dwelling humans, urban rats, and Pb dosed wildfowl, as long as the blood Pb concentrations are moderately elevated. If the blood Pb increases above a moderate level blood, ALA-D activity fails to decrease further. This has been observed in pigeons and humans (Hutton, 1980). The inhibition of ALA-D leads to accumulation of  $\delta$ -aminolevulinic acid (ALA) and excessive amounts of ALA are excreted in the urine.

Because Pb inhibits heme synthetase, protoporphyrin IX also accumulates in the erythrocytes. In human Pb poisoning, free erythrocyte protoporphyrin (FEPP) is found in the range of 300 to 3000  $\mu\text{g}/\text{dl}$  (reference range 15 to 60  $\mu\text{g}/\text{dl}$ ). If a fresh wet film of blood of a patient is examined under UV



**FIGURE 28-19** Schematic representation of heme synthesis. Lead interferes with the enzyme  $\delta$ -aminolevulinic acid dehydratase (ALA-D), resulting in a lower activity of ALA-D in blood and a higher concentration of  $\delta$ -aminolevulinic acid in the urine. Interference with the enzyme heme synthetase leads to an accumulation of protoporphyrin IX in the erythrocytes, which can be measured as FEPP or ZPP and leads to fluorocytosis. Reprinted with permission from Lumeij (1985b).

light (400nm), 75% to 100% of the erythrocytes show a red fluorescence: fluorocytes. The accumulated protoporphyrin imparts the red fluorescence to fluorocytes (Beeson *et al.*, 1979). The fluorocyte test has also been used successfully for the diagnosis of Pb poisoning in rabbits (Roscoe *et al.*, 1975) and waterfowl (Barret and Karstad, 1971).

In humans, FEPP binds to zinc to form the fluorescent compound zinc protoporphyrin (ZPP), which can be measured fluorometrically in a single drop of whole blood (Roscoe *et al.*, 1979). Roscoe *et al.* (1979) found that blood fluorescence spectra of Pb-poisoned mallards scanned on a fluorescence spectrophotometer were characteristic of metal-free protoporphyrin IX. They suggested that the reason for chelation of zinc by FEPP in human erythrocytes and not in duck erythrocytes might be due in part to the fact that duck erythrocytes contained only about one-third as much zinc as the human erythrocytes. By changing the factory-installed emission filter in a commercially available fluorometer used to screen humans for Pb intoxication by measurement of ZPP, they made the instrument suitable to measure FEPP. They found that FEPP concentrations were at their highest 8 days after Pb-shot ingestion in mallard ducks. The highest value they recorded was 2284  $\mu\text{g}/\text{dl}$ . FEPP was rarely elevated ( $>40 \mu\text{g}/\text{dl}$ ) in freshly drawn blood from Pb-poisoned ducks. However, when the same blood was oxygenated and refrigerated before testing, FEPP concentrations increased because of *in vitro* synthesis, which terminated within 2 days. No such increase was manifested by controls. They found that FEPP concentrations were related to the clinical signs of

**TABLE 28-4** Blood Protoporphyrin IX Concentrations Measured on the Hematofluorometer and Corresponding Clinical Signs of Pb Poisoning in Mallard Ducks

Blood Protoporphyrin IX	Clinical Signs
$>801 \mu\text{g}/\text{dl}$ ( $14.4 \mu\text{mol}/\text{L}$ )	Death Inability to stand, walk, fly Loss of voice Green watery diarrhea
$501\text{--}800 \mu\text{g}/\text{dl}$ ( $9.0\text{--}14.4 \mu\text{mol}/\text{L}$ )	Muscular weakness Easily fatigued Unsteady gait Slight tail drop Green watery diarrhea
$201\text{--}500 \mu\text{g}/\text{dl}$ ( $3.6\text{--}9.0 \mu\text{mol}/\text{L}$ )	Hyperexcitability Green watery diarrhea
$40\text{--}200 \mu\text{g}/\text{dl}$ ( $0.7\text{--}3.6 \mu\text{mol}/\text{L}$ )	Green watery diarrhea
$0\text{--}39 \mu\text{g}/\text{dl}$ $0\text{--}0.7 \mu\text{mol}/\text{L}$	No evidence of Pb poisoning

From Roscoe *et al.* (1979).

Pb poisoning in mallard ducks, and those with FEPP higher than  $500 \mu\text{g}/\text{dl}$  began to show impaired motor function that could seriously affect their survival (Table 28-4).

In raptors, birds showing clinical signs of Pb toxicosis had consistently higher ZPP levels than other Pb-dosed birds with similar blood Pb values (Reiser and Temple, 1981). False-positive FEPP and ZPP elevations occur in humans with iron deficiency anemia or erythrocytic protoporphyria (Wijngaarden and Smith, 1982).

## B. Zinc

Zinc poisoning has been reported in birds after ingesting (United States) pennies minted after 1983 (98% zinc) or metal fence clips (96% zinc). Galvanized wire is another well-known source of zinc poisoning in aviary birds (new wire disease). Clinical signs include weight loss, depression, anorexia, gastrointestinal signs, and posterior paresis. Pathological lesions are especially seen in the pancreas and include acinar atrophy and proliferation of pancreatic ductules (Howard, 1992; Labonde 1995; Lloyd, 1992; Morris, 1985; Reece, 1986; Wight *et al.*, 1986; Zdziarski *et al.*, 1994).

Serum zinc concentrations can be used to establish a diagnosis, but extreme care must be taken to exclude contamination from zinc containing grommets from plastic syringes or rubber stoppers from collecting tubes (Minnick *et al.*, 1982). Serum zinc concentrations in an affected group of ducks were 1260 to 1660  $\mu\text{g}/\text{dl}$ . Values in a reference

group ranged between 184 and 465  $\mu\text{g}/\text{dl}$ . In a group of normal cockatiels, the mean serum zinc concentration was 163  $\mu\text{g}/\text{dl}$ . It has been stated that in general blood zinc concentrations  $>1000\mu\text{g}/\text{dl}$  ( $>150\mu\text{mol}/\text{L}$ ) are considered diagnostic and  $>200\mu\text{g}/\text{dl}$  ( $>30\mu\text{mol}/\text{L}$ ) suggest zinc poisoning in psittacine birds (Labonde, 1995).

### C. Organophosphate and Carbamate

Organophosphates (OPs) and carbamates (CBMs) are the most common causes of avian insecticide poisoning. Poisoning occurs through inhalation or ingestion. The mechanism of OP and CBM poisoning is acetylcholinesterase (AChE) inhibition. The LD-50 of this group of poisons is 10 to 20 times higher in birds than in mammals. Binding of CBM to AChE is reversible as opposed to OP. Clinical signs include acute anorexia, crop stasis, ptialism, ataxia, wing twitching, star gazing, weakness, diarrhea, prolapsed nictitans, and muscular tremors or stiffness. Dyspnea and bradycardia may be observed as the toxicity progresses. In severe cases, the birds may be recumbent with varying degrees of paralysis or seizures. An organophosphorus ester-induced delayed neuropathy has been reported in mammals and birds. The onset occurs 1 to 3 weeks after exposure and is not associated with plasma cholinesterase (ChE) inhibition. With aging of some OP compounds, a metabolite can affect peripheral axons and myelin sheaths, resulting in sensory and motor neuropathy. Associated clinical signs include weakness, ataxia, and decreased proprioception in the limbs progressing to paralysis (LaBonde, 1992, 1995; Lumeij *et al.*, 1993b; Porter, 1993).

Diagnosis of OP or CBM poisoning can be established by AChE activity in blood, plasma, or serum. There are a number of different test procedures, of which the results are not interchangeable. Besides AChE, another compound called pseudocholinesterase or butyrylcholinesterase (BChE, EC 3.1.1.8.) is found in sera. Although its physiological role has not been well defined, it is a useful indicator of exposure to OP and CBM compounds (Ludke *et al.*, 1975; Sherman *et al.*, 1964).

Because plasma BChE activity increases with age in nestling passerines, this might partially account for decreasing sensitivity in older birds to OP and CBM poisoning. Plasma BChE usually is inhibited more rapidly and to a larger degree than brain AChE and may be scavenging the active oxon forms of OP compounds that otherwise might inhibit brain AChE activity. Because of the lack of OP hydrolyzing enzymes in the plasma of many bird species or the low affinity of this class of enzymes for OP compounds in birds, the role of BChE in protecting individuals becomes important (Gard and Hooper, 1993).

It is important that results of ChE, AChE, or BChE determinations are compared with results of samples from nonexposed animals of the same species and age. Age-dependent changes in plasma ChE activities have been

reported for many avian species. Furthermore, development patterns of plasma ChE differ between altricial and precocial species. In contrast to plasma BChE activities in nestlings of altricial species, plasma AChE and BChE activity decreased significantly with age in precocial species (Bennet and Bennet, 1991; Gard and Hooper, 1993).

Samples from cases of suspected CBM toxicity may show normal ChE activities because of rapid regeneration, and therefore these samples should be run as soon as possible to be accurate. Because CBMs are reversible ChE inhibitors in contrast to OP compounds, ChE inhibition followed by thermal reactivation has been employed to discriminate between these poisonings (Hunt and Hooper 1993; Hunt *et al.*, 1993, 1995; Stansley, 1993).

Roy *et al.* (2005), after studying 729 European raptors of 20 species, reported age- and sex-related differences in ChE activities and found a negative correlation between ChE activity and body mass. They reported baseline values for these raptor species to evaluate the effect of anticholinesterase insecticides in the field.

## XII. BLOOD COAGULATION

### A. Introduction

Hemostatic disorders in birds have received less attention than those in mammals, but they can be considered clinically relevant. Although the knowledge of avian bleeding disorders lags behind that of mammals, it was already in 1929 in chickens that the role of vitamin K in blood coagulation was discovered in (Dam, 1935). Currently avian hemostasis research is still in its infancy, and the pathophysiology of many clinically intriguing bleeding disorders, such as the conure bleeding syndrome, awaits further clarification. Although blood coagulation in birds was addressed extensively in textbooks of avian physiology more than 30 years ago (e.g., Sturkie and Griminger, 1976), inclusion of separate chapters on avian coagulation in clinical textbooks was only initiated at the beginning of this century (Espada, 2000; Powers, 2000). A brief synopsis of avian coagulation will be presented here, followed by diagnostic tests and a brief description of some known coagulation disorders.

### B. Normal Hemostasis in Birds

When the vascular integrity in birds is disrupted, there are several mechanisms that prevent blood loss from the circulation, which are similar to those in mammals. In response to small vascular defects, thrombocytes aggregate to form a vascular plug. In larger defects, vasoconstriction reduces blood flow to the area and the blood starts to clot. Briefly, coagulation is a cascade of proteolytic reactions initiated through an extrinsic or intrinsic pathway and ending in a common pathway of which the end product is a solid fibrin plug.

Coagulation in birds is thought to be mainly initiated through the extrinsic pathway by the release of tissue thromboplastin (factor III) after vascular injury. Five proteases (factors VII, IX, X, protein C, and prothrombin) act with two cofactors (factors V and VII),  $\text{Ca}^{2+}$ , and phospholipids to form thrombin (factor IIa) from prothrombin (factor II), followed by the formation of fibrin (factor Ia) from fibrinogen (factor I).

The existence of an intrinsic pathway in birds (involving factors XII, XI, IX), which is initiated by the exposure to vascular subendothelium, is controversial. Although the intrinsic pathway is generally considered to be unimportant, Doerr and Hamilton (1981) did provide some evidence for the existence of such a pathway in chickens.

### C. Diagnostic Tests

#### 1. Sample Collection

Blood samples for coagulation studies in birds should be collected in plastic or siliconized tubes containing 3.8% sodium citrate. Samples should be fresh as freezing and thawing may interfere with the results. The principle of various tests is that clotting in the blood sample is inhibited by the binding of calcium by sodium citrate, and the presence of sufficient coagulation factors is examined by establishing the clotting time after the addition of calcium chloride and the missing factor. In the prothrombin test, where the extrinsic and common pathways are evaluated, tissue thromboplastin is added to initiate the clotting cascade (discussed later).

#### 2. Whole Blood Clotting Time

The whole blood clotting time (WBCT), which evaluates the intrinsic and common coagulation pathways, should be performed in samples collected in nonsiliconized glass tubes or capillary tubes (discussed later), whereby contact with tissue thromboplastin should be avoided. Excessive contamination with tissue juices will reduce the WBCT considerably.

#### 3. Blood Smears for Thrombocyte Counts

In birds in which there is a clinical suspicion of a coagulation disorder, a thrombocyte count should be estimated from a peripheral blood smear. The best-quality blood smears for an estimated thrombocyte count can be obtained from whole fresh blood without an anticoagulant, using the two-slide wedge technique with bevel-edged microscope slides.

Avian thrombocytes are oval nucleated cells that are smaller and more rounded than avian erythrocytes. Because thrombocytes tend to clump in a peripheral blood smear, an actual thrombocyte count is difficult. In normal birds, one or two thrombocytes are expected to be seen in an average monolayer oil immersion field. The estimated number of thrombocytes in a bird with a normal hematocrit

is equal to the average number of thrombocytes in five monolayer fields multiplied by 3500 and should normally range between 20,000 and 30,000/ul.

#### 4. Prothrombine Time

The single most useful coagulation test in birds is establishment of the prothrombine time (PT) or tissue thromboplastin time. PT is a measure of the extrinsic and common coagulation pathways. It should be stressed that PT in birds should be performed with homologous brain thromboplastin, as PT significantly increases when heterologous avian or even mammalian thromboplastin is used. The use of the PT in birds has been considered inconvenient because of the unavailability of species-specific brain thromboplastin. Reportedly, commercially available Russels's viper venom (RVV) may be used instead of homologous brain thromboplastin (Powers, 2000). PT times using RVV are considerably shorter compared to those using mammalian brain thromboplastin, but they are longer than those using a homologous brain thromboplastin (Timms, 1977). Details of performing a prothrombin test in chickens have been reported by Doerr *et al.* (1975).

#### 5. Modified Russels's Viper Venom Test (MRVVT)

Russels's viper venom, in the presence of  $\text{Ca}^{2+}$  and phospholipids, is a powerful coagulant of normal plasma and plasma from humans deficient in factors VII, VIII (antihemophilic factor A), and IX (antihemophilic factor B, Christmas factor). It is an activator of the common coagulation pathway by activation of factor X. In humans with factor V or X deficiency, the RVVT is prolonged. The conventional RVVT cannot be used in birds because the phospholipids in the rabbit-brain cephalin inhibits coagulation in the presence of raw RVV. However, use of purified factor X activating enzyme (RVV-X) eliminates this interference. It has been shown that experimental infection of turkeys with *Pasteurella multocida* increases MRVVT, indicative of a consumptive coagulopathy, possibly caused by increased consumption of factors X, V, II, or I (Friedlander and Olson, 1995).

#### 6. Fibrinogen Estimation

Fibrinogen is formed and stored in the liver and is important for the final stage of blood coagulation where it is transformed into fibrin. Plasma fibrinogen concentrations decrease when there is severe liver damage. A variety of inflammatory, suppurating, traumatic, and neoplastic diseases can increase fibrinogen concentrations in humans and domestic animals (Schalm *et al.*, 1975). Hawkey and Hart (1988) concluded that fibrinogen estimation in conjunction with a heterophil count was a useful screening test for birds to detect infections.

Fibrinogen can be measured by the micro heat-precipitation test at 56°C. This test is based on the principle that fibrinogen

will precipitate at 56°C, while the other plasma proteins remain in solution. EDTA rather than heparin should be used as an anticoagulant when this test is performed (Hawkey and Hart, 1988; Schlam *et al.*, 1975). Protein concentrations can be estimated in the plasma column of two hematocrit tubes, one of which has been placed in a water bath at 56°C to 58°C for 3 min. Fibrinogen concentration is the difference between the protein concentration of the two plasma columns (Schalm *et al.*, 1975). See also Section IV.B.

Because the difference between plasma and serum is the absence of fibrinogen in the latter, it is possible to locate the fibrinogen fraction in the electrophoretic gel of a particular species by performing a comparative protein electrophoresis in serum and plasma from the same sample of this particular avian species (Roman *et al.*, 2006).

## D. Hemostatic Disorders

### 1. Bacterial and Viral Infections

A variety of bacterial and viral diseases in a variety of avian species have caused hemostatic disorders. Examples are circovirus and polyomavirus in psittacines. Reasons for the increased bleeding tendency seen with these infections may include thrombocytopenia, liver failure leading to a lack of clotting factors, vasculitis, and disseminated intravascular coagulation (DIC). In DIC, the chain of events is initiated by exogenous or endogenous procoagulants, which stimulate the formation of fibrin, which is followed by fibrinolysis. The combination of consumption of thrombocytes and clotting factors and the inhibition of fibrin formation by fibrin degradation products may result in consumptive coagulopathy.

### 2. Vitamin K Deficiency

Because vitamin K is essential for the formation of prothrombin and factors VII, IX and X, both the extrinsic and the common coagulation pathway is affected in vitamin K deficiency, leading to a prolonged PT in birds. Vitamin K deficiency is well known in birds and has been reported in chickens fed a diet low in fat (Dam, 1935). A syndrome resembling the disease in chickens has been reported in a pigeon with exocrine pancreatic insufficiency by Amann *et al.* (2006), supposedly because of malabsorption of the fat-soluble vitamin K. Intoxication with anticoagulant rodenticides interferes with the formation of active vitamin K and produces similar clinical effects. Clinical signs are widely reported (Powers, 2000) but depend on species, susceptibility and the type of anticoagulant used, poultry being 10-fold more sensitive than pigeons and quail (Towsend and Tarrant, 1997). History, clinical signs, prolonged PT, and toxicological investigation of gastrointestinal contents can confirm the diagnosis. It has also been suggested that Vitamin K deficiency in birds is caused by oversupplementation

with vitamin E, causing a competitive inhibition of vitamin K by  $\alpha$ -tocopherol (Nichols *et al.*, 1989). A similar antagonism has been reported with the use of sulphonamides in birds (Griminger and Donis, 1960).

### 3. Fatty Liver Hemorrhagic Syndrome

It has been suggested that alterations in the composition of the phospholipids that are essential cofactors in the thrombin formation may be a contributing factor in the development of fatty liver hemorrhagic syndrome (FLHS) in laying hens (Thomson *et al.*, 2003).

### 4. Aflatoxicosis

Aflatoxins originating from *Aspergillus* fungi can be found on moldy feed and are a well-known cause of fatty liver degeneration and bile duct proliferation in poultry. In experimental aflatoxicosis, the increase of the PT was dependent on the aflatoxin dose. The specific activity of clotting factors I, II, V, VII, and X was reduced (Fernandez *et al.*, 1995).

## ACKNOWLEDGMENTS

The author is grateful to the publishers of the journals *Avian Diseases*, *Avian Pathology*, *Seminars in Avian and Exotic Pet Medicine*, and *The Veterinary Quarterly* for permission to use illustrations that were published previously in these journals and to Wingers Publishing Inc. (Lake Worth, Florida) for using material previously published in *Avian Medicine: Principles and Application* (B. W. Ritchie, G. J. Harrison, and L. R. Harrison, Eds.), 1994. The respective sources have been indicated in the text were appropriate. The critical remarks on the draft document from various diplomats of the European College of Avian Medicine and Surgery were highly appreciated: Dr. Med. Vet. Petra Zsivanovits, MRCVS; Brian Coles, BVSc, FRCVS; Brian Speer, DVM, Dip ABVP-certified in avian practice; Prof. Dr. Med. Vet. Marina Krautwald-Junghanns and Frank Verstappen, DVM.

## REFERENCES

- Ahmed, A. A. S., El-Abdin, Y. Z., Hamza, A., and Saad, F. E. (1974). *Avian Dis.* **19**, 305–309.
- Altman, R. B., and Kirmayer, A. H. (1976). *J. Am. Anim. Hosp. Assoc.* **12**, 531–537.
- Amann, O., Visschers, M. J., Dorrestein, G. M., Westerhof, I., and Lumeij, J. T. (2006). *Avian Pathol.* **35**, 58–62.
- Andreasen, C. B., Latimer, K. S., Kircher, I. M., and Brown, J. (1989). *Avian Dis.* **33**, 93–96.
- Archer, F. J., and Battison, A. L. (1997). *Avian Pathol.* **26**, 865–870.
- Baker, J. R. (1980). *Vet. Rec.* **106**, 10–12.
- Barnes, A., and Smith, R. (1977). *Infect. Immun.* **16**, 876–884.
- Barret, M. W., and Karstad, L. H. (1971). *J. Wildl. Manage* **35**, 109–118.



- Barthalmus, G. T., Leander, J. D., McMillan, D. E., Munsak, P., and Krigman, J. R. (1977). *Toxicol. Appl. Pharmacol.* **42**, 271–284.
- Battley, P. F. (2003). *Asia Pac. J. Clin. Nutr.* **12**(suppl), S3.
- Beeson, P. B., McDermott, W., and Wijngaarden, J. B. (1979). “Cecil Textbook of Medicine,” 15th ed. Saunders, London.
- Bennet, R. S., and Bennet, J. W. (1991). *J. Wildl. Dis.* **27**, 116–118.
- Blem, C. R. (2000). In “Sturkies’s Avian Physiology” (C. Whittow, Ed.), pp. 327–341. Academic Press, San Diego, CA.
- Boink, A. B. T. J., Buckley, B. M., Christiansen, T. F., Covington, A. K., Maas, A. H. J., Mueller-Plathe, O., Sachs, C. H., and Siggaard-Andersen, O. (1991). *Eur. J. Clin. Chem. Clin. Biochem.* **29**, 767–772.
- Bordel, R., and Haase, E. (1993). *J. Comp. Physiol. B* **163**, 219–224.
- Bordel, R., and Haase, E. (1998). *Zoology* **101**, 94–100.
- Bordel, R., and Haase, E. (2000). *J. Comp. Physiol. B* **170**, 51–58.
- Brannian, R. E., Graham, D. L., and Creswell, J. (1982). *Proc. Am. Assoc. Zoo Vet.* **12**, 21–23.
- Brewster, L. M., and De Visser, M. (1988). *Acta Neurol. Scand.* **77**, 60–63.
- Brixen, K., Nielsen, H., Eriksen, E., Charles, P., and Mosekilde, L. (1989). *Calc. Tissue Int.* **44**, 93–98.
- Brue, R. N. (1994). In “Avian Medicine: Principles and Application” (B. W. Ritchie, G. J. Harrison, and L. R. Harrison, Eds.), pp. 63–95. Wingers, Lake Worth, FL.
- Buggiani, S. S., and Rindi, S. (1980). *Bull. Environm. Contam. Toxicol.* **24**, 152–155.
- Butler, E. J. (1976). *Avian Pathol.* **5**, 1–14.
- Calle, P. P., Dierenfeld, E. S., and Robert, M. E. (1989). *J. Zoo Wildl. Med.* **20**, 62–67.
- Campbell, G., and Montali, R. J. (1980). *J. Zoo Anim. Med.* **11**, 35–40.
- Campbell, T. W. (1986). *Proc. Ann. Meeting. Assoc. Avian Vet.*, 43–51. Miami, FL.
- Candeletta, S. C., Homer, B. C., Garner, M. M., and Isaza, R. (1993). *J. Assoc. Avian Vet.* **7**, 39–43.
- Carpenter, J. W., Spann, J. W., and Norvilla, M. N. (1979). *Proc. Am. Assoc. Zoo Vet.*, 51–55.
- Carpenter, J. W., Thomas, N. J., and Reeves, S. (1991). *J. Zoo Wildl. Med.* **22**, 488–493.
- Chalmers, G. A., and Barret, M. W. (1982). In “Noninfectious Diseases in Wildlife” (G. L. Hoff and J. W. Davis, Eds.), pp. 84–94. Iowa State University Press, Ames.
- Chang, L., Munro, S. L. A., Richardson, J., and Schreiber, G. (1999). *Eur. J. Biochem.* **259**, 534–542.
- Cookson, E. J., Hall, M. R., and Glover, J. (1988). *J. Endocrinol.* **117**, 75–84.
- Cooper, J. E., and Forbes, N. (1983). *Vet. Rec.* **112**, 182–183.
- Cork, S. (2000). *Avian Pathol.* **29**, 7–12.
- Cray, C. (2005). *Am. J. Vet. Res.* **66**, 936.
- Dabbert, C. B., and Powell, K. C. (1993). *J. Wildl. Dis.* **29**, 304–309.
- Dam, H. (1935). *Nature* **135**, 652–653.
- De Bruijne, J. J., and Rothuizen, J. (1988). In “Animal Clinical Biochemistry: The Future” (D. J. Blackmore, O. D. Eckersall, G. O. Evans, H. Sommer, M. D. Stonard, and D. D. Woodman, Eds.), pp. 175–180. Cambridge University Press, Cambridge.
- De Wit, M., Schoemaker, N. J., Kik, M. J., and Westerhof, I. (2003). *Avian Dis.* **47**, 223–228.
- Degernes, L. A. (1995). *Seminars in Avian and Exotic Pet Medicine* **4**, 15–22.
- Dein, F. J. (1986a). In “Clinical Avian Medicine and Surgery” (G. J. Harrison and L. R. Harrison, Eds.), pp. 174–191. Saunders, Philadelphia.
- Dein, F. J. (1986b). *Proc. Annual Meeting Assoc. Avian Vet.*, 41–42.
- Dierenfeld, E. S. (1989). *J. Zoo Wildl. Med.* **10**, 3–11.
- Dierenfeld, E. S., Sandford, C. E., and Satterfield, W. D. (1989). *J. Wildl. Manage* **53**, 160–164.
- Dierenfeld, E. S., Sheppard, C. D., Langenberg, J., Mirande, C., Spratt, J., and Dein, F. J. (1993). *J. Wildl. Dis.* **29**, 98–102.
- Dieter, M. P. (1979). In “Animals as monitors of environmental pollutants” (F. W. Nielsen, G. Migaki, and D. G. Scarpelli, Eds.), pp. 177–191. National Academy of Sciences, Washington, DC.
- Djojosingito, A. M., Folkow, B., and Kovach, A. G. B. (1968). *Acta Physiol. Scand.* **74**, 114–122.
- Dohm, G. L., Kasperek, G. J., Tapscott, E. B., and Barakat, H. A. (1985). *Fed. Proc.* **44**, 345–352.
- Dolensek, E., and Bruning, D. (1978). In “Zoo and Wild Animal Medicine” (M. E. Fowler, Ed.), pp. 165–180. Saunders, Philadelphia.
- Dominici, R., Infusino, I., Valente, C., Moraschchinelli, I., and Franzini, C. (2004). *Clin. Chem. Lab. Med.* **42**, 945–951.
- Draury, R. W., Schwab, F., and Bateman, M. C. (1993). *J. Wildl. Dis.* **29**, 577–581.
- Driver, E. A. (1981). *J. Wildl. Dis.* **17**, 413.
- Duke, G. E. (1986). In “Avian Physiology” (P. D. Sturkie, Ed.), 4th ed., pp. 289–302. Springer Verlag, New York.
- Dumonceaux, G., and Harrison, G. J. (1994). In “Avian Medicine: Principles and Application” (B. W. Ritchie, G. J. Harrison, and L. R. Harrison, Eds.), pp. 1030–1052. Wingers, Lake Worth, FL.
- Ekstrom, D. D., and Degernes, L. (1989). *Proc. Ann. Meeting Assoc. Avian Vet., Seattle*, pp. 130–138.
- Espada, Y. (2000). In “Schalm’s Veterinary Hematology” (B. V. Feldman, J. G. Zinkl, and N. C. Jain, Eds.), 5th ed., pp. 552–555. Lippincott Williams & Wilkins, Baltimore.
- Ettinger, S. J. (Ed.) (1989). “Textbook of Veterinary Internal Medicine.” vol. 2, 3rd ed., pp. 1579–1774. Saunders, Philadelphia.
- Fennely, J., Dunne, J., and McGeeney, K. (1969). *Ann. NY Acad. Sci.* **166**, 794–807.
- Fernandez, A., Verde, M. T., Gomez, J., Gascon, M., and Rames, J. J. (1995). *Res. Vet. Sci.* **58**, 119–122.
- Fitzgerald, M., Fennely, J., and McGeeney, K. (1969). *Am. J. Clin. Path.* **51**, 194–201.
- Flammer, K., and Clubb, S. L. (1994). In “Avian Medicine: Principles and Application” (B. W. Ritchie, G. J. Harrison, and L. R. Harrison, Eds.), pp. 805–838. Wingers, Lake Worth, FL.
- Forbes, N. A., and Cooper, J. E. (1993). In “Raptor Biomedicine” (P. T. Redig, J. E. Cooper, D. Remple, and B. Hunter, Eds.), pp. 45–48. University of Minnesota Press, Minneapolis.
- Fourie, F. le R. (1977). *Poultry Sci.* **56**, 1842–1846.
- Fowler, M. E. (1978a). In “Zoo and Wild Animal Medicine” (M. E. Fowler, Ed.), pp. 33–34. Saunders, Philadelphia.
- Fowler, M. E. (1978b). In “Zoo and Wild Animal Medicine” (M. E. Fowler, Ed.), p. 215. Saunders, Philadelphia.
- Fowler, M. E. (1978c). “Restraint and Handling of Wild and Domestic Animals,” 2d ed., pp. 304–332. Iowa State University Press, Ames.
- Galvin, C. (1980). *Proc. 47th Ann. Meeting Am. Animal Hosp. Assoc.*, 41–52.
- Gard, N. W., and Hooper, M. J. (1993). *J. Wildl. Dis.* **29**, 1–7.
- Gazdinski, P., Squires, E. J., and Julian, R. J. (1994). *Avian Dis.* **38**, 379–384.
- George, J. C., John, T. M., and Koike, T. I. (1992). *Biol. Signals* **1**, 160–166.
- George, J. C., John, T. M., and Mitchell, M. A. (1989). *Horm. Metab. Res.* **21**, 542–545.
- Giladi, I., Goldstein, D. L., Pinshow, B., and Gerstberger, R. (1997). *J. Exp. Biol.* **200**, 3203–3211.

- Gratzl, E., and Koehler, H. (Eds.) (1968). "Spezielle Pathologie und Therapie der Geflügelkrankheiten." p. 14. Ferdinand Enke Verlag, Stuttgart.
- Griffin, H. D., Perry, M. M., and Gilbert, A. B. (1984). In "Physiology and Biochemistry of the Domestic Fowl," (B. M. Freeman Ed.) vol. 5, pp. 345–380. Academic Press, London.
- Griminger, P. (1976). In "Avian Physiology" (P. Sturkie, Ed.), 3rd ed., pp. 233–251. Springer Verlag, New York.
- Griminger, P., and Donis, O. (1960). *J. Nutr.* **70**, 361–368.
- Hagberg, M., Michaelson, G., and Örtelius, A. (1982). *Int. Arch. Occup. Environ. Health* **50**, 377–386.
- Harrison, G. J. (1991). *Proc. 1st Conf. Eur. Comm. Assoc. Avian Vet.*, pp. 230–242.
- Hawkey, C., and Hart, G. M. (1988). *Avian Pathol.* **17**, 427–432.
- Hawkey, C., Samour, J. H., Ashton, D. G., Hart, M. G., Cindery, R. N., Finch, J. M., and Jones, D. M. (1983). *Avian Pathol.* **12**, 73–84.
- Heffron, J. J. A., Bomzon, L., and Pattinson, R. A. (1976). *Vet. Rec.* **98**, 338–340.
- Hendriks, H. J., Haage, A., and De Bruijne, J. J. (1976). *Zentralblatt für Veterinärmedizin A* **23**, 683–687.
- Hill, K. (1983). In "Physiology and Biochemistry of the Domestic Fowl," (B. M. Freeman, Ed.) vol. 4, pp. 31–49. Academic Press, London.
- Hochleithner, M. (1989a). *Proc. Annual Meeting Assoc. Avian Vet., Seattle*, 78–81.
- Hochleithner, M. (1989b). *J. Assoc. Avian Vet.* **3**, 207–209.
- Hoffmann, W. E., Baker, G., Rieser, S., and Dorner, J. L. (1987). *Am. J. Vet. Res.* **48**, 1343–1347.
- Howard, B. R. (1992). *J. Am. Vet. Med. Assoc.* **200**, 1667–1674.
- Howard, L. L., Kass, P. H., Lamberski, N., and Wack, R. F. (2004). *J. Zoo Wildl. Med.* **35**, 147–153.
- Hunt, K. A., and Hooper, M. J. (1993). *Analyt. Biochem.* **212**, 335–343.
- Hunt, K. A., Hooper, M. J., and Littrell, E. (1995). *J. Wildl. Dis.* **31**, 186–192.
- Hunt, K. A., Hooper, M. J., and Weisskopf, C. P. (1993). *Toxicologist* **13**, 371.
- Hutton, M. (1980). *Environm. Pollut. Ser. A* **22**, 281–293.
- Jaensch, S. M., Cullen, L., and Raidal, S. R. (2000a). *Avian Pathol.* **29**, 109–116.
- Jaensch, S. M., Cullen, L., and Raidal, S. R. (2000b). *J. Avian Med. Surg.* **14**, 164–171.
- James, S. B., Raphael, B. L., and Clippinger, T. J. (2000). *J. Avian Med. Surg.* **14**, 268–272.
- Jenkins, J. (1994). *Sem. Avian Exotic Pet Med.* **3**, 25–32.
- Jenni, J., Jenni-Eiermann, S., Spina, F., and Schwabl, H. (2000). *Am. J. Physiol. Regul. Integr. Physiol.* **278**, R1182–R1189.
- Johnson, R., Ellingboe, K., and Gibbs, P. (1972). *Clin. Chem.* **19**, 110–115.
- Julian, R. J. (1991). In "Diseases of Poultry" (B. W. Calnek, H. J. Barnes, C. W. Beard, W. M. Reid, and H. W. Yoder, Eds.), 9th ed., pp. 863–884. Iowa State University Press, Ames.
- Kaplan, M. M., and Righetti, A. (1969). *Biochim. Biophys. Acta* **184**, 667–669.
- Kern, M. D., and De Graw, W. A. (1978). *Condor* **80**, 230.
- Klaassen, M. (1996). *J. Exp. Biol.* **199**, 57–64.
- Klein, P. N., and Galey, F. D. (1989). *Proc. Ann. Meet. Assoc. Avian Vet., Seattle*, 139–143.
- Kocan, R. M. (1972). *J. Wildl. Dis.* **8**, 115.
- Kocan, R. M., and Pits, S. M. (1976). *J. Wildl. Dis.* **12**, 341.
- Kodak Company (1986). "Kodak Ektachem DT system, test methodologies." Eastman Kodak Company, Rochester, NY.
- Kolmstetter, C. M., and Ramsay, E. C. (2000). *J. Avian Med. Surg.* **14**, 177–179.
- Kováč, A. G. B., Szasz, E., and Pilmayer, N. (1969). *Acta Physiol. Acad. Sci. Hung.* **35**, 109–116.
- Kryszewski, A. J., Neale, G., and Whitfield, J. B. (1973). *Clin. Chim. Acta* **47**, 175–182.
- LaBonde, J. (1992). *Proc. Ann. Meet. Assoc. Avian Vet.*, 113–118.
- LaBonde, J. (1995). *Sem. Avian Exotic Pet Med.* **4**, 23–31.
- Laessig, R. H., Indriksons, A. A., Hassemer, D. J., Paskey, T. A., and Schwartz, T. H. (1976). *Amer. J. Clin. Pathol.* **66**, 560–598.
- Larsson, M., Petterson, T., and Carlstrom, A. (1985). *Gen. Comp. Endocrinol.* **58**, 360–375.
- Law, G. R. J. (1960). *Poultry Sci.* **39**, 1450–1452.
- Le Maho, Y., Robin, J.-P., and Cherel, Y. (1988). *News Physiol. Sci.* **3**, 21–24.
- Leveille, G. A., and Sauberlich, H. E. (1961). *J. Nutr.* **74**, 500.
- Lin, G. L., Himes, J. A., and Cornelius, C. E. (1974). *Am. J. Physiol.* **226**, 881–885.
- Lind, G. W., Gronwall, R. R., and Cornelius, C. E. (1967). *Res. Vet. Sci.* **8**, 280–282.
- Liu, M. R. S., Fie, A. C. Y., and Lee, Y. C. (1984). *J. Chin. Soc. Vet. Sci.* **10**, 125–130.
- Lloyd, M. (1992). *J. Assoc. Avian Vet.* **6**, 25–29.
- Lothrop, C., Harrison, G., Schultz, D., and Utteridge, T. (1986). In "Clinical Avian Medicine and Surgery" (G. J. Harrison and L. R. Harrison, Eds.), pp. 525–536. Saunders, Philadelphia.
- Ludke, J. L., Hill, E. F., and Dieter, M. P. (1975). *Arch. Environm. Contam. Toxicol.* **3**, 1–21.
- Lumeij, J. T. (1985a). *Avian Pathol.* **14**, 257–260.
- Lumeij, J. T. (1985b). *Vet. Quart.* **7**, 133–136.
- Lumeij, J. T. (1987a). *Vet. Quart.* **9**, 249–254.
- Lumeij, J. T. (1987b). In "A Contribution to Clinical Investigative Methods for Birds, with Special Reference to the Racing Pigeon *Columba livia domestica*" (Ph.D. thesis), pp. 26–30. University of Utrecht, Utrecht.
- Lumeij, J. T. (1987c). *Avian Pathol.* **16**, 377–382.
- Lumeij, J. T. (1987d). *Vet. Quart.* **9**, 255–261.
- Lumeij, J. T. (1987e). *Vet. Quart.* **9**, 262–268.
- Lumeij, J. T. (1987f). In "A Contribution to Clinical Investigative Methods for Birds, with Special Reference to the Racing Pigeon *Columba livia domestica*" (Ph.D. thesis), pp. 35–77. University of Utrecht, Utrecht.
- Lumeij, J. T. (1988). In "Animal Clinical Biochemistry: The Future" (D. J. Blackmore, O. D. Eckersall, G. O. Evans, H. Sommer, M. D. Stonard, and D. D. Woodman, Eds.), pp. 161–174. Cambridge University Press, Cambridge.
- Lumeij, J. T. (1990). *Avian Pathol.* **19**, 661–667.
- Lumeij, J. T. (1991). *J. Assoc. Avian Vet.* **5**, 197–200.
- Lumeij, J. T. (1994a). In "Avian Medicine: Principles and Application" (B. W. Ritchie, G. J. Harrison, and L. R. Harrison, Eds.), pp. 522–537. Wingers, Lake Worth, FL.
- Lumeij, J. T. (1994b). In "Avian Medicine: Principles and Application" (B. W. Ritchie, G. J. Harrison, and L. R. Harrison, Eds.), pp. 538–555. Wingers, Lake Worth, FL.
- Lumeij, J. T. (1994c). In "Avian Medicine: Principles and Application" (B. W. Ritchie, G. J. Harrison, and L. R. Harrison, Eds.), pp. 582–606. Wingers, Lake Worth, FL.
- Lumeij, J. T. (1994d). *Sem. Avian Exotic Pet Med.* **3**, 14–24.
- Lumeij, J. T., Boschma, Y., Mol, J., De Kloet, E. R., and Van den Brom, W. E. (1987a). *Avian Pathol.* **16**, 199–204.
- Lumeij, J. T., and De Bruijne, J. J. (1985a). *Avian Pathol.* **14**, 401–408.

- Lumeij, J. T., and De Bruijne, J. J. (1985b). *Avian Pathol.* **14**, 441–444.
- Lumeij, J. T., De Bruijne, J. J., and Kwant, M. M. (1990). *Avian Pathol.* **19**, 255–261.
- Lumeij, J. T., De Bruijne, J. J., Slob, A., Wolfswinkel, J., and Rothuizen, J. (1988a). *Avian Pathol.* **17**, 851–864.
- Lumeij, J. T., Kantor, A., and Van den Brom, W. E. (1987b). In “A Contribution to Clinical Investigative Methods for Birds, with Special Reference to the Racing Pigeon *Columba livia domestica*” (Ph.D. thesis J. T. Lumeij), pp. 31–34. University of Utrecht, Utrecht.
- Lumeij, J. T., and Maclean, B. (1996). *J. Avian Med. Surg.* **10**, 150–152.
- Lumeij, J. T., Meidam, M., Wolfswinkel, J., Van der Hage, M. H., and Dorresteijn, G. M. (1988b). *Avian Pathol.* **17**, 865–874.
- Lumeij, J. T., and Overduin, L. M. (1990). *Avian Pathol.* **19**, 235–244.
- Lumeij, J. T., and Peccati, C. (1993). *Proc. Eur. Assoc. Avian Vet., Utrecht*, 558–566.
- Lumeij, J. T., and Redig, P. T. (1992). *Proc. VIII. Tagung über Vogelkrankheiten. München* 1992, pp. 265–269. Deutsche Veterinärmedizinische Gesellschaft, Giessen.
- Lumeij, J. T., and Remple, J. D. (1991). *Avian Pathol.* **20**, 79–83.
- Lumeij, J. T., and Remple, J. D. (1992). *Avian Dis.* **36**, 1060–1062.
- Lumeij, J. T., Remple, J. D., and Riddle, K. E. (1993a). *Avian Pathol.* **22**, 183–188.
- Lumeij, J. T., and Westerhof, I. (1987). *Vet. Quart.* **9**, 255–261.
- Lumeij, J. T., and Westerhof, I. (1988a). *Avian Pathol.* **17**, 63–70.
- Lumeij, J. T., and Westerhof, I. (1988b). *Avian Pathol.* **17**, 875–878.
- Lumeij, J. T., Westerhof, I., Smit, T., and Spierenburg, T. J. (1993b). In “Raptor Biomedicine” (P. T. Redig, J. E. Cooper, D. Remple, and D. B. Hunter, Eds.), pp. 233–238. University of Minnesota Press, Minneapolis.
- Lumeij, J. T., and Wolfswinkel, J. (1987). In “A Contribution to Clinical Investigative Methods for Birds, with Special Reference to the Racing Pigeon *Columba livia domestica*” (Ph.D. thesis J. T. Lumeij), pp. 71–77. University of Utrecht, Utrecht.
- Lumeij, J. T., and Wolfswinkel, J. (1988). *Avian Pathol.* **17**, 515–517.
- Machlin, L. J. (1984). “Handbook of Vitamins.” Dekker, New York.
- Maxwell, M. H., Robertson, G. W., and Moseley, D. (1995). *Avian Pathol.* **24**, 333–346.
- McClure, H. E., and Cedeno, R. (1955). *J. Wildl. Manage* **19**, 477–478.
- McGrath, J. J. (1971). *J. Appl. Physiol.* **31**, 274–276.
- McIntire, M. S., Wolf, G. L., and Angle, C. R. (1973). *Clin. Toxicol.* **6**, 183–188.
- Meric, S. M. (1995). In “Textbook of Veterinary Internal Medicine” (S. J. Ettner and E. C. Feldman, Eds.), pp. 159–163. Saunders, Philadelphia.
- Minnick, P. D., Braselton, W. E., and Meerdink, G. L. (1982). *Vet. Human Toxicol.* **24**, 413–414.
- Mori, J. G., and George, J. C. (1978). *Comp. Biochem. Physiol. B* **59**, 263.
- Morris, P. (1985). *Assoc. Avian Vet. Newsletter* **6**, 75.
- Murphey, J. (1992a). *Proc. Annual Meeting Assoc. Avian Vet., New Orleans*, 78–82.
- Murphey, J. (1992b). *Proc. Annual Meeting Assoc. Avian Vet., New Orleans*, 165–170.
- Newham, D. J., Jones, D. A., and Edwards, R. H. T. (1983). *Muscle Nerve* **6**, 380–385.
- Nichols, D. K., Campbell, V. L., and Montali, R. J. (1986). *J. Am. Vet. Med. Assoc.* **189**, 1110–1112.
- Nichols, D. K., and Montali, R. J. (1987). *Proc. Annual Meeting Assoc. Avian Vet., Oahu*, 419–421.
- Nichols, D. K., Wolff, M. J., Philips, L. G., et al. (1989). *J. Zoo Wildl. Med.* **20**, 57–61.
- Nichols, P. K., Bailey, T. A., and Samour, J. A. (1997). *Avian Pathol.* **26**, 19–31.
- Nott, H. M. R., and Taylor, E. J. (1993). In “The Waltham Book of Companion Animal Nutrition” (I. Burger, Ed.), pp. 69–84. Pergamon Press, Oxford.
- Okinaka, S., Sugita, H., Momoi, H., Toyokura, Y., Watanabe, T., Ebashi, F., and Ebashi, S. (1964). *J. Lab. Clin. Med.* **64**, 299–305.
- Phalen, D. N., Ambrus, S., and Graham, D. L. (1990). *Proc. Ann. Meeting Assoc. Avian Vet., Phoenix*, pp. 44–57.
- Phalen, D. N., Homco, L. D., Graham, D. L., and Jaeger, L. A. (1997). *Proc. Ann. Meeting Assoc. Avian Vet., Reno*, pp. 53–58.
- Porter, S. (1993). In “Raptor Biomedicine” (P. T. Redig, J. E. Cooper, D. Remple, and D. B. Hunter, Eds.), pp. 239–245. University of Minnesota Press, Minneapolis.
- Posen, S., Neale, F., and Clubb, J. (1965). *Ann. Int. Med.* **62**, 1234.
- Powers, L. V. (2000). In “Laboratory Medicine Avian and Exotic Pets” (A. M. Fudge, Ed.), pp. 35–45. Saunders, Philadelphia.
- Rae, M. (1992). *Proc. Annual Meeting Assoc. Avian Vet.*, 328–335.
- Reece, R. (1986). *Austr. Vet. J.* **63**, 199.
- Reiser, M. H., and Temple, S. A. (1981). In “Recent Advances in the Study of Raptor Diseases” (J. E. Cooper and A. G. Greenwood, Eds.), pp. 21–25. Chiron, Keighly, United Kingdom.
- Robin, J. -P., Boucontet, L., Cillet, P., and Groscolas, R. (1998). *Am. J. Physiol.* **274** (Regulatory Integrative Comp. Physiol) **43**: R746–R753.
- Robin, J. P., Cherel, Y., Girard, H., Géloen, A., and LeMaho, Y. (1987). *J. Comp. Physiol. B.* **157**, 491–499.
- Roman, Y., Ordonneau, D., Chaste-Duveroy, D., Saint Jalme, M., Bomsel, M. C., and Hingrat, Y. (2005). *Proc. 8th Conf. Eur. Assoc. Avian Vet., Arles*, pp. 290–297.
- Roman, Y., Levrier, J., Ordonneau, D., Chaste-Duveroy, D., Saint Jalme, M., and Bomsel-Demontoy, M. C. (2006). *Proc. 9th Conf. Eur. Assoc. Avian Vet., Zurich*, pp. 264–272.
- Rosalki, S., and Foo, A. (1984). *Clin. Chem.* **30**, 1182–1186.
- Roscoe, D. E., Nielsen, S. W., Eaton, H. D., and Rousseau, J. E. (1975). *Am. J. Vet. Res.* **26**, 1225–1229.
- Roscoe, D. E., Nielsen, S. W., Lamola, A. A., and Zuckerman, D. (1979). *J. Wildl. Dis.* **15**, 127–136.
- Rosenthal, K. L., Johnston, M. S., and Shofer, F. S. (2005a). *Am. J. Vet. Res.* **66**, 375–378.
- Rosenthal, K. L., Shofer, F. S., and Johnston, M. S. (2005b). *Am. J. Vet. Res.* **66**, 936.
- Roskopf, W. J., Woerpel, R. W., and Lane, R. A. (1985). *Proc. Annual Meeting Assoc. Avian Vet., Boulder*, 129–131.
- Roskopf, W. J., Woerpel, R. W., Roskopf, G., and Van de Water, D. (1982). *Vet. Med. Small Anim. Clin.* **77**, 1233–1239.
- Roy, C., Grolleau, G., Chamoulaud, S., and Rivière, J. -L. (2005). *J. Wildl. Dis.* **41**, 184–208.
- Rutgers, H. C., Stradley, R. P., and Johnson, S. E. (1988). *Am. J. Vet. Res.* **49**, 317–320.
- Sanger, V., Burmester, B., and Morril, C. (1986). *Avian Dis.* **10**, 364–371.
- Savova, M. N., and Kirev, T. (1992). *Avian Pathol.* **21**, 667–673.
- Schalm, O. W., Jain, N. C., and Carroll, E. J. (1975). “Veterinary Hematology.” pp. 50, 609. Lea & Febiger, Philadelphia.
- Schenk, P. A., and Chew, D. J. (2005). *Am. J. Vet. Res.* **66**, 1330–1336.
- Schlumberger, H. G. (1956). *Cancer Res.* **16**, 149–153.
- Schmidt, C. H., Hane, M. E., and Gomez, D. C. (1963). *U.S. Armed Forces Med. J.* **4**, 1556.
- Scope, A. J. (2002). *Avian Med. Surg.* **16**, 10–15.
- Scope, A., Filip, T., Gabler, C., and Rensch, F. (2002). *Avian Dis.* **46**, 224–229.

- Shane, S. M., Young, R. J., and Krook, L. (1969). *Avian Dis.* **13**, 558–567.
- Sherman, M. E., Ross, E., and Chang, M. T. Y. (1964). *Toxicol. Appl. Pharmacol.* **6**, 147–153.
- Simkiss, K. (1967). In “Calcium in Reproductive Physiology: A Comparative Study of Vertebrates.” pp. 155–196. Chapman & Hall, London.
- Skadhauge, E. (1981). “Osmoregulation in Birds.” pp. 84–91. Springer-Verlag, Berlin.
- Spano, J. S., Pedersoli, W. M., Kempainen, R. J., Krista, L. M., and Young, D. W. (1987). *Avian Dis.* **31**, 800–803.
- Spano, J. S., Whiteside, M. S., Pedersoli, W. M., Krista, L. M., and Ravis, W. M. (1988). *Am. J. Vet. Res.* **49**, 325–326.
- Spira, A. (1981). *Proc. 48th Annual Meeting Am. Anim. Hosp. Assoc., Atlanta*, 13.
- Spraker, T. R. (1980). In “The Comparative Pathology of Zoo Animals” (R. J. Montali and G. Migaki, Eds.), pp. 403–414. Smithsonian Institution Press, Washington, DC.
- Spraker, T. R., Adrian, W. J., and Lance, W. R. (1987). *J. Wildl. Dis.* **23**, 447–453.
- Sribhen, C., Choothesa, A., Songserm, T., and Issariyodon, S. (2006). *Vet. Clin. Pathol.* **35**, 291–294.
- Stanford, M. (2003a). *Exotic DVM* **5**, 1–6.
- Stanford, M. (2003b). *Proc. 7th Eur. Conf. Assoc. Avian Vet.*, 269–275.
- Stanford, M. (2005). “Calcium Metabolism in Grey Parrots: The Effects of Husbandry.” Thesis Royal College of Veterinary Surgeons, London.
- Stansley, W. (1993). *Arch. Environm. Contam. Toxicol.* **25**, 315–321.
- Steiner, C. V., and Davis, R. B. (1981). “Caged Bird Medicine.” Iowa State University Press, Ames.
- Stevens, R. W. C., and Ridgway, C. J. (1966). *Poultry Sci.* **45**, 204–205.
- Stolbach, L. (1969). *Ann NY Acad. Sci.* **166**, 760–773.
- Sturkie, P. D., and Griminger, (1976). In “Avian Physiology” (P. D. Sturkie, Ed.), 3rd ed., pp. 54–75. Springer-Verlag, New York.
- Takeshita, K., Graham, D. L., and Silverman, S. (1986). *Proc. Assoc. Avian Vet.*, pp. 341–346.
- Tatum, L. M., Zaias, J., Mealy, B. K., Cray, C., and Bossart, G. D. (2000). *J. Zoo Wildl. Med.* **31**, 497–502.
- Tenhunen, R. (1971). *Scand. J. Clin. Lab. Invest.* **116(suppl 27)**, 9.
- Thomson, A. E., Gentry, P. A., and Squires, E. J. (2003). *Br. Poult. Sci.* **44**, 626–633.
- Timms, L. (1977). *Br. Vet. J.* **133**, 623–628.
- Tripp, M. J., and Schmitz, J. A. (1982). *Am. J. Vet. Res.* **43**, 2220–2223.
- Verstappen, F. A. L. M., Lumeij, J. T., and Bronnenberg, R. G. G. (2002). *J. Wildl. Dis.* **38**, 154–159.
- Viswanathan, T. T. M., John, T. M., George, J. C., and Etches, R. J. (1987). *Horm. Metab. Res.* **19**, 400–402.
- Viswanathan, T. T. M., George, J. C., and Scabes, C. G. (1988). *Horm. Metab. Res.* **20**, 271–273.
- Vuillaume, A. (1983). *Avian Pathol.* **12**, 389–391.
- Wadsworth, P. F., Jones, D. M., and Pugsley, S. L. (1984). *Avian Pathol.* **13**, 231–239.
- Wallner-Pendleton, E. A., Rogers, D., and Epple, A. (1993). *Avian Pathol.* **22**, 631–635.
- Watts, R. W. E. (1978). In “Price’s Textbook of the Practice of Medicine” (R. B. Scott, Ed.), 12th ed., pp. 1056–1074. Oxford University Press, Oxford.
- Webb, D. M., Denicola, D. B., and Van Vleet, C. R. (1991). *Avian Dis.* **5**, 662–667.
- Westermarck, E., and Sandholm, M. (1980). *Res. Vet. Sci.* **28**, 341.
- Wiesner, H. (1971). *Der Praktische Tierarzt* **13**, 594–596.
- Wight, P. A., Dewar, W. A., and Saunderson, C. L. (1986). *Avian Pathol.* **15**, 23–38.
- Wijngaarden, J. B., and Smith, L. H. (1982). “Cecil Textbook of Medicine,” 16th ed. Saunders, London.
- Windingstad, R. M., Hurley, S. S., and Sileo, L. (1983). *J. Wildl. Dis.* **19**, 289–290.
- Woerpel, R. W., Rosskopf, W. J., and Monahan-Brennan, M. (1987). In “Companion Bird Medicine” (E. W. Burr, Ed.), pp. 180–196. Iowa State University Press, Ames.
- Wyse, D. G., and Nickerson, M. (1971). *Canad. J. Physiol. Pharmacol.* **49**, 919–926.
- Young, E. (1967). *Int. Zoo Yearb.* **7**, 226–227.
- Zdziarski, J. M., Mattix, M., Bush, R. M., and Montalli, R. J. (1994). *J. Zoo Wildl. Med.* **25**, 438–445.

# SI Units

The Systeme International d'Unites (SI), or the International System of Units, was recommended for use in the health professions by the World Health Assembly (WHA 30.39) in May of 1977. The SI is the culmination of more than a century of effort to develop a universally acceptable system of units of measure. Since the 1990s, the use of SI has been rapidly gaining acceptance with many nations now mandating

its use and many others strongly recommending its use. Furthermore, many scientific journals now require that units be expressed in SI along with the conventional units, if used. The following tables in this appendix briefly describe the basis of SI and provide factors for the conversion of conventional units to SI.

**TABLE A** SI Base Units

Quantity	Name of Unit	Symbol
Length	meter (metre)	m
Mass	kilogram	kg
Time	second	s
Electric current	ampere	A
Thermodynamic temperature	kelvin	K
Luminous intensity	candela	cd
Amount of substance	mole	mol

**TABLE B** SI Derived Units

Quantity	Name of Unit	Symbol
Area	square meter	m <sup>2</sup>
Volume	cubic meter	m <sup>3</sup>
Speed, velocity	meter per second	m/s
Acceleration	meter per second squared	m/s <sup>2</sup>
Substance concentration	mole per cubic meter	mol/m <sup>3</sup>
Pressure	pascal	Pa
Work, energy	joule	J
Celsius temperature	degree Celsius	°C

**TABLE C** SI Prefixes

Factor	Prefix	Symbol	Factor	Prefix	Symbol
10 <sup>18</sup>	exa	E	10 <sup>-1</sup>	deci	d
10 <sup>15</sup>	peta	P	10 <sup>-2</sup>	centi	c
10 <sup>12</sup>	tera	T	10 <sup>-3</sup>	milli	m
10 <sup>9</sup>	giga	G	10 <sup>-6</sup>	micro	μ
10 <sup>6</sup>	mega	M	10 <sup>-9</sup>	nano	n
10 <sup>3</sup>	kilo	k	10 <sup>-12</sup>	pico	p
10 <sup>2</sup>	hector	h	10 <sup>-15</sup>	femto	f
10 <sup>1</sup>	deca	da	10 <sup>-18</sup>	atto	a

**TABLE D** Non-SI Units Still in General Use

Quantity	Unit	Symbol	Value in SI
Time	minute	m	60s
	hour	h	3,600s
	day	d	86,400s
Volume	liter (litre)	l <sup>a</sup>	10 <sup>-3</sup> m <sup>3</sup>
Mass	tonne	t	1,000kg
Length	angstrom	Å	10 <sup>-10</sup> m (0.1 nm)
	bar	bar	10 <sup>5</sup> Pa
	atmosphere	atm	101,325 Pa
Pressure	mmHg	mmHg	1.333 × 10 <sup>-4</sup> Pa
	Radioactivity	curie	Ci
Radioactivity	roentgen	R	2.58 × 10 <sup>-4</sup> Ci/kg
	rad	rad	10 <sup>-2</sup> gray(Gy)
	rem	rem	10 <sup>-2</sup> sievert(Sv)

<sup>a</sup> Liter is often spelled out or symbolized by L to avoid confusion.

**TABLE E** SI Conversion Factors

Chemical Constituent	Conventional "Old Unit"	×	Factor	=	New SI Unit
Acetoacetate	mg/dL		0.098		mmol/L
Acetone	mg/dL		0.172		mmol/L
Albumin	g/dL		10.0		g/L
Ammonia	μg/dL		0.5872		μmol/L
Bicarbonate	mEq/L		1.0		mmol/L
Bilirubin	mg/dL		17.10		μmol/L
Bromsulphthalein	mg/dL		11.93		μmol/L
Calcium	mg/dL		0.2495		mmol/L
Carotenes	μg/dL		0.01863		μmol/L
Chloride	mEq/L		1.0		mmol/L
Cholesterol	mg/dL		0.02586		mmol/L
Cobalt	μg/dL		0.1697		μmol/L
Coproporphyrin	μg/dL		15.0		nmol/L
Cortisol	μg/dL		27.59		nmol/L
CO <sub>2</sub> , total	mEq/L		1.0		mmol/L
CO <sub>2</sub> Pressure, pCO <sub>2</sub>	mmHg		0.1333		kPa
Copper	μg/dL		0.1574		μmol/L
Creatinine	mg/dL		88.40		μmol/L
Fibrinogen	mg/dL		0.01		g/L
Fructose	mg/dL		55.51		μmol/L
Glucose	mg/dL		0.05551		mmol/L
Haptoglobin	mg/dL		0.01		g/L
Hemoglobin	g/dL		10.0		g/L
3-Hydroxybutyrate	mg/dL		0.096		mmol/L
Iodine	μg/dL		78.8		nmol/L
Insulin	μU/ml		7.175		pmol/L
Iron	μg/dL		0.1791		μmol/L
Lactate	mg/dL		0.1110		mmol/L
Lead	μg/dL		0.04826		μmol/L
Magnesium	mg/dL		0.4114		mmol/L
Manganese	μg/dL		0.1820		μmol/L
Mercury	μg/L		4.985		nmol/L
Methemoglobin	g/dL		10.0		g/L
Molybdenum	μg/dL		0.1042		μmol/L
Myoglobin	mg/dL		0.5848		μmol/L
Nitrogen	mg/dL		0.7138		mmol/L
O <sub>2</sub> Pressure, pO <sub>2</sub>	mmHg		0.1333		kPa

(continued)

**TABLE E** (Continued)

Chemical Constituent	Conventional "Old Unit"	×	Factor	=	New SI Unit
Phosphorus	g/dL		0.3229		mmol/L
Porphobilinogen	mg/dL		44.20		$\mu$ mol/L
Potassium	mEq/L		1		mmol/L
Protein	g/dL		10		g/L
Protoporphyrin	$\mu$ g/dL		0.0178		$\mu$ mol/L
Pyruvate	mg/dL		113.6		$\mu$ mol/L
Selenium	$\mu$ g/dL		0.1266		$\mu$ mol/L
Sodium	mEq/L		1		mmol/L
Thyroxine	$\mu$ g/dL		12.87		nmol/L
Transferrin	mg/dL		0.01		g/L
Triglycerides (triolein)	mg/dL		0.01129		mmol/L
Triiodothyronine	ng/dL		0.01536		nmol/L
Urate	mg/dL		59.48		$\mu$ mol/L
Urea nitrogen	mg/dL		0.7140		mmol/L
Urea nitrogen	mg/dL		0.3570		mmol Urea/L
Urea	mg/dL		0.1665		mmol/L
Urobilinogen	mg/dL		16.90		$\mu$ mol/L
Uroporphyrin	$\mu$ g/dL		12.00		nmol/L
Vitamin A	$\mu$ g/dL		0.03491		$\mu$ mol/L
Xylose	mg/dL		0.06660		mmol/L
Zinc	$\mu$ g/dL		0.1530		$\mu$ mol/L
Enzymes <sup>a</sup>	U/L		16.67		nkatal

<sup>a</sup> There is yet no general agreement nor recommendation for the use of the katal (1 kat = 1 mol/s) in place of the widely used international unit (1 U = 1  $\mu$ mol/m). The U/L should continue to be used for all enzyme activities.

## Conversion Factors of Some Non-SI Serum Enzyme Units to SI International Enzyme Units<sup>a</sup>

Serum Enzyme	Non-SI Unit	×	Factor	=	SI
Aldolase (ALD)	Sibley-Lehninger Unit (SLU) (mg DNP/hr/mL)		0.75		U/L
Amylase (AMYL)	Somogyi Unit (SU) (mg G/30 m)		1.85		U/L
Glutamic-oxalacetic Transaminase (SGOT, AST)	Sigma-Frankel Unit (SFU) Karmen Unit (KU) Wroblewski-LaDue Unit (WLU) Reitman-Frankel Unit (RFU) (0.001 OD/m/mL)		0.48		U/L
Glutamic Pyruvic Transaminase (SGPT, ALT)	Sigma-Frankel Unit (SFU) Karmen Unit (KU) Wroblewski-LaDue Unit (WLU) Reitman-Frankel Unit (RFU) (0.001 OD/m/mL)		0.48		U/L
Isocitric Dehydrogenase (ICD)	Wolfson-Williams-Ashman Unit (WWAU) (nmol/h/mL)		0.0167		U/L
Lipase	Roe-Byler Unit (RBU) ( $\mu\text{mol/h/mL}$ )		16.7		U/
	Cherry-Crandall Unit (CCU) ( $50 \mu\text{mol/3 h/mL}$ )		2.77		U/L
Phosphatase, acid	King-Armstrong Unit (KAU) (mg Phenyl-P/30 m)		1.85		U/L
Phosphatase, Alkaline (ALP)	King-Armstrong Unit (KAU) (mg Phenyl-P/30 m)		7.10		U/L
	Bodansky Unit (BU) (mg P/hr)		5.4		U/L
Sorbitol (Iditol) Dehydrogenase (SDH, IDH)	Sigma-Frankel Unit (SFU) (nmol/hr/mL)		0.0167		U/L

<sup>a</sup> U = 1 International Unit =  $1 \mu\text{mol/m} = 16.67 \text{ nmol/s} = 16.67 \text{ nkatal/s} = 0.01667 \mu\text{katal/s}$ .



## Temperature Correction Factors (Tf) for Some Common Enzymes

Assay Temperature (EC)	ALP	CK	LDH	SDH	ALT/AST
20	2.61	2.05	2.10	1.48	2.29
21	2.37	1.82	1.96	1.42	1.85
22	2.15	1.70	1.80	1.37	1.71
23	1.95	1.59	1.67	1.32	1.59
24	1.77	1.49	1.55	1.27	1.45
25	1.61	1.39	1.45	1.22	1.37
26	1.46	1.31	1.33	1.17	1.29
27	1.33	1.23	1.26	1.12	1.21
28	1.21	1.15	1.16	1.08	1.12
29	1.10	1.07	1.07	1.04	1.05
30	1.00	1.00	1.00	1.00	1.00
31	0.90	0.93	0.93	0.96	0.95
32	0.81	0.87	0.86	0.93	0.89
33	0.73	0.81	0.80	0.89	0.85
34	0.66	0.75	0.74	0.85	0.80
35	0.59	0.70	0.68	0.82	0.77
36	0.53	0.65	0.64	0.79	0.73
37	0.48	0.50	0.59	0.76	0.70

Abbreviations: ALP, alkaline phosphatase; CK, creatine kinase; LDH, lactate dehydrogenase; SDH, sorbitol (iditol) dehydrogenase; ALT, alanine aminotransferase; AST, aspartate aminotransferase.

### Examples of Use

- A. To correct an enzyme activity to a standard temperature of 30EC, multiply the assay value at any temperature by the Tf of that temperature:

AIP activity at 27EC = 48 U/L; correct it to 30EC

$$48 \times 1.33 = 63.8 \text{ U/L}$$

- B. To correct an enzyme activity at any one temperature to another temperature, multiply the assay value at the first temperature by the ratio of the Tf of the first temperature to the Tf of the second temperature:

AIP activity at 22EC = 38 U/L; correct it to 37EC

$$38 \text{ U/L} \times 2.15/0.48 = 170.2 \text{ U/L at 37EC}$$

## Stability of Serum Enzymes under Various Storage Conditions<sup>a</sup>

Enzyme	25EC	4EC	-25EC
Acid phosphatase	4 h <sup>b</sup>	3 d <sup>c</sup>	3 d <sup>c</sup>
Alkaline phosphatase	2-3 d <sup>d</sup>	2-3 d	1 month
Aldolase	2 d	2 d	Unstable <sup>e</sup>
Amylase	1 month	7 months	2 months
Cholinesterase	1 wk	1 wk	1 wk
Creatine kinase	2 d	1 wk	1 month
γ-Glutamyl transferase	2 d	1 wk	1 month
Glutamate dehydrogenase	1 d	2 d	1 d
Aspartate aminotransferase	3 d	1 wk	1 month
Alanine aminotransferase	2 d	1 wk	Unstable <sup>e</sup>
Hydroxybutyrate dehydrogenase	Unstable	3 d	Unstable <sup>e</sup>
Isocitrate dehydrogenase	5 h	3 d	3 wk
Leucine aminopeptidase	1 wk	1 wk	1 wk
Lactate dehydrogenase	1 wk	1-3 d <sup>f</sup>	1-3 d <sup>f</sup>
Malate dehydrogenase	Unstable	3 d	3 d
Sorbitol (Iditol)dehydrogenase	Unstable	1 d	2 d

<sup>a</sup>No more than 10% of the original activity lost during the specified time.

<sup>b</sup>At pH 5-6.

<sup>c</sup>With added citrate or acetate.

<sup>d</sup>Activity may increase.

<sup>e</sup>Enzyme does not tolerate thawing well.

<sup>f</sup>Depends on the isoenzyme profile.

## Temperature Conversions among Degrees Celsius, Degrees Fahrenheit, and Degrees Kelvin

$$EC = 5/9 \times (EF - 32)$$

$$EF = (9/5 \times EC) + 32$$

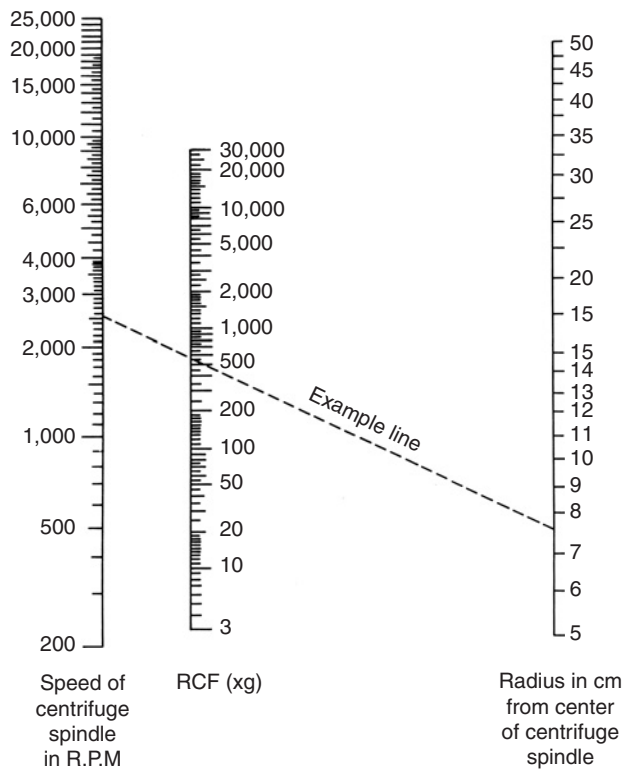
$$EK = EC + 273.15$$

$$EC = EK - 273.15$$

$$EF = (9/5 \times EK) - 459.67$$

$$EK = (5/9 \times EF) + 255.37$$

# Nomogram for Computing Relative Centrifugal Forces (RCF)



**FIGURE VI-1** To calculate the RCF value at any point along the tube, measure the radius in cm from the center of the centrifuge spindle to the point. Draw a line from this radius value on the right-hand column to the centrifuge speed on the left-hand column. The RCF value is the point where the line intersects the center column. The nomogram is based on the following formula:

$$\text{RCF} = 0.00001118 \times \text{radius} \times \text{RPM}^2.$$

# Conversions of Body Weight to Square Meters of Body Surface Area for Dogs and Cats<sup>a</sup>

Kg	M <sup>2</sup>	Kg	M <sup>2</sup>
0.5	0.06		
1.0	0.10	26.0	0.89
2.0	0.16	27.0	0.91
3.0	0.21	28.0	0.93
4.0	0.26	29.0	0.95
5.0	0.30	30.0	0.98
6.0	0.33	31.0	1.00
7.0	0.37	32.0	1.02
8.0	0.40	33.0	1.04
9.0	0.44	34.0	1.06
10.0	0.47	35.0	1.08
11.0	0.50	36.0	1.10
12.0	0.53	37.0	1.12
13.0	0.56	38.0	1.14
14.0	0.59	39.0	1.16
15.0	0.62	40.0	1.18
16.0	0.64	41.0	1.20
17.0	0.67	42.0	1.22
18.0	0.69	43.0	1.24
19.0	0.72	44.0	1.26
20.0	0.74	45.0	1.28
21.0	0.77	46.0	1.30
22.0	0.79	47.0	1.32
23.0	0.82	48.0	1.33
24.0	0.84	49.0	1.35
25.0	0.86	50.0	1.37

<sup>a</sup> Calculated from:  $A = k W^{0.667} \times 10^{-4}$ , where A = body surface area in square meters (M<sup>2</sup>); k = constant 10.1 for dogs; W = body weight in grams. For cats, the constant, k, is 10.0 so the conversion to body surface area closely approximates that for the dog and may be used interchangeably.

# Appendix VIII Blood Analyte Reference Values in Large Animals<sup>a</sup>

Analyte <sup>b</sup>	Unit	Horse	Cow	Sheep	Goat	Llama	Pig
Acetylcholinesterase (AcChE): R	U/L	450–790	1270–2430	640	270		930
Alanine aminotransferase (ALT, GPT): S, HP	U/L	3–23 (14 ± 11)	11–40 (27 ± 14)	(30 ± 4)	6–19	6–14 (8.8 ± 2.6)	31–58 (45 ± 14)
Aldolase (ALD): S, HP	U/L						
Ammonia (NH <sub>4</sub> ): S, HP	μmol/L	7.63–63.4 (35.8 ± 17.0)					
	μg/dL	13–108 (61 ± 29)					
Amylase (Amyl): S, HP	U/L	75–150					
Arginase (ARG): S, HP	U/L	0–14 (11 ± 18)	1–30 (8.3 ± 6)	0–14 (5 ± 1)			0–14
Aspartate aminotransferase (AST, GOT): S, HP	U/L	226–366 (296 ± 70)	78–132 (105 ± 27)	60–280 (307 ± 43)	167–513	216–378 (292 ± 50)	32–84 (61 ± 26)
Bicarbonate (HCO <sub>3</sub> ): S, P	mmol/L	20–28	17–29	20–25			18–27
Bile acids, total (TBA): S	μmol/L	5–28	20–80				
Bilirubin: S, P, HP Conjugated (CB)	μmol/L	0–6.84 (1.71)	0.68–7.52 (3.08)	0–4.61 (2.05)			0–5.13 (1.71 ± 1.71)
	mg/dL	0–0.4 (0.1)	0.04–0.44 (0.18)	0–0.27 (0.12)			0–0.3 (0.1 ± 0.1)
Unconjugated (UCB)	μmol/L	3.42–34.2	0.51	0–2.05 (17.1)			0–5.13
	mg/dL	0.2–2.0 (1.0)	0.03	0–0.12			0–0.3
Total (TB)	μmol/L	7.1–34.2 (17.1)	0.17–8.55 (3.42)	1.71–8.55 (3.93 ± 1.71)	0–1.71	0–17.1 (3.42 ± 3.42)	0–17.1 (3.42 ± 3.42)
	mg/dL	1–2.0 (1.0)	0.01–0.5 (0.2)	0.1–0.5 (0.23 ± 0.1)	0–0.1	0–1.0 (0.2 ± 0.2)	0–1.0 (0.2 ± 0.2)
Butyrylcholinesterase (ButChE): P	U/L	2000–3100	70	0–70	110		400–430

Calcium (Ca): S, HP	mmol/L	2.80–3.40 (3.10 ± 0.14)	2.43–3.10 (2.78 ± 0.15)	2.88–3.20 (3.04 ± 0.07)	2.23–2.93 (2.58 ± 0.18)	2.20–2.58 (2.30 ± 0.23)	1.78–2.90 (2.41 ± 0.25)
	mg/dL	11.2–13.6 (12.4 ± 0.58)	9.7–12.4 (11.08 ± 0.67)	11.5–12.8 (12.16 ± 0.28)	8.9–11.7 (10.3 ± 0.7)	8.0–10.3 (9.2 ± 0.9)	7.1–11.6 (9.65 ± 0.99)
Carbon dioxide, pressure (pCO <sub>2</sub> ): S, P	mmHg	38–46 (42.4 ± 2.0)	35–44	(41.3 ± 4.7)			
Carbon dioxide, total (TCO <sub>2</sub> ): S, P	mmol/L	24–32 (28)	21.2–32.2 (26.5)	21–28 (26.2)	25.6–29.6 (27.4 ± 1.4)		
Chloride (Cl): S, HP	mmol/L	99–109 (104 ± 2.6)	97–111 (104)	95–103	99–110.3 (105.1 ± 2.9)	102–109 (105 ± 2)	94–106
Cholesterol (Chol): S, P, HP	mmol/L		1.50–2.28 (1.89 ± 0.39)				
Ester	mg/dL		58–88 (81.1)	(73 ± 15)			28–48
Free	mmol/L	(0.41)	0.57–1.35 (0.96 ± 0.39)	(1.66 ± 0.31)			0.72–1.24
	mg/dL	(15.7)	22–52 (37 ± 15)				5.7–10.9
Total	mmol/L	1.94–3.89 (2.88 ± 0.47)	2.07–3.11	1.35–1.97 (1.66–0.31)	2.07–3.37 (1.55 ± 0.67)	0.91–2.93	0.93–1.40
	mg/dL	75–150 (111 ± 18)	80–120	52–76 (64 ± 12)	80–130	35–113 (60 ± 26)	36–54
Copper (Cu): S	μmol/L		5.16–5.54	9.13–25.2			20.9–43.8 (32.4)
	μg/dL		32.8–35.2	58–160			133–278 (206)
Coproporphyrin (COPRO): HB, HP, R	μmol/L μg/dL		trace trace				
Cortisol (Cort-RIA): S, HP	nmol/L μg/dL	36–81	(17 ± 2)	(62 ± 10)	(65 ± 8)		(82 ± 3)
		1.30–2.93	(0.61 ± 0.07)	(2.24 ± 0.36)	(2.35 ± 0.29)		(2.97 ± 0.10)
Creatine kinase (CK): S, HP	U/L	2.4–23.4 (12.9 ± 5.2)	4.8–12.1 (7.4 ± 2.4)	8.1–12.9 (10.3 ± 1.6)	0.8–8.9 (4.5 ± 2.8)	17–101 (40.8 ± 29.9)	2.4–22.5 (8.9 ± 6.0)
Creatinine (Creat): S, P, HP	μmol/L	106–168	88.4–177	106–168	88.4–159	97.2–221 (150 ± 35.4)	141–239 (141 ± 5.3)
	mg/dL	1.2–1.9	1.0–2.0	1.2–1.9	1.0–1.8	1.1–2.5 (1.7 ± 0.4)	1.0–2.7 (1.6 ± 0.06)

(Continued)

(Continued)

Analyte <sup>b</sup>	Unit	Horse	Cow	Sheep	Goat	Llama	Pig
Fatty acid, free (FFA): HP	mg/L		30–100				
Fibrinogen (Fibr): P, HP	μmol/L	2.94–11.8 (7.65 ± 2.35)	8.82–20.6	2.94–14.7	2.94–11.8		2.94–14.7
	g/L	1.0–4.0 (2.6 ± 0.8)	3.0–7.0	1.0–5.0	1.0–4.0		1.0–5.0
	mg/dL	100–400 (260 ± 80)	300–700	100–500	100–400		100–500
Glucose (Glu): S, P, HP	mmol/L	4.16–6.39 (5.30 ± 0.47)	2.50–4.16 (3.19 ± 0.38)	2.78–4.44 (3.80 ± 0.33)	2.78–4.16 (3.49 ± 0.39)	5.72–8.89 (7.10 ± 0.89)	4.72–8.33 (6.61 ± 0.96)
	mg/dL	75–115 (95.6 ± 8.5)	45–75 (57.4 ± 6.8)	50–80 (68.4 ± 6.0)	50–75 (62.8 ± 7.1)	103–160 (128 ± 16)	85–150 (119 ± 17)
Glutamate dehydrogenase (GD): S, HP	U/L	0–11.8 (5.6 ± 4.2)	31	20			0
Glutamic oxaloacetic transaminase (GOT): see AST							
Glutamic pyruvate transaminase (GPT): see ALT							
γ-Glutamyl transferase (GGT): S, P	U/L	4.3–13.4 (7.6 ± 1.5)	6.1–17.4 (15.7 ± 4.0)	20–52 (33.5 ± 4.3)	20–56 (38 ± 13)	7–29 (15.8 ± 6.4)	10–60 (35 ± 21)
Glutathione (GSH): B	mmol/L		2.47–3.67 (2.89 ± 0.46)				
Glutathione (GSH): B	mg/dL		76–113 (89 ± 14)				
Glutathione peroxidase (GP <sub>x</sub> ): H, B	U/100 g Hb	(7931 ± 1620)					
Glutathione reductase (GR): H, B	U/100 g Hb	(33.3 ± 10.5)	(19.5 ± 3.9)	(34.3 ± 7.5)	(98 ± 16)		(68.2 ± 9.2)
Haptoglobin (Hp): S, HP	g/L						
Hemoglobin (Hb): B	g/L	110–190 (144 ± 17)	80–150 (110)	90–140 (115)	80–120 (100)	132–205 (173)	100–160 (130)
Icterus index (II): P, HP	Unit	5–20	5–15	2–5	2–5		2–5
Iditol dehydrogenase (ID): see SDH							
Insulin (Ins): S, HP	pmol/L μU/mL		0–35.9 0–5				
Iodine, total (I): S	nmol/L μg/dL						394–946 5–12



Iron (Fe): S	$\mu\text{mol/L}$	13.1–25.1 (19.9 $\pm$ 1.97)	10.2–29.0 (17.4 $\pm$ 5.19)	29.7–39.7 (34.5 $\pm$ 1.25)	16.3–35.6 (21.7 $\pm$ 5.91)
	$\mu\text{g/dL}$	73–140 (111 $\pm$ 11)	57–162 (97 $\pm$ 29)	166–222 (193 $\pm$ 7)	91–199 (121 $\pm$ 33)
Iron binding capacity, total (TIBC): S	$\mu\text{mol/L}$	59.1 $\pm$ 5.7 (330 $\pm$ 32)	41.2 $\pm$ 11.6 (230 $\pm$ 65)		74.6 $\pm$ 12.9 (417 $\pm$ 72)
Iron binding capacity, unbound (UIBC): S	$\mu\text{mol/L}$	35.8–46.9 (39.0 $\pm$ 3.8)	11.3–33.3 (23.5 $\pm$ 6.4)		100–262 (196 $\pm$ 39)
	$\mu\text{g/dL}$	200–262 (218 $\pm$ 21)	63–186 (131 $\pm$ 36)		
Isocitrate dehydrogenase (ICD): S, HP	U/L	4.8–18.0 (10.0 $\pm$ 3.3)	9.4–21.9 (16.7 $\pm$ 2.8)	0.4–8.0 (4.7 $\pm$ 2.8)	
Ketones (Ket): HP	mmol/L		0–0.11 (0.043 $\pm$ 0)	(0.030 $\pm$ 0.002)	
Acetoacetate (AcAc):	mg/dL		0–1.1 (0.5)	(0.30 $\pm$ 0.02)	
Acetone (Ac):	mmol/L		0–1.72 (0–10)	0–1.72	
$\beta$ -Hydroxybutyrate ( $\beta$ -OHB) or 3-Hydroxybutyrate (3-OHB):	mmol/L		0.41 $\pm$ 0.03 (9.90 $\pm$ 1.88)	(0.55 $\pm$ 0.04) (5.73 $\pm$ 0.42)	
Lactate (Lac): B	mmol/L	1.11–1.78 (10–16)	0.56–2.22 (5–20)	1.00–1.33 (9–12)	
Lactate dehydrogenase (LDH): S, HP	U/L	162–412 (252 $\pm$ 63)	692–1445 (1061 $\pm$ 222)	238–440 (352 $\pm$ 59)	380–634 (499 $\pm$ 75)
LDH isoenzymes: S, P					
LDH-1 (heart, anodal)	%	6.3–18.5 (11.5 $\pm$ 4.0)	39.8–63.5 (49.0 $\pm$ 5.4)	45.7–63.6 (54.3 $\pm$ 6.5)	34.1–61.8 (50.8 $\pm$ 10.1)
LDH-2	%	8.4–20.5 (14.8 $\pm$ 3.2)	19.7–34.8 (27.8 $\pm$ 3.4)	0–3.0 (0.8 $\pm$ 1.2)	5.9–9.2 (7.3–1.2)
LDH-3	%	41.0–65.9 (50.2 $\pm$ 7.2)	11.7–18.1 (14.5 $\pm$ 1.9)	16.4–29.9 (23.3 $\pm$ 4.0)	5.7–11.7 (7.4 $\pm$ 1.9)
LDH-4	%	9.5–20.9 (16.2 $\pm$ 3.8)	0–8.8 (4.4 $\pm$ 2.4)	4.3–7.3 (5.3 $\pm$ 1.0)	6.9–15.9 (10.9 $\pm$ 3.1)
LDH-5 (liver, muscle, cathodal)	%	1.7–16.5 (7.3 $\pm$ 4)	0–12.4 (4.3 $\pm$ 3.4)	10.5–29.1 (16.3 $\pm$ 6.2)	16.3–35.2 (23.6 $\pm$ 6.5)

(Continued)

(Continued)

Analyte <sup>b</sup>	Unit	Horse	Cow	Sheep	Goat	Llama	Pig
Lead (Pb): HB	$\mu\text{mol/L}$	0.24–1.21	0–1.16 (0.48 $\pm$ 0.29)	0.24–1.21	0.24–1.21		
	$\mu\text{g/dL}$	5–25	0–24 (10 $\pm$ 6)	5–25	5–25		
Magnesium (Mg): S	mmol/L	0.90–1.15 (1.03 $\pm$ 0.13)	0.74–0.95 (0.84 $\pm$ 0.10)	0.90–0.31 (1.03 $\pm$ 0.12)	0.31–1.48 (1.32 $\pm$ 0.14)	0.75–1.55 (0.95 $\pm$ 0.10)	1.11–1.52 (1.31 $\pm$ 0.20)
	mg/dL	2.2–2.8 (2.5 $\pm$ 0.31)	1.8–2.3 (2.05 $\pm$ 0.25)	2.2–2.8 (2.5 $\pm$ 0.3)	2.8–3.6 (3.2 $\pm$ 0.35)	1.82–3.77 (2.31 $\pm$ 0.24)	2.7–3.7 (3.2 $\pm$ 0.49)
Ornithine carbamyl transferase (OCT): S, HP	U/L	(3.3 $\pm$ 4.2)	(4.7 $\pm$ 0.3)				
pH: HB	Unit	7.32 $\pm$ 7.44 (7.38 $\pm$ 0.03)	7.31–7.53 (7.38)	7.32–7.54 (7.44)			
Phosphatase, alkaline (ALP): S, HP	U/L	143–395 (244 $\pm$ 101)	0–488 (194 $\pm$ 126)	68–387 (178 $\pm$ 102)	93–387 (219 $\pm$ 76)	41–92 (63 $\pm$ 17)	118–395 (194 $\pm$ 84)
Phosphate, Inorg (Pi): S, HP	mmol/L	1.00–1.81	1.81–2.10	1.62–2.36 (2.07 $\pm$ 0.06)	(4.62 $\pm$ 0.25)	1.00–3.49 (2.06 $\pm$ 0.87)	1.71–3.10
	mg/dL	3.1–5.6	5.6–6.5	5.0–7.3 (6.4 $\pm$ 0.2)	(6.5)	3.1–10.8 (6.4 $\pm$ 2.7)	5.3–9.6
Potassium (K): S, HP	mmol/L	2.4–4.7 (3.51 $\pm$ 0.57)	3.9–5.8 (4.8)	3.9–5.4	3.5–6.7 (4.3 $\pm$ 0.5)	4.6–7.1 (5.6 $\pm$ 0.8)	4.4–6.7
Potassium (K): R	mmol/L	(88)	10–45 (24 $\pm$ 7.0)	(64 or 18)			(100)
Protein (Prot): S							
Total (TP)	g/L	52.0–79.0 (63.5 $\pm$ 5.9)	67.4–74.6 (71.0 $\pm$ 1.8)	60.0–79.0 (72.0 $\pm$ 5.2)	64.0–70.0 (69.0 $\pm$ 4.8)	58.0–75.0 (64.9 $\pm$ 4.9)	79.0–89.0 (84.0 $\pm$ 5.0)
Protein (Prot): S							
Electrophoresis (SPE), cellulose acetate (CA):							
Albumin	g/L	26.0–37.0 (30.9 $\pm$ 2.8)	30.3–35.5 (32.9 $\pm$ 1.3)	24.0–30.0 (27.0 $\pm$ 1.9)	27.0–39.0 (33.0 $\pm$ 3.3)	36.0–48.0 (42.5 $\pm$ 3.9)	19.0–39.0 (25.9 $\pm$ 7.1)
Globulin, total	g/L	26.2–40.4 (33.3 $\pm$ 7.1)	30.0–34.8 (32.4 $\pm$ 2.4)	35.0–57.0 (44.0 $\pm$ 5.3)	27.0–41.0 (36.0 $\pm$ 5.0)	16.0–29.0 (22.4 $\pm$ 3.9)	52.9–64.3 (58.6 $\pm$ 5.7)
$\alpha$	g/L		7.5–8.8 (7.9 $\pm$ 0.2)	3.0–6.0 (5.0 $\pm$ 1.0)	5.0–7.0 (6.0 $\pm$ 0.6)	6.0–9.0 (7.7 $\pm$ 1.3)	
$\alpha_1$	g/L	0.6–7.0 (1.9 $\pm$ 2.6)					3.2–4.4 (3.8 $\pm$ 0.6)

$\alpha_2$	g/L	3.1-13.1 (6.5 ± 1.3)				12.8-15.4 (14.1 ± 1.3)
$\beta$	g/L		8.0-11.2 (9.6 ± 0.8)		10.0-11.0 (10.3 ± 0.5)	
$\beta_1$	g/L	4.0-15.8 (9.2 ± 3.0)		7.0-12.0 (10.0 ± 1.4)	7.0-12.0 (9.0 ± 1.0)	1.3-3.3 (2.3 ± 1.0)
$\beta_2$	g/L	2.9-8.9 (5.7 ± 1.1)		4.0-14.0 (7.0 ± 2.6)	3.0-6.0 (4.0 ± 0.2)	12.6-16.8 (14.7 ± 2.1)
$\gamma$	g/L	5.5-19.0 (10.0 ± 1.4)	16.9-22.5 (19.7 ± 1.4)		9.0-30.0 (17.0 ± 4.4)	22.4-24.6 (23.5 ± 1.1)
$\gamma_1$	g/L			7.0-22.0 (16.0 ± 4.1)		
$\gamma_2$	g/L			2.0-11.0 (8.0 ± 3.0)		
A/G Ratio	—	6.2-14.6 (9.6 ± 1.7)	8.4-9.4 (8.9 ± 0.5)	4.2-7.6 (6.3 ± 0.9)	6.3-12.6 (9.5 ± 1.7)	3.7-5.1 (4.4 ± 0.7)
Protoporphyrin (PROTO): R	$\mu\text{mol/L}$ $\mu\text{g/dL}$		trace trace			(2.1) 118
Pseudocholinesterase (PsChE); see ButChE						
Pyruvate (PYR): R	$\mu\text{mol/L}$		(54.0 ± 24.0)			
Sodium (Na): S, HP	mmol/L	132-146 (139 ± 3.5)	132-152 (142)	139-152	142-155 (150 ± 3.1)	148-155 (152 ± 1.9)
Sorbitol dehydrogenase (SDH): S, HP	U/L	1.9-5.8 (3.3 ± 1.3)	4.3-15.3 (9.2 ± 3.1)	5.8-27.9 (15.7 ± 7.5)	14.0-23.6 (19.4 ± 3.6)	1-17 (4.9 ± 6.2)
Thyroxine (T <sub>4</sub> -RIA): S	nmol/L $\mu\text{g/dL}$	11.6-36.0 (0.024 ± 0.004)	54.0-110.7 (82.4)			131.6-286.4 (185.8 ± 50.3)
		0.9-2.8 (1.55 ± 0.27)	4.2-8.6 (6.4)			10.2-22.2 (14.4 ± 3.9)

(Continued)

(Continued)							
Analyte <sup>b</sup>	Unit	Horse	Cow	Sheep	Goat	Llama	Pig
Thyroxine, free (FT <sub>4</sub> ): S	pmol/L pg/dL						
Triglyceride, total (TG): S	mmol/L mg/dL	0.1–0.5 4–44	0–0.2 0–14				
Triiodothyronine (T <sub>3</sub> -RIA)	nmol/L ng/dL	(0.85 ± 0.52) (55.34 ± 33.9)				1.35–4.06 (2.27 ± 0.94) 88–264	
Urate (UA): S, P, HP	mmol/L mg/dL	53.5–65.4 0.9–1.1	0–119.0 0–2	0–113.0 0–1.9	17.8–59.5 0.3–1		
Urea (UR): S, P, HP	mmol/L	3.57–8.57	7.14–10.7	2.86–7.14	3.57–7.14 (5.36 ± 0.71)	4.28–12.14 (9.71 ± 2.61)	3.57–10.7
Urea nitrogen (UN): S, P, HP	mg/dL	10–24	20–30	8–20	10–20 (15 ± 2.0)	12–34 (27.2 ± 7.3)	10–30
Vitamin A (Vit A): Carotene: S	μmol/L μg/dL	0.37–3.26 (1.86) 20–175 (100)	0.47–17.7 (0.74) 25–950 (40)	0–0.37 (18.8) 0–20 (10)			
Carotenol: S	μmol/L μg/dL	0.17–0.30 (0.22) 9–16 (12)	0.19–0.56 (0.45) 10–30 (24)	0.37–0.84 20–45			0.19–0.65 (0.37) 10–35 (20)

<sup>a</sup> Ranges with means and standard deviations in parentheses.

<sup>b</sup> Abbreviations: B, blood; HB, heparinized blood; HP, heparinized plasma; P, plasma; S, serum; R, erythrocytes.

# Appendix IX Blood Analyte Reference Values in Small and Some Laboratory Animals<sup>a</sup>

Analyte <sup>b</sup>	Unit	Dog	Cat	Rat	Mouse	Rabbit	Monkey
Acetylcholinesterase (AcChE): R	U/L	270	540				
Alanine amino transferase (ALT, GPT): S, HP	U/L	21–102 (47 ± 26)	6–83 (26 ± 16)	(35.1 ± 13.3)	(19.0)	(79.0)	0–82 (27 ± 28)
Aldolase (ALD): S, HP	U/L						
Ammonia (NH <sub>4</sub> ): S, HP	μmol/L	11.2–70.4	(31.1 ± 14.7)				
	μg/dL	19–120 (53 ± 25)					
Amylase (Amyl): S, HP	U/L	185–700					
Arginase (ARG): S, HP	U/L	0–14	0–14	(21.3)			
Aspartate amino transferase (AST, GOT): S, HP	U/L	23–66 (33 ± 12)	26–43 (35 ± 9)	(42.9 ± 10.1)	(37.0)	(47.0)	13–37 (22 ± 8)
Bicarbonate (HCO <sub>3</sub> ): S, P	mmol/L	18–24	17–21				
Bilirubin: S, P, HP	μmol/L	1.03–2.05					0.68–5.98 (0.68 ± 0.68)
Conjugated (CB)	mg/dL	0.06–0.12					0.04–0.35 (0.04 ± 0.04)
Total (TB)	μmol/L	1.71–8.55 (3.42 ± 1.71)	2.57–8.55	(5.13 ± 2.39)	(6.84 ± 8.55)	(6.84 ± 8.55)	1.71–8.55 (4.28 ± 0.86)
	mg/dL	0.10–0.50 (0.20 ± 0.10)	0.15–0.50	(0.30 ± 0.14)	(0.4 ± 0.5)	(0.40 ± 0.50)	0.10–0.50 (0.25 ± 0.05)
Unconjugated (UCB)	μmol/L	0.17–8.38					0–3.76 (3.42 ± 3.08)
	mg/dL	0.01–0.49 (0.20 ± 0.18)					0–0.22

(Continued)

(Continued)

Analyte <sup>b</sup>	Unit	Dog	Cat	Rat	Mouse	Rabbit	Monkey
Bile acid, total (TBA): S	$\mu\text{mol/L}$	0-5.0 (2.60 $\pm$ 0.40)	0-5.0 (1.70 $\pm$ 0.30)				5.0-14.0 (10)
Butyrylcholinesterase (ButChE): P	U/L	1210-3020	640-1400				523-1711 (589 $\pm$ 260)
Calcium (Ca): S, HP	mmol/L	2.25-2.83 (2.55 $\pm$ 0.15)	1.55-2.55 (2.06-0.24)	1.50-2.65 (2.00 $\pm$ 0.32)	1.20-1.86 (1.39 $\pm$ 0.20)	1.46-3.60 (2.50 $\pm$ 0.56)	2.28-2.95 (2.55 $\pm$ 1.50)
	mg/dL	9.0-11.3 (10.2 $\pm$ 0.60)	6.2-10.2 (8.22 $\pm$ 0.97)	6.00-10.6 (8.00 $\pm$ 1.28)	4.80-7.44 (5.56 $\pm$ 0.80)	5.84-14.4 (10.0 $\pm$ 2.24)	9.1-11.8 (10.2 $\pm$ 6.0)
Carbon dioxide, pressure (pCO <sub>2</sub> ): S, P	mmHg	(38)	(36)				
Carbon dioxide, total (TCO <sub>2</sub> ): S, P	mmol/L	17-24 (21.4)	17-24 (20.4)				9.6-25.9 (18.6 $\pm$ 4.0)
Chloride (Cl): S, HP	mmol/L	105-115	117-123	79.4-111.3 (96.8 $\pm$ 6.4)	95.6-128.9 (107.6 $\pm$ 6.7)	85.0-105.3 (96.5 $\pm$ 6.8)	97.5-113.5 (105 $\pm$ 4.0)
Cholesterol (Chol): S, P, HP							
Ester	mmol/L	1.04-2.02 (1.53 $\pm$ 0.49)	1.04-2.23 (1.63 $\pm$ 0.60)				
	mg/dL	40-78 (59 $\pm$ 19)	40-86 (63 $\pm$ 23)				
Free	mmol/L	0.80-1.84 (1.32 $\pm$ 0.52)	0.52-1.04 (0.78 $\pm$ 0.26)				0.19-1.08 (0.57 $\pm$ 0.26)
	mg/dL	31-71 (51 $\pm$ 20)	20-40 (30 $\pm$ 10)				7.4-41.7 (22 $\pm$ 10)
Total	mmol/L	3.50-6.99 (4.61 $\pm$ 0.98)	2.46-3.37	0.13-1.41 (0.73 $\pm$ 0.35)	0.74-2.86 (1.61 $\pm$ 0.43)	0.14-1.86 (0.69 $\pm$ 0.41)	2.51-4.82 (3.81 $\pm$ 0.88)
	mg/dL	135-270 (178 $\pm$ 38)	95-130	5.1-54.2 (28.3 $\pm$ 13.7)	28.6-110.4 (62.1 $\pm$ 16.7)	5.3-71.0 (26.7 $\pm$ 15.9)	97-186 (147 $\pm$ 34)
Copper (Cu): S	$\mu\text{mol/L}$ $\mu\text{g/dL}$	15.7-31.5 100-200					
Cortisol (Cort-RIA): S, HP	nmol/L	27-188	9-71				(850 $\pm$ 224)
	$\mu\text{g/dL}$	0.96-6.81	0.33-2.57				(30.8 $\pm$ 8.1)
Creatine kinase (CK): S, HP	U/L	1.15-28.40 (6.25 $\pm$ 2.06)	7.2-28.2 (19.5 $\pm$ 6.7)	(183)	(155)	(544)	(125)
Creatinine (Creat): S, P, HP	$\mu\text{mol/L}$	44.2-132.6	70.7-159	35.4-331.5 (140.6 $\pm$ 69.8)	44.2-123.8 (74.2 $\pm$ 16.8)	70.7-227.2 (140.6 $\pm$ 30.1)	70.7-205.0 (124.6 $\pm$ 27.4)
	mg/dL	0.5-1.5	0.8-1.8	(1.59 $\pm$ 0.79)	0.5-1.4 (0.84 $\pm$ 0.19)	0.8-2.57 (1.59 $\pm$ 0.34)	0.8-2.32 (1.41 $\pm$ 0.31)

Fibrinogen (Fibr): P, HP	$\mu\text{mol/L}$ g/L mg/dL	5.88–11.8 2.0–4.0 200–400	1.47–8.82 0.5–3.0 50–300	
Fructosamine (FrAm): S, P, HP (Sigma method)	mmol/L	1.70–3.38 (2.54 $\pm$ 0.42)	2.19–3.47 (2.83 $\pm$ 0.32)	
(BMC method)	$\mu\text{mol/L}$	170–338 (182.30 $\pm$ 30.14)	219–347 (203 $\pm$ 22.96)	
Glucose (Glu): S, P, HP	mmol/L	3.61–6.55 (5.05 $\pm$ 0.67)	3.89–6.11 (5.05 $\pm$ 0.42)	2.78–5.18 (4.08 $\pm$ 0.53)
	mg/dL	65–118 (91 $\pm$ 12)	73–134 (91 $\pm$ 7.5)	50.0–93.2 (73.4 $\pm$ 9.5)
Glutamate dehydrogenase (GD): S, HP	U/L	(3)	(4)	(9) (16) (40)
Glutamic oxaloacetic transaminase (GOT): see AST				
Glutamic pyruvate transaminase (GPT): see ALT				
$\gamma$ -Glutamyl transferase (GGT): S, P	U/L	1.2–6.4 (3.5 $\pm$ 1.8)	1.3–5.1	(9) (62)
Glutathione (GSH): R	mmol/L	(2.07 $\pm$ 0.36)	(1.97 $\pm$ 0.19)	
Glutathione peroxidase (GP <sub>x</sub> ): HB	U/100 gHb	(8921 $\pm$ 237)	(12135 $\pm$ 616)	
Glutathione reductase (GR): HB	U/100 gHb	(137 $\pm$ 7.0)	(405 $\pm$ 48)	
Hemoglobin (Hb): B	g/L	12–18	8–14	
Hemoglobin A1c (HbA1c): HB	%	2.3–6.4		
Icterus index (II): P, HP	Unit	2–5	2–5	
Iditol dehydrogenase (ID): see SDH				
Insulin (Ins): S, HP	pmol/L	36–144 (86.1 $\pm$ 35.9)	0–129	
	$\mu\text{U/mL}$	5–20 (12 $\pm$ 5)	0–18	
Iodine, total (I): S	nmol/L	394–1576 (473 $\pm$ 276)		
	$\mu\text{g/dL}$	5–20 (6.0 $\pm$ 3.5)		
Iron (Fe): S	$\mu\text{mol/L}$	5.37–32.2 (15.5 $\pm$ 5.5)	12.2–38.5 (25.1)	(36.5 $\pm$ 33.4)
	$\mu\text{g/dL}$	30–180 (86.4 $\pm$ 30.8)	68–215 (140)	(204 $\pm$ 19)

(Continued)

(Continued)

Analyte <sup>b</sup>	Unit	Dog	Cat	Rat	Mouse	Rabbit	Monkey
Iron binding capacity, total (TIBC): S	$\mu\text{mol/L}$	29.5–74.9 (57.7 $\pm$ 7.9)	(51.9)	(65.9)		(48.4)	(79.7)
	$\mu\text{g/dL}$	165–418 (322 $\pm$ 44)	(290)	(368)		(270)	(445)
Iron binding capacity, unbound (UIBC): S	$\mu\text{mol/L}$	30.4–39.7 (35.8)	18.8–36.7 (26.9)				
	$\mu\text{g/dL}$	170–222 (200)	105–205 (150)				
Isocitrate dehydrogenase (ICD): S, HP	U/L	0.4–7.3 (3.0 $\pm$ 1.7)	2.0–11.7 (5.3 $\pm$ 3.2)	(4)	(32)	(137)	(28)
Ketones (Ket): HP Acetoacetic acid (AcAc)	mmol/L mg/dL	(0.018 $\pm$ 0.018) (0.18 $\pm$ 0.18)					
3-Hydroxybutyric acid (3-OHB)	mmol/L mg/dL	(0.030 $\pm$ 0.006) (0.30 $\pm$ 0.06)					
Lactate (Lac): B	mol/L mg/dL	0.22–1.44 2–13					
Lactate dehydrogenase (LDH): S, HP	U/L	45–233 (93 $\pm$ 50)	63–273 (137 $\pm$ 59)	(46.6 $\pm$ 22.0)	(366)	(94.3 $\pm$ 28.8)	173–275 (232 $\pm$ 31)
LDH isoenzymes: S, HP LDH-1 (heart, anodal)	%	1.7–30.2 (13.9 $\pm$ 9.5)	0–8.0 (4.5 $\pm$ 2.8)				2.7–38.2 (17.2 $\pm$ 8.4)
LDH-2	%	1.2–11.7 (5.5 $\pm$ 4.2)	3.3–13.7 (6.1 $\pm$ 3.4)				4.3–39.7 (19.8 $\pm$ 9.4)
LDH-3	%	10.9–25.0 (17.1 $\pm$ 5.7)	10.2–20.4 (13.3 $\pm$ 3.4)				12.8–50.4 (24.5 $\pm$ 7.2)
LDH-4	%	11.9–15.4 (13.0 $\pm$ 1.2)	11.6–35.9 (23.6 $\pm$ 8.6)				0.8–38.0 (17.7 $\pm$ 10.6)
LDH-5 (liver, muscle, cathodal)	%	30.0–72.8 (50.5 $\pm$ 16.9)	40.0–66.3 (52.5 $\pm$ 9.3)				4.7–36.3 (18.6 $\pm$ 8.3)
Lead (Pb): HB	$\mu\text{mol/L}$ $\mu\text{g/dL}$	0–2.42 0–50					
Leucine aminopeptidase (LAP): S, HP	U/L	(13)		(25)	(25)	(46)	(29)



Lipase (Lip): S	U/L	13–200	0–83		
Magnesium (Mg): S	mmol/L	0.74–0.99 (0.86 ± 0.12)	(0.90)	(1.28 ± 0.17)	(1.28 ± 0.15) (0.92 ± 0.07) (0.68 ± 0.13)
	mg/dL	1.8–2.4 (2.1 ± 0.3)	(2.2)	(3.12 ± 0.41)	(3.11 ± 0.37) (2.25 ± 0.16) (1.65 ± 0.32)
Malate dehydrogenase (MD): S, HP	U/L	(199)	(132)	(118)	(419) (1000) (109)
Ornithine carbamyl transferase (OCT): S, HP	U/L	(2.7 ± 0.7)	(3.8 ± 1.0)		
Oxygen, pressure (pO <sub>2</sub> ): HB	mmHg	85–100	78–100		
pH: HB	Unit	7.31–7.42 (7.36)	7.24–7.40 (7.35)		
Phosphatase, acid (AcP): S, HP	U/L	5–25	0.5–24		
Phosphatase, alkaline (AlP): S, HP	U/L	20–156 (66 ± 36)	25–93 (50 ± 35)	(133 ± 134)	(66 ± 19) (120 ± 13.8) 100–277 (171 ± 55)
Phosphate (Pi): S, HP	mmol/L	0.84–2.00 (1.39 ± 0.29)	1.45–2.62 (2.00)	(2.29 ± 0.38)	(2.12 ± 0.42) (1.34 ± 0.15) 1.42–1.78 (1.62 ± 0.13)
	mg/dL	2.6–6.2 (4.3 ± 0.9)	4.5–8.1 (6.2)	(7.08 ± 1.19)	(6.55 ± 1.30) (4.16 ± 0.46) 4.4–5.5 (5.0 ± 0.4)
Potassium (K): S, HP	mmol/L	4.37–5.35 (4.90)	4.0–4.5 (4.3)	(6.50 ± 1.33)	(5.40 ± 0.15) (5.3 ± 0.5) 3.5–6.5 (4.7 ± 0.6)
Protein (Prot): S	g/L	54.0–71.0 (61.0 ± 5.2)	54.0–78.0 (66.0 ± 7.0)	(75.2 ± 2.7)	(62.0 ± 2.0) (64.5 ± 3.1) 78.0–96.0 (87.2 ± 7.3)
Total (TP)					
Electrophoresis (SPE), cellulose acetate (CA): Albumin	g/L	26.0–33.0 (29.1 ± 1.9)	21.0–33.0 (27.0 ± 1.7)	(41.7 ± 2.1)	(34.0 ± 1.0) (27.3 ± 3.0) 31.3–53.0 (42.1 ± 2.0)
Globulin, total	g/L	27.0–44.0 (34.0 ± 5.1)	26.0–51.0 (39.0 ± 6.9)		30.5–52.2 (41.4–2.0)
α <sub>1</sub>	g/L	2.0–5.0 (3.0 ± 0.3)	2.0–11.0 (7.0 ± 0.2)		1.0–4.9 (2.7 ± 0.3)
α <sub>2</sub>	g/L	3.0–11.0 (6.0 ± 2.1)	4.0–9.0 (7.0 ± 0.2)		2.5–8.0 (4.7 ± 0.5)
β	g/L				9.6–27.2 (18.9 ± 1.7)
β <sub>1</sub>	g/L	7.0–13.0 (8.2 ± 2.3)	3.0–9.0 (7.0 ± 0.3)		
β <sub>2</sub>	g/L	6.0–14.0 (8.9 ± 3.3)	6.0–10.0 (7.0 ± 0.2)		
γ	g/L				7.3–28.4

(Continued)

(Continued)

Analyte <sup>6</sup>	Unit	Dog	Cat	Rat	Mouse	Rabbit	Monkey
$\gamma_1$	g/L	5.0-13.0 (8.0 ± 2.5)	3.0-25.0 (16.0 ± 7.7)				
$\gamma_2$	g/L	4.0-9.0 (7.0 ± 1.4)	14.0-19.0 (17.0 ± 3.6)				
A/G ratio	--	0.59-1.11 (0.83 ± 0.16)	0.45-1.19 (0.71 ± 0.20)	(0.59)	(0.62)	(0.58)	0.72-1.21 (0.94 ± 0.16)
Pseudocholinesterase (PsChE); see ButChE							
Sodium (Na): S, HP	mmol/L	141-152 (146)	147-156 (152)	(146.8 ± 0.93)	(138.0 ± 2.9)	(141.0 ± 4.5)	142-160 (149 ± 5)
Sodium (Na): R	mmol/L	(107)	(104)				
Sorbitol dehydrogenase (SDH): S, HP	U/L	2.9-8.2 (4.5 ± 1.9)	3.9-7.7 (5.4 ± 1.3)	(20.3 ± 4.16)	(29.6 ± 7.4)		
Thyroxine (T <sub>4</sub> -RIA): S	nmol/L	7.7-46.4 (29.7 ± 10.3)	1.3-32.3 (12.9 ± 6.5)				
	μg/dL	0.6-3.6 (2.3 ± 0.8)	0.1-2.5 (1.0 ± 0.5)				(4.1 ± 0.6)
Thyroxine, free (FT <sub>4</sub> ): S	pmol/L	6.35-34.75 (45.5 ± 4.4)					
	ng/dL	0.5-2.7 (3.53 ± 0.34)					
Triglyceride, total (TG): S	mmol/L	(0.43)	(0.40)	(1.96 ± 0.29)	(1.53)	(1.38)	(0.75 ± 0.58)
	mg/dL	(38.1)	(35.4)	(173.3 ± 25.9)	(135.4)	(122.0)	(66.6 ± 51.3)

Triiodothyronine (T <sub>3</sub> -RIA): S	nmol/L	1.26–2.13 (1.65 ± 0.28)	0.23–1.59
	ng/dL	82–138 (107 ± 18)	15–104
Triglyceride, total (TG): S	mmol/L	0.2–1.3	0.1–1.3
	mg/dL	20–112	10–114
Urate (UA): S, P, HP	mmol/L	0–119	0–59.5
	mg/dL	0–2	0–1
		(90.4 ± 17.8)	(70.2 ± 16.6)
		(1.52 ± 0.30)	(1.20 ± 0.28)
Urea (UR): S, P, HP	mmol/L	1.67–3.33 (2.83 ± 0.67)	3.33–5.00
		(2.82 ± 0.35)	(3.45 ± 0.85)
Urea nitrogen (UN): S, P, HP	mg/dL	10–28 (17 ± 4.0)	20–30
		(16.9 ± 2.1)	(20.7 ± 5.1)
Vitamin A (Vit A): Carotenol: S	nmol/L	0–93 (56)	932–3614
	μg/dL	0–5 (3.0)	50–194
Carotene: S	μmol/L	652–1677	(3502)
	μg/dL	35–90	(188)
Vitamin B <sub>12</sub> : S	pmol/L	125–133	
	pg/mL	170–180	
Zinc (Zn): S	μmol/L		(12.1 ± 0.6)
	μg/dL		(79 ± 4.0)

<sup>a</sup> Ranges with means and standard deviations in parentheses.

<sup>b</sup> Abbreviations: B, blood; HB, heparinized blood; HP, heparinized plasma; P, plasma; S, serum; R, erythrocytes.

# Appendix X Blood Analyte Reference Values in Selected Avians<sup>a</sup>

Analyte <sup>b</sup>	Unit	Chicken	Budgeriger	Cockatoo	Macaw	Eagle	Hawk
Amylase (Amyl): S, HP	U/L		185–585				
Aspartate amino transferase (AST, GOT): S, HP	U/L	(174.8)	150–350	59–1310 (410 ± 452)	40–2408 (508 ± 950)	316–2881 (1045 ± 918)	126–500 (266 ± 117)
Calcium (Ca): S, HP	mmol/L	(7.10)		1.30–2.83 (2.20 ± 0.45)	1.93–3.73 (2.41 ± 0.66)	2.25–3.08 (2.58 ± 0.26)	0.90–2.80 (2.28 ± 0.58)
	mg/dL	(28.4)		5.2–11.3 (8.81 ± 1.80)	7.70–14.9 (9.64 ± 2.65)	9.0–12.3 (10.3 ± 1.05)	3.60–11.2 (9.13 ± 2.30)
Chloride (Cl): S, HP	mmol/L					(116)	
Cholesterol (Chol): S, P, HP Total	mmol/L mg/dL	(4.75) (183.8)					
Creatinine (Creat): S, P, HP	μmol/L mg/dL		8.8–35.4 0.1–0.4	26.5–167.9 (68.1 ± 52.2) 0.3–1.9 (0.77 ± 0.59)	35.4–247.5 (64.5 ± 50.4) 0.4–2.0 (0.73 ± 0.57)	70.7–132.6 (91.9 ± 25.6) 0.8–1.5 (1.04 ± 0.29)	26.5–79.6 (48.6 ± 15.9) 0.3–0.9 (0.55 ± 0.18)
Glucose (Glu): S, P, HP	mmol/L mg/dL	(9.3)	11.1–22.2 200–400	10.2–20.8 (15.8 ± 5.3) 184–375 (285 ± 95)	11.9–23.2 (16.9 ± 3.2) 215–418 (304 ± 57)	14.9–32.6 (19.9 ± 8.6) 268–587 (359 ± 154)	8.5–20.7 (16.7 ± 4.1) 153–373 (301 ± 74)
Glutamic oxaloacetic transaminase (GOT): see AST							
Lactate dehydrogenase (LDH): S, HP	U/L	(636.0)	150–450	151–1337 (467 ± 435)	48–831 (293 ± 269)	358–3400 (1256 ± 1072)	58–708 (301 ± 226)
Osmolality (mOsm): S, P, HP	mOsm/kg			317–347	319–378		
Phosphatase, alkaline (ALP): S, HP	U/L	(482.5)		36–229 (109 ± 60)	10–239 (88.5 ± 75.0)	63–174 (61.8 ± 57.8)	6–235 (88.7 ± 84.0)

Phosphate (Pi): S, HP	mmol/L	0.23–1.91 (1.0 ± 0.6)	0.70–3.36 (1.68 ± 0.84)	0.68–3.55 (1.58 ± 1.00)	1.16–2.16 (1.58 ± 0.32)
	mg/dL	0.7–5.9 (3.1 ± 1.7)	2–10.4 (5.2 ± 2.6)	2.1–11.1 (4.9 ± 3.1)	3.6–6.7 (4.9 ± 1.0)
Potassium (K): S, HP	mmol/L	2.9–11.0 (6.0 ± 3.2)	2.2–10.1 (4.7 ± 2.7)	2.4–4.4 (3.6 ± 0.7)	1.6–4.2 (3.0 ± 0.9)
Protein (Prot): S Total (TP)	g/L	25.0–45.0 (56.0)	22.0–52.0 (35.8 ± 7.3)	32.0–49.0 (38.7 ± 6.4)	27.0–46.0 (37.6 ± 6.3)
Electrophoresis (SPE), cellulose acetate (CA): Prealbumin	g/L		5.0–11.1 (8.1 ± 5.0)		
Albumin	g/L	21.0–33.0 (27.0 ± 1.7)	11.0–24.0 (17.3 ± 5.3)		
Globulin, total	g/L	26.0–51.0 (39.0 ± 6.9)	8.0–33.0 (19.7 ± 10.0)		
A/G Ratio		0.45–1.19 (0.71 ± 0.20)	1.40–3.90 (1.96 ± 1.29)		
Sodium (Na): S, HP	mmol/L	149.0–155.0 (153.7 ± 2.1)	138.0–157.0 (148.6 ± 5.3)	147–171 (159.0 ± 7.0)	154.0–158 (156.4 ± 1.6)
Urate (UA): S, P, HP	mmol/L	0.24–0.83	0.09–0.88 (0.39 ± 0.27)	0.26–2.28 (1.07 ± 0.60)	0.37–1.77 (0.77 ± 0.50)
	mg/dL	4.0–14.0	1.6–18.0 (7.8 ± 4.8)	4.3–38.4 (18.0 ± 10.0)	6.2–29.8 (13.0 ± 8.4)
Urea (UR): S, P, HP	mmol/L		0.8–2.1 (4.80–12.6)		
	mg/dL		1.60–4.20 (2.24–5.88)		
Urea Nitrogen (UN): S, P, HP	mmol/L				
	mg/dL				

<sup>a</sup> Ranges with means and standard deviations in parentheses.

<sup>b</sup> Abbreviations: B, blood; HB, heparinized blood; HP, heparinized plasma; P, plasma; S, serum; R, erythrocytes.

# Appendix XI Blood Analyte Reference Values in Selected Avians-II<sup>a</sup>

Analyte <sup>b</sup>	Unit	Ostrich	Peregrine Falcon	Pigeon	African Grey Parrot	Amazon Parrot
Alanine aminotransferase	U/L		29-90	19-48	12-59	19-98
Amylase (Amyl): S, HP	U/L					571-1987
Aspartate aminotransferase (AST, GOT): S, HP	U/L	252-401	34-116	45-123	54-155	57-194
Bile Acids	$\mu$ mol/L	8-30	5-69	22-60	18-71	19-144
Calcium (Ca): S, HP	mmol/L	2.5-4.6	1.9-2.4	1.9-2.6	2.1-2.6	2.0-2.8
	mg/dL	10.0-18.4	7.6-9.6	7.6-10.4	8.4-10.4	8.0-11.2
Chloride (Cl): S, HP	mmol/L	94-105	114-131	101-113		
Corticosterone: S, P, HP	nmol/L			6-36		16-39
Pre-250 $\mu$ g/kg ACTH	nmol/L			64-324		108-506
Post-250 $\mu$ g/kg ACTH	nmol/L					
Creatinine (Creat): S, P, HP	$\mu$ mol/L		24-64	23-36	23-40	19-33
	mg/dL		0.27-0.72	0.26-0.40	0.26-0.45	0.21-0.37
Creatine kinase (CK): S, P, HP	U/L	1655-4246	120-442	110-480	123-875	45-265
Glucose (Glu): S, P, HP	mmol/L	10.4-13.7	16.5-22.0	12.9-20.5	11.4-16.1	12.6-16.9
	mg/dL	187-247	297-396	232-369	205-290	227-304
Glutamate dehydrogenase (GD): S, P, HP	U/L	<8	<8	<8	<8	<8
Glutamic oxaloacetic transaminase (GOT): see AST						
Glutamic pyruvic transaminase (GPT: see ALT)						

γ-Glutamyl transferase (GGT): S, P, HP	U/L	0-1	0-3	0-4	1-10
Lactate dehydrogenase (LD): S, P, HP	U/L	869-2047	1008-2650	147-384	46-208
Lipase (Lip): S,P,HP	U/L				268-1161
Osmolality (mOsm): S, P, HP	mOsm/kg	305-328	322-356	320-347	316-373
Phosphate (Pi): S, HP	mmol/L	1.3-2.2	0.55-1.53		0.57-1.33
	mg/dL	4.0-6.80	1.70-4.74		1.76-4.12
Potassium (K): S, HP	mmol/L	4.5-5.9		3.9-4.7	2.3-4.2
Protein (Prot): S	g/L	40-54	24-39	32-44	33-50
Total (TP)					
Albumin/Globulin (A/G) Ratio		0.9-1.4	0.8-2.4	1.4-4.7	2.6-7.0
Sodium (Na): S, HP	mmol/L	147-157	150-170	141-149	149-164
Thyroxine (T <sub>4</sub> ): S, P, HP	nmol/L				6-35
Pre-2 IU/kg TSH IM	mg/dL				0.46-2.72
Post-2 IU/kg TSH IM	nmol/L				100-300
	mg/dL				7.77-23.3
Urate (UA): S, P, HP	μmol/L	357-643	253-996	93-414	72-312
	mg/dL	6.00-10.80	4.26-16.75	1.56-6.96	1.21-5.25
Urea (UR): S, P, HP	mmol/L	0.5-0.8	0.8-2.9	0.4-0.7	0.9-4.6
	mg/dL	3.0-4.8	4.8-17.4	2.4-4.2	5.4-27.6
Urea nitrogen (UN): S, P, HP	mmol/L	0.99-1.57	1.52-2.07	1.43-4.78	1.79-9.20
	mg/dL	1.4-2.2	2.2-8.1	2.0-6.7	2.5-27.6

<sup>a</sup> Ranges with means and standard deviations in parentheses.

<sup>b</sup> Abbreviations: B, blood; HB, heparinized blood; HP, heparinized plasma; P, plasma; S, serum; R, erythrocytes.

# Appendix XII Urine Analyte Reference Values in Animals

Analyte	Units	Horse	Cow	Sheep	Pig	Dog	Cat	Goat
Allantoin	mg/kg/d	5-15	20-60	20-50	20-80	35-45	80	
Arsenic	$\mu\text{g/dL}$					30-150		
Bicarbonate	mmol/kg/d					0.05-3.2		
Calcium	mg/kg/d		0.10-1.40	2.0		1-3	0.20-0.45	1.0
Chloride	mmol/kg/d		0.10-1.10			0-10.3		
Coproporphyrin	$\mu\text{g/dL}$		5-14	8.8		16-28		
Creatinine	mg/kg/d		15-20	10	20-90	30-80	12-20	10.0
Cystine	mg/g Creatinine					(67 $\pm$ 15)		
Hydrogen Ion (pH)	unit	7.0-8.0	7.4-8.4	7.4-8.4	5.0-8.0	5.0-7.0	5.0-7.0	7.4-8.4
Lead	$\mu\text{g/dL}$					20-75		
Lysine	mg/g Creatinine					21 $\pm$ 6		
Magnesium	mg/kg/d		3.7			1.7-3.0	3-12	
Mercury	$\mu\text{g/dL}$					1.0-10		
Nitrogen								
Urea N	mg/kg/d		23-28	98	201	140-230	374-1872	107
Total N	mg/kg/d	100-600	40-450	120-350	40-240	250-800	500-1100	120-400
Ammonia N	mg/kg/d		1.0-17.0			30-60	60	3-5
Phosphorus	mg/kg/d			0.2		20-30	108	1.0
Potassium	mmol/kg/d		0.08-0.15			0.1-2.4		
Sodium	mmol/kg/d		0.2-1.1			0.04-13.0		
Specific gravity	units	1.020-1.050	1.025-1.045	1.015-1.045	1.010-1.030	1.015-1.045	1.015-1.065	1.015-1.045
Sulfate	mg/kg/d		3.0-5.0			30-50		
Uric acid	mg/kg/d	1-2	1-4	2-4	1-2			2-5
Urine volume	mL/kg/d	3-18	17-45	10-40	5-30	17-45	10-20	10-40
Uroporphyrin	mg/dL		1.5-7.0	3.8	5.0			



# Appendix XIII Cerebrospinal Fluid (CSF) Reference Values in Large Animals

Analyte	Units	Horse	Cow	Sheep	Goat	Llama	Pig
Rate of formation	$\mu\text{L}/\text{m}$		290	118	164		
Alkaline phosphatase (ALP)	U/L	0-8 (0.8 $\pm$ 0.9)					
Aspartate aminotransferase (AST)	U/L	15-50 (30.7 $\pm$ 6.3)					
Calcium	mg/dL	2.5-6.0 (4.2 $\pm$ 0.9)	5.1-6.3	5.1-5.5	4.6		
Chloride	mmol/L	95-123 (109.2 $\pm$ 6.9)	111-123	128-148	116-130	116-143	(13.4 $\pm$ 6.5)
Cholesterol (Chol)	mg/dL	0.20.0 (4.8 $\pm$ 5.7)					
Creatine kinase (CK)	U/L	0-8 (1.1 $\pm$ 3.1)					
Glucose	mg/dL	30-70 (48.0 $\pm$ 10.0)	37-51 (42.9 $\pm$ 1.0)	52-85	70	59-86 (69.3 $\pm$ 7.35)	45-87
$\gamma$ -Glutamyl transferase (GGT)	U/L	0.8-4.2 (2.6 $\pm$ 1.9)					
Hydrogen Ion (pH)	units	7.13-7.36	7.22-7.26	7.3-7.4 (7.35)			
Lactate dehydrogenase LD)	U/L	12-34 (27.7 $\pm$ 8.0)	2-25 (13.94 $\pm$ 1.32)			7-24 (13 $\pm$ 5.6)	
Lactic acid (LAC)	mg/dL	(2.3 $\pm$ 0.2)					
Magnesium	mg/dL	1.1-3.0 (2.0)	1.8-2.1 (1.99 $\pm$ 0.03)	2.2-2.8	2.3		

(Continued)

(Continued)

Analyte	Units	Horse	Cow	Sheep	Goat	Llama	Pig
Phosphorus	mg/dL	0.5-1.5 (0.8 ± 0.2)	0.9-2.5	1.2-2.0			
Potassium	mmol/L	2.5-3.5 (3.0 ± 0.1)	2.7-3.2 (2.96 ± 0.03)	3.0-3.3	3.0	2.9-3.3 (3.19 ± 0.10)	
Pressure	mm H <sub>2</sub> O	272-490					
Protein Total	mg/dL	40-170 (105 ± 38)	23.4-66.3 (39.1 ± 3.39)	29-42	12	31.2-66.8 (43.1 ± 9.0)	24-29
Albumin	mg/dL	22.6-67.9 (38.6)	8.21-28.71 (15.75 ± 1.53)			11.8-27.1 (17.9 ± 4.45)	17-24
Globulin: γ-globulin	mg/dL	3.4-18.4 (9.3)	2.46-8.85			3.4-13.8	5-10
Sodium	mmol/L	140-150 (144.6 ± 1.9)	132-142 (140 ± 0.78)	145-157	131	134-160 (154 ± 5.8)	134-144
Specific gravity	unit	1.004-1.008	1.005-1.008				
Urea (UR)	mg/dL mmol/L	0-43.2 0-7.2					
Urea nitrogen(UN)	mg/dL mmol/L	0-20 (11.8 ± 3.3) 0-14.3 (0 ± 3.4)	8-11				
Viscosity	unit	1.00-1.05	1.019-1.029				
Cells (Total WBC)	#/μl	0-6	0.85-3.52	0-5	0-4	0-3	0-7
Cells (Total RBC)	#/μl	(195 ± 512)	5-1930			0-1360	

# Appendix XIV Cerebrospinal Fluid Reference Values in Small and Some Laboratory Animals

Analyte	Units	Dog	Cat	Rat	Mouse	Rabbit	Monkey
Rate of formation	$\mu\text{L}/\text{m}$	47-66	20-22	2.1-5.4	0.325	10	28.6-41.0
Alanine aminotransferase (ALT)	U/L	0.96-15.36 (6.58 $\pm$ 0.65)					
Aspartate aminotransferase (AST)	U/L	4.32-22.08 (9.65 $\pm$ 0.65)	0-34 (17 $\pm$ 7)				
Calcium	mg/dL	5.13-7.40 (6.56)	5.1-6.3 (6.0 $\pm$ 0.24)				
Chloride	mmol/L	109-126 (130 $\pm$ 0.5)	111-123				
Creatine kinase (CK)	U/L	(23.5 $\pm$ 0.19)	2-236 (47 $\pm$ 51)				
Glucose	mg/dL	48-57	18.2-130.9 (74.5 $\pm$ 23.6)				
Hydrogen Ion (pH)	units	7.13-7.36	7.22-7.26				
Lactate dehydrogenase (LD)	U/L		0-24 (12 $\pm$ 5)				
Magnesium	mg/dL	25.8-3.81	(3.24 $\pm$ 0.05)				
Phosphorus	mg/dL	2.82-3.47 (3.09)					
Potassium	mmol/L	2.9-3.2 (3.3 $\pm$ 0.04)	(2.69 $\pm$ 0.09)				
Pressure	mm H <sub>2</sub> O	24-172					

(Continued)

Continued

Analyte	Units	Dog	Cat	Rat	Mouse	Rabbit	Monkey
Protein Total	mg/dL	18-44 (28.68 ± 5.52)	0-30 (5 ± 9)				
Albumin	mg/dL	7.5-27.6 (17.1 ± 6.7)	19-25 (10.1 ± 12.9)				
Globulin:							
		14.0-21.1 (17.45 ± 0.83)					
IgA	µg/mL	0-0.2 (0.08)					
IgG	mg/dL	2.5-8.5 (4.68 ± 0.68)	0-5.3 (1.4 ± 0.27)				
IgM	µg/mL	0-5.8 (1.7)					
Sodium	mmol/L	151.6-155 (153 ± 0.5)	158 (158 ± 4)				
Specific gravity	unit	1.003-1.012 (1.005)					
Urea	mg/dL mmol/L	10-11 1.7-1.8	21.5-23.6 3.6-3.9				
Urea Nitrogen	mg/dL mmol/L	4.7-5.1 3.3-3.7	10-11 7.1-7.9				
Cells (total WBC)	#/µl	0-25	0-1				
Small Mononuclear	%	15-95					
Large Mononuclear	%	5-40					
Degenerate	%	0-40					
Cells (Total RBC)	#/µl	< 1500	< 30				