

THE FREE-ENERGY DEVICE HANDBOOK

A Compilation of Patents & Reports



The Free-Energy Device Handbook

Copyright 1994, 2004
by David Hatcher Childress

All Rights Reserved

ISBN 0-932813-24-0

Printed in the United States of America

Published by
Adventures Unlimited Press
One Adventure Place
Kempton, Illinois 60946 USA
auphq@frontiernet.net

www.wexclub.com/aup
www.adventuresunlimitedpress.com
www.adventuresunlimited.nl

1098765

TABLE OF CONTENTS

1 Nikola Tesla and Free-Energy	7
2 A Permanent Magnet Motor, 1269 A.D.	25
3 Non-Conventional Energy and Propulsion Methods	83
4 The One-Piece Faraday Generator: Research Results	109
5 Macroscopic Vacuum Polarization	131
6 The Adams Pulsed Electric Motor Generator	153
7 Homopolar "Free-Energy" Generator	169
8 Phenomenon of Electric Charge Generation by Space Rotation	189
9 The Worthington Magnet Motor	197
10 The Swiss M-L Converter	225
11 Unified Particle Theory	231
12 A Selection of Patents	247
13 News Articles	289
14 Free-Energy Devices and Pop Culture	297

Authorities, disciples, and schools are the curse of science and do more to interfere with the work of the scientific spirit than all its enemies.
—T. H. Huxley

There isn't any energy crisis.
It's simply a crisis of ignorance.
—R. Buckminster Fuller

1

Nikola Tesla and Free-Energy

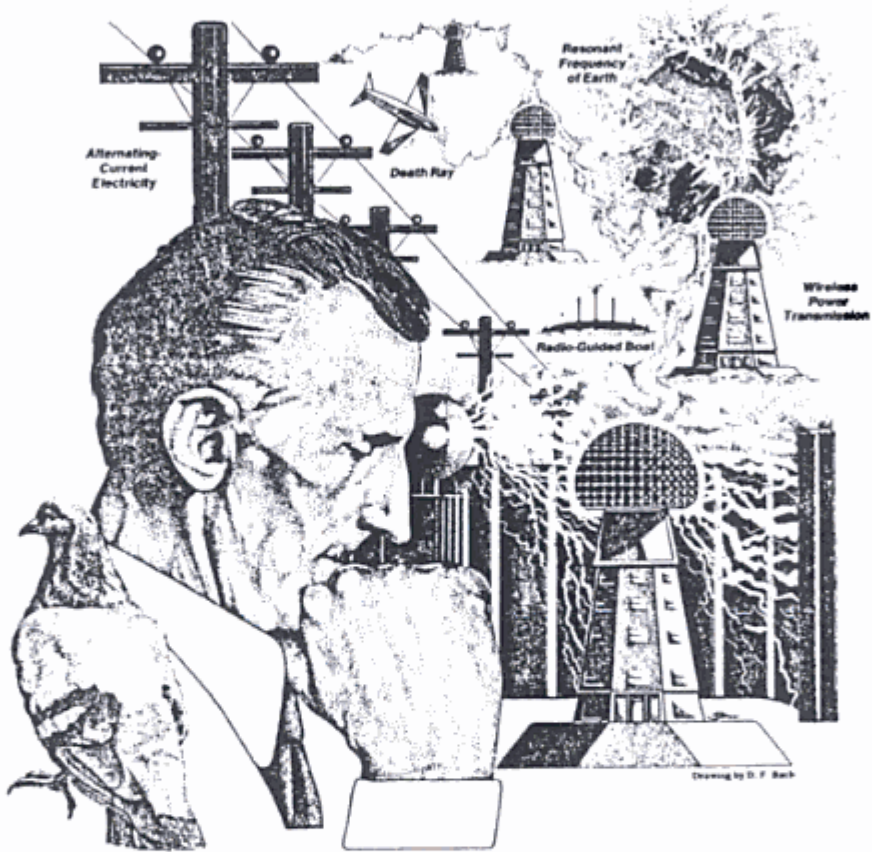

Nikola Tesla's "Free Energy" Documents

Oliver Nichelson
333 North 760 East
American Fork, Utah 84003

Copyright © 1992

Ten years after patenting a successful method for producing alternating current, Nikola Tesla claimed the invention of an electrical generator that would not "consume any fuel." Such a generator would not have an external prime mover such as steam or falling water.

The documents that establish Tesla's involvement in this line of research are presented below.

On June 9th, 1902, the *New York Times* and the *New York Herald* carried a story of a Clemente Figueras, a "woods and forest engineer," who had invented a device for generating electricity without burning any fuel. In the Nikola Tesla Collection, at Columbia University Library is a letter from the inventor to his friend Robert Underwood Johnson, the editor of *Century Magazine*, with a clipping of the *Herald* article enclosed.¹

In the three page letter Tesla states that he suggested such a generator in his *Century* magazine article, and that he has worked on such a design for sometime (Figures 2 & 3).

Herald, June 9, 1902

USES ELECTRICITY WITHOUT A MEDIUM

Scientist Declares He Can Apply Atmospheric Current Without Motive Force.

WAS SIMPLE DISCOVERY

Senor Clemente Figueras, Engineer, of Canary Isles, Inventor of the Method.

[Special Issue of the Herald.]
The Herald's European edition publishes the following from its correspondent:—
"London, Monday.—A most remarkable claim, the genuineness of which it is as yet impossible to test, says a cable despatch published by the Daily Mail from Las Palmas correspondent, has been made by Senor Clemente Figueras, Engineer of Woods and Forests in the Canary Islands, for many years professor of physics at St. Augustine's College at Las Palmas.
It seems that for many years he has been working silently at a method of directly utilizing atmospheric electricity—that is to say, without chemicals or dynamos—and making a practical application of it without the need of employing any motive force.
A true revelation might rob him of his reward, and even now, while he claims to have succeeded, he is silent concerning the exact principles of his discovery.
He asserts, however, he has invented a generator by which he can collect electric fluid so as to be able to store it and apply it for infinite purposes—for instance, in connection with ships, railways and manufactures.
He says he expects its effect will be a tremendous economic and industrial revolution. He will not give the key to the invention, but declares that the only extraordinary point about it is that it has taken so long to discover a simple scientific fact.
He intends shortly going to Madrid and Berlin to patent his invention.
In addition to the discovery, the Daily Mail says that, according to letters received in London from his friends in Tenerife, Senor Figueras has constructed a rough apparatus by which, in spite of his small size and defects, he obtains a current of 50 volts, which he utilizes in his own house for lighting purposes and driving a motor of twenty horse power.
His inventions comprise a generator, a motor and a sort of governor or regulator, the whole apparatus being so simple that a child could work it."

1. *N. Y. Herald*, June 9, 1902

Page 200 from the June 1900 *Century* article is reproduced below. Tesla once called this article the most important that he wrote. The "novel facts" citation mentioned in the letter is found in the first column, next to the last paragraph, first sentence.² Discussion of the "novel facts" just precedes the article's subsection dealing with a "Self-Acting' Machine...Capable...of Deriving Energy From the Medium."

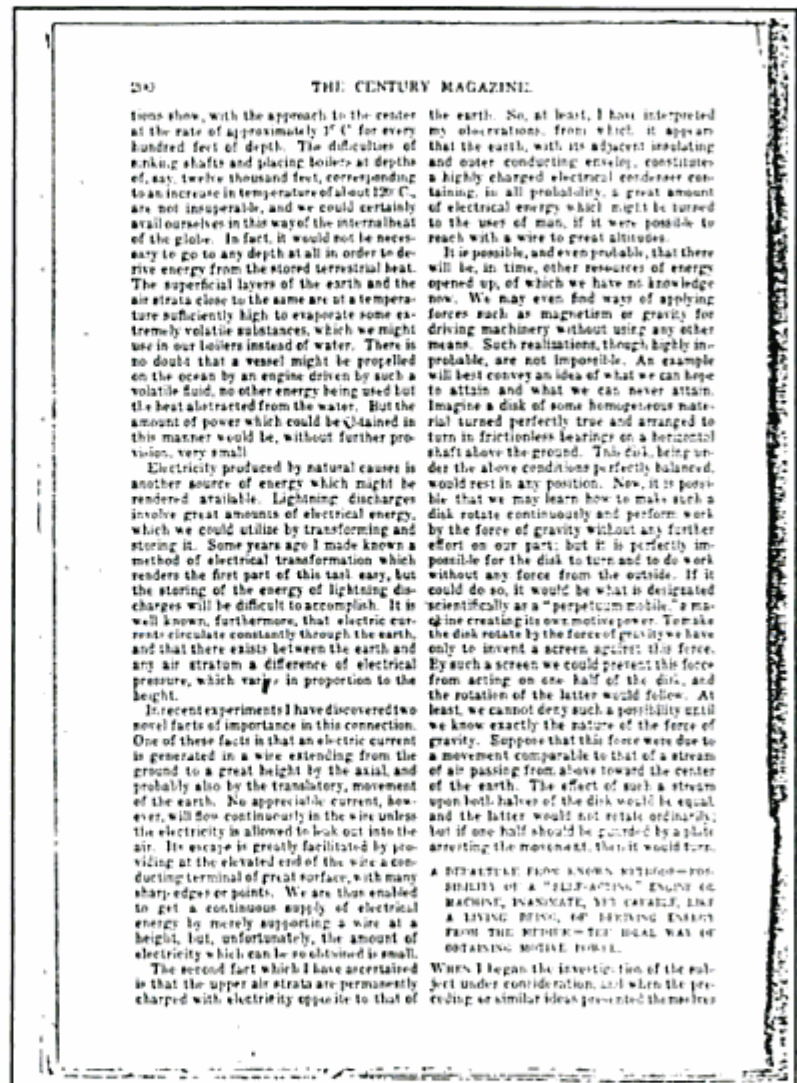

Century, June 1900, p. 200.

A careful examination of the article reveals the inventor believed his design for an electrical generator which is its own prime mover, that is, does not "consume any fuel," would not violate the energy conservation principle. Tesla believed, rather, that his design transformed one form of energy into another.

Earth's Magnetic Field

-THE OLD CONCEPTS-

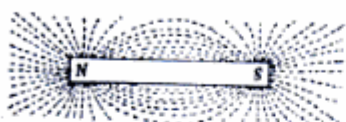

-THE NEW CONCEPTS-

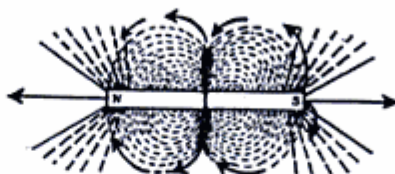

-THE OLD-

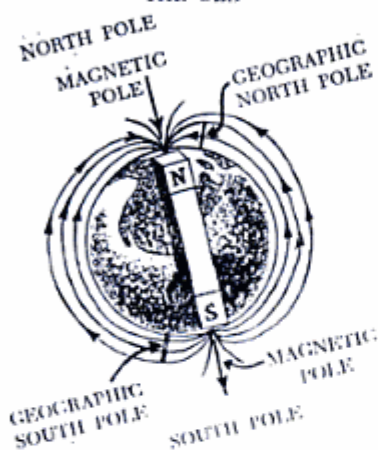

The Old Concepts of the Laws of Magnetism

-THE NEW-

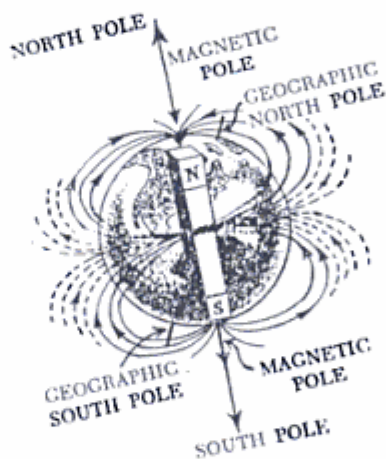

The New Concepts of the Laws of Magnetism

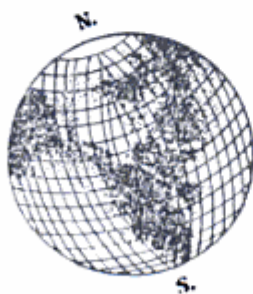

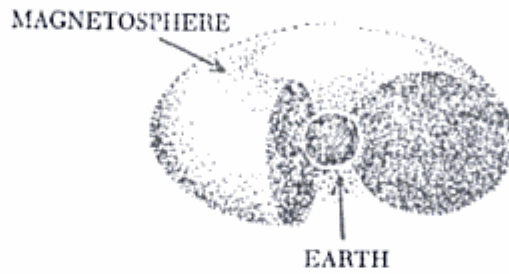
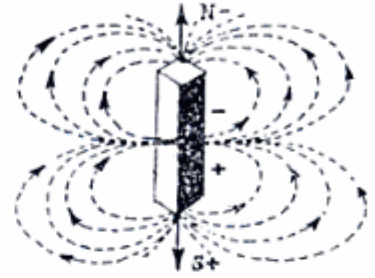
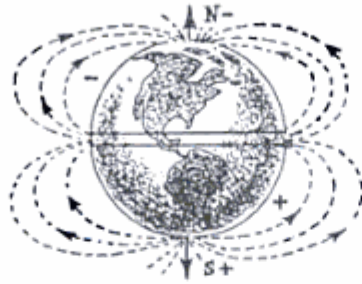

From the book, **MAGNETISM AND ITS EFFECTS ON THE LIVING SYSTEM** by Albert Davis and Walter Rawls, Jr. Here we see how the Earth's Magnetic Field creates an electro-magnetic grid around the earth. What does this grid have to do with the earth's gravitational field?

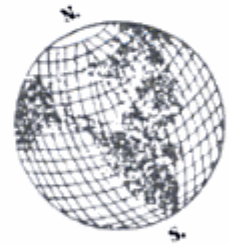

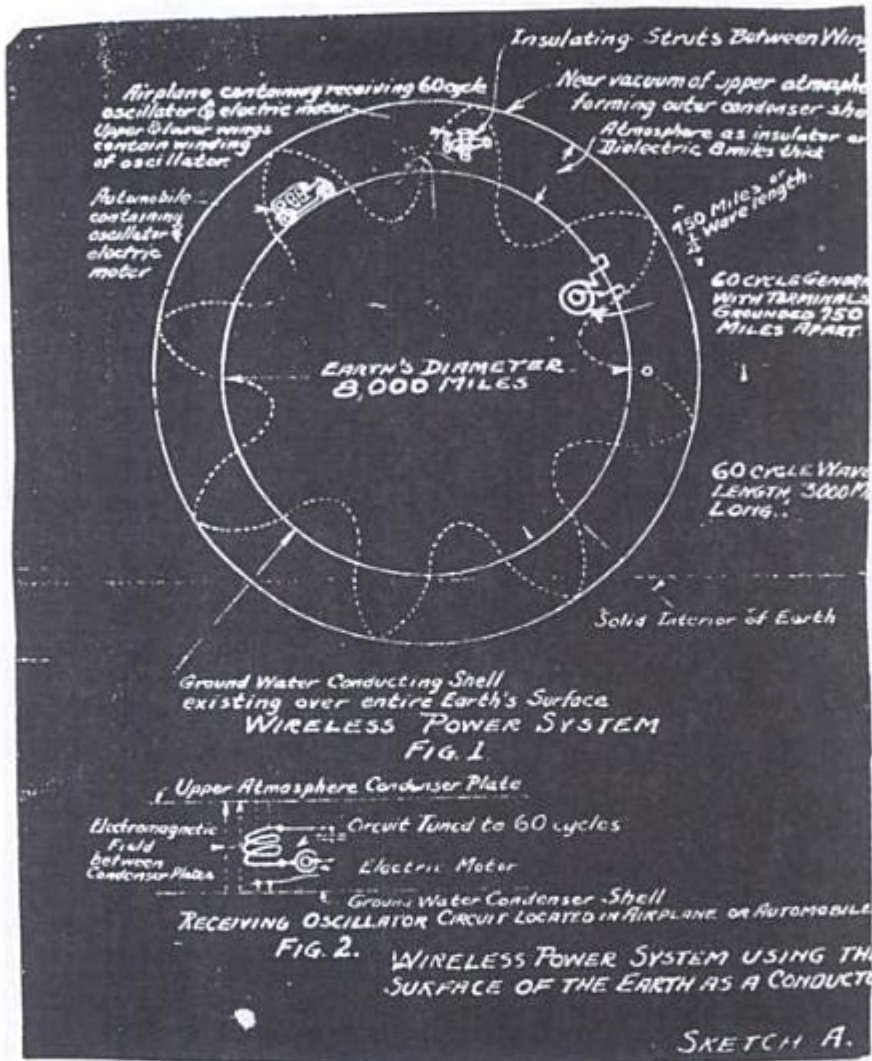

Tesla's sketch of the terrestrial resonator operating at a frequency of 60Hz. He has drawn a standing wave with 8 cycles. This gives the fundamental as $60/8 = 7.5\text{Hz}$. The sketch is from a memo in 1925

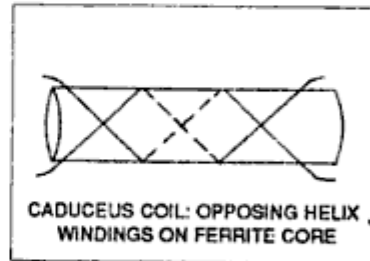
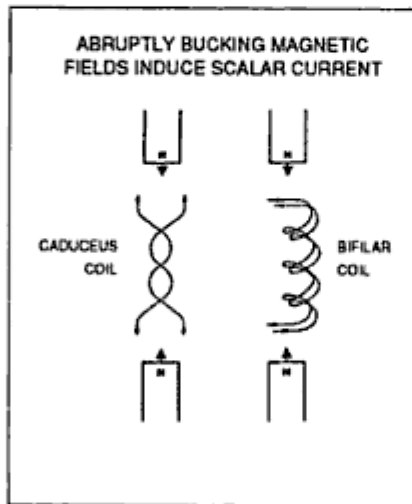
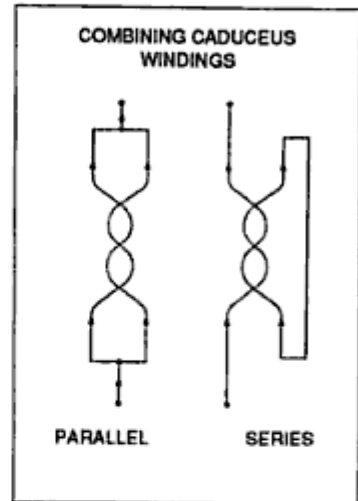
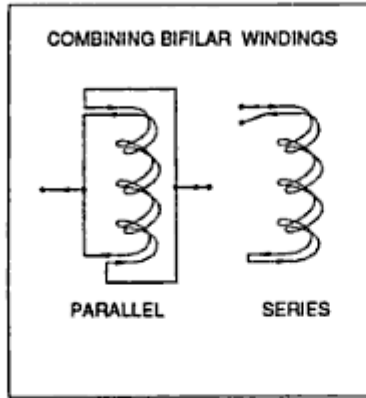

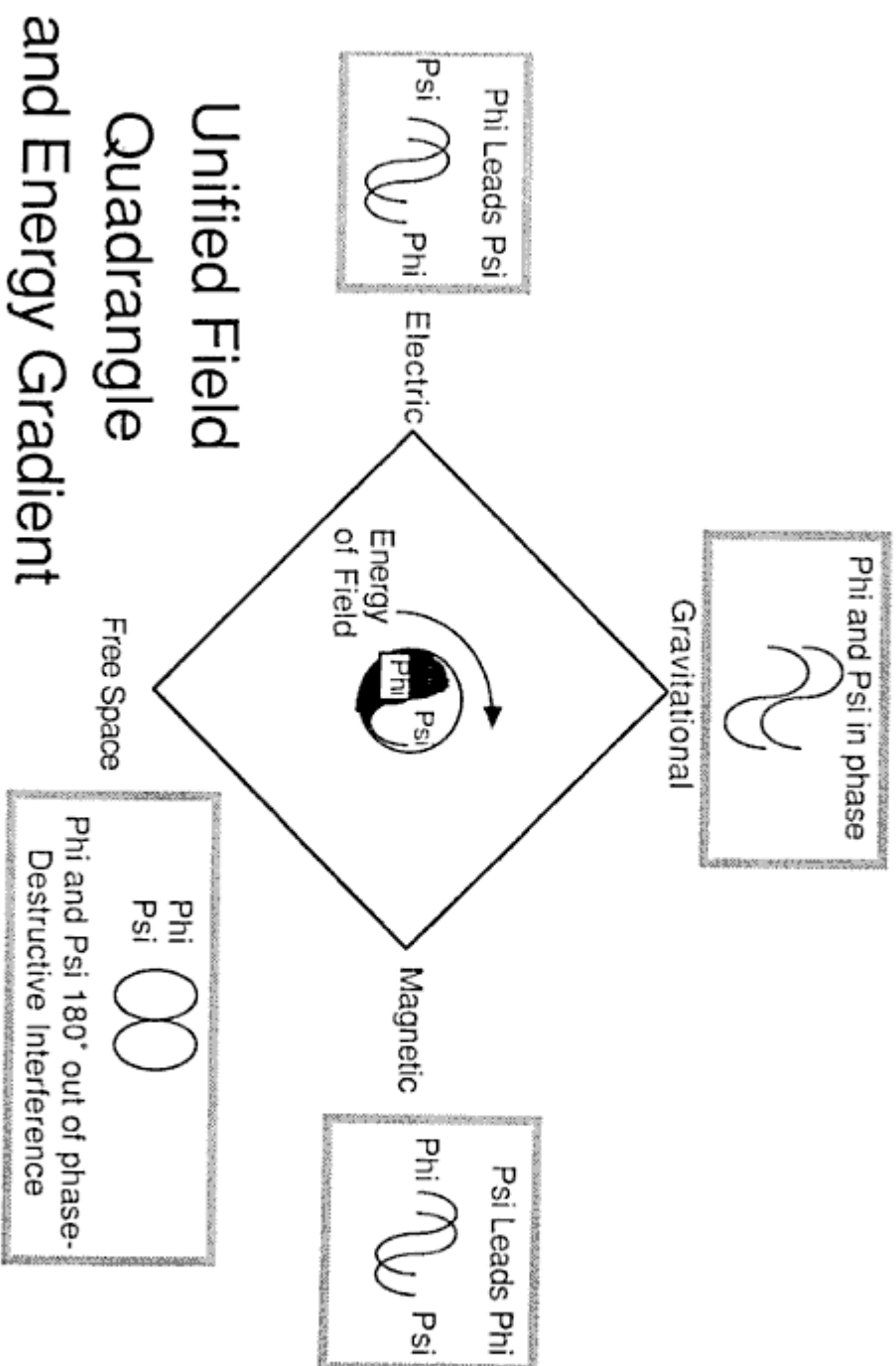

TESLA TECHNOLOGY AND RADIOISOTOPIC ENERGY GENERATION

**BY
PAUL M. BROWN**

JUNE 27, 1990

**PAPER PRESENTED AT THE
1990 TESLA SYMPOSIUM
JULY 26-29, 1990
COLORADO SPRINGS, COLORADO**



Nucell, Inc.

A Subsidiary of Peripheral Systems, Inc.

Peripheral Systems, Inc.

TESLA TECHNOLOGY AND RADIOISOTOPIC ENERGY GENERATION

BY
PAUL M. BROWN

JUNE 27, 1990

The basic electrical resonance principles pioneered by Nikola Tesla in the late 1800's are now being applied to a method of generating electricity from natural radioactive decay. Nucell, Inc. a subsidiary of Peripheral Systems, Inc. of Portland, Oregon, received a patent May, 1989, for their resonant nuclear oscillator (Figure 1). In general, the resonant nuclear oscillator is an LCR tank circuit tuned to oscillate at its self resonant frequency. Energy in excess of the operational losses is contributed from a radioactive source to the tank circuit through a phenomenon known as the Beta Voltaic Effect. Net electric current is then removed from the oscillator through an impedance matched transformer to deliver high frequency electricity in usable form to drive a load.

The Beta Voltaic Effect may simply be defined as the conversion of ionizing radiation to electrical energy by a material or combination of materials. Radiation that is absorbed in the vicinity of any potential barrier will generate separated electron-hole pairs which in turn flow in an electric circuit in response to the influence of the electric potential field.

Radioactive decay energy is several orders of magnitude greater than chemical energy. For this reason, this technology has promise of yielding low volume, low weight, high energy density power sources that will be economical for long unattended life with high reliability.

Devices for converting natural radioactive decay directly into electricity are nothing new (Figure 2). The Beta Cell was first demonstrated by Moseley in 1913 and over the years many types and methods have been developed. This technology has been made possible due to the electrical nature of alpha and beta disintegrations.

(Figure 3) The simplest form of nuclear battery is the Burke Cell. This method consists of a conventional battery and a conventional load connected by means of a radioactive conductor. If we inspect this arrangement we find that all of the power dissipated in the load is not drawn from the battery. And upon closer examination we find that a current amplification occurs within the radioactive conductor.

This phenomenon is known as the Beta Voltaic Effect and may be explained by referring to Figure 4. For the simple case of this example, we will set the radioactive source (any alpha or beta emitter) external and separate from a silver wire. Now the battery from Figure 3 provides an electromotive force (emf) across the wire and consequently, conduction electrons within the wire are set in uniform motion. By definition, electricity is measured in terms of the number of charged particles (electrons) moving past a point in a unit of time and we call this amperes.

The process by which a beta particle is absorbed, is such that the beta particle collides with the molecular structure of the copper knocking electrons free. This electron avalanche occurs until the beta particle (electron) effectively comes to rest. A single beta particle emitted from strontium-90 that is absorbed in copper will generate 80,000 ions in a distance of .030 inches. Now, as soon as these electrons are knocked loose, they effectively become free electrons in the wire, and as such these additional electrons are acted upon by the emf applied across the wire to give the avalanche electrons a uniform direction of flow, regardless of their incident angle. This increase in the number of moving charge carriers is measured in the real world

as increased current. We also measure a reduction in the resistance of the wire, and an increase in its conductivity while the current is directly proportional to the voltage. In other words, the current goes up with an increase in voltage. This is basically attributed to the increased emf acting on a greater number of avalanche electrons.

(Figure 5) a cartoon representation of the basic beta voltaic converter is shown. Electrode A has a positive potential while Electrode B is negative with the potential difference provided by any conventional means. An electric field exists between the electrodes and we shall call this zone the junction. The junction between the two electrodes is thus comprised of a suitably ionizable medium exposed to decay particles emitted from a radioactive source.

In general, the introduction of ions from any source into an electric field will generate electricity in accordance with well-known physical or chemical principles and may be satisfactorily explained in terms commonly associated with the Beta Voltaic Effect. The energy contributed to such a circuit does not come from the ions themselves but rather from the work done on the circuit to generate the ions, known as the ionization potential of that particular material.

An amount of work must be performed on a neutral atom to remove electrons (ionize the atom). This work manifests itself as increased potential energy and may be utilized to do work before allowing the electron and ion to recombine.

Neither the electric field, the electrodes or the medium between the electrodes contribute any energy in the Beta Voltaic Effect. The energy is contributed by the ion generator whether this mechanism is chemical, electromagnetic or nuclear is irrelevant.

In other words, assume the conductor is irradiated with beta particles. As these particles penetrate the conductor, collisions occur with electrons in the lattice of the conductor resulting in the transfer of energy to these electrons and exciting them to a higher energy level in the conduction band.

Now we will look at how we apply this phenomenon to our device. Figure 6 depicts a basic LC tank circuit comprised of an inductor and a capacitor. Theoretically, if this LC circuit were superconductive, then an externally applied electric impulse would yield an LC oscillation that would continue to oscillate forever due to no losses in the system.

However, our LC circuit is not superconductive and the oscillation damps out due to the losses inherent to the LC tank. To minimize these inherent losses, we tune the circuit into resonance at the self-resonant frequency of the inductor. This causes the inductive and capacitive reactances to cancel leaving only ohmic losses (resistance).

(Figure 7) If we apply a radioactive source as part of the LC tank, then through every cycle of the oscillation of which current is flowing, that current gets amplified by an amount proportional to the activity of the source. All we need is an input of an amount of energy equal to the system losses to achieve a sustained oscillation. At this point, we have a self-driven oscillator what we call a Nuclear Powered Oscillator.

Any energy contributed to this oscillating LC tank must be removed and we accomplish this (Figure 8) by simply impedance matching a transformer which yields high frequency AC current to drive a load. In a nutshell, that is the principle of operation for the Resonant Nuclear Power Supply an LC tank circuit oscillating at its self-resonant frequency, driven by natural radioactive decay energy. Energy in excess of the operational requirements is removed through a transfer to yield electrical energy in usable form to drive a load.

Figure 9 depicts the starting method which involves the use of a high voltage source to charge the capacitor of the tank circuit, which

is then discharged to ground through a Class C amplifier at a rate equal to the resonant frequency of the tank circuit. A spectrum analyzer is used to monitor the activity within the tank and once a clean oscillation is started, the high voltage power supply and Class C amplifier are removed; a process that takes a few seconds, then the power removed from the tank circuit is determined by measuring the voltage drop across a resistor of known value and double-checked by directly measuring the current delivered to the load.

The great attraction of radioisotope generators lies in the fact that isotope energy densities are several orders of magnitude greater than chemical energy density. However, the technology currently in use for radioisotope power generation is severely limited by its low efficiency, isotope limitations and heavy shielding requirements, while a resonant nuclear generator does not suffer from these limitations.

(Figure 10) Here we have the actual component layout of an early resonant nuclear power supply. We can see the radioactive source and its mount along with the primary inductor and matching transformer. The tuning capacitors are not shown.

(Figure 11) This is the actual wiring of the prototype shown in the previous slide. Although this generated electricity, it also demonstrated a frequency stability problem and showed signs of material degradation.

Economic studies indicate that a radioisotopic nuclear battery is economically competitive with chemical batteries for applications requiring lifetimes of over two years at remote locations where the expense of charging or changing batteries is significant. Applications where the inaccessibility after implantation is a consideration that leads to selection of nuclear batteries due to their superior reliability and life.

We have pursued several design variations and are currently working with an independent nuclear engineering firm. Our current program will generate engineering data in the coming months. Of course any alpha or beta emitting isotope will work while a design variation also allows the use of gamma sources. We have experimented with cesium, strontium, radium, krypton, tritium, promethium and probably some others. All these sources have worked, however, for personnel safety and application considerations we are currently planning to use krypton-85 as the fuel source, although strontium-90 is also a good candidate.

Large quantities of krypton-85 are contained in stored power-reactor fuels and about 1 MegaCurie per year is available from processed fuel. It is estimated that 42 MegaCuries of krypton-85 could be obtained from existing inventories in power-reactor fuels with the content in spent power-reactor fuels at about 8,500 Curies per ton.

Of the many radioactive isotopes generated by the fission of uranium, krypton-85 has many unique properties of which the most important is its advantage of being environmentally the most acceptable radioisotope available for power production.

Preliminary data suggests that energy densities on the order of .25 watt per cubic centimeter is achievable.

Market surveys have been conducted by the nuclear industry in the past and the conclusion has been that there is a need for long-life radioisotope nuclear batteries. Of course, economic and logistical factors must be considered for comparison (Figure 12).

Obviously the physical size and shape of the radioisotope batteries will need to be related to the intended applications. For example, in oil and gas well drilling, there is an increasing benefit in continuously measuring and monitoring geo-physical data from the bottom of the hole. Under these circumstances it would be necessary

to accommodate the battery within the diameter of the drilling tubes. Another important potential market is to supply long life, electrical service to the sonar detectors which are in locations throughout the oceans of the world. The overall configuration in the case would probably be quite different. All of these possible applications need to be considered throughout the development phase.

Based on applications surveys, a design, development and testing program is being conducted on novel radioisotopic batteries that will be economical for long unattended life with high reliability, low weight and volume in the power range of 10 to 5,000 mW (e).

References:

- (1) Brown, Paul. THE MORAY DEVICE AND THE HUBBARD COIL WERE NUCLEAR BATTERIES in Magnets In Your Future Magazine, Vol. 2, No. 3, March 1987.
- (2) Brown, Paul. RESONANT NUCLEAR POWER SUPPLY in Raum & Zeit Magazine, Vol. 1, No. 2, August-September, 1989.
- (3) Brown, Paul. American Nuclear Society 1989 Winter Meeting, San Francisco, California, November 26-30, 1989, RESONANT NUCLEAR BATTERY MAY AID IN MITIGATING THE GREENHOUSE EFFECT.
- (4) Brown, Paul. American Nuclear Society Annual Meeting, June 10-14, 1990, Nashville, Tennessee, THE BETA VOLTAIC EFFECT APPLIED TO RADIOISOTOPIC POWER GENERATION.

For More Information Contact:

Paul Brown
Nucell, Inc.
12725 S.W. 66th Avenue, Suite 102
Portland, Oregon 97223
503/624-8586

NUCELL, INC. A SUBSIDIARY OF PERIPHERAL SYSTEMS, INC.

United States Patent (14) **Patent Number:** 4,815,433
Issue (15) **Date of Patent:** May 31, 1989

(14) **APPARATUS FOR DIRECT CONVERSION OF RADIOACTIVE DECAY ENERGY TO ELECTRICAL ENERGY**
 (15) **Inventor:** Paul M. Brown, Stone, IA
 (16) **Assignor:** Paul M. Brown, Stone, IA
 (17) **App. No.:** 033,976
 (18) **Filed:** Feb. 8, 1988

Related U.S. Application Data
 (19) **Continuation of Ser. No. 011,807, Apr. 21, 1984, now closed.**
 (20) **Int. Cl.:** H01L 31/00
 (21) **U.S. Cl.:** 314/305; 314/315; 314/320
 (22) **Field of Search:** 314/305, 315, 309, 301, 310, 304, 303, 314, 312

Reference Cited
U.S. PATENT DOCUMENTS
 3,442,311 4-1961 Luder 310/304
 3,712,897 8-1961 Auerer 310/308
 3,792,857 5-1974 Rading 310/301
 3,983,327 12-1986 Grant 310/301

ABSTRACT
 A nuclear battery is which the energy obtained in radioactive decay produces during the spontaneous disintegration of radioactive material is utilized to ionize and empty the depletion or a high-V J.C. section a p-n junction. The nuclear subelement comprises a coil wound on a core composed of radioactive isotopes connected in series with the primary winding of a power transformer. The core is fabricated from a mixture of three radioactive materials which decay produce in equal amounts and provide a greater flux of radioactive decay products than the equivalent amount of a single radioactive isotope.

FIG. 1

Figure 1

(A) **USP 2,552,050 Beta Cell**

(B) **USP 2,858,459 Secondary Emission**

(C) **USP 3,094,634 p-n junction**

(D) **SNAP - 27 NASA RTG**

Figure 4

United States Patents

2,617,120	2,661,730	2,810,850	3,053,927
2,620,603	2,661,431	2,817,776	3,094,634
2,627,945	2,669,608	2,819,414	3,095,476
2,643,039	2,696,564	2,847,585	3,290,522
2,648,225	2,745,973	2,858,459	3,361,866
2,652,050	2,748,339	2,892,904	3,409,820
2,655,116	2,749,251	2,930,909	3,484,040
2,655,143	2,754,428	2,976,433	3,533,316
2,669,924	2,768,313	3,031,519	3,714,474
2,698,925	2,774,891	3,037,067	3,939,366
2,614,986	2,789,240	3,050,684	4,097,654

Figure 2

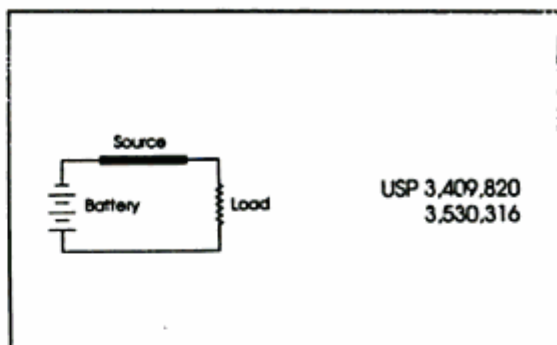

Figure 3

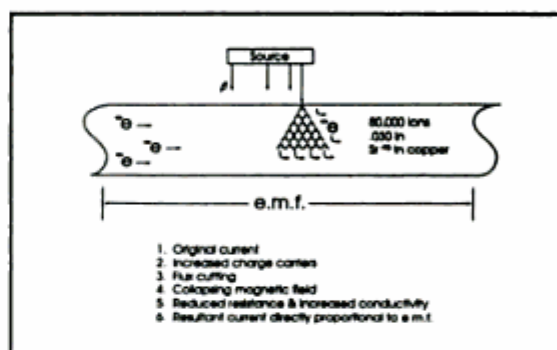

Figure 4

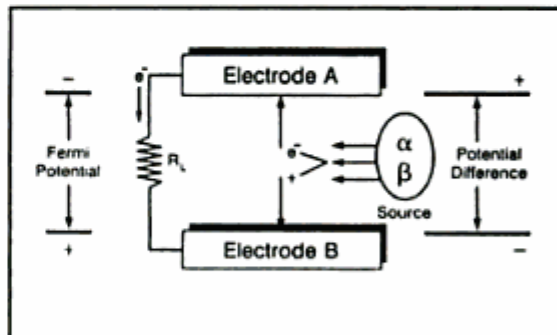

Figure 5

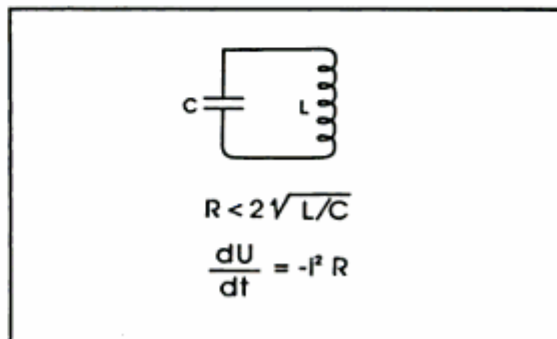

Figure 6

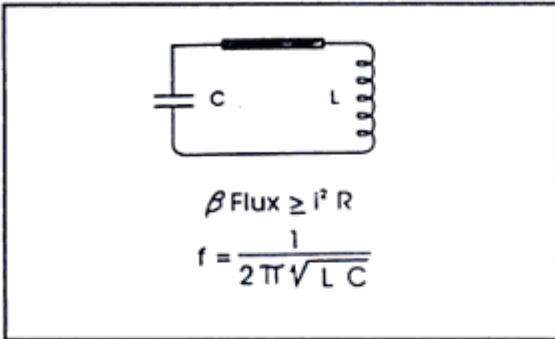

Figure 7

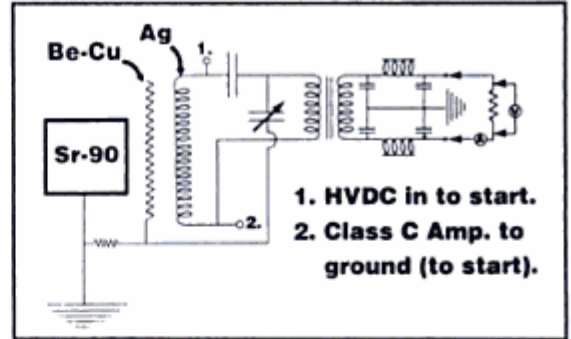

Figure 11

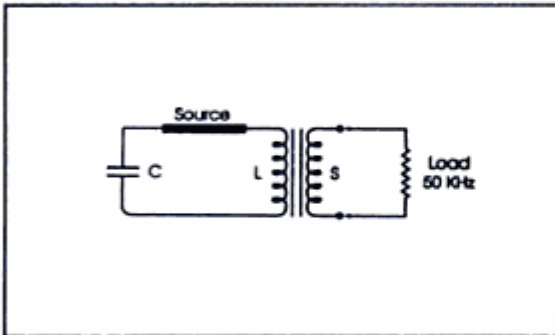

Figure 8

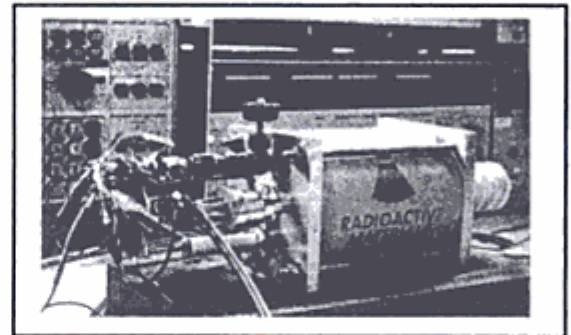

Figure 12

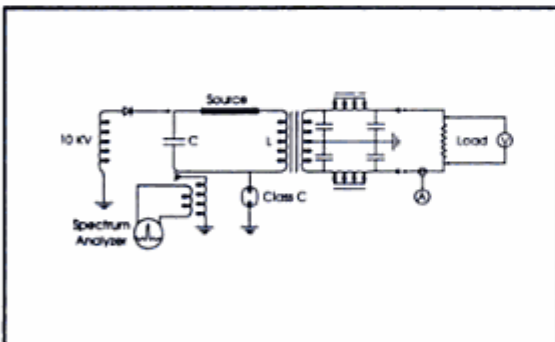

Figure 9

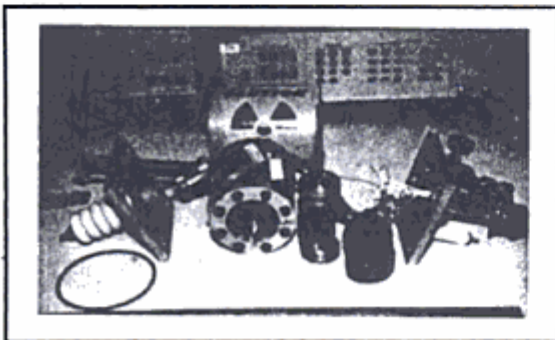

Figure 10

VARIABLE RELUCTANCE ALTERNATOR

John Ecklin - Flux Switch Alternator U. S. Pat. No. 4,567,407

The patent number for the bottom of the previous page is 4,567,407 and it was granted on Jan. 28, 1986. Fig. 3A and 3B depicts how the magnetic fields are reversed in both AC output coils simultaneously. The preferred embodiment for Fig. 4 is to have no windings on the rotor (5). The rotor is then made up of steel laminations. This is what in the 1890's was called a flux switch alternator. It had no brushes in this century old technology.

Patent 4,567,407 combines this old technology with the newer electronically commutated motor controllers. Sensors determine the position of the rotor and increase the saturation of the stator from 80% to 98% to pull the rotor in faster than normal. This gives a motor action and since the saturation of the stator is increased the required power is automatically captured by the AC output coils. Fig. 1 demonstrates the principle. 19 is a 3/8ths inch diameter ball bearing on top of a 1/2" diameter by 1/4" thick ceramic button magnet resting on a horizontal steel surface 23. When the ball is pulled to the edge of the magnet and is released you will see a highly damped oscillatory motion. Turn the magnet over and you see the same thing. The ball is equivalent to either rotor pole and the magnet is equivalent to any stator pole. In other words the patent pulls the rotor to the stator and you no longer have to use input torque to force the rotor to the stator. This is how you skirt Lenz's Law compared to all of today's Faraday generators.

If you tie a very springy (high steel content) paper clip to a 6" thread you can actually see the source of the energy which is unpaired electron spin in iron atoms. With practice clip can lift ball from magnet in less than 1/10th of a second and will hang there for 50 years and more. How can we store enough energy in the clip in 1/10th second to keep the ball from falling for 50 years? We can't. The energy is already in the iron atoms of the crystal or clip. The magnet merely sets the direction of spin of most of the 4 unpaired electrons in most of the atoms in the clip. As long as the clip and ball stay together these electrons keep spinning in the same direction. If you ever separate the clip and ball you will have to use the magnet again before clip will lift ball.

Since all electrons in all atoms spin on their axis with the same angular momentum each one is an infinite source of energy. I call this God's perfect flywheel. Something about his atoms always keep the electrons spinning at the same rate. This patent is an over-unity device from the standpoint of torque but it is way, way under unity when we consider the energy in electron spin. This atomic energy as we do not change the atom eternally by splitting or joining atoms as in fission and fusion which are nuclear energy and very polluting.

b) Paul Brown, Bliss, Idaho (June, 1982)

Paul Brown, as an independent researcher, has accomplished some significant project work in the area of John Ecklin's original S.A.G. concept, by expanding on the basic principles involved in the functioning of the S.A.G.'s.

His *Magnetic distributor Generator*, which is also known as a *Variable Reluctance Alternator*, consists of utilizing both D.C. input coils and A.C. output coils wound on 90 degree crossed laminations. The iron laminations are in the form of an exact ninety degree cross-over so that exactly opposite North-South magnetic poles are established, as in normal two-pole D.C. motor design.

A split iron and aluminum rotor provides the alternating make and break magnetic circuits between the D.C. and A.C. iron laminations, and their corresponding D.C. and A.C. coils, respectively. When the matching arms of the rotor close the gap between the stator laminations, a magnetic flux flows through the closed circuit, which causes E.M.F. flow within one set of (A.C.) of coils, which are opposite to each other.

As the rotor is turned through ninety degrees, this magnetic gap opened and the magnetic flux and corresponding E.M.F. in the coil cease. Since the iron laminations with their D.C. coils are energized by a D.C. input, this D.C. input is converted (through basic transformer action) to an A.C. flow by the uniform making and breaking of the A.C. iron laminations and their associated A.C. coils.

The characteristics of the Variable Reluctance Alternator are as follows:

- 1) Voltage increase with an increase in R.P.M.
- 2) Voltage increases with the number of turns of wire on the output coil (per transformer theory). (The project work of R. Alexander teaches us that it is advantageous to increase the turns, and hence voltage, in the output coil. Section VI, (c).)
- 3) Power increases with an increase in magnetic field strength. (A function of the wattage of the D.C. input E.M.F.)
- 4) When compared with conventional generators/alternators, there is no counter-torque on the rotor.
- 5) Very high efficiency, when compared with conventional generators. The recorded efficiency is: 125%.

For more information see Paul Brown's article titled — *The Moray Device and Hubbard Coil were Nuclear Batteries* on page 121.

Paul Brown's Project Work

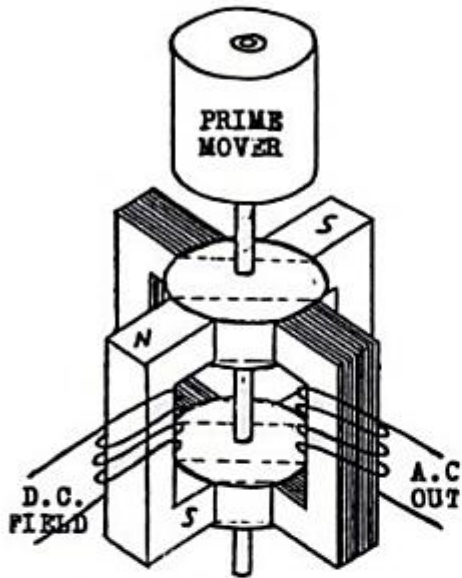

H Note solid core in D.C.
f field coils.

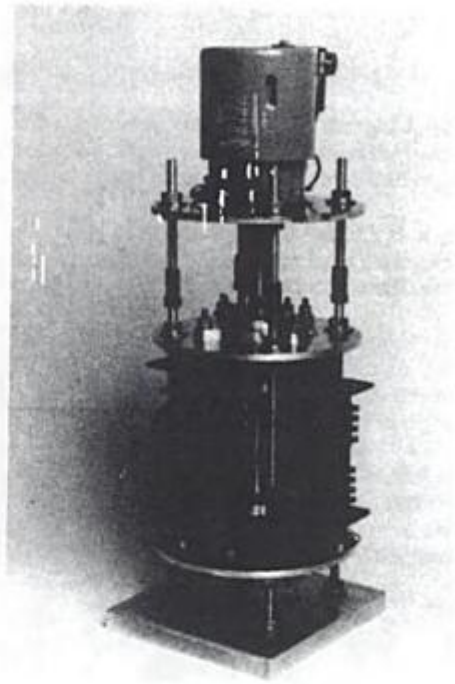

DIMENSIONS AS ASSEMBLED

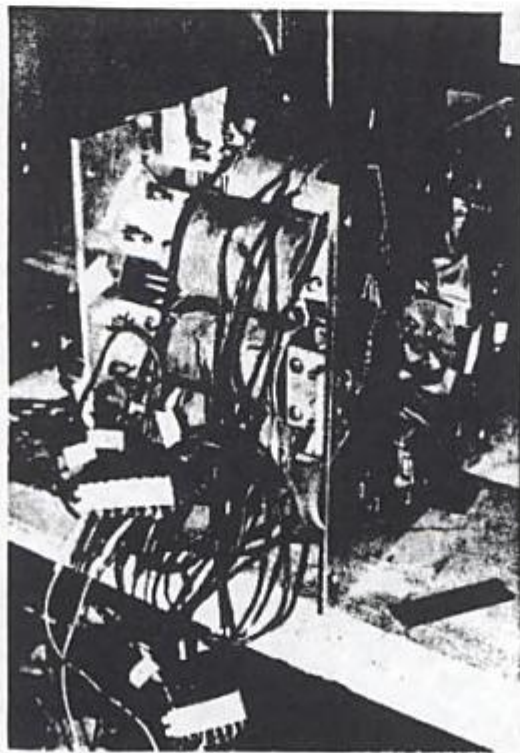

Variable Reluctance Generator

2

A Permanent Magnet Motor, 1269 A.D.

PERMANENT MAGNET MOTORS

Peregrinus (1269 A.D.) to Lee Bowman in 1954.

Peter Peregrinus is credited with the development of the first known and recorded permanent magnet motor in 1269. His original work has been translated from Latin and the work is on file at the New York City Public Library.

The Peregrinus P.M.M. work remained dormant over the centuries until it was revived by Mr. Lee Bowman of California in 1954, who evolved a small scale working model.

The device consisted of three parallel shafts supported in bearings within end plates secured to a solid base plate. Three gears were secured at one end of each of the three shafts, at a two-to-one ratio, with one larger gear on the central shaft, as shown.

At the opposite end, three discs were secured to the shaft ends with one larger disc on the central shaft, and the two equal size smaller discs on the two, outer shafts. The discs were also fixed at a two-to-one ratio, the same as the gear ratios at the opposite shaft ends.

Eight Alnico rod permanent magnets were equally spaced on the one large disc, and four magnets each on the two smaller discs, so that they would coincide in position when the three discs were revolved. The elongated Alnico permanent magnets were placed on each of the discs so that they revolved parallel to the shafts, and their ends passed each other with a close air gap of about .005".

When the discs were moved by hand, the magnets passing each other were so phased as to be synchronized at each passing position, as shown in the sketches.

The operation of the magnetic device required the positioning of a single cylindrical permanent magnet which was placed at an angle relative to the lower quadrant of the end discs, as shown. This single magnet acted as the actuator magnet which caused the rotation of the disc by unbalancing the magnetic forces of the three magnetic discs.

The Bowman magnetic motor was witnessed by several people including an electrical engineer who was impressed with its operation at the time of the demonstration. Although the Bowman device had received some exposure it never received any development interest and was eventually dismantled and destroyed, with no records made of its development potential.

The Bowman Permanent Magnet Motor

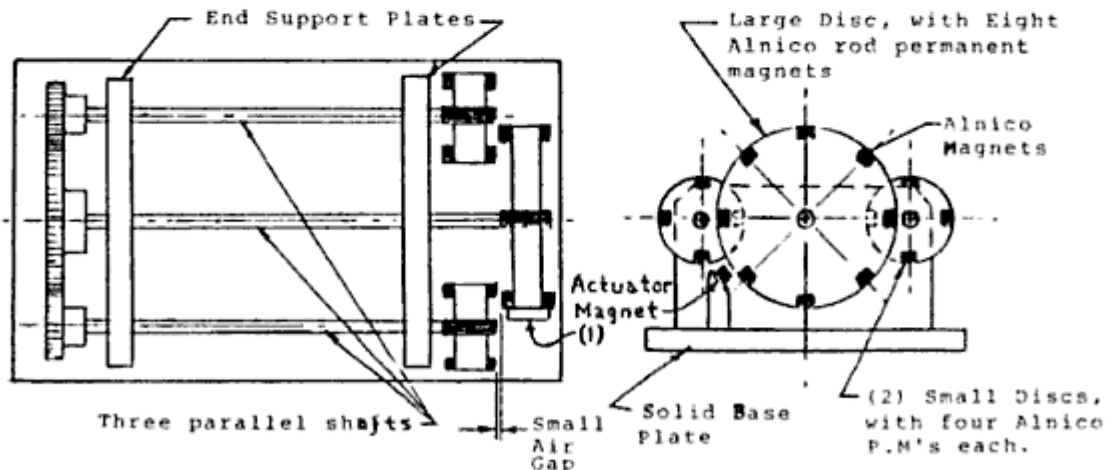

THE LETTER OF
P E T R U S
PEREGRINUS
ON THE MAGNET, A.D. 1269

TRANSLATED BY

BROTHER ARNOLD, M.Sc.
PRINCIPAL OF LA SALLE INSTITUTE, TROY

WITH

INTRODUCTORY NOTICE

BY

BROTHER POTAMIAN, D.Sc.
PROFESSOR OF PHYSICS IN MANHATTAN
COLLEGE, NEW YORK

NEW YORK
McGRAW PUBLISHING COMPANY
MCMIV

INTRODUCTORY

THE magnetic lore of classic antiquity was scanty indeed, being limited to the attraction which the lodestone manifests for iron. Lucretius (99-55 B. C.), however, in his poetical dissertation on the magnet, contained in *De Rerum Natura*, Book VI,¹ recognizes magnetic repulsion, magnetic induction, and to some extent the magnetic field with its lines of force, for in verse 1040 he writes :

Oft from the magnet, too, the steel recedes,
Repelled by turns and re-attracted close.

And in verse 1085 :

Its viewless, potent virtues men surprise ;
Its strange effects, they view with wond'ring eyes

¹ With very few exceptions all the works referred to in this notice will be found in the Wheeler Collection in the Library of the American Institute of Electrical Engineers, New York.

THE LETTER OF PEREGRINUS

When without aid of hinges, links or springs
 A pendant chain we hold of steely rings
 Dropt from the stone—the stone the binding source—
 Ring cleaves to ring and owns magnetic force :
 Those held above, the ones below maintain,
 Circle 'neath circle downward draws in vain
 Whilst free in air disports the oscillating chain.

The poet Claudian (365-408 A. D.) wrote a short idyll on the attractive virtue of the lodestone and its symbolism ; St. Augustine (354-430), in his work *De Civitate Dei*, records the fact that a lodestone, held under a silver plate, draws after it a scrap of iron lying on the plate. Abbot Neckam, the Augustinian (1157-1217), distinguishes between the properties of the two ends of the lodestone, and gives in his *De Uten-silibus*, what is perhaps the earliest reference to the mariner's compass that we have. Albertus Magnus, the Dominican (1193-1280), in his treatise, *De Mineralibus*, enumerates different kinds of natural magnets and states some of the properties commonly attributed to them ; the minstrel, Guyot de Provins, in a famous satirical poem, written about 1208, refers to the directive qual-

INTRODUCTORY

ity of the lodestone and its use in navigation, as do also Cardinal de Vitry in his *Historia Orientalis* (1215-1220); Brunetto Latini, poet, orator and philosopher, in his *Trésor des Sciences*, a veritable library, written in Paris in 1260; Raymond Lully, the Enlightened Doctor, in his treatise, *De Contemplatione*, begun in 1272, and Guido Guinicelli, the poet-priest of Bologna, who died in 1276.

The authors of these learned works were too busy with the pen to find time to devote to the close and prolonged study of natural phenomena necessary for fruitful discovery, and so had to content themselves with recording and discussing in their tomes the scientific knowledge of their age without making any notable additions to it.

But this was not the case with such contemporaries of theirs as Roger Bacon, the Franciscan, and his Gallic friend, Pierre de Maricourt, commonly called Petrus Peregrinus, the subject of the present notice, a man of academic culture and of a practical rather than speculative turn of mind. Of the early years of Peregrinus nothing

THE LETTER OF PEREGRINUS

is known save that he studied probably at the University of Paris, and that he graduated with the highest scholastic honors. He owes his surname to the village of Maricourt, in Picardy, and the appellation Peregrinus, or Pilgrim, to his having visited the Holy Land as a member of one of the crusading expeditions of the time.

In 1269 we find him in the engineering corps of the French army then besieging Lucera, in Southern Italy, which had revolted from the authority of its French master, Charles of Anjou. To Peregrinus was assigned the work of fortifying the camp and laying mines as well as of constructing engines for projecting stones and fireballs into the beleaguered city.

It was in the midst of such warlike preoccupations that the idea seems to have occurred to him of devising a piece of mechanism to keep the astronomical sphere of Archimedes in uniform rotation for a definite time. In the course of his work over the new motor, Peregrinus was gradually led to consider the more fascinating problem of perpetual motion itself with the result

INTRODUCTORY

that he showed, at least diagrammatically, and to his own evident satisfaction, how a wheel might be driven round forever by the power of magnetic attraction.

Elated over his imaginary success, Peregrinus hastened to inform a friend of his at home; and that his friend might the more readily comprehend the mechanism of the motor and the functions of its parts, he proceeds to set forth in a methodical manner all the properties of the lodestone, most of which he himself had discovered. It is a fortunate circumstance that this Picard friend of his was not a man learned in the sciences, otherwise we would probably never have had the remarkable exposition which Peregrinus gives of the phenomena and laws of magnetism. This letter of 3,500 words is the first great landmark in the domain of magnetic philosophy, the next being Gilbert's *De Magnete*, in 1600.

The letter was addressed from the trenches at Lucera, Southern Italy, in August, 1269, to Sigerus de Foucaucourt, his "amicorum intimus," the dearest of friends. A more enlightened friend,

THE LETTER OF PEREGRINUS

however, than the knight of Foucaucourt was Roger Bacon, who held Peregrinus in the very highest esteem, as the following glowing testimony shows: "There are but two perfect mathematicians," wrote the English monk, "John of London and Petrus de Maharne-Curia, a Picard." Further on in his *Opus Tertium*, Bacon thus appraises the merits of the Picard: "I know of only one person who deserves praise for his work in experimental philosophy, for he does not care for the discourses of men and their wordy warfare, but quietly and diligently pursues the works of wisdom. Therefore, what others grope after blindly, as bats in the evening twilight, this man contemplates in all their brilliancy because he is a master of experiment. Hence, he knows all natural science whether pertaining to medicine and alchemy, or to matters celestial and terrestrial. He has worked diligently in the smelting of ores as also in the working of minerals; he is thoroughly acquainted with all sorts of arms and implements used in military service and in hunting, besides which he is skilled in agriculture and

INTRODUCTORY

in the measurement of lands. It is impossible to write a useful or correct treatise in experimental philosophy without mentioning this man's name. Moreover, he pursues knowledge for its own sake; for if he wished to obtain royal favor, he could easily find sovereigns who would honor and enrich him."

This last statement is worthy of the best utterances of the twentieth century. Say what they will, the most ardent pleaders of our day for original work and laboratory methods cannot surpass the Franciscan monk of the thirteenth century in his denunciation of mere book learning or in his advocacy of experiment and research, while in Peregrinus, the mediævalist, they have Bacon's impersonation of what a student of science ought to be. Peregrinus was a hard worker, nor a mere theorizer, preferring, Procrustean-like, to make theory fit the facts rather than facts the theory; he was a brilliant discoverer who knew at the same time how to use his discoveries for the benefit of mankind; he was a pioneer of science and a leader in the progress of the world.

THE LETTER OF PEREGRINUS

An analysis of the "Epistola" shows that

(a) Peregrinus was the first to assign a definite position to the poles of a lodestone, and to give directions for determining which is north and which south;

(b) He proved that unlike poles attract each other, and that similar ones repel;

(c) He established by experiment that every fragment of a lodestone, however small, is a complete magnet, thus anticipating one of our fundamental laboratory illustrations of the molecular theory;

(d) He recognized that a pole of a magnet may neutralize a weaker one of the same name, and even reverse its polarity;

(e) He was the first to pivot a magnetized needle and surround it with a graduated circle, Figs. 2 and 3.¹

(f) He determined the position of an object by its magnetic bearing as done to-day in compass surveying; and

¹ It is probable that Flavio Gioja, an Italian pilot, some fifty years later, added the compass-card and attached it to the magnet.

INTRODUCTORY

(g) He introduced into his perpetual motion machine, Fig. 4, the idea of a magnetic motor, a clever idea, indeed, for a thirteenth century engineer.

This rapid summary will serve to show that the letter of Peregrinus is one of great interest in physics as well as in navigation and geodesy. For nearly three centuries, it lay unnoticed among the libraries of Europe, but it did not escape Gilbert, who makes frequent mention of it in his *De Magnete*, 1600; nor the illustrious Jesuit writers, Cabæus, who refers to it in his *Philosophia Magnetica*, 1629, and Kircher, who quotes from it in his *De Arte Magnetica*, 1641; it was well known to Jean Taisnier, the Belgian plagiarist, who transferred a great part of it verbatim to the pages of his *De Natura Magnetis*, 1562, without a word of acknowledgment. By this piece of fraud, Taisnier acquired considerable celebrity, a fact that goes to show the meritorious character of the work which he unscrupulously copied.

This memorable letter is divided into two

THE LETTER OF PEREGRINUS

parts : the first contains ten chapters on the general properties of the lodestone ; the second has but three chapters, and shows how the author proposed to use a lodestone for the purpose of producing continuous rotation.

There are many manuscript copies of the letter in European libraries : the Bodleian has six ; the Vatican, two ; Trinity College, Dublin, one ; the Bibliothèque Nationale, Paris, one ; Leyden, Geneva and Turin, one each. The Leyden MS. has acquired special notoriety from a passage which appears near the end of it in which reference is made to magnetic declination and its value given : but Prof. W. Wenckebach, of The Hague, has shown¹ that the lines are spurious, having been interpolated in the manuscript in the early part of the sixteenth century.

The Leyden manuscript has also led some writers to believe in a fictitious author of the letter, one Peter Adsiger, or Petrus Adsigerus. As said above, Sigerus was the name of his countryman, to whom Peregrinus addressed his letter,

¹ *Annali di Matematica Pura ed Applicata*, 1865.

INTRODUCTORY

the *Epistola ad Sigerum*, from the trenches at Lucera, in August, 1269.

Magnetic declination was unknown to Peregrius, else he would not have written the following words: "Wherever a man may be, he finds the lodestone pointing to the heavens in accordance with the position of the meridian" (Chapter X). Of course, the geographical meridian is the one here meant, as the necessity of a distinct magnetic meridian had not yet occurred to any one.

Nor was this important magnetic element known to Columbus when he sailed from the shores of the Old World in 1492 as appears from the surprise with which he noticed the deviation of the needle from North as well as from the consternation of his pilots. Columbus has the unquestionable merit of being the first to observe and record the change of declination with change of place.

The first printed edition of the *Epistola*, now very rare, was prepared by Achilles Gasser, a physician of Lindau, a man well versed in mathe-

THE LETTER OF PEREGRINUS

matics, astronomy, history and philosophy. The work was printed in Augsburg in 1558. A copy of this early print is among the treasures of the Wheeler collection in the library of the American Institute of Electrical Engineers, New York. It was from this text that the translation which follows was made.

Besides the Latin edition of Gasser, 1558, there is also that of Libri in his *Histoire des Sciences Mathématiques*, 1838; of Bertelli, 1868, and Hellmann, 1898. Bertelli's is a learned and exhaustive work in which the Barnabite monk, sometimes called by mistake, Barnabita, instead of Bertelli, collates and compares the readings of the two Vatican codices with other texts, adding copious references and explanatory notes. It appeared in the *Bulletino di Bibliografia e di Storia delle Scienze Matematiche e Fisiche* for 1868.

Of translations, we have that which Richard Eden made from Taisnier's pirated extracts, the first dated edition appearing in 1579. Cavallo's *Treatise on Magnetism*, 1800, also contains some of the more remarkable passages. The only com-

INTRODUCTORY

plete English translation that we have, appeared in 1902 from the scholarly pen of Prof. Silvanus P. Thompson, of London. It is an *édition de luxe* beautifully rubricated, but limited to 250 copies. The translation was based on the texts of Gasser and Hellmann, amended by reference to a manuscript in the author's possession, dated 1391. We are informed that Mr. Fleury P. Mottelay, of New York, the learned translator of Gilbert's *De Magnete*, possesses a manuscript version by Prof. Peirce, of Harvard, of the Paris codex, of which he made a careful study in an endeavor to decipher the illegible parts.

THE LETTER OF
P E R E G R I N U S

PART I

CHAPTER I

PURPOSE OF THIS WORK

DEAREST OF FRIENDS:

AT your earnest request, I will now make known to you, in an unpolished narrative, the undoubted though hidden virtue of the lodestone, concerning which philosophers up to the present time give us no information, because it is characteristic of good things to be hidden in darkness until they are brought to light by application to public utility. Out of affection for you, I will write in a simple style about things entirely unknown to the ordinary individual. Nevertheless I will speak only of the manifest properties of the lodestone, because this tract will form part of a work on the construction of philosophical instruments. The disclosing of the

THE LETTER OF PEREGRINUS

terial ; one having reddish spots and small holes in it should not be chosen ; yet a lodestone is hardly ever found entirely free from such blemishes. On account of uniformity in its composition and the compactness of its innermost parts, such a stone is heavy and therefore more valuable. Its strength is known by its vigorous attraction for a large mass of iron ; further on I will explain the nature of this attraction. If you chance to see a stone with all these characteristics, secure it if you can.

CHAPTER IV

HOW TO DISTINGUISH THE POLES OF A
LODESTONE

I WISH to inform you that this stone bears in itself the likeness of the heavens, as I will now clearly demonstrate. There are in the heavens two points more important than all others, because on them, as on pivots, the celestial sphere revolves : these points are called, one the arctic or north pole, the other the antarctic or south pole. Similarly you must fully realize that in

THE LETTER OF PEREGRINUS

this stone there are two points styled respectively the north pole and the south pole. If you are very careful, you can discover these two points in a general way. One method for doing so is the following: With an instrument with which crystals and other stones are rounded let a lodestone be made into a globe and then polished. A needle or an elongated piece of iron is then placed on top of the lodestone and a line is drawn in the direction of the needle or iron, thus dividing the stone into two equal parts. The needle is next placed on another part of the stone and a second median line drawn. If desired, this operation may be performed on many different parts, and undoubtedly all these lines will meet in two points just as all meridian or azimuth circles meet in the two opposite poles of the globe. One of these is the north pole, the other the south pole. Proof of this will be found in a subsequent chapter of this tract.

A second method for determining these important points is this: Note the place on the above-mentioned spherical lodestone where the point of the needle clings most frequently and

THE LETTER OF PEREGRINUS

most strongly ; for this will be one of the poles as discovered by the previous method. In order to determine this point exactly, break off a small piece of the needle or iron so as to obtain a fragment about the length of two fingernails ; then put it on the spot which was found to be the pole by the former operation. If the fragment stands perpendicular to the stone, then that is, unquestionably, the pole sought ; if not, then move the iron fragment about until it becomes so ; mark this point carefully ; on the opposite end another point may be found in a similar manner. If all this has been done rightly, and if the stone is homogeneous throughout and a choice specimen, these two points will be diametrically opposite, like the poles of a sphere.

CHAPTER V

HOW TO DISCOVER THE POLES OF A LODESTONE AND HOW TO TELL WHICH IS NORTH AND WHICH SOUTH

THE poles of a lodestone having been located in a general way, you will determine which is north and which south in the following man-

THE LETTER OF PEREGRINUS

ner : Take a wooden vessel rounded like a platter or dish, and in it place the stone in such a way that the two poles will be equidistant from the edge of the vessel ; then place the dish in another and larger vessel full of water, so that the stone in the first-mentioned dish may be like a sailor in a boat. The second vessel should be of considerable size so that the first may resemble a ship floating in a river or on the sea. I insist upon the larger size of the second vessel in order that the natural tendency of the lodestone may not be impeded by contact of one vessel against the sides of the other. When the stone has been thus placed, it will turn the dish round until the north pole lies in the direction of the north pole of the heavens, and the south pole of the stone points to the south pole of the heavens. Even if the stone be moved a thousand times away from its position, it will return thereto a thousand times, as by natural instinct. Since the north and south parts of the heavens are known, these same points will then be easily recognized in the stone because each part of the lodestone will turn to the corresponding one of the heavens.

THE LETTER OF PEREGRINUS

that the last impression acts, confounds, or counteracts and alters the force of the original movement.

CHAPTER IX

WHY THE NORTH POLE OF ONE LODESTONE
ATTRACTS THE SOUTH POLE OF AN-
OTHER AND VICE VERSA

AS already stated, the north pole of one lodestone attracts the south pole of another and conversely; in this case the virtue of the stronger becomes active, whilst that of the weaker becomes obedient or passive. I consider the following to be the cause of this phenomenon: the active agent requires a passive subject, not merely to be joined to it, but also to be united with it, so that the two make but one by nature. In the case of this wonderful lodestone this may be shown in the following manner: Take a lodestone which you may call *AD*, in which *A* is the north pole and *D* the south; cut this stone into two parts, so that you may have two distinct

THE LETTER OF PEREGRINUS

stones; place the stone having the pole *A* so that it may float on water and you will observe that *A* turns towards the north as before; the breaking did not destroy the properties of the parts of the stone, since it is homogeneous; hence it follows that the part of the stone at the point of fracture, which may be marked *B*, must be a south pole; this broken part of which we are now speaking may be called *AB*. The other, which contains *D*, should then be placed so as to float on water, when you will see *D* point towards the south because it is a south pole; but the other end at the point of fracture, lettered *C*, will be a north pole; this stone may now be named *CD*. If we consider the first stone as the active agent, then the second, or *CD*, will be the passive subject. You will also notice that the ends of the two stones which before their separation were together, after breaking will become one a north pole and the other a south pole. If now these same broken portions are brought near each other, one will attract the other, so that they will again be

THE LETTER OF PEREGRINUS

joined at the points *B* and *C*, where the fracture occurred. Thus, by natural instinct, one single stone will be formed as before. This may be demonstrated fully by cementing the parts together, when the same effects will be produced as before the stone was broken. As you will perceive from this experiment, the active agent desires to become one with the passive subject because of the similarity that exists between them. Hence *C*, being a north pole, must be brought close to *B*, so that the agent and its subject may form one and the same straight line in the order *A B, C D* and *B* and *C* being at the same point. In this union the identity of the extreme parts is retained and preserved just as they were at first; for *A* is the north pole in the entire line as it was in the divided one; so also *D* is the south pole as it was in the divided passive subject, but *B* and *C* have been made effectually into one. In the same way it happens that if *A* be joined to *D* so as to make the two lines one, in virtue of this union due to attraction in the order *C D A B*, then *A* and *D*

THE LETTER OF PEREGRINUS

PART II



CHAPTER I

THE CONSTRUCTION OF AN INSTRUMENT FOR MEAS- URING THE AZIMUTH OF THE SUN THE MOON OR ANY STAR ON THE HORIZON

HAVING fully examined all the properties of the lodestone and the phenomena connected therewith, let us now come to those instruments which depend for their operation on the knowledge of those facts. Take a rounded lodestone,¹ and after determining its poles in the manner already mentioned, file its two sides so that it becomes elongated at its poles and occupies less space. The lodestone prepared in this wise is then enclosed within two capsules after the fashion of a mirror. Let these capsules be so joined together that they cannot be sepa-

¹ A *terrella*, or earthkin.

THE LETTER OF PEREGRINUS

rated and that water cannot enter ; they should be made of light wood and fastened with cement suited to the purpose. Having done this, place them in a large vessel of water on the edges of which the two parts of the world, i. e., the north and south points, have been found and marked. These points may be united by a thread stretched across from north to south. Then float the capsules and place a smooth strip of wood over them in the manner of a diameter. Move the strip until it is equally distant from the meridian-line, previously determined and marked by a thread, or else until it coincides therewith. Then mark a line on the capsules according to the position of the strip, and this will indicate forever the meridian of that place. Let this line be divided at its middle by another cutting it at right angles, which will give the east and west line ; thus the four cardinal points will be determined and indicated on the edge of the capsules. Each quarter is to be subdivided into 90 parts, making 360 in the circumference of the capsules. Engrave these divi-

THE LETTER OF PEREGRINUS

sions on them as usually done on the back of an astrolabe. On the top or edge of the capsules thus marked place a thin ruler like the pointer on the back of the astrolabe; instead of the sights attach two perpendicular pins, one at each end. If, therefore, you desire to take the azimuth of the sun, place the capsules in water and let them move freely until they come to rest in their natural position. Hold them firmly in one hand, while with the other you move the ruler until the shadow of the pins falls along the length of the ruler; then the end of the ruler which is towards the sun will indicate the azimuth of the sun. Should it be windy, let the capsules be covered with a suitable vessel until they have taken their position north and south. The same method, namely, by sighting, may be followed at night for determining the azimuth of the moon and stars; move the ruler until the ends of the pins are in the same line with the moon or star; the end of the ruler will then indicate the azimuth just as in the case of the sun. By means of the azimuth may then be deter-

THE LETTER OF PEREGRINUS

the wheel is continuous in one direction, so the fall of the weight will be continuous in the other. Being caught between the teeth of a wheel which is continuously revolving, it seeks the centre of the earth in virtue of its own weight, thereby aiding the motion of the teeth and preventing them from coming to rest in a direct line with the lodestone. Let the places between the teeth be suitably hollowed out so that they may easily catch the body in its fall, as shown in the diagram above. (Fig. 4.)

Farewell: finished in camp at the siege of Lucera on the eighth day of August, Anno Domini MCCLXIX.

EARLY REFERENCES TO THE MARINER'S COMPASS

THE following are the passages referred to in the introductory notice:

Abbot Neckam (1157-1217), in his *De Naturis Rerum*, writes:

“The sailors, moreover, as they sail over the sea, when in cloudy weather they can no longer profit by the light of the sun, or when the world is wrapped up in the darkness of the shades of night and they are ignorant to what point their ship’s course is directed, these mariners touch the lodestone with a needle, which (the needle) is whirled round in a circle until when its motion ceases, its point looks direct to the north. (*Cuspis ipsius septentrionalem plagam respiciat.*)”

In his *De Utensilibus*, we read:

“Among other stores of a ship, there must be a needle mounted on a dart (*habeat etiam acum jaculo superpositam*) which will oscillate and turn until the point looks to the north, and the sailors will thus know how to direct their course when

THE LETTER OF PEREGRINUS

the pole star is concealed through the troubled state of the atmosphere."¹

Alexander Neckam was born at St. Albans in 1157, joined the Augustinian Order and taught in the University of Paris from 1180 to 1187, after which he returned to England to take charge of a College of his Order at Dunstable. He was elected Abbot of Cirencester in 1213 and died at Kemsey, near Worcester, in 1217.

The satirical poem of Guyot de Provins, written about 1208, contains the following passage:

The mariners employ an art which cannot deceive,
 By the property of the lodestone,
 An ugly stone and brown,
 To which iron joints itself willingly
 They have; they attend to where it points
 After they have applied a needle to it;
 And they lay the latter on a straw
 And put it simply in the water
 Where the straw makes it float.
 Then the point turns direct
 To the star with such certainty
 That no man will ever doubt it,
 Nor will it ever go wrong.
 When the sea is dark and hazy,
 That one sees neither star nor moon,
 Then they put a light by the needle
 And have no fear of losing their way.
 The point turns towards the star;

¹The Chronicles and Memoirs of Great Britain and Ireland during the Middle Ages, by Thomas Wright (1863).

NOTES

And the mariners are taught
 To follow the right way.
 It is an art which cannot fail.

Provins, from which Guyot took his surname, was a small town in the vicinity of Paris.

Cardinal Jacques de Vitry, in his *Historia Orientalis*, Cap. 89, writes:

"An iron needle, after having been in contact with the lodestone, turns towards the north star, so that it is very necessary for those who navigate the seas."

Jacques de Vitry was born at Argenteuil, near Paris, joined the fourth crusade, became Bishop of Ptolemais, and died in Rome in 1244. He wrote his "Description of Palestine," which forms the first book of his *Historia Orientalis*, in the East, between 1215 and 1220.

Albertus Magnus (1193-1280) in his *De Mineralibus*, Lib. II., Tract 3, Cap. 6, writes:

"It is the end of the lodestone which makes the iron that touched it turn to the north (*ad zoron*) and which is of use to mariners; but the other end of the needle turns toward the south (*ad aphron*)."

This illustrious Bavarian schoolman joined the Dominican Order in his youth, lectured to great audiences in Cologne, became bishop of Ratisbonne in 1260, and died in 1280. Thomas Aquinas the greatest of schoolmen, was among his pupils.

NOTES

Ristoro d'Arezzo, in his *Libro della Composizione del Mondo*, written in 1282, has the following:

"Besides this, there is the needle which guides the mariner, and which is itself directed by the star called the tramontane."¹

The following metrical translation of a poem by Guido Guinicelli, an Italian priest, 1276, is from the pen of Dr. Park Benjamin, of New York:

In what strange regions 'neath the polar star
 May the great hills of massy lodestone rise,
 Virtue imparting to the ambient air
 To draw the stubborn iron; while afar
 From that same stone, the hidden virtue flies
 To turn the quivering needle to the Bear
 In splendor blazing in the Northern skies.

The above extracts show that the directive property of the magnetic needle was well known in England, France, Germany, Spain and Italy in the thirteenth century. In the passage from Neckam, the *acum jaculo superpositam* has been construed by some to mean a form of pivoted needle, while in the letter of Peregrinus, 1269, the double pivoted form is clearly described.

¹The pole-star was thus named in the south of France and the north of Italy because seen beyond the mountains (the Alps).

Become a Member of the International Tesla Society!

Get the facts behind Tesla Technology, Alternate Energy, Bioelectromagnetics, Scalar Electromagnetics, and much, much more ...

When new ideas involving *power* and *resonance* (Tesla Technology) are being explored, news of these explorations are not readily available in most orthodox scientific publications. By being a member of the International Tesla Society and receiving *Extraordinary Science*, the Society's quarterly magazine, you have an invaluable resource for the latest in technical advances, available books and upcoming events.

Other Membership Benefits include a Membership Card, a quarterly news bulletin, discounts on mail orders from the museum bookstore, and discounts on symposium and conference admission fees.

International Tesla Society, Inc



PO Box 5636
Colorado Springs, CO 80931
United States of America
(719)

US- \$25.00 CANADA/MEXICO- \$30.00 OTHER- \$50.00

BECOME A MEMBER TODAY!!!

The oldest known writings..... *...on Alternate Energy!*

The *quest for energy* has occupied the efforts of the human race, since Prometheus stole fire from the Gods and then delivered it to mankind! Petrus Peregrinus, was an engineer in the engineering corps of the French army during their seige of Lucera in southern Italy (1269AD).

In the midst of these hostilities, Petrus turned his thoughts to magnetism and its peculiar properties. Fortunately, Petrus was a scholar as well as a gentleman, and placed his thoughts on parchment where they laid undisturbed for hundreds of years in the libraries of Europe.

After its discovery, this letter of 3500 words was deemed the *first great landmark in the domain of magnetic philosophy....* the next being Gilbert's writing on magnetism--*De Magnete*--in 1690. Gilbert, himself, often refers to Petrus's letter in his treatise.

Now, for the first time since the turn of the century, Petrus Peregrinus's letter is being made available. Whether you are a historian, scientist or engineer, you will find this ancient document a unique and interesting perspective on a somewhat controversial topic..... *perpetual motion!*

Don't Delay..... Get your Copy Today!

\$6.95US

3

Non-Conventional Energy and Propulsion Methods

Proc. Intersoc. Energy Conver. Eng. Confer., 1991

as a regulated voltage source has been experimentally determined, and 3) an effect, involving the lack of measurable voltage in the rotating frame, has been verified with a specially designed LED voltmeter. A back torque value of 0.17 N-m for a 25 Watt generator was obtained, in agreement with theory.

INTRODUCTION

The general homopolar generator (HPG) is one in which a disk or a drum is rotated *adjacent* to a magnet of the same size and shape. It has been suggested by DePalma that the one-piece Faraday generator (OPFG) may have the unusual possibility of the absence of back torque [1]. Subsequently, the author [2], Trombly [3], and Wilhelm [4] began three independent experiments to replicate DePalma's results. Only one of us claim success in that endeavor, while Wilhelm and the author experienced back torque which compensated for the generated power in most cases. All three of the above scientists used liquid metal brushes in their experiments (Trombly-NaK; Wilhelm-Hg; Valone-low temperature solder) to reduce contact resistance. It is agreed that Trombly's sodium-potassium, having the viscosity of water, was superior to the other two. A major problem affecting all liquid metal brushes is the MHD instability caused by electrical conduction and motion in the presence of the magnetic field. None of us have calculated the measurable effect due to MHD that may have contributed to our results but they are expected to be negligible [5]. Referred to as an electromagnetic pumping force [6], the liquid metal becomes turbulent when the Reynolds number exceeds 2000. Eddy current and MHD losses then occur [7].

Eddy currents in the solid conducting disk are not a contributing factor to losses since there is no changing magnetic field. However, the motion of the conductor through the magnetic field, which remains station-

Proc. Intersoc. Energy Conver. Eng. Confer., 1991

is self-sustaining. "The crucial question is how the core liquid flows to act as a dynamo. Also a self-sustaining dynamo does not require a constant supply of magnetic field, it does require a constant supply of mechanical energy to keep the conducting material moving. In the case of the earth's core this means not only that the metallic fluid must flow in the right manner but also that some energy source must sustain the flow" [9]. Helical convection patterns called "rollers" created from conducting liquid metal are the best explanation of the mysterious secret of the earth's self-sustaining OPFG (SSOPFG).

In regards to the back torque of the earth's SSOPFG, Busse, Roberts, Lowes, and Wilkinson of the University of Newcastle upon Tyne are working on mechanical models of the earth's core to explain the changes in the fluid's speed and direction when the magnetic forces are large. A slightly different model that is being tested as well is the self-exciting OPFG (SEOPFG) which requires a spirally-segmented disk and/or external current-carrying coils as Tesla suggested. Since he noted that the armature current tends to demagnetize the field, in a normal solid disk configuration, Tesla felt that the subdivision of the disk would be an enhancement. In regards to these beneficial eddy currents, he writes, "*The current, once started, may then be sufficient to maintain itself and even increase in strength, and then we have the case of Sir William Thomson's 'current accumulator'*" [8].

A laboratory SEOPFG has been built by the Lowes and Wilkinson team [11]. Using metal rollers to simulate the earth's cylindrical eddy currents, the team found some interesting results after beginning with a few viscosity problems. "...a more efficient geometry was found, so efficient that the dynamo would self-excite in a completely homogeneous state (i.e. with *no insulation*) at a much lower rotor speed than was believed possible" [12]. Upon achieving this breakthrough, their next goal is to look into the stability of the dynamo mechanism, hoping to observe reversals of its magnetic field.

An illustration of a self-excited Faraday generator (SEFG) is shown in Fig. 1, where the implication is that the model is a portion of the earth's