

THE FERTILE EARTH



Nature's Energies in Agriculture,
Soil Fertilisation and Forestry

Viktor Schauberger

Translated and edited by Callum Coats

VOLUME THREE OF ECO-TECHNOLOGY

Contents

Figures	vi	
Introduction by Callum Coats	vii	
Sources	xii	
1. A DIFFERENT VIEW OF NATURAL PHENOMENA		1
Nature's Secrets Unveiled: In Transmutation Lies Eternity	1	
Does an insuperable force of gravity actually exist?	4	
Weightlessness prevails over gravity	6	
Decomposive energy triggers cancer	6	
Effect on Earth's orbit of weight of growing things	7	
Distinguishing a genuine emulsion from one created by ultrasound	11	
The creation of higher-quality products of emulsion	12	
Conditions under which eggs, seeds and cells can engender	13	
How is a bird able to become temporarily independent of the ground?	14	
All life emerges from the Mr-form of the egg	17	
How did originally aquatic plants escape from the medium of water?	18	
What role does water, as a carrier, play in these formative and transformative processes?	19	
What is to be understood by a biological vacuum?	20	
What is planetary mass-motion?	22	
Life is indestructible!	23	
All growth must be preceded by decomposition	24	
She half-pulled him down; he half-sank on her	24	
How can the existence of these reciprocities actually be proven?	25	
Distinguishing magnetically charged water from water with the opposite potential	26	
The discovery of a new highly potent form of energy	29	
A Small Difference — Decomposition or Life-Force?	32	
A Different View of Atomic Fission	32	
New Concepts of Electricity	35	
How does lightning occur?	38	
Electrolysis	39	
iii		

2. THE INFLUENCE OF TEMPERATURE AND WATER MOVEMENT (on Forestry, Water Resources Management and the Formation of Structures)	48	
The Formation of Structures	48	
The Dying Forest	50	
Clear-felling	53	
The Circulation of Water Inside the Earth and the Supply of Nutritive Matter	57	
The Effects of Groundwater Removal	68	
Incorrect Metabolism Destroys the Quality of Water	72	
Postscript	75	
The Secret of the Trout Motor	75	
3. FORESTRY — AGRICULTURE — THE ENERGY INDUSTRY		91
The Forest	91	
Agriculture	92	
The Energy Industry	93	
The First Doubts	93	
The Timber Industry, Forestry and Wood Production	94	
The Forest and its Significance	98	
The Dying Forest — a Peril of Central Europe	108	
The Dangerous Sinking of the Groundwater Table	108	
Detrimental Technological Influences	109	
1. THE DYING FOREST		112
Nature's Increasing Baldness	112	
How the Farmer uses his Scythe and Sharpens it by Hammering	113	
How the Cow Grazes	115	
About the Wild Boar	115	
Concerning Dew-Drops	116	
How the Forest Sustains Itself	118	
Concerning the Russian Cotton Industry	120	
The Dying Forest (Part Two)	121	
A Global Perspective	121	
The Tree as a Water-Factory	122	
Wooden or Copper-Plated Ploughs	124	
The Effect of Iron Ploughs	126	
The Heart of the Plant	126	

5. TIMBER AND WATER IN THE BUILDING INDUSTRY	
Caution in the Use of Timber in the Building Industry	131
The Character of Water in the Building Industry	134
Constructional Defects and their Prevention	137
Lost Knowledge of Timber Growth and Quality	139
6. AGRICULTURE — SOIL FERTILISATION — INCREASED PRODUCTIVITY	142
Noble Fertilisation with the Aid of Planetary Motion	142
Bipolarity	143
The Planetary Movement of Mass	145
Bioecological Agriculture	148
Increase In Soil Productivity	157
Life Force and Natural Fertiliser	163
The Earthworm Sanatorium	166
Building Compost Heaps	168
White Juvenile Earth	175
Concerning the Treatment of the Soil	175
Natural Farm Husbandry	176
Some Pertinent References to 'Tonsingen' and the Use of Water Barrels	182
A Biological Hint	183
Copper Water	184
Re-enlivening Sick Fields	184
Experiments with Copper Implements in Agriculture	185
Field Trials at Farmleiten-Gut Heuberg	186
Results of 1949 Field Trials with Copper Attachments	189
Appendix: Austrian Patent Office — Description of Patent No. 166644	194
Glossary	196
Index	201

Figures	
The Repulsator.	27
Location of other +4°C isotherms in the atmosphere.	37
Annual ring variations in a 33-year-old plantation tree.	51
The combination of H ₂ O and CO ₂ into H ₂ CO ₃ (carbonic acid).	61
The Bio-Plough.	72
Cross-sections of naturally and artificially grown shade-demanding timbers.	104
Unequal growth due to one-sided illumination.	106
The copper-plated plough and harrow.	125
Radiant energies in inorganic (metal) and organic (tree) magnets.	128
The in-ground cistern of amniotic fluid (liquid manure transformer).	154
The subtler processes of growth.	164
The egg-shaped fermentation chamber.	165
The egg-shaped compost heap built around a tree.	170
Sun-ploughing.	179
Showing 15 cm (6 in.) long ears of rye with up to 104 grains per ear.	188
Potatoes grown on alpine farm at Kitzbiihel, Tyrol.	191
VI	

Introduction

What is the essence of a tree? How does a blade of grass grow? What do we really understand of the internal events and forces responsible for their upward thrust towards the heavens, and on what conditions do these energies depend? Where do they come from and how do they interact? What inhibits their proper interaction, and what enhances it? As the pages in this book unfold the reader will not only come to appreciate the immense contribution to humanity of Viktor Schauberg's life-work, but also that humanity must now seize upon his enlightened, penetrating perception of the energetic phenomena underlying physical manifestation and apply them to safeguard its future. Through his deep understanding of the energies responsible for all organic growth and development, his writings in this volume focus on those domains of Nature which are at this time in the greatest need of massive rehabilitative intervention.

These are the world's rapidly dwindling forests and the vast expanses of arable land, today increasingly threatened by drought, desertification, fire and flood. This wholesale eradication of the Earth's lungs simply cannot continue. Present systems of land and forest management are largely responsible for the present climatic instability. Mechanistic methods of regeneration and production, which have no truly long-term view and are wholly profit oriented, give no consideration either to the forest's true function or to a living soil's continuing ability to sustain future generations. As has already become evident, the current practice of over-clearing of forest for agriculture and subsequent tillage leads to soil erosion, desertification, mineral impoverishment and developing salination. The inadequacies in the management, or even the actual mismanagement, of the world's stocks of these important resources have now reached a point where the problems of providing an equitable and adequate supply of food to an expanding global population appear almost insuperable. Despite the fertiliser and pesticide industry's extravagant claims, it is becoming more and more apparent that these methods are no longer effective and are providing both timber and food of increasingly inferior quality. It is therefore time to consider fresh approaches.

What is necessary is to employ many more people in developing and applying methods for improving food quality. With higher-quality food,

people would not only be healthier physically and in mind and spirit, but they would also require less food to maintain life. Far from seeing the present population explosion as a problem, Viktor Schauberger advocated it, posing the question: 'Is it therefore so illogical to recognise the Will of Nature in the rapid increase in the number of human beings? Surely several hundred million more people are needed, who with their energy and strength can help restore this ravished lump of excrement, the Earth, to its former glory!'

It is here that Viktor Schauberger has a great deal to offer in the way of remedies and provides us with pioneering insights into what makes the world's forests and soils tick. While the restoration of these realms cannot be divorced from the management of water resources conducted in accordance with Nature's laws, these same laws also apply to the ways in which forestry and agriculture should be administered. That is to say, the emphasis should be on long-term continuity and sustainability using natural methods of regeneration and fertilisation, which requires deep knowledge of the interconnected energies that govern these subtle processes. This can only come with both an open mind and a willingness to comprehend the higher dimensional powers that order physical existence. In other words, we must learn to think one octave higher, as Viktor Schauberger often urges.

Nature's formative and reproductive processes are extremely subtle, and are based on a delicate, easily upset balance in the intermixture of energies and materials on which they are founded. In our failure either to understand or perceive them, however, we have literally trodden them into the ground. Yet this is the same ground which is supposed to sustain and nourish us, and from which life itself evolves. The time has come for a long overdue and urgent reappraisal of what we are doing; indeed it has now become the imperative of the hour; more particularly, in terms of the fundamentals of forestry and agriculture. Instead of the former vibrant luxuriance of natural forests, where one species fosters the growth and development of another, in today's plantation forests, monocultures of single species of the same age are forced to compete with one another for their necessities of life. In other words, competition, with all its negative consequences, has been introduced into a long-standing, integrated harmony where it never existed before. Instead of smaller acreages and holdings, where produce was fertilised largely organically and crops were religiously rotated, in modern agri-businesses carbon-dioxide-trapping hedgerows were swept away and crops are grown without rotation on an increasingly barren heath. These have to be propped up with artificial fertiliser, which ultimately destroys the soil and its micro-organisms. All the important preconditions and parameters which ensure thriving growth have been altered arbitrarily with scant regard for Nature's essentials.

The fundamental flaw in our appreciation of the world and of Nature, and the roots of our present predicament, lie in our unquestioning belief in the

correctness of our competitive ideology. This we apply not only to the treatment of our fellow human beings, but also to long-suffering Mother Nature who nurtures us. So thoroughly are we suffused with this inherently divisive philosophy almost from the day we are born, that we have great difficulty in divorcing ourselves from it and in considering any alternative approach. As its philosophical offshoot, present economic policy worldwide is driven by the perceived desirability of quantitative growth without limit, deemed to be the only solution to international economic stability. Such unlimited growth, however, is impossible on this finite planet, where there is an equally finite amount of raw material from which all else is derived. The only possible future for unlimited growth is therefore a growth in quality.

This quantitative drive has resulted in the competitive manufacture and marketing of more and more sophisticated trivia, which have no real and lasting value in terms of natural upward evolutionary progress. Western society, which largely controls global events, has become fascinated with itself and its new toys, and concerns itself mainly with the next innovation. Coupled with this acquisitive urge, of which it is also the cause, there is a huge distortion in perceptions of what is of real worth, when millions are spent on the purchase of football clubs, entertainment facilities and other fantasia. This money should more properly have been spent on redressing the vastly more pressing problems of widespread famine, disease and the environment. However, in this world of economic rationalism, which treats humans merely as the means to an economic end, there is no immediate profit in such action.

Material acquisition and the pursuit of pleasure seem to be uppermost in the minds of the majority in so-called 'civilised' countries, who, enclosed within their cities, are almost totally estranged from Nature. Into this invidious scheme of things, the so-called 'third world' countries are also being inexorably drawn in their quest for the same ephemerae. Worse than this, in the process they have lost their traditional values and practices, their natural interaction with their habitat, which hitherto had sustained them over aeons. Culture, in the truest meaning of the word, has become the almost universal victim of this malevolent philosophy.

This single-minded preoccupation with mundanities and obliviousness to the gathering storm that looms will propel humanity into a disaster of hitherto unparalleled proportions. The mistaken belief that people can blithely continue to dissociate themselves from the demands of the natural world and continue to bask in the glories of technology, is a dangerous fallacy. Since all life is inextricably interconnected, the massive disruption that has been insensitively inflicted on the Earth and its life-giving waters must inevitably rebound in poetic measure on the perpetrators. Balancing precariously on its artificially contrived foundations, urbanised humanity has largely lost touch

with its roots, and as Viktor Schauberger states elsewhere in this book, 'Masses without roots perish!' This is now beginning to happen — and at a rapidly accelerating pace!

Competition, however, is totally at odds with Nature's ways. The dreadful irony of the whole scenario is that today attempts are being made to create a harmoniously integrated and co-operative world with the very philosophy that must inevitably destroy it. If ultimate survival is indeed what presently looms ahead, then the chances of real success in achieving it lie in the reversal of the present code, namely a return to co-operative activity, where the efforts of every individual are required for the ultimate well-being of the whole. In this context Viktor Schauberger conceived humanity's foreordained tasks to be threefold:

1. To make a small piece of the Earth fertile.
2. To evolve oneself to a higher level.
3. To preserve oneself and the species.

Acting on this, we should focus our closest attention on Nature's modus operandi to secure a wholesome, healthy, long-term future for the Earth's inhabitants. Which brings me once more to the question at the beginning: How does a blade of grass grow? All organic and therefore animate growth in Nature arises from the processes of fusion, in which a given structure is built up incrementally through the mutual attraction of molecules. This attraction could be likened to an elementary form of love — a desire to unite in a fruitful way, when each individual component is necessary for the formation of the whole. Without this there would be no creative build-up of substance, no development of physical form. This combinant and recombinant activity is therefore synonymous with co-operative endeavour. Viewed in this light, it becomes clear that for the world to exist in all its physical majesty, Nature's ways must be far more co-operative than we have hitherto been led to believe. Her order is founded on co-operation and ethical fairness in the interaction between her countless organisms. In our approach towards the environment we could therefore not do better than to emulate the behaviour of the bees, who as Viktor Schauberger states, 'are known to dispense and to give whenever they take.' Trees too are extraordinarily selfless. They silently and consistently temper the climate, tame the tempests and supply us with oxygen to breathe and water to drink. In the light of this knowledge, we should therefore turn away from the present divisive competitive ideology and follow Nature's lead, for it is only in this way that the natural world can be truly restored to its former glory.

All the above tasks demand a long-term appraisal and in-depth examination of the fundamentals of life and its continuance. This also

involves a reinterpretation of the proper sphere and application of competition. Instead of its present emphasis on external action, competition should rightly be strictly applied to the internal assessment of one's own personal behaviour and performance; to how one's own talents and abilities and relationship with the outer world can continue to be improved, the better to co-operate, rather than compete, with others. The transference of this intent to the outer world, which would do so much to restore human relationships and the natural world to a universal state of harmony, was so ably expressed, though slightly paraphrased here, in President John F. Kennedy's famous exhortation:

'Do not ask what the world can do for you, but ask what you can do for the world!'

Callum Coats — March 1999

Sources

The sources from which the following writings were obtained are as follows:

Our Senseless Toil

Written by Viktor Schauberger between 1932 and 1933, it was originally published in a two-part book entitled, Our Senseless Toil — the Cause of the World Crisis, subtitled Growth through Transformation not Destruction of the Atom (Unsere sinnlose Arbeit — die Quelle der Weltkrise. Der Aufbau durch Atomverwandlung, nicht Atomzertriimmerung). Part I first appeared in 1933 and Part II in 1934. Both Parts I and II of Our Senseless Toil were published by Krystall-Verlag GmbH, which due to financial difficulties was finally closed down in April 1939 by its then editor-director Franz Juraschek.

Mensch und Technik — naturgemass

Originally Kosmische Evolution or Cosmic Evolution, the German periodical, Mensch und Technik — naturgemass (Humanity & Technology — in accordance with Nature), is funded by private subscription and published by the Gruppe der Neuen, or the New Group, whose aim was to explore Viktor Schauberger's theories and to interpret them scientifically. Volume 2, 1993, is devoted entirely to the recently discovered (early 1990s) transcript of a notebook compiled in 1941 by a Swiss, Arnold Hohl, which includes reports on his visits to Viktor Schauberger in 1936 and 1937. It is from this volume that the passages in this book are obtained.

Implosion

Implosion is a quarterly magazine, funded by private subscription and generally oriented towards the lay reader. It was originally published by Aloys Kokaly from about 1958 and now runs to 127 issues. Kokaly also founded the Verein zur Forderung der Biotechnik e.V. (Association for the Advancement of Biotechnology) specifically for the research and evaluation of Viktor's theories and through Implosion to provide a platform for Viktor Schauberger's various writings, of which Kokaly had many originals.

The Schauberger Archives

Forming the greater part of Viktor Schauberger's estate, these are the private archives of the Schauberger family and the PKS (Pythagoras-Kepler-School) at Lauffen, near Bad Ischl in Upper Austria.

Other Sources

Various newspapers, periodicals and personal letters from Viktor Schauberger to various individuals.

Notes

1 Quoted from Increase In Soil Productivity — VS — Implosion Magazine, No. 60.

-

Ed.

2 From Implosion Magazine, No. 64, p. 17. — Ed.

1.

A Different View of Natural Phenomena

From Heaven descending,

To Heaven ascending,

To Earth returning,

Eternally changing.

Johann Wolfgang von Goethe

Nature's Secrets Unveiled: In Transmutation Lies

Eternity

From Implosion Magazine, No. 48 — written in Salzburg, 1954.

Since the beginning of the First World War and the resulting spread of our technical industrial processes there has been a striking deterioration in quality. The disappearance of water that this has produced has become so evident that this vital necessity of life should already be considered a scarce commodity.

The scientific profession is helpless against this coming catastrophe otherwise the crisis would not have developed to the extent that it has. The situation has to be studied from every angle and the causes of the deterioration of water exhaustively demonstrated. It must be stated at the very outset that here we are dealing with the demagnetisation of springwater, which should be seen as the blood of the Earth. This happens through over-illumination by sunlight and therefore over-warming of the ground, or through unnatural methods of conduction and water storage. Because no one knows what electricity and magnetism actually are, it makes it all very hard to understand. Such ignorance likewise makes the explanation of these causes uncommonly difficult.

The demagnetisation of water signifies the removal of its soul. The widespread over-exploitation of forest has caused the mountain springs to dry up, leading to the desolation of high alpine pastures. A particularly striking phenomenon, however, is the constant deterioration in the quality of young stands of timber, in spite of all the conservation measures applied by forestry. Former higher-grade species of timber and high-quality species of fish in the river-channels where water continues to flow are disappearing in the same way as former mountain springs, which dry up when robbed of their shade-giving protectors and are thus over-illuminated and exposed to direct sunlight.

Even glaciers are retreating noticeably. Wild deer are also becoming many as a result of deforestation, because they can no longer find medicinal herbs rich in ethereal (volatile, essential) oils, since these do not grow in lower lying areas. The Earth's solid crust is gradually drying out, and it is no exaggeration to predict that one day the major cities will cry out for water and that our great-grandchildren will have to dig for it as today we dig for gold or other valuable substances.

One word suffices to describe the mistakes made by contemporary leaders of industry and scientific advisors to government, whose experience is usually far more academic than it is practical. In various academic institutions they are schooled in unnatural (unreal) systems of water management, which I refer to as techno-academic systems. The present evils are wholly to be ascribed to the erroneous forms of water movement thus produced, and it is for this reason that the above term has been coined. Only in this way can one explain the bioecological consequences which logically follow, if the 'original',¹ planetary movement of mass is replaced by a heat- and pressure-increasing form of motion. This inaugurated the demagnetisation of the ur-source² of all life — water. Just how far advanced this danger to life has already become is shown by a report in the periodical *Der Spiegel* of 9 April 1954, according to which at least 10,000 million Deutschmarks will have to be spent merely to repair the most flagrant depredations caused by the mismanagement of water resources. An extended period of drought would be quite sufficient to provoke chaotic conditions in the supply of drinking and general-purpose water. German rivers are already so polluted that an average of 400,000 parasitic embryos per cubic millimetre make all use of even filtered riverwater impossible.

It is an open secret that scientists concerned with hydrology are both helpless and perplexed in the face of these catastrophes, for otherwise these malheures would never have happened. The consequences of their incompetence are incalculable, and will become all the more so if present methods of water reticulation, storage and regulation are not radically altered. Natural methods of water conservation and treatment will have to be introduced through the

enactment of a uniform set of regulations with universal application. However, ail experience and know-how is lacking in this area due to the unquestioning acceptance of methods used over thousands of years. It is therefore high time that these errors be exhaustively addressed.

What is to be understood by the concept of techno-academic motion? It is diametrically opposed to the one that wise Nature uses to move and ur-procreate water, giving it every possibility to reproduce, regenerate and qualitatively evolve. However, this natural form of motion assures not only the increase and maintenance of this vital asset, but the qualitative improvement of increasingly diverse forms of growth and life as well.

This natural form of motion will here be called planetary motion, for the reason that all planets, including our Earth, move in just such a manner. Moreover, the various kinds of blood, sap and juices have also to avail themselves of this type of motion in order to maintain and constantly improve the progressive forces of reproduction and upward evolution.

However, when techno-academic motion was introduced, the vital opportunities mentioned above became increasingly inhibited, as technology expanded the application of the reversed form of motion. In view of this, it is also necessary to define the term 'technical', or 'techno-academic motion' more precisely. 'Technical' is derived from the ancient Greek word *technao*, which means skill or artifice — and hence something unnatural, or not naturally occurring and therefore deceitful. On these grounds even the ancient Greeks unconditionally rejected such motion, for with it, heat-intensifying, centrifuging and destructive forces are triggered off in substances having a bipolar charge (earth, water and air).

According to ancient knowledge, the economy of any people or nation who make use of this treacherous form of mass-motion will collapse, because it confers spiritual and physical ponderousness. As a result earlier cultures disappeared in conformity with natural law, as little by little the original (planetary) form of mass-motion was replaced by the techno-academic form.

In order to comprehend the full ramifications of the unnatural motion introduced by mechanically minded science, the term 'motion' or 'movement' must likewise be defined in terms of its natural manifestation. According to an old saying, 'The wrong motive impulse can turn the whole world upside down'. In an intermixture of bipolar elements, every motion triggers reactive effects of an atomic and imperceptible nature. Whether supplementary energies evolve from sediment, minerals or metallic trace elements, or from the earthly remains of earlier life-forms, depends on the shape of the apparatus in which these substances are moved and the alloys used in its fabrication. As reactive components of pressure and traction (suction) these forces control the metaphysical, metamorphic currents {*panta rhei*) already known to antiquity.

Techno-academic motion, together with its unnatural appliances and unsuitable alloys, causes the emission of X-ray-like emanations which penetrate all resistance and build up pressure and heat in surrounding cell structures. They are the true cause of cancer since they provoke nuclear fission in the cell nucleus and turn every cell into an epicentre of decay. Exactly the opposite reactive effects take place, however, if the various media of earth, water and air are artificially accelerated planetarily and in a predominantly centripetal manner. In this instance radiation is emitted from substances, acting to invigorate surrounding cell structures. Here it triggers cell division and an increase in the number of cells, leading to the creation of additional nuclei for growth. It is therefore radiation of a type which is the very antithesis of that produced by techno-academic motion, the latter being supercharged bioelectrically and functioning electrolytically. In contrast, planetary motion leads to biomagnetic supercharging and has a contractive (structure-densifying) property. In the form of new, juvenile, cell formations, it propagates a cooling tendency and maintains the optimum condition of health.

With these products of interaction, whose effect and characteristics can be controlled, wise Nature regulates reproduction, upward evolution and the multiplication and ennoblement of later life-forms. However, if techno-academic motion is employed, then a centrifugally-propagating impulse is imparted to these life-forms. In this case oxidising processes are initiated and decomposive energies activated and liberated. These lead to inflammation and swellings and provoke the regressive development of cancer. This explains in general terms the erroneous form of motion that is today cultivated and promoted in all areas of human activity.

In consequence the possibility for water, the blood of the Earth, to reproduce, regenerate and upwardly evolve has been perverted and prevented, which applies equally to all growth. In lieu of growth, a retrogressive cancerous development has inevitably set in and, as a degenerative process, assumed more and more dangerous forms the greater the ramification of these errors and the intensity of their effects. The prime question therefore is:

Does an insuperable force of gravity actually exist?

A variety of experiments led to the insight, startling to all technologists no doubt, that a physical force of gravity exists only in the atmospheric living-space, and even then only to a certain extent. At first view it seems amazing, even impossible, that the force of gravity can be overcome almost effortlessly, and that physical heaviness will become equally non-existent, in the same way that a healthy organism is barely conscious of its own bodily weight.

The most instructive and revealing demonstration of this phenomenon is not only the mountain trout's almost motionless stance amidst torrential flows of springwater, but also its lightning flight upstream when danger threatens. In the spawning season — during the period of highest sexual arousal — it can surmount waterfalls many metres high with the greatest of ease. For this to happen the falling water has to wind in about its own fall-axis through a system of hollow, spiral curves. In the process of falling, its density is increased mechanically, it becomes specifically heavier through coactive physical influences, and approaches its anomaly point of $+4^{\circ}\text{C}$ ($+39.2^{\circ}\text{F}$).

Such waterfalls exhibit a fall-pattern that becomes progressively more conical towards the base, and within it a biomagnetic field evolves that radiates levitative substances. These substances should be understood as formative and uplifting atomic forces, which on a larger scale trigger off hitherto unidentified forces which are active in cyclones. In this instance, however, they screw the trout's body upwards along a spiral path until the point of the initial downward curvature of the water is reached. The trout then leaps under its own power, entering the upwardly tractive water flow above the waterfall in which it moves effortlessly upstream with a characteristic twisting and looping movement, eventually reaching the vicinity of a spring. Here it lays its shell-less eggs, which without any physical contact are then fertilised by the milt (the male trout). This is only possible, however, if the water is temperature-less; if it lies at the anomaly point of $+4^{\circ}\text{C}$ ($+39.2^{\circ}\text{F}$), and if it is deficient in oxygen and extremely rich in volatile ethericities³ of carbonic acid. The same also applies to herring, which congregate so closely together during the spawning season that there seems to be more fish than water.

These preconditions for reproduction were once known to fishermen closely connected to Nature. Similarly, in the past every butcher knew that the body of a calf slaughtered during the cold part of the year would weigh more on the scales dead than alive, provided that it had been expertly hung in such a way as to prevent the blood congealing. This only holds true if the appropriate temperature-gradient⁴ is activated indirectly by way of the filter wall, which hermetically seals the thorax. Between lungs and pleura the necessary biological vacuum must be maintained. For this reason the old huntsmen took great pains to hang the deer they shot properly in order to preserve the venison's full flavour. In another example, under certain conditions of temperature the drowned are drawn towards the bottom, whereas under other conditions they become bloated and are deposited at very particular places on the banks. Here too, therefore, no constant law of gravity exists.

Weightlessness prevails over gravity

Many interesting examples follow which illustrate that there is no constantly active force of gravity in the atmospheric living-space. From this it can be inferred that there is neither a constant conservation of energy, nor any other rigid regularity. On the contrary, there is only a rhythmical reciprocity, which can be mechanically controlled so that levitation prevails over gravitation (physical weight). The spiritedness of an animated organism such as water can be so intensified that it surges upwards, as happens in mountain springs, or it can gently pulsate on steep slopes. It can therefore overcome its physical weight, the prerequisite for this phenomenon being planetary motion.

Decomposive energy triggers cancer

The centrifugal form of motion, which increases pressure and heat, was first recognised for what it was when it triggered the release of decomposive energies. This is what happens when the media of earth, water and air are over-illuminated or warmed up, which today occurs virtually all over the world. The seed of decay is created in this way, which reproduces and establishes itself, and is the unresearched, causal agent of cancer. In this case, instead of the negative pressure normally prevailing, an atomic excess pressure develops in every blood and sap vessel. This acts not only as a resistance to motion, but in addition fosters the decay of amorphous structures, and explains, for instance, the tumorous swellings that can clearly be distinguished in shade-demanding trees over-exposed to light or otherwise overheated. This is known as light-induced growth, with which modern forestry strives to achieve accelerated growth and thereby reduce the period of rotation. In reality, however, it is tree-cancer.

The magnitude of this disastrous blunder in forest management will only be appreciated once it is realised that a genetically-diseased (cancer-impregnated) shade-loving tree sustains such a loss of reproductive and upwardly-evolving power that the seeds produced by the immediately succeeding generation are already sterile. Instead of being a water-producer, the tree becomes a water-consumer, thus turning into a veritable forest parasite that extracts the last residues of water from the soil.

Through an intermixture of diffuse substances, the shade-demanding tree becomes a water (blood) donor. As a result, the more water that is produced, the more luxuriantly a healthy mixed forest thrives. Even the modern botanist is guilty of fallacious reasoning, when he assumes that the plant absorbs dissolved substances along with groundwater. Qualified hydraulic and hydroelectric engineers suffer from similar flawed logic, and must be retrained as quickly as possible if forests, fields, pasture lands and the

remaining waters are to be rescued from disaster, by the introduction of proper bioecological and environmental laws.

Whether any given organism is exposed to strong influences of heat, or whether these are augmented or generated by centrifugal, pressure-increasing motion is quite immaterial. In both cases powerful quasi-material atomic forces of a predominantly bioelectric nature evolve. These obstruct the original circulation of water, blood and sap, and their destructive action increases in step with the increase in the speed of motion. In fact today no stone has been left unturned in the attempt to intensify this unnatural system of moving bipolar entities. Over the course of time the self-deception mentioned at the beginning has become a betrayal of humanity, to which the whole civilised world will unsuspectingly fall victim.

Should any recovery be forced through under the aegis of contemporary centrifugal technology, then, conforming to natural law, it will inevitably bring about a third and last World War which will certainly be fought with nuclear bombs. This will complete the radical extermination of mankind to the extent that it has not already succumbed to that progeny of technology, the scourge of cancer, which is assuming greater and greater proportions. Contemporary science, whose level of knowledge is one octave too low, must be shown the true foundation of evolution. If not of its own free will, then it should be forced to change its views by plebiscite.

Effect on Earth's orbit of weight of growing things

Why does the Earth continue to float in space despite the constantly increasing weight of growing things? In principle this question is quite easy to answer. It floats in space because it orbits around, rotates about and circulates through its longitudinal, biomagnetic axis, its ideal axis! In the course of this peculiar movement it ur-procreates what Goethe called The Eternally Female or the All-Uplifting, here simply called qualigen. It endows all forms of growth with the natural ability to reproduce and establish themselves on a higher plane of evolution. Through unnatural, unreal and excessively one-sided centrifugal motion this capacity was disturbed to such a degree that we now face a general economic collapse and the decline of the last vestiges of culture.

Contemporary physicists are concerned only with the respective change in state and pay no heed to material change. Conversely, chemists are only interested in the latter. Nuclear physicists applied techno-academic motion to producing concentrates of those products of emulsion that categorically destroy everything. Therefore every intelligent person must concede that this ill-informed academic science, which promotes the reversed form of motion and teaches it in all schools and universities, will become all the more dangerous to humanity the more it achieves its supposed successes in kinetics.

In view of the fact that there is no force of gravity above the atmospheric living-space, the force of gravity must be variable. The patents applied for in twenty-six countries demonstrate that with the aid of planetary motion it is possible to overcome physical weight with little effort or cost. This is done in the same way that Nature has done it for millions of years. The biomagnetic force of attraction (contraction) is progressively intensified through a rapid succession of purifying and refining processes.

Therefore all contemporary concepts of reality and all world-views will have to change fundamentally. It is not the Earth that attracts any given mass, rather it is the Earth itself that is maintained in a labile state of equilibrium through the forces of levitation, which intensify with increasing altitude. Hence it is only the quantitative increase in the weight of growing things that prevents the Earth from being torn skywards and pulverised into atoms.

An example of this are the fish found in the ocean deeps. These are equipped with extremely delicate skeletal frames which rupture immediately if they are drawn upwards into the zone where the water is under excessive atmospheric pressure. This zone in the surface waters of the ocean is the filter-belt for the diffusion of incident solar radiation harmful to the growth and development taking place below. In the forest this radiation is absorbed by leaves and pine needles in the tree's crown. For healthy growth, only filtered ethericities of radiation, which are invigorating and refreshing, should reach the interior of the tree. All plants, animals and human beings are therefore equipped with diffusion vessels which enable them to acclimatise to fluctuating ambient temperatures and radiant influences. These contract or dilate and are therefore not rigid structures, but temperature-controlled organs.

But what of levitation? How do levitative forces come into being and where? The term levitation is derived from the Greek word *levit* and means a formative, upwardly-propelling suctional force in which an atomic (metaphysical) energy is active, whose direction of propagation is mainly vertical. If it is introduced into a vacuum tube in bundled form, it produces a bluish-green glow. It is akin to the odic rays discovered by Baron von Reichenbach.⁵ Every force, whether it stimulates or suppresses the life in any form of growth or more highly evolved life-form, unfolds itself and springs forth from the ur-form of life, the egg. As a rule, seeds and cell structures have an egg-shaped appearance. It is the type of excitation or motion that determines whether a highly potent new form of life or a rotten egg eventually develops. Temperature also plays a role here, often involving differences of a mere 0.1°C (0.18°F), or in the case of a chicken's egg, in the order of 0.2°C (0.36°F). All excessive warming or cooling of the blood or sap makes it impossible for life to renew itself in a younger, but evolutionally older entity.

It therefore becomes apparent that a young shade-demanding tree has no hope of survival if it is suddenly set out in the open. Similarly water inevitably

degenerates when it is either over-illuminated or forced into a heat and pressure-increasing motion. In which case the same symptoms of decay appear as in the over-warmed contents of eggs.

Through planetary mass-motion, which reduces pressure and dissipates heat, the desired anomaly state can be attained and maintained at an almost constant level by regulating the rate of rotation of suction whorl-pipes.⁶ The particular state of excitation that triggers off the formative type of motion can therefore be achieved and maintained, which replenishes the supply of qualigens mentioned at the beginning. The rays emitted by this specifically densified assemblage of basic elements then overcome the force of gravity.

Here we are therefore concerned with a rhythmical interplay between various component forces, including those of suction and pressure. Whatever form the associated temperature-gradient eventually assumes is therefore crucial in terms of molecular growth or deterioration — the latter being induced by a temperature-gradient in which the pressure component prevails. With centrifugal, techno-academic motion this is the outcome in every case. It is thus quite clear that decomposive products, harmful to development, will multiply as the velocity of such a system of mass-motion rises.

On the other hand, if the various media are moved planetarily, then a negative pressure evolves which can be measured with a pressure gauge. When the rate of rotation is extremely high over-cooling occurs and if the pH value rises above 8 saponification, or an excessive concentration of ethereal oils, takes place making any freezing impossible. If these products of emulsion are extremely finely dispersed and are subsequently mixed with diffuse atmospheric oxygen, then they expand, and will do so under the very slightest pressure of a piston. The mixture then transfers to a gaseous state with a simultaneous 1,800-fold increase in volume and represents a controllable expansive force derived from an incombustible propellant or fuel.

In 1917, John Andrew demonstrated this to the United States Department of the Navy. Accused of being a fraud by the investigating commission, he put a few drops of a crystal-clear concentrate into ten litres of both freshwater and sea water and challenged the investigators to test the mixture in an internal combustion engine. Boiling with indignation, he then left the test laboratory. When the test motor started, the significance of this ideal source of power became quite apparent. A subsequent search for the inventor found him murdered in his living room. So the discovery which that atomic wizard, John Worrell Keely, had made prior to John Andrew was lost for the second time. Having been derided and scorned all his life, Keely took his secret to the grave destroying his hydro-pneumatic vacuum-pulsation machine before he died in 1898. With this machine he repeatedly produced a cold vapour which was triggered by a pressure of 35,000 kg/cm³ (1,262,295 lbs/in³). Such a force relegates all petroleum fuels into obscurity.⁷

Systems of motion in use everywhere today produce over-acidification, leading to the formation of products of emulsion that function in exactly the opposite way. Fatty concentrates become bound by oxygen at temperatures above $+40^{\circ}\text{C}$ ($+104^{\circ}\text{F}$). Extreme pressure or an igniting spark will then cause combustion. This concentrate of fatty matter is used as a fuel to produce the incalculably harmful explosions currently taking place in petrol and diesel engines.

It has been known for some time in medical circles that all bodily organs and their secretions carry opposite charges to those created in the process above. This opposite charge gives rise to oscillations which create differences in potential, leading to the generation of unknown kinetic energies. It is possible to initiate various kinds of motion through bipolar interactions. In contrast, different kinetic energies can also trigger pulsations in which the osmotic, insuctional force exceeds the counterforce of pressure. This results in a molecular evolution and an increase in the performance of qualigen-deficient and therefore over-fatigued blood and sap vessels.

On the other hand, if techno-academic pressure and heat-intensifying mass-motion is employed, then exactly the opposite interaction between charged substances results. The insuctional force is weakened and the atomic pressural force increases, leading to sclerotic deposits on the walls of blood (and sap) vessels, which harden and stiffen those affected. This is cumulative, ultimately resulting in an apoplectic fit or a stroke due to the rupture of the encrusted vessel's walls. Similar stiffening also happens when mature corn is flattened by a downpour and the soaked stalks are irradiated by the Sun immediately afterwards. Very strong oxidation then follows in the cornstalks, which promotes the formation of crystalline structures. As a result they are no longer able to stand up again and begin to decay. Health or sickness therefore depend on the right type of interaction between the bipolar ethericities involved.

In other words, this means that survival or extinction is dependent on the regulation of electromagnetic interactions. For this reason the blood of the Earth — water — will also deteriorate and die if it is over-illuminated, over-warmed or moved in a predominantly centrifugal and pressure-intensifying way. This happens in every regulated waterway and artificial reservoir. The water then loses its carrying capacity and tractive force,⁸ becomes tired, sluggish and sinks back into the ground. Moreover, if it is impelled through high-speed water-turbines, excessively strong pressures evolve, whose rapid, internal pressure-inducing pulsations rob the groundwater of its soul. For the first time this explains why the present sinking of the water table is so apparently unstoppable. The deep, submerged springs in a lake will also be blocked if too much water is drawn off at too great a depth, thus removing the $+4^{\circ}\text{C}$ ($+39.2^{\circ}\text{F}$) water stratum in which detritus is normally held in suspension. This weakens the filtering action of the water strata lying immediately above.

Distinguishing a genuine emulsion from one created by ultrasound

How can a product of emulsion resulting from an intermixture created by ultrasound be distinguished from a genuine emulsion in which a fatty concentrate binds oxygen that has become inactive? The vibrators currently in use can produce an emulsion or water intermixture with about 600,000 extremely finely dispersed molecules of fat. However, a genuine emulsion or fusion of these antitheses is not possible under such conditions. The swaying branches of a mother-tree provide a naturalesque⁹ example of how true emulsions can be effected. With her fluttering leaves and waving branches, the mother-tree diffuses her oxygen and makes this now high-grade nutritive material available to young saplings beneath, which can absorb it only in this state. This higher-grade product of emulsion is also created when a trout sucks in water containing high-quality basic substances. Emulsifying these basic substances with the aid of its gill system, it uses them to sustain life. The expelled residues of this intermixture of diffused matter migrate upstream against the oncoming water, and as upsuctional energies maintain the fish's labile station in what is the stream's biomagnetic longitudinal axis. The fish will suffocate immediately while still on the hook if it is allowed to drift downstream at the same speed as the current.

The same thing happens if a young shade-loving tree (fir, oak, etc.) is suddenly exposed to direct light. Excessively strong pressure-inducing pulsations in the sap ducts result in another case of suffocation here too, because the young tree can only absorb filtered ethericities through diffusion. This explains the proliferation of protective branches on the exposed trunk of a shade-demanding tree, which can only begin to grow healthily again once its root system and the lower part of the trunk are again in shade. Pith-rot is due to the effect of unfiltered solar radiation and it already develops in such trees when they are a suitable age for making poles. Modern plantation methods therefore do not provide young trees with the preconditions to thrive and for genetically sound growth.

Such young plantation forests have neither fully developed nor even adequate filtering mechanisms. They take up partially dissolved substances along with water and thereby become water-consumers. Equipped with flawlessly functioning filter glands, a naturally healthy young tree only absorbs high-quality nutrients already in an etheric state, and in this way it becomes a water-producer. In this case the groundwater under the forest increases as young growth flourishes. The groundwater then becomes an accumulator of levitational energies, which retain it in a labile state of equilibrium in the root-zone. Surpluses of these levitational energies provide the young tree with higher-grade, etherealised nourishment. This clearly demonstrates the

malpractices of modern forestry, which has altered natural, sustainable methods of replanting, conservation and felling, and above all has introduced excessive thinning. Later on further examples of this will be discussed.

The creation of higher-quality products of emulsion

The creation of higher-quality products of emulsion depends on the way in which all forms of growth are moved, stimulated and alloyed. If a moving or stimulating device (a steel plough, an improperly-alloyed pressure-turbine, a high-speed propeller or a pressure pump) operates in a way where centrifugence¹⁰ predominates, then decomposive, electrolytic forces develop. These are unaffected by resistance and radiate in all directions, decomposing the surrounding groundwater and subsequently the cells in the body as well. It is the identical process that takes place when an electric current is conducted through the media of earth, air and water.

Under natural and healthy (normal) conditions the carrier and accumulator — hydrogen — is so saturated with ethericities produced by natural processes of diffusion that surface-draining springwater or even clouds cannot freeze, even at the extreme low temperature of -50°C (-58°F). However, if a propeller-driven or jet-propelled aircraft flies through such a cloud, either above or below the speed of sound, then shock waves occur instantaneously, leading to severe icing. This is the biological consequence of the sudden discharge of such a cloud-accumulator. For this reason, it is equally necessary to differentiate clearly between processes of evaporation and vaporisation. This explains, for example, why air crashes often occur over large areas of forest and high-quality rivers and lakes, above which predominantly negatively-charged dynagen concentrates are to be found. Their sudden discharge provokes these catastrophes, because in such instances and as in centrifuged water, the carrying capacity and tractive force diminish very rapidly as the speed of the aircraft rises.

All present methods of fertilisation using unfermented stocks of faecal matter and liquid manure should also be addressed in this chapter. If these raw materials are placed in an appropriately formed manure pit (see Figs. 10 and 12) and swirled around alternately in an unwinding-inwinding vortical circulation with the aid of naturally shaped and alloyed suction whorl-pipes (inverted propellers), then a pure, crystal-clear, odourless product of emulsion is produced within a few days. This is so over-saturated with high-grade formative and levitative substances that it seeks a natural interaction with oppositely-potentiated, atmospheric ethericities. These ordain higher-quality growth, which is none other than the solidified product of transcending, fructigenic ethericities. The legendary harvests of the ancient Greeks can be ascribed to these natural methods of fertilisation. They too

eschewed techno-academic techniques for cultivating and fertilising the soil, so avoiding decomposive phenomena, the emergence of parasitic pests and a partial loss of reproductive potency. It is these that are responsible for the slow but steady decline in productivity today, which can only just be maintained under the lash of artificial fertiliser, a substance that also handsomely provides for the growth of destructive entities.

High-quality fertilising substances can only come into being under cold processes of fermentation (viz. biodynamics — Ed.). In properly designed and constructed fermentation cellars, these processes take place slowly and produce excellent wine. These high-grade products of emulsion at once decay as demonstrated by the apparently spontaneous bursting of wine bottles, if the cellar is over-illuminated and over-warmed during fermentation. With naturally built and alloyed suction whorl-pipes the above process of cold fermentation can be completed in a matter of weeks. These products of emulsion become of increasingly higher value and richer in qualigens, as the rotational velocity of the whorl-pipes increases. However, exactly the opposite occurs, if the same mixture of raw materials is centrifuged with a steel impeller. Then the effects of unnatural systems of mass-motion become quite self-evident.

Conditions under which eggs, seeds and cells can engender

All life springs forth from such conformations as eggs, seeds and cells, provided they have micro-fine diffusion-filters and are thus able to breathe. But what is to be understood by breathing? It is nothing more than the fertilising of fructigenic ethericities that have entered the blood and sap vessels via the intestinal filter. These originate in the Earth and are therefore predominantly negatively (geospherically) charged. Under naturalesque preconditions the product of this intermixture of diffuse matter is biomagnetism, which then interacts with cosmic ethericities. The product of this even more exalted commingling of diffuse essences, quite simply is life itself.

For this reason every biologist should be made thoroughly aware of these diffusion-devices or fine-matter filters. These are present in all eggshells or seed-casings and give rise to the Mr-fertilisation of counter-polar concentrates of dynagens, thereby enabling the unfolding of embryos. The prime function of the gills, lungs and all protoplasmic whatevers of whatever kind, therefore, is to awaken life. No one can claim that this primordial process of fertilisation has ever been given the attention it warrants. Just the opposite has been the case! Through over-illumination, over-warming and in particular centrifugal mass-motion which is pressure- and heat-increasing, the first beginnings of life are disturbed or even destroyed in their most fundamental phase. The accuracy of this serious assertion should be proven by the following illustrative example.

Fish lay shell-less eggs. They are thus bound to the world of water all their lives, because only through this thin, vulnerable filter-membrane can they abstract diffuse ethericities from water, which to a greater or lesser extent is over-saturated with products of emulsion. Certain species of newt do not return to the water to lay their eggs. They crawl into damp and moist holes, lie over their eggs, sprinkle them with urine and cover them with a special secretion which they exude from the skin of the stomach. By creating somewhat thicker filter-systems they free themselves from the water. Slightly more highly-evolved amphibians have become adept at enveloping their eggs with an even thicker skin. The first skins (filters) were as thin as paper and later on they were coated with calcium and became as hard as porcelain. Ever since then the airtight, sealed egg has existed, which is the product of a struggle over millions of years to be able to live and move freely in the realm of the atmosphere.

How is a bird able to become temporarily independent of the ground?

How does it manage to overcome its own physical weight and to master flight without undue physical exertion? A bird lays its eggs in hard shells in which the embryo's breathing apparatuses are incorporated. As long as it can breathe naturally, the embryo grows from fertilised protein concentrates. An adult bird is equipped with sacs located in the quills of its wing-feathers, which are similar to shell-less eggs. The lung-fish of Australia and South America possess similar air-bladders, called swim-bladders. During the rainy season they live in shallow water and breathe through their gills. In summer they have a sort of siesta, and in this intervening period they live in holes in dried-out mud, which encloses them like a carapace. Breathing takes place through the swim-bladder, which now functions as a lung. During this period the body-temperature drops, as occurs with all hibernation, because a vacuum develops as a result of the lowering internal temperature. It is a biological vacuum, which enables the sucking in of high-grade respiratory (fertilising) substances, keeping the creature alive. These indrawn substances are emulsified by accumulated concentrates of fat, which the animal stores away as hard rations during the feeding season in preparation for its coming fast.

Precisely the opposite takes place with birds, because they breathe through their lungs while at rest. When they fly, they breathe through the oscillating planetary movement of their air-bladders, which now become accumulators of dynagens. These air-bladders inflate during flight and assume a well-rounded shape, as they do in fish when their owners wish to levitate. However, these bladders are not filled with air, but with a helium-like gas, which the

bird produces as a supplementary levitational force through the intermixture of diffuse ethericities and in this way the body is endowed with its soul. A world-famous anatomist once declared, 'I have opened up the bodies of hundreds of creatures, both alive and dead, but nowhere and never could I find the soul'. Derived from the Greek word selen (Selena — the attracting Goddess of the Moon), this soul is a biomagnetic energy-concentrate. It not only explains the bird's flight, but also the hitherto inexplicable phenomenon of migratory birds, which have particularly well-developed soul-cells. With the aid of these vibrating protoplasms they can reach their distant destination almost effortlessly and without food. Migrating birds also achieve this by means of opposing potentials, which trigger off an appropriate temperature-gradient. So in a sense they are remotely controlled.

This almost non-spacial, or quasi-immaterial, uplifting and forward-impelling substance can also be produced mechanically and virtually cost free, in specially constructed and alloyed, spirally coiled devices, akin to sap or blood vessels. All contemporary systems of propulsion for ships and aeroplanes will soon become museum exhibits, because this solves the problem of overcoming gravity by natural means. The present form of today's technology and its methods will fortunately be superseded, because with its continued use people will only become all the more stupid, the more spongy and qualigen-deficient the substances of their bodies and their food. This will result in premature impotence and an inability to reproduce.

But to return once more to the discussion of birds. While in principle their means of flight are the same, migratory birds can be distinguished from non-migratory species by the way they flap their wings and the arrangement of their pinions. The example which most characterises the factors governing long-range flight is the set of the wings and the flight-feathers of the albatross, which in a certain sense swims through the ocean of the air. Its wing tips extend far forwards in order to embrace the oncoming air-masses. With a wide, cavitating sweep of the wings, it causes these air-masses to rotate and inwind about themselves and about their longitudinal axes. A fundamentally different wing arrangement is exhibited by that king of the air, the Golden Eagle. It spirals up to great heights in order to survey the wide sweep of its hunting territory as it floats almost motionlessly in the air. The golden eagle is not really a bird of prey, but rather the sanitary inspector of the high mountains. Its task is to cull infirm or incapacitated wild animals for the benefit of the healthy and natural progress of evolution. It therefore weeds out all that is inferior to ensure the genetic health of the rising generation.

But how is it possible for this bird's heavy body to float in ever-decreasing circles in the rarefied upper atmosphere, in defiance of the laws of gravity and without any noticeable flapping of the wings? It is because wise Nature endowed it with specially formed protoplasms which reside in the quills of

the flight-feathers. These are accumulators which store additional levitative energies. However, they function substantially differently from balloons filled with a lighter-than-air gas, which are known to burst when they reach higher, more rarefied altitudes. In principle the eagle ur-procreates formative and levitative concentrates, whose emitted radiation creates a biological vacuum in the eagle's immediate vicinity, mostly above it. It is the same upward-sucking force that allows the stationary trout to flee upstream like lightning. This biological vacuum is a hitherto unresearched phenomenon and is the specific type of vacuum that also enables humans to breathe. Professor Ernst Ferdinand Sauerbruch discovered it between the pleura and the surface of the lungs. Breathing is explained by the fertilisation of bipolar ethericities arising through digestive processes, which invalidates the widely held view that the heart activates the circulation of the blood hydraulically.

Any perforation of this vacuum results in immediate suffocation. If the eagle's quill-protoplasm is perforated, then the bird loses the ability to float motionlessly until such time as the perforated or otherwise injured protoplasm heals and closes up again. Even the perforation of a single vibrating protoplasm makes any flying arduous should the eagle continue to fly during the healing period. If the protoplasm is punctured by a red-hot needle, which burns them and also the surrounding quill, then the bird's ability to fly is over forever, because this wound will never close. In captivity, for example, with domesticated ducks, geese and chickens, these protoplasm atrophy. Even song birds which have been kept in cages over a long period must practise for quite a while in order to re-acquire their former flying ability. If larks are held in extended captivity, they are only able to rise warbling into the air after many lengthy attempts. Without warbling, with which the lark generates the necessary vibrations, its upward flight is impossible.

Now to an observation which resulted in the achievement of bird-flight by mechanical means that faithfully emulate Nature. This observation that will also lead to the reinstatement of the culture of our ancient ancestors, who had mastered a different form of chemistry, meteorology, astronomy and medicine. The fundamental element of human knowledge lost thousands of years ago is what is today called animal magnetism or mesmerism. This was rediscovered by Franz Anton Mesmer, who was born at Iznang on Lake Konstanz in 1734 (died 1815). Nobody had any idea that he had actually rediscovered the long-lost ancient knowledge of a naturalesque Eco-Technology. Amongst other things he also invented the famous baquet,¹¹ a magical device, which had a particular shape and was made of certain alloys. From this baquet, in which he prepared magnetic, medicinal water, a number of iron rods protruded. These rods were grasped by the sick to enable the transfer of biomagnetic ethericities into their wasting bodies.

All life emerges from the ur-form of the egg

The golden eagle makes its nest at altitudes that are already more or less deficient in oxygen. Here it lays its eggs with their particularly distinctive shells, in well-shaded and protected lairs. The diffusion-pores in these eggshells enable only the highest quality substances to enter. In zones inhabited by the eagle no manner of empty space or void prevails, but the specifically densified, dynagenic concentrates,¹² which to a certain degree are already in an etherealised state. It is to these influence-imparting substances that the eagle owes its build-up of biomagnetic levitational energies, which begins when the bird is still an embryo.

This egg-shaped, energy-producing vessel can be copied and in lieu of pores, the smallest diffusion-jets can be incorporated in the design. Providing it is hermetically sealed against light, heat and external air, and all other preconditions are satisfied, then Mesmer's healing marvel can be produced from ordinary water, if the water inside the container is moved planetarily. Many diseases can be cured by this healing water; which are otherwise irremediable with conventional therapies. Moreover, its behaviour baffles all physicists when it no longer obeys the law of communication, but appears to rise in a glass tube with an internal diameter of 3-4 cm (1 5/16-1 9/16 in.).¹³ In fact, if the upwardly spiralling biomagnetic ethericities in the tube interact with the counter-flowing incident radiation from the predominantly positively-charged atmosphere then juvenile, newly born water is actually formed.

This specifically-dense, new water is nearly weightless and subsides when its surface is touched by the tip of an steel needle, because the predominantly biomagnetically supercharged, levitational forces are discharged into the body holding the needle. All this goes to prove the efficacy of the healing miracle produced by Mesmer's baquet, which was so derided by his contemporaries.

Forces that function in the same way also evolve in the blood of the eagle in its embryonic state. If this train of thought is carried to its naturalesque conclusion, then the adult bird's mysterious ability to float in space becomes clear, when it spirals aloft to where the natural loss of gravitational force begins.

It is a sufficiently well-known and undisputed fact that blood and sap move planetarily. So far it has never occurred to anyone to copy this phenomenal form of motion or to generate these biomagnetic, upsuctional forces under normal conditions of atmospheric pressure. In view of the intellectual inertia of techno-academically trained scientists, it is no wonder that, despite numerous demonstrations, they still consider it impossible to neutralise the attractive force of gravity, which only exists in the atmospheric living-space. However, let us continue with presenting further graphic examples taken from Nature.

How did originally aquatic plants escape from the medium of water?

How do formerly aquatic plants manage to exist on dry land almost without water? Moreover, how was it once possible to grow the most noble of cereals in waterless deserts? How were the seeds found in the tombs of the Pharaohs able to maintain their germinating ability over thousands of years?

Over millions of years the plants were able to achieve this by gradually covering their seeds with a hard outer casing. At the very end of the root-tips, fructigenic filters form, which only permit the entry of high-quality substances. These filters deny all access to dissolved substances and their carrier — water. It is only possible for fourth-dimensional nutrients in the form of exalted ethericities to develop into increased and qualitatively improved forms of growth.

If these diffusion mechanisms are damaged or cauterised by artificial fertiliser, then the filters, which permit the entry of reduced elements only, become porous. The same thing happens if they are over-illuminated or over-warmed, or if the body of the seed is overheated. Due to the absence of an animating rhythm, the filters then become permeable and regressive development or cancer soon sets in. The plant runs to leaf, the seeds become sterile and decay like an over-warmed chicken's egg.

Today biologists are not only of the mistaken opinion that plants absorb and draw up dissolved substances along with their carrier, water, but they also fail to see the shell-less eggs on the tips of the roots, which, like dew-drops, burst when exposed for only a few seconds to direct sunlight. This leaves the root-stomata open and unprotected, and the plant actually absorbs undissolved instead of exalted (fermented) nutrients. The botanist is equally unaware that a biological insuctional vacuum is also active in the plant.

If, in the case of cut flowers, for example, the surfaces of the sliced ends are bound together tightly, then the blooms will last slightly longer, because they are forced to draw in purified nutrients through the stomata in the stalk itself. Cut flowers such as alpine roses, which normally have dark red blossoms, grow dirty white flowers when placed in lime water. However, if the lime milk is vibrated with ultrasound, these will become pure white. This whitening, the result of an absence of red sap-corpuscles, is none other than a form of leukaemia, and should provide a clue to doctors, who try in vain to cure this particular blood disease. They overlook the fact that it is associated with excess blood pressure, which inevitably results, if the intermixture of products of diffusion is inhibited. Leukaemia is, and will continue to be, incurable for as long as the supply of genuine immulsion (inner emulsion of a higher order) products remains irregular. The significance of the Indian healing art of breathing (prana yoga) therefore becomes quite apparent. Prana

yoga encompasses the full control of the entire process of breathing, which is responsible for the supply of seminal matter and fructigens alike. Symptoms of decay and putrefaction will therefore appear if, for one reason or another, the uptake of unfertilised ethericities of nutritive material does not occur. Fertilised protein concentrates must be respired so as to be able to reproduce and upwardly evolve. For this reason all symptoms of cancer of whatever kind originate from the disturbance of the animating rhythm.

If techno-academic motion is considered in this light, then every layman will have to concede that the animating energies in any unnaturally-moved earth, water or air will be inhibited in their most fundamental phase with the application of additional pressure — even if atomic (metaphysical) in nature. The development of cancer then begins. In this way, a high-speed pressure-turbine, a Pelton-wheel, a pressure pump or a propeller for example, unavoidably causes the build-up of decomposive energies. The same applies to all machines made of steel or iron in which heat and pressure increase during their operation. Genuine products of emulsion can only be produced with the aid of properly alloyed, Earth-shaped (egg-shaped) appliances and the strict regulation of the dynamic rhythms.

The most difficult aspect of these explanations is that technical terms have to be used, which are largely unfamiliar, or have other meanings and interpretations. Therefore misconceptions are unavoidable and the reader might be led to believe that everything stated so far is merely a play on words to impress the experts. These experts, however, have never really contemplated the fact that with every breath, life is renewed through the influx of qualigen, and that the necessity for life, perhaps the most vital necessity for life, the biological vacuum, begins to wane, if breathing is impeded. This is a concept that still cannot be found in any scientific textbook. The same applies to the term levitation, for up to now the supposedly invincible law of gravity, the constant laws of equivalence and conservation of energy were all that were known.

What role does water, as a carrier, play in these formative and transformative processes?

Since in Nature nothing is ever lost, one cannot properly speak of the disappearance of water. There are minerals and other intermediate substances that have a very high content of crystallised-out hydrogen. To avoid even further confusion it must be stated that there is more to the term hydrogen than the word itself expresses (hydro = water, gen - that which produces).

In Goethe's Faust, Mephisto relates: 'Upon my wanderings I also saw people in crystal garb.' This is how the term water content is to be interpreted, which is

found in a particularly luxuriant form in amber, for example. It is a fossilised resin (solidified sap), whose chemical formula — $C_{40}H_{64}O_4$ — is wholly inadequate to define what is actually a concentrate of ethericities. These ethericities are first liberated and assume their normal state when this dynagen concentration is moved planetarily. In the process, atomic suction-forces develop, whose measurable manifestation is the biological vacuum. This special vacuum emulsifies bipolar ethericities, and in this way a specifically densified, non-spacial, new entity is created, whose emitted radiation organises physical space.

Every new form requires its appropriate carrier, which is actually the resistance necessary for every interaction. Without this resistance no inner motion is possible, either as excitation or pulsation, which orders the localised distribution of matter.

The natural conversion of seawater into fresh or general purpose water is impossible without amber. This explains why the Baltic Sea, in which large quantities of amber abound, contains almost drinkable water. Another phenomenon of this region is that seawater-ice, which has been exposed to the atmosphere for about a year, can hardly be differentiated from fresh water. Seawater precipitates almost acid-free, condensated water, if it is exposed to direct sunlight in a filter-sack. This requires exactly the opposite temperature-gradient to that required for producing freshwater from seawater.

In the long term distilled water acts as a poison. In consequence Eskimos or the inhabitants of karsts (limestone areas), who are forced to drink polluted tank-water, have to counteract this with blubber or goat suet respectively. If eggs formed part of the staple diet of Eskimos they would die, because their digestive filters are different (coarser) to those in people who obtain their food almost exclusively from warm-blooded animals. When dairy cows are given sour hay from the pastures, the fat content of their milk changes immediately.

What is to be understood by a biological vacuum?

It is a non-spacial concentration of energy which simulates a vacuity in the air. In reality it is a biomagnetic field, which gives birth to very high insuctional forces. These suck up water, blood and sap in their wake and energise them through planetary motion occurring during their ascent. Without this inwinding motion, no circulation of blood, sap, juices or water is possible in Nature.

Contemporary physicists and chemists consider a vacuum to be a space where the air is rarefied, and which is achieved when oxygenous air is evacuated or drawn upwards by the straight, sucking action of a piston. However, this process has nothing to do with the formation of a biological vacuum,

which can only be achieved with a rotating whorl-pipe. Fundamentally different apparatuses must therefore be employed in order to attain the most fully densified condition of qualigen. Similarly, a biological vacuum has nothing to do with the rarefaction of air and is a concept that breaks entirely new ground. Goethe sought to describe it with the words *The Eternally Female* and *The All-Uplifting*.

To activate this specifically densified qualigen, solid, liquid and gaseous media must first be introduced into a specially shaped and alloyed vessel. It then depends on the type of movement, for everything has to be inwound towards the centre along cycloid-spiral space-curves after the manner of upwardly-spiralling dust-twisters in whose central axis the intimate intermixture (marriage) of bipolar basic elements takes place. In a sense it represents the formation of an alloy composed of variously charged ethericities at the expense of oxygen, which is a precipitate of solar energy in gaseous form. In other words, oxygen as the more inactive is bound by exalted ethericities of carbone¹⁴ and carbonic acid. This process was previously unknown, and as a result the term implosion, as the exact opposite of explosion, was likewise unknown. Equally incomprehensible initially is the accompanying phenomenon associated with the preparation of qualigen. By regulating the rate of rotation in biotechnical machines the temperature can be brought down to the anomaly point (+4°C/+39.2°F) and maintained there almost constantly.

At this, its highest state of specific density, spacial oxygen becomes so inactive that it can be bound or consumed by the counter-polar (geospheric) ethericity. Here, it is important to monitor the anomaly state of the latter, because it reaches its highest level of activity in this state. Although specially constituted catalysts are also involved, it would serve no useful purpose at this point to elaborate on their effects. During this process these geospheric ethericities generate a biomagnetic field whose surplus energies radiate vertically and draw the surrounding mass of basic elements up with them as they ascend. This creates an artificial cyclone, a tornado or waterspout, which carries away everything in its immediate vicinity. Exactly the opposite effects are obtained, if any given mass is accelerated centrifugally, i.e. from the inside outwards. In those devices which apply centrifugal motion, the temperature of the mass rises in step with the increase in rotational velocity (viz. wind-tunnels).

A biological vacuum operates with the same force as normal atmospheric pressure or at about one atm/cm², and as pulsations increase during the implosive process this force is intensified a hundred- or a thousand-fold. This is the first time the immense cyclonic power of a hurricane¹⁵ has been explained.

With implosion, however, no heat is generated, nor are any of the motional resistances familiar to engineers. On the contrary, there is an increase in

performance, because the moving masses become increasingly cooler. It is worth mentioning here that magnetic and almost heatless light can also be generated by the same process. The phenomenon of the cold light emitted by abyssal fish, which can only be produced under the particular conditions of potential found in abyssal waters, proves this. This same potential can be produced with planetary motion at almost no cost. So, it is now possible for the naturally minded to overcome the forces of gravity present in the zone of the atmosphere, as well as to build up their own spiritual and physical gravitational field.

What is planetary mass-motion?

When a relatively heavy maple seed matures and drops off the mother-tree, its fall is braked by two archimedean propeller-like wings and spiralling slowly earthwards, it is often carried a kilometre or so by the wind. Curiously, this natural braking-propeller is currently used in pressure-turbines as an impeller and as the means of propulsion for ships and aircraft. It is also used to drive hydroelectric generators. The faster these braking-propellers rotate, the greater the area over which groundwater sinks. The active surfaces in these turbines become pitted and sometimes even holed. The reason why was never discovered, however, because the X-ray-like, horizontally emitted rays can only be measured, if their speed is considerably reduced by filters made of fats (paraffin wax, etc.). These rays have an electrolytic effect over a wide area.

The decomposition of farm produce and other forms of growth should also be mentioned here, which is caused by the rapid movement of steel tractor-drawn ploughs. Apart from the depotentiation of the groundwater due to the creation of a film of rust, the rapid, pressurising movement of the ploughshare causes shock-waves, which destroy the finely attuned harmony of the soil's vibrations. This has the same effect as jazz-music on the ears. It is no wonder, therefore, that a world of parasites proliferates as a result. Poisoning them is completely useless, because this microbial kingdom will only multiply and spread even more.

Planetary motion consists of an inwinding, vortical movement that simultaneously narrows towards a point. Here, rotational velocity constantly increases as the orbital radius constantly reduces. At the centre of this in-rolling vortex a densation is produced, which in turn develops into an attracting, inward-pulling pole.

This densation is not limited to physical space alone. On the contrary, it is also raised to a spaceless condition through an increase in the frequency of the oscillations. It is this spacelessness or vacuity that generates the biological vacuum. The relation between the material, energetic and more subtle worlds

should be conceived as a pyramid, wherein coarser, less energetic matter occupies the lower portion. As the volume reduces with height, the proportion between matter and energy gradually reverses until at the very apex all that is left is extremely fine matter or energies in a subtle or etheric state, above which the biological vacuum begins.

Planetary in-rolling, which we see in the movement of the stars and galaxies, has no fixed axis. In-rolling motion is also never circular. Rather, we should speak of an egg-shaped orbital path which has an aspect of endlessness. Evolution therefore has no boundaries.

If water, earth or air-masses are moved in such spiralling systems, then the additional power and efficiency increases by the square of the rotational velocity. This should be compared with the disintegration of energetic substances provoked by the systems of techno-academic motion that have so impoverished us all. We shall be faced with the unstoppable destruction of our daily bread, if present methods of cultivation continue unchanged.

Life is indestructible!

The way earth, water and air are moved determines whether pathogenic or healthy life-forms come into being. The results of the latest research produced the surprising discovery that there is no constantly sterile water! Indeed, at the hands of nature-alienated hydraulic engineers it most certainly does degenerate. It rears up against such treatment, and as a catastrophic mass it causes immense havoc, but in spite of this they are still unable to realise their mistakes. This water then sinks down into the depths and makes its escape to areas beneath deserts. Here, in underground streams it is once more able to move itself planetarily.

New life can even arise from burnt (carbonised) bacterial cultures, but if it is wrongly moved and processed then its parasitic nature soon becomes evident. However, if this culture is placed in soil that has been spared humanity's misguided interference, then its life-force blossoms again immediately.

Science has also failed to see that there are two fundamentally different forms of temperature-gradient. One is water-synthesising and the other water-analysing. It is to this ignorance that science owes its inability to transmute seawater into freshwater, and to do so cheaply and in a natural way. With the same process of cold agitation it is also possible to disinfect bacterially contaminated water. For millions of years Nature has shown us how this is done. Paradise could very quickly be reinstated once humanity realises that primordial, formative motion cannot be replaced by an unnatural, techno-academic one.

All growth must be preceded by decomposition

All growth must be preceded by the thorough decomposition of earthly life! Without the evolutionally-younger generation of waste-matter, no evolutionally older, rising generation can continue to evolve. Eternal rest for the deceased is therefore impossible, because it is the earthly remains of former life that breathes life into the rising generation.

Even in his time, Goethe was aware that human beings also exist in crystalline form. The formation or decomposition of the hardest rocks depends on whether the rocks are able to breathe naturally or unnaturally. For example, let us examine the growth of a rock crystal (quartz). This ceases immediately if the crystal is removed from its place of origin, or if the diffuse air of its environment, suffused with high-grade nutrients, is in any way altered climatically through over-illumination or over-warming. By a similar logic, the alteration of natural systems of seeding, conservation and felling in old-growth forests, resulting in the depletion or lack of vital nutritive material, is responsible for the wasting and almost imperceptible slow death of the replanted young forest.

She half-pulled him down; he half-sank on her

In order to understand the full significance of this rather suggestive, but evolutionally important, rhythmical interplay, the procreation of water within the dew-drop should be described in more detail. Dew can only be formed in very particular places and environments. These must possess all the geological and topographical features conducive to the intermixture of specific diffuse substances. The location itself must be oriented so that the Mr-fertilisation of geospheric ethericities by the early rays of the rising Sun can take place at the proper angle.

Temperature is another important factor and should not be overlooked, for it is only the still heatless rays of the Sun that enable the formation and accumulation of water. As soon as the Sun's rays become warmer the dew-drop bursts. Where the right conditions prevail, soap-bubble-like vessels, in which mysterious levitative substances accumulate, appear on the tips of the blades of grass. These little sacs are formed in the first light of early morning, when the air becomes conspicuously cooler. When the first rays of the rising Sun encounter this Mr-egg, the Mr-fertilisation of its contents and the genesis of crystal-clear water take place, filling the sac by about two-thirds. The remaining space is filled with a noble gas, which holds the dew-drop erect until it is eventually demagnetised by the increasing influence of heat.

The dew-drop then becomes heavy and begins to keel over, bending the tip of the grass downwards at the same time. That it does not fall immediately

indicates that its magnetic adhesion is still active. Finally the little balloon bursts and the water, ur-procreated through the crossing of diffuse ethericities of converse nature, trickles down to the ground. If this little sac of dynagen is trodden on by warm, bare feet, then a tingling sensation is felt, whereas if well-polished shoes are worn, the soles and the upper shoe turn reddish in colour and become permeable to water. However, if one walks through grass, especially in alpine pastures, where the dew is in the process of evaporating during the day, shoes then become covered with a glossy fat-filter, which waterproofs them far better than the best polish. Today the knowledge of this best-possible waxing is as good as completely lost. The old foresters and farmers knew of it and referred to it as the extreme unction. It is a treatment to which all seeds should be subjected in order to make them impervious and able to germinate vigorously. Even on desiccated soils good after-growth can be achieved in this way.

The growing sterility and increasing susceptibility of seed materials to moulds are to be attributed to present methods of cultivation. The increasing sterility of shade-demanding timbers can be observed even as they grow towards maturity, which is the combined result of exposure to direct light and the absence of thick, protective bark.

Over-illuminated and over-warmed rivers also lose their inward-drawing biomagnetism in exactly the same fashion. Having lost its regenerative ability, riverwater begins to deteriorate and eventually dies. It literally suffocates due to the loss of this insuational force. It can no longer absorb incident radiation and therefore fertilisation no longer occurs. In stretches where the fall is steep it also becomes unstable and its flow uncontrolled, because the energy-axis created by differences in temperature has lost its power. Under normal conditions this force pulls upstream towards the lowest temperatures at the spring and therefore functions as a regulating brake. Water flowing planetarily is a dynamo and emits radiation in the form of corpuscular energies which permeate the surrounding soil and enhance the growth of the vegetation. In hydraulically regulated streams and rivers this dynamo has been switched off.

How can the existence of these reciprocities actually be proven?

Measurement with existing methods is impossible because there are no instruments sensitive enough to pick up the frequency range. We are concerned here with energies, which indirectly create all we are able to perceive around us, but as agents they are never manifested materially and can only be measured by their obverse function. The only means of doing this is to brake them with fat in sheet or slab form (paraffin wax). It is then possible to study the various light-phenomena and establish whether the rays

are formative or disintegrative. All normal resistances such as glass porcelain, metals or minerals have no braking effect and will be transpierced.

Water is produced through the intermixture of high-grade, vertically radiant energies with diffuse counter-flowing radiation, under the hermetic exclusion of light, heat and external air. If the inherent quality of life-imbuing (fertilising) substances is high enough then the water develops a shimmering, bluish-green hue. For this reason no high-grade water is ever colourless. Water of this quality can only be ur-produced with the aid of the original, in-rolling form of mass-motion. However, this should in no way be considered as consisting of centripetal motion only, for no such one-sided mass-motion exists. The important thing is that the insuctional component predominates.

Water of this order moves almost silently and has such an extraordinarily high specific weight, that under the effect of heavy frost, which densities surface water and the air immediately above it, egg-shaped stones composed of metalliferous limestone can even rise to the surface. Once there they are rapidly encircled by a collar of ice and a protective layer of ice peppered with these stones gradually forms, which prevents the over-cooling of the underlying water-strata.

Biomagnetically supercharged riverwater never freezes, and its temperature even increases slightly, if the degree of frost drops below a certain level. When this happens watercress begins to grow luxuriantly on the bottom and the old foresters used to use it as a natural camouflage for their traps. So far this water-warming phenomenon under heavy frost has never been explained. It immediately becomes clear, however, if the diverse nature of the potentials produced when water is moved planetarily are compared to those resulting from centrifugal motion.

Distinguishing magnetically charged water from water with the opposite potential

How can magnetically charged water be differentiated from water with the opposite potential? Since this involves different types of potential, it can only be established indirectly. For this reason even a chemist would be unable to determine its beneficial quality. His knowledge is limited to the sort of water that is able to communicate¹⁶ — water whose various potentials are in labile equilibrium and which is incapable of reproduction and upward evolution. Even the best mountain springwater loses this ability once it enters the external atmosphere.

On this account biomagnetically supercharged water can only be produced artificially and made use of as an all-healing medicinal drink as follows: the best water to use for this purpose is condensated water that has been distilled

or well-boiled — salt-free, well-oxygenated water that has been demagnetised by the Sun or by heating with fire. If seawater is to be used as the starting material, then it has first to be condensed by way of cold circulating currents, which is only possible with the use of a specially shaped and alloyed suction whorl-pipe. This is very inexpensive to operate and any desired quantity of condensed water can be obtained in a very short space of time. As almost chemically pure, raw water, this is then transferred to a hermetically sealed, egg-shaped vessel, well insulated against the effects of light, heat and external air. In this vessel a biological vacuum is created by means of a cone-shaped, double-rilled suction-diaphragm.¹⁷ (See Fig. 1) Through the action of appropriate catalysts and the influx of predominantly negatively charged salts, biomagnetism then develops. This accumulates in the carrier (water) in a fashion similar to the storage of an electric charge.

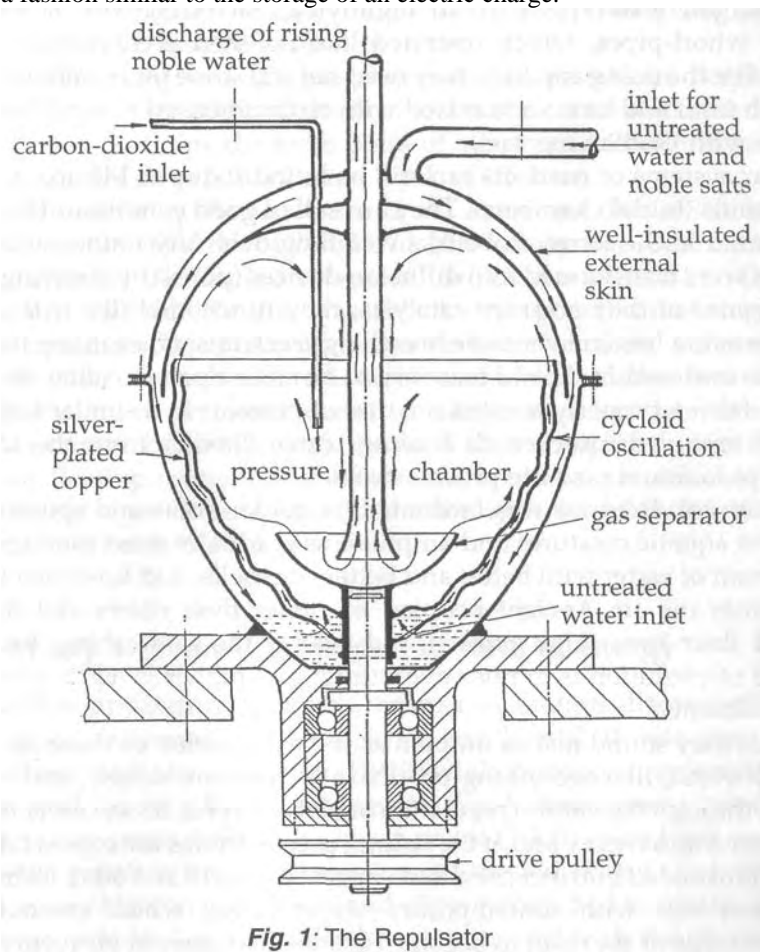

Fig. 1: The Repulsator

If a thick-walled glass tube of suitable internal diameter is inserted into the biomagnetised water, then corpuscular, biomagnetic emanations rise upwards, and under cool environmental conditions bind the atmospheric oxygen present in the upper part of tube. Newly formed juvenile water comes into being in this way, provided certain other preconditions are met. Being in a labile state of equilibrium akin to high-grade groundwater it begins to float and gently pulsate. The above suction-inducing device constantly produces biomagnetism, which permeates the water as it levitates, binding oxygen, as mentioned above.

The newly formed water begins to well up, becoming more and more strongly biomagnetically charged, and rises up the pipe to any desired height where it flows out as an artificial mountain spring. The same principle was applied by the peoples of ancient cultures, who raised biomagnetically supercharged water right up to high-lying, sacred groves of trees using suction whorl-pipes, which operated like inverted archimedean pressure-screws. For the rising conduits they used natural stone pipes laid with mortar, in which sand and lime were mixed with biomagnetised water. This was also the case with 'Roman mortar'.

Similar systems of conduits can still be found today in Mexico in the form of pyramids (burial chambers). They are still in good condition. They are also to be found in the form of obelisks weighing over fifty tonnes, whose outer surfaces were transformed into diffusion devices (pores) by sintering.¹⁸ Due to the presence of the necessary catalysts, they functioned like true eggshells. They therefore became veritable breathing mechanisms, enabling the various elements enclosed in the old masonry to be emancipated. A live chicken also evolves from a properly aerated mixture of proteins in a similar fashion, and like the ensouled (quickened) healing water flowing from the top of the standpipe, another new life-process unfolds.

This natural Ascension was facilitated by golden roofs and spires. We have seen how aquatic creatures and amphibians gradually freed themselves from the domain of water with better and better eggshells, and how they were able to rise into the air. Ancient peoples, or rather their rulers and those who directed their lives (high priests), did exactly the same thing, for the true purpose of evolution is to raise everything to a higher level of development or unfoldment.

All this may sound just as Utopian as the explanation of these processes of renewal which, like everything proper to Nature, are simple, and which are ordered through the natural regulation of metamorphic flows (*panta rhei*). Mass is converted into energy and, if the natural preconditions are copied faithfully, it is then transmuted into increased and ennobled growth and other forms of life.¹⁹

Compare this with contemporary world-views, which promulgate the ascent of souls of the dead to become hallelujah-singers in Heaven, or eternal

rest after death, while simultaneously threatening eternal damnation in Hell. It is thus all the more remarkable that in this age of nuclear power anyone can still believe in such fairy-tales, and at the same time treat earlier truths and sayings with such disdain. People hope and believe in vain that they will be able to create paradisiacal conditions with the wrong form of motion, which has actually turned this unique and unparalleled existence on Earth into hellish torment.

It is a paradox of history that the unnatural movement of the ur-source of life on this Earth — water — is solely and entirely to blame for the deplorable state of affairs. Throughout the whole civilised world water is now in flight, for by destroying its naturally ordained form of movement, humanity robbed it of any possibility of evolvement. While the world may continue to survive a little longer off the spoils of over-exploitation, and pretend to a state of well-being, it will eventually become more and more poverty-stricken as it inexorably gravitates towards a ghastly future.

The world has been wrongly programmed, and people are beginning to curse those who contrived our diabolical technological thralldom; those, who so intensified it, that now the mere press of a button is all that is needed to irradiate at one fell swoop this Divine Work of Creation.

'Mix the substances of the Heavens and the Earth and thou wilt be joyful, independent and contented thine whole life long' — so says the most ancient (ur-aryan) testament of the Tabula Smaragdina,²⁰ which was incised into the hardest stone, the emerald. No one was able to interpret the meaning of this enigmatic transmission, so incomprehensible to conventional science. Was it a higher direction of events or a remarkable accident that led to the revelation of evolution's most profound secret, a secret that has lain buried for thousands of years, by of all things the most silent creature on this Earth? It was a trout floating motionlessly amidst the torrential waters of an alpine stream that divulged it to a young forester with an inherited gift of an intimate connection with Nature.

The discovery of a new highly potent form of energy

How was this apparently harmless, erroneous motion discovered, whose effect is more dangerous than the hydrogen bomb? It was one Sunday morning about thirty-five years ago (1919) while stalking a gamecock, whose mating ground lay in a high alpine corrie, that I came upon a crystal-clear, fast-flowing mountain stream about one metre (3.3 ft) wide lying across my path. On the point of jumping over it with the aid of my staff and while seeking a secure hold on the smooth and slippery rock bed for its tip, I flushed a large trout from its lair. Its colour blended so well with the surroundings

that it almost escaped my eye. As if shot from a bow, the trout darted upstream and vanished. Several questions flashed through my mind just as quickly as the trout sped upstream.

1. How did the trout — and later I saw dozens of them in the same stream — actually manage to get to this spot? It was cut off by a 100-metre (330 ft) high waterfall about a kilometre downstream, where the water was atomised into a veil of mist.

2. How was it able to flee upstream like a streak of greased lightning in defiance of all the laws of gravity?

3. How was it possible for this fish to stand so motionlessly in this wildly torrential flow, which made my staff shake so much that I could hardly hang on to it?

4. What forces enabled the trout to overcome its own body-weight so effortlessly and quickly, and at the same time overcome the weight of water flowing against it?

5. Why didn't the water freeze, even during periods of severe frost with temperatures below -30°C (-22°F)?

Even in hottest summer these springwaters maintain their characteristic temperature of $+4^{\circ}\text{C}$ ($+39.2^{\circ}\text{F}$). Wild animals that have been shot or are sick come to these springs to heal their painful wounds or other inflammations, or to die there without pain. Once there, they are almost oblivious of approaching huntsmen, who release them with a merciful coup de grace.

This upwelling flow was called healing water by the old huntsmen, because it alleviated gout, arthritis and other ailments of old age. Smirking, they declared emphatically that it restored virility or maintained it right into old age, which was why even feudal lords, who had become slightly dodderly, never failed to drink the water from these youth-restoring springs.

After the First World War the feudal owners of Austrian hunting estates lost their great wealth. Widespread over-exploitation of the forest, even in remote areas, began with the aid of tilt-gate sluices, which were installed in narrow defiles. The previously healthy spring-streams were soon turned into veritable ruins. Millions of cubic metres of solid timber fell victim to the more rational operation of log-flumes. All warnings were ignored and brutal self-interest alone was the order of the day. The obviously thriving stands of up-and-coming timber were relegated to second place in favour of uniform silviculture (monoculture), where young trees were marshalled in rank and file like soldiers, thus producing a completely different image of the forest. However, within a few years there was already sufficient evidence to show that stands of young plantation timbers, raised according to conventional scientific methods, had developed a thoroughly spongy structure. Their

widening annual rings were nothing more than incipient tree-cancer. Today's young stands of timber are already as good as lost. They are no longer water-producers, but water-consumers, for they are only able to produce porous or permeable root protoplasts, if indeed they can produce any protoplasts at all.

About a quarter of a million hectares of former high-forest today remain treeless or are already unreaforestable wastelands, which are slowly turning into karsts (treeless wastes). In these areas the temperature in the root-zone rises above +9°C (+48.2°F). Upwards of this, the germinating power of seeds and the restoration of good quality timber is impossible. Inasmuch as they are still capable of germination, the only solution left is to give them the extreme unktion in order artificially to improve the capacity of the evolutionally vital diffusive skin.

If the forest dies, water also perishes and sinks with it. Water is being tortured to death by the installation of pressure-turbines, by the straightening of those rivers in which it still flows, and by contamination with waste-water and sewage. In these heavily polluted waters even the parasites die off, which normally thrive on decay. If nothing happens very soon then our own children will be the hapless victims of a natural disaster of an order that will eclipse even the biblical Flood.

The whole purpose of this exposition is to highlight the errors that have been made in all areas of science and industry concerning motion and stimulation. It was also done to draw attention to the rediscovery, after decades of observation of the stationary trout, of machines that produce the particular motion, which enables the generation of biomagnetic energy-concentrates. The immediate task of government is to seek the necessary ways and means of carrying out the unavoidable transition, and having done so, to implement them as fast as possible so as to spare our young people a grisly fate.

Much of what has been written here will not and cannot be understood, because the technical terminology newly coined or applied here will be wrongly construed or totally foreign even to sympathetic experts. For those unable to think objectively it will all seem to be a play on words. Many will deem what has been stated to be an attack on the dogma of the Church, since in their opinion God creates life and takes it away, and that its creation is the execution of Divine Will. All this, despite the fact that its product is a monstrosity, an idiot or a dangerous common criminal.

In any case, this information is not intended for the likes of people such as these, because they are neither willing, nor are they in a position to act in any positive way against the coming chaos.

A Small Difference — Decomposition or Life-Force?

From Implosion Magazine, No. 44 — written in Linz, December 1957.

Simple people never sense the Devil's presence,
even when he has them by the throat!

Johann Wolfgang von Goethe, the wise man from Weimar.

A Different View of Atomic Fission

The reasons for the suicidal madness of present methods of obtaining energy are as follows: In the media of air and water there are two stores of inherent basic elements, which are distinct both in nature and kind. The chemist calls them hydrogen and oxygen. As they do everywhere, they also play a major role in the generation of atomic energy. The difference between them resides in the fact that hydrogen becomes active with coolness, whereas oxygen becomes active and reacts aggressively under the influence of heat.

If water and air are made to move techno-academically — in a pressure, friction and heat-increasing manner — then oxygen becomes active and binds (emulsifies) hydrogen, which under the influence of these fever-temperatures becomes passive (inactive). In this case water movement follows an axial -> radial, or centrifugal and exploding path. The product of this molecular restructuring — a decentrating, decomposive energy — can be determined with precision.

On the other hand, if water and/or air are moved in exactly the opposite way, then as a result of cooling, the hydrogen component becomes highly active and binds (emulsifies) the oxygen, which becomes increasingly passive and inactive as the temperature drops. This process involves a centripetal movement from the outside inwards. The product of this emulsion or ur-procreation, which again can be determined precisely, is a concentrating, formative and levitational energy. It is exactly the opposite of what is today called electricity.

Up to now nobody has known what electricity actually is, and how and whence this water-decomposing energy came into being. No one has any idea what the movement of a medial structure — earth, air or water — signifies ecologically or biologically. Nor do they know how to interpret the concept of specific densation — the inner binding (emulsion) of the antithetical basic elements of hydrogen and oxygen. In this regard the process has to take place with a drop in temperature favourable to hydrogen. For this reason it was also impossible to determine the extent of decomposition taking place with a rise in temperature in accordance with natural law.

No war, no epidemic, nor an even worse natural disaster could have caused more havoc than has arisen due to pressure, friction and heat-increasing methods of moving such media as earth, air and water. Huge quantities of taxpayers' money have been squandered on this crime. It could only have happened because no one noticed that heat of whatever kind is the most inferior, water-decomposing form of energy, if it predominates or is excessive in molecular recombination.

Water treated in this way becomes deficient in qualigen, genetically diseased and cancer promoting. It begins to decay, and gives birth to pathogenic bacteria out of the decomposing trace elements — the latter being residues of previous processes of purification and exaltation. These germs are then transferred to more highly evolved life-forms through the consumption of cancer-impregnated water or contaminated foods. Additional motive impulses of a mechanical, physical or psychic nature also act to intensify heat. Via the indirect route of retrograde molecular recombination, they trigger off the terrible scourge of the techno-academic age of deformed development, the putrefaction of blood and sap.

Nature moves media of all kinds planetarily — her motion is predominantly radial -> axial. Water thus moved becomes health-promoting and full of qualigen, because of its ability to reproduce, regenerate and upwardly evolve. Such water is also negatively supercharged with levitational substances. Conditioned by differences in potential, it rises to the highest mountain peaks. It acts to intensify growth, because it conveys the highest grade nutrients to the plant world by way of processes of diffusion. In comparison, water moved in the opposite way (inversely stimulated) becomes over-acidified, loses its levitational power, sinks downwards and disappears, provoking the decline of vegetation for lack of nutrients.

In the majority of cases, all turbines of contemporary design move the evolutionary source of all life — water — centrifugally. They therefore generate all manner of decomposive energies, which become all the more environmentally hazardous the faster they rotate, depending on the hydraulic head of pressure available. This can be determined with great accuracy. The same also applies to all kinds of expansion, explosion and propeller-driven (pressure-screw) machines, and likewise to contemporary agricultural implements such as ploughs and harrows.

In contrast, suction turbines or implosive machines actuate a decrease in heat, and with this the development of natural growth-promoting levitational energy. This heat drop is actually known to science, but the means of initiating it are not understood. Because of this the rising heat-gradient, which induces processes of decomposition, has been employed almost exclusively. The developmentally regressive spread of cancer also accelerates in step with the achievement of these supposed successes.

Instead of evolution promoting, performance and potential enhancing, supplementary energies, these machines produce reactive, repulsive forces, which inhabit water and air by the trillion. However, because a nine-fold amount of fuel is required to overcome the resistance to motion, an increasingly widespread scarcity of raw materials is inevitable as a result of their over-exploitation. Larger and larger, and more and more expensive mammoth structures will therefore be required which, in the case of hydroelectric power stations, will worsen the condition of the water and the air in increasing measure. The present concerns for their financial viability are the direct consequence of this. For this reason there is only one way out; either to reduce the tariffs radically, or to introduce cheaper and better generating equipment.

The same error of over-warming and over-illumination has also been made in forestry and agriculture. A complete change is therefore necessary. Understandably, this cannot be carried out by those who consciously or unconsciously altered the preconditions for growth and development. Nor can they admit to their failure, because it concerns the prestige of the scientific establishment and its political adherents. A completely new foundation must therefore be laid in order to prevent the total contamination of water and air, so vital for the well-being of all people.

The implosion machines, which make use of the temperature-gradient that increases growth and further development to achieve this, can only be entrusted to those who place the common good before their own well-being. They should have absolutely no interest in clinging to any kind of craving for power. It should be as Albert Schweitzer stated in his conclusion: 'Public opinion has no need of referenda or the creation of commissions to express itself — it is effective merely because it exists.'

The will of the people must become the supreme guiding principle. This will happen automatically once the broad mass of humanity finally realises that it cannot correct wise Nature, but can only copy her. The continued exploitation of present systems of energy production for peaceful purposes, which result in total annihilation (Einsteinian forms of atomic energy), will then be unnecessary.

Everything else Albert Schweitzer has already stated. In amplification of this, Borne once declared: 'What only yesterday was either derided or decried as occult, and even today is marvelled at with certain timidity, will tomorrow be accepted as commonplace.' All that is now required is for people to recognise that the rise in temperature and fever caused by unreal techno-academic forms of motion, is a function of the retroactive molecular motion thus engendered and therefore the true cause of cancer.

All that is necessary to re-establish the natural world order, is to regulate the anomaly state of health by means of the temperature-gradient. This condition

has been disturbed at its most fundamental level by the errors in motion that have been made. By the sweat of his brow, therefore, man must now suffer the consequences of his pressure- and fire-technology.

As for the rest, it is merely a question of the inauguration of Eco-Technology, since the machines and devices it requires are already available; at any event, to those who have an earnest will to combat this madness with every means at their disposal. All those, who still believe they can create a healthy economy or culture using atomic excess pressure and the influence of fire, should be totally ignored.

New Concepts of Electricity

An article from Der Wiener Tag, Sunday 18 December 1932, No. 3443, p. 20.

Long ago the ancient Greeks had already observed the energy in amber, today called electricity. Since then the use of electricity has undergone a tremendous and quite undreamt of evolution, so that we can rightly describe the present era as the Age of Electricity. Now, more than ever before, interest is being shown in understanding its essential nature.

As is known, both dualistic and Unitarian hypotheses addressing this problem were put forward about the middle of the eighteenth century. According to the former, which stems from Sumerian concepts, every body or substance was originally supposed to have been charged with equal quantities of positive and negative fluidium, i.e. electricity. According to this view, an electric charge could be generated either by the addition of positive fluidium or by the removal of negative fluidium, as a result of which the original state of equilibrium would appear to be disturbed. According to the unitarian or single-fluid hypothesis proposed by Benjamin Franklin, every substance possessed a normal amount of electricity. An electrically charged body, by comparison, had a superfluity or an insufficiency of fluidium. In this regard, the physicist Rosenberg states that, on the basis of this theory, the question of the material nature of electricity is in no way clarified. From the most recent research into the conduction of electricity in rarefied gases, however, we now know that electrically charged particles (electrons) come into being, their mass amounting to 1/1700 th of the mass of a hydrogen atom.²¹

In view of the various avenues of research at the disposal of all branches of science today, attempting to answer the question of the nature of electricity on the basis of findings taken from only one or two directly associated fields of knowledge will not provide a satisfactory solution.

Rather we should consider 'rays of electrical force', as Heinrich Hertz described them; firstly in their relation to other radiation phenomena and

secondly in terms of their oscillator) activity in relation to pulsation. The later is synonymous with the life-activity in organic bodies and this pulsation takes place wherever carbon and oxygen come in contact with each other. Pulsation takes place in all the smallest particles in the smallest measure, and to a correspondingly greater extent in all the larger bodies created from them, due to the continuing existence of pulsations in the smaller bodies. In solid matter these processes take place by way of a carrier, whose role is always assumed by hydrogen, as has already been described by the author elsewhere.

This constant pulsation is synonymous with the processes leading to interactions between oxygen and carbon groups. It results in the progressive ennoblement of carbon with each successive encounter, if the relative distribution of both elements is correct. These pulsations can be detected in ordinary riverwater by the fluctuation of the water surface in a Darcy-pipe, or in plants with the auranograph experiment (by Sir J. Chandra Bose), whereas in animal life, pulsations are provided throughout their whole bodies through the process of breathing and the heart's activity. Even our Earth and the surrounding spheres produce a certain rhythmical, inhaling-exhaling movement, which arises as follows.

High above us is the stratosphere and far beneath us the carbonosphere, between which lies our living-space, the space where our lives unfold and in which we breathe in the substances of the aforementioned spheres together with hydrogen. The zones of demarcation between the central sphere — the living-space — and the neighbouring spheres form two neutral strata, strata where isotherms corresponding to our concept of $+4^{\circ}\text{C}$ ($+39.2^{\circ}\text{F}$) lie. (See Fig. 2)

With the alternation of night and day and the associated fluctuations in temperature, the positions of both neutral strata are subjected to minor displacements, whereas with changing seasons and weather they experience far more major shifts. With the advance and retreat of both neutral strata, oxygen is brought into the living sphere from above and suitably preconditioned carbon from the carbonosphere below. Through this process, through this 'breathing in the living-space' as it were, formative substances succeed in entering atmospheric water. Every interaction represents a qualitative enhancement, an ennoblement, if the ratio between oxygen and carbon is correct.

If too much oxygen is present, a depreciation must inevitably ensue, i.e. a decomposition of carbon takes place. Here the combustion of carbon occurs; phenomena which are directly related to destruction and increased temperature. Since the distribution between oxygen and carbon is dependent upon the temperature indirectly caused by one of them, processes of amelioration or deterioration also depend on whether the temperature influence acts directly or indirectly. At the moment however, there is no exact definition of any particular thermal motion and hence no temperature as

such. All we can speak of is a temperature gradient, or a movement of temperature, The temperature-gradient is therefore something that is immaterial, a phenomenon subjected to constant change in time as well as space, where it exhibits characteristics otherwise only attributed to rays. Following on from this, we could describe the temperature-gradient as an inferior form of ray, which provides the impulse for other interactive phenomena, which themselves enable the emergence of other forms of radiation.

Fig. 2: Location of other +4°C isotherms in the atmosphere.

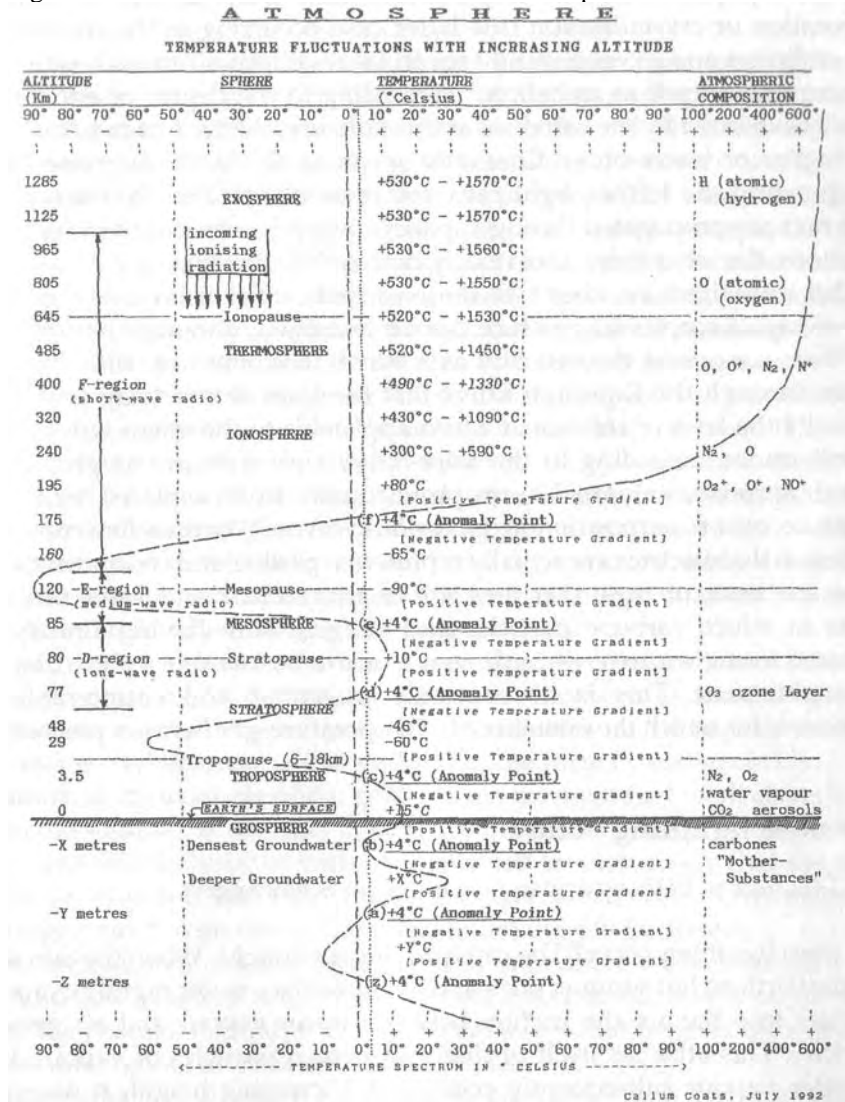

Everywhere we look, we find the temperature gradient active; in the hydrological cycle, in the energy cycle, in the transmutation of energy either from material energy into living energy or from a moving energy-form into a structured one. The purpose of the temperature-gradient is the continual redistribution of quantities and the regulation of qualities of carbon and oxygen present in the carrier, i.e. the water.

Therefore, if as a result of the action of temperature influences, hydrogen becomes separated into fine ice-particles at low temperatures, be it through evaporation or crystallisation (the latter case occurring in the stratosphere), then carbon and oxygen stand face to face without a carrier, a state which now expresses itself as radiation.²³ According to the degree of ennoblement actually exhibited by the carbon at this juncture, the type of radiation is also of a higher or lower order. Generally speaking the latter comprise thermal radiation and the former, light rays and cosmic rays. Due to resistances, all these rays are propagated through space in wave-like form and in the form of vibrations, the latter being most easily detected by Branly's coherer. According to other investigations, above all those carried out by Schrodinger, a further type of ray of corpuscular nature can be imagined, although hitherto it has only been conceived theoretically as a wave. In connection with this it was proven through the Compton Effect that the laws of everyday physics and especially the laws of collision are also applicable to the micro-world.

Furthermore, according to the wave-theory view of matter as proposed by Smekal, corpuscular particles are provisionally to be replaced by a wave-packet, i.e. by a superpositioning of various waves.²⁴ We therefore come to the conclusion that electric rays actually represent a particular developmental stage in the spectrum of rays; that they are of corpuscular and wave-theoretical nature in which carbon particles and oxygen, both having already been separated from the carrier — hydrogen — are to be found in a particular stage of ennoblement. This is a constantly pulsating and counterbalancing movement, for which the existence of a temperature-gradient is a precondition.

How does lightning occur?

From TAU, 145, p. 19 (handwritten note by Viktor Schauburger).

How does lightning occur? The cause of this is sunlight. When the Sun shines onto the Earth on hot summer days and all the surface water rapidly evaporates and rises into the air, the friction between water vapour and air generates electricity. This attaches itself to finely dispersed particles of vapour. When the water vapour subsequently cools with increasing height, it necessarily condenses and aggregates into raindrops, whose size is dependent on the

surface tension and the intensity of the cooling. This condensation is inseparable from the release of electricity, which can no longer be stored in the clouds and has to re-establish equilibrium with the Earth as lightning.²⁵

Electrolysis

An article from Der Wiener Tag, Sunday 6 November 1932, No. 3402, p. 20.

In the Neues Wiener Tagblatt, a well-known Viennese engineer and hydraulics expert recently put forward the idea of decomposing water into its constituent gases, hydrogen and oxygen, with the aid of cheap and often unusable offpeak electricity at night, thus making these very useful cheap gases available to industry for all manner of purposes. The idea of being able to decompose water is so deeply ingrained in our mental concepts that great effort is needed to make the absurdity of such an idea clear to independently minded people. This belief is roughly equivalent to the alchemy of the Middle Ages, where dozens of people set about making gold and either deceived their fellow-men or were often the victims of their own madness.

The extent to which this engineer and hydraulics expert had considered the details of his suggestion, naturally cannot be ascertained here. It is to be assumed, however, that he really believes that water can in fact be decomposed by an electric current. On closer reflection it becomes quite clear that in the well-known process of electrolysis, we are not dealing with the decomposition of water itself, only with the separation of water's legitimate admixture of carbonates and oxygens. The former being contained in water in the widest variety of gradations and compositions.

In good well-water these carbonates are naturally present, even if in very modest proportions. In the case of water that has been exposed to external temperatures over a lengthy period or conducted in improperly installed water mains, carbonates are usually added in the form of various acids.

To return to the example of the gold-maker, we must first of all cleverly add gold to the solution, if we wish to produce gold. Today the process involving the analysis (electrolysis) of water is explained in such a way that the water itself is decomposed into two completely new substances — hydrogen gas and oxygen gas.²⁶ With this in mind the following can be stated.

It is a well-known fact that electrolysis is impossible with chemically pure water and that a catalyst is necessary which, it is claimed, is only supposed to initiate the process. A catalyst is the neutral agent that triggers off a reaction without undergoing any material change itself.

However the added acid is qualitatively changed in the decomposition of water. The explanation for this is as follows: While it is true that oxygen is

dissociated during the analysis, water, however, is merely transferred from a liquid to a gaseous state and in this form still retains its function as the carrier of the oxygen and carbon in the same way that all acids of whatever composition are viewed as carriers. With the apparent combustion of hydrogen gas to water, we are in reality concerned with the fact that it is the carbon particles carried by and contained in the hydrogen itself and also in the introduced acid that combust, and that water once more assumes its original liquid state after combustion has ceased.

Now, as it ever was, water itself remains the indivisible element that carries carbon and oxygen. These two elements energetically interact in the water and express their material processes of transformation as pulsation. The fact that the whole of science will be somewhat offended by the exposure of this untenable view, is of course totally unimportant in any material sense. The very moment this misconception is revealed for what it is, those who continue to believe that water can be decomposed by an electric current will have joined the ranks of the gold-maker, who on occasion was imprisoned or derided as a poor fool.

At a temperature of $+4^{\circ}\text{C}$ ($+39.2^{\circ}\text{F}$), the reciprocally interactive basic elements in water achieve a certain state of equilibrium. These substances, namely the gaseous and ethereal carbon, are endowed with a certain buoyancy and become infinitely, finely dispersed in the water at this temperature. The oxygen, by comparison, is very condensed at $+4^{\circ}\text{C}$ ($+39.2^{\circ}\text{F}$) and, because of its known higher specific weight, acts against the ascending carbon. If there is any change whatsoever in the direction of movement of temperature, then a corresponding shift in the state of equilibrium occurs and hence a return to the situation described earlier. This inevitably results in the encounter of the mutually interactive elements present in the water.

Every time these elements encounter each other along their oppositely oriented paths, an exchange of energy occurs. According to the existing preconditions, themselves dependent on temperature influences, this interaction functions either positively and formatively, or negatively and decomposively, depending on whether the energies are discharged in a constructive or destructive manner. Whether formative or decomposive, it is the action of the prevailing temperature that tips the scales, since it is through its effect that a redistribution of quantities and decisive qualities occurs and hence absorption or emission of one or other of the basic elements. The correct ratio in the distribution of these elements and their proper metabolism are conditioned by a correctly and, above all, evenly acting temperature. Conversely, if the metabolic processes take place correctly, then an almost uniform condition of temperature is established.

Therefore, as long as the thermometer indicates an almost uniform temperature, the metabolism and hence the formative processes in the

respective body or substance are in order. Any alteration or disturbance of metabolic processes causes a change in the temperature of the water or the respective body. To ensure that these metabolic processes are not disturbed by outside influences, all the capillaries are insulated by suitably poor conductors of heat, such as wood, bark, fat or oil. The more important the capillary and its function, the more essential the insulation becomes.

Naturally, even if it proceeds in the proper manner, every interaction must finally come to an end, resulting in a complete reversal of the processes — a re-decomposition occurs. Therefore, the more correctly the formation proceeds, the slower and hence for humanity, the more advantageously the decomposition takes place. This fact is of great significance in relation to such substances as metals and timber, for example, which serve as raw material for man-made products. However, if the interaction is exposed to any disturbing outside influences or if the organism's formative processes are disturbed, this decomposition will set in before the ultimate objective is reached, i.e. before the time when the interaction would normally cease.

We can perceive the causes of this in two different types of formation. In one case the termination of this energetic interaction, which, for example, we can observe in various structures and living systems we find in Nature, manifests itself in such a way as to redirect or rearrange the formative pathways, capillaries or rivers. Because of this, essential high-grade substances, which are not easily transported, can no longer be distributed correctly.

In other cases the disintegration (decomposition) of the developmental pathways — capillaries — ensues. Hence the circulation of that substance is brought to a standstill, which is the carrier of the decisive raw materials and which we describe as water, blood, sap, etc. according to the location in which it moves. The usual end-product of such an interaction is the sedimentation of the body's capillaries, which in the animal kingdom is represented by sclerosis, in the vegetable kingdom by resinification, and in the so-called inorganic world by calcination.

This phenomenon only occurs when carbonates are present in sufficient quantity. However, if these substances are missing and a concentration of oxygen occurs due to abnormal temperature influences, then in the absence of sufficient sheathing material (protective lining), the oxygen attacks the wall-surfaces of the vessels, since these are composed of carbonous matter. Ultimately these vessels are either weakened to such an extent that they burst, or direct manifestations of decay and unnatural growths develop in the familiar form of cancerous tumours. In these transformations, the extent to which radiant emissions play a role, which are themselves a product of these processes, will be addressed in more detail in a later article.

In every respect, contemporary practices of science and technology operate in opposition to the correct and hence positive processes of formation and

development. For this reason, very advanced processes of degeneration that have long remained unnoticed will inevitably begin to surface everywhere. These are now assuming such catastrophic proportions that everything is beginning to suffer from them. We shall therefore become more and more consciously aware that we are not concerned with a world crisis here, but with the complete collapse of everything we have come to call culture.

If these manifestations of collapse have actually reached such a stage today that any possible recovery is in doubt, it is because the strictly regulated correlation between quantities and qualities has already been so totally dislocated. It is also because really monstrous mistakes are being made everywhere. In view of this chaos of errors and insanities, attention should be drawn to two extremely dangerous factors. These are our electrical machines and their practical application today.

Were our authorities really to understand the true nature of electricity, then our present-day hydroelectric power stations would be forbidden by law. The same would also apply to radio and the present use of short-wave radiation (X-rays) in medicine. Out of a substance totally foreign to them — water — our science and technology are creating a product, the nature of which is even more unknown to them.

Under certain preconditions the carbonates of whatever variety present in water, which conforming to natural law are inversely proportional to the oxygen likewise present, are precipitated from the water or hydrogen and are replaced by oxygen.

The third metabolic process between the basic elements contained in water is a question of the thermodynamic processes taking place in it. Apart from the usual outside influences, these are also dependent upon the type of movement of the water itself. For example, if the carrier of these two basic elements (carbonate and oxygen) — namely the water — is caused to rotate over-rapidly by the blades of turbines, then it exceeds its so called critical velocity, and breaks. The carbonates are then precipitated. Behind the blade a vacuum is created. The specifically heavier oxygen is the first to reach the undersurface of the blade and is there dispersed mechanically.

Due to the particular temperature-gradient provoked by this event, corrosion occurs on the underside of the blade in such a severe form that finger-size holes are created, which very quickly render the turbine blade totally useless. This phenomenon is again attributable to the exceptional interactions of energy, which occur through the direct contact between the carbonates (turbine blades) and the oxygen, the latter having become almost carrier-less owing to the high rotational velocity.

Similar processes are evident in the high-pressure boilers of ocean-going ships and, inter alia, in the widely known Kneipp cure,²⁷ which is nothing more than an energetic charging of the body in the form of a weak electric current,

induced when cold dew-drops on the grass are wiped off by the feet of a body warm from bed.

However, to return to the theme of hydroelectric machines. The first task of the water discharged from the outlet pipe is to restore its inner state of equilibrium, lost through the precipitation of its carbonates. The water greedily absorbs oxygen from the air. This process, however, is only the means to an end which is the replacement of the lost carbonates.

With the onset of night cooling, wherein it actually becomes heavier, and with the additional assistance of the surplus oxygen, water must either sink down or infiltrate through the riverbanks and into the ground. Through the drainage and seepage of these heavily oxygenated water-masses,²⁸ a temperature-gradient is created, which is strongly negative from the water towards the surroundings, and conversely, strongly positive from the environs towards the water. In this way an inflow of the carbonates present in both ground water and atmosphere arises, which are then sucked into the strongly oxygenated riverwater and hence into an interaction. This interaction, however, naturally occurs at the expense of carbonous matter in groundwater, and thus to the detriment of the intrinsic quality of the soil.

Once this interaction has terminated, then the groundwater has to a certain extent lost its inner state of equilibrium again, owing to the removal of carbonates and the accretion of oxygen due to the interaction described above. In conjunction with the reduction in temperature thus caused, the ground-temperature-gradient also reverses during the night, leading to a further interaction in a vertical plane. Having been depleted physically, so to speak, due to the lateral withdrawal of the carbonates, the over-oxygenated groundwater now sinks. These processes are the true cause of the sinking of the groundwater table now increasingly evident throughout the whole of Central Europe.

In this way it is inevitable that formative substances absolutely essential for the growth of all vegetation, namely carbonates rising from the Earth with water, will in the end be entirely incorrectly distributed and deposited. This will result in the ever more widespread degradation of our native soil. Ultimately it will not even be able to provide our daily bread, for the simple reason that with our technical equipment we have not only halted the influx of raw materials required for all existence, but we have actually transformed them into negatively acting, decomposive substances.

Notes

1 Here 'original' also means form- or structure-originating or form- or structure-bestowing motion. — Ed.

2 Ur-source: In Viktor Schauberger's writings in German, the prefix 'Ur' is often separated from the rest of the word by a hyphen, e.g. 'Ur-sache' in lieu of 'Ursache', when normally it would be joined. By this he intends to place a particular emphasis on the prefix, thus endowing it with a more profound meaning than the merely superficial. This prefix belongs not only to the German language, but in former times also to the English, a usage which has now lapsed. According to the Oxford English Dictionary, 'ur' denotes 'primitive', 'original', 'earliest', giving such examples as 'ur-Shakespeare' or 'ur-origin'. This begins to get to the root of Viktor's use of it and the deeper significance he placed upon it. If one expands upon the interpretation given in the Oxford English Dictionary, then the concepts of 'primordial', 'primeval', 'primal', 'fundamental', 'elementary', 'of first principle', come to mind, which further encompass such meanings as: pertaining to the first age of the world, or of anything ancient; pertaining to or existing from the earliest beginnings; constituting the earliest beginning or starting point; from which something else is derived, developed or depends; applying to parts or structures in their earliest or rudimentary stage; the first or earliest formed in the course of growth. To this can be added the concept of an 'ur-condition' or 'ur-state' of extremely high potential or potency, a latent evolutionary ripeness, which given the correct impulse can unloose all of Nature's innate creative forces. In the English text, therefore, the prefix 'ur' will also be used wherever it occurs in the original German and the reader is asked to bear the above in mind when reading what follows. — Ed.

3 Ethericities: This term refers to those supranormal, near non-dimensional, energetic, bioelectric, biomagnetic, catalytic, high-frequency, vibratory, super-potent entities of quasi-material, quasi-etheric nature belonging to the fourth and fifth dimensions of being. As such they can be further categorised as fructigens, qualigens and dynagens, which respectively represent those subtle energies, whose function is the enhancement of fructification (fructigens), the generation of quality (qualigens) and the amplification of immaterial energy (dynagens). According to their function or location these may be male or female in nature. — Ed.

4 Temperature-Gradient: This refers to a movement of temperature, where temperature is seen as a condition of energy. A decrease in temperature towards +4°C (+39.2°F), the so-called anomaly point of water, is a positive temperature-gradient, where water gains in density, dynamics, potential and energy content, reaching its maxima at +4°C. A movement of temperature in the opposite direction, either upwards or downwards from +4°C is a negative temperature-gradient. — Ed.

5 Od was a hypothetical force held by Baron von Reichenbach (1788-1869) to pervade all Nature, manifesting itself in persons of sensitive temperament (streaming from their fingertips), and exhibited specially by magnets, crystals, heat, light and chemical action; it has been held to explain the phenomenon of

mesmerism and animal magnetism. It forms the second element in chemical derivatives as biod; the od of animal life; chymod — chemical od; crystallo - the od of crystallisation; elod — electric od; heliod — the od of the Sun; magnetod — magnetic od; pantod — od in general; selenod or artemod — lunar od; thermod — heat

od. (Oxford English Dictionary). — Ed.

6 Whorl pipe: These have an egg-shaped cross-section, narrowing conically towards their ends and which have an impressed indentation over their whole length, by means of which the 'in-rolling' of air or water is enabled. The narrowing of the cross-section occurs harmonically (proportionally), the exit nozzles can be of any size and the pipes of any length. In the implosion machine, several pipes are mounted on a conical rotor and radiate outwards from a common inlet. Through the rotor's rotation, the medium in the pipes (water or air) is subjected to centrifugal acceleration, resulting in its split-second in-rolling, which leads to its cooling and densification. Through the discharge of this condensed and twisted water-plait, powerful repulsive forces are generated, if the water-plait is centrifuged against the fluted outer walls. This recoil is the driving force. — A. Khammas, Implosion Magazine No. 83, p. 14-15. Also see other descriptions in Energy Evolution, Vol. 4 of the Eco-Technology series. — Ed.

7 In The Secret Doctrine by H P Blavatsky, p. 555, reference is made to the 'newly discovered potency which the discoverer (Keely) has named "Inter-Etheric Force or Forces" and on page 556 it continues, 'Mr Keely, in explanation of the working of his engine, says, "In the conception of any machine heretofore constructed, the medium for inducing a neutral centre has never been found. If it had, the difficulties of perpetual motion seekers would have ended and this problem would have become an established and operating fact. It would only require the introductory impulse of a few pounds on such a device, to cause it to run for centuries. In the conception of my vibratory engine, I did not seek to attain perpetual motion; but a circuit is formed that actually has a neutral centre, which is in a condition to be vivified by my vibratory ether, and, while under operation by the said substance, is really a machine that is virtually independent (independently active) of the mass (or globe), and it is the wonderful velocity of the vibratory circuit that makes it so. Still, with all its perfection, it requires to be fed with vibratory ether to make it an independent motor.'" ' — Ed.

8 Tractive force: This refers to the force described hydraulically as 'shear force' — the force that acts to 'shear off or to dredge and dislodge sediment. In German the term for shear force is 'Schubkraft', meaning 'to push', 'to shove' as well as 'to shear', whereas Viktor Schauberger uses the word 'Schleppkraft'. The verb 'schleppen' means to drag, draw or pull. Viktor Schauberger's choice of 'Schleppkraft' here is quite specific, since in his view the movement of sediment is due to the sucking action of fast flowing, dense cold water downstream, rather than to the mechanical impact of the water coming from upstream. In view of this subtle change in emphasis, in lieu of the hydraulically correct term 'shear force', the term 'tractive force' will be used. This dynamic is similar to the effect of wind on roofs, where a roof is blown off not by force from the windward side, but rather by the sucking effect of vortices created on the leeward side. — Ed.

9 Naturalesque: As adjective or adverb, in the Oxford English Dictionary this is defined

as 'Having the characteristics of Nature or natural objects.' and 'Imitation or adherence to nature.' Us use here and elsewhere is to differentiate between processes and objects that occur naturally and similar objects and processes that are technically contrived so as to accord with Nature's own functions. — Ed.

10 The term 'centrifugence' relates to all centrifugal phenomena; its counterpart 'centripetence' relating to all centripetal phenomena. — Ed.

11 A small tub or trough which Mesmer filled with water in his magnetic experiments. Mesmerism was the system or doctrine popularised by Mesmer, according to which, a hypnotic state, usually accompanied by insensibility to pain or muscular rigidity, can be induced by an influence (at first known as 'animal magnetism') exercised by an operator over the will and nervous system of the patient. Mesmerism is the process or practice of inducing such a hypnotic state; it is also the influence supposed to operate — animal magnetism. — Oxford English Dictionary.— Ed.

12 This concentration is non-spacial in the sense that it involves the concentration of immaterial energies or energetic ethers. — Ed.

13 See An experiment and associated illustration, in *The Water Wizard*, Vol. 1, p. 50, of the Eco-Technology series. — Ed.

14 Carbone: In contrast to the normal use and definition of 'carbon', Viktor Schauberger grouped all the known elements and their compounds, with the exception of oxygen and hydrogen, under the general classification of 'Mother Substances', which he described with the word 'Kohle-stoffe', normally spelt 'Kohlenstoffe' and meaning carbon. Apart from the above definition the hyphen also signifies a higher aspect of carbon, both physically and energetically or immaterially. The additional 'e' in the English word is therefore intended to redefine and enlarge the scope of the usual term 'carbon' in accordance with Viktor's concepts. — Ed.

15 The energy of the hurricane 'Beulah' was measured and found to be the equivalent of the explosive force of 140 hydrogen bombs. — VS.

16 To come to a common water-level via connecting tubes or passages. — Ed.

17 This device is described in more detail in *Energy Evolution*, Vol. 4 of the Eco-Technology series. — Ed.

18 Sintering: 'The process of heating and compacting a powdered material at a temperature below its melting point in order to weld the particles together into a single rigid shape. Materials commonly sintered include metals and alloys, glass, and ceramic oxides. Sintered magnetic materials, cooled in a magnetic field, make especially retentive permanent magnets.' — *Concise Science Dictionary*.

'The development of a whitish, porous encrustation, usually consisting of silica.' — *Oxford English Dictionary*. — Ed.

19 Sir Isaac Newton refers to it thus: 'Nature is a perpetual circulatory worker, generating fluids out of solids, fixed things out of volatile, and volatile out of fixed, subtle out of gross and gross out of subtle. Thus perhaps may all things be originated from Ether.' (*Hypotheses*. 1675). Extract from *The Secret Doctrine* by H. P. Blavatsky, p. 13. — Ed.

20 The Tabula Smaragdina was a spiritual testament incised into an emerald tablet akin

to the tablets of Moses. — Ed.

21 More recent findings place the mass of the electron at 1/1836 th of the mass of the hydrogen atom. — Ed.

22 Apart from the two +4°C isotherms lying above and below the ground surface mentioned here, there are also others at various higher altitudes — see Fig. 2 — lid.

23 See also The Learned Scientist and the Star in the Hailstone, in The Water Wizard, Vol.

1, p. 193, of the Eco-Technology series. — Ed.

24 Wave theory and corpuscular theory have now been superseded by quantum theory and wave mechanics. — Ed.

25 'Over the whole world 1,888 thunderstorms are active at any given time. Thirty lightning strikes hit the Earth every second. The average energy of a lightning strike is estimated at 1,700 kW. Lightning strikes can be up to 9 km (5 miles) long, and sheet lightning up to 100 km (60 miles) long.' — Implosion Magazine No. 77, p. 22. In this process ozone or O₃ is also produced. — Ed.

26 'Recently the formula determining the gross elements in the constitution of water has altered many times. Today, however, we have just learnt, that one cubic centimetre of water contains 1,234 cm³ of hydrogen and 622.1 cm³ of oxygen, which together produce 1,856.1 cm³ of oxyhydrogen, or detonating gas. During combustion this quantity of oxyhydrogen gas delivers 3.83 large/macro calories, which are able to heat up 3.83 litres of water from 14.5°C to 15.5°C (58.1-59.9°F). In accordance with the 'Brussels Convention', a normal drop-count was agreed, whereunder 20 drops of pure water at a temperature of 15.5°C (59.9°F) exactly fill the volume of 1 cm³.' — Heinrich Huber. Implosion No. 20, p. 5.

27 Kneipp cures: Sebastian Kneipp (1821-97) developed a spiritual and natural therapy, which made specific use of certain kinds of water. — Data from the Deutsches Universal Wörterbuch by Duden. — Ed.

28 Water-masses: this expression refers not only refers to the body of water generally, but also to the various swirling volumes and filaments of water of different temperatures, densities and energetic content whose values are prescribed by the inner dynamics of the water. — Ed.

The Formation of Structures

The safe lifetime, therefore the stability, of a dam is not only a question of correct static calculation. Rather, it is dependent on the influences of temperature exerted on the wall by the surrounding air and water strata.¹ If through outside influences, a negative temperature-gradient is established in a dam wall, or if the temperature of water-particles in it diverges from $+4^{\circ}\text{C}$ ($+39.2^{\circ}\text{F}$), then a cavitating action (as differentiated from a sedimentating action) takes place.² The latter occurs in the wall when the water-particles present in it approach a temperature of $+4^{\circ}\text{C}$ (positive temperature-gradient). Cavitating action is the enlargement of pores and thus the loosening of the wall-structure through dissolution and leaching of certain salts at certain temperatures. Whereas, sedimentating action is the sealing of the wall-structure (pores and voids) through internal deposition of certain salts due to a particular movement of temperature.

Degradation or amelioration of the wall-structure is thus dependent on the relative proportions between periods of positive and negative temperature-gradients inside the dam wall. The type and duration of the respective movements of temperature is a question of location, general climatic conditions and principally, the orientation of the wall (direct or indirect influence of the Sun). In the dam wall, therefore, the very same phenomena are manifested

2.

The Influence of Temperature and Water Movement

(on Forestry, Water Resources Management and the Formation of Structures)

From Die Wasserwirtschaft, the Austrian Journal of Hydrology, Vol. 3,1931, pp. 44-7.

that occur in Nature, for instance in the erosion of mountains under the Sun's influence (negative temperature-gradient), and their reformation with the exclusion of the Sun and under the influence of the low temperatures. To a certain extent these are present in the oceans and in the Earth's interior (positive temperature-gradient).

Coming-into-being and passing away are therefore a question of a hitherto-ignored, unrecognised form of temperature movement in bodies. This movement is the legitimate consequence of the anomalous character of water whose significance has still not been evaluated. The formation and destruction of rock (walls and suchlike), however, is not the only area in which this plays a major role. Because of the anomalous condition of water, the organic or inorganic development of the structure will either be changed or altogether created. Thus, both the lifetime of a dam wall and even the possibility for Life itself will be influenced through the correct formation of the respective structure. This includes the plant kingdom too and the reproductive capacity of living things.

The existence or non-existence of all bodies and products of Nature is hence a question of the way in which water moves; whether it is a correct form of movement according to natural principles or an incorrect form that takes place in its inner circulation through the Earth. Thus the energy-form A of water movement, which in one instance represents the affirmation of Life and in the other its negation, is a function f of the water's hitherto neglected temperature-gradient tg.

$A=f(tg)$

It is well-known that water is the carrier of certain nutrient salts. At certain water temperatures, but under one particular temperature-gradient, these salts will be dissolved, under another transported and under a third deposited. The type of temperature movement, the temperature-gradient, and hence the effect of the energy of the water in the Earth, the body or the living creature, plays a greater role than has been so far assumed in relation to vegetation and the essential supply of nutritive material from the Earth's interior. Logically, the form of temperature movement of water within the Earth and other bodies, however, is once again merely a question of the possibilities for direct or indirect radiation by the Sun. Therefore it is a question of associated climatic conditions and this naturally encompasses the disposition of mountain ranges and intervening valleys.

The temperature-associated processes mentioned above are responsible for the supply of nutrients to the Earth's surface, through which the very existence of any vegetation is made possible. Once established, vegetation is then able to moderate extremes (direct solar radiation) at any given altitude,

through low temperatures caused by strong evapo-transpiration. In the mountains, where the need is greatest, this counterbalancing function and the especially important retention of groundwater on steep slopes can only be achieved by a healthy forest, appropriately graduated according to altitude, area, age and species. Without these preconditions and without taking the overall climatic conditions, the situation and state of the forest into account, there can be no healthy condition of water or its orderly distribution. Hence there can be no profitable use of upland areas for agricultural purposes. This problem will naturally be all the more critical, the higher the situation and the more extreme the climate.

In these locations hard winters with deeply permeating belts of frost make essential maintenance of high internal ground temperatures possible. Contrasting conditions of temperature come into being, creating stresses in the ground. Water will be forced upwards by an extremely simple process of densation, which in spring necessarily intensifies in the process of rising. In summer it is the turn of properly graduated forest, which through its low ground temperatures retains water closer to the surface, thereby maintaining nutrients in proximity to a naturalesque distribution of root systems.³

Up to now the forestry industry has regrettably paid no attention to this process of Nature. Through the very antithesis of proper management practices (clear-felling operations), a reduction in potential differences in the ground inevitably occurs through the break in forest cover, which also results in water sinking. Instead of an increase in cultivable land, a decrease ensues as a direct consequence of such systems of forest management. Instead of these systems building up the forest (this primary and most important precondition for culture),⁴ they qualitatively mismanage it to death. The main reasons for our cultural decline are:

- contemporary administration of forest resources, centralised in large industrial complexes, which is not only self-destructive but also destroys other cultivable land
- totally faulty river regulation and torrent confinement
- misguided and arbitrary management of the hydroelectric power industry.

The Dying Forest

For decades vigorous generations of young trees once lived in equable conditions of temperature, humidity and illumination under the protection of mother-trees in healthy, natural forests untouched by humanity and its science. It was only through the death of the mother-trees that the majority of

the young tree population, having meanwhile come of age, were able to attain the enjoyment of direct light and heat. In other words, not before the period of infancy had passed; a period during which trees react to extreme environmental conditions with very wide annual rings. (See Fig. 3) The naturally-ordained increase in light and heat not only promotes well-balanced further development, but also gives a necessary and beneficial impetus to reproduction. It is to be emphasised that under these conditions the trunk itself will still remain shielded from direct sunlight and only the crown of the tree will be exposed. The enormous importance attaching to this sequence of events will become apparent in what follows.

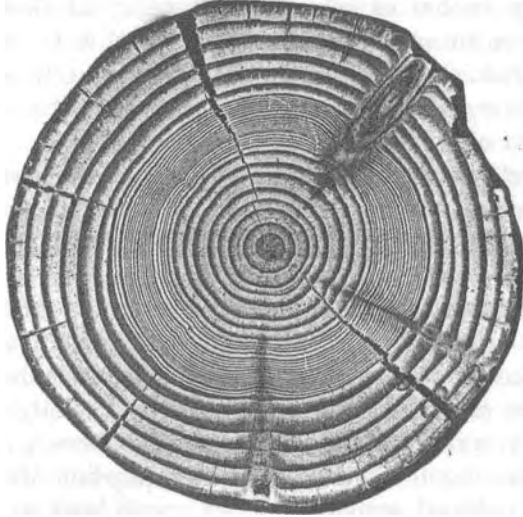

Fig. 3: A 33-year old plantation tree showing wide annual rings in early years. Gradually narrowing due to the shielding of its companion trees, the rings expand again abruptly once this protection has been removed.

The forester, who naturally could not fail to notice the phenomenon of so-called 'light-induced growth', saw in this the possibility for the scientific manipulation of growth and the opportunity it offered him to correct Nature. Even if contrary to the natural order, he advanced new, and in his opinion, better and more appropriate laws. For his new plantation forests he exploited this factor at the very moment when a young tree reacts to an excess of light and heat with lateral expansion — with excessive growth of its annual rings. Furthermore, by concentrating the areas of work, this newly adopted method now made clear-felling and a supposedly more rational management possible. Even when this system was first introduced, the disappearance of certain

types of understorey was already evident. This was not perceived as a disadvantage, however, but rather as an advantage, because the unnecessary over-consumption of the soil's water and nutrients by unprofitable undergrowth was thus averted.

Inevitably this new system of forestry also caused premature exposure to the elements of frost-sensitive, shade-demanding species of timber, the pine for example, which under natural processes of regeneration congregate under the protection of older trees. If a larger number of these young trees subsequently die of frost, then as a result the remainder exhibit an increase in light-induced growth that almost leaps to the eye. However, the annual rings put on by pines, due to this sudden exposure are often a centimetre wide and produce a spongy timber of inferior consistency at these locations. After telling and even in standing timber, it often splits in an annular fashion producing ring-shakes). In the process of drying out, these spongy sections do not contract in the same way as healthily grown timber and its commercial use is naturally out of the question.

The pernicious effects of this well-known ring-shake proneness of pine, and the internal sickening it creates are transmitted to the rising generation, which is badly mistreated too. On qualitative grounds alone this must lead, even if imperceptibly, to the slow but sure dying out of this species of timber, a species that is necessary for the whole existence of the forest in those regions where pine grows naturally. The decline of the pines, which the forester cannot fail to see, could be tolerated in his view, because the pine produces an inferior wood, not especially sought after commercially, which can be far better replaced by spruce or fir. This opinion, however, is a common and unfortunately even more far-reaching misconception than the previously mentioned 'light-induced growth', which must lead to the extinction of certain species of timber, based as it is on unhealthy methods of regeneration. It is well-known that the most qualitatively valuable timber to be found in our region [Austria], so-called 'resonant timber', disappeared almost overnight when the principles of scientific forest management were introduced. This timber was rarely to be found even in primeval forest. Not merely dependent on the very extensive protection of the mother-tree, it could only grow in rough-like depressions under extremely sheltered environmental conditions, where it was immune to all outside influences. Here, in really poor soil conditions, it grows up in deep shade under precisely the opposite conditions to those created by contemporary systems of forestry. In contrast to the timber grown rapidly using modern methods, this slow-growing timber exhibits annual rings that can barely be distinguished by the naked eye. Moreover its organic structure displays a truly remarkable uniformity. Resonant timber (such as hazel, spruce and silver fir) is mainly used in the manufacture of musical instruments. The marvellous tone colour of the

instruments made from such wood (Stradivarius fashioned his famous violins with it) is not only indicative of the healthiest and therefore the most natural growth and development, but also of an almost unlimited durability.⁵ If we now compare the structure of the timber produced by modern forestry with the high-quality timber, now almost legendary in our indigenous forests, then for the first time we become fully conscious of the well-nigh irretrievable loss we have suffered; largely through the failure to appreciate the facts of the matter cited above.

In answer to possible objections that the other great advantages accruing from modern forest management cannot be sacrificed merely for the sake of a few rare resonant timbers, it is to be stressed that the above example was only used to highlight the qualitative differences between naturally and artificially grown and regenerated timber. In the very near future the increasingly noticeable deterioration in the quality of timber from decade to decade and the escalating problems of extending the upper limits of plantation on steep southerly slopes, should indeed provoke an urgent question. 'Is it, for the sake of relatively poor-quality light-induced growth, actually worth accepting the catastrophic loss in quality already evident after barely a century's operation of modern forestry, and therefore to put the very existence of our high forests at risk through such practices?'

A more detailed study and above all a return to natural processes, which will become all the more urgent in the near future, will reveal that the forest is not merely an object for exploitation, but an absolutely indispensable precondition for all forms of cultivation, particularly in mountainous areas. Also ever-increasing social privation is the result of the current destruction of the forest. What therefore appeared to be a great advantage at first view, indeed a real scientific achievement, in practice reveals itself as a perhaps totally irremediable disadvantage, a cultural decline.

The forester believed he could outdo Nature. What he achieved was the death and extinction of certain species of timber through the untimely application of a physical influence (sunlight), unknown in its actual effects. Through the forester's erroneous conduct of affairs outlined above, sunlight affects the structure of the timber and hence its organic development in the most detrimental fashion imaginable. The gross errors of contemporary clear-felling methods unfortunately have even graver consequences, which will now be addressed in greater detail.

Clear-felling

The mixture of species in undisturbed virgin forests is, and most certainly was, never accidental. In its existing proportion each variety of timber was

necessary in the other, the maintenance of the forest is not only a question of its above-ground composition, but also a matter of the distribution of species according to their root systems. This question becomes all the more important the higher the elevation of the forest (in mountainous regions).

Thorough observation cannot fail to register the fact that the dying out of one variety of timber creates a void in the nutritive medium (the soil) and therefore the elimination of one variety of tree results in the disappearance of another. It is the disruption of water supply and hence the supply of nutrients that we are concerned with here. The principles applied to silviculture by forestry today, such as clear-felling and artificial systems of regeneration, lead to a qualitative and therefore general deterioration.

Instead of the former coniferous old-growth forest, the undiminished natural force of which provided for its continued existence without human assistance, we are today presented with that woeful product of industrialisation, the timber of our modern forest industry. As quality timber it will be unusable after one further rotation and moreover, according to all prognoses, its seeds may well become infertile.

The recent protest (early 1931) against the import duty on fine Polish timber for the manufacture of pianos and violins, indeed the very objection to the use of native timbers for the fabrication of better furniture, demonstrates the severity of the decline. Through the continuation of current systems of management, this decline must lead to the total collapse of this income-earning area of employment, so vital to the national economy. We therefore stand literally before a dying forest, and the recent rebuttals to the warnings of the agronomist, Dr Kaltenbrunner, emanating from forestry circles, are irrelevant inasmuch as the decisive factor here is not the quantity of the miscellaneous remnants of old-growth forest, but the quality of artificially replanted young stands of timber, which will eventually become mother-trees. If the fir disappears, then in this part of the world the beech will become the most important species to suffer next.

Although it lies beyond the scope of the present theme, an explanation of the circumstances surrounding the disappearance of springs in beech forests should nevertheless be provided, if only briefly. An example of the adverse effect of temperature-influenced water movement, which is not conducive to the organic development of a body, is the appearance of tuberculosis in humans and animals in the vicinity of large beech forests with water-abundant soils. This is to be attributed to the abnormal evolution of chemically pure water vapour, which is nutrient-less water.

At certain temperatures chemically pure water has the property of greedily absorbing nutritive substances. In this process the structure of respiratory organs will be attacked, thus creating preconditions for this dangerous scourge in the lungs. This phenomenon naturally first makes its appearance

in those humans and animals, whose organic constitution (structure of the respiratory organs) is not accustomed to such an abnormal intake of water vapour. The enormous number of fatalities due to tuberculosis and internal haemorrhaging amongst black soldiers transported to Western Europe from hot climates during World War I cannot just be traced back to this phenomenon on its own, but also to the sick forest which created it. A sick forest does not die alone, but in dying also kills its destroyer — humanity.

At this point, attention should also be drawn to the tuberculosis prevalent in large enclosed beech reserves. If their stay in these areas is too prolonged, young forest workers, transferred from coniferous districts, fall victim to this affliction. Similar, but more severe effects than those in the respiratory organs appear in the stomach and digestive tract, if chemically pure water (tank or snow water) of less than +4°C (+39.2°F) or if +4°C springwater is drunk continually.

In common with animals and humans, plants too are adapted to their own individual temperature, which precisely corresponds to their species and the climatic conditions of their natural habitat. Here they are able to live unimpeded, maintaining and reproducing themselves to their full capacity. However the maintenance of the proper internal temperature is not only a question of habitat. More importantly, it is a question of the formation of the structure in which water is always found, even though it may differ in form and composition.

Once again, it is due to the irregularity, the anomalous condition of water, that under certain specific conditions even one ray of sunlight is sufficient to alter the state of equilibrium between the body and the water. This in turn leads to a movement induced by a change in the causes of motion (change in ambient temperature), to a pulsation and hence to an autonomous circulation, i.e. to life itself. Therefore, the more direct the Sun's influence, the more irregular the process of development as a result of the more marked alternation between day, night and the seasons, and the greater the demand for water becomes. The structure will become coarser and in the same measure the quality of the timber will also deteriorate.

Under the protection of mother-trees (natural regeneration), a moderate heat influence (indirect sunlight) leads to the formation of a close-knit and uniform structure throughout the whole period of growth. Quality timber can thus thrive only in the way Nature intended, in the sheltered environment of the mother-trees. The earlier the young shade-loving plant is exposed to direct sunlight and the greater the frequency of exposure, the sooner its structural formation must deteriorate qualitatively as a result of unnatural growth.

This is why all varieties of light-demanding timber protect their internal growth processes from the Sun by forming a thick layer of bark, which is not the case with shade-demanding species, however. The pine therefore will be the first to perish at the hands of contemporary forestry. For the same reason

even the spruce, which is equipped with a thicker formation of bark, will be beyond all help and in the end must also die, although more slowly than the pine. Naturally, the disappearance of the spruce first occurs on higher southerly slopes. Here, owing to the pine's departure and because of the strong sunlight, this flat-rooted tree is no longer able to draw up and retain the water it needs due to its enlarged structure.

Spruce that grows in good soil but under unrestricted light conditions, once again produces such spongy, soft wood, that red rot is already evident in the felled timber after it has been stored for barely a year. Indeed this even occurs in standing timber to some extent. The quality of such wood in its finished state is at best mediocre and naturally its use cannot be considered for the manufacture of high-quality products, let alone for export.

The manipulation of the forces of Nature through conventional systems of forestry has in any case achieved only very short-term and therefore illusory successes. Nature legitimately reacts with an appreciable decline in quality, so that we will certainly witness the strenuous efforts of our rather more far-sighted entrepreneurs to preserve the right to import foreign high-grade timber, obtained from forest reserves where modern forestry has so far had no such drastic effect, as is unfortunately already the case locally.

In the construction of dams, under certain preconditions derived from inattention to the important form of temperature movement (temperature-gradient) in the wall, a really dreadful danger can be created for those living below. Moreover, changes in the ground temperature resulting from an incorrect temperature-gradient in the impounded water can cause a shift in the climatic conditions. As everything in Nature, this is not immediately apparent, but will manifest itself later in a far more severe form.

The consequences of massive intrusions by forestry into Nature have now become evident after barely one full rotation. This can only be rectified at enormous cost, if it is not already too late. There is an increasingly persistent irregularity in the distribution of water in recent years. Flood catastrophes, droughts, landslides, even the emission of poisonous gases or 'Death Fogs' from the Earth, and the upsurge in illnesses when warm vapours rise from the ground in winter, together with the constantly strengthening negative temperature-gradient, are the legitimate reactive symptoms of our present utterly faulty management of water resources. The principal mistakes in such management are solely to be traced back to the contemporary administration of the forests.

Without exaggeration, modern forestry can be described as one of the greatest threats to culture. If the widespread cultural decline already evident is to be arrested, we will have to revert immediately to natural methods of regeneration, to the ways of the former natural forest. Such natural forest never evolved simply by the juxtaposition of species, but developed over millions of years through their superimposition and replacement.

A few vestiges of this natural forest can still be found on smaller land holdings, where clear-cutting and the large-scale methods of regeneration associated with it were always impracticable, because of their limited surface area. In this natural forest, apparently in the most haphazard and colourful array, age-group upon age-group (overstorey and understorey) and species next to species grow up under the shelter of mother-trees. In supposedly cultivated and improved forest, the individual species and age-groups appear as a uniform mass⁶ (in clear-felling systems) and are ranged alongside each other (horizontal instead of superimposed development) without regard to either climate or altitude. To put it mildly, this unnatural treatment of the forest (systematic concatenation of one denuded surface after another) leads, through the redistribution of ground temperatures, to a systematic and progressive reduction of potential differences in the ground.

The inevitable sequel to this systematic neutralisation of contrasting temperatures in the Earth's interior is the now incipient sinking of the groundwater table on the slopes and the increasing swamp development on more level terrain. As will be seen later, these differences in temperature are absolutely essential for a flourishing vegetation. Their elimination signals the termination of the hitherto unknown supply of nutritive material from the Earth's interior, which again is exclusively a function of the temperature-gradient. The importance of this is still unrecognised today.

The temperature-gradient can be described as a properly ordered or functionally graduated energy-form of water as it moves in its internal cycle. It is the necessary precondition for a supply of-nutrients to the root-zone of the plants. The disturbance of the water cycle and consequent breakdown in nutrient supply from the inner regions of the Earth, foreshadows the decline of the vegetation, leading to a reduction in cultivation and the demise of agriculture. No machine in the world and no rationalisation can prevent this, but even at this late hour such a demise may yet be arrested by an immediate and properly instituted management of water resources.

The Circulation of Water Inside the Earth and the Supply of Nutritive Matter

From 'The Circulation of Water Inside the Earth and the Associated Supply of Nutritive Matter to the Vegetation', *Die Wasserwirtschaft*, the Austrian Journal of Hydrology, Vol. 5, 1931, pp. 73-7.

If we consider the consequences that have arisen through disregarding effects of temperature in the field of forestry, now evident after barely one rotation, then the question arises as to whether a condition analogous to the structural

deterioration of the tree will sooner or later be found in dams and dam walls made of mass-concrete.

Measurements recorded so far have furnished proof that here too, especially in structures of a certain size, processes similar to those in the tree or inside the Earth take place. Under certain conditions of temperature and in conformity with natural law these must lead to signs of decay in both instances.⁷ On the other hand, it is equally evident that certain other movements of temperature can undoubtedly give rise to outward signs of consolidation instead of decomposition, of formation instead of disintegration. If the wall-structure and therefore the wall itself deteriorates, or if the decline of vegetation becomes apparent, this then provides indisputable proof that the error, with all its ramifications, lies unequivocally in the neglect of temperature-gradient.

In forestry the effect of short-sighted practices can already be seen. In the construction of dams, a correctly positioned thermometer indicates immediately whether disintegration or consolidation will take place. In the case of disintegration, this simple instrument can be used to determine whether a catastrophe is to be expected. Should it now be argued that a number of dams already exist and successfully fulfil their function, then it is to be pointed out that it is totally irrelevant when the catastrophe actually happens. As soon as the inbuilt thermometer registers the energy-form of disintegration, the dam is already in a condition to fall victim to the often rapidly fluctuating temperatures in the next largish flood.⁸

The question as to whether the authorities can assume responsibility for such a construction, faced with the knowledge that such a humanly uncontrollable catastrophe is legitimately to be expected, and whether the population to be protected from such an event (and therefore imperilled by it) will give its consent, is hardly to be answered in the affirmative. The same is equally applicable to forestry. So the justifiable question arises: 'Has research so far pursued the right course, or did it consciously or unconsciously go astray through inattention to the critical factor of the effect of temperature?'

If we proceed on the basis that social and economic development, therefore the culture of a nation, is inextricably connected with its reserves of forest, then in view of the mistakes that have been made, we should no longer be surprised at our social, economic and therefore cultural collapse. If temperature were shown to have such grave consequences in the above two instances, then it now becomes all the more imperative to base subsequent investigations in all other areas on the experience gained here.

Current theories and doctrines concerning the movement of water and the associated supply of nutrients from the Earth's interior to the root-zone of the plants, tend to arrive at a point where the causes of this phenomena cannot be further explained. The discussions terminate with the statement, 'cause not known with certainty', or 'cause unresearched'. Should the sequence of events

leading to the developments outlined above now be analysed, then, as practical observations clearly show, a fork is reached where theory has taken precisely the wrong turn.

The influence of this form of energy or temperature-movement, which in water continually varies in step with fluctuations in external temperature, is a factor that has always existed. It appears new now only because it has hitherto been consistently disregarded. If at this juncture this additional factor is introduced, we then not only arrive effortlessly at the goal of our research, but completely new findings also come to light. Quite frankly these are in stark contrast to conventional theories.

One of the questions still not clarified today is the movement of water in plants. The obvious course of action is to include this new factor in all future observations of Nature. Powerful forces, whose origins are still unknown, create steady flows of water with relatively high velocities from the finest roots right up to the leaves and needles of the high forest. While it is essential to understand what forces perform this work, it is equally important to understand how this supply of water is regulated, such that each leaf and every needle receives as much water as it needs.

Ultimately the cardinal question arises as to the cause of this mass-transport of water, which increases or decreases according to the time of year. If present assumptions, in some cases completely unfounded, are set aside for the moment, and the generally well-known processes of temperature are adopted instead, then to some extent many hitherto unresolved questions already solve themselves. However, we can go a step further and observe the way energies change according to the type of temperature-movement and how, with and without the influence of light and air (oxygen), the energy-forms of water continually readjust themselves to suit the constant fluctuations in external temperature. It then becomes apparent that present explanations are highly inadequate. Moreover, any practical endeavour undertaken without considering these important natural processes not only results in wasted effort, but also in the decline of vegetation, achieved with a great deal of trouble, labour and expense, and in consequence the failure of every attempt at cultivation.

Simple observations and measurements show that the uptake of water (or more accurately, the velocity of the rising water-masses in plants) varies continually not only according to season, but even with diurnal fluctuations in temperature. A further phenomenon is that the rate of flow actually varies according to location, climate and altitude with respect to the seasonal maxima and minima. If this change in velocity is already noticeable during the day (due to the position of the Sun), then it is all the more evident with the alternation of the seasons. The hotter the time of day and the time of year, the greater the velocity of rising sap. The difference between the state of rest

in winter and the strongest sap flow in summer is in excess of three metres (10 ft) per hour.⁹

Curiously enough, with very particular species of timber, a reversal in the direction of movement occurs at a certain temperature. In high summer, for example, sap flows in the opposite direction from the crown towards the roots, when too much heat becomes bound through the process of evaporation and low temperatures become established below the crown-closure. It rises upwards shortly thereafter when this excessive evaporative process has ceased and temperatures have once again reversed.¹⁰

If one reflects on the fact that water is raised to any given height through the Sun's influence, then it is only one small step to understanding that this hitherto inexplicable phenomenon is in part a process of evaporation, determined by the effective surface area of the tree's crown. The quantities of water evaporating from leaf surfaces will be replaced by the upward movement of water-particles in the countless feeder vessels — again a function of temperature. This movement will also be assisted by bubbles of carbonic acid gas¹¹ rising with them. The proper structural formation of the plant and its importance for this vital assistance will be addressed in more detail later.

As the Sun's heat becomes stronger (at the turn of the year), the velocity and kinetic energy of ascending water-masses also increase, resulting in a simultaneous rise in the supply of nutrient salts required for further growth and development. If the process of autonomous development prevailing throughout Nature (in trees this is growth in height but not artificially induced growth in girth) is to be realised, it is of supreme importance that the extraction (solution) and supply of nutrient salts from the Earth's interior should keep pace in the same ratio that the uptake of water in the plants is increased through the effects of temperature.

The nutrient supply and with it the biological structure of the plants, therefore, is primarily a question of temperature. At the same time, temperature is also the regulator of the water and nutrient supply, since the energy-forms of water are continually modified by climate and altitude. With the proviso that nutritive substances are actually present in the soil, an improved capacity to dissolve and to rise upwards inevitably occurs with higher temperature. Conversely, with a decrease in temperature in the shade of a properly formed crown or, in the case of light-demanding timbers, under the protection of the bark, the deposition of the widest variety of salts proceeds from the top of the tree downwards. This explains the degeneration in the growth of shade-demanding timbers, which have to congregate in dense stands for their mutual protection against direct sunlight. If their crowns are damaged or if they are suddenly exposed to light and the elements, degeneration sets in. This degeneration can neither be checked by the thickening of the bark (even if this occurs immediately) nor arrested through the rapid growth of protective lower branches.

We are now confronted by a new question concerning the origin of nutrient salts required for plant growth and by the even more complex problem of their extraction, transportation and proper distribution. How these processes actually take place will be discussed later, where it should be noted that methods of nutrient supply will be described in general without reference to other processes in the plants themselves.

If, after infiltrating into the ground through clefts and fissures by virtue of its weight and often immense head of pressure, water penetrates the important thermal zones existing in the interior of the Earth, and if it encounters the carbonates (residues of vegetable matter) present there, then a material transformation takes place in the substances that have come in contact with the water. In principle the process is summarised by the equation:

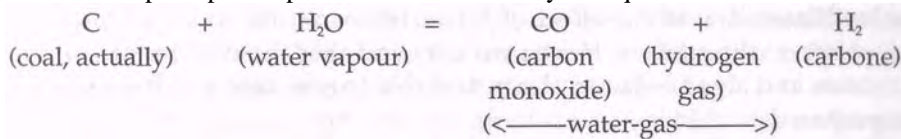

In this process oxygen will be dissociated from hydrogen. The renewed rise in temperature indirectly ensuing from this forces the humid water-gas up towards the surface under enormous pressure. This new substance releases carbonic acid into the suffused soil,¹² resulting in the dissolution of salts, which at these high temperatures can not only be held in suspension, but also transported.

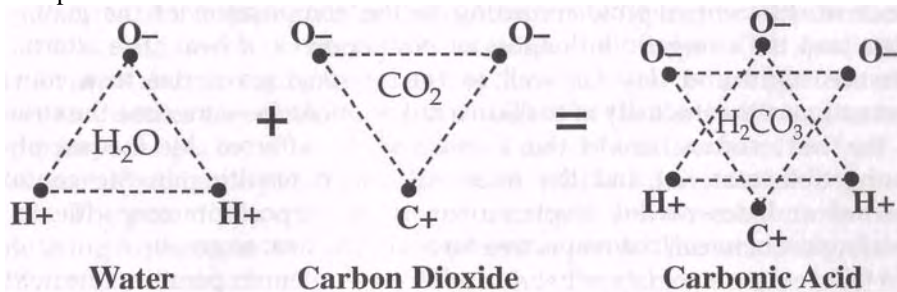

Fig. 4: The combination of H₂O and CO₂ into H₂CO₃ viz. Chapter 2, endnotes 11 and 12.

Under conditions of powerful alternating pressure the following occurs:

1. Influx of water.
2. Superheating (a reaction due to the process of decomposition), which further leads to:

3. The shutting off of the water supply. The repetition of these processes will pump this new mixture, the atmosphere, as it were, in the Earth's interior and required by the vegetation, in a three-stroke rhythm towards the surface, dissolving salts en route.

As a result of this pressure, the salts destined for vegetation are deposited along their prescribed pathways in the upper strata of the Earth. This process of deposition takes place under a very specific temperature-gradient through a filtering action of the soil (to be described later); an action which becomes all the more effective the further removed these vapours are from the heat source in the innermost regions of the Earth — in other words, the more they cool off.

At the same time the salts are also graded according to quality. The hard-to-dissolve salts (rare salts) are deposited earlier, the more inferior salts dissolved later, due to the effect of lower temperatures in the ground strata lying closer to the surface. Hence we also find that the first genera of plants are mosses and algae — those plants first able to take root and flourish on soil thus prepared.

As long as the Earth's surface was devoid of vegetation, the Sun's heat could penetrate to a certain depth. On the other hand, in the Earth's core we also find a heat source which radiates heat towards the surface and in the process of rising — of moving away from the centre — this naturally decreases in strength. Somewhere below the surface we therefore find a zone where the temperatures induced by the Sun and the Earth's core meet.

Naturally the line of demarcation between respective temperatures is neither sharp nor uniform, but will and can be of various dimensions and hence at different depths, according to the composition of the geological strata and the energetic influences of both sources of heat. The alternation between night and day (as well as the seasons) gives rise to a constant fluctuation in the intensity of the Sun's radiation. At the same time the strength of the heat source inside the Earth will be affected by the supply of combustible material and the influx of water, resulting in the continual upward and downward displacement of the deposition zone due to the distribution between the respective forces of the heat sources.

In this zone, which naturally has a relatively lower temperature, the mixture of rising gases condenses in conjunction with the simultaneous influx of oxygen from the surface regions. This condensation process inevitably results in the deposition of nutrient salts, which can only be dissolved in the oxygen-deficient, vaporous form described earlier. They are now put to their intended use; the constitution (chemical composition) and hardening of the groundwater.

The above processes in the interior of the Earth form the basis for production and supply of nutrients needed by vegetation. Though perhaps sparse in the beginning, this primitive vegetation provides the bare ground

with a protective cover against the effects of direct radiation. This cover, however, already reduces the power of the Sun's rays quite considerably, so that shade, coolness and humidity are created in the immediate vicinity of the root-zone of the plants. As a result the heat source of the Earth's core is also able to exert an influence on higher-lying strata, due to the resulting shift in the distribution of forces. This has the effect of raising the deposition zone of nutrient salts, thus displacing the zone containing hard-to-dissolve (rare) salts, whose deposition occurs with only a slight increase in temperature, within reach of the roots.

At this juncture, particular attention should be drawn to the fact that the ground will also be warmed by the rising heat from below. The ground water and its content of dissolved nutritive matter will be forced towards the surface without the traversed ground strata acting as a filter. In the opposite case, when the ground surface cools off (night cooling), the groundwater sinks because of its increasing weight and because of the simultaneous reduction in the upward force of the counter-influence, namely the heat from below.

The ground strata cools off and the groundwater, which also sinks under these conditions, will be filtered for the first time; nutrient salts will be deposited and remain behind in the root-zone of the plants, despite further subsidence of the water. The now nutrient-less water retreats into the Earth in order to begin the whole process anew as the warmth of the rising Sun begins to take effect. Since the world began, this constantly self-repeating process has given rise to the creation of a nutrient depot just below the ground surface. Once this depot is saturated, the surplus automatically migrates towards higher and more sparsely vegetated strata, due to the difference in the prevailing temperatures of the respective locations, thus enabling the development of a more advanced form of vegetation at higher altitudes. The qualitative improvement and increasing luxuriance of the vegetation creates a consistently denser and thicker green mantle over the surface of the Earth, offering an ever greater impediment to the intrusive effect of direct radiation from the Sun.

The root systems of plants will be more ramified and extend to greater depths. The potential for the uptake of nutrients will be greatly enhanced, stimulating further growth and development of plants. The increasing overall depth of the depot-zone (groundwater) thus brought about, results in a reduction of the space available to water vapours. As the volume of this space decreases, the pressure in it increases, through which, upon the lowering of the boiling point, the pressure further intensifies,¹³ leading to a revitalised supply of nutritive material. The more luxuriant the vegetation, the greater the detention of surface run-off, which the ground is now in a condition to absorb. The over-charging of the subterranean retention basin thus created leads to the rise of often-mighty underground rivers, through which large quantities of water will be conducted back into the interior of the Earth, thus

completing the final phase in the Earth's internal water cycle. These processes again result in an increased supply of fresh nutrients by virtue of the Earth's internal circulation, whose significance has so far remained unrecognised.¹⁴

The aforementioned processes that take place within the Earth and latterly at the surface, first began during its earliest evolutionary period and in our era are only operative in regions of evergreen vegetation. At higher latitudes and in regions with more extreme climates (mountains, etc.), these processes do not take place in such a simple fashion and we find that the influence of the heat source in the Earth's interior is insufficient to displace the depot-zone towards the surface. Here Nature invokes the aid of another factor; she plays off one opposite against the other and with the coming of winter, she temporarily suspends the growth of the otherwise evergreen vegetation. The onset of cold causes the water in the ground to freeze to a certain depth, which in keeping with the anomalous condition of water, gives rise to the progressive development of a hermetic seal from the outside inwards in the form of a belt of frost. Snow cover lying above this cannot be pierced by the Sun, which by this time has suffered a considerable loss in power due to the advance of the season.

Whereas under the protection of this double outer covering paralysis and peace prevail, inside the Earth heat and nutritive material begins to accumulate. The stronger the influence of cold from outside, the more hermetic the seal and the greater the internal accumulation.¹⁵ The pressure-induced lowering of the boiling point enables the superheat radiating from the Earth's interior to have an increasingly stronger effect at higher and higher levels. Above, the power of the Sun grows with the advent of spring. The outer covering of frost becomes thinner, ultimately to be breached by the forces emanating from below. Once freed, the heat streams upwards, breaking up the soil, and encounters the 'aggressive' melt-water approaching from above. Having a temperature of about $+4^{\circ}\text{C}$ ($+39.2^{\circ}\text{F}$), this water hungrily ingests the rising nutrients¹⁶ and in the interim, having come under pressure from below itself, it is now in a position to carry nutrients upwards via the roots of vegetation.

The supply of nutrient salts and their deposition in plants naturally proceeds in a similar fashion to that described above and the explanations relating to this will follow in the forthcoming chapter concerning the laws of movement of water.¹⁷

To summarise briefly, the following interdependencies come to light. As mentioned above, the vegetation cover, originally consisting of primitive plants, already enables an improvement in the nutrient supply. On its part, increased nutrient supply creates preconditions for the evolution of plants of a higher order, which in turn leads to an enhanced influx of nutrients. From this the mutual interdependence between vegetation and nutrient supply

would appear to be established, giving rise to the unavoidable conclusion that the removal (clear-cutting) of one type of vegetation suited to the respective altitude results in a disturbance in the nutrient supply and hence to a further decline in the vegetation as a whole.

Through the clearing of previously forested areas or with the extinction of certain species of timber, a reduction of potential differences in the ground is caused by inhibiting the build-up of the respective counter-temperatures. These are, in varying degrees according to altitude, essential for an undisturbed supply of nutrients. Due to the now direct radiation from the Sun, the denuded surfaces heat up to such an extent that the condensation process takes place at far deeper levels. Because of this, the deposition of noble salts (rare salts) once more (as was once the case long ago) occurs at such a depth that the roots of the plants can no longer reach them. Contemporary forestry has sanctioned the clearing of one area after another. Larger and larger surfaces have been laid bare without regard to the height and position of the Sun. As a result, the area of receding groundwater expands, the distance between root-zone and nutrient depot constantly increases and the supply of nutrient salts becomes increasingly scarce. In short, the decline of the vegetation has occurred and the development of karst begins.

For example, if potential differences in the ground are reduced by clear-felling; if ground temperatures change; if the groundwater table sinks, and if the nutrient depot withdraws from the root-zone; then water, at best still available through atmospheric precipitation and therefore almost devoid of nutrients, will be absorbed and drawn upwards by plants at appropriate temperatures. Spongy, coarse-grained wood and the dying out of certain species of timber and plants are the inevitable sequel. In addition to this, however, there are a whole series of factors which immediately lead to the further degeneration of the vegetation.

Through the extinction of certain varieties of timber, the continuity of the crown-closure is broken. The Sun penetrates more and more strongly and directly. The uptake of water becomes stronger, the ground temperatures change, the depot-zone of nutrient salts subsides and their supply decreases at the same rate as the uptake of water increases. The excessive uptake of empty, content-less water loosens and coarsens the structure and thus the profiles of the rising sap vessels become enlarged. The relative thermal influences from the leaf surfaces becomes all the more negligible, the greater the increase in the amount of water in the supply vessels. Furthermore, owing to the subsidence of the nutrient-salt zone, the uptake of nutrients and the concentration of carbonic acid closely connected with it decreases in the rising water.

If on the one hand it now becomes impossible for the Sun, with the aid of leaf- or needle-surfaces, to influence and therefore to draw an ever-larger column of water up the widening rising-ducts, then because of this and also

due to the simultaneous decrease in the concentration of carbonic acid, bubbles of carbonic acid gas will become smaller and smaller. Finally, due to the constant dilation of the profile resulting from the excessive uptake of water and insufficient nutrient content, bubbles of carbonic acid gas (CO₂) can no longer totally fill the rising-duct. Instead of continuing to rise like corks, which previously completely filled the profile and pushed the water upwards, the carbonic acid gases now ascend in bead-like form without raising water. The death of the vegetation and the demise of any form of culture is the natural and inevitable consequence.

As long as the correct temperature influences prevailed, the regular supply of water and nutrient salts and the proper profiling of the supply vessels (capillaries) could also proceed without interruption. As long as this mutual interdependency continued to exist in its proper proportions, the process of biological growth could also proceed correctly according to natural law; water and nutrient salts took the shortest and straightest route and the water rose vertically (plumb). The structure was built up in parallel, closely packed layers (viz. resonant timber). Under these conditions of correct, naturally ordained growth, a tree-trunk necessarily assumes a cylindrical form. Such trees exhibit extremely narrow annual rings and a tall, branchless (therefore knot-free)¹⁸ and fully lignified trunk.

However the manipulated exploitation of light-induced growth by forestry (clear-felling operations) has been carried out with the aim of reducing the period of rotation, so as to make the greatest possible use of forest areas. Whilst this undeniably leads to an increase in quantity, it also results in a simultaneous drop in quality. With excessive illumination, too much water enters the supply vessels, the depot of nutrient substances sinks because the ground temperatures have been altered significantly, the uptake of nutrient salts is reduced and the rising-ducts can no longer lignify themselves as fully as before.

The excessive influence of temperature — too meagre a crown-closure in the case of shade-demanding timbers during their youth, or too thin a bark in the case of light-demanding timbers — overheats the ascending water in the rising-ducts, which then inevitably dilate as a result of the temperature-induced increase in the volume of water. The Sun not only loses the ability to draw up an increasing amount of water in these enlarged rising-ducts, but the support from below provided by ascending carbonic acid gases (CO₂) is also absent. These ascending gases, in the form of increasingly buoyant bubbles that progressively expand with warming, normally fill the rising-ducts like corks and thrust the water ahead of them. Clearly evident here is the necessity for the proper interaction between the forces of traction (suction) and pressure, which are brought into being exclusively by inversions in the movement of temperature in the water.

Now, how does this affect the uptake and processing of nutrient salts? We have stated that the nutrient depot has subsided owing to the sinking of the ground water table. A fresh supply of nutrients for plants is therefore out of the question. All that remains is the small quantity left behind in the soil after the retreat of the depot. In point of fact, these residual salts will be dissolved by atmospheric water and eventually taken up by the plants, but because of the above shift in the forces, they are no longer able to benefit the whole plant and in the main are actually left lying in its lower portions. A more detailed examination of such a tree unquestionably shows us that in the lower parts, even if lignification has occurred, it cannot be described as being of high quality. Whereas towards the crown growth becomes increasingly disorderly and malformed (as though mauled by wild animals!). The very outward appearance of such a tree proves the accuracy of this assertion. From the lower portions of the trunk the branches spread far out. The closer to the crown, the more slender the branches become, due to poorer nutrition. In short, the tree becomes what is commonly described as a beautiful Christmas tree (cone-shaped structure, full of branches, a typical plantation tree), but cannot be described as a high-quality forest tree.

What does the structure of such a tree look like? Since with the exclusion of air (oxygen), deposition always occurs at the location of the lowest temperature (to differentiate from the processes of deposition under the influence of air), alternating influences of light and shade (alternation between direct and indirect solar influences) give rise to an irregular deposition of salts over the full height of the tree. When the tree-trunk is exposed in this way, the supply of nutrients by the most natural and optimal route (shortest and straightest) will be broken off and the supply vessels will be forced to adopt a serpentine or spiral-like conformation for lack of the requisite forces. We also find a phenomenon identical to that in the tree on the surface of the Earth, in the curvilinear form of brooks, streams and rivers, the only difference being that here the deposition of suspended matter does not occur at low temperatures, but under the influence of heat.

For a further example of processes of deposition taking place with the exclusion of light and air, the reader is referred to the instances of sedimentation and disintegration in mass-concrete dam walls discussed elsewhere.¹⁹ Even if slightly out of context here, attention should nevertheless be drawn to the processes of deposition in the human body, i.e. to arteriosclerosis!

In the light of all these explanations let us now ask ourselves: What does the forester desire and what has he achieved? He sought a more rapid turnover, because from his point of view Mother Nature's tempo was too slow. In the exploitation of light and heat, his purported science saw a way of achieving a quantitative increase in growth. He applied this here in ignorance of the

prevailing laws and it was thus inevitable that his science should become an unprecedented fallacy.

Superficially, more timber can actually be seen and also measured. Indeed the amount felled might also be increased temporarily. However, in reality the decline and destruction of our former high forest was perpetrated with singular thoroughness. The forest is now in the direst of straits and the moment has arrived when, as a matter of course, help is normally extended to those in crisis. Hundreds of thousands of people are without bread and the forest owner is destitute.

From what has already been stated, it should be quite superfluous to make a more detailed analysis of the present lamentable decline in the state of agriculture. There is essentially no difference in the growth of plants, whether it be tree, bush, cereal, grass, or vegetation of a lower order. It would be a grievous error, if remedial measures other than those now essential for forestry were to be applied to a foundering agriculture.

In Nature a law of growth and synthesis prevails, just as does a law of decay and disintegration. Whether growth or decline takes place is exclusively a question of temperature, which hitherto has been so grossly neglected. It endows water with its utterly essential energy form.

In one case this signifies growth or life, and in the other, decline or death. Forest science unfortunately chose the latter, and in accordance with the laws of Nature, the consequences have already become well and truly evident after just one full rotation.

The movement of temperature in water not only plays the principal role in the supply of nutrients, primarily in the circulation of water through the interior of the Earth, but also in all other areas of water resources management, such as river engineering, water supply and most particularly, in the hydro-power industry.

The Effects of Groundwater Removal

From Implosion Magazine, No. 94 — letter to Aloys Kokaly, 1954.

What repercussions are to be anticipated if the groundwater in the brown-coal district of the Rhineland were to be extracted to a depth of 250 metres (820 ft)? This was the question you raised and quite obviously the following question can only be interpreted informatively.

Here we are concerned with a case similar to that of the Traunsee, where the lowering of the outflow was likewise considered desirable in the belief that more water would thus be made available to the projected Traun power station during dry periods. Energetic protests by the local community

prevented this happening, because the most senior officials of the Water Resources Department were unable to refute the counter-objections with which I equipped Mr Eibeshuber, the Burgomaster of Gmunden, at his request. And in your case the following is also to be understood analogously in order to avert an irretrievable disaster. If the water disappears in the productive Rhineland — and this will and must be the case if the above project is carried out — then the repercussions are truly incalculable.

Science is still very much in the dark about the consequences of arbitrarily interfering with Nature's water balance; a fact demonstrated by water shortages throughout the world, which would not exist if things were otherwise. What is even more alarming is that nobody knows how to remedy these increasingly menacing water shortages on the one hand and the constant increase in catastrophic floods on the other.

Water is the blood of the Earth and like the blood in our bodies, requires very specific preconditions for its development, to which above all belong the hermetic exclusion of air, light and heat. If these conditions are absent, then it is impossible for the water to breathe. Integral to this is the 'original' form of motion, which is engendered by the planetary motion of the Earth.

Now if, as proposed, a deep shaft or several deep shafts were sunk, then in the first place the surrounding groundwater would stream into the pump-wells. Nature on the other hand raises the groundwater by means of differences in atomic potential in exactly the same way as occurs with blood and sap. Due to the head of pressure of the surrounding groundwater the inflow velocity increases, resulting in the enlargement of the soil capillaries.

The volume of the inflow increases as a result. The erosive forces associated with this dislodge and transport the soil from all sides. With increasing speed the water streams into the pump-well, there to be pressed upwards with brute force in steel pipes. In the process the water becomes de-energised and is subsequently exposed to direct sunlight and meteorological influences in either natural or artificial channels.

Fresh air is pumped into the now waterless shaft and all stale air extracted to prevent the development of 'firedamp', the origins and formation of which are still unresearched today. It arises when weak retrograde intermixtures of dispersed matter are triggered between warmed coal-gas and diffuse atmospheric oxygen (viz. the finest coal or corn dust, which subsequently explodes when conducted in straight conduits at high speed under strong suction).

In similar fashion, barely perceptible micro-explosions take place when water, which contains the most finely dispersed carbonic sediments and atmospheric oxygen slightly warmed by friction, is forcibly over-accelerated centrifugally by pumps or by too strong a head of pressure.

The effect of these micro-explosions — they could also be termed oxyhydrogen gas explosions — becomes all the more powerful as the profiles

in which they occur narrow towards the end. They intensify in these hair-thin vessels and propel the contained water forwards and along the enlarging passages.

In this way the structure of the soil is shaken up over an increasingly wider area, which until now has gone entirely unnoticed. It becomes loosened and as a result of the above erosion, more porous.

As is the case in every hot fire, explosions induce the inflow of oxygen, which in turn provokes further micro-explosions in the influent capillaries. The upshot of this is that, despite supposedly impervious earth strata, the over-acidified groundwater becomes de-energised and discharged, and begins to sink even in distant areas. One day the whole Rhineland, far removed from the actual source of the error, would be waterless.

Water and air are harmonically structured bodies that have to be moved with great care in order to prevent a change in consistency. Practically, this can only be achieved with the aid of a cycloid-spiral space-curve. Like blood and sap, the conducted material must be moved in a predominantly inwinding way; it must move about its own axis radially -> axially — hence almost without friction.

By moving in this way, a drop in pressure and heat takes place in the direction of the so-called anomaly point. With water this is +4°C (+39.2°F), at which temperature the extremely finely dispersed carbonic acid elements attain and maintain their atomic potential state. With the presence of appropriate catalysts, they ultimately emulsify. The emulsion product of this primordial intermixture of sexual essences is then the child, as it were; namely water. This is the accumulator that binds the dynagens (atomic levitative substances) released by the ur-procreative process, which then lift their carrier substance into the zone of the root systems. The protoplasts found on the root-tips during the growing season take up the surplus formative and uplifting concentrates, which interact with their diffuse counterparts in the positively surcharged atmosphere. What then subsequently occurs I have already told you either in writing or orally.

I have discussed the above briefly in order to give you an inkling of the inescapable outcome, which in accordance with natural law, would inevitably be the result of interfering with the last reserves of water in the Rhineland.

Science, which thinks too mechanically, has no inkling of these things and is therefore able neither to assess nor to anticipate the repercussions mentioned. Moreover it only sees the momentary advantages and fails to take note of the after-effects of energy production. Little by little Nature is becoming incapable of rectifying the resulting damage.

I have told you that completely new types of devices and machines exist, which generate higher-grade potential differences. These in turn produce propagative and upwardly evolving (multiplying and ennobling) reactive

forces, which can be used to drive biomachines almost without any cost. These reactive forces also give rise to enormous growth. They are not only development-furthering, but also perform so rationally and efficiently that instead of the braking forces mentioned earlier, they generate additional motive forces that permit up to a nine-fold increase in the capacity to do work.

It is therefore totally unnecessary to burn coal, oil or gas so that people can generate 'firedamp' as it were, in today's explosion and expansion machines by the sweat of their brows. In so doing they rob our innocent youth of that national asset so vital to life — water.

'Well,' your response was, 'that is just not poossible!' The face you made then, reminded me of a comedian who has used this expression to make his fortune, although in fact he was a good psychologist. Sometimes, however, his jests involved a deadly serious matter. I often allowed myself the pleasure of holding up science to such ridicule, so that after the second 'It's just not poossible!' their eyes were as round as balls. Then, perhaps, these scientists would be ready to enter into a preliminary contract that would protect me from recent attempts at theft. Were you here, you could entirely satisfy yourself that such things have occurred time and time again.

To put it briefly, dear Mr Kokaly, I have the firm intention of exposing today's pseudoscience, which is only impressed by power-producing machines that roar, belch smoke and stink, to mortal ridicule. I am therefore not at all surprised that I am never offered a preliminary contract.

Yesterday an expert from Venezuela came to see me and gave me the despatch I passed to you to read. He explained that his government was ready to enter into a preliminary contract with me. The whole of South America was reduced to a state of panic when seventeen squadrons of UFOs flew silently by at a height of about 300 metres.

I have told you about these implosion machines; where they were built in 1943-5, who built them in 1943-5, who stole them, and who destroyed them at the end of the war on the orders of Field Marshal Keitel. Many political and technical leading lights actually emigrated to Argentina. They were more intelligent than those who brought me such an implosion motor recently, who were unable to manufacture the special system of jet-nozzles, which are protected by worldwide patents. These can transform highly compressed air into etheric, levitating and lightning-like structures.

The terrified passengers will no longer be able to declare 'It's just not poossible!', and precisely because of this, the order will one day be given to those who are now hard at work, to dig out the last remnants of good water for the poor Rhinelanders.

Best wishes,

Viktor Schauburger

Incorrect Metabolism Destroys the Quality of Water

An amalgam of two similar articles from Implosion Magazine, Nos. 33 and 45 — written in Linz, 24 February 1958.

The newly designed spiral plough made of copper (see Fig. 5) and the associated system of fertilising with natural compounds (concentrations of high-potency substances),²¹ will produce a striking increase in yield, even in water-deficient soils, without artificial fertiliser. This involves the increased concentration of qualigen — a concept foreign to contemporary science. Very successful field trials met with resistance, because farmers feared a considerable reduction in the price of their produce, though even in the first year they achieved about a sixty per cent increase in yield.

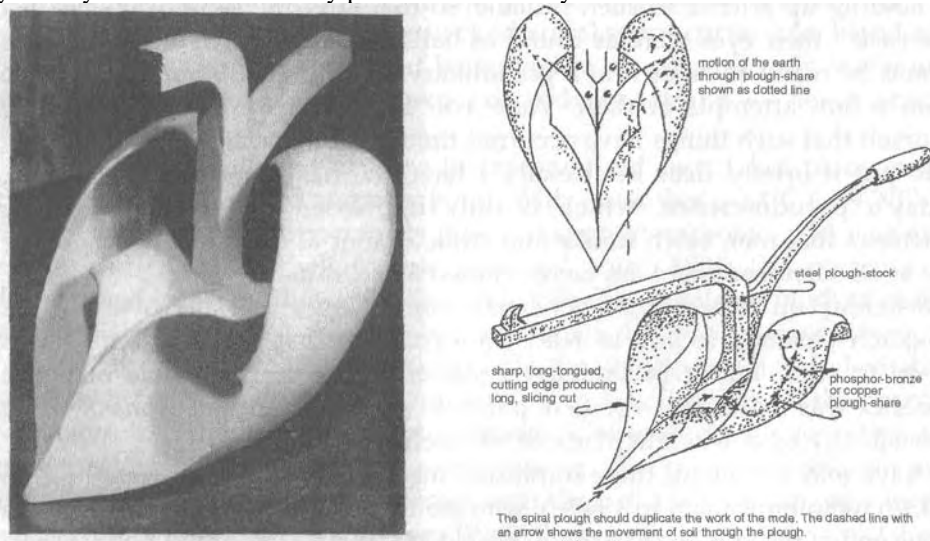

Fig. 5: The Bio-Plough

The only advantage the farmers acknowledged was the elimination of high pest-control costs, since, as is the case in any naturally healthy forest, no parasites can continue to survive. Their survival is equally impossible in a negatively and highly potentiated (diamagnetically charged) soil wherein no conditions conducive to propagation exist, because parasites can only thrive in genetically degraded (positively overcharged, cancer impregnated) terrain. This is also interconnected with the inexorable sinking of the groundwater table in all developed countries, because decentering²² radiation (emanations) has a decomposing effect on groundwater. In consequence it loses its levitational capacity and its natural ability to supply the plant world.

This also explains the subsidence of water. Deep wells also can be positively supercharged if atmospheric oxygen is continually forced into them with pressure pumps. In the groundwater zone accessed by a bore an excess mechanical pressure as well as a biological pressure is created. Acting as a counter-pressure, this produces a form of sclerosis (crystallisation), blocking up the soil's capillaries. As a result inflowing water becomes positively overcharged, leading to a gradual but constantly increasing restriction of the flow in the vicinity of the pump.

These events are reported to me almost daily, against which the mechanically orientated water-supply authorities are helpless, because they are unaware of the root of the problem. Here we are concerned with dysfunctions of the metabolism, which are constantly on the increase in surface-draining waters due to excessive oxidation. This is the principal cause of the increasingly threatening disappearance of water.

I will explain what happens. Water (the blood of the Earth) is subject to the same evolutionary laws as is sap and blood in more highly evolved organisms. This involves mutually reactive elements which possess different atomic weights. For example, under normal circumstances 12 grams of reduced carbon always combine with 32 grams of diffuse oxygen. Viewed as a unit of mass, the carbon atom weighs 12 and the oxygen atom 16. If atmospheric oxygen is forced in with pressure pumps, then the above ratio is altered to the detriment of the demand for carbon, because in this case, by being forcibly impressed and therefore heated, the oxygen becomes aggressive and binds its co-reactant.

Water then becomes over-acidified and assumes a crystalline structure, which is what actually blocks up the soil capillaries. High-grade water has an amorphous structure through which, as a result of a reduction in volume, an atomic low pressure evolves, conducive to the concentration of diamagnetic dynagens. In the process an insuctional force also develops.

Owing to the increased influx of negatively supercharged, fresh (cool) influent water, exactly the opposite emulsifying (ur-procreative) processes take place, whose effect is to increase the amount of water and to concentrate the qualigen. Water rich in qualigen levitates, because the diamagnetically supercharged medium, the indifferent (neutral) carrier — water — is carried up in the wake of formative and levitative energies. From this it is apparent that pure unadulterated groundwater is partly drawn and partly pushed upwards, and in this way can rise thousands of metres in order to deliver the best nutrients to the plant world. Diamagnetically supercharged medicinal herbs come into being in the same manner. Domestic animals and wild deer grazing on alpine pastures would become genetically diseased, cancer-prone and mangy were they to lack these negatively charged sap-formations, and to be exposed to positively supercharged rays of the Sun at the same time.

Even in our blood, this incident radiation induces strong symptoms of fever, even blood degeneration, if we expose ourselves to such dangerous radiation for too long at high altitudes without adequate protection. Excessively oxygenated water, sap or blood inevitably suffocates, because it can no longer bind oxygen that is too dense and too warm. This comes about because in the process powerful back-pressures evolve that weaken the normal metabolic process, which is controlled by levitational forces. In place of the latter, excessive gravitational forces develop under the aegis of an excess atomic pressure.

Returning once more to the consideration of deep wells, the following aspects are important and should be taken into account. Firstly, all lateral induction of additional atmospheric oxygen via the pressure pump must be prevented. Both piston and piston rod must be well sealed, as no oxygen should be present in the pump shaft. Secondly, pieces of copper that have been hammered on wood and mixed with a little silver should be introduced into the shaft, since these catalysts intensify the emulsion and improve and increase the amount of water. Furthermore, pumped water should be analysed chemically, and its composition compared with that of mountain springwater in order to determine which elements are missing. The most important factor is the content of carbonic acid or bound carbon dioxide, which can be activated through the introduction of a few cubes of carbonate.

As far as possible, all iron and steel components should be copper-plated, because both iron and steel are paramagnetically supercharged, and like dynamos, function in exactly the same way as iron and steel ploughs, whose use generates electric emanations that decompose water.

Another measure, very effective on occasion, is to throw house leek [*Sempervivum tectorum*], common house leek or stone crop (*sedum*), which has been well-dried in the shade, into the shaft sump, where it cools the water and makes it specifically denser. It is an age-old remedy that our naturalistic forefathers used very successfully.

It would have been far better to have paid greater heed to these natural processes, which increase the potential of life-forces, instead of proliferating the use of nuclear power, which increases the burden on the environment with radioactive contamination. However, we preach to deaf ears, and a catastrophic lack of water will have to occur before today's science will ever decide to rectify the errors it has made with regard to motion and stimulation. Such a water-shortage will be the only way to force the reintroduction of these age-old measures. That is, if it is not already too late.

Postscript

Apart from iron, nickel and cobalt, whose magnetic properties are already well-known, other paramagnetic metals are osmium and almost all compounds of iron.²³ On the other hand, excellent diamagnetic elements are bismuth, antimony, zinc, tin, lead, copper, silver and gold. Glass, carbon disulphide and other non-conductors are strongly diamagnetic as well. Diamagnetism plays a decisive role in, and is responsible for, transformation and growth. It comes into being when, under the exclusion of light, heat and air, the media of earth, air and water are made to move radially -> axially by means of the cycloid-spiral space-curve, i.e. screw-form motion from the outside inwards. Since today's technology is unaware of this form of motion, it is unable to produce diamagnetism and therefore cannot make any practical use of it. Thus far, use has been made exclusively of paramagnetic and centrifuging forms of motion, through which decadent potential differences are created that disturb the evolutionary development of life.

The Secret of the Trout Motor

From Implosion Magazine, No. 15 — written in Leonstein, June 1945.

Anyone who has closely observed a stationary trout in its cool torrential mountain stream close to the spring-line, will have noticed how it flees upstream like lightning when danger threatens. Oddly enough, no one has ever bothered to investigate the mysterious motor that enables the trout to overcome so effortlessly its own body-weight and the force of the fast-flowing water. Here we are concerned with a phenomenon in which the levitational energies intensify in proportion to the acceleration in the flow of the cool, dense water, where the temperature approximates the anomaly point of +4°C (+39.2°F). In the process, the water is constantly dispersed and diffused mechanically by countless boulders and on steep gradients develops flow-curves of a particularly distinctive character. More uncanny still, however, is the motor-force of this trout-moving machine, when at spawning time, like a sleepwalker on nights of the full Moon, and with no apparent effort, it surmounts the sheer drop of dozens of waterfalls found in such streams. Driven by an instinctive urge, the trout achieves all this in order to reach the waters which, in the vicinity of the spring, are charged with negative-ions.

Neither Ressel nor Diesel²⁴ could solve this riddle due to their blinkered education. Both inventors were incapable of thinking a stimulating thought right through to its logical and natural conclusion. Had it been otherwise, neither diesel engine nor ship's screw would ever have existed.

Once the viability of the trout-motor has been established, these two systems of propulsion will be superseded, because no shipwright or aircraft manufacturer in his right mind will see any profit or benefit in the continued production of the artefacts of a totally flawed technology. The building of space rockets, jet aircraft and all devices of war, which exploit the power of explosion, will cease for the same reason. By reversing metabolic processes and exploiting cold oxidation, propulsive and levitative forces can be produced. These are considerably more powerful and environmentally friendly than any hot combustion process in use today, which exclusively generates forces of disintegration and recoil.

All forms of motion, in and on water, air and land as well as all steam- and explosion-powered machines, dynamos and turbines based on warm oxidation — combustion, have now been superseded. They will be displayed in museums as horrendous examples of a fire-spitting technological age alongside the instruments of torture of the darkest Middle Ages. Submarines, the terror of the seas, will be replaced by gliding underwater vessels. Automobiles, which are noisy and emit toxic gases, along with all other similar mechanical monstrosities of current design and construction, whether mobile or stationary, will also cease to exist.

All those who direct policy on industry, forestry, agriculture, water and energy resources including scientists, industrialists, doctors, intellectuals of right and left, politicians and dignitaries of the Church will be caught unawares. With the introduction of cold oxidising processes, mechanical power will be virtually free for the first time and therefore of real benefit. Food, raw materials, fuel and power will become available in superfluity. With the aid of specific healing agents in the form of negative-ion concentrations, people will no longer be under the thumb of doctors and the pharmaceutical industry and will enjoy a carefree existence, retaining their full potency well into old age. With the rediscovery of this supreme interactive effect, no one will continue to be tortured by meaningless equations at school. All spurious concepts and findings of contemporary physics and chemistry will be rendered worthless and will have to yield to these biophysical and biochemical, i.e. 'metaphysical', discoveries. Our ancestors used these to bring forth their legendary harvests and attain their high levels of culture.

Compulsory labour, drudgery and the problems of society will soon belong to history. With the aid of 'cold flow-systems', all manner of formative and levitative embryonic matter in any quality and quantity will be produced mechanically. When these are impregnated with seeds of fertilising matter, it will eliminate all problems of raw materials, fuel, energy and food supply, which are the major causes of human conflict.

Armies, labour exchanges and enforced servitude will cease to exist for everyone will be able to live how and where they wish, each according to the

call of their blood and their own requirements for health and happiness. Land hunger, the plunder of the soil and other activities associated with this dreadful, debasing machine age will no longer occur, since the noblest of waters will again be made to flow from the highest mountain peaks by faithfully copying Nature's mountain springs. This all-healing mother-water will then be conducted to the wasting fields and meadows in serpentine, underground channels.²⁵ Even the waterless wastes will be infused with life-blood and furnished with the ennobling substances of reproduction and material exaltation. Because the origins of all life and the ur-elemental cause of all motion have been rediscovered, leading to the production and increase of qualigen in accordance with the inner laws of Nature, the legendary ages of high culture will again become a reality.

These embryos of qualigen or geospheric, negative-ion concentrations are the true atoms responsible for formation and levitation. With the aid of cycloid-space-curve motion they can be created mechanically in any quantity and quality and very inexpensively from bacteriophagous²⁶ threshold-matter (sediment and suspended matter) in air and water. This is the process employed by the motionless trout to maintain its station in torrentially flowing spring-fed water, which it does with the aid of its gills and body shape, merely by allowing fresh, geospherically charged springwater to flow through the gills. However, if the water is warm and saturated with positive ions, and therefore an ideal culture medium for germinating pathogenic and life-threatening bacteria, then the trout is unable to hold its own against the swift current. In water thus charged, those oxidising processes take place that today's technology unwittingly exploits, and whose effect on natural development and its products is all the more injurious, the greater the compass and intensity of this self-deception.

The explanation for this is simple. Oxygenes, referred to biotechnically as 'seminal' or 'fertilising' substances, are released above a temperature of +44°C (+111.2°F), and in the process become unipolar and aggressive. At this temperature, elements of carbonic acid, biotechnically termed 'fruit' or 'fecund' substances and henceforth referred to as 'fructigens', agglomerate and become inactive. In consequence these oppositely charged, formative and levitative substances of the Earth become bound by the precipitate of the fertilising Sun, i.e. oxygen, which cannot be detected precisely in the atmosphere. This is because it has already assumed an etheric or purely energetic character due to the cycloid motion of the Earth. Hence, the beads of carbon dioxide created under the influence of heat, are actually the retrogressive products of former ethericities or energetic entities. On the other hand, if air or water with a high content of gas and bipolar sediments is moved cycloidally in coolness and darkness, then any solid ingredients initially become liquid, then gaseous, and finally transfer to an etheric or energetic

state. Apart from all this, catalytic and other preconditions must be taken into account, which will be addressed briefly later.

During this production of qualigen (growth), heat is absorbed and hence, the more the fructigens are diffused owing to the increase in coolness, the more energetically the metabolic processes proceed. Ultimately the fructigens attain their relatively highest dispersal, the energetic condition mentioned earlier, and in this free, unipolar and highly active state, they bind (consume) the solar precipitate (oxygen). For this to occur the agglomerations of fructigens should be distributed and dispersed mechanically. In this instance, the inferior, sluggishly reacting, formative and levitative substances can be reconstituted and qualitatively enhanced into high-grade quality products by means of the ennobling process described above.

Diesel succeeded in overcoming the sluggish reaction of inferior (unripe) basic elements in precisely the opposite way. Quite naturally, he also harvested the opposite products. Instead of natural formative and levitative forces, forces of disintegration and recoil appeared. When free, unipolar and increasingly aggressive oxygen consumes (binds) the mechanically dispersed fructigens (oils) introduced into his engine by high-pressure injectors, then an environmentally harmful, toxic waste-product is produced. When viewed as expanding agglomerations of energy, the power of these explosive elements is very small compared to the extremely high rate of expansion of qualigen.

The wagging branches in the well-mixed, multicoloured overstoreys and understoreys in natural old-growth forests demonstrates the vital role the distribution (dispersion) of the cool waste-products of the Sun plays in relation to the fructigens that have been brought to a high state of potential by the cycloid motion of the Earth. Where these wagging distributors are lacking, i.e. in artificial, monocultivated plantation forests, the air-masses lying above them are inadequately nourished. Such forests are oppressively hot and unhealthy.

Good climatic conditions are dependent on the wholesome growth arising from consumption of mechanically distributed (thoroughly masticated) stocks of oxygen, the waste-product of the Sun. Similarly, in a river where cycloid-space-curve motion is missing, the water will become warm, stale, listless, infested with bacteria, destructive of its banks and poor in fish-life. A river that swings to left and right in rapid succession in naturally disposed spiral curves, remains fresh, lively, bank-building and rich in fish-life, despite the scorching rays of the Sun.

If this is transposed into the human and animal organism, then the importance of the natural movement of the blood becomes quite obvious. The quality of the blood depends on its motion, which in turn depends on the quality of the blood. Symptoms of fatigue, blood deterioration and so on, are the biological consequences of a disturbed metabolism and lead directly to circulation disorders. In naturally regulated watercourses the force of

gravity has just as little effect on the water flowing down a steep gradient as the weight of the body has on a healthy human or animal organism. The same holds true for the Law of Conservation of Energy, which does not apply here, because a growing body autonomously increases its energy supply in proportion to its increasing bodily weight. If the state of health alters, i.e. if unhealthy blood generates insufficient carrying and tractive power, then less energy is produced and the human or animal organism so afflicted is less able to overcome its own body-weight.

The equation $E = 1/2 * mv^2$

is only valid, if the labile flow of water, blood or sap is naturalesquely regulated by a naturalesque form of motion, whereas an unnatural form of motion can totally destroy it. It is equally true that water can become diseased if the oxidations taking place in it are altered, and its naturally ordained motion destroyed. The same applies to the bloodstream and the flow of sap. The natural uptake of nutrients, which is conditioned by the natural movement of the nutrient supply, creates the precondition for health and a surplus of energy. In a healthy body, therefore, the Conservation of Energy Law has no meaning. Equally incorrect is the law stating that the resistance to motion increases with increasing velocity. Any increase in this resistance is indicative of unnatural, disease-promoting motion.

In the spawning season, when the rays of the full Moon strike water with a high content of negative-ions at the right angle, its levitational force intensifies to such an extent that even small stimuli are enough to cause a highly excited trout to float upwards in plunging waterfalls. The effect of gravity on the respective body is therefore a question of the inner constitution of the water, the blood or the sap. Apart from the movement arising from their healthy composition, the carrying and tractive forces of these vital fluids are also influenced by the Sun and the Moon. For instance, were there no Moon, then the heavy Earth would be unable to float autonomously in the space infused with high concentrations of qualigen surrounding it.

It is upon these additional influences that the mobility of an organism, even a river, depends. Strong sunlight can make a watercourse just as lethargic as it can a human being. Conversely, bodies with a higher specific weight than water, which in sunlight sink and lie on the bottom, on nights of the full Moon begin to float. Any change in the metabolism always produces a corresponding change in the form of movement and the absolute, or specific weight, which is why the flow of water down the steepest gradients remains so relatively steady.

The effect of these interactions is less a question of the quantity of propellant, but more of its quality and intrinsic energy. For example, the

average expansive force of water, when it instantaneously transfers from a liquid to a gaseous state, amounts to 2,000 atmospheres.²⁷ This expansive force, however, can be amplified many times without any additional input of dynagen, if the quality of the potential-energy conglomerate is raised by means of a prior charge-building motion. 'Motion' can be defined as the partly physical and partly mechanical separation (dispersion) of bipolar basic elements. In water moved correctly, that basic element which consumes the formative substances must be freed, in order to increase the carrying power and tractive force. If the opposite occurs, then the nutritive matter required for the creation of inner potential will be released through strong solar influences, to the detriment of these inner forces. The formative fructigen will then become passive, because it will not only be mechanically torn apart by the through-flowing water, but in this state it will also be consumed (bound) by the aggressive, fertilising substances (oxygenes). The final outcome of this reversal of the metabolic processes is the decomposition of water, blood and sap, resulting in putrefaction, the emergence of pathogenic bacteria and ultimately in the death of the disabled organism. Any technology that ignores these regulating metabolic processes, but calculatedly generates mechanical forces that disturb evolution and constantly increases their scope and intensity, can only expect a general economic collapse.

- Diesel and petrol engines burn the most valuable concentrations of fructigens.

- By straightening the river channels, river engineering systematically destroys the formative type of motion.

- With its systems of monoculture, modern forestry constantly inhibits the generation of formative and levitative forces. They systematise clear-felling and light-induced shock and force sluggishly reactive, inferior substances to combine, which produces spongy material deficient in high-quality substances.

- Blast-furnace slag, so-called artificial fertiliser, flays the soil and discharges its potential.

- There is clear evidence of cancerous development in every case! As long as no fundamental changes occur, things cannot and will not improve economically, when viewed in the long term.

If ordinary air is enriched by the admixture of negative forms of qualigen with the aid of repulsive motion in naturalesquely shaped devices, then all that is needed to generate elemental interactive forces is a sliding centrifugal pressure. Here lies the precondition for the generation of any amount of power, in which the centrifuging fertilising substances are segregated through the centrifuge and the dispersion of the fructigens.

Every other type of motion generates rising and expanding forms of heat. These reverse the metabolic processes and at the same time create the reversed products of interaction (toxic substances), which lead to decay and spontaneous combustion. Retrogression and degeneration are the biological sequel to this metabolic process, which is induced by unnatural heat-forms and which triggers off a type of motion, wherein the resistance to motion understandably increases by the square of the increasing velocity.

Contemporary technology would have already destroyed the whole world long ago if this braking principle did not exist. The economic evils that beset humanity are therefore Nature's way of stopping the senseless violation of the environment. One day all the various combustible materials will in any case be exhausted and the grotesque charade will then be over.

Here are examples of how the above processes can be achieved practically and in accordance with Nature's laws, always providing the necessary insight is there. This only seems to come, however, when the deterioration and decay have reached a certain natural limit through a general state of anarchy.

A general collapse can only be averted through the mechanical production of noble fertilisers, or more precisely, the increase in the natural growth of water. Properly constructed Repulsators²⁸ enrich areas of land deficient in qualigen. The principle by which the mediator of life — water — can be enriched with qualigen is relatively simple to understand, if the previously mentioned radiation is viewed as the highest expansive force, which makes the formative fructigens free and almost unipolar. They then become so highly active that they consume the mechanically dispersed seminal substances, which act destructively when they become highly potent, concentrated and aggressive, i.e. under the influence of rising and expanding forms of heat.

Biocentrifuged water, which under the exclusion of light and heat has been properly mixed with noble salts and other ingredients, converts bipolar sedimentary matter into highly expansive forms of radiation. The higher the biomachine's rate of rotation, the greater the radius over which the embryos of qualigen are broadcast. These bundles of fructigenic rays are waviform and propagate vertically towards the ground surface.²⁹ Their encounter and interaction with the diffuse, incident ultra-rays from the Sun results in the formation of the groundwater and with it the absorption of the harmful forms of heat. In the germinating zones in the earth, the fructigens become free and active, and seek a union with the seminal substances, which become dispersed and passive through centrifugence.

The slight movement of the tree-root caused by the wind suffices to stimulate the release of the potential latent in the root protoplasm. One only has to observe the lush, verdant meadows, wherein these stimuli are provided by various species of fruit tree, each with a different shape and system of root and crown. Mother Earth responds to these stimuli with

prolific growth. All the 'Evolved' have been created through a very particular form of motion, where even the minutest stimulating impulse has to be provided in exactly the right way. (A single glance is enough to arouse devotion or wither it.) Given at the right moment, stimulation can produce staggering effects and for this reason it is possible to promote all forms of growth. All that is needed is a naturalesque, procreative motion (cycloid-space-curve), which forces the fructigenic embryos to coalesce with the segregated and finely dispersed seminal substances, thereby enabling the out-birth of ennobled higher forms of growth.

Whatever is valid for the propagation of growth also holds true for the growth of qualigen, i.e. for the upward evolution of quality to an octave higher. In these forms of growth, specifically densified combinations of pressure and suction play a decisive role. Concentrated energetic masses of bipolar threshold substances therefore require only the slightest motive impulse in order to interact with each other with elemental force (viz. the expansive force of high-grade oxyhydrogen or detonating gas). The sublime actuator of motion is known as the 'energy-gradient'. It is none other than a specifically densified form of latent energy. The slightest agitating impulse activates an elemental, formative process or an annihilating detonation.

This is how the generation of sunlight is also to be understood. It takes place at very high altitudes, when the specifically dense, formative entities shoot upwards at a tremendous speed, due to the low temperatures prevailing at such heights and the soaring, expanding influences of cold. Were the Sun merely a fiery ball of gas, as primitive thinkers believe, then the reactions of the fructigenic elements, which produce sunlight on their upward developmental path, would be sluggish and the opposite substance highly active. Were this the case, then the logical outcome of these interactions would be cold light and a heat-form, whose intensity decreases with increasing distance from the heat source, i.e. from the Sun. It is common knowledge, however, that with sunlight precisely the opposite occurs and therefore this involves exactly the opposite metabolic products and functions. This explains the increasing heating effect of falling and concentrating forms of heat. Although the intensity of these heat-forms decreases in winter, when the Earth is closer to the Sun,³⁰ the intensity of light actually increases. Appropriate experiments led directly to the design and construction of naturalesque light-emitting devices. These generate rising and expanding bundles of light rays, which scatter as they propagate and increase in reactivity. In this state and as a result of increasing velocity, they disintegrate the seminal substances falling in the opposite direction and in this way give birth to more intense beams of light. The result of these experiments, is that natural daylight can be reproduced very cheaply. This should signal the demise of contemporary, degenerative lighting systems, which impair the eyesight.

Simply reversing the metabolic process into a formative mode could bring about a state of prosperity of a magnitude presently quite inconceivable. One day the time will come when people will look back and say to themselves, 'In those days there were idiots, who truly believed they could create a high culture through the enforced use of a technology based on destruction.' As a result of this technology, any metabolism in which disease is latent and for which no external means of therapy is available, will inevitably eat itself away. It is a sickness, which will become all the more dangerous, the more widespread the machinations of our unnatural thinking become.

And now to some associated phenomena, which develop as functional aids to the rhythmical dynamics of the metabolic process. Much has already been stated and written about the characteristics and function of the so-called trace elements, although the nature of these impulse providers and their contribution towards the creation of pressure and suction have not been recognised. For example, when we observe the fall of water through a cone-shaped outlet, which widens towards the bottom, then amidst the spirally rotating water-masses we cannot fail to see a shimmering, white, reflux flow-path, which narrows towards the top. This funnel-shaped reflux-channel is the conveyor of specifically densified products of dynagen, whose sense of rotation reverses as they are conducted in the opposite direction through 'cycloid-spiral space-curve' motion. It is these energetic entities that regulate the velocity of draining and falling water.³¹

How could the unvented bladder otherwise be emptied of urine? When this reflux of dynagen reaches the warm, far side bladder space, then it immediately devolves into gaseous back-pressure. When such reflux entities encounter the jaws of a trout, however, they then open out into a waterspout-like (vortical) formation, whereupon an upward suction develops akin to that of a cyclone. Due to the resulting counter-reaction, the flow of water comes to a halt, its forward flow impeded, and in the axis of flow a trumpet-shaped vacuity evolves and widens in an upstream direction.

The discharged (deoxygenated) water-particles streaming from the trout's gills envelope its tear-shaped body like a cloak and in their neutral state, immediately interact with the surrounding substances of a highly polarised nature³² in the main body of water. Juvenile water is then formed, which cannot mix with the main body of water due to its different state of potential. This continually creates a zone of pressure, which acts at right angles to the longitudinal axis and squeezes the fish upstream. The combined action of the suction in front and the counter-pressure behind, which act in the same direction along a common axis, explains the trout's phenomenal means of movement upstream.

If a thin filament of water is expressed from a nozzle under pressure and falls rapidly without auto-rotation, then the waste-products of potentiated

substances are propagated horizontally as emanations. If these are suitably braked and conducted into a vacuum tube, then they produce a strongly pulsating, dark-red glow on the inner surfaces of the tube. Under similar preconditions, however, if the same jet of water is made to fall in 'cycloid-space-curves', then a dazzling light appears in an evacuated glass bulb held above the longitudinal axis, which fills the entire volume and appears to be completely motionless. At the same time an updraught or an after-flow of cool, tornado-like, air currents is distinctly felt. The more the glass bulb is evacuated, the more dazzling the almost colourless, daylight-quality and totally temperatureless body of light. It is an artificially generated Sun, the best and cheapest artificial light possible.

If this experiment is extrapolated into other fields, then it explains the origin of the circulation of water, sap and also the blood, whose regulating valve is the heart. Therefore the heart should not be viewed as a pump, since it does not pump, but is activated or 'pumped' by the blood. If illness or blood infection alters the labile blood temperatures, then the heartbeat and pulse-rate change. Were the heart merely a blood-pump in the conventional sense, then it would transport diseased blood just as efficiently as healthy blood.

Transposed into the field of bio-eco-technology, this would result in the design and manufacture of a bio-pump. The internal suction and pressure components for such a pump would evolve through inner motive impulses operating along a common axis, as happens with the blood as it passes through the energy-form (the heart). In this way it is possible to raise large volumes of water to any desired height and at enormous velocities with virtually no expenditure of energy. Once it has been elevated, this spacially condensed, sweet, fresh water is completely bacteria-free and can be used as cool drinking water immediately, or it can be further improved with the use of repulsive, quality-enhancing processes. The secret of the trout-motor therefore lies in the laminar, ramified lattice of gills. This lattice contains the previously described trace elements, which as 'il primo movere' provide the impulse for raising the quality of the assembly of naturalesquely moved material by one octave.

The interaction between substances of opposite gender takes place according to similar principles. The most powerful effect of these processes, which produce physical motion and which are themselves triggered by inner motive impulses, takes place in the vortical, upwardly streaming and broadening currents of cyclones.

It would take too long here to discuss the various trials and experiments that were necessary to determine the right design and construction of a device to exploit these elemental translatory and levitational forces for the naturalesque propulsion of aircraft and submarines. All that need be said here, is that the task of bringing about the collapse of the present machine age

has been successful and any further comment is superfluous. As a result of the knowledge gained from many experiments, two machines can now be built/ which have two different applications. No doubt in the eyes of every technician and engineer it will all appear as pure fantasy. In this regard, it can only be stressed: 'Whoever exploits retrograde oxidising processes must inevitably inaugurate a scarcity and shortage of food, raw materials and fuels.'

If these technically contrived metabolic processes are turned through 180 degrees, then logically, exactly the opposite has to happen through the formative and levitative after-effects of cold oxidation. Their physical manifestation will result in absolute independence and a superfluity of high-quality food. The previously mentioned means of levitation will also lead to absolute freedom of movement on land, under water and in the air. This signals the end of the technology that believed it could create a culture with annihilating fire and the aid of rising and expanding forms of heat. In Nature these forms of heat are used to initiate processes of decomposition and the creation of bad weather.

/Notes

1 See The Movement of Temperature in Mass-Concrete Dam Walls, in *The Water Wizard*,

Vol. 1, p. 122 of the Eco-Technology series. — Ed.

2 There appears to be no actual verb for the process of depositing sediment similar to the process of cavitation (cavitating), therefore the word sedimentating has been coined here. — Ed.

3 An edifying note concerning the temperature of the soil at different depths: By employing thermometers with their bulbs buried in the earth, and their stems projecting above, numerous observations have been made of the temperature from day to day at different depths from one inch (2.5 cm) to two feet (0.6 m) or three feet (0.9144 m); and at a few places observations of the same kind have been made by means of gigantic spirit thermometers with exceedingly strong bulbs, at depths extending to about twenty-five feet (7.62 m). It is found that variations depending on the hour of the day are scarcely sensible at the depth of two or three feet (0.6 or 0.9144 m), and that those which depend on the time of year decrease gradually as the depth increases, but still remain sensible at the depth of twenty-five feet (7.62 m), the range of temperature during a year at this depth being usually about 2°F (1.111°C) or 3°F (1.666°C). It is also found that, as we descend from the surface, the seasons lag more and more behind those at the surface, the retardation amounting usually to something less than a week for each foot (0.25 m) of descent; so that, at the depth of twenty-five feet (7.62 m) in these latitudes (Great Britain), the lowest temperature occurs about June and the highest about December. — Extract from Dechanel's *Natural Philosophy* (pp. 520-4) by Prof. J.D. Everett. — Ed.

4 Culture can here also relate to such aspects as silviculture or agriculture, as differentiated from social 'culture' per se, although Viktor Schaubergger viewed the conservation of the high forest and a high level of social culture, in all its forms, as

totally interdependent. The decline of the former therefore inevitably signalled the breakdown of the latter. — Ed.

5 Timbre of the voice! Timbre or timber seems to be associated with resonance! 'Apparently the violins built by Stradivarius of Cremona were so famous and had such a hitherto unattainable tonal quality, because the consistency of the wood and not the glue is decisive. Large quantities of mulberry wood were brought down to Cremona by alpine streams and the long sojourn in the water apparently endowed the wood with these properties.' — Das Neue Zeitalter. — Ed.

6 Plantation forests also have an irritating effect on the eye, due to a lower state of order and the unnatural, common horizontality of their branches, whereas a natural mixed forest has no such visual discomfort. — Ed.

7 See The Movement of Temperature in Mass-Concrete Dam Walls, in The Water Wizard,

Vol. 1, p. 122 of the Eco-Technology series. — Ed.

8 In the tree, the curve of an incorrect process of development is expressed by the degree of divergence from a pattern of a straight structural growth. In the case of the mass-concrete wall, the curve of correct or incorrect development is indicated by the thermometer. (Practical examples of incorrect structure [pore-formation] in rock will follow later.) — VS.

9 In mixed forests all the species of trees have different root systems. There are flat-rooted, heart-rooted and deep-rooted trees. The root-zone is thus widely diversified and reaches a depth of about five metres. Such a forest cannot be torn apart by storms. In the growing season, one hectare of forest evaporates about 50,000 litres of water, or 50 m³ per day. In the process a quantity of heat will be extracted through evaporative cooling, which is sufficient to cool three million litres of water by 10°C. The sap in the stomata under the surface of the leaves is over-cooled, thereby becoming heavier and sinks down to the root-area, which it then cools, creating a zone of coolness, whereas the warmer and lighter sap rises in the sap ducts. (From an infinite number of the tiny stomata in the leaves and needles, which represent the finest imaginable sieve, the spiralling light ray draws out the minute particle of water and screws it up into the sky.) — VS — From Implosion Magazine, Nos. 54/5, p. 39 and No. 62, p. 10. — Ed.

Every minute droplet of water in the order of one cubic millilitre contains about 10,000 billion water molecules. Each contributes to the cooling effect of evaporation. These droplets rise in spiral paths towards the light (photophoresis). Walter Schauburger — Implosion Magazine, No. 5, p. 29. — Ed.

10 As a case in point, in the Amazon rainforest, the production of oxygen ceases at about midday, due to a cessation of photosynthesis. This is possibly caused by interruption in the necessary nutrient supply by a perhaps longer-lasting reversal of sap flow due to the greater heat, due to a greater evaporative cooling, resulting in a greater sinking of sap, which does not recover or reverse direction until the following day. — Ed.

11 The molecular compound takes the form H₂O + CO₂ (water + carbon dioxide) or H₂CO₃ (carbonic acid) depending on temperature and pressure. With warming and reduced pressure, carbonic acid converts to carbon dioxide and water. See also Fig. 4. — Ed.

12 Under certain preconditions approximately the following occurs:

$C + H_2O = CO + H_2$

$CO + H_2O = CO_2 + H_2$

$CO_2 + H_2O = H_2CO_3$ (= carbonic acid).

Hydrogen produced can now react chemically with the salts in the Earth and liberates various acids or precipitates metals. — VS.

13 As originally written in German, the meaning of this sentence is not entirely clear, perhaps due to a printing error where the word 'lowering' was inserted instead of 'raising'. Since the boiling point of a given medium is relative to the density of, or the counter-pressure exerted by, the molecules of the medium surrounding it, then the temperature of the boiling point would normally rise with increased external pressure, as the molecules of the heated medium would require greater kinetic energy to overcome the enclosing resistance of the surrounding medium. On the other hand, it is to be noted in this regard, firstly, that little or no oxygen is present and secondly, that in the oceans the water temperature decreases (to about +3°C [+37.4°F]) and in freshwater lakes (to +4°C [+39.2°F]) with increasing depth and pressure, so that the exertion of pressure is not necessarily concomitant with an increase in temperature. However, since we are here concerned with water, even if in vaporous form, of whose actual nature and behaviour in the dark recesses of the Earth we are still largely ignorant, the same phenomenon may also apply here. On many occasions Viktor Schauberger put forward hypotheses contrary to established theory, which ultimately proved to be correct. — Ed.

14 Here Viktor Schauberger refers the reader to his article Temperature and the Movement of Water, which is to be found in The Water Wizard, Vol. 1, p. 94 of the Eco-Technology series. — Ed.

15 Poor winters (meagre snow cover and a permeable frost belt) enable the inner atmosphere prescribed for the plants to escape from the Earth. Diseases of the respiratory organs, symptoms of fever are the inevitable consequence. Such winters result in poor harvests, due to insufficient accumulation of nutrients. — VS.

16 For example, washing with snow or rainwater (soft water) removes dirt and salts (sweat) better than hard water. — VS.

17 Here Viktor Schauberger refers the reader to Parts I and II of The Natural Movement

of Water over the Earth's Surface to be found in The Water Wizard, Vol. 1, p. 135 and p. 145 respectively of the Eco-Technology series. — Ed.

18 No enforced growth or development of large protective lower branches occurred due to exposure to excessive heat and light. — Ed.

19 See The Movement of Temperature in Mass-Concrete Dam Walls in The Water Wizard,

Vol. 1, p. 122 of the Eco-Technology series. — Ed.

20 The German word used here is *ubersauerte*, the root of which is *sauer*, which means

'sour' or 'acid'. In German oxygen is called *Sauerstoff* and thus reflects the German concept of oxygen as the element responsible for the formation of acid or sourness in its capacity either as catalyst or active ingredient. Here the groundwater would have a low pH value, the pH of 7 being the mid-point between acid and alkaline values. — Ed.

21 See Experiments with Copper Implements in Agriculture, p. 185. — Ed.

22 Decentrating: Converse of concentrating. — Ed.

23 NOTES ON MAGNETISM. (Quoted from the Penguin Dictionary of Physics). — Ed.

Ferromagnetism (p. 147). A property of certain solid substances that, having a large positive magnetic susceptibility, are capable of being magnetised by weak magnetic fields. The chief ferromagnetic elements are IRON, COBALT and NICKEL; many ferromagnetic alloys based on these metals also exist. Ferromagnetic materials exhibit 'hysteresis'. Their relative permeability is much greater than unity and they achieve saturation at fairly low magnetic field strengths. At a certain temperature, the Curie Point, there is a change from ferromagnetism to paramagnetism. The characteristic features of ferromagnetism are explained by the presence of domains. A ferromagnetic domain is a region of crystalline matter whose volume may be between 10⁻¹² and 10⁻⁸ cubic metres (353-424 and 353-282 cu ft), which contains atoms whose magnetic moments are aligned in the same direction. The domain is thus magnetically saturated and behaves like a magnet with its own magnetic axis and moment. The magnetic moment of a ferromagnetic atom results from the spin of the electrons in an unfilled inner shell of the atom. In an unmagnetised volume of a specimen, the domains are arranged in a random fashion with their magnetic axes pointing in all directions so that the specimen has no resultant magnetic moment. Under the influence of a weak magnetic field those domains, whose magnetic axes have directions near to that of the field, grow at the expense of their neighbours. In this process the atoms of neighbouring domains tend to be aligned in the direction of the field, but the strong influence of the growing domain causes their axes to align parallel to its magnetic axis. The growth of these domains leads to a resultant magnetic moment and hence magnetisation of the field. With increasing field strength the growth of the domains proceeds until there is, effectively, only one domain whose magnetic axis approximates to the field direction. The specimen now exhibits strong magnetisation. Further increases in field strength cause the final alignment and magnetic saturation in the field direction.

Paramagnetism (p. 273). The property of substances that have a positive magnetic susceptibility. It is caused by the spins of electrons, paramagnetic substances having molecules or atoms in which there are unpaired electrons and thus a resulting magnetic dipole moment. There is also a contribution to the magnetic properties from the orbital motion of the electron. The relative permeability of a paramagnetic substance is thus greater than that of a vacuum, i.e. it is slightly greater than unity. A paramagnetic substance is regarded as an assembly of magnetic dipoles that have random orientation. In the presence of a field, the magnetisation is determined by competition between the effect of the field, in tending to align the dipoles, and the random thermal agitation. For small fields and high temperatures the magnetisation produced is proportional to the field strength. At low temperatures or high field strengths a state of saturation is approached. As the temperature rises, the susceptibility falls according to Curie's Law. Solids, liquids and gases can exhibit paramagnetism. Some paramagnetic substances are ferromagnetic below their Curie Point.

Diamagnetism (p. 101). A property of substances having negative magnetic susceptibility so that the relative permeability is less than that of a vacuum. It is caused by the motion of electrons in atoms around the nuclei. An orbiting electron

produces a magnetic field in the same way as an electric current flow in a coil of wire. If an external magnetic field is applied, the electrons change their orbits and velocities so as to produce a magnetic field that opposes the applied field.

Lines representing the flux in a uniform magnetic field become more separated when passing through the material; similarly, if a diamagnetic substance is placed in a non-uniform field, it tends to move from the stronger to the weaker part of the field. If a bar of diamagnetic material is placed in a uniform magnetic field, it tends to orientate itself so that the longer axis is at right angles to the flux. Diamagnetism is a very weak effect; its permeability is only slightly less than one. Copper, Bismuth and Hydrogen are purely diamagnetic. The diamagnetic properties of materials is not affected by temperature.

Antiferromagnetism (p. 23). The property of certain materials that have low positive magnetic susceptibility (as in paramagnetism) and exhibit a temperature dependence similar to that encountered in ferromagnetism. The susceptibility increases with increasing temperature up to a certain point, called the Neel temperature, and then falls with increasing temperature according to the Curie-Weiss Law. The material thus becomes paramagnetic above the Neel temperature, which is analogous to the Curie Point in the transition from ferromagnetism to paramagnetism. Antiferromagnetism is a property of certain inorganic compounds such as MnO, FeO and MnS. It results from interactions between neighbouring atoms leading to an anti-parallel arrangement of adjacent magnetic dipole moments.

24 Ressel, also an Austrian forester, was the inventor of the ship's screw or propeller. The two German inventors, R. Diesel (1858-1913) and N. Otto (1832-91) respectively invented the diesel engine and the petrol engine. — Ed.

25 Sven Hedin describes these in his book, *The Flight of the Great Horse (Die Flucht des grossen Pferdes)*. — VS.

26 According to Collins English Dictionary a bacteriophage is 'a virus that is parasitic in a bacterium and multiplies within its host, which is destroyed when the new viruses are released.'

Here the meaning of bacteriophagous has little to do with bacteria as such, but tries to express the notion of highly subtle, autonomous entities within entities endowed with the potential to impart life- or death-decisive influences. — Ed.

27 With sudden vaporisation due to heat, the expansion of water is 64,000 times its original liquid volume. — Ed.

28 This device is described in more detail in *Energy Evolution*, Vol. 4 of the Eco-Technology series. — Ed.

29 See quotation from *The Pattern of the Past* by Guy Underwood — *Nature as Teacher*, p. 101, Vol. 2 of the Eco-Technology series. — Ed.

30 This relates to the northern hemisphere when the Earth is at Perihelion, its closest orbital approach to the sun, which currently occurs about 1 January, thus in northern mid-winter, whereas in the southern hemisphere this takes place in high summer. — Ed.

31 See also 'Experience is gained the hard way' in *Nature as Teacher*, Vol. 2., p 57, of the Eco-Technology series. — Ed.

32 Described in the original German as *Differenzstoffe* (Difference-substances). This refers to diverse elements, essences, or ethericities, whose mutual differences or

natural characteristics are, or have been, intensified for one reason or another. In other words, they are in a highly polarised state, their various charges and potentials thereby approaching a more or less extreme monopolar condition, a condition where their differences are equally extreme, hence the expression 'Difference-substances'. In this unbalanced state they develop an extreme attraction, or hunger, for their counterpart, a thirst which until assuaged, disables them from any creative or formative activity. — Ed.

3.

Forestry

— Agriculture —

The Energy Industry

From *Our Senseless Toil*, Part 1, pp. 16-20.

'Unfortunately, catastrophes or scandalous disclosures always have to happen before humanity

realises that it is only its own mistakes that have led it into misfortune. These are all the more

difficult to rectify, because in the main they have been made by the authorities, who will not

commit suicide themselves, but in order to save their own skins, they would rather that all Life

should perish before they acknowledge their errors.'

Viktor Schauberger, 1933 — *Implosion Magazine*, No. 2, p. 23.

The Forest

Foremost amongst the various professions is modern forestry, which for a century has unsuccessfully attempted to transform the highest plant organism, forest, into a timber factory. Trees are set out in rows and the preconditions for the natural regeneration and intermixture of species are altered arbitrarily. Nobody has any idea what happens in the interior of a tree. Or why, contrary to all the laws of mechanics, water can rise with its various substances to the very top of a tree via its capillaries. Some talk of osmotic pressure, while others speak of root-stimulation. All agree, however, that the Sun is the ultimate driving force. What none of them know is how.

This research is carried out with the aid of mechanical equipment. So their attempts to find out are coloured by mistaken thinking and are therefore useless. In the first place every pump requires a motor. Secondly, it is not enough merely to tickle the trees' toes. Thirdly, it is a well-known fact that trees cover themselves with branches, a sure sign that they desire to shield

themselves from the Sun and its direct warming influence, for they are only able to benefit from sunlight indirectly. But what does the forester care? He simply plants 'shade-demanding' trees in the light, and lo, they grow more readily! Unfortunately even this magic is short-lived. The structure of such trees becomes looser and more coarsely-knit and ultimately the identical process begins that is now apparent in our increasingly filthy river-systems. Discoloured blotches initially appear in the cross-section of the trunk. Then the rotting process sets in, spreading from the centre outwards. In the interior of the tree a multitude of alien life-forms develop — cancer — to which the macro-organism, the tree, gradually falls victim. Various microbes are now eagerly collected, receive Latin names, and many people are gainfully employed in documenting the innumerable diseases which from year to year and in ever greater number assail the tree's prime asset — its health. All fail to see that the much sought-after instigator of this alien life-form is the forester and his absurd practices.

Agriculture

Hand in hand with the forester works the landowner. The blood of the Earth constantly deteriorates, the fertility of the soil decreases and happily the need to fertilise is there! Forward strides the chemist and strews his salts! Unfortunately this good man neither has any inkling why and how these salts are dissolved, nor what processes enable the development of the energies required for thriving plant growth.

Success lasts only a few years, after which the soil very quickly becomes clogged with artificial fertiliser. Once again Man has worked against Nature, by cheerfully plugging up the last sources of food, the capillaries in the soil. At a complete loss, the farmer now stands bewildered in his field, which for a short time rewarded him very handsomely with quantity at the increasing expense of the quality of his produce. As a result he actually harvested less in the long term, although short term his harvests were almost unlimited in quantity. Instinctively seeking vital substances in the Earth, he gets out his deep-cut plough and destroys the soil's capillaries.

The same thing now happens to agriculture as is happening to the forests. Superficially everything appears to blossom and flourish. These are but false blossoms, which are nurtured by rotting marrow. More than ever before they now begin to bear the fruits of decay — cancer. Cereals lose their starch content, the meadows become overgrown with mosses and the fields with weeds. All that increases is the labour and the expense. The end is the loss of soil, house and home.

The Energy Industry

The energy-technologist is the true ringleader in this merry-go-round. Where still available in sufficient quantity, coal (the Earth's Bread) and water (the Earth's Blood) are used to produce various forms of energy. Enormous quantities of energy are being produced, electrical energy in particular, but even today nobody knows what electricity actually is. The possible uses of electricity are enormous. How it comes into being, the consequences and the after-effects of present methods of its production, remain unknown however.¹ Humanity has wallowed in this fortuitously-discovered wealth for only a few decades. The water to drive its machines will become increasingly scarce and of worsening quality. The catastrophes which beset the Earth will also become more and more violent, for humanity has stolen carbons (her bread), water (her blood) and energy (her soul). Untiringly, humanity labours on and plunges deeper and deeper into abject misery.

The First Doubts

The more that exact science, the very foundation of such practices, begins to shake, the greater will be humanity's mistrust of it. The deeper the groundwater sinks into the Earth, the worse the climatic conditions will become, and the more forlorn the future and the more characterless the people. Hardship and hardship alone will increase. Gradually mothers will begin to sell their love and their souls in the streets. Fathers will begin to beg, contemplating robbery and murder, and the political situation will become increasingly fraught. The greater the stench of this deranged and lunatic industrial society, the paler the cheeks and the more garish the artificial rouge. The more terrible the weapons of war, the greater the fear between one people and another. Every statistic bears witness to the increase in the ultimate and most dangerous disease — cancer. Doctors stand helpless and perplexed before this unbridled development. The victims of this terrible disease are without number. Blindly the knife hacks away and overcome with pain, people rot away in hospitals. Nobody understands why this hideous disease is reaching epidemic proportions. Everything is registered and organised. Innocent animals are tortured in the search for the virus of our most dangerous enemy. They will never find it in this way, for it is inherent in the very nature of the way we work.

The Timber Industry, Forestry and Wood Production

The latter part of Return to Culture published in Architektur & Bautechnik, September 1932.2

Since time immemorial the forest, apart from performing other functions, has been the foster-mother of our domestic wood processing industries and businesses, and of the domestic and foreign trade in timber. This timber trade cannot exist in the long term without sustainable forestry, for wood has been a much sought-after requisite of humanity since ancient times. In earliest times vast primeval forests covered Central Europe. They were regarded then as an obstacle to the development of culture and were recklessly felled and laid waste in order to create a cultural prosperity based on agriculture. At this time there was still no need for care and attention, for sowing or planting, since the products of the forest were abundantly to hand to exploit. This all happened without any regard for regeneration or conservation for the sake of future generations.

This was the age of the timber industry. Not far from the German border the Yugoslavian karst and treeless Italy begin. Further to the south-east the barren coastal areas of Africa bear witness to a carelessly implemented timber industry, which on the north Mediterranean coast had already led to karst-development. Out of this crisis arose forestry, which is an organised and methodical activity based on the founding, care and exploitation of forest. Forestry was developed principally in Central Europe. Once, imperial Austria in consort with Germany, also played a large active part and in the north of Germany there already existed well-established commercial enterprises. In the alpine countries [Austria and Switzerland] forestry was hampered by the roughness of the terrain and in the south [Yugoslavia and Italy] there was karst-forest with many barren areas as a result of the reckless timber industry of the time. While in the west inroads were still being made into virgin forest, in the south and the east the rebuilding of the forest was the task of the new forestry industry.

In Old Austria during the 1850s it was decreed that approved forest owners were to be appointed to the larger forest enterprises. They were to be responsible for the methodical, rational and sustainable management of the forests. Since in most areas these forest enterprises had long been dormant, in the majority of cases there was either no demonstrable success or only a very minor achievement in the implementation of contemporary forestry. Large-scale and concentrated felling operations were supposed to make the continuously rising overheads competitive. The more the profits diminished, the more timber had to be felled if a balance in the economic budget was to be maintained. The greater the quantity of timber placed on the market, the

lower the timber price and in turn the more extensive the felling of trees. Here and there enterprises for the exploitation of timber sprang up, which over an extended period annually extracted millions of cubic metres from what was left of the primeval forests and dumped them on the market.

In the remaining areas of forest, where timber could no longer be extracted from apparently inexhaustible primeval forest areas, older, higher-quality timbers disappeared and the felling therefore shifted more and more towards younger trees. The younger the trees felled, the smaller the overall volume and of course the greater the size of the areas cleared. A continuation of these management strategies would have led to the quantitative decline and ultimately to the disappearance of the forest. Therefore if the forest industry was to be sustained, then felling had to be less and the volume of felled timber greater. The forest had to be made to grow more rapidly; people concerned themselves with the causes of growth and the science of forestry began.

Since time immemorial it was known that primeval forests did not grow evenly, but that where the trees were exposed to the light of the Sun, they formed much wider annual rings. The wood, as the timber merchant termed it, was 'milder'. What could be better than to place this natural phenomenon at the service of the then-contemporary science of forestry? Modern scientific forestry began. In this modern industry, timber was no longer something provided by Nature, but something created artificially. Forestry was turned into a timber production industry.

In the management of hardwood forest, the period of rotation was fixed at between seventy and 140 years, and in softwood forest, between fifteen and forty years. In these modern 'timber factories' the timber was to be produced in an orderly fashion and delivered as if by conveyor-belt. The very careful selection of varieties of timber was a first priority and endeavours were made to grow only the most valuable timbers on the smallest possible areas and to exclude all the other valueless 'co-consuming' plants and 'soil-miners'. Within the space of a few decades the modern forest, planted out with strings in rank and file, was established. All growth was carefully monitored and the period of rotation cut short when the annual rings began to narrow and the capillaries to form. Since under these conditions of reduced growth the forest could only yield a poor return on investment, it was therefore ready for felling to make room for fast-growing species. Thanks to this rational and sustainable forest-factory industry the economy in Central Europe seemed to have been saved. With a continuously rising production of timber, trade and thus the national budget appeared to be safeguarded.

A few years after a burgeoning boom and excessive over-felling, the groundwater table in Central Europe began to sink in a particularly alarming way. At the same time a sinister decay in the wood also became evident. The once valuable spruce developed red-rot and blackened branches, which broke off

and fell to the ground; the pine, inasmuch as it was able to survive, became ring-shake prone and the beech developed a rotten core — indeed further symptoms of disease very similar to cancerous growths in living things became evident. In Poland, Carpathian Russia, Transylvania and deep into Romania, as in Austria, the beech has lost almost all value as usable timber. Countless millions of cubic metres of timber now cover whole tracts of country with almost worthless firewood which can barely cover its cost of felling, let alone the costs of reforestation, to say absolutely nothing of returns on investment.

In more westerly regions the pine has disappeared almost completely, the red larch has for long been a rarity and the main product of modern forestry, the cultivation of pure spruce forest, can no longer be sold on lucrative foreign markets. Because of the poor quality of our timberware, the export quota to France could no longer be filled. Italy refused to buy round saw-logs, because the boards often fell apart. Mining operations were undertaken with extreme caution, because the compressive strength of today's pitprops has diminished by fifty per cent relative to its earlier capacity. Cellulose manufacturers complain about the poor quality of fibres. Domestic furniture and cabinetmakers had to protest to their own government against the introduction of an import duty on high-quality timbers from abroad, because they could no longer obtain it locally. They would therefore no longer be able to maintain their businesses were the frontier to be closed or these varieties of timber made more expensive through import levies.

This phenomenon, this 'forest death' (Waldsterben), is becoming particularly evident in eastern and southern Central Europe, gradually decreasing towards the west. However even in northern countries the new generation of young forest no longer has the quality of former times. Upon closer objective examination, these issues are less concerned with a general crisis in timber, but rather with an exceptional crisis in its quality, whose cause is to be found in the large quantities of timber of indifferent quality dumped on the market.

The water table, which has already been retreating throughout all Central Europe, has sunk about two metres (6.5 ft) on average since 1928 alone. The fall in quality and the disappearance of our native varieties of timber, not forgetting the decline of all the upland farmland in western Europe associated with it, demonstrates that we have committed dreadful mistakes — economic mistakes which will lead us down the road to total ruin, if we do not quickly intervene and learn to understand that the forest was not created by Providence merely for the sake of timber production. As an organism the once-natural forest played an irreplaceable role in the balance of Nature. These important functions can no longer be achieved by our present artificial woodlands, which are not normal to Nature and in fact are totally alien to her. In these plantation-forests, which have nothing in common with earlier forests created by Nature, water disappears from the zone of vegetation. Without water life is

unthinkable, for in Nature's housekeeping, water plays the role of the untiring carrier of light, energy and heat. First and foremost, it is the carrier of all the substances that create and sustain life. The metabolism of the vegetation is exclusively a question of correct water temperatures.

The forester failed to see these great laws. Water, which through his deeds has in many instances become nutritionless and thereby unstable, can no longer fulfil its legitimate purposes. From being 'the blood of the Earth' it will turn into 'the curse of humanity' and the endeavours we deign to call culture. The view that the forest is exclusively a foster-mother of our commerce is a grave error. Interference on the part of the forester in the evolutionary laws of the forest is a grosser error, which can be made good again only after a laborious work of reconstruction lasting centuries.

Only water that has been brought into the proper temperature-gradient through the agency of the forest is able to carry oxygen down into the depths. With the aid of higher temperatures in the carbonosphere this triggers processes of oxidation which awaken life. In conjunction with these oxidising processes a pulsation begins. Time and time again this pulsation is able to bring substances won from the Earth into new oxidations and to transform them. Every single one of the oxidations that take place under lower temperatures ennobles the substance, which through these reciprocally stimulated processes is also pumped upwards and in this way made available to the vegetation. Further transformed within the capillaries of the vegetation and by means of the carrier, water vapour, the substances obtained from the Earth receive light from the Sun, in whose orb the ultimate oxidation finally takes place under very low temperatures. The cold rays of the Sun are transformed into light through the resistance of the carrier, water, and brought down to the Earth as heat, through which life is then made possible. Our general climatic conditions are dependent upon an undisturbed development of the processes described above.

During the earlier period of reckless timber felling, these vital functions of the forest were quantitatively weakened. Later they were finally destroyed by forestry science and so the pulsebeat of the Earth was arrested by the modern timber production industry. Today we stand confronted by the dying forest, by the decline of the highest vegetation, and by the demise of our timber industry. At the same time we stand before the total collapse of our whole system of soil-cultivation and agriculture, because with the dying of the forest the substances required for growth can no longer be supplied to the remaining vegetation. Through the exploitation of light-induced growth in shade-demanding timbers, and as a result of the increase in the width of the annual rings thus achieved, the capillaries are lost, which the forest has laboriously built up over hundreds of years of evolution for the purposes of its further development.

The forester has not only endangered the quality of timber, the forest and thus himself, but he has also destroyed precisely those crucial pathways destined to supply higher vegetation with its nutrients. The farmer with his highly developed crops was also endangered, as well as the daily bread which makes us independent and free.

The Forest and its Significance

From TAU Magazine/No. 146, June 1936.

The natural habitat of water is the forest. If water's habitat is destroyed, it becomes unstable and hunts about everywhere, ceaselessly seeking out those substances needed for the growth of vegetation. All the processes that take place in the water are also reflected in the individual types of vegetation. Without doubt the forest represents the highest form of vegetation and many thousands of years of evolution are required for the creation of this mighty plant organism. The forest is the habitat of water and as such the habitat of life processes too, whose quality declines as the organic development of the forest is disturbed.

All transformation processes essential for life, including the development of our own mind and intellect, are associated with a continuous reciprocal activity which takes place according to an inner ordering principle. This activity is initiated through the alternation between night and day. In more highly organised systems this happens under the influence of shade, which no organism is able to provide in the same measure as the forest. This is why the disturbance of organic processes of growth leads to the disruption of external climatic conditions. In further consequence, this inaugurates an unfavourable rearrangement in the status of the inner climate of remaining forms of vegetation, and ourselves included.

In order to understand the meaning behind this, it is necessary to say something about 'biocenosis' — the relationships and interactions between the organisms of a natural community in a particular area. In a healthy forest, apart from the many other types of plants forming the undergrowth there is an untold number of animals of all types; from wild game to caterpillars in the treetops, from beetles in the bark to microscopically-small mites, which in their millions inhabit the decomposing layer of plant matter on the ground. Only when these organisms are taken as a whole do we arrive at the concept of forest'. In a healthy forest they are all so attuned to each other that all members of this forest community can play their appointed part. Biocenosis is then in a state of balance.

All these creatures live in a visible state of mutual tolerance, which at first sight appears extremely curious, but on closer inspection it can be seen as

Absolutely necessary. In order to preserve this state of equilibrium, it is vital that the characteristic inner temperature of each of these millions of micro-organisms be maintained. Only under such conditions can the higher forms of life evolve as Nature ordains, and only thus will countless rival organisms be kept in an embryonic state. The slightest disturbance of this harmony can lead to disastrous consequences for the major life-forms.

To be or not to be. In Nature all life is a question of the minutest but precisely graduated differences in thermal motion within every single body, which continually changes in rhythm with the processes of pulsation. Every disruption or suppression of these infinitely finely attuned organic interrelationships must lead to deterioration of the healthy condition of each individual, to a state of disease. Today we consider every known disease to be caused by a micro-organism, which dwells and develops within the macro-organism, and to be an attack by Nature on its rightful existence.

Through such changes in temperature, the danger of the development of micro-organisms arises for which an increased or decreased microclimate is the precondition for the onset of their vital activity. For the original macro-organism, the host body, this new development is what we commonly understand as 'disease' which through the gradual proliferation of such micro-organisms can increase until it decomposes the juices in the macro-organism. This development proceeds at the same rate as the new and alien life obtains its prescribed substances and creates its own circulation system.

The lower the state of such development, the stronger the influence required to disturb the inner equilibrium of a living being and to awaken a new form of micro-organism. According to its state of organisation this development may be deemed to be responsible for the disease or death of the original host. A highly evolved being is endowed with intelligence and every macro-organism contains a multitude of micro-organisms which have no actual independent existence, but which can exert a positive or negative influence on the host body. Yet there are also other influences of a higher nature. Such an influence is radiation in its widest variety of forms and action, which remains of corpuscular nature under all circumstances and is always in a position to transmit information to all lower forms of life. Through this process it can either further their development or destroy it.

The lowest form of radiation is temperature radiation, which, without prior transformation, has the capacity to affect an organism directly. If such thermal radiation is able to act directly, it does so on the appropriate external organs, yet it is not able to come into contact with the fluids of the respective bodies. The higher the organism, the higher (generally speaking) the form of radiation involved in its growth and life functions. The higher the radiation, the more it must be transformed and tempered by means of resistances, if the most simply organised life-forms are not to be destroyed. This is synonymous

with the disease or death of a macro-organism and the eventual development of a rival form of life.

The highest forms of radiation belong to those arising from the high-grade transformation processes in the vicinity of the Sun. So long as radiation does not impinge on the correspondingly less-complex substances required for growth present within forest trees, microscopically small rival forms of life will be unable to exert an independent influence. Such micro-organisms, whose vital activity would otherwise develop under conditions of direct heat and light, have for the time being too low an inner temperature. Similarly, prevailing temperature conditions will prevent chemical reactions in these growth substances, i.e. the processes of oxidation, and the emergence of an independent circulation system.

In order to shield radiation-sensitive types of tree from the effects of too strongly active radiation, Nature gave them either protective bark, or the ability to shade themselves with branches right down to the ground. This process of branch development or bark formation enables the tree to transmute and accumulate the Sun's energies without which no growth would be possible.

One of the most marvellous processes in Nature is that of assimilation, which is the only direct means for the transformation of solar energy into other forms of energy. For this transformation and subsequent accumulation of energy an appropriate temperature-gradient is necessary. This gradient is brought about by the alternation between night and day. The periodic change in the direction of temperature-gradient (from outside inwards and from inside outwards) within a plant is a precondition for the transformation of accumulated solar energy into chemical forms of energy. Through the agency of water, which acts as a carrier and conductor of heat, various forms of carbon³ and oxygen, energy-rich starches and proteins can be created.

The thermal gradient plays a decisive role in creating pathways through which matter is drawn up from the Earth such as the formation of capillaries, the processes of oxidation, the promotion of pulsation and the transmutation of radiant energy.

But, let us return again to consider bark or outer skin. The types of timber described by forestry experts as light-demanding have a thick bark in contrast to shade-demanding timbers which have a thin protective sheath. If the types of timber described as 'shade' timber, or more correctly 'shade-demanding' timber, have no protective layer of bark against direct sunlight, then as fast as possible, they must cover themselves with branches all the way to the base, in order to shield themselves from the damaging effects of direct radiation. In most cases sufficient protective measures are possible only in the earliest youth of a tree. However, these take place at the cost of the proper structural development of the wood and therefore at the expense of the correct development of the tree's trunk. As long as radiation has no effect on less-

organised formative substances present within a tree, no higher-grade interactions (oxidation) can take place, and thus the preconditions for the emergence of higher forms of life do not come about.

However, if these shade-demanding varieties of timber are planted out in direct sunlight, which varies in intensity and effect according to the time of year, the hard radiation, rich in 'capacity for work', will succeed in reaching the interior of a tree. There it affects temperature conditions to the extent to which water, as resistance and the conductor of heat, is present. The particles of corpuscular radiation are essentially the same as the oxygen, proteins and cellulose contained in the tree, namely male and female substances. The only difference lies in the valencies of these substances.

If a condition approaching a direct balance between these substances should occur, then the inner temperature rises and the interactive processes intensify. From this arise correspondingly stronger pulsations and accompanying oxidations due to increased thermal energy and the formation of an independent circulatory system. In the case of larger organisms this leads to the appearance of scorching and inflammation synonymous with the propagation of many life-forms alien to the body. These cause a sickening and a halt in the development of the macro-organism, leading to its decline. Thus the development of micro-organisms and the opportunities for their propagation are simply a result of the condition in which the respective sickening macro-organism finds itself. It will be attacked by these parasites and eventually must fall victim to them if its inner climatic conditions are no longer strictly regulated.⁴

We are confronted here by a series of developments which are now damagingly afflicting our forests and whose significance has so far been almost entirely disregarded. The present condition of the world's 'ploughed' forests, the continuous reduction in the qualitative structure of our timbers and the rapid escalation in the deficit of all forest industry, must be the most striking proof of the forest's organic degeneration. An overall view of modern forestry practices will first be discussed before addressing the ways in which the inner ordering principle within the tree functions.

When the Pilgrim Fathers set foot on American soil a virgin forest covered 681 million acres in the east of the country and 141 million acres in the west. Today [1936] these have sunk to 60.7 and 77.4 million acres respectively. The forest land in America therefore has been quantitatively reduced from 822 to 138 million acres. Large areas of this former forest land have been transformed into arable land on which cereals and other agricultural produce are grown today.

Curiously, there is evidence to show that on this arable land, which has been worked and deep-ploughed by machines, the cereals contain fewer starches and the soil can no longer yield 100 per cent wholly nutritional produce. The soil-capillaries of these over-exploited soils have been destroyed by deep ploughing, but should they be restored to their original function, then even

low-grade natural forest would barely be able to grow on such areas. During the course of time areas left to lie fallow will be washed out by rain, so that today 81 million acres lie barren and infertile. Consequently the conditions are beginning to arise in America, which in Europe are already apparent in many regions of Spain, in the karsts of Yugoslavia and Italy, and also in the deserts of Africa and Asia.

Lack of humidity and the increasingly severe drying up of the soil on the one hand, and floods and devastation due to heavy downpours on the other, are already presenting governments of all countries with difficult problems and heavy expenses.

All humanity's needs can be satisfied by the raw materials obtained from the soil. Apart from the increase in obvious damage revealed in the qualitative deterioration of the soil and the sinking of the water table, there is also in evidence an undesirable change in drainage conditions and an adverse shift in the state of the macro-sphere and the micro-sphere. Where this disregard for all the organic processes of growth has led, is demonstrated not only in the changes in water level and drainage situation already mentioned, but is also glaringly demonstrated in the general economic state of our own (Austrian) forest enterprises.

The Austrian Forestry Department annually fells solid timber
for sale on the market in the order of 1,000,000 m³
(1,300,000 cu yds)

— The average annual deficit amounts to 10,000,000 schillings

— Thus the figurative loss per cubic metre felled
and sold is 10 schillings

— The staff of administrative personnel required
amounts to 700 men

— and the labour force for forestry operations requires 4,000 men

To maintain this annual production level of 1,000,000 m³ of high-grade solid timber (ST) — by not felling timber in the usual way, and if the number of people presently employed are to be looked after as well as circumstances permit, then the annual financial burden would amount to approximately the following:

700 officials at an average salary of 300 schillings/month 2,100,000 schillings

4,000 workers employed in a supervisory capacity

@ 4,000 x 5 schillings x 300 working days 6,000,000 schillings

Thus the total cost is 8,100,000 schillings

From a purely moral point of view, if this provisional

— financial load is compared with the annual deficit of 10,000,000 schillings

— then the actual remaining net profit is 1,900,000 schillings

— and the stupendous real value of 1,000,000 m³ ST 1.9 schillings/m³

Pension costs, which apply in any case, have not been taken into account.

The situation as set out above is absolutely no accident, but due to gross mismanagement. If there is no radical departure from current economic and scientific forestry practices, the complete collapse of all forestry enterprise must come about in a very short time.

The economic death of a people has always been preceded by the death of its forests. The latest and most terrible of misused Nature's warning signs was the drying up of springs, the increase in catastrophes and the nascent fickleness in the behaviour of water. Its unending cycle destroyed, water punishes and eradicates the cause of the interference — an arrogant humanity — whenever it dares to offend against the unbending laws of all Creation.

The sinking of the water table by almost two metres (6.6 ft), recorded in many localities of Central Europe over the last few years, is a very serious indication of a disturbed Nature. It brings the danger of steppe-development in the upland regions of Central Europe ever closer.

The poor market for timber cannot only be blamed on dumping by Russia. For a long time to come Russia will be in a position to supply world markets with valuable, naturally grown high-grade timber obtained from its vast primeval forests. There exist no grounds, therefore, for the frequently expressed view that an early change will come about through this healthier and more naturally based competition. From a practical point of view, there are only two possible solutions:

1. Either it will be possible to produce exceptionally high-quality goods and place them on the market, or
2. A form of business enterprise, in which time and economy play no part, must be chosen with regard to the present low-grade timber, which is unsaleable at a suitable price.

The first possibility is rendered null and void by the fact that a quality product is not to be found in our present woodland and that it will require several generations before the mistakes made by today's forest industry can again be made good. There now remains the second possibility, which is:

- a. To institute the proper type of forest management required for the production of good quality timber, and
- b. To determine how to put the present low-grade timber to the best use in the meantime.

Since the various administrative regimes of the forest industry have misappropriated five schillings per hectare in the pre-war years (pre-WW1), then the presence of good older stands of timber might just enable them to get by, but only if the cheapest clear-felling operations, which are the most

damaging to all forms of forest culture, are applied. If however a system of selective felling⁵ is implemented, coupled with the natural process of regeneration, which is absolutely necessary for the care and maintenance of a healthy forest, then the administrative costs will rise by about thirty per cent.

It is well known that in order for the forestry industry to operate at all, the first system of management mentioned is chosen. With it, of course, comes the qualitative deterioration of the forest due to the disturbance of the organic laws governing growth within the tree and the decline in the value of the shade-demanding timbers grown under light-shock.

The very expression 'shade-demander' decrees that these types of tree can only flourish properly under the protection of a mother-tree. If large areas of forest are now laid bare by clear-felling, then the ground, exposed to the unrestricted glare of solar radiation, is warmed down to great depths. The immediate result is not only evaporation of the water in the vegetation zone, but also the presence of extremely unfavourable metabolic processes, which are inevitable due to the direct warming of soil strata. Together with the evaporating water, gaseous water-bound nutrients, which are partially responsible for keeping the solid raw materials in solution, rise up with the water. The groundwater, thus discharged and weakened, sinks deep into the ground seeking new substances. The drying up of mountain springs, the change in the whole pattern of motion of groundwater, and the disturbance in the blood circulation of the organism-Earth, is the direct result of modern forestry practices.

Fig. 6: Contrasting trunk cross-sections of naturally and artificially grown, same-age, shade-demanding timbers.

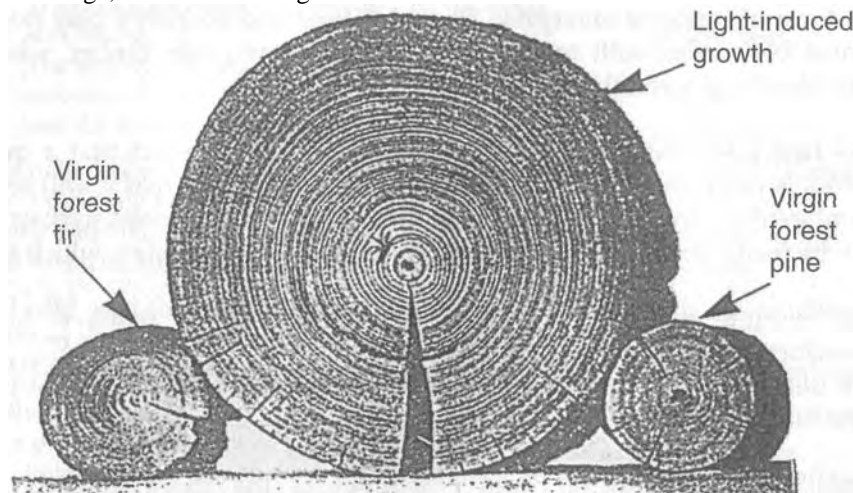

Without the proper circulation of water in the Earth there is no development and hence no rising up of the sap required for growth of vegetation. Under such circumstances the withering-away of undernourished young plants is inevitable. Those plants which can only prosper under shade conditions surround themselves with sun-protecting branches at the cost of their own development, so that through their own shade they can obtain the absolutely vital coolness without which no organic processes of growth within the plant can take place at all.

Examination of the transverse section of a tree grown under such conditions reveals a conspicuous loosely knit structure, which is conclusive evidence of the hard struggle such a mistreated tree has had to withstand in its youth. (See Fig. 6)

The following will briefly outline what really takes place in the interior of a tree, how it grows and why the quality of forest must be destroyed by the systems of management usually practised today.

Under the influence of the rising morning Sun, those areas of the ground shaded by the overhanging crown of the tree and through which the root structures are distributed slowly warm up. The isothermal flow will be rather thick and uniform. The indirect influence of sunlight leads to energetic interactions and thus to phenomena similar to those that occur on the surfaces of the lungs in animals. The product of these transformation processes rises upwards in the root capillaries. The more even the temperature-gradient due to the diffused shading effect of the crown, the more well-balanced the mixture of the substances required for growth.

Due to the effects of radiant heat on the sunny side of the trunk, an accumulation of male substances occurs, which flows towards the warming influence, whereas the gaseous female substances tend to concentrate away from it, i.e. from the inside towards the outside of the cool, shaded area. During the day, however, substances in the tree's capillaries are also drawn upwards. Those of the highest quality forge ahead, leaving the correspondingly larger quantity of lower-grade substances to follow along behind more slowly. As the influence of the external temperature reverses during the night, the exterior not only becomes cooler, but due to oxidising processes now occurring, the interior also becomes warmer. A positive temperature-gradient now slopes towards the cooler temperatures from the inside outwards.

If the amount of shade relative to height is properly distributed by the natural intermixture of timber age and species, then the growth of the tree is increasingly inclined towards a cylindrical shape. If the shading effect is incorrectly distributed, however, then the growth of the trunk is cone-shaped. With the aid of ever-present pressure due to the resistance of water, the solid matter is deposited horizontally, thus increasing the girth of the tree. In this regard, the methods of forest management employed today lead to a

completely distorted growth, which is clearly evident in birth the longitudinal and transverse sections of a tree thus grown.

In its youth the growth of a cone-shaped trunk is indicated by thicker, stronger branches around the base. Later, as the foliage thickens and the crowns become denser, the external pattern of shading changes and lower-lying branches die off. The incorrect inner growth of the core, however, remains unchanged and its longitudinal section exhibits a widening of annual rings from the bottom upwards. The outer increase in girth, which occurs after the crown reaches maturity, reveals this back-to-front development. Moreover in the transverse section of the trunk a widening of the annual rings on the sunny side of the trunk and a narrowing on the shaded side can be observed. (See Fig. 7) The result of this unbalanced growth is the irregular stress phenomena in objects made from such wood. Other shortfalls in quality are also evident in the form of red- and white-rot, ring-shakes and other symptoms of decay. These appear shortly after the timber has been processed or even in the standing trunk itself. The clearest evidence of organically correct or incorrect growth is shown by the inner structure of a light-demanding timber below the thick protective bark; timber such as highland larch or pine.

Fig. 7: Unequal growth due to one-sided illumination

After two generations at the most, incorrectly grown timber loses its suitability for building and other practical purposes, and therefore through the perpetuation of such disastrous methods of management, our present forest industry will write its own death warrant. Most people allow themselves to be deceived by the outward appearance of forests planted in lines and rows. Therefore the saving of the last stands of our once so beautiful

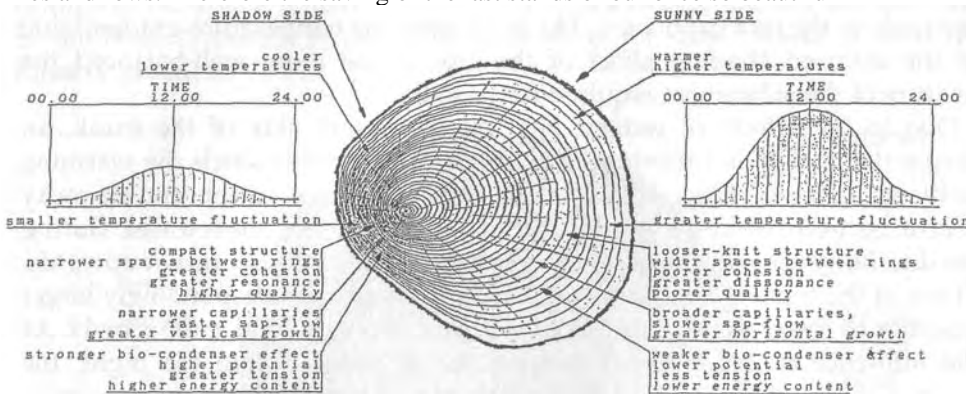

forest can now only be achieved by a constant decline in timber prices, until finally the forest has completely lost its economic role. The collapse of price in the timber market is thus the only hope for the regeneration of the forest.

However, our forest industry does not only alter the tree's natural inner processes of growth. It also eliminates all the forest's ostensibly worthless types of undergrowth and in this way changes the whole environment of the roots and the crown. Root-systems and crown-systems, however, stand in a profound and intimate relationship with each other. Modern forestry disturbs all the natural laws of growth. In the endeavour to extract timber as if from a factory, all it causes is the decline in the quality of the forest.

If the forest in America is being devastated quantitatively, then the European forest industry is destroying the forest qualitatively almost to the last tree. Red-rot, the ring-shake prone condition now appearing in our shade-demanding timbers, the development of a diseased core and most recently the especially widespread manifestations of cancer-like formations are all explicit warning signs of the qualitative death of our high forest. If the forest dies as a result of these utterly absurd experiments, the farmer must also perish, for with the decline of the forest its very important shading effect is also lost. This must again result in a more and more disastrous disturbance of the circulation of water in and above the Earth and thus to a general fall in the productivity of the soil.

Every year a total of nine million solid cubic metres (11,772,000 cu yds) of timber are felled in Austria and about 35,000 hectares (86,485 acres) are laid bare annually. Over almost a quarter of a century roughly 700,000 hectares (17,297,000 acres) of unprotected mountain soil have been exposed to the scorching rays of the Sun. Millions of small young trees, which are only able to thrive under the shelter of mother-trees, wage a pitiful struggle against the Sun's rays. Our experts haven't the slightest notion of the harmful effect of such rays on the tender organisms of these young plants, for they have absolutely no inkling why and how water with its various substances can rise up the tree.

In its final hour the forest is handed over to the farmer, or its exploitation is surrendered into the ways of servitude in which thousands of people, who are today out of work and unoccupied, find employment. Did the farmer but know how important the forest is, he would cherish it as he would life itself. And, were he aware of the true cause of the sinking of the water table and the real reason for his economic decline, he would intervene with his work-worn hands and make good what has been perpetrated on his soil by the mindless destruction of the forest.

Strict laws and careful supervision will contribute to the rebuilding of this, the highest national estate and with the newly blossoming forest we will feel that we are moving on the upward path once more and lost confidence will once again be restored.

Our primeval Mother Earth is an organism which no science in the world can rationalise.

Everything upon her that crawls and flies is dependent upon her and all must hopelessly

perish, if that Earth that feeds us dies.

The Dying Forest — a Peril of Central Europe

From the *Mitteleuropäische Wirtschaft*, 11 June 1932.

As is reported in trade circles, forestry stands before its demise. The dying forest is the progeny of the brainwork of 150 years of forest science. In this era of general depression there is hardly any branch of industry which has been allowed to become so totally ruined and which has caused such damage as modern forestry. All agriculture in Central Europe is on the decline. Due to the unparalleled mistakes made by forestry, the groundwater is sinking and the nutrients contained in it and needed by the vegetation are being deposited at depths inaccessible to any roots. This sinking is not only evident in the Alps, where the alpine meadows are karstifying and the springs are drying up, but also in the lowlands, where the groundwater is retreating into the depths.

Observations over many years have produced the following data. If the groundwater lies 8 cm (3 in.) below the ground surface in the period of growth, then reeds and rushes develop; mosses grow when the groundwater lies at 15 cm (6 in.); at a depth of 30 cm (12 in.) good growth of grasses evolves; from 38-60 cm (15-24 in.) cereals thrive; below 75-100 cm (30-40 in.) cereals are no longer to be found, but xerophilous (dry-soil loving) forms of vegetation develop. However, where water begins to rise from the ground through mechanical pressure alone, swamps develop, the ground becomes waterlogged and the fields sour. In both cases the landowner is the victim of modern forestry, for due to the unholy idea of exploiting the light-induced growth of shade-demanding timbers (pine, fir, beech), the annual rings become thoroughly enlarged. At the same time, capillary action in the tree is lost, which is decisive for the further development of vegetation. This capillary action was laboriously built up by the forest over the thousands of years of its development.

The Dangerous Sinking of the Groundwater Table

As the groundwater began to sink with the loss of this capillary action and the vegetation zone became generally deficient in formative substances, the farmer intuitively began to seek for them in the soil. What could be more obvious than deep ploughing? The deeper the soil was loosened, the more the

oxygen sank to the depths where carbonates are normally present. Because of this, the transformation processes or oxidations, between carbonates rising with groundwater and oxygen infiltrating with rainwater, were displaced downwards. In the process, nitrogenous substances, the products of this transformative process, could be drawn up less and less by the shallow-rooted plants located in the upper strata. Thus the farmer, through his diligence and labour, badly advised by agricultural technology and provided with wrongly conceived machines, inhibited the supply of formative substances for his produce.

The monoculture of pines results in the alteration of crown and root systems through clear-felling and exposure of shade-demanding timbers, which can thrive only in diffused light. Through this and too large a conversion of forested areas into farmland, the retentive capacity of soil diminished and the atmosphere became deficient in water vapour. The forest began to die owing to the destruction of its capillaries and groundwater inevitably sank to depths where the power of the Sun no longer had any effect. With the progressive-reduction of water in the atmosphere, the protective girdle of water vapour against the incident rays of the Sun now also disappeared, and with it the possibility of absorbing and transforming radiant energy into diffuse heat.

In the current management of hydrological projects, attention is always given to the bed-gradient as the only decisive factor. Such projects are considered purely 'hydraulically', without taking heed of the fact that water itself is the carrier of certain substances and processes. The effect of the temperature-gradient was totally neglected, although all hydraulic processes take place under its influence. The metabolism of water, including the build-up of matter present in it, represents the essential physical aspects of these processes. It is only possible with the superposition of both mechanical and physical processes to achieve the right results. The importance attached to the temperature-gradient is best demonstrated by the fact that to heat 1 m³ (35 cu ft) of water by only 0.1°C (0.18°F), and such variations in temperature are to be found in every cross-section of water, roughly 570 hp is required. This simple example demonstrates what enormous energies are bound with an increase in temperature or conversely, are freed with its decrease.

Detrimental Technological Influences

Water is the carrier of two substances of life, oxygen and carbonates, the latter being contained in water in a gaseous or solid state of aggregation. Between these two elements a variety of oxidations take place under certain temperature-gradients. These act to ennoble or decompose carbonates in water, depending on whether these gradients are positive or negative. If the water is

under the influence of a positive temperature gradient, i.e. if it approaches a temperature of $+4^{\circ}\text{C}$ ($+39.2^{\circ}\text{F}$), then the oxygen content is densified and sinks towards the bottom due to its own weight. In this event the carbonates are evenly dispersed through the water. In this case the direction in which the oxidation occurs is from the bottom upwards and backwards, i.e. anticlockwise. However, if the water is under a negative temperature-gradient, i.e. its temperature deviates from $+4^{\circ}\text{C}$, then its content of gaseous carbonates, principally carbonic acid, condenses and escapes from the water as small bubbles of carbon dioxide, leaving the solid carbonates to sink to the bottom. In this case the oxygen is thoroughly dispersed and mixed with the water, after which the water then acts as an inert, sluggish mass on the bed and banks of the river, stirring up the bottom in search of fresh carbonates from the Earth.

In both instances, due to physical causes which subsequently take effect mechanically, the water-filaments are automatically braked, which is the reason why water cannot accelerate even on unimpeded bed-gradients. On the contrary, it will be braked even more severely, the steeper the gradient, because the water is subjected to frictional heat and the influence of external temperature. The physical cause of these dislocating phenomena (formation of vortices, turbulence, etc) is the reorganisation of particles of oxygen and carbonates under the influence of the hitherto neglected temperature-gradient. To differ from the current definition of heat equivalence, the immense forces evolving from the rapid dissociation of oxygen and carbonates from their hydrogen carrier, result in the freeing of 34.46 kilocalories (kcal), when the associated highest-potency oxygen and carbonates become bound in only one gram of hydrogen. In other words, with the total decomposition of every gram of water, forces are freed amounting to 204 hp per second per gram of water. If one considers the activity of the state-controlled management of water resources throughout the whole of Central Europe, there is now no stream, no river and no flow which remains unregulated. To give just one small example: over 1,000,000 hectares (2.5 million acres) of agricultural land have been lost in the lower reaches of the Danube since the regulation of its upper reaches.

During the 150-year activity of our state-controlled forestry about 45,000,000 hectares (111,200,000 acres) of forest land have been converted from natural forest into plantation forest, the latter having nothing in common with the organic growth and function of naturally grown timber. Today, thanks to the incorrect advice of politically influenced agriculture, there is not even a hand's breadth of agricultural soil in Central Europe where the proper process of development can take place according to natural law without disturbance. In view of all this, it is quite apparent why all culture and civilisation in Central Europe will inevitably collapse. Nevertheless, it is precisely the legally prescribed procedures which are propelling us over the abyss.

Notes

1 'We seek to obtain power for our machines through destruction, through explosion and in the near future, the actual destruction of atoms will even be deemed worthy for such ends. We extract coal, we suck oils and gases from the bowels of the Earth and thoughtlessly vaporise and detonate them. We tear ores from the interior of mountains, destroy the purposively emplaced, conductive ore-veins (similar to nerve fibres and pathways) and hoard gold in the vaults of major banks in a way which can never be conducive to Nature's purposes. Who has ever questioned whether or not all these substances inside the Earth have important tasks to perform? Whether the tensions and stresses vital for the support of the whole are not irresponsibly released? Whether cavities are formed, which cause earthquakes due to the caving-in of the Earth, or into which water plunges, there to suffer serious injury? After all, it is only Mother-Earth whom we rob and rape and she neither cries out, nor apparently does she defend herself. The fatal consequences, however, will descend upon us with unfailing certainty.' — VS. — TAU 137, p. 31.

2 The first part of this article appears in *Nature as Teacher*, Vol. 2, p. 70, of the Eco-Technology series. — Ed.

3 Carbons are not to be understood here in terms of conventional chemistry, but as biological mother-substances and the counterpart of fertilising oxygen. — VS.

4 'The inner climate stamps each individual with its character. Every life-form has its own individual anomaly point of health, which makes the orderly reproduction of the species possible. This also explains why the world of parasites increases with fever.' — VS. — *Implosion Magazine* No. 43, p. 19. — Ed.

5 Selective felling: In terms of Viktor Schauberg's concepts, this is a system of felling

which leaves the greatest mixture of age-groups and species and which removes trees in such a way as to admit as little additional light as possible, over and above the level of illumination that would occur naturally. — Ed.

Nature's Increasing Baldness

The bobbed hair mode is still in fashion and already it is occasionally evident that in places the hair is becoming thin on the heads of mature women. Now and then little incipient actual bald spots are apparent and it is profoundly regrettable that in this women are beginning to emulate men. Increasing baldness is a truly threadbare phenomenon of an age when everything is going wrong and there is so little that is either beautiful or wholesome. No wonder we cannot see the increasing baldness on our mountains. The responsibility for this, as with the baldness of women, lies with the hairdressers, i.e. the foresters. They have no idea that all manifestations of growth, such as hair or trees, are the mediators of the atmospheric and geospheric interactions without which there would be neither fertility nor virility, if the places Nature has covered with hair or trees become barren or exhibit other mangy characteristics.

While the stroking of a bushy male head by a soft female hand was once quite enough to make emotions crackle and spark, today no massage, no washing or brushing of the hair is able to evoke even the slightest ray of hope from a more or less barren head. The same also applies to our present forests, whose inroads into arable land had once to be prevented by force or fire. Then their vigour was such that lightning-like sparks flew from the tips of the leaves or needles, if the latter were merely ruffled by the wind. Today, however, almost every young tree must be supported somehow so that it does not snap off when the wind's mantle falls upon it.

The attention of the authorities responsible for the conservation of this most valuable national estate must be drawn to these symptoms of degeneration.

4.

The Dying Forest

Excerpts from TAU Magazine, No. 151, p. 20, November 1936.

They should review all the regulations to determine whether they are really appropriate both in meaning and intent. Since the heads of the officials have unfortunately lost the potentials so essential to life, little or nothing can be expected from these quarters either. All that remains is to turn to the common people, who have still retained a certain connection with Nature. The slow but sure dying of the high forest has become so evident already that the older generation and even the daily newspapers are raising their voices in alarm. Although those who work in the papers are surrounded by a different rustling of leaves, they also notice the appalling devastation when they vainly seek peace and recreation in today's timber factories during their summer holidays. Even these countless warnings are as little heeded as the increasingly devastating sand and dust storms that sweep over America laying vast tracts of land to waste.

How the Farmer uses his Scythe and Sharpens it by Hammering

In order to demonstrate the importance of a healthy forest and to explain the terrible havoc caused by clear-felling and light-shock, we must draw upon other examples. Why do pastures deteriorate when the grass is cut with mechanised mowers? Many people may well have observed that at sunrise and without the slightest breath of air, dead leaves flutter to the ground in their thousands and that this leaf-fall ceases immediately, once the Sun has actually risen and a certain warmth in the air has been attained.

Elsewhere it has already been explained that the radiation intensity is strongest in the morning and results in the peak-production of oxygen. Oxygen, which is in a nascent state in the morning, burns the leaves at the stipule and closes the wound caused by the separation of the leaf. Through this simple procedure Nature stops the Earth from bleeding to death, for through this combustion process all the openings are sealed and rendered airtight.

A similar phenomenon occurs when the grass is cut with hammer-sharpened scythes. By hammering a scythe or sickle opposing charges are created in the metal, which are subsequently discharged via minute serrations as the scythe is swung through the cool and dew-laden grass at a low angle. In this way the grass is cauterised by an animalistic current that flows from the point of the scythe towards the handle, resulting in the immediate closure of the wound and therefore neither soil nor cut fodder can lose its energies. Because the scythe is insulated by the handle, these extremely volatile energetic substances cannot discharge, but are made to arc through contact with the grass.

If we examine a properly hammered and sharpened scythe under a microscope, then as the temperature changes, we can see flashes of light flitting from one serration to the next. In the grey of the dawn, when we draw the scythe through the grass at the correct angle under suitable conditions of temperature, we can observe thread-like currents in the dew-laden grasses, which instantaneously slice off the stalk without any pressure. As the Sun rises higher, the scythe slowly discharges and with every additional degree of ambient heat, work becomes harder until it finally comes to a standstill, despite the very keen edge of the blade.

As a result of these phenomena, fields cut by properly designed and expertly hammer-sharpened scythes will maintain their productivity with little use of fertiliser, whereas in those fields mown with horizontally reciprocating, mechanical cutters the yield rapidly declines and they visibly become infested with mosses. Here, as in many other instances, the former artisan skills have sadly been lost and therefore today there are only a few farmers, who really know how to hammer-sharpen their scythes. It was not without good reason that the scythe of such a farmer, ever devoted to his soil, never left his hands and that towards evening he lovingly hammered and sharpened it, so that it could charge up overnight. He also took great care to ensure that it was stored well out of the light to avoid its discharge by the rays of the Sun.

In this simple example we can see not only the earlier close connection of simple people with Nature, but moreover the majesty of an all-wise Nature and the magnitude of the mistakes of a mechanistic humanity. Through its technical achievements, it steps further and further beyond Nature's truths and cast-iron laws and as a result its mental and physical abilities will inevitably wane.

Every disturbance of the preconditions for growth results in the disturbance of the whole, because evolution's universal processes are dependent on a very precisely graduated disposition of the elements of the 'beside', the 'above' and the 'below'. Every organism has its ordained function, which it can only fulfil, if its preconditions for growth and development remain undisturbed. Modern forestry has almost totally destroyed these conditions. It wilfully altered the vitally important balance in the mixture of mutually interrelated crown and root systems as well as the overall character of growth itself, thereby changing the character of the whole radiation field.

The same applies to the exploitation of the forest, for by felling the trees with saws in clear-felling operations, not only does the soil bleed to death, but the foundations for the growth of the vegetation are also severely damaged. Through felling in lots, the all-important accumulation of magnetic charges or the breathing of the forest is neutralised, thus affecting the goodness of the soil extremely detrimentally.

How the Cow Grazes

Had our academic foresters ever observed a cow grazing, then they would have perceived the extraordinary ingenuity with which this passive beast sets about eating in obedience to Nature's laws. This cow has absolutely no notion of the important potentials and counter-potentials that orchestrate the whys and wherefores of every process of growth. In spite of this, whatever she does, she does so naturally that all scientists would be filled with shame could they but clearly recognise the unnaturalness of their present endeavours.

If we watch a cow as she crops the tufts of grass, then we can see that she gathers the grasses with her supposedly rough tongue and twists them around in a very particular direction. By being rotated about their own axes, these grasses, which serve the growth of this higher form of life, break off exactly at the place where Nature in her wisdom ordains. Once the grazing cow has wrenched the stalks from the ground with a tearing sound, she then nuzzles the resulting wounds and in this way alters the material composition of the air around them. It is only thus that the strongly opposing energies come into being, which trigger those vital interactions that close the open wounds almost instantaneously. Whatever the cow has loosened by her tugging, she carefully compacts again with the weight of her body and in the process returns far more heat to the ground than was removed from it due to the vacuum caused by the pulling.

In this regard heat and cold are merely to be considered as functional events associated with a series of charging and discharging processes. Through these, and provided the method of harvesting is correct, what was removed from the soil will be returned to it many times over through the harvesting of its produce. It is to this naturalesque system of harvesting that the forest owes its wealth, wherein the quality of its nourishing soil increases the more the various species of plant 'withdraw the energies' from it.

This total reversal of contemporary assumptions and the actual sequence of events described here also conceal the whole secret as to why the forest loses quality in step with its disturbance by nature-alienated administrators.

About the Wild Boar

Had our forestry professors ever made the effort to observe a wild boar in the process of digging for truffles, they would have obtained some idea of the magnetic forces, for example, that are tucked away inside a pig's snout. So-called electrons play such an outstanding, mediatory role between wild boar and truffles, that it is hard to believe that our learned scientists could have failed to grasp the purpose and nature of these ceaselessly interactive life-

rays. Although these emissaries of life are constantly shoved under their noses, scientists are only able to smell them once they have been transformed in the mucous membranes. This also proves that electrons are organic in nature and therefore electricity is an organic current manifested materially in fourth dimensional form. This will be clear to these scientists, however, once they understand why a pig has such a particularly wily look when it scents a truffle many metres away.

Only when the devastated forest literally stinks to high heaven will there be any hope of a return to healthy forest conditions and an end to the crisis caused by the associated disturbance of the water balance, due to which the ensuing shortages of food will spread trouble, alarm and despondency over the whole face of the Earth. A small example will provide the necessary clarification of the differences arising between a fact (heat or cold) and functions.

Concerning Dew-Drops

Many people must surely have noticed that the air suddenly becomes conspicuously chillier just before the Sun rises. When the first rays of the Sun light up the forest glades, the wind shifts and all at once all forces and energies change direction and completely different conditions prevail. With the arrival of the Sun, as if by order, the thriving grasses in these clearings begin to weep. Dew-drops stand in their millions like tears right on the very tips of grasses in mockery of the hitherto accepted laws of gravity, for only when the dew-drops become warm and therefore lighter, it is assumed, do the grasses begin to bend towards the ground.

Is Nature really mischievous enough to do things in total contradiction to the beloved presumptions of science, or do people do everything back-to-front out of sheer stupidity? This will be determined once scientists, obsessed as they are with quantifying everything, accept that even the apparently incontestable results of their activities are not enduring facts, but eternally changing functional events, which are constantly modified according to the quality of their quantities.

How our scientists will have to hang their heads, once they understand why these evidently heavy dew-drops stand erect like candle flames in the early morning coolness, only to keel over, lose their hold and inevitably fall, once the Sun has warmed them, thus becoming lighter or so it is supposed.

Every spring shows us, however, that the heavier the water gushing from it, the fresher and healthier it is. This and hundreds of other examples serve as a powerful indictment or proof of the flawed logic of reputedly intelligent people. By altering the most elementary processes of life, they are destroying everything around us upon which these minutiae so essential to Nature depend.

If we wade through this dew-water, created by levitational and gravitational forces, with our warm and bare feet, we experience a pleasant tingling sensation which very quickly removes all symptoms of fatigue. Indeed the so-called Kneipp or Priessnitz cures¹ provide the clearest proof of the healing powers of this virgin water; water that has touched no discharging iron pipes and which makes a tired, sick body more healthy than all medicines put together.

In reality these dew-drops are countless sources of power that discharge their organic energies into the air or the body, if the differences in temperature which enable these forces to be emitted, are arranged according to a precisely ordered gradient. Here the most important factor is the direction of the gradient itself, to which a very specific polarity gives rise. In exactly the same way that the tractive force diminishes in rivers when these kinetic energies are dissipated by the Sun, the water in the body also acts to weaken and impede the circulation of the blood, if the polarities are reversed and interact in the opposite direction.

A great law prevails throughout Nature, which is expressed in the gains and losses inherent in all motion. Whatever the Earth expels, contributes to the formation of the atmosphere, whereas those substances that surrender their spaciality on their upward path further the development of the Earth. In this also lies the great secret of natural fertilisation or the production of nitrogen-like precipitates, which deplete the soil if the orderly direction of the gradient is reversed and also trigger off tremendous catastrophes. These only occur when man destroys the natural order, and it is their task to restore with elemental power all that man has destroyed. All nations could save vast quantities of hard-earned taxes, if they but recognised the true nature of the temperature-gradient or the direction in which the energies are discharged within, into or out of water. On its winding way into the valley, any water subjected to direct sunlight becomes torpid and insipid, if it no longer has the power to ingest those provisions for its journey that are contained in its sediment.

In Nature nothing is ever lost. Has science ever addressed the crucial question concerning the ultimate destination of the many permanent rays that can actually be measured or otherwise detected in every metal and mineral? Have our scientists no idea whence temperature or other charges and discharges arise and where, how and under what circumstances they must manifest themselves again? Are they totally unaware that through processes of cooling, which can only occur through emission of heat, organic vacuum-forces necessarily evolve, which convey less complex substances such as nutrients in a very particular direction?

How the Forest Sustains Itself

All natural processes of growth take place indirectly. Each has a normal (characteristic) direction in relation to the others. The energies in a magnet are accumulated through the ends and emitted laterally over its length. A tree is created out of metals and minerals. It stands normally in the isotherms of the air and is the axial counterpart to the accumulation of laterally directed potential in its vicinity. As a result, the tree which is a product of metamorphosis, builds up its charge laterally and discharges it via the root and crown systems.² Through the ebb and flow of the seasons, these systems exchange their polarities and hence their respective directions reverse according to the presence or absence of light.

This explains why substances released into the atmosphere by forest plants during the day are different to those released at night. In essence each plant is a bipolar anode-cathode³ system, which functions as an attracting or a repelling pole according to the varying angle of the Sun. The rotation of the Earth produces constant fluctuations in the respective radiation emitted by the bipolar extremes of Sun and Moon, which completes the cycle of the substances circulating between the geosphere and the atmosphere, which carry opposite charges. Thus, in the same way that a neutral zone is created between the negatively charged geosphere and the positively charged atmosphere, which forms the storage depot for the root system, so too are similar transitional zones created above the ground between the roots and crowns.

If we observe alders ranged along the banks of a stream, we can see that they do not grow towards the light, but arch towards each other, the tops of their crowns almost touching. They thus create a vault containing the right nutritive or diffusive mixture, which they then inhale through the bark, the latter's function being analogous to gills. The tips of the branches of every exotic tree point towards its homeland and not towards the Sun, because blood and soil are inseparable concepts. Therefore even in apparently insensible trees, we can perceive a certain homesickness. The same applies to everything that humanity thoughtlessly transplants.

There would be no need of such exotic species, did we but take heed of the essential conditions for life in our own environment and give our indigenous trees the chance to take up the energies they require. As long as we do not disturb its enjoyment of the primordial laws of growth, each tree, by means of its own crown-closure, coalesces these various energies in a manner suited to the location where it needs them. However, if through the senseless rearrangement of its crown and root systems, we rob the forest of the airs conducive to its health; if we remove its necessary and naturally ordained juxtaposition of higher and lower orders of plant; and if we oust everything

from its natural, normal direction in the process, then we should not be surprised that the forest is beginning to die, dragging everything down with it.

Every simple and naturalistic person knows that when a tree's vital system of closure or self-protection is disturbed, it immediately alters its bark or outer covering. The polarity of bark, or outer covering, is intermediate and sensibly modifies itself to suit the prevailing respiratory conditions. Were they merely suction-appendages, it would be impossible for the little bubbles (protoplasm) visible on the tips of roots to come into being, nor would the root-tips themselves be able to taper, were the uptake of geospheric dynagens only to take place there. Even the rhythmical alteration in the disposition of the leaves reflects the constantly changing weather pattern, which is itself responsible for the ceaseless reformation of the substances vital to the plant's nourishment.

Every human being and every animal has an orifice for the intake of raw materials as well as openings for breathing and other functions. The fish has gills with which to extract its air from the water and the tree naturally has its various openings too, which serve various metabolic processes. But this naturally ordained order is of little concern to the academic forester and so, for the sake of simplicity, he streamlines everything and arranges excretion, mouth, lungs and heart uniformly. How the various egressing and ingressing substances actually find their way about is simply left up to the tree, all of which produces putrefying excrement in the shape of enlarged annual rings, which the forester then proudly calls 'light-induced growth'. He has no idea, however, that both tree and forest are mediators of interactions between air and soil. As a result he gives not the slightest thought to the fact that those substances which should normally return to the tree or to the soil, will subsequently trigger off catastrophes in the atmosphere. Because he has prevented these vital substances from returning to their cradle in the earth, even worms and other creatures rain down onto the Earth in various places.⁴

So minute are the numerous instigators of disease that they are undetectable with the highest-resolution microscope. Some scientists are already questioning whether they are more or less lifeless energetic entities which come to life only under certain preconditions and vigorously thrive in enfeebled bodies. In their pursuit of this train of thought, they come very close to the oft-derided process of ur-genesis or pre-creation,⁵ which actually has to precede every subjective process of creation, because nothing happens directly in this indirectly ordered universe.

The same applies to the tree as applies to man or beast. We are what we eat. It is no wonder, therefore, that under current conditions the forest has become the carrier of these agents provocateurs of disease which, in their more highly evolved form, are making people insane. The adoption of the cure presupposes a recognition of the error, so once farmers understand that the

soil obtains its nutrients via the forest trees they will see to the rehabilitation of the forest. The forest is still strong enough to overcome this setback, though its existence in the natural groves we occasionally spot amongst manicured plantation forests is threatened by catastrophes in statu nascendi.

Hence the most effective way to re-establish orderly conditions in the world is to enact the strictest forestry regulations. Then to hand over this most valuable national estate to the farmers. Once they finally understand that trees breathe through their bark and that they cannot breathe if they are exposed to the light, the farmers will become the cheapest and most naturalesque preservers of the soil and hence the forest.⁶

Concerning the Russian Cotton Industry

To remove all doubt concerning the accuracy of the above statements, mention must be made of a malpractice perpetrated in the production of cotton in Russia today. In order to shorten the ripening period and at the same time achieve greater yields, the young cotton-shoots are lightly burnt with equipment akin to small flame-throwers. This scorching results in the development of pressure-stresses or fever-like symptoms in the interior of the young plant, causing the potentials in the natural alternating temperature-gradient to reverse. Although stronger shoots are produced, the nutritive substances are more thoroughly dissociated due to the rise in internal temperatures.

It is therefore quite obvious that in this way the soil is deprived of the products of the plant's normal metabolism. Since in this particular case the overriding aim was the fastest possible exploitation of favourable economic conditions, the degradation of the soil indirectly brought about in this way, was considered of lesser importance. Therefore the short-term demands of the moment were satisfied through the production of these false blossoms. Similar symptoms of soil and plant degeneration, now spreading over large areas, have also been achieved by modern foresters, for they have seared the young saplings through systematic denudation or clear-felling operations.

All that needs to be done to check the accuracy of the above statements concerning the reversal of the soil-energies, is to spray any given soil with cold water during the midday heat in order to cool or de-stress it. Through the sudden cooling or de-stressing of the soil, the direction of the energy's movement (the temperature-gradient) reverses, which results in the immediate discharge of the soil's plant-fostering energies, i.e. the plant keels over and dies.

Although known only to a few people, the Sun is a bipolar cathode system and therefore everything but a zone of incandescence. Rather, it is a spherical

focus of energy. Upon reaching the atmosphere, its rays promote the formation of oxygen, which in turn directs its high metallic potency towards the mineral counter-radiations emanating from the Earth. Therefore the life and vitality of the tree can only develop to a high state of order, if the ratio between the atmospheric and geospheric substances inside the tree is correct and they are able to interact in an organised and harmonious manner.

The tree receives its actual life-impulse through the normal disposition of the atmospheric isotherms relative to its own axis, the impulse itself being imparted via the diffusive tissue of the bark. If the condition of this extremely finely attuned tissue is altered, then the vitally important uptake of energetic matter is also modified. The logical outcome of this is the increasingly widespread dying of the forest.

The forest should only be tended by people who love it. Those who view it merely as an object of vulgar speculation, not only harm the forest, but everything that crawls on the face of this Earth as well; for the forest is the cradle of water. If the forest dies, then the springs dry up and the pastures laid to waste. The Earth will then be engulfed by a restlessness from which none of us will escape. The rescue of the forest signifies the rescue of peace.

Viktor Schaubberger, Vienna, October 1936.

The Dying Forest (Part Two)

Excerpts from TAU Magazine, No. 153, p. 5, January 1937.

A Global Perspective

Government scientists and experts in the USA are extremely worried and facing a problem fraught with the gravest of consequences. Their vast land has, since 1858, exported large quantities of cereals, but since 1934 the USA has had to import about \$500 million worth of wheat, flour and maize. This fact threatens to become a disaster. Which nation on Earth still has a surplus of food? It is dangerous to speak of surplus, when the limit is already too close for comfort. This is the main reason why the world's leaders are so worried and uneasy. Statistically-proven malnutrition amongst the common people of the European nations is becoming more widespread.

According to informed circles in the USA the harm done to agriculture in 1934 alone, due to desertification of the wheatlands by sand and dust storms, was estimated to have cost more than \$5,000 million. The responsible authorities would feel much happier if their defensive campaign was at least successful. However, any kind of success has so far eluded them because even

the Asiatic desert plants they introduced are being torn up, roots and all, by churning dust storms. This being so, how is it possible for young, indigenous trees to take root?

The origin of this appalling catastrophe lies in the reckless uprooting and eradication of the former forests and prairies and in the ploughing of the great steppe lands with tractor-drawn ploughs. These ploughs discharge the soil and the energies that bind it are lost.

Apart from the terrible unemployment, there is a sinister decrease in soil productivity and a real danger of famine for millions of people, who will be forced to congregate in smaller and smaller food-producing areas and could reach the end of their tethers. America is not the only nation beginning to dry up: South Africa is faced with the same danger, which is engulfing more and more countries. In many regions of Central Europe the ground water table has sunk by about two metres (6.5 ft) and a further subsidence of just 60 cm (2 ft) will suffice to render all cereal production impossible. Fateful errors in the management of forests and farmland throughout the world are now exacting their terrible toll. Because of them, water, the very carrier of life, is disappearing — water which the scientists with their chemical formulae are denying all possibility of life. This is not a question of the well-being or woes of individual countries, it concerns the existence or non-existence of all humanity. Therefore all those, who instinctually or otherwise recognise the origins of this dreadful deterioration, have a duty, regardless of personal cost, to denounce the existing institutions so as to rescue millions of human beings from hunger and thirst.

The decline of a people is always preceded by the death of its forests. For decades the European forest has been declining qualitatively. The resonant timber has disappeared, the elms are dying and the yew has already become a rarity. Red-rot and white-rot prevail everywhere. The price of timber is sinking and the forest has become more of a burden than a benefit.

The Tree as a Water-Factory

It is a fatal error to believe that water directly nourishes a tree or that the roots can likewise directly supply the tree with water. In reality the process is reversed: the tree or the plant produces water or a water-like substance, or amniotic fluid. Therefore without any forest there is also no water, and the greater the quantity of water flowing into the valley, the more forest there is, and vice versa. If the forest's production of water is disrupted through errors in management, then healthy forest ceases to exist and wholesome water is no longer available for other forms of life. Any attack on the forest's immutable laws of growth is punished by Nature with death. Every tree or every plant is

a kind of water-factory, which produces a form of water suited to its nature, from which the appropriate type of blood or sap is then built up by indirect means.⁷

What we call 'water' is a waste product, a precipitate, whose origin lies in biological processes of transformation. Furthermore, levitational (upwardly impelling) energies are created during this transformation, which are discharged into the tree's capillaries via the roots. With the assistance of minute particles of hydrogen drawn in through this energetic interaction, the build-up of various types of blood and sap then takes place. The circulation of these fluids (water, blood, sap) is therefore not to be attributed to any mechanical impulse, but rather to processes of energy transformation. Plant physiologists will therefore have to change their way of thinking.

This is why everything deteriorates when all economic activity is founded on ridiculous pump-systems, which are nowhere to be found in Nature. Nature separates her substances into their constituent parts and then raises them up by virtue of intra-atomic potentials occurring in their relative proportions. Each variety of plant produces its characteristic type of water: in consequence we have to differentiate between as many types of water as there are species of plants. Even in individual human beings or trees, blood and sap have their own special nature. For this reason every product of Nature is best able to thrive on its own waste-matter. In this regard human beings can only be created through the agency of other human beings (the best fertiliser for their produce is their own faecal matter in the same way that a tree is best fertilised with its own fruit).

Evolution not only requires the maintenance of the species, but also the renewal of spiritual Will, which arises from the dissociated products of physical decomposition. If we study history, we can see that a people which has burnt its corpses is condemned to decline. Without the decomposition of the physical form in the ground, the species cannot renew itself and for this reason is unable to maintain itself in the long term.

Water too lives and moves by virtue of the energies inherent in it. These energies are responsible for the analyses and syntheses which take place in their interconnecting medium — water — and which determine the type of temperature-gradient as well as the form of movement. Consequently, temperatures are not to be construed as the causes of motion, because they are themselves products of processes of an energetic nature. Such after-effects also encompass the formation of river-bends, the deposition of sediment and the increasing or reducing tractive force of the water. Water owes its life to these energetic processes which move it, sweeping it upwards, downwards and sideways, and ultimately keep it healthy or ruin it.

Water radiates. Its radiation originates from the decomposing bodies in the Earth. Because of this it cannot renew itself if we extract all the materials

required for its reconstitution and if insufficient quantities of residual matter are able to infiltrate into the ground.

Wooden or Copper-Plated Ploughs

The productivity of arable soils can be maintained for longer periods, if they are cropped by grazing cattle or harvested with properly hammer-sharpened scythes, whereas wounds are torn open with mechanical mowers, causing the leakage of the soil's vital energies. Similarly, a forest, which is exploited recurrently through clear-felling and worked with the wrong tools (saws), cannot continue to grow healthily. This is because the potentials in the ground so essential to growth are lost if the ground is suddenly laid bare and the stump-wounds cannot heal over due to the fibre-ripping action of the saw.⁸

Like a generator, which loses all its power when it is placed in a vacuum, the forest too can no longer continue to thrive, if its mediatory force-field is lost, for like a magnet, the soil's potential-field is discharged through exposure to direct sunlight. The qualitative deterioration of the forest, initiated by the de-energising of the soil, is far more dangerous than the violent removal and destruction of the timber, because the resultant delayed reaction manifests itself in the form of insidious and imperceptible crises, which as a rule are first noticed when it is already too late.

In the same way that steel, machine-drawn ploughs progressively discharge the soil and the incidence of cancer increases in proportion to the length of the iron water mains, the various species of plant also begin to degenerate, if their roots are loosened and systematically discharged by steel hoes. Iron and steel, which have been polarised by fire, are very dangerous to forest and field alike, because these discharged substances attract the valuable soil-energies like a magnet. This effect is intensified when modern, multi-gang, ploughs are drawn too rapidly through the soil.

The best proof of this is the dynamo, which in essence is a matter-transmuting machine. From the air or its constituents, it not only generates a magnetic field around the axis of the rotor by way of centrifugence, but it also produces so-called electricity. This is actually the product of the transformations taking place in the interstitial zone between rotor and stator. The processes whereby air generates and discharges electricity through the interaction between the levitating and gravitating elements of the air, are exactly the same as those taking place in the geosphere. It is these fourth-dimensional substances that are responsible for the quality of the soil, for all growth and the overcoming of physical weight. Without these electrozoic or animalistic currents no motion or growth is possible. This is why the soils are being degraded and de-energised, sand and dust storms are becoming more

Fig. 8: The copper-plated plough and harrow. For full patent description see Appendix.

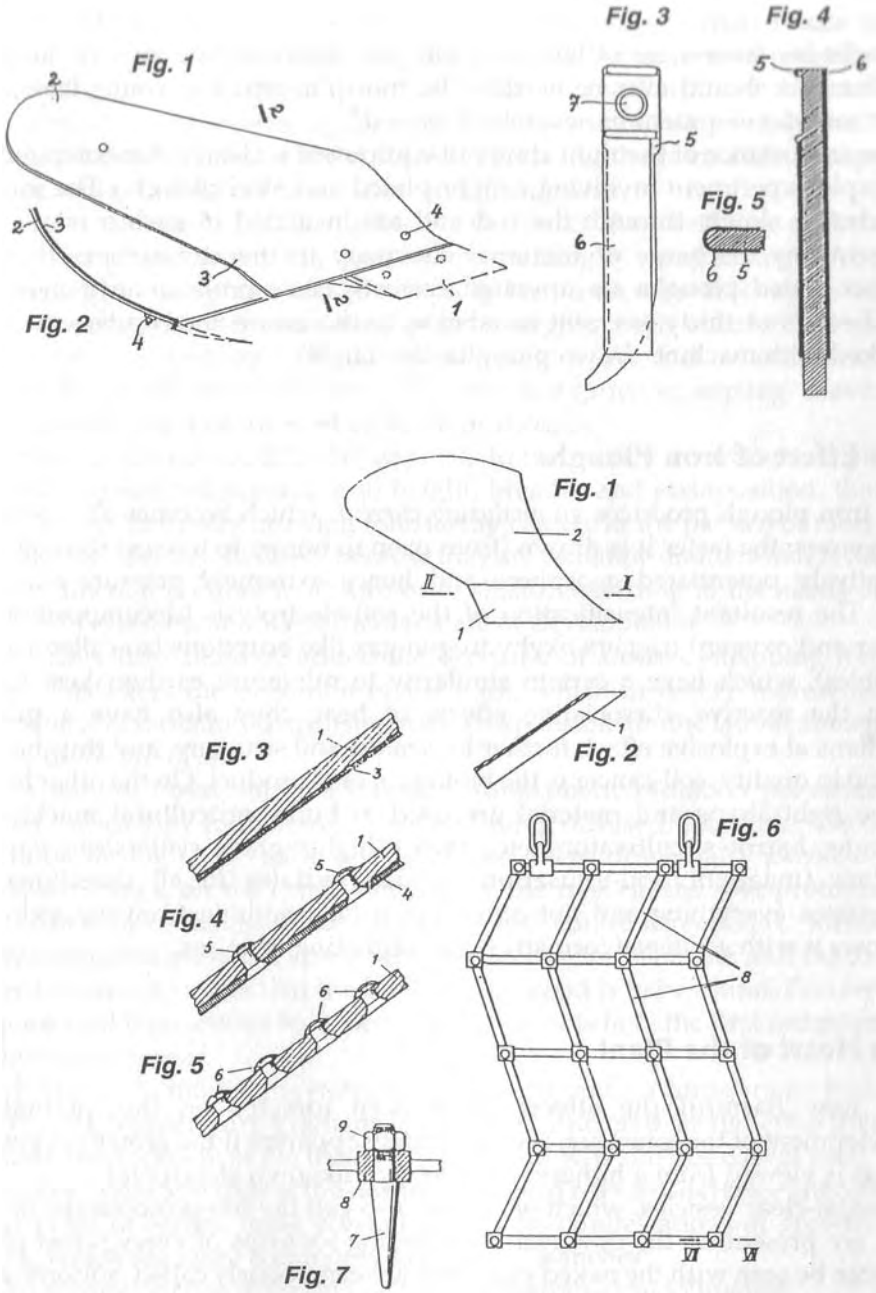

widespread and the spectra of world famine is looming larger, which is now much closer than we think. For the very reason that steel, machine-drawn ploughs lay large areas of land to waste and discharge the ground, no steel implements should ever be used in the transplantation of young trees, lest their root development be severely impaired.⁹

The importance of the right choice of equipment is clearly demonstrated by a simple experiment involving copper-plated and steel ploughs. The former are drawn slowly through the soil and are insulated in such a way as to prevent any discharge of frictional electricity to the atmosphere. If these copper-plated ploughs are operated correctly, they produce an increase in yield of about thirty per cent in relation to the immediately adjacent areas worked with machine-drawn ploughs. (See Fig. 8)

The Effect of Iron Ploughs

The iron plough produces an analysing current, which becomes all the more dangerous, the faster it is drawn (from oxen to horses to tractor) through the negatively potentiated geosphere and hence extremely pressure-sensitive soil. The resultant intensification of the soil-electrolysis (decomposition of water and oxygen) triggers oxyhydrogen-gas-like eruptions (so-called earth-rumbles), which have a certain similarity to miniature earthquakes. Apart from the reactive, dissociative effects of heat, they also have a purely mechanical explosive effect, further loosen the soil structure, and thus hasten a drop in quality; soil-cancer is the biological end-product. On the other hand, if the right shape and material are used to build agricultural machinery, ploughs, harrows, cultivators, etc., then a higher-grade synthesising current evolves (magnetic soil-ionisation), which radiates in all directions. It penetrates everything and not only does it take nothing from the soil, but endows it with additional formative and animating energies.

The Heart of the Plant

Just how harmful the effects of modern forestry on the qualitative development of the forest are, is immediately apparent if the growth of young plants is viewed from a hitherto completely unknown standpoint.

Crystal-clear vesicles, which we could also call the life-protoplasms of the tree, are present on the downwardly tapering root-tips of every forest plant and can be seen with the naked eye. They are erroneously called 'suckers' and collapse with exposure to light. The formation of these fragile vesicles would be impossible if, as is generally assumed, the function of the root-tip is to suck up water. On the basis of its shape alone it is unsuited for this purpose.

In a manner of speaking these protoplasm-like structures are the heart of the plant or its sac of amniotic fluid. In other words, they are isotropes¹⁰ and while they have as yet no predetermined axes, they are the unformed juvenile axis of new life, the connecting link between Heaven and Earth and the cradle of water, which comes into being through the union of the two ur-magnitudes of Plus and Minus. They also order the formation and the circulation of sap, but wither away if subjected to aeration and illumination.

Therefore in relation to the qualitative decline of the forest, one of the most dangerous procedures is the repeated transplanting of young saplings. Already weakened by transplantation, the sapling has to recreate this organ, which interconnects geosphere and atmosphere every time this occurs. This results in the wasteful leakage of these exalted energies. For lack of such energies owing to its violent transplantation, the fast-growing sapling inevitably becomes the target of the seed of death or disease.

If they are disturbed, this also happens to the motley assortment of plants, infinitely graduated according to height, breadth and juxtaposition, that we find in every naturally growing forest. Any change in the pattern of roots and crowns has a pernicious effect, because they are radiation emitters and receivers whose function is either to absorb or to shield, according to the needs of the species in question and its particular state of development.

To such effects must be added the exposure of shade-demanding trees to light. This alters the condition of the bark, which in reality represents the diffusing and radiation-dispersing tissue responsible for the lateral absorption of the tree's life-rays.

In a natural forest, various forms of atmospheric radiation penetrate the closed leaf-canopy from above. Thus becoming diffused, they enter the trunk laterally through the bark and continue their downward journey. The geospheric rays, on the other hand, enter the tree via the root-protoplasm and from there begin their ascent. These contra-directional, formative substances interact in the space between the base of the trunk and the lowest branches, and it is here that the best quality wood is to be found. Conversely, if these vital interactions have been corrupted, it is here the first symptoms of putrescence appear.

Whether these interacting energies are flowing under a correct or an incorrect energy- or temperature-gradient is faithfully mirrored in the cylindrical or conical development of the trunk. This explains why the tree covers itself with branches, if the Sun causes the normally vertical rays to discharge laterally. At their point of egress, those crystallisations or manifestations of growth take place, which are more commonly known as 'branches'.

The accompanying diagram (see Fig. 9) illustrates the following:

Fig. 9

I An inorganic magnet accumulates its radiant energies axially and discharges them laterally.

II An organic magnet (tree) accumulates its energies laterally and discharges them axially.

III Conical formation of the trunk results in an abnormal radiation pattern.

IV Cylindrical formation of the trunk produces the correct emission of radiation.

The protective regrowth over the sites of cuts or wounds is likewise to be attributed to the condition of radiation emitted at the time by the 'sculptor of life'. This explains why stones lying on the bed of a healthy stream give birth to algae-like growths on their uppermost surfaces, which are rooted in the fabric of the stone. Such growth is usually ascribed to the purely mechanical deposition of spores or seeds. This explanation, however, is not correct.

Whoever observes the course of natural development can recognise that much of what is advocated today by nature-alienated science is false. It is therefore no exaggeration to say that the true origins of the decline in the quality of so many different forms of growth lie in the errors of science. Indeed, it is the regulations and practices governing the management of forestry, land and water resources that are responsible for the worldwide impoverishment and famine, which are now just around the corner. For a long time Nature has watched the senseless antics of a nature-estranged humanity with equanimity. One day and without fail, however, she will exact her toll.

Mother Earth nurtures us all and provides us with a superabundance of everything we need as long as we do not disturb her and disrupt the growth

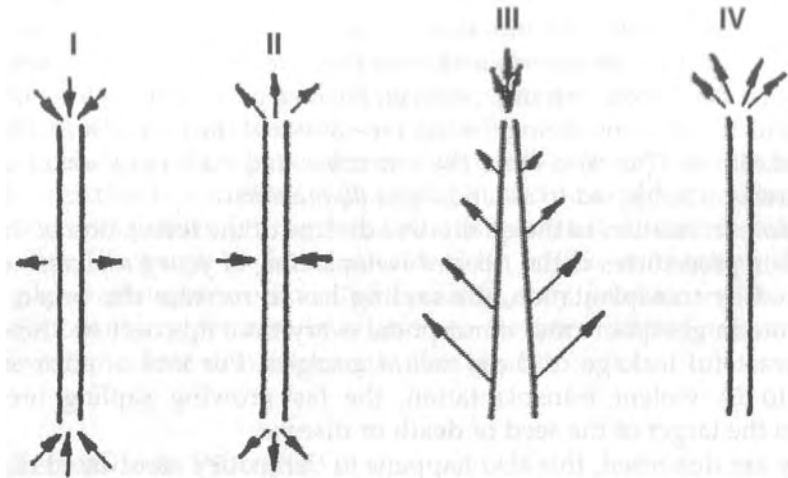

of her creations. However, if blind greed drives us to mindless rape, then the forest will die. In its passing, water, as the blood of the Earth, the mediator and giver of life, will also vanish. But perhaps this realisation has already come too late!

Viktor Schauberger, Vienna, December 1936.

Notes

1 Priessnitz cures: Vinzenz Priessnitz (1799-1851) developed a form of naturopathic healing in which patients, for instance, with fever, were first wrapped in cold, wet linen sheets and then further wrapped in dry blankets of wool or flannel. — Data from the Deutsches Universal Wörterbuch by Duden. — Ed.

2 See *The Heart of the Plant* and accompanying Fig. 9, p. 128. — Ed.

3 An anode is an electrode carrying a positive charge to which negatively charged ions, also electrons, are attracted. Similarly, a cathode is an electrode carrying a negative charge, to which positively charged cations migrate. In this sense therefore, the condition, movement and energetic character of water, its resultant interaction with its surroundings, respond to the fluctuating influences of the oppositely charged Sun (cathode) and Moon (anode). Elsewhere Schauberger refers to cathode-water and anode-water which respectively carry high percentages of carbone-energies and oxygen-energies. — Ed.

4 See description of worm rains in Lapland under 'Concerning Micro-organisms', in *Nature as Teacher*, Vol. 2, p. 19 of the Eco-Technology series. — Ed.

5 This process is something akin to the generation of the morphogenetic fields of Rupert Sheldrake. — Ed.

6 Addendum: Due to the impact of the Sun's rays the temperature of the air at the surfaces of the bark and leaves has been measured at +40°C (+104°F) and more. In contrast, the temperature immediately under the bark amounts to only 9°C-10°C (48.2°F-50°F) and in the interior of the tree it is even lower. In late autumn the pattern is reversed. The external air is colder than the internal heat and the movement of sap ceases. Such differences in temperature can signify enormous losses or gains in energy. As has been shown in the case of the Rhine, the losses in tractive force can amount to as much as 60,000,000 hp per day. If the trunk of a tree is precisely oriented to the normal lateral potentials of the air and if the large differences in temperature and the thermal functions per millimetre of depth are taken into consideration, then it will dawn on us what new and immeasurable magnitudes of energy are involved. According to their functions these energies either signify growth or destruction. — VS.

7 'According to H. Mayer-Krapoll, the physiology of plants is such, that during the growing period the average daily transpiration of water from a forest amounts to between 40,000 and 50,000 litres per hectare. According to Risler, under certain conditions, grass or lucerne will transpire about 52,000 litres of water per day.' - Walter Schauberger — *Implosion Magazine*, No. 9, p. 21.

'One hectare of mixed forest can retain 2,000 m³ of water; 10,000 m² of forest retains two million litres; one square metre of mixed forest enables the accumulation of 200 litres in the soil.' — Linus Kefer — Implosion Magazine, No. 3, p. 19. — Ed.

'In order to create one gram of above-ground plant mass, the plant requires 250-1,000 grams of water.' — A. Metternich — Implosion Magazine, No. 4, p. 26. — Ed.

8 Today we still speak of felling a forest, but never of sawing it. The slicing action of a sharp axe leaves a smooth, clean cut, enabling the wound to heal completely and far more easily, whereas the saw tears the wound to pieces. For this reason roofing shingles split by the axe last far longer than those cut with a saw. Today's machines work mechanistically, rather than organically, killing life and soul and therefore their use must be confined within strict limits. — VS.

9 The ploughing of water-producing steppe-grasses inevitably leads to the elimination of the soil's potential, to the disappearance of water and ultimately to desertification. — VS.

10 The Isotope can be defined as a non-polar or virginal entity, whose eventual gender is determined by subsequent inbound radiation. If this aqueous fluid is created inside the Earth, then the isotope will develop a feminine or negative potential (maternal, ovigenous water). On the other hand, if it evolves in the atmosphere, then it will be endowed with a masculine or positive potential (fertilising water). The ur-substance or the 'almost material' is the tipper of the scales of life. It has almost uniform properties in all directions, is almost equally balanced and is the isotope. The 'substantiative' life-form is terrestrial or atmospheric water, which is inherently bi-polar, however, and is therefore subjected to constant metamorphosis, thus having the capacity to act in a motherly up-building or a fatherly disintegrative (spermeating) manner (fertilisation represents the disintegration of the existing form through the input of new directional energies). — VS.

5.

Timber and Water in the Building Industry

Caution in the Use of Timber in the Building Industry

From *Architektur & Bautechnik*, No. 23, 15 December 1932.

Every timber expert is aware that, despite the high level of development of forestry science, the quality of timber is becoming poorer year by year so that genuine quality products are becoming a rarity. In the building trade every effort is made to avoid using timber and to replace it with steel, concrete or other building materials. The principal cause of the qualitative deterioration of timber lies not only in the disregard of decisive factors concerning the vital internal laws of growth and formation, but also in the unintelligent way in which our forests are managed. Forests, perhaps the highest national estate, are now threatened with extinction at the hands of its custodians and conservators.

Good wood is the product of certain transformation processes between carbon, i.e. nutritive substances, and oxygen, which take place under the influence of a very particular temperature-gradient in the interior of the tree, if the rising sap is correctly conducted, processed and deposited. These correct, natural processes of transformation and growth are themselves dependent on specific external influences through which the proper proportion between the quantities and the here-decisive qualities in the rising water (sap) is established. The basic elements required for the growth of timber are absorbed into the water through its breathing processes, which are regulated by the temperature-gradient. Consequently, they are drawn up into the interior of the tree, where interactions take place under very specific and characteristic temperatures. These interactions transform carbon extracted from the Earth into formaldehyde, sugar, starch, and ultimately into cellulose. The quality and hence the durability of finished timber is naturally

dependent on the conditions under which these transformative processes proceed.

Every living body is the carrier of a greater or lesser number of different bacteria. Sudden extreme changes in the temperature-gradient as well as the creation of other unfavourable preconditions for the life and growth activity of the macro-organism, can simultaneously produce living conditions favourable to micro-organisms, leading to the sickening and malformation of the organic host-body (the macro-organism). Since we are concerned here with equilibrium related processes, the manifestations of decay and degeneration in the macro-organism are associated with a rise in temperature and humidity. This is because, where all atmospheric oxygen is excluded, the increased consumption of oxygen by the microbe world can only take place through an increased supply of water occurring under a negative temperature-gradient.

Even standing timber in the forest is a carrier of bacteria, although it is still considered healthy. Under certain conditions, however, as soon as timber produced by modern forestry is installed in its appointed place, it tends to fall prey to the vital activity of the microbe world and so becomes diseased. The practices that are particularly disastrous to timber are:

- The reduction of the period of rotation to 120 years, indeed in some cases down to 80 years, resulting in the marketing of timber which is far too young and immature.
- The monoculture of certain flat-rooted species of timber, through which valuable, more deeply lying, formative substances are not available to the root-zone. These can no longer be drawn up and the tree gradually becomes undernourished.
- The exploitation of light-induced growth in our particularly susceptible shade-demanding timbers. Due to direct radiation by the Sun, this inevitably results in unsuitable temperature conditions, unfavourable forms of transformation and hence in the development of organically malformed timber.

The most serious danger in the case of the exposure of shade-demanding species insufficiently protected by suitably thick bark, arises because thin bark is penetrated by direct radiation, rich in 'capacity for work'. In its rapid passage through the inner sections of tissue, such radiation produces secondary rays, and with them, decomposive acids, causing the emergence of plant-cancer, which is synonymous with the decay of portions of the tissue.

Although seemingly healthy while still in the forest, timber grown in such a fashion carries within it the seed of premature decay, because proteins in the cells, not yet completely metabolised, are predisposed to become diseased after the tree has been felled. Under certain conditions they make possible the formation and vital activity of inferior, destructive micro-organisms.

The point of view proffered by science, that certain symptoms of disease and decay require an initial infection before appearing, is to be countered above all with the question: How and where do the necessary infecting microbial spores come into being? This all-important question, decisive for the continuing existence of our forests, will be answered correctly once scientific research re-establishes the organic connection between increasingly specialised and disparate fields of research. It must also become apparent to science that the differentiation it has established between the organic and inorganic world, between matter and moving energy, inter alia, cannot continue to be supported in the long term.

In all matter, whether dead or alive by today's concepts, interactions take place constantly between carbon and oxygen, expressing themselves in the particular form of pulsation that we can detect in water (a supposedly inorganic substance) with a Darcy-pipe. These interactions are also evident in the decomposition by suffocation of a stone, whose 'breathing' possibilities have been removed by cutting off its supply of external air. In the organic world, such exchanges of energy are only possible because of various levels of vital activity. However, even in the forms of energy we presently conceive as immaterial, we find these same interactions between carbon and oxygen taking place. Their outwardly detectable patterns of motion are vibrations whose wavelength and frequency determine the type and action of the ray. Through the vibratory effect of the ray, the 'life-functions' of more deeply lying systems are stimulated; these systems being equally built up of carbon and oxygen. Everywhere we encounter the same combinant and recombinant activity, in which the wide variety of forms that we perceive represent but different stages in these interactive processes. Ultimately these depend on the ratio of carbon to oxygen and on the quality of the former.

In the chemistry of proteins these important questions are still completely unresolved. So, it is thus understandable that biochemical technology is quite unable to state when the incipient pre-disease stage actually begins. Not only is the moment of spore formation still entirely unknown, but the beginning of the micro-organism's vital activity is unknown as well. For this reason no practical method of prevention exists at present, which can protect building timber from degenerative phenomena.

As long as mature and organically grown timber was available, all such questions were superfluous. Under these circumstances wood was almost entirely composed of cellulose and lignin. Generally speaking, the timber delivered to industry today, apart from being far too young, is also clear-felled from southerly slopes as growth is faster there. It can only be described as totally unsuitable for building purposes, because the resulting serious and unavoidable defects suffered by all timber components are so great that no builder can risk using it.

Since in all instances we are concerned here with highly complex metabolic processes of extremely sensitive protein compounds, all expert opinion on the possible uses of timber inevitably contains a large number of qualifications.

Therefore the simplest and the most appropriate course of action is to avoid using the qualities of timber presently available for building, as far as this is possible.

The Character of Water in the Building Industry

From the *Oesterreichische Bauzeitung*, Vol. 14, 3 April 1933.

In the technical newspaper *Lidove Noviny* a report appeared on 4 May 1931, stating that in the large forest tracts of the republic of Czechoslovakia, principally in the eastern region of the country where beech predominates, defects had appeared in the timber which could have very serious ramifications for the management of forests. The extensive beech forests in this area apparently survived the preceding winter without damage. When the trunk cross-sections of the following year's felling were examined, however, they exhibited the formation of a second heart, which was completely different to the original heart both in colour and structure. This heart, the so-called 'peripheral heart', rapidly changes colour when exposed to air, and in most cases soon becomes grey, and in almost all cases leads to the dreaded white-rot, which is a cancer in the heartwood of the beech.

The Institute for Forestry Research was unable to present an agreed opinion as to the cause of this phenomenon. Meanwhile it became evident that these defects had already become extremely widespread, even appearing in Romania, devaluing millions of solid cubic metres of beech wood. Large areas of valuable forest were now only suitable as firewood and had suffered a considerable depreciation in commercial value such as could never have been predicted.

A builder is already forced to take extreme care in the selection and use of the qualities and varieties of timber currently available, if he is not to be held responsible for subsequent dilapidation and damage. There is a lot of expert opinion concerning this, but not a single recommended procedure that actually addresses the root of the evil. This matter is of great importance to the whole of the building industry, because the phenomenon can not only occur in all timbers built into walls, but also in walls themselves, if certain dictates of Nature (about which contemporary science is still ignorant) are overlooked.

Today no builder is unaware of the fact that under certain circumstances settlement occurs in foundations, or that other defects appear, against which people have so far been almost helpless. When designing foundations we have long been accustomed to thinking purely mechanically. Once the bearing

capacity of the ground has been determined, then general compliance with the regulations is deemed to have been satisfied. However, the fact, rarely taken into account, is that under certain conditions the widest variety of incipiently dangerous changes of a purely physical nature can be caused by the excavation of deep footings, if excavations or boreholes are beyond a certain size. In fact, the character of water is not only of great significance in terms of its utilisation, but in particular in relation to the stability of walls placed in deep excavations. Without exception, so-called acidogenic effects are to be traced back to negligence. Today we should not lose sight of the fact that we human beings have quite arbitrarily changed the face of the Earth. Not only have all the conditions of water distribution and drainage been altered, but water's metabolic processes have also been changed very substantially, resulting in defects to be dealt with today which were simply unheard of in earlier times.

The metabolic processes of water in the Earth are dependent on the prevailing ground temperatures and the influence of light or air. If we observe good springwater in winter, then we can ascertain that it does not freeze, even at a temperature of -30°C (-22°F). However, in the case of soft riverwater, everyone knows that such water is covered with a thick sheet of ice at temperatures just a few degrees below zero. Where lies the difference? In effect it is purely and simply in the character of the water, i.e. its relative proportions and qualities of carbonates and oxygenes. It is upon the interaction between these elements that the properties of water depend.

These carbonates encompass all the materials present in the Earth, and include all carbon compounds, metals, salts, chemical elements and their derivatives with the exception of hydrogen and oxygen. In contrast to conventional systems of classification, no differentiation is made here between organic and inorganic matter.

As long as no clear-felling occurred in forestry, the ground could only be warmed in summer and cooled in winter down to a certain depth. However, if heat or cold penetrates deeper strata due to the warming of exposed, clear-felled surfaces, then the same thing happens to the groundwater that we can observe in every glass of water that is left standing for a long period; small bubbles form in the warming water which eventually rise to the surface and escape. These bubbles consist of the bound and semi-bound carbonic acid or carbon dioxide contained in the water, which contribute towards the maintenance of other aqueous substances in solution. The latter sink down, if these noble substances (the water's psyche) are forcibly expelled from the water by being indirectly warmed by the warm ground. The remaining water then takes up an excessive quantity of oxygen, assuming other highly undesirable physical characteristics in the process. Not only this, but also it is easily frozen in the ground as well as in a wall, and naturally it also freezes in the timber. This is what happened in the Czechoslovakian beech forests.

Occasionally the over warming of ground occurs in primeval forests due to the rotting of a large quantity of fallen leaves. On the other hand, strong warming is provoked through extensive clear-felling carried out from time to time. Because of the massive fluctuations in temperature which sometimes occur, even faraway regions can still be influenced. This is because we are concerned here with water, which is continuously in motion, whose particles of matter are in a constantly interactive metabolic exchange. The magnitude of the powerful energies in question here, is first recognised when we consider that in order to heat one cubic metre of water by only 0.1°C (0.18°F), work in the order of 42,700 kgm is necessary.¹ From this small example it can already be seen what tremendous energies can either be freed or bound with variations in temperature, which in the present case often fluctuates by up to 60°C (108°F) between winter and summer.

The resulting metabolic activity must naturally assume increasingly greater proportions, the more extensive the areas exposed to the elements. Within one forest rotation, changes have already occurred which have had quite a catastrophic effect on agriculture. If radical changes are not put in hand immediately, therefore, the forest industry will not only annihilate itself, but will also instigate further damage, which could bring about economic collapse in the whole of Central Europe. These forestry practices have resulted in the uninterrupted deterioration of all groundwater reserves, which must ultimately lead to the most disastrous outbreaks of decay and premature frost damage. The perilous ramifications of these are of an order quite inconceivable to us. To such harmful defects belong all those neoplasms and malformations we collectively term cancer.

Whatever applies to the tree and the wall also applies to other organisms. Our doctors would be much further advanced in their fight against cancer were they to take note of the metabolic processes that take place in water under the influence of interrelated conditions of temperature.

Obviously the uptake of nutrients also has a role to play in this regard. However, in the same way that the uptake of nutrients in the tree leaves much to be desired when only a small quantity or an inferior quality of formative substances are taken up by it (aptly demonstrated by the deterioration of our various timbers), this consideration also applies analogously to the way we conduct our lives, which are supported by similar preconditions. Ultimately this deficiency extends to the substances in the wall, which are leached from it if it possesses a predominantly one-sided charge, i.e. excessive quantities of oxygen are present. It is upon the degree of oxygen concentration that the aggressiveness of the water depends.

It should therefore come as no surprise that groundwater can later on cause damage to a building if it has been temporarily exposed to atmospheric influences through excavation. Many people living below dams would not

sleep as soundly, if they were aware of the chance nature of the minor events upon which their lives and the preservation of their worldly goods depend.

In the final analysis, the qualitative decline of our indigenous species of timber and of all other produce of the soil is the result of the arbitrary changes wrought by contemporary technology. In particular it is attributable to the severe disturbances in Nature's water balance instigated by modern forestry. Hence our builders will really have to take into account the fact that under these circumstances, building will become an increasingly risky business, year on year.

Many builders can spare themselves much time, effort, worry and expense, if they always bear in mind that the water that serves their every use also has a character, and that it is not only humanity that loses its character due to the general degradation of water. Through continuous disturbance of the balance and distribution of water in the ground, all building works will begin to suffer from the changed nature of the groundwater. In most cases the builder will be unjustly held responsible for the damage.

Constructional Defects and their Prevention

From Allgemeine Bauzeitung, No. 365, 24 December 1932.

In issue No. 361 of Allgemeine Bauzeitung, dated 26 November 1932, an article appeared under the above heading signed by H. Bronneck, a builder and civil engineer. According to him constructional defects caused by microbial activity are without exception attributable to irresponsible building procedures, and should be avoided by strict adherence to fundamental construction principles. This opinion, and the widely propounded arguments put forward in this article, could under certain circumstances cause tremendous damage to the whole of the building industry, and I therefore consider it my duty to draw attention to what follows.

In 1925 the leading industrialist W. Rieder, his engineer Klamt, and secretary E. Gebauer, were convicted of violating safety regulations at the Reichenberger District Court. The court, after hearing the expert opinion of engineers Huber and Kluger, held that the principal cause of the breaching of the dam on the Weisse Desse was to be traced back to faulty structural engineering. Six years later it transpired that the opinion of the above experts was incorrect and that the true causes of the breach were not to be ascribed to negligent construction, but rather to hitherto undetected processes. These had occurred because of a flow of groundwater, whose very peculiar composition had never previously been detected in the reservoir. As a result of a recent survey by professors Dr Wohner, Dr Thum and Dr Brandl, which was only

made possible by uncovering the dam's foundations, the High Court ordered the case to be specially reopened, to the benefit of the above three accused.

Today the scientific world still has no idea when and where the spore-formation of micro-organisms begins, and how the vital activity of the first spores is brought about. Apart from very specific conditions where air is excluded, certain humid conditions are also necessary before any micro-organism can begin its vital activity. These can only ever occur after the construction in question has been completed. Strangely enough, this degree of humidity is still viewed and assessed from a purely mechanical point of view today.

In the past softwood floors were washed down once a week with such copious quantities of water that the flooring and the blinding layer of gravel never had time to dry out completely. Despite this, these floors lasted for many decades. The only reason they were replaced was because they had either worn down or had actually been scrubbed right through. It was absolutely unheard of for such floors to be destroyed by microbes. However, where dry-rot or similar micro-organisms appeared, it was always assumed that for some reason or other the walls were permanently wet, i.e. that the groundwater constantly rose into the masonry. It was never ascribed to the action of water which had been exposed to the Sun, and which had gained access to the interior of the structure, for example, during the course of construction or when being cleaned. If rising groundwater is prevented from entering the masonry or if appropriate ventilation is provided, then the damage arising from microbial activity will cease automatically. The underlying origins of the formation of microbes and the defects they cause will be briefly addressed in the following.

In common with all other bodies, wood is a carrier of bacteria. Sudden, major changes in the temperature-gradient as well as the creation of other unfavourable conditions for the growth of the living body can also create favourable living conditions for such micro-organisms. These preconditions are met, for example, when shade-demanding species such as pine, fir or beech, which have no protective bark to shield them against the direct rays of the Sun, are grown under light-shock in clear-felled and prematurely felled areas, and when such inorganically produced timber is installed while still immature.

The water rising up in the interior of the tree is the carrier of substances from which, under a very specific temperature-gradient, the wood is constituted. Apart from the proper distribution of decisive basic elements, whose reciprocal intermixture is dependent on both internal and external temperatures, the proper process of timber growth is principally a question of the Sun's radiation for the following reasons.

For lack of suitably protective bark, exposed shade-demanding species are exposed to the direct rays of the Sun, rich in 'capacity for work', which cause

an internal rise in temperature and the formation of secondary kinds of radiation. As a direct result of this, decisive interactions take place between low-grade carbonates of the tree and high-grade carbonates of the rays, and between the oxygen in the tree and highly active oxygen of the rays, leading to the formation of acids.² As a consequence, such interactions precipitate tumorous growths in the organism of the tree. These growths and manifestations of decay in the tissue of the tree develop through the vital activity of certain bacteria, which evolve from the partially metabolised proteins. As a result of too high an internal temperature, insufficient carbonates from the root-zone and excessive oxygen succeed in entering the tree's capillaries. If sufficiently unfavourable microclimatic conditions are created in the interior of the timber, due to the effect of direct solar radiation, then its natural organic growth is halted. A new form of life then begins inside the tree, accompanied by symptoms we have come to term collectively as plant-cancer.

If such timber is felled or 'clean cut', and is subsequently installed under certain conditions of isolation, and if insolated groundwater is drawn up into the masonry under a suitable temperature-gradient, micro-organic life-forms develop, which on occasion achieve such proportions that their carrier, the timber, decays into dust within a very short space of time. As the timber had been cleanly and healthily cut, firstly in the forest and subsequently at the sawmill, a given timber company has no clue as to whether the timber has been infected with micro-organisms or not, as this can only be determined by examining a section under a microscope.

At present no timber supplier can be expected to examine timber, board by board, under the microscope prior to its installation. Science is still ignorant as to how and why bacterial life forms in the interior of timber. So, it is quite irresponsible for a building surveyor, who has not actually studied the material in sufficient depth, to speak of negligent workmanship when such defects appear, and to produce a report that can lead to a miscarriage of justice and the ruination of many lives.

Lost Knowledge of Timber Growth and Quality

From Implosion Magazine, No. 78, p. 29 — Aloys Kokaly.

The interest and diligence of our ancestors in observing the growth of timber and the proper time to fell it, is demonstrated by the records of a master cartwright dated 1843:

- There are only three days suited to kiln-drying in the year: April 3, July 30 and St Catherine's day. The latter is also good for casting ball and shot.

Notes

1 Concepts of Efficiency and Performance: Quoted from TAU Magazine, No. 148, p. 25, and written by Prof. Werner Zimmermann. — Ed.

If one kilogram is raised one metre for the first time in one second, and for the second time in one hour, then the same work is done, but the performance is different. In the first case the performance amounted to 1 kgm/sec, in the second

- To make sure that timber is solid and firm it should be felled during the first eight days after the new Moon, if this is in a 'soft sign' (i.e. in any of the zodiacal signs of Virgo, Pisces, Gemini or Libra).
- To make sure that timber does not rot after felling, there are only three days in the year when it can be felled. The first day after the Conversion of St. Paul (26 January) and 10 and 13 of February.
- To obtain incombustible timber, it should be felled the first day in March, when the Moon still has 48 hours to wane.
- The best day for felling timber so that it does not shrink is the third day in autumn when daylight is reducing and the Moon waxes above the first quarter.
- In order that there should be good regrowth, firewood should be cut in October during the first quarter of the rising Moon.
- Saw logs should be cut under the rising sign of Pisces. They should be leached out in water under the sinking signs of Pisces or Cancer.
- So that it does not shrink, timber should be felled when the Moon is three days old, on a Friday and under the sign of Cancer.
- The straight and true wood required by cartwrights, coopers and the like, should be felled under a new Moon and the signs of Scorpio or Cancer. The wood will then remain firm and solid.
- To ensure that timber does not swell up, it should be felled in November on the first and second days before the new Moon.

And from old timber-getters in Australia:³

- The eastern side of the tree trunk should be marked with a cross prior to felling and when milled, the eastern side should be cut first. This will reduce the curling and warping of the timbers once cut.
- After felling, a tree should be left lying with the crown still attached. The leaves will then draw off the sap in the trunk prior to milling, which will render the timber less likely to shrink.
- Lightning-struck trees exhibit a more waviform grain, which is harder to cut, less easy to burn and generally more durable.

case, 1 kgm/h (= 1/3,600 kgm/sec). If an output of 1 kgm/sec is developed, then in one hour 3,600 kg can be lifted, in the second case, however, only 1 kg. Whereas energy can be viewed as a quantitative concept, performance can be described as a qualitative concept, namely the quality of a machine or a functional process to transform a certain energy (in a certain way) in a certain period of time. Performance is energy per unit of time, energy is output multiplied by time during the performance.

The Technical Dimensions of Energy

kilogram-metre (kgm) [mechanical] 1 kWh = 367,700 kgm

kilowatt hours (kWh) [electrical] 1 kcal = 427 kgm

kilocalories (kcal) [thermal] 1 kWh = 860 kcal

The Technical Dimensions of Efficiency and Performance

kilogram-metre/sec (kgm/sec) 1 kW = 101.8 kgm

horsepower (un-useful) (hp) 1 hp = 75 kgm

kilowatt (kW) 1 kW = 1.36 hp

2 "The most important precondition for the correct organic growth of the tree is the occurrence of a uniformly acting temperature-gradient in the interior of the tree as well as the establishment of a suitable temperature-gradient outside the tree and in the crown zone, through changes to the crown and root systems. Through enlargement of the capillaries (enlargement of the annual rings through exposure and exploitation of light-induced growth) and over-warming of the trunk through direct radiation by the Sun, too much and too aggressive oxygen reaches the interior of the trunk." — VS — Wiener Neueste Nachrichten, 18 August 1932. — Ed.

3 This additional useful knowledge about timber was related to the editor by an old Australian timber-getter and seemed worthy of inclusion. This interesting effect may be due to the fact that the morning Sun (eastern side of the trunk) has a greater proportion of cooler, high frequency, blue light than the afternoon Sun, which has a greater content of hotter, low-frequency, red light, due to the Earth's rotation. Therefore the eastern side of the trunk receives a greater intensity of energy than the western, which may affect its structure. — Ed.

6.

Agriculture — Soil Fertilisation —

Increased Productivity

Noble Fertilisation with the Aid of Planetary Motion

From Implosion Magazine, No. 45 — first written in 1957.

The past (all that existed previously) gives life to the present (all that now exists), which in turn procreates the future (oncoming existence). The manifestations of the future, however, will deteriorate and pass away prematurely if the present moves the past in a technical fashion. To understand this, it is important to highlight the difference between technical and planetary forms of motion.

By 'technical motion' is meant the forces that strive to move away from a central point, whereby pressure against the inner surfaces of an enclosing structure is intensified, reactive heat-forms are generated and the density of the given medium is specifically reduced. Technical motion therefore represents the artificial, de-animating, centrifugating acceleration of mass. It is antagonistic to life and leads to decline. In the bipolar intermixture of basic elements it triggers off low-grade fermentation processes. Their end-product is electricity, which is a decomposive and decay-promoting form of energy.

In contrast, 'planetary motion' is characterised by forces that strive to reach the central point and reduce the outward pressure on peripheral wall-surfaces. They generate reactive forms of cold and lead to specific densation. Planetary motion involves the natural, animating, centripetal acceleration of mass, which initiates higher-grade fermentation processes of an invigorating nature in the bipolar intermixture of basic elements. The end-product is biomagnetism, a reproductive, regenerative and upwardly evolving form of energy.

Bioelectricity promotes processes of decay and putrefaction; biomagnetism on the other hand inaugurates processes of rotting and decomposition. In .•lied faecal matter and deceased life-forms, new evolution-enhancing forms of energy arise, whereas in bioelectric processes of decay, pathogenic, evolution-impeding parasites come into being.

Technical motion takes place under atmospheric environmental influences. Planetary motion, in contrast, occurs under geospheric environmental influences.

Under the microscope technically moved masses exhibit coarse crystalline structures. Masses moved in planetary fashion, however, exhibit structures of amorphous character. In other words, technical methods of mass-motion ur-generate cell-splitting and tissue- and structure-enlarging dynagenic rays. These are emanations that penetrate all resistance and rupture the cell-nucleus, which normally has a negative potential, provoking the emergence of inferior incarnations (materialisations) commonly known as cancerous tumours.

Planetary systems of mass-motion ur-procreate cell-building forces that possess tissue- and structure-densifying properties. These reinforce the life-forces and are the rays emitted by higher-grade emulsions. Today all media are moved and accelerated technically. Therefore in conformity with natural law an increase and intensification of the pathogenic world of parasites must legitimately follow, instead of an increase in substances of higher quality. The technologist is thus to be seen as the instigator of cancer, because technology generates life-destroying forces. In contrast, bio-eco-technology creates animating and vitalising atomic energies.

According to Indian concepts the visible world is the result of the interaction of two forces. Within the atom these encompass forces with either active and expansive or passive and receptive functions. These opposite forms of energetic essences are symbolised as male and female. In every form of life they alone determine whether decomposition (reversion, recoil) or growth (buoyancy, uplift) is to occur. Whichever ur-force prevails or predominates determines the type of motion of the medium, which is the bipolar carrier of basic elements.

Bipolarity

Every medium contains basic elements with opposite potential, a disunity that strives for union and which subsequently creates further disunity due to the ever-changing influences of the environs. Should whatever is excreted or precipitated fall back into the womb of the Earth, then through the constant upwelling (incarnation, materialisation) of geospheric dynagen formations on

the one hand and the subsidence of leaf and pine-needle waste on the other, it is shielded from the effects of light and heat. It is also subjected to the influence of the planetary movement of the Earth's mass.

If these excreta subsequently enter the boundary or anomaly zone, the 'zone of indifference', where the positively charged atmosphere and the negatively charged geosphere collide, then a vigorous interaction between these elemental powers occurs, which produces a formative nucleus. This nucleus or embryo is immersed in a sac of amniotic fluid and enveloped by a thin protoplasmic membrane. The embryo obtains the energies for its development from a nutrient sac. These energies, however, can just as easily be applied to regressive development, if the sac of amniotic fluid is exposed to positive influences. In the latter case a seed of decay develops and in the former case, the beginnings of reproductive and upwardly evolving life unfolds. These forces take the form of transitional bacteriophagous structures which evolve out of the excreted or precipitated earthly remains of former life.

It is in this way that high-grade products of interaction gain access to the interior of the plants. The resultant product of this emulsion is sap, surrounded by solidified (incarnated) substantiality that already functions as a more robust diffusion device. This is how the lignification of the roots, trunk and crown comes about. The purpose of these three elements is to absorb decadent incident radiation and what Goethe called The Eternally Female and The All Uplifting, which can only couple with the noblest, fertilising entities.

If protective vegetation is missing as a result of excessive deforestation or through the creation of over-size, treeless fields and if water is over-exposed to light and heat, then decadent fertilising essences can penetrate right down to the root-zone of plants. In this case the so-called indifferent anomaly zone in the ground becomes positively overcharged and the groundwater sinks as a result. Shortly thereafter the vegetation begins to suffer from a deficiency in higher-grade, formative and levitational essences. In trees this causes enlargement of the annual rings and the formation of a spongy structure, all of which are well-known phenomena and occur through the exploitation of light-induced growth, which alters the interactions between the basic elements in the sap-stream.

In lakes the anomaly zone of $+4^{\circ}\text{C}$ ($+39.2^{\circ}\text{F}$) begins to change, displace and break up due to over-illumination and overheating. Silt and rotting matter normally retained in this dense zone sink to the bottom and block off the influx of groundwater by sealing the lake bed. The lake is then cut off from all regenerative energetic essences emanating from the depths of the Earth and the lake has to rely on surface water only for its recharge. The lake water begins to putrefy and the putrefying matter sinks even deeper. The product of this decay is oil, which little by little solidifies into coal. In the natural, untrammelled progress of evolution, coal provides the basis for the formation

of reserves of carbonic acid, without which no water can come into being. With today's technological methods and processes the carbonic-acid-sphere is ruthlessly torn from the Earth and used to generate mechanical power. Both coal and oil then contribute to the excessive build-up of decomposive energies.

While the qualitative and quantitative destruction of the forest opened the cycle of self-destruction, the elimination of reserves of oil, natural gas and coal closed it. The end of this insane over-exploitation will be Hell on Earth, upon which humanity, which is completely out of its mind, will factually self-combust; humans being the principal source of fatty matter, the formative material in Nature most crucial to life.² In cold-fermentation processes this fatty matter is reconstituted into what are today called 'bases', which make the groundwater — the Blood of the Earth — extremely wholesome and which raise it to within reach of human and beast alike.

The same process of ennoblement takes place in cold-fermented mixtures of faecal matter. As a rule it takes about a week, if the reconstituting process is merely given the right motive impulse. During this regenerative process or rhythmical interplay of motion, suction components must prevail over their pressure counterparts. However, if the opposite impulse is given, then the ignoramus responsible for it will lift the whole world off its hinges — hinges that are oiled with basal fats. This tragic error is the cause of the universal decline as well as the appalling increase in the number of people stricken with cancer. Cancer cannot be cured in this advanced state for the following simple reason. Owing to the prevalence of processes in which embryonic substances are subjected to warm fermentation, decay not only spreads through the whole body, particularly to the vital organs, but does so even while the body is still alive.

The Planetary Movement of Mass

For a better understanding of the whole, various concepts must be clarified before these regenerative processes are addressed. As has already been stated, the Blood of the Earth — water — is the accumulator of the true kinetic energies.

Viewed biologically, motion is a rhythmical interplay between component forces of inverse nature, i.e. of suction and pressure. The pressure component triggers reactive heating effects and the suction component triggers reactive cooling effects. From a physical standpoint they are forces of expansion and impansion (contraction), which trigger interactions between various basic elements in the course of their exchanges of energy.

If movement proceeds in the direction of the suction component, i.e. planetarily from the outside inwards (implosion), then the resistance diminishes and a levitational form of energy is created, which intensifies growth in quite inconceivable measure. To achieve this, an in-winding,

involuting apparatus is required as well as the catalyst that triggers the forces for growth. Just what is a catalyst? It is an element with very particular properties that regulate the speed of a reaction. This reaction consists of the analysis of the existing compounds, the reconstitution of dissociated basic elements and the eventual recombination of more highly reduced essences for the purposes of creating higher-grade products of emulsion.

All of which begs the question: What does 'emulsion' mean? It is the intimate intermixture (marriage) of bipolar basic elements. Whether this union actually takes place is dependent on the nature of the catalyst. In order to obtain a high-quality emulsion, three factors have to be taken into account:

- the mechanical involution of mass with the aid of specially constructed and alloyed whorl-pipes. This in-spooling of mass has to take place in a geospheric environment;
- the physical (specific) densation of the trinity of the solid, liquid or gaseous media to be accelerated — earth, water and air;
- the procurement of the secondary dynagenic radiation from involuted (in-winding) whorl-pipes constructed with bipolar alloys. These generate suction-vortices in the moving mass, whose narrow ends project downwards. Upwardly whirling pressure-vortices then evolve, which flow back into the suction-vortex. It is a metabolic cycle moving in cycloid-spiral space-curves in an endless screw-form motion. Expressed even more clearly, it is a motion within and about itself.

Once again it is to be stressed that all this has to take place in a domain of geospheric nature. This first results in a condition of indifference, in a transitional state from which, what is to be regenerated can be raised one stage higher in the process of synthesis. A preponderance of bases is created, which restores over-acidified and regenerated media to a state of health. As a result, they can then reproduce and upwardly evolve with their own forces and energies, i.e. they can increase and ennoble themselves.

The products of this implosive process have no spacial magnitude and thus create a biological vacuum in a fermentation vessel. A biological vacuum is the function of a mass of earth, water or air carrying a predominantly magnetic charge. It is the metaphysical ur-force of life. This primordial yet new form of life, which overcomes all physical weight and mental inertia, can be produced for virtually nothing in any naturalesquely designed and alloyed liquid-manure pit within a week. When these energies, ascending autonomously from the vegetation, intermix with direct rays of light and heat, they coalesce into further physical growth.

The Tabula Smaragdina, the oldest Aryan testament, which was incised into the hardest of precious stones (the emerald), contains the following exhortation:

'Mix the substances of the Heavens and the Earth in a natural way, then you will remain healthy and content all your life'. The people of ancient Indo-Germanic cultures took great care of the planetary force of implosion. They produced and raised their all-healing water in correctly profiled and alloyed reconstituent pathways, with which they achieved their legendary harvests. However they were unaware of the end-effect of these metaphysical, levitational forces and what happens if they are allowed to develop to their extreme limit. Cyclonic energies were unleashed, which tore whole sections of the Earth skywards and atomised them, provoking major disturbances in the cosmos. Deluging cloudbursts rained down from the heavens and these prosperous regions of the Earth were sent to the bottom of the sea.

Biblical history attests to this catastrophe, although it is described differently. Two thousand years ago Christ spoke of turning water into wine and bread into spirit. To do this he used that age-old vessel, the Holy Grail, the extreme egg-shape, the specially alloyed chalice. A mendicant friar is reputed to have discovered the motive power of steam. Equally ancient is the explosive force produced by powdered mixtures of basic elements. Through all these things technology gradually developed, but in the wrong way!

The biological vacuum, the negatively potentiated concentrate of dynagens, has not the slightest connection with present expensive methods of rarefaction. A biological vacuum arises when naturalesque mixtures of fatty substances present in every blade of grass and other 'cadavers'³ are moved planetarily under conditions where the influences of light and heat are excluded. After just a quarter of an hour of planetary motion, water no longer obeys the Law of Communication. In a U-shaped system of pipes, it rises up the leg in which negatively supercharged catalysts (trace elements) have been incorporated. These catalysts are also present in every vein in our bodies.⁴

This is the first time that the driving force of blood and sap circulation systems has been correctly explained. In summary, the following can be stated: 'A man is what he eats'. The higher the quality of the food he eats, the more noble the products (thoughts) of the energies created in the digestive system. This is only true, however, if the basal substances contained in all food have not been degraded by overcooking. Nobody should ever drink any water supplied through wrongly profiled and alloyed (iron) pipes. Nor should they breathe air that has been contaminated or polluted with technical or chemical exhaust fumes. Humanity should only apply fertilisers that have been regenerated by planetary mass-motion in exactly the same way as occurs in our own organism in the digestive tract. As a result, even nobler thought-producing substances evolve, which in turn lead to better coexistence between fellow human beings.

The process of cold fermentation encounters the greatest resistance from farmers simply because the ensuing overproduction of foodstuffs would

immediately inaugurate a rapid fall in price. This process, however, will put a stop to all speculation in food commodities and demands a complete reorientation in today's commercial attitudes and economic life. Today people have become so destitute and have been so intellectually castrated through perverted methods of food production, that they will now have to dance around the Golden Calf. They can see no other possibility of regaining their lost freedom and personal independence other than through the enforced redistribution (communism) of the necessities of life that are still available. Should they do this, however, then they will find themselves in slavery of a hitherto unknown order. Amen.

Bioecological Agriculture

From Implosion Magazine, No. 37 — first written in 1940.

Many people are now involved in biological farming and the number of those who intuitively refuse all food grown with artificial fertiliser is on the increase. Curiously enough, however, it is almost impossible to obtain greater clarification about the essential nature of such methods of agriculture. From the various opinions and interpretations expressed, it is quite evident that even in informed circles the underlying cause of the conspicuously wholesome quality of biologically grown produce is still very incomplete. While some attribute its quality to cosmic influences, others ascribe it exclusively to the appropriate rotting of compost, rich in decomposing material. In fact, the ur-cause of the success of biological methods lies in the right mixture of terrestrial and cosmic substances. Examining the matter very closely, one arrives at the surprising perception that these processes of growth and formation are virtually unknown and that nobody is able to explain what growth actually is. When asked such a question, even the best farmer becomes profoundly embarrassed. Nor is this question exhaustively treated in any textbook. It is therefore increasingly understandable why the general quality of agricultural produce is deteriorating and why the problem of food supply has become such a burning question.

Biological farming involves nothing more than the naturalesque treatment and cultivation of the soil. This is an impossibility if these all-important questions remain unanswered. Namely, how do life's formative processes take place in the lower world of living things and what is to be understood by the external influences affecting growth? Anyone unable to answer these questions thoroughly has to depend on unpredictable harvests and is therefore no practical farmer.

Many experiments have shown that the actual type of soil is immaterial and that good quality food can be produced even in wholly sandy soils, or even

without any soil at all with the aid of a solution of high grade nutrients (hydroponics). Reference to the general climatic conditions also often no solid grounds for success or failure and we are therefore confronted by the humbling realisation that the degeneration in soil-produce is simply due to ignorance of those processes so crucial to growth. The best evidence of the declining quality of soil-produce is the sinister increase in cancerous diseases, which is why many doctors are trying to combat this scourge with biologically fertilised foods. This is a clear pointer to the devastating consequences of only fertilising with chemicals, which first poisons the soil and then its products.

The proliferation of all manner of parasites and the necessity for ridding all foodstuffs of pests with powerful poisons, makes even the most dogged supporter of artificial fertiliser begin to wonder. The most remarkable aspect is that the best biological fare is produced by amateurs (so disdained by established science), and that those people, especially concerned for their own health and well-being, who can afford to get their vegetables, etc, from these scorned outsiders, nevertheless recommend the widespread use of artificial fertiliser in order to feed the wider population. It is also very revealing that profit-oriented farmers themselves, who set great store by the necessary over-exploitation of the soil, prefer quality produce for their own household use, which they grow in areas allocated for the purpose. It therefore becomes clear, why cancerous diseases are on the increase where such foods are consumed in bulk. The assertion that physical decay also provokes mental decay is very hard to refute. It is therefore high time that the true foundations of quality-improving, bio-logical farming should be explained in more detail.

All physical manifestations of growth are actually the discharged precipitates or the waste-matter of energetic interactions, and hence are determinative of the quality of two substances of opposite sex and provenance. These approach each other from different directions and intersect (interbreed) and multiply themselves through the expulsion of a third substance. The product of this procreative process, which principally takes place as an interaction between counter-flowing currents, is either a polar precipitate or an exception to the rule, which is determined by the way it manifests itself. The rule: The two-way interaction between high- and low-grade substances out of which arises the Will to act in certain directions. The first precipitate to be manifested is a gaseous condensation, which as a result of the bipolarity exhibited in all matter, provokes new interactions. In this way aqueous and ultimately solid forms of growth are produced. Always of bipolar nature, these masses have the property of attracting higher-grade substances to themselves, which can be described as strains or provenances, or as higher-quality formative matter stemming from a higher plane of existence. These masses consist of the reconstituted manifestations of former life and impregnate any quickened

substances spiritually. Thus, apart from a purely sexual process of procreation, we are here confronted by a process of higher genesis with the ability to endow quantity with quality.

This higher procreation takes place by way of a hitherto unknown electrical process of respiration, which is to be understood as an interaction involving rays or radiation. It is associated with the material, physical (in the sense of physics) and hydrolytic intake of food, to the extent that these interactive rays are actually the cause of the intake of food in the first place.

Accordingly, water is a manifestation, which comes into being through an interaction between two counter-polar substances of ur-Will (primordial Will), and is therefore an ur-child, which on its part is then able to absorb and divest itself of matter and is hence both accumulator and transformer.⁵ The formation of atmospheric and geospheric water is a result of electrozoic rays (currents of energy), which intersect each other at a particular angle. For this reason it is possible to produce any kind of water, gaseous or solid matter of a higher order almost without cost, through the appropriate intermixture of animalistic or organic currents. Having been created out of the most thoroughly rotted elements of former life, these emanations are the most natural fertilisers, which have metamorphosed their erstwhile spaciality (spacial volume) to such a degree, that they can only manifest themselves as highly concentrated energetic matter. These eternally recycling, radiant substances are the higher provenances that enhance the attributes of the inward falling masses and which interbreed with the subsiding surplus or unfixated material of the Earth, producing the living and moving matter we perceive as the manifestations of life. In the final analysis, any such manifestation, whether human, animal, plant, mineral or metal, is to be attributed to processes of ur-genesis, which are fostered through the excitation of germinating impulses.

Whoever understands these all-important antecedent processes is in a position not only to produce all the substances that we perceive around and beneath us in any quantity and quality artificially, but also to do so in the way that it happens in Nature. As a result all industrial and technical processes of food production will be shaken to their very foundations, because in the future fertilisation with such muck and filth will no longer be necessary. Instead, Mother Earth will be furnished with radiant maternal essences, which then will dispense such a superfluity of high-quality substances that all black market trade in foodstuffs will cease. In this way and for the first time, humanity will then attain the level of animals, which have no difficulty finding their food as long as a selfish and self-seeking mankind does not interfere with the processes of reproduction and regeneration. Human beings will thereby become true creators, who can so order the processes of growth that the Earth will produce a superabundance of everything the increasing world-population needs in the way of food.

All interactions take place along a normal (characteristic) axial direction, that is to say, we have to differentiate between substances, whose spacial extension is either vertical or horizontal. So-called high growth and wide or broad growth is therefore to be ascribed to the interaction between these axis-related potentialities. Depending on their ur-provenance, these interactive potentialities are nothing more than super-ordinate and infra-ordinate magnetic functions and are thus either attracting or repelling forces, which in their highest form are the above non-spacial (etheric) electrozoic aspects of matter.

As phenomena, so-called electricity and magnetism are the result of interactions of the highest order, which produce the biodynamic motion, whose most sublime precipitate is so-called life, or expressed more accurately in biological terms, the secondary effect or reflected form. This condenses as a third substance after the interchange between the emanations of the Wills of the ur-father and the ur-mother. As the 'child' it is not the 'younger', but the 'older', i.e. the more highly or later evolved. Hence all water originates from the essences of ur-Will and all life did not, as is generally believed, emerge from water, which as the mysterious 'third entity' or as the 'child', is the most sublime form of manifestation (providing these interactions are undisturbed and can take place correctly).

Herein lies hidden the whole secret of Evolution and the riddle of quantitative increase.

Water is the ideal substance that extends itself along the horizontal plane (axis), and which can be charged with gravitating matter from above and levitating matter from below. The logical outcome of this directionally alternating ingress of charging substances is the rising and falling of the groundwater table, whose direction of movement is determined either by the highest grade transformative products, or cosmic and geospheric rays, originating from above or below. The water will be endowed with a maternal character by being supercharged with geospheric, levitating substances. Conversely, the groundwater table will sink, if it is overburdened with gravitating substances. These downward-pressing substances originate from the cathode system of the Sun, which in a sense is the pressure pole, the outward radiation of which is manifested in the sinking water level.

The attracting pole for the substances radiated from the Earth-pole is the Moon, or the spherical anode, which attracts surplus (as yet unfixed) matter from the Earth upwards and restructures it. By means of this contra-directionally active system of poles, the height of the groundwater table is fixed, i.e. maintained at a more or less stable height. The water itself is therefore only the carrier of the radiation coming from above or below, and is hence an accumulator. Depending on its absorptivity it either rises (swells up like a

wave) or sinks. A wave is a flow pattern resulting from the expression of two Wills. Rising or sinking is controlled through the effects of organic heat or cold. Cooling signifies increasing levitation, whereas warming is indicative of increasing gravitation. We are therefore concerned here with entirely new forms of heat and cold, which are triggered through pure, natural metabolic processes, where the direction of propagation has nothing in common with the one we normally associate with heat. With the usual form of heat, substances are made to rise, whereas in this case exactly the opposite occurs.

From where does this levitating, cold influence come? When matter decays, heat is released. Heat released under the correct influences, radiates radially (horizontally), transforms itself and appears as an organic cold, which after maturing completely, normally changes direction and streams upwards axially (vortically). The above, laterally moving radiation, however, is sourced from very specific substances, which for the sake of simplicity will be described as maternal impulses and which foster the general intent of evolution within the Earth. The opposite impulses are paternal, which stem from earth-masses, and foster the gravitating direction of the axially incident matter. The means of charging the soil with either gravitating or levitating, impulse-imparting substances already lies completely in humanity's hands. Therefore the thoughtful, intelligent farmer can further the course of development either gravitationally or levitationally through the timely dosage of bipolar precipitates. This charging of the soil with upwardly impelling or downwardly pressing, impulse-imparting substances is also related to the properties of the substance itself. It is therefore of supreme importance that a nature-loving farmer should be fully informed of the types of substance that spread the amniotic fluid through the soil maternally and horizontally. These maternally oriented substances are limestone, gold and copper, whereas silicon, zinc and silver are paternally oriented counter-substances.

Through the proper organisation of these materials according to their intrinsic directionality, humanity is in a position to produce elements, which are the ur-source of vertically or horizontally propagated impulses. (Under 'elements' no chemical elements are to be implied, but rather sources of energy akin to the elements of electricity.)

Should humanity desire to increase growth, then it must ensure that the Earth's rhythm is strengthened through the artificial creation of maternal amniotic fluid. By taking such precautions, mankind is in a position to fertilise the geopsyché in the sense of maternal impregnation. Since this artificially induced impulse involves very subtle fertilising agents that have virtually no spacial magnitude, it is therefore possible to infuse the groundwater with unlimited quantities of these growth-enhancing substances. The effect of this is to transform the groundwater into a maternal amniotic fluid, from which a further unlimited number of growing systems

evolve, when the vertically ascending, transformative products contained in this nutritive solution directly cross with cosmic rays.

The great secret of bio-logical fertilisation is the proper inflow of supreme quality, transformative substances. From these a feminine psyche is created in the ground, which in turn gives rise to a general Will-to-grow in the form of levitating rays, producing a superabundance of growth at the point where light and darkness meet. The substance of this growth is none other than the discharged precipitates of interactions between two potentials acting in opposite directions.

The essential nature of growth is none other than the overcoming of earthly weight.

In order to get a better idea of these processes, we must observe the rhythmical interplay of life extremely closely and above all, delve into the inner life of the lower orders of matter.

Mother Earth is a genetic stockpile, which reabsorbs all deceased life and transmutes it in order to create a psyche from it. Once formed, it then fashions the Earth's solid forms and various gas-like envelopes. The highest grade products of potential are mineral-metals or metallic-minerals. The former generate maternal, formative rays and the latter paternal, quickening rays. If the groundwater is predominantly dosed with maternal rays, then with increasing horizontally spreading potential, those paternal rays are deactivated, whose spacial extension under the influence of heat is vertical.

Due to their deactivation, these paternal essences sink further into the Earth, giving rise to renewed stimuli in the more deeply lying regions. The ultimate effect of these stimuli is the recreation of potentials that are discharged towards the surface. Every discharge in this outward direction is associated with a reduction in the spaciality of the original volume by 1/273 rd part per degree Celsius. In this way a female embryo, in the form of a geospheric psyche, is born out of the initial paternal stimulus. This female psyche attains its highest potency in the boundary layer that separates atmosphere from geosphere. Through a high-grade interaction between the upwardly striving levitation rays and the incident gravitation rays, geospheric water or more accurately, a hydrogen-like entity, is created inter alia in the cambium ring of the Earth. This spreads out laterally and attracts to itself the residual amniotic fluid of the growing, i.e. self-charging and self-discharging, vegetation. This isotrope-like mass⁶ (see also endnote 10, page 130), the neutral zone, now attracts potentiated substances from above and below, and subsequently repels them laterally. It is equally obvious that the diversely charged (highly polarised positive, negative or magnetic) substances that come into being through the action of the horizontally propagated, electrical potential, become separated along this axis (mutual

repulsion). Through these continual, lateral and upward increases and decreases in potential, contra-directional rays evolve, which act downwards and toward the centre. The final outcome of these countless increases and decreases in potential is the densification occurring along and about the vertical axis and which in material form is reflected in the formation of the trunk, crown and root system of trees.

This completed whole is the organic magnet, or the potential-deficient vacuity arising from the deposition of waste-matter, which once again attracts energetic essences to itself laterally. Once these have been transmuted in the interior of the physical manifestation, they are then propelled upwards and downwards along the vertical axis, leading to renewed fertilisation, the breaking down of the original form and ultimately to a material outgrowth. This outgrowth we are accustomed to call 'physical manifestations of growth', which in essence are none other than more highly evolved conducting vessels, or energy-pathways radiating in all directions.

If we can succeed in creating a suitably large sac of amniotic fluid in the ground (see Fig. 10) through the proper organisation of axially and radially propagating maternal and paternal impulse-imparting substances, then we are possessed of an element that despatches stimulating paternal substances downwards and broadcasts maternal embryonic matter horizontally.⁷ In this fashion the fecund zones horizontally circumscribing the Earth's core then come into being, which in their upward progression, terminate in a high-quality cambium ring, or ring of life, in which the various cereals and fruits take root.⁸

Fig. 10: The in-ground cistern of amniotic fluid.

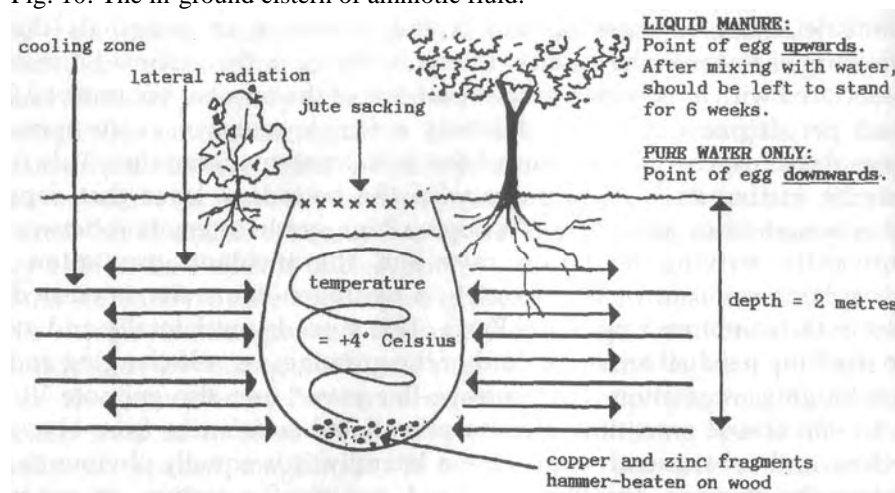

The nature-alienated farmer, however, has to be satisfied with leaving these marvellous processes of energetic transmutation to blind chance and tance does what he considers best, namely to fertilise his fields with filth and rubbish. A more naturalistic farmer will collect the rotting remains and allow them to rot down and ferment in properly laid compost heaps in order to fertilise the already energetically charged topsoil with them. The truly naturalistic farmer, however, will scoop out suitably shaped sacs for amniotic fluids on his land. Through the appropriate apportionment of mineral-metals and metallic-minerals in these well-like cavities, he will induce the lateral propagation of impulses and extend the effect of cosmic inflows to greater depths down the vertical axis.⁹ Through this arrangement a potent geopsyche evolves, which as a further consequence leads to the formation of growth-inducing products. These in turn emit life-affirming energy-rays, which in terms of human beings, for example, we would describe as benevolent thoughts.

All systems of artificial fertilisation, which of their very nature are exposed to the influences of fire and chemicals, have the opposite effect, i.e. as a rule these more or less unipolar products attract the laterally broadcast maternal impulses and divert the transformed products up the vertical axis. In so doing, despite a short-term achievement of increased quantitative growth, the fertile topsoil continues to deteriorate. This is because the topsoil will be discharged centripetally over an area of many square kilometres, the outlying nutritive elements being drawn in towards the centre due to the anode-like effect of artificial fertilisers.

As a result of this method of fertilisation, the geopsyche in the soil vanishes. The various species of vegetation that still manage to survive over a few short years in such soils, also have a deleterious effect on the organism, because they reverse the life-rhythms. This mortifying reversal results in the decay of the body and the constant decline of spiritual and mental powers. The skill of a good farmer lies in his ability to bring the potential-rhythm of the so-called fertiliser into harmony with the potential-rhythm of the Earth, through which the greatest possible effects can be achieved with the minutest impulses. The concocted generation of an individual rhythm in these artificial fertilisers can indeed lead to a short-term increase in quantitative production, but never to qualitatively enhanced foods, since the effect of these fertilisers is to create a sort of cacophony in the ground. Because this generates such an overriding din, it always remains an alien body within the surrounding mother-soil through lack of resonance. This can be compared to musical harmony. High-quality instruments are able to create the tonal sequences and tone-structures that have been written by gifted composers and which make the rest of the world co-vibrate. This less-developed environment (Nature), which once inspired such persons of genius to create their works of art in the first place, is receptive to these high-quality vibrations. As it comes into involuntary

contact with this sublime rhythm, it either becomes the genetic source of highly evolved species or turns into a kind of resonant sounding board for inspired impulses, which were previously isolated from the general rhythm of life and thus had no effect on the broader mass.

Every entity that relapses back into the Earth and is unable to attune itself to the Earth's life-rhythm, is left behind for as long as it takes to decay. It has to travel the road of decomposition until it loses its own Will entirely. Having descended to this state, it is then able to reintegrate with the whole.

Today there are many who in one way or another feel compelled to make amends for the interference and disturbance of the life-rhythm and therefore refuse to eat artificially fertilised produce. This is a sign that an instinctive awareness is active, which warns them to refrain from all speculation with the iron laws of Nature's Will, because nothing in Nature is ever lost and the rectifying of any mistakes may only be possible after thousands of years. That a benevolent way of thinking is followed by a benevolent physical form has already been perceived by a few philosophers. What has remained unknown, however, is that even primitive life-forms (it is immaterial whether these are of mineral, metal, vegetable or animal nature) are also able to radiate benevolent or malevolent energies as a form of embodied thought, or attract surrounding energetic rays towards themselves.

It is quite impossible that man's idea of extracting the last ounce out of Mother Earth and his conception of an activity exclusively directed towards the reckless pillage of those fundamental building blocks required for the further transformation of evolution for other purposes, can bring about the prosperity that nature-alienated people seek to achieve with such mental or physical endeavours. In Nature everything happens indirectly and it is therefore not enough merely to think logically. Whoever desires to evolve personally or to contribute towards a general improvement, will have to get used to thinking and acting bio-logically.

A free people can only grow out of a free Earth. Any people that violates Mother Earth has no right to a homeland, because in soils destroyed by speculation, high-quality races can find no abode. They are physical masses divorced of all connection with the Earth. Masses without roots perish. They have to travel the terrible road of decay until, like unsuitable fertilisers, they lose their stubborn Wills and only when they have reached this condition and started again from the very beginning, will they be allowed to re-enter the mighty course of evolution.

The ur-purpose of life is to cultivate a small piece of this Earth.

Cultivation of the soil means the organisation of its inherent forces in such a way that they are able to propagate maternal, impulse-imparting substances

laterally and to propel the fertilising, paternal impulse-imparting forces down into the depths. Once there, these paternal essences broadcast themselves laterally and stimulate those things that have sunk deep into the Earth to await the awakening call that naturalistic farmers are able to give. These people can only do this, if they have grown up with Mother Earth and are aware that the Earth is no dead lump of matter, but is the ur-mother for whose love we are all indebted, and who are thus able to care for those processes that enable her to remain the mother of all life to come.

Increase In Soil Productivity

From Implosion Magazine, No. 60 — first written in 1955.

In his books, Sven Hedin describes canals that were laid between one and two metres underground in desert areas and whose gradients followed the contours of the ground surface. As a rule their longitudinal shape is wave-form and they represent a kind of artificial geotherm (stratum of equal temperature). At intervals these conduits are interrupted by shafts which are inclined in the direction of flow. These are used for access, for the cleansing of the channel and to enable the water to regenerate itself with the induction of oxygen and carbon dioxide. The orientation of these canals is mainly north-south, although where the topography permitted, these wavy waterways are laid from west to east on principle. In such cases, and right in the middle of the desert, thriving growth of the noblest cereals can be seen on both sides of these underground canals. Wars either decimated those entrusted with the techniques of building these aqueducts or drove them from their homeland, and in this way the art of growing corn in desert regions was lost.

Similar installations were built by Moorish peoples. The only difference being that the Moors dug no canals. They dug funnel-shaped cisterns in the ground instead, which had certain longitudinal and transverse cross-sections. A few remnants of this aquaculture are still to be found in Lower Austria, where migrant monks tended their monastery gardens. As a rule these funnel-shaped cisterns were dug in marshy and sour ground, whereon a lush growth of sweet grasses appeared shortly thereafter.

Apart from a few scanty references in old chronicles and oral transmissions, more detailed information about these curious structures cannot be found and so the valuable knowledge of the essential nature of these water-cultures was lost. It was only observations in field and forest over many years that led to the resurrection of this long-lost knowledge. This will soon change all forestry, agriculture and water resources management, for with the installation of such water conduits and cisterns it is possible to increase the productivity of the soil several times over.

These water conduits, or the chambers with unusual longitudinal and transverse cross-sections, have to be placed at a certain depth. They are none other than electrical devices, a special type of dynamo, and emit an animal radiation into the surrounding soil which is generated by the movement of water. This radiation is broadcast laterally and generates a stratified potential-field in the ground (in contrast to all contemporary surface channels, which discharge the ground). Following the ground contours, this potential-field is essentially magnetic in nature. It is propagated horizontally and exhibits centrifugal- and centripetal-type pulsations. This regular rhythmical movement moves in towards the centre only to move outwards again.

Pulsations are always indicative of organic life. Wherever rhythmical pulsations are in evidence the widest variety of life is manifested. Whether this is described as bacteria, plants, animals or human beings or anything else is of secondary importance. All manifestations of life are the discharged products of interactions between positive and negative potentials. For this reason all biological phenomena are the result of organic interactions and in essence are therefore a process of ur-genesis or the reanimation of a previous life-form. Through the decomposition of its physical envelope it is transformed into an disembodied energy. The death of an entity is the basis for new life.

As a result of this perception all dogmatic concepts become suspect, for life itself is expressed in the growth and formation of the respective body. It is extinguished immediately once growth and transformation have reached their culmination and maturity. After death, however, there is no after-life as an individual. The fall of the fruit is the death or the discontinuance, as it were, of the physical temporally limited form.

Shut off from light in the ground, the germination of the seed represents a reincarnation into a qualitatively and quantitatively higher form, provided preconditions for maintaining the integrity of outer covering exist and provided the forces for this reborn Will-to-live are present in the emerging life-form.

The most recent research has revealed that bacteria are electrically charged. This is actually quite obvious, for in the final analysis every manifestation of life is to be founded on electromagnetic potentials. In exactly the same way that electric charges can be detected in bacteria, brain activity in humans can also be measured, which is none other than the rhythmical interaction between opposite charges.

Strictly speaking, every life-form is nothing more than an evolved form of soil. Biological in nature and viewed with regard to the logic of the laws of life, soil is the ur-source of all life-forms. What is far more important, however, is that it is also the ur-source of all charge-related processes. Good soil has a very high potential. If we can succeed in establishing and apportioning the potential differences in the ground correctly, then the

emergence of animated natural forms is the logical outcome. The movement of the form thus created is dependent on the way it is animated. It is therefore apparent that by generating these vital potentials artificially, it is possible not only to cause the various manifestations of life to quicken, but also to make them grow rapidly.

According to contemporary theory, thriving growth is founded on the presence of certain bacteria. It is assumed that nutrients are only made available to plants after having first been accumulated and processed by bacteria (viz. the nitrogen-fixing bacterial nodules on the roots of leguminous plants). This view is incorrect, however, since bacteria are themselves the products of interactions. For this reason even higher agents must be present, which are the true causes of the animation of an autonomously mobile life-form. A few researchers refer to bacteriophages, to animate life that cannot even be detected with high-resolution microscopes. These are bacteria-eaters and therefore more highly evolved creatures when considered from a naturalistic point of view and it is borne in mind that, qualitatively speaking, the later-born are actually the evolutionally older. Since they come from a higher, later stage of evolution they function more vigorously. This point of view becomes immediately understandable, if one considers that all current life-forms are dependent on those that preceded them. The wholly rotted-down remains of former organisms undergo a metamorphosis which raises them to the relatively highest state of evolvement. Accordingly it can perhaps be understood that these highly qualified and evolved substances play a decisive role in the development of the forces of growth.

The logical and irrefutable determination of the matter, however, would lead to endless

debates were it not possible to furnish the relevant proof.

Those born earlier on this Earth have an obligation to care for the rising generation. If this duty is not fulfilled, the up-and-coming life is unable to support itself, because whatever it needs for survival is missing. Rising shortages of food lead to disorderly behaviour and turmoil, to theft and robbery and ultimately to self-extinction through mutual combat. Food, but more importantly its quality, provides the real basis for the further development of all terrestrial life.

Preoccupation with personal survival leads to materialistic egoism rather than to spiritual idealism. The latter can only be acquired by way of the most highly developed genetic material, through higher-quality formative matter originating from a higher plane of existence, i.e. spirit. Without this spiritualising quality no state of well-being can be maintained on Earth, because spiritual renewal is a prerequisite for the maintenance of the physical. For this reason the principal duty of a farmer, who has a thorough knowledge

of the soil, is primarily to ensure that his produce can take up and process these spiritually renewing substances. As a priority a naturalistic farmer must see to it that the highest state of preparedness (soil friability) can develop in the soil through its proper structural organisation. This is only possible if maternal potentials can be generated in the ground, which await fertilisation by the counter-potentials approaching from their normal (vertical) direction. The more thoroughly spiritually permeated the decomposing matter, the more highly transformed are the elements that can be produced during this cosmic transformation. In their turn, these elements endow the growing entities of the Earth with a higher quality. The thorough knowledge of the true nature of these events is beyond all understanding, for we are concerned here with those processes which either show themselves first in the developed product itself, or only become evident through their secondary effects.

The prime factor in all processes of sexual procreation is the creation of the necessary desire. This feeling is first created not only by the Will to reproduce physically, but also by the Will to be spiritually renewed. For this reason the nurture of the spiritual driving force of life is always more important than the nourishment of the physical form that merely enfolds the soul. The physical form becomes the framework for the spiritual forces of regeneration once it has reached maturity. For this reason there can be no thriving growth without quality food. These foods are the outfall of geophysical forces evolving in the ground, which are stratified and known as 'geotherms' (strata of equal temperature). Every geotherm is a horizontally disposed zone of potential, fed by decaying life-forms. Every phase of potential has its own particular temperature and in its graduated upward progression it approaches the level where the temperature is $+4^{\circ}\text{C}$ ($+39.2^{\circ}\text{F}$). However, with movement in the opposite direction, temperatures in the order of hundreds and thousands of degrees can be reached. The actual germinating zone lies in the coolest stratum ($+4^{\circ}\text{C}$) in which the highest grade transformations take place as the Sun's diffuse rays pass through this zone of potential.

These contrasting and opposing, but ultimately complementary forms of radiation propagate, both horizontally and vertically. Where they intersect each other at right angles energy is released, which streams upwards about its vertical axis. The precipitate of this interpenetration of energies is a geospheric amniotic fluid, which combines with the substances of the Earth and broadcasts itself horizontally. The rising and falling of the groundwater is also determined by its inner potential and the stronger this is, the higher it rises. If these inner potentials are discharged by unfiltered, directly incident rays of the Sun, then groundwater sinks, its uplifting energies removed. Scythes that have been properly tempered through hammering also lose their potential, if exposed to direct sunlight, and are no longer able to cut. The same thing happens to all gardening tools if they are warmed and discharged by the Sun's rays.

The groundwater is the actual accumulator and transformer of these energies and can be regulated like any other accumulator and charged up as desired. The only way to maintain this ground-accumulator in a constant state of hyperpotential is to install galvanic, egg-shaped, in-ground cisterns, which have both cathodic and anodic functions. (See Figs. 10 and 12) Some of their radiant products are emitted radially and in this way create an artificial, +4°C (+39.2°F) germinating zone. These in-ground cisterns can be compared to a selenium cell.¹⁰ They generate a lateral geospheric potential, the essential nature of which is very similar to ground electricity or horizontally disposed Earth magnetism, the latter being maintained in a particular state of potential by the axially incident longitudinal emissions from the cosmos.

This in-ground element is thus a kind of geocathode (positive pole) which, like a brain, ceaselessly emits lateral rays. These intersect the cathodic rays of the Sun. Thought-like germinal essences come into being as a result. As these buoyant animating rays leave the Earth, they repeatedly cross with the direct rays of the Sun. Whatever is of high quality, streams upwards after this repeated process of insemination. Whatever is of too low a grade for this higher ascent, is left behind and slowly solidifies or crystallises out as visible growth.

In its anodic function, such an in-ground cistern broadcasts its rays vertically over seeds and plants as they accelerate on their upward path towards the incident cosmic rays. As a result of the ensuing intermixture, physical matter is created, i.e. what we call 'growth'. The skill of a naturalistic farmer lies in his ability to create an extremely powerful Will-to-surrender in a particular zone within the Earth, in other words to imbue it with voluptuousness. As we have seen with the inhabitants of the desert, this condition is very easy to achieve, if the above energy-generators are installed in the ground. Furthermore, the in-ground cistern should be alloyed with certain metals and minerals (such as copper or zinc) and then filled with rainwater. A current then flows constantly, which spreads out laterally and fills the germinating zone with maternal, germinal substances. The in-ground cistern can be charged as desired and the amount of germinating power that can be supplied is almost unlimited. The radius of action of the potential is equally controllable and therefore one or two cisterns are enough to permeate the soil over several square kilometres with voluptuous substances imbued with the Will-to-germinate.

The present use of artificial fertiliser discharges the soil and attracts the germinal substances and soil-energies in the ground which, discharged through chemical influences, become unipolar in the process. A short-term increase in growth results, but in one or two decades the ground becomes so depleted and de-energised that more and more stimulants in the form of additional artificial fertiliser are required.

Every secondary school student knows that, when exposed to sunlight, galvanised copper plates produce an electric current capable of driving small

motors. The weak current produced in properly constructed in-ground cisterns can be conducted into the cambium ring of a plant. Phenomena are then produced that have much in common with the mango-tree marvel,¹¹ because here too an almost visible growth takes place. These emanations can penetrate right through a dark cloth and into the plant, and are akin to those emitted by the eyes of strong-willed individuals.

The healing of the sick with magnets can be likened to the remedying of deficiencies, which in essence is what every growing plant does. Every plant is a natural accumulator and transformer and has the capacity to absorb and transform appropriate emanations of Will. These causal emanations of Will are exalted concentrates of the rotted matter of former life. In consort with the incident ethericities from the cosmos, they provide water with its soul. It is these relatively highest entities that are responsible for spiritual renewal.

Growth is the direct result of the transmission of Will, which takes place through the rhythmical reversal in the polarity of the mediator of life, water. For this reason it is possible to make any soil fertile, because the soil as such only acts as a resistance to the movement of nascent Will. The creation of naturalesque pathways of Will that lead to the emergence of life is the task of those who are able to reawaken to life the sterile and half-dead soil and thereby to recreate a paradise on Earth. Today the forces of destruction are well known, but since it is also now known how to make infertile soils and deserts productive again with the aid of these naturalesque in-ground cisterns, every possibility is now available to all people.

Humanity has been entrusted with dominion over Creation and only needs to apply its Will, since whatever becomes manifest is merely the biological expression of the conceived idea. The precipitate of every thought produces seeds which serve to create the subsequent physical form. Is it therefore so illogical to recognise the Will of Nature in the rapid increase in the number of human beings (the population explosion)? Surely several hundred million more people are needed, who with their energy and strength can help restore this ravished lump of excrement, the Earth, to its former glory! Indeed, we have seen the indomitable Will to survive of the German people after the War, who man for man and with the most primitive hand-tools, rebuilt houses, factories and even whole cities out of the rubble, that are now more beautiful than before.

The spiritual renewal of nascent life takes place through the possibility of transformation,

the reversal of polarity or the transmutation of matter.

In Nature there is no dogma. It is only the intellectual obfuscation of humanity that has created it. The only valid law is that of the constant change and transformation of the original form. Every transformation signifies the

progressive amelioration or deterioration of the potential of the substance in question. Spirit or energy can only be liberated through the complete collapse of the spacial condition, or the disintegration of an entity through which all sense of individuality ceases to exist.

What falls back to Earth from the cosmos and reactivates the spiritual renewal of the succeeding physical form are objectively created substances, which serve all those things that are inherent in the Will itself and which the Will has a mind to realise.

A naturalistic individual who understands Creation can influence this Will for better or for worse. For this reason a human being is also the embodiment of the Will that he or she can transmit with his or her own hands. Therefore the hand that only desires, yet offers nothing in return, will never understand the 'desire'. It must therefore painfully atone for all that it has perpetrated against the omnipotent Will of evolution.

All Nature desires is growth! Humanity, take care lest you disturb this Will through speculation and never forget the power that lies in your hands!

Life Force and Natural Fertiliser

From a letter to Dr Dagmar Sarkar in India. — Written in the early 1950s.

No plant is actually nourished by dissolved matter, but rather with 'ascended' nutritive entities of geospheric provenance in a fourth-dimensional state. These diffuse ethericities can only enter the sap-stream via the root-protoplasms, where they are fertilised by diffuse oxygenic ethericities. The higher out-birth of this emulsion (ur-procreation) is an ethericity that belongs to the fifth dimension. These concentrations of dynagen emit negative, hypercharged emanations in all directions and bind the positively charged ethericities entering through the skin or bark. Some of this emulsion solidifies and whatever is subsequently manifested is what we call 'growth'. (See Fig. 11)

In terms of homoeopathic principles and attempts to produce superdilutions in order to still the 'specific' hunger of the plants, the more dilute the fertilising agent, the more it approximates the character of the above ethericities, thus facilitating further interactions that in turn result in increased growth.

To return to the nub of the matter, stable-manure, excreta and other waste-matter in the freshest possible state must be broken down into the finest particles. These waste-products are then mixed with liquid manure and placed in an egg-shaped fermentation chamber in the ground (see Fig. 12), which must be well insulated externally against light and heat. For the best results, oxygenated rainwater or well-insolated riverwater should be introduced to

which minerals of different potential are then added. At nightfall a small vortex-inducer is switched on, which rotates in the lower third of the manure chamber and generates a vortex about the vertical axis. This atomises the mechanically dissociated waste, thus producing the relatively highest rarefaction. The vortex-inducer itself is alloyed with bipolar elements. In this process the 'connecting link' (Goethe) is created between opposites. From a biological point of view, secondary emanations are emitted. These are coactive, catalytic opposites and internally cohere (emulsify) the introduced elements of Earth and Heaven (viz. the Tabula Smaragdina). This results in the accumulation of a geospheric charge, whose emitted radiation cannot escape owing to the external insulation.

Fig. 11: The subtler processes of growth.

This is actually a high negative potency that permeates and combines with the carrier-substance, water, which very quickly becomes crystal-clear and sweet-smelling (odourless). No trace of any faecal or waste-matter is left. As evening falls, small but nonetheless highly potent quantities of this exalted liquid manure are sprayed over the ground. Being of a 'nymphomaniac' nature, it

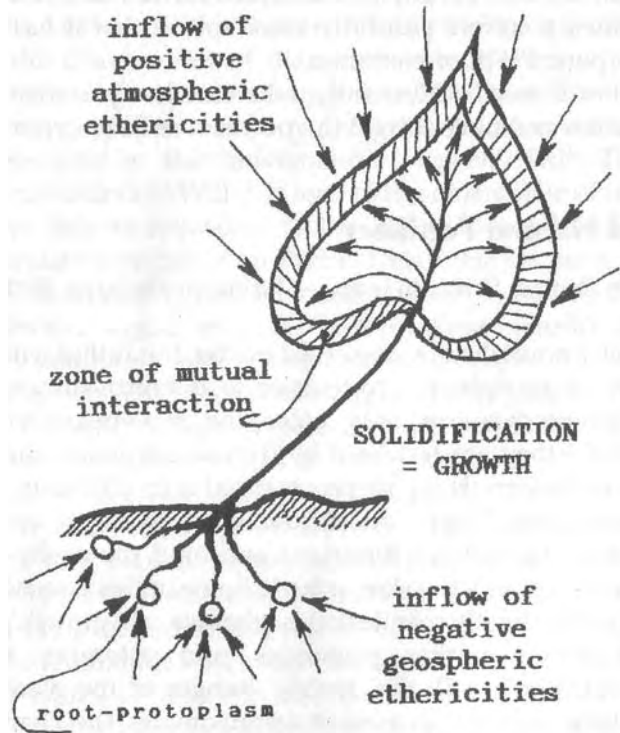

hungrily attracts the positive ethericities of the atmosphere. Indeed their fertilising capacity is nine times greater than all other fertilisers. When the fertilising Sun appears the following day, the higher out-birth of this ur-procreation takes place. Whatever partially solidifies or crystallises out, owing to the effects of heat and light, is super-quality growth, because the field has been manured with the high ethericities evolving during this process of cold fermentation.

Fig. 12: The egg-shaped fermentation chamber.

This is similar to the way in which sweet and turbid grape juice is transformed into clear dry wine in cool maturation cellars. This process normally takes about a year, whereas with this mechanically induced acceleration of motion (metabolism), only two to three nights are required. This exalted fertilising preparation is so promotive of growth, that a superabundance of the highest quality food results within a few years. If this

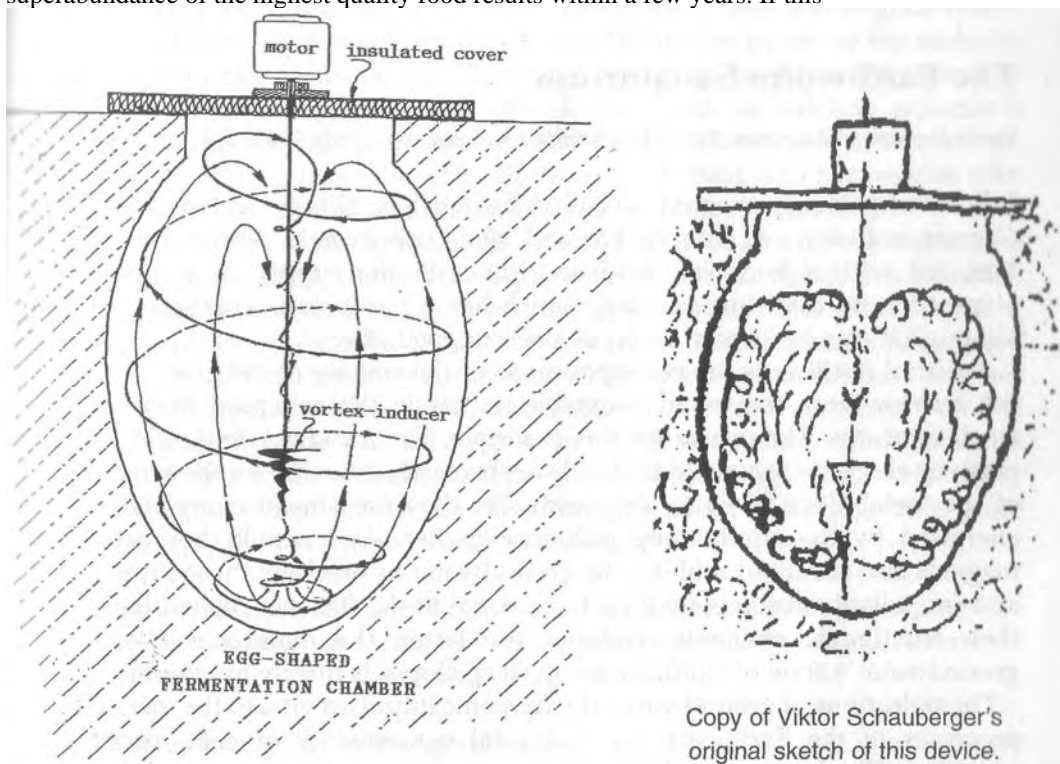

method is carried out systematically and the increasingly fertile Mother Earth is ploughed and harrowed with correctly alloyed tractive (attracting) implements that cool and refresh the soil, which in turn has been sprayed with regenerated aluminium-bearing and therefore indifferent (neutral) loam), then the interstitial, di-electromagnetic skin, the diffusing device or virgin hymen, comes into being. This permits the entry and exit of only the most exalted. In this way waterless deserts can be restored to cultivation. India, for example, would revert to a true paradise were these methods officially sanctioned and implemented — as Das Gupta proposed.

The Earthworm Sanatorium

From Implosion Magazine, No. 21 — written in Leonstein, July 1945.

Julius von Liebig invented so-called artificial fertiliser¹² and as a result German industry was severely harmed, albeit unwittingly. We are concerned here not with a fructigenic fertiliser, but with the supply of a stimulant obtained from blast-furnace slag, which has a particularly injurious effect, although it was believed it could be used to good effect.

Artificial fertiliser is the principal cause of the sinking of the groundwater, not burrow-litter, the rotted vegetable matter in the collapsed burrows of small creatures. The reason for this is simple. The incombustible residues of catalytic elements contained in slag¹³ are absolutely essential for the activation of the metabolism of every organism. Yet they are almost completely de-energised by the annihilating influence of fire. As a result they act like magnets and set about robbing the groundwater of precisely those formative and propellant substances with a force equal to the fire that robbed them of their fructigenic elements. Without the latter, the maintenance of the groundwater's state of equilibrium on steep slopes is utterly impossible.

The pulsations of groundwater, the dynamic impulses vital to the metabolic processes of the Earth, are the biological consequence of cold oxidising processes. These generate the counterforce to physical weight, the hitherto unknown 'levitational force', which in turn gives rise to interactions between gravitating and levitating basic elements and thus to an increase in quantity as well as quality. With further interactions those oscillating movements arise that people normally refer to as pulsations, but have no knowledge of the origins or the significance of these actuators of motion.

These catalytic stimulants, wrongly called fertilisers, have the same effect as injections of cocaine. There is a brief blossoming followed by collapse. The end can only be staved off by stronger and stronger injections. This is the effect of the soil-destroying artificial fertilisers produced from blast-furnace slag.

In order to understand this assertion, the function of naturalesque compost heaps and the way to construct them will be briefly described. In such heap no putrefaction (warm processes of oxidation) takes place. On the contrary, a completely natural rotting down of the waste-matter occurs during the period in which the number of suppliers of fatty matter (worms) increases. The true replenishment of fructigens then proceeds in the best possible way. The steady and sustainable biological consequence of this best and cheapest method of fertilising is a roughly thirty per cent increase in yield.

Nature is, and will always be, the best and cheapest teacher. She sees to it that every living thing has its so-called enemy, which eats it with great relish. Thus the goose has its fox, the fly its spider, the mouse its cat, or the snake its adoring buzzard. Ultimately, however, everything, be it human, beast or plant, is consumed by our dear old Mother Earth in order to rejuvenate herself. In this way she is able to provide for the self-renewal of that which, as a 'later-comer', creeps and flies on this manure heap and has no idea why it actually lives, has its favourite dishes or is a favourite dish itself.

This whole ball of dung, the Earth and all that lives and moves and has its being on it, is nothing more than a pile of evolution-fostering raw material. However, this raw material does not devolve into dust and ashes, nor is it senselessly strewn over the fields. It is a high-grade transmutational energy, provided that it evolves through cold-oxidising processes in the dark recesses of the Earth and by various indirect means is once more resurrected from the dead. For all that, it is still just a repository for waste-matter, which solidifies under the influences of incident light and concentrating heat. It eventually becomes that, which in the full flowering splendour of spring, once more brings us joy in the form of blossoming dung.¹⁴

What actually 'ascends' from the dead, what is truly valuable, we are quite unable to apprehend with our normal eyes. We can only comprehend it through an inner, intuitive perception.

All symptoms of disease, especially those of the stomach and intestines, are to a greater or lesser extent manifestations of cancerous decay. They are the biological consequences of destructive, invasive human activity that arrests metaphysical processes of further evolution, which would otherwise only ensue immediately after the death of an organic substance. For this reason most people can neither understand nor grasp that Nature has no other way of ridding herself of the intruders and mischief-makers in this wonderful and eternal process of self-renewal. Such people therefore have no inkling why they are condemned to a premature and painful death, which has actually been brought about by the very thing they have themselves produced by the sweat of their brows and which they still have the audacity to call progress.

After the last frightful war (WW2), the repercussions of which we shall experience for many years to come, it will be possible hopefully to put an end to this terrible self-deception in a newly rebuilt Austria. But under no circumstances should Austria be allowed to become a 'Cloistria'. Here the expression 'Cloistria' has been chosen to indicate the grave errors that have also been made by the Church, which inspires and nurtures the belief that after death the 'poor souls' go to heaven, hell or purgatory. With its present credo, the Church has failed to interpret the real sense and purpose of all physical corporeality. In exactly the same way, those in agriculture cannot differentiate between a fertiliser and a stimulant, and in the final analysis, consciously or unconsciously deceive their fellow human beings about the true zest that all living things have for life.

Whatever passes away into higher realms, travels further along the other-worldly paths of evolution. It does not actually appear temporarily in the heavens arching over our heads, but it is present all the same. Whatever enters our bodies in the form of expelled ballast is waste-matter, whose value has to be raised through reconstitution. In terms of levitation, it is the divesting of impedimenta, of useless material, in order to enable the re-attainment of a higher level of vibration. Once levitation finally reaches its goal, the zenith of its relatively highest state of potential, it then has to interact once more with what has reached the nadir at the opposite end of this process of renewal. Then the whole business of resurrection starts all over again. In turn it provides for a renewed increase in the various raw materials and for the build-up of qualigen arising from them.

The Eternally Female or the All-Uplifting, as Goethe called the upward emanations of the Earth, is the opposite to what we call the 'gravitating'. Without the action of levitational force at each of the many different levels there could be no so-called gravity active there either. II Primo Motore is moved by II Primo Movere, through which II Primo Motore rises from the dead in an increased and qualitatively-improved transitory state. Thus it can be seen that everything living, moves, and all that moves, is renewed life.

Biomachines can now be built which copy this perpetual motion and mechanically produce the embryonic qualigen here described. However, it is not at all easy and may yet take many years to overcome the last resistances of those who, with their unnatural practices, are to blame for today's appalling state of affairs. For the time being we shall have to content ourselves with the 'earthworm sanatorium', which will now be described in more detail.

Building Compost Heaps

Up to now it was both custom and tradition to build manure and compost heaps in which all kinds of waste-matter decompose, or more commonly, rot

down. These composted products are then laboriously carried out to the fields, spread and then carefully ploughed under in the belief that the soils then received the best possible treatment and only God could do better.

Certainly everything grows better, but nobody ever asked themselves what it is that is actually evolving in these manure and compost heaps. Warm processes of oxidation take place, which are assumed to increase fertilising effects. While they do maintain an almost unchanging level of productivity over an extended period, there is no increase in yield and above all no rise in quality, because in the soils where such compost is applied, that special something is missing — what Goethe called the 'connecting link'.

Increased productivity of an entirely different order and, above all, an improvement in quality will be achieved, if the fresh waste-matter rotting down in naturalesquely built compost heaps undergoes the necessary reconstitution through cold processes of fermentation. In this instance no products of putrefaction and no pathogenic bacteria are formed, whereas non-pathogens are, which could equally be called 'health stimulators'. The predators of these health stimulators are the pathogens propagated by warm oxidation, which are just as fond of good, healthy fare as we are. They live at the expense of the soil's productivity, become increasingly voracious, multiply and subsequently emerge in a higher organism as the carrier of disease. There they quietly tuck into their favourite meal and inaugurate the despatch of the host organism. The perplexed doctor then prescribes further rest in bed and goes to a lot of trouble to poison whatever appears harmful to him. Is he then any better than a farmer, who sprays his land to eradicate so-called 'vermin'?

In his very own manure heaps the farmer breeds the enemy of his harvest by the very sweat of his brow. How long would be his face were he one day to find out that exactly the 'opposite' to what was hammered into his head in school and in church, was the actual cause of all sickness and ultimately the reason for humanity's expulsion from paradise.

Just next to a field, under a tap- or heart-rooted tree or better still, a fruit tree with as broad a crown-canopy as possible, a hemispherical hole should be scooped out around the trunk in the area shaded by the crown. (See Fig. 13) Great care must be taken to ensure that the roots are not damaged. The trunk itself should then be shielded from direct contact with the composting Earth by encasing it with paper, bark or cardboard. This eventually functions as a duct for diffuse air after contraction and settlement has taken place, due to decomposition arising from the unavoidable entry of light. Then a 40-50 cm (16-20 in.) thick layer of newly-mown grass or hay should be finely chopped up together with the widest variety of refuse, such as potato peel, apple skins, stalks and stems, and put in place in the freshest and driest possible-condition.¹⁵ Additional ingredients are also added by way of leaves and straw of high quality produce that has already been grown and will be grown again

later. In this regard crop rotation is necessary, because it takes quite a while for the soil to recover and rebuild itself.

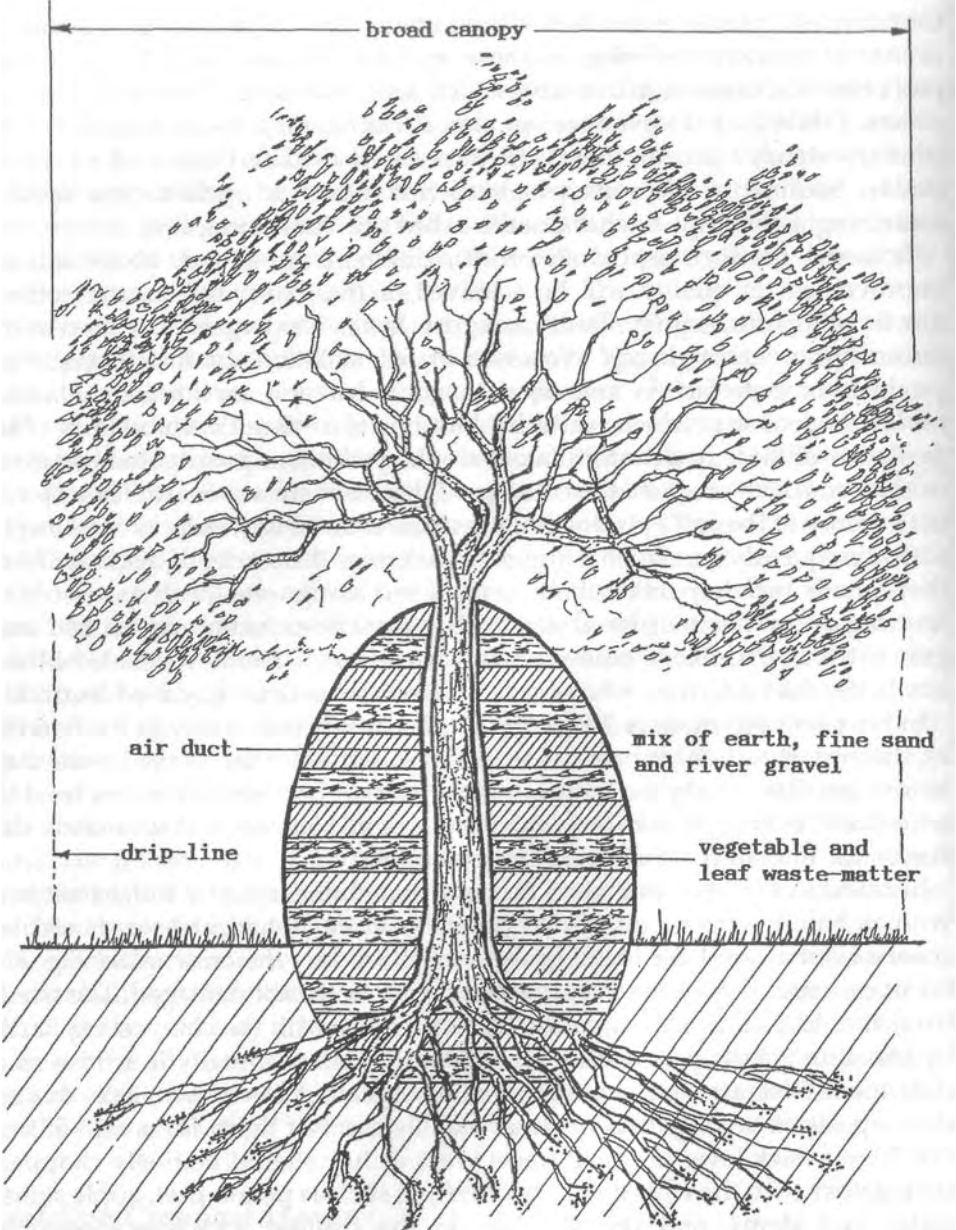

Fig. 13: The egg-shaped compost heap built around a tree.

This assorted and well-mixed layer of grass should now be furnished with an oligo-dynamic (decay-promoting) and catalytic (growth-stimulating) coating of powdered copper and zinc. This is best obtained by filing old pieces of copper and zinc; even minimal quantities are enough to provide the soil with energising trace elements. Trace elements are those solidified products which, as positive and negative minerals and metals, are the physical evidence (traces) of what has passed to higher realms. A certain amount of salt and very small quantities of raw sugar, which as the most refined residues of carbon, work wonders later on. The whole is then firmly trodden into the hole, covered with a layer of earth and protected against all entry of rainwater.

As a case in point, the tombs of the higher dignitaries of the Church often lie behind western walls and, in most cases, under a protective roof. Their mortal remains were thereby assured of natural decomposition and safeguarded against the putrefaction that can also be triggered in the ground through the infiltration of heavy rain (excessive oxygenation). Great artists and geniuses, people closely connected to Nature, were particularly keen on having their graves covered by a slab of natural stone, as demonstrated by the Nuremberg grave mounds.

The initial stages completed, the compost heap is then left undisturbed until fresh waste-material is available. This is again mixed with fresh grass and other leftovers of vegetable matter and then dried. These are then spread and covered with a further 20 cm (8 in.) thick layer of earth, which has been mixed either with fine-grained crushed gravel (as far as possible brought in from elsewhere) or best of all, sandy gravel taken from the bed of a nearby stream. Layer upon layer is built up in this fashion, even if in the meantime the strata have settled slightly. The higher the heap becomes, the smaller its radius, so that in the end an egg-shaped compost body (a protoplasm) is created, which is the right form for increasing potency. At this point the airhole at the top is blocked up with fallen leaves and the whole exterior flattened with the back of a shovel, so that the misting rain drifting down from the canopy only moistens the outer surface. The surface tension, important at this stage, can now begin to build up.

In the autumn, after all the tree's leaves have fallen, the whole egg-shaped structure must be covered with them, because at this stage the compost heap begins to warm up. It is a sign that the hibernal metabolism has set in. Whereas during the summer this heap was a cool sanatorium for the earth-dwelling creatures that live in small burrows (earthworms) and provided an environment in which they could thrive and multiply particularly vigorously, with the onset of the above metabolic process the earthworms begin to die off en masse. But before they die, these creatures distribute themselves evenly throughout the whole heap in their hungry search for oxygen, so that a good mixture results. In a well-built, three metre wide and five metre high (10 ft x 16 ft) compost heap

the weight of earthworm corpses can amount to half a tonne or more. These now begin to decompose under the influence of the new metabolism.

In late winter, when it gradually begins to get warm and when poorly installed water pipes usually burst, the ground suddenly gets cold. This is the moment when the real build-up of fertilising potency begins and the liquefied corpses of the earthworms are partially transformed into ethereal oils from which soil-energies evolve as the process continues. These energies then become bound by the increasingly fat-infused humus.

When the thermometer indicates a temperature of +4°C (+39.2°F), then the compost heap blooms. The blossoming period lasts for about two weeks. The build-up is then complete and the process of composting is finished. It is entirely bacteria-free, because everything has been transformed and built up into high-quality bacteriophagous matter in a latent' transitional state. The whole heap of nutrient humus is impregnated with high-grade germinal matter. These intermediate products could be likened to vitamins A, B or C, since they represent the highest energy-concentrates of the remains of former fructigenic, seminal and carrier substances, or the specifically highest density, high-potency, spacial concentrations — the embryos of noble matter. They could also be called the organic Holy Trinity, which now await their triplicity, their threefold new separation.

It is now time to spread this higher-quality compost with a rust-free, copper or bronze shovel over the field to be ploughed. A wooden shovel can also be used if fitted with a copper lip. A layer about 1/2 cm (1/4 in.) thick will be enough, although it can be even thinner because of the tremendous intrinsic worth of this downy, sweet-smelling, fatty loam. All must be quickly ploughed under in order to protect it from the discharging effect of direct sunlight.

The plough too must be rust-free so as to avoid the formation of a film of rust, the puerperal fever of the now-pregnant soil. The same applies to the teeth of the harrow.¹⁶ It is then time to sow. Anyone who wants to take a little more trouble should sprinkle the soil with naturalesquely produced noble water and then quietly sit back and wait for the fruits of their natural labour. No vermin will show their faces and hardly a weed will be seen. What is growing so exuberantly is the noblest produce and in autumn the tree that protected the compost heap will bend down under the burden of worm-free fruit.

The thirty per cent increased yield mentioned earlier and the considerably ennobled quality of the harvest can be sustained and can continue to be sustained if, instead of being burnt, the vegetable litter, stalks and leaves are immediately placed in a newly laid, noble compost heap. Apart from the higher yield, the field need not lie fallow and the whole land area can be ploughed continuously.

Another important factor is the so-called 'extreme unction'. This refers to the coating of hard seed-kernels (seeds of cereals) with fruit oil shortly before

sowing. If this process is carried out in dry granary on cool, overcast days, it provides the seed with an extremely fine diffusive film, which permits only the influx and efflux of the very finest substances after the seed has been interred.

What happens in the ground should now be described briefly. In a well-mixed forest, the profound secret of growth lies in the multicoloured assortment of upper and lower storeys and undergrowth. This is also the case in a field, where the greatest attention should be paid to the various differences in crown and root systems. Every crown system has its characteristic stem and leaf. The various root-systems are equally diverse. Every root-tip or root-meristem has its own little sac of fructigenic matter, its protoplasm, in which the genital organs of the positively charged atmosphere reside. Every breath of air, the result of differences in potential, causes this transducer of solar energy to stir slightly. The whole root-zone is stimulated in the process, because shallow-rooted trees do not extend their roots into the same areas as tap- or heart-rooted trees. The high negative potential receives an impulse, causing its pulsation, which then leads to an interaction between dynagens.

The lateral discharge of energy from the tips of the roots leads to the immediate, higher out-birth of groundwater, whereas inside the plant the emission from the fertilised sac of protoplasm on the root-tip is more or less vertical. The more this emission comes under the influence of light and heat, the more trumpet-like or bell-shaped its development. Everything of inferior quality solidifies under this discharging double-influence and is left behind as the material destined to vegetate (lignify). Only the most refined substances continue to rise, and upon entering into the open light they are gradually separated and solidified in the formation of the uppermost and outermost shoots.

The lower-grade, more easily dispersed precipitates of dynagen, are spread out just above the base of the trunk, in which the best cast-off material is deposited. Hence it is here that the most solid wood is also to be found. This is a wise arrangement of Nature's, because when the tree is felled, it is the stump that is left behind. As a result the raw materials needed for the replenishment of fructigens remain in the ground, become covered with leaves and moss and, insulated from heat and light, begin to rot.

It is in this sense that the following processes of secretion and precipitation are to be understood. With naturalesque methods of fertilising only minimal oxidising processes take place and then only inferior ones. For this reason there is also little outfall of what is unusable for higher evolvment. Choice and wholesome food produces little excrement. The biological result of this is a constant increase in productivity and a continuous rise in quality, resulting in a commensurate increase in the quantity and quality of the food supply and other necessities of life.

In the usual methods of fertilising with stable-manure there is a greater incidence of warm oxidising processes. Due to the lack of metabolic processes

of a higher order, the declining or unchanging quality of the product gradually becomes noticeable. Any rise in quality is no longer possible. In such cases the farmer has to be content with the production of fairly uniform annual yields and any shortfall has to be made good by increasing the area under cultivation. The crisis in the soil and the associated scarcity of food now begins to declare itself.

If artificial fertiliser is spread, then the slag-residues, utterly devoid of potential due to the annihilating influences of fire, rob the groundwater of its levitative and stimulating substances. The biological consequences of this violent system of replenishment is a phoney productivity, which delivers a great deal of material but leaves little of any nutritive value in the soil. The deterioration of mountain and soil climates and the sinking of discharged groundwater are again the biological sequel. Hardship and privation increase, and for lack of high-quality food, morality and health also degenerate. What we are experiencing today, therefore, is the result of an activity that is totally ignorant of the naturalesque processes of transformation.

Abundance creates harmony, whereas necessity not only breaks iron, but also the ordering bonds of human society. It was Justus von Liebig who inaugurated the collapse. What we now see around us is the result of his fatal blunder. The effects of this error can be alleviated temporarily by building noble compost heaps. It can be rectified entirely with the use of the biomachines previously mentioned.

Inflexible laws are just as impossible as dogmas in Nature's eternal process of transformation. Here simple orders of change are not only involved, but also changing changes and varying variations. Only thus can different potentials, different temperatures and different kinds of motion evolve.

When a breath of air is induced by potential differences and eventually develops into a wind, a storm or a hurricane through active and reactive fluctuations and counter-fluctuations, then logically the stimulating reactions in the roots also intensify. The further the trunks and the crowns of large trees are bent over by a wildly raging storm, the stronger are the root reactions. These in turn despatch correspondingly stronger reaction-products vertically, which straighten and stretch the tree up just before it is uprooted. For this reason action and reaction are also bipolar opposites. The stronger the action of the former, the stronger the after-effects inevitably become.

If the process is inverted, then reactive forces can be strengthened by active forces and ultimately the very smallest of impulses is all that is needed to trigger off elemental, reactive effects. In this connection the requisite naturalesque conformation must be employed, namely the Repulsators and Repulsines built with the proper materials and copied faithfully from Nature. Then even the impulse produced by a kick might be enough to actuate the mutual amplification of resonant oscillation between action and reaction. This

is akin to the thirty per cent increase in quantity and quality mentioned before, which in turn intensifies subsequent growth activity.

It is therefore apparent that by applying this knowledge and the associated processes and equipment, the present misery and starvation can be replaced by surpluses of food. In other words, dependency can be replaced by an almost completely independent existence. The levitative and propulsive forces (ur-elemental kinetic energies) which evolve simultaneously, become so dynamic that a naturalistic individual actually has need of a highly developed mind in order to keep the 'braking' processes on a tight rein. These processes would quickly be beyond all control should such an individual not bend these elemental forces of Nature to his or her service and make them work hard.

At first sight this would appear to be a paradox. Whoever knows how to brake can produce this ur-elemental motion. Whoever moves senselessly in circles reaps the natural brake. Whoever merely stimulates (artificial fertiliser) gains a brief stay of execution, for the next strong gust of wind will be his undoing, because the reactive, uprighting forces are missing. Everything collapses, as will happen to all contemporary ordinances and dogmas once a hoodwinked humanity understands how to organise the right processes in a naturalesquely built compost heap. In this pile of rotting matter, 'something' raises itself up which then has to fall back again, for only thus is it able to stand erect once more as 'excellence'.

Nothing falls entirely! Nothing dies away completely! Nothing can totally deprive another

of its rights! On the contrary, the deeper the fall, the higher the reactive upswing!

White Juvenile Earth¹⁷

Mountain springwater that has never come in contact with fire-treated metal, should be poured into a natural limestone or marble bowl and at midday the Sun's rays (strongest on the 21 June) should be concentrated on it with a magnifying glass. After 10-12 minutes a white juvenile earth forms on the water around the rim, which floats. Fertilising plants with this earth gives rise to faster growth.

Concerning the Treatment of the Soil

From special edition of Mensch und Technik, Vol. 2,1993, Section 5.0. Letters to A. Hohl, W. Zimmermann and others from 1936-7.

Contemporary science has no idea what effect industrially processed iron has on the soil, and that without the soil's organic radiation and counter-radiation

there can be no synthesis and no quantitative and qualitative growth. Calcium and sodium are producers of opposite forms of radiation and what we call potassium is juvenile earth (juvenile = youthful).

If the soil is fertilised with such earth and the corn subsequently grown on it is given to chickens, it is impossible to make the blood of these chickens coagulate. However, if the substance (the life-vitamin) incorporated into the body through the agency of potassium is missing, then the blood actually congeals in the living organism; it begins to putrefy, and this is called cancer.

Every acid is a liquid metal, and without metal there is no energy or life-electricity of any kind. Metals absorb minus-rays and vice versa. If the soil exposed to sunlight scatters and loses its liquid metals, then the inflammation-inhibiting calcareous metals remain in the ground, petrifying, karstifying and desertifying it. Parasitic life is then kindled at the surface, which consumes the developing macro-organism instead of serving it as micro-organisms. In Nature the law of reciprocities prevails, out of which each individual entity evolves.

Bivalent metals begin to emit rays, i.e. they continuously generate a flowing current even under the influence of daylight. They consume the substances of the air, transform gases into energies, which in turn produce flowing heat and cold.

Natural Farm Husbandry

From Implosion Magazine, No. 10 — first written in 1945.

There are no accidents, only incidents, which as a rule we perceive as unexpected accidents, because at a given moment we had not been thinking of this or that possibility. As a result we are more or less surprised by it. In any event, having given considerable thought to a person, a matter or whatever it is that interests us, we are either pleased or annoyed when this mental activity unexpectedly resurfaces for one reason or another. Without stimulus there is no motion.

It was as a young forestry warden that I visited a farmhouse I regularly passed by in the course of my duties. A farmer lived here, who was derided as a fool by everyone in the district. I thoroughly enjoyed visiting this wise old man in order to discuss agricultural affairs with him. I did not do it because I had an overriding interest in agriculture, but because I wanted to learn how this 'crazy' farmer, as he was called, was able to produce his outstanding yields. In every respect his soil was in better condition than that of his immediate neighbours. This farmer ploughed in a different way. He harrowed differently and sowed at different times. In short, everything he did

was different. He never went to church, which was greatly taken amiss. Nor was he ever seen at the inn, where the other farmers discussed their everyday affairs. Nobody ever sought his advice and he suffered no argument from his employees. Whoever failed to obey his orders immediately had to pack up their belongings and leave. In spite of this, few people ever left his employ. It was only with his adult son, who had gone to agricultural college and who always wanted and knew how to do everything better, that there were endless violent disagreements.

One day I was passing by the farm as dusk was falling. Following a sudden hunch, I retraced my steps. I wanted to spend a little more time with the old farmer. I encountered the somewhat unsympathetic son in the farmyard and asked the whereabouts of his father. 'He's around the back,' he responded with a brusque gesture, 'Just yell and he'll certainly answer.' I followed his directions, crossed the barn floor and finally discovered the old fellow. He was singing a curious song and standing in front of a wooden barrel with a capacity of three to four buckets. As he sang, he stirred the contents with a large wooden spoon. It wasn't actually a recognisable melody, but a scale, sung mostly with vowels, which he raised to a falsetto, only to descend once more to a bass voice. As he did this, he stooped over the barrel and sang loudly into it. If he sang in rising tones, then he stirred the spoon to the left. When he changed to descending tones, he also changed the direction of stirring. He didn't hear me approach and after watching him for a while, I wanted to see what he was actually stirring. Still unnoticed, I drew closer and looked into the barrel, which only contained clear water. Finally the old man saw me, nodded briefly in acknowledgement of my greeting and continued to stir away. I looked alternately at the farmer and then at the contents. From time to time he threw in small lumps of clay that he had crumbled in his hands, and stirred the contents first right and then left, during which he sang rather loudly and not at all beautifully into the water. 'Thank God,' I thought to myself, 'nothing lasts foreverY

Finally the old man removed the large wooden spoon, which was actually more like a small oar, and said 'There! Now it can ferment!' I nodded as though I thought it all quite normal. I nodded again when he asked whether I was thirsty and would like a tankard of fresh cider. Having carefully wiped his hands on his apron, we then returned to the house. I went into the living room, while he fetched some cool cider from the cellar. 'Hope you enjoy itV and with these words he slid the cider tankard invitingly towards me. 'Well, are you going to think me mad too, just like the others?' he asked. "They can think what they like,' I replied.

During the course of our conversation I gradually learnt what it was all about. When clay (well-crushed aluminium-bearing clay) is well-mixed into cooling water along with exhaled carbon dioxide, which the water absorbs,

then a neutral potential is created. After harrowing (the harrow itself having no iron teeth, but wooden ones), this neutrally charged water is sprinkled over the sown fields with so-called palm fronds (faggots). This process is similar to the blessing of the fields. The water evaporates and extremely small crystalline particles are left in the ground in the form of negatively charged carrier-structures. These attract radiation from all sides and conversely emit radiation in all directions.

Between the atmosphere and the geosphere an extremely finely meshed, skin-like, shimmering, violet net is formed, which only permits the inward and outward flow of the highest grade radiation. The naturalistic farmer calls this net the 'hymen'. This self-evolving coating enables such a high-grade diffusion (inhaling and exhaling) to occur, that soils thus treated remain cool and moist even in the driest part of the year. As a result, the temperature of the germination zone, which is bounded by the atmosphere and the geosphere, always lies close to the anomaly point of $+4^{\circ}\text{C}$ ($+39.2^{\circ}\text{F}$). At this temperature the fructigen retains its highest potency, whereas the seminal substances are in their relatively most passive state. The increase in yield resulting from this simple care for the respiration of the Earth's skin amounts to about thirty per cent, in contrast to soils where these breathing processes have been ignored. This attention to the breath was known in ancient times as 'tone chanting'.

'Sun-ploughing' was likewise a widespread custom until the middle of the 1880s. This involves the ploughing of furrows in as wave-like a pattern as possible and at the same time orienting them to the normal path of the Sun. (See Fig. 14) In this way, on the one hand a beneficial irradiation by the Sun's fertilising rays at their normal angle is achieved and on the other, a constantly varying pattern of shade and the avoidance of direct radiation, resulting in a continuous, diffuse exposure to the Sun's rays. A favourable wind direction also achieves good root-stimulation and accelerates growth. The difference in productivity in comparison with improperly angled furrows is quite remarkable.

Near the Black Sea, while on a trip to Bulgaria, I was able to observe something as surprising as it was interesting. Far and wide there was a barren, grassless and treeless expanse. It had been leached by both wind and water. Deep gullies showed that no rainwater was able to infiltrate despite the porosity of the soil. It was a condition similar to the one that can be found under suitably oriented and alloyed (metalliferous) stones, where earthworms congregate. They depart en masse, however, if lightning strikes alter the potential of the ground and thus its permeability to water.

In the middle of this treeless wasteland, splendid stands of corn could be found in the vicinity of Turkish villages. Today, as thousands of years ago, these areas are cultivated with small wooden ploughs, which as a rule are

drawn through the earth by the womenfolk. There, harrows were apparently unknown. The clods were broken up with a hoe and the fields, which have a singularly undulating character, were then sown. The ripened corn is not cut with a scythe, but with a sickle. I found out that the reason it was cut like this was because there was a marked fall in productivity wherever an iron plough had passed, which was ultimately followed by complete crop failure. Nobody was able to explain why this happened.

Fig. 14: Sun-ploughing.

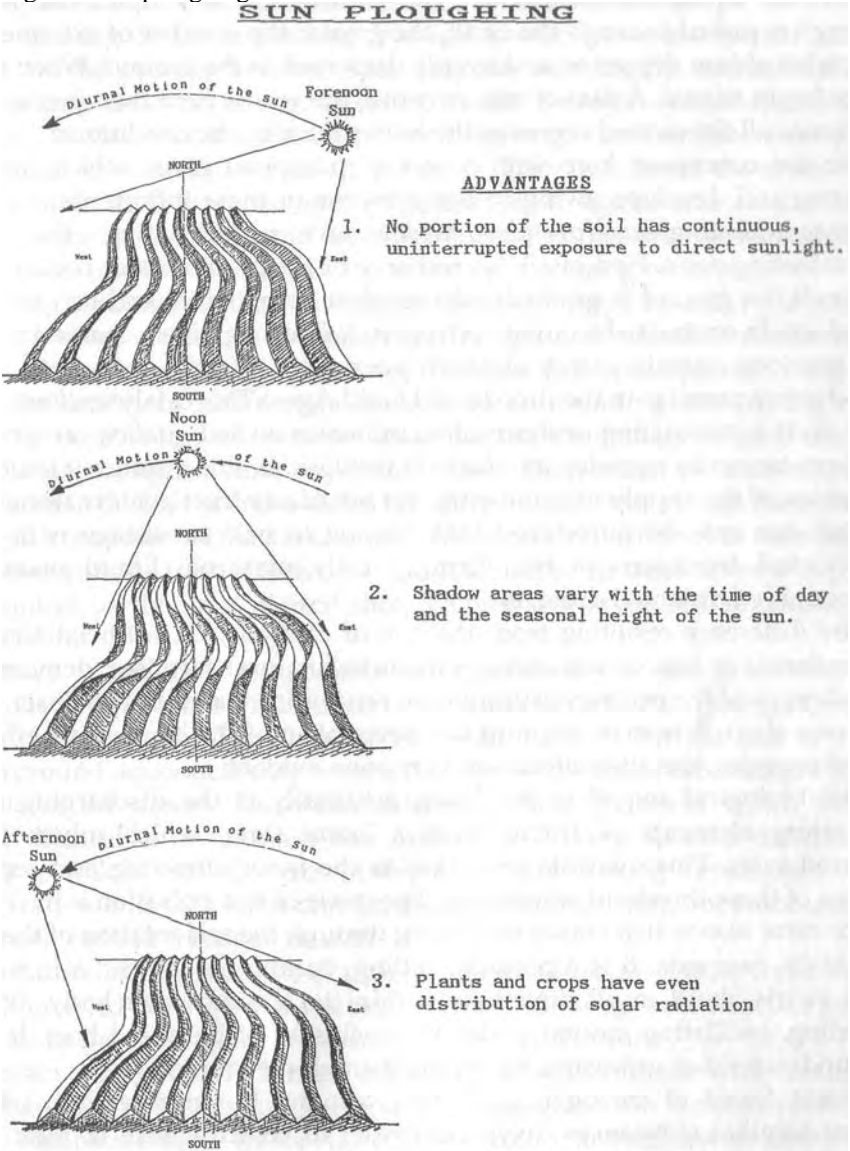

By way of experiment I determined that a small film of rust was sufficient to discharge the water completely. Falling water, every drop of which has a capacitance of 12,000 electron volts and can produce a strong glow in a vacuum tube, is unable to release energy if even a little iron is added. It is known that there is a drop in the productive capacity of soil, which has been rapidly tilled with double-bladed, tractor-drawn ploughs. Even when ploughed with horses or oxen, differences in yield were evident under otherwise equal soil conditions. The explanation is simple. The faster a plough is pulled through the earth, the greater the number of extremely fine particles of iron deposited and evenly dispersed in the ground. When it rains they begin to rust. A film of rust covering the whole field then forms, which becomes all the more dangerous the hotter the climatic conditions.

We are concerned here with a sort of puerperal fever, which the fruit-bearing soil develops owing to the presence of these infinitesimal, energy-release-inhibiting rust particles, which have a devastating effect in the germinating zone. First of all, no recharge of the groundwater occurs and as a result the ground is gradually divested of its potential and its capacity to produce. In contrast, the radiation from rust-free, negatively charged residues of precious metals can transform poor and infertile soils into highly productive ones (as in the Bronze and Gold Ages). This catalytic effect, which can exert a stimulating or destructive influence on soil quality, can under no circumstances be regarded as a form of fertiliser. In this instance it is simply a question of the supply of stimulants, but not of any fructigenic material itself, which can only be introduced into the soil to best advantage with rotted fermented fructigens in the form of fully matured, liquid manure or thoroughly fermented dung, etc.

The difference resulting from the use of catalytic, i.e. artificial fertilising stimulants, in lieu of soil-energy-enhancing natural fertiliser, demonstrates the danger of the excessive stimulation arising from artificial fertiliser (blast-furnace slag). Where no account has been taken of the contrasting effects of these energies, the after-effects are very soon evident.

The biological sequel to fertilising artificially is the discharging of the levitating elements of fructigen in a latent state, which inhere in the groundwater. This owes its pulsation to the inner attracting and repelling forces of these threshold ethericities. The cause of this pulsation is the cycloid-space-curve motion that comes into being through the self-rotation of the Earth about its own axis. It is a peculiar, coiling, curling movement, a movement that swirls about in all directions within the groundwater body. With its swirling, oscillating motion under the exclusion of light and heat, it is the groundwater that unleashes the whole marvel of evolution.

Latent forms of fructigen (carbonates) respond to centripetence, whereas latent seminal substances (oxygenes) react to centrifugence in their latent

state. Through this coiling, swirling motion, these two substances are brought into intimate contact with each other, wherein the fructigen binds (consumes) the seminal substances. The decisive impulse here is the repulse arising through the mechanically generated resistance in this cycloid-space-curve. If this is missing then the clusters of fertilising substances cannot be bound. However, if this oxidising process is inverted through the expanding influence of heat, then disintegration and a recoil results. The fructigens that are degraded in this way become destructive and poisonous.

The swirling of the expanding fructigenic ethericities mentioned earlier, which in the process become free, unipolar and highly excited through contributing catalytic effects, is only possible through cycloid-space-curve motion. In the course of this the swirling-in of the seminal substances responsive to centrifugence also takes place. They only await the mechanical impulse, which separates and disperses them again and makes them palatable to the formative and levitative substances in statu nascendi whirling about them (viz. the swaying of branches and fluttering of leaves).

The slightest stimulating movement of the root-tips caused by a gust of wind or when a passing animal crops the grass overhead, wherein every single tremor is sensed by the sac of fructigen (root-protoplasm), results in frenzy of activity in the fructigen-sac and the surrounding germinating zone. Countless factors immediately set about putting the damage to good use and any compensating activities are strengthened. Conversely, the trace elements contained in the leaves and needles reinforce the interaction with the counter-charged ethericities of the atmosphere. These return the leaves to their proper receptive attitude from which the wind had displaced them. Even this partly mechanical, partly physical oscillation is a precisely structured, organisational movement.

Perhaps it will now be possible to understand the canals built by the naturalistic inhabitants of the desert, that were described in general terms in Sven Hedin's book, *The Flight of the Great Horse*. With the aid of these underground aqueducts they were able to grow the finest cereals right in the middle of the desert. The water-masses in these channels, which wound about themselves in a snake-like manner in a very specific direction in swirling, cycloid curves, were nothing more than flowing Repulsators. They were waterworks which not only functioned automatically, but automatically produced radiant fructigen as well.

The naturalistic high priests of ancient cultures also built similar waterworks, which enabled the holy (all-healing) water to flow up to the sacred groves high up in the mountains. In faithful emulation of Nature, they copied high-mountain springs in which these same products of synthesis were created.

Perhaps it will now be understood why I provided the shocked professors at the Technical University for Agricultural Science in Vienna with an example

of the cycloid space curve produced by a boar which urinated as it ran.¹⁸ These professors understood me just as little as the doctor, who was outraged, when I told him that it was not the spermatozoa that bored into the egg awaiting fertilisation, as had been assumed in medical circles, but that an intermixture of dynagens was initiated when, with the rhythmical upward and downward movement of its fertilising stalk, the carrier of seminal substances aroused the inversely characteristic sac of embryonic fecund matter.

Whatever the case may be, it is very distressing to see just how far contemporary science is removed from naturalistic agriculture. It does precisely the opposite to what Nature, where still unviolated by humanity, is able to demonstrate to us. In all truth, it is no wonder that throughout the whole world, instead of a surplus of foodstuffs, a shortage prevails and with it a thriving and profitable traffic in the necessities of life.

Today's science thinks too primitively; indeed it could be said that its thinking is an octave too low. It has still not ventured far enough into the realm of energy and its attitude has remained purely materialistic. For this reason it is principally to blame for the state of affairs we are experiencing today. In all probability, this development was necessary, for how else should a misguided mankind perceive the true interdependencies.

For the present, it is high time to demonstrate practical examples as to how a naturalistic agriculture can be introduced before all humanity becomes totally brutalised.

Some Pertinent References to 'Tonsingen' and the Use of Water Barrels

'Frequency Aviation'

From Implosion Magazine, No. 64, p. 9.

As the Sun went down, Viktor Schauburger found the farmer behind the house, busily engaged in stirring water in a wooden barrel with an oar. Into this he crumbled some clay while singing the full scale from deepest basso right up to falsetto. Changing the direction of stirring, he then sang from falsetto down to basso again. During this activity, the farmer bent over the moving water and sang into it. Dipl. Ing. Kindt Flyborg would have called the activity of the farmer, the 'frequency activation' of the water; the farmer just called it 'tone singing'.

The farmer continued what he was doing as Viktor entered. He only stopped long after the Sun had set and then explained his work to Schauburger. He had learnt tone singing from his grandfather, and he referred to it as an inheritance from the greyest past. In tone singing the water must be infused

with the live Od, or breath, of life, so that it can become benign, fruitful and fertile. Clay on the other hand, is the carrier of the finest trace elements, which become charged by singing into the 'cooling' water, which thus becomes the carrier of the life-force needed by the soil. Mankind must see to it that the earth is able to breathe properly. The next day the intoned water is sprinkled over the appointed field with palm-fronds and sprinkled so thoroughly that the earth is coated with it. Due to the pulsating breathing of the earth, the groundwater sinks and draws the metallic substances down into ground. — Hermann J. Dorr.

A Biological Hint

From Implosion Magazine, No. 33, p. 5.

Between 1935 and 1937 we published (in TAU magazine) many treatises of the researcher and expert, Viktor Schauburger, which laid the foundations for biological land, forest and water management. He warned against using cement in biological agriculture. Such substances discharge the soil and water, robbing them of their potential energy. By using wooden implements and ploughs sheeted with copper, these energies are maintained and richer harvests are achieved.

For thousands of years the Tartars in southern Russia have used a highly developed system for cultivating their gardens. An acquaintance, who lived there for many years, observed that they hung sheets of copper in their water supply conduits. Once home, he experimented with this himself. He filled two large barrels with water and placed some pieces of copper and horn-shavings in them. The life in the water blossomed. Algae and microbes turned it green and a small sprinkling of this activated liquid powerfully stimulated the growth and health of the plants.

Schauburger, with whom I visited the garden, at once perceived the deeper correlations and asked my friend, 'Why do you do this? How do you explain these effects?'

Since my friend could only refer to his observation of the Tartars, with no understanding of what was happening, Viktor Schauburger said to him,

'You have incorporated electric elements in your garden. The water irradiates these barrels. It is active in all directions and even radiates from the barrels before you have poured any out. Such energies and radiant forces stimulate growth. The way you apply the water, however, results in a large loss of energy. Bury your barrels in the earth and remove the iron hoops! You can use wooden or copper ties instead, or earthenware or glass

vessels. Apart from the horn-shavings (or other organic substances), you must place pieces of copper in the barrels, which you have first hammered thoroughly on wood. You

can also include some similarly hammered zinc. Instead of burying a barrel, you can also build a clay pit for a water container. It would be ideal to make it two metres deep, egg-shaped, and with the pointed end uppermost. There you must leave a small hole and cover it with linen cloth, canvas or other porous material, so that atmospheric oxygen only enters the water in a diffused state. In this way the water will cool to about +4°C and powerful forces will be created and radiated into the surrounding soil.'

— Werner Zimmermann.

Copper Water

From Implosion Magazine, No. 42, p. 26.

In a copy of Implosion I read about Viktor Schauberg's visit to a farmer in the Bavarian forest, who scooped water out of a barrel and sprinkled it over his produce. In answer to a question the farmer replied, 'I make copper water in the barrel. In the First World War I was a prisoner of war in southern Russia and there I heard that the Tartars had put copper in their streams since time immemorial and sprayed their gardens with this copper water with great success.' To which Viktor Schauberg replied, 'If you also add zinc to the water, however, then you will obtain an even greater effect.' — Heinz Erven.

Re-enlivening Sick Fields

In order to enrich sour pastures with sweet-matter, one metre (3 ft) of thin copper wire should be buried in the ground at intervals of 50 cm (20 in.), such that the roughly 15 cm (6 in.) long upper end of the copper wire is made to lie horizontally below the ground surface. Now and again a thin zinc wire is placed within the triangular arrangement of the copper wires and lying in the same direction, in order to bring about the desired ionic interaction.

A fairly large barrel, with no metal bands or fittings, is placed in the vicinity of the sick field and buried at such a depth that rainwater can be channelled into it with surface channels. The barrel is then covered over so that only a five cm (2 in.) wide hole is left to permit the entry of diffuse atmospheric oxygen — the hole must be covered with a filter made of the best quality linen. On the lid, rods of zinc and copper are suspended in the ratio of two copper : one zinc. When the water develops a green, algae-like layer, then it is ready to use for watering the sick field.

Experiments with Copper Implements in Agriculture

From Implosion Magazine, No. 29 — written in Salzburg in 1949.

With contemporary ploughs, the shape of the ploughshares themselves and the material used to make them trigger off the following biological effects in the soil:

1. Construction Material

Through mechanical wear and tear, the finest particles of iron are deposited in the soil year by year and function like trace elements. These are oxidised into rust and in the process the soil is endowed with a film of rust, which has a deleterious effect on the soil-moisture and hence promotes the drying out of the soil. This is borne out by observations in Nature, which show that in districts where iron (Fe) ores are present the prevailing vegetation is poor and emaciated.

2. Method Of Use

In addition to the above, ploughs as currently designed create strong friction between the ploughshare and the earth, resulting in the generation of heat and weak electric currents. This further results in the loosening of the soil structure through heat and its electrolysis by the electric current. These processes also reduce the moisture content of the soil.

How can these harmful effects be eliminated?

1. Concerning the Material

Observations in Nature have shown that minerals containing copper (Cu) are very water-retentive (malachite, for example, has a retentive capacity of forty per cent) and that districts where copper ores are present have thriving growth. This led to the conclusion that the presence of copper in lieu of iron acts to increase the amount of water in the soil instead of decomposing it.

For me, therefore, the obvious thing to do was to apply these findings to the operation of ploughs and as a result I succeeded in designing simple attachments to such implements as ploughs, harrows and cultivators. The relevant Austrian patents have been applied for and are also being applied for in other major industrial and agricultural countries so that their priority will in any event be established.¹⁹

2. Concerning the Design

In order to eliminate the harmful effects due to friction, it is necessary to depart completely from current plough designs and to discover the most appropriate design by observing Nature.

Question: What is the best plough in Nature?

Answer: The mole. With its small strength, the mole shifts several times its own body-weight in soil within the space of a few seconds.

Why? Because it does not work centrifugally and generates no resistance. It actually works centripetally and thus avoids any resistance!

Following on from this observation, I succeeded in developing the right design (Bio-plough). The way it operated was already quite evident while still only a prototype: Very little application of force was needed, hence no generation of friction and thus the chain reactions under Point 2. were avoided.

The following field trials were based on the use of various implements fitted with the above copper attachment.

Field trials at Farmleiten-Gut Heuberg

Cultivation with copper implements at a farm near Salzburg.

Field Trial No. 1: Area, 1,880 m² (0.46 acre); altitude, about 630 m (2,000 ft) above sea level.

Soil Preparation:

Previous crop — 1946-7 winter rye sown after initial ploughing; yield = 180 kg (400 lb);

Autumn 1947 — light application of stable-manure, ploughed in and the ground left fallow over winter;

March 1948 — cultivated with newly designed cultivator, harrowed and sown with 30 kg (66 lb) Donara summer barley.

Unfortunately no second iron plough was available and so no parallel control experiment was possible using conventional methods of soil preparation.

Trial No. 1 can therefore not be considered representative. The growth of the summer barley was very good over the whole growing season. The harvest produced a net yield of 630 kg (1,388 lb), corresponding to 3,351 kg/hectare (2,990 lb/acre). The weight of harvested straw amounted to 1,200 kg (2,645 lb).

Field Trial No. 2: Area, 2,050 m² (0.5 acre); altitude, about 650 m (2,130 ft) above sea level.

Soil Preparation:

Previous crop — 1946-7 winter wheat sown after initial ploughing; Light fertilisation with 2,500 kg (5,115 lb) stable-manure, roughly ploughed in and allowed to lie fallow;

Late March 1947 — field divided into two equal portions; Portion 1 was cultivated with the new plough, Portion 2 with the steel plough; Sowing took place on 2 April 1947 and both portions were sown with Endress-Weisshafer oats.

Harvest yields:

Portion 1 = 342 kg (754 lb); = 1,668 kg/hectare (1,488 lb/acre);

Portion 2 = 216 kg (476 lb); = 1,054 kg/hectare (940 lb/acre);

The increased yield of Portion 1 was thus 614 kg/hectare (548 lb/acre) or 58% greater.

Field Trial No. 3: Area, 3,000 m² (0.74 acre); altitude, about 660 m (2,165 ft) above sea level.

Soil Preparation:

Previous crop — 1946-7 winter wheat as in Trial No. 2, fertilised with stable-manure, ploughed in autumn 1946, ploughed again spring 1947; Field divided into two portions in May; Portion 1 was cultivated with the steel plough; Portion 2 was cultivated with the new plough; Mid-May; sown to seed maize for silage.

Apart from weather very unfavourable for growing maize, much damage was also caused by pigeons and crows; the crop was poor and full of gaps. Even at the beginning of the growing season, however, it was evident that Portion 2 was growing better, which was particularly apparent due to its rich, dark green colour in contrast to the pale, yellowish colour exhibited by Portion 1. Since it was harvested green, it could not be weighed. However, Portion 2 yielded about a third more.

Field Trial No. 4: The fourth trial I carried out, the results of which I was only able to establish four weeks ago, was just as successful as the previous ones. In this instance the crop was carrots, which produced almost double the yield achieved under normal methods of cultivation.

Field Trials In 1949

In 1949 rye was sown in soils already worked with copper implements in 1948. The series of field trials 1-4, with normal fertilisation with stable-manure and

no artificial fertiliser, at an altitude of 630 m (2,000 ft) above sea level, produced the following results. (See Fig. 15)



Fig. 15: 15 cm (6 in.) long ears of rye with up to 104 grains per ear.

Result: Ears containing up to 104 grains of extraordinary size. Length of ears 15 cm (6 in.) and more; lengths of individual grains of one cm (0.4 in.). Such results were unheard of in this district and had not been achieved even in areas well-suited to cereal crops.

Explanation: Increase in growth due to the regulation of the water content. Of especial note was the further increase in the already increased yield the second time these implements were used.

Laboratory Analysis of Rye using material from the 1949 field trials

Transcript of the report by Leopold Rauch & Sohne, Walzmuhle, Salzburg, concerning the test results. Items investigated were: two samples of rye (No. 1 and No. 2), supplied by Ing. Franz Rosenberger, Salzburg. Date of analysis: 18 November 1949.

Findings — Test No. 1

Result: (Cu) Weight/hectolitre (22 gal) — 72.35 g (2.55 oz); H₂O — 15.6%; whole corn ash weight 2.364 g (0.084 oz); Content—ergot 5%; Overall content = 0.35%; 1,000 grain test (volume) — 40 cm³ (2.44 in³); weight — 28.7066 g (1.01 oz).

Baking Test: H₂O = 600 cm³ (36.6 in³); Care = 40'; dough weight 1,620 g (57 oz); bread weight 1,420 g (50 oz); volume 2,650 cm³ (162 in³), pore development good.

1,000-Grain Sieve Analysis:

No. of grains larger than 2.5 mm mesh = 368 (36.8%)

No. of grains larger than 2.3 mm mesh = 258 (25.8%)

No. of grains smaller than 2.3 mm mesh = 376 (37.6%)

Findings — Test No. 2

Result: (Fe) Weight/hectolitre (22 gal) — 72.85 g (2.57 oz); H₂O — 15.6%; whole corn ash weight 2.359 g (0.083 oz); Content — ergot 2%; Overall content = 0.85%; 1,000 grain test (volume) — 36 cm³ (2.2 in³); weight — 27.4342 g (0.96 oz). Baking Test: H₂O = 600 cm³ (36.6 in³); Care = 40'; dough weight 1,620 g (57 oz); bread weight 1,420 g (50 oz); volume 2,600 cm³ (158 in³), pore development good.

1,000-Grain Sieve Analysis:

No. of grains larger than 2.5 mm mesh = 291 (29.1%)

No. of grains larger than 2.3 mm mesh = 274 (27.4%)

No. of grains smaller than 2.3 mm mesh = 435 (43.5%)

These findings demonstrate the quantitative and qualitative superiority of Test No.1 and therefore of the cultivation of the soil with copper. From these figures a substantial improvement in flour yield is evident.

Results of 1949 Field Trials with Copper Attachments

Observations from four fields in Salzburg and environs.

The cereals (barley, corn, oats) exhibit a remarkably healthy growth in terms of thick stalks and very dark colour during the period of growth. The ears are larger and the increase in the number of grains per ear was estimated at twenty per cent. The grains themselves are larger and hence heavier.

Precise data concerning the increase in yield are not yet available, since the determination of weight can only be carried out after processing. The estimated increase in yield, however, is in the order of thirty to fifty per cent in view of the above increase in ear length of twenty per cent.

Observations on an alpine farm, 1,100 m (3,600 ft) above sea level in Kitzbuhel, Tyrol.

This farm is characterised by the exceptional degradation of its soil as a result of insufficient fertilising over more than ten years and inadequate cultivation. It had been tenanted by neighbouring farmers over a number of years, who over-exploited it and on occasion diverted the manure to their own properties. The cultivable areas consisted of leached, degraded alpine

pastures, which were lightly fertilised with stable-manure before ploughing. Ploughing took place in early May 1949, after which the land was sown to oats and corn.

The growth of these cereals was conspicuously good and was characterised by robust growth of the stalk and remarkably dark green colour. The development of the grain itself was equally exceptional. With regard to the oats, the number of grains per head was never less than sixty and often as high as ninety, whereas the grain-count per ear of corn lay between fifty-six and sixty-four. When the number of grains per ear were counted in neighbouring fields, which were in a substantially more favourable location and on well-cultivated soil, the number was found to be half the above figures.

Having no knowledge of the implements used in its cultivation, the Council's survey of all the farms in Kitzbuhel described the cereal grown on this farm as the best in the district. The property in question is the highest lying farm in the area, is described as being located on the shadow side and considered to be the most degraded, owing to the frequent changes in tenancy. I ascribe these extraordinary yields to the use of copper implements.

Cultivation of potatoes on this farm

Area under cultivation — 825 m² (985 yd²); tillage in May 1949 with the 'Golden Plough', light fertilising with stable-manure, seed stock — 200 kg (410 lb) of Ackersegen.

Yield: 2,500 kg (5,511.5 lb) = 12.5 times the average = 30,000 kg/hectare (26,766 lb/acre). This yield is extraordinarily high even without taking the altitude into account. The potatoes have a very healthy appearance and have an extremely good flavour. (See Fig. 16)

Field Trial No. 5: Parkland belonging to the Salzburg Municipal Council
Soil Preparation:

Previous crop — oats: Cultivated autumn 1948 with steel plough. Spring 1949, reploughed for parallel trials. Half with steel plough and half with 'Golden Plough'.

Observations:

Iron sector — Strong weed growth, yellowish colour, patchy, poor development of grass and clover, hence little root development, resulting in deep tractor tracks.

Copper sector — Few weeds, dark green colour, strong, thick grass and root development, tractor tracks half as deep as the iron sector.

All in all the growth on the copper side is strikingly healthy and growing strongly, which is not the case on the iron side. The difference in colour can be clearly seen. According to the owner of the land, the yield in green fodder at the last

mowing on the area of the field worked with the 'Golden Plough' was one hundred per cent more than on the area cultivated with the conventional iron plough. Investigation by the Primary Industry Department in Salzburg carried out by the Chief Agronomist, Dipl. Ing. Reach.



Fig. 16: Potatoes grown on alpine farm at Kitzbuhel, Tyrol.
Field Trial No. 6: (I) 1949 intermediate crop, Muhlbach field, Klessheim
Silage Maize:

The silage maize was harvested on 9 September 1949, when the cob was beginning to form; due to insufficient time, no detailed comparison between crops treated with Iron (Fe) and Copper (Cu) could be undertaken. The crop treated with Cu, however, appeared to be growing much more vigorously and in the short period between 27 July 1949 and 13 September 1949, i.e. seven weeks, a twenty-five per cent better yield was estimated; the Cu-plants were stronger and compared with the Fe-plants, were of much darker, rich colour and the cob development much further advanced.

Field Trial No. 7: (II) Schlagler winter rye, Schloss field, Klessheim
Sown 27 September 1949 on 1.76 hectares (4.35 acres) with 290 kg (639 lb) of Schlagler rye.

Inspection date: 31 October 1949.

Findings: Cu-area substantially better germination, better colour and growth.

Field trial No. 8: Winter barley: Wasserturm field, Klessheim
Sown on 26 September 1949 with 162 kg (357 lb) winter barley.
Inspection date: 31 October 1949.

Findings: Cu-area exhibited fewer yellow plants, lusher green colour and stronger plants than on the Fe-area.

Signed: Dipl. Ing. Resch. Chief Agronomist, Primary Industry Department, Ignaz-Harrer Strasse 79, Salzburg, 10 November 1949.

With regard to field trials Nos. 1-8, the parallel trials, without exception, were carried out under impeccable scientific procedures and under identical field conditions. The investigations were undertaken voluntarily and those in charge of trials 1-4 and 6-8 were agricultural scientists with university degrees and they provided the originals of the reports quoted here. All field trials were carried out in fields fertilised with stable-manure only.

The effect of these implements was to increase growth all the more, where the soil to be cultivated was very dry, for thorough observations in Nature it was determined that under certain conditions, particles of copper influence the recycling of water and the water budget very favourably, whereas in the same areas iron promoted stagnation.

The initial objection, namely that these implements had a leaching effect on the soil, has in the interim been withdrawn, in writing, by the above experts.

The copper implements and attachments have an effect similar to irrigation and are thus a natural influence.

Notes

1 Here the use of the word 'decadent' can also signify energies with a lower or reducing frequency or potential. — Ed.

2 Fats are bioelectric charge-separating dielectrics. — Ed.

3 Viktor Schauburger's use of the word 'cadaver' reflects his view that all physical manifestation is the solidified waste-matter accruing from energetic etheric interactions. — Ed.

4 See description of apparatus in 'An Experiment', in *The Water Wizard*, Vol. 1, p. 50

of the Eco-Technology series. — Ed.

5 It would seem that what is implied here is the creation of a water-psyche, an immaterial, intelligent energy, possessed of the will to impart life and to manifest itself physically as water. By its very nature, this water-psyche is all-pervasive, permeating every form of life, even the living rock. In its initial etheric and later physical state, it penetrates and animates all of Nature's fundamental creative substances in their latent state and thus can be viewed as one of the principal

currents of life energy. — Ed.

6 Isotropic: Having uniform physical properties in all directions or not having predetermined axes. — Oxford English Dictionary. — Ed.

7 This 'horizontality', as it were, depends on the scale at which it is observed. At a small scale this extension appears flat and planar, whereas viewed over the Earth as a whole, it is actually curvilinear and spherical and coupled with a certain expansive movement. — Ed.

8 Without in any way wishing to be offensive, perhaps the simplest representation of what is involved here is the straight-line (axial), penile, penetration of the female by the male. This pulsating movement along its characteristic (vertical) axis is metabolically transmuted into, or results in, a rotund expansion in a dimension (axis), which in a certain sense is perpendicular to the male fertilising axis. This spherical expansion is characterised by a lateral stretch-expansion at the surface due to the radial pressures in the interior resulting from the conversion of the combined energetic essences of opposite gender into quasi-physical mass. If this process of impregnation is repeated continually, then there is a continuous outward- and upward-moving (radial), pulsating flux of maternal matter, which culminates and concentrates at the ground surface. — Ed.

9 This is perhaps why the Tibetans considered that gold and other precious metals were best left undisturbed in the ground and also why they buried their 'treasure vases' in special places in the ground to enhance and protect it. This may also explain in part why the Australian aboriginals feel the same way about uranium. — Ed.

10 Selenium cell: In some instances Viktor Schauberger refers to such cells as 'soul-cells', 'selenium' being derived from the Greek word selen (moon) or Selena, the goddess of the moon. — Ed.

11 This refers to an Indian conjuring trick, wherein a mango seed appears to evolve into a fruit-bearing tree within the space of one or two hours. — Ed.

12 The over-simplistic nitrogen-phosphorus-potassium (NPK) treatment. Von Liebig later realised the matter was far more complex, requiring a wider infusion of trace elements, etc, but by that time it was too late, because the chemical companies had already heavily invested in the NPK system. — Ed.

13 This usually consists of a mixture of silicates with calcium, phosphorus and sulphur. — Collins English Dictionary — Ed.

14 In Viktor Schauberger's view, all manifested life is merely the waste or faecal matter, the atomic mass-defect, released or left behind through the interaction of higher immaterial energies of opposite potential. From this viewpoint all physical manifestation represents dung, even flowers. — Ed.

15 This is necessary in order to reduce the moisture content to a minimum. — Ed.

16 See patent description in the Appendix, p. 194. — Ed.

17 Paragraph 7.1.3, special edition of Mensch und Technik, Vol. 2, 1993. — Ed.

18 See 'River Regulation — My Visit to the Technical University for Agricultural Science', p. 82, The Water Wizard, Vol. 1 of the Eco-Technology series. — Ed.

19 See patents of the 'Golden Plough' and the harrow in Appendix p. 194. — Ed.

Appendix

Austrian Patent Office — Description of Patent No.
166644

Class 45 a. Issued 25 August 1950.

VIKTOR SCHAUBERGER and Dipl. Ing. FRANZ ROSENBERGER in
SALZBURG

Agricultural Implement

Application date: 17 February 1949.

Patent applies from: 15 February 1950.

Longest possible duration: 14 April 1951.

Numerous experiments have determined that a substantial increase in soil productivity can be achieved if agricultural implements made of copper or copper alloys are used, instead of the usual implements made of iron and steel. This difference is all the more noticeable, the faster the implement is pulled through the earth and the greater the friction between the soil and the respective parts of the implement. This surprising effect arising from the use of copper or copper alloys is supposedly attributed to catalytic processes, which may possibly result in an increase in the water-content of the ground and thus in an increase in yield.

With regard to the invention, therefore, the active surfaces of an agricultural implement in moving contact with the soil, will be made of copper or copper alloys. Since it is inexpedient to manufacture the whole implement with these metals, it has been advantageously determined that the active surfaces alone

should be covered with hard copper sheet or the like. The use of hard copper sheet or the like has proven to be especially advantageous, purportedly due to the fact that by being case-hardened by hammering or turning on a lathe, potentials are generated in the sheet-metal mechanically, which are transformed into magnetic (diamagnetic) potentials, which further the desired objective.

On the attached drawing, two designs related to the invention are portrayed schematically, which usefully show the active parts of a plough in elevation and section 2-2 in Figures 1 and 2; and the side view, longitudinal and transverse sections of the tine of a harrow in Figures 3-5.

On the plough depicted in Figures 1 and 2, the ploughshare 1 is made out of steel in the usual way; it could, however, equally be made of a suitable copper alloy. This component slides smoothly through the earth and hence produces no significant friction between itself and the soil. The situation is different, however, with regard to the mouldboard 2, where the surface exerts considerable pressure on the turning sod. This is therefore to be covered with sheet-copper 3 and fixed to the mouldboard 2 with countersunk screws 4. In order to achieve the necessary degree of hardness, the copper sheet 3 is screw-fixed to the mouldboard 2 and hammered in the same way that a scythe is hammered.

The harrow-tine 5 shown in Figures 3—5 is fitted with a sheath 6 made of copper sheet, which is open at the back. This is fixed to the tine with the same bolt that attaches the tine to the harrow frame, in such a way that one side of the sheath 6 is carried up sufficiently and provided with an appropriate sized hole to enable it to be fitted with the same bolt as the tine. Here it is appropriate to hammer the copper sheath after it is fixed to the tine.

In similar fashion, the iron or steel parts of other agricultural machinery can also be covered with copper or copper alloys.

Patent Claims

1. The agricultural implement is characterised by the covering with copper or copper alloys of those of its active parts that move through the soil.
2. In accordance with Claim 1, the implement is characterised by the facing of these parts with hard copper or hard copper alloy.
3. The process to be employed in the manufacture of the facings for agricultural equipment in regard to Claim 2 is characterised by the facing of the respective parts with copper sheet or the like, which is then hammered after being fitted.

See Fig. 8, p. 125.

Glossary

ANODE: An electrode carrying a positive charge, to which unions, also electrons, are attracted. (See Chapter 2, endnote 29)

BACTERIOPHAGES: Autonomous substances with life- or death-decisive influence. (See Chapter 2, endnote 26)

BIOELECTRICISM: A higher, more ethereal form of electricity involved in electrical interactions in living systems and tissues. It is responsible for the healthy decomposition (not putrefaction) of formerly living matter and the subsequent transmutation of this into development-ripe raw material in consort with its counterpart - biomagnetism.

BIOMAGNETISM: A higher, more ethereal form of magnetism and the counterpart of bioelectricism. It is the form of magnetism responsible for uplift (both physical and spiritual), levitation and the generation of life-enhancing energies.

CARBONES: Principally those basic elements and raw materials of carbonous nature, although the term also includes all the elements of the chemist and physicist with the exclusion of oxygen and hydrogen. They are what Viktor Schauburger called 'Mother-Substances' or the Earth's 'bread', as they form the matrix from which all life is created. (See Chapter 1, endnote 15)

CARBONESPHERE: That region in the Earth's surface where carbones are found.

CENTRIFUGENCE: The function of so-called centrifugal force, which acts from the inside outwards. This is conventionally thought to eject any material exposed to it radially from the centre outwards, whereas in actual fact the material is expelled tangentially.

CENTRIPETENCE: The function of centripetal force. This is a force that acts from the outside inwards. Its most frequently observed manifestation takes the form of vortices.

CENTRIPULSER: A device having a number of whorl-pipes attached to a central hollow hub, whereby the medium (water or air) is moved in such

a way that the forces of centrifugence and centripetence operate on a common axis. As the water is centrifuged from the centre of the hub outwards through the whorl-pipes, it is also caused to inwind centripetally due to the spiral configuration of the latter.

CONDENSATED WATER: Chemically pure, raw and well oxygenated.

CYCLOID-SPIRAL SPACE-CURVE MOTION: This can be a simple helical or spiral motion about the longitudinal axis, which on occasion pulsatingly expands from and contracts towards this axis. It can also embody a double spiral movement, in which the moving medium spirals about itself, while simultaneously following a spiral path. It is a form of motion analogous to the rotation of the Earth about the Sun, where the Earth gyrates about its own axis while moving along its orbital path. It is the form of motion Viktor Schauberger referred to as the 'original' or 'form-originating' motion responsible for the evolutionary dynamics of the Earth and Cosmos.

DENSATION, DENSIFYING: The process of becoming physically denser or more condensed. (See Chapter 1, endnote 8)

DYNAGENS: The entities or ethericities belonging to the fourth and fifth dimensions which enhance the creation of dynamic energy on lower planes of existence.

DYNAMIC ENERGY: This is energy that has more to do with the energising of all life-processes, subtle and otherwise, than purely physical phenomena for which the term kinetic energy, i.e. energy in motion, is normally used. (See Potential Energy)

DYNAMITIC SUBSTANCES: The violent, concentrated effect of oxygen in a spacially compressed, carbone-hungry form.

ELECTROZOIC ESSENCES: Also interpreted as animalistic or organismic essences or energy currents.

EMANATION: Any form of gaseous, vaporous, ethereal, spiritual, or electromagnetic emission of radiation, rays or energies.

ETHERIALISATION: The process of raising or exalting energies or matter to higher, more subtle states of being.

ETHERICITIES: This refers to those supranormal, energetic, bioelectric, biomagnetic, catalytic, high-frequency, vibratory, super-potent energies of quasi-material, quasi-etheric nature belonging to the fourth and fifth dimensions of being.

FLUIDIUM: A type of electricity.

FRUCTIGENS: The ethericities (subtle energies) responsible for increasing the fecundity or capacity for fructification and fertilisation of and by living things.

HALF-HYDROLOGICAL CYCLE: A truncated version of the full hydrological cycle in which no rainwater infiltrates the ground, but either drains away over the ground surface or re-evaporates into the atmosphere

with unnatural rapidity, leading to excessive agglomerations and the uneven distribution of water vapour.

HYDROLOGICAL CYCLE: The full, balanced and regulated natural cycle of water from deep within the Earth to the upper regions of the atmosphere and back, in which rainwater is able to percolate into the ground and the amount of atmospheric water is more evenly distributed and maintained at a more or less constant level. (See Half-Hydrological Cycle)

GEO THERM: Stratum of equal temperature.

IMMATURE WATER: Groundwater that has not yet accumulated and absorbed minerals, salts and trace elements, which it requires in order to become mature.

IMPELLER: A mechanism for moving water or other liquid mechanically.

Centrifugal impeller — The intake of water is along the axis of rotation in front of and perpendicular to the radially-ribbed impeller disc and is expelled tangentially under pressure at right angles to the direction of inflow due to the action of centrifugal force. It has a disintegrative effect on water.

Centripetal impeller — The water is introduced tangentially and exits axially in a longitudinal vortex down the central axis of rotation, which creates suction, cools and coheres the structure of the water.

INDIFFERENCE: Generally speaking, an unstable state of equilibrium where the organism or system in question is possessed of its highest potential, vitality, health and energy and is therefore able to operate at the optimal temperature and/or energy level appropriate to its proper function. Viktor Schauberger also defined this condition as 'temperatureless'. For human beings this state of indifference obtains at a temperature of +37oC, and for water relates to its condition of least volume, highest density and energy content at a temperature of +4oC, its so-called anomaly point.

INERTIA: The tendency or capacity of a given object or system to resist movement, acceleration or any change of status.

ISOTROPE: A non-polar or virginal entity, in which eventual polarity characteristics will eventually be determined by subsequent inbound radiation. (See Chapter 4, endnote 10)

JUVENILE WATER: Akin to immature water, the term juvenile generally refers to rainwater, which lacks minerals, salts and trace elements.

KINETIC ENERGY: Energy in motion or doing work. (See Potential Energy and Dynamic Energy)

LAW OF ANTI-CONSERVATION OF ENERGY: The law postulated by Viktor Schauberger, where the amount of available energy, potential, dynamic or kinetic is not constant, which, by means of the appropriate device or dynamic process, can be increased at will to virtually any order of magnitude. It is the rational counterpart of the Law of Conservation of Energy.

LAW OF CEASELESS CYCLES: The primordial, immutable law of Nature that governs and is responsible for all cyclical phenomena such as the changing seasons, the alternation between night and day, the ebb and flood of tides, the diurnal fluctuations in the flow of sap in trees, the alternating pulsations between electric and magnetic fields, the movement of galaxies, and so on.

LAW OF COMMUNICATION: The law relating to liquids, which states that if any two or more bodies of a given liquid, water for instance, communicate directly with one another via some form of opening, then the surfaces of the respective liquids are brought to a common, uniform level, provided always that they have the same specific density or weight.

LAW OF CONSERVATION OF ENERGY: The law stating that the amount of energy throughout the Universe is finite; that there can be neither more nor less energy, which therefore always remains constant and thus can never be lost. Energy merely changes from one form to another, such as the transfer from a potential state to a kinetic state and vice versa.

LAW OF GRAVITY: The law governing the attraction of bodies towards the centre of a heavenly body or the mutual attraction between two or more such bodies. (See Law of Levity)

LAW OF LEVITY: The law postulated by Viktor Schauberger that governs and is responsible for all upward movement of energy, uplift, upward growth, the upright stature of human beings, animals and other organisms, and is the counterpart to the Law of Gravity. As the force of gravity decreases the force of levity increases.

LAW OF THERMODYNAMICS, SECOND: The law related to temperature derived from the Law of Conservation of Energy, stating inter alia that with no additional input of energy from some external source, the energy in all closed systems (the whole universe included) will eventually be transformed into heat and ultimately reduced to a condition of uniform temperature known as the 'Heat Death'.

LEVITATIVE: Viktor Schauberger frequently uses this term. Gravity has a more materialistic value to it, while levitative is the subtle, creative energy flow.

LIGHT-INDUCED GROWTH: The rapid and unhealthy increase in the girth of shade-demanding species of timber when over-exposed to light, radiation and heat from the Sun.

LIGNIFICATION: The process of wood becoming hard and durable.

NATURALESQUE: Refers to artificially contrived processes or mechanical devices that conform to or emulate Nature's laws, or operate in a naturally correct way. (See Chapter 1, endnote 9)

OXYGENES: Oxygen-related essences.

POTENTIAL ENERGY: Stored energy or energy that as yet is unmanifested as dynamic or kinetic energy.

QUALIGENS: The ethericities responsible for the enhancement of quality and increase in quality matter.

RESINIFICATION: The blocking up of plant capillaries.

TECHNO-ACADEMIC: Not naturally occurring and therefore deceitful.

TEMPERAMENT: In Viktor Schauburger's terminology, this refers to the behaviour, character, gender and intrinsic properties, sometimes temperature-induced, of various immaterial and other energies, such as electricism, biomagnetism, gravity and levity as well as the media of earth, air and water.

TEMPERATURE GRADIENTS: In terms of Viktor Schauburger's concepts, temperature gradients are principally related to the direction of movement of temperature within and between the respective temperatures of the ground, water and atmosphere, which can either take a positive or negative form. A positive temperature gradient occurs when the direction of temperature movement is towards the anomaly-point of water, i.e. towards +4oC. A negative temperature gradient occurs when the direction of temperature movement is either upwards or downwards from +4oC.

TRACTIVE FORCE: The force that acts to 'shear off or to dredge and dislodge sediment. (See Chapter 1, endnote 8)

TURBIDITY: A measure of the opaqueness, cloudiness or muddiness of water due its content of suspended matter.

UNDERSTOREY: The level of vegetation in a natural forest which is below the overstorey or top layer.

'UR' STATE: Primordial, highly charged. (See Chapter 1, endnote 2)

VALENCY: Highly polarised, pregnant state.

WATER MASSES: Both the body of water generally, but also the various swirling volumes and filaments of water of different temperatures, densities and energetic content whose values are prescribed by the inner densities of the water.

WHORL-PIPES: Pipes, principally made of copper or its alloys, having a spiral configuration akin to that of a Kudu antelope, through which the transported medium is caused to move centripetally and vortically in a double spiral motion. (See Chapter 1, endnote 6)

XEROPHILOUS: Dry soil-loving.