

The Lakhovsky Multiple Wave Oscillator Handbook

Comprising the
Borderland Sciences Research Foundation
Lakhovsky Multiple Wave Oscillator
&
Radio-Cellular Oscillator
Research Files

Compiled and Edited by
Thomas J. Brown
Director of
Borderland Sciences Research Foundation

Published August 31, 1994
in the Light of further Research,
in the interests of BSRF Associates by:



Garberville, California

© 1986, 1988, 1992, 1994 Borderland Sciences Research Foundation

All rights reserved. No part of this publication may be reproduced, stored in a retrieval system or transmitted in any form or by any means, electronic, mechanical, photocopying, recording or otherwise without the prior permission of the publisher except for brief passages quoted in reviews.

ISBN 0-945685-03-3

Library of Congress Catalog Number 92-71664

Fourth Revised Edition. Published August 31, 1994 by:

Borderland Sciences Research Foundation
c/o Post Office Box 429
Garberville, California Republic

10 9 8 7 6 5 4 3 2 1

DISCLAIMER

This book is a research publication of Borderland Sciences Research Foundation. It consists of our MWO and RCO files which have been put into some semblance of order to preserve the records of many people with new and different ideas on how to study the energetic states of living systems and how these systems may be influenced by externally applied energies, and also to allow for further experimentation in this field by competent researchers. Read this book thoroughly before undertaking any experiments because you will find many different opinions, some conflicting, as to how to proceed. High frequency electrical apparatus can cause serious shock injury and should only be handled by knowledgeable, competent researchers. All experiments are conducted solely at your own risk. We disclaim any responsibility for the use or misuse of any information in this book. While this book touches on the subject of human health, all information should be considered as anecdotal and should not in anyway be construed as medical advice. We are not qualified to give medical advice and the use of the experimental equipment and research techniques described in this book may provide a false sense of security wherein one may neglect professional medical care. Use your brains. Thanks.

Thomas J. Brown, BSRF
Editor/Publisher

Table of Contents

PART ONE – Lakhovsky's Writings and Work

Radiations and Waves – Source of Our Life by Georges Lakhovsky	5-6
Science & Health, Longevity & Immortality through Vibrations, and, The Earth and Ourselves , by Georges Lakhovsky, books reviewed by Jorge Resines	7-11
Influence of Cosmic Waves on the Oscillation of Living Cells by Georges Lakhovsky	12-13
The Radio-Cellular Oscillator and its Applications by Georges Lakhovsky	14-15
Attempt at Treatment of Experimental Plant Cancer by Georges Lakhovsky	16-18
Lakhovsky's Vibratory Circle	19-20
The Lakhovsky Radio-Cellular Oscillator by Jorge Resines	21-26
Apparatus With Circuits Oscillating Under Multiple Wave Lengths by Georges Lakhovsky, U.S. Patent 1,962,565	27-28
Tube for Producing Multiple Wave Lengths by G. Lakhovsky, U.S. Patent 2,351,055	29-32

PART TWO – The BSRF MWO Research Reports

The Russian Lakhovsky Rejuvenation Machine by Bob Beck, 1963	33-38
Transistorized MWO by G.W. Steele	39-40
The Lakhovsky Multi-Wave Oscillator Power Supply by Klark Kent	41-48
Excerpts from The Waves That Heal by Mark Clement with commentary by Riley Crabb	49-55
Curing Cancerous Plant With Ultra Radio Frequencies by Georges Lakhovsky, 1926	55-56
Excerpts from The Journal of Borderland Research, 1964-1971	57-71
BSRF MWO 1988 Update	71-79
The Spiral Coil Multi-Wave Oscillator by Louis A. Schad	80-89
Electrostatic MWO by Peter Lindemann	90-91
The Sun-Ether Disc of Oscar Korschelt	92-93
View From the Borderlands by Tom Brown, 1988-90	94-97
Excerpts from The Journal of Borderland Research, 1990-1992	98-110
On the Trail of the Lakhovsky M.W.O. by Jorge Resines	111-113
Some MWO/RCO Questions Answered! by Tom Brown	114-115
MWO Roundup by Peter Lindemann	116-118
The Lakhovsky MWO: Back to Square One by Peter Lindemann	119-121
Lakhovsky's MWO: The Final Approach by Peter Lindemann	122-126
The Song of Longevity by Michael Theroux	127-129
My Meeting with Serge Lakhovsky by Hessel Hoornveld	130-134

PART THREE – Reference Materials

Old Electrotherapeutic Devices by Jorge Resines	135-138
High Frequency Oscillators for Electro-Therapeutic Purposes by Nikola Tesla	139-149
The Magnetic-Arc Instrument of S.S. Knight by Mark Gallert	150
Frequency-Independent Antennas by John D. Dyson	151-153
Short Waves in Medicine: Medical Aspects of Ultra Short Waves , C.H. West; Ultra Short Waves in Medicine , Dr. F. Noack; Human Beings as Antennas , Dr. I. Schliephake	153-158
Distributed Series Capacity by Charles Proteus Steinmetz	159-160

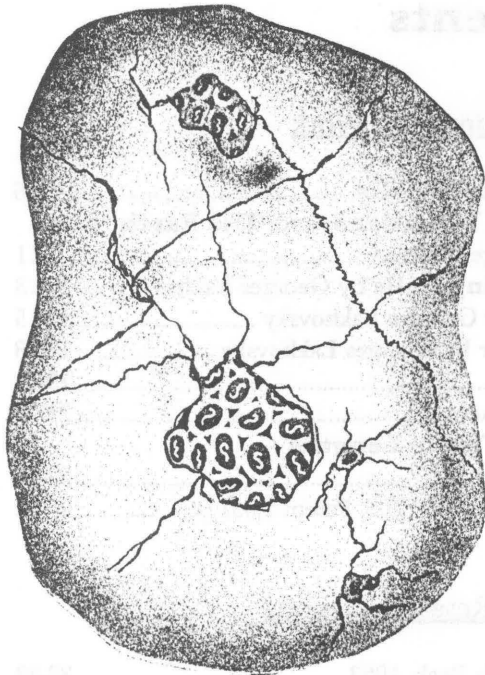

A dead cell. This diagram shows a cell where the chromosomes have stopped oscillating, and for this reason have ceased to live. But the chondromes, visible through the opening, continue to live an independent life. They are surrounded by a tough membrane and are multiplying so as to burst open the outside of the cell, as a baby chick, when it comes to maturity, breaks through the egg shell to come out.



Photograph taken during the treatment of Mrs S..., who sits between the MWO antennas at Calvary. Behind the patient is Dr. Marquer, head physician of the hospital, to the left is Dr Z..., assistant, three voluntary Nurses, & to the right is Georges Lakhovsky.

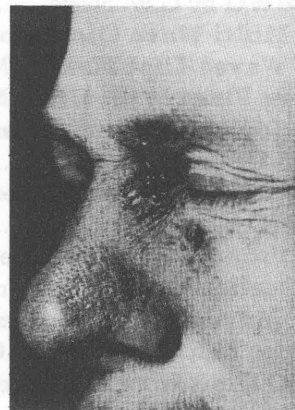

At left, Madame C... Before Treatment. Rodent Ulcer in inner angle of left eye.

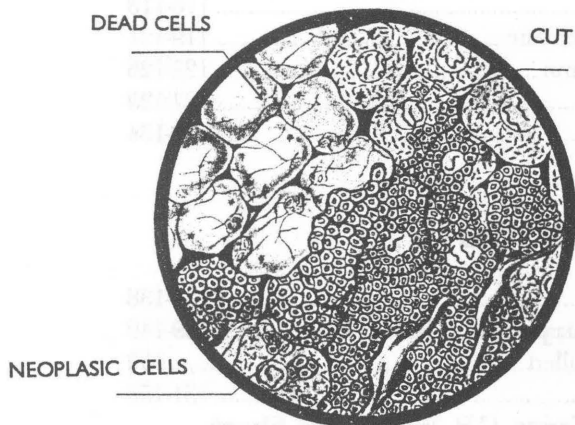

A group of dead cells, but not yet destroyed, in which the neoplastic cells are forming. One can see the transformation in the neoplastic tissue.

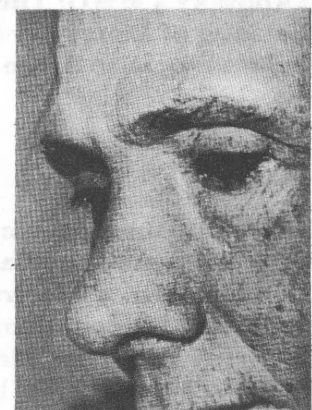

At right, Madame C... After Treatment.

Excerpts from:

RADIATIONS AND WAVES

Source of Our Life

by Georges Lakhovsky, 1941

THEORY OF CELLULAR OSCILLATION

Before presenting the therapeutic results obtained with my multiple short wave oscillator and presented at the International Congress of Short Waves in Vienna (July, 1937) it may be useful to give a rapid survey of my theory of cellular oscillation which I have developed fully in a number of books.*

All living cells are composed of two essential elements; the nucleus and the protoplasm in which it is bathed. This nucleus is itself composed of many tubular filaments: the chromosomes. In addition, hundreds of much smaller filaments or chondromes are present in the cytoplasm.

Chromosomes and chondromes are sheathed in an insulating substance (cholesterine, resin, fat, plastrin, etc.) and contain a liquid-like serum with the same mineral content as sea water, and consequently a conductor of electricity. Thus, these filaments constitute ultramicroscopic oscillating circuits capable of oscillating electrically over a wide scale of very short wavelengths.

I have demonstrated in my works that these cellular oscillating circuits, chromosomes and chondromes, vibrate electrically under the stimulus of electro-magnetic waves: cosmic, atmospheric and telluric.

Now, many internal and external influences may upset the oscillating equilibrium of these cells. For instance, a variation or change in the field of cosmic, telluric or atmospheric waves, a demineralization of the organic matter constituting the cellular substance, traumas causing the destruction by shock of the protoplasm or the nucleus.

I have shown in my books, *The Secret of Life* and especially in *The Earth and Ourselves*, that every living cell draws its oscillatory energy from the field of secondary radiations resulting from the ionization of the geological substances of the earth by cosmic radiations.

But certain natural radiations are particularly toxic, especially those originating in geologically-induced geopathic zones. Many cancer cases have been attributed to these toxic radiations which has been proven experimen-

tally, notably in Germany by Dr. Rambeau of Marburg. Therefore, earth radiations sometimes cause disturbance of the cellular oscillatory equilibrium of the organism.

Under these varied circumstances cellular oscillation may cease; the cell is then dead. But within the dead cell, the chondromes sometimes continue to oscillate electrically on their own natural frequencies. Fortunately, this phenomenon occurs rarely, or all humanity would already have perished from cancer.

The chondromes then envelope themselves in a membrane and continue to oscillate and multiply independently of the cell. They may then become neoplastic cells.

THE RADIO CELLULAR OSCILLATOR

To re-establish this equilibrium, I thought of creating, in 1923, a constant compensating field of very short radiations (2 to 10 metre wavelengths) to neutralize the action of the disturbing rays, and give the living cell the necessary stimulation for a return to its normal oscillation.

To this end, in 1923, I constructed my short-wave oscillator, using two triode tubes for very short waves made especially for this apparatus. I tried several cross leakages for this machine using one or more tubes and then multiple triodes with a tube containing oscillatory circuits within the bulb. Finally I adopted the oscillator with symmetrical cross leakage comprising two triodes. The oscillating circuits formed a single spiral, branched between the two grilles and the two anodes. It was fed directly by alternating current from the local supply circuit.

With this short-wave apparatus I was able to cure plants inoculated with cancer. For six years at the Saltpetriere I observed and checked the effects of these short waves.

Using very low power, from 10 to 12 watts, and a limited duration of treatment, I succeeded in curing cancer in human beings, but also had to record some failures.

The news of the success of my experiments became widespread. In many countries, as early as 1928, they began to build short-wave oscillators of considerable power producing thermal effects.

But here was great danger that the chromosomes and

* *The Secret of Life; Contribution to the Etiology of Cancer; The Earth and Ourselves; Cellular Oscillation; Nature and Her Wonders.*

chondromes, which are barely a ten-thousandth or twenty-thousandth of a millimeter in thickness, might not survive under a high frequency current. They offer much resistance, even to a low current which is sufficient to dissolve and destroy them.

It is simple to prove this by bringing a small bulb of from 2 to 5 volts with a filament of several hundredths of a millimeter, inserted between metal rods forming antennas, within the radius of a short wave transmitter. The bulb will light up and sometimes burn out, if it is brought too near the apparatus.

Moreover, the chondromes and chromosomes of all living cells, which are infinitely finer than the filaments of the bulbs, are sensitive centers of thermal phenomena, which may provoke their fusion. Undoubtedly this method is effective in killing microbes in the organism and in neoplastic cells. But it can also destroy millions of cells of healthy tissue in every irradiation.

THE MULTIPLE WAVE OSCILLATOR

On the other hand, I thought it possible to obtain better results by administering an oscillatory shock to all the cells in the organism simultaneously. Such a shock, very brief, produced by dampened or weakened electrostatic waves, does not provoke thermal and prolonged effects and involves no risk of burning living cells.

I therefore sought to produce an artificial oscillatory shock causing a periodic oscillation of the weak or dead cells.

At first glance this problem seems physically insoluble as there are approximately 200 quintillion cells in our bodies, each oscillating on its own natural wavelength. Theoretically, therefore, we would have to have a different wave length for each cell, so that every cell in the organism would oscillate in resonance on its own wavelength.

After much research I was able to construct an apparatus creating an electrostatic field covering all frequencies from 3 metres to the infra-red, so that every cell can find its natural frequency and vibrate in resonance.

We know that in physics, a circuit fed by damped or weakened high frequency currents creates many harmonics. Consequently, I conceived an oscillator of multiple wavelengths with a broad scale in which every organ, every gland, every tissue, every nerve, could find its natural frequency.

To obtain this result I set up a transmitter composed of a series of circular concentric oscillating circuits linked by a silk cord but not contiguous. These circuits are stimulated by damped high frequency currents from a spark gap. Thus each circuit of the transmitter vibrates not only on its natural frequency, but also on numerous

harmonics.

Thus, I built an oscillator with all the basic wavelengths from 10 centimetres to 400 metres, that is, all frequencies from 750,000 to 3,000,000,000 cycles per second. But each circuit also emits many harmonics, which, with their basic waves, their interferences and their effluvia can reach the scale of infra-red and even that of visible light (1 to 3000 trillion vibrations per second.)

Since all the cells as well as the chondromes oscillate precisely at frequencies in that range, they can therefore find, in the output of such an oscillator, the frequencies which cause them to vibrate in resonance.

You know the results I obtained with continuous very short waves using triode tubes at a distance, with no contact electrode....

As early as 1931, I began using this multiple wave oscillator in various Paris hospitals: the Saint Louis, Val-de-Grace, Calvary, Necker, etc... Among the many cures with this treatment, I will mention especially those of various cases of cancer which X-ray and radium treatments failed to improve. These patients, cured six years ago, have had no recurrence and are in perfect health at this date. In all pathogenic cases this treatment gives very good results. As it does not attack the microbes directly, it does not destroy live tissue, but reinforces the vitality of the organism by accelerating cellular oscillation. It is therefore the reinforced organism that successfully resists the microbes and all pathogenic causes.

So, while X-rays and radium destroy microbes, neoplastic cells and healthy tissue at the same time -- which accounts for the serious accidents which occur during and after such treatments -- high frequency radiations (short waves) applied at a distance and without thermal effect cure diseases of all kinds, even those of the prostate to a considerable degree.

Whatever the pathogenic cause, the multiple wave oscillator reproduced the frequencies necessary to re-establish the cellular oscillatory equilibrium.

In general, it is sufficient to seat the patient, or to have him stand in the radius of the apparatus, before the transmitter. The duration of the treatment is usually from five to ten minutes, every other day. These figures are purely arbitrary, since these radiations reinforcing cellular oscillation do not produce organic disturbances, whatever the duration of the treatment may be.

Despite the many cases successfully treated, almost without exception, it must be understood that my oscillator cannot cure all types of cancer in all its stages of development. In many cases, when the cancerous tumor has already destroyed important blood vessels, my apparatus is powerless to rebuild that tissue before the fatal haemorrhage.

Book Reviews by Jorge Resines

La Science et le Bonheur

LONGEVITE ET IMMORTALITE PAR LES VIBRATIONS
(Science and Health, Longevity & Immortality through Vibrations)

and

La Terre et Nous

(The Earth and Ourselves)

both by Georges Lakhovsky

INTRODUCTION

When reading both of these works for review, I thought it would be better for BSRF's readership to "group" the subjects broached in both and to include in every grouping what Lakhovsky says, with my comments added. This was done to avoid including, as he does, plenty of anecdotes and tales irrelevant to the analysis and study of his theories and actions. For the sake of completeness, I now detail his written works up to 1933 minus his scientific papers as published in French scientific journals:

- 1) L'origine de la Vie (Origins of Life), Gauthier-Villars Editors, Paris, 1926.
- 2) Contribution a l'Étiologie du Cancer (Contribution to Cancer Etiology), Gauthier-Villars Editor, Paris, 1927.
- 3) Universion ('Universion' is Lakhovsky's term for the Ether), Gauthier Villars, Paris, 1927.
- 4) Le Secret de la Vie (Secret of Life, actually it is (1) with some added chapters and more information), Gauthier-Villars, Paris, 1929.
- 5) La Science et le Bonheur (Science and Good Health), Gauthier-Villars Editors, Paris, 1930.
- 6) L'Oscillation Cellulaire (Cellular Oscillation, a collection of experimental researches according to the source in (9)), G. Doin et Cie, Paris, 1931.
- 7) La Formation Neoplasique et le Desequilibre Oscillatoire Cellulaire (Neoplastic Formation and the Cellular Oscillatory Unbalance), G. Doin et Cie, Paris, 1932.
- 8) L'Éternite, la Vie et la Mort (Eternity, Life and Death), Fasquelle Editors, Paris, 1932.
- 9) La Terre et Nous (The Earth and Us), Fasquelle Editors, Paris, 1933.

From these I have read the Spanish translation to (4), published in 1929 by Aguilar, Madrid, Spain, and works (5) and (9).

THE "UNIVERSION" AND OSCILLATIONS

"Universion" was the name given by Georges Lakhovsky to what us Borderlanders call "The Ether", meaning an all-space filling force capable of producing, when properly excited and manipulated, all kinds of effects. To Lakhovsky the Ether was not motionless but full of many different oscillations of electromagnetic character. And when he stated this, he meant of Hertzian-type oscillations. In his view these oscillations happened within the Ether, and NOT as it is meant today within "empty space" as dictated by Relativity Theory.

Please notice that what I am reviewing are Lakhovsky's ideas as told in his publicly available written works. If he had a personal and secret viewpoint, I do not know so, wherever deemed necessary, I will insert the proper comments related to BSRF

literature and findings. Considering that Hertzian-type oscillations were the only ones that could be produced in the Ether, Lakhovsky began to research in earnest correspondences between living organisms and the current (1920/1930) oscillation-producing equipment:

For example, he likened the twisted filament within a cell (see Figure 1) with the self-inductance or coil in a radio transmitter/receiver, he also did the same with filaments within micro-organisms such as the "Corynactis viridis" (with a current size of 0.1 millimeter, and living in the sea), as shown in Figure 2.

But, to Georges Lakhovsky, the filaments were not the only oscillating members within a living organism. As seen in Figure 3, within a cell also exist Chromosomes and Chondriomes:

Both elements, Chromosomes and Chondriomes, he likened with capacitors as is seen in Figure 4.

Each of the elements within a cell oscillated in a particular manner, according to Georges Lakhovsky, so that the combined oscillations produced the well-being of the cell and all cells vibrating harmoniously generated the well-being of the whole body.

In continuing with his viewpoint (5), Lakhovsky likens the "a-b" cellular axis, as shown in Figure 5 with the "North-South" ferromagnetic axis (same illustration). The cell's internal filaments (see I in Figure 5) he equals with a coil of wire wound around the magnetic axis (see (II), same illustration).

As seen in Figure 6, over these lines, he likens the homoeotypical process of cell-division ("according to

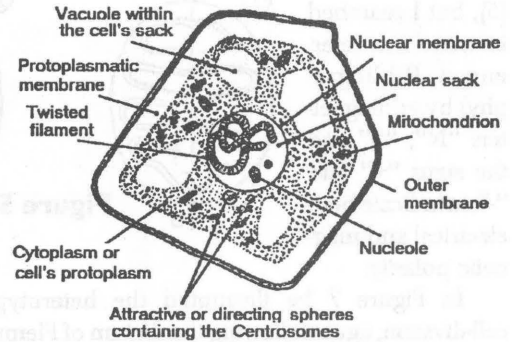

Figure 1

Figure 2

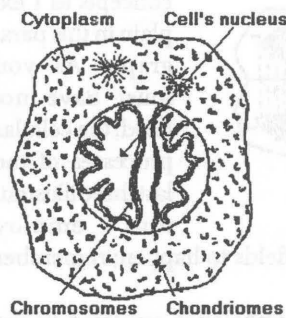
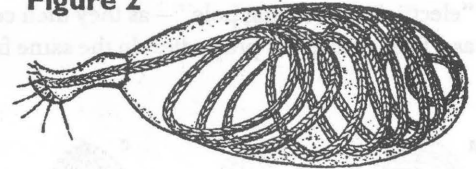

Figure 3

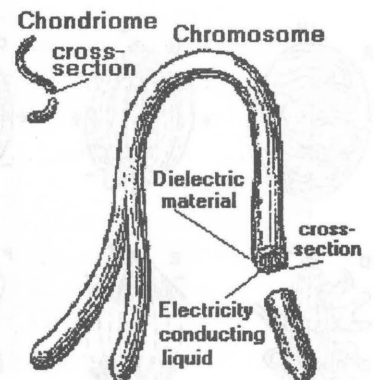

Figure 4

Flemming”, he says (5), but I searched in vain for a referenced Bibliography) by adding letters “N”, “S” and the signs “+” and “-”, to indicate both electrical and magnetic polarity.

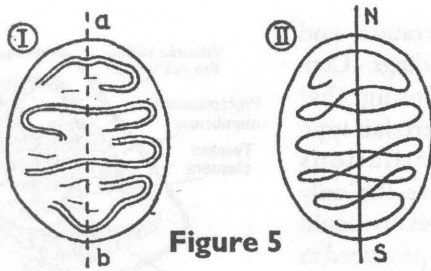

Figure 5

In Figure 7 he illustrated the heterotypical process of cell-division, again following the dictum of Flemming and adding also letters for magnetic and electrical polarity:

From one Mr Henneguy (also, unreferenced) he takes illustration of germ-reproduction.

In Figure 8, over these lines, we see: at (I) the actual physical events as depicted by Henneguy and at (II) Lakhovsky's view with electrical polarities added. One pertinent remark here: “NEGATIVE Polarity” was for the early electricians the “electricity-absorbing pole” — as they then considered electricity as a fluid with given properties. In the same fashion, “POSITIVE Polarity” meant the “electricity-

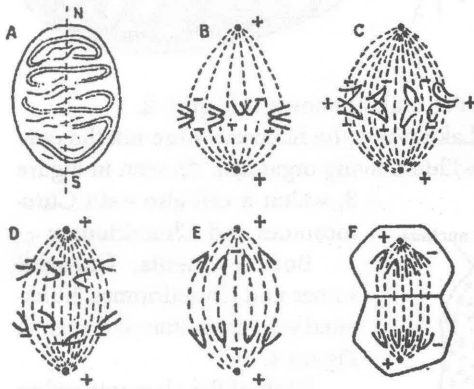
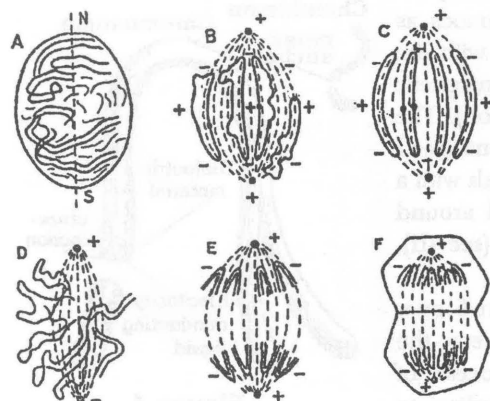

Figure 6

three different types of non-uniform fields to happen; remember this fact later.

Whenever a given oscillatory imbalance occurred in the body, according to Lakhovsky, normal healthy cells first died and later they began to transform into cancerous cells to later form

Figure 7



tissues of this very kind, as illustrated in Figure 9.

This given oscillatory imbalance destroyed most of the cell's internal constituents and hardened its membrane, first; to gener-

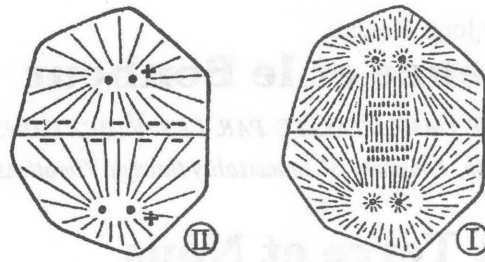

Figure 8

wildly, without any restriction, and thus cancer spread itself throughout the body. How the imbalance was created, and Lakhovsky's solution to it, will be seen in coming points to this review. One note of caution, however: What is written in both works hap-

pended over 60 years ago, our environmental conditions have changed since then. So, whosoever attempts to do anything concrete with Lakhovsky's findings will have to ADAPT his/her efforts to these changes. Please do not forget this important point!

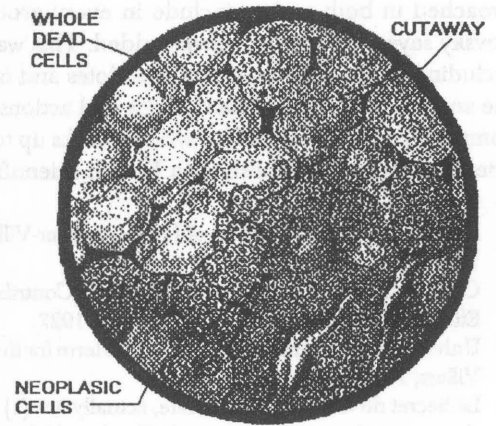
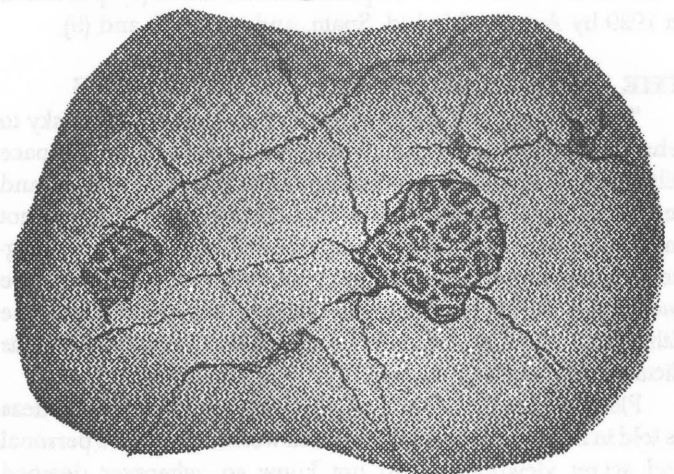

Figure 9

DIFFERENT POLARITIES IN THE SOIL

One of Lakhovsky's most interesting findings is that the different strata and groupings of localized character of the same soil-constituents do have electrical polarities. Soils of “Negative Polarity” absorbed and conducted the etheric waves coming to Earth from the Cosmic space into deeper rock-strata; by opposi-

Figure 10



ate a massive reproduction of Chondriomes, second. See Figure 10. The Chondriomes multiplied

tion, soils of "Positive Polarity" reflected, refracted or changed these waves before these waves were sent somewhere else because of other wave-trains coming behind.

Both kinds of soil, according to Lakhovsky, affected human health differently and these are the main representatives for each class:

<u>Negative Polarity</u>	<u>Positive Polarity</u>
(-) Sand and sandstone	(+) Plastic Clay
(-) Thick-calcareous	(+) Gypsum loam
(-) Gypsum (un-alloyed)	(+) Saint-Ouen calcareous
(-) Recent alluvial deposits <i>rich in freshly-broken small rocks and sand</i>	(+) Green marl
	(+) Phosphorous chalk
	(+) Iron minerals

Now, very strange effects happen where two different kinds of soil meet — at frontiers called "faulty-lines" by Lakhovsky. Let us see each effect separately:

As shown in Figure 11, over these lines, each kind of soil imparts its own electrical polarity to storm-clouds above. Lakhovsky says lightning strikes the ground only in the faulty-lines because each different type of soil is like a plate of a massive electrical condenser charged with one kind of electricity until it discharges at the "breaking level". He carries the idea even further, as illustrated in Figure 12, by indicating that massive amounts of electricity could be obtained from underground strata by sinking deeply into the ground metallic shafts of the right metals and tap said electrical charges accordingly. Cities, towns, trains, etc., could be electrified cheaply and permanently by these means he states.

What he says of the storm-clouds' electrification, I have read nowhere else; I only found some complementary data in "The Earth's Electricity" by the late Dr. James McDonald of UFO-research fame (see the April 1953 issue of "Scientific American").

About tapping the Earth's underground electrical fields in this manner, I found at no other place what he states of the different soils possessing opposite electrical charges. Yes, I am acquainted with Nathan Stubblefield's "Earth Battery" but, so far, nothing as definite as Lakhovsky indicates. *Please, should someone possess more info, write to Borderland Science, forwarding it.*

From this conception, Lakhovsky originated his view of why Volcanism exists, he states where two different geological formations meet each other and produce a massive electrical sparking that, in turn, fuses and vaporizes the underground rocks to later expel the—in this state—upwards, where they cool and form the usual volcanic cone, as seen in Figure 13. The way and extent with which this viewpoint complements itself with what has been postulated (and mathematically backed, so that anyone with the proper knowledge and calculating-means can duplicate it) by Bruce L. Cathie is not known to me. Cathie has not extended his

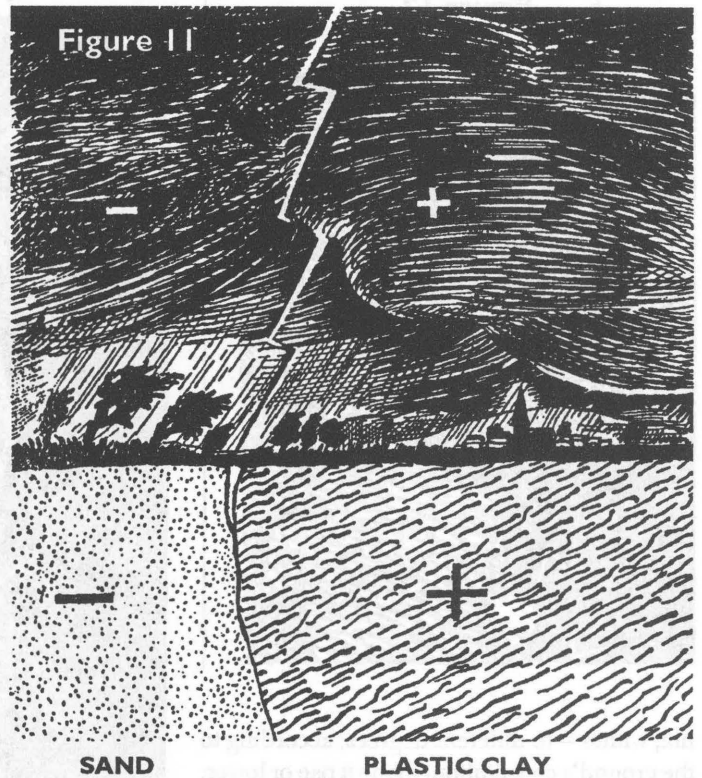

research into the analysis of soils and rock-strata to make it fit his grid-theory (I have not yet done so in my work either).

The faulty-lines do affect human health; for example, should someone sleep as seen in Figure 14, over a line of these, the individual would develop a cancer of the stomach. Not only the faulty-lines produced cancer, according to Lakhovsky, who also states that living in Positive Polarity-type of soils does, together with other diseases coming from being bombarded with reflected and self-interfering radiation.

If, as shown at (A) in Figure 15, your bed is on the path of a faulty-line, one way to contribute improving your condition is to move it into a zone — (B) — which the line traverses not.

In case you live upon a Positive Polarity-type of soil, you can get sick from the environmental reflected radiations but you can reduce the risk of getting sick by "polarizing" yourself like the ground you live over. Lakhovsky mentions that the inhabitants of Memphis, just to name a case, drilled a deep well to get water for drinking and that this water was positively-polarized; drinking the liquid, Lakhovsky states, effectively immunized them against any soil-produced disease.

Lakhovsky recommended living upon Negative Polarity-type of soil, such as deserts or similar zones, for the continued conduction of incoming energy guaranteed it would not accumulate in the body. He mentions, to this effect, that the healthiest portions of Paris were those built upon this kind of soil. Yet, one wonders, the extent to which this generalizing statement is correct nowadays with all the many changes which have happened...

Finally, he postulates that the tides are not due to "rising and lowering of the waters" but of the ground by them! This we see illustrated at Figure 16. Lakhovsky considered as "invariable" the level of water, while thinking that the different radiations — mostly, solar ones — falling upon the ground (and penetrating, or

Figure 12

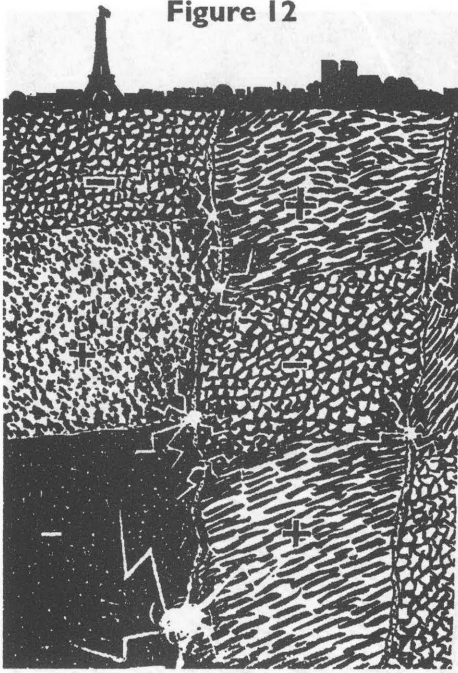

not, within — to different degrees, according to the ground's constitution) made it rise or lower. In this manner, he explains the different heights reached by the waters at different coastal locations.

Has anyone in the readership more data concerning this conception? Please let us know.

THE LAKHOVSKY MULTI-WAVE OSCILLATOR

I will refrain here from analyzing what Lakhovsky says about his "Radio Cel-

Figure 14

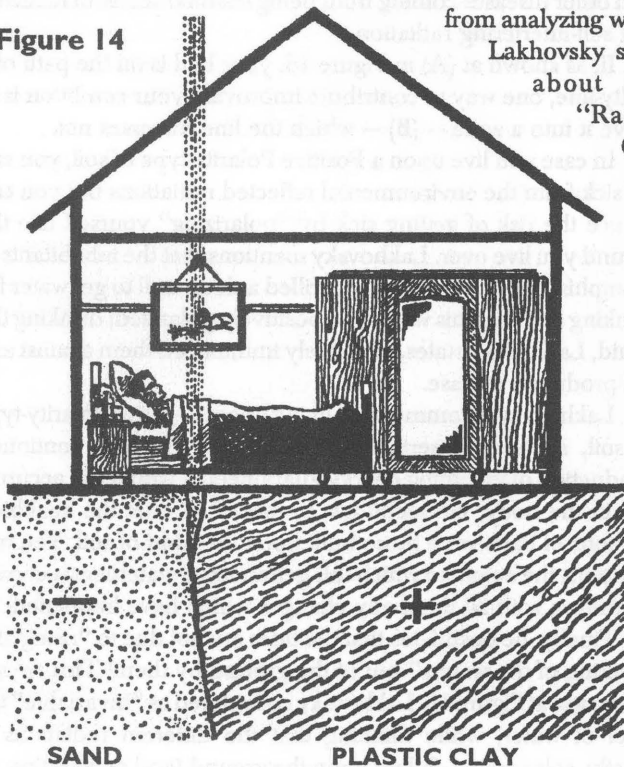
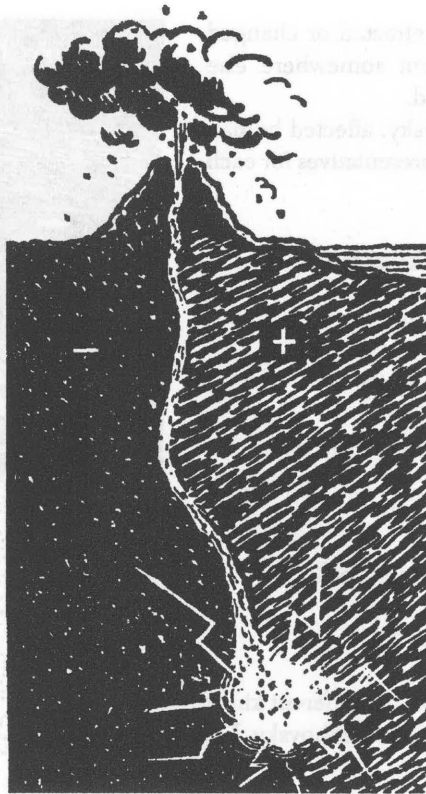

Figure 13



lular Oscillator", for this is included in "The MWO Handbook" (1992 edition by BSRF). The data included in this section is taken from both reviewed works (5), (9), and even so I think it is too small to "break" into Lakhovsky's way of thinking and the resulting experimentation he must have performed.

In Figure 17, we have the following type of Hertzian oscillators: (I) Open Hertz-resonator, (II) Hertz-resonator closed by a capacity, (III) Hertzian dipole and (IV) Setup of dipole with a coupled oscillating circuit. Throughout both books (5), (9), Lakhovsky never talks about any other kind of oscillator that is not Hertz-based. Lakhovsky employed a "proportional antenna", whose elements were concentric cylindrical metallic tubes ending in spheres. The way he established the proportion in-between different metallic tubes is illustrated in Figure 18.

From a given length "l", the basic wavelength in his device, he first established a radius "r" (by dividing "l" by "Pi") that he multiplied by a constant "a". You see at (I), of Figure 18, the wavelength "l" when in a Hertzian dipole and at (II) when in Lakhovsky's metallic tubes ending in spheres. Yet, in none of the books reviewed is it indicated WHICH are the numerical values under consideration and WHY these specific values are employed. A "thunderous silence" is found when looking for them...

The only information Lakhovsky furnishes us with is that he generated "many different waves, from 10 centimeters to 400 meters" by using the fundamental wave, its harmonics and the interferences (with other waves) that are produced in the process. The reason behind this idea, he states is that "We know in Physics

Figure 15

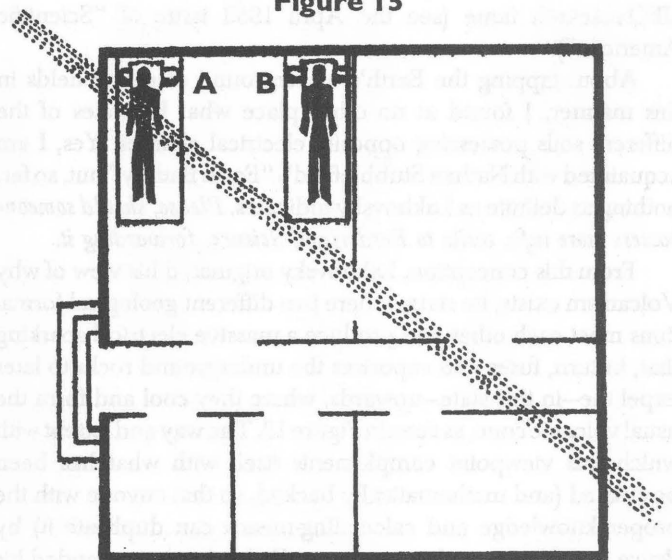

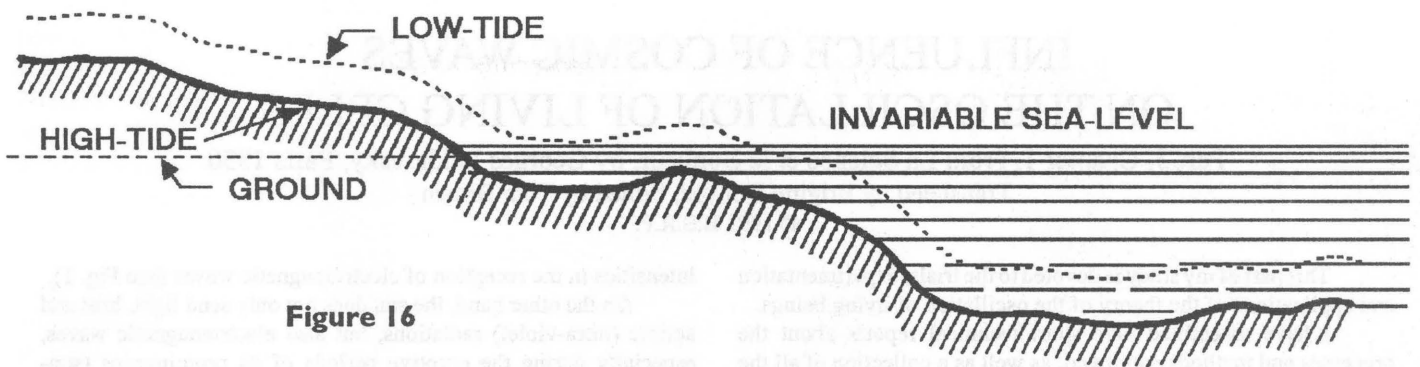

Figure 16

that a circuit fed by high-frequency damped currents creates many harmonics" (from pages 147-148 of (9)).

These many different wavelengths would be selectively

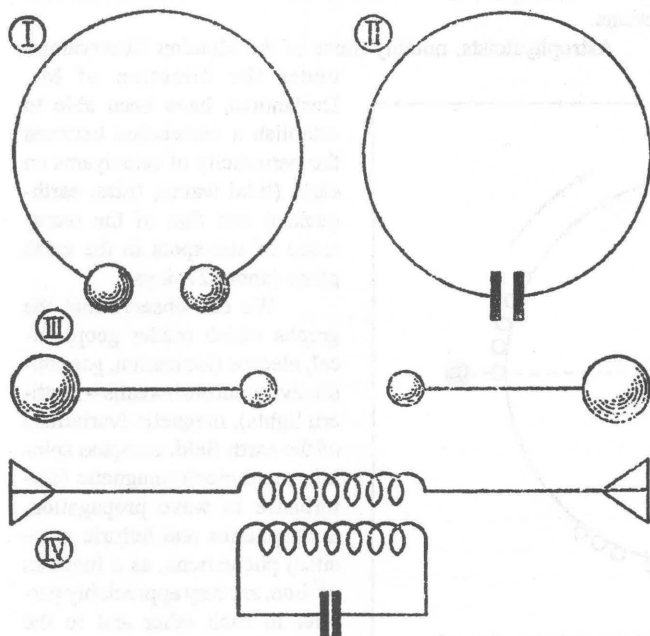

Figure 17

absorbed by the cells and tissues in our body lacking in the proper wavelengths to maintain the proper oscillatory balance; this would be done, he states, because cells can act both as emitters and receivers of waves.

By February 1931, the first Multi-Wave Oscillator was finally built and was in working condition and in July 1931 it was tested at the Saint-Louis Hospital, with success.

This first model is seen in Figure 19, and it is taken from page 135 of (9) with the following explanation beneath the photo: "Multiple-Waves Oscillator. Lakhovsky device complete with its two resonators (that) create an electromagnetic field in-between its two elements".

In short, the two sets of concentric rings are the "resonators" to create the in-between field. This model is a far cry from the more elaborate one shown by Mark Clement in his "The Waves That Heal". Only a few features remain:

a) The thick tubes holding the set of rings; yet in this Figure

19 the rings are ABOVE the tubes and in Clement's book they are BENEATH—why?—unless this is purely a mechanical concern.

b) I assume that the thick cylinder at the foot of the right-unit, (Figure 19) contained the original electronic equipment needed

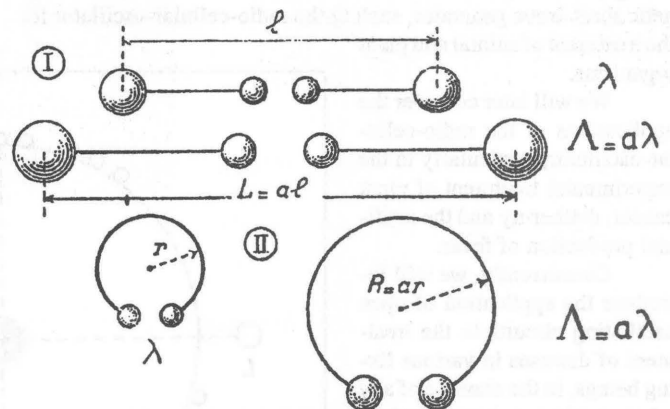

Figure 18

to make the machine work. Compare with the photo on page 29 of Clement's book and you will see the volume involved is tripled (or closely). What changes were made and WHY???

To end this two-book review, I would like to ask anyone possessing a copy of the referenced Lakhovsky works to send a duplicate to BSRF to see how much can be cleared of both the M.W.O. and any other research by Georges Lakhovsky.

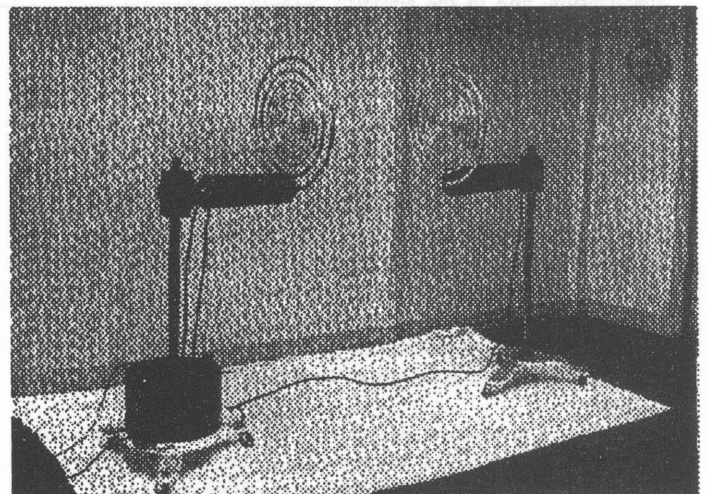

Figure 19

INFLUENCE OF COSMIC WAVES ON THE OSCILLATION OF LIVING CELLS

Part 3, Chapter 1, From *La Science et le Bonheur*, by Georges Lakhovsky, Paris 1930

Translated by Brigitte Donvez, Edited by Tom Brown

© 1991 B.S.R.F.

This part of my study is devoted to the trials, experimentation and applications of the theory of the oscillation of living beings.

I have assembled here short technical reports about the processes and methods employed, as well as a collection of all the papers read at the French Sciences Academy and at various French and foreign Scientific Societies about oscillatory therapeutics and all its domains of application.

We intend first to examine successively the influence of cosmic waves on the oscillation of living cells, taking as a concrete example the influence of solar activity upon the quality of wine and vintage. Then we will examine the construction of an electromagnetic short-wave generator, such as the radio-cellular-oscillator for the treatment of animal and plant organisms.

We will later consider the applications of the radio-cellular-oscillator, particularly in the experimental treatment of plant cancer, diathermy and the artificial production of fever.

Concurrently, we will introduce the application of open oscillating circuits to the treatment of diseases in various living beings, in the absence of any other oscillations but those produced by the natural cosmic and atmospheric waves. We will also review in this chapter the observations of scientists and practitioners who clinically applied my oscillating circuits.

Finally we will take up the very latest applications of oscillating circuits to water and liquid sterilization, and to the activation of the germinative power of plants.

Obviously, the number of these applications, presently limited to certain domains, tends to rapidly expand and touch upon the various problems presented by therapeutics, biology, agriculture and zoology.

I have discussed elsewhere the role played by cosmic radiations in the development of living beings, due to the very oscillatory nature of the cell. Now, as a consequence of the earth's rotation and the stars' reciprocal motion, the cosmic and atmospheric radiation field is not constant, but rather variable. Living beings are subsequently under the influence of these variable cosmic radiations, whose nature either weakens or strengthens the cell's oscillatory balance.

I have mentioned elsewhere¹ that the lunar radiation interferes with the waves of radioelectric stations. Every week, the recurrence of moon phases enables us to obtain highest and lowest

intensities in the reception of electromagnetic waves (see Fig. 1).

On the other hand, the sun does not only send light, heat and actinic (ultra-violet) radiations, but also electromagnetic waves, especially during the eruptive periods of its prominences (sun-spots). The influence of the sun's electromagnetic radiation becomes obvious if we consider the variations in the earth's magnetic field and the spinning of a compass' magnetic needle during magnetic storms, under the influence of the telluric currents induced in the ground. The ionization produced by the sun's radiation also generates atmospheric and statics which disturb radioelectric receptions.

Astrophysicists, notably those of the Meudon Observatoire under the direction of Mr. Deslandres, have been able to establish a correlation between the periodicity of cataclysms on earth (tidal waves, tides, earthquakes) and that of the recurrence of sun-spots in the earth plane (about 27 days).

We can observe that the graphs which reader geophysical, electric (ionization, gas conductivity, aurora borealis--northern lights), magnetic (variations of the earth field, compass spinning) and electromagnetic (disturbance in wave propagation, atmospheric and telluric parasites) phenomena, as a function of time, are very appreciably parallel to each other and to the curve of solar activity. An 11½ year periodicity appears on these graphs, confirmed by numerous, previous observations in the domain of meteorology. In particular

certain tropical rainfall patterns show a 33 to 35 year periodicity, three times longer than the previous one.

I researched the extent to which cosmic radiations which condition physical and meteorological phenomena, also influence biological phenomena and the development of living beings.

As early as 1801, while cosmic radiations were not even suspected, Hershel pointed out: "the scarcity of vegetation when the sun has no spots". Starvations recur every eleven years in India with alternances of heat and rain. From 1901 to 1909, the canon Th. Moreux noticed that the wheat crop in France and in the world more or less followed the solar activity, so did arthritic conditions, and the nervousness of students and teachers.

I compared the graphs of the solar activity, as recorded at the Meudon Observatory, with the statistics of wine production in the Bourgogne and Beaujolais regions, and I noticed that the outstanding vintages coincided precisely with the year of recrudescence solar activity.

On this topic, Professor d'Arsonval agreed to present in my

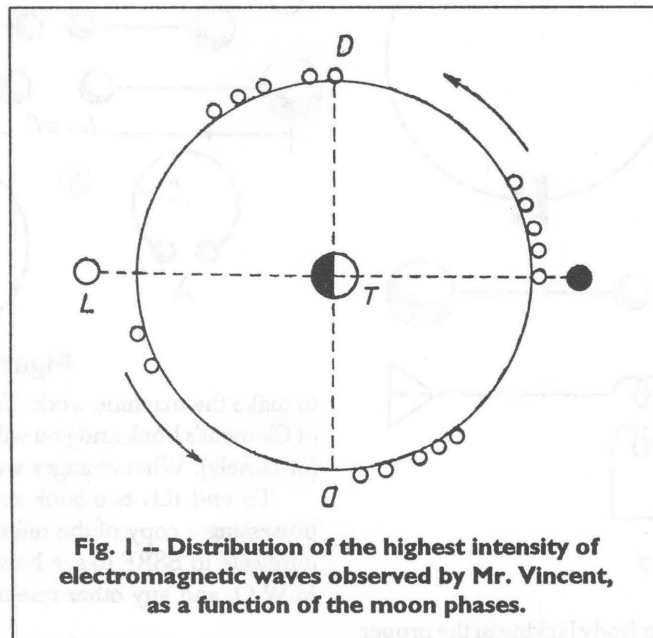

Fig. 1 -- Distribution of the highest intensity of electromagnetic waves observed by Mr. Vincent, as a function of the moon phases.

1. L'universon, p.127, Gauthiers Villars publishers

name at the Academie des Sciences (Academy of Sciences) on March 28, 1927, an original report entitled Influence of Cosmic Waves On The Oscillations Of Living Cells which is entirely reproduced here.

INFLUENCE OF COSMIC WAVES ON THE OSCILLATION OF LIVING CELLS

(Paper by Mr. Georges Lakhovsky, presented on March 28, 1927 to the Academie des Sciences (Academy of Science) by Professor d'Arsonval.)

In my book The Origin of Life, Radiation and Living Beings, that Professor D'Arsonval did me the honor to present to the Academie des Sciences (Academy of Science), at the sitting of the 15th of February 1926, I exposed my theory about the influence of (cosmic) penetrating radiations on living beings. As a matter of fact, I demonstrated that the nucleus of each living cell, having the form of a tubular filament made of a dielectric matter filled with a conductive substance, could be compared to an oscillating circuit, equipped with self-inductances, electric resistance and capacity. The living cells can thus oscillate at very high frequencies under the influence of cosmic radiation emitted by stars.

I made certain to verify the exactness of this theory by studying the influence of cosmic radiations (sun-spots, comets, interferences of stars' radiations, etc...) on biological matter.

My observations were based on the curves recorded by the astrophysicists of the Meudon Observatoire, curves which revealed since 1845 the activities of the sun-spots, the frequency of magnetic disturbances, and the frequency of aurora borealis -- northern lights.

These three curves are appreciably parallel. I endeavored to study the existing correlation between these cosmic radiations, on the one hand, and the development of vital activity in the plant and animal domains, on the other. As for any given individual, periods of fatigue and illness alternate with periods of health, in the same way there is, for fruit and crops in general, for each species, years of good quality and years of rather mediocre quality.

As to what concerns wine, according to the documentation established by the Chambers of Commerce of the Bordeaux and Bourgogne regions, I observed that, from 1845 until 1915, the outstanding vintages corresponded exactly to the highest activity of the sun-spots, as shown by the curves on Figure 2.

The results for red Bordeaux wines are:
 Maximum of 1848: outstanding vintages of 1847 and 1848;
 Maximum of 1858: outstanding vintages of 1857 and 1858;
 Maximum of 1869: outstanding vintages of 1869 and 1870;
 From 1880 to 1889: period of phylloxera.
 Maximum of 1893: rather good vintages of 1890 and 1893;
 Maximum of 1906: good vintages of 1906 and 1907.

In addition, let's point out that the wine of 1811 was called the wine of the comet, and we could ascribe its excellent quality to this comet's radiation. It is the same with white Bordeaux and Bourgogne wines.

I am sure that there are many other biological phenomena which recur periodically after a few years or a few centuries as a function of the relative revolution of the earth around the stars. I am convinced that all the scourges which ravaged humanity during the Middle-Ages: plague, leprosy, cholera, etc... and disappeared thereafter without traces in other regions will reappear some day, when the earth shall once more occupy the same position as then in relation to the stars, producing thus by interference with the cosmic waves the same oscillatory imbalances of the cells, which at that time, had produced these same diseases.

Fortunately till then, thanks to the oscillating circuits and the new methods that scientific discoveries will put to our disposal without delay, we'll be in a position to fight victoriously against these illnesses provoked by the interference of the stars' radiations.

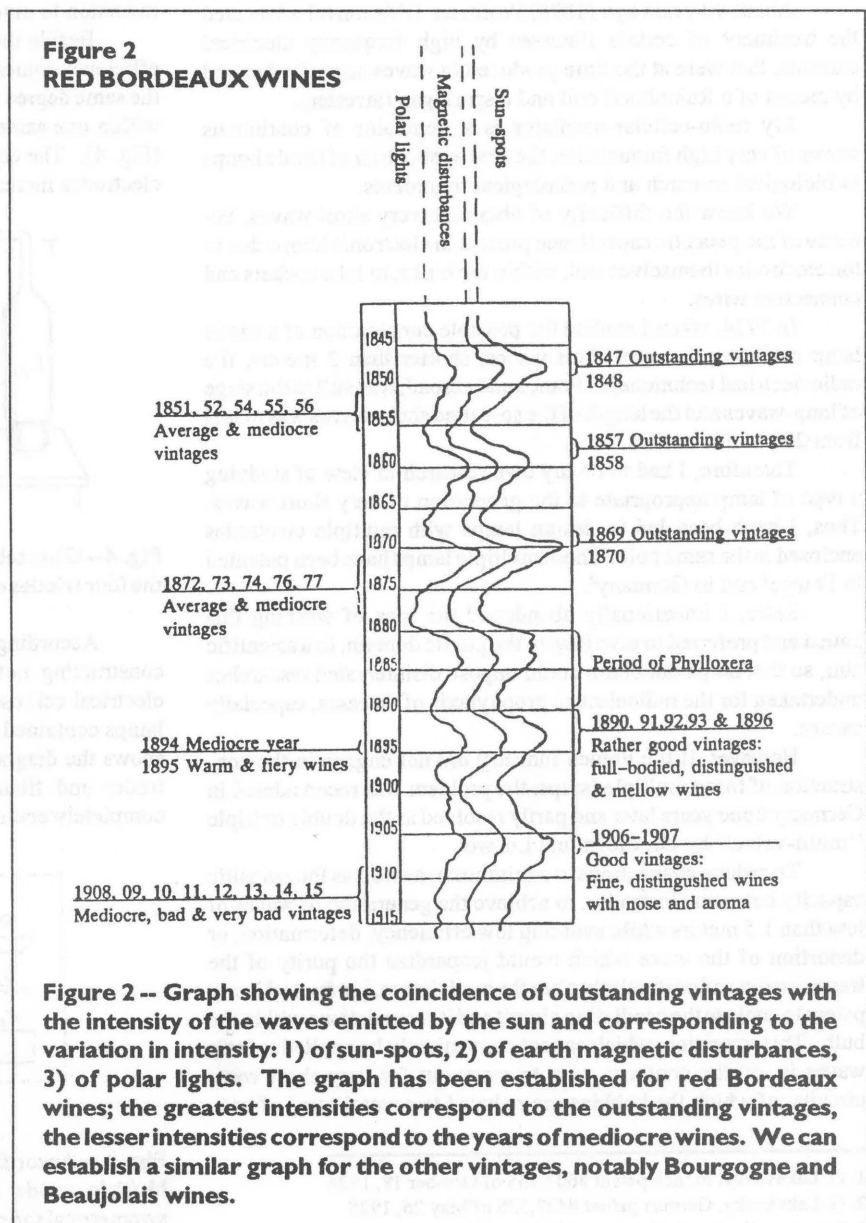

THE RADIO-CELLULAR-OSCILLATOR AND ITS APPLICATIONS

by Georges Lakhovsky

Part 3, Chapter 2, from *La Science et le Bonheur*, Paris 1930

I demonstrated in the last chapter, how, according to my cellular oscillation theory, alteration in organic tissues came from a variation in the intensity of the cosmic waves' radiations and from these waves' frequency, thus causing the oscillation of the cells.

To reestablish the balance of these natural astral fields, the radiation of which we can no more directly influence, than a meteorologist can influence the weather, I thought of using a local oscillator, generating waves and creating an artificial and auxiliary magnetic field.

Incidentally, I should add that this method is analogous to the methods used in radiotelegraphy, known as heterodyne and super-heterodyne methods. These methods use the interferences produced between the waves received and the waves generated by the local generator at the required frequency and intensity.

About 40 years ago (1890) Professor D'Arsonval advocated the treatment of certain illnesses by high frequency electrical currents, that were at the time produced in waves strongly damped by means of a Ruhmkorff coil and a spark gap (arrestor).

My radio-cellular-oscillator is a generator of continuous waves of very high frequencies, the first application of triode lamps to biological research and pathological treatments.

We know the difficulty of obtaining very short waves, because of the parasitic capacitance present in electronic lamps due to the electrodes themselves and, within the bulbs, to tube sockets and connective wires.

In 1924, when I studied the possible construction of a triode lamp oscillator for very short waves, shorter than 2 meters, the radioelectrical technique, in France and abroad, was still at the stage of long-waves and the length of the so-called short-waves was in fact from 200 to 500 meters.

Therefore, I had to do my own research in view of studying a type of lamp appropriate to the generation of very short waves. Thus, I have been led to design lamps with multiple electrodes enclosed in the same bulb. These multiple lamps have been patented in France¹ and in Germany².

Later, I intentionally abandoned the idea of working this patent and preferred to give it up to the public domain, in a scientific aim, so that no patent claim could oppose disinterested researches undertaken for the radioelectric prophylaxis of diseases, especially cancer.

However, if the French industry did not engage in the construction of these multiple lamps, the problem was reconsidered in Germany three years later and partly resolved as the double or triple "multi-valve" by Dr. Siegmund Loewe³.

To reduce connections to a minimum, as well as the parasitic capacity between electrodes, to achieve the generation of waves of less than 1.5 meters while avoiding low efficiency, deformation, or distortion of the wave which would jeopardize the purity of the transmission and particularly alter the modulation, I proposed in my patent to enclose the oscillating circuit and its connections within the bulb. This invention, which cannot conveniently be applied to long waves is, on the contrary, easy to carry out for very short wave circuits, of which the bobbins are reduced to several turns of coil,

even to a fraction of a turn, and of which the condensers have a very small capacity (Fig. 3).

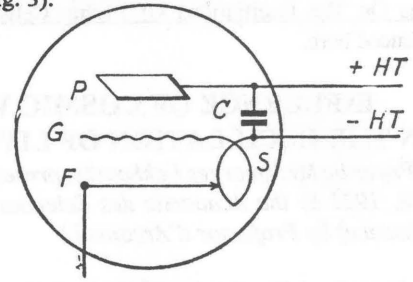

Fig. 3 -- Triode generator of very short waves, after the original drawing of Lakhovsky's patent.

Practically, the oscillating circuit only includes a turn of several centimeters in diameter. The only connections getting out of the tube are the feeders, bringing in the plate voltage (anode voltage) and the heating current (thermo-current).

These tubes can generate oscillations and transmit them by induction to outer circuits (aerials, loops, antennas).

Beside the practical simplification, the improvement of the efficiency comes from the fact that all electronic elements work with the same degree of vacuum. This is what I observed when I grouped within one same glass tubing the bulbs of a 4 triode lamp device (Fig. 4). The equal distribution of the vacuum among the various electrodes increases the purity and stabilizes the functioning.

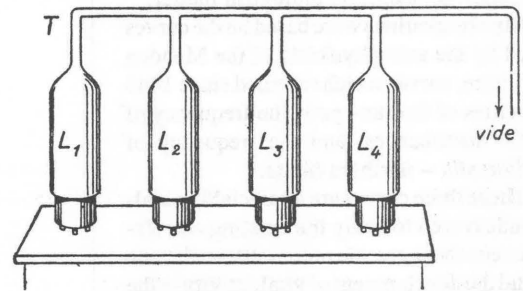

Fig. 4 -- Glass tube T helps maintain the same vacuum pressure inside the four triodes of a classic resonance receiver. Author's realization.

According to this principle, I indicated the possibility of constructing not only a certain number of simple or multiple electrical cell oscillators but also all kinds of triodes or electronic lamps contained in a same bulb. Figure 5, quoted from my patent, shows the diagram of a symmetrical oscillator, with double electrodes and filaments connected in parallel. This oscillator is completely enclosed in a same casing.

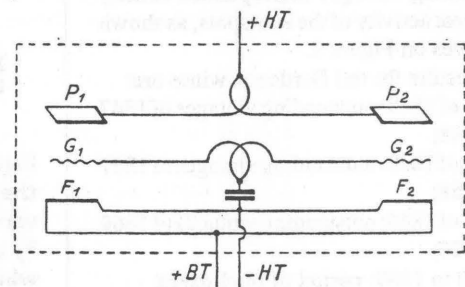

Fig. 5 -- According to the original drawing of the author's patent. Multiple triode including inside the bulb the connections of a symmetrical short-wave transmitter, with filaments set up in parallel.

1. G. Lakhovsky. French patent #601,155 of October 18, 1924
 2. G. Lakhovsky. German patent #427,596 of May 26, 1925
 3. Patent application in France on May 7, 1927

Figure 6, also taken from my patent, presents a double, symmetrical oscillator of which the filaments are connected in series. A possible tuning condenser is anticipated, which would be placed in the same vacuumed bulb as the electrodes and turns of the circuit.

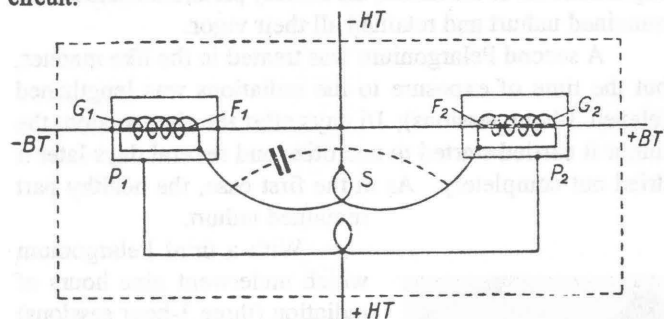

Fig. 6 -- Multiple triode symmetrically connected with filaments in series, according to the original drawing of the author's patent.

Figure 7 shows the case of a double oscillator with a unique filament.

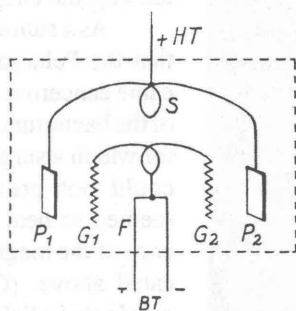

Fig. 7 -- Double triode multiple lamp with symmetrical connections and a single filament, according to the original drawing of the author's patent.

For long-waves, moreover, I indicated the possibility of putting together the circuits outside the bulb.

These various constructions are extremely general. We know that for all practical purposes Dr. Loewe has only introduced resistances and capacitances inside his multiple lamps, reducing therefore its use to low and high frequencies amplifications of long waves. These lamps' efficiency is bound to be rather mediocre for the following reasons: great connection resistances, strong plate voltage (about 160 to 200 volts), and impossibility to stabilize the circuits and cause a resonance.

On the contrary, I always anticipated inner couplings through bobbins and capacitances ensuring the greatest efficiency. The resonance is obtained through a variable condenser inside the lamp and commanded from outside without any mechanical element. For example, if you use the gravity field, it suffices to place a counterweight on the sliding condenser and to direct the lamp in space. Or you can use a magnetic field produced by a magnet or an electromagnet. (Fig. 8).

I indicated the means of building an oscillator of good efficiency for ultra-short waves, with the possibility to tune it into a whole range of frequencies.

To resolve this problem on a practical level, before people started to produce multiple lamps, I used a symmetrical oscillator including two triode lamps. It is the radio-cellular-oscillator which I used in 1924, at the wards of the Saltpetriere Hospital in Paris, to

treat and heal geraniums inoculated with experimental plant cancer.

Fig. 8 -- Variable sliding condenser M, balanced with a counterweight W within a triode lamp, according to the original drawing in author's patent.

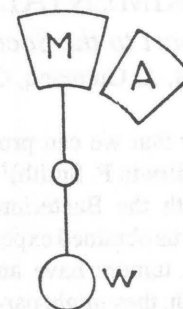

The simplified diagram of the radio-cellular-oscillator is indicated in Figure 9 (Mesny set-up).

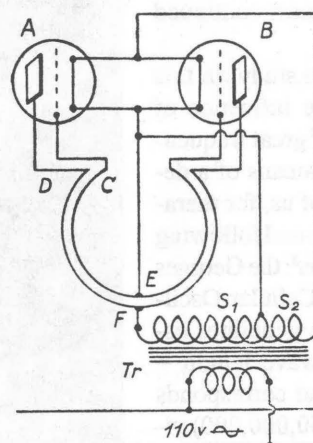

Fig. 9 -- Simplified diagram of the Lakhovsky radio-cellular-oscillator.

Plates, grids and filaments parallel connected. The grids and plates circuits all comprise one turn. These two turns are variably coupled between them. Plates and filaments are directly supplied with alternating current of the mains by means of the appropriate transformer. In these conditions, the transmission of waves starts as soon as the plug is connected onto the mains. By using a tuning condenser, one can produce the entire range of waves of a length comprised between 2 and 10 meters. The supply of alternating current creates a great number of harmonics with which the oscillations of the various cells can enter into resonance. The fundamental wave length can moreover be regulated according to the nature of the cells to be treated.

The biological role of the radio-cellular-oscillator is to reestablish the oscillatory equilibrium of the living cell, threatened by any alteration, and in particular by neighboring microbes. When it resumes its normal vigor, thanks to the auxiliary radiation of the radio-cellular-oscillator, the cell can destroy the microbe itself by damping down its pernicious radiations.

The fundamental experiment I presented at the Saltpetriere Hospital demonstrates the functioning of the radio-cellular-oscillator. It dealt with cancerous plants inoculated according to Erwin Smith's method.

This fundamental experiment was the subject, on the 26th of July 1924, of a report to the Societe de Biologie (Society of Biology) and it is reproduced here in extenso, from the society's newsletter.

ATTEMPT AT TREATMENT OF EXPERIMENTAL PLANT CANCER

Report to the Society of Biology

by A. Gosset, A. Gutmann, G. Lakhovsky, J. Magrou

We know that we can produce tumors comparable to animal cancer (Erwin F. Smith)¹ on various plants, by inoculating them with the *Bacterium tumefaciens*. Using this method², one of us obtained experimentally a great number of tumors. These tumors have an indefinite growth; they might partially necrotize but they only die completely when the entire plant or at least the branch infected by the tumor has succumbed to the cachexia. Even when surgically removed, these tumors continued to proliferate.

We intend to study, in this present report, the influence of magnetic waves of great frequencies, obtained by means of a device built by one of us, for therapeutic applications and following his theoretical views³: the Georges Lakhovsky Radio-Cellular-Oscillator. This device generates oscillations of a λ wave length = about 2 meters, and corresponds to 150 millions (150,000,000) vibrations per second.

A first plant (*Pelargonium zonatum*) has been experimented with a month after its inoculation with *Bacterium tumefaciens*; it showed at that point several, small, white tumors, of the approximate volume of a cherry kernel. The plant has been exposed twice to the radiation, with a 24-hour break and during three hours each time.

In the days following the treatment, the tumor continued to grow rapidly, like the check sample tumors, forming a great plurilobate mass. About sixteen days later, after the first treatment day, the tumor suddenly started to necrotize. A few days later (about 15 days) the necrosis was complete; the lobes of the tumor, retracted and completely dried out, separated from the stalk bearing them, through furrows of elimination,



Fig. 10 -- Sight of the tumor of an untreated witness check sample. -- Subject: *Pelargonium zonatum* inoculated April 10, 1924. We see the growth of the cancerous tumor on the stalk. (*Clinique Chirurgicale de la Saltpetriere*).

1. Erwin F. Smith, *An Introduction to Bacterial Diseases of Plants*, 1st vol., Philadelphia and London 1920.

2. J. Magrou, *Revue de pathologie comparee*, March 1924. Two other reports will be soon published in the *Revue de pathologie vegetale et d'entomologie agricole* and in the *Annales de l'Institut Pasteur*.

3. Georges Lakhovsky, *Radio-revue*, November 1923 and Conference to *L'Ecole Superieure des P.T.T.*, June 2nd, 1924.

and the tumor could be taken off by the slightest traction. The necrosis effect of the radiation was extremely elective, limited only to the cancerous tissues which it followed into the very depth and root of the tumor; the healthy parts, stalk and leaves remained unhurt and retained all their vigor.

A second *Pelargonium* was treated in the like manner, but the time of exposure to the radiations was lengthened (eleven 3-hour sessions); 16 days after the first session, the tumor it carried started to necrotize and several days later it dried out completely. As in the first case, the healthy part remained unhurt.

With a third *Pelargonium* which underwent nine hours of radiation (three 3-hour sessions) the necrosis of the tumor's lobes followed the same path.

Sixteen control *Pelargonium*s remained untreated. All bore tumors in full activity which often became enormous.

As a summary, we may say that the *Pelargonium* which became cancerous after inoculation of the bacterium *tumefaciens* and for which a surgical intervention could not prevent recurrence seemed to heal under the influence of the magnetic waves indicated above. (*Clinique Chirurgicale de la Saltpetriere*.)

A very clear conclusion can be drawn from this experiment and its counterpart.

On the one side, we observe that, on the control subjects, inoculated with the *Bacterium tumefaciens* and left untreated, enormous tumors grew which by absorbing the plants' vital energy lead them to a quick and certain death.

On the other hand, the plants treated by the radio-cellular-oscillator, and moreover taken at random from among the inoculated subjects, have been healed quickly and acquired a considerable vitality, as is proven by their growth, their continual development and abundant flowering.

We can see it in the photograph (Figure 12), taken one year after the healing of the geranium.

My theory of cellular oscillation, that I had moreover proposed before I realized this experiment, enables us to understand cancer pathology and to direct its therapy onto a new path.

Cancer, mostly reaching older people, comes from the ageing of tissues as a result of the cells and blood decay. This impairing of the cells results from a modification of the

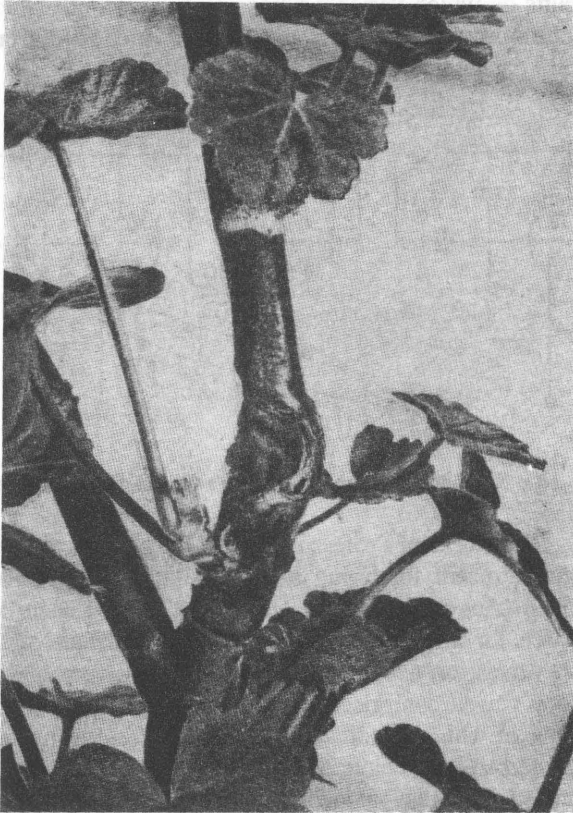

Fig. 11 Sight of the scar of the treated subject. Subject: *Pelargonium zonatum*, inoculated April 10, 1924 with the *Bacterium tumefaciens*, treated from May 24, to June 14, 1924, during eleven three-hour sessions with the Lakhovsky oscillator with antennas, photographed after it healed on July 24, 1924. (*Clinique Chirurgicale de la Saltpetriere*).

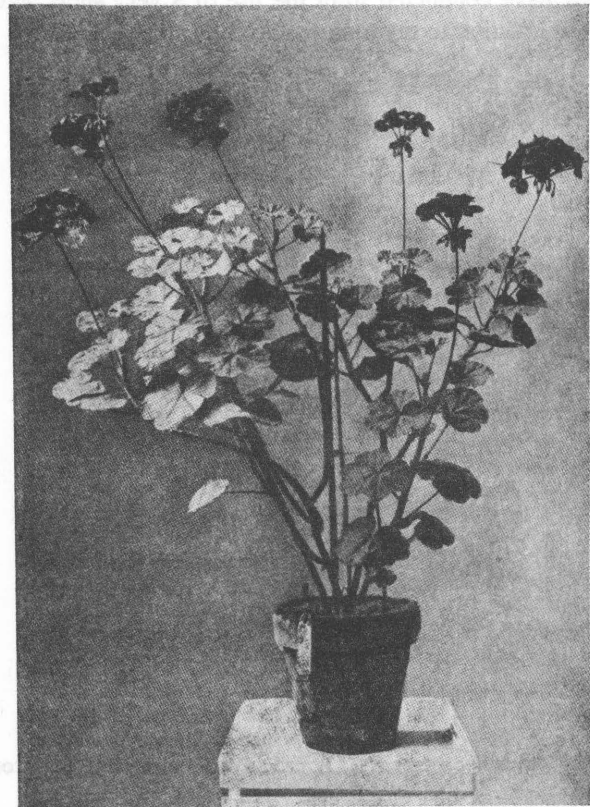

Figure 12 Sight of the treated subject after healing. — This pelargonium is no other than the one of Figure 10, treated by the Lakhovsky oscillator, on May 24, 1924, healed on the 4th of June, 1924, and photographed in July 1925. As you can see, this plant is in perfect health and abundantly flowered. On the other hand, the sixteen inoculated but untreated check samples died long ago.

chemical composition due to the contribution of foreign bodies which appear as residues of the organism. Such are, for instance, blood haematoblasts, rich in iron and phosphorus, produced by residues of fibrin, leucocytes, and hematites. Each cell destruction brings with it a small mass of cholesterol, an insulating substance forming the armature of the nuclear filament, which later clogs the nucleus. Therefore older people first experience a decrease in the number of active cells and of the white and red corpuscles, which is reflected in the regression of the blood count, and on the other hand, an increase of the quantity of mineral (iron, phosphorus, haematoblasts) and organic (cholesterol) residues. These chemical modifications of the cell result in the variation of the cellular oscillation both in intensity, as a consequence of the changes of electric conductivity and resistance, and in the radiation frequency, because of the changes of capacitance and inductance.

The decayed cell appears like a pendulum with a pendulum-bob one could have lengthened, shortened or damaged. This oscillatory disorder provokes, because of the excess of cosmic waves, a too rapid cellular division, which results in the formation of neoplasms, or cells vibrating at a different frequency from the regular frequency of the tissue.

For long years, it has been wondered whether cancer is contagious and hereditary, or whether it is caused by a microbe. Histological analyses seem to invalidate the existence of a microbe. On the other hand, inoculations of cancer only succeed, and moreover very rarely, with impaired tissues composed of abnormal cells, such as certain moles and this would seem to ruin the hypothesis of contagion and heredity.

In fact, I believe that the true cancer microbe is the neoplastic cell which forces the neighboring cells into oscillating at its own frequency, thus transforming by electromagnetic induction, the healthy cells into neoplasms. To prevent cancer, is to prevent this neoplastic induction and to give back the healthy cell enough vigor to reestablish its oscillatory equilibrium.

I was pleased to observe that, apart from the skepticism of a few, my experiments have been taken up again with great success in France and abroad by various scientists and practitioners who understood the future of oscillation therapeutics.

It seems appropriate to quote the works pursued in Germany by Professor Esau at the Technisch-Psychisches Institut of Iena.

Although directed toward paths sometimes very different from mine, these works present a very clear analogy with

those I have conducted from the use of a very short wave oscillator similar to my radio-cellular-oscillator.

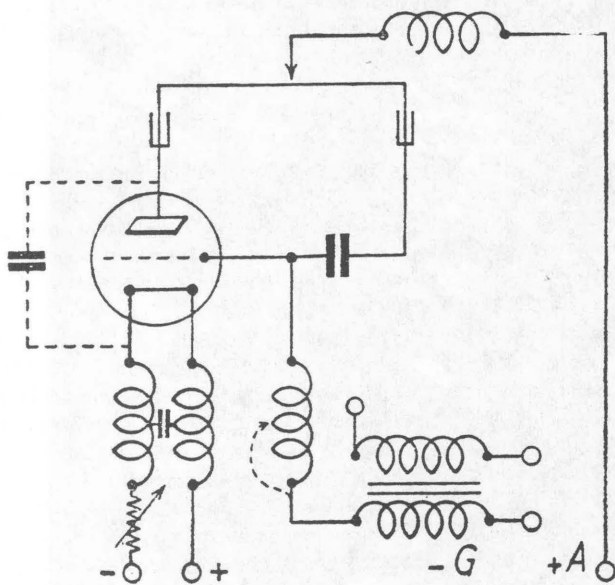

Fig. 13 -- Simplified diagram of Dr. Esau's very short wave oscillator.

The transmitter-receivers used by Professor Esau do not essentially differ from the devices I advocated. I indicated moreover that connections were irrelevant as long as they produced the desired very short waves. Professor Esau's connections, which were described in the technical magazines of Dr. Ernest Busse, assistant at the Ieana Institute⁴, are characterized by the use of a single triode lamp, functioning in direct current. The transmitter's filament (Fig. 13) is supplied through a filter preventing high frequency back currents. The coils are simple fractions of turns, as in the radio-cellular-oscillator, which only includes about half a turn for each oscillating circuit.

A test receiver (Fig. 14) is provided with square loop

circuits on which variable plugs can be installed. Another device is provided with a circular turn, of which a radial cursor allows connection to the necessary position.

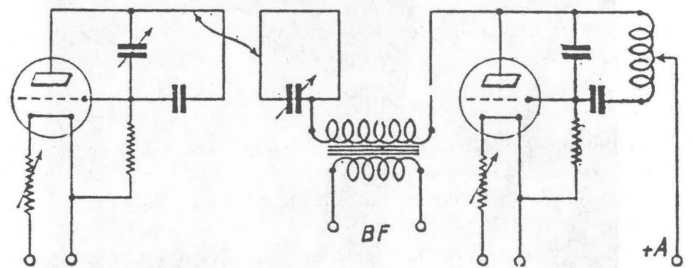

Fig. 14 -- Simplified diagram of Dr. Esau's very short wave receiver.

The works of Professor Esau in the biological domain are rather recent, for during the Radio-electric Symposium in Bremen (August 1928)⁵, he stated that he had been doing research, for only a year, on the physiological effects of *ultra-short* waves, or, according to his definition, very high frequency waves comprised between a length of 1.50 and 3 meters, of which I indicated the use in 1924 in my report addressed to the Societe de Biologie, reproduced here. He indicated then that since July 1928, he successfully constructed a very short wave receiver.

About this subject Professor Esau pointed to the fact that the main difficulties came from the electronic lamps, and that he had to use foreign lamps, particularly French lamps, which are more appropriate for very short waves techniques. I indicated earlier that, 4 years before, I had studied and had these special short-wave lamps built, which were designed for my radio-cellular-oscillator.

I shall also point out that a very short transmitter has recently been used by Dr. Frantz Seidel from Vienna, for the destruction of bacteria, particularly in the sterilization of milk.⁶ This subject will be investigated at a later time.

4. Dr. Ernest Busse, *Die Erzeugung ultrakurzer Wellen.* (*Radio-Welt*, No. 49, 1928, p. 77. Vienna.)

5. Oscar Gadamer, *The ultra-short waves and their field of application.* (*Der Deutsche Rundfunk*, August 31, 1928, t. VI, p. 240, Berlin.)

6. *Les ondes ultra-courte contre les bacteries.* (*Radio-Welt*, January 27, 1929, No. 4, p. 108, Vienna.)

LAKHOVSKY'S VIBRATORY CIRCLE

Author Unknown, Source: BSRF files

Translated from the German by Bodo Capeller, 1988

"We owe to magic all progress in physics and chemistry."

(Jules Lermna, 1915)

The Paris professor with the Russian name Georges Lakhovsky claims to capture, with so called open vibratory circuits (circuits oscillants), cosmic waves and pass them on to humans (neck antenna) and plants. Healing of people has been verified by French and Italian medical practitioners, healing of Cancer injected plants has been proven through photographic records.

The vibratory circles are manufactured from heavy copper wire with a diameter of 5-10 millimeters. Those wires 5-8 millimeters in diameter had a more pronounced effect than the much thinner variety. The spiral (of the open ended circle), which can be single or double, is guided around the plant and is supposed to be insulated against its support by "Ebonit" (1).

Instead of copper wire medical practitioner Dr. Ernst Busse (Garmisch, Germany) recommends the use of thin copper tubing: "because of the short wavelength of cosmic vibration only the surface effect (skin effect) is effective (that means electricity is only present on the surface of a conductor, not in the middle) which requires the use of maximum surface area. Besides this the tubing is easier to work with and has less weight. (Private Correspondence 1/10/1953)

Helmut Friedensdorff (Berlin, Germany) did report already in 1932, from himself as well as others, on the effectiveness of an open vibratory circuit against lumbago among other ailments. He inserted a simple isolated copper wire into surgical tubing and positioned it at the problem spot in a manner that both wire ends did not touch(2).

Canon Smythe of Great Britain did proceed in a similar manner: "The only tools required are a one meter length of flexible electrical wire and a sidereal pendulum. The insulation is removed at both ends for a length of 2 centimeters, the wire is stripped and the wire strands are removed except a single strand. Then the wire is laid out on a table and the pendulum is positioned over the wire ends. It will rotate over the positive end in a clockwise motion, over the negative end in reverse. Then one proceeds to make a knot at the negative end for identification purposes. It should be positioned on the left side of the body or in the vicinity of the leg, the bare wire pointing to the left. The wire may be installed over the clothing and can be braided or fastened with safety pins, the ends should point into the proper direction.

"Arthritis in one toe should be treated by using the wire like a stocking holder wound around the leg where the knotted end will point to the left. The author makes no claims for the healing arthritis but reports a lessening of pain.

"With severe headaches the wire is wound just above the eye level around the head so that the negative end rests over the left temple.

"Severe coughing is treated with one wire around the throat, another one around the abdomen.

A just started cold is removed by our associate in a few hours with two wires, one with the positive connected to the negative end of the next wire joined as a 2 meter long wire. "I wound the wire over the shirt under a sweater around the chest until I reached under the arm pits and made sure that the negative end is on left side of the chest pointing to the left, the positive end pointing the opposite way.

Smythe published this in a paper many years ago called "The Other Half of Medicine". He is supported by the research of a recently deceased friend, Dr. Martin of Airaines, France who had been promoted to the medical faculty in Paris in 1932 with a dissertation "Diagnostic Radiesthesique en medecine veterinaire" under the tutelage of Professor Nathering—without an examination! In 1935 a Dr. Girard presented a similar thesis before the University at Lyon.

Medical practitioner Arnold Mannlicher (1880-1958) from Salzburg carried in his rear pocket an open vibratory circuit which also acted as a cell detector.

Vibratory circuits proliferated after the announcements by Lakhovsky's discovery as "throat antennas, broadcast jewelry and healing chains" in the market place. I cannot say at the moment if they were of the open or closed kind. Apparently between the two kinds exists a fundamental difference in their effectiveness, open circuits reduce the tension within the body, closed circuits raise it. A closed broadcast chain can easily be transformed into an open one when it is opened and is closed with an insulator in-between (rubber band, silk thread).

The open circuit is nothing new at all. Dr. Beck, former head of the municipal children's clinic in Bayreuth says: "the open bronze rings of the Hallstadt area from grave sites can be understood as protection against radiation effects very similar to the rings worn by the Negro tribes around the arms, legs and throat." The ancient Germans wore "broadcast jewelry"—in order to coin a modern word—an open solar spiral. Dr. Heermann has revived this. He writes: "invigorating liver and intestines the solar wheel acts like a plated iron spiral with the windings running from the center clockwise."

Smaller—sewn into green material—is my usual aid in stomach ulcers and swollen glands. Underneath his illustration (not shown) the researcher explains: "a spiral ending growth rays to the abdomen"(3).

The never tired Dr. Busse, since 1954 has also tried out open rings beside vibratory chains and belts. Earlier he replaced acupuncture needles

with metal foil band aids and states now in a letter dated 4/19/1954: "instead of metal foil one may arrive at the same effect by wearing open copper rings on certain fingers and joints. When you put a ring that is cut open or manufactured from heavy copper wire on the corresponding finger an immediate change of pulse at the radial pulsation can be observed".

One of his associates who experimented with these open finger rings was surprised by the achieved results.

I am very much indebted to this versatile medical practitioner.

Because copper rings are a tuner (strengthening, invigorating) it was required to find a second metal which reduces organic functions. It turned out to be aluminum. On closed rings it was already reported in the chapter "Amulets". As far as the application of aluminum is concerned the welder Herbert Bauer (born 1921) from Freiburg, Germany has manufactured many years ago the so called "Zelemente". According to the description it was recently manufactured from a three metal alloy which reminds of the "seven metal (electrum magicum)" of Hermetic fame. We are dealing here with closed chains that are supposed to protect from dangerous radiations of technical and cosmic nature and are therefore named "radiation protective antennas." They look flat and are meant to be moistened in the morning and evening.

Whatever the effect is of the vibratory circuit on the world of plants has been shown in 1905 when sick elm trees were healed on a Hamburg street.

The Vienna engineer Lambert Binder (born 1905) caused, during a growth experiment in 1944 on orange trees, accelerated growth by surrounding the tree with an isolated wire spool.

R.E. Esspiau tried out in 1954 the following experiment with the Lakhovsky antenna arrangement. He connected the first on a three stalk head of cabbage to free standing antenna, the second to ground, the third one to water which was replaced every 24 hours. In less than a week the first buds began to form, within four weeks other stalks were formed and developed leaves while a control plant withered away(4).

BIBLIOGRAPHY

- (1) Lakhovsky, Georges: Das Geheimnis des Lebens (Secret of Life), Kosmische Wellen und vitale Schwingungen, Munich 1931. Schroedter, Willy: "Der Drahttring um die Geranie, Frankfurter Illustrierte, #15, 1932, page 356.
- (2) Frensdorff, Helmut: Einfache Mittel gegen Hexenschuss und Gliederschmerzen, "Die Zukunft", #31, Berlin 1932.
- (3) Heermann, Alex, M.D.: Neues von Strahlen, Stroemen und Wellen, Bad Ausee 1935, page 13.
- (4) "La Radiesthesie pour Tous", December 1954, Paris. Schroedter, Willy: Kosmische Strahlen und vitale Schwingungen, "Mensch & Schicksal", #5, 5/15/1953, Villach, page 7.

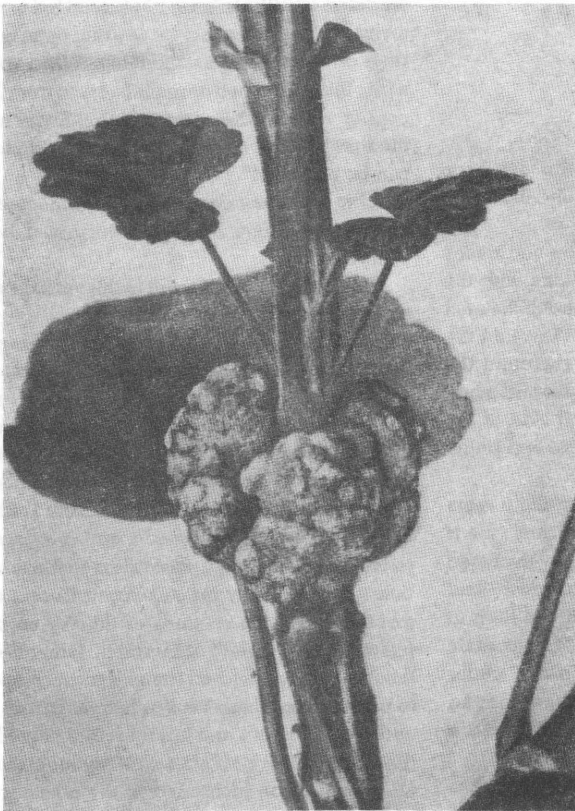

Illustration A: This illustration shows a Lakhovsky experiment on a Cancer infected geranium plant. The cancerous growth is clearly visible. Pelargonium zonatum (Geranium) inoculated with Bacterium tumefaciens on April 10th, 1924 and photographed June 6th, 1924. It will be observed that the stem of the plant bears a massive tumour.

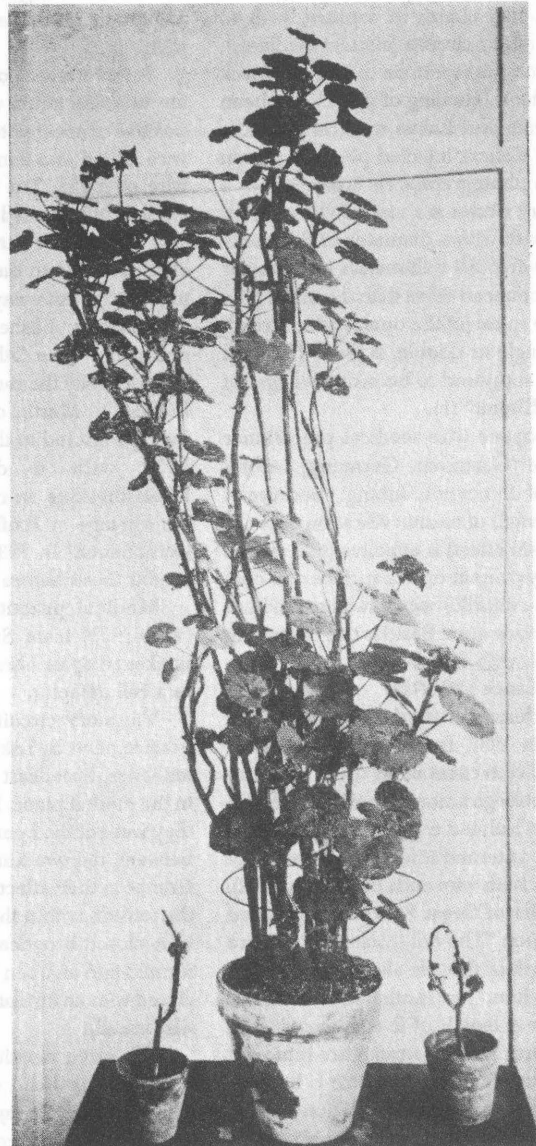

Illustration C: The test plant three years later. The antenna ring has completely healed the plant and protected it from other damage. To the side are two unprotected similar control plants of same age that became victims of the same disease. Photographed on March 13, 1928.

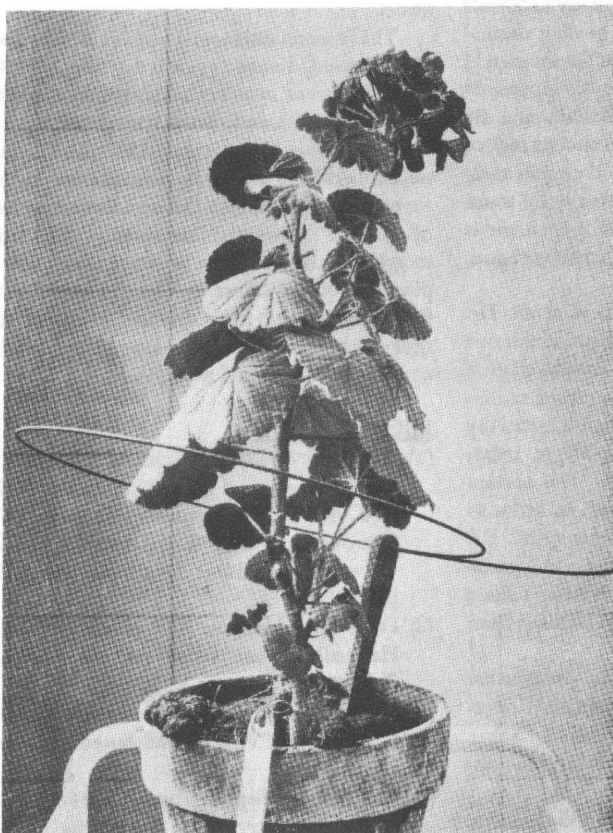

Illustration B: An astounding discovery by Prof. Lakhovsky: a free standing antenna ring manufactured from copper that surrounds the geranium caused the plant to drop the cancerous growth (resting on the rim of the container) and made the plant whole again. Photographed June 1925.

Picture credits: These three illustrations are designated tables II, V, and VII in Lakhovsky's Secret of Life.

THE LAKHOVSKY RADIO-CELLULAR OSCILLATOR

a synopsis by Jorge Resines

What you are about to read is my resume of the book La Science et le Bonheur, Longevite et Immortalite par les vibrations -- *Science and Good Health, Longevity and Immortality Through Vibrations* -- by Georges Lakhovsky. More specifically, this synopsis encompasses Part III, chapters 1 and 2, being pages from 137-171 of said work, and whatever I translate from it will be forwarded by the words "Lakhovsky said:".

Mr. Lakhovsky begins by indicating the influence of heavenly bodies upon all facets of everyday life, from their influence upon the cells up to how magnetic compasses are affected by magnetic storms originating in the Sun (he refers the readership to his book L'Universion, published by Gauthier-Villars of Paris, France). He says that the French Astronomer Mr. Deslandres with his collaborators at the Observatory of Meudon have established a cycle of about 27 days for sunspots affecting both tides and earthquakes. This lapse is part of another larger cycle of 11½ years (or about) that most usually forms in turn part of another, larger, cycle of 33 to 35 years.

Mr. Lakhovsky also discovered, as indicated by the small circles at the lunar orbit of Figure 1, that lunar radiations provoke interferences with the waves broadcasted from radioelectric stations at said marked positions.

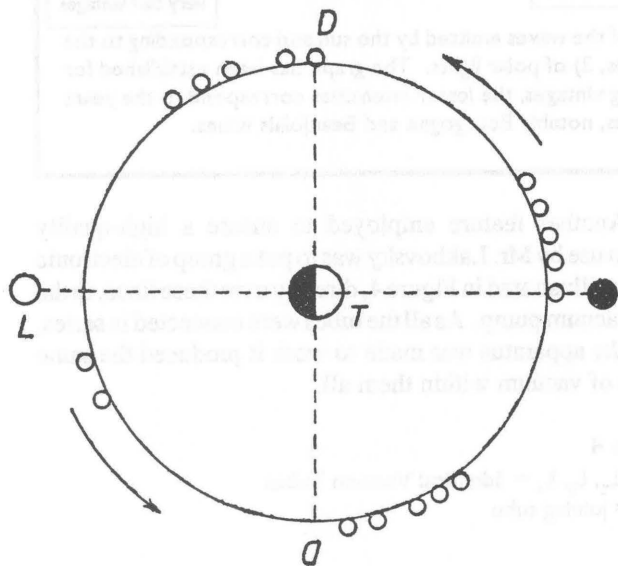

Figure 1

L1 = Full Moon

L2 = Waning Moon

L3 = New (Dark) Moon

T = Earth

L2 = Waning Moon

L4 = Waxing Moon

Carrying his researches a step further, helped also by the people at the Observatory of Meudon, he correlated the highs-and-lows of three different factors (to wit: a. Sunspot activity, b. Perturbations of Terrestrial Magnetism, and c. Polar Aurora) with the type of wines collected at different French regions. For a single zone and type of wine, his findings are

shown in Figure 2 (next page). You will easily notice how the highs of the three factors are in coincidence with the best collections of wines, with a single exception: the 1880-1889 period when the grape-wines were massively attacked at France by the "Phylloxera" plague. Though Mr. Lakhovsky does not explain the reason for this adverse period (when the opposite was expected), he does voice his opinion that cellular and biological phenomena is periodically affected by the same type of radiations (and the generated-sicknesses they produce), proposing at the same time to destroy the scourges by overriding the "astrally-produced radiations" (his words) with this "Radio-Cellular Oscillator."

About the basic concept behind his devices, Lakhovsky said: "To re-establish the balance of these heavenly fields from nature, upon which variations we are able to act directly, unlike Meteorology which cannot make weather change, I will resort to a local oscillating-generator of waves creating an auxiliary artificial electromagnetic field.

"By the way, I must add this method is analogous to that employed in radiotelegraphy and known under the names of heterodyning and superheterodyning. These procedures employ the interferences generated between the received and generated waves by a local generator, at the necessary frequency and intensity."

Mr. Lakhovsky states that his inspiration came from Professor Arsene D'Arsonval, who in 1890 had put forth the opinion that different sicknesses could be eliminated by means of high-frequency currents. He continues on, explaining that by about 1924 he studied the possibility of generating waves under 2 meters in length, but that the electronics of said period considered "short" only those waves from 200 to 500 meters.

To overcome such a hindrance, Lakhovsky developed a vacuum tube with multiple-electrodes and received two patents for it -- French Patent No. 601,155 granted in October 18, 1924 and German Patent No. 427,596 granted in May 26th, 1925 -- afterwards another scientist of that time, Dr. Siegmund Loewe, improved on his ideas and demanded a French Patent on May 07, 1927 (this Patent is not indicated as either granted or not; further investigation is needed here).

Figure 3

+HT = Positive High Voltage

-HT = Negative High Voltage

G = Grid

P = Plate

C = Condenser

S = Loop of Coil

F = Filament

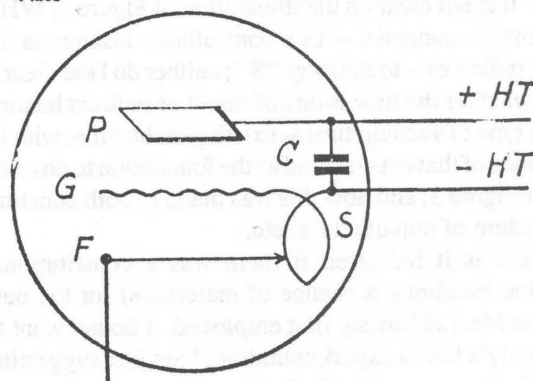
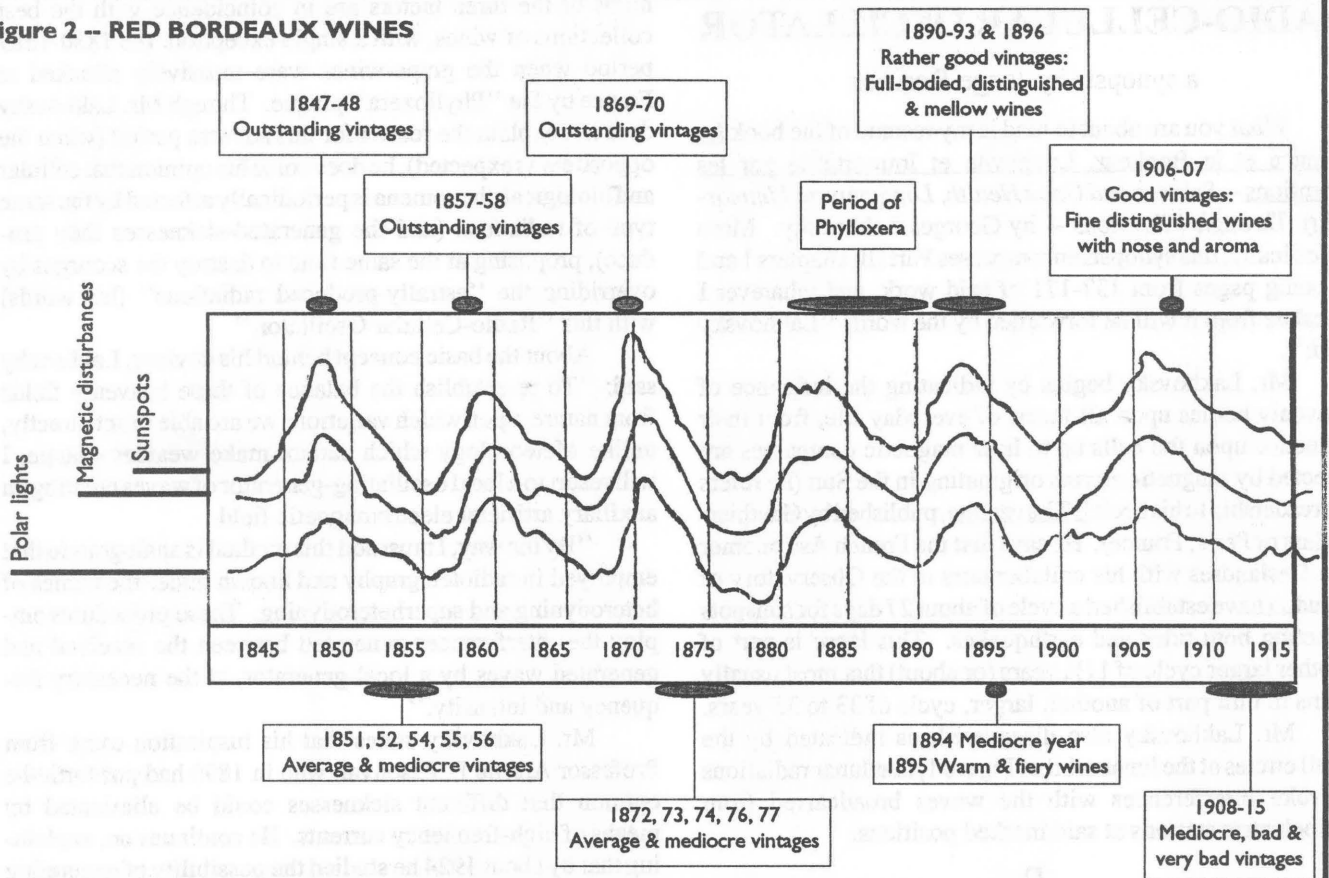

Figure 2 -- RED BORDEAUX WINES



Graph showing the coincidence of outstanding vintages with the intensity of the waves emitted by the sun and corresponding to the variation in the intensity: 1) of sun-spots, 2) of earth magnetic disturbances, 3) of polar lights. The graph has been established for red Bordeaux wines; the greatest intensities correspond to the outstanding vintages, the lesser intensities correspond to the years of mediocre wines. We can establish a similar graph for the other vintages, notably Bourgogne and Beaujolais wines.

To produce waves “under 1½ meters” (his words), Mr. Lakhovsky enclosed within a vacuum tube’s glass vessel different elements, as is seen in Figure 3. About this new type of tube, Lakhovsky said: “The oscillating circuit does not involve but a loop with a diameter of several centimeters. The only connections going out of the tube are the supply-wires, leading the plate-voltage and the heating current. These tubes can generate oscillations and transmit them to external circuits (square-loop antennas) by induction.”

I will stop now the synopsis to introduce a personal comment: It is not clear on the illustration of Figure 3, WHY the filament is connected -- in a controllable fashion as the schematic indicates -- to the loop “S”; neither do I see clearly indicated whether the tube is one of direct or indirect heating and which type of vacuum tube -- existing at the time, with its specifications of that era -- served as the foundation to develop the tube of Figure 3, and how this was made in both constituents, procedure of manufacture, etc.

Neither is it indicated if there was a constitutional modification involving a change of material(s) for the new type of tube Mr. Lakhovsky first employed. I do not want to spoil anybody’s fun in experimentation, I am just suggesting caution... Let’s go on with Mr. Lakhovsky.

Another feature employed to ensure a high-quality when in use by Mr. Lakhovsky was to put a group of electronic tubes, as illustrated in Figure 4, directly over these lines, in the same vacuum pump. As all the tubes were connected in series, when the apparatus was made to work it produced the same degree of vacuum within them all.

Figure 4

L_1, L_2, L_3, L_4 = Identical Vacuum Tubes
 T = joining tube

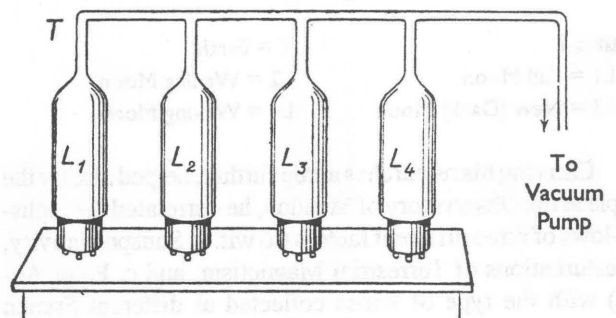

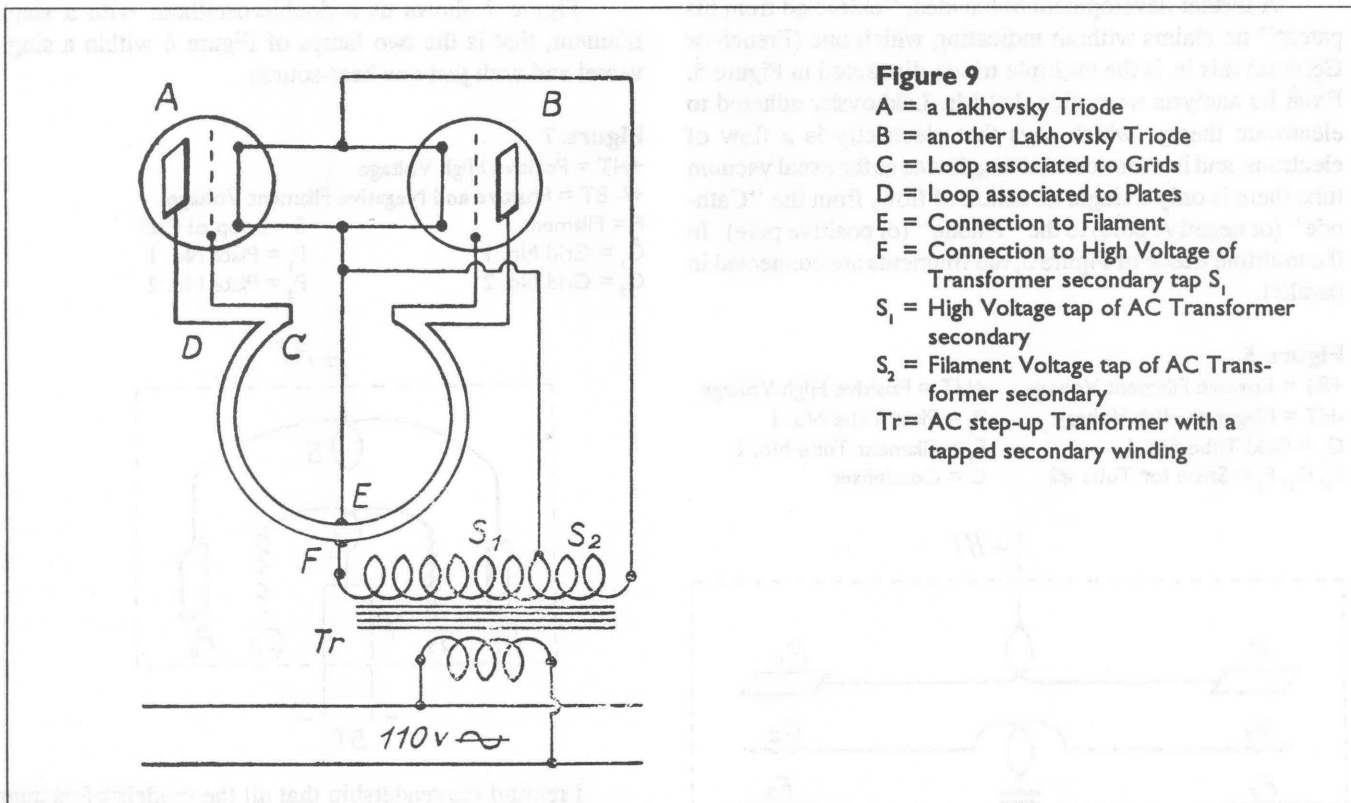

same time he did the same! But Lakhovsky's capacitors are different to the common types.

What he did was to "separate" a variable condenser's blades and to "counterweight" the moving blades, as indicated in Figure 8, so that the blades would move within the fixed armature of the condenser as the whole tube was rotated and weight "W" responded to gravity! He does not indicate, thus making it an object of personal experimentation on the part of the readership, if there was just one or more of these special variable condensers.

Now, in order to produce a wide range of frequencies with only two of his special triodes, Lakhovsky built the "Radio-Cellular Oscillator" that is shown in schematic form in Figure 9, which he used at the Clinic of Salpetriere in 1924 to treat and heal Geranium plants which he experimentally inoculated with the disease of cancer; it was mounted, he says, according to the "Montage Mesny," thus indicating that one man called Mesny originated the setup at that time (this is another source for research, try finding in old books from either the '20s or '30s anything made by a Mr. Mesny).

This is what, on the device, Lakhovsky says: "Plates, grids and filaments are connected in parallel. The circuits of grid and plate have each a single loop. These two loops are coupled variably between themselves. Plates and filaments are fed directly from the Alternating Current of the place by means of the appropriated transformer. Within these conditions, it is produced the emission of waves because it is branched the intake of current upon the electrified section.

"Using, accordingly, a condenser it is possible to produce the whole spectrum of waves between 2 and 10 meters of wavelength. The supply from AC produces a large number

of harmonics upon which can enter into resonance the oscillations of different cells. Therefore, the fundamental wavelength can be regulated according to the nature of those cells to treat.

"The biological role of the Radio-Cellular Oscillator is to re-establish the oscillatory equilibrium in the living cell, under threat by any alteration, particularly by a close microbe. When recovering its normal strength thanks to the auxiliary irradiation from the Radio-Cellular Oscillator, the cell can all-by-itself destroy the microbe by counter-acting its deleterious radiation."

Mr. Lakhovsky goes on indicating that he established the aforementioned concept as the foundation of his device by first inoculating several plants of *Pelargonium zonatum* with the *Bacterium tumefaciens* in order to generate tumors similar to those of animals in plants (his source was: An Introduction to Bacterial Diseases of Plants by Erwin F. Smith, London and Philadelphia, 1920). He was helped with inoculating the plants by Mr. A. Gosset, Mr. A. Gutmann and Mr. J. Magrou, the latter being the one who had more articles published on the subject of plant-inoculation (see the Revue de Pathol. Vegetale et d'entomologie agricole and within that the Annales de L'Institut Pasteur, by this author).

He then applied his Radio-Cellular Oscillator, using waves of about 2 meters, which he equated with a vibration of 150,000,000 cycles per common-second. He broadcasted the oscillator's output upon the infected plants and got them all back to health after a given time. He had already explained how his oscillator worked to his fellow Frenchmen in an article (Radio-Revue, November 1923) and a conference (given at the Ecole Superieur des Postes, Telegraphes and Telephones

Figure 10

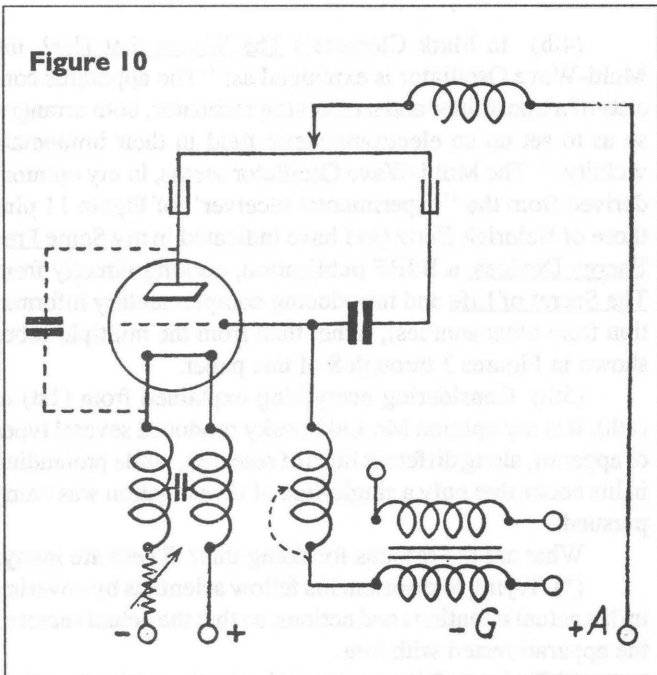

on June 2nd, 1924).

After detailing how the experiment in plant-healing progressed and how the plants were healed, he goes on to explain that -- in his conception -- cancer is provoked by an "aging" of the cells that makes them both reproduce at a slower rate and to evacuate a higher amount of wastes. This, in combination with radiations coming from space at different times, produces an oscillatory disequilibrium in the cells resulting in cancer of different types. Mr. Lakhovsky rejects, on the ground of histological examinations he performed, both the "microbial" theory of cancer and its hereditary transmission.

If you have followed all of the writing up to this point, carefully noting the concepts involved in Lakhovsky's procedures, you will remember that:

(1) His Radio-Cellular Oscillator created an auxiliary electromagnetic field capable of restoring balance to the diseased cell(s) and body.

(2) This was done by means of very short waves (during the period he experimented) of about 2 meters and 150,000,000 cycles per second.

(3) To achieve the necessary shortness of wave he introduced different elements within an evacuated glass-vessel, thus creating a different type of vacuum tube.

(4) He purposely indicated that external elements created long

waves that did NOT comply with what he needed for therapy.

(5) He included, within his special tubes, a variable condenser that could be tuned to the desired capacity by moving the tube in space so that the internal variable capacity could generate the coupling needed in therapy.

If all of this has been, so far, an essential group of conditions necessary to produce the short waves of about 2 meters, then why -- as seen in Figure 9 -- does he place two electrified loops OUTSIDE the vacuum tubes of his special design????

In compliance with this "loops outside" line, he goes on quoting the works by one of many foreign scientists who, he claims, have followed his line of research:

Lakhovsky says: "It is convenient to quote the works made by Professor Esau at Jena's Technisch-Physicalishes Institut (Germany). If they are directed by ways somewhat different to mine, his works show the similitude of using an oscillator of very short waves similar to my Radio-Cellular Oscillator. Professor Esau's emitters and receivers do not differ essentially from the apparatus I champion. I have already indicated that the arrangements of constituents are indifferent, because they produce the very short waves needed.

"The setups by Professor Esau -- described in the Institute's technical magazines by Dr. Ernest Busse (see *Die Erzeugung Ultrakurzer Wellen -- Research on Ultrashort Waves* -- in *Radio Welt*, No. 49, page 77, Vienna, 1928), secretary to the Institute of Jena, are characteristic because they employ a single triode working with DC.

"The emitter's filament -- as seen in Figure 10 -- is fed by a filter preventing the return of high-frequency currents. Windings are made with simple fractions of turns, as in the Radio-Cellular Oscillator, which does not involve but a half-turn per oscillating circuit.

"An experimental receiver (see Figure 11) is supplied with a circuit possessing a single square-loop, upon which can be made variable taps. Another apparatus is possessed of a single circular-loop upon which a radial cursor allows to take just the necessary fraction of circuit.

"Works by Professor Esau in the realm of Biology are very recent, because at the August 1928 Radioelectric Con-

Figure 11

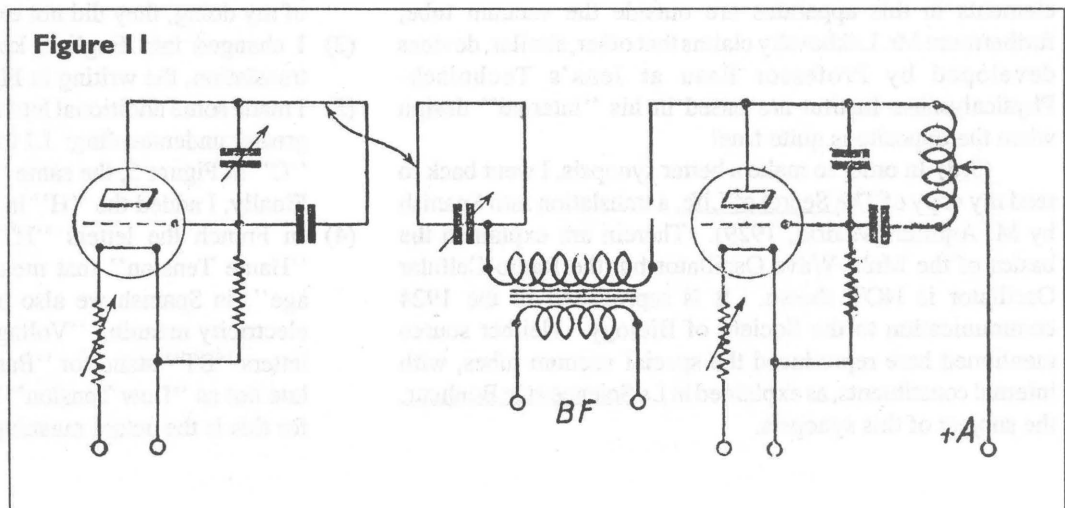

gress of Bremen (see Les ondes ultra-courtes et leur champ d'application -- *Ultrashort-waves and Their Field of Application* -- by Oscar Gadamer in Der Deutsche Rundfunk -- *German Radio* -- of August 31st, 1928, volume VI, page 240, Berlin) this author states that after about a year he investigated the physiological effects of ultrashort-waves that is, according to his definition, waves of very high frequencies between 1½ and 3 meters in length, of which I have indicated how I employ them in a 1924 communication to the Society of Biology (Note: It is on the inoculation and healing of the *Pelargonium zonatum*, as explained on page four of this writing). Prof. Esau then indicated that, since July 1928, he built a receiver of very short waves.

“About this subject, Professor Esau remarked that the main difficulties come from electronic tubes, for he was forced to use foreign tubes, particularly French ones, that are better fitted to the technology of very short waves. I must remind (the readership) that four years before him I studied and had built these special lamps for short waves, to be used in my Radio-Cellular Oscillator.

“I will also point out that an emitter of very short waves has recently been employed by Dr. Franz Seidel of Vienna for destroying bacteria, particularly to sterilize milk (see Les ondes ultra-courtes contre les bacteries -- *Ultra-short Waves Against Bacteria* -- in Radio Welt -- *Radio World*, January 27th, 1929, No. 4, page 108, Vienna).”

We have two definitely contradictory positions in the same chapter dealing with the same type of device:

(1st) In the paragraph translated under Figure 3 of this paper, Lakhovksy emphasized that the elements to produce ultrashort waves (under 2 meters) must be inside the tube. Figures 3 to 8 are dedicated to showing specific constituents for this special type of tube. Though he only speaks on Triodes, there is no reason to suppose he did not experiment with Tetrode and Pentode tubes (plus others of his own design not usually covered in publicly available technical literature).

(2nd) The formerly-indicated conditions change radically when he speaks of his experimental device employed to eliminate tumors affecting inoculated plants, this being the device of Figure 9 of this paper. Notice how the emitting elements in this apparatus are outside the vacuum tube; furthermore Mr. Lakhovsky claims that other, similar, devices developed by Professor Esau at Jena's Technisch-Physicalysches Institut are based in his “internal” design when the opposite is quite true!

(3rd) In order to make a better synopsis, I went back to read my copy of The Secret of Life, a translation into Spanish by M. Aquilar (Madrid, 1929). Therein are explained the basics of the Multi-Wave Oscillator but the Radio-Cellular Oscillator is NOT shown. It is reproduced in the 1924 communication to the Society of Biology. Neither source mentioned here reproduced the special vacuum tubes, with internal constituents, as explained in La Science et le Bonheur, the subject of this synopsis.

(4th) In Mark Clement's The Waves that Heal, the Multi-Wave Oscillator is explained as: “The apparatus consists of a transmitter and a receiving resonator, both arranged so as to set up an electromagnetic field in their immediate vicinity.” The Multi-Wave Oscillator seems, in my opinion, derived from the “experimental receiver” of Figure 11 plus those of Heinrich Hertz (as I have indicated in my Some Free Energy Devices, a BSRF publication, quoting directly from The Secret of Life and introducing complementary information from other sources), rather than from the multiple-tubes shown in Figures 3 through 8 of this paper.

(5th) Considering everything explained from (1st) to (4th), it is my opinion Mr. Lakhovsky produced several types of apparatus, along different lines of research, while pretending in his books that only a single-line of investigation was being pursued.

What are the reasons for doing this? There are many:

(*) Trying to disorient his fellow scientists by covering up his actual intentions and actions, so that the actual secret of the apparatus rested with him.

(*) Trying to foil any attempt by the “organised medical profession” to steal his “secret” -- whatever this could actually be.

(*) Having discovered something that he wanted to keep for himself in the course of his researches. This is, in my opinion, the most likely possibility, for Mr. Lakhovsky's researches were well-received in Europe, South America and Asia before WWII began. Even more, he was outspokenly backed by men of science and Academies of great reputation and his enemies were very few (outside of the USA, of course....).

I do not mean to slander him and his researches, I just want to indicate the necessity for greater and deeper research into what he did from all possible sources of information.

VERY IMPORTANT NOTE

In order to facilitate the understanding of the illustrations, I have taken a few liberties to aid the non-French speaking associates:

- (1) All the “lateral letterings” from Figure 3 to Figure 9 are of my doing, they did not exist in the original text.
- (2) I changed into English, keeping the true meaning in translation, the writing in Figure 2.
- (3) I made some additional lettering in some illustrations for greater understanding: L1 to L4 in Figure 1; I added the “C” in Figure 5, the same “C” was added in Figure 6; Finally, I added the “H” in Figure 8 for greater clarity.
- (4) In French the letters “HT” are the abbreviation of “Haute Tension” that means in English “High Voltage”; in Spanish we also use the word “Tension” in electricity meaning “Voltage,” as the French do. The letters “BT” stand for “Basse Tension” which I translate not as “Low Tension” but as “Filament Voltage” for this is the actual meaning.

UNITED STATES PATENT OFFICE

1,962,565

APPARATUS WITH CIRCUITS OSCILLATING UNDER MULTIPLE WAVE LENGTHS

Application November. 13, 1931, Serial No. 574,907

In France, May 2, 1931

7 Claims. (Cl. 250-23)

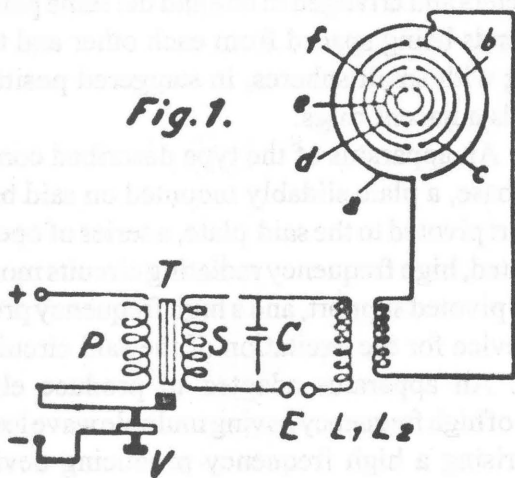

Fig. 1.

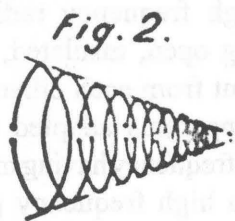

Fig. 2.

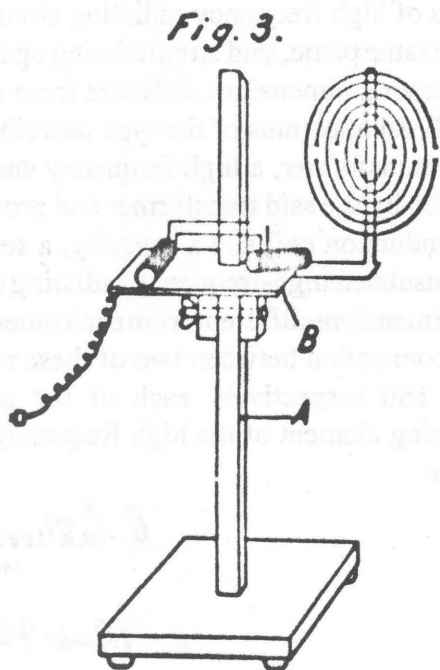

Fig. 3.

The present invention has for its object an apparatus capable of sending out simultaneously different wave lengths so that among these waves or their harmonics there is found almost always one or several capable of producing the best effect sought for any application whatever.

There is used for that purpose the property of open circuits having well determined wave length if they are excited by electric impulses emanating from discharges of any source.

The radiating part of the system, producing waves of various lengths, is therefore constituted by a certain number of concentric open rings of different diameters, which are maintained insulated by any appropriate means. These rings may or may not be terminated by small spheres forming capacities.

These rings may be arranged either in the same plane or in different planes so as to form any surfaces, such as portions of cones, spheres, paraboloids, ellipsoids, etc..., these surfaces being of a nature to concentrate the waves in a determined direction in the manner of a reflector, for example.

These rings may be fed by any producing device whatever of high frequency, for example, a combination comprising a trembler coil (or any other transformer) and a high frequency circuit provided with a self-induction coil and a capacity.

One of several points of this high frequency circuit is or are connected to the end of one or several of the rings forming the radiating apparatus. The other rings not connected are excited by induction.

The complete apparatus (coil, high frequency circuits, rings, etc...), may be mounted in a box or upon a small board capable of sliding along a guide or rocking so as to be able to be placed in the most convenient position.

In the accompanying drawing, by way of ex-

ample, not limitative, there is shown:

Fig. 1 a diagram of the system.

Fig. 2 the position of the rings in the form of a cone.

Fig. 3 the apparatus mounted upon a foot or base.

In Fig. 1 there is seen at T the transformer or coil (P the primary, S the secondary of this coil), V the screw of the trembler, C the condenser the discharge of which across the spark gap E produces oscillations in the self-induction coil L1, which in its turn acts by induction upon the self-induction coil L2; this self-induction coil L2 is connected on one side to the first exterior ring a, on the other side to the following ring b. It thus forms an electrostatic field of high frequency which induces oscillations in the other rings c, d, e, f.

As a modification, L2 may be suppressed and the rings a and b may be connected each to one of the ends of L1.

One of the ends, or even any point of the self-induction coils L1 or L2 may likewise be connected to any one of the rings.

Fig. 2 shows the arrangement of the rings in the form of a cone. The open circuits a, b, c....f can be constituted by solid conductors. They can also be tubular circuits, this being advantageous, since, for the same bulk, the radiating surface is larger. Finally, the area of the cross section of each of these various circuits can vary from one circuit to the other for instance, this area can decrease from the periphery (ring a) to the center (ring f) of the radiating system.

Fig. 3 shows the apparatus mounted upon a foot A along which it can slide, in order to be placed at any desired height and upon a hinge B which allows it to be oriented upon the horizon.

I claim:--

1. An apparatus adapted to produce electric fields of high frequency having multiple wave lengths, comprising a high frequency producing device, a series of high frequency radiating circuits constituted by concentric insulated split rings of different diameters, the split ends being spaced from each other and terminating with small spheres.

2. An apparatus adapted to produce electric fields of high frequency having multiple wave lengths,

comprising a high frequency producing device, a series of high frequency radiating circuits constituted by concentric insulated split rings of different diameters and terminated by small spheres forming capacities.

3. An apparatus adapted to produce electric fields of high frequency having multiple wave lengths, comprising a high frequency producing device, a series of high frequency radiating circuits constituted by concentric insulated split rings of different diameters and arranged in one and the same plane the split ends being spaced from each other and terminating with small spheres, in staggered position as regards adjacent rings.

4. An apparatus of the type described comprising a base, a plate slidably mounted on said base, a support pivoted to the said plate, a series of open and insulated, high frequency radiating circuits mounted on the pivoted support, and a high frequency producing device for the excitation of the said circuits.

5. An apparatus adapted to produce electric fields of high frequency having multiple wave lengths, comprising a high frequency producing device, a series of high frequency radiating circuits, said circuits being open, insulated, and having dimensions different from each other.

6. An apparatus adapted to produce electric fields of high frequency having multiple wave lengths, comprising a high frequency producing device, a series of high frequency radiating circuits arranged in the same plane, said circuits being open, insulated, and having dimensions different from each other.

7. An apparatus of the type described comprising a transformer, a high frequency energizing circuit fed by the said transformer and provided with a self-induction coil and a capacity, a series of open and insulated high-frequency radiating circuits having dimensions different from each other, and inductive connection between two of these radiating circuits and respectively each of the poles of the outgoing element of the high frequency energizing circuit.

G. Lakhovsky
INVENTOR

By: Mark H. Clark
ATTY.

June 13, 1944.

G. LAKHOVSKY

2,351,055

TUBE FOR PRODUCING MULTIPLE WAVE LENGTHS

Filed Nov. 21, 1941

Fig. 1.

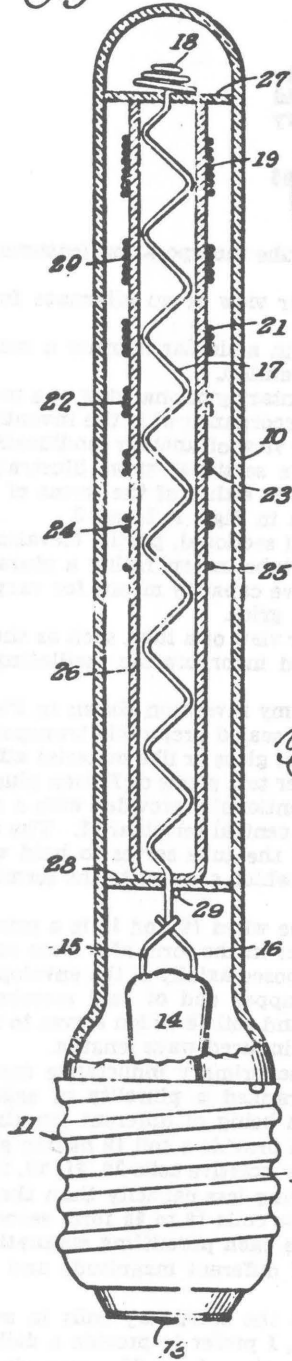

Fig. 2.

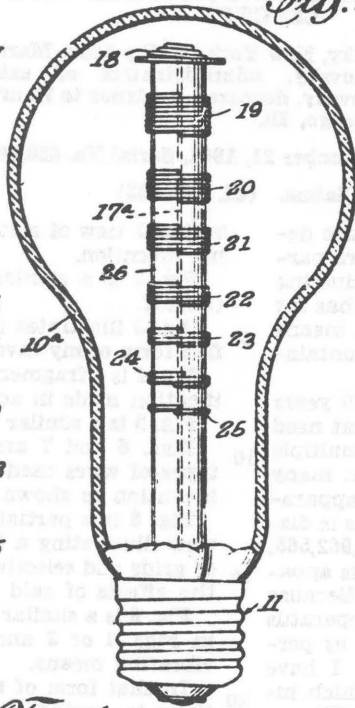

Fig. 3.

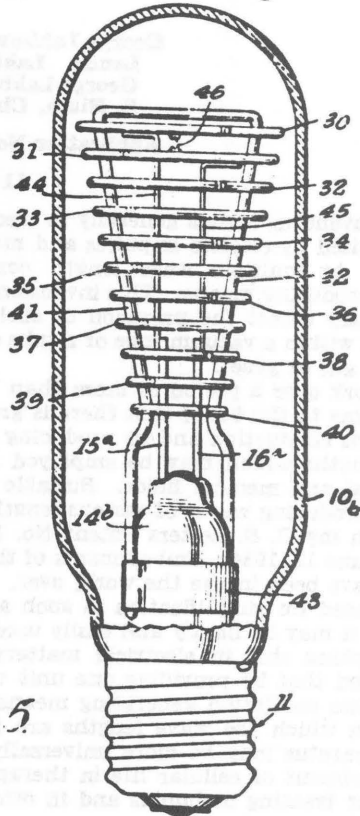

Fig. 4.

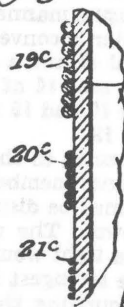

Fig. 5.



Fig. 6.

Fig. 7.

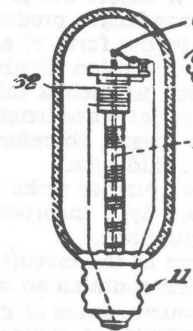

Fig. 8.

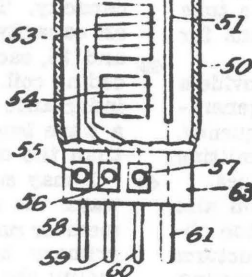
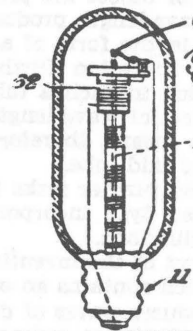

Fig. 9.



INVENTOR
GEORGE LAKHOVSKY

BY *Leon M. Strauss*
ATTY.

UNITED STATES PATENT OFFICE

2,351,055

TUBE FOR PRODUCING MULTIPLE WAVE LENGTHS

George Lakhovsky, New York, N. Y.; Anne-Marie Louise Lakhovsky, administratrix of said George Lakhovsky, deceased, assignor to Henry S. Blum, Chicago, Ill.

Application November 21, 1941, Serial No. 420,006

11 Claims. (Cl. 250—33)

This invention relates generally to electric devices excited by electric impulses and more particularly to multiple wave length conducting and/or producing means. This invention has for its primary object the provision of such means disposed within a vacuum tube or a tube containing rare gas or gases.

My work over a period of more than 20 years has led me to the belief that there is great need for means conducting and/or producing multiple wave lengths which may be employed in many industrial and medical fields. Suitable apparatus for producing waves of various lengths is disclosed in my U. S. Letters Patent No. 1,962,565, dated June 12, 1934. Embodiments of this apparatus have been in use the world over. Because of the need for simplification in such apparatus so that it may be handy and easily used by persons lacking skill in electrical matters, I have concluded that by providing one unit which incorporates oscillation generating means and another in which the wave lengths are produced, the apparatus may be more universally used in the treatment of cellular life in therapy, in the aging or treating of liquids and in other industrial fields.

The present invention deals with those units, preferably combined with one another and constructed as a portable device and as stated above, has for its major object the provision of a unitary multiple wave length producing and/or conducting device in the form of a vacuum tube.

The present invention further contemplates the incorporation in such a tube, of means for varying the effect of wave lengths, or selectively employing the means therefor enclosed in or forming part of said tube.

This invention further seeks to provide a tube of the indicated type incorporating means for generating oscillations.

Another object of the invention is to provide a single unit which contains an oscillation generator, which produces waves of definite frequency, and further inductance means each permitting emanation of wave lengths of various values.

The structural features of my invention also form a material part of this disclosure, the objects and advantages being attained in structures such as shown in the accompanying drawing, which exemplifies the invention. The following specification, based on said drawing, more clearly points out the purposes and advantages of my invention.

In the drawing:

Fig. 1 is a vertical, partial sectional, partial ele-

vational view of a tube incorporating features of my invention.

Fig. 2 is a similar view of an alternate form thereof.

Fig. 3 illustrates in a similar manner a modified form of my invention.

Fig. 4 is a fragmentary sectional view of a modification made in accordance with the invention.

Fig. 5 is a similar view of another modification.

Figs. 6 and 7 are sectional views illustrating types of wires used in either of the forms of my invention as shown in Figs. 1, 2 and 3.

Fig. 8 is a partial sectional, partial elevational view illustrating a tube incorporating a plurality of grids and selective capacity means for varying the effects of said grids.

Fig. 9 is a similar view of a tube, such as shown in Figs. 1 or 2 and incorporating oscillating or vibrating means.

In that form of my invention shown in Fig. 1, there is provided a sealed preferably transparent envelope 10 made of glass or like material affixed in the usual manner to a screw or Edison plug 11. The latter is conventionally provided with a shell terminal 12 and a central terminal 13. The support or seal 14 of the tube serves to hold wires such as 15 and 16 which connect to the terminals 12 and 13.

Connected to the wires 15 and 16 is a primary inductance member in the form of a loose coil 17 which may be disposed axially of the envelope 10, as shown. The upper end of said member 17 forms a tight wound coil 18 which serves to radiate the strongest induced wave lengths.

Surrounding the primary inductance member 17, there are arranged a plurality of separate coils of wire each being of different length and capacity. Thus, I provide a coil 19 having greatest capacity and successive coils 20, 21, 22, 23, 24, and 25, each having less capacity than the preceding coil. These coils 19 to 25 form secondary inductance means each permitting emanation of a wave length of different magnitude and value than the other.

I may support the secondary coils in several ways. As shown, I prefer to provide a dielectric member such as a glass sleeve 26 surrounding the primary inductance wire member 17 and to mount the secondary coils 19 to 25 on the outer surface of said sleeve, leaving the coil 18 exposed at the top thereof. In order to effectively support and centralize the glass sleeve 26, I provide spacing washers 27 and 28 of mica or the like, top and bottom, and provide a supporting cross-piece 29 on the lower portion of the wire 17.

The tube above described may be employed as indicated for the treatment of cellular structures by connecting it to any one of the rings in the electrostatic field of high frequency, such as shown in said U. S. Letters Patent No. 1,962,565, each of the coils 18 to 25 producing by induction a different wave length, as can be understood.

In the form of my invention shown in Fig. 2, the envelope 10a is somewhat differently shaped, and the wire 17a straight instead of arranged as an open coil. In other respects, the structure follows that described with reference to Fig. 1.

As shown in Fig. 3, there may be arranged a plurality of open rings 30, 31, 32, 33, 34, 35, 36, 37, 38, 39, and 40 in frustro-conical form, for instance, with the largest of said rings at the top and the smallest one adjacent the bottom. I have shown said rings as supported, for instance, by glass posts 41 and 42, said posts being supported on the seal 14b, as by a band 43. I provide extensions for the terminal wires 15a and 16a and connect said extensions 44 and 45 to the upper ring 30 and the next lower ring 31, respectively.

The rings 30 and 31 may become the primary inductance members, whereas the remaining rings constitute the secondary inductance members as before set forth. Electric current conducted to the suitably spaced rings 30, 31 will cause a spark 48 to be drawn between the rings 30 and 31 providing oscillations emanating from electrical discharges therebetween and causing the radiation of waves of various lengths within the envelope 10b and affecting the remaining rings.

In Figs. 1 and 2, I have shown the secondary coils as formed of wires having uniform cross-section. Fig. 4 illustrates how such wires may be made progressively smaller in the succeeding coils 19c, 20c, and 21c, etc. Similarly, I have shown the rings of Fig. 3 made progressively smaller in Fig. 5, said rings being designated by numerals 30d, 31d, 32d, 33d, 34d and 35d, etc. In such various manners, the wave length producing effect of the secondary coils or rings may be arrived at.

The secondary coils or rings may be round or somewhat flattened wire as shown in Fig. 6 or tubular as in Fig. 7, offering a yet greater flexibility of design.

The devices of Figs. 1 and 2 above described may be incorporated in the system shown in said U. S. Letters Patent by connecting one of the rings a, b, c, d, e, or f with plug 11 of Fig. 1, since either terminal 15, 16 is in contact with primary inductance member 17. To this end a conductor (not shown) connects such a ring with said plug or socket.

In Fig. 8, I have shown a modification of the invention which comprises a vacuum tube 50 containing a plate 51 and a plurality of different wave lengths producing grids 52, 53, and 54. I connect each grid with a variable capacity device, such as 55, 56, and 57 carried by said tube 50 and preferably by its base support 63, whereby the grids may be selectively connected into an operating circuit (not shown) by means of the respective prongs 58, 59, and 60, and the plate prong 61. Heating or other exciting means may be incorporated in the tube in a well-known manner. This combination tube 50 is designed to replace a plurality of known tubes each operating with different and variable wave length effect, mere exterior manipulation at said base support brings about change of the capacities 55, 56, and 57 and cutting in one or more of the grids 52, 53, and 54.

56, and 57 and cutting in one or more of the grids 52, 53, and 54.

The effect of the spark as produced in the form of the invention depicted in Fig. 3 may be further utilized in Fig. 9 in which I also incorporate a vibrator 62 which produces electrical oscillations by a spark intermittently generated between the end of the primary inductance member 17d and vibrator armature 64. In other respects the structure follows that of Fig. 1.

It may be noted that any type of spark producing or oscillation generating means may be substituted for the vibrator shown. The tubes shown in Figs. 3 and 9 may be used in the manner described for Fig. 1 by connecting one terminal of the base as set forth to produce an induction effect. These tubes may be also connected across both terminals with a suitable potential to obtain the spark effect.

From the foregoing it may be seen that I have provided tubes in various forms for the purpose of generating and conducting multiple wave lengths. Other forms of the invention may be produced within the spirit and scope of the invention as claimed.

Having thus described my invention, what I claim as new and desire to be secured by Letters Patent, is:

1. A device of the character described comprising a vacuum tube having an envelope and base, primary inductance means, and a plurality of separate secondary inductance means of different length for radiating waves of various lengths extending above said primary inductance means, all said inductance means being arranged within said envelope.

2. A device of the character described comprising a vacuum tube having an envelope and base, a primary inductance member axially arranged in said envelope, and a plurality of secondary inductance members spaced apart and independent from each other each member surrounding a respective portion of said primary inductance member and within the field of influence thereof.

3. A device of the character described comprising a vacuum tube having an envelope and base, a primary inductance member axially arranged in said envelope, and a plurality of secondary inductance members each surrounding the primary inductance member and within the field of influence thereof, each of said secondary inductance members having a different wave length effect than the others.

4. A device of the character described comprising a vacuum tube having an envelope and base, a primary inductance member comprising a pair of split rings in inductive relation, and a plurality of secondary inductance members each comprising split rings.

5. A device of the character described comprising a vacuum tube having an envelope and base, a primary inductance member comprising a pair of split rings in inductive relation, and a plurality of secondary inductance members each comprising split rings, said latter rings being arranged in different planes and being of different length to produce a different wave length effect.

6. In a device of the character described, means for producing multiple wave lengths comprising a wire member, enclosing dielectric means for said member, and a plurality of separate wire coils of different lengths on said dielectric means and in the field of inductance of said wire member.

7. In a device of the character described,

means for producing multiple wave lengths comprising a wire member, enclosing dielectric means for said member, and a plurality of wire coils on said dielectric means and in the field of inductance of said wire member, each coil extending over said wire member and having a different number of convolutions than the others.

8. In a device of the character described, means for producing multiple wave lengths comprising two split rings in inductive relation, and a plurality of split rings in inductive relation to the two split rings.

9. In a device of the character described, means for producing multiple wave lengths comprising two split rings in inductive relation, and a plurality of split rings in inductive relation to the two split rings, the plurality of rings being of smaller diameter than the mentioned two rings and each progressively smaller than the others.

10. In a device of the character described, means for producing multiple wave lengths comprising two split rings in inductive relation, and a plurality of split rings in inductive relation to the two split rings, the plurality of rings being of smaller diameter than the mentioned two rings and each progressively smaller than the others, all of the rings being arranged in frusto-conical disposition.

11. In a vacuum tube having a primary inductance member and secondary inductance members, a vibrator arranged in the field of influence of said primary inductance member and secondary inductance members, a vibrator arranged in the field of influence of said primary inductance member for affecting the induction of said secondary members.

GEORGE LAKHOVSKY.

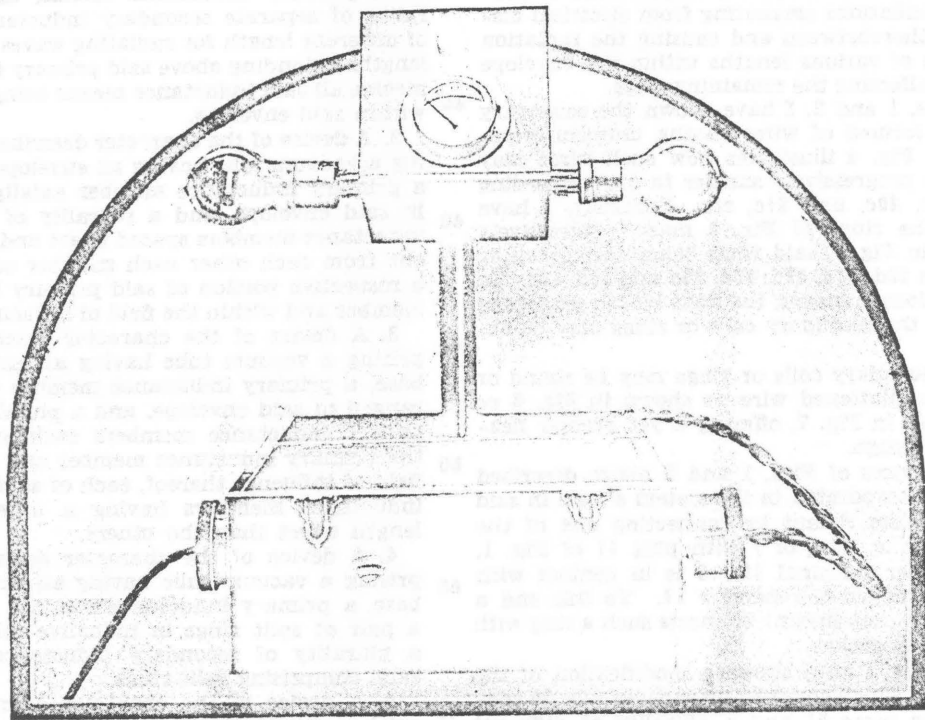

The two-meter oscillator used by the author in his experiments with the supply box containing the necessary controls and transformers.

Picture from *Radio News* for February 1925
 Curing Cancer with Ultra Radio Frequencies
 by George Lakhovsky

THE RUSSIAN LAKHOVSKY REJUVENATION MACHINE

by Bob Beck

from the November 1963 Journal of Borderland Research

In September 1963, Dr. L.O. Anderson, Anderson Research Center Director and BSR Associate, phoned me about a "marvelous electronic machine" purported to "cure" almost any human ailment. I've looked into dozens of these "modalities" every year; so with extreme skepticism I gathered instruments and took off to check another possible hoax.

I found a heavy spark-gap Tesla Coil inside a four-foot cabinet. This console was rigged to circular "antennas" and was partially shielded inside a home-built Faraday cage in the living room of Dr. Anderson's friend. It hadn't functioned in over a decade, and had been given up by some twenty-odd medical instrument repairmen and engineers as unfathomable.

The machine, which had no nameplate or other identification, turned out to be a Lakhovsky "Multiple Wave Oscillator", or MWO. Fortunately the present owner had found patents and two books describing its operation. We were able to reconstruct the circuits and after several hours had it operating perfectly. The machine was not a hoax.

Lakhovsky did his research prior to world War II and died in 1942. No infringement can be involved in duplicating Lakhovsky's work, since his U.S. Patent #1,962,565 expired in 1951 and is in public domain. I have found from the book *The Waves that Heal* by Mark Clements that MWOs are extensively used in hospitals in France, Germany and Italy, and although tested in a New York Hospital with fantastic success, MWOs remain practically unknown in the United States.

MDs testing Multiple Wave Oscillators reported up to 98% cures of terminal cancer, arthritis and other "hopeless" conditions. Case histories were complete with before-and-after photos. Often rejuvenation was demonstrated, not only in human beings but in plants and animals as well!

So, on Sept. 18, 1963, I designed and built a modern MWO based on Nikola Tesla and Lakhovsky's original work and patents. The transistorized instrument fits into a brief case and weighs under 14 lbs. Experiments with the MWO on some eighteen volunteers have demonstrated almost unbelievable results. At this writing, Oct 20th, every single subject, including myself, reports fantastic gains.

My mother, age 72, who has suffered from hypertension and glaucoma for many years, measured absolutely normal blood pressure the morning after her first treat-

ment. And the eye tension, tested by her MD the week following, had dropped to a lower point than in the previous two years. Another woman with a long-standing back condition says she was permanently relieved in one 15 minute exposure. An asthmatic with chronic bronchial complications claims he is now symptom-free after two exposures and her husband with a bad dermatological condition of seven years history appears to be very definitely improved. Perhaps the most dramatic is Mr. N.V.C. who had broken his leg skiing last December. Because of an old polio complication the broken leg had never healed and flesh surrounding the fracture was in a very poor, waxy condition. After one exposure he phoned to say he had regained feeling in the area. The next day we made an "after" photo slide of nearly normal tissue.

A friend suffering allergies of long standing says she can now eat anything and her MD admits he is startled by her youthful appearance and new vitality. The Lakhovsky literature illustrated many such rejuvenations as an unexpected side effect of cancer cases. Subject's wrinkles disappeared along with the tumors!

THEORY OF OPERATION

Lakhovsky pointed out that all cells capable of reproduction contain in their nuclei "filaments" of highly conductive material surrounded by insulating media. This filament, which may be the RNA-DNA complex, is always in the form of a spiral or helix -- in other words, a coil. Therefore, each will react as a tuned circuit if its resonant frequency can be approximated by an external oscillating coil.

Lakhovsky didn't carry this to its conclusion; however, I postulate that by exciting the nuclei with electromagnetic energy a "charge" can be induced by the long established principle of electromagnetic induction. This demonstratively raises the energy level and perhaps the vitality of every cell in the field simultaneously. Since each cell is an individual, and of slightly different physical dimensions, the exciting wavelengths must be multiple, and must span a broad frequency spectrum. Diathermy machines, limited to crystal-controlled single frequencies in the 27.255 MC region, can do nothing but heat the tissue; and yet this approach, abandoned by Lakhovsky in the 1930s, can still be found in "modern" doctor's offices!

The Electromotive Force (EMF) produced by the MWO and induced in the cell

nucleus, can raise the cell's metabolic rate by Electrolysis, and perhaps jog the RNA-DNA "memory" and reproductive capabilities to their level at an earlier, younger age, thus the rejuvenation. Even more subtle changes might be postulated, such as magnetic "progression" effects as evidenced by heavy water in magnetic fields.

By contrast, any chemical taken into one's system by mouth or by injection -- such as vitamins, food or medicine -- must first be absorbed in proper solution and ratio with unknown tract elements, then be transported by the blood to affected tissue only to be possibly rejected by the target areas.

Perhaps in cancer the EMF induced by the MWO raises the vitality and memory of marginal cells to normal reproduction levels. In the case of other disease, perhaps a cell's given higher energy levels can more readily throw off affliction.

A WAVE FOR EVERY BODY CELL

The Multiple Wave Oscillator described here radiates a bandwidth of radio frequency (RF) energy from the audio frequencies up beyond microwave frequencies. By actual measurement with standard field strength meters, this vast bandwidth of frequencies and harmonics can be shown. In fact, a bluish glow of "brush discharge" surrounds the antenna when operating. A fluorescent lamp held anywhere within several feet of the subject glows brilliantly. Within this multiple-wave range of frequencies, every cell in the body can find its ONE resonant frequency and absorb energy at its own natural wavelength.

Obviously the Electrostatic energy cannot penetrate the body. This is known as the "skin effect". However, the Electromagnetic component of the energy can and does permeate and will induce an EMF in each cell. It is precisely this energy to which Lakhovsky attributes his almost miraculous "cures".

A word of warning, although no deleterious side effects have ever been reported for human reactions, the MWO has input power exceeding 35 watts. It radiates RF interference over a bandpass of 15 Kilocycles to well beyond 250 Megacycles. The Federal Communications Commission has stiff penalties for unlicensed transmitters and radio and TV interference -- not to mention making all your neighbors very unhappy. We operate our machine in a shielded room, and the battery input prevents RF interference from feeding back into the power line.

The deluxe MWO diagrammed here can be built by any intelligent 16-year old with readily available electronic parts. I do not plan to build, manufacture, sell or otherwise exploit this device, as my interest is purely in

Original cover providing template
for aluminum MWO antenna.

Antenna

Terminal

The Lakhovsky MWO

(Multi-Wave Oscillator)

Antenna Terminal



P.O. BOX 429 ★ GARBERVILLE, CA 95440-0429 ★ U.S.A.

research. Several Associates given this circuit have successfully constructed MWOs. We would certainly like to hear from any BSR Associates who undertake this project, but please do not communicate until after building the unit. I cannot correspond over details which any intelligent person would be able to thresh out with his or her own technical friends.

At one stage we had planned constructing a much higher-powered unit but the results with the "portable" are so gratifying that Model Two was shelved. Extensive tests are scheduled with plants and animals, and every effort is being made to remove any element of "suggestion" from results. A physician friend is cooperating with the project by sending a few "problem" patients for test. It is much too soon, however, to make a finished statement concerning the MWO's potential. No cures can be claimed even if obviously demonstrated, since our laws are controlled by medical unions forbidding the use of the word except by MDs. But I have satisfied myself with nearly twenty miracles in these few weeks of tests that the MWO might well be the most promising device to come to light in many years.

I have one request, that no one building this device ever be tempted to charge a fee, donation, or reimbursement of any kind whatsoever for its use. I feel most strongly that any device potentially helpful to suffering humanity should be available completely free of charge to anyone needing it.

CONSTRUCTION TIPS

My MWO is built on an 11 x 11 1/2 inch plastic panel. Components extend 3 1/2 in. below this, so the unit fits nicely into a small attache case. The 6 volt battery was a Sonotone lifetime Nickel Cadmium unit; however, five war-surplus NiCads (1.2 v each) wired in series would be less expensive.

My first unit used a transistorized driver for the Tesla Coil but the Ford coil works equally well, is far cheaper, but has the disadvantage of making a buzzing noise. The Ford Model T coils may still

be available at Pep Boys stores in California, or can possibly still be purchased from J.C. Whitney & Co., 1917 Archer Ave., Chicago, IL 60616. The spark gap was made from salvaged tungsten relay contact points about 1/4 in. in diameter. (Chevrolet Six timer points, 1950, do very well). The relay spring arm can be tuned by a Nylon 6-32 screw adjusting its natural spring tension. The gap must be carefully tuned for maximum output for every individual, since the subject's absorption seems dependent on his body fluids and weight. *Adjust for maximum sparking at random times and intervals between several of the inner antenna rings.*

The automatic timer, zero to 15 minutes, the meter, the internal battery charger, the

RFC circuits, etc. are all simply conveniences and may be left out of the circuit without in any way subtracting from results. By not building in these deluxe features, the entire MWO will cost much less to build. Use plastic instead of metal screws around the high voltage coils. High voltage capacitors can be tracked down at surplus stores or well stocked electronics parts sources. The Tesla Coil must be hand wound as it is not available commercially.

We have determined experimentally that a workable pair of antennas, radiator and resonator, can consist of 16 concentric rings, ranging from an outside diameter of 10-3/4 inches down to 1/2 inch. These were constructed by cementing a one-foot square of

BECK ADAPTATION OF LAKHOVSKY MULTIPLE-WAVE OSCILLATOR, U.S. Patent #1,962,565

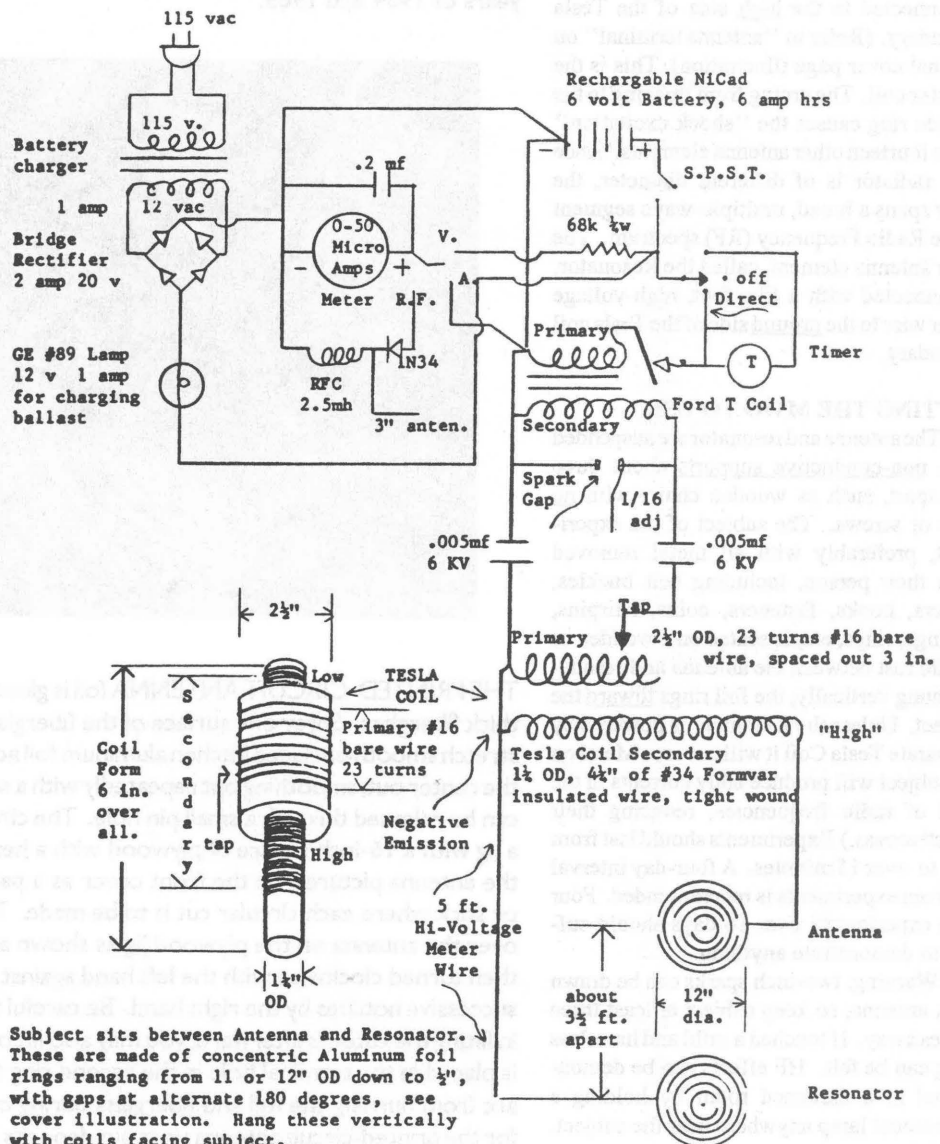

Reynolds kitchen aluminum foil to an 11-inch square of thin fiberglass. The outline of each set of circles was carefully scribed with a sharpened compass, razor or Scripto blade. By scoring or cutting the aluminum foil was cut through to the plastic backing and the waste area strips pulled away before the cement hardened. Excess cement was removed with a solvent. The gaps were then cut with the razor. Note that gaps are alternated in position each 180°, as per drawing on original cover page. This was drawn from an actual antenna and you can set your compass distances for each ring from it. Keep gaps between inner rings narrow to encourage random arcing between rings. Trim the corners from the gaps of the three or four outside rings to discourage fixed arcing at these places. Also be sure to clean away any bits of foil between rings. These also will cause fixed arcing.

In use, the ring second from the outside is connected to the high side of the Tesla secondary. (Refer to "antenna terminal" on original cover page illustration) This is the radiator coil. The arcing from this ring to the outside ring causes the "shock excitation" of the fourteen other antenna elements. Since each radiator is of different diameter, the array spans a broad, multiple-wave segment of the Radio Frequency (RF) spectrum. The other antenna element, called the Resonator, is connected with a five-foot, high-voltage meter wire to the ground side of the Tesla coil secondary.

PUTTING THE MWO TO USE

The antenna and resonator are suspended from non-conductive supports about three feet apart, such as wooden chairs with no nails or screws. The subject of the experiment, preferably with all metal removed from their person, including belt buckles, zippers, hooks, fasteners, coins, hairpins, earrings, rings, etc, is seated on a wooden or plastic rest between the antenna and resonator (hung vertically, the foil rings toward the subject. Unless the Resonator is powered by a separate Tesla Coil it will not arc. Metal on the subject will produce eddy currents in the field of radio frequencies, reducing their effectiveness.) Experiments should last from nine to over 15 minutes. A four-day interval between experiments is recommended. Four such experiments over 16 days should suffice to demonstrate anything.

Warning, two-inch sparks can be drawn from antenna; so keep subject at least three inches away. If touched a mild and harmless sting can be felt. HF effects can be demonstrated in a darkened room by holding a fluorescent lamp anywhere near the subject. The RF energy will cause the lamp to light although no wires are touching it. Field

strength measurements read several watts of power from the audio frequency spectrum to beyond 250 megacycles.

The illustration to the right is from Clement's *Waves That Heal*, Lakhovsky's illustration of a living cell. "In the centre is a twisted filament which, possessing self-inductance and capacity, constitutes an oscillating circuit. The similarity to a short-wave circuit is manifest; the filament shown here oscillates like a coil having a very small number of spirals." He quotes Lakhovsky: "Every living being emits radiations", and adds: "the living cell can thus play the part of a transmitter or receiver of exceedingly short radio-electric waves which give rise to high frequency currents in the circuits of the cellular nucleus."

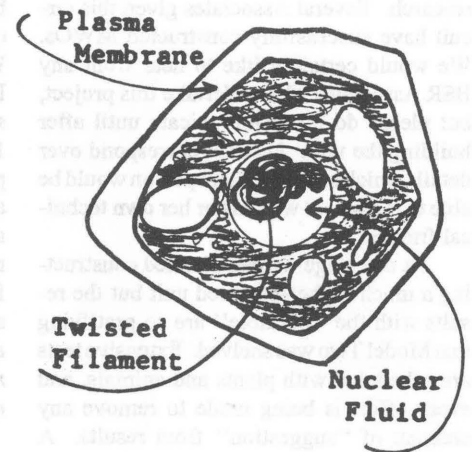

THE FOLLOWING PHOTOS were kindly furnished by Borderland Sciences Research Associates from their own experimental work with the MWO during the years of 1964 and 1965.

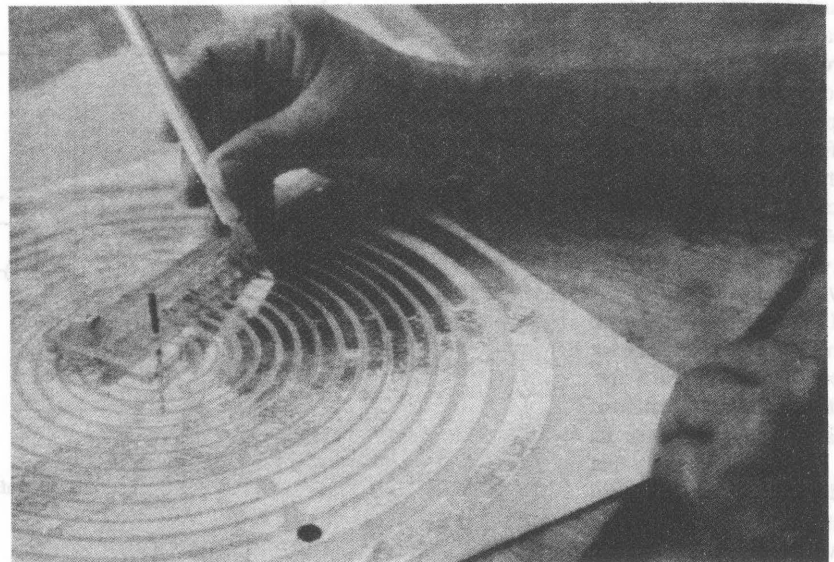

THE PRINTED-CIRCUIT ANTENNA foil is glued to an 11-inch square of 1/16th inch thick fiberglass. Spray one surface of the fiberglass with Hobby Shop spray glue and stretch smooth-surfaced kitchen aluminum foil across it. Press the foil on firmly from the center out, smoothing out repeatedly with a soft cloth. Any remaining air bubbles can be released through a small pin hole. The circles are more easily cut if you make a jig with a 16-inch square of plywood with a headless nail for a center post. Using the antenna pictured on the front cover as a pattern, mark and notch an old ruler or stick where each circular cut is to be made. This marked guide ruler is mounted over the antenna on the plywood jig as shown at right. The foil-covered surface is then turned clockwise with the left hand against the Scripto blade held firmly in the successive notches by the right hand. Be careful to cut through the foil. If you don't, in lifting the cutouts afterward, you may also lift or tear the rings. If a metal grommet is placed in the terminal hole in the second ring this will prevent the high-frequency arc from burning the foil and fiberglass during operation. Copper foil can be used for the printed-circuit antenna rings but deposits build up on it from arcing, wherever it occurs. There is no deposit buildup on aluminum foil.

THE RADIANT ENERGY of the MWO is obvious in this three-minute time exposure during operation in a darkened room. Note the brush discharge of etheric energy all along the edge of the outside ring, going three or four inches. Look at the random arcing between the antenna rings, down to the eighth ring! This antenna received full power by being mounted on the MWO case, directly at the positive end of the Tesla Coil.

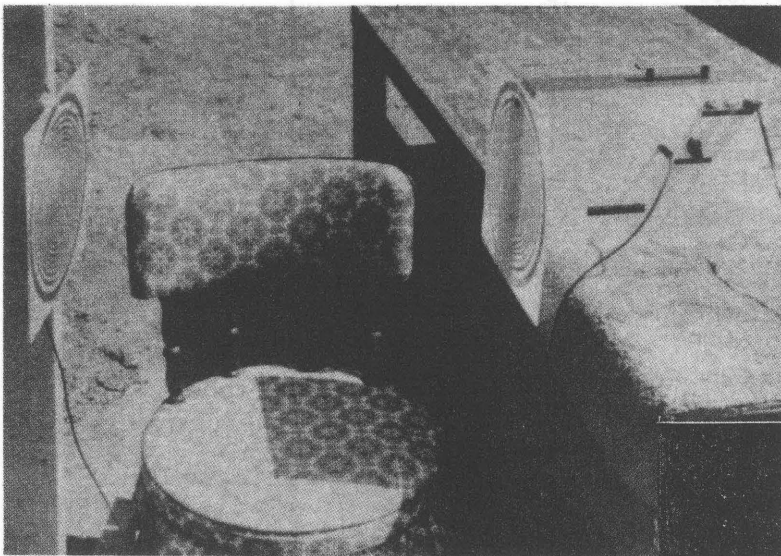
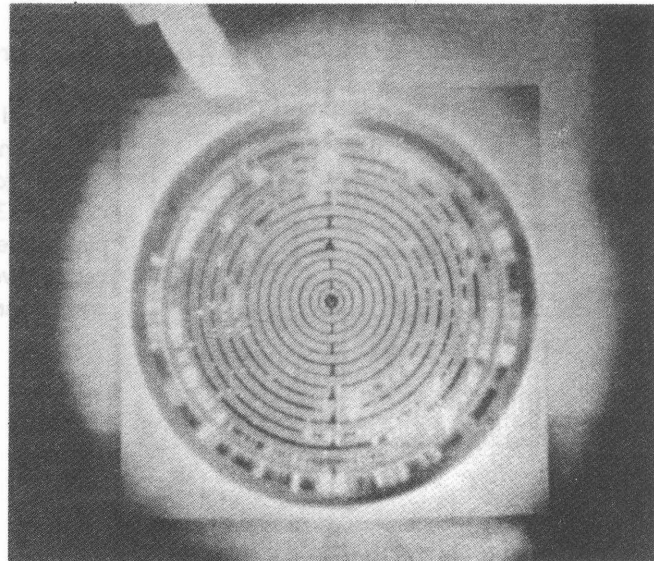

AT LEFT IS A TYPICAL EXPERIMENTAL SETUP, with a chair for "guinea pig" between antenna and resonator. Beck's original equipment called for an 18-inch lead wire from the positive end of the Tesla coil to the antenna. It was found that there was too much loss of power along this wire. The later development shown above has the MWO set upright, with the antenna mounted directly against the positive end of the Tesla Coil in the case.

THE INTERIOR HARDWARE LAYOUT is shown at right in this photo of another MWO, neatly packaged for an attache case. A. The five Ni-Cad batteries, 1-1/4 volts each at full power. B. Timer. C. Tesla Coil. D. 115VAC transformer (for house current operation if desired). E. Spark-gap using modified Chevy Six points. F. Model T Ford Coil. G. Battery Charger.

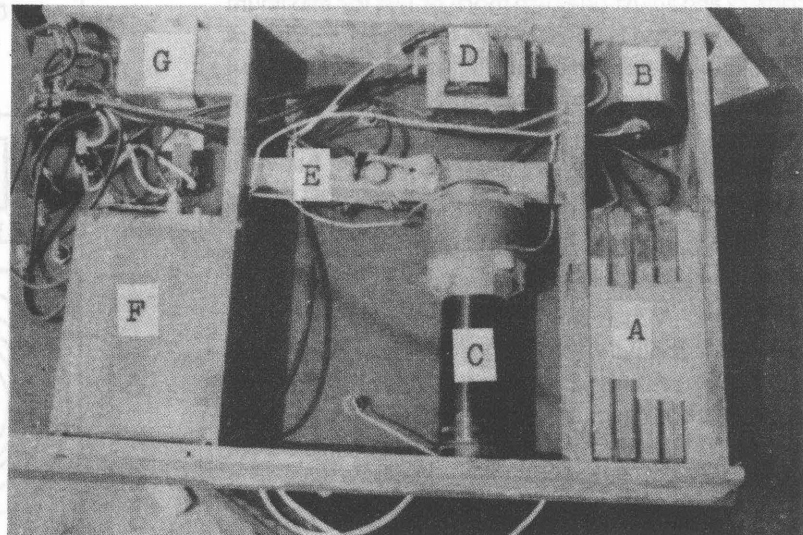

RECTIFYING THE FORD COIL OUTPUT using a 1B3GT or 1G3GT high-voltage tube.

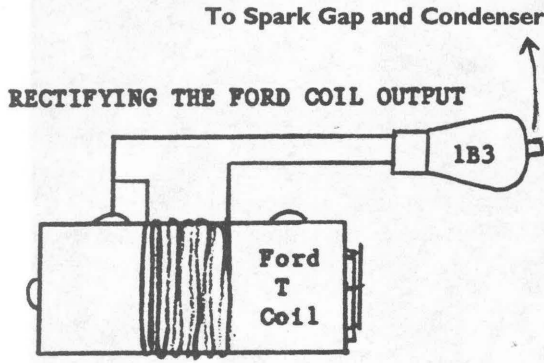

Wind 15 or more turns of fairly heavy insulated copper wire around the middle of the Model T Ford Coil. One lead from the winding goes to the Hi-voltage output of the Coil, and to pin 2 or 7 of the 1B3 tube. The other lead goes to the other pin, as only two pins of the tube, 2 and 7, are used in this hookup. The souped-up or rectified voltage is drawn off the top of the tube to the spark gap and condenser.

MODIFIED VERSION OF THE BECK TESLA COIL

115 volt house current into the black leads of the 6 volt transformer, one green lead to the T Coil negative terminal, the other to an SCR 45 amp Diode to make direct current to the Plus terminal of the T Coil. A 12-volt current to the T Coil heats it up and will not increase the spark. Radio Shack's 6.3 volt, 3 amp transformer does very well for a power supply.

Wrap 16 turns of insulated hookup wire around the middle of the T Coil and feed to pins 2 and 7 of the 1B3 rectifier tube. Feed the plus output of the T Coil into pin 2 or 7 of the 1B3 also.

Hi-voltage from the top of 1B3 goes to Spark plug. Widen gap of plug to 1/8 inch or more for maximum output of Secondary coil to Antenna.

One 10,000 WVDC (Working Volts Direct Current) commercial-type Capacitor, on the plus side, will do very well in this circuit. Capacity can be from .0015 to .005 microfarads.

Beck's tunable Tesla Primary called for 20 or more turns of bare wire for his movable contact but experience shows that 16 turns of insulated #19 wire for a Primary and adjust one turn more or less for maximum spark at Plus end Secondary coil. This is 4-1/4 inches of #34 insulated wire, or 4-3/4 inches of #32 insulated wire, for 420 turns more or less on 1-1/4 inch coil form 6 in. long. The Primary is wound on a 2 or 2 1/2 in. coil form. There should be heavy insulation between Primary and Secondary to prevent power-loss arcing between Coils.

REMEMBER, the goal is a thin blue, or blue-white spark at least 3/4 inch long at the plus end of the Secondary. When fed into the center hole of the Antenna it should light up like a Christmas tree, with arcing between every ring. Feeding the coil output into the center hole gives more power to the shorter wave lengths. We get plenty of the longer wave-lengths from other electrical apparatus and from power lines.

This coil would be a good high-frequency power supply for Kirlian Photography.

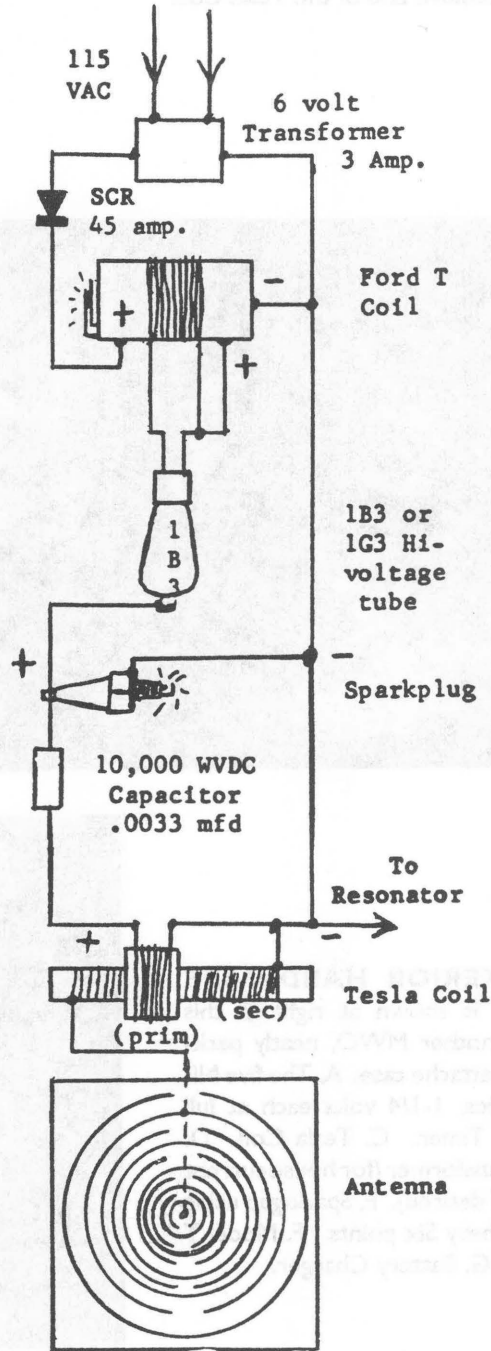

THE TRANSISTORIZED MWO

By Gerald W. Steele

Here is tentative information on the solid-state MWO. I say tentative since this is the 3rd version I've built. The first used an automobile spark coil for T2 but I found this undesirable since it lacked higher frequency harmonics. Even worse, the lower frequency ones could be harmful to living systems.

Version 2 was with a small black and white TV flyback transformer running at a slow (100 pulses per sec.) pulse rate. I eventually sped it up but could never get the required 1" spark from the Tesla coil.

This version uses a color TV flyback and a higher power discharge circuit. Nominal lowest frequency is 1.5 KHz though it could go as low as 270 Hz.

All diodes, SCR, and transistor can be substituted with universal replacement types available at electric part outlets.

As you can see, electronically it is simple. The power metering circuitry in the original MWO can also be used here if desired. I've had enough trouble maximizing the output of this device to worry about monitoring the power.

This device is excellent for use in Kirlian photography several ways: A modified circuit could be used for A, for a wide range of pulse rate settings.

There are two possible voltage sources for Kirlian use, each with unique characteristics. First is the output directly from T2 with or without the Tesla coil circuitry connected. Second is the Tesla coil output itself.

Other modifications include rectifying T2's output. The old MWO manual recommended the use of a tube rectifier out there are solid state types available.

Be sure it is a color TV high voltage rectifier. Connect as shown:

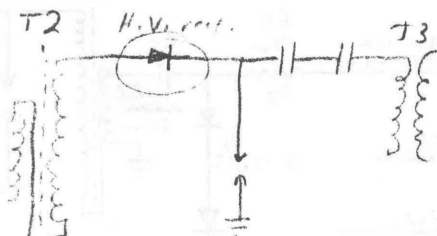

One question may arise in the builders mind: the need to heatsink SCR. No need. Not much heat generated.

Be sure R3 (or combination of resistors forming it) get ventilation. They get hot.

Always short C1 just after turning off power to work on the device. Remove short before reapplying power. The device is perfectly safe if you exercise care. R6 is a safety feature, it discharges C1 when turned off - but still short C1 when servicing, a standard safety procedure.

I am making constant improvements. The alternate values given for R3, C5 may give greater power at a higher pulse rate. I have yet to try them since 225 watt resistors are hard to find and apply. Besides it seems to work quite well as it stands. The only complaint one might have is the cost of construction principally due to the flyback transformer T2. But scavenging could help here.

Enclosing the spark gap in a plastic box could reduce its audible noise level. Ventilation of the spark gap gives more consistent operation. If the spark gap can be physically constructed above R3 the heat will produce air currents giving natural ventilation.

As I said, I am making constant improvements. Its too early to finalize it, but perhaps other associates may be interested in constructing and improving it. The lack of interrupter contacts gives a high level of reliability and consistent output.

Its too early in use for me to comment on its effects except that I think it is quite positive.

CIRCUIT DESCRIPTION:

The circuit consists of: low voltage oscillator, high voltage capacitive discharge generator, and Tesla coil.

The low voltage oscillator consists of Q1 a unijunction transistor operating as a relaxation oscillator. Frequency is variable from 270 Hz to 26 KHz with most power generated at 1500 Hz. VR1 controls this frequency. The DC Power for this circuit comes from a voltage doubler on the power transformer low voltage windings. The low voltage DC value was chosen to be as low as possible with consistent firing of the SCR.

The high DC voltage is rectified and filtered in C1. R1 is surge protection. The high DC voltage charges C5 through R3 until Q1 fires SCR1 whereby C5 is discharged through the primary of flyback transformer T2. D5 protects the SCR from high reverse voltage transients.

The secondary of T2 feeds the adjustable shunt spark gap and then through the Tesla coil resonating capacitors. Two capacitors are used here due to voltage requirements though one 15Kv capacitor could be used. From this point on it is all standard MWO fare.

Transformer T2 is expensive although any used color TV flyback could be tried. In all experimentation or adjustment the goal is maximum spark output at the Tesla coil secondary.

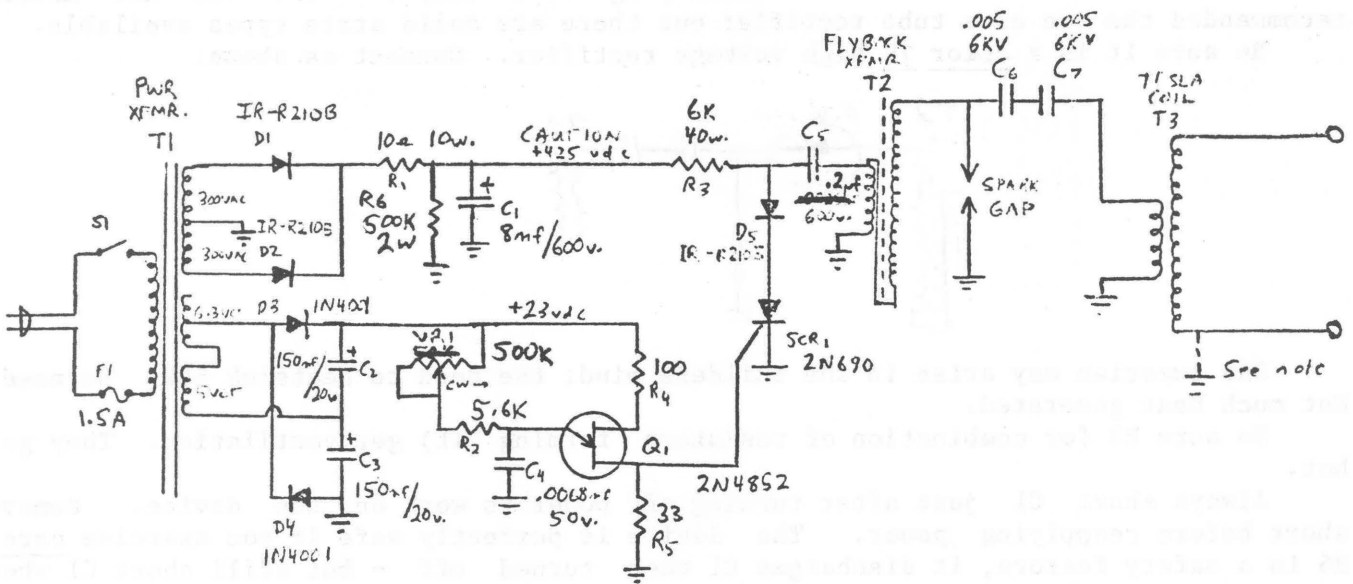

Note: Optional ground for Tesla coil secondary, if it reduces output do not use. R3 made from four 25K 10w resistors in parallel. VR1 linear taper. C1 may or may not be polarized. C6, C7 could be single .0025/15KV capacitor. SCR1, Q1 and all diodes can be standard replacement equivalents. MFR Type: T1 - TRIAD. T2 - Stancor HO 6246, Thordarson fly. Alternate values: R3 - 1K ohm, 225 watts; C5 - 1 microfarad, 600v.

THE LAKHOVSKY MULTI-WAVE POWER SUPPLY
by KLARK KENT

Many of us have read the Borderland Sciences Research Foundation (BSRF) publication "The Lakhovsky MWO" in which electrical wizard Bob Beck astounds us with tales of wonder. He tells how he was informed of the location of an old Lakhovsky Multi-Wave Oscillator that had been declared "unfathomable". He was able to reconstruct the circuits and after several hours the machine worked perfectly!

Mr. Beck and fellow experimenter Ed Skilling designed and built a modern version of the MWO based upon Nikola Tesla's and Lakhovsky's original works and patents. Georges Lakhovsky, a herald of the New Age, was no doubt a skilled experimenter and investigator of the Life Energy. This is evident by his practical application of Nikola Tesla's famous coil.

Super Science has updated both Lakhovsky's original and Bob Beck's adaptation of the Multi-Wave Oscillator. Looking at the schematic diagram in Bob Beck's article, we will eliminate everything but the 12 volt battery (or 12 volt power supply), switch, Model T Ford Coil, high voltage capacitors, and the Tesla Coil. A large high voltage diode is added to rectify the output of the Model T Ford coil which leaves us with a stripped down but thoroughly functional MWO power supply.

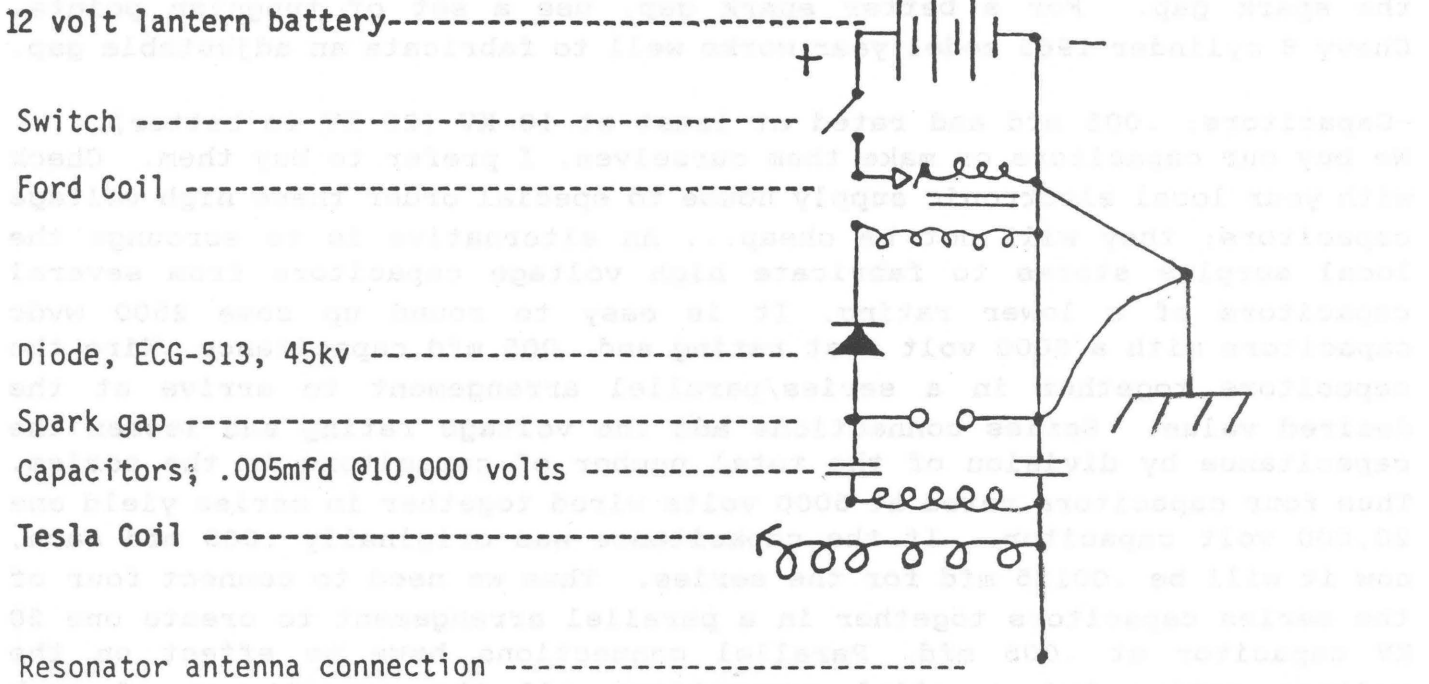

Before proceeding further, let's remember that the MWO is an experimental device and not for any healing or medical purposes! All experimenters should be in at least reasonably good health when building or experimenting with this high voltage, high frequency Tesla Coil Multi-Wave Oscillator power supply.

LET'S BUILD!

To begin our MWO Tesla Coil power supply project, we can round up the needed parts and components. Basic parts list:

-12 volt power supply; this can be a 12 volt lantern battery available from Radio Shack or any plug in power supply rated from approx 2 to 7 amperes.

-Model T Ford Coil; these old time induction coils are still available from J.C. Whitney Co, 1917 Archer Ave, PO Box 8410, Chicago, IL 60680. The MWO power supply will work adequately with the Model T Ford coil but a transistorized driver for a modern "hot rod" auto ignition coil will produce a Tesla Coil power supply with far more power!

-Switch; the on/off switch can be of any type. There is a switch already present on the plug in 12 volt power supply. I prefer to add a second switch of the key type, which prevents unauthorized use of the unit and a piece of vinyl tubing can be fitted over the metal key to create an insulated switch (this is important when turning the unit off).

-Diode, ECG-513 at 45 KV. The diode rectifies the output from the Model T Ford coil or the auto ignition coil by taking out the stray ac signals. This diode is a high voltage device rated at 45 Kilovolts (45 KV) peak inverse voltage.

-Spark Gap; an ordinary spark plug works adequately in this application. Try wrapping the spark plug in a large piece of vinyl tubing to insulate the spark gap. For a better spark gap, use a set of tungsten points. Chevy 6 cylinder 1965 model year works well to fabricate an adjustable gap.

-Capacitors; .005 mfd and rated at least at 10 KV (20 KV is better). We buy our capacitors or make them ourselves. I prefer to buy them. Check with your local electronic supply house to special order these high voltage capacitors; they will not be cheap... An alternative is to scrounge the local surplus stores to fabricate high voltage capacitors from several capacitors of a lower rating. It is easy to round up some 2500 wvdc capacitors with a 5000 volt test rating and .005 mfd capacitance. Wire the capacitors together in a series/parallel arrangement to arrive at the desired value. Series connections add the voltage rating and lessen the capacitance by division of the total number of capacitors in the series. Thus four capacitors rated at 5000 volts wired together in series yield one 20,000 volt capacitor. If the capacitance was originally .005 mfd each, now it will be .00125 mfd for the series. Thus we need to connect four of the series capacitors together in a parallel arrangement to create one 20 KV capacitor at .005 mfd. Parallel connections have no effect on the voltage rating but parallel connections add the capacitance of each individual capacitor.

CAUTION! Capacitors store electrical energy and can shock even when unit is turned off. Be sure to discharge the capacitors before touching them...

TESLA COIL

We make the Tesla Coil ourselves using the basic parameters worked out by Bob Beck in his original MWO adaptation from Georges Lakhovsky. The Super Science Tesla Coil is a close coupled, liquid filled coil that produces a 3" spark discharge when driven by a Darlington transistor and "hot rod" auto ignition coil setup.

For making the Tesla Coil, I like to use pvc pipe for the secondary coil form and acrylic tube for the primary coil form. The acrylic is transparent which permits visual inspection of the interior of the coil to observe any corona leakage or malfunction.

For the secondary winding: cut a 1 1/4" outside diameter piece of pvc pipe seven inches long. For the primary winding: cut a 2 1/2" outside diameter piece of clear acrylic tubing (1/4" wall thickness) seven inches long. Wind the secondary coil form with #32 gauge bare enameled copper wire so that the turns are tightly packed to create a winding approx six inches long with a 1/2" gap at either end. Wind the primary coil form with #14 gauge stranded and insulated copper wire. Wind exactly 18 turns and tightly pack them together. The vinyl insulation on the #14 gauge stranded wire will provide the correct spacing between turns.

Place the secondary winding inside the primary winding and use Super glue to hold the windings in place. For the terminals of the windings, use ordinary banana jacks to create a modular coil with a standard banana plug connector system. There will be tremendous electrical stress between the primary and secondary windings. We could reduce this dielectric stress by using a pancake style primary winding, but the pancake style primary takes up a lot of room. To solve the dielectric breakdown between the two windings, we insulate the space with liquid mineral oil. The liquid mineral oil is self healing should a dielectric breakdown occur. Solid forms of insulation such as paraffin wax are useless once a short circuit path has been created between the two windings.

To use the mineral oil insulation system, finish the coil first. Then drill a small hole in one end and squirt the oil in using a squeeze bottle. Then seal the hole using a piece of acrylic and Super glue. A word about Super Glue! This stuff is quite remarkable and is sold in hobby shops that specialize in flying, gas powered, model airplanes. Use accelerator to fast dry the glue. The brand name of the Super glue is "Gap Filler" and the accelerator is "Insta Set" both made by Bob Smith Industries.

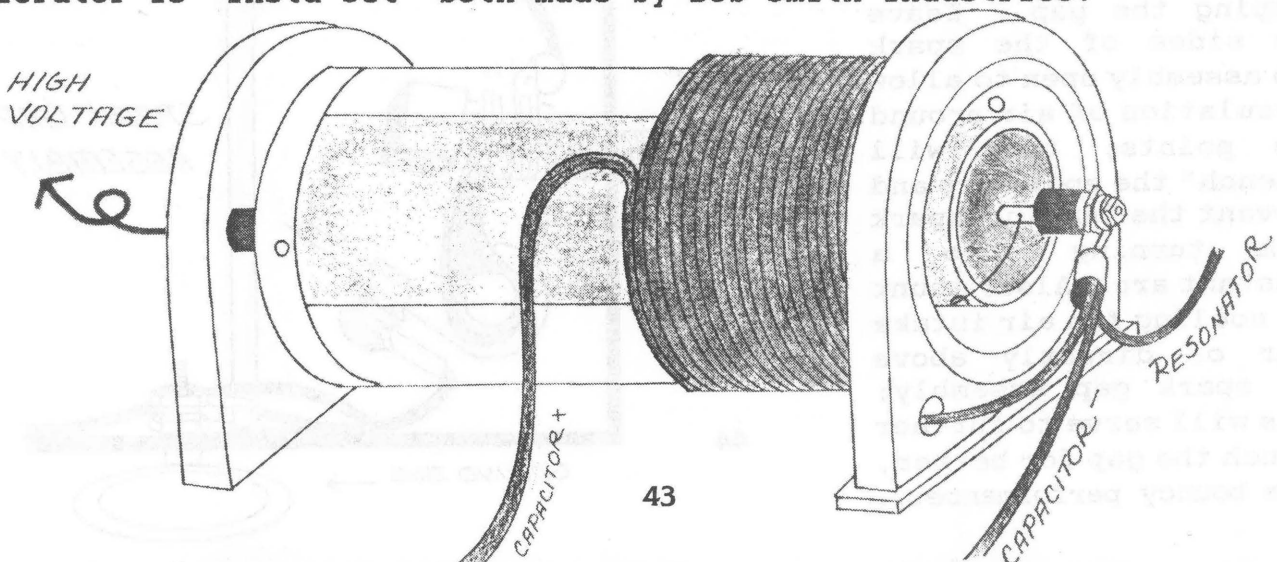

SPARK GAP

Even though an ordinary spark plug will work for a spark gap, we can do much better with an adjustable spark gap made from a set of tungsten auto ignition points. Chevy six cylinder, vintage 1960's are fine. To fabricate the adjustable spark gap, cut the base plate of the point assembly into two parts; make the cut near the spot where the two tungsten contacts normally meet. You should now have two base sections, with a contact point on each section. The reason we cut the base plate is to prevent the high voltage from jumping from the connections to the base and bypassing the breaker points. File down any sharp points where the base was cut. Mount the two tungsten points in such a way that the contact points barely touch each other and the base sections are as far apart as possible. Mount the spark gap assembly on a small piece of acrylic sheet. Wood is not suitable to mount the spark gap because the high voltage current will pass right through the wood base, possibly setting it on fire! Use a large nylon bolt to mechanically adjust the points. Mount the nylon bolt (Toilet seat bolts work well) in the side of the briefcase so that it butts against the spring loaded contact arm; this acts as a spark gap adjuster.

The advantage with an adjustable spark gap is that we can tune the gap while the MWO is in operation. The closer the two tungsten points are to each other, the faster the frequency of the spark jumping the gap. The further apart, the slower the frequency of the spark jumping the gap. Typically the Violet Ray Bulb Assembly calls for a fast frequency spark gap setting; while the High Power Radiator Antenna or Golden Ratio Antenna call for a wider gap spark setting to produce more power.

One side of the spark gap points will be at "ground" potential; while the other side will be at "high voltage" potential. Leave a metal discharge point exposed on the high voltage side of the spark gap assembly. We do this so that the entire MWO power supply may be discharged with a test wire running from the Ground Bus to the high voltage point. This provides a quick way to discharge the capacitors before troubleshooting the unit.

Also, cover the spark gap assembly with a visual block made from translucent acrylic. This visual screen will block the ultraviolet light emitted by the spark jumping the gap. Leave the sides of the spark gap assembly open to allow circulation of air around the points; this will "quench" the spark gap and prevent the jumping spark from turning into a constant arc. Also, mount the cooling fan air intake near or directly above the spark gap assembly; this will serve to further quench the gap for better, more bouncy performance...

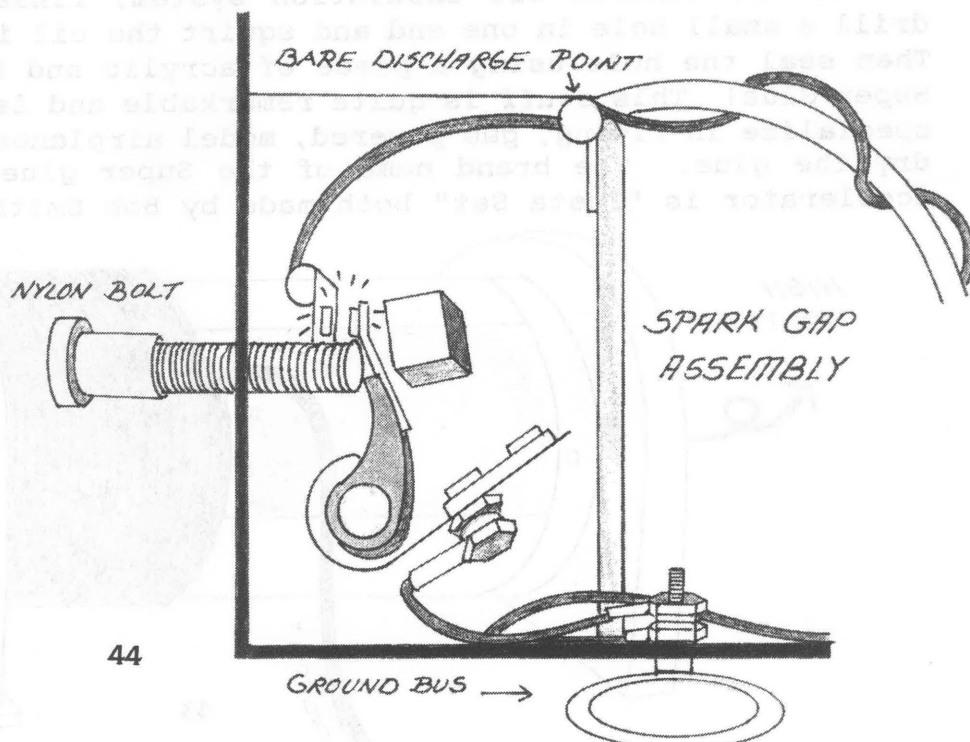

555 TIMER AND TRANSISTORIZED DRIVER

Even though the Model T Ford coil works adequately to power the MWO Tesla Coil power supply, we can really do better with a modern "hot rod" auto ignition coil. Mallory makes an aftermarket coil for drag racing that puts out approx 45 KV. The "MSD Blaster" is another aftermarket auto ignition coil that really gets the job done. Even an ordinary UC-15 replacement coil with its 30 KV rating will outperform the Model T Ford coil.

However there is one consideration to using an auto ignition coil as the primary high voltage source. Since we are working with 12 volts direct current, we need to interrupt or chop the 12 volts going into the auto coil to enable it to function as a transformer. The Model T Ford coil had a built in interrupter for this purpose. We will make a much better interrupter from a 555 timer chip and a high power Darlington transistor. The 555 timer chip will chop or interrupt the 12 volts going into the auto ignition coil from 130 times per second to 1300 times per second while the Darlington transistor handles the power. With the Model T Ford coil we were stuck with the fixed frequency of the interrupter (approx 200 Hz). With the 555 timer system, we can tune the frequency of the primary high voltage from 130 Hz to 1300 Hz. This really makes a difference when we try to get maximum performance from our Tesla Coil when it is driving the MWO Golden Ratio Radiator Antenna or driving the Violet Ray Bulb Assembly for direct stimulation.

Below is the schematic for the 555 Timer/Transistor Assembly. It is shown hooked up to the auto ignition coil. You can hardwire this circuit using a Radio Shack #276-162 project board. I use a large heatsink to mount the Darlington transistor (RCA 8766) and to mount the 50K ohm tuning potentiometer. When the MWO power supply is housed in a briefcase, the shaft of the 50K ohm potentiometer can extend through a hole in the side of the case. Go ahead & slip a short piece of vinyl tubing over the potentiometer shaft both to extend the shaft and to insulate it from high voltage.

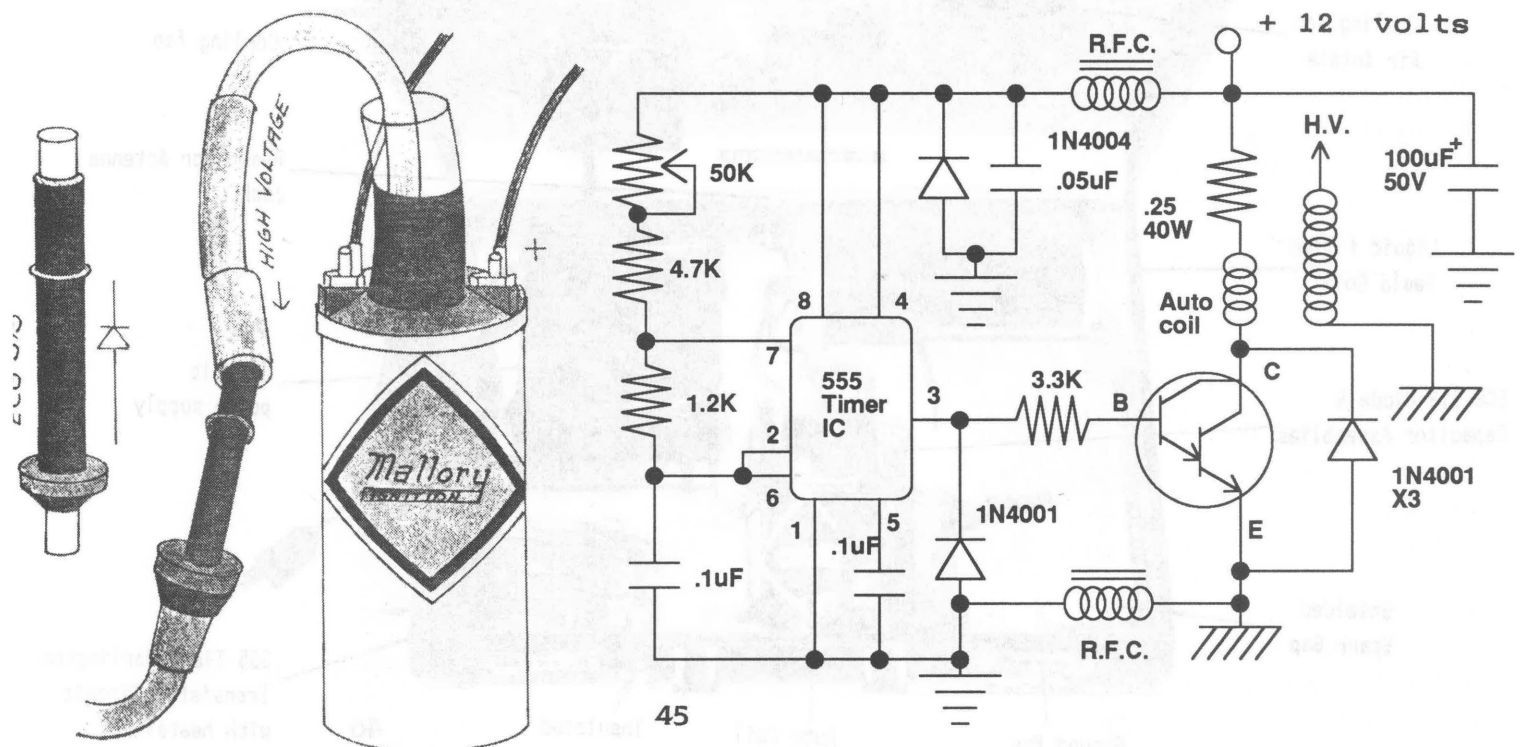

GROUND BUS

An external Ground Bus is important because it lets us reference the high voltage to the zero potential of the Earth itself. Without a true Earth ground, the negative side of the circuit can pick up a substantial voltage by induction from the high voltage potentials in the circuit. This condition is known as a "floating ground" and could result in the experimenter getting shocked. The shock itself is harmless, but the surprise that an accidental shock causes may lead the experimenter to jump back and bump his head! The Ground Bus may be connected by a long wire to a cold water pipe or to a steel fence post or to a piece of rebar driven into the ground. The Ground Bus is a handy reference point when discharging the circuit before troubleshooting.

SAFETY

Try to follow the "one hand rule" when actively adjusting the live high voltage circuit. This means keep one hand in your pocket or one hand behind your back. If an accidental shock should occur, then the electrical current does not travel across the heart when the experimenter follows the "one hand rule". Another safety procedure is to use a 12 volt lantern battery to power the circuit while it is still under construction. Once all the problems have been solved, then a more powerful 12 volt supply can be used.

TESTING THE CIRCUIT

Let the circuit run in darkness and try to observe any corona leaking from exposed high voltage points. There are two good and easy ways to stop high voltage leaks. One method is ordinary vinyl tubing: wrap wires carrying high voltage in vinyl tubing to absolutely stop them from leaking power robbing corona. Auto parts store sell expensive spark plug wire which will withstand the high voltages we are dealing with. If you use spark plug wire, be sure that it is metal wire, not "radio suppressor" wire (it's carbon fiber and impossible to solder or connect to).

Another good method of insulating high voltage is 100% silicone clear caulk! With your caulking gun, apply some 100% silicone clear caulking to exposed wires, exposed high voltage points and other places where you can observe leaking high voltage corona.

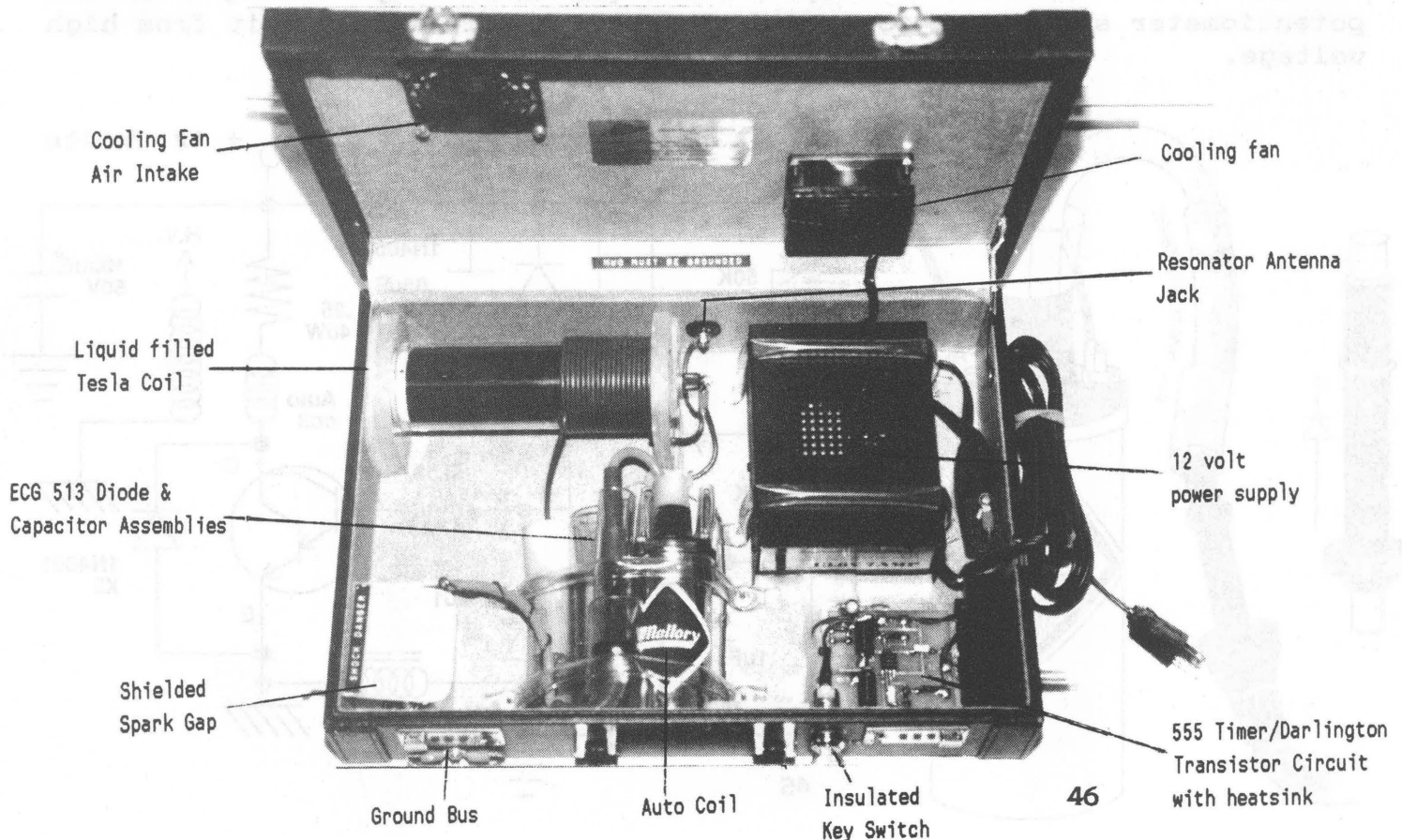

LAKHOVSKY MULTI-WAVE OSCILLATOR.

HOW IT WORKS:

The MWO sets up a high voltage oscillating electromagnetic field between the two antennas. Experimental subject sits or stands in this field and every cell in the body is exposed to the resonant effect of the multiple waves. Just as one guitar string will sound when exposed to its resonant tone; so will each cell vibrate to its own natural frequency!

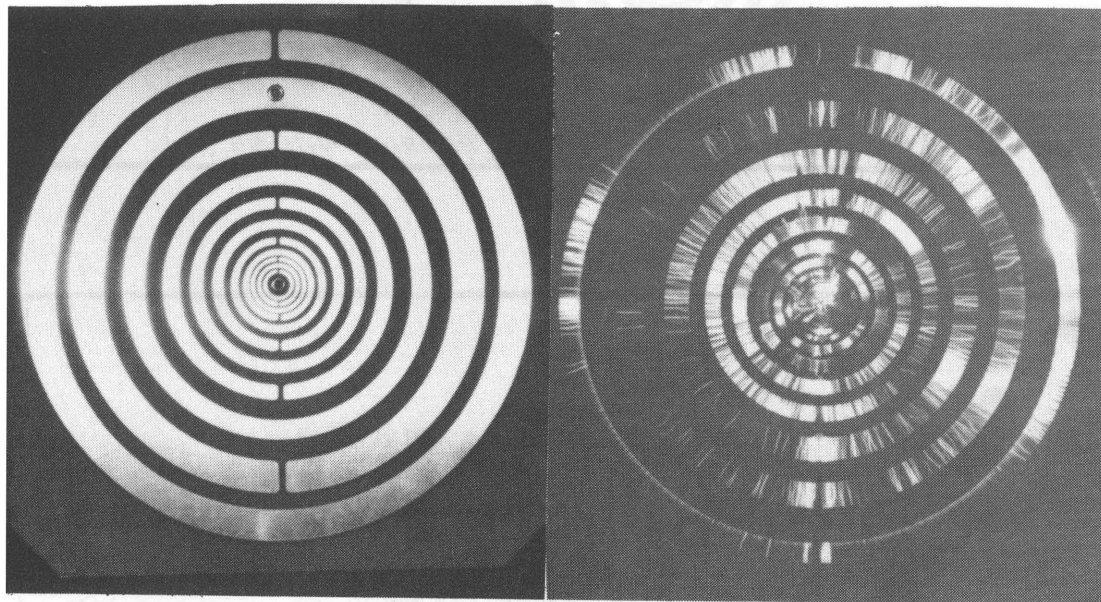
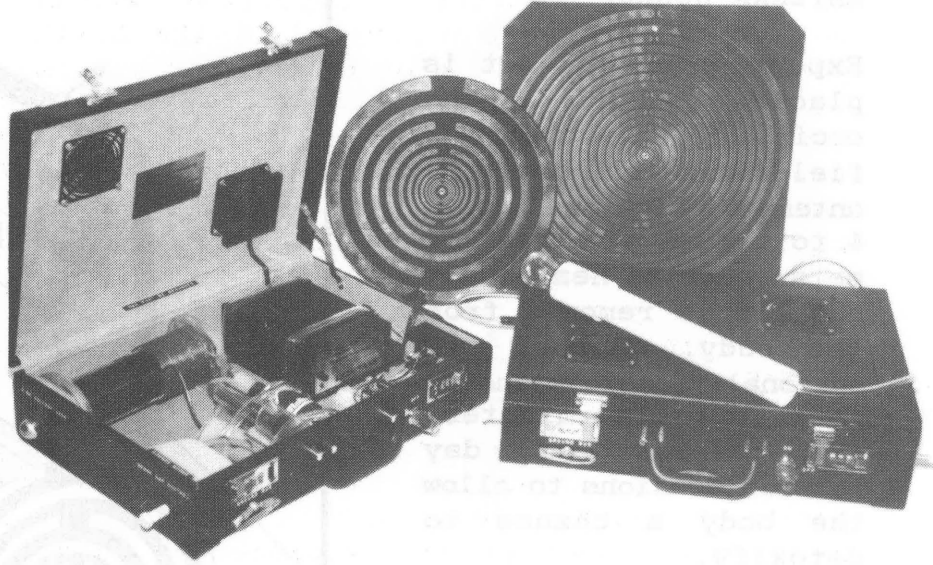

In this time lapse photo, we can see the dramatic effect of the high voltage excitation of each ring of the MWO antenna! Each ring radiates at its characteristic wavelength and frequency to cover a range from approx 200 Hz to 14 Giga Hz!

Modular construction works well for the Tesla Coil in the Super Science MWO power supply. This high voltage Tesla Coil can produce a 3" spark discharge from the smooth HV Discharge Terminal! The unit is a versatile experimenter's kit that can be used for Kirlian photography, or to create a plasma of Argon gas in the Violet Ray Bulb Assembly.

SUPER SCIENCE

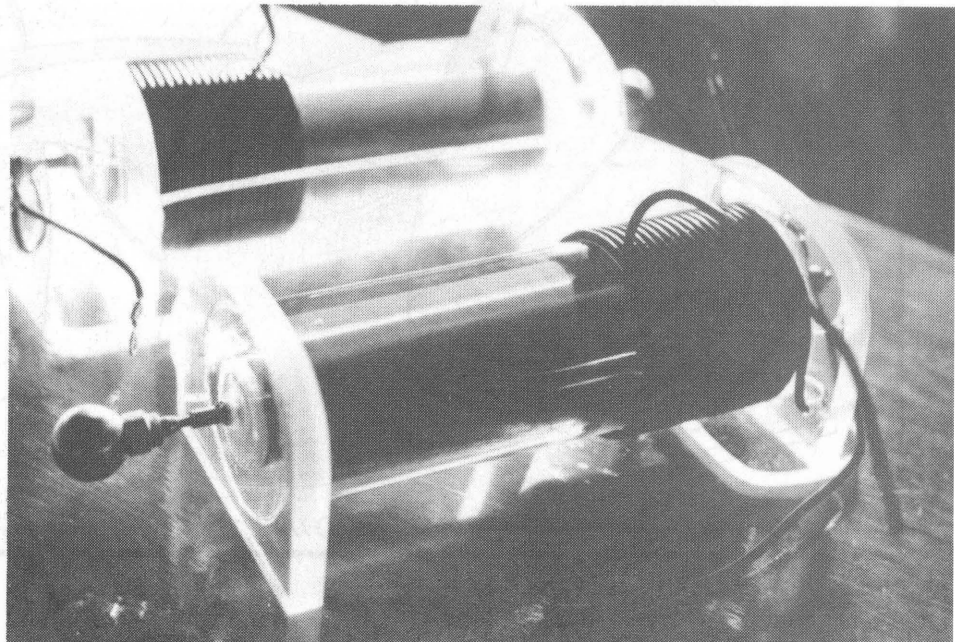

ANTENNA HOOKUP

Experimental subject is placed within the oscillating electrostatic field between the two antennas which are approx 4 to 6 feet apart. All metal such as heavy belt buckles is removed from the body. Clothes are optional. Sessions should last approx 20 minutes; skip at least one day between sessions to allow the body a chance to detoxify. With the Golden Ratio Radiator Antenna, the use of the second Resonator is not required due to the unique "Scalar" properties of this design.

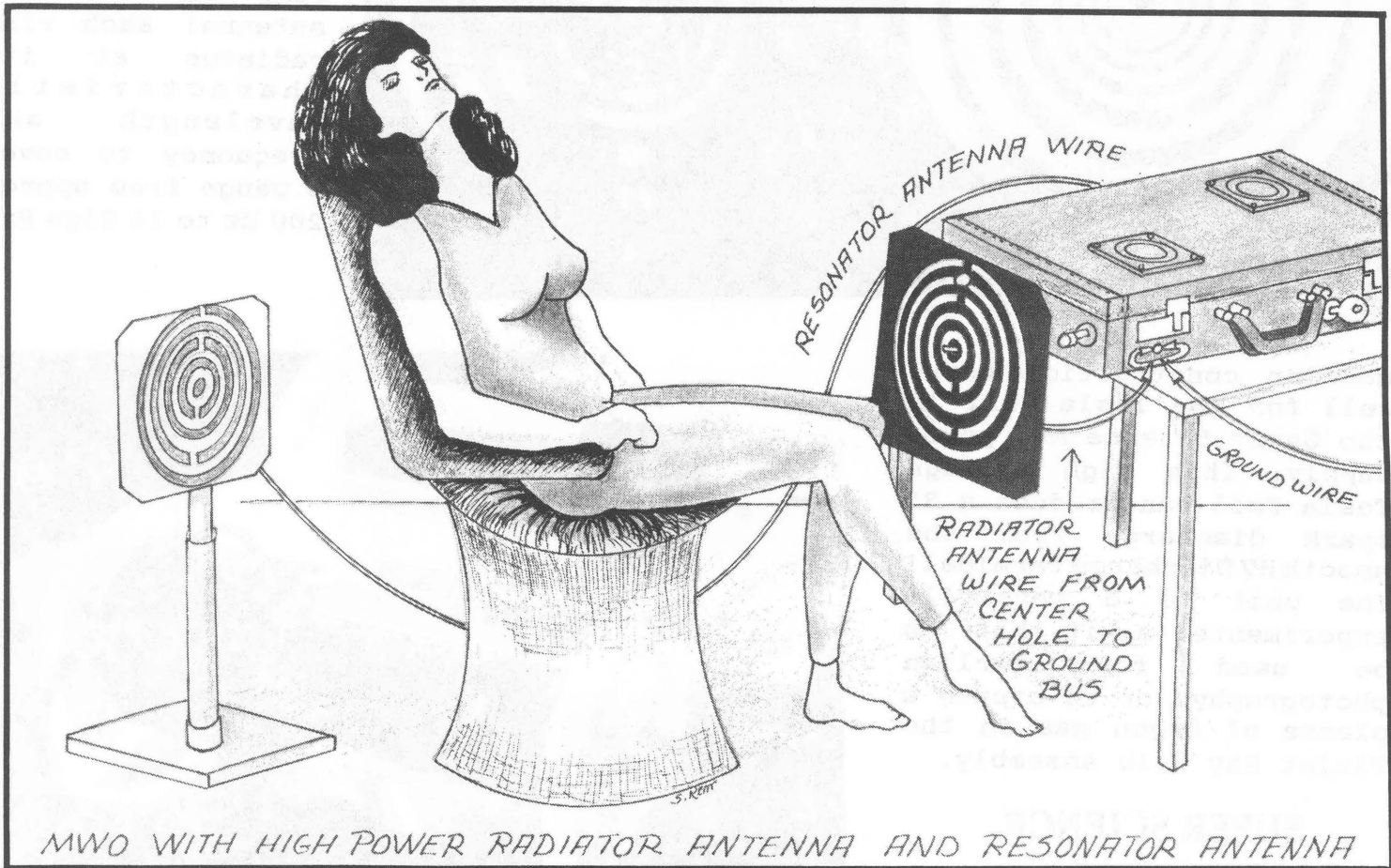
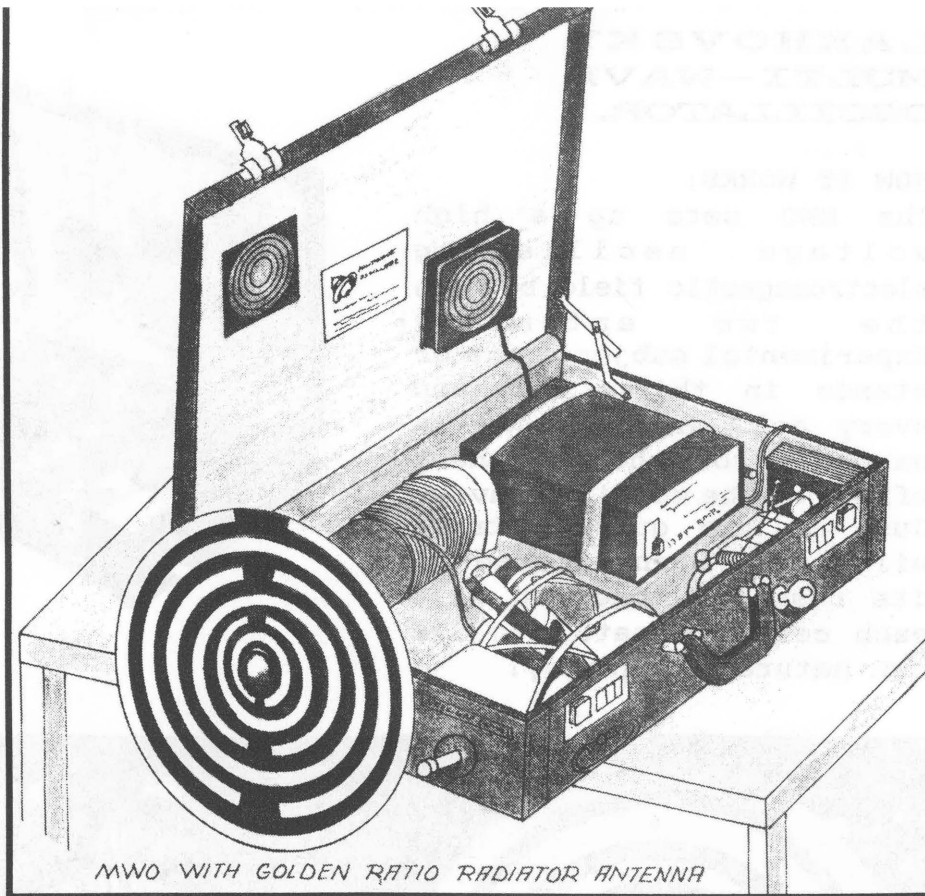

From the December 1963 Journal of Borderland Research
Excerpts from:

THE WAVES THAT HEAL

The New Science of Radiobiology

by Mark Clement

edited with commentary by Riley Hansard Crabb

Bob Beck has loaned us a copy of the late Mark Clement's brief, illustrated review of Georges Lakhovsky's Multiple Wave Oscillator showing pictures of antennas, before-and-after skin cancers apparently cured by the Oscillator, and of cancerous plants returned to normal health by two means: 1. Radio-Cellular Oscillator, and 2. Single Wire Oscillating Circuits.

"On the day Hitler's mechanized hordes drove into Prague a book was published in London entitled *The Secret of Life* by Georges Lakhovsky, a Russian-born engineer resident of Paris. The book had previously appeared in French, German, Italian and Spanish translations and Lakhovsky's theories were well known on the Continent long before the English Translation was published.

"The evil designs of the Nazis soon gave rise to depressing repercussions in all spheres of human activity and Lakhovsky's remarkable work was left virtually unnoticed in this country (England) by the medical profession and the public alike. A few discerning critics, however, expressed their views with appreciative understanding. *The Hospital* said 'Lakhovsky's theories are so interesting from the point of view of future developments that it will repay any keen hospital officer to give them his close attention.' *Science Forum* said 'The admirable translation of Lakhovsky's *The Secret of Life* will be heartily welcomed in progressive circles. The general theory is one which physicists, biologists and medical men cannot afford to ignore.' But these were voices in the wilderness and the field for experimental investigation was left open to a few amateurs devoid of scientific training and lacking the necessary resources.

"The impartial investigation of claims of cure of various diseases by un-orthodox methods demands high qualities of mind and character possessed by very few men indeed. Scientific truth is no respecter of persons or of vested interests, and Lakhovsky's spectacular results in the treatment of plants and animals and human beings were inevitably bound to antagonize orthodox practitioners and exponents of popular medical cults.

"On the Continent Lakhovsky's work attracted a great deal of attention in scientific

circles, particularly in Germany and Italy. Italian investigators were among the first to study Lakhovsky's theories and put them to the test in laboratories and clinics. It was, of course, to be expected that the new science of Radiobiology should make a special appeal to the intellectual heirs of Galvani, Volta and Marconi. It is somewhat depressing to observe that in England, the country of Faraday and Clerk Maxwell, Lakhovsky's theories have not yet received the attention they deserve.

REGENERATING OSCILLATING CIRCUITS

"Lakhovsky has been criticized by physicists ignorant of biology and by biologists ignorant of physics! These self-appointed censors of knowledge soon found they were confronted with a redoubtable opponent who fully realized the value of experimental evidence. Its publication resulted in causing annoyance to the custodians of infallible doctrines who made up with carping verbiage what they lacked in clarity of vision. But Lakhovsky's achievements with his oscillating circuits supported by astonishing photographs of regenerated tissues in plants and human beings could not be exploded by mere verbal fireworks, and as evidence accumulated the skepticism of hostile critics melted into morose silence.

"The indisputable fact remains that Lakhovsky was the first experimenter to make use of high frequency electro-magnetic waves in the domain of biology. Thus out of the application of radio-electricity to biology his work developed and gradually established the foundations of the new science of Radiobiology. The first international Congress of Radiobiology was held in Venice in 1934. A leading authority on electro-therapy, the late Dr. E.P. Cumberbatch, wrote: 'Although it had been frequently observed that the short Hertzian waves could produce heat at a distance from the transmitter the first scientific investigation from a biological point of view was made by Lakhovsky and his colleagues who published a paper in 1924 on the effects of very short waves on cancer in plants...'

"When France was occupied by German troops, Lakhovsky, being a prominent anti-Nazi, decided to leave Paris and made

his way to New York where he died in 1942 at the age of 73.

"In the United States Lakhovsky's theories were put to the practical test with typical American speed. Noticing that patients treated with Lakhovsky's Multiple Wave Oscillator showed signs of rejuvenating appearance, the possibility of exploiting this side-effect proved irresistible to an enterprising 'beautician'. A film was made featuring cases after treatment with Lakhovsky's MWO, which proved to be both interesting and convincing.

"In New York Lakhovsky was approached by several hospitals with a view to testing his apparatus experimentally. The remarkable results obtained . . . in a large New York City hospital, and also by a prominent Brooklyn urologist are fully set out in the text.

"In this country (England), owing mainly to the inauspicious time at which Lakhovsky's major work was published, very little interest has been shown on the part of those best qualified to judge its merits. The medical profession, whose conservatism is the most formidable barrier to progress, has been notoriously slack in investigating the new radio-electrical methods of treating disease as originated by Lakhovsky...."

Mark Clement's observation on the formidable conservatism of the medical profession in 1949 is still true today. Effective electronic diagnosis and treatment of disease is still a closed door here in America as far as the AMA is concerned. Those brave MDs who have tried to keep medical practice abreast of developments in electronic science have been discouraged, if not actually driven out of practice. Dr Abrams is a good example, with his Oscilloclast, developed and proven effective in San Francisco about the time Lakhovsky was developing the MWO in Paris in the 1920s. Radical innovations in any line of endeavor are usually thought up and proven by rank outsiders. Georges Lakhovsky was no doctor, but an electrical engineer!

Doctors, with their own pharmacies and with massive investments in the drug industry, are not likely to show much interest in radical new ways for treating human ailments, especially if the new way is a threat to profitable practice; and, as long as Americans think they can buy health in a pill or a shot in the fanny, doctors will continue to treat them with poisonous drugs at top prices. This is good business.

BORDERLAND RESEARCH

But for those of us who would like to keep our bodies as uncontaminated -- and as healthy -- as possible, Lakhovsky's theories

offer a way out of the clutches of the medical trust. There is little likelihood that the AMA will support research in this area of electronic science for years to come. There is every probability that there will be murderous opposition to any attempt to exploit the MWO on a national scale. This means that you will have to build and test your own equipment, or make friends with some electronic technician — engineer, TV or radio repairman — and prevail upon him or her to build it for you. This is the active kind of borderland research which requires that you get up out of your easy chair and get to work! If you live in an isolated spot, take a mail order course in basic radio construction. If you live near a high school that has an adult education program, sign up for the evening class in radio theory and bench work. I did at Barstow in 1958, so can you. If you want to be a citizen of the New Age you should make some effort to keep up to date, even if the sick industry doesn't!

What are Lakhovsky's general theories? Mark Clement sums them up neatly in Chapter One of **The Waves That Heal**:

"The fundamental principle of Lakhovsky's scientific system may be summed up in the axiom 'Every living being emits radiation'. Guided by this principle Lakhovsky was able to explain such diverse phenomena as instinct in animals, migration in birds, health, disease, and, in general, all the manifestations of organic life.

"According to Lakhovsky the nucleus of a living cell may be compared to an electrical oscillating circuit. This nucleus consists of tubular filaments and chromosomes made up of insulating material and filled with a conducting fluid containing all the mineral salts found in sea water. These filaments constitute minute oscillating circuits endowed with capacity and inductance and capable of oscillating according to a specific frequency. They are comparable to the circuits, coils and windings of radio receivers."

I believe Clement's comparison of a body cell with a radio receiver is only half-true. The cell can also be compared with a radio transmitter when it is releasing energy. We are both radio-receptive and radio-active! Lakhovsky's theory should be acceptable to any occult scientist. The push-pull idea, the positive and the negative, the Law of Opposites, is basic to all forms and to all life at this level of existence. By inductance Clement means that radio-electricity can be induced or put into every cell of your body. By capacity he means that each body cell can hold a charge of radio-electricity, just as the battery of your car can carry a charge of electricity. In the case of your body, the charge is put in through invisible but very

real radio waves. These can travel unimpeded through any solid object!

"The living cell can thus play the part of a transmitter or receiver of exceedingly short radio-electric waves which give rise to high frequency currents in the circuits of the cellular nucleus. Now the vibration of an oscillating circuit is maintained by radiated energy. But where does it come from.

COSMIC RAYS

"Scientists have established the existence of highly penetrating waves to which, by reason of their universality, they have given the name of cosmic rays. These rays, generated by the interference of astral radiations, are capable of traversing dense metals and soils to a great depth. Lakhovsky has demonstrated the cellular oscillation of living organisms is maintained by cosmic radiation. According to him disease may be said to result from oscillatory dis-equilibrium due to either a deficiency or an excess of cellular radiation. An important factor in this connection is the nature of the soil. A reinforcement of cosmic rays takes place on soils which are good conductors of electricity such as clay, ferruginous and carboniferous soils.

RESONATE IN HARMONY WITH THE UNIVERSE

"To avoid the harmful effects of loss of oscillatory equilibrium it is necessary to ensure the regularization of the cosmic field round the living organism by filtration. Lakhovsky's own explanation of the problem of filtration is as follows: 'The terrestrial atmosphere is known to be impregnated by a vast range of electro-magnetic oscillations of all wave lengths and intensities as a result of unceasing electrical discharges (thunder, etc.). Besides that we know that electric motors and other electrical machines create in the atmosphere a field of auxiliary waves. Moreover, during the past 25 years the earth has been flooded with radio-telegraphic, radio-telephonic and other waves. Under such conditions it is easy to understand why any oscillating circuit of any form or dimensions is likely to find in this vast field of waves its own resonance with which it can vibrate harmoniously. It is therefore obvious that to make any oscillating circuit oscillate there is no need to have recourse to a local generator such as the Radio Cellular Oscillator used by Lakhovsky in 1924 when he first treated and cured geraniums inoculated with cancer. The oscillating circuit utilized by Lakhovsky in his second series of experiments — a circuit having no artificial source of excitation — proved equally effective in curing geraniums rendered cancerous by inoculation."

Yes, in 1924 Lakhovsky 'graduated'

from electronics to radionics! He discovered and proved to his own satisfaction that in some ways a simple, one-turn coil of wire or fibre was as effective as the electric powered Multiple Wave Oscillator. The simple Oscillating Circuit, as Lakhovsky called it, has two advantages over the MWO. It doesn't have to be plugged in to a battery or 110 volt home power supply, and it broadcasts no interference with radio and TV sets. It acts as a step down transformer for life-positive cosmic radiation.

Clement says that "it must be particularly stressed that only Circuits made in strict accordance with Lakhovsky's directions should be used, otherwise the results will prove to be entirely negative." Unfortunately we do not have Lakhovsky's directions, and Clement certainly doesn't give them. You are still free to investigate this type of research and many have. If you want to experiment in this area then get yourself some copper wire (solid or stranded, research should be done on both) in various lengths, (8 inches is one wave length which has worked well on tomato plants) and make them into a circle with the ends overlapping, but with the metal ends insulated or separated from each other. Lengths can be determined through radiesthetic means (that is, by dowsing) or perhaps in geometric relationship with the structure of the plant. Considering the radionic and radiesthetic viewpoint geometric shapes would also have an influence and can be experimented with. Always use control samples in your experiments to see what works and what doesn't.

To get back to Clement's text: "Through the action of this constant field of radio-electric waves which emanates from the surrounding atmosphere the oscillating circuit is made to resonate like an instrument in tune with certain sounds. Thus the oscillating circuit creates a field which canalizes and filters, so to speak, the cosmic waves necessary for cellular oscillation.

THE DANGER OF BURNING X-RAYS

"Furthermore, this filtration is a general phenomenon. It has been discovered, through the investigations of Lakhovsky, that radiations such as those associated with light, ultra-violet rays, X-rays, etc., have the property of making cosmic rays act, as it were, to the advantage or disadvantage of the cells. Now the field created by an oscillating circuit is constant and emits a steady and sustained force. It invariably acts in a favorable manner on the oscillation of the body cells, facilitating by the filtration of cosmic rays, regular cellular division, a fact which explains the immunity imparted to the cells and their consequent capacity of resistance to diseases and microbes.

It is highly significant that about the only rays and ray machines approved for general use by the American Medical Association are the destructive ones of X-rays and atomic radiation for the mis-treatment of cancer.

“Since Lakhovsky’s oscillating circuits were first used for the treatment of cancerous geraniums, an experiment fully described in communications to the French Academy of Science, the same method has been successfully applied in Continental hospitals and nursing homes.”

Photos of the successful treatment of cancerous geranium plants are included in Clement’s book, along with the pictures of the disappearing skin cancers in human beings. So Clement describes the major features of Lakhovsky’s work in this first chapter, the simple, one-coil Oscillating Circuit powered by cosmic rays, and the electric-powered Multiple Wave Oscillator. There are photos of the Multiple Wave Oscillator, showing clearly the unique circular antennas. These were made of metal tubing, separated and suspended with silk thread. The simpler, aluminum-foil printed circuit in Bob Beck’s adaptation is an easy way to experiment with the idea.

THE OSCILLATING CIRCUIT

“The diagram on this page shows where the oscillating circuits should be worn, i.e. round the neck, waist, and above the elbows and knees. The effect is intensified if more than one circuit is worn. Generally speaking, the neck and waist are the favoured sites and likely to bring about the best results.

“In the light of Lakhovsky’s theories the fight between the living organism and microbes is fundamentally a ‘war of radiations’. If the radiations of the microbe win the cell ceases to oscillate and death is the ultimate result. If, on the other hand, radiations of the cell gain the ascendant the microbe is killed and health is preserved.

THE SECRET OF LIFE (AT THE FORM LEVEL)

“Broadly speaking, health is equivalent to oscillatory equilibrium of living cells whereas disease is characterized by oscillatory dis-equilibrium. This general principle has given rise to a vast number of experiments covering the whole field of biology. Plants, animals and human beings have been successfully treated by the application of Lakhovsky’s oscillating circuits and the reader is referred to his major work The Secret of Life for a full discussion of this important subject.

Those of you who have been studying the Kabala with Mrs. Crabb and me must have been struck immediately by the meta-

physical soundness of Lakhovsky’s basic theory expressed above. One wonders if this Russian escapee from Communism, and from Naziism, wasn’t indeed a student of the Western Mystery Tradition, perhaps even an Initiate! The Tree of Life is the groundplan of our Tradition. On the Tree we show the descent and the ascent of power, oscillating back and forth from left to right and right to left across the Middle Pillar, or balance point.

Now for the final paragraph of Chapter One. “During recent years observations on the part of several investigators have established the fact that most animals, including insects and birds, emit radiations while they are also sensitive to the influence of external electromagnetic waves. These radiations

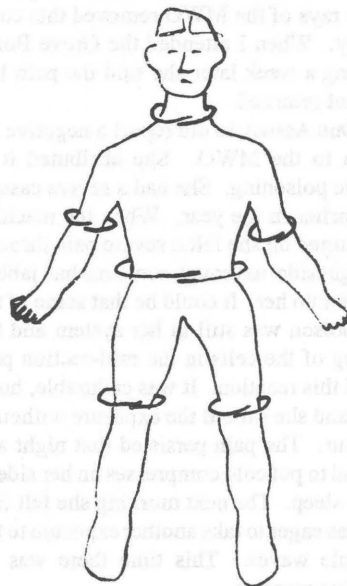

Single wire oscillating circuits around subject’s neck, arms, waist and knees.

emitted by all living beings cover an indefinite range (infinite range?) and are characterized by a multitude of different wave lengths. In the immense range of existing radiations we can only perceive the luminous octave (visible light) but we know that whole gamuts of radiations exist beyond the narrow limits of the visible spectrum. The limitations of our senses prevent us from perceiving radiations of living beings and this sensory incapacity also excludes from the field of direct awareness the vast gamut of electromagnetic waves traversing our atmosphere. Yet all these radiations and waves exist and affect all forms of organic life in various ways.”

DR. RAUL ARAUJO’S REPORT

In Chapter Two Mark Clement gives “Medical Reports on Lakhovsky’s Oscillating Circuits.” We’ll give only one, by Dr.

Araujo, Physician at the Prophylactic Institute, Montevideo Uruguay. “In 1929, Dr. Araujo was suffering from a long-standing infection of the larynx which his eminent colleagues had failed to cure. While in Paris he met Lakhovsky who advised him to wear one of his oscillating circuits in the form of a collar. Although feeling rather skeptical about this unorthodox method of treatment Dr. Araujo wore the oscillating circuit for several months with the result that he fully recovered and has had no relapse since. This personal experience led him to treat his own patients with Lakhovsky’s oscillating circuits. Having treated over 300 patients suffering from a wide variety of diseases Dr. Araujo succeeded in curing or greatly improving cases of rheumatism, asthma, anemia, neuralgia, gastric ulcer, colitis, glandular disturbances, sterility, genito-urinary affections, general weakness and even cancer. Dr. Araujo observed that in cases in which Lakhovsky’s oscillating circuits appeared to give no definite results there was invariably a latent infection which required special treatment such as syphilis, cholecystitis, sinusitis, pyelitis, dental sepsis, etc. . . A full account of Dr. Araujo’s Report appeared in a monograph entitled ‘Cosmic Rays and Oscillating Circuits’ by Dr. P. Rigaux, Paris, 1932.”

CHAPTER THREE, THE MULTIPLE WAVE OSCILLATOR

Most of this has been well explained by Bob Beck in his article in the November Journal, though we might quote again in Clement’s own words: “After many experiments Lakhovsky succeeded in constructing an apparatus generating an electrostatic field in which all frequencies from 3 metres to the infra-red region could be produced. Hence in this field every cell could find its own frequency in resonance... Thus a type of oscillator was obtained giving all fundamental wave lengths from 10 cms. to 400 metres, corresponding to frequencies of 750,000 to 3 milliards per second. . .

“Since 1931 the Multiple Wave Oscillator has been used in most European countries and in America for the treatment of many diseases including cancer. No contraindications for the use of the apparatus nor any harmful effects on patients have ever been reported. This is in striking contrast with short-wave therapy in general, X-rays and radium whose application in the hands of experts has not infrequently been followed by the most serious consequences. . .”

Then follow several pages of photos of before-and-after cancer cures and medical reports from doctors. This one is typical, from Dr. Nicholas Gentile, Chief Radiologist of the Clinic for Incurables of the Apostolic Ladies of the Sacred Heart of Jesus,

Rome, published in the medical review *Medicina Nuova XXVI, N.5., 1935, Rome: "Effects On The Nervous System.* Generally speaking I have observed a marked analgesic action following the application of the Multiple Wave Oscillator in all affections associated with pain, particularly in the classical cases typical of such affections. For example, a patient suffering from cephalgia, resulting from violent cranial trauma, for a duration of 10 years, was subjected to a great variety of treatments, but all in vain. The patient was definitely cured after 2 months' treatment with the MWO. Improvement was manifest after only 3 applications."

Dr. Gentile also reported the effects of the MWO on the Central Nervous System, on Chronic Inflammations, on Metabolism, on Disorders of the Cardio-Vascular System, and on miscellaneous cases. He says he adopted the "technique of localized irradiation. Generally speaking, treatment is given every 4 days for a duration of 5-15 minutes per session. This is the technique which has given me the best results after having experimented with many forms of application. For children, old people and debilitated women, a relatively weaker application is indicated. If results are not apparent after 7 or 8 applications, I continue until 15-30 applications are given at the rate of a single treatment once a week. I have never observed any ill-effects from the MWO treatment, whatever the number of applications was in any given case. Moreover, the general condition of patients is always improved, even if only temporarily, so much so that the patients themselves sometimes insist on having further treatments. . ."

This chapter on the MWO concludes with four pages of reports of notable improvement or cure by American doctors. Chapter Five is concerned with the remarkable results obtained by using the Multiple Wave Oscillator on animals. Chapter Six contains Lakhovsky's prophecy that some time in the future diagnosis of disease would be obtained by television! This is something which Dr. Ruth Drown's Radio-Vision and Homo-Vibra Ray instruments have already accomplished.

THE NOVEMBER CONVENTION TESTING PROGRAM

There were two Multiple Wave Oscillators available. These were generously furnished by Bob Beck and Ed Skilling, and were set up in the shielded seance room. Only short exposures of from 2 to 5 minutes were given, during the lunch and dinner hours on Saturday and Sunday. In that time perhaps 100 people volunteered for tests. Until a follow up inquiry is made, no statistical conclusion can be made, or even begun!

A few individual cases reported to your Director are worthy of note, including my own. By mid-morning on Saturday a spinal injury from my old, hockey-playing days was acting up. Doctors have called it a spasm in the sacro-iliac area. Ed Skilling invited me to sit in the rays from the MWO for a couple of minutes while the seance room was being readied for testing. Within a minute the spasm relaxed completely and the pain was gone. This was not a permanent change, of course, but the analgesic effect was certainly noticeable.

Mrs. Fred Rannenber, financial secretary of Harmony Grove and a BSR Associate, told me she had had a sharp pain in the area of her left hip for over two weeks at the time of the Convention. One 3-minute exposure to the rays of the MWO removed this completely. When I attended the Grove Board meeting a week later she said the pain had still not returned.

One Associate did report a negative reaction to the MWO. She attributed it to arsenic poisoning. She had a severe case of this earlier in the year. When the machine was turned on she felt a severe pain through her right side, as though someone had jabbed a knife into her. It could be that some of the lead poison was still in her system and the stirring of the cells in the mid-section produced this reaction. It was endurable, however, and she sat out the exposure without a murmur. The pain persisted that night and she had to put cold compresses on her side to get to sleep. The next morning she felt fine and was eager to take another exposure to the multiple waves. This time there was no negative reaction.

The most startling subject of all was the woman who had been awake all Saturday night with a migraine headache, an old and recurring ailment. By Sunday morning, Nov. 10th, she was sick and nauseated. It was suggested that before taking her to a doctor or hospital she be given a short exposure to MWO rays. Within minutes all pain was gone and she returned to her cottage to lay down and sleep like a baby.

THE PSYCHEDELIC EFFECT

Ed Skilling is the only I know who has stayed in the MWO field or rays for longer than 15 minutes. While testing and adjusting his equipment at his microphone factory several weeks ago he deliberately stayed between the antennas for an hour. At the end of that time he was beginning to feel light-headed and dreamy he thought it a good idea to get out before losing consciousness altogether.

An even more spectacular possibility is the Time-Machine effect in connection with rejuvenation. If, as Bob Beck suggested in

his article, the MWO tends to take the body cell back down the time-track to a more youthful, more vital period, what would happen to a person who stayed in the field of the machine for four hours? Would his vibratory rate be speeded up to where he would disappear completely? Like the hero of H.G. Wells' "Time Machine"? Anybody want to try it? It seems, from hints George Van Tassel has been dropping over the years, that his Integratron at Giant Rock, California might do something like this -- if and when he gets it working! As I recall, both George and the Canadian Saucerian, the late W.B. Smith, spoke of the four dimensions of electricity: 1. is the electricity moving in one direction along a copper wire, 2. is the magnetic field around the wire, 3. is the static charge created by the first two effects, and 4. is Time -- or the "tempic field" as Smith called it. The Time Field equates with Space, where consciousness is everywhere present. Seems to me Lakhovsky's Multiple Wave Oscillator is a gadget which gives us the opportunity -- for the first time -- of approaching the Time Field with scientifically acceptable equipment, operating in known frequencies. Remember, that with its circular antennas it operates on the vortex principle. Each individual antenna in the group is a segment of a 60 degree cone. The 1/2 inch gaps, at alternate 180 degrees from each other, conform to the alternating principle and give a damped or pulsed wave.

THE SPACE AGE EFFECT

Copies of our November 1963 *Journal* have gone all over the world. Each day's mail brings new orders. We are confident that Lakhovsky's invention, far ahead of its time in the 1920s and 30s, has been given a new lease on life and will be pushed to its ultimate development on every continent. There will be vigorous opposition from the right-wing conservatives and reactionaries. Their resistance will furnish the platform from which electronic "medicine" will eventually sweep the world.

I see the day when a device, similar to the MWO, will be a standard part of every home bathroom or cleansing center. You will consider it as necessary and as routine to take an electronic showerbath, as to take a water bath. Home from work, tired, dirty and discouraged, you strip, flip on the MWO switch, and while shaving, doing your hair or whatever, re-balance your whole system with a two or three minutes exposure to the pulsing waves from the oscillator as they flood the whole room. For the sale of the house of the future it will be as important for the ad to say "shielded bath with MWO" as it will to say "tile bath with radiant heat."

Mr. Skilling told me he was tired and

“dragged out” after processing dozens of volunteer “guinea pigs” late Saturday afternoon. Before shutting down the equipment he sat in the nail-less wooden chair between the antennas and gave himself a three minute shot of pulsed waves. Refreshed and revived he looked forward to a good dinner and the full evening program.

I don't know of a better Christmas gift we could have given the Associates than the idea and the plans for the Lakhovsky MWO, researched and so generously offered us by Bob Beck in the true borderland science tradition. Now it is up to you to carry it forward in your own individual way. We welcome your comments, observations and research data as you develop equipment and a testing program.

AND NOTHING HAPPENED!

“No doubt you are deluged with correspondence about your articles on the Lakhovsky Rejuvenation Machine. Since you said it is possible for any intelligent 16-year-old to build one that is exactly that which I have had to rely on. Fortunately, my son is fairly well informed on electronics but obviously no expert at his age, 16. He followed your diagram but instead of battery power he used an electric train transformer, which he assures me, is equally efficient. He also found he had to make one change in the hookup of the Tesla Coil. I have taken four exposures and the results! **Nil!**”

Maybe this lady expected to be rejuvenated back to her early twenties. As far as we know, no such claims have ever been made for the Lakhovsky gadgets -- though it would be interesting if it happened! As for power supply to the Model T Ford coil, any 6, 8, 10 or 12 volt battery or transformer should do, depending on what you have available and where you intend to do your experimenting. We understand the old Model T magneto delivered as high as 18 volts to the four coils. One handy source of 6 or 12 volt electricity is the cigarette lighter on the dash of the car. Plug in there for power when you want to expose yourself while driving or out in the country.

“I had been fighting a virus for several days and the day after the first exposure I felt a great deal better, but the second day I was right back where I had been. But that was the pattern the virus had been taking. One day I'd feel fairly normal, the next miserable again. So it is difficult to know if the Lakhovsky machine could be credited with the temporary improvement.”

That's right, ma'am, some people show little or no reaction to the mytogenic waves put out by the Lakhovsky instrument. The results are unpredictable. Perhaps that's why the research was pushed no further in the

1930s by authorities here in the United States. You, like most people, think that health can be bought in a package. Lakhovsky didn't agree with this erroneous conclusion. His theory was that health is a condition of balance of all the forces of the body. Ill health is a condition of imbalance caused by your misbehavior. If you continue to misbehave, any force applied from the outside, whether it be mytogenic waves, manipulation, drugs, medicine or surgery, will only bring temporary relief. Pain is an insistent teacher, urging you to change your mind; but if you can't change your mind, how can you change your body?

“One possible reaction to the exposure I can report is that I took the first one just before going to bed at night. It took me three hours to get to sleep. Several things puzzle me about the machine we have constructed. First of all, although we have experimented with a Tesla coil of the size your diagram calls for, as well as one almost twice the size and strength, we cannot get a two-inch spark from the antenna or resonator, 1/2 to 3/4 of an inch is the absolute maximum.”

The mention of the two-inch spark was Mr. Beck's error. 1/2 to 3/4 inch arcing is all this circuitry will produce and that is adequate to affect notable changes in many forms of cell life. More power might produce faster changes, and much harm! Be reasonable, a living cell is so small as to be invisible without a microscope. Only minute amounts of energy are necessary to affect a cell, to stimulate it or to kill it.

“Second, under no conditions do we get the ‘bluish glow of brush discharge’ from the antenna that you mention; although we have no trouble lighting up a two-foot fluorescent lamp.”

Operate your Oscillator in total darkness and you should see some brush discharge at some points on the antenna. True this re-designed equipment puts out nothing like the five-inch brush discharge visible in the photo of some of the original Lakhovsky equipment in Mark Clement's book, “Waves That Heal”, and Lakhovsky's antenna appears to be at least two feet across.

But power is not the answer to balanced cell life! Dr. Abrams discovered this with his early electronic experiments in San Francisco in the 1920s. It is the quality and the variety of the pulsed waves that counts! In any event weaker equipment can be compensated by longer exposure, and this may be more beneficial to living matter.

“And thirdly, since we have not constructed any outer shield for the machine, such as a Faraday cage of copper screen, I have been monitoring the operation on our radios and television. On the radio, one notes an annoying and loud buzz, but on T.V.

except for a couple of light horizontal lines and a very slight hum, there is no serious effect. So I doubt that we're bothering our neighbors very much. In any case, we try to use the oscillator very early or very late in the day, when few people are using their radios or TV. I have sent for Clement's book, ‘Waves That Heal,’ and Lakhovsky's ‘The Secret of Life’, not only to better understand what we are trying to work with but also in the anxious hope that I will find out why our machine does not have the affect it apparently should have.”

Let me assure you, good lady, there is no single cure-all for man's ills. The clue to better health is in the profound statement of the Savior of our race: “As a man thinketh in his heart, so is he.” Pain is still the great teacher in the world and will be for a long, long time to come. I don't know what your physical condition is and it's none of my business; that's between you and your doctor. If you have a long history of frustration and thwarted ambition, going back to childhood and even into past lives, this mass of energy of crystallized thought-forms, is not going to be broken up and dissipated overnight. If you have consciously and willfully flouted Cosmic laws, or have turned them to your own selfish ends, the consequences of this misbehavior will have to be worked out at this level. The occult scientist calls this Fixed Karma. In this connection, one of my favorite teachers, Dion Fortune, reminds us: “What cannot be cured must be endured.”

If the Lakhovsky oscillator does have an analgesic affect -- as it appears to have had in some cases -- it has this advantage over pain-relieving drugs; it does not leave a residue of poison in our already over-loaded liver and kidneys!

WORD OF A SIMILAR INSTRUMENT UNDER DEVELOPMENT

We have a second letter from this same lady Associate, also worthy of note in connection with the Lakhovsky Multi-Wave Oscillator.

“First off, when my brother received the machine we had built for him, using the battery indicated in the schematic, he felt the power source might be too weak. It so happens he has a business contact with one of the largest electronic instrument companies in the area where he lives. He decided to go straight to the president and seek his advice. With the whole idea placed before him this gentleman said, ‘This is very interesting. I want you to meet one of our physicists who is working on a very similar instrument.’ A meeting with the physicist revealed two interesting pieces of information: first, the physicist had never heard of Lakhovsky or his machine; second as soon as this new

instrument was completed, arrangements had been made to test it in a large nearby hospital! Is this latter not a cheering bit of news?"

Both cheering and discouraging. The basic principle discovered by Lakhovsky is certainly available to the mental probing of other sincere researchers, so let us keep it alive by all means. But barring a revolution in the ultra-conservative leadership of the American Medical Association, no electronic developments will be allowed to threaten the high-profit position of the drug industry.

"In their discussion of the power source, the physicist suggested my brother use a wet-cell car battery, #50, 39 plates, 70 A.H. We are using one too and it makes a much better spark from the antenna, although it still is no greater than 1/2 to 3/4 inch. It does seem stronger. Of course the machine is not so readily portable with such a heavy battery. My brother had only one exposure at this writing but he reports a noticeable improvement in the arthritic pain bothering him in his right arm for months. On the other hand, the report on the use of my own machine is somewhat less encouraging. The only positive results concern my husband. After his first ten-minute exposure, within a few hours, a painful bursitis in his shoulder cleared up. He has been subject to off-again, on-again attacks of bursitis there for some 15 years; for which he had taken medication, short wave, and even X-ray treatments, when the attacks were severe. He has since taken another exposure, but neither this nor the first one seemed to help an itching-skin allergy which has bothered him for some years.

NOT THE FOUNTAIN OF YOUTH SHE EXPECTED!

"As for myself, I have taken at least a half-dozen exposures and cannot in all honesty detect the slightest difference from them. I'm not sure if it is a matter of 'suggestion' or a desire to prove the capabilities of the machine. On the contrary, I notice such strange contradictions as the fact that although I took an exposure yesterday morning, in the evening the fourth and fifth fingers on my right hand were painful, from some kind of arthritis or rheumatism. I had never had anything like this before. Does it not seem odd that it should develop on the day of the exposure?"

Not at all! Any positive reaction to exposure to the mytogenic rays of the Lakhovsky oscillator indicates that it is working! Mr. Lakhovsky's theory is that the waves or oscillations excite the cell, causing it to release mor energy, also to shake off accumulated poisons and/or tensions. If your system is loaded down with tensions from daily living in America, if your system is loaded down with poisons from processed foods and contaminated air and water, you

can expect painful reactions when the junk breaks free. I believe that is what sickness is the body struggling to get rid of poison. For you, things may get worse before they get better!

HOW OFTEN AND HOW LONG?

"With the mention of two successive exposures in two days I get to what is the most important question in the use of the MWO. No one has explained why exposures are suggested at four-day intervals. Is it harmful or useless to take them more frequently? When one is uncomfortable or in pain, one is anxious to rid oneself of the discomfort as quickly as possible. And to have to wait four more days for additional improvement seems unnecessary if there is no harm in the exposures. I have exposed myself at more frequent intervals and still have observed no reactions?"

The suggested exposure rate of fifteen minutes every four days came from Dr. Gentile's extensive researches with Lakhovsky equipment in Rome in the 1930s. This is a typical professional approach to treatment of disease by doctors. From long experience with drugs and other proven forms of therapy, they know that it takes time for the human organism to adjust itself to radical changes -- without harming the organism.

Whether or not this holds true for the operation and effect of the Lakhovsky machine remains to be proven and you'll have to be your own guinea pig. It's your machine; it's your body; it's your life. You can take an exposure every hour on the hour if you like; stay in all day. Who's going to stop you? This is borderland research and you are a borderland scientist, looking for new knowledge which may be of benefit to yourself and the human race, judging from the last lines of your letter.

"I am so excited and hopeful of the efficacy of this MWO machine that I do not want to leave any avenue unexplored that may possibly help in understanding its use and making it freely available to anybody I can possibly help. May I take this opportunity to tell you how tremendously enthusiastic and interested I am in BSRA, not only what you are trying to do but what you are accomplishing, too. From what you imply of the financial situation, it seems to be largely a labor of love and service on your part, for which you deserve great praise and the heartfelt thanks of every BSRA member and others whose lives they touch. Please accept this very, very small donation of the enclosed check, as a symbol of my appreciation."

The donation is most welcome and will be put toward the expenses of carrying on this work, also the words of appreciation. The lady was also most curious about the La-

khovsky circuits, those single bands of wire which are placed around the waist, or knees, or ankles, wrist or neck, and seem to have a subtle but very real affect on the wearers. We have some information on the Lakhovsky Circuits or Belts from Associate A.E. Powell, a retired lieutenant colonel of the British Indian Army:

THE OSCILLATING CIRCUIT

"The Belts can be made by almost anyone, for a few cents. At most hardware stores, for a few cents per foot, one can buy twin electric cable insulated with white rubber, used for lamps, etc. Get the smaller size 1/4 inch wide, having 42 strands of copper wire. Slit an end with a knife and the two wires easily tear apart.

"For the button, get white sheet plastic about 1/8th inch thick, saw it into pieces about 1 1/2 by 5/8th inches, and drill near each end a hole large enough to take two wires. Round the corners of the plastic and bevel edges. Thread the wires, from opposite directions, up through one hold and down through the other, leaving about half an inch projecting beyond each end of the button. Where a circuit can be slipped off the body without unbuttoning, you may overlap the ends of the wire belt an inch or two, bind with fine string and smear with Duco cement for strength.

"Parallelism and overlap of the ends are important. This builds up capacitance, produces inductance and generates an alternating current. Circuits may be worn, as many as you please, round chest, waist, neck, arms, wrists, legs, ankles, neck or head continuously. Water will do them no harm.

"Gladly will I supply Circuits, in any quantity, with buttons or bound ends. To avoid trouble with the Food and Drug people, I make no charge. Donations, however, are acceptable, and go intact into my Fund for the Sick. For long this has been doing fine work and I'm sure you will approve. For reasons stated I make no claims whatsoever for the Circuits, and no guarantee or promise of any kind. If you want to give them a trial, that is wholly your affair." Col. A.E. Powell (Col. Powell died in March 1969).

MWO USED TWENTY YEARS AGO

"The recent article in the BSRA Journal pertaining to the Lakhovsky Oscillator is of special interest to me. First, I am an engineer, Physician and Surgeon, and a Scientific Consultant for the U.S. Government. (Technical Intelligence). I am not in any manner snooping for the government. This is completely personal. We built several oscillators in 1944. These were used in my sanatorium in Dallas where we had some startling results. As we did not have the proper facilities

to research the instruments adequately, we became more and more conservative. Many patients would show reactions, resembling the old fashioned Flu, after a few days following exposure to the oscillator. I realized we were using too much power, so cut the level several times with good results; but we did not completely eliminate the side effects. In 1946 I was sent to Germany for the Government to explore Electro-biology and Biophysics in its application to electro-medical equipment. I felt it wise to destroy the machines so injudicious use would not be indulged. The possibilities have intrigued me ever since. It looks as though you have solved most if not all of the problems involved. Hence my renewed interest. The excess power upset the enzyme complex of the body, or as some felt, distorted the double electric layers of charge carried on the cells, hence allowing for the penetration of virii directly into the cells (virii operate within the cells -- bacteria operate between the cells). Cells as well as organs function in a force field so mild oscillating currents not only work through resonance but seem to regenerate these force fields. Here is where application to cancer can be optimistically explored."

Speak for your own state, Doc! Here in California the medical association has decreed that only four forms of treatment for cancer are legal; drugs, surgery, burning rays and death.

"Proof of energy flow from the fingers and thumb is here and must be recognized. We have demonstrated it by its effect on Yeast cells, viewed under the microscope (Girwich research). Whether it comes from the conscious rather than the subconscious mind is harder to prove, but I am impelled to believe it does. This may interest you. Years ago we experimented with crystallization. Precipitated water vapor to snowflakes in a chamber with electrodes planted in two sides. When we threw a current into the chamber at a given frequency the flakes were all the same. Changing the wave length changed the crystallization pattern. Each frequency had its own pattern. Here is the explanation of energy absorption by the chemical used, and the control of the crystalline patterns by the nature of the energy flowing."

Naturopaths are in 100% disagreement with the doctor's above explanation of the side affects of his use of the MWO on his patients. If I understand the theory correctly, according the natural view of colds, flu, virus infections, etc., these are attempts by the human organism to throw off mucous, to eliminate intolerable accumulations of poison from the system. Exposure to the field created by the MWO tends to raise the general tone of the whole system by stimulation. The raised vibrations release an unusual

amount of mucous and other junk into the elimination channels, and until this is eliminated one would have a cold or flu and the usual aches and pains which generally go with such a condition.

Another doctor stopped by here not long ago to tell of his sad experience in trying to use spark-gap electronic equipment in his medical practice "for those suffering patients not helped by drugs." This powerful, high-frequency machine produced a two-

inch spark! Every time he turned it on, everyone in town seemed to know it and the phone would ring. Even a Faraday cage didn't shield the output of this monster. Finally he was called before the county medical board to explain what he was doing. The board presented a staggering combination of fatuous conceit and stubborn ignorance. "They didn't want to know anything about the affects of radio waves on the body and didn't care!"

CURING CANCEROUS PLANTS WITH ULTRA RADIO FREQUENCIES

by Georges Lakhovsky

From Radio News February 1925

"The new application of short wavelength oscillations described in the following article" wrote the Editor of Radio News, "is one of the most important ever found, and we are pleased to present to our readers this article by Mr. Georges Lakhovsky, the well known French scientist. The experiments described were carried out in collaboration with several doctors and scientists of high standing and it seems from results obtained, that the very high frequency treatments will play an important role in the future. We shall publish in a later issue another article on this new system together with the effects of ultra radio frequencies in the treatment of diseases in human beings."

Since November 1923 I have published in various technical and radio publications, several papers in which I explained my theory that the instinct or special feeling, which permits birds to direct themselves in space, is only the results of the emission and reception of rays by living beings. While developing this theory, I explained how thoroughly I was convinced that science will discover, some day, not only the nature of microbes by the radiation which they produce, but also a method of killing disease bacilli within the human body by means of the proper radiations.

The researches I have made by means of special apparatus have shown such results, that I believe my theory is correct. This theory is that life is born from radiations, kept going by radiation and suppressed by any accident producing the destruction of the oscillatory equilibrium, especially by the radiations of certain microbes, which suppress those of the weaker cells.

Before going any further in our reasoning, it is necessary, in order to present the facts to the uninitiated reader, to imagine what oscillations really are. The motion of a pendulum will be used for this explanation. When a pendulum is displaced from the

position of equilibrium, it moves back and forth producing what are known as ochrone oscillations, until the energy stored is entirely exhausted. By means of a motor, a spring, or an electro-magnet, it is possible to keep the motion of the pendulum of constant amplitude, producing undamped oscillations. If, on the contrary, the source of power is removed, the oscillations die down and it is necessary not only to re-apply the power sustaining the oscillations, but also to furnish additional energy to start the pendulum in motion. This oscillation of a pendulum reproduces exactly what happens in the cells of a living being.

Our organs are composed of cells formed of protoplasm containing various mineral matters and acids, such as iron, chloride, phosphorous, etc. It is by the combination of these elements that the cells detect outside waves and vibrate continuously at a very high frequency, probably higher than the period of X-rays or over all other vibrations known and measured today (1925). The amplitude of cell oscillations must reach a certain value, in order that the organism be strong enough to repulse the destructive vibrations from certain microbes.

COSMIC RAYS AND CELL LIFE

The astrophysicians are actually carrying out experiments of great interest on the existence of vibrations, which have been called penetration rays and of which the frequency is higher than that of X-rays and of the alpha, beta and gamma rays of radium. Such rays, according to the theory, are produced by the earth itself and some others come from outer space. Some accurate measurements have proved the correctness of this theory. Therefore, it is quite permissible to believe that these penetration rays, or at least some of them, produce the vibratory motion of living cells and consequently their life.

For instance, let us suppose a cell vibrates at a certain frequency and a microbe vibrates at a different frequency; the microbe begins to fight the cell, and sickness is started. If the cell cannot repel the stronger vibrations and if the amplitude of its own vibration decreases, the microbe gains and its vibrations in decreasing and stopping those of the cells, bring dangerous sickness or death. If, on the contrary, the living cell is started vibrating with the proper amplitude by inside or outside causes, the oscillatory attack is repulsed. Such is my theory.

The problem is somewhat similar to the situation in which a rescuer finds himself when, coming to help a friend in a dangerous situation, finds himself fighting hand to hand against strong aggressors. The rescuer does not dare to fire his gun; fearing to harm his friend mixed up with the aggressors in the melee. Similarly, microbes and healthy cells are exposed to electric or radio-active action, which could be used to destroy the unwanted rays and it is difficult to suppress them without harming or killing at the same time, the cells which are to be treated. In fact, since Pasteur, scientists have been constantly searching for means of destroying microbes. The great difficulty with all methods found was that in destroying the bacillae, the cell was attacked too. The experience gained in cancer and tuberculosis treated with radium, X-ray, or ultra-violet rays, shows how difficult is the work of the investigators.

A RADICALLY NEW METHOD

The remedy in my opinion is not to kill the microbes in contact with the healthy cells, but to reinforce the oscillations of the cell either directly by reinforcing the radio activity of the blood or in producing on the cells a direct action by means of the proper rays. During January 1924 I began to build, according to this theory, and with the purpose of therapeutic applications, an apparatus which I have called Radio-Cellular-Oscillator, with the firm belief that the cells vibrating at extremely short wave-lengths would find their own in the Hertzian waves, which have the properties of producing extremely short harmonics. The cell with very weak vibrations, when placed in the field of multiple radiations, finds its own frequency and starts again to oscillate normally through the phenomenon of resonance. This type of vibration which I propose to use, is harmless, unlike those of X-rays and radium. Their application, therefore, does not present any danger to the operator.

I exposed in front of my apparatus, during long periods, a certain number of microbes in culture, which developed themselves normally. I, myself, have never felt

the effect of these ultra radio frequencies, although I remained for a great many days near the apparatus, during the treatment applied to the living cells. It is only when two living beings such as a cell and a microbe, are in contact, that the rays produced by the Radio-Cellular-Oscillator have any direct effect upon cellular structure.

WORK IN A FRENCH HOSPITAL

The experiments which I carried out at the Salpetriere Hospital in Paris, in the service and with the collaboration of Prof. Gosset, were made with plants inoculated with cancer, and the results were described in a paper presented on July 26, last year, before the Biological Society. The text of this paper follows.

“One knows that it is possible to produce by inoculation of Bacterium tumefaciens in plants tumors similar to those of cancer in animals. One of us obtained experimentally by this method, a great number of tumors. These had various degrees of development. Some of them dry up partially, but do not die entirely until the entire plant or at least the limb bearing the tumor dies. Even removed by surgical methods, these grew again on a sick limb.

“We propose to describe in this paper, the action of electromagnetic waves of very high frequency obtained by means of the Radio-Cellular-Oscillator of Georges Lakhovsky. This apparatus produces wave-lengths of the order of two meters and less, corresponding to 150 million cycles per second. A first plant was submitted to the effect of radiation one month after being inoculated with cancer; at this time small tumors of the size of a cherry stone were visible upon it. This plant was submitted to the rays twice, for three hours each time. During the following days, the tumors continued to grow rapidly in the same way as those on plants, which had not been submitted to the effect of radiations. However, 16 days after the first treatment, the tumors began to shrink and dry up. A few days later the tumors were entirely dried up and could be very easily detached from the limb of the plant by merely touching them. The drying action of the radio frequency radiations is selective and affects only the sick part of the plant. Even the inside sick tissues were destroyed, although they were next to healthy cells in the center of the limb, showing that the radiations had not affected the healthy parts.

“Another plant was treated in the same way, except that it was exposed 11 times for three hours each time, to the radiations of the oscillator. Sixteen days after the first exposure the tumors, which were rather large as shown in one of the photographs, began to

shrink and dry up and were easily detached from the limb exactly as in the first case. Again in this case, the healthy parts of the plant were not affected in the least. A third plant exposed to the radiations for nine hours, that is, three treatments of three hours each, was cured in the same manner as the two others. Sixteen plants also inoculated with cancer, were left without treatment. They have tumors in full activity, several of which are very large. These experiments show conclusively that plants inoculated with cancer can be treated and cured by means of the ultra radio frequency vibrations, whereas surgical treatment fails.

“Such are the results of my researches with plants. At the present time, similar experiments are being carried out with animals and it seems that the effect on cancerous animals is the same as on cancerous plants.

“I am highly pleased to present my theory and the results of my work in a scientific review of the United States, this great country, which has always been in the lead in the fight against this horrible sickness, cancer, and whose sympathy and help I would greatly appreciate.

“In conclusion I wish to call the attention of the reader to the fact that I have obtained very conclusive results not only with a wave length of two meters, but with longer and shorter wave-lengths. The main thing is to produce the greatest number of harmonics possible.”

* * *

This February 1925 article from Radio News magazine shows how long some of Lakhovsky's theories have been known in America. This article was furnished to BSRA by an Associate who had met the Russian-French scientist in New York. He claims also to have visited several times the New York hospital which set up a research program on the Multi-Wave Oscillator and saw the Lakhovsky-type equipment. No information on the machine or its effects could be elicited from the hospital authorities and in the early 1950s the shielded room was dismantled and equipment destroyed.

We feel that Lakhovsky's theories and early researches should be followed up. It should be publicly proven that high-frequency waves, in the proper concentrations, do affect living organisms in a beneficial way, or that Lakhovsky be declared an idle dreamer. Since research of this kind falls within the purposes of Borderland Sciences Research Foundation, Inc., members are encouraged to build their own equipment and, in a suitably shielded or isolated environment, carry on their own research program. If you cannot

obtain the necessary materials, BSRF may be able to put you in touch with another borderlander who can be of help. Until the medical authorities come forth with official approval of this radical approach to the state of imbalance or un-health attributed to disease, no one but a fool would go into commercial production of this kind of equipment in America today. It is now said to take a minimum of \$300,000 in research money and three years of testing to develop medically acceptable data.

HOW DR. JAMISON WAS TRAPPED

In a letter dated Aug. 29, 1967, Dr. Jamison enclosed this news clip from the **Modesto Bee**: "Turlock -- Veterinarian Stanton L. Jamison yesterday was fined \$249 in Turlock Judicial District Court after being convicted of three charges stemming from his use of an electronic machine to treat human patients for cancer. A jury of nine women and three men returned a verdict of guilty on one count of practicing medicine without a license and two counts of advertising a device represented to have effect on cancer, stomach ulcers or bone diseases. The decision followed a two day trial in which Jamison defended himself. . .

"They (Jamison and his assistant, Martha Ann Davis) were arrested last December following a lengthy investigation by Turlock police officers and agents of the State Bureau of Food and Drug Inspection. The investigation began when Police Chief John Viarengo requested assistance from the bureau after learning 'the cancer-curing machine' was being operated here.

"During the investigation, Food and Drug agents Willis Worley and Harvey Lee arranged several meetings with Jamison on the pretense they were interested in purchasing machines similar to his. Jamison reportedly organized a church as a front for his operation. The facility, located at 200 West Main St., was known as the Life Aquarium Center. Worley and Lee became bishops of the church as did deputy District Attorney Frank Damrell, Jr., who prosecuted the case. At the time of the investigation, Damrell was employed in the State Attorney General's office.

"Worley said Jamison's intention was to open other treatment centers throughout the state, using his bishops to set up facilities under protection of the church. 'This was the most fantastic investigation I've ever been involved in,' said the agent this morning.

(Yes, it is fantastic to think anyone would want to give or donate healing services free when there are billions to be made on the four kinds of cancer treatment authorized by the California Medical Association: Drugs, Sur-

gery, Radiation and Death. RHC.)

"Worley points out the manufacturer of Jamison's machine was convicted of grand theft two weeks ago in Los Angeles after selling a similar machine to a Food and Drug agent under false pretenses. (This was probably Ralph Bergstresser, Burbank, Calif., who was manufacturing and selling the Bob Beck MWO for \$250.)

"After Jamison's conviction yesterday, Damrell called for imposition of a prison term for the veterinarian. If he had received the maximum penalty, he could have been sentenced to 18 months in jail and fined \$1,500.

"We felt very strongly on this," said Worley, "because Jamison could easily become a menace to many innocent victims throughout the state."

MWO IN USE AT INDIAN CLINIC

"I am continuing my experiments with the MWO and my experience is that in practically all cases there is an aggravation of the existing symptoms, and previous symptoms are brought to the surface. Hemorrhage was seen in another case and treatment was stopped forthwith. This is one problem which has to be tackled before MWO can be used with confidence. I think MWO treatment should not be given to tubercular cases. Also in cases where there is a hemorrhagic tendency this would do more harm than good.

"Neuritis seems to respond nicely to this treatment. Sciatica is definitely cured by this. Some cases of Rheumatism and Arthritis are benefited, responding at first but the improvement does not last much longer. I cannot understand the reason for this eccentric behavior. I think there must be something with the frequencies."

Don't blame it on the frequencies, Doc, blame it on the patients who stubbornly cling to their fixed ideas and rigid unyielding mental patterns. We have no evidence that the radio frequencies of the MWO reach into the mental world. Each person's aura is loaded with "signatures", national, family and religious concepts hammered into him over the years. His creative energies, flowing freely down from the higher worlds, channel through these deeply cut "grooves" in mind and emotions. The health or illth of the physical body indicate whether the person's ideas are in tune or out of tune with Creation. As a man thinketh in his heart, so is he.

"Can you please let me know what are the ranges of frequencies these machines have? Have they been measured and are they the same in all instruments? Is there any difference in the models prepared in the USA and France? Which model was tried by

Lakhovsky in the New York hospital? What are the actual frequencies used by him?"

The only frequency readings we have on an MWO were those submitted by Bob Beck originally, from the output of his own machine. "It radiates RF interference over a bandpass of 15 Kilocycles to well beyond 250 Megacycles. This blocks AM, FM and Television reception for hundreds of yards" But so does my electric razor, and I've been using one for years. I was told by a sailor that electric razors are very effective as "scramblers" for knocking out the electronic brains of guided missiles, and have been so used as defensive equipment during missile exercises on aircraft carriers at sea. No one has furnished us with RF output figures from original Lakhovsky equipment, either at the New York hospital or from Europe. If anyone has these figures I hope they will be kind enough to forward them to you. Lakhovsky's available technical record is very slim.

"An Associate writes 'A very good psychic in Florida gave the following, in a sitting devoted to the MWO. It is not anywhere near developed to its potential. It has unlimited amplifications to be made. The use of the MWO can change the auric field, thus spiritually it can change the individual. This is done with the work of the seven rays of life. The MWO should be used in conjunction with the radionics instrument.' What about this radionics instrument? I would appreciate it if you can throw some light on this."

Sorry Doc, the punitive hand of the American Medical Association has driven radionics builders and users underground here in the United States. No one but a fool like me would stand up on the firing line. England isn't quite the police state America is and you can get information on radionics and radionics equipment from the Delaware Laboratories, in England, and from Bruce Copen, in Sussex, England. Radionics experts have developed rates for every organ in the body. Equilibrating those rates with specific radio frequencies offers an interesting field for borderland research.

"I have tried both the Vitic and the Eeman Screens. I am still continuing my experiments with the Eeman Screens. Only a couple of days back I gave a set of screens to a patient who is having an encyclopedia of complaints. The MWO did not give her much improvement hence the change. I have one set of Vitic with me and whenever I feel a bit out of sorts I sit for ten minutes and get back my vigor. I am using a very strong pair of magnets and a carbon rod 1½ inch in diameter. After I received the MWO my interest in the other two flagged. I think I will have to cultivate them again."

Dr. A.K. Bhattacharya

From the **March 1964 Journal of Borderland Research:**

ARMY MEDICAL RESEARCH SUPPORTS LAKHOVSKY THEORY!

That's our headline, and it's derived from news clips loaned to us by an Associate. One especially is from the New York "Times" for Friday, Aug. 19, 1960 by John Osmundsen.

The heading says that Radio Microwaves Produce Molecular Changes in Human Beings. This is merely a repetition of what Georges Lakhovsky proved with his pioneering work in Paris hospitals in the 1920s!

"New and possibly important biological effects of radio and radar waves were reported at a three-day scientific meeting that concluded here yesterday. One scientist told of producing 'a profound molecular change' in human gamma globulin with specific wave lengths of radio waves in the high frequency to very high frequency, or VHF range.

"Alterations so created in the molecules that constitute an important part of the body's defense apparatus were accompanied by at least a fourfold increase in their biological activity, the scientist said. 'The changes can be produced under widely varying conditions of voltage, power, pulse width, and pulse repetition rate, provided the frequency is suitable,' according to Lieut. Col. Sven A. Bach of the Army Medical Research Laboratory in Fort Knox, Ky."

If Col. Bach had been working from Lakhovsky's original theories and equipment, he wasn't saying. This is obvious in reporter Osmundsen's next paragraph.

"This is believed to be the first report of a proven frequency-specific effect of radio waves on human chemistry. Dr. Bach's report appeared to cause more comment at the conference than almost any other, for the effect of radio frequencies on human gamma globulin in the test tube were clearly not a result of heating.

It was suggested by Dr. Bach that the increased biological activity of the molecules as measured against a rabbit serum sensitized to them might have resulted from an unfolding of their structure, thus exposing more active spots."

YUP, THEY MIGHT EVEN CURE CANCER

Later in 1960 an electronics magazine revealed even more about the proceedings of this Fourth Annual Tri-Service Microwave Conference held in New York. Our news clip is only half a page which reveals neither the magazine nor the writer, but about Dr. Bach's claim of a four-fold increase in the production of gamma globulin, he says:

"What does this mean to you? Gamma globulin plays an important part in the body's defenses against disease. Speed up its activity fourfold and it may be four times as effective a disease fighter. Some day your doctor may give you 'a shot of microwave' to keep you well.

Dr. Joe Howland of the University of Rochester found that dogs which had been exposed to microwaves were able to withstand heavy doses of X-rays far better than dogs not so treated. No specific application for this technique is now known, but such discoveries frequently lead to undreamed-of advances.

"And finally, some evidence has been gathered to indicate that certain kinds of cells, under the right conditions, will simply disintegrate — fly to pieces — in the presence of the right radiation. But surrounding cells are unaffected. Could such a selective beam ever be used to destroy cancer cells while leaving healthy tissue unaffected? Scientists don't yet know."

The writer didn't say which scientists he is speaking for, certainly not for Georges Lakhovsky, who died in that very same New York City 17 years before the Microwave Conference. Before-and-after photos of skin cancer cures effected by the Lakhovsky Multi-Wave Oscillator in Paris hospitals in the 1930s show that the Russian inventor did know just how selective radio microwaves can be. These

pictures are reproduced in Lakhovsky's book, "The Secret of Life".

To continue with the magazine article: "said Col. George M. Knauf, one of the foremost experts on the biological effects of microwaves, speaking of these recent advances, 'Our work has progressed sufficiently for us to be fairly certain that the beneficial uses to which this energy may be put will greatly outweigh any harmful results it may produce in men.' All this of course does not mean we should forget that uncontrolled microwave energy can be dangerous. But like fire or X-rays, microwaves can, when used intelligently and with understanding and respect for the hazards involved, be among man's most valuable tools."

MWO USE IN A NEW YORK HOSPITAL

Georges Lakhovsky crossed the Atlantic to New York City in 1941, there to observe the effects of his MWO under controlled, technical conditions in a New York Hospital. A brief report of the positive and beneficial results of MWO treatments is appended to the English translation of his book, "The Secret of Life", by Mark Clement, on page 201. These treatments were given from July 1st to Aug. 21st and the name of the hospital and of each patient are withheld for ethical reasons.

<u>Patient</u>	<u>Illness</u>	<u>Treatments</u>	<u>Results</u>
X.	Arthritis, both knees	14	Good improvement
O. P.	Endocervicitis. Abdom. pain	6	Condition good
F. T.	Periarthritis of shoulder	12	Marked improvement after first treatment, condition good
M. M.	Osteoarthritis	7	Marked improvement after two treatments, stiffness diminished
M. K.	General Chronic Arthritis	11	Slight improvement
M. O.	Arthritis of ankle	3	Results good
A. E.	Postoperative fracture	6	Results good
C. V.	Arthritis, both knees	14	Marked improvement
M.D.	General arthritis	8	Marked improvement
J.H.	Epicondylitis of elbow	7	Results good
D.G.	Chronic arthritis	10	No cough, no soreness marked improvement
S.L.	General arthritis	10	Marked improvement
B.M.	Arthritis and circulatory disturbances	6	Improving
M.L.	Arthritis of ankle and knee	7	Improvement, no recurrence
M.B.	Arthritis of shoulder	7	Marked improvement
M.O.	Tenosynovitis, hand	6	Improvement
S.S.	Arthritis, both knees	7	Improvement
S.C.N.	Congenital hip dislocation	3	Marked improvement
R.L.	Fracture, both ulnae. Synovitis, both knees	5	No pain

Additional Cases

Case 1. G.D., female, aged 25: Patient complained of pain in the chest and muscles of the right arm and back, and constant cough. She did not respond to medical treatment and massage. Treatment with Lakhovsky Multiple Wave Oscillator was instituted. After the fourth treatment coughing stopped, pain in the chest became infrequent, and the tired feeling in the back disappeared. At the end of 12 treatments the patient no longer complained of previous symptoms.

Case 2. M.M., female, aged 51: Patient complained of pain and stiffness in the right hip. X-ray examination disclosed a marked narrowing of this articulation associated with large spurs at the margin of the acetabulum which appeared to ankylose the joint. There were proliferative changes in the upper margin of the femoral head. Diathermy

and massage failed to relieve the pain and stiffness. After 10 treatments with Lakhovsky's M.W.O. the stiffness markedly reduced.

Case 3. F.T., female, aged 38: For two months the patient complained of pain in both shoulders. Abduction of the right humerus was limited to 45 degrees. A diagnosis of peri-arthritis was made and treatment with Lakhovsky's M.W.O. was started. After three treatments the patient said she felt much better. The improvement continued. After a series of 11 treatments the patient did not return. Apparently permanent relief had been obtained.

Case 4. A.B., male, aged 60: Patient gave history of pain in both knees beginning in 1940. Diathermy and massage for one year gave only slight relief. Treatment with Lakhovsky's M.W.O. was instituted. After one treatment patient stated that he felt better. After four treatments patient felt so much better that he took only one treatment in two weeks.

Case 5. M.M., female, aged 42: Patient complained of pain in lower left back and hip. X-ray examination of the lumbar spine and pelvis showed calcification at the anterior margins of the intervertebral discs between the ninth and tenth and the tenth and eleventh vertebrae. There was also a slight scoliosis of the lumbar spine. Treatment with Lakhovsky's M.W.O. was instituted. After the first treatment patient felt better. After the fifth treatment improvement was very marked. Patient did not return after nine treatments.

Case 6. S.N., female, aged 59: Patient complained of pain in the right shoulder and inability to extend the arm more than 5-10 degrees, accompanied by severe pain. X-ray examination disclosed irregular calcification in the region of the greater tuberosity of the right humerus. Treatment with Lakhovsky's M.W.O. was instituted. After one treatment patient said she felt much better. The improvement continued steadily until 10 treatments were completed.

Case 7. C.P., female, aged 38: Gynecological examination showed uterus slightly enlarged and hard. Right para-metrium tender. Diagnosis - Parametritis. Treatment with Lakhovsky's M.W.O. was instituted on July 17, 1941. After four treatments patient felt better, and after 12 treatments patient was found to be much improved. Examination on Oct. 7th showed the adnexa and parametrium to be painless. Patient was considered cured.

REPORT OF CASES TREATED WITH LAKHOVSKY'S MWO BY A PROMINENT BROOKLYN UROLOGIST

The following results were obtained by a prominent Brooklyn urologist whose name must be omitted for ethical reasons. He is a Fellow of the American College of Surgeons and enjoys a great reputation as a skilled specialist. He treated hundreds of patients with Lakhovsky's MWO but only a few typical cases can be given here.

Patient	Illness	Treatments	Results
H. G.	Acute urinary retention due to enlarged prostate	2	Retention ceased
R.B.	Bleeding from uterine fibroids of two years standing	3	Bleeding ceased
S.M.	Mild multiple sclerosis with halting gait	6	Marked improvement, was able to run on several occasions
R.R.	Cellulitis of nose with pain	2	Cleared completely after two treatments of ten minutes each in one day.
B.T.	Acute urinary retention due to enlarged prostate	2	Retention ceased.
S.B.	Bleeding from cancer of the bladder	3	Bleeding checked. The tumor cleared up nicely and was reduced in size when

seen again on cystoscopy three weeks later.

J.G.	Chronic aczema of Axilla	2	Cleared entirely.
L.G.	Severe pains from duodenal ulcer	2	Greatly improved.

In addition to the above cases this Brooklyn specialist treated six cases of enlarged prostate with nocturnal frequency (three to five times per night). After two treatments with Lakhovsky's M.W.O. frequency was reduced "to only once a night or did not occur at all..."

The above American reports were not included in the first edition of Georges Lakhovsky's "The Secret of Life", published in 1935, but were added by the English translator, Mark Clement, to later editions. We are quoting from the 1963 edition published by Health Science Press, Sussex, England. Health Research, (P.O.Box 70 Moke-lumne Hill, California 95245) offers this same book.

This early (1941) research with the Lakhovsky equipment seems to have been ignored by the American medical authorities, who are still concentrating on cure by surgery or medicine. If you want to discover the effects of weak radio waves on living organisms you'll have to dig for yourself. Our BSRA brochure, "The Lakhovsky Multi-Wave Oscillator", will give you some hints about setting up your own research program, and is available from headquarters.

'DOCTORS SAY RADIO TREATMENT IS EFFECTIVE AGAINST ARTHRITIS'

Apparently some doctors didn't ignore the research work done by George Lakhovsky. Take this news item from the New York "Post" for Feb. 8, 1962, with an Associated Press dateline from Washington, D.C. "A device theoretically capable of bouncing radio signals off the moon has yielded highly effective results in the treatment of stubborn cases of arthritis and certain other ills, a group of doctors reported today. The machine generates high-frequency, short-wave-length radio waves and emits them as pulses lasting only 1/17,000th of a second each. The pulsed currents are directed into a patient's body, with a maximum achievable penetration of eight inches.

"Use of the technique in treating arthritis, bone infection after hip operations, inflammation of the female pelvis due to gonorrhea and other conditions, and in speeding the healing of surgical wounds was described in reports by Dr. Euclid M. Smith of Hot Springs, Ark.; Dr. Dana Street of the University of Arkansas; Dr. Bruce Camern of Baylor University; Dr. Marshall Lobell of Harlem Hospital, N.Y.; and Dr. Solon N. Blackberg of Chicago. The reports were made last night at a private conference to which several Congressmen and Public Health Service doctors were invited. Blackberg later told reporters the researchers would like to enlist government support for expanded research by themselves and their investigators.

"Smith, in his report on arthritis, said the technique had been employed with "highly "effective results in 99 out of a series of 100 cases treated by him. Declaring that some of the patients treated had arthritis for up to 25 years before receiving radioactive treatment. Smith told reporters that "marked improvement" was achieved in all cases in from three to six months.

PUBLIC RECOGNITION OF RADIOWAVE TREATMENT

This sensational advance in the treatment of human ailments should have been welcomed from coast to coast in every newspaper. Dr. Blackberg and his distinguished fellow scientists from Baylor, Arkansas and Harlem should have received public acclaim from President Kennedy's Dept. of Health and Welfare and from the American Medical Association. But only a thunderous silence followed that early 1962 news item ion the private meeting in Washington - until the

Aug. 24, 1963 edition of the Saturday evening Post! In this national magazine, radiowave treatment of arthritis was branded medical quackery in the article "Hucksters of Pain". There Drs. Smith, Street, Camern, Lobell and Blackberg had their answer to "government support for expanded research". Fortunately, not every American is going to take this kind of libel without striking back at the mouthpieces of the vested interests who lend themselves so readily to control of the mass mind. Read this news clip from the Los Angeles "Times" for Nov. 1, 1963:

"SATURDAY EVENING POST SUED FOR \$7.5 MILLION"

"New York — The Saturday Evening Post, still smarting from one of the largest libel awards in history, was hit Thursday with another libel suit demanding \$7.5 million.

"The suit was filed in Federal District Court here by the Diapulse Corp. of America, manufacturer of a machine that employs high-frequency waves in the treatment of infections and inflammations, including arthritis. The company said it was defamed in an article, "The Hucksters of Pain", which appeared in the Aug. 24 edition of the magazine. The article dealt with quack remedies for arthritis. The suit seeks \$2.5 million in compensatory damages and \$5 million in exemplary damages.

From the **June 1964 Journal of Borderland Research:**

LAKHOVSKY OSCILLATING CIRCUITS

"About eight years ago I sent to the Health Science Press, Sussex, England for a little book, "Quick and Free Healing", and also "The Waves That Heal" and found that there are healing waves in the air we breathe. I am a sensitive with the pendulum. The book told to take an insulated copper wire and find the positive and negative ends with the pendulum, so I would know which end to put to the left side of my body — positive to the right and the ends overlapping. If you can't keep them in place, wrap an elastic band around them. For me, the pendulum swings clockwise for negative and back and forth for positive. First use of the wire came when I skinned my shin with a five-inch gash. The bleeding made me sick and I had to lie down. I thought of my wire circuit, got up and put it on just above the knee. It always had taken a long time for sores to heal on my body but this healed in three days time and showed only a narrow line about the width of small yarn. This convinced me that the oscillating circuit wasn't foolish.

"I loaned my little books to a high school student that was taking science. I thought they would interest him but he made all manner of fun of me, for believing such a thing. None of my family are interested in the good things that I have learned. I have been a member of BSRA since 1951 and think your journal is the best magazine I have ever read. Anyone wanting to learn more about the Lakhovsky circuits can write to Col. A. E. Powell. (Now deceased)

"Forty years ago I was taking treatments from an osteopathic doctor who sometimes diagnosed with the pendulum. When I became pregnant he told me he was going to discover the sex of my unborn child. He took his gold band ring off, tied a string to it and held it over me. It didn't seem to have any definite swing, maybe around once and back and forth. "That's strange," he said, "I've never missed yet!" When the baby came there were two, a boy and a girl! I didn't ask him then where he learned about the pendulum or what it meant. Years afterward I sent to New York for one and found that I could ask questions and get yes or no answers that satisfied me. A medium told me that the pendulum is spirit controlled and mine was controlled by a young girl who was rather mischievous. If you want to put my experiences in the BSRF Journal it is all right with me. I got my education in the little red schoolhouse. I am 73 years old and still

learning. They say you never get too old to learn and I find it is very true."

Mrs. E.H., Piqua, Ohio

A "HOPPED UP MWO" IS DANGEROUS!

"It is far too early to draw final conclusions regarding my experiences with the higher powered Multi-Wave Oscillator, a word of warning is in order. I powered mine with a 250 VA, 10 KV oil burner transformer. This is DYNAMITE and could, in my opinion, be fatal if too much power is used and I didn't miss it by much. My equipment sparks the antenna down to the 4th ring and the resonator to the second, with occasionally a week spark to the third. 10 hours after the first high-power exposure I felt like running instead of walking (age 72) and walked all around town and back, about six miles and no tiredness, whereas two miles would tire me before. That first exposure was about ten minutes for me and four for the wife (age 75). Immediate reaction for me was a moderately strong sensation of tingling from head to foot for about three hours before I could get back to sleep. None of this for the wife. Then, as aforementioned, I felt on top of the world. 24 hours after that, however, the wife and I developed the grand-daddy of all colds and flu symptoms that we'd ever had. I hadn't had any real cold or flu in 15 years. This one dredged such an amount of mucus and toxic waste as I'd never seen before in my life. It was rough. It lasted two days before it wore off.

"This all had me guessing until your brochure arrived, with the experience of your Engineer-Physician Associate. He told that many of his patients developed flu symptoms after MWO exposure. His increasing conservatism was well founded. I decided to find out if the doctor's hypothesis of viral penetration would hold up. If so, a second high-powered treatment of equal strength and duration should produce much the same flu symptoms. But, having wound another coil, I used more power than the first time, sparking antenna and resonator down to the fourth and fifth rings. Results: no more flu, only a very slight tingling sensation, no feeling of exhilaration as before. Five days later I took another exposure, of seven minutes, with a little less power. This one did it. No tingle, no exhilaration, only a feeling of rapidly increasing depression, no sleep that night, a rather severe pain in the chest and heart region, extremely weak pulse, hardly pep enough to life an arm, and a nervous shaking all over. For a while I thought, this is it. It took five days for this to wear off and it isn't all gone yet. One night I lay awake until three a.m. figuring out how to pep up the MWO still more. Out of the blue, a voice clear and distinct and very emphatic: "This is dangerous!" Again very emphatically, "Yes!" Normally I am not the least psychic, clairvoyant or clairaudient; so I choose to heed this as a warning from a discarnate guide or guardian."

Let this Associate's experience be a warning to you, if you feel the urge to build a hopped-up Oscillator, to transform yourself overnight! Bob Beck's original article cautions against this and his original equipment falls well within the safety tolerances set by the Air Force and the telephone companies for personnel working around radar and microwave broadcasting and relay equipment. Most of you taking part in this research program have built your equipment only in the last two or three months. It would be wise to stick closely to the original design for a year before altering it for further research.

LAKHOVSKY'S ORIGINAL THEORIES ARE SOUND!

With one or two exceptions all reports in to date show beyond question that Georges Lakhovsky's theories are sound: Radio waves do effect living organisms. In certain concentrations these waves appear to benefit cell growth, even to stimulate it. These BSR Associates have proven to their own satisfaction in only six months from the publication of our first article. Now it is up to others to exploit this knowledge while we turn our attention to other projects.

From the **Jul-Aug 1964 Journal of Borderland Research:**

LAKHOVSKY OSCILLATING CIRCUITS

"The danger of strong reaction to a hopped up MWO, as told in the June Journal, reminds me of my experience with the single circuits. Months ago I wrote to Col. A. E. Powell and he sent me single circuits to wear around waist, neck etc. This I did for two months or so, daily. I'd been under the weather enough to hope for benefit. Instead, I had three successive colds — something I never, never had in my life before, even during the worst of my catarrh years. It never once dawned on me it could have been the Lakhovsky oscillating circuits; now I wonder?"

A California Associate

Yes, it had been the experience of others that the apparently powerless Oscillating circuit, of only one wire looped around the body, can produce a strong reaction on living tissue. A San Francisco Associate told us during our May trip north that she received a wire loop from Co. Powell and wore it to bed that night, and forgot about it. Early in the morning she awoke with such a violent pain through her middle she thought she'd die! She lay there and stuck it out until the pain left and went back to sleep. In the morning she awoke refreshed and ready to go, with the oscillating circuit still around her middle. It began to dawn on her that this was the cause of the pain, but it also had affected the healing of a long-suffered condition. At the time we were there, weeks later, the condition had not returned. Certainly no permanent cure of any condition can be expected unless the original cause in mind, emotions or spirit is changed, and if a person insists on indulging his vices, use of oscillating circuits may only cause needless pain!

From the **October 1964 Journal of Borderland Research:**

HE PREFERS VITIC TO MWO

"Personally, while feeling the passage of the high tension flow from the antenna of the Multi-Wave Oscillator, I found no beneficial effect. On the other hand, the Associate with whom I obtained the MWO realized definite improvement. He has kept up the use and told me lately that he is feeling steadily better and lays the improvement to the use of the outfit. Some years ago I had frequent conferences (thru a medium) with one who was said to be Madame Blavatsky. During the course of these talks she dismissed the subject of electricity as of little value in comparison with a study of magnetism. That in the study of magnetism lay the secrets of many valuable matters. I am led to refer to this because I recently obtained relief, and apparent cure, from a troublesome irritability of the bladder by the use of a magnet. Other treatments had been of no value. I made no report of this until the fact was definite. The use of the magnet was experimental and came from the suggestions of a Chicago University specialist in the subject, relayed to me via various Biomagnetic reports and some correspondence."

Associate A. N. Onymous, Dixie, U.S.A.

This letter from an elderly Associate was dated Sept. 3, 1964. It certainly provides an interesting and stimulating commentary on the material in the preceding pages of the Journal. Interestingly enough, we've had many reports of successful and continued relief of irritating bladder and prostate conditions from exposure to the MWO. In the Vitic device we now have a borderland gadget that is far less troublesome to build and to operate. How effective it is remains to be proven.

THOSE LAKHOVSKY CIRCUITS AT WORK

"About the Lakhovsky wire circuits, there is no other way to account for the consistently maintained energy I receive. I wear one all the

time as do several others I know, all of whom report amazing results. One man past 80 finds it peeps him up too much, so he wears it intermittently."

H.C., Yucca Valley, Calif.

From **Jan-Feb 1965 Journal of Borderland Research:**

HE WORKED WITH GEORGES LAKHOVSKY

"A friend of mine sent me your pamphlet describing the Lakhovsky Multiple Wave Oscillator. I was the first man that bought this instrument in New York in 1940, on the advice of a physician who saw it at a medical congress in Vienna. My young son had developed a face lesion. It was diagnosed as tubercular. I was having a joint office at that time with a progressive MD. I was practicing dentistry. Her success with the MWO was phenomenal, but when she began to treat cancer cases the American Medical Association got after her and me and revoked our licenses. I had translated some of Lakhovsky's works into English from the French. Professor Lakhovsky came often to my New York office. He told me the Pope was using one of his instruments. The success obtained in the hospitals was excellent but the reports were suppressed. The good professor died of a broken heart. Our case was a regular frame-up by the AMA, the lawyers and the courts. I was foolish enough to fight the case and spend lots of money, not knowing that the AMA controls even the courts and judges. I still have some copies of the booklet and a photo of my Lakhovsky instrument. If I can locate them I'll send them to you. I sold my instrument to a doctor in Texas and left New York state in 1945. I am a licensed Naturopath in Florida and Chiropractor in California. Am enclosing \$ for membership. I belonged to BSRA several years ago."

Dr. N. S. Hanoka, Miami Beach, Florida

From **March 1965 Journal Borderland Research:**

"THE SECRET OF LIFE"

"I loaned my copy of Lakhovsky's 'The Secret of Life' to my chiropractor, also your Journal. He had one build and I've been taking treatments from him on the Multi-Wave Oscillator. After two treatments I got an awful cold and I have never blown so much bloody mucous out of my nose. Also, after each treatment, it would leave me weak. I would have to lie down several times a day. There always was a reaction but my bad sinus condition has cleared up considerable. I also had trouble with my liver and there were so many things that I hadn't been able to eat, for 15 years or more. Now I can eat them and enjoy them. The MWO is certainly worth having and I am improving."

Mrs. A. N. Onymous, Somewhere, Indiana.

From the **October 1966 Journal of Borderland Research:**

HITTING THE HEALING TRAIL WITH THE MWO

"It would be appreciated if you would put an announcement in the Journal that Dr. S. L. Jamison, D. V. M., N.D. (Gr. Br.) announces the opening of a practice of naturopathy in Santa Cruz, California."

"The climate has changed greatly from the old burning-of-books days by the FDA. We cannot all stand back and wait for "George" to do something. I have the advantage of a lot of training in a legitimate field of allelopathic medicine. Only a veterinarian would be able to make such a move and escape retribution for it. A regular M.D. would be branded a traitor to his fellows.

"I have moved to Santa Cruz to set up practice as a naturopath, using the M.W.O. unit, spiritual healing and diet — along with naturopathy measures for the healing of old injuries and chronic degenerative diseases. There will be no charge if there are no results. Since my fees will have no legal status, this will be made clear to the

people using the service so they will be under no compulsion to pay, even if results are satisfactory!

"There are no incurable diseases but there are incurable patients!

"With the MWO we have not gotten uniform results classified by the disease the patient had. About two out of ten people do not respond to the MWO unit at all. You had just as well breathe on them. I strongly suspect that these people should consult an allelopathic physician, M.D., as they would be helped better by conventional medicine. You might say our cases were selected, as people came to us in the last stages of sheer desperation — conventional methods (including chiropractic) having failed.

"Some of these (not many) also do not respond to the MWO. They usually respond to spiritual healing methods when this happens. This I have not figured out good as yet. Once in awhile an arthritic will claim to have been worsened by the unit. This occurs usually in an arthritic with arthritis in a number of joints. One treatment seems to break the poison loose in their body, and they fall like the wrath of hell about two days after. Get them in immediately and run them again, and everything is alright.

"To sum it all up, I have got so I do not care what disease a person has got as long as it is not an acute infectious disease, or a recent stroke case. I have been afraid to try it on either of these as all we would need is for somebody to fall over dead while on the unit and we would be wearing striped suits or breathing HCN in a gasper chamber. . . The unit regenerates the whole body."

S.L. Jamison, D. V. M.

From the **July-Aug 1967 Journal of Borderland Research:**

A TRANSISTORIZED MWO

"I would like to compare operational notes with some one who has built one of these MWOs because I question some of the statements made in the original article. I'll just give a brief description of mine and some of the things I ended up doing. I started with aluminum elements but had trouble with the gluing process so ended up with using printed circuit boards so my elements (antennas) are copper. I have good arcing between first four rings. Can make 'em all arc if I bring point of wooden pencil near the smallest, but pencil must be held certain way or I'll get knocked on my haunches.

"I ended up with a 9 in. Tesla coil. Tried 7, 6 and 5 but ended up with nine. The trouble here was with leakage between primary and secondary. It was terrific until I took means to reduce to a minimum. The transistorized drive I use is partially a hangover from the days of when I used transistorized ignition in my one vehicle. The ignition coil was modified to increase the step-up ratio and since the coil was mounted originally in oil, it was a 'slippery as an eel' project. The driver uses 5 transistors plus diode and operates on a source power supply which can supply up to 20 volts d.c. The drive seems to function best at about 15 - 16 volts." Now for a question. If Mr. Beck, as he indicated in his original article, 'reconstructed the circuits' of an original MWO in a certain man's house, why didn't you people publish a diagram and dimensional data on that original piece of equipment? That would be a project a man could sink his teeth in. Instead this pee-wee MWO which you now say is not much good unless everything arcs. You mean arcing all the way down to the smallest ring????? When you get your updated MWO data published, let me know as I would like a copy.

R.A.R., Rochester, Minn.

Arcing between the first four rings, from the outside in on the MWO antenna, is about as good as any we saw when we were researching the instrument in 1964; 80 it sounds as though your transistorized MWO — the first we've heard of — is doing very well and should be putting out enough energy to affect living cells. You any

wish you had cut aluminum antenna rings after all. For some reason, the arcing between copper rings builds up deposits which must be cleaned off periodically. Bob Beck didn't offer us a schematic of the original Lakhovsky equipment he saw. He said it was housed in a 300 lb. cabinet. The antennas were of circular-formed pipe rings. The outside ring was two feet in diameter. There was a large, separate Tesla Coil driving each antenna. This is a professional model designed to impress the patient. It also probably puts out enough static to antagonize the neighbors for blocks around. We believe Bob Beck deserves all credit for grasping the principle of multiple wave propagation developed by Lakhovsky during radio's infancy in the 1920s and redesigning it into a simpler, smaller device for present-day borderland research.

LATER COMMENT ON THE MWO BY MR. BECK

"The key factor is that the rings MUST arc profusely all around the circumference of the outside and THIRD ring simultaneously. There is no effect, either on a calibrated Hewlett-Packard field strength meter, or physiologically, at the target frequencies if this arcing does not shock-excite the rings. And yet I have seen at least three machines that did not have sufficient voltage from the Tesla Coil to even drive the outside ring, let alone the third element! It would be a shame to invalidate the device because of this. Some of the machines I've seen drive the Model T Coil from an A. C. transformer! The obvious fallacy here is that the coil's vibrator is a resonant device supplying the make-and-break voltages (and magnetic field) to the T coil primary at the designed frequency. Since the transformer is on and off 120 times a second, the chances of the T coil points 'breaking' at the precise instant that the 60-cycle house current is at a POSITIVE peak is about one in fifty. And even if it fires 'sometimes', the T coil is modulated with the 120 cycle line (twice the 60 cycle frequency, since each cycle has two peaks, both a positive and a negative).

"Try it at 300 mc. and 10 kmc. on a field-strength meter some time. You'll see what I mean. The Tesla Coil, incidentally, is just a convenient supply of free electrons. The cascade of electrons or 'high voltage' breaks down the air's resistance (by arcing) and then drives the antenna rings. But if the drive is interrupted, the rings may not absorb and resonate properly. At any rate, it is difficult to kid the Hewlett-Packard meter, and I'd like to see the original design followed, at least for the first year."

AN IMPORTANT MODIFICATION

"The greatest modification to date was the discovery of a box of war surplus very high voltage rectifiers in a bin at a Burbank electronics store. The 30,000 to 60,000 volt selenium stack rectifiers ... eliminates the necessity for a tunable gap, and roughly quadruples the output of the Tesla Coil, also lowers battery drain to half."

BEWARE THE PUNITIVE HAND OF THE AMA

Turlock, Calif. "Daily Journal", Dec. 2, 1966: "Dr. Stanton L. Jamison, formerly in charge of the state Poultry Pathological Lab here, was arrested yesterday for practicing medicine without a license. The veterinarian is charged with using an electronic device — with high voltage sparks crackling and jumping about on either side of a patient — with the claim it was beneficial in cancer and bone diseases.

"After posting \$1100 bail, Dr. Jamison defended his machine. He said parts for the machine cost less than \$50. If someone followed up on the apparatus, he claimed, it would be a 'blessing to humanity'. Police Chief John Viarengo, Lt. Bill Ladd and investigators for the California Bureau of Food and Drug Inspection took Dr. Jamison into custody in the offices of his Life Aquarian Center in the Mercantile Building. Lt. Ladd said a sign reading 'Universal Life Church, Inc.' was prominently displayed in the front office. He said four or five agents had been 'ordained' as ministers in the church by telling Dr.

Jamison they wanted to become preachers. Soon their official ordination certificates arrived in the mail, said Lt. Ladd.

"Police described the apparatus as similar to an electric chair, with four-inch metal rings looking like handcuffs hanging over doors to the room. The theory was to determine polarity of a patient with a pendulum and then proceed to change negative polarity to positive with the 70,000 volt device. Chief Viarengo said patients were being treated for a variety of diseases, including stomach ulcers and cancer. Investigation into Dr. Jamison's operations started in May, when police began receiving complaints from relatives of patients. No money was charged for treatment, according to Lt. Ladd, but patients were expected to make donations to the church. Dr. Jamison headed the state poultry lab here for a decade. He will be arraigned on the charges in Turlock Judicial Court next Friday morning.

"In a statement released following his arrest, Dr. Jamison said the 'multiple wave oscillator' picked up by police resembles many electronic gadgets used, usually ineffectively, in the past for treatment of many complaints. However, he insisted, his oscillator appears to be the exception that proves the rule.

"The unit suffers from a sort of 'guilt by association' with other electronic gadgets to the point where serious doubt would be the reaction of any trained scientist on first observing it,' he admitted. 'I know that this was my reaction.' However, he said he suffered continuous pain following a 1962 automobile accident and, willing to try anything, tried the unit. It helped him, he insisted, and has helped many others. He said the unit had been tested and checked by qualified medical men in Europe in the late 1930s. 'Some progressive healer will follow up my lead in continuing to develop the electronic unit,' he said.

From the **Nov 1968 Journal of Borderland Research:**

AN MWO PHENOMENON

"Please find enclosed \$ for another year's subscription to your wonderful Journal. It has been very enlightening, and I always look forward to receiving it. I have taken treatments on the MWO for a long time and have been puzzled. Soon after I started to take treatments, the hair stopped growing under my arms. I have wondered about this and if anyone else has had the same reactions?"

Mrs. E. H. Piqua, Ohio

This is new to us! If any of you researchers have experienced or observed a similar phenomenon, we'd be glad to hear about it and share it with the rest through the pages of the Journal. The Tesla Coil problem has been solved with the discovery of a good commercial coil made by Master Appliances, Marion, Indiana. This coil will drive one antenna very well.

From the **Jan-Feb 1971 Journal of Borderland Research:**

THE PASSING OF CYRIL SCOTT

Cyril Scott, born Sept. 27, 1879 in England, died first week of 1971, so two friends here inform me. I'm always happy to see one who writes so intelligently regarding diet and health, vindicates his ideas by living that long. Not many do BUT, I read in our local paper yesterday of the death of a former neighbor who died on 11th January at 93, and she knew *nothing* regarding diet, positive thinking, etc. So, where are we? I can't ever make 2 & 2 come to four, woe is me.

Two small books come from Muriel Archdale, England, by Cyril Scott, 'Safe and Saner Remedies', and 'Health, Diet and Common Sense'. On page 162 of the latter he mentions the George Lakhovsky book, 'The Secret of Life', memory of which caused Mr. Scott to suggest using a copper wire around his middle to a man who was too breathless to walk far or uphill. The man wore the Lakhovsky loop for

twelve hours, had a copious and offensive bowel movement, then on following day and another uphill walk, the man was able to keep up with Scott! I found my copper flex soon after but it is awkward to keep in place to make sure the negative end is to the left. Cyril Scott gives the homeopathic remedies needed, particularly emphasizes potassium for cancer."

A. F., Santa Cruz, California

COPPER BRACELET CURES "TENNIS ELBOW"

News Item from Crosby Golf Tournament at Pebble Beach, California a year ago. 1/24/70: "Bert Yancey one had to give up golf because of a nervous breakdown. He also came close to quitting the professional tour last year because of a 'tennis elbow'. But he didn't mainly because he found a remedy endorsed by Australian tennis pros John Newcombe and Tony Roche. The so-called remedy is a \$7.50 copper bracelet, otherwise known as 'The Absorber' or a 'Voodoo Bracelet.

"Yancey wears one on his right wrist to correct an arthritic condition in his elbow and he has worn it for the past five tournaments, including the \$150,000 Bing Crosby National Pro-Am, which he leads by two strokes at 137 going into today's third round.

"I don't know why it works, but it does,' said Yancey, a 31-year old former West Point cadet who finished third in the 1967 and 1968 Masters and won the Atlanta Classic last year. He said a tennis pro in Napa Valley suggested last summer that he wear the bracelet and got confirmation from Newcombe and Roche, who have suffered from similar ailments, that it would work.

Yancey strained his right elbow two summers ago lifting a concrete birdbath in the backyard of his home in Tallahassee, Fla. He took a pain-killing drug that enabled him to compete in the U.S. Open at Rochester (where he finished third), but he was warned that the drug was 'dangerous ... that it gives you ulcers'. 'I never got ulcers, but I felt a pull in my stomach. That's when I quit using the drug.'

'He said he hasn't needed the pills anyway, since wearing the bracelet. The therapeutic effect of the copper, he said, has to do with chemical displacement within the body. 'I majored in chemistry while taking pre-med courses in college and I think I know enough about copper deficiency in the body to believe that, somehow, the bracelet can help me.

"Somebody then pressed Yancey for an answer about what makes the bracelet such an effective remedy. 'I don't know for sure,' he drawled, 'maybe it's all psychological.'"

YANCEY WINS THE CROSBY OPEN

Sports writers are always looking for a new angle for stories and Bert Yancey withstood a spectacular charge by Jack Nicklaus on the final round, with a 65, and came in with a hot round of his own a 69, to win the tournament and a cash prize of \$25,000. Yancey and his Voodoo Bracelet were headlined all over the country. The LA "Times" called it a "Copper Caper" in its Jan. 26, 1970 story.

As was to be expected, the medical authorities in desperation had to prepare an immediate counter blast of propaganda to keep the public hypnotized. The sales of medical snakeoil went down as arthritis sufferers flocked to buy non-medical copper bracelets! The "Times" and other metropolitan newspapers willingly cooperated. After all, patent medicine advertising is a big source of revenue, and who knows how much profitable pharmaceutical stock is owned by the publishers of the papers?

The "Times" medical writer, Harry Nelson, dutifully wrote: "The Arthritis Foundation, a legitimate group interested in getting better treatment for arthritis sufferers (There is a contradiction here, Harry, for medical authorities claim there is no cure for arthritis!) refers to copper bracelets as 'an age-old fraud which has no scientific basis whatsoever'. Yancey is the latest sports figure to get taken by the 'copper caper', which the attorney general of New York last summer

called 'one of the oldest and most vicious swindles'."

These opinions by the Arthritic Foundation and the attorney general are of course; utterly worthless. They are not based on the results of intelligent scientific research, but are based on the profit motive of the medical trust. The electrical nature of living cells was established beyond any shadow of a doubt two generations ago, by the sound theories and research of Dr. Abrams in San Francisco and Georges Lakhovsky in Paris. Thousands of supporting tests since then have proven conclusively that body cells have polarity, and that in an unbalanced or unpolarized condition, disease or injury, the subtle oscillations of a wire coil or loop will restore polarity. Sad to say, there is nothing of this in the training of medical students today and it is left to Borderland Science to carry the torch. The honest, straightforward testimony of public figures like Bert Yancey, Tony Roche and John Newcombe is ridiculed by the witch doctors of authority for medicine.

JUST KEEP TAKING YOUR EXPENSIVE PILLS!

Under orders from above Harry Nelson interviewed Dr. John Calabro, the arthritis authority at University of California in Los Angeles, "He points out that the bracelets may seem to work because arthritis can improve spontaneously and it is easy for the person to associate his improvement with the bracelet.

"I tell patients it's OK to wear the bracelet providing they do all the other things I ask them to do," said Dr. Calabro." Including, of course, the purchase of poisonous pain killers at fancy prices. How much scientific integrity does Dr. Calabro have when he and his university accepts fat research contracts from the medical trust? Is it any wonder that today's Aquarian Age students are publicly questioning the morals and ethics of their professors? They are told that the goal of a university is the search for truth — at least that is what the Chancellors say in their public speeches. But when the student gets to the laboratory he finds that the search is for profitable products for industry — or help maintain a well established profit position.

LAKHOVSKY BELTS, LOOPS, OR OPEN CIRCUITS

"Thank you for the clarification of the Lakhovsky belts described by the late Col. Powell in his publication. I tried what you suggested and after some thought I finally understood what he meant and I believe the belts should look like this:

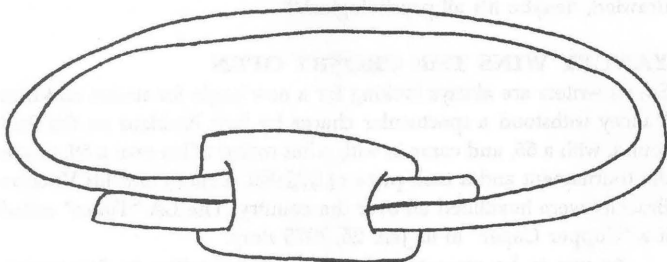

You might want to try experimenting with flat ribbon cable for these belts or coils. It can be bought at most electronic stores and it comes in different widths or colors. I am wondering also, is it really necessary to separate the lamp cord and use only half of it? Could it not be used as it is, with two strands of copper wire, insulated, side by side?"

G.B.F., San Fernando, California

Yes, in our one-loop coils of white insulated lamp cord, we now use it just as it comes from the store, without separating the two strands. But you plastic 'buckle' or 'button' shown above may allow too much slippage; so the ones we make for ourselves and for research-minded

Associates have separate entrance and exit holes for each end of the insulated wire. The white insulated wire seems preferable from the hygiene angle, seeing that it is usually worn next to the skin.

From the **Mar-Apr 1971 Journal of Borderland Research:**

OUR LOOP-THE LOOP PROJECT

"It looks to me like the Lakhovsky loops work homeopathically. It's not the copper element, per se, but the loop the loops it makes, throwing back into the body forces which the body is throwing off. It's an automatic homeopathic prescription, *each body being its own pharmacist.*

"The Yogi does it when he goes into suspended animation, re-breathing his own air. Urine therapy, drinking one's own urine, as described by Armstrong, is homeopathic. An ostrich putting his head in the sand breathes his own air. Breathing into a paper bag and re-breathing the contents is a specific cure for old age pains and hiccoughs. Dianetics was mental homeopathy, i.e., the original book but not no more. Dianetics is re-thinking one's own thoughts. You imbibe your own aberrations, attaching like with like. Homeopathy is like a feedback system. Gods ate their own offspring. It's Isis picking up the pieces. The smaller the dose the more potent the cure. Etc. Etc. Send me two kits of three experimental loops. Maybe I can fatten up on them."

P. F., Florence, Arizona

HE FEELS LIKE A NEW PERSON

"I read that part in the Journal about the copper wire loop; so today I did loop one around me and sure enough the oscillating motion calmed me down. It sure was a sensational feeling because lately at times it got so bad I thought I would spin off, even though I do the Five Rites nightly. On occasion I also experience a terrific pain in my left side which forces me to sit down, just a great pressure especially after standing over the stove preparing meals for maybe three to four hours at a time. The customers just couldn't understand how I stood up under pressure of serving so many people. Seems like mass production.

"So with this new item I feel like a new person! And I'm going to have you send me one of your experimental kits, to see how it compares to what I hooked up on myself. Of course I just taped the wire on and this is only about six hours since I put it on."

J. M. S., Charleston, South Carolina

A DEDICATED BORDERLANDER

"Enclosed is a check for membership renewal and for five sets of experimental loops. I want to compare the effects of the Lakhovsky coil with the Japanese-made magnetic health bands which I sell to my tennis customers. I am very active in tennis playing and teaching. The results with this band are very good."

A. M., Miami, Florida

BEYOND THE PHYSICAL

An Associate writes that she had success in "curing" and arthritic elbow by wearing a copper bracelet on her wrist. Then the pesky condition showed up in her knee! From there is moved to another part of her body. Then it began to dawn on her that their Higher Self was trying to tell her something, that the swollen and painful joints were an outward manifestation of an inner mento-emotional condition of resentment and bitterness over an unhappy marriage. With the cooperation of an understanding doctor and more orthodox heat treatments, etc., and a more positive and cheerful attitude on her part, the condition was finally eliminated. It took months to cleanse the system of the accumulated poisons, physical, emotional and mental.

From the **Jan-Feb 1966 Journal of Borderland Research:**

THE LAKHOVSKY MWO IN INDIA

"The MWO is giving wonderful service and days are passing and I am gaining some new experiences which have not been recorded in the book. I will appreciate if you kindly clear some of my doubts. In practically all the cases I am finding aggravation after three or four sittings. Do you think that it is due to a sudden oscillatory shock that is given to the patient as it so happens when Homeopathic medicine is given? I feel that it should have at least been recorded by someone. One more question. What is the reason for metals being removed from the person of the patient? In case they are not removed will there be any adverse effect? This is very vital because here in Bengal there is a custom that the married ladies must wear one iron bangle. They will not remove it under any circumstances. What is the remedy for this?"

"I find that the appetite improves in practically all cases. Rheumatism and Arthritis cases are definitely benefited. In one case a tumour which is there since about 20 years has definitely gone down with only 4 sittings. I am watching the case carefully and if the Tumour disappears it will be a great achievement for the MWO. Debility is markedly reduced in nearly all cases. In a recent case of Spondylitis the MWO has done wonderful work. The flexibility was 8½" from the floor which has come to 6" after 7 treatments and all the pains have practically disappeared. Due to the New Moon and Eclipse there is an aggravation but I hope it will gradually go. Asthma cases have not responded so well but I am not yet disappointed with the results. It is as yet too early for me to assess the capabilities of the MWO on various diseases. As you say I also believe that this instrument will work on all persons irrespective of their complaints but still there must be some specific organs on which there is more influence of this.

"Something which I forgot to mention previously, can you tell me whether you have seen Hemorrhage as a result of MWO treatment? In at least 3 cases I have seen bleeding start where there was no previous history of bleeding. What is it due to? In one case there was profuse bleeding after 2 sittings and that has made me a bit nervous. Just now a patient reported that he was getting blood in the sputum even though there is nothing in the lungs. In the third case blood appeared in the urine. Please give a thought to this as this is a very serious complication if it is caused by the MWO."

Dr. A. K. Bhattacharya, West Bengal, India.

The above is a portion of a letter to Associate Al Goeke, Redmond, Washington, which Al passed on to me for comment. I thought the rest of you would be pleased to know that this East Indian doctor has gotten very encouraging results from the very beginning in the use of the Multi-Wave Oscillator. If by aggravation the doctor means a sudden release of mucous, heavy cold or flu, this is a sure indication that the MWO is working and affecting a release of accumulated poisons in the body. This is touched on in our brochure, in the comment from a Midwestern doctor which built and used such equipment in the 1940s. When he began producing mild flu — as he called it — in his patients, he got scared off! The hemorrhaging by the doctor's East Indian patients is more serious but we believe it is still a result of the same thing, a sudden releasing of accumulated poisons through the shedding of bad blood. We know one oriental who had a heavy nose bleed after the first exposure to the MWO field. Apparently orientals, some of them at least, are more sensitive to the soft radio wavers than Caucasians living in America; so the doctor's prescribed treatments should probably be somewhat shorter in duration and spaced further apart.

Yet I well remember the radio technicians in Honolulu, Hawaii. I was an announcer and producer there for several years. Some of

them were of Chinese and Japanese ancestry. When repairs were needed on the radio towers, these men wouldn't hesitate to jump on, climb up and work for hours while the station was putting out a steady five to ten thousand watts of power. I don't recall any of them suffering any ill effects such as internal bleeding. Yet their tools would get so hot because of the strong field that they would have to wear gloves in handling them! It was these eddy currents caused by an inert piece of metal in the pulsing field that Bob Beck was concerned about. There isn't enough power in the MWO to cause heating in bits of metal about the body, if one can't strip down for an exposure. The piece of metal, say a zipper or a ring, might reduce the efficiency of the field in that area but we didn't worry about this when testing the equipment we had for a short while in 1964. I don't think Dr. Bhattacharya should either. The machine seems to produce results anyhow.

From the **March 1966 Journal of Borderland Research:**

BASIC NEW AGE PHYSICS

by Trevor Constable

(Publication of Dr. Bhattacharya's letter in the Journal, Jan-Feb 1966 issue, elicited the following significant comments by Mr. Constable.) A word on Dr. A. K. Bhattacharya's reports concerning the Lakhovsky Multi-Wave Oscillator he is using successfully at his West Bengal, India clinic. The results are indistinguishable from those systematically recorded and published over a long period by the late Dr. Wilhelm Reich, M.D., concerning his orgone therapy. Reich was the discoverer of Primary Energy — pre-material and mass-free — which he named Orgone.

The improvement of the appetite, the reversal of rheumatism and arthritis even to structural changes, the rapid reduction of tumors and the hemorrhage effects are all to be found in Reich's massive clinical literature on orgone therapy. Dr. Bhattacharya's reports, plus others any my own experiences with the MWO serve to confirm my previous evaluation of this unit as published in the Journal over two years ago. In essence, the MWO is a device for orgone therapy. It achieves its startling results because it is a generator of primary energy, or at least a *focus* for primary energy.

Any person with a modest extension of physical vision who will observe an operating MWO under conditions of indirect, rather dim fluorescent lighting, will see for himself that primary energy from the earth's atmosphere (the Orgone of Reich) condenses prolifically between the coils of the unit. The concentration is many times that which normally surrounds a living organism.

The basic New Age physics involved, for which we are indebted to Reich, are as follows: Wherever secondary energy, i.e. energy obtained from matter in some way, is released, primary energy tends to concentrate to extinguish this energy. Secondary energy is life-negative, i.e. inimical to the living, a fact which is illustrated, in its ultimate extension, in the lethality of atomic energy. Where so-called soft radio waves are involved, the antagonism of primary energy to their emission is evidently considerably diminished over the violent effects that accompany radioactive substances in the presence of primary energy accumulators.

In the case of the MWO, the tremendous band of frequencies covered results in an extreme concentration of primary energy, which also has its frequencies and correspondence (the Rates of radionics) with the secondary, electromagnetic spectrum. That this effect is achieved with minimal secondary emission is the beauty of the Lakhovsky unit.

TWO-FOLD FUNCTION OF THE MWO

In my view, the dramatic results obtained are due to a two-fold function of the unit. First, there is the undeniable concentration of primary

energy around the body of the patient, particularly potent where a limb or other readily accessible member may be exposed. Secondly, there is the reaction of the specific biological energy of the individual organism, from within, to the stimulus of the secondary waves, which it rushes to combat.

Under the laws of primary energy first discovered by Reich, the patient, as a living organism, is a stronger vital system than the MWO. Accordingly the patient attracts and withdraws the charge of primary energy produced by the device. This is in direct contradiction to formal electrical laws, and as such is typical of the criteria that rule primary energy. The continued emissions of the Lakhovsky unit provide a continuous concentration of primary energy on which the patient draws. Just how long this process should be allowed to continue, per treatment, is where we run afoul of allopathic (MD) thinking.

The acquisition of a strong primary energy charge by the ailing organism results in a reversal, or at least in the reduction of life-negative, i.e. diseased, processes. Reich found with his orgone accumulators that the reduction of tumors was not as great a problem as the auto-infection resulting from the overloading of the excretory apparatus. The debris and bacilli from the diminishing tumors must be eliminated, and unfortunately, because the excretory apparatus is frequently involved in the general putrefaction of which the tumor is the end result, this was the major problem in managing such cases, in Reich's experience.

The medical lectures of Rudolf Steiner, Ph.D., contain one of the master keys to successful therapy, particularly appropriate to the use of the MWO. Steiner points out that what the ailing organism needs is the significant, vital *impulse* in the right direction, then careful nursing and management as it recovers out of its own forces. This was also the view of another genius, the late Dr. Ruth Drown, who knew from experience how important the first impulse back to health is for the sick individual.

Hence, it seems that the old allopathic urge to convulse the patient with therapy, to repeat the massive dose again and again, is something that should be resisted in using the MWO, at least where tumors are being dealt with. The idea of applying the MWO in daily doses may stand in need of modification. We are all to some degree creatures of gross, non-vital thinking that stands behind our allopathic medical civilization, and we will need to carefully train and think ourselves out of the absurdity that the massive dose is the sine qua non of therapeutic success.

THE TRUE-BLUE ROOT CAUSE OF DISEASE

As far as unexpected hemorrhaging from the lungs and similar manifestations are concerned, I think the problem is essentially that diagnosis is so inept and inaccurate that the physician does not have a true blueprint of his patient. After my years of association with Dr. Drown I am sharply aware of the fact that nobody just has one ailment or problem, but that we are all bearers of a veritable plexus of malfunctions which usually proceed from one primary and obscure root cause. What happens with the MWO is that the injection of primary energy into an ailing organism results in multiple manifestations of the healing impulse, and not just a direct effect upon the object of our attention — which may be a tumor, ulcer or other extreme symptom.

All the effects produced by exposure to MWO units are identical to those experienced in orgone accumulator. The healing agency in both cases is primary energy, and I hold that this is so no matter what plausible arguments might be advanced to reconcile the MWO with formal theories and thus win the neurotically desired approval of physicists and doctors. It perhaps seems incredible that one can obtain the same effects produced by the MWO by sitting in an orgone accumulator, with absolutely no electronic apparatus connected to it, but it happens to be so. Try it and see!

MWO experimenters owe it to themselves to study Reich's work

in full. As long as they wander in these fields, they may as well build into themselves the realization that electromagnetic energy has an inevitable, unavoidable and inescapable concomitant — primary energy, life-positive, mass-free energy whose criteria and laws are the exact opposite of the energy accepted by formal physics. The best testimony to Reich's tremendous contribution to human advancement is that he died in a U.S. Federal Prison. As all Borderlanders know, innocent bumblers die in bed in their own homes, untroubled by the status quo.

From the **April 1966 Journal of Borderland Research:**

MWO SURGERY AT SHASTRI VILLAGE AND RELATED MATTERS

by Al Goeke

I believe you and the Associates would like to hear the latest comments from Dr. A. K. Bhattacharya, Naihati, West Bengal, India on the Beck adaptation of the Lakhovsky Multi-Wave Oscillator he is using in his clinic there.

"The other day I had an unique experience with the MWO. I think this should be published. I was treating a lady for rheumatism. After four sittings, once a week, she had a pain under the tongue and there was some inflammation with pus coming out. I asked her to take a further sitting. After about five minutes all of a sudden the thing burst inside the mouth and five pieces of stone came out. When I took her medical history I found that she had an operation two years before and a bit of Salivary Calculi was extracted, but the surgeon had told her that some still remained behind. The MWO treatment eliminated the foreign matter which would not have come out without an operation. This then paves the way for research with Gall Stones and Kidney Stones. I would like to know if anyone else had an experience like mine.

"This time I can give you some reports about the special attachment you sent. A patient was having much pain in the knee and there was swelling. I held the Bulb against the knee for five minutes, and after that it was found that the swelling had reduced and the pain also was much less. In an asthma case I applied the Bulb on the chest for ten minutes. The report is the patient had no recurring attack for two days. Yesterday I was having pain in my thigh so I applied the Bulb. In five minutes I got wonderful relief. Gradually I am getting the hang of it and I think I will be using it more and more."

I, too, am using the Argon more and more, and the more I experiment with it, the greater I think it is, also the MWO. I have had two test cases of young men who, after five minutes in the MWO, said they could feel something happening inside their heads. Both cases had a history of head injuries. I take it that the MWO reactivates a dormant, abnormal condition that perhaps one day would cause trouble. Another test case was a mental patient in Texas. The use of the MWO was part of the test program which brought about a marked improvement in only nine days.

Some time ago a BSRA associate spent an evening with me and told of an interesting borderland gadget. People came from miles around to sit in its healing radiations. I built one for experimentation and found the results good. A Texas Associate says that it works! The original was set in the ground, but I wanted it in the house where it would be more convenient, and figured on running a ground wire outside; but this is not necessary. I have found that it corrects polarity of anyone sitting in the same room. The one I built radiates out 25 ft. One length of 6" stovepipe is used, filled with alternate 2 layers of crushed granite, and of charcoal. For a quick charge of energy, touch your foot on wire at lower end and hand on wire or rod sticking out of the upper end. I have checked the walls and ceilings or rooms (with pendulum) and found them negative. After a few minutes with this borderland gadget in a room, the walls and ceilings check positive!

Here is something that should be shared with Associates.

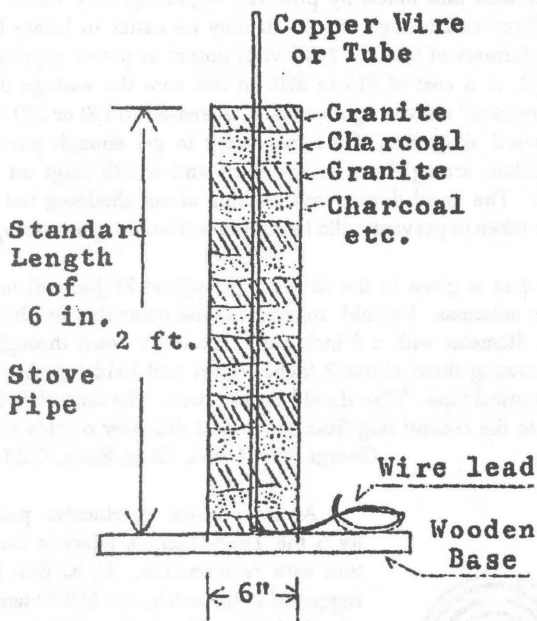

(Here is our drawing from the rough sketch in Goeke's letter, of the borderland gadget explained above. This is just another of many simple devices which concentrate or condense etheric energies of the higher physical sublevels into a field or vortex of force available or useful in beneficial amounts to a living organism within that field. The drawing is not to scale. The dimensions are not critical. It is the relation of the parts that is important. You can consider the upper end of the copper wire as positive and the lower end coming out of the base as negative, but with the alternating layers of crushed granite and charcoal there must be an alternating or pulsating effect. Remember, charcoal is carbon, so this Etheric Condenser is a Vitic device, but not nearly so concentrated as the field between the Alnico magnets of Vitic. Iron filings sifted in the crushed granite would probably increase the power of this thing. This gadget would augment the power of your Eeman Screens, if you are using them, by adding extra etheric vitality to the circuit. Add long wire leads to the upper and lower ends of the Condenser, so you can hold one in each hand while holding the handles of the Eeman Screen leads. Which Condenser lead should go to each hand? I dunno! This is borderland research and you'll have to experiment on yourself, and be your own authority! This is one of the first principles of the Aquarian Age into which we are moving at breakneck speed. Now to continue Al Goeke's article. RHC)

GERMICIDAL EFFECT OF ULTRA-VIOLET LIGHT

The use of the Argon bulb (General Electric AR-1) as a pain-killer and infection reducer is not a new idea. Nikola Tesla used a gas-filled tube or bulb, excited by high-frequency current to rejuvenate himself every day in his laboratory. 40 years ago the RenuLife Electric Co. of Detroit was making and selling such a treating device to doctors all over the country. They offered a choice selection of vacuum tubes for getting into the body to release rejuvenating, purifying ultraviolet rays. I don't know that their tubes were filled with Argon gas, as is the current General Electric bulb. Maybe this is why the GE bulb is so effective. There is a greater concentration of ultra-violet light in the most beneficial wave-lengths, from pure, excited Argon gas.

We visited one chiropractor on a trip last year who used an MWO

machine on his patients, and also uses the Tesla Coil of the MWO to drive the Argon bulb. General Electric designed this little gas-filled bulb for use on the regular 115 volt house current. As a very dimly burning, ultra-violet night light it is a good spook-chaser and can be left on all the time because it uses only pennies worth of electricity in a month! The little bulb has a curved metal plate inside it, as shown here, on which you can see a faint, ultra-violet luminescence when it is turned on, in a standard light socket.

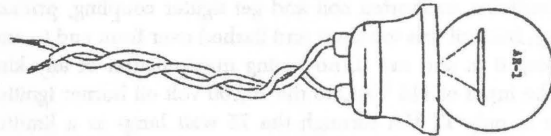

BUT, when you put a *hundred thousand* volts through it from the MWO Tesla Coil, that Argon gas gets real excited and throws off powerful ultra-violet energy which can penetrate into the body and destroy infection and break up tension, inflammation. Showers of sparks jump from the surface of the clear glass to the skin unless the bulb is held so it touches. Sparks will also jump into your hand unless the socket mounting is well insulated. The mounting or socket shown here is the standard rubber base with heavy, six-inch leads for outdoor lighting. Our local hardware store sells the socket for 39 cents. The Argon bulb needs only *one* connection — to the antenna lead of your MWO. The black and white leads from the socket can be twisted together and soldered to a female Banana Plug. This will take the male connection from the antenna lead. The twisted socket leads can be wrapped with heavy, insulating tape if any of the ultra-high voltage gets through to tickle your hand.

The chiropractor who makes use of this in his work asks his patients if they have any infected teeth, or a toothache. One five-minute treatment over an aching tooth, rubbing the Argon bulb on the cheek over the infected area, stopped a toothache for us. It also relieved a throat, sore from too much lecturing.

General Electric also makes an identical Neon bulb. This gas throws off an orange radiation, which would probably give off more of a surface-heating effect because of the longer wave-length. You won't find these special bulbs in your local stores, probably, but will have to order them through some wholesale dealer, say an electric contractor and builder who has the GE catalog of special bulbs. A compact, professionally built Tesla Coil can be bought from Edmond Scientific Co, Barrington, New Jersey. It doesn't put out as much energy as the MWO coil designed by Bob Beck, but it will cause the GE Argon bulb to emit considerably more ultra-violet radiation than the 115 volt house current.

From the **May-Jun 1971 Journal of Borderland Research:**

A HIGH-POWERED MULTI-WAVE OSCILLATOR

"Your brochure article stating that Georges Lakhovsky's original MWO had a separate Tesla coil driving each antenna is most interesting. This is in line with my experience here in Manila. I find that when livening up both antennas to full voltage, to spark each antenna down to the 3rd ring with an occasional slop-over to the 4th ring, it is *much* more effective than when keeping one antenna (or resonator) down to near ground potential; and it is least effective when actually grounding this antenna — as Mr. Beck does — through a 1/10 MF capacitor!

"One five minute treatment a week is enough for me and the equivalent of two 15 minute treatments with only one antenna up to full voltage. However, I drive both antennas up to full voltage with only one Tesla coil. It has rather tightly coupled primary and secondary windings, wound as an auto-transformer, on a 4-1/4 in. diameter glass jar, as per enclosed sketch.

"The present spark gap is 1/8 inch, a fixed, constant gap, needs no turning with variable distances between antennas, subject or no subject. The sparking is much the same and the gap is not at all critical, 1/32nd, plus or minus, works just as well. Gap electrodes are 1/4 inch tungsten. The present primary circuit capacitor is .0015 Micro Farads, but this also is not at all critical, can be varied up to .0025 and still give much the same sparking and effect on subject.

"I tried using #28 Formvar wire, heavy insulated, 70 turns each on the secondaries, to shorten coil and get tighter coupling, primary to secondary, but coil was too short and flashed over from end to end.

"Just plug it in and use it, no tuning manipulation of any kind required. The input of 115 VAC to the 10,000 volt oil burner ignition transformer is only 17 VA through the 75 watt lamp as a limiting resistor. Never use more than a 100 watt lamp. This is all I can take. More power becomes rapidly depressing. And the full 250 VA out put of the transformer I once used, with a 5/8 inch spark gap, was nearly fatal. It took me four months to get over the effects of it. Pass this info on to your Associates."

J. Gilbert E. Wright

Associates can benefit from this dedicated borderlander's experience, which confirms Lakhovsky's warning that healthy cells can be over-stimulated and killed by powerful high-frequency waves — as well by X-ray and radium waves. It may be easier to locate Neon Sign transformers of 5,000 to 7,500 volts output as power supplies for this MWO, at a cost of \$15 to \$20. In this case the wattage of the "limiting resistor" electric light could be increased to 150 or 200 watts, or eliminated altogether, if it is necessary to get enough power to cause random arcing down to the third and fourth rings on both antennae. The good doctor says nothing about shielding but care should be taken to prevent radio interference from this powerful spark.

"No data is given in the drawing (May-June 71 Journal) on the size of the antennas. I would suggest that the outer ring be about 18 inches in diameter with a 3 inch gap. Alternate down through the rings separating them about 2 inches apart and held together with plastic electrical tape. Wire should be #10 bare. The secondary leads connects to the second ring from the largest diameter outside ring."

George Van Tassel, Giant Rock, California

A HIGH-POWER MULTI-WAVE OSCILLATOR

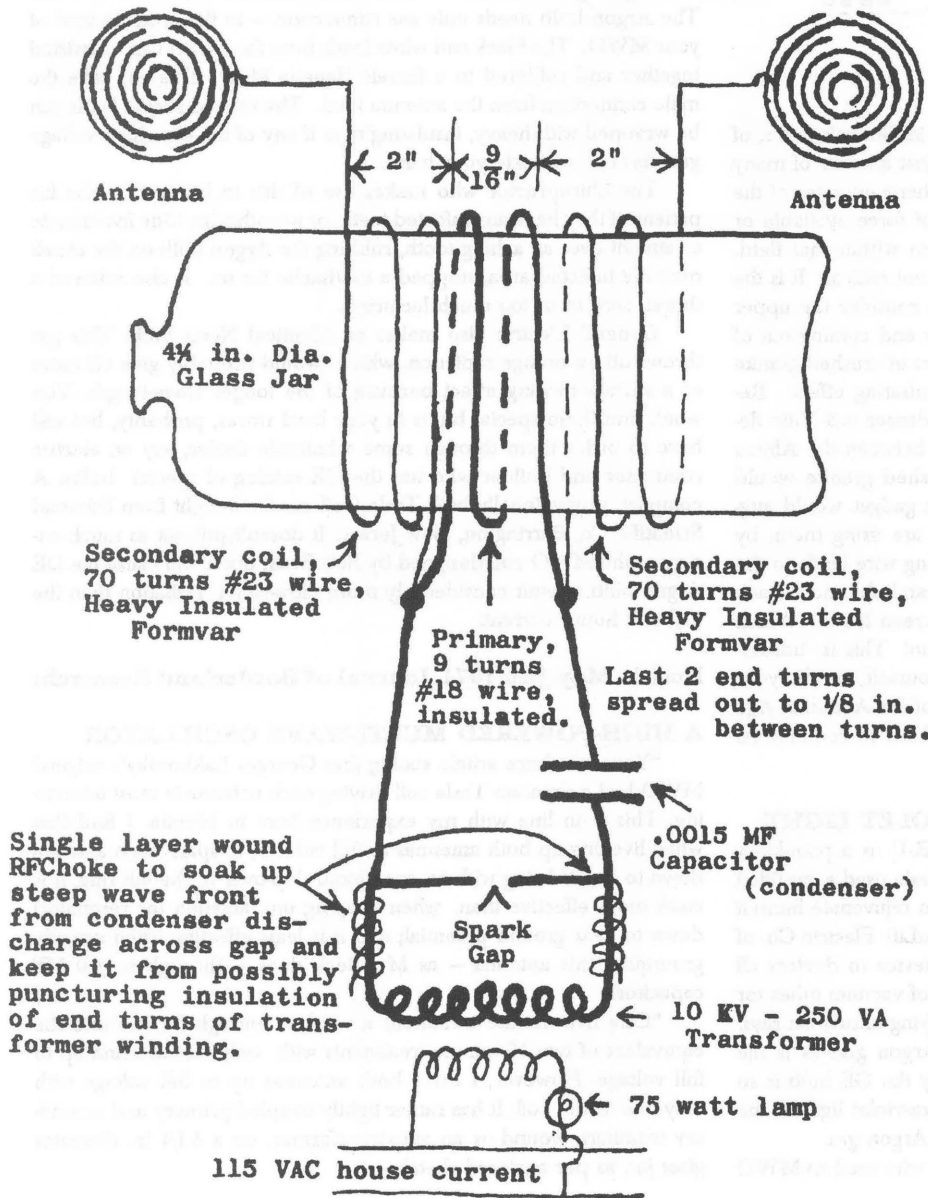

An even more spectacular possibility is the Time-Machine effect in connection with rejuvenation. If, as Bob Beck suggested in his article, the MWO tends to take the body cell back down the time-track to a more youthful, more vital period, what would happen to a person who stayed in the field of the machine for four hours? Would his vibratory rate be speeded up to where he would disappear completely? Like the hero of H.G. Wells' 'Time Machine'? Anybody want to try it? It seems, from hints George Van Tassel has been dropping over the years, that his Integratron at Giant Rock, California might do something like this — if and when he gets it working! As I recall, both George and the Canadian Saucerian, the late W.B. Smith, spoke of the four dimensions of electricity: 1. is the electricity moving in one direction along a copper wire, 2. is the magnetic field around the wire, 3. is the static charge created by the first two effects, and 4. is Time — or the 'tempic field' as Smith called it. The Time Field equates with Space, where consciousness is everywhere present. Seems to me Lakhovsky's Multiple Wave Oscillator is a gadget which gives us the opportunity — for the first time — of approaching the Time Field with scientifically acceptable equipment, operating in known frequencies.

BIOPHYSICIST CONFIRMS LAKHOVSKY'S THEORIES!

LA "Times", March 28, 1971: "The 'magnetic resonance' of the nuclei of atoms (in living cells) has been used to tell the difference between cancer and normal tissues. This resonance is the reaction of the nuclei to electromagnetic energy — first its absorption and then its emission. The process can be timed.

"Raymond Damadian, a biophysicist

at the State University of New York's Manhattan Medical Center, said his achievement may open the way to major advances in the diagnosis of cancer in humans... Like other attempts to find a way of making early diagnosis of cancer, Damadian's research began with a hunt for significant differences between cancer and normal cells.

"He relied on a law of physics on which nuclear magnetic resonance is based — that the atoms in each element in the periodic table absorb and then emit electromagnetic energy on an individual wavelength that is different from that absorbed and emitted by the atoms of any other element. In his system, radio waves are aimed at atoms in strong magnetic fields. If the wavelength is the right one for that atom, the atom will absorb the energy and then emit it, returning to a 'resting' state afterwards.

"The reactions differ according to the kind of molecule the various atoms are incorporated in. They also differ when very subtle changes have taken place in the molecules. The measure Damadian uses is what is called the 'relaxation time' of hydrogen atoms in water molecules within the (body) cells... He found that it takes longer for protons (nuclei) in cancerous tissue to 'relax' than it does for protons in normal tissue... The relaxation time of protons in normal liver tissue, as one example, was .25 of a second, compared with .86 of a second for cancerous tissue.

"Damadian's findings confirm the theory proposed by several scientists that water molecules in a normal cell are held in a fairly well organized structure by electromagnetic attraction exerted by the molecules in the cell. But, it was theorized, when a cell begins the uncontrolled growth of cancer, the structure begins to collapse because of the cell's increasing disorganization.

"Damadian thinks the device for detecting cancer in humans (his experiments were conducted on mice and mouse tissue) that may come out of his work would be a radio frequency coil to emit the electromagnetic waves to be aimed at the atoms in the water molecules under study. The device also would include a magnet to create the field required for measurement.

"The coil would be wrapped around the patient while the magnet would be moved back and forth over his body. The reading of how long it takes the atomic nuclei to relax would be made and then computers would do the matching up and make the diagnosis."

Interesting, isn't it, how in the 1970s researches of biophysicist Damadian parallel the pioneering work of electrical engineer Georges Lakhovsky in the 1920s? The goals are quite different, of course, in that Damadian only wants to prove the existence of cancer so the victim can go on to be drugged, operated or radiated with destructive X-rays or cobalt rays, at fancy prices, a procedure inspired by the soulless monsters who guide the American Medical Association from the Lower Astral plane.

The irony of Damadian's proposed diagnostic technique is that it combines two electro-magnetic *healing* procedures. If it is used on sick people, sooner or later someone is going to be healed of cancer while being diagnosed! Can you imagine the disagreeable shock this would cause in orthodox medical circles? Extensive surgery would have to be cancelled. The sale of drugs would be lost. Under these circumstances it isn't likely that his diagnostic technique will ever receive the approval of the AMA.

So, borderland science will have to continue to carry the torch of research on electro-magnetics in this area, as George Van Tassel is doing with his Integratron up at Giant Rock, California. In his newsletter "Proceedings" he gives more details of his research program there. We learn that in addition to creating a field of soft, high frequency radio waves, and a magnetic field, the Integratron will also bathe the subject in an atmosphere charged with negative ions.

HOPPING UP THE HIGHER FREQUENCIES

"There is one thing you may wish to try on the MWO. Close the

center hole in the driven antenna with a washer and screw. Connect this to the driven ring (second ring from the outside) with a 500 mmf condenser, 10,000 volt rating. This increases the power of the higher frequencies. I think you will be pleased with the results. Mount the condenser at the back of the antenna. Mankind has been saturated with the lower frequencies for years; 60 cycles and their first few harmonics are almost everywhere in more than adequate power. Radio, TV, radar, etc. also saturate our world but the amount of power available to the average person is very small. In 1942 I used to cure my sinus trouble in minutes by getting close to the transmitter section of a radar transmitter. Few get that close, though, and it is a good thing as this power can kill. I have seen birds and larger animals killed instantly. It can happen to humans, too."

H. B., Melbourne, Florida

SEND A FEW BUTTONS

"Received the Lakhovsky loops and am pleased to feel the response to the body. I wear my belt only at night. I gave one to a friend who was having a problem with her leg and anticipating hospital treatment for same and the response was also to the good... So all I want now is for you to send me a few buttons so I can make some more loops myself and help to lessen some misery around here, for someone. I tried to have some buttons made here, but no success."

J. M. S., Charleston, S.C.

The non-slip loop buttons we made are of 1/16 inch thick, white fiberglass plastic.

MORE POWER NEEDED

"Enclosed is \$. Please send me the magnet assembly with carbon rod (March-April 71 Journal). Have not had the hoped for results with the loops. Possibly the assembly, which can be used more directly over the research area, will be more effective."

M. S., Ellensburg, Washington

If we've proven one thing in our borderland research, there is no single cure for any or all of mankind's ailments. Injury and disease are outward manifestations of an invisible cause, which may involve three or four levels of consciousness and extend back two or three lives. Your Director has found in over thirty years of counselling people on their borderland problems, half of them don't really want to get well, they just want to be free of pain so they can go on indulging their vices. And by the time the hidden vice surfaces as a disease in some target organ of the body, an unhealthy trend has been established in the cell life there. It usually requires a strong jolt or shock to reverse this trend, such as a powerful magnetic field, a drug, chiropractic, even surgery — anything to break the negative pattern which created the condition. One of the simplest and most effective methods, and cheapest, is fasting for a week or two. This gives the system a chance to purge itself of all filth.

OPEN ENDED COPPER BRACELETS

"Your article on copper bracelets sent me to the typewriter! It is quite well known in England and has figured on TV as anklets for race-horses! Open-ended copper bracelets sold freely in shops for some years here, but not recently. However, I have a copper bracelet from Rhodesia which I wear always, never take it off, and of course no arthritis or rheumatism. But I'd like your experimental loops for throat, waist and wrist.

J.G., London, England

THE PRO AND THE CON

"Thanks for the wire rings. Sorry to report no favorable results. My husband refused to try. I wore them several nights but seemed to feel

even worse afterward. It was a good experiment. I guess my trouble is psychosomatic.'

"I want to thank you for sending me the kit of Lakhovsky coils. I especially appreciate your taking the time to prepare a larger-than-usual coil for my chest. I guess I'm, too young to have any really serious physical ailments — except for insomnia! And the coils eliminated that the first night I wore them to bed!"

J. T. D., Venice, California

From the **Sep-Oct 1971 Journal of Borderland Research:**

UPGRADING CELLULAR ACTIVITY WITH ELECTRO-MAGNETISM

By Aaron H. Steinberg, Ph.D.

For too many years now the scientific knowledge of electro-magnetics and its positive effects on cell life has been collecting dust and cobwebs on the shelves of ignorance, brought on by those special interests who fear the Truth. We are now seeing a rebirth, if you will, with scientists both professional and amateur, who are reviewing the work of their predecessors and making improvements in the mechanical application of magnetic fields.

In 1969 I visited the USSR to see for myself what and how they were utilizing Electro-magnetism. In several country homes for retirees I was most pleasantly surprised to see electro-magnetism used daily on most of the old folks. I should say young folks since many who claimed to be over 100 years young, looked and acted like most people at 50! The main object of the E-M was to reverse the ageing process by altering the cellular structure. I was most anxious to purchase a piece of the equipment, but alas no sale.

Seek and you shall find has always been one of my dominant characteristics. So when I learned that Japan was truly advanced in this field, having been using such equipment since 1936, I decided to go there in 1970. I sought out the one company that had been most productive in this field. They were most kind and cooperative. I was introduced to several scientists who had done much useful research. Their claims were backed up by scientific facts and I was convinced that they had a well constructed instrument, simple to use by anyone so desirous. They named their equipment The Magnetizer.

I returned to the U.S. with a Magnetizer and immediately began a research program. I can report that the results obtained to date have been most favorable, after nine months of experimentation. The magnetic flux generated by the coils can be measured accurately over any part of the body, thus determining those areas where the flux is penetrating as well as those where it is weak.

Chemicals and pollution are surely contributing to an unhealthy alteration in our cellular activity and human magnetic field. It will be many years, if at all, before this mess can be rectified and controlled. But in the meantime, those who are aware and see the danger signals, will not sit by and wait for the clean up, which may never happen. Instead they will seek to upgrade their cellular activity so that the body's natural resistance may be at peak ohms. There is some indication that the aura force centers known as chakras or vortexes are stimulated by electro-magnetism.

From the Japanese scientists I learned the following about the effects of magnetic flux. It is different from ordinary electric current, which only flows along the surface of matter. It is different from X-rays, which do not penetrate the bones. The magnetic flux of ultra-long wave generated by the Magnetizer penetrates deeply in muscles, fat and bones and has an intensive effect on the nerves.

Magnetic flux never causes unpleasant sensations in the body, such as pain or shock, but instead produces comfortable, warm sensations. These sensations are also known as Joule's heat, which strengthens the function of the cell, corrects spasms and inflammations. When

magnetic flux passes through tissues, a secondary electric current called the eddy current is created around the magnetic lines of force in the tissue cells, which ionized the protoplasm and rejuvenates the tissues as a result of activating metabolism. Furthermore, magnetic flux, in the process of penetrating the tissues, works to increase hormone secretions. These maintain youth by providing energy as a result of normalizing function of the internal organs.

Flux strongly stimulates magnetic substances in the blood, like iron. Accordingly, the hemoglobin in the blood vessels moves actively, accompanying the lymph circulation, when the Magnetizer is turned on. The therapeutic effect is not singular but collective, thus eliminating constitutional weakness.

From the **May-June 1971 Journal of Borderland Research:**

OSCILLATING LOOPS AND COILS

I have a necklace which is definitely an oscillating circuit. I'm sure you have seen them. They are a wire around the neck instead of a chain. The only thing is that they come with a hook arrangement to clasp them. I cut the ends off, and rounded them to make a real oscillating circuit. Then, too, I got a pair of earrings which are simply coiled wires, like this:

One of these days maybe I'll have a headache (this is rare), and I will try either or both of them.

Mrs. C. M., Watertown, Wisconsin

REMEDIES, HOMEOPATHIC & ELECTRO-MAGNETIC

"You might spread the word around that the Copen Vibro-Potentizer actually can make any Homeopathic remedy in any potency from 1X to 10M.

"Since the medical-industrial complex is trying to destroy Homeopathy and its pharmacists, those who know of it and are doing research on its remedies would do well to get such a machine. It can also make a remedy from a radionic rate. I made Skull-Staphylococcus 10M and reduced an intractable sinus infection. The possibilities are fantastic and open up a new field in healing. One can make color remedies and aura remedies with greater power than radionic treatment of the same."

From his own research this Associate is suggesting that homeopathic remedies, being closer to physical matter than radionic treatment rates, may bring physical body changes more effectively. A hundred years ago in Philadelphia, Dr. Pancoast was curing practically every known human disease with colored light, either blue or red. But he also prepared color-treated dosages of oil or water for internal use, to back up or augment the shining of colored light on the outside of the body.

"May I remind you that the Multi-Wave Oscillator requires an antenna without any *edges*, to give efficient radiation. Lakhovsky's original had *round* bars or tubing with *spherical* ends. Edges lose most of the radiation. In addition the largest ring should be based on that fundamental resonance of the human organism, 3.66 meters as discovered by Bell Laboratories. This could be a quarter-wave antenna length of .91 meters or a circle of pi diameter.

"However, this should be doubled so that the human organism resonance is the first octave. Individual resonances vary slightly above and below 3.66 meters. By giving lower octave and with the variations supplied by the spark gap all wavelengths would be reached. Therefore, the outer ring should be 1.82/pi meters.

"The relative size of the outer rings could be determined by examining one of Lakhovsky's original antennas. The outer ring should be fed current at *both ends*, quarter wave style, I believe (to a H.V. Coil) not at the middle of the second ring as the Beck antenna does. The frequency of human resonance, 3.66 meters or approximately

84.6 megacycles is the key to radionics. [By my calculations, using the formula wavelength in meters (3.66 meters) equals (=) the speed of light in meters per second (300,000,000 m/s) divided by the frequency in cycles per second, I figure the frequency to be 81.97 megacycles. T.J.B.] The human sample or witness-blood spot, etc. radiates around that frequency, varying according to the disease and the person, I believe. The homeopathic remedy also has a resonant frequency and alters the human frequency for better (or worse). In addition there are harmonics and possibly sub-harmonics.

"The resistance rates discovered by Dr. Abrams, followed by Guyon Richards, are still valid even though this work was done 50 years ago. The rate for Aqua Marina (sea water) put on a Copen V.P. produces a very effective remedy good for almost everyone. This rate comes from Richards' book 'Chain of Life', 1934."

S. M. S., Chicago, Illinois

We welcome this Associate's observations on the MWO antenna, radionics rates and homeopathic remedies.

Riley Hansard Crabb, editor JBR 1959-1985

BSRF MWO Update - Issued May 31, 1988 (1986-1987 MWO UPDATE BROCHURE)

Compiled by Tom Brown from the BSRF Files

in consultation with Eric Dollard & other BSRF Associates

As there has been a continuing strong interest in the Lakhovsky Multi-Wave Oscillator we felt the need to compile this information into the present book. This documentation is the result of a wide variety of analysis and experimentation with the MWO and covers many years of active research.

There have been many comments made concerning the inherent healing effects of the MWO, but as it cannot be stated enough, the device is merely a tool of research, of which one may draw their own conclusions as to whether or not the device actually has any healing properties. It may be interesting to note that in a personal conversation with Dr. Ita Wegman, Rudolf Steiner stated that electricity, magnetism, and the force upon which nuclear phenomena is based, are all corrupted ethers.

We have found through studying Goethe's indications on the phenomenon of Light and Color in conjunction with Eric Dollard's high frequency researches that electricity is a reflection of the Light Ether. This matter is being discussed further in The Journal of Borderland Research, so it is sufficient for present reference to say that Light has its two poles, red-yellow and blue-violet. The red-yellow pole in nature is longitudinal (direct rays from sun) and the blue-violet pole is a progressive type of transverse wave (rounded sky, Reich's KRW wave/blue orgone). Electricity has its two poles, electro-magnetism: red-yellow-hot, (retarded transverse); and dielectricity: blue-violet-cold (longitudinal). Hence, there are experimental indications that electricity really is a reflection of the Light Ether.

In light of this train of thought we quote with permission from a 1986 private communication with Trevor James Constable: "The MWO I regard as a false path. The cellular stimulation theories sound and seem good because they are mechanistic, and therefore sympathetic with the mechanistic *weltanschauung*. With the MWO you can avoid the etheric—or so it seems—and therefore those who feel adrift in the etheric ocean cling to things like this. Healing is one hundred percent an etheric problem. Any dysfunction or hyperfunction not caused by direct trauma has to be tackled via the ether body, and even the direct traumas respond best to etheric correction, such as getting the displaced double back into occlusion through the use of arnica compresses, etc., etc. In between the MWO antennas, there is

a general marshaling or focus of light and chemical ethers. Its quite evident even with a minor extension of vision. This is the healing agency, not the sparks. The ether rushes to suppress the EM activity, and because it is low power, the ether accumulates around the spirals and in between them. Any stricken area placed in such a high concentration of formative energy, is going to respond with a return towards normal. BUT, why go to all that trouble when a simple orgone blanket—a layered structure that can be directly applied to a traumatized or dysfunctional area—does a much more efficient, controllable job without that infernal juice. In my time with Ruth Drown, I heard it over and over again, and I pass it on to you: keep that 115V juice away from the organism. The post material EM energy is life negative, but no one seems to feel that they can get results unless they INJECT the alien EM activity into the stricken carcass. It's pure ignorance really. My own experience with orgone accumulators and blankets leaves me with no other choice but to regard the MWO as superfluous. A good rule for any experimenter: If it gets simpler, you are on the right track. Remember always Steiner's dictum: "the spirit of man is always healthy! . . . It is the obstruction or dysfunction in the lower sheaths that distorts the manifestation of the spirit and personality via the body."

Not much more need be said in that vein except that of a reinforcement of Trevor's comment. Our present society is not on the path of Nature so therefore some people feel the need for a device such as this. Wilhelm Reich discovered how to concentrate the living energy of the universe, which he termed the Orgone. The Yogic sciences teach us how to accumulate this energy without any outside apparatus, so therefore the simpler and more passive a device is, the closer it resembles Nature.

On these pages you will find some of the reports of MWO experimentation and consideration by BSRF and Associates. We hope the information proves useful, but again it is for research purposes only. We do not recommend the MWO for medical use because we are not qualified to give medical advice, nor do we want to create any false hope where one may neglect professional health care. We do fully support an intelligent, aware human being's right to investigate and research with devices such as the MWO. No one has all the answers and the MWO is an interesting device which deserves true scientific verification or rejection.

THE BASICS

The general theory behind the MWO is to excite a concentric ring antenna which produces a wide spectrum of radio frequency waves. In this theory it is understood that the RNA-DNA coil in the nucleus of every cell has a resonant frequency within this range. Just as a tuning fork will ring when an identical fork is struck in close proximity, the cells will resonate to their individual frequency pulled from the frequency ocean of the MWO. Most people don't consider that there are different types of waves and two poles of electricity, and these distinction have not generally been noted.

The antennas on the currently popular Beck MWO system, serve as simple capacitor plates which transmit dielectric waves out of the Tesla Coil (see figure 1 and photos 1 and 2). The second MWO plate in such a system must be connected to a second Tesla coil or to a double pole (half wave) Tesla coil (May-June 1971 JBR), not a single pole (quarter wave) Tesla coil as per the Bob Beck/Klark Kent style MWO. Action in the MWO antenna is neutralized by the fact that capacitor currents flow radially inward and little electron current flows around the loops. Copper plates can be substituted for the ring antennas. This system operates 1000 times stronger if a spark gap exists across the double coil. A description of the action is in DIELECTRIC & MAGNETIC DISCHARGES IN ELECTRICAL WINDINGS by Eric Dollard from BSRF.

Lakhovsky's Multi-Wave Oscillator, as pictured in THE SECRET

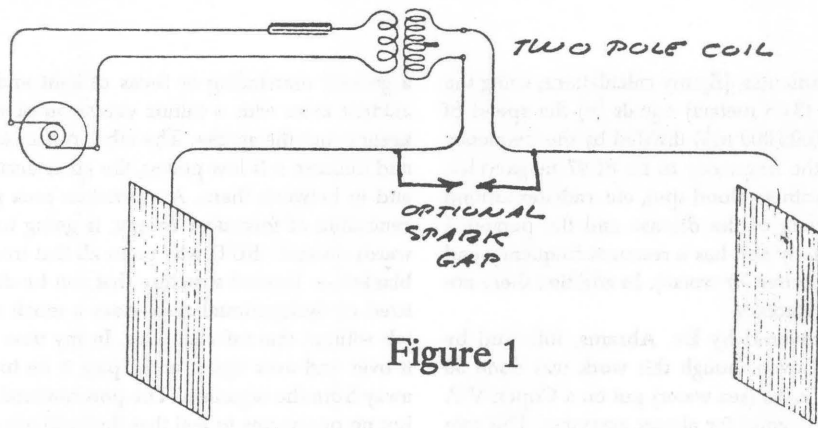

Figure 1

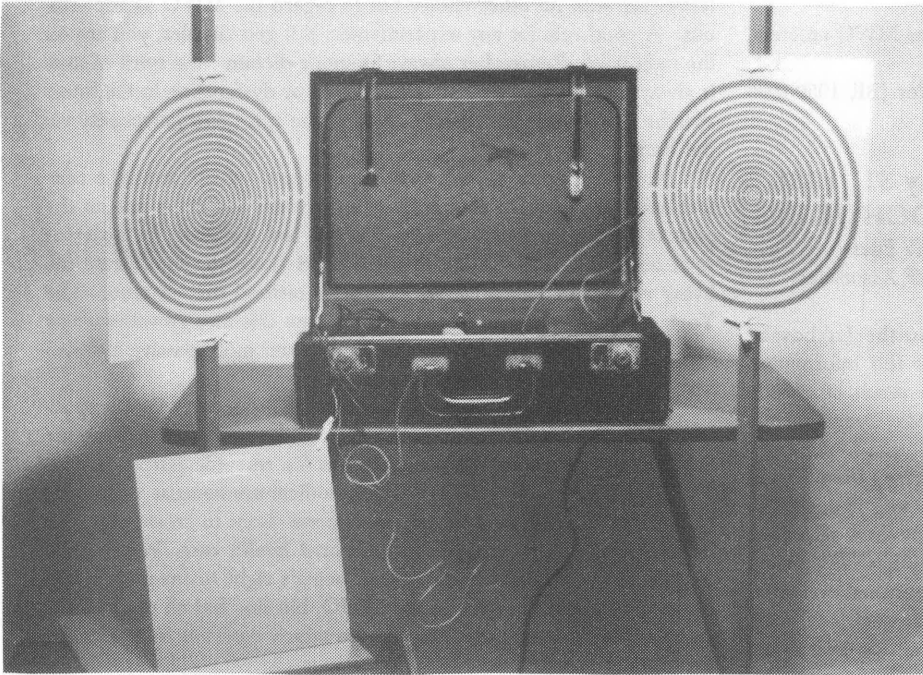
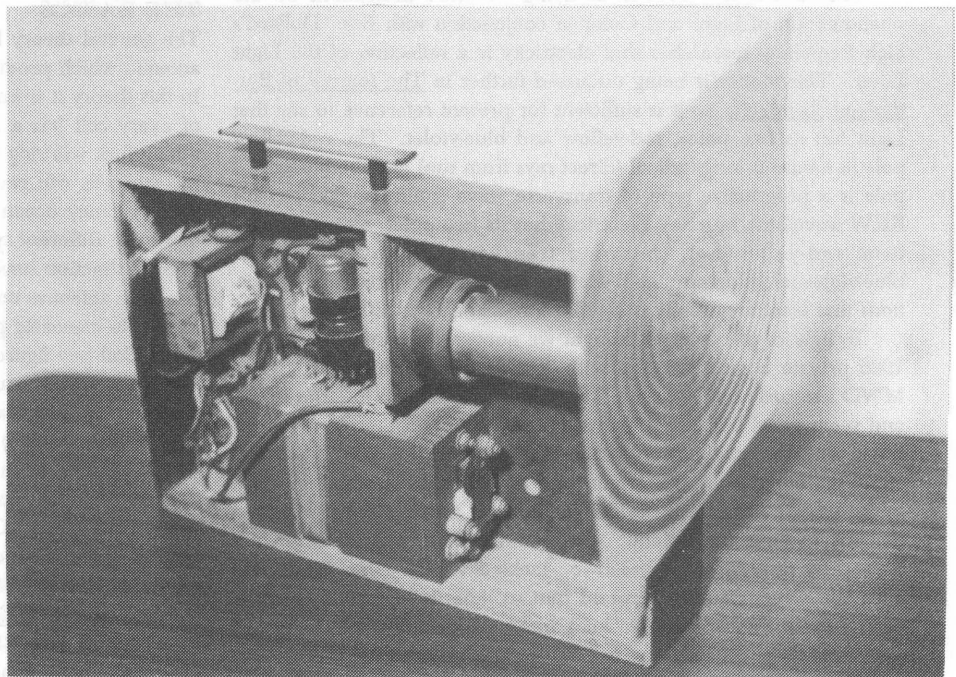

Photo 1
 "Beck" style MWO from
 the BSRF collection
 (note: foot plate at lower
 left goes to ground)

Photo 2
 Single antenna version
 from the BSRF collection
 (Resonator antenna can
 be attached at ground)



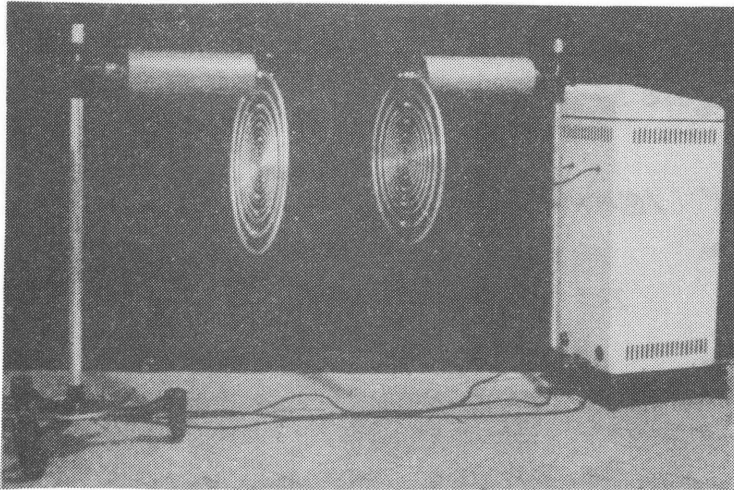

Photo 3
Lakhovsky's Multiple Wave Oscillator

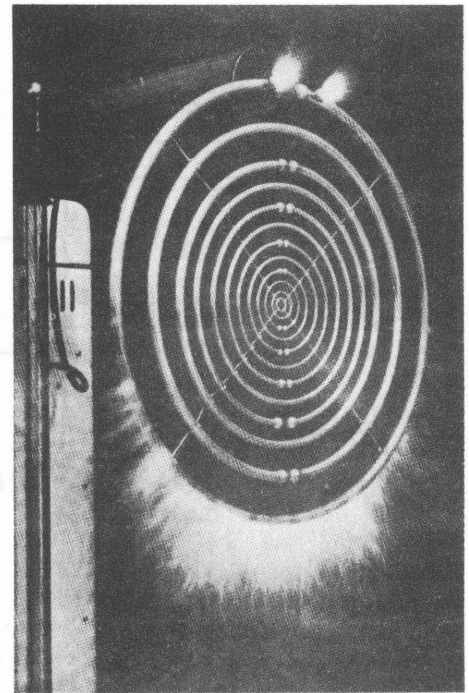

Photo 4
Lakhovsky's MWO. Close-up of transmitter in action, showing effluve (electric brush). Note this is end-fire antenna. Regeneration may have come from novel component at 90° to antenna plane.

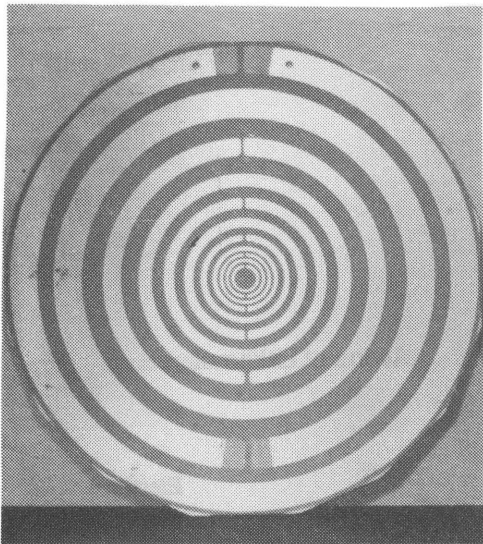

Photo 5
Yagi MWO antenna

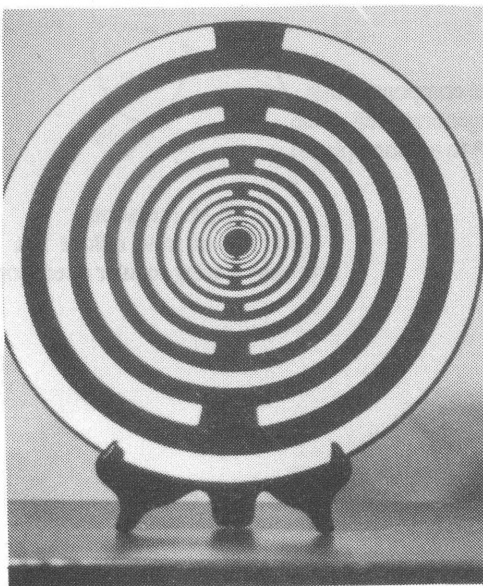
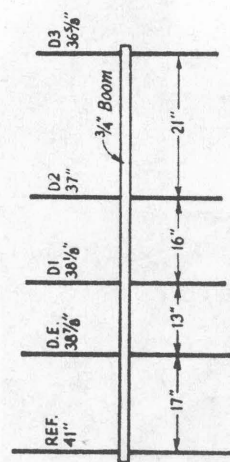
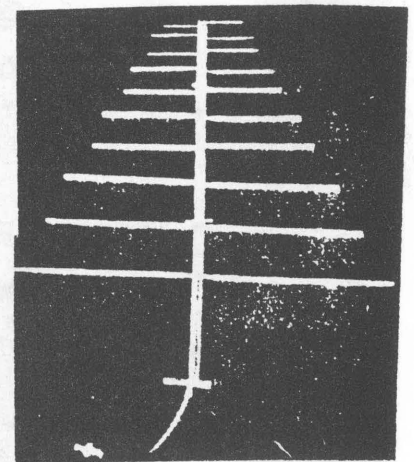

Photo 6
Golden Ratio -- Log Periodic MWO antenna



Yagi antenna



Log periodic antenna

Figure 2

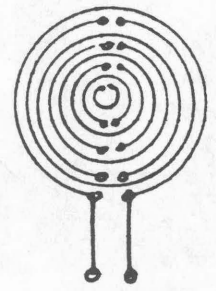
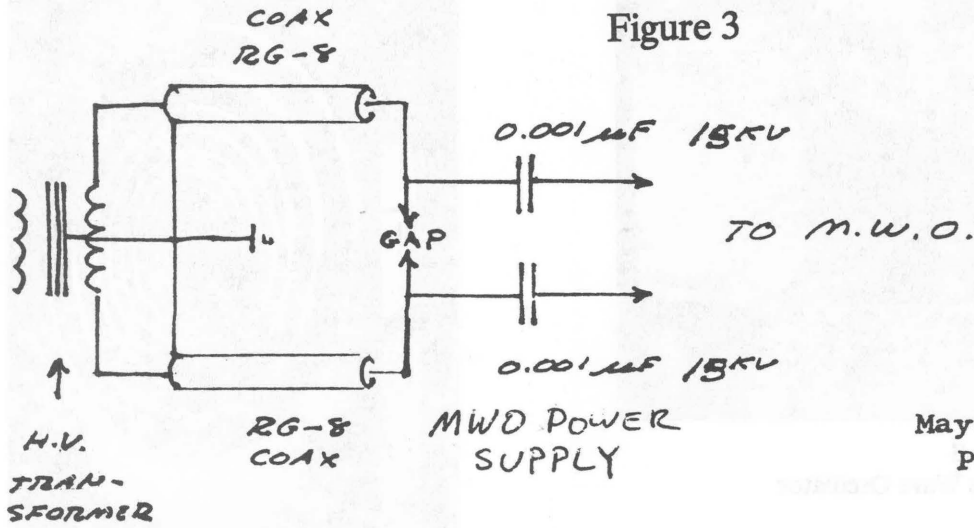

May-June 1986 JBR,
Page 33

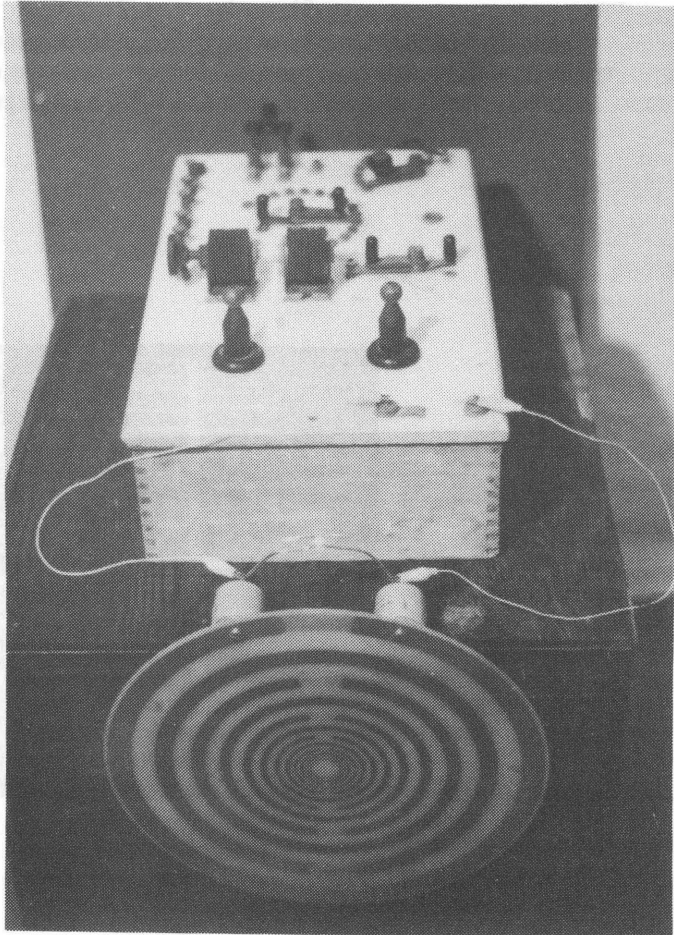
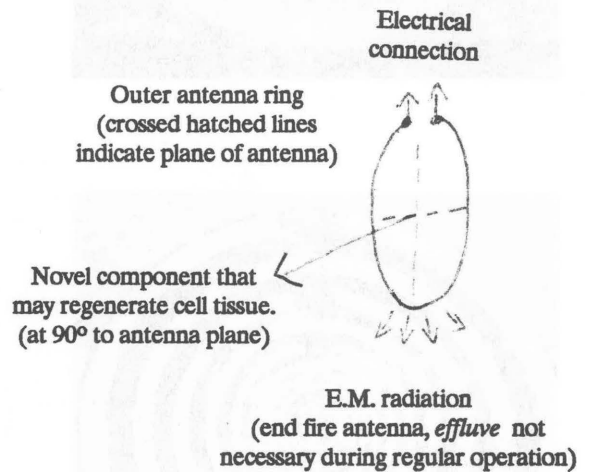

Photo 7

Golden Ratio antenna driven by 1919 era double-phase marble-top medical Tesla Coil. Mid-frequency D'Arsonval currents are utilized in this arrangement. Setup is as per Figure 3 (above), and is our understanding of the arrangement as utilized in THE SECRET OF LIFE. Coil donated to BSRF by John Crane from laboratory of Royal R. Rife.

Action of Lakhovsky setup



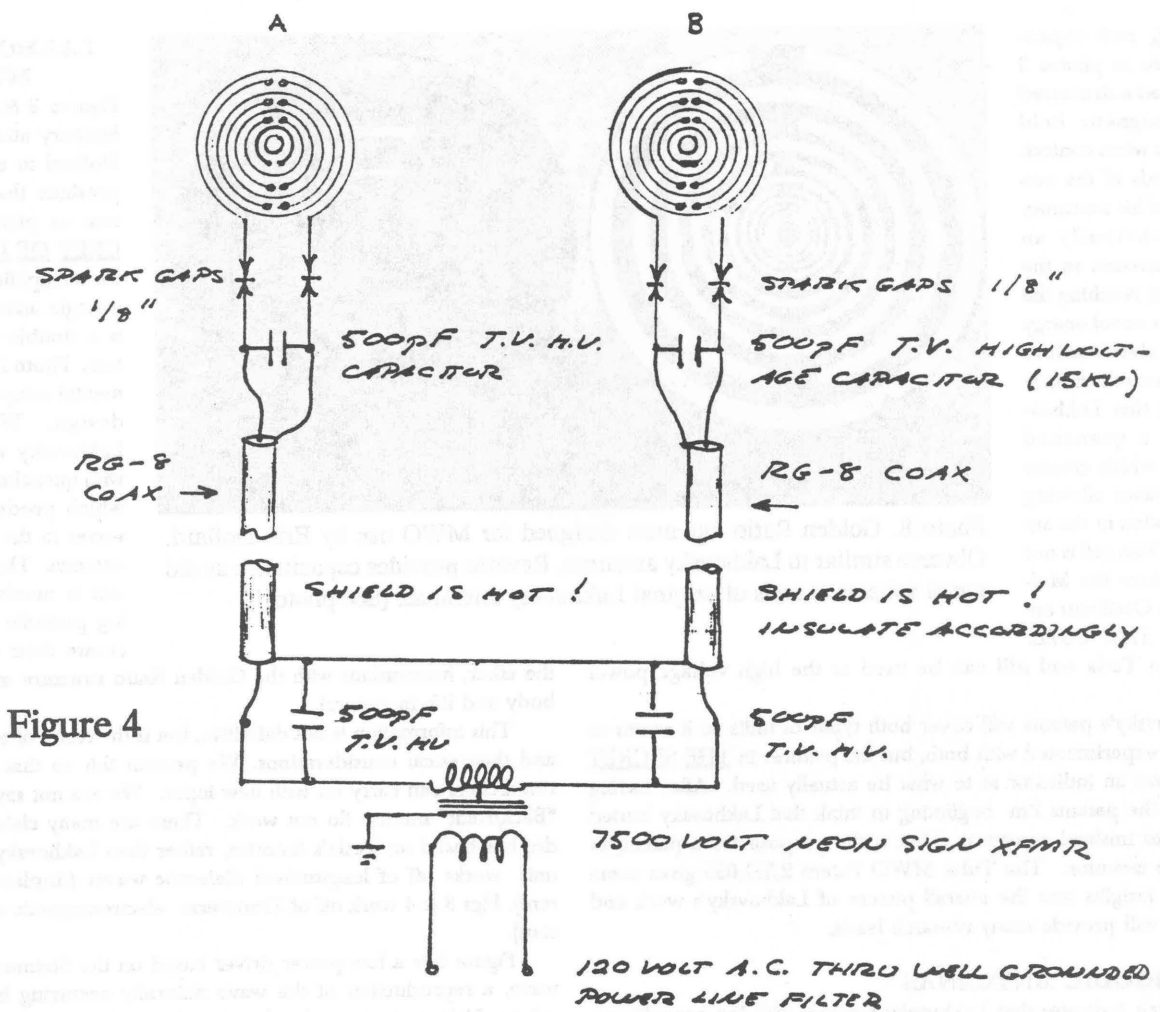
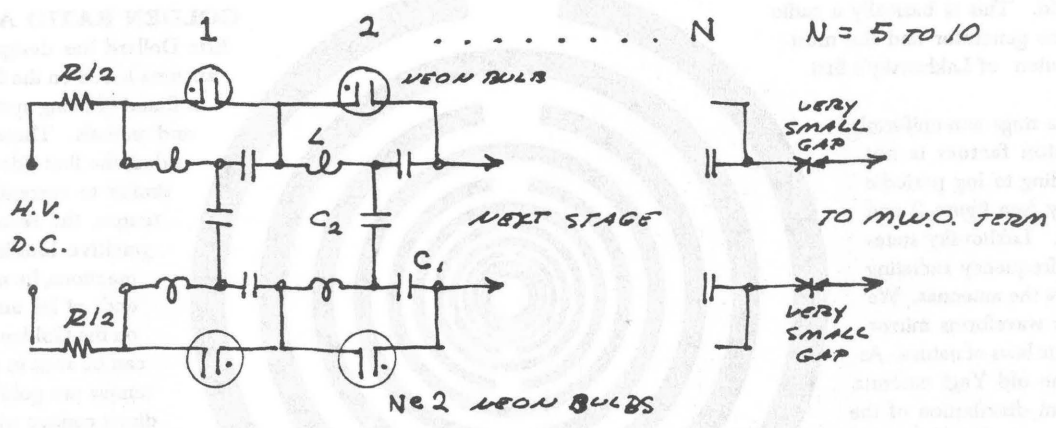

Figure 4



D.C. INPUT = 240V / STAGE ALL C₁ RATED 600V

R = 100KΩ / STAGE 1 WATT / STAGE

L = 1μH / STAGE C₁ = 100pF X N# OF STAGES

C₂ = 0.02μF / STAGE 600V X N# OF STAGES

OF LIFE and reproduced here as photos 3 & 4, created a structured electro-magnetic field fed by two wires contacting the ends of the outside ring of his antennas. This is obviously an end-fire antenna so the component reaching the person is a novel energy needing clarification. Several researchers have expressed that Lakhovsky used a quenched spark gap which creates damped waves allowing free oscillation in the antenna. A Tesla coil is not required since the Multiple Wave Oscillator antenna *IS THE COIL*.

However a Tesla coil still can be used as the high voltage power supply.

Lakhovsky's patents will cover both types of units so it seems as though he experimented with both, but the pictures in THE SECRET OF LIFE are an indicator as to what he actually used. After having gone over the patents I'm beginning to think that Lakhovsky buried his secret to mislead copycats. That is the purpose for a patent, to protect the inventor. The Tube MWO Patent 2,351,055 gives some interesting insights into the overall picture of Lakhovsky's work and study of it will provide many research leads.

LOG PERIODIC ANTENNAS

Our research indicates that Lakhovsky worked with log periodic antennas and may have been the first to use them. The antenna will create a harmonious structure in the ether. The Beck style MWO produces a dielectric field 90 degrees out of phase with this, and utilizes the dielectric breakdown (arcing) of the field. This is basically a radio frequency noise generator and the most popular derivation of Lakhovsky's first MWO patent.

Scaling the rings non-uniformly using correction factors is not needed according to log periodic antenna theory (see figure 2 and photos 5 & 6). Lakhovsky states that any high frequency radiating circuit will drive the antennas. We are striving for waveforms mirroring the harmonic laws of nature. As an example the old Yagi antenna has non-uniform distribution of the elements. Log periodic design uses the uniform distribution of the elements such as is found everywhere in nature. This presents superior MWO performance. Lakhovsky's Speaker and Microphone Patent indicates that the log periodic design can be applied to sound as well as radio frequency energy.

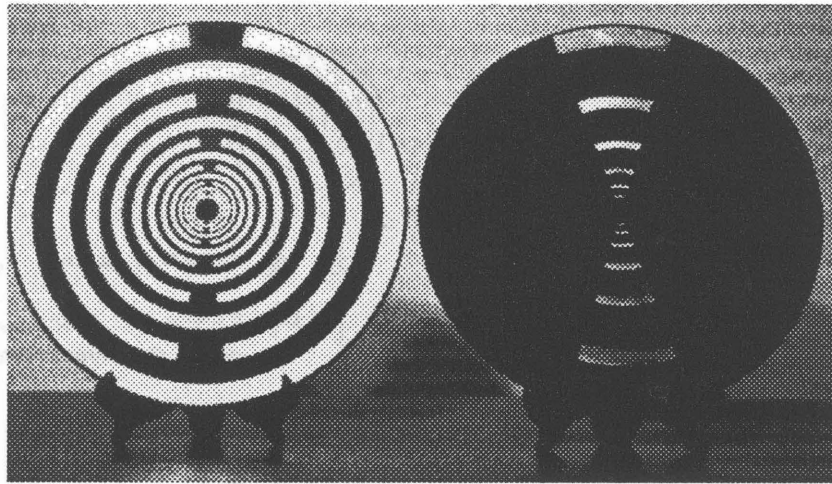
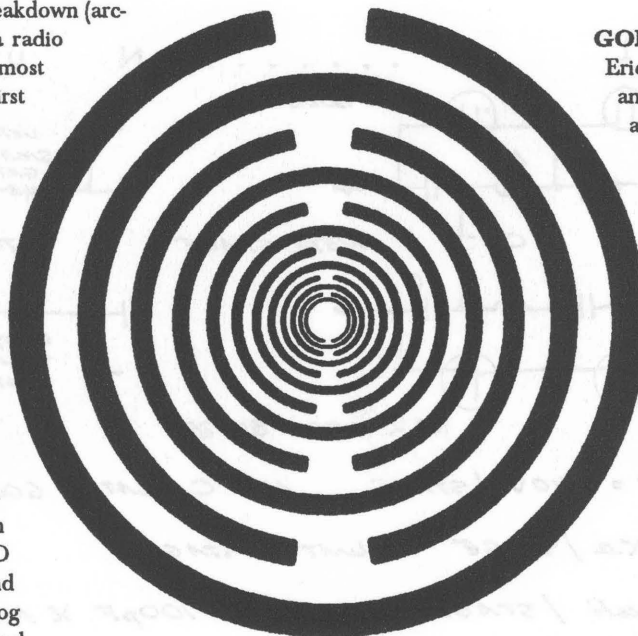

Photo 8. Golden Ratio antennas designed for MWO use by Eric Dollard. Obverse similar to Lakhovsky antennas. Reverse provides capacitance as did metal spheres at ends of original Lakhovsky antennas. (See photo 4)

the ether, harmonious with the Golden Ratio structure of the human body and life in general.

This information is not definitive, but is the result of experimental and theoretical considerations. We present this so that Borderland researchers can carry on with new input. We are not saying that the "Beck/Kent" models do not work. There are many claims that they do, but based on Tesla's theories, rather than Lakhovsky's. Figure 1 unit works off of longitudinal dielectric waves (displacement current). Figs 3 & 4 work off of Transverse electromagnetic waves (Hertzian).

Figure 5 is a low power driver based on the Steinmetz lightning wave, a reproduction of the wave naturally occurring in the atmosphere. Values given need to be experimented on for optimum pulse formation. A mathematical analysis of this wave by Steinmetz is included as an addendum to this book. See DISTRIBUTED SERIES CAPACITY on pages 159-160 of this book.



GOLDEN RATIO — Log Periodic design for research into the subtle vibrations from patterns

LAKHOVSKY'S MWO

Figures 3 & 4 are a preliminary attempt by Eric Dollard to accurately reproduce the MWO system as pictured in SECRET OF LIFE. Figure 3 is a simplified version for a single antenna, figure 4 is a double antenna system. Photo 7 is an experimental setup utilizing this design. We feel that Lakhovsky was working with quenched spark gaps which produce damped waves in the form of the antenna. This type of circuit is needed to power log periodic antennas to create their structure in

GOLDEN RATIO ANTENNA

Eric Dollard has designed a log periodic antenna based on the Golden Proportion, as found in living systems such as plants and animals. These antennas are two sided, the first side looking somewhat similar to currently used MWO antennas, the second side being capacitive loading (as Lakhovsky mentions, he used spheres on the ends of his antenna rings) based on the Golden Ratio. This design can be seen in photo 8. These antennas are gold plated to provide direct contact with the ether. Their actual size is 12" in diameter.

The term Golden Mean, Ratio or Section refers to the mathematics of life, which is a logarithmic function. This ratio can be found everywhere in nature. It is the Sacred Geometry used in the architecture of ancient Greek and Roman temples, the Great Pyramid, etc. It has also been con-

cluded by certain Orgonomists that "the Golden Ratio is a basic mathematical property of the orgone energy" discovered by Dr. Wilhelm Reich. (Journal of Orgonomy, V.8, N.2, Rosenblum, THE GOLDEN SECTION). It is evident from Lakhovsky's MWO Tube patent that he was aware of the Log Periodic design.

The MWO has usually been understood as having to be driven by a high-frequency source such as Tesla Coils and neon transformers generate. However, those who have looked into Lakhovsky's work know that he used simple wire circles to cure plants of cancers, and to make plants grow better in general. The Golden Ratio Antenna is a series of Lakhovsky rings because the rear conjugate strips on the antenna close the loops and in effect make Lakhovsky oscillating rings which are a complete circuit for focusing the ethers. The log periodic (following a logarithmic pattern) antenna design carries this effect further and preliminary indications are that the log periodic design creates a structure in the ether even without power, it may be an orgone accumulator of sorts! Further experimentation in this vein is being undertaken.

Log periodic antennas have the interesting property of creating a virtual (non existent but functioning) antenna extending about 4 times beyond the actual. It is also frequency independent and is an excellent antenna for Amateur Radio communications.

The ethers harmonize to Golden Section Mathematics, (as demonstrated by Trevor Constable in his ETHERIC WEATHER ENGINEERING ON THE HIGH SEAS video), so it can be understood that a living organism is a discharge of energy into the Golden Section space. We have observed the discharge of sprout energy into living sprouts when one of these antennas is directed at them. We found that it makes the sprouts grow better. Then we found that simply the pattern makes the sprouts grow better. So here we present you with the Golden Ratio Pattern that you can photocopy and use for experiments. This pattern may be copied as many times as you like for experimentation. We have reports that this pattern keeps the scale out of water heaters and fish tanks.

In 1986 Borderland produced a limited amount of Golden Ratio

Antennas in copper and gold. These were precision engineered Log Periodic antennas, and were quickly absorbed into the research network. There is an appendix on log periodic antennas in this book for those who wish to pursue this interesting subject directly related to MWO research.

BUT . . . DO THEY WORK???

For all the material in this book we still haven't personally seen any solid documentation on the results of either type of MWO that could be re-verified as true to any present-day investigator. I've seen listings and testimonials, but even the photos in THE SECRET OF LIFE look doctored to enhance the cancers (tar can be seen on the wound and the hair). What was Lakhovsky really up to and which type of device works better? In Lakhovsky's Tube patent he states that his instruments are in use the world over. It is important to check out one of his originals first hand, if any readers have access to such please drop Borderland Sciences a line. We'll make the information available for research. Thanks.

CONCLUSIONS

There are no conclusions at this point in time. Borderland has been publishing MWO information since 1963 [31 years as of this 1994 edition]. This book marks the beginning of a new phase of research and development. Perhaps in the future, after people do some serious clinical and laboratory research into the subject of the Multi-Wave Oscillator can some conclusions be drawn.

It is important to keep in mind during these researches that just because a frog leg will jump when electricity is applied it doesn't necessarily mean that electricity and the life energy are the same thing. If we labor under this (quite common) delusion we may as well hope for our television sets to heal us of our ills. Rather, as astute phenomenological observers, we see that there is a relationship between electricity and life and in the understanding of that relationship we can approach a more lucid comprehension of our place in this manifest universe.

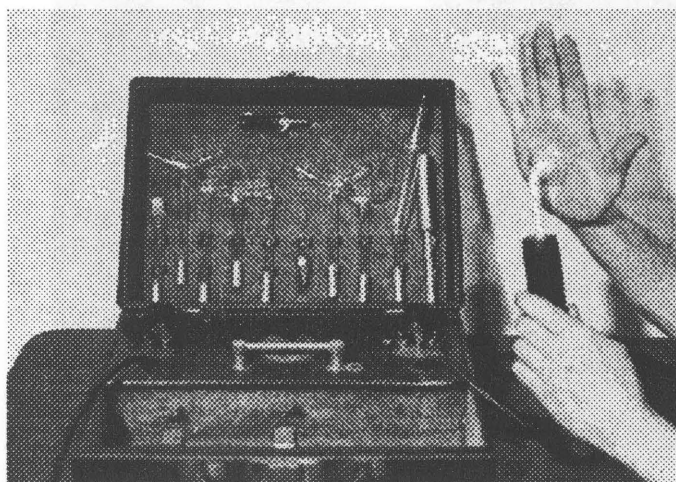

1920's era Violet Ray Massager. This device uses a small Tesla coil to drive various gas attachments which are applied to various parts of the body. Some MWOs have bulb attachments based on this device. Made by the RenuLife Company of Detroit, Michigan.

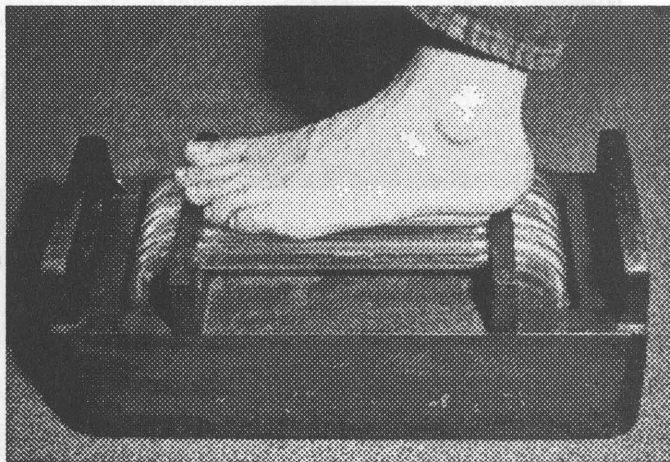

"Foot Fixer". This device uses a small Tesla coil to drive alternating tubes of argon and neon. Exact use and manufacturer unknown. Probably used to stimulate circulation.

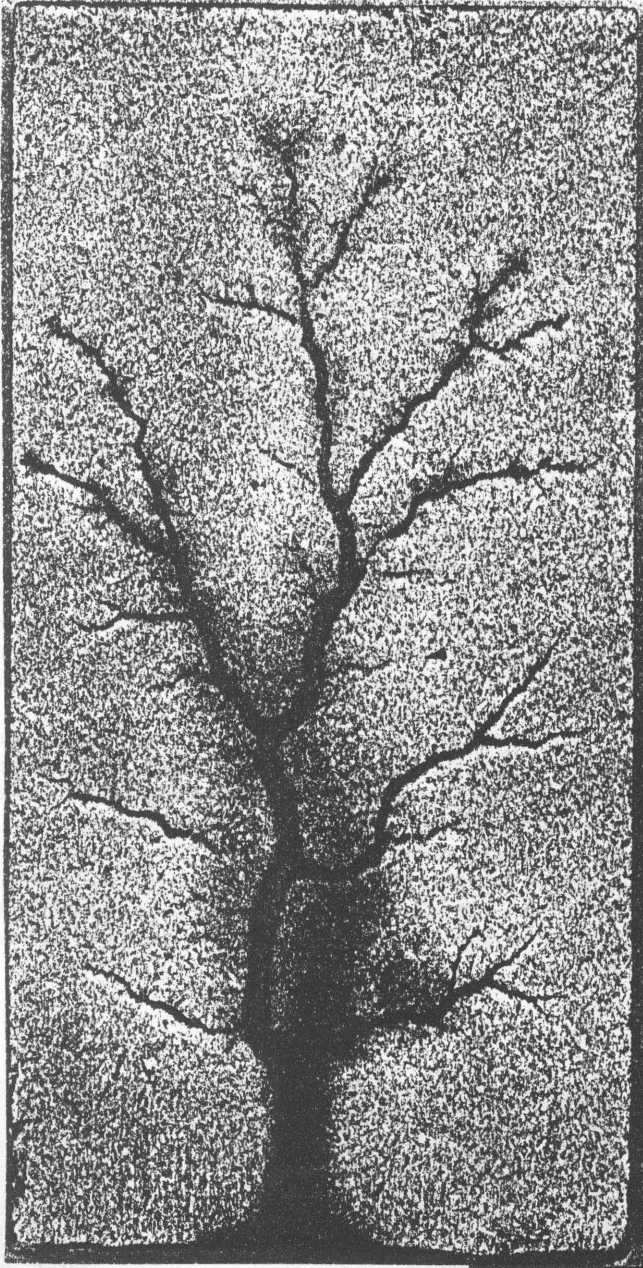

At left is a Golden Ratio pattern burned into particle board using Tesla Coil pictured below, seen here discharging into free space. Scientist Eric Dollard, builder of this coil, has deduced that the Golden Ratio is a property of space itself. The proportions are decided by the amount and type of discharge.

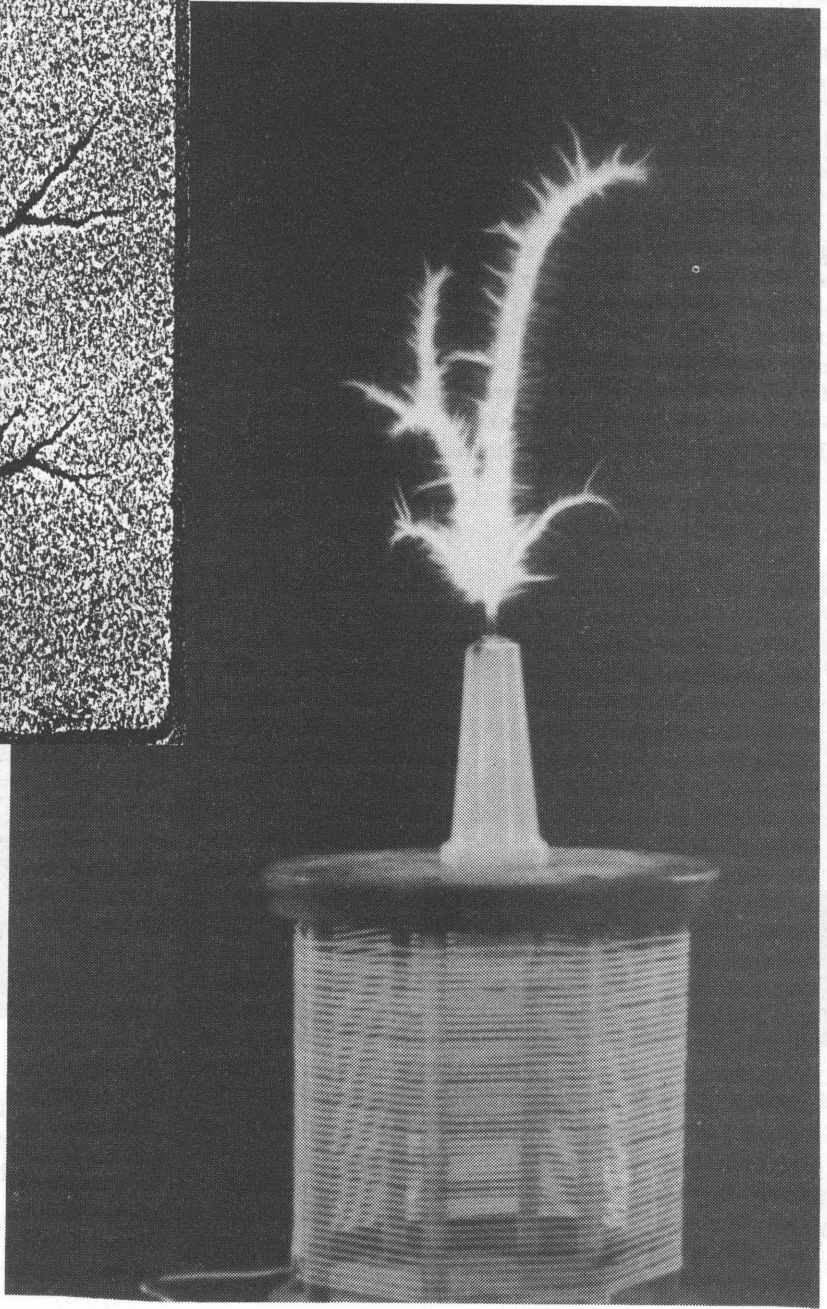

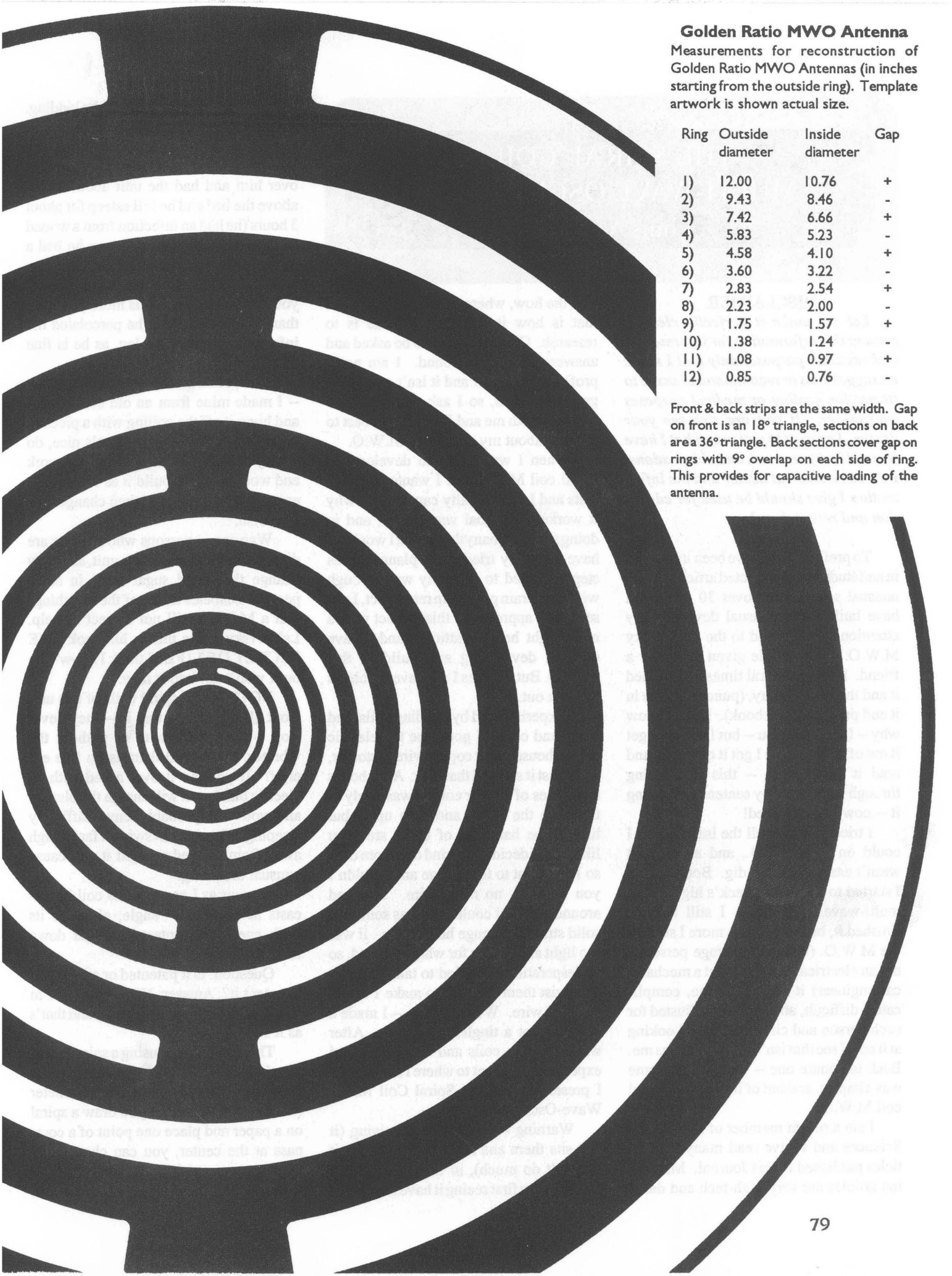

Golden Ratio MWO Antenna
 Measurements for reconstruction of Golden Ratio MWO Antennas (in inches starting from the outside ring). Template artwork is shown actual size.

Ring	Outside diameter	Inside diameter	Gap
1)	12.00	10.76	+
2)	9.43	8.46	-
3)	7.42	6.66	+
4)	5.83	5.23	-
5)	4.58	4.10	+
6)	3.60	3.22	-
7)	2.83	2.54	+
8)	2.23	2.00	-
9)	1.75	1.57	+
10)	1.38	1.24	-
11)	1.08	0.97	+
12)	0.85	0.76	-

Front & back strips are the same width. Gap on front is an 18° triangle, sections on back are a 36° triangle. Back sections cover gap on rings with 9° overlap on each side of ring. This provides for capacitive loading of the antenna.

THE SPIRAL COIL MULTI-WAVE OSCILLATOR

Louis A. Schad

DISCLAIMER

Let me make it perfectly clear, I present this information for information and research purposes only and I make no suggestions or recommendations as to its use for healing or medical purposes whatsoever. If you are sick see your doctor. I present to you only what I have learned in my research and observations. I am not a medical doctor and the information I give should be used for education and research only.

To preface this, I have been interested in and studied and collected articles on the unusual sciences for over 30 years and have built many unusual devices. My attention was directed to the Lakhovsky M.W.O. by an article given to me by a friend. I read it several times and studied it and then put it away, (punched holes in it and put it in a notebook). I don't know why -- I can't tell you -- but I couldn't get it out of my mind, so I got it out again and read it some more -- this time going through it sentence by sentence digesting it -- now I was hooked!

I tried to gather all the information I could on the M.W.O., and as usual it wasn't easy -- I had to dig. Bottom line, I started to build Bob Beck's high power multi-wave oscillator -- I still haven't finished it, but I will. The more I studied the M.W.O. (being an average person -- not an electrical engineer, but a mechanical engineer) it seemed to me, complicated, difficult, and had to be adjusted for each person and circumstance. Looking at it now I see that isn't all true -- it was me. Back to square one -- I search for some way simpler, and out of it came the spiral coil M.W.O.

I am a recent member of Borderland Sciences and I have read many fine articles published in this Journal. Many of the articles are very high-tech and delve

into the how, where, when and why, and that is how it should be if one is to research. Questions have to be asked and answers have to be found. I am not a professional writer and it isn't one of my greatest talents, so I ask that you have patience with me and I will do my best to tell you about my spiral coil M.W.O.

When I was trying to develop this spiral coil M.W.O. all I wanted was results and I didn't really care how or why it worked, my goal was results, and in doing so I tried many things that I wouldn't have normally tried had I planned each step and tried to fight my way through with pure brain power. In retrospect, I can see that I approached this project with a more light hearted attitude and I have enjoyed developing and building this M.W.O. But at times I did have problems to work out.

I experimented by winding coils, and coils, and coils. I got to be the electric supply house's best copper wire customer, or at least it seemed that way. After boxes and boxes of copper coils, I was ready to throw in the towel and give up -- but having the handicap of being stubborn like I am, I decided to wind one more coil, so I went out to the garage and wouldn't you know it, no more wire. I looked around and all I could find was some old solid strand 16 gauge house wire. It was too light and flimsy for what I wanted, so in desperation I decided to take 2 pieces and twist them together to make 1 heavy piece of wire. Well -- bingo -- I made a coil and got a tingle, that did it. After winding more coils and more coils and experimenting I got to where I am now, so I present to you the Spiral Coil Multi-Wave-Oscillator.

Warning -- this unit is deceiving (it just sits there and looks innocent like it couldn't do much), in fact some of my friends upon first seeing it have laughed at

it, and commented you have to be kidding. Another friend of mine asked me to help him build one -- which I did -- and he was lying on his bed in his shorts with a sheet over him and had the unit about 2 foot above the bed and he fell asleep for about 3 hours (he had an infection from a wound in his leg). When he woke up he had a white blister on him about the size of a nickel -- he has done this twice. I warn you, use it with care, it is more powerful than it seems. I think he percolated the infection up out of his leg, as he is fine now.

Now, I know someone is going to say -- I made mine from an old coat hanger and hung it off the coiling with a piece of string, and I'll say -- gee that's nice, do what you wish -- but if you want it to work and work properly build it as it is, use it, experiment with it, and then change it as you wish.

Warning -- persons who have or are diabetic should not use this unit, as it may change the blood sugar level in some people. Diabetes is one of the few things that a M.W.O. will not correct or help. Lakhovsky states this in his book **THE SECRET OF LIFE**. I think I know why but I won't get into it now.

NOTE -- The spiral coils of this unit work all the time -- that is -- they never stop -- they work with or without the vibrator. Who said there is no free energy? If you put it over a bed with an electric blanket, it will charge the blanket and you will probably have difficulty sleeping. If you do not swing it far enough away from the bed at night it will cause unusual dreaming.

As near as I can tell this coil broadcasts at about 120° angle, although its peak energy is centered straight down from the small coil.

Question: is it patented or am I going to patent it? Answer: NO -- as far as I'm concerned it's free to everybody and that's as it should be.

The advantage of using a spiral is that one should get all the frequencies up to the maximum diameter of the outer diameter (O.D.) of the spiral. If you draw a spiral on a paper and place one point of a compass at the center, you can choose any diameter you wish up to the coil O.D. diameter and the scribing diameter will

fall some place on the spiral.

This unit can be operated in 6 modes:

1. The coil only.
2. The coil plus the vibrator.
3. The coil plus the vibrator plus the coil shocker.
4. The coil plus the vibrator plus constant coil charge.
5. The coil (no vibrator) plus the coil shocker.
6. The coil (no vibrator) plus the constant coil charge.

So as one can see there is plenty to experiment with here.

NOTE -- I also tried connecting a ion generator to mine -- that really blows me away -- try it if you have one.

If you are experimenting with magnets -- be careful if you use them with this unit as some people get bad reactions. I personally have used magnetic water and this M.W.O. and have had no bad reactions.

Warning -- although I have -- I suggest you do not use this on the head or above the neck.

Warning -- if you have a heart problem do not use this unit as in some people it tends to reduce blood pressure and lower the pulse or heart rate.

Well -- now that I've scared the hell out of you, if you still want to build it I'll tell you the good side. In most all people who have used it or tried it they get a tingle or a feeling of heat (light). Most people get a boost of energy when they use it and it seems to help circulation. I am not sure why. I don't know if it tends to dilate the blood vessels of not. One man that used it can now wiggle his toes and he hadn't been able to do that for about 3 to 4 years.

I know someone will ask what type or kind and amount of energy is emitted by these coils and the answer is I do not know, but I do know that it works. I will leave that to someone who has the proper

instruments and the know how to check it, so there is still a lot of work to be done here if someone wishes to do it. Now, before someone starts climbing my ladder, let me say that I give the credit to Lakhovsky -- what I did was to modify, update and expand upon the base of some of his work. You do not have to be gifted in the knowl-

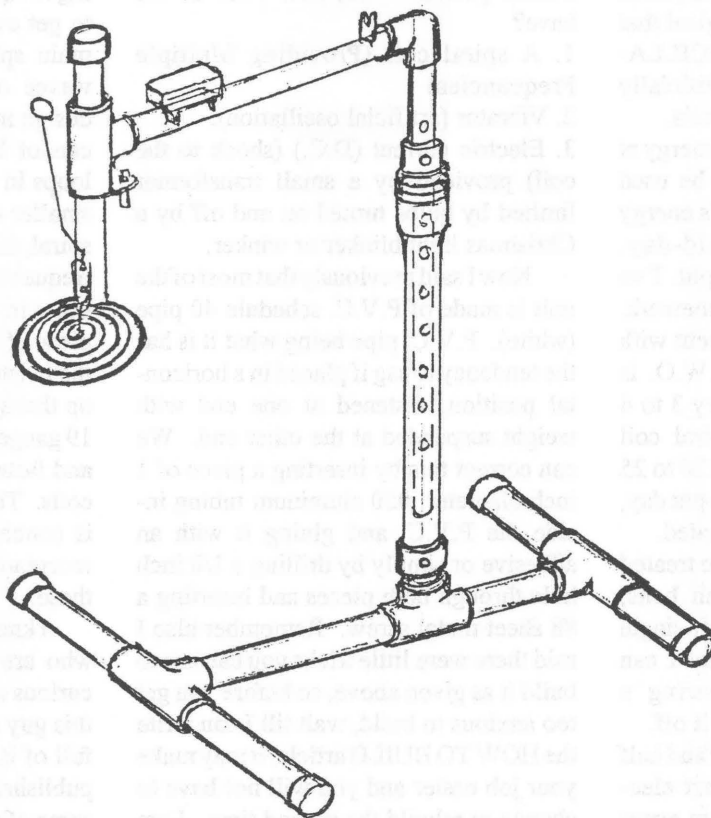

SPIRAL COIL MULTIPLE WAVE OSCILLATOR

edge of the sciences to build this M.W.O. and do not need special equipment or tools. However, there are little tricks that I have learned that make it easier to build that I will give in another article. The body or base of this unit is made of P.V.C. pipe, also the vertical and swing arm, the vibrator base and also the drop tube that hangs the coils. We want a unit that is low in cost, tough and durable, light in weight, corrosion resistant, portable, easy to fabricate (and repair if necessary) and looks nice, so we will build our unit out of P.V.C. pipe.

ALL COILS ON THIS M.W.O. MUST BE RIGHT HAND COILS, IN

RELATION TO THE UNIT AND EACH OTHER. If they are not you will get negative energy. (I'm not speaking of polarity here.)

I use a fish tank air pump (modified) -- (Challenger 1) about \$8.50. This provides the oscillatory motion to the coils. I'm not in love with it and would like to find something better -- something of higher frequency, but it works. If anyone has any suggestions on this I would like to hear from them.

I chose to design the unit so it can access any part of the body freely without a lot of excess adjustments. The body when lying down is in one plane or height (approximately), so I built the unit so it would extend over a bed or table, added a swing arm, and a vertical adjustment (holes in the vertical tube arm and a wood dowel or pin stop) -- that seemed simple enough, remember we're trying not to get complicated here.

If you are going to build this M.W.O. I strongly suggest that you read Lakhovsky's book, THE SECRET OF LIFE. When I finally decided to try to build an alternative type of M.W.O., I read everything I could get my

hands on about the subject. I read carefully and took notes of key points, functions etc., then I put my books away and studied my notes -- the basics.

M.W.O. -- MULTI-WAVE OSCILLATOR

MULTI -- meaning more than one or many.

WAVE -- energy (given off)

OSCILLATOR -- I looked this up in Webster's -- and simply stated it says -- motion deflected from center to one side -- back to center -- deflected to the opposite side -- back to center, OR -- Vibration.

Now, Lakhovsky in his book stated he made an oscillator of 1 loop or coil of wire

of a given diameter that overlapped. Also, I have read that it isn't the intensity or power of the unit that is desired, but the quality of the signal and also the number of frequencies, signals or waves, as the power can be offset by a longer exposure time. It seemed obvious that a spiral should produce all or most of the waves or signals desired and that it would be better than one loop with a limited signal effect. If Lakhovsky could cure cancer in plants and people with one loop it is logical that a spiral should be even better. OSCILLATION -- how about inducing it artificially -- vibrate or agitate the coil or coils.

This unit produces its peak energy at 12 o'clock at night, but it can be used during the daylight hours too; its energy diminishes some toward mid-day. Lakhovsky stated this and he is right. I've got to give it to him, he did his homework. Exposure rates or time of treatment with an electronic double screen M.W.O. is said to be 10 to 15 minutes every 3 to 4 days. Exposure time for a spiral coil M.W.O. (rule of thumb) is about 20 to 25 minutes or 45 minutes maximum per day, or less, depending on what is treated.

Lakhovsky also stated that he treated plants, animals and people with belts, collars, bracelets etc., consisting of a single loop of copper wire. From what I can gather, if a subject was wearing a Lakhovsky coil they never took it off.

My spiral coil M.W.O. is half and half -- part 1 loop + of wire, and part electronic. If a subject got 1 exposure every 3 to 4 days with a conventional M.W.O., it means that the subject's system was hit hard or shocked, and it needs time to adjust. A spiral coil M.W.O. requires a longer or more often exposure and this can be an advantage as it gives us more control of the research subject's requirements. The negative side is that the subject has to spend more time more often.

There is one unusual thing that I and others have experienced with this unit. When you first use it the sensation of heat or tingling is light and you require longer exposure time, like about 25 minutes before you feel that you have had enough. After you use it for about 1 to 2 weeks you will find that after 10 to 15 minutes you feel that you have had enough. Simply stated Lakhovsky said that a M.W.O.

activates or excites the cells. It's kind of like pushing a car, it takes a lot of energy to get it started, but once it's rolling it's easier to push. Maybe the body just becomes more sensitized to the energy after the M.W.O. is used for a while. In Lakhovsky's THE SECRET OF LIFE on page 75, "The circuit is subjected to any kind of electric or magnetic shock it is then said that it vibrates according to its natural period." So, now what do we have?

1. A spiral coil (Providing Multiple Frequencies)
2. Vibrator (artificial oscillation).
3. Electric current (D.C.) (shock to the coil) provided by a small transformer limited by bulbs turned on and off by a Christmas light blinker or winker.

Now I said previously that most of the unit is made of P.V.C. schedule 40 pipe (white). P.V.C. pipe being what it is has the tendency to sag if placed in a horizontal position, fastened at one end with weight suspended at the other end. We can correct this by inserting a piece of 1 inch diameter .050 aluminum tubing inside the P.V.C. and gluing it with an adhesive or simply by drilling a 1/8 inch hole through both pieces and inserting a #8 sheet metal screw. Remember also I said there were little tricks you can use to build it as given above, so before you get too anxious to build, wait till I can write the HOW TO BUILD article, it may make your job easier and you will not have to change or rebuild the second time. I am trying to save some of you all the mistakes I made.

The heart of this M.W.O. is the large main spiral coil. This coil is in simple terms an antenna. It is a dual antenna, that is, 2 in 1 as it is a receiving antenna and also a broadcasting antenna. The antenna can be shaped in many forms and still retain the right hand spiral. Do we wind it tight toward the center and increase the spacing as we go out? This configuration I have found best, but other configurations can be formed to achieve different effects. I have experimented with different shapes and some have given unusual results. There is still a lot of work that could be done here also. I wound a 3 wire coil that was very effective but I had problems twisting the copper wire and

lost several of them. I would suggest that the first coil you make be a 2 wire twist coil. If you want to build the M.W.O. complete you will have a total of 4 coils.

1 large main spiral coil.

1 small spiral coil (that is mounted under the large coil).

2 straight tube coils.

We use these coils because they all have independent functions. We are going to squeeze it and milk it for all we can, to get everything we can out of it. The main spiral coil produces most of the waves or energy, however, due to its design and nature the inside of the spiral cannot be wound tight to create small loops in the coil, so we will add another smaller spiral coil under the large main-spiral, this will give us the higher waves or frequencies we desire. We drill 2 small holes in the main spiral and tight wind a piece of 19 gauge coated coil wire around the twisted copper wire, and pull the wire up through the holes, leaving 2 standing 19 gauge wires. We sand the ends of these and fasten spring clips that hold the tube coils. The other end of the tube coil wire is connected to a banana plug -- into a receptacle, we connect our coil shock to these.

I know there are some of you out there who are like I am, (impatient) and are curious and would like to try this to see if this guy is telling the truth or if he is just full of it. I am aware that the Journal is published every 2 months and maybe some of you don't want to wait 2 months, so for those of you who are like I am -- let me tell you how to build the main spiral coil. This one coil in and of itself won't knock you over -- but you can get started, and you can play with it until I can write the HOW TO BUILD article. This coil will emit energy by itself if suspended horizontally. Fasten it to something, a piece of plastic tube or wood dowel etc. Try it on your feet as the feet seem to be sensitive to these energies. Well -- here we go.

HOW TO BUILD THE MAIN SPIRAL COIL

You will need to purchase a few things.

1. You need 17-1/2 feet of 10 gauge (solid) bare copper wire (cost about 14 cents per foot). You can get this at any

electrical supply house. If you cannot get bare wire, you will have to get plastic coated and strip the coating with a sharp jack knife, taking care not to nick the wire, or yourself.

2. You need a piece of aluminum bar 3/16 x 1-1/2 inches, 20 to 24 inches long.

3. You need a medium size pair of pliers.

4. Soldering iron and acid core solder.

5. Small coil of 19 gauge coated (shellacked) copper wire.

Now — we have 17-1/2 ft. of 10 gauge copper wire, lay it out on a flat clean surface and straighten it out taking the curve out of it and the kinks and bends. Next we need a secure and strong place to fasten the ends of the wire to — like a trailer hitch or bumper of a car or truck etc. After you have found a place to secure your wire, fasten both ends of the wire to it as shown in Fig. 1.

Slowly pull the center of the wire so that you have 2 pieces of wire, put your aluminum bar in the loop and pull tight. With a pair of pliers close the wire down on the bar tight so that it passes between the screws. Pull hard on the wire with the bar — it won't break. Start twisting as shown in Fig. 1 — always keep tension on the wire — do not let go of the bar. (COUNTER CLOCKWISE). Twist the wire, stopping at time, give the wire a couple of good yanks. NO, it won't break. Twist the wire until you have a good tight twist on it. When you think you have twisted it enough — twist it a little more. When you get it where you like it — SLOWLY back the pressure off of the bar.

Remove 1 screw on the bar and slide the loop out or off of the bar. Unfasten the wire where you secured it and cut the spiral wire as close as possible at secured end. Lay the twisted wire down flat. Measure 3" down from the top of the loop as shown in Fig. 2 and mark it with a pencil or pen. Hard or tight bend the wires as shown in Fig 2, 90 degrees. Grip the twisted wire at the bend point with a pair of pliers, and start forming the spiral. Continue forming 1 or 2 loops. Remove the pliers, grip the wire and hand form the spiral as shown in the drawing #2. When you have formed about 4 loops of the spiral, stop and apply light heat to the coil with a hair dryer or similar device to relieve some of the stress in the wire, so

that the loops that you have formed will stay where you have bent them. Repeat the operations and continue forming until you have your spiral.

DO NOT BEND END OR TIP IN YET.

Put your spiral in the freezer of your refrigerator for 30 to 45 minutes, and freeze it. This will tend to stabilize the copper some and relieve some more of the stress.

In Fig. 4 we can see that if we bend a piece of metal the inside of the curve is compressed and the outside is stretched, this stress is what we are trying to get rid of. About now some of you will be thinking — GAD — he even tells us how to hold the hammer. I am sure that some of you who are pro's at metal forming and fabrication can build this thing — WHAM-BANG, but please have patience, not all are gifted in some of these skills.

When you have formed your spiral and it is shaped as you want it, hold the loop of the spiral with your thumb and point fingers at eye level height and sight across the spiral, it should hang so that all coils are level and even with each other, so that it is flat — if not form it so it is. Put the coil in the freezer again, repeat freezing operation several times, this tends to age harden the coil some.

With a very hot soldering iron solder the end of the coil, wash it in warm water, dry it, and bend end in as on drawing #2. After you bend the tip in, bend it down a little bit so the bent in tip clears the crossed coil by about 1/4 inch.

Drill 2 small holes in the spiral at points marked on Fig. 6, taking care not to break the drill, use light pressure. Cut 1 piece of coated coil wire (19 ga.) about 4 1/2 feet long. Push one end of wire (about 1-1/2 inches) up through bottom of hole in spiral, and wrap wind (twisted) loops of wire to second hole. Straight wrap 1 loop at hole area, this locks the standing wire. Pull standing wires tight with pliers and cut standing wires to about 1-1/4 inches.

Refreeze spiral and warm to room temperature. Sand or remove shellac from standing wires down about 3/4 of an inch, this makes electrical contact for the coil shocker. You have finished the main spiral coil. You have just done the hardest part, the rest of it is easy. Save your

aluminum bar; you may want to build other types and shapes of coils and spirals to experiment with. I have wound and tried 2 wire coils, 3 wire coils, cone shaped spirals, step spirals, spirals with wires attached and hanging down with soldered tips etc. There is no end — you can experiment to your heart's delight, it's only limited by your imagination.

In closing, I would like to tell you a story — a true story about a close relative who gave me permission to tell of his experience with my M.W.O., but prefers to remain anonymous. I will not elaborate, but just state the facts as told to me by him and his nurse.

This relative took a trip by car to the southwest part of the U.S. with some friends. Before he left he called me and said that he would come to California and would stop to visit with me. This was in the late summer of 1990. After arriving at his destination in the southwest, the weather turned very hot for the whole western U.S. Due to this extreme hot spell, he phoned me and said he was returning home and would not come to California.

When I talked to him on the phone before he left, I told him I had built a Multi Wave Oscillator for him and I would give it to him when he came to see me, and he could take it back with him. He did not make it to Calif. but returned to his home in the midwest. After returning home he became ill and went to see his doctor. After being checked by his doctor, he had tests, and the doctors discovered that he had cancer of the large intestine. When I phoned him and found that he had cancer, I asked him if he wanted to try my M.W.O. I told him that I could not guarantee that it would help him — but I said — what do you have to lose. He said yes, he wanted to try it, so I sent it to him.

When he received the M.W.O., it was assembled from instructions I sent him. He used it twice a day for approximately 6 weeks. He had additional medical problems, he had diabetes and congestive heart failure plus the cancer plus a back problem. I had made the M.W.O. for him in hopes that it might help his back. When he went back in 6 weeks to see a cancer specialist doctor they gave him extensive tests and could not find any traces of

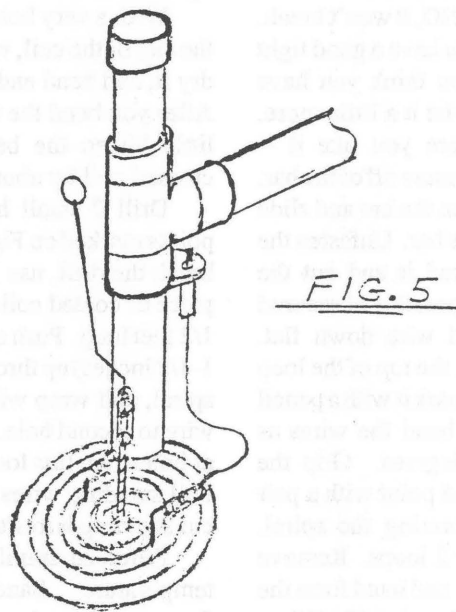
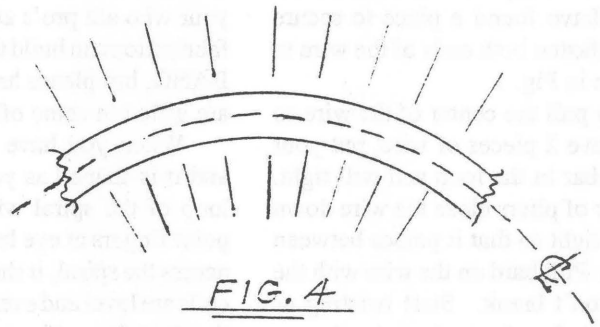
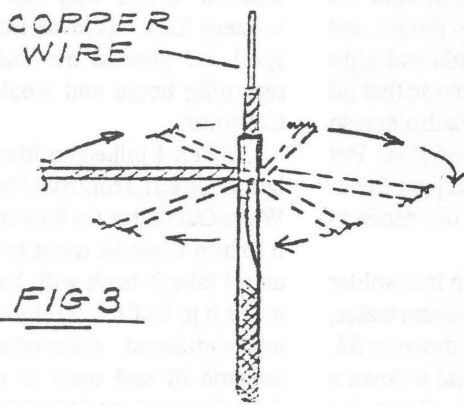
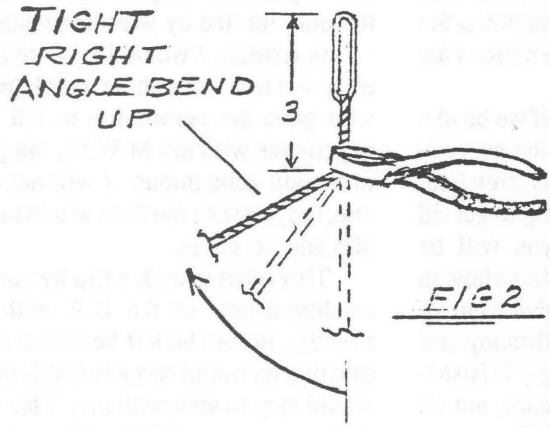
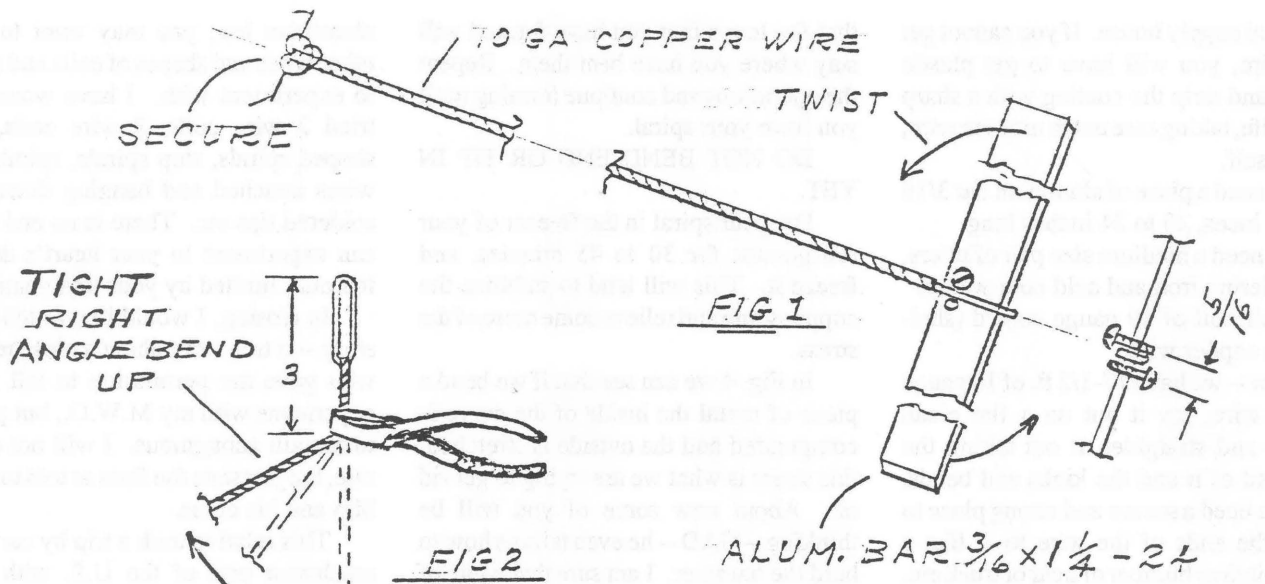

SPIRAL COIL MULTIPLE WAVE
 OSCILLATOR ANTENNA
 CONSTRUCTION DRAWINGS
 FIGURES 1-5

cancer. After his tests he phoned me and said the doctors could find NO traces of cancer whatsoever. I asked him -- did you take any medications whatsoever for your cancer? -- he said NO. I asked him -- did you take any radiation treatments for your cancer? -- he said NO. I asked him -- did you take anything at all for your cancer? -- he said NO. To this date he has not had any return of his cancer.

Now, where does this leave us? He either had spontaneous remission or he was helped by the M.W.O. As I understand and have been told, some forms of cancer in the upper stomach are inoperable. My relative is the 3rd person who seemingly has had remission from cancer from using my M.W.O. I do not like to use the word cured when speaking of cancer, and I say seemingly as this is all in the experimental stages of research.

Then there is Al Mills who built and used a copy of my M.W.O. He had prostate cancer; he's fine now, but we can't count him as he has taken medications for it. I have heard that doctors have said that prostate cancer is very difficult to treat. Then there also is Simon Lucas who built my M.W.O. and loaned it to a lady who has LUPUS (a cutaneous disease due to the tubercle bacillus). He said she is feeling and doing much better now. I also built a M.W.O. for my mother who lives in So. Sioux City, Nebraska, across the river from Sioux City, Iowa. I sent it to her -- she could not assemble it so I flew back to do it for her.

Several years back she was leaving a market and caught her foot in a disposed plastic bag on the sidewalk, fell and broke her hip and leg. The doctors repaired it by wrapping screen around the bone and added a few screws and pins here and there. She was OK for several years and then she got to the point where the pain was so bad she could walk only a short dis-

tance.

her leg -- (some choice). NOTE -- She does not have a coil shocker on her unit.

In all honesty I have to say that my spiral coil M.W.O. does not affect all people the same. I have had no negative or bad reports to date from anyone using it with good common sense and discretion. There are a few people that it does not seem to help to any great degree. There are also some people that it seems to almost work miracles for them. I would say of these persons that maybe it was mental, except that I have been told that some have said --

"well, I don't think the damned thing will do any good, but I'll try it". I could go on and on but we'll leave it at that.

If you decide to build my M.W.O. I would welcome any serious and honest experimental input as this unit still has many areas that need to be explored.

Sometimes I back way off and just stop and look at all this -- and realize that it should be the scientists and doctors doing what is being done -- but I'm not going to hold my breath until that

happens. I guess the only way it's going to get done is for people like you and me getting off our backsides and getting it done. If enough will work at it and add a little bit, it'll get done. I sometimes wonder what the end-run potential of my M.W.O. is. I love the doctors (God Bless them!), we need them, but I wish they were more open minded and that they were not so profit orientated and stigmatized by their organizations. I think these ideas I present here will help.

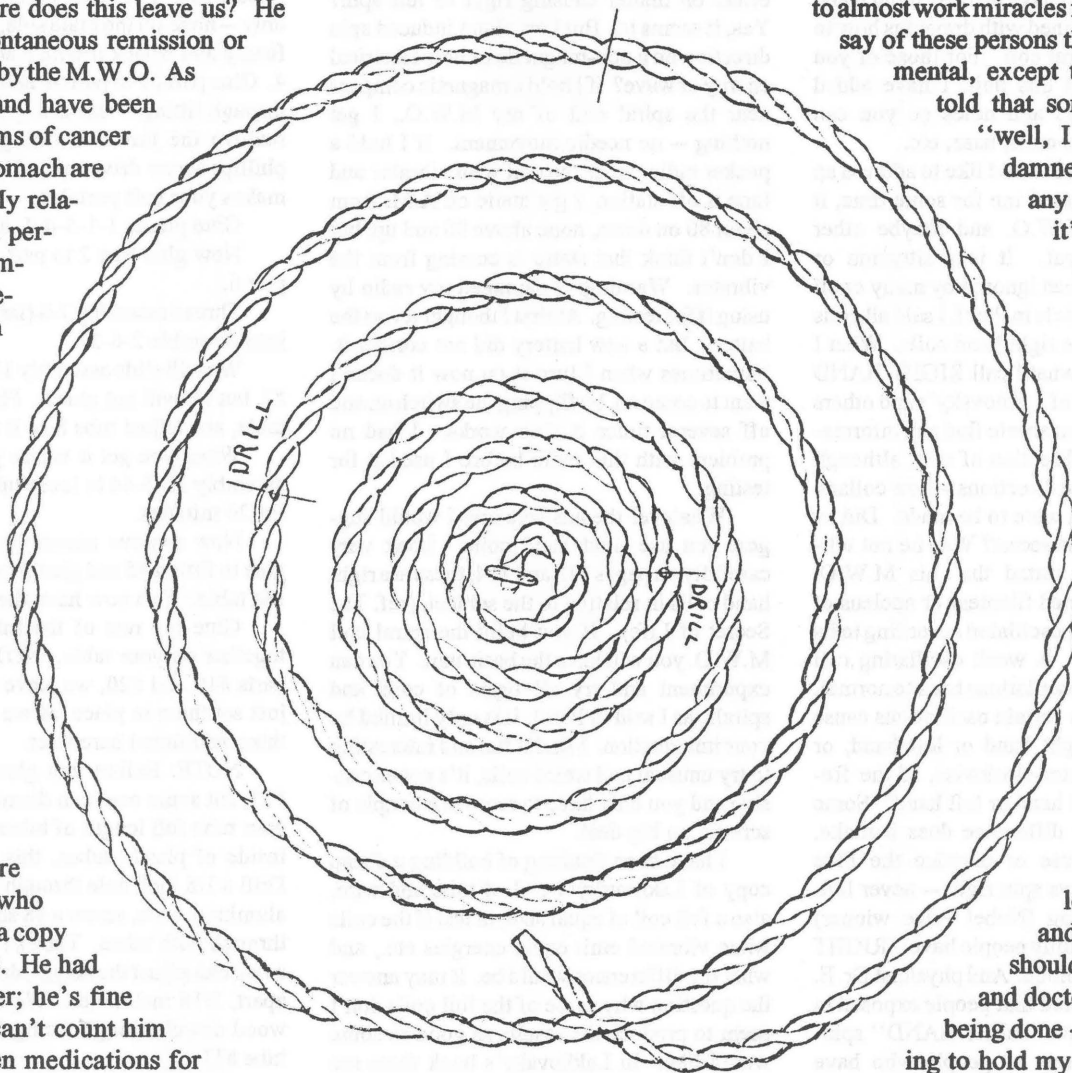

FIGURE 6

She has used the M.W.O. for about 2 months. She called me the other day and said she took the bus all over town, did shopping, came back, took her pull cart and did her food shopping -- 6 blocks up and 6 blocks back -- and then walked up to the restaurant and got her dinner, all in 1 day and she said she feels fine. The doctors gave her the choice of pain shots or cutting off

THE SPIRAL COIL M.W.O.

PART II - HOW TO BUILD

by Lou Schad

In Part One I explained how the spiral coil M.W.O. evolved and how I came to build it and notes on things I have learned about it and its use. I also explained with drawings how to build the main spiral coil. For those of you who wish to build this unit, I have added additional drawings and notes so you can build the rest of the coils, base, etc.

Before I begin I would like to address an issue that has bothered me for some time, it pertains to my M.W.O. and maybe other M.W.O.'s in general. It is a situation or function that has been ignored by many or all but a few. In my article in Part I, I said all coils on this unit must be right hand coils. What I am referring to is what I call RIGHT HAND SPIN. In my study of Lakhovsky's and others work, I have not been able to find any information pertaining to direction of spin, although he gave very precise directions -- how collars, belts, bracelets etc. were to be made. Did he know and was it his secret? Was he not telling? Lakhovsky stated that his M.W.O. stimulated the twisted filament or nucleus of the cell, and the cell oscillated according to its natural frequency. A weak oscillating cell would increase its oscillations back to normal. The question is, do certain oscillations cause the cell to spin right hand or left hand, or clockwise or counter-clockwise, if the frequencies spin right hand or left hand? Some might say -- what difference does it make. The people who use or practice the Five Tibetan Rites always spin right -- never left. Sir Lawrence Bragg (Nobel Prize winner) discovered that healthy people have "RIGHT HAND" spinning blood. And physicist Dr. E. Mersmann discovered that people exposed to electronic smog have "LEFT HAND" spinning blood, the same as people who have cancer -- they also have "LEFT HAND" spin blood. Maybe if the earth spun in the opposite direction, left hand spin blood would be normal. So, is left hand spin or right hand spin important? Yes, I think so. I have purposely made and used left hand coils and they made me feel sick and ill. There is an instrument that has been built that emits weak pulsed electromagnetic waves that causes the blood to spin right hand in people who have left hand spin blood, however if the unit is removed the blood will go back to abnormal left hand spin.

If you put your hand in a bucket of water

you can spin it to the right or to the left -- is this polarity? Does magnetic polarity have an effect on matter causing right or left spin? Yes, it seems to. But how about induced spin direction on a non-magnetic or non-electrical energy or wave? If I hold a magnetic compass near the spiral coil of my M.W.O., I get nothing -- no needle movement. If I hold a pocket radio under the coil with vibrator and tune it off station, I get static on A.M. from about 80 on down, none above 90 and up, but I don't think that static is coming from the vibrator. Warning: I damaged my radio by using it for testing. At first I thought it was the battery, but a new battery did not correct it. Sometimes when I turn it on now it doesn't want to come on, by flipping the switch on and off several times it then works. I had no problem with this radio before I used it for testing.

Whatever the answers are, I would suggest you use right hand coils. Look very carefully on pages 113 and 114, these are right hand coils in relation to the subject, (ref. The Secret of Life). If you build the spiral coil M.W.O. you will have the basic unit. You can experiment and try all types of coils and spirals, as I said in Part I, it is only limited by your imagination. I find it fun and interesting to try unusual and weird coils, it's not expensive and you only have to remove a couple of screws, no big deal.

I have been thinking of building a cheap copy of Lakhovsky's coil of tube and wire, also a foil coil of equal size, to test if the coils when vibrated emit equal energies etc., and what the differences would be. It may answer the question why some of the foil coils don't seem to produce the results as good as some would like. In Lakhovsky's book there are pictures of, and he speaks of, the oscillator coils of Hertz. There is a striking resemblance of Lakhovsky's coils on his oscillator antenna to Hertz's coil. Could he have been influenced by or borrowed the Hertz oscillator coil for his unit -- did he expand upon the base of Hertz's work for his antenna coil? (interesting thought)

Enough digression -- back to our spiral coil building project. If you look at drawing #3 you will see that it is self descriptive, giving diameters, lengths etc. We make most all of our unit out of schedule 40 PVC plastic

pipe. Take enough care to make your cuts square and clean, debur the ends of the tubes so they will slide into the glued slip fittings correctly. Now, here comes the stinky part. If you want your unit to look nice, you will have to clean the tube, (after cutting), taking off all the dirt, the ink lettering etc. I use a laundry detergent, Comet, and some wet or dry #200 sandpaper and a lot of elbow grease.

Warning: PVC glue sets fast, in a matter of seconds. I put glue on the female fittings only -- none on the male side, slide it together firmly and whack it with a short piece of 2 x 4. Glue part #7 to part #8 and drill a 5/16 hole through fitting -- this is so you can tighten or remove the threaded fitting by inserting a phillips screw driver or rod in the hole. This makes your unit portable.

Glue pieces 1-1-5-4-4, also 3-3-5-4-4.

Now glue part 2 to part 6, also part 3 to part 6.

Thread assembly 7-8 (large vertical tube) into assemble 2-6-3.

We will slide assembly 11-5-44 onto tube #2, but we will not glue it. Place this on a flat table, and adjust tube 8 so it is vertical.

When you get it where you like it, glue assembly 33-5-44 to loose tube 3, let this dry for 20 minutes.

Now remove assembly 11-5-44, apply glue to fitting #5 and glue it to tube #2 on your flat table. You now have the base finished.

Glue the rest of the tubes and fittings together on your table. NOTE: Do not glue parts #19 and #20, we leave these loose and just set them in place, as we may add something additional here later.

NOTE: Before you glue tubes #11 and #15, cut some one inch diameter .050 aluminum tube full length of tubes and slide them inside of plastic tubes, this eliminates sag. Drill a 1/8 inch hole through plastic tube and aluminum tube, screw a #8 sheet metal screw through both tubes. Tube #11 has holes in it so we can adjust the height, drill these 2 inches apart, 5/16 inch holes. We insert a 1/4 inch wood dowel through fitting #10 and through tube #11.

We drill 2 holes in tube #21 and thread them 10-24, we fasten our spiral coils and antenna to these. The first hole is drilled 5/16 of an inch up from the bottom edge of the tube and the second hole is drilled 3/4 of an inch from the first hole.

When you buy your 1-1/2 PVC tube, get a piece with a flared end, as we set a reducer fitting in it to make a sleeve for the #11 one inch tube. To keep tube #11 guided at the bottom of tube #8, drill 3 holes at the bottom of tube #11 equally spaced around the diameter and insert 3 #8 sheet metal screws.

Parts #9 and #10 will have to be filed out or machined out so the one inch tube will slide through them.

Part #16, the vibrator base, is made of flat stock PVC. If you cannot buy it from a plastic supply house, cut a couple pieces of 1-1/2 PVC tube about 3-1/2 inches long, cut them again length wise, so you have half tube pieces. Place the half tube pieces between two - 1/8 inch aluminum plates and heat in a stove oven with a brick or weight on top. Let them cool and the plastic will come out flat. Layout and mark parts on flat sheet and cut out.

Glue all the pieces of vibrator base together and fit to tube #15 and glue it tight. A wood match works wood to lay glue in joints.

Make and fit your metal brace from aluminum or non-corrosive metal and fasted with two - #8 sheet metal screws. Cut out part #23, fit it to T - #22, drill two holes for banana receptacles and glue securely, also cord holder #14.

Make your small spiral coil from .0625 low carbon stainless steel heli-arc welding rod -- 36 inches long, do not twist wire, use as is. You can get this from any welding supply; get

4 or 5 pieces. Also make antenna from same wire. To make small spiral use the full length or rod. Start by forming an eye on one end for the 10-24 screw. Move down 3 1/4 inches and form spiral same as large spiral coil, also bending end tip in. Put an offset kink in the stem so it will pass through the main coil.

The tube coils are made from #19 shellac insulated coil wire, 12 to 14 turns. I tight bend a 90 degree bend, so I have a 1 inch long tail. I place this parallel on a pencil or wood dowel and tight wind the coil. Grip the wire tail and dowel with a pair of pliers. Remove the dowel and freeze for 30 minutes, warm to room temperature. Grip the ends of the coil with your thumb and middle finger nails and stretch the coil to the desired length, refreeze for 30 minutes. Bend long tail of coil 90 degrees and fit to banana plug. Trim short end to 3/4 inch, clean and solder pinch clip to coil. The pinch clip is made from light gauge hard stainless or brass. Blank size is 7/32 x 1-1/4.

After you have everything glued and finished put a coat of auto polish on PVC tubes, as this keeps them clean and they will not finger mark or get dirty. Also put a coat of

vaseline on the threaded fittings so they can be removed easily as they tend to stick.

If you are, or want to be, the serious experimenter type, buy a note book and keep records and notes. Keeping a log with dates, exposure times, etc. can be a very useful tool to compare results of different coils etc. I would welcome hearing from you on the use of the spiral coil M.W.O., i.e. your success and problems. NOTE: Don't expect results in 2 or 3 exposures, as this unit is more gentle and may require a longer time of weeks or several months to get permanent results. To this date I have not had a single report from anyone for over-exposure if used with common discretion. I have used belts, collars, wire loops etc. with the M.W.O., this seems to multiply the energy. I also have used a spin magnetic unit with a reticular energy filter before and after M.W.O. exposure. This seems to work well for joint problems.

Please Note: Lou Schad does not manufacture or sell this MWO. He is giving his knowledge and experience as a gift to the world. He may be written c/- BSRF.

LEGEND

USE P.V.C. (WHITE) SCHEDULE 40

KEY

L=LENGTH D=DIAMETER C=CUT
T=TUBE T.F.=THREADED FITTING

PART # DESCRIPTION (in inches)

- 1. T-D=1-1/2, CL=10
- 2. T-D=1-1/2, CL=15-1/2
- 3. T-D=1-1/2, CL=8-1/4
- 4. CAP-D=1-1/2 (4)
- 5. TEE-D=1-1/2 (2)
- 6. TEE-D=1-1/2 THD'D
- 7. NIPPLE-D=1-1/2 THD'D
- 8. T-D=1-1/2, CL=28-1/2
- 9. REDUCER - D=1-1/2 TO 1
- 10. REDUCER - D=1-1/2 TO 1 INV.
- 11. T-D=1, CL=28-1/2
- 12. T.F.-D=1 NIPPLE
- 13. ELBOW - D=1 - T.F.
- 14. CORD HOLDER (ELEC.)
- 15. T-D=1, CL=20-1/2
- 16. VIBRATOR BASE
- 17. METAL BRACE
- 18. TEE-D=1
- 19. T-D=1, CL=3-1/4
- 20. CAP - D=1
- 21. T-D=1, CL=5-1/2
- 22. ANTENNA
- 23. F.T.G. BANANA RECP.

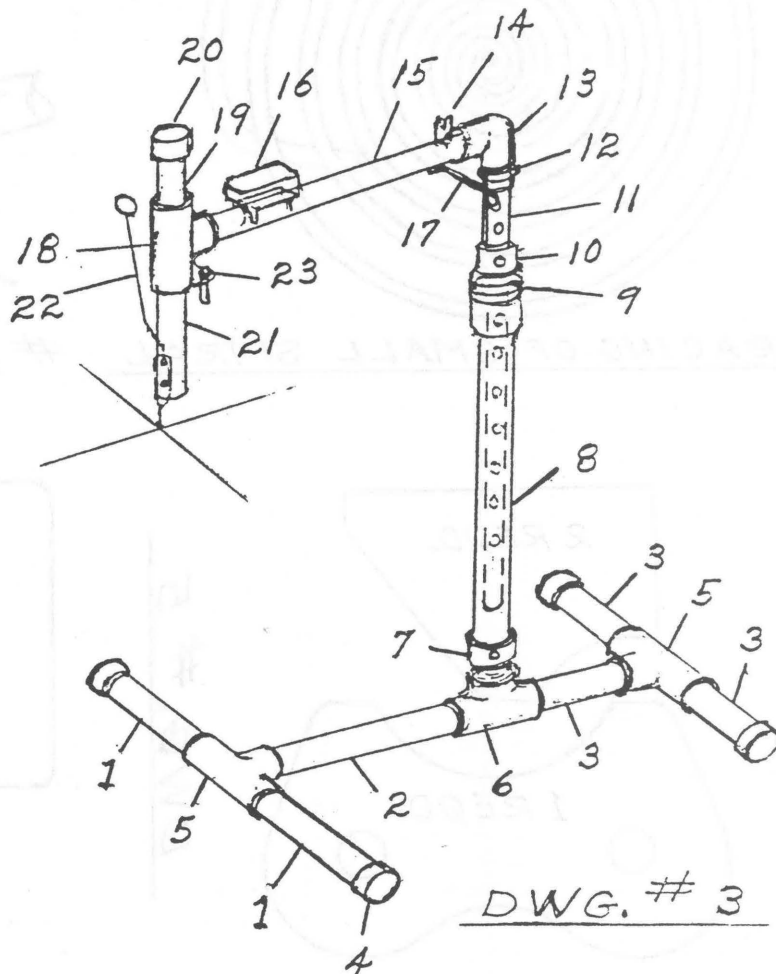

**COIL SHOCKER FOR
SCHAD SPIRAL COIL M.W.O.**

This unit provides a D.C. shock to the spiral coil. It should be built in a wood box, or grounded metal box for safety sake as we use 115V A.C. power source. All the parts can be purchased from an electrical supply, except auto bulb and socket. Get these from an auto parts supply house.

The Leviton dimmer is not necessary, but it gives more control. I use a ceramic base for 40 watt bulb. A smaller transformer can be used, but I find the 3A-12V best. It is nice to add a handle to the box. I dropped mine once. Put ventilation holes in the box, and rubber bumper feet on the bottom.

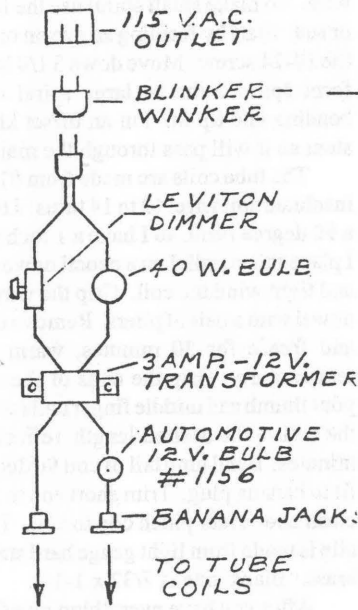

POOR MANS
COIL SHOCKER

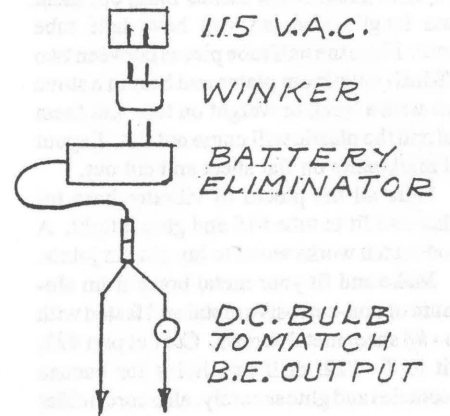

DWG. # 4

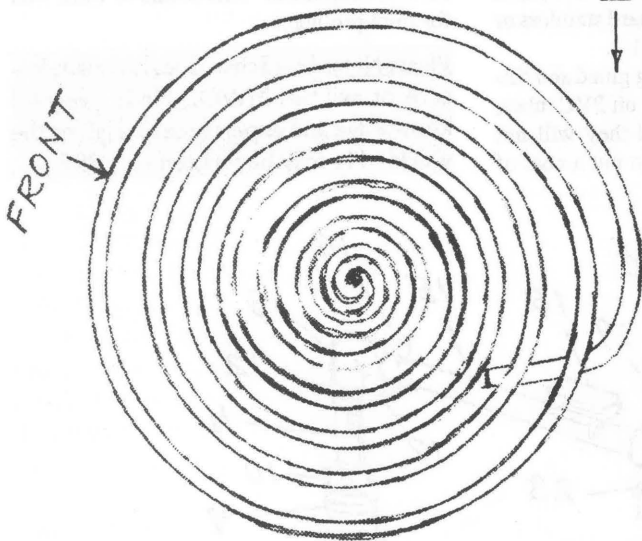

TRACING OF SMALL SPTRAL

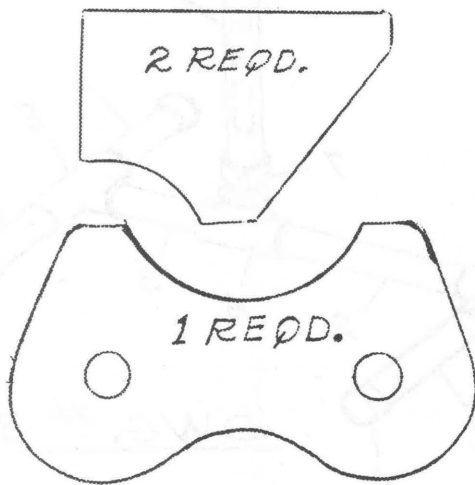
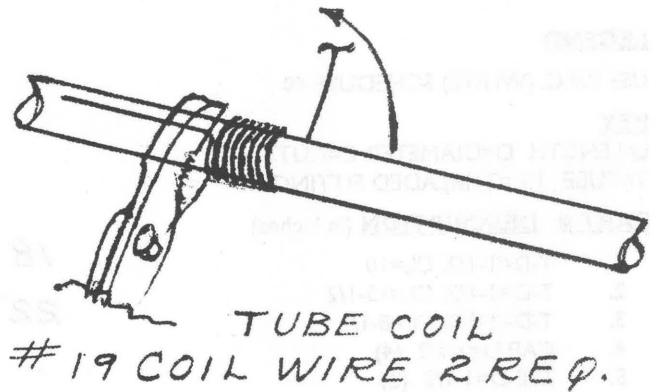

DWG. # 5

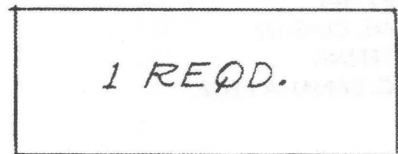
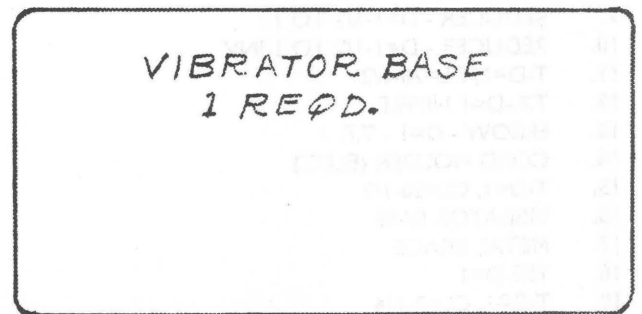

SPIRAL COIL M.W.O. UPDATE

Lou Schad

This is an update on the work I have done on the spiral coil MWO. I have built and tested several new coils and made changes in design of shapes and twist of the wire and different size of wires etc. I have experimented on plants and myself for the past several months.

In my article in the *Journal of Borderland Research* of March-April 1991, page 15, figure 1, I stated, to twist the wire counter clockwise, as I was told by someone of authority that this was best. I now find after experimenting and testing that this is not so. I now twist the wire clockwise, causing a left hand spin of the wire when viewed -- or counter clockwise. If the wire is twisted in this manner it more than doubles the energy and the plants and I both seem to like it better. If the wire is twisted as stated it will produce energy not only in a spiral shape but also in single loop rings (overlapped) and also in just a straight length of twisted wire.

I made a coil like a target or a series of one loop rings of twisted wire of different diameters and wire sizes, from about 1 inch to 8 inch and overlapped them about $\frac{3}{4}$ inch and wired them to a X shaped piece of thin plywood, and it produces more energy than I need. I can stay under it only about 7 to 10 minutes. If I stay under it longer than this, I get over exposure or too much energy in my body, and it makes my feet and hands tingle.

I made a spiral coil from $\frac{1}{8}$ inch copper tubing, twisting it like a solid wire, and it produces more energy than a like

spiral made from solid wire. I do not know if the energy travels on the inside of the tube and the outside also, but the energy produced is much more than is required for normal use.

I also have been experimenting with new and different ways to pump or project the energy. In my original design I used a vibrator to increase the output. I now

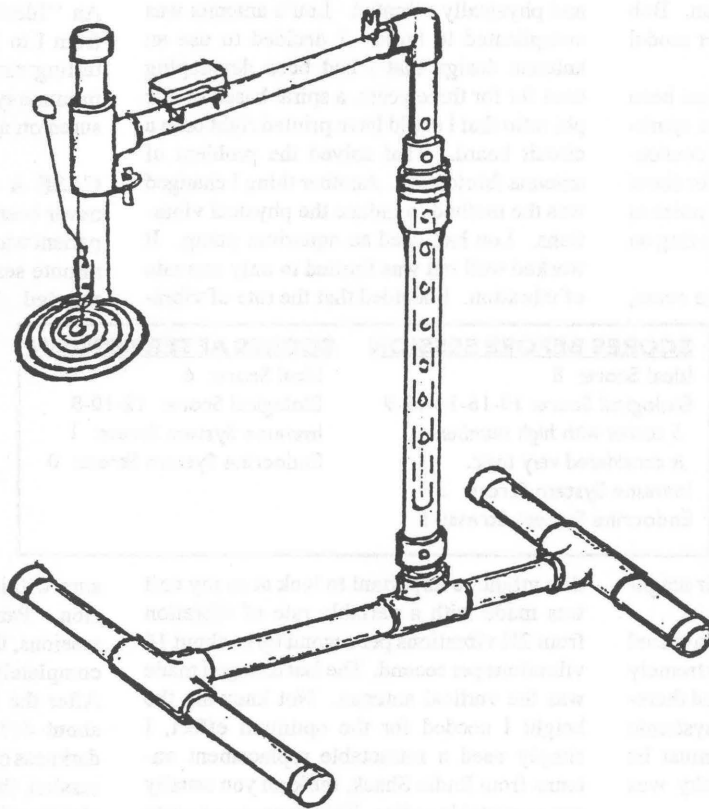

SPIRAL COIL MULTIPLE WAVE OSCILLATOR

find that with the new coils (twisted as stated) that they develop as much or more energy without the vibrator as the old coils did with the vibrator. It seems that the field or energy pattern given off by a straight (twisted) wire is different than those of a single loop (twisted wire) shape or spiral shape.

I am building a new coil that uses both and looks like a spider with 8 legs of different length. It has 2 single loops

(overlapped). One loop is 2-3/8 in diameter and the other is 4-1/8 in diameter. The small loop is centered in the large loop and in the same plane. I made a wood jig with nails for pins to hold them in place and soldered twisted straight lengths of wire pointing from the center outward. I will bend the tips of the straight twisted wires down 90° producing a shape like a spider. I'll let you know if it is different from the spiral coil shape in energy output.

It now becomes obvious that a spiral is not the only configuration that will generate or collect and broadcast energy of unknown origin. If other shapes or designs will also produce energy, is their output different? If so, what are the differences? Are the wave lengths different, are there different patterns to the waves or energy? How does it affect the living organism?

When a spiral or coil is placed in front of a reticular energy field it produces unusual results. Coils can be combined with many other forms of energy, magnetics, light, audio, vibration etc.

In my article I said you can design and build coils of all shapes and types, as it is only limited by your imagination. It is my personal belief that someday someone will design and develop a coil of a nature that will be highly beneficial to humanity, we need your input, ideas and help.

If a coil of twisted wire was built in a target configuration of a series of overlapping loops so as to be similar in design to a Lakhovsky coil, and was powered by a Beck MWO output, what would be the results? If a twisted wire coil will produce and project energy, connecting it to the field of a Beck type unit should be interesting. Are there any takers?

ELECTROSTATIC M.W.O.

INTRODUCTION TO A NEW PHASE OF RESEARCH

by Peter A. Lindemann

Lakhovsky's multiple wave oscillator has always intrigued me. I tried to build my first one in 1976 based on Bob Beck's schematics. These early experiments failed miserably, but I remained interested. In 1987, I had the opportunity to see one of Bob Beck's MWOs at a meeting of the Los Angeles Psychotronics Association. I am a healer and a sensitive by nature, and I was looking forward to finally seeing the mythical machine in action. Bob had said that it was a very high power model and he was right about that.

The unit was of the design that has been popular since the 60s; a high voltage spark-gap transmitter driving an antenna of concentric rings. Bob turned it on and ran it for about three minutes. It made a loud zapping noise as hundred of sparks jumped from ring to ring on the antenna.

I was standing in the back of the room, about 30 feet from Bob's MWO. As soon as he turned it on I felt a blast of irritation hit my aura. I could handle the etheric frying of my energy field for only about thirty seconds before I had to leave the room. When I came back in, everyone's energy had been fried. The meeting quickly digressed into a break, with everyone talking to their neighbor. It was quite a sensation!

In thirty seconds I had become convinced of two things. First, this MWO was extremely damaging to the subtle energy field and therefore must be incapable of promoting systemic healing. And second, this MWO must be unrelated to what Georges Lakhovsky was reporting in his book *Secret of Life*.

Since I drew those conclusions back in 1987, I have been confronted with numerous testimonials of people gaining benefit from this style of MWO. While I do not doubt the accuracy of these stories, I must admit, I do not understand by what process the benefit is derived.

Here is where the MWO languished in my mind until Lou Schad's articles appeared in the March/April and May/June 1991 issues of this journal. Intuitively I felt Lou was on to something very important. On a visit to Borderland Headquarters, I had a chance to evaluate a unit Lou had given to Tom. The energy coming from the antenna was gentle but very penetrating. I was excited. I went

home with the intention of building one of Lou's units to experiment with.

After considering Lou's design carefully, I decided to make a few changes and by late May 1991 I had my first unit. As it turned out, my unit did not look at all like Lou's, but it did embody the fundamental principles that he innovated. These included a spiral main antenna that was charged with static electricity and physically vibrated. Lou's antenna was complicated to build. I decided to use an antenna design that I had been developing uses for for three years, a spiral based on the phi ratio that I could have printed right onto a circuit board. That solved the problem of antenna fabrication. Another thing I changed was the method to induce the physical vibrations. Lou had used an aquarium pump. It worked well but was limited to only one rate of vibration. I decided that the rate of vibra-

SCORES BEFORE SESSION

Ideal Score: 8
Biological Score: 19-16-14-12-9
5 scores with high numbers
is considered very toxic.
Immune System Stress: 3
Endocrine System Stress: 5

SCORES AFTER SESSION

Ideal Score: 6
Biological Score: 12-10-8
Immune System Stress: 1
Endocrine System Stress: 0

tion might be important to look at so my unit was made with a variable rate of vibration from 2½ vibrations per second up to about 14 vibrations per second. The last change I made was the vertical antenna. Not knowing the height I needed for the optimum effect, I simply used a retractable replacement antenna from Radio Shack, the kind you usually see on portable radios. This gave me a way to vary the electrostatic charge on the spiral, by raising or lowering the antenna.

By early June 1991 I had made an arrangement with a local acupuncturist in town to run some clinical trials with the unit. This medical professional has asked to remain anonymous and so for the purposes of this article, I will refer to this person as "John". John is a gifted sensitive and an advanced bioenergetic diagnostician using equipment from Germany called the VegaTest. John also has had assistance in this evaluation by another gifted sensitive who can see auras in vivid color and detail. I will refer to this second person as "Pam". As of this writing in early November, their evaluation has been on-go-

ing for 4½ months or since mid-June. The results are preliminary. No cures are claimed. However, all indications point to systemic detoxification, energizing and rejuvenation, just what you would expect to see from a broadly stimulated natural healing process.

The VegaTest procedure is very sophisticated. It uses a bio-feedback mechanism to establish baselines for toxicity level, systemic stress and specific organ stress as well as the presence and location of specific pathogens and types of toxic substances. Toxicity level is measured on a scale of 0 to 21, where 21 is the most toxic. A "Biological Score" is developed from the toxicity values that come up and can have from 1 to 6 numbers ranging from 1 to 21, 6 numbers being the most toxic. An "Ideal Score" is determined on a scale from 1 to 15 where normal for adults on first testing range from 7 to 11. Stress on the immune system and endocrine system is measured on a scale from 0 to 5.

CASE A is a 21-year old female who has never been treated with other remedies. The patient was VegaTested, then received one 20 minute session with the MWO and then was retested. (See box insert) These scores suggest that even one session can temporarily reduce stress levels significantly and promote detoxification.

CASE B is a 72-year old male with extreme intraocular pressure. The patient received only three sessions with the MWO. The pressure within the eyes lessened with each session. Pam reported that before the MWO sessions, the region of the eyes and head was completely dark and devoid of life force. After the first session, the darkness cleared about 40%. With the second session, the darkness cleared about 80% and with the third session, the energy around the eyes was completely vibrant.

Without going into a lot of specific case histories, or naming disease conditions treated, John and Pam are consistently seeing the following:

1. The MWO expands the energy field around the body 3 to 6 feet.
2. It functions to reduce accumulated stress on many levels.
3. It clears the energetic imprints of illnesses.
4. It fills in breaks and cracks in the aura.
5. It builds vitality at a very deep level and combats fatigue.
6. It promotes the drainage of stale and stagnant life energy down the arms and legs and out the hands and feet. Several times

Pam has seen dark yellow or dark green energy drain out of acupuncture points or organs, to be replaced by cleaner and clearer colors.

7. Everyone experienced improvement, regardless of their condition.

METHOD OF USE FOR THE MWO, (developed by John and Pam during this testing period) is as follows:

1. A person using the MWO should sit in a comfortable chair with their feet flat on the floor and their hands apart, laying on their thighs, palms up is best. The chair should be about 6 feet from the MWO. During the session they should periodically rotate their wrists and ankles to help promote the draining.
2. The MWO should be started at slow vibration rates (2-3) and slowly moved to higher vibration rates (5-9) and then at the end, moved to slower ones again. Sessions can be from 10 to 25 minutes.
3. After the MWO is turned off, the person should remain seated for 10-15 minutes to continue to drain while the energy field

slowly shrinks back from its highly expanded state.

4. Rooms where the MWO is used may need to be cleared after its use due to the stale energies that drain out. Sun light, fresh air, toning, sage or other means may need to be employed to keep the MWO session room clear.

THE BSRF MWO PROJECT continues to develop, as this and other articles in this issue clearly show. A special thanks to Lou Schad for his brilliant and original departure from the errors of the past and showing us the true Borderland spirit in action.

One final note. We at Borderland are constantly railing against people who invoke the name of some famous researcher, like Rife, Tesla or Lakhovsky, and then sell the public a piece of equipment unrelated to the original work. This is no better than bait-and-switch hucksterism and we deplore it. Therefore, let us state for the record from the outset, that this new Electrostatic MWO is not what Georges Lakhovsky was doing. Neither is it a direct attempt to duplicate his work. Lak-

hovsky claimed to have had his units in use around the world, but after years of research we have found no physical evidence of this. He never published detailed schematics of any complete devices. This new MWO is a modern attempt to address the same problems that Lakhovsky was grappling with. We call it a multiple wave oscillator because it is, clearly, a device that produces a wide spectrum of oscillatory emissions simultaneously. Lakhovsky pioneered this line of research. This unit is not a "Lakhovsky MWO" but, strictly speaking, no other unit sold in the last 30 years has been either.

As this MWO is part of an ongoing research project, a limited number of these units will be produced and made available to the public.

The new BSRF Electrostatic MWO is for investigational purposes only. It is not a substitute for professional medical care and is not indicated as a specific cure for any disease condition. Any such use goes directly against the intent of the manufacturer. The performance characteristics of this device have not been established.

MULTIPLE WAVE OSCILLATOR

Borderland Sciences Research Foundation is proud to announce that their new Electrostatic Multiple Wave Oscillator is now available for investigational purposes.

TOTALLY NEW APPROACH

This unique Multiple Wave Oscillator uses a specially designed spiral coil that is both physically vibrated and simultaneously charged with a safe quantity of static potential, unlike designs using high voltage discharges between concentric rings. The result is a wide-spectrum wavefront of electromagnetic and etheric vibrations. It also provides a means to introduce a wide variety of other subtle influences into the broadcast much like a substance biocircuit. The Electrostatic MWO from Borderland Sciences is a versatile investigational tool.

The MWO has a wide range of vibratory rates and charge intensities. It is a one square foot cube with a Golden Mean Spiral MWO antenna on the front and a retractable antenna on the top for tuning. Powered with standard AC. Constructed using no toxic materials.

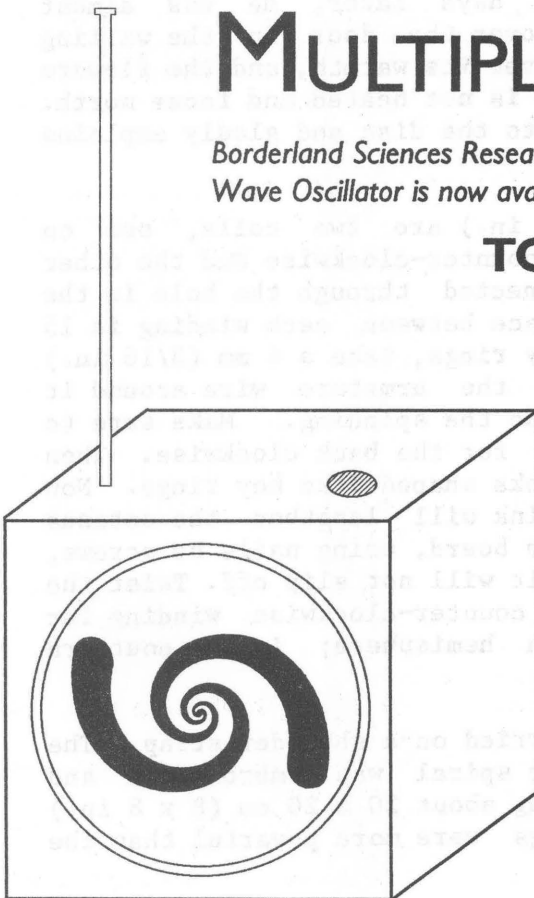

ELECTROSTATIC MWO

The Electrostatic MWO is a high quality device which was produced in limited quantity for our research network. This unit is no longer available, and it was a complex mechanical device not readily translated to schematic form. Interested researchers will find the best path to pursue in this vein is in LouSchad's Spiral Coil MWO.

SUN-ETHER DISC
By Albert Zock

The German inventor Oscar Korschelt based his cosmic ether accumulator, German Patent #69340, dated July 14, 1891, on the teaching of Wilhelm Weber not realizing that it incorporated the implosion principle as well. Weber professed that all particles of the ether, having an electrical charge, are circling around solid objects without touching them, the molecular particles being negative and the ether particles being positive, according to the law of attraction and repulsion. Since a solid body attracts ether particles, Korschelt searched for a way to collect, condense and to rectify them.

On a wooden disc with a hole in its center, Korschelt fastened spirals of copper wire, on both sides, one wound clockwise and the other, as a mirror image, counter clockwise, and connected the ends together through the hole in the center. His assumption was that the collected energy would be condensed in the center and then be beamed off at a right angle to the disc. He termed the side facing the light positive and the other negative. To increase the condensation and lengthen the antenna, Korschelt wound small coils like key rings and assembled them like links in a chain. He was convinced this device would give additional life energy if the beam was directed at the neck of a person in the height where the 18 cranial nerves are leaving the skull, (medulla oblongata). Such a spiral resembles a Nornen coil, which is stretched out and is used to eliminate undesirable emanations.

An application of a Korschelt coil seems to have its merits. In one case a relative of an elderly man suffering an acute pneumonia, being already unconscious and according to his physician, beyond hope, hung a Sun-Ether Disc over his bed. From this moment, his condition improved rapidly. Fourteen days later, he was almost normal again. In another case, a Sun-Ether Disc hangs over the door in the waiting room of a Naturopath. Every one walking in is amazed over its warmth, and the flowers are flourishing like in a green house, even though it is not heated and faces north. When asked for the reason, the owner points smilingly to the disc and gladly explains how it works and how to build one.

On a plywood disc with a diameter of 50 cm (20-3/4 in.) are two coils, one on each side, wound in a mirror image, the front one counter-clockwise and the other clockwise, almost on top of each other. Both are connected through the hole in the center which has a diameter of 10 mm (6/8 in.). The space between each winding is 15 mm (5/8 in.). Aluminum wire is best. To make the key rings, take a 4 mm (3/16 in.) thick wire, fasten it into an electric drill and wind the armature wire around it tightly, by allowing the rotating wire in the drill to do the spinning. Make sure to wind the links for the front counter-clockwise and for the back clockwise. Then separate every fourth winding and cut it to get the links shaped like key rings. Now attach the rings onto one another like a chain. Each link will lengthen the antenna and work like an oscillator. Fasten the chain onto the board, using nails or screws, but to be accurate, give the chain a light tension so it will not slip off. Twist the ends in the hole together, or better, solder them. The counter-clockwise winding for the front applies to people living in the northern hemisphere; in the southern hemisphere it might need to be reversed.

In Korschelt's time, some made "beam-handbags" carried on a shoulder strap. The material had to be framed to it could not move, then the spiral was embroidered and fasted to the inside of the bag, the whole bag measuring about 20 x 20 cm (8 x 8 in.) and the windings being 1 cm (3/8 in.) apart. Such bags were more powerful than the disc.

ETHER RADIATING APPARATUS

An Apparatus For Therapeutic Use Without Direct Or Indirect Suggestion

Oscar Korschelt of Leipzig. German Patent #69340, July 14, 1891

Translated from the German by Bodo Capeller, 1986

This apparatus utilizes the living forces of the ethers for healing purposes. The electro dynamic theory of Wilhelm Weber concerning the structure of smallest parts results in the insight that all ether is identical with Webers electric particles, that all solids rotate around it at a certain distance because of attraction of positive to negative ether particles in relation to solids. Through a corresponding arrangement of solids it ought to be possible to condense the diffuse ether and redirect it. A similar arrangement has been utilized in the following described apparatus which has been named by the inventor "Ether Radiating Apparatus".

This apparatus can be used for the purpose of increasing the intensity of the power of living ether. The difference between several versions of this apparatus is that of shape of materials used. In order to get increased power electric current may be used. Since the same appears to consist of positive and negative particles that try to find equilibrium, the amount of liberated ether particles within the wiring of the apparatus and the diameter of the wire formed ether vortex will increase with the spun off ether particles.

In drawings 1 through 5 an ether radiating device is shown. Within the apparatus the arrangement of the metal wiring is formed in a spiral that will cause ether particles to spin in a predetermined direction so that the living force can be utilized in many ways.

The version in drawing #3 shows the wire is formed in spiral configuration on both sides of plate E and is connected in the center. Through this arrangement the ether particles will accumulate in the center of the disk and be thrown forward. In order to achieve a longer path for the ether vortex one may utilize a chain instead of a simple wire which consists of horizontal displaced links (drawing #5). The disk is intended to cause physiological changes in humans (see drawing #1).

Patent request: An apparatus for therapeutic purposes with direct or indirect suggestion consisting of a non conductive disk (E), free standing or installed in a tube, where both sides of the disk contain spiral wound wire with the side toward the light exposed as the collector and the opposite the radiating portion.

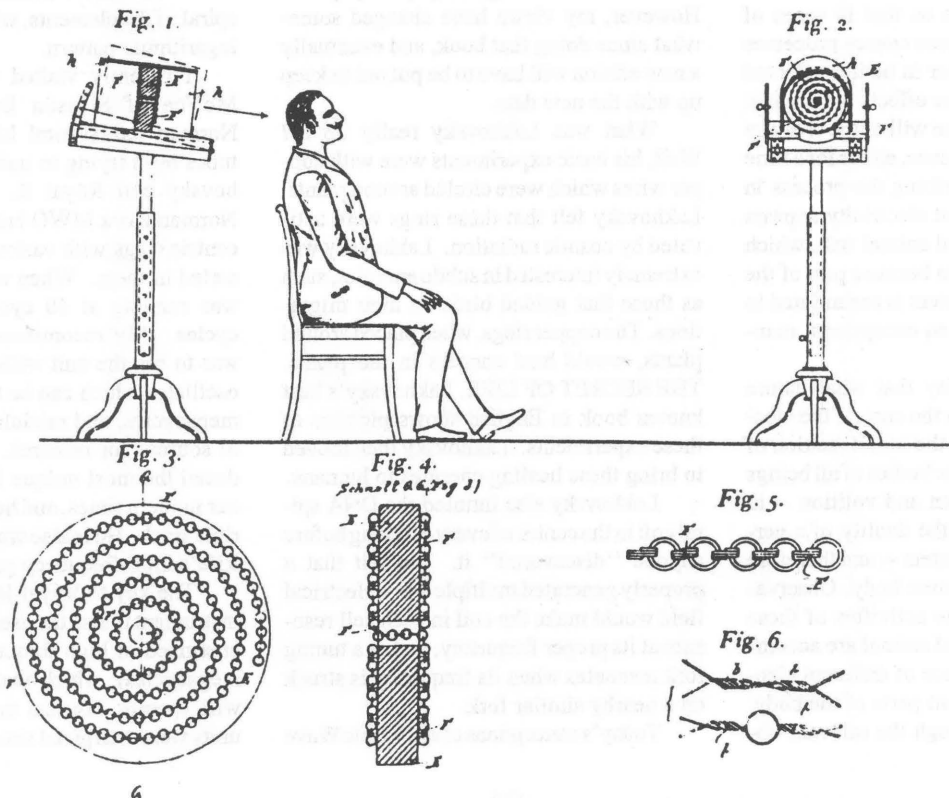

**March-April 1988 JBR,
VIEW FROM THE BORDERLANDS
by Tom Brown**

NATURAL ELECTRICITY

Ernst Lehrs, writing in **MAN OR MATTER** about early views by Volta and Galvani on electric fish, provides insight into the nature of animal electricity. "The electric organ of such a fish consists of many thousands of little piles, each made up of a very great number of plates of two different kinds, arranged in alternating layers. The two kinds differ in substance: in one case the plate is made from a material similar to that present in the nervous system of animals: in the other the resemblance is to a substance present in the muscular system, though only when the muscles are in a state of decay. In this way the two opposing systems of the animal body seem to be brought here into direct contact, repeated many thousands of times.

"In the electric fishes, accordingly, sensation and will are brought into a peculiar interrelation. For as a result of the spatial fixation and the state of deterioration of its bodily foundation the animal's will-pole is related to its bodily foundation in a manner which otherwise obtains only between the nervous system and the psychological processes co-ordinated with it. These fishes have the capacity to send out force-currents which produce in other animals and in man 'concussion of the limbs', or in extreme cases paralysis and even death. When contemplated with pure observation this phenomenon tells us that in cases of minor strength, this force causes processes of a volitional character in bodies affected by it. Through stronger effects the organic system which serves the will of the creature involved passes into disuse, either for a time or for good. By describing the process in this way we realize that electricity appears here as metamorphosed animal will, which takes this peculiar form because part of the animals' volitional system is assimilated to its sensory system in an exceptional manner.

"It is known today that what nature reveals so strikingly in the case of the electric fish is nothing but the manifestation of a principle at work in the bodies of all beings endowed with sensation and volition -- in corporeal terms, with the duality of a nervous and a muscular system -- and therefore at work also in the human body. Observation has shown that the activities of these two systems in man and animal are accompanied by the occurrence of different electric potential in different parts of the body. Manifolds in detail though the relevant ob-

servations are, they all confirm a definite correlation of negative electricity with the nerve-and-sense pole (sensation) and of positive electricity with the blood-and-muscle pole (volition)." From **MAN OR MATTER**, © 1958 Ernst Lehrs, Rudolf Steiner Press, London.

Thus we see that natural electricity is formed by processes which can be mirrored in non-living matter. But if we can have access to the primary form of the energy why pursue the secondary, and seek out that "magic frequency" that will cure AIDS, cancer, and assorted body clogs that go under fancy medical names? The answer is that everyone has their individual path to travel. Spiritual healing sometimes takes a long time, while an electronic device may get the person back on the track of their day-to-day life. The spiritual lesson of the sickness is buried for the future. Electricity is the subsensible force, but it is a real force with the ability to alter the functioning of the human body.

**November-December 1989 JBR,
VIEW FROM THE BORDERLANDS
by Tom Brown**

MWO NOTES

The work of Georges Lakhovsky continues to be of strong interest. I have been investigating the Lakhovsky MWO for about four years now and my views have consistently changed with new information. BSRF's MWO Handbook is getting quite popular! However, my views have changed somewhat since doing that book, and eventually a new edition will have to be put out to keep up with the new data.

What was Lakhovsky really up to? Well, his basic experiments were with copper wires which were circled around plants. Lakhovsky felt that these rings were activated by cosmic radiation. Lakhovsky was extremely interested in subtle energies, such as those that guided birds on their migrations. The copper rings, when placed around plants, would heal cancers in the plants. **THE SECRET OF LIFE**, Lakhovsky's best known book in English shows pictures of these experiments. Lakhovsky then moved to bring these healing energies to humans.

Lakhovsky also intuited the DNA spiral coil in the center of every cell long before anyone "discovered" it. He felt that a properly generated multiple wave electrical field would make the coil in each cell resonate at its proper frequency, just as a tuning fork resonates when its frequency is struck on a nearby similar fork.

Today's conceptions of a Multiple Wave

Oscillator (MWO) are quite different from what Lakhovsky was really doing. Lakhovsky tried to reproduce the healing energies of the cosmos by electrically energizing coils to produce energy fields which apparently regenerated aberrant cells along the lines of his theories. Lakhovsky first did this by producing an antenna, comprised of concentric copper tubes, the outer one being energized with two wires from his power source. Our impression of his antennas is that they were log periodic, that is logarithmic in nature (Lakhovsky doesn't come right out and say this, but his patents are definitely worded to cover such an arrangement). New data coming in (but not yet verified) tells us that these copper tubes were filled with one or more of the noble gasses (also called rare, or inert gasses).

As anyone could guess, these antennas would be somewhat hard to manufacture. Lakhovsky then miniaturized the antenna and inserted it in a gas bulb. His US patent #2,351,055 says vacuum bulb, but also covers low pressure gasses. There are two main keys here. One is the log periodic antenna. All higher forms of life are based on logarithmic patterns, from ferns to humans. Lakhovsky was creating a structure in the ether which would bring cells into proper functioning. The other is the vacuum / low pressure gas effect. For those who wish to understand the potent effect of the vacuum on life then the reading of *The Nature Of Substance* by Rudolf Hauschka is required. According to Walter Russell the noble gasses are the octave markers in the harmonic spiral of the elements, which also exists in a logarithmic pattern.

I recently visited with Dr. Norman McVea of Stinson Beach, California. Norman has several high frequency gas tubes built trying to understand what Lakhovsky and Royal R. Rife were up to. Norman has a MWO built of 12 glass concentric rings with various noble gasses inserted in them. When we checked it out it was running at 60 cycles, pulsed at 7.8 cycles. My recommendation to Norman was to run the unit with a radio-frequency oscillator which can be tuned from 1 to 30 megacycles, and modulated with a variety of sources for research. Norman has produced the most unique MWO I've seen in our modern times, and he is certainly on the right track. He is also working to reproduce Rife's high-frequency gas bulbs.

The key to Royal R. Rife's frequency instrument is also the use of the noble gasses energized at high frequency (possibly 4.5 megacycles), which were then modulated with specific musical tones. Lakhovsky's units were energized similarly, but used the

frequency-independent log periodic antennas, giving a broad band of treatment, rather than the specifics of Rife's units. In many ways these two pioneers were working with the same keys.

WHO DUNNIT?

Rife and Lakhovsky have another similarity, that is, that people today are building equipment obliquely related to their work and offering them as original, or "improvements." This needs serious examination. The last two years has brought on an underground cult of so called "Rife Frequency Generators." There are hordes of these so-called "Rife" units being sold which are merely fancy variations of TENS (Transcutaneous Electrical Nerve Stimulation) devices. The conception for these units, usually producing square audio waves, comes from John Crane who knew and worked with Rife in his later years. John has affidavits from people who swear that they were healed from cancers and such by his square wave units in the early 1960's. It is extremely important to note that Rife's work in the 1930's through the 1950's was with high frequency gas tubes and all his documentation covers those units. History is rapidly becoming blurred in the race to cash in on people's poor health.

Modern purveyors of the so-called "Rife" equipment are making several errors: The first is that they claim that Rife developed the use of the square wave generators with electrodes. That is incorrect, it was John Crane (which makes Crane a pioneer of TENS research!). The second is that they claim that Crane's equipment was junk and would never work. Maybe the equipment wasn't of the highest quality (we have an original unit in our collection!) but Crane does have a lot of signed affidavits, several of them in our files, claiming that the units worked on specific diseases. In general, people are being misled in order to sell them equipment they probably don't need. That is a bad reflection on the field of electrotherapeutic research.

Perhaps these modern "Rife" (TENS) units have some merit in killing certain types of pathogens. I've spoken with many people who were completely dissatisfied with their so-called "Rife" units, and I've spoken with two people who have claimed that they have killed infections such as foot rot and herpes. Maybe they do, but for all of the thousands of devices being put out where is the documentation? Where is the proof? I have seen Crane's affidavits of the early 1960's, but have seen no medical studies from anyone, not even basic notes!!! There is obviously a very important bit of work to

do in researching the effects of pulsed DC on the human body. TENS units kill pain, that has been clinically documented. The claims of the so-called "Rife" units are just that -- claims, and unsubstantiated to boot. Until any substantial research work is done in this area I would recommend that people do not follow the mob hysteria which shrewd hucksters have instigated over Royal R. Rife's work.

Lakhovsky's story is similar. All the units being built today are based on Bob Beck's early 1960's interpretation of Lakhovsky's first patent (#1,962,565). After four years of looking at these devices and reading Lakhovsky's patents and books I've come to the conclusion that Bob was misled by the patent. From an electrical engineer's viewpoint Bob's units make sense. From the standpoint of understanding subtle energies within and surrounding the body the units are merely RF noise generators which have questionable effects on the body, and most likely interfere with natural energetic processes (chi flow, etc.). The Beck MWO is a variation of one of Tesla's electrotherapeutic devices, the variation being that Tesla went to great pains to make the antennas spark-proof, and Beck's antennas spark away. Lakhovsky's units didn't spark either!

What makes this more interesting is an article which appeared some months ago in the Health Freedom News, titled Who Dunnit? by Mike Brown. Mike gives a weak case for his view that Lakhovsky was inept, that his earlier units didn't work, and who needed Tesla to fix them up and make them work. Perhaps Mike didn't notice that Lakhovsky's SECRET OF LIFE, which he sells to promote his units (in the ad following the article), is based on the units he claims in the article didn't work! Mike refers readers to Tesla's article High Frequency Oscillators For Electro-Therapeutic And Other Purposes (Lectures, Patents, Articles by Nikola Tesla, Beograd, 1956), but fails to notice that Tesla's article contradicts what he is doing with his units. I wonder how that article got past the editors?

CORRECT DIRECTIONS

Lakhovsky was a brilliant scientist, highly regarded on the European continent. His name comes up in many books, most recently I found him referenced in Lilly Kolisko's AGRICULTURE OF TOMORROW. If he and Tesla met, I'm sure it was for more than to fix poorly engineered units. There are three types of units that I feel should be built for research into this area: One is Tesla's oscillator circuit. The higher quality Beck MWO units, such as those

built by Klark Kent, can be converted fairly easily. Use the unit's power supply as is, but for antennas use insulated copper plates (or spheres, as Tesla preferred for maximum effect) coated with heavy dielectric material such as beeswax. Eliminate the sparking! A necessary design change for future units will be to change the ¼ wave coil to ½ wave.

The second is a reproduction of Lakhovsky's Tube MWO. It will take miniaturizing the Golden Ratio antennas that Eric Dollard designed for the MWO and inserting them into low-pressure rare gas bulbs, which will then be driven at high frequencies. It is my estimation that this is the best way to pursue Lakhovsky's high frequency researches. The mathematics for the antenna, along with further reference materials on log periodic antennas, are in The Lakhovsky MWO Handbook.

The third is a reproduction of Rife's original type of equipment being a rare gas bulb driven at high frequencies, modulated with musical tones. This will take RF broadcast equipment and a rare gas tube. No electrodes!

It is time that researchers in this area begin to go in the correct direction. Bob Beck made a noble effort in the early 1960's with his conception of the MWO, and gave people something to work with for 25 years. That phase is definitely over and a new one beginning.

The "Rife generator" craze should be stopped now before it takes people another 25 years to find they've been misled. Serious research into the effects of pulsed DC should be undertaken by those with the wherewithal.

And keep it uppermost in your mind that electricity is a sub-sensible force. In the borderland sciences one should look to the supersensible, such as Dr. Wilhelm Reich's orgone energy (which, by the way, reacts to electricity in such a way that makes it detrimental to the human body), and the human vital energy such as is utilized in Biocircuit research (as begun by L.E. Eeman).

**January-February 1990 JBR,
VIEW FROM THE BORDERLANDS
by Tom Brown**

THE WONDROUS ELECTRICAL FORCES

Electrical research is a primary area of borderland research. While the term "occult" puts many people off, it should be realized that electricity is an occult force whose effects we only see when equipment is properly engineered. Four to five hun-

dred years ago one would probably be burned at the stake if it would have been possible for them to demonstrate electrical devices.

Electricity is considered by some to be a degraded form of the Light Ether, that the etheric force gets bound up in matter in a way that it can be used. But being bound up in matter it provides mankind with the option of using it properly or improperly. Many articles on the detrimental effects of electric fields have been published, and more studies are no doubt underway on this important topic. There are also some records of electro-therapeutic devices that used this force for healing. Tesla envisioned a worldwide electrical power system and did the basic testing to show himself that it was viable, and needed but to be built. Tesla was a man of great intellect and was a reader of Goethe and other great minds. One would feel that he was in some way familiar with Goethe's *Farbenlehre* (color theory). The type of electricity being sent around our globe on wires is of a different, lower form than that of Tesla's transmission of electricity without wires. It is quite possible that Tesla's electricity was of a beneficial nature. Tesla did research into electrotherapeutics and was no doubt aware of both beneficial and detrimental effects. With the power system he envisioned on line we may not have ended up with the electrical problem we are just beginning to see the "tip of the iceberg" of.

This point needs clarification and elaboration beyond what most people now imagine. We periodically mention certain aspects of Dr. Lilly Kolisko's experiments with the crystallization of metallic salts rising *contra* gravity. These experiments were done to establish whether or not the planets had any direct connection to the metals as alchemical lore supposed.

The connections she investigated are Gold-Sun, Silver-Moon, Mercury-Mercury, Copper-Venus, Iron-Mars, Tin-Jupiter, Lead-Saturn. For example Dr. Kolisko would take a gold chloride solution (1%) and allow a portion of it in a laboratory dish to *climb* a segment of blotter paper. As it dried the fine details of crystalline form could be seen. After many experiments the characteristic form of each metal's salt could be comprehended. It was scientifically established that the actions of cosmic bodies would have direct effects upon the crystallizing actions in the lab. Gold chloride

would not crystallize properly during several solar eclipses that Dr. Kolisko reported on (1927, 1947). A darkening effect was noticed on these slides.

Just recently I came across this in the recollections of Dr. Rudolf Hauschka, founder of Wala Pharmaceuticals: "In the course of researches into the delicate changes in matter which are revealed in the capillary-dynamic method, an alarming symptom came to the fore. At one of the Easter conferences of the Anthroposophical Doctors' Working Group in Comburg in 1964, Frau Kolisko, the past-master of the capillary-dynamic method, spoke on 'Gold and the Signs of the Times.' In earlier years she

earlier, in the first half of the century, only at the time of a sun eclipse. She closed her lecture with a question to the doctors, namely whether, considering the change now in gold, they could still be answerable for its use as a medicine. There was no doubt about it: since the middle of the century gold had become different -- it was sick. Or, to express it differently, the connection between the spheres of the sun which stream down and the metal which they permeate is disturbed."

ELECTRICITY: THE MAIN CULPRIT

The main culprit in this sickness of earthly matter is none other than the electrical environment that has manifested on this planet. Certainly there were radio communications going during Dr. Kolisko's early experiments, but as this chart from Trevor Constable's *COSMIC PULSE OF LIFE* shows, the post WWII environment was heavy with these signals, culminating in today's total saturation point. Imagine what the *Steigbild* would have shown in previous centuries before the electrical force began its manifestation.

Nuclear proliferation must also be considered as adding to this phenomenon, but electricity is the degraded form of the light ether, whose source the sun is related to gold. Walter Russell, in *ATOMIC SUICIDE*, indicates that the spread of nuclear energy will destroy the atmosphere surrounding this planet and now scientists are scratching their heads as the hole in the planetary ozone layer gets larger. (Of course chlorofluorocarbons and New Zealand sheep farts have all been blamed for the ozone depletion, but nuclear energy is a primary cause.) This atmospheric destruction could well aid in cutting off gold from its cosmic wellspring of life.

cutting off gold from its cosmic wellspring of life.

Rudolf Steiner had many insights into the true nature of electricity, its relationship to humanity and its role in our future. Pertinent to the matter at hand let us consider the following remarks, a portion of his answer to a question about electrical treatment of animal fodder:

"You must consider the whole part played by electricity in Nature ... to the effect that human beings cannot go on developing in the same way in an atmosphere permeated on all sides by electric currents



PLANET EARTH—PRE-RADAR

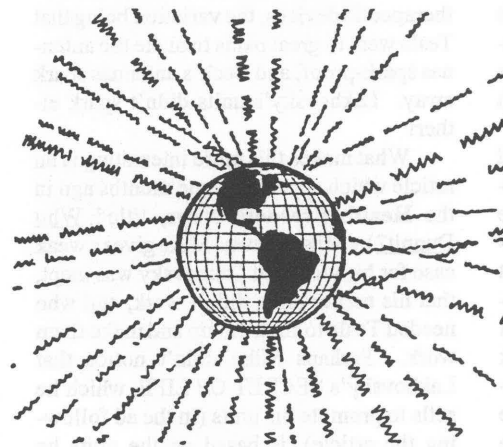

PLANET EARTH—POST-RADAR

Entire planetary environment permeated with pulsed electromagnetic radiation—an unprecedented condition.

had demonstrated by means of the *Steigbild* (literally rising pictures, also known as chromatograms) the connections between the metals and the planets, and in particular the effect on gold of an eclipse of the sun. During an eclipse of the sun the gold *Steigbild* which normally glows with beautiful colors, shows a darkening and the emergence of grey formations. Frau Kolisko now showed a series of gold *Steigbild* produced in the last years almost hourly and at all times of the day and of the year. Without exception all of them showed the same sinister dark formations which had appeared

and radiations. It has an influence on the whole development of man. This is quite true; man's inner life will become different if these things are carried as far as is now intended. It makes a difference whether you simply supply a certain district with steam-engines or electrify the railway lines. Steam works more consciously, whereas electricity has an appallingly unconscious influence; people simply do not know where certain things are coming from. Without a doubt there is a trend of evolution in the following direction. Consider how electricity is now being used above the earth as radiant and as conducted electricity, to carry the news as quickly as possible from one place to another. This life of men in the midst of electricity, notably radiant electricity, will presently affect them in such a way that they will no longer be able to understand the news which they receive so rapidly. The effect is to damp down their intelligence. Such effects are already to be seen today. Even today you can notice how people understand the things that come to them with far greater difficulty than they did a few decades ago.

"It is a remarkable fact that whenever something new appears, as a rule in the early stages it is heralded as a remedy--a means of healing. Then the prophets get hold of it. It is strange, where a new thing appears, clairvoyant perception is often reduced to a very human level! Here is a man who makes all sorts of prophecies about the healing powers of electricity, where no such thing would previously have occurred to him. Things become fashionable! No one was able to imagine healing people by electricity so long as electricity was not there. Now--not because it is there, but because it has become the fashion--now it is suddenly proclaimed as a means of healing. Electricity--applied as radiant electricity--is often no more a means of healing than it would be to take tiny little needles and prick the patient all over with them. It is not the electricity--it is the shock that has the healing effect.

"Now you must not forget that electricity always works on the higher organization, the head-organization both of man and animal; and correspondingly, on the root-organization in the plant. It works very strongly there. If... you pour electricity through the foodstuffs--you create foodstuffs which will gradually cause the animal that feeds on them to grow sclerotic. It is a slow process; it will not be observed at once. Electricity will not at first be recognized as the cause; it will be ascribed to all manner of other things.

"Electricity, once and for all, is not intended to work into the realm of the liv-

ing--it is not meant to help living things especially; it cannot do so. You must know that electricity is at a lower level than that of living things." (from *Agriculture* by Rudolf Steiner)

How pertinent and timely these words are today on many levels of borderland research. Electrical/electronic medicine has the glamorous position on stage at most of the conferences, and in many people's minds, in today's 'borderland' field. People are racing to buy instruments which are designed by electronic engineers with little or no training in the comprehensive constitution of humans. *It is the fashion!* There is no consideration that true healing comes from the spiritual realms, that the spirit is always healthy, and that dis-ease comes from a condition where the various subtle levels of the body are not aligned properly with the physical.

These electrical instruments have the potential to produce apparent results in treating disease symptoms. But what of the long term effects of the subsensible electric current? Considering the alarming state of affairs viewed through the information just presented I pose the question to the reader, "Do you prefer the natural or the unnatural forms of treatment?" Many people flock to electronic medicine because they feel that the petro-chemical drugs that are prescribed by the medical establishment are detrimental to their long term health. Very possibly so, but will electricity be any better? What about your own vital energy and its relation to cosmic life forces?

Electrical stimulation of the body treats a symptom and fails to allow for the body's natural healing process. As electricity is an externalized part of humanity's inner volitional force we can see that there will be definite effects from the subsensible current. But the effects will be relative and the inner healing process put on secondary mode. Electro-therapy, while emerging as a viable medicine of the future, still ignores the natural healing process.

This does not mean that we should not research electro-therapy. In what may seem a contradiction to many readers, I am 100% for further research into this area. It will no doubt be of benefit to many. Our relationship with electricity is one of the greatest questions of our time. People unconsciously use this force, and the results are such as those noted by Lilly Kolisko. Electricity is intimately connected to the Life Force, but great care must be taken not to confuse the two. Electro-therapeutic research helps define the boundaries, and thus is of interest to Borderland Researchers, but it certainly does not mean I recommend it!

MWO QUESTIONS

Your comments re the MWO in the Nov-Dec 89 JBR are of much interest and raise the following questions in my mind:

1. Will you be publishing any information by Dr. Norman McVea?
2. How can the Kent units now in circulation be converted to produce a 1/2 wave? Perhaps Klark would be willing to publish an article on this or be willing to do the converting for a price.
3. Has any member ever tried to obtain any information on the circumstances of Lakhovsky's death? About three years ago a reference librarian made a serious effort for me to obtain any information re Lakhovsky, with absolutely no success. Perhaps there was an obit in the NY Times at the time he died, assuming that is where he was at the time.
4. Where in the world would we obtain copper spheres like Tesla used? Perhaps a member can suggest a source.
P.V.P.
California

In answer to your questions:

1. Norman McVea has sent us in a bit of material on his latest oxygen researches. He has opted for the oxygenation approach instead of the electrical.
2. I don't know about conversion of Kent's units to 1/2 wave, you should check with him on that. It will probably be easier to use it as it is -- they are good power supplies for experimentation -- and in the future engineer units with more refined outputs. After reading my column Klark added a rare gas tube assembly to his "Rife" units. He has always listened to other people and has constantly worked to improve his units.
3. If any readers have info on Lakhovsky's death, or his life for that matter, these pages are open to pursue the matter.
4. Anybody know where to get copper spheres? Tesla also used copper plates coated with a heavy dielectric.

September-October 1990 JBR BSRF Bulletin Board

MWO EXPERIMENTS

I have been very fascinated with your Journal. Thank you for the new world you have opened up to me. For the last few months I have begun to work on an MWO.

I have completed the antennas but did not do as well with the Tesla-coil. I decided to buy the ready made coil from

"Edmonds". I connected the secondary to the center of my antennas and did get some action in the form of a purple glow around the third and fourth smaller rings. I can only assume that I need more power to this unit although I was "Quite" pleased at the limited reaction on my first attempt. I would like to reach out to a fellow member who might be able to help me with some advice at this point.

Any advice you would send my way would be greatly appreciated.

P.D.
New York

Naturally, the quality of output of any electrical device is dependent on not only the quality of materials, but also the geometry of structure and arrangement. The better the coil, the better the antenna, the more refined the fields will be that are put out around the device. As I have pointed out in the article mentioned above in my remarks about the "Rife" devices, the types of "Lakhovsky" MWO's being built today vary quite a bit from what Lakhovsky was actually building and using himself.

Lakhovsky used very refined electrical designs and probably log-periodic antennas with both poles of a Tesla coil feeding the outside ring in such a manner that there was a logarithmic, electro-magnetic structure oscillating in space which apparently had quite beneficial effects on living organisms.

The modern variations, based on Bob Beck's schematic of 1963, feed one pole into an antenna (and the other into a second antenna), creating a dielectric field, which when it collapses, due to the rings on the antennas, creates unnecessary sparking and random radio-frequency noise with questionable effects. It is an organic system alterant, but is quite different electrically from Lakhovsky's original equipment.

Nov-Dec 1990 JBR,
BSRF Bulletin Board

THAT MWO AGAIN

I recently purchased your MWO HANDBOOK. In the book are many references to the "Golden Ratio". I was unable to determine what the mathematical basis for the Golden Ratio is. I have other material which describe the Golden Section, and it is a ratio of .618 to 1. The closest I came to a value for the Golden Ratio is from the MWO antenna data on page 188 of your book the ratio appears to be 1.27:1. Could you please clarify the mathematics of the Golden Ratio antenna?
B.C.S., California

* I recently purchased THE LAKHOVSKY MWO HANDBOOK. I am in the process of building an oscillator. I have all the parts except 6Kv .005mf capacitors. No electronic store in Alaska has them, or knows how to get them. I would appreciate it if you would send the address of either the manufacturer or an electronic store that carries 6Kv .005mf capacitors. I have one more question. Do you know of a meter or electronic apparatus that measures the amount of energy level the human body produces? It seems that like fingerprints, all human bodies are different in the amount of energy they use or produce. If one can coordinate the energy level of the oscillator to that of the body far less damage would be done and far greater healing potential be made.

S.N.
Alaska

For the first question, the Golden Ratio antenna uses the golden ratio as a base, but it was engineered to conform to other considerations of antenna propagation. It is what is called a log periodic antenna. These antennas are based on the square root of phi, that is the inner ring is multiplied by the square root of phi to get the next ring, or inversely the outer ring is multiplied by one over the square root of phi to get the next inner, etc. This provides the Golden Ratio mathematics (every other ring is phi related).

MWO NEWS FROM FRANCE

I'd like to mention with regard to "Electricity the Main Culprit" that just after the war, Gurdjieff wrote a chapter in his book ALL AND EVERYTHING entitled "Beelzebub says that man's capture and subsequent destruction of electricity from nature is one of the main causes of the reduction in the human lifespan." And you are lucky in the US. In Europe we have a 230V system that is far more harmful than yours.

A final comment on the MWO which seems as popular as ever. When I lived in Paris I made the acquaintance of Lakhovsky's son and saw two of the MWO's built by his father in operation. The demonstration was very impressive but it didn't last too long because the old units interfered seriously with radio and television reception in the area. They were very big units, about as large as an early TV set. I don't know where they are now since he later loaned them to friends living in the country.

R.C.
France

Very curious quote from Gurdjieff as it concurs with what Steiner indicated, that electricity makes living things sclerotic. If perhaps you wouldn't mind searching your memory a bit more I have a question about Lakhovsky's device: You say it interfered with radio and television reception. Was this from internal spark gaps, or did any unit you see arc between antenna coils. The pictures in THE SECRET OF LIFE indicate that the then necessary spark gaps were interior to the unit, and the pictures of the effluvia coming off the antenna are obviously pictures of corona discharge and not arcing as in the units built in the US today. Bob Beck, in his 1963 article on MWO's claims he built a unit from an original, but his antenna hook-up is quite different from Lakhovsky's pictures. Many years of searching have failed to produce an original unit. The modern units are derived from the most obvious derivation of Lakhovsky's first MWO patent, which is written to both protect his design and cover infinite variations thereof. A detailed account of an original MWO in action would be of great value in this research.

SOUTH OF THE BORDERLAND

I have read Mark Clement's THE WAVES THAT HEAL and discovered a little piece of information not included in the current edition to THE LAKHOVSKY M.W.O. HANDBOOK. In WAVES I noted a short sentence indicating that one set of rings transmits energy through space which falls upon the patient's body and (it must be ascertained through experiment whether this is as I tell here or otherwise) later absorbed by the receiving resonator which resonates it for re-broadcasting into the patient's body. Thus the true Lakhovsky MWO, and UNLIKE the Beck-reconstructed model, would be a more-complex device involving features so-far unthought of. It must be ascertained what KIND of "receiving resonator" Lakhovsky employed, if it had or not special constituents not described at any of his patents included in the MWO HANDBOOK and what other features could be complementary to both.

Another feature to be considered, and which I discovered in the photo on page 30 of Clement's book is that there are two protruding spheres connected to the outermost ring of the Lakhovsky setup. In the copy of the BSRF publication I have, these two photographs are reduced and with not the same kind of resolution of the work by Clement. Each protruding sphere is connected to a cable and following the path of least resistance

the electrostatic current flows both along the metallic path of the outermost ring and the excesses accumulated from attracting ether from the environment are projected towards the patient (in the case of the transmitter) and collected for resonating (in the instance of the receiving resonator). Also notice that there are two "bracing wires" to both keep the rings in place and at the same time to fulfill the 90° division determined for Earth by the metric theorems which are the foundation of the Energy Grid! This adds another feature of complexity to the duplication of the MWO, which carries the Lakhovsky invention, again, farther from the Beck-built model.

Please mention my paper **SOME FREE-ENERGY DEVICES** for the MWO analysis I made is at best very incomplete, not including the feature of non-uniformity the true MWO does possess.

Jorge Resines
Buenos Aires, Argentina

Thanks for your further insights into the MWO. I feel that a continuing dialogue will eventually produce more evidence as to what type of equipment Lakhovsky used in his successful researches into cell regeneration and how to best reproduce it. The resonator antenna setup on Lakhovsky's original is more complex than the Beck MWO, as, like the primary antenna, it also has two feeder wires. The two spheres you mention, from which brush discharges can be seen, have always struck me as the nuts that held the heavy antenna onto its stand. Some mechanical contrivance was necessary and the mini-spheres fit the bill with the possibility that they may have been further configured to produce a specific capacitance, as our evidence indicates that Lakhovsky's antennas were very precisely built, probably log periodic. We have heard that Lakhovsky was a radiesthesiast and would dowse the sites where he set his equipment up. He was certainly into the subtle energies, and the French school was very precise in its radiesthetic work, being the source material for much of Christopher Hills Supersensomics work. We have an unconfirmed report that the original tube antennas were filled with a rare gas such as argon. This would seem to be the case as in Lakhovsky's second MWO patent he reduced the antennas and puts them into vacuum or low pressure gas bulbs

(as the first, this patent is written to be very specifically vague). This was meant to be an improvement over the original units, and probably was. What it tells us is that the "Beck" units appear to be far from what Lakhovsky was doing and where he was going, though because of more than 25 years of people building and using Beck models it

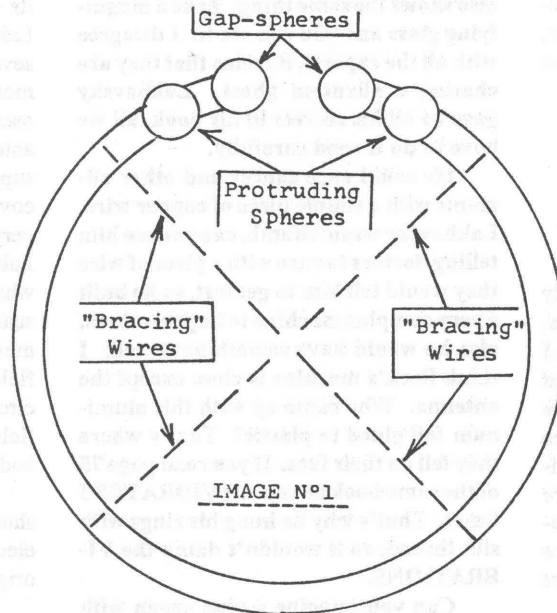

**Detail of outer ring on Lakhovsky's original MWO antenna.
Front view above, side view below**

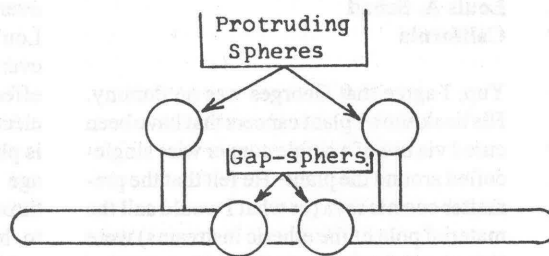

is hard find information on the original. The "bracing wires" are supposedly silk. Their angle was probably determined solely by mechanical function.

We have actually come under attack for our attempts to clarify the MWO story! In a brochure put out by MWO salesman Mike Brown, Box 25, Pleasant Hope, MO 65725, we come in for the following treatment: "Then there are the characters who, with no formal training whatsoever, denigrate tings

[sic] they know less than nothing about. One outfit calling itself Borderland Research sent out a bulletin claiming that no-one today is manufacturing a Lakhovsky Multiple Wave Oscillator. These characters arrived at their conclusion by comparing photos of a 1935 unit to ones being made today. The units don't have the same external appearance. Quite often people with no formal training in electronics or electricity don't understand that an electronic device and how it operates are determined by the circuitry contained within the unit, not by the box it comes in." My comments are that there are perhaps *tings* we don't know but we do know that what is inside counts as much as the outside on the MWO. I have put five years of serious investigation into the MWO and would have to say that what we published is the result of serious consideration by a number of intelligent people--some highly trained electrical and mechanical engineers--interacting and exchanging ideas. We have published the evidence to support our contention, and have in fact stated that if we can be shown to be wrong then we would like to know, that we have no final conclusions, just some of the facts. A crude attempt to belittle BSRF's research by ignoring the main facts does not change the facts and the facts are that the units pictured in Lakhovsky's book **THE SECRET OF LIFE** are quite a bit different than the units being built today, indicated specifically by the antenna hookups, from which basic logic would indicate the need for a different interior setup. A thorough analysis of the basic differences between the two types of units can be found in *The Lakhovsky Multiple Wave Oscillator Handbook*, edited by myself, Tom Brown (no relation to Mike). Mike's brochure then goes on to claim that "the equipment necessary to regrow arms and legs can be purchased at Radio Shack for about \$10", that is a "metal plate, copper wire, battery, and 100 K-ohm to 1.5 Megohm resistor." Heck, if you can regenerate an amputated limb with a only battery and a resistor then why do we need all the electronics in a MWO just to drive out mere cancerous tissue?!

As a final note on this, I would like to point out that electricity is a system alterant. Whether it alters the system for better or worse depends on many other factors, in-

cluding mental status and diet. As Trevor Constable pointed out back in the 1960s in this Journal, the healing powers attributed to the MWO could be caused by the etheric force rushing to suppress the life-negative electro-magnetic activity. It is also possible that any benefits coming from modern day MWOs are psycho-tronic in nature -- that is the mind is doing the cure and the instrument provides a physical anchor for the psychic energies. The actual operation of the equipment, the sparking and gross electrical output, is superfluous to the matter, other than in convincing the mind that *something* is happening.

**Jan-Feb 1991 JBR
BSRF Bulletin Board**

LAKHOVSKY'S ORIGINAL

You ask whether the original Lakhovsky MWO had any arc between antenna coils. I don't remember any but to make sure I checked up with a friend who has worked on the MWO and knows it inside out. He was also present when I saw the device working. He tells me that there is definitely no arc between coils. The arc occurs inside the machine after the "Ruhmkorff coil". He also says that there are two tungsten plates which are drawn apart and brought together manually.

The other thing I remember is a sort of metal wand with a knob at one end which is used between the two units to treat people. At the time I saw it, one of the persons present had a bad back. The two MWO antennas were turned on and were facing each other about 6 ft apart. The "wand" was applied to the sore back. I seem to remember that it kind of gave off sparks, but I'm not sure of this. I touched the wand and I could clearly feel something coming through. My knowledge of electricity is nil, however, if you have further questions, I could always try my friend who should be able to answer them for you.

R.C., France

Many thanks, as this confirms the evidence of Lakhovsky's own pictures used in his books. Would you be so kind as to ask your friend if it is possible to get a schematic (even a rough drawing from memory) of the basic layout of the MWO, which we could reproduce on these pages, also any antenna construction details. Many questions remain such as what components are in the metallic tubes holding the antennas up, and such (Eric Dollard finger-dowsed the pictures of the tubes and felt it was an arrange-

ment of capacitors and spark gaps -- his basic MWO diagram, an intelligent guess of what Lakhovsky was doing, is in this Handbook). A basic schematic would probably be the most important piece of information to date. Please read on, pot has been stirred....

LAKHOVSKY ANTENNAS

I got my Nov-Dec 89 Journal where it shows an update on Lakhovsky's antennas. On page 181 of SECRET OF LIFE it also shows the same thing. Take a magnifying glass and you can see it. I disagree with all the experts, it seems that they are chasing a phantom ghost. Lakhovsky gave us all his secrets in his book, all we have to do is read carefully.

He could cure cancer and other ailments with a simple piece of copper wire. Lakhovsky wasn't dumb, can you see him telling doctors to cure with a piece of wire they would tell him to get lost, so he built a very complex machine to impress them, also he would have something to sell. I think Beck's machine is close except the antenna. Who came up with this aluminum foil glued to plastic? That's where they fell on their face. If you read page 75 of the same book he repeats VIBRATES 3 times. That's why he hung his rings with silk thread, so it wouldn't damp the VIBRATIONS.

Can you imagine a pipe organ with copper strips glued to a board? I have designed an antenna using copper tube of varying sizes held by fish leader that I think would work fine. I'd bet a penny to 10 bucks that George used thin wall bronze tube as it will resonate better -- but it's expensive to fabricate.

Louis A. Schad
California

Yup, I agree that Georges was no dummy. His book shows plant cancers that have been cured via use of a single copper wire single-coiled around the plant. He felt that the pre-matter cosmic rays (or what I would call the material pole of the etheric instreams) were "ringing" the copper coil, in effect creating a tone that would heal the plant. I got the impression, from studying Lakhovsky's progress towards the vacuum (or low pressure rare gas) patent, that in his equipment Georges tried to invert the process -- exciting the ring with a post-material high frequency current that would create a healing tone. By using log periodic antennas (as would be allowed under the MWO patents) a vibrant chorus would ring in the ether, the tones, via the structure of the antenna, would be such that they could harmonize the functioning of the human body.

The aluminum foil antennas were developed by Riley Crabb, as a low cost way for experimenters to make their own antennas without having to have printed circuit boards made, and many folks were quite happy with the results. The physical evidence now clearly indicates that the Beck unit is quite different from the original Lakhovsky unit for which the cell regeneration results were recorded. What I have termed the "BECK MWO" must stand on its own merits and it can lay no claim to Lakhovsky's recorded results. As stated several times in the past Beck's device is more like one of Tesla's electro-therapeutic oscillators, except Tesla used copper sphere antennas, coated with a heavy dielectric to suppress sparking. Beck's unit would be covered under Lakhovsky's original (and very generalized) patent, but research of Lakhovsky's own material shows it is not what he used for electro-therapeutic researches. To excite the antennas in the Beck manner will not create the same vibrating field that Lakhovsky's antennas excitation circuit will. But it does create an electrical field that some claim is beneficial to a live body placed in its proximity.

It makes much sense that the antenna should also vibrate physically as well as electrically. Ah... if we simply had an original unit to weigh and measure...

Lou has sent us in a MWO of his own design with a single spiral antenna made of two twisted bare copper wires. We will be running a several part article on construction and use starting next issue. This unit is reminiscent of the Sun-Ether disc of Oscar Korschelt, circa 1891. Having sat in front of a number of different operating MWO's over the last six years I have to say that Lou's unit is the most exciting thing I've ever seen like this. I could strongly feel the effect 10-12 inches away, and there was no electrical excitation of the antenna, rather it is physically vibrated. There is a low voltage shocker that can drive the antenna through two smaller copper coils. It's easy to build and use, simpler than the Beck units, and should provide borderlanders with years of workable ideas. Lou will not be selling these devices but will provide complete building plans in the JBR.

We received a call from Patrick Flanagan. He reports that he has a MWO unit built by Lakhovsky's son in Paris. It is a little box with a one tube white noise generator and it has a multi-stranded cable which wraps around the body. It shows that the evolution of Lakhovsky's device has taken a different turn among those who actually knew what he was doing. This unit is based on the Radio-Cellular Oscillator.

Also, Klark Kent (of Super Science, Box 392, Dayton OH 45409) just called to say that he has completed a run of Golden Ratio antennas from the original B.S.R.F. artwork. These are double sided (with inverse gap strips, to simulate the ball capacitance on the original tube antennas, on back) gold plated and are available from Klark for \$100 each. (These antennas have produced beneficial effects on plants without any electrical excitation. Many experiments can be done and the results quantified with various protocols such as those used by Rudolf Hauschka and Lilly Kolisko.)

There is no doubt that there is a new phase of MWO research being undertaken. For 25 years people built Beck's model, with many people claiming beneficial results, and others experiencing nothing but no one keeping track of results for evaluation. Thanks to Bob Beck's schematic (published by B.S.R.F. in 1963) the idea was kept alive and now people will have many ideas to choose from in their search for measurable effects from energies ranging from the gross electrical to the fine etheric. Thanks to everyone who has interacted on this ongoing aspect of our researches!

EVEN MORE LAKHOVSKY STUFF

Some time ago I bought your excellent handbook of the Lakhovsky Multi Wave Oscillator and due to pressure of other things have only just found time to read it. Interesting because it parallels some research done by myself and friends, or should I say we duplicated some of the original. This was only to be expected as the entire principle is so outrageously simple, too simple for establishment minds to comprehend.

I should like to offer a few ideas which might be of interest and in return I would be grateful for some additional information.

I helped develop the Betatron now sold by All-Source Systems, PO Box 596, Morton, WA 98356. The Betatron uses a TV Flyback transformer and is very similar to the Master Violet Ray devices. The nicest feature is that the applicator is an ordinary clear light bulb. Even a burnt out one will do. There are differences; some makes of bulb will not work at all, perhaps due to different gas fillings. The Betatron can also be used with the Lakhovsky concentric antenna with spectacular results. This of course has been done in the book's articles although as far as I know it was not actually copied, but was an obvious choice of experiment.

I have tried out an improvement which I did not see in the Handbook or

anywhere else, perhaps you will be interested. The Standard circuit whilst apparently covering a very wide range of frequencies, must, because of its inherent fixed inductance and capacitance have its own natural fundamental frequency. Our Betatron is around 21 Kilocycles (I refuse to use the meaningless term Kilo Hertz), and other units seem to be basically tuned to one fundamental even though they do stray and produce an almost infinite range of harmonics.

My first improvement is to substitute a "Jacob's Ladder" for the spark gap. This consists of two 1/4" copper tubes spaced 5/32" apart at the bottom and tapering outwards to 1" at the top then abruptly turning out at 1" radius. The spark travels up the ladder from bottom to top and is extinguished by the sudden increase of gap, then begins again at the bottom. This sequence takes place at about 2 second intervals. The whole point of this is, as the spark progresses up the ladder, the length of the tuned circuit is progressively increased, then suddenly decreased again ditto repeat. As the ladder is about 9" long the length of the tuned primary of the Tesla coil is progressively made 18" longer, then back to its original length. Thereby resonating at infinite numbers of frequencies within its range and delivering virtually the same power at all those frequencies.

A further improvement on this feature is to make the ladder a Spiral Staircase by using a solid rigid central electrode, say a 1/2" copper tube and the spiral be wound in an ever increasing diameter on the outside, the start being about 5/32" gap and vertical to begin with.

Alternatively the spiral can be the inside element wound on a porcelain former such as is used in radiant "bowl" heaters with a plain copper tube surrounding it or perhaps a perforated tube as used in decorative lighting fixtures. The spark winds its way around the spiral staircase and alters the frequency accordingly. The Spiral Staircase provides a much longer path and more variation in frequency range. I have not yet perfected this and ruined a few porcelain formers in the process. It requires some exact progressive increases in the travelling spark gap but there are no serious obstacles.

Both the Jacobs Ladder and the Spiral Staircase have the advantage of easily cooling the spark gap. We had experienced problems due to overheating of the electrodes in a fixed gap, even spark plugs transmitted the heat to other parts and carbonized insulation. The addition of a

cooling fan (the low power kind used in computers) provides a current of air which accelerated the progress of the spark up the Jacobs Ladder and more importantly up the Spiral Staircase. The spark is sometimes reluctant to leave its easy path at the base of the ladder and even more reluctant to wend its winding way up the coil, but the air flow does the trick and keeps everything cool.

The fan also helps remove Ozone from the enclosure. Ozone has the delightful habit of attacking insulation. It has also been blamed for respiratory illnesses. I am skeptical of the latter as I have breathed plenty of Ozone and found it exhilarating.

Master Violet Ray even included an Ozone Inhaler with its de-luxe model!!!, recommended for asthma, bronchitis etc. What's more M.D.s used it on their patients. Certainly Ozone is about the only thing which will quickly digest Carbon Monoxide in a hurry and it deodorizes a room when the cat has misbehaved.

The Betatron and Lakhovsky machine both can be used to destroy troublesome warts and moles, by simply wrapping a wire around the electrode and applying the point of the wire to the offending growth. I had some troublesome warts removed in this way by a Dermatologist. It was not until I got involved with this project that I realized the Dermatologist was using a Lakhovsky device.

He anesthetized the area first but I have since got rid of warts and moles without this. It caused some "Discomfort" which as any mother knows is worse than mere pain, but it was tolerable.

I hope the foregoing will be useful and will not be in the least surprised it has not already been done, but I would like to know what you think of it.

Regarding Spark Coils. I recently found at the local Flea Market, a small spark coil about 3 1/2" overall length 2" dia. with a sturdy vibrator assembly and a turret mounted sideways. It looked like a small steam boiler in fact. It is labelled "Coil, Booster, Battery Operated. Type C1, (24 Volts DC) Spec. #94-32182, Serial #96082, order #A,C 27073, Eclipse Aviation Bendix, N.J. Division of Bendix Corp. I don't know what it is for but on 12 volts it delivers a lively 3/8" spark. The absence of a Zip Code suggests it is fairly old, but this is the ideal driver for a compact tesla coil. I do not know if it contains condensers but I added some anyway. The adjusting screw has a click stop adjustment. Have you come across

one of these? It works well on 6 volts which is just as well as it draws a lot of juice and 8 D cells won't fire it.

Now a request for information about Lakhovsky Treatment and parts. Please Please. On my knees!! Where can I obtain High Voltage Capacitors as used in the Lakhovsky Machine????? I have tried all the surplus stores I know of in this area but the highest voltage they have is 450. I recently paid over \$50 for a 660 volt one for a 12 v trailer power supply and that was ordered specially from New York. HELP!!! I even tried making one from instructions in the Boy Electrician, a Sunday School prize from the 1930s. I used Acrylic 1/8" dielectrics instead of glass. They worked well for a time but soon tracked and failed. I don't fancy using glass plates any way but I desper-

ately need some H V Capacitors at less than Pentagon prices.

Re Treatments. One of the contributors to the Handbook reports that treatment with the Lakhovsky Machine resulted in the dis-appearance of underarm hair. (The report of decreasing underarm hair is from the Nov. 1968 Journal of Borderland Research by Mrs. E.H., Piqua, Ohio.) This is very interesting as I am a heavy construction worker, and after a hard day at the office I like to drop in for a cool beer and fraternize with nice hot ladies. However, underarm odor which results from my daily exertion and defies Right Guard AFTER for 2 hours, is a Repellant. I did find that shaving the offending fuzz helped a lot. Tearing it out by the roots was even better; it seemed to de-activate the sweat glands.

After I sprained my shoulder I used the Betatron all around the joint and have noticed that underarm hair now grows much more slowly, and I have much less trouble with B.O. I used the Betatron frequently and the Ozone removes any residual stink...

NOW the Big question. Has anyone succeeded in using the Lakhovsky machine to stimulate hair growth??? I have hair like Yul Brynner. Maybe some folks think its sexy but I find it repulsive and worst of all it makes me look and feel 20 years older at least without a hat. It seems to me that the machine could well be used to rejuvenate hair cells since it can reverse most other degenerative processes. Its a strange thing that men who are short on top have an overabundance of superfluous body hair in places where it is utterly wasted.

Has anyone done any research on this subject with the Lakhovsky Machine??? If so please let me know. I will be most grateful for any information and will of course inform you of the results of my own experiments.

It occurs to me that such a phenomenon could well dispense with the daily chore of shaving and make Gillette obsolete. I am forever disgusted that such a lot of life force is wasted growing hair on my face instead of where it belongs, On Top! Would be most grateful for your ideas.

I remember the Master Violet ray being demonstrated in a department store in the 1930s, I must have been about 7 years old. My mother who was with me watched the demonstration and I, of course, was fascinated. I said, "Oh Mom do buy one, it's just what you need for your rheumatism". Mother replied, "Oh no, You just want it to play with". How right she was. Well, in spite of all the quack devices which come and go, Lakhovsky in all his forms is still with us. That's recommendation enough. The AMA persecution of course confirms its effectiveness.

A Naturopathic Doctor saw me wearing a copper bracelet. He was treating me for arthritis, effectively with electro therapy etc. and asked if I really believed in the copper. I said "No", then he said "Why wear it?" "Because it works." He laughed and said,

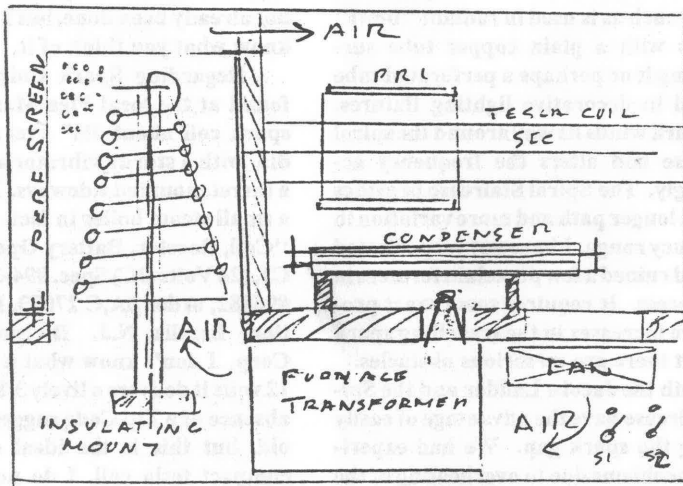
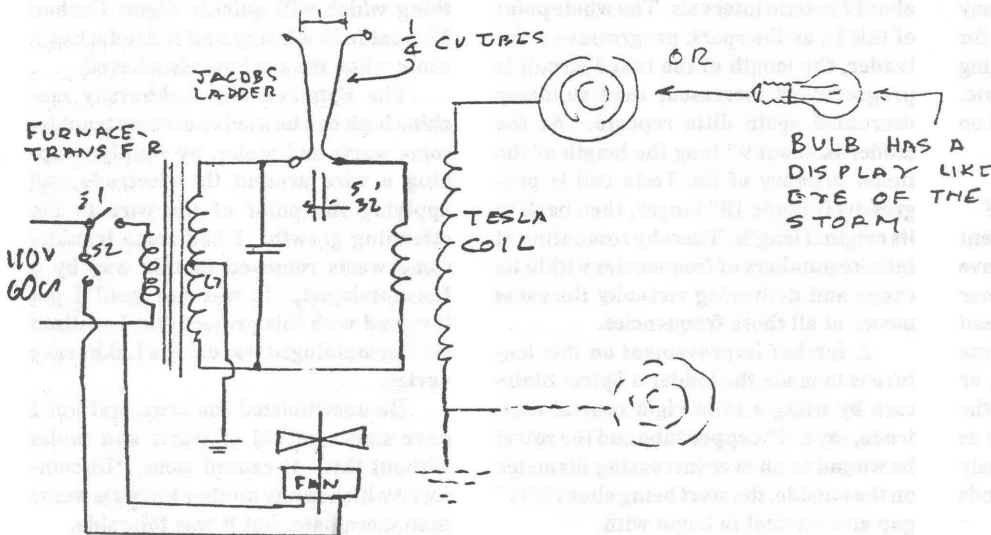

UNIT MOUNTED IN TYPEWRITER CASE WITH ACRYLIC FRONT COVER TO DIRECT AIR FLOW

"Look at that green stain on your wrist. That's copper salts and they are being ingested; maybe that's how it works, you might have a copper deficiency, well it's cheaper than pills."

Very Sincerely,
K.V.A.R., Washington

First off, without further ado, let me congratulate you on taking a stand on refusing to use the word Hertz to designate cycles per second. Why use mumbo-jumbo designators when simple English will do. Tesla said that the acceptance of the Hertzian theory would come to be seen by future generations as the greatest aberration of the scientific mind. Of course Tesla is probably rolling in his grave (at 3600 rpm?) at the modern etherless explanations of electricity. He, and others of his day, regarded the (transverse) Hertzian waves as the "waste" put off by coils. The Tesla (longitudinal) wireless system would have been worldwide (including radio and power), with the transverse waves engineered to a minimum, whereas the radio we have today, with the transverse waves engineered to a peak, fades out as one goes around a hill or a decent distance from the emitting source. This is dealt with much more specifically in THE THEORY OF WIRELESS POWER by Eric Dollard. Regarding use of the Jacobs Ladder as a spark gap, that is an interesting idea and thanks for sending it in. As far as your hair growth problems go, perhaps our other readers have further comments. You have provided a lot of food for thought, thanks!

HIGH VOLTAGE SOURCES:

Re: Nov/Dec Journal and inquiry of S.N. Capacitor 6KV (6000V) .0047 uF (which is the standard value, not .005!) available (\$4.90) from: Antique Electronic Supply, 6221 S. Maple Ave., Tempe, Arizona 85283. (602) 820-5411.

A.A.
Massachusetts

Source for high voltage equipment: Plastic Capacitors, Inc., 2623 N. Pulaski Rd., Chicago IL 60639-2190. Write for catalog (Dealer for above is Newark Electronics). Also recommended is Homemade Lightning: Creative Experiments in Electricity by R.A. Ford, ISBN 0-8306-3576-9, TAB Books, Blue Ridge Summit, PA 17294-0850. Can be ordered through your bookstore.

Simplified Tech Service
PO Box 2140A, Champaign IL 61825

In the Nov-Dec 90 issue S.N. of Alaska asks about a 6Kv .005 uf capacitor. Radio

Shack sells a 2Kv .01 capacitor #272-160. Three connected in series will be 6Kv .003 uf, another 3 connected in parallel across the first three will be 6Kv .006 uf. Six of these costs about \$3.

Regarding the MWO, when Hieronymus lived near me in Ft. Lauderdale I asked him about the MWO. He didn't recommend it because the broad spectrum of frequencies had both beneficial and harmful frequencies which could not be separated.

R.B.
Florida

Thanks for all the input on where to get HV capacitors. Also, thanks Ron, for Hieronymus' viewpoint. With the Beck style MWOs I would agree. A mass of radio frequency noise is generated. With Lakhovsky's original units driving structured antennas one could produce multiple wavelengths of a more refined nature. We don't recommend the MWO to anyone, that is not our purpose. This Journal acts as a forum to ideas such as these to be explored, and the MWO refuses to go away, rather interest is growing and it is time we closely examine the field. Read on...

THE BECK MWO

My MWO is a Beck model. It has successfully killed a skin cancer on the back of my hand. Yet I am wondering about its resonator. There seems to be no action, it's of no use and is as if dead. I did not realize that we are having trouble establishing a real Georges Lakhovsky MWO. This [enclosed] information from Europe may help clear up our need.

D.M.
Bryte,

A good puzzle truly has many pieces, so thanks for your experiences. I never said that the Beck MWOs didn't work, but that they are not the same as Lakhovsky built. The enclosed ad was for radionic and related equipment including MWOs from Radionic Instrumentation & Research, Dorset, England. It may be that this is the radionic type of MWO originally sold by Copen Labs. I honestly don't know a thing about these MWOs, so any info would be greatly appreciated especially a schematic. Years ago I had heard them spoken of disparagingly by people who claimed that they wouldn't work because there wasn't enough power, an argument I never bought. It would seem that the more subtle and refined the energy the more beneficial it is to the human organism. The field is still open for new ideas and fresh impulses...

May-June 1991 JBR, BSRF Bulletin Board

KLARK KENT CHECKS IN!

Just a note to say thanks for the mention in the Journal about the availability of the Golden Ratio Antennas from Super Science. And also to say that the articles on the continuing developments of the MWO are most welcome. Especially interesting is the comparison of the Beck MWO to the Lakhovsky original!

I have never seen an original Lakhovsky MWO. Only from the patent information can we really get schematic information, circuit diagrams, antenna structures, etc. As you know from all of the free energy patents circulating around, a patent wrapper and drawing is not really enough to produce the claimed device. If it were, then we should have many free energy devices in production today!

Several months ago a contact in New York made a generous offer to procure an original Lakhovsky MWO. I passed this information along to you and to others. So far no one has come forth to my knowledge with information leading to the whereabouts of an original Lakhovsky MWO. What this means is that we must grope our own way in replicating the technology first developed by Lakhovsky.

So I guess I owe Bob Beck a word of thanks because he was the one who made it possible for researchers to actually build a MWO. The information left to the world by Lakhovsky is (in my opinion) wholly inadequate to build and construct the device. The patent information is, like most patents, just not adequate to enable someone to replicate the device. And this brings up the question: Just what constitutes the original Lakhovsky MWO? We don't have an original device (and a bounty of \$100,000 has so far failed to produce one). The information given in the patents doesn't really tell us enough.

Borderland Sciences can help out by continuing to publish articles about the MWO which emphasize circuit diagrams and construction details. In this way, Borderland researchers can redevelop this important technology.

I enclose a letter we received from a customer. Since the letter is of the testimonial variety, it is best not to reference it in the Journal. But the point is that even a Beck adaptation MWO can seem to produce positive experimental results! Klark Kent, Super Science, P.O. Box 392, Dayton, OH 45409

Glad to hear you are open to new research. Lakhovsky left much information -- it just never got translated into English. BSRF will continually publish the results of ongoing MWO research, and will always be on the lookout for the best information available. Here is the letter submitted to Klark, from a person known to us here also:

Dear Mr. Kent,
At long last I get around writing to you and share some of my experiences with the MWO I bought from you.

The unit arrived on May 17, 1990 in excellent condition. Your packaging is superb. I inspected the unit superficially but, because of some professional problems, was not able to make use of it until October.

Let me comment first on general appearance and workmanship. While obviously not industrially produced, this is a well-built high quality machine, using fine components. Having been an electronics engineer part of my life (before I became a philosopher), I feel well qualified to make that judgement.

The instructions are generally adequate but I was glad that I did order your audio cassette, done by you with a fine dramatic flair, worthy of Christopher Reeve, who does resemble you. My suggestion: include the cassette with the MWO as a matter of course.

I used the machine about thirty times, sometimes daily, sometimes skipping a day or two for 35 min. per session, mostly in the High Power Radiator mode.

I suffered over a period of about fifteen years from a mild chronic bronchitis, some coughing in the morning with some phlegm, rest of the day just fine. The medicine men told me that I "just have to live with it". Though I am 70, I judge myself being in great health.

Now, your machine has definitely improved my condition. I know, of course, that my testimonial is worthless to you, since you cannot make, and do not make, any health claims. But still I thought you might want to know.

I do have several radionics machines (De la Warr and Copen) but we all realize that this is sympathetic magic; great stuff, though!

With best wishes, faithfully yours,
NAME WITHHELD

ELECTRONIC ENTITY REMOVAL

Judging by the letters you receive and print in the BULLETIN BOARD people

are still experimenting and building MWOs. It should be accepted that no two MWOs will be identical due to different components, circuits, etc. Also, Lakhovsky did not have some mystical secret that is exclusive to his particular instruments; he built one that generated his required multi-frequencies and there are no doubt many ways to effect this.

The large MWO I built in 1966 worked as well as I could expect and, although I never use it now, its circuit can be regarded as a basic Tesla coil, starting out with a 12KV neon transformer. Other circuits I have experimented with unfortunately appeared not to give the same results. Your MWO Handbook should be the starting point for would-be experimenters keeping in mind that most of the 'transistorized' models do not have enough energy to effect the desired results.

A major point that never seems to be mentioned is that the subject should be seated ON AN INSULATED PLATFORM with the antenna about six inches from the back. In this way all the cells of the body are raised to their full potential for, say, ten minutes during which each cell can absorb energy at its one resonant frequency. The subject should ground himself for an instant before stepping off the platform. Then switch off the instrument. I found this procedure mandatory to obtaining positive results and have found it odd that this point has never been mentioned in the literature.

I might also bring up the very real possibility (discussed with Riley Crabb in the past) that at least part of the positive results obtained with the MWO could be attributed to the removal of spirit entities by the high voltage involved. Regrettably, Borderland appears to skirt this issue.

As I have stated before, the Journal is an important platform for the meeting of the minds and I wish you well in your efforts.

R.M.
Nevada

Appreciate your input and valuable ideas. I'm certainly open to the possibility that the results obtained from the MWO could be attributed to the removal of spirit entities. This should also bring up the question of whether or not what is perceived as spirit entities (negative in this sense) could be also related to their potential physical anchors, i.e. virus and bacteria. Maybe we see the same thing but interpret differently.

As far as using different configurations

to achieve multiple wavelengths, different arrangements will produce qualitatively different results. A French horn and a clarinet will show the same frequency for the same note played, but the difference in quality of sound should be obvious to all. The major difference between the hookup of Lakhovsky's and Beck's units makes them fall into quite separate categories. A silver bell rings finer than tin.

MWO REPORT FROM FRANCE

I finally managed to get hold of my friend (see BSRF Bulletin Board, Jan-Feb 1991) but he is very, very busy and only gave me some of the information I wanted.

Firstly, he declined to provide any basic layout of the MWO because he says no two units were the same. Apparently Lakhovsky experimented all the time and each machine was a "one-off" model, different from the others.

The origins of the MWO are in Tesla's work. A French professor, Mr. D'Arsonval took some of Tesla's equipment and modified it. Lakhovsky used D'Arsonval's work to build his machine. Tesla heard about D'Arsonval's experiments and, convinced that D'Arsonval was stealing his patents, came to France with the idea of starting legal proceedings against the professor. However, he found D'Arsonval so courteous and charming that he returned to America having dropped the idea of court action.

My friend tells me that the whole secret of the MWO is in the "diffuseur". He further indicated two sources of information, both in French. A series of books have been written and published by the Study Group "Arkall" called "L'Emergence de l'Enel" dealing with all aspects of the MWO. The second source is George Lakhovsky's book "L'oscillation cellulaire" which has been re-edited in Belgium. Unfortunately, my friend did not know the editor, so I suggest you will have to contact the American Embassy in Belgium and they should be able to give you addresses of bookshops where it can be obtained. Apparently, this book gives all the references concerning the people I have mentioned.

I'm sorry I can't be more helpful but the whole question seems to be much more complicated than I at first thought. In short, I'm afraid you will have to wade through "L'oscillation cellulaire" and the "L'Emergence de Enel" to see how Lakhovsky himself worked out the idea of the first MWO's.

R.C.
France

Thank you, your input has been most valuable and stimulating. The "diffuseur" (literally: loudspeaker or nozzle) would probably be the antenna, so the "secret" could very well be (as we have intimated over the years) in his mathematical arrangement -- a much more important consideration under Lakhovsky's antenna feed arrangement than with Beck's.

Jul-Aug 1991 JBR,
BSRF Bulletin Board

MWO CORNER

Received the Journal yesterday and was very excited about the Spiral Coil MWO. I congratulate Mr. Schad on doing a very good job and would submit the following input for future models.

1) No aluminium tubing should be used. Copper or steel tubing should be used instead. Aluminium is wholly negative. It attracts negative radiation like honey attracts flies. In this connection, I heard this morning on the British radio that a "mobile home" site had just been devastated in the USA. If I'm right, "mobile home" site means trailer park, in which there is a huge quantity of Al. These are prime targets for tornadoes and all kinds of negative influence. My chief reference for this is Dr. Starbard Webb, Box 200, Orangevale, CA 95662. She has been studying the subject since 1956 and has accumulated a mass of data. Be patient for she travels a lot in the States doing seminars etc.

2) The rest is from a Tibetan lama to whom I showed the drawing. If you're wondering what a lama would know about the MWO I would say that they seem to know about everything that matters. For instance, in my own field (medicinal plants), their knowledge is not great, it is simply colossal, far beyond anything known in the West. The Lama tells me that there should be 12 coils, no more no less (Fig. 6). The "up" wire (see illustration) should be five times longer than the diameter of the coil. No doubt further information will be forthcoming when the whole of the MWO is described.

Yours sincerely,
R.C.
France.

Glad to hear of your suggestions for further research on Lou's spiral coil MWO. His articles have stimulated a lot of work that should provide a lot of new ideas over time. Peter Lindemann has taken Lou's concept of physical vibration and is experimenting

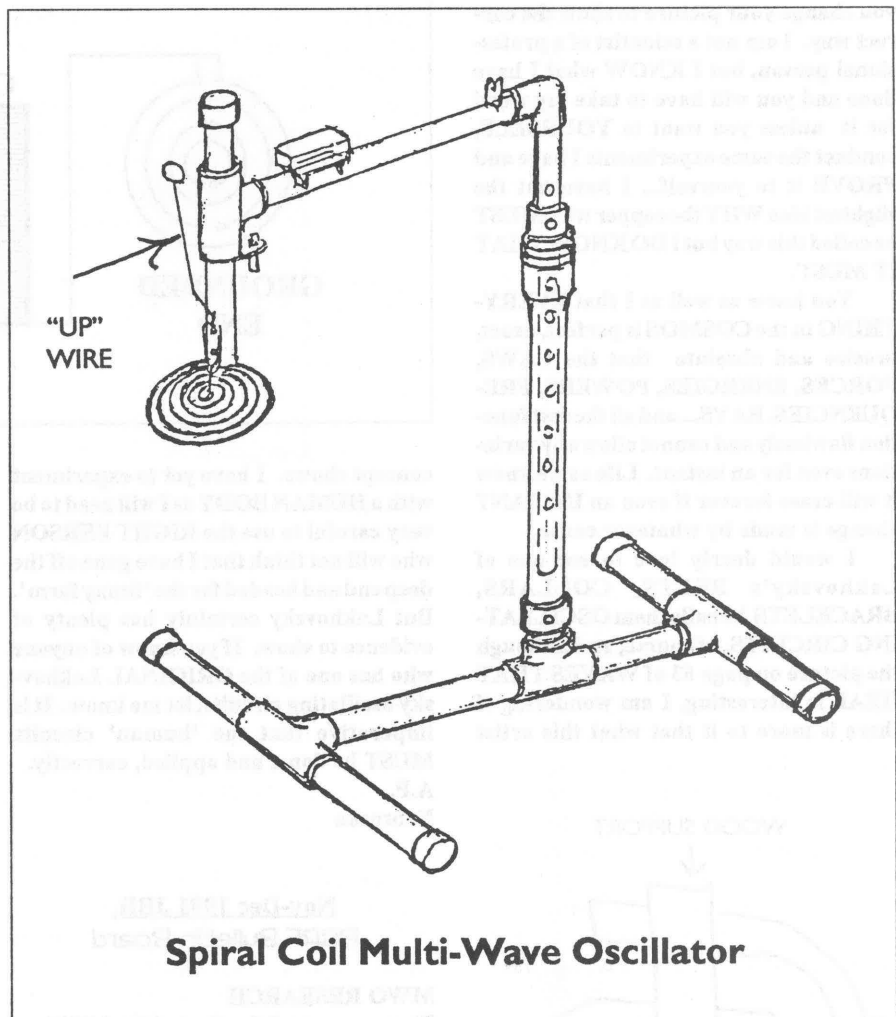

Spiral Coil Multi-Wave Oscillator

with phi ratioed antennas that are stimulated with sub-audible sound. Also, Lou called to make sure that it was clear that the antenna side facing the subject is a counterclockwise spiral. It is clockwise from the top.

Interesting thoughts on the mobile homes, which are reverse orgone accumulators. A few items congruent with your comments have showed up over the years and perhaps we can get more on that in an upcoming issue.

LAKHOVSKY COIL INFORMATION

The following was forwarded to us from Health Research, Box 70, Mokelumne Hill CA 95245:

On Health Research's flyer for THE HANDBOOK OF UNUSUAL ENERGIES, the artist shows the copper wire positioned incorrectly through the wood support.

I have made a number of discoveries which I even find hard to believe by using this COILED COPPER WIRE. I expect to write a booklet on my findings and you

may want to represent it in your sales catalog. I have proven over and over again what I have done but, to date, have not shared anything with anyone else. I had to be ABSOLUTELY CERTAIN before I 'went public'.

When I first received the books THE SECRET OF LIFE and THE WAVES THAT HEAL from you about 4 years ago, I noted carefully just how the copper wire was COILED around the plant. Please note that the copper wire STARTS from INSIDE THE EBONITE and MOVES COUNTER CLOCKWISE and then ends ABOVE the ebonite... This is shown on page 14 of THE WAVES THAT HEAL and page 110 of THE SECRET OF LIFE.

In the past four years I have made dozens of experiments and I've gone far beyond what even Lakhovsky did or thought of. NOW, to prove my point about the proper way the copper MUST be coiled, I deliberately experimented by coiling the wire the way you have shown it and NOTHING HAPPENED in all my experiments. That's why I KNOW THAT

I AM RIGHT and it is imperative that you change your picture to show the correct way. I am not a scientist of a professional person, but I KNOW what I have done and you will have to take my word for it unless you want to YOURSELF, conduct the same experiments I have and PROVE it to yourself... I have not the slightest idea WHY the copper wire MUST be coiled this way but I DO KNOW THAT IT MUST.

You know as well as I that EVERYTHING in the COSMOS is perfect, exact, precise and absolute that the LAWS, FORCES, ENERGIES, POWERS, FREQUENCIES, RAYS... and all the rest function flawlessly and cannot allow any variations even for an instant. Life as we know it will cease forever if even an INSTANT change is made by whatever cause.

I would dearly love to see one of Lakhovsky's BELTS, COLLARS, BRACELETS he calls them OSCILLATING CIRCUITS, of course, and although the picture on page 63 of WAVES THAT HEAL is interesting, I am wondering if there is more to it that what this artist

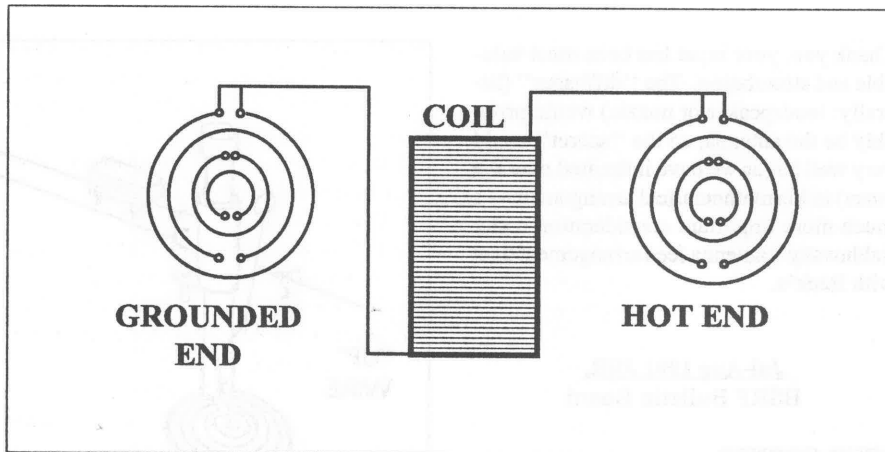

concept shows. I have yet to experiment with a HUMAN BODY as I will need to be very careful to use the RIGHT PERSON who will not think that I have gone off the deep end and headed for the 'funny farm'. But Lakhovsky certainly has plenty of evidence to show. If you know of anyone who has one of the ORIGINAL Lakhovsky oscillating circuits, let me know. It is imperative that the 'human' circuits MUST be done, and applied, correctly. A.P. Nebraska

Nov-Dec 1991 JBR,
BSRF Bulletin Board

MWO RESEARCH

Five years ago I duplicated the MWO as best I could with my limited knowledge. I scaled up the antennas from the book WAVES THAT HEAL using copper tubing of all different sizes and soldering brass hex caps of various sizes on the ends after I rounded them off with a grinder. The outside ring was about 2 ft. across.

I was able to duplicate the exact brush discharge pattern in the picture with Tesla coil 4" diameter with about 1,000 turns of regular hook up wire. 500 turns gave a discharge of 2"-3" evenly all around the outer ring. 1,000 turns gave a discharge of 5"-6" at the bottom with less and less towards the top except for some off the two balls at the top, like in the picture.

I found it necessary to run two connections from the feed wire otherwise with one connection the spark would travel around the ring and out the other end burning anything used to suspend the ring. Two connections eliminated this problem forcing all energy towards the bottom of the ring like in the picture.

The resonator was grounded just like the Beck model to the ground end al-

though I used two wires one going to each end of the outer ring. Even so, at this power you could draw a small spark off the outer ring and if you turned the unit off and on you could hear the resonator ring just like it was struck by a small hammer.

I used a 30mA 15,000 volt sign transformer or stronger. These tend to burn out unless you put the primaries of two in series to share the load and restrict current. Actually, I started using half burned out transformers using mid point ground and the good half for 7,500 volts which is much safer for the capacitors. I used two .005 uf 20,000 volt capacitors in parallel for .010. The stationary spark gap was air cooled with a small blower fan.

There was no spark between rings. The side effects from this unit were too strong to continue treatments so I am now working on smaller units. After 15 minutes your head would be full of mucus. The closer the antennas were to each other the stronger the effect to the point of making one very nauseous.

Also, did anyone else purchase and test Dr. Charles T. Turley's square wave sound MWO two printed antennas powered by a sound generator?

J.A.
Ohio

Thanks for your most helpful input. Would be most interested in Dr. Turley's MWO as it may very well relate to Lou Schad's spiral coil MWO, presented several issues back, which worked on physically vibrating the coil. Peter Lindemann has picked up on this and is experimenting with vibrating the antennas with sound waves and through other mechanical means. A whole new field of MWO research is opening up and it sounds like Dr. Turley is working in the same direction. Please send us any information you may have on this. Thanks.

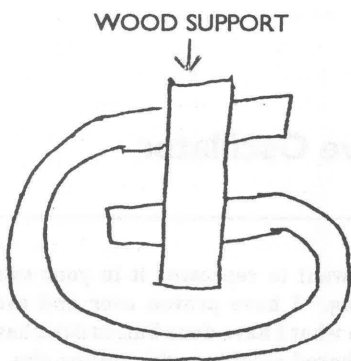

WRONG

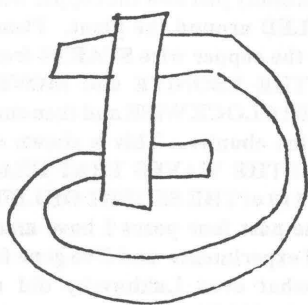

RIGHT

From the March-April 1992 JBR
BSRF Bulletin Board

MWO CORNER!

Here is a nice present for you and your readers. Some tidbits about George Lakhovsky. I phoned my knowledgeable friend on Sat, 14th Dec. To my surprise not only was he at home but he invited me to spend the afternoon with him the following day.

Firstly, it is comforting to know that there are still about four original MWO's within a radius of 200 miles from Paris, and the people who have them are likely to take good care of them.

Secondly, from what I can gather, L. took very great pains with each MWO. I understand now what my friend meant when he said that each one was different. L. would calculate all sorts of parameters relating to the place where the MWO was to be used. He would then do the "fine tuning" with the help, sometimes, of an unusual cleric Abbe Breuil.

L. arrived in France around 1896. He was a friend of Tesla and when the latter came to France the first person he wanted to see was L. I don't know anything about this early period but two episodes occurred later which gave L. quite a bit of money and enabled him to finance his future research himself. 1) During the 1914 war, there was a dearth of methylated spirits in France and L. negotiated supplies, on behalf of the French government, with the Russians. 2) He invented a gadget which was used everywhere on the French railways and which brought in tidy sums in royalties. He was thus able to invite titled people to his table, the Count of this and the Duke of that and, of course, Abbe Breuil. This curious cleric was very well known in France, not for saintly endeavors on behalf of the Church but for his exploration of caves in search of traces of early man. He became the High Priest of Pre-history. However, what interests us here is that he was an extraordinary medium. For instance, L. at table, would say something like this: "Abbe, I've just thought up a new design for the MWO (passing him the drawings) what do you think of it?" And the Abbe might reply: "The antenna's too thick here, you should take 1 millimetre off and here, you are using the wrong kind of metal." In this way, L. gradually refined each model, using the Abbe's intuition to verify his own findings, until he got it as near perfect as possible.

What follows is a translation of the

notes scribbled down by my friend yesterday. I offer no comments because I wouldn't know a Hertz dipole if I fell over one in the dark.

These are some of the parameters taken into consideration by L.

- 1) Diameter: D.
- 2) Thickness of the wire of the tube (not to be confused with the section).
- 3) Distance "e" between the two ends.
- 4) Orientation of the circuit with respect to the horizontal plane (29° 70' N).
- 5) Kind of circuit. Should it be made of metal or hollow glass containing chemical salts.
- 6) Orientation of the distance "e" with respect to the magnetic North.
- 7) Study of the terrain: the mineralogical, geological, geodesic and tectonic factors.
- 8) Study of the nature of the surface of the circuit and whether and how it should be covered.

I see now that what I had taken for solid rods making up the antenna were in reality hollow tubes.

I hope that you and your readers will find this information interesting. It sheds a new light on how L. operated. He used the pendulum a lot and, as we have seen, the mediumistic talents of his friend Abbe Breuil. My best wishes to yourself and to BSRF in 1992.

R.C.
France

Your input on the MWO project has been most helpful to everyone trying to find the truth of the story, and I offer my thanks and I'm sure the thanks of BSRF members the world around. Georges Lakhovsky was a complex individual whose ideas on cell regeneration have ignited many a seeking mind. It seems as though he had some rather interesting friends also, Nikola Tesla, Professor D'Arsonval, and the curious Abbe Breuil! Your friend's comments indicate some important factors in Lakhovsky's considerations: He was very concerned about the orientation towards the natural energetic lines of the earth, even considering latitude (what you have termed the horizontal plane) as a determining factor in the energetic output of his devices. He must have been aware of the interaction of the electric output with the planetary magnetic, electro-

static and etheric fields. He was also concerned about the underlying earth itself. In his *Secret of Life* he proposes his theory that cancers are more predominant in areas where the soils (such as clays) reflect the cosmic radiation back to the surface, causing interference patterns that disrupt the body's energetic flows. It is interesting to note that his antennas were constructed with all these factors involved. It is also very interesting that he relied on the pendulum and the mediumship of Abbe Breuil for his refinements. Lakhovsky was a true borderland scientist! Also of note is your point #5 mentioning the hollow glass circuit containing chemical salts. Something new to figure in our researches. We also have the open question of whether or not some of his tube antennas contained rare gases, which his MWO Tube Patent implies by its refinements in miniaturization. This has been an exciting period of discovering what Lakhovsky was really up to in his vast researches. Please read on....

A REAL LAKHOVSKY SCHEMATIC!

This schematic is from a Lakhovsky Radio Cellular Oscillator manufactured by Lakhovsky's son in Paris long after the untimely death his father in the early 1940s. It shows that the Lakhovsky's own family followed the path of the radio-cellular oscillator and not that suggested by Lakhovsky's turn to damped electrostatic power supplies in his MWO. Our many thanks go to Patrick Flanagan for providing this information to BSRF. Patrick obtained the unit, removed the seal at risk of voiding the warranty, and provided us with the circuit description you see here. Also, a special thanks to Roger Modjeski of RAM Tube Works of Santa Barbara, California for providing the pinouts and tube conversion info. As far as our extensive research notes show, this is the first real, complete schematic of an working Lakhovsky device that has been published in the US!

This unit, which fits in a small box that can be held in the hand, is a very powerful white noise generator with a treatment coil comprising of coax cable which is looped around the subject when in use. The treatment coil loop is 1 meter in length, the center wire and shield are connected. This unit will interfere with electronic communication devices up to the satellite TV range, and may be illegal to operate under FCC rules. The tube is an EL83, a French tube (Telefunken manual gives the German number as PL83) whose US equivalent is given as a 6CK6 video output pentode, but GE never made them. It is very similar in function to a 6CL6 which has a different

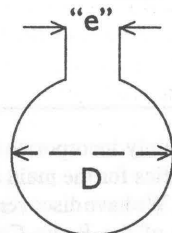

Hertz dipole
MWO antenna

Lakhovsky MWO/Radio Cellular Oscillator submitted by Patrick Flanagan

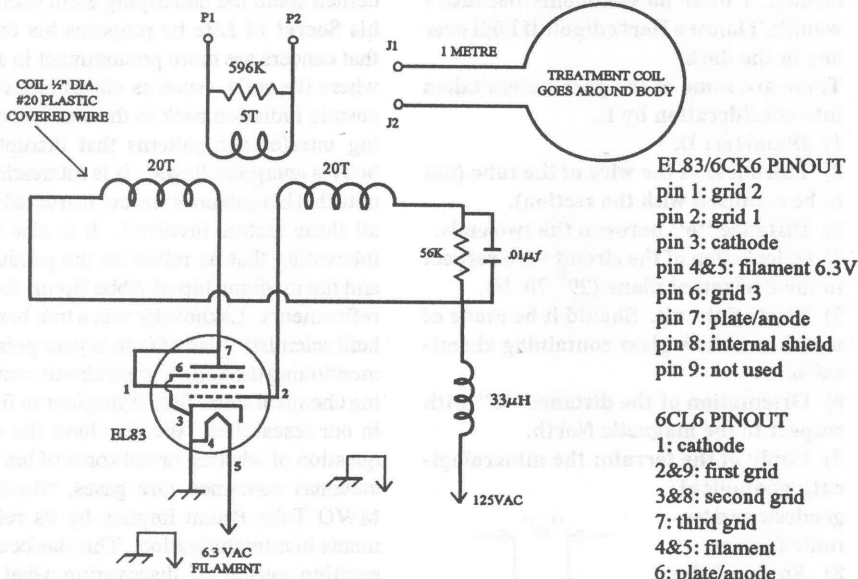

pinout. We provide the pinouts for both. The 5 and 20 turn coils are 1/2 inch diameter tightly wound with #20 plastic coated wire. They are air core and all three are wound in the same right hand direction. They are spaced tightly and arranged exactly as shown. Varying the physical distance between the primary and secondary coils would vary the output strength. The resistors are 1/2 watt. The .01 capacitor is ceramic at 500 volts. The choke is 33 µH. The power supply is not shown, but is implied by the circuit.

We have no exact details of the interaction of this generation of Lakhovsky device with the human system, only that suggested by Lakhovsky's original RCO research and its extension through time. This data is provided for research purposes and to record yet another development in radio-biological research.

We would still be most interested in finding the schematic of one of the original MWOs pictured in Lakhovsky's various publications such as that pictured below from his book *La Terre Et Nous (The Earth and Ourselves)*, Fasquelle Editeurs, Paris, 1933, as it would provide the exact antenna feed for the concentric ring antennas and other pertinent details. Note that the antennas on this unit stand above the arm, unlike the well publicized pictures from *The Waves that Heal* and *Secret of Life*. This indicates that the protruding spheres seen in the detail on those pictures have a mechanical function, perhaps more important than their electrical function, though with Lakhovsky's methodology, he would

certainly incorporate the optimum characteristics for the main antenna feeds. We have discovered the basic construction of the Radio-Cellular Oscillator and know that Lakhovsky moved from them to the MWOs with damped electrostatic power supplies and concentric ring antennas because of the potential for thermal shortwave

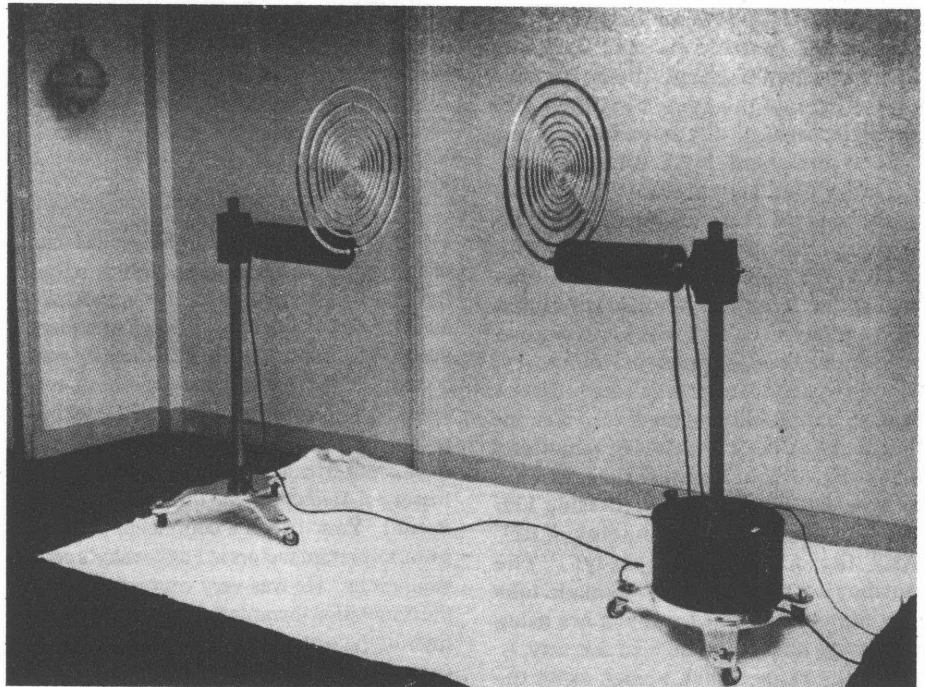

The complete Lakhovsky Multiple Wave Oscillator apparatus which creates an ambient electromagnetic field between its two resonators.

damage from continuous-wave radio frequencies. But then we see that Lakhovsky's son was still manufacturing RCOs after the death of his father! So we can see that the final conclusion has yet to be drawn as to exactly how the original MWOs were built, and of course we would also like to see some actual MWO Tube units that Lakhovsky patented. We also see the RCO as a potential low-cost method of researching Lakhovsky's basic theory of radio-frequency cell regeneration. This MWO Handbook contains the essential keys to all our questions and more. Much research has to be done and Borderland Sciences is willing to help any serious researcher who wishes to pursue these streams of activity.

The Journal of Borderland Research is the publication of record in the English language for these and many other research subjects. Please join in and exchange information with us. Without the help of the many borderland researchers sending us their ideas for over a quarter of a century this book would not exist. Thanks to all and best wishes on your researches -- may they be serious, straightforward, and well documented for others to learn from.

Tom Brown

From the Jul-Aug 1992 **Journal of Borderland Research**:

MWO REPORTS

Please allow me to input these comments about the on-going search for the ultimate MWO, and most especially for a working model of Lakhovsky's alleged cure-all MWO. I submit a slightly different configuration of a MWO and wish to add some findings and opinions of my own. Let me say to any or all, these are only opinions backed with some results of a beneficial nature, yet still personal and so accept whatever you will and discard anything that does not have an affinity with your own feelings and thoughts.

I have read many times in the **Journal** and in the **MWO Handbook** of those who used any of the many modalities who did then experience a feeling of nausea and other internal discomforts. It seems that no one has understood the reason for this and assumes it has something to do with frequencies/power. Not so. This is only a result of the ozone produced by either the spark gap, antenna, or the atomic and sub-atomic particle wave ions penetrating the organism and therein transmuting to ozone. Anyone who has ingested hydrogen peroxide during oxygen therapy would immediately recognize the taste, smell and effects of oxygen such as H_2O_2 , and thus O_3 (ozone) is more intense not only in its slight discomfort, but in the benefits derived therefrom.

When any MWO of whatever configuration is activated the HVHF is producing billions of ions which are electrically activated atoms and these are passed from the antenna to the body and within to a depth determined by frequency/power and so in this respect frequency/voltage is important but only to produce/drive the ions which are of oxygen, hydrogen, nitrogen, copper from the coils/antenna and... anything that one would affix to the antenna.

These ions, at a speed exceeding 60,000 miles per second penetrate the integument into the tissue to a greater or lesser degree de-

pending upon the above stated factors of oscillation/voltage where they become O_3 . Too, with a pulsating break of 11 to 13 Hz before the primary of the power transformer there will be an added stimulation of nerve endings/synapses producing a metabolic increase.

Then, with the diagram submitted here of an instrument producing much ionization and an intense electro-static field in conjunction with multiple waves reaching many millions of Hz, along with a means of manual control of frequency and static field the ultra-high voltage is taken into the body. Thus we combine most of the ideas advanced by others than Lakhovsky.

I submit that it is the ozone that is the primary healing agent. Not only that produced within the cellular tissue but especially that breathed in from the generator. Long before Lakhovsky doctors were using ozone cabinets and portable chambers for this therapy with excellent results dealing with tuberculosis and what we now call emphysema. The serum levels of oxygen will be greatly enhanced by this method and may be verified by means of a blood test.

No alien viral invader will long survive in the presence of intense oxygen. This statement includes plant, animal or human. So I repeat: I do not consider any frequency of any value in the treatment of any disease. However... The frequencies and the sufficient power to drive them will do this: The oscillations, if resonant with the many groups within the body will cause the cell membrane to open and so allow the ozone producing ions to penetrate to the mitochondria, and thus either stimulate the cell as a friendly agent as with any vitamin or mineral, or will act as a warrior and slay any alien microbial/viral invader. Acting as a natural booster protector of the immune system.

So with the correct group of frequencies we effect the cell only by causing harmonious and friendly resonance that allows the ion in. To think that the cells are

directly affected would require many hundreds of gigahertz and would even then prove more harmful than healing.

The diagram of the instrument submitted is driven by a 15Kv/30ma/450va neon transformer and is enough power. However I have used a 750va and 900va with a corresponding increase in the other components but that is not necessary.

Perhaps the most important item is the 1" copper pipe flattened on one end. This, when held to the antenna or the outer static ring causes a 10x increase in frequency by using the capacitance of the body. By slowly approaching the antenna with the flattened end the electro-static field is also increased so that the entire body is stimulated and especially so if the person is seated within two feet and leaning toward the antenna. With a 900va unit and using a six foot diameter static ring of 1.5" copper the field is so intense as to cause some of the phenomena associated with a Whimshurst generator.

Excuse this long-winded comment, and yet it is not long enough to relate the various effects observed both personally and upon cats, dogs and birds with serious disease. For myself, and I submit this is purely anecdotal, at age 69 I jog/run from six to ten miles each morning for four days per week. I lift a lot of iron three days per week in addition to much work in my garden and upon the grounds here. I had my last cold in 1969 and have never experienced any of the many influenzas. My cholesterol counts at 152. My blood pressure is 120/70. I do have diabetes, (adult onset) but this is a result of genetic disorder and is of no problem.

As we all know: if the catalyst of disease is determined by pre-incarnative choice little can be done unless the person is willing to let go of the underlying cause which is deep within mind. If a person has so distorted the endocrine system by whatever means and especially anger and the desire for control over others, then these glands will be damaged and here the instrument is of help. Still...

only the etheric body and the deep levels of mind can produce health. The etheric is perfect and is the form maker and is the holder of the energy centers called chakras which have their physical counterparts in the endocrine glands. Let go of those old demons of the ego, anger and fear. Then you will remove the materializing influence of negativity from your awareness. You will, then, emerge from illusion and set up a powerful resonance: a morphogenetic field that radiates outwardly and inwardly that not only heals self, but other selves with whom you may come in contact.

I submit finally, that the solar light is radiating at a frequency of perhaps 600 trillion cycles per second (600 gigaHz). It is not that these etiolated frequencies cannot be obtained, but what would happen if directed at delicate tissue? A rapid burning as with a microwave oven and a total dehydration. The cells, too, are taking from this great ocean of frequencies and utilizing frequencies of from perhaps 100 MHz up to and exceeding 900 MHz. But... they are doing this naturally and yet even so, sunlight does burn, does dehydrate, does act as a carcinogenic. The instrument herein submitted, while producing up to 400-500MHz does not cause heating and yet one should wear welding goggles to protect against any danger of cataract forming from arcing/sparking.

I would appreciate hearing from any researcher who builds and uses this system/instrument. If I can answer any questions pertaining to operation or construction I will be happy to do so.

Sincerely,
T.H., Cimarron, New Mexico

** I am getting so weary of reading articles about MWOs, that I feel that I should either attempt to clarify on this issue a bit, or just quit reading the material. I don't really wish to do either, but as you requested feedback, perhaps this should be done.

I own a MWO which was built by Klark Kent of Super Science. It

allegedly was built with a Tesla Coil incorporated into it. I have had no other machine to compare it with, therefore I can only base my findings on that particular model and design. I find that for my needs it works totally and beautifully. In design, it is a work of art.

I suggest that ANY of the myriads of designed MWOs also perform adequately. Why? Because their sole purpose is to convert an unusable form of electricity into a usable form of electricity. Why? That's the sixty-four dollar question. What use does one want for it? Why does one wish to transmute electricity? As far as I know (which leaves a wide gap of ignorance) there is but ONE use for this particular instrument. I will leave off this subject with one more hint. In my opinion, laboring with a radiator antenna is just that, a labor in ignorance. One might wish to experiment with the transmuted energy AND a violet ray apparatus INSTEAD OF constantly trying to build a better version than already is in existence.

There is one other factor that has to be in this "equation" if one actually want to find their answers to their present dilemma. That factor is something I call GOD. GOD works WITH one, but not FOR one. In my life, that has been the most

important part of the equation.

You have my permission to reprint this letter if my name and address are left off. I insist upon total anonymity. If times were different, if people in general and scientists in particular were more in balance and therefore more courageous, I have no doubt that this issue could be resolved. As it stands, humanity is funding its own demise. It's an interesting time to be alive.

Thank you for your efforts in keeping open a forum of opinion not common any longer in this country. Please continue with your efforts to do so.

With kindest regards,
Name withheld upon request.

Thanks for both of your insights. Oxygen? God? You're both right and on the right track. We're a bit tired of it all ourselves, for the main reason that we are not trying to build a "better" MWO, but are trying to discover the original, which would dramatically regenerate diseased tissue unlike any of the modern variations. We are not picking at straws, but pointing out a major discrepancy in the information that BSRF has been publishing since 1963. We have come into contact with Serge Lakhovsky and have requested a schematic of the original unit. With the publication of that, if received, we will labor no more other than to report on actual experiments. [Thomas J. Brown]

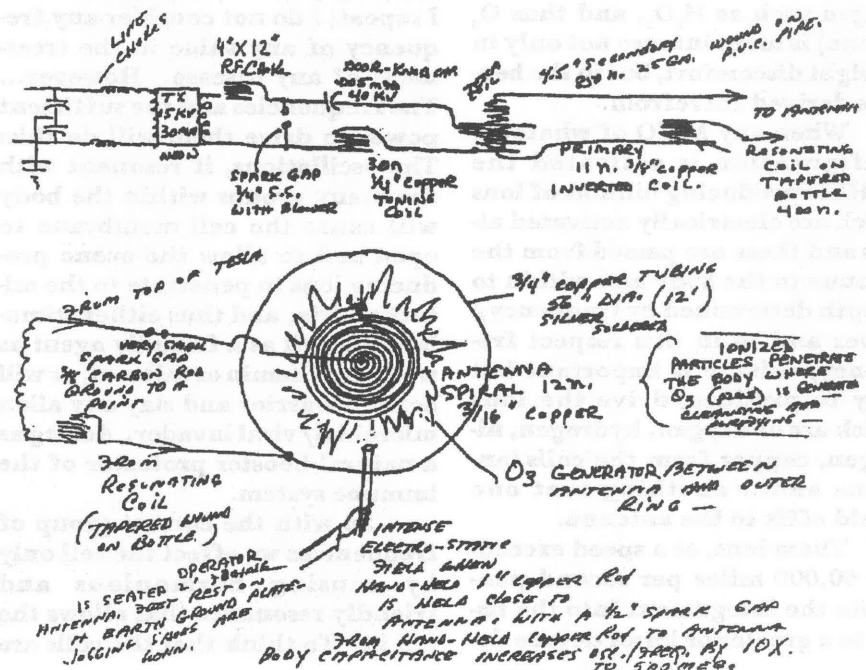

ON THE TRAIL OF THE LAKHOVSKY M.W.O.

by Jorge Resines

INTRODUCTION

When I wrote "The Lakhovsky Radio-cellular Oscillator" (Jan-Feb 1992 JBR), making a synopsis of information released by Georges Lakhovsky himself, I indicated my doubts on the quality of the information, and in the end, how in my opinion he was pursuing (at least) two very different lines of research. Later, I thought it proper to have a greater understanding of the technology from Lakhovsky's time of early researches, so I went in to the library of the Argentine Scientific Society to try obtaining more data.

My search was rewarded with the book *Les Ondes Electriques Courtes (Short Electric Waves)* by Mr Rene Mesny, the French Navy's Professor of Hydrography, which was no more than the publication in print by Les Presses Universitaires de France (Paris, 1927) of a lecture given by him.

In this present writing I will show the schematics given by Mr Mesny together with a brief explanation (based on his writings) and the corresponding reference publication, so that whosoever wants to know more on the subject can go directly to the source. This I do because many of the references given in Mesny's work are not available to me; hence, I will also refrain from a deep analysis of the information for the present.

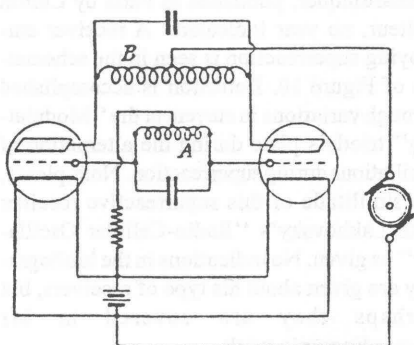

Figure 1

In the early days of radio, there were problems associated with the generation of short waves, due not only to the primitiveness of the equipment but also to defective manufacturing. Figure 1, directly above, is a "symmetrical arrangement" employed to circumvent those troubles for the oscillations generating the short waves happen only in oscillating circuits "A" and "B".

You will notice how AC and DC were mixed in a single circuit; this feature is almost non-existent in today's broadcasting equipment.

A simplified version of the symmetrical arrangement is seen at Figure 2. Please notice how close it is to the Lakhovsky Radio-Cellular Oscillator that I have shown as Figure 9 in my former writing. The only difference seems to be the replacement of the DC batteries in Figure 2, by a filament/high-voltage transformer.

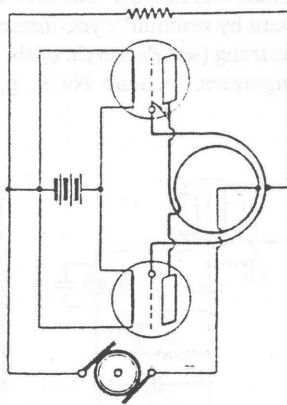

Figure 2

Now, one interesting feature that must be in every wave-broadcaster is a stable frequency. One such frequency-stabiliser was invented by the French Radio-Electric Society and is shown in Figure 3.

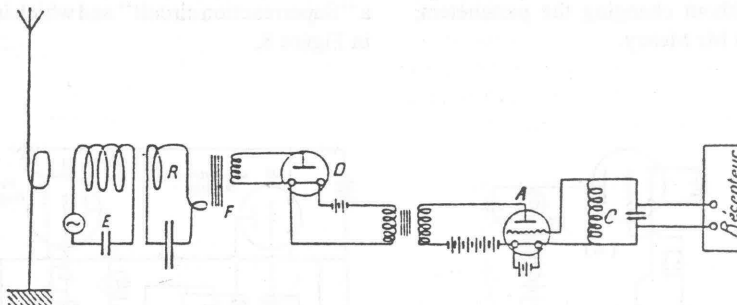

Figure 3

It employs iron's properties of magnetic saturation (see the magazine *Onde Electrique*, Volume No 5, pp 237-263, June 1926) and it uses a powerful triode "A" which generates oscillations directly into circuit "E", exciting the antenna directly. Coupled to "E" is

the circuit "R", wound partially over an iron-core "F". Any variation in this core's saturation will change its permeability and consequently the inductance in "R", allowing either an increase or decrease in broadcasting. The whole setup shown is, according to the French text, an emitter; yet at the extreme right appears the word "recepteur" meaning receiver. Maybe an analysis of the whole original reference in *Onde Electrique* magazine will show the reason for this discordance.

The "great-granddaddy" of today's satellite TV antennas appears in Figure 4. It is a parabolic reflector of 340 centimeters in wavelength and an aperture of 600 centimeters. Its job was to focus in a narrow beam (with the minimum of dispersion for that time) of the broadcast. While reading *Waves That Heal* by Mark Clement I found out that the MWO had a transmitter and a resonating receiver, yet there was no specific technical data pertaining to either in the book. I, for one, would like to know what led Georges Lakhovsky from the Radio-Cellular Oscillator (as already explained) to the Multi-Wave Oscillator in which the antennas differ from those of the time, such as the one seen in Figure 4.

As for the receiver themselves, Mr Mesny quotes the work *Les Lampes a Trois Electrodes* by one Mr C. Gutton (Also published by Les Presses Universitaires de France in the collection *Conferences-rapport de documentation*) indicating something not usually thought of nowadays such as including negative resistance in the circuit. One kind of this circuit is seen at Figure 5, Where the coupling is by means of (ferro-)magnetism and the received broadcasts are heard through the earphone "(E)".

Figure 6, shows us a coupling that is effected, at the same time, by ferro-magnetic and electric means. Mr Mesny indicates the

most used arrangements are those made by one Mr Reinartz and one Mr Bourne.

The idea of using negative resistance in a circuit was first suggested by one Mr E. Fromy (See *Onde Electrique*, Volume No 2, pp 168-173 and 636, 1923) and a simple circuit is

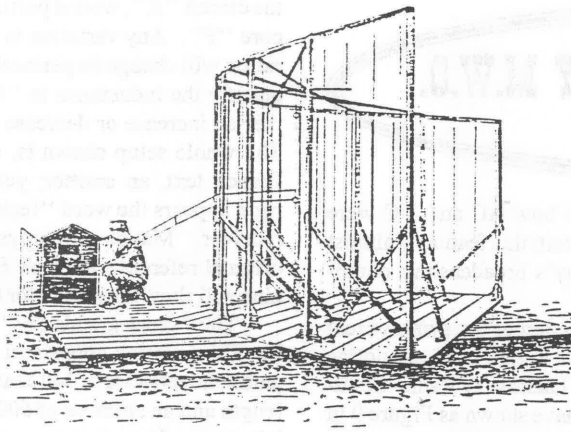

Figure 4

shown at Figure 7. There, the adjusting of condenser "C" imparts within resistance "R" a more or less important portion of current "(C)", as the dampening of the circuits is modified. The most optimum operation is

This idea was called a "reactive circuit" or a "circuit by reaction"; yet, formerly, Mr E.H. Armstrong (see *Proceeds. of the Inst. of Radio Engineers*, Volume No 9, pp 3-27,

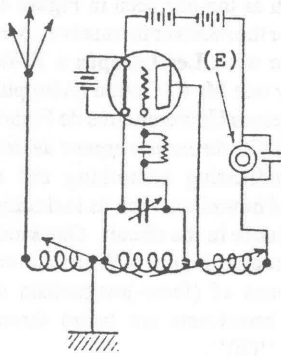

Figure 5

achieved without changing the parameters, according to Mr Mesny.

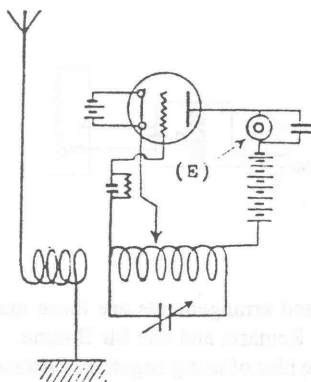

Figure 6

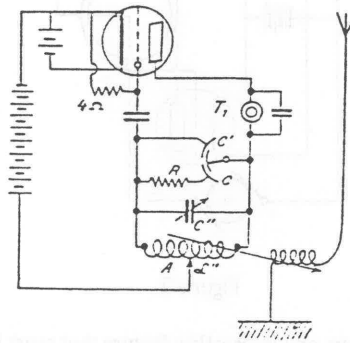

Figure 7

1921, and *Onde Electrique*, Volume No 1, pp 625-636, 1922) had developed what he called a "Superreaction circuit" and which is shown in Figure 8.

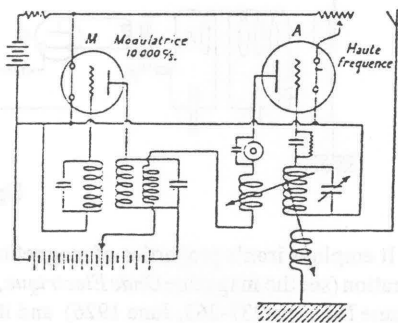

Figure 8

Mr. Armstrong's idea, called "Superheterodyning" today, was based on the superimposition of two frequencies, to yield four more frequencies in the end; all of them 'alloyed' to give a greater and more efficient output in early radio-broadcast. In the "superreactive" circuit of Figure 8, we have a triode of high-frequency ("Haute Fréquence") in which the grid is fed by a DC voltage upon which is superimposed a pulsation of 10,000 cycles per second produced by the modulating ("Modulatrice") triode lamp.

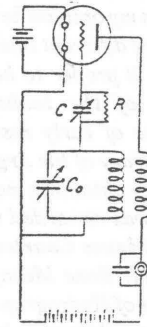

Figure 9

Mr Fromy's own system of "Superreaction" is seen at Figure 10. He achieved the same effect by shunting a capacitor (or several of them), to the triode's grid, possessing a strong capacity together with a resistance "R" of feeble power (see *Onde Electrique*, Volume 4, page 200, 1925) Mr Mesny refers the reader to the treatise *La Superheterodyne et la Superreaction* (Heterodyning and Superreaction) by one Mr Hemardinquer, published in Paris by Chiron Editeur, no year indicated. A receiver employing superreaction is seen in the schematics of Figure 10. Detection is accomplished through variations in current at the "Modulating" triode's plate during the alternation of oscillations during superreaction. Note, please, the similitude of this superreactive receiver with Lakhovsky's "Radio-Cellular Oscillator" as given. No indications in the bibliography are given about his type of receivers, but perhaps they are covered in Mr Hemardinquer's work.

Now if Lakhovsky himself indicated very short waves were needed in his oscillators (at least, in the beginning of his researches), how to generate and measure them?

Mr Mesny himself used the arrangement of Figure 11 to generate waves with a length of one meter (see *Onde Electrique*, vol 3, pp 25-37, January 1924).

Yet, shorter waves of 80 centimeters (or 0.8 meter) were achieved by one Mr Laville using "common triodes" in the arrangement

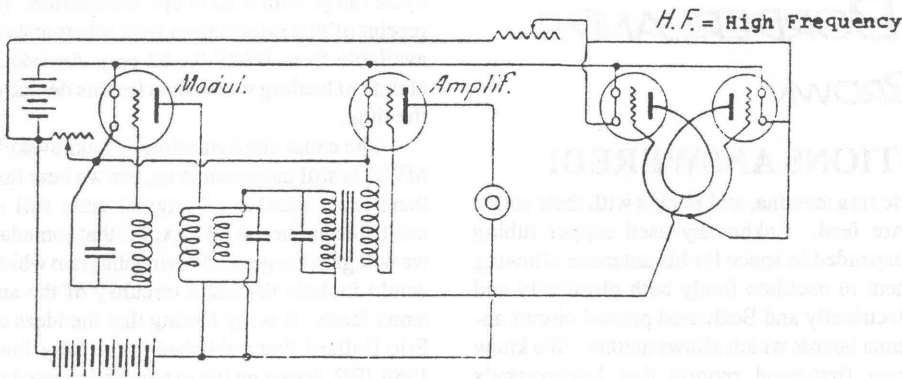

Figure 10

of Figure 12. Though no reference was directly given for consulting, reading the bibliography disclosed the existence of the thesis, *Recherches experimentales sur la propagation des ondes electromagnetiques le lng des fils* by one Mr G. Laville, published by Masson in 1924 (no place of publication is given, but it is safe to assume it is Paris as the most important publishing houses of France are located there).

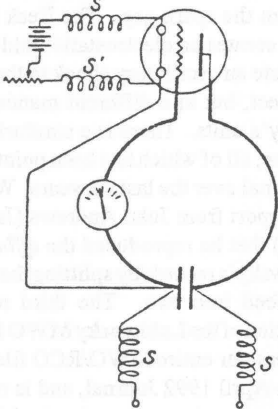

Figure 11

Another way to generate very short waves (of about 43 centimeters) was found by the German scientists Barkhausen and Kurz:

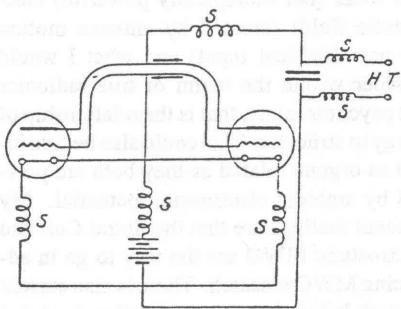

Figure 12

This they did in 1919 (see *Physicalische Zeitung*, Vol 25, page 1, 1920) and a few years later the scientist Scheibe improved on the idea producing waves from 30 to 334 centimeters (see *Annale der Physik*, Vol 73, pp 54-

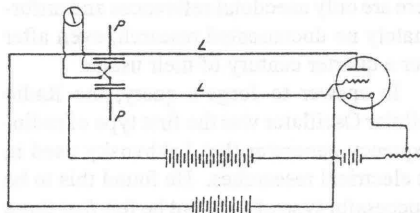

Figure 13

88, year 1924).

Experiments were undertaken by the British scientist Mr R. Whiddington (see *Radio Review*, Volume 1, pp 53-58, 1919) and by Gill and Morrell (see *Philosophical Magazine*

Vol 44, p. 161, 1922, and Vol 49, pp 369-379, Feb 1925) using a setup similar to the one illustrated at Figure 14.

Please notice that I have eliminated pertinent technical explanations concerning the devices by Barkhausen-Kurz, Whiddington, and Gill-Morrell, as they would be far too extensive for this article. Those investigating the references themselves, do take note.

After reading the pertinent portions of Mr Mesny's work, I felt myself closer to the full understanding of Lakhovsky's "Radio-Cellular Oscillator", yet I also felt myself no closer to that of the Multi-Wave Oscillator. These points are yet to be cleared:

1. How many (and which kind) of vacuum tubes (either by him or from others) were included by Lakhovsky in his MWO?
2. How much of the "Radio-Cellular Oscillator" entered (or not) into the MWO?
3. Which researches lead Lakhovsky from the Radio-Cellular Oscillator into the MWO and what initiated them?
4. Is there a "Final" or "Ultimate MWO" (capable of curing all illness) or just one model of a kind that is fit to heal a given group of diseases?

Any datum clearing these points (and others I have been unable to formulate) is valuable, no matter how small you think it is. So, in case you have anything, please send it to the Journal of Borderland Research for us all to know....

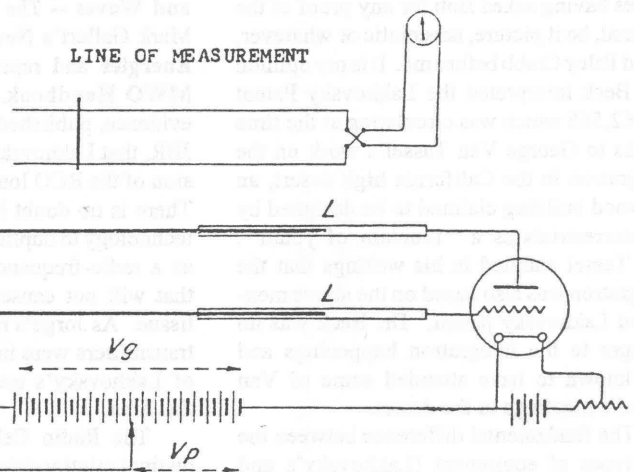

Figure 14

VIEW FROM THE BORDERLANDS

BY TOM BROWN

SOME MWO/RCO QUESTIONS ANSWERED!

*In response to Jorge's questions and also to collect my thoughts on this matter, after completing the third revised edition of **The Lakhovsky Multiple Wave Oscillator Handbook**, I would like to present what my general conclusion is at this point in time on the **Multiple Wave Oscillator and Radio Cellular Oscillator**. I know that some readers will think we belabor this field of research, while others keenly await any development. I didn't start this; BSRF has been investigating this area since I was in grade school, and I have kept up with the demand for information, although my primary interests definitely lay elsewhere. However, we have come a long way in understanding what Georges Lakhovsky was up to and it has been an exciting period of discovery.*

Lakhovsky's researches indicated that electric fields in the radio-frequency range can be generated in such a manner as to regenerate diseased (but not overly necrotic) tissue. This was well documented in medical research in France and New York.

Borderlanders were first introduced to this idea in 1963 when Dr. Robert (Bob) Beck gave us his interpretation of Lakhovsky's "rejuvenation machine". He claimed to have had access to an original, but 7 years of inquiry have led me to believe this was an exaggerated claim. Beck is known as a meticulous documenter of all equipment he comes across, as anyone who has seen him give a presentation would know. I am basing my opinion on the available evidence which includes having asked Bob for any proof of the original, be it picture, schematic or whatever, as did Riley Crabb before me. It is my opinion that Beck interpreted the Lakhovsky Patent #1,962,565 which was circulating at the time thanks to George Van Tassel's work on the Integratron in the California high desert, an all-wood building claimed to be designed by extraterrestrials as a "fountain of youth". Van Tassel claimed in his writings that the Integratron was also based on the above mentioned Lakhovsky patent. Dr. Beck was no stranger to the Integratron happenings and was known to have attended some of Van Tassel's meetings in the desert.

The fundamental difference between the two types of equipment (Lakhovsky's and Beck's) can clearly be seen by simply looking at pictures of Lakhovsky's units, with their two leads feeding the outer ring of the concen-

tric ring antenna, and Beck's with their single wire feed. Lakhovsky used copper tubing suspended in space for his antennas allowing them to oscillate freely both physically and electrically and Beck used printed circuit antenna boards which allows neither. We know from first-hand reports that Lakhovsky's MWOs did not arc between the antenna rings and Beck's MWOs are based on this arcing taking place. However, there is a similarity between the two in that they both create a field of multiple wavelengths, but certainly of different quality and character. Lakhovsky's units were scientifically documented in curing certain types of cancer. Many users of Beck's equipment have claimed such, but there are only anecdotal references and unfortunately no documented research, even after over a quarter century of their usage.

In answer to Jorge's query, the Radio Cellular Oscillator was the first type of radio-frequency generator that Lakhovsky used in his electrical researches. He found this to be a successful type of unit, but he felt that there was the potential danger of thermal damage to the tissue from extended use of the continuous wave output. In one sense he took a technological step backwards by moving to a spark gap driven Rhumkorff coil (what most people erroneously consider to be a Tesla coil) feeding a pair of concentric ring antennas. Lakhovsky stated that he used damped waves (created by a quenched spark gap) to eliminate the potential for thermal damage. This is mentioned in the excerpts from **Radiation and Waves -- The Source of Our Life** from Mark Gallert's **New Light on Therapeutic Energies** and reprinted in the **Lakhovsky MWO Handbook**. However, we have the evidence, published in the March-April 1992 JBR, that Lakhovsky's son was selling a version of the RCO long after his father's death. There is no doubt that the RCO is an easier technology to duplicate and it can be designed as a radio-frequency white noise generator that will not cause any thermal damage to tissue. As Jorge's research shows shortwave transmitters were in their infancy at the time of Lakhovsky's preliminary excursion into that area.

The Radio Cellular Oscillator bears a distinct relationship to a device published in this Journal in 1975 called the Phoenix Radioclast. The Phoenix Radioclast was a radio-frequency generator in the 43 mega-

cycle range with a 2000 cps modulation. (A reprint of this information with schematics is available from BSRF for \$2 pp.) Anecdotal claims of healing were made for this device at the time.

The exact configuration of Lakhovsky's MWO is still unknown to us, but we hear that there are a number of original units still in existence in Europe. We expect that someday we will gain the general wiring diagram which would include the exact circuitry of the antenna feeds. It is my feeling that the ideas of Eric Dollard first published in the May-June 1986 JBR, based on his extensive knowledge and insight, are fundamentally a move in the correct direction, though I think that Mike Theroux's suggestion at the end of this article may be the closest we have seen. While Lakhovsky states that his units are electrostatic his two antenna feeds to the outside ring (which we have established absolutely as the correct configuration on the equipment he used in his published researches) would generate an electromagnetic field, with the inner concentric rings acting as secondaries to the outer ring primary. In general this unit could still be considered electrostatic with damped waves from the spark gap. The Beck MWO definitely creates an electrostatic field which would create an oscillatory shock to the treatment subject, but in a different manner than Lakhovsky's units. There is a similarity and a difference, all of which has been pointed out in this Journal over the last six years. We also have the report from John Andrews (Jan-Feb 1992 JBR) that he reproduced the *effluvia* as per Lakhovsky's records by splitting the single terminal feed into two. The third revised (1992) edition of the **Lakhovsky MWO Handbook** covers our entire MWO/RCO file up to the March-April 1992 Journal, and is recommended to any serious researcher in this field as the most complete record in English of MWO/RCO research.

Lou Schad's Spiral Coil MWO is an important development in this field and Peter Lindemann's Electrostatic MWO is an outgrowth of that. These two devices are working with weak (but biologically powerful) electrostatic fields (created by antenna motion and not electrical input) and what I would consider within the realm of true radionics (not psychotronics), that is the relationship of energy to structure. This could also be considered as orgone related as they both are powered by ambient electrostatic potential. My personal feelings are that the Spiral Coil and Electrostatic MWO are the way to go in advancing MWO research. There is also current research being done on the RCO and related circuitry, of which we hope to hear more from serious researchers.

There is a lot of electro-therapeutic equipment (including alleged Rife devices and various MWOs) being sold these days with the claim that they are not for medical use. None-the-less I would have to consider myself stupid if I thought that everyone was building and buying these units purely for research. The information and equipment that BSRF makes available really is intended for research purposes and we don't say that with a nod and a wink. If I knew for sure that a specific reproducible device would cure any disease I would say so without fear or trepidation and provide the plans. To those who do use this information we sincerely hope that you provide BSRF with documentation on use and effect. This is an experimental field, with exact details of the original equipment still in question, and to rely on this for health one has to base their motives on faith and not on fact. This is extremely important and is the fundamental purpose for our making all this available. It is our avowed policy to discourage people from relying on experimental equipment as a healing modality. Not that there isn't a basis for thinking that there is promise in this field of research, but as stated before there are still many questions to be answered,

not the least of which is the mass of information now becoming available on the disastrous health effects of electricity and electrical fields. Much needs to be sorted out here.

Rudolf Steiner pointed out in his Agriculture course (circa 1924) that just because electricity was now available there were prophets who claimed it as a great cure, not withstanding that there were no such prophets before electricity was available. He also pointed out that with radio signals information could be transferred around the world at amazing speed, but that the effect of the electricity was such that people couldn't comprehend the information as well as they used to! This is an important caveat to consider before any experimentation with electrical equipment (including computers!).

There are avenues of research into biologically positive energies that do not partake of the subsensible electrical currents. L.E. Eeman's biocircuits are a well documented means of balancing the body's energies and it is merely a sign of the times that there is very little interest in such (not as sexy as an electrostim unit!). Color therapy is also an important area of research (electricity is used to power the light source but its electrical effect on the

experimental subject would be negligible). Dr. Wilhelm Reich's orgone energy research also indicates that there are potent non-electrical energies that are incredibly bio-positive if applied in the correct manner. Competent research needs to be done in all these areas, and this Journal is open to all ideas of this character.

And in closing I must state that there is the more refined view of disease, that it is a problem of alignment between physical and etheric. Rudolf Steiner indicated that the etheric is always healthy, but when out of phase with the physical we experience health problems. Our true purpose in the Borderland fields of research is not to cure disease, but to learn how to attain the supersensible overview of our existence — *to reach beyond the borders of our senses*. Our orientation is of course to seek across the upper borders of the senses. Electricity is a sub-sensible force, beneath the senses, and is an organic system alterant. Whether it alters a system for better or worse depends on many factors, state of mind, diet, life-style, etc. It is very possible that many claims for various devices are based on placebo effect. That is why we support serious research and not widespread equipment sales.

Eric Dollard's suggestions for single antenna hookup

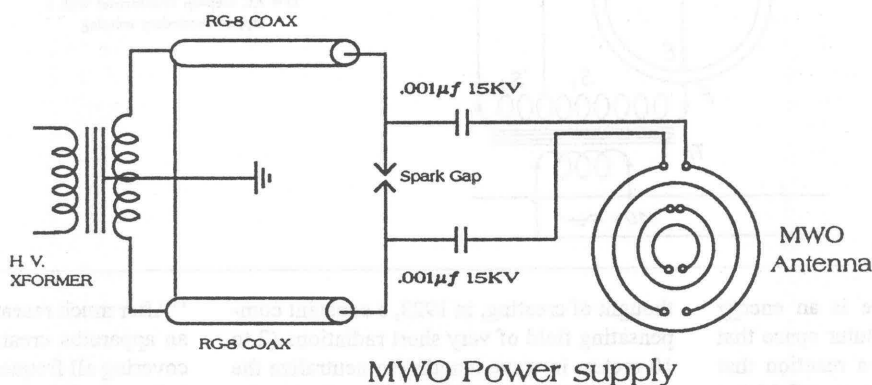

Michael Theroux's ideas for two antenna hookup based on the photographs of Lakhovsky's apparatus.

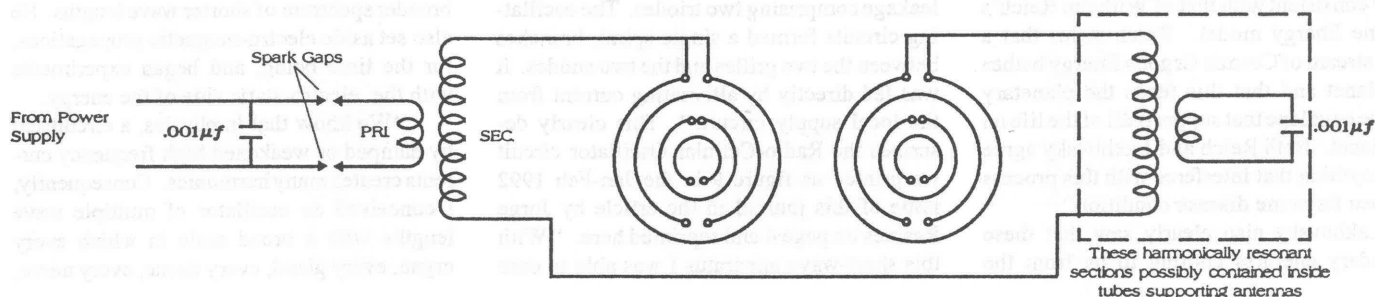

MWO ROUNDUP

by Peter A. Lindemann

After years and years of guessing, hoping and wondering what Lakhovsky was really doing, the fish is about to hit the pan! In the last two issues of this journal, a number of schematics have been reprinted for devices capable of producing oscillations of multiple wavelengths simultaneously. In this article, I will present another schematic of an easy to build MWO submitted by an associate from Texas. But first I would like to go over some of the basic information that all of this is about and attempt to make some sense of it, finally.

The understanding that I now present is based on an article written by Georges Lakhovsky in 1941 entitled *Radiations and Waves - Source of Our Life*, excerpts of which appear on pages 98 - 100 in

The Lakhovsky MULTIPLE WAVE OSCILLATOR Handbook, second edition, by BSRF.

Quoting Lakhovsky, "I have shown in my books, *The Secret of Life*, and especially in *The Earth and Ourselves*, that every living cell draws its oscillatory energy from the field of secondary radiations resulting from the ionization of the geological substances of the earth by cosmic radiations." By this I believe he is saying that there is an energy coming to this planet from outer space that enters the earth and causes a reaction that brings into being a secondary energy field that every living cell draws its oscillatory energy from. At first glance, it may not register, but on careful examination, this "model" is entirely consistent with that of Wilhelm Reich's Orgone Energy model. Reich states that a great stream of Cosmic Orgone Energy bathes the planet and that this feeds the planetary orgone envelope that supports all of the life on the planet. Both Reich and Lakhovsky agree that anything that interferes with this process is cause for some disease condition.

Lakhovsky also clearly saw that these secondary energies coming to us from the

ground were not always beneficial, depending on the geological formations underneath. "But certain natural radiations are particularly toxic, especially those originating in earth programs [coarse ground formations]. Many cancer cases have been attributed to these toxic radiations and proven experimentally, notably in Germany by Dr. Rambeau of Marburg. Therefore, earth radiations sometimes cause disturbance of the cellular oscillatory equilibrium of the organism." Here, when Lakhovsky refers to "natural radiations" that are toxic, he was not talking about radioactive emissions or chemical poisons, but what are now called *geopathic zones*.

"To re-establish this equilibrium, I

plants inoculated with cancer. For six years at the Saltpetriere I observed and checked the effects of these short waves. Using very low power, from 10 to 12 watts, and a limited duration of treatment, I succeeded in curing cancer in human beings, but also had to record some failures."

Lakhovsky goes on to say that by 1928, the news of his successes had caused widespread interest in Europe, and that researchers were building higher and higher powered units. He felt that more power just caused dangerous thermal effects that could kill micro-organisms but also healthy cells. This is no doubt the advent of today's Diathermy machines, a direction that Lakhovsky clearly rejected.

At this stage, he changed his fundamental assumption. "I thought it possible to obtain better results by administering an oscillatory shock to all the cells in the organism simultaneously. Such a shock, very brief, produced by dampened or weakened electro-static waves, does not provoke thermal and prolonged effects and involves no risk of burning

living cells." Mind you, before this, Lakhovsky had already succeeded in curing various cancers with 10 watts of electro-magnetic propagations between 2 and 10 meters. Also, he never mentions that thermal effects are a problem at these power levels. These "Radio-Cellular Oscillators" were his first successful device and they remain very, very effective for many disease conditions. But he was not satisfied.

"After much research I was able to construct an apparatus creating an electro-static field covering all frequencies from 3 meters to the infra-red, so that every cell can find its natural frequency and vibrate in resonance." Here, Lakhovsky shows us his reasoning. He rejected higher power outputs and went for a broader spectrum of shorter wave lengths. He also set aside electro-magnetic propagations, for the time being, and began experiments with the electro-static side of the energy.

"We know that in physics, a circuit fed by damped or weakened high frequency currents creates many harmonics. Consequently, I conceived an oscillator of multiple wave lengths with a broad scale in which every organ, every gland, every tissue, every nerve,

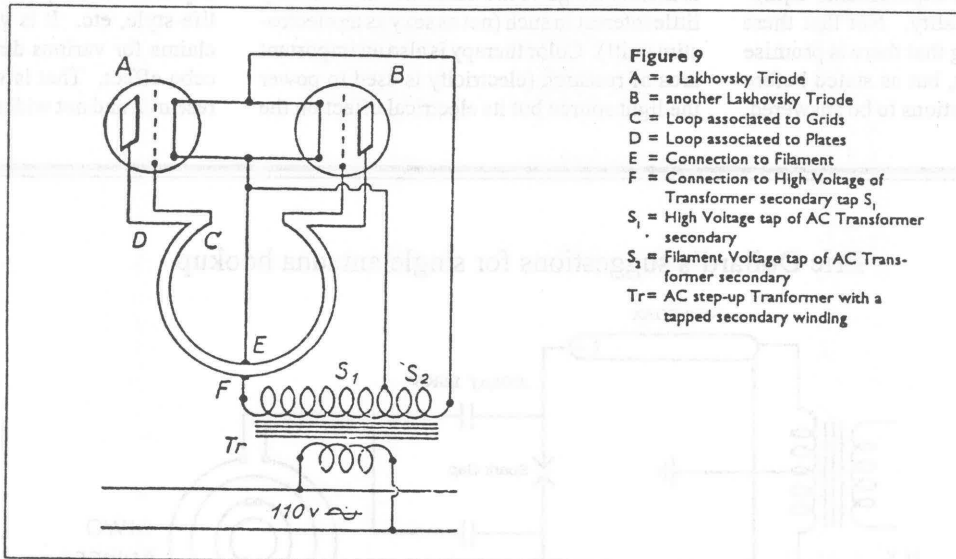

thought of creating, in 1923, a constant compensating field of very short radiations (2 to 10 meters in wave lengths) to neutralize the action of the disturbing rays, and give the living cell the necessary stimulation for a return to its normal oscillation." "Finally I adopted the oscillator with symmetrical cross leakage comprising two triodes. The oscillating circuits formed a single spiral, branches between the two grilles and the two anodes. It was fed directly by alternating current from the local supply circuit." This clearly describes the Radio-Cellular Oscillator circuit we printed as figure 9 in the Jan-Feb 1992 issue of this journal in the article by Jorge Resines on page 4 and reprinted here. "With this short-wave apparatus I was able to cure

Lakhovsky MWO/Radio Cellular Oscillator submitted by Patrick Flanagan

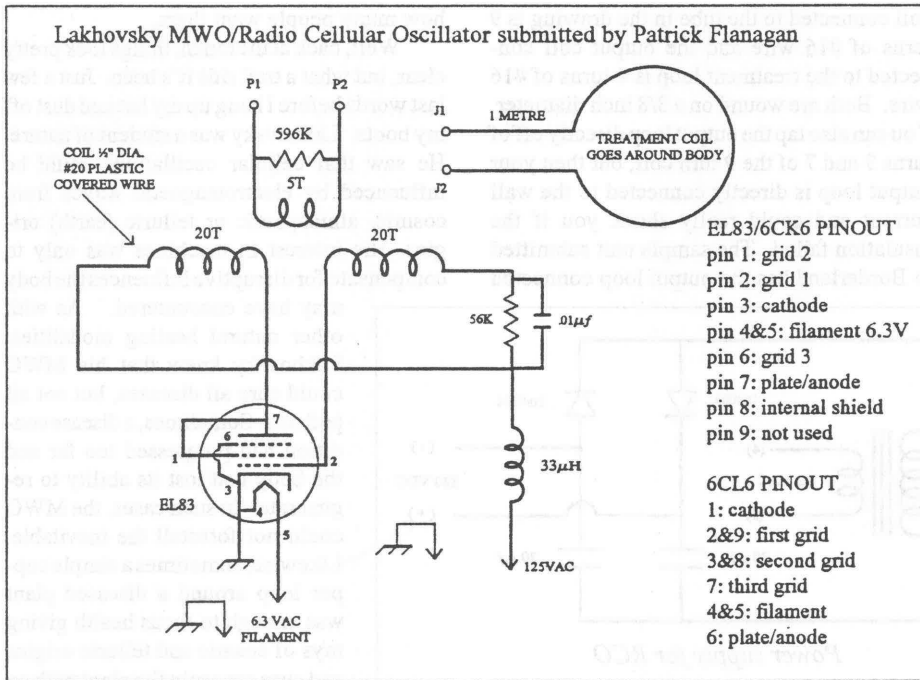

could find its natural frequency." It is at this stage that he introduces the now famous antenna of concentric rings. "To obtain this result I set up a transmitter composed of a series of circular concentric oscillating circuits linked by a silk cord but not contiguous. These circuits are stimulated by damped high frequency currents from a spark gap. Thus each circuit of the transmitter vibrates not only on its natural frequency, but also on numerous harmonics." "Thus, I built an oscillator with all the basic wave lengths from 1/10th of a meter to 400 meters. But each circuit also emits many harmonics, which with their basic waves, their interferences and their effluvia can reach the scale of infra-red and even that of visible light."

Notice here that Lakhovsky never mentions power outputs or high voltage in the output circuits. Also, in Fig. 1 of Lakhovsky's 1931 US patent #1,962,565, a very simple drive circuit of an interrupted inductor feeding an L-C spark-gap oscillator is shown. But notice these important details. First, the output coil L2 has fewer windings than L1 so that the voltage is stepped down to the antenna. Second, that the antenna connection is for electro-static output as it is an open circuit of differential capacitance, the two output leads connected to separate rings. In spite of his references to electrostatic outputs, Lakhovsky leaves this issue wide open. Quoting from the body of the patent, Lakhovsky states, "One or several points of this high frequency circuit is or are connected to the end of one or several of

the rings forming the radiating apparatus. The other rings not connected are excited by induction." This broad statement is typical of patent 'lingo' and clearly leaves unresolved the exact output connection.

Two last points should be mentioned here. Lakhovsky speaks of his output circuit being "stimulated by damped high frequency currents from a spark gap". The question is, what is a damped oscillation? Tesla also used

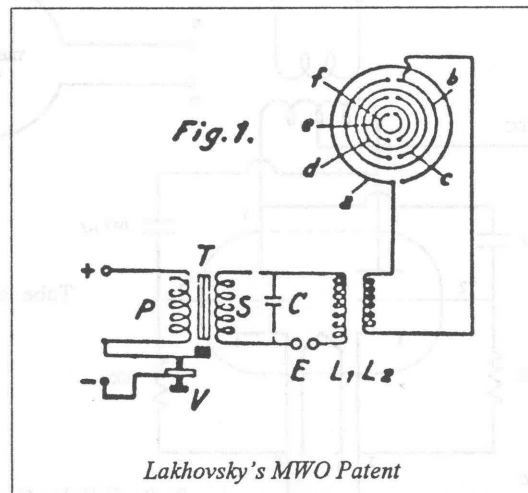

such terminology and it is from his writings that I draw my conclusion. I speculate that this could refer to the oscillations produced across a quenched spark-gap. Spark gaps tend to ionize gas particles between the two electrodes and the presence of this conductive plasma creates a tendency to sustain the arcing process. A quenched gap reduces or

eliminates this tendency thereby sharpening the transitions between the on and off phases of the spark. This intensifies the nature of the oscillations and produces extremely high harmonics. My guess is that in Fig 1, E, in the L-C oscillator section of the circuit, is a quenched spark gap. The other speculation I would like to add here is about the construction of the concentric ring antennas. For the last 30 years here in the USA, these antennas have been made of copper foil on a dielectric material, like a printed circuit board. BSRF has been a major source of these antennas. Recent experiments that I have run suggest strongly that this design adds unwanted capacitance to the output circuit and could clip off the very short wave emissions from the output. This would be even more pronounced in a system set up for electro-static output as Lakhovsky specifies in his patent. Only a sequence of copper rings, suspended in the air, like Lakhovsky shows, would be free to oscillate up into the gigacycle range, without any arching between the rings. These printed antennas do work well, however, with the RCO.

After all this, I now must say that there is nothing sacred about any of these circuit designs. I'm a strong believer in the motto "if it's not broken, don't fix it", however, there are many ways to produce the effects Lakhovsky was producing. Even Lakhovsky states in his 1931 patent, "These rings may be fed by any producing device whatever of high frequency..." This is well illustrated by the schematic published in the March-April 1992 issue of this journal submitted by Pat Flanagan. This circuit, while resembling one of the earlier Radio-Cellular Oscillators, seems capable of producing waves well below 1/10th of a meter (as Pat told me that it interferes with his satellite TV reception!) and therefore should be considered associated with Lakhovsky's later work on the MWO. The output of this unit is not electrostatic. In fact, Borderland has found no evidence at all that any of Lakhovsky's units actually operated in the electrostatic mode, regardless of his 1931 patent claims.

Here then is the difference between the RCO and the later MWO. The target of frequencies for the RCO was between 2 and 10 meters. With this, Lakhovsky was able to cure cancer and many other conditions. It seems to stimulate the organs and glands and promote de-toxification. The researcher whose RCO schematic follows, says that 43 megacycles (approx. 7 meters) is the primary target for a device like this and that its primary action is to cleanse the body and rebuild the organs. He has seen dramatic cleansing of the liver and bowels, reduction of

tumors, natural hair color returning in the elderly, and many more benefits including increased vitality. No doubt, Lakhovsky saw these types of benefits too. But he was not satisfied with success. He went on to make the MWO. The target of frequencies for the MWO was between 1/10th of a meter and 400 meters. He was not satisfied by stimulating the organs, he wanted to stimulate each and every cell individually also. For this he needed shorter wave lengths. He wanted to include a range of frequencies so that even the strands of DNA could find their own natural resonance and be directly stimulated by it.

The MWO, as conceived by Georges Lakhovsky, was not an intrusive influence, but one that promoted the natural healing processes of the body. "In all pathogenic cases this treatment gives very good results. As it does not attack the microbes directly, it does not destroy live tissue, but reinforces the vitality of the organism by accelerating cellular oscillation. It is therefore the reinforced organism that successfully resists the microbes and all pathogenic causes." Here then is the clear difference between what Royal R. Rife was doing and what Lakhovsky was doing. Rife discovered specific "mortal oscillatory rates" that were capable of killing microbes directly while Lakhovsky let a strengthened and normally functioning immune system do that work. Rife was working on the magic bullet while Lakhovsky was working on a shotgun panacea. Both apparently were successful!

On this page is the schematic from the Borderland Associate in Texas. He gave me permission to use his name, but did not want to be associated with the claims for his unit. I decided to use his claims, above, so his name is withheld here. Although he calls his unit an MWO, it is more correctly an RCO, based on a twin triode oscillator with target frequencies between 2 and 10 meters. Unlike any Lakhovsky built, this unit is a simple multi-vibrator based on the 6CG7, twin triode nine pin vacuum tube. It works. It can be built for about \$40 from this schematic. Make sure you get a good tube where both triodes operate equally well. The

coil connected to the tube in the drawing is 9 turns of #16 wire and the output coil connected to the treatment loop is 4 turns of #16 wire. Both are wound on a 3/8 inch diameter. You can also tap the output loop directly off of turns 3 and 7 of the 9 turn coil, but then your output loop is directly connected to the wall current and could really shock you if the insulation failed. The sample unit submitted to Borderland has the output loop connected

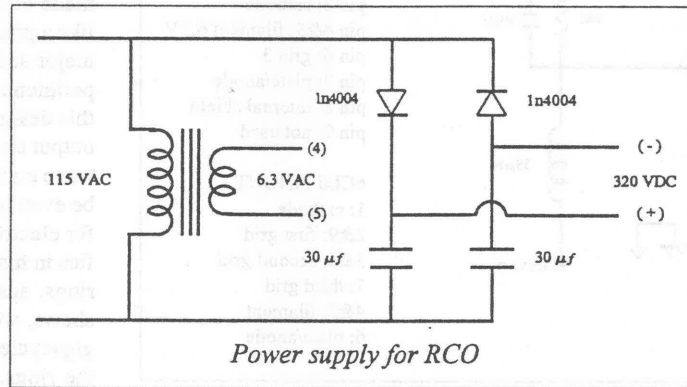

directly. The treatment loop is 8 inches in diameter connected to 6 feet of #18 zip cord. The loop is made of some well insulated, stiff wire.

As we have in the past, a limited number of units based on this design may be made available for further research, either as a fully

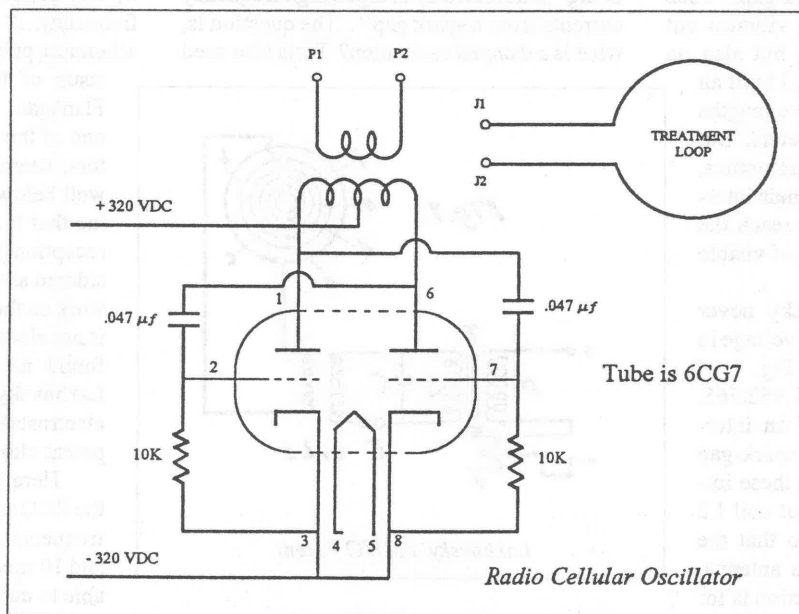

assembled unit, or as a kit. The retail price for the unit will be *N/A* for non-members and *N/A* for members. The kit will be *N/A*. As these devices have to be built in groups to keep the costs down, it is best to get your order in as soon as possible, so we can get an idea of

how many people want them.

Well, back at the ranch, things look pretty clear, but what a trail ride it's been. Just a few last words before I hang up my hat and dust off my boots. Lakhovsky was a student of nature. He saw that cellular oscillations could be influenced by electromagnetic waves from cosmic, atmospheric or telluric (earth) origins. His interest in machines was only to compensate for disruptive influences the body may have encountered. As with other natural healing modalities, Lakhovsky knew that his MWO could cure all diseases, but not all patients. Sometimes, a disease condition had progressed too far and the body had lost its ability to regenerate. In such cases, the MWO could not forestall the inevitable. Likewise, sometimes a simple copper loop around a diseased plant was enough to focus health giving rays of cosmic and telluric origins and cure cancer in the plant with no "machine" at all. Seeing that

Lakhovsky's focus was on the earth energies, it seems reasonable to assume that the effective use of such copper rings may be *location dependent*, as a copper ring around a plant in a geopathic zone may very well accelerate its death. The quality of the energy coming to us from the environment today is far more disturbed and far less capable of sustaining vibrant life than in Lakhovsky's day. More and more locations are becoming life negative, or at least less life positive. This just makes it harder for all of us to stay healthy. The main message in the work of Georges Lakhovsky is not that we can now cure cancer with a new machine. Although this is good news, we should not lose sight of his other discoveries. I think Lakhovsky's primary message is that our health is directly connected to the quality of energy coming to us from the earth, and that it is essential to good health that we develop our sensitivity to these subtle forces so we can live in harmony with its health giving rays. He developed the MWO to help people compensate for living in less than ideal environments. In the future, we may need these compensations more than ever. Adios.

★ ★ ★ ★ ★

The Lakhovsky MWO: Back To Square One

Peter A. Lindemann

Sometimes the most obvious things take the longest. I am reminded of all the wild hype that surrounded Tesla's work back in the 1980's and the crazy new theories that were put forth on how his wireless power system supposedly operated. Smelling a rubber fish in the pan, BSRF railed against the madness and eventually released a video presentation of Tesla's wireless power system in action. Remarkably, all it took was the genius of Eric Dollard and *going back to Tesla's patent*. The model built from the patent performed as claimed. No new theories or explanations were needed. This video, **Tesla's Longitudinal Electricity** is proof enough that going back to the original design is the best place to start when trying to understand or *duplicate* someone's work.

So, the question is, has anyone ever tried to *duplicate* Lakhovsky's MWO as it is described in his patent? After finally asking myself the right question, I carefully read through **The Lakhovsky Multiple Wave Oscillator Handbook** for the answer. What I found is quite interesting. Every single MWO schematic printed in the book, except for Lakhovsky's patent diagram, is a model of or a variation on one of Tesla's electro-therapeutic devices! It seems that for the last 30 years, people have just been putting Lakhovsky's famous multi-ringed antenna at the end of a Tesla circuit and thinking that they had the real thing. All of these units, variations on a circuit presented by Bob Beck in 1963, spark profusely between the rings of the antenna. Bob has repeatedly told experimenters to build their MWOs with more and more power so that they will produce increasing amounts of sparking on the antenna. Our files contain letters from people who report excellent results from these devices. The accolades, however, have not been universal. The big problem with this style of MWO is that people who are sensitive to subtle energy, like myself, can't stand to be in the same room with one of them while they are operating because they are so irritating. Something was not right in all of this, and I wanted to figure it out.

To illustrate the problem, I have included four schematic diagrams here for reference. Figure 1 is the schematic of Lakhovsky's MWO taken from his patent. Figure 2 is a schematic taken from an article by Tesla on his electro-therapeutic experiments. Figure 3 is the schematic for a "high power MWO" taken from page 77 of the **MWO Handbook**, and

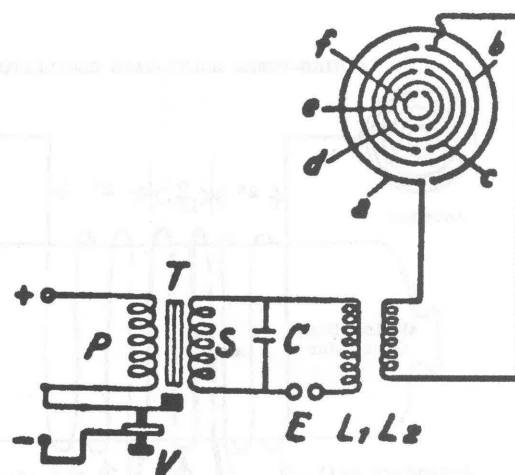

Figure 1

Figure 4 is the schematic of the Bob Beck/Klark Kent MWO (simplified). After

studying these circuits for a while, I realized that there were a number of basic differences. Lakhovsky had placed the spark-gap and the capacitor in a different relationship in the middle section of the circuit than Tesla and the others. Could this be important? Lakhovsky had also stepped the voltage down in the final stage of the circuit where Tesla and the others all stepped the voltage way up. Was this significant? What was Lakhovsky trying to do that was different than what Tesla was trying to do?

There were some other things that also puzzled me. Both Lakhovsky and Tesla had well developed subtle sensitivities. Lakhovsky used a pendulum to help him in his design work and Tesla's expanded sensory abilities are mentioned throughout his writings and the writings of his biographers. Because of this, I assume that both of their electro-therapeutic devices were totally benign to be near, even to very sensitive people, like themselves. I assume this because nothing leaves my laboratory that I don't personally like. Experiments I have run strongly suggest that all of the effects that cause sensitive people to be irritated by these units (Beck/Kent style MWO) come from the sparking between the rings of the antenna. This brings up the question of whether or not the MWO antenna is supposed to spark. Tesla is very clear in his writing that his units worked much better when all electrical discharges from the terminals were suppressed. At one point, he even describes using 2 inches of wax to cover the terminals (antennas). Likewise, Lakhovsky never mentions sparking discharges between the rings of his antennas. Some photos show a brush or corona discharge off the

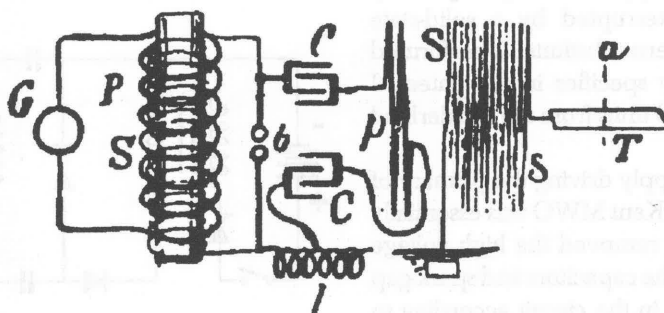

Figure 2

outermost ring of his MWO antennas, but no mention is made of this being the normal therapeutic operating mode. Also, no photo of Lakhovsky's MWOs ever show arcing *between* the rings. In light of this, I am convinced that both Tesla and Lakhovsky designed their devices to eliminate this behavior. I strongly believe that Lakhovsky's real MWO does not create sparking discharges

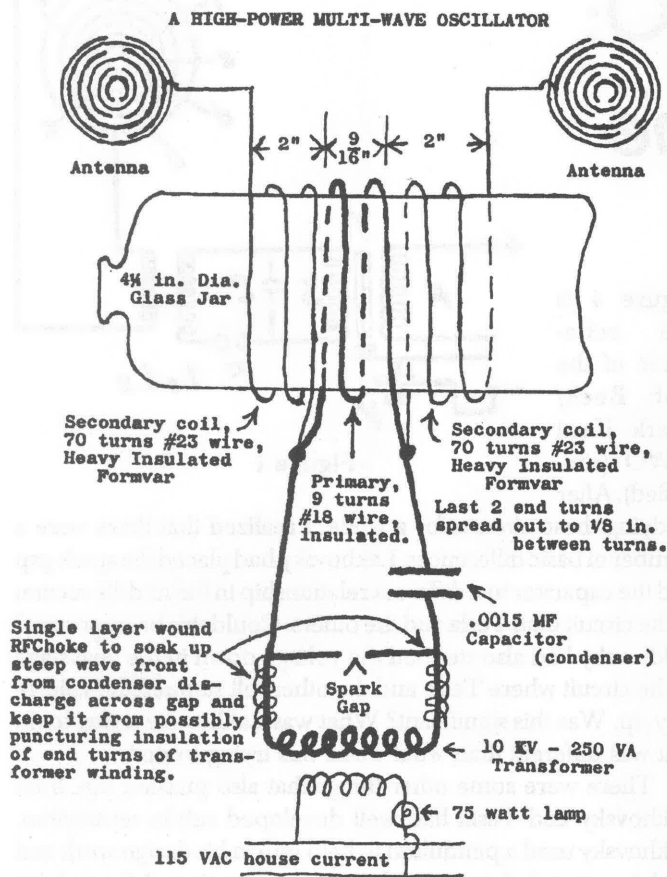

Figure 3

between the rings of the antenna.

Having resolved these issues to my own satisfaction, I decided that the only way to find out the rest of the facts was to actually build a circuit that behaved like the circuit in Lakhovsky's patent. To do this I had to decide what components to use, as no parts values are given in the patent. Even if they were, these parts would not be available today. What to do? In Figure 1, Lakhovsky begins by powering the primary coil of a transformer on DC (direct current) that is rapidly interrupted by a device he calls a "trembler" (V in Figure 1). The purpose and function of this trembler is to provide a sequence of DC pulses to the primary of the transformer by mechanically making and breaking the DC power feed to the primary winding. I decided that one of Klark Kent's 12 VDC power supplies driving the primary of an automobile ignition coil interrupted by a solid-state transistor circuit was a suitable modern substitute. It performed the same functions that Lakhovsky specifies in the patent. I 'acquired' one of Klark Kent's MWO units from the Borderland collection and went to work.

Besides the first stage power supply driving the primary of the coil, everything else in the Klark Kent MWO was essentially a Tesla circuit, so I took it apart. I removed the high voltage output coil completely and rewired the capacitors and spark-gap so that they were in the right place in the circuit according to Lakhovsky. The L1 and L2 output coils I decided to build, since

no suitable replacements were available. Without any clear directions from the patent about the proper dimensions for these coils, I actually had to *think* about it. Small, tightly wound coils usually block high frequency signals and, for this reason, are sometimes called "chokes". Obviously, these coils were not supposed to be extremely small because passing a wide spectrum of high frequency currents was their purpose. By contrast, one of Tesla's designs specifies a 2 foot diameter coil set in this location in the output. But photos of Lakhovsky's MWOs clearly show no coils that large. I decided to wind two coils about 2 inches in diameter to begin my experiments. L1, the primary, I wound with 7 turns of bare #18 single strand copper wire. The turns are about 1/3 of an inch apart and stand free in the open air with no dielectric material or coil form near-by. L2, the secondary, is only 5 turns of similar wire and dimension. The two coils are placed end to end about an inch apart. The ends of L2 are connected to rings 1 and 2 of the printed circuit board MWO antenna developed by Eric Dollard and BSRF, as illustrated in Lakhovsky's patent. L1 is connected to the capacitor and the spark-gap.

Awesome! I was finally in possession of a reasonable facsimile of a *real* Lakhovsky MWO (Figure 5). [I decided to retain the high voltage diode from the Klark Kent circuit to help protect the ignition coil from the discharge of the capacitor. This was the only deviation from the Lakhovsky circuit that I made, and I do not believe it negatively affects the quality of the output since it is not in the capacitor discharge loop.] In trembling anticipation; (not really) I turned the unit on. Besides the irritating noise of the spark-gap, the energy effect coming from the antenna was very gentle and very penetrating. Within 15 minutes, a noticeable relaxation effect was evident and a gentle "buzz" feeling was present throughout my body. This experiment, long overdue, begins to confirm my many speculations about the nature of Lakhovsky's MWO and opens up a clear, new direction for future research.

The two design changes that this article addresses are: 1) the location of the spark-gap in the circuit and 2) the method of driving the antenna. In Tesla's circuits and the Bob Beck/Klark Kent style of MWOs, the spark-gap is driven by the *inductive collapse* of the secondary coil and the output primary coil is capacitively coupled to this source of oscillations. In Lakhovsky's circuit, the inductive collapse of the secondary coil charges the capacitor and the *capacitor discharge* drives the spark-gap directly through the primary of the output coil. This difference has never been discussed before and I believe it to be important. A

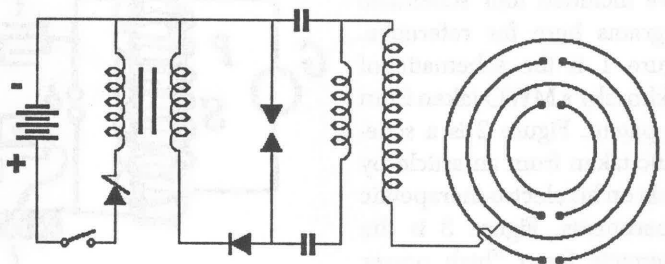

Figure 4

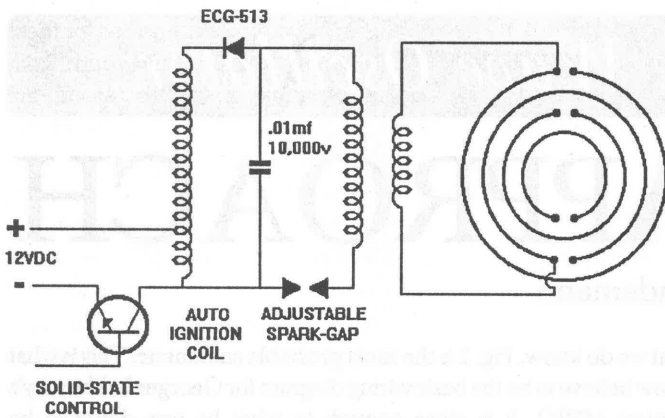

Figure 5

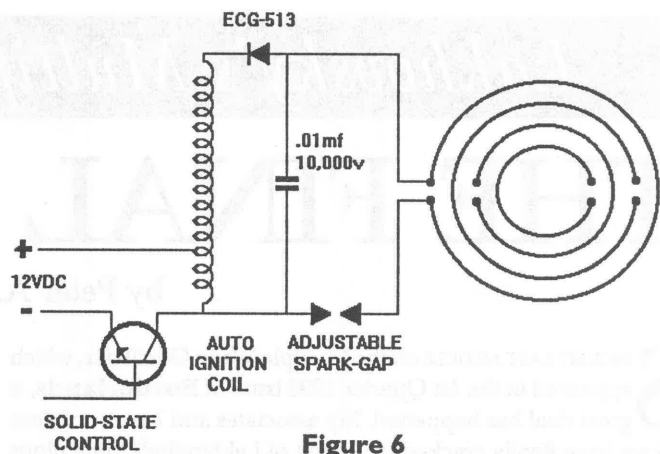

Figure 6

capacitor discharge creates a very different kind of “spark” than an inductive collapse. (Anyone not understanding this should watch the first 20 minutes of the BSRF video **Free Energy Research**. In it, Eric Dollard demonstrates both inductive and capacitive arcs and discusses the differences between them.) The Beck/Kent style of MWO uses the circuit primarily as a source of high voltage to produce arcing between the rings of the antenna. The various lengths of sparks at the antenna become the source of the wide spectrum of frequencies produced by the device. While this method may produce the required wide band of emissions, it was not the method Lakhovsky was working on. The patent is clear on this point, Lakhovsky envisioned the capacitor discharge as the source of his wide spectrum of frequencies and the multi-ringed antenna as a resonator system to draw out even more and higher harmonics by induction. As usual, the simple creation of multiple frequencies is not enough. The subtle nature of these frequencies and how they are created is also important.

Many experiments need to be tried on all of the possible methods of driving the antenna that are covered by the patent. Beyond that, the patent describes using only one antenna, whereas all of the photos of Lakhovsky’s MWOs show him using two antennas. The exact antenna hook-up is still unknown. I have now driven the antenna both electro-statically, as specified in the patent (Figure 5), and electro-magnetically by eliminating

L1 & L2 and directly connecting the outer ring of the antenna in the place of L1 (Figure 6). The effects subjectively seem stronger in the direct connection mode, but both are gentle and penetrating. I have also driven two phi-ratio spiral antennas in the electro-static mode facing each other, each spiral connected at its center to one end of L2 (Figure 7). The effects in the space between the two antennas are the most powerful I have seen yet. While use of these golden section spirals is a deviation from Lakhovsky’s designs, the configuration of using two antennas to set up an area of high frequency electrostatic oscillations between them was his intent, it seems. The effect in the area between the antennas is quite strong and lends credence to the electro-static mode of operation. Tesla also experimented with this method of driving the antennas which he called terminals (t) as shown in Figure 8. He used large copper plates for these terminals, and as such, did not expect them to augment the total frequency response of the system as Lakhovsky did with his multi-ringed antennas. My experiments suggest that when using one antenna, the electro-magnetic hook-up is the strongest, as in Lakhovsky’s RCO circuits. When using two antennas, the electro-static hook-up is the strongest, as in Lakhovsky’s MWO circuits.

In future articles, I plan to address the construction of a real Lakhovsky MWO antenna made from copper tubes suspended on silk threads as specified in the patent. I believe that the copper rings, unencumbered by the proximity of any dielectric material, will be able to ‘ring’ freely up into the very high harmonics Lakhovsky envisioned. This could be the final ‘improvement’ necessary to get us all the way back to where Lakhovsky was in 1931. The design for the real MWO may have been with us all along. Sometimes the most obvious things take the longest.

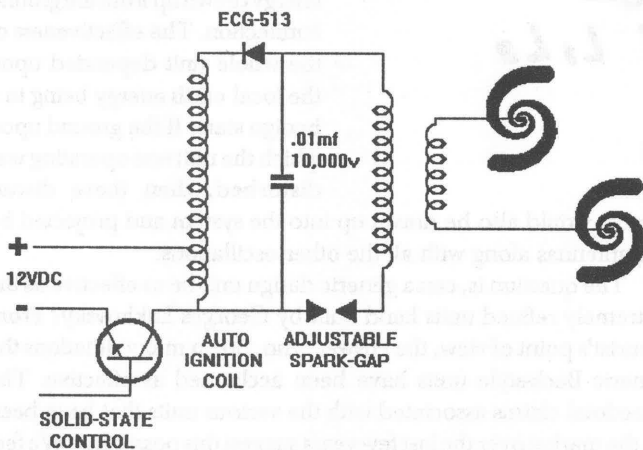

Figure 7

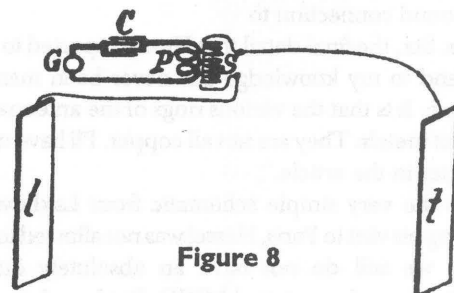

Figure 8

Lakhovsky's Multiple Wave Oscillator:

THE FINAL APPROACH

by Peter A. Lindemann

SINCE MY LAST ARTICLE on the Multiple Wave Oscillator, which appeared in the 1st Quarter 1993 issue of **Borderlands**, a great deal has happened. My associates and I are confident that we have finally cracked the secret of Lakhovsky's miraculous MWO. For much of this breakthrough, I am deeply indebted to Hessel Hoornveld of the Netherlands. First of all, Hessel has run quite a few experiments and tested many different variations. Besides that, he visited Serge Lakhovsky in Paris, France in the early summer. His eyewitness account of a true Lakhovsky MWO in operation has solved most of the remaining puzzles. So much is now known that I, at least, consider the mysteries either solved or within reach. This article will lay out clearly what we now know and what we believe will fill in the gaps.

Hessel reported to me the following details of his eyewitness account. First, as Tom Brown and I have claimed for years, there is NO arcing between the rings of the antenna. Second, the unit DOES operate in the high voltage mode, with a two inch corona coming off the outer ring during operation. Third, the dark tubes holding the antennas to the stands each contain a high voltage step-up coil, so that both antennas are powered with high voltage independently. The wires that connect the antennas to the power supply are low voltage wiring. Four, Hessel was not allowed to see how many spark-gaps there are. However, both Hessel and I have run experiments with spark-gaps and we both believe that a number of small gaps in series work better than a single large gap. Five, there is a ground connection to the antennas. Six, the final detail that Hessel reported to me is very interesting and to my knowledge has never been mentioned by anyone before. It is that the various rings of the antenna are made from different metals. They are not all copper. I'll have more to say about this later in the article.

Fig. 1 is the very simple schematic from Lakhovsky's 1934 patent. During his visit to Paris, Hessel was not allowed to see inside the unit, so we still do not have an absolutely authoritative schematic diagram of an original MWO. But based on everything

that we do know, Fig. 2 is the most probable schematic. This is what I now believe to be the basic wiring diagram for Georges Lakhovsky's clinical MWO. It is close enough to what he was doing to be considered the real thing. I base this on what Hessel has told me and on the photo of Lakhovsky's clinical unit reproduced here as Fig. 3. Please notice that there are three wires on the ground going from the case on the right to the antenna on the left. I now believe that two of these wires carried the low voltage supply to the primary coil of the output and the third wire was the ground connection as illustrated in Fig. 2.

Lakhovsky's extensive work with the RCO and the MWO was motivated by his interest in overcoming the debilitating effects of living in and near noxious earth energies. Consistent with this, Jorge Resines tells me Lakhovsky wrote that the MWO would give the

best results when operated over sandy soils. These are the so-called "negative polarity" soils that can cleanly absorb the incoming cosmic radiations without reflecting back any disruptive interference. Now I can understand why these devices were never mass produced. All the rumors we have heard, that each unit was "fine tuned" to the specific location in which it was to operate, now make perfect sense. As Fig. 2 suggests, the multiple oscillations appearing at the antennas were not merely electric in nature, but were in fact earth energy drawn up from the ground connection. The effectiveness of the whole unit depended upon the local earth energy being in a benign state. If the ground upon which the unit was operating was disturbed, then these distur-

bances would also be drawn up into the system and projected by the antennas along with all the other oscillations.

The question is, can a generic design unit be as effective as the extremely refined units hand built by Georges Lakhovsky? From a purist's point of view, the answer is no. But in many situations the generic Beck-style units have been acclaimed as effective. The anecdotal claims associated with the various units that have been on the market over the last few years suggest this possibility. We feel that the closer one gets to Lakhovsky's actual work, the better the

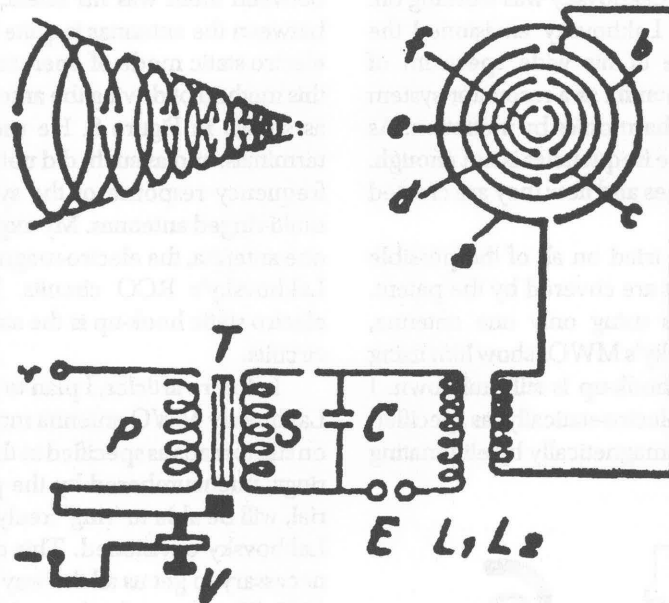
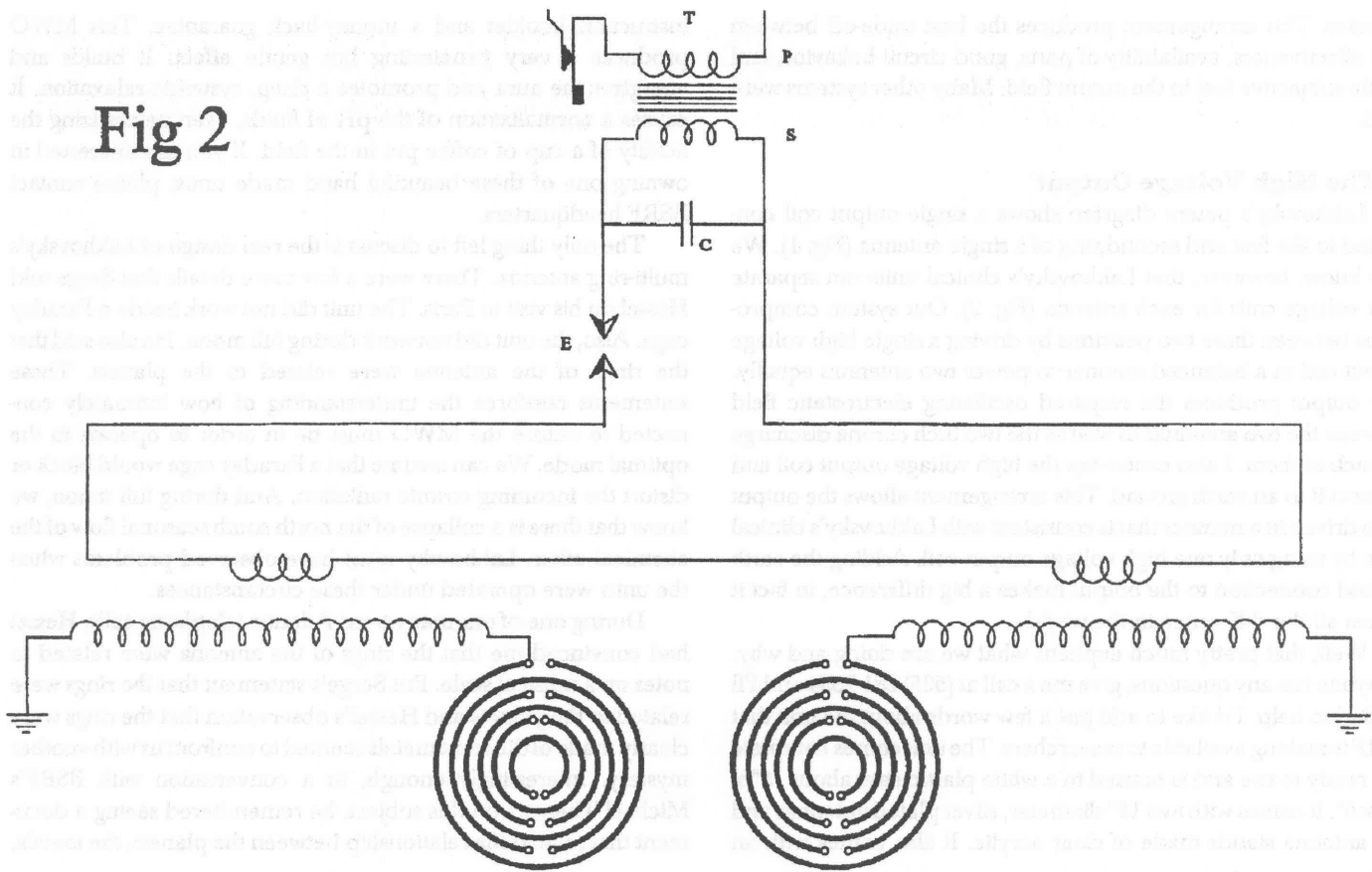

Figure 1

Fig 2



units will perform. Because of this, we are publishing this schematic diagram (Fig. 4) and parts list so that home builders can now make their own superior Lakhovsky-style units. We are also making these units available in limited quantities for serious amateur experimenters.

The current unit consists of four sections: (1) the power supply, (2) the capacitor charging system, (3) the spark-gap discharge section, and (4) the high voltage output and antenna hook-up. Each of these will be discussed separately and compared to Lakhovsky's patent diagram in order to promote clear understanding.

(1) The Power Supply

Lakhovsky's patent diagram does not specify a power supply, but does show the unit needing to connect to a source of Direct Current, as noted by the (-) and (+) connections at the left of Fig. 1. Experiments by Hessel Hoomveld and myself suggest that the best source of DC in this case is a battery. The units definitely work better on batteries. A little market research, however, told me that most people would prefer a unit that could run for long periods, if necessary, and simply plug into the wall socket. Most people did not want to be bothered by battery charging protocols. Therefore, the power supply given here consists of a transformer, rectifier, and filter capacitor as shown in the schematic in Fig. 4.

(2) The Capacitor Charging System

Lakhovsky's patent diagram shows a primary coil, a magnetizable member, a secondary coil, the capacitor, and a device called the *trembler*. The purpose of the trembler is to mechanically make and break the DC current connected to the primary coil. This

arrangement produces pulses coming out of the secondary coil that can be used to charge the capacitor. The circuit we use here is a variation of the one developed by Klark Kent. It consists of a 555 timer chip, protected by some RF chokes, controlling a power transistor that makes and breaks the DC current to the primary of an automobile ignition coil. The pulsed output of the auto coil is then used to charge the capacitor. The high voltage diode between the coil and the capacitor is a necessary addition to this circuit because the capacitor does not charge properly without the diode in place. For you purists, the solid-state section can be replaced by a self-actuating mechanical relay that operates like the trembler. I don't use it because it makes a lot of noise and the solid-state circuit runs quietly and reliably. The solid-state circuit also gives us an adjustable feature to control the capacitor charging rate, like the adjustable trembler would. I have also added a third RF choke between the auto coil and the capacitor on the low voltage side to block the high frequency rebound of the capacitor discharge from feeding back to the power supply.

(3) The Spark-Gap Discharge Section

Lakhovsky's patent diagram shows the capacitor discharging through the primary of the output coil and the spark-gap. Our circuit is essentially the same here. This seems to be the heart of the system and I wanted to leave it alone. Still, a great deal of work went into researching the optimum design for the spark-gap. Straight, open air spark-gaps produce a subjectively harsh feeling in the field between the antennas and a nasty, irritating noise. By contrast, high vacuum, quenched spark-gaps (5 microns) don't work well in the circuit. The unit we are selling uses four enclosed spark plugs wired

in series. This arrangement produces the best trade-off between cost effectiveness, availability of parts, good circuit behavior, and gentle subjective feel in the output field. Many other systems were tried.

(4) The High Voltage Output

Lakhovsky's patent diagram shows a single output coil connected to the first and second ring of a single antenna (Fig. 1). We now know, however, that Lakhovsky's clinical units ran separate high voltage coils for each antenna (Fig. 2). Our system compromises between these two positions by driving a single high voltage output coil in a balanced manner to power two antennas equally. The output produces the required oscillating electrostatic field between the two antennas as well as the two inch corona discharge on each of them. I also center-tap the high voltage output coil and connect it to an earth ground. This arrangement allows the output to be driven in a manner that is consistent with Lakhovsky's clinical units by using only one high voltage output coil. Adding the earth ground connection to the output makes a big difference, in fact it makes all the difference in the world.

Well, that pretty much explains what we are doing and why. If anyone has any questions, give me a call at (505) 281-7554 and I'll be glad to help. I'd like to add just a few words about the unit that BSRF is making available to researchers. The unit comes complete and ready to use and is housed in a white plastic case about 15" x 15" x 5". It comes with two 15" diameter, silver plated antennas and two antenna stands made of clear acrylic. It also comes with an

instruction booklet and a money-back guarantee. This MWO produces a very penetrating but gentle effect. It builds and energizes the aura and promotes a deep, systemic relaxation. It causes a normalization of the pH of fluids, even neutralizing the acidity of a cup of coffee put in the field. If you are interested in owning one of these beautiful hand made units, please contact BSRF headquarters.

The only thing left to discuss is the real design of Lakhovsky's multi-ring antenna. There were a few more details that Serge told Hessel on his visit to Paris. The unit did not work inside a Faraday cage. Also, the unit did not work during full moon. He also said that the rings of the antenna were related to the planets. These statements reinforce the understanding of how intimately connected to nature the MWO must be in order to operate in the optimal mode. We can assume that a Faraday cage would block or distort the incoming cosmic radiation. And during full moon, we know that there is a collapse of the north-south seasonal flow of the chemical ether. Lakhovsky must have observed problems when the units were operated under these circumstances.

During one of our many trans-Atlantic telephone calls, Hessel had convinced me that the rings of the antenna were related to notes on a musical scale. But Serge's statement that the rings were related to the planets and Hessel's observation that the rings were clearly made of different metals seemed to confront us with another mystery. Interestingly enough, in a conversation with BSRF's Michael Theroux on this subject, he remembered seeing a document that related the relationship between the planets, the metals,

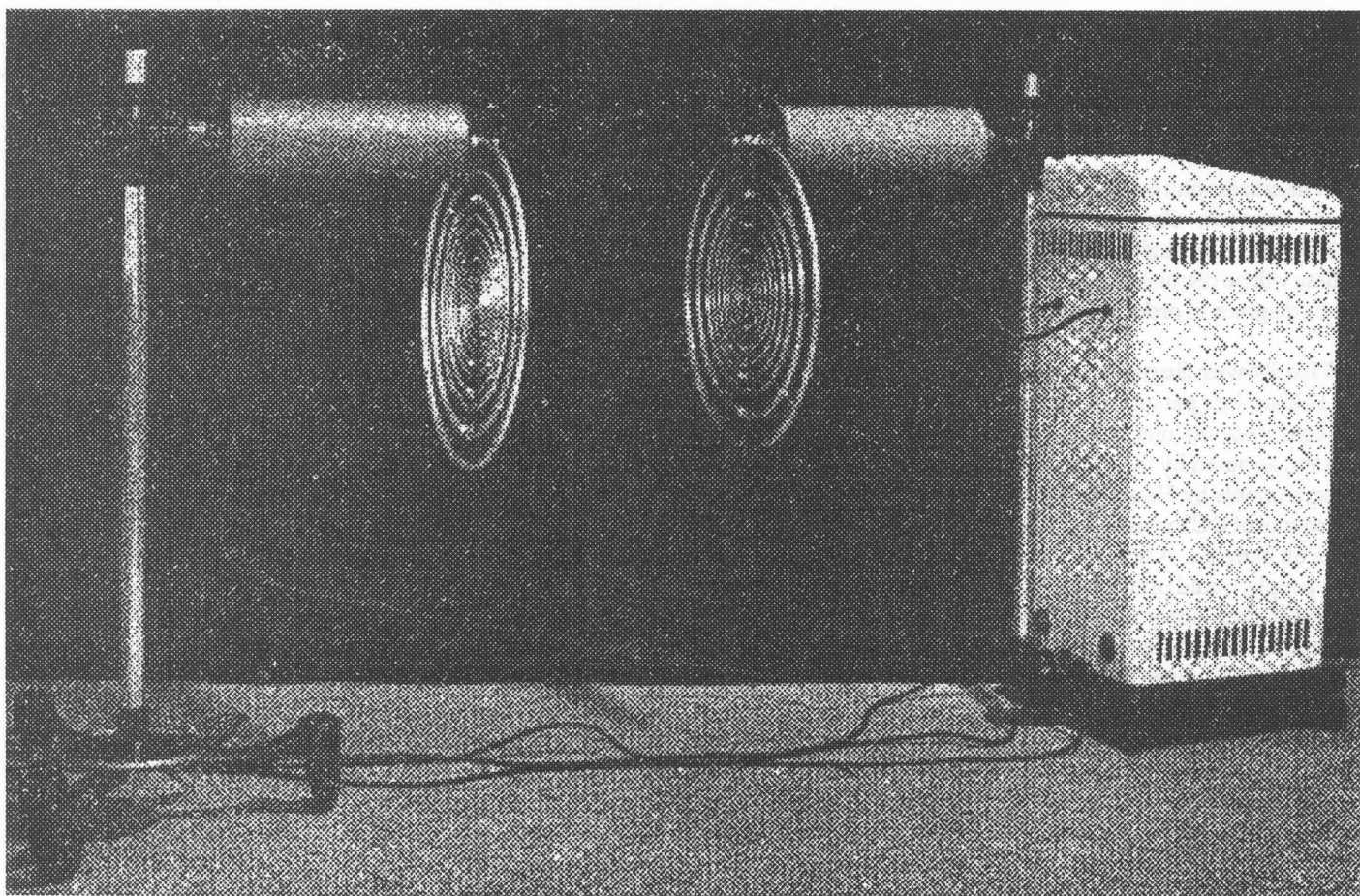

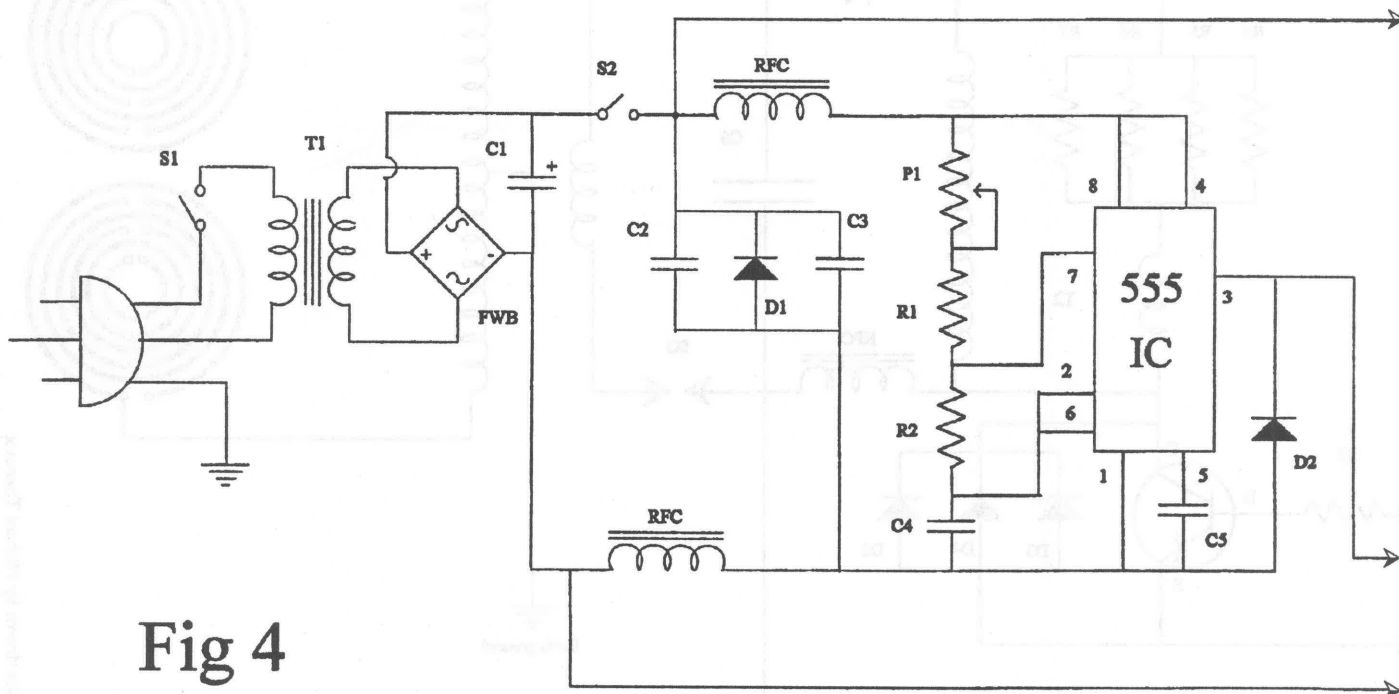

Fig 4

and the musical tones from some research done by an H. Kayser, published in Berlin in 1932. Since we know that Lakhovsky was working with some German doctors with his RCO and early earth energy research, we strongly suspect this information could be the basis for the development of the multi-ring, multimetal, tubular antenna during that same time period. This research document is included as a footnote to an article entitled *The Gravitational Wave* in the BSRF reprint of the **1950 Proceedings of the Scientific and Technical Congress of Radionics and Radiesthesia**. The following article, *The Song of Longevity*, contains Michael's insights into these relationships. In the future we are hoping to prototype some antennas and try them out to see if they broaden the action of the MWO to near universal effectiveness as Lakhovsky claims. Until then, the units we are making available function extremely well as a refined MWO power supply.

I know that some of you have enjoyed this flurry of articles on the MWO. I also know that some have felt that too many pages were given to this topic over the last few years. I can only say that being on the trail of this discovery has been exciting, especially this year. Now that it is nearing completion, I would like to acknowledge how much Tom Brown has contributed to this project. First, he kept the whole project alive by constantly up-dating the **MWO Handbook**. He took the initiative to translate and condense the two Lakhovsky titles, **Science and Good Health** and **The Earth and Ourselves**. These little books told us a great deal about Lakhovsky's work with earth energies and the Radio Cellular Oscillators, the forerunner of the MWO. He first sparked my interest and helped me overcome my reluctance to get involved. Even though he has not written any of the articles in this current series, our telephone conversations have been an integral part of my growing understanding of the MWO. During countless phone

calls, we continued to refine our collective understanding about what Lakhovsky was really doing.

This has really been a global BSRF project and the following people have all contributed in significant ways. A special thanks go to the following: Ralph Bergstresser, who apparently designed the "Magnetic Wave Oscillator" which has been the basis of MWO research for the last 30+ years; Bob Beck, for igniting interest in the MWO in 1963 by reproducing this basic "MWO" design; Riley Crabb, for printing that diagram in the BSRF Journal; Klark Kent, for actually building units that gave people something to work with and gave us something strong enough to whack on for years; Eric Dollard, for an irreplaceable education concerning the properties of high voltage dielectric fields, and for showing us the major divergences from Lakhovsky's actual work by the previous researchers; Ron Crossley, who reported on his first hand observations of Lakhovsky's MWO and helped track down numerous important details; Louis Schad, for bold and original thinking, and experimentation when things were looking pretty stuck; Larry Binger, for work with RCO circuits and sharing generously; Michael Theroux, for timely and insightful input; Jorge Resines, for multi-language translations, tireless research, and remarkable analysis of hard-to-find documents; Hessel Hoornveld, for the eye-witness account of a real MWO in operation, and for extensive clinical testing and in-depth experimentation with MWOs of various types in the Netherlands. Also, many thanks to all the other experimenters out there who have written letters to the Editor and kept the interest high. Thank you all again.

I have had the privilege of having all of this input to sort through and synthesize because these others were willing to share their knowledge freely. I am deeply indebted to all of them.

At this point, I consider the Lakhovsky MWO mystery essen-

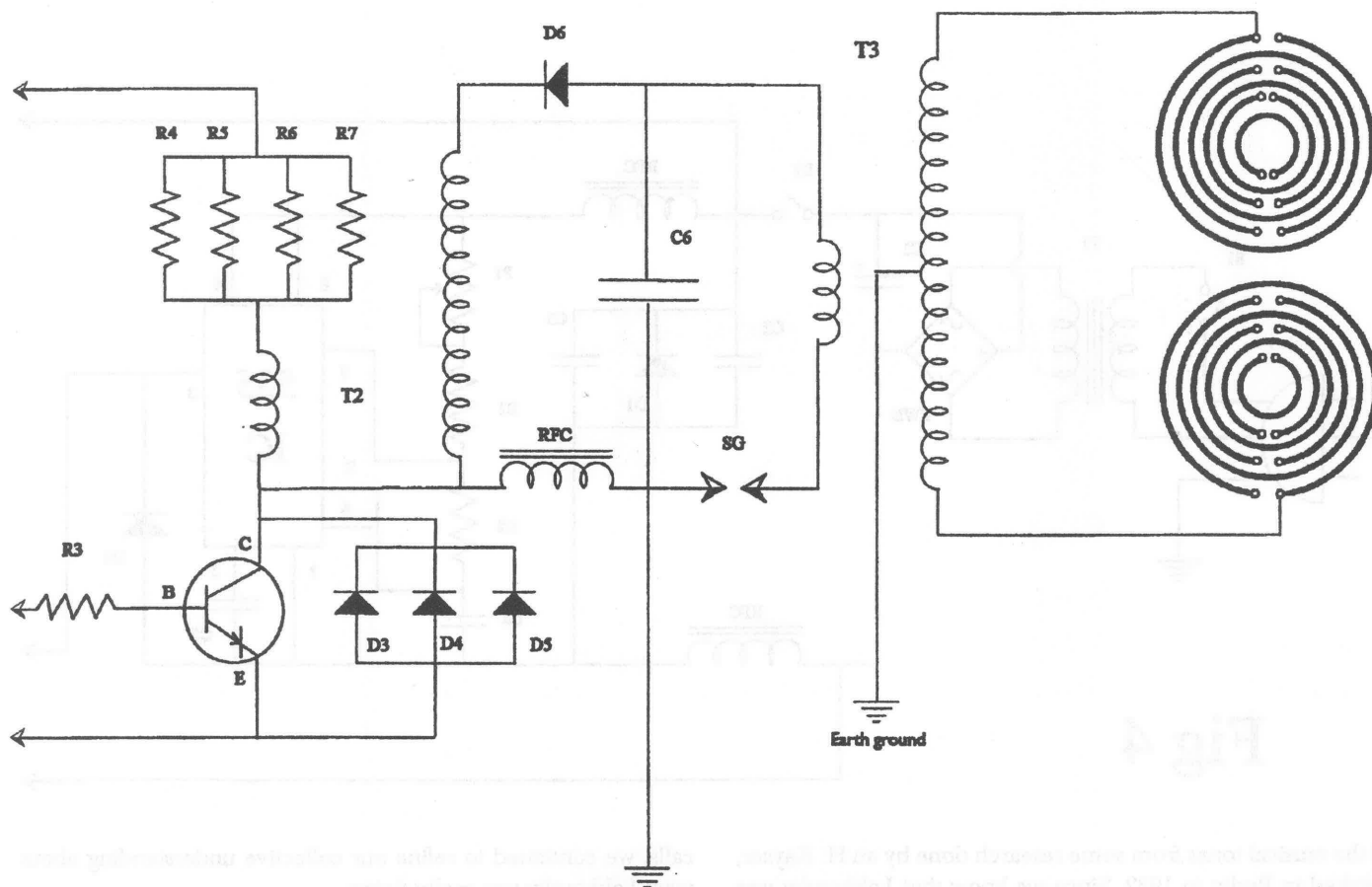

Schematics drawn by Michael Theroux

tially solved. The following is the parts list that goes with the schematic in Fig. 4. for people interested in building a unit themselves.

Parts List

- T1 1 20VAC to 1 2.6VAC, 4.4amp transformer
- FWB Full Wave Bridge 250 volts, 6 amps
- RFC Radio Frequency Hash Chokes, 250uh
- C1 10,000uf 25v Electrolytic Capacitor
- C2 100uf 25v Electrolytic Capacitor
- C3 .047uf 50v Ceramic Capacitor
- C4, C5 .1 uf 100v Polyester and Foil Capacitor
- C6 .01 uf 15,000v Electrolytic Capacitor JAQ-15KMY0103
- IC 555 Timer
- R1 10K 1/2 watt Resistor
- R2,3 1.2K 1/2 watt Resistor
- R4-7 10 ohm, 10 watt Resistors
- D1-2 1N4148 fast switching silicon Diode
- D3-5 1N4004 200 volt, 1 amp Diodes
- D6 ECG 527A 15,000 volt Diode
- P1 50K Variable Potentiometer plus a knob
- Q1 ECG 247 100 volt, 12 amp Power Darlington
- S1-2 SPST Switches rated for 120VAC (plastic handle to reduce shock hazard)
- SG Spark-gap, four automotive spark plugs, enclosed, wired in

series, gaps set at .017"

T2 Automobile Ignition Coil for a 12 volt system

T3 Hand-made High Voltage Output Coil:

Primary: 5½ turns of #18 wire (insulated to 30,000 volts) wound on 2" ID PVC

Secondary: 5½ inches of tightly spaced #33 magnet wire (720 turns) wound on 1" ID PVC. Primary wound around middle of secondary. Secondary is center-tapped.

Notes on the parts list

T2 should not be a hot-rod coil because they put out too much voltage and will destroy C6. An average coil for a V-8 will do just fine. C6 and D6 are hard to find, but they can be special ordered from an electronic parts store (not Radio Shack). Q1 must be protected by a heat sink. T1 and R4-7 get hot during operation. Our production units include a fan-blown cooling system, and separate indicator lights to show when the power supply is on and when radio frequency currents are present at the output. These features are not shown in either the schematic or the parts list. Also needed are a variety of wire, a grounded plug, and other miscellaneous hardware. Once production is in full swing, kits and/or hard to find parts will be available to home builders. Call (505) 281-7554 for more information on parts and on availability of completed units for research.

Happy building and good luck!

THE SONG OF LONGEVITY

by
MICHAEL BRIAN THEROUX

"The earliest prehistoric symbols — the curves, spirals, etc. of the most ancient art — are attempts to render for the eye those primordial energies who have their being in sound alone." Joscelyn Godwin — from the introduction to *Cosmic Music*

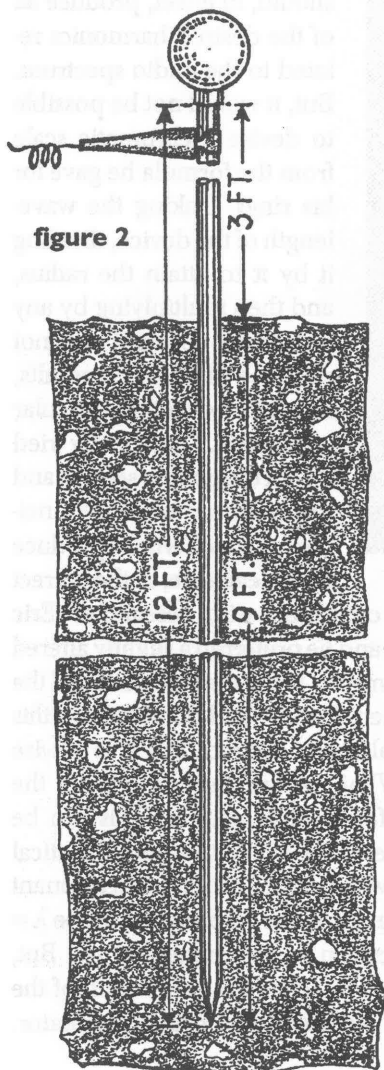

THE MOST FUNDAMENTAL of ancient symbols is quite unmistakably the circle. The next and most obvious progression of this archetype is found in the ever expanding and contracting universe, as depicted by a series of concentric rings. This symbol of concentric rings finds within its compass the models of both the spiral and labyrinth, and cannot be confined to its apparent 2-dimensional interpretation (and we will find its 3-dimensionality unfolding in the armillary sphere.) It is, therefore, no coincidence that Lakhovsky chose such a concentric ring design for his MWO antennas. The antenna system is truly the most important component in the device, and it is well known that Lakhovsky used simple, one-ringed and non-electrical contrivances in his healing experiments with plants.

The latest information concerning the design of Lakhovsky's multi-ring antenna for the MWO, would strongly suggest that he not only incorporated the alchemical correspondences of the metals and planets in the antenna's construction, but that the thirteen ring structure was based on the fundamental harmonics of music. (See *Lakhovsky's MWO: The Final Approach*, by Peter Lindemann)

Before assailing some of the possibilities in designing these antennas, it will be

of great importance to analyze a n d

compare the nature of how a device such as this fits into the musical element, and also to try to interpret the means by which the musical correspondences are arrived at.

In 1918, a Russian inventor named Leon Theremin invented the first electronic musical instrument. Originally called the *Ætherphone*, this musical instrument (now universally known as the theremin) was played by moving the hands in the vicinity of two antennas, (not touching the instrument) hence its original name. The instrument produces its tones by the beat frequency oscillations of two radio frequency oscillators. The antenna, attached to one of the oscillators works like a variable capacitor in conjunction with the hand's presence. Changes in capacitance, effected by the proximity of the hand, actually raise or lower the pitch of the instrument. Very recently, I attended a lecture and demonstration of the theremin by Robert Moog, one of the pioneers of the synthesizer. In his lecture he provided video documentation of several of the early performers on the instrument, and

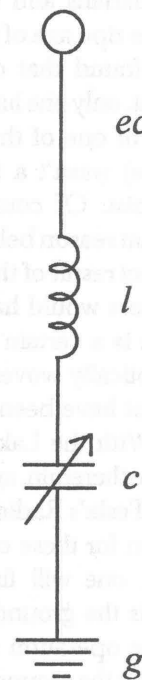

Figure 1

made curious mention that all of these people were still living – octogenarians and older. Leon Theremin himself is still alive at the ripe age of 97! In a lengthy conversation with Mr. Moog, I found that of all the people connected with the instrument, only one has since passed away. Nadia Reisenberg, the sister of one of the theremin's greatest virtuosos (Clara Rockmore) wasn't a theremin player at all, but the piano accompanist. Of course it would be pure speculation to assume that reason behind the theremin performers longevity was a direct result of their contact with the instrument. Many other factors would have to be taken into account.

There is a certain and most common thread which has been cryptically woven into all of these inventions and may or may not have been coincidental. With the Lakhovsky MWO, the theremin, and most certainly Tesla's Radio (as the foundation for these other inventions), one will find that not only is the ground essential for the operation of such devices, but the grounding circuitry is nearly tantamount in all. The basic circuitry is as follows (figure 1): Where *ec* is the elevated capacity, *l* is the inductive coil, *c* is the variable (sometimes fixed) capacitor, and *g* is the grounding apparatus. In the MWO, *ec* would be the multi-ring antenna. In the theremin, *ec* would be the pitch antenna, etc. The rest of the componentry can be found in each device as well, with little variation. Another device that easily fits into this category is the Cosmo-Electro-Energy Condenser invented by George Starr White (see figure 2 & 3). This device was used in the healing of various ailments and possesses the basic structure and symmetry of the others. This is not an electrical device though, and is quite simply connected to the earth.

I believe this most important feature found in all of these apparatuses is the key to understanding the true nature of how they work. With this basic circuit, one can radionically *tune* the earth energy for whatever purpose one desires. In all cases it is the interaction of the organism with this properly entuned earth energy (VRIL) that seems to produce results – whether electrically powered or not.

It now becomes quite apparent why Lakhovsky placed so much importance on ground energies, and constructed each

MWO according to individual specifications calculated in accordance with the local geography. Lakhovsky was tuning each device to a particular earth energy.

Lakhovsky was also very much interested in the sonorous possibilities of his devices as evidenced by his patent for more natural sounding loudspeakers and microphones (see **The Lakhovsky MWO Handbook Second Edition 1989**, compiled by Tom Brown). If the MWO antennas were constructed with concern for their musical properties (which would appear to be true) then several variables need to be figured into their calculation. Based on the information I received concerning the observations of Hesel Hoornveldt, the diameter of the outside ring was approximately 36 inches

and there were a total of 13 rings. From the photos in **The Lakhovsky MWO Handbook** I could only count 12 rings, but in any case we would be dealing with a ring system that was based on an equally tempered chromatic scale. This should, in effect, produce all of the desired harmonics related to the audio spectrum. But, it would not be possible to devise a chromatic scale from the formula he gave for his rings. Taking the wavelength of the device, dividing it by π to attain the radius, and then multiplying by any individual constant will not produce the desired results, no matter what the particular constant is. I personally tried it with the golden section and the twelfth root of two, neither of which would produce a musical scale, or the correct

geometrical symmetry. I consulted with researcher Eric Dollard about the problem, and he preferred a slightly altered method of using the golden mean. Thus, the calculation of the rings would alternate between Φ and $\sqrt{\Phi}$. I don't believe this would produce the musical tones desired, but it is a wise alternative in any case. What we are dealing with is the calculation of frequencies for a set of chimes. This can be most complex, and I have yet to see a definitive mathematical analysis. If we were dealing with nothing more than a resonant chamber such as in an organ pipe, the formula would be $\lambda = 2L/n$, and then the frequency can be determined by v/λ . But, in the case of a chime there would be the calculation of the resonant chamber and the 3-dimensional primary vibrator.

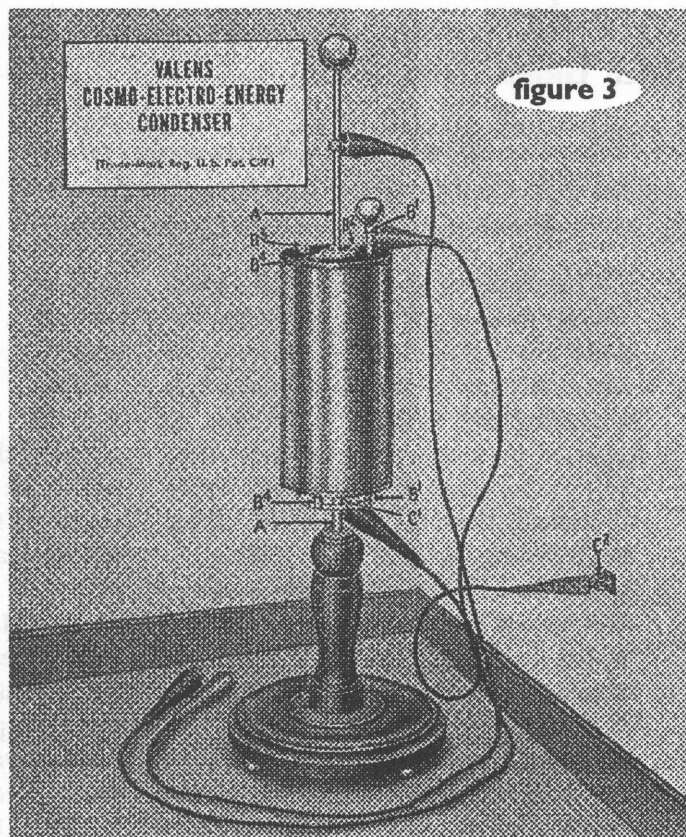

figure 3

MY MEETING WITH SERGE LAKHOVSKY

Paris, July 7, 1993

by Hessel Hoornveld

SERGE LAKHOVSKY is the son of George Lakhovsky. Serge's father was a brilliant scientist, a man of genius. George Lakhovsky was the developer of the 'Radio Cellular Oscillator' and the 'Multiple Wave Oscillator'. Serge's father's discoveries are still the subject of great interest; in his time, the years between 1900 and 1940, he brought about a veritable revolution with his discoveries and theories. It is not easy to go through life as the son of a famous father, it has a great affect on you. In the room where we held the interview, his father's presence could be felt everywhere, in the form of paintings and the devices he developed.

The device that attracted my attention the most was the 'Multiple Wave Oscillator'. The MWO was specially developed to cure cancer.

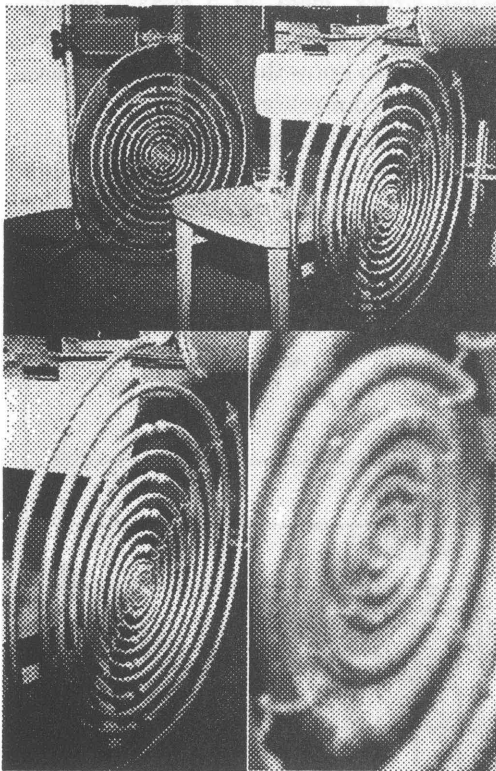

The above sequence of three scans of the same photo shows a 14 ring arrangement used on this unit. Hessel counted 13 rings being tuned from middle C to high C, one octave of tones. Hessel measured the rings with a tuner and discerned the C tuning. The 9 outer rings are suspended with silk string, the 5 inner rings (above right) are mounted on a mica plate. The 14th ring was not counted as it is continuous, unlike the other 13, thus not being part of the tonal-oscillating circuit, but possibly acting as an anchor for the antenna supports and/or as an added dimension to the electrical circuit.

George Lakhovsky was not thanked for the fact that he was able to do this with his apparatus.

George Lakhovsky carried out a great deal of research at a university level, with truly astonishing results. In other words, both past and present scientific research has proved that his method works.

George Lakhovsky died under extremely suspicious circumstances. He was hit by a car during a stay in America and, despite his protests, was taken to a hospital from which he never returned alive. The death of Serge's father and the Second World War meant that his discoveries and developments subsequently fell into neglect.

What was a fact though, was that the discoveries of a genius, and an indispensable instrument in the fight against cancer and other degenerative diseases, had been temporarily eliminated from the scene.

Fortunately, information is now coming to light that allows us to benefit from these techniques of yesteryear. Some time ago, a respected newspaper reported research findings to the effect that one in three Germans, Americans or Dutchmen suffered from, or was developing, a form of cancer.

Nowadays, it is becoming virtually impossible to find sufficient funding to support the entire health-care system. And it is not inconceivable that the fossilized medical industry, along with its many branches, will go completely or partially bankrupt.

Serge Lakhovsky was born in Paris in 1913, and, after finishing his studies, went to America in 1940. He worked there together with Doctor Kovac at the University of Chicago, where they carried out additional research into the effects of the MWO, research which confirmed his father's discovery time and time again.

Serge Lakhovsky has worked in the perfume industry for more than 30 years as a developer and producer of new scents. Serge also treated many of his scents with the Multiple Wave Oscillator, which resulted in exceptional energy-rich combinations and results. In a large room under his house in Paris, thousands of phials with the most unusual scents and compounds are kept.

THE ONE AND ONLY

Serge Lakhovsky does not have a very high opinion of so-called Multi Wave Oscillators.

'Everyone making a high-frequency device these days calls it a Lakhovsky Multi Wave Oscillator,' he says, 'And what's more,

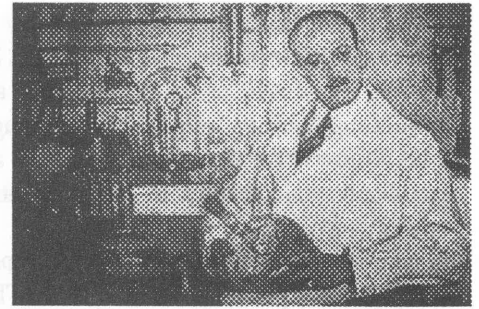

A painting of Georges Lakhovsky, who was a tremendous inventor and scientist, and whose work covered many areas of endeavor.

they don't work'. He thinks that it's fine for people to look for ways that do work, 'But you must take their effect on people into account.'

By this he means that scientific research should be carried out, and that it should not just be allowed to run its course.

Serge told of the extensive scientific research his father had carried out at universities in Paris, Vienna and elsewhere, but added that he always took a great deal of care with his research data and results.

Serge Lakhovsky thinks that there are a lot of unjustified claims being made these days, and that there is too much reference being made to the published research results of his father.

'The reason that I am sitting here talking to you is that before I leave this earthly plane, I want to set matters straight.' Serge is resolute. 'No-one makes the MWO as my father did, and none of them work as my father's did, so the claims that are being made in my father's name are unjust and far from true.'

During my visit with Serge Lakhovsky, I was able to see and feel the original MWO in action.

We were able to carry out various water tests, using radiation from the MWO, and noticed a change in taste and an increased radiation of energy from the water (energetic or cosmic energy).

I have to agree with Serge that the original Lakhovsky MWO works as no other I know. Furthermore, its antenna is totally different to that used on other devices. Most use a Bergstresser or Beck antenna, this MWO works with hollow antenna rings, which are tuned.

I confirmed that they were really tuned when I checked them using my electronic tuning device. When I tapped the second ring, my tuning device clearly indicated a C Sharp. The outermost ring is a fixed ring directly attached to the coil and is a C. The next ring is a C Sharp, the next a D and so on until the innermost ring, which is a C. In other words, a full octave complete with semitones.

If we examine the tuned rings (sound therapy), they also correspond to the chakras (energy points on the body). C is the base chakra, D the sex chakra, E the solar plexus chakra and so on.

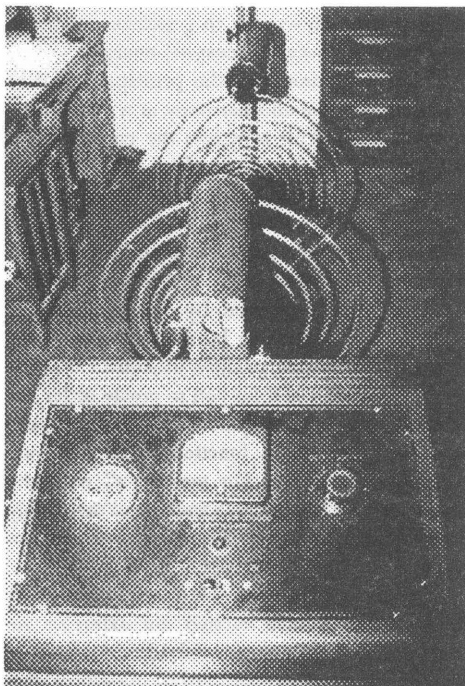

Photo showing top view of Lakhovsky's own MWO. These original photos are in color and show that the rings of the antennas are of different colored metals. It appears that the outer ring is brass (B), the 2nd ring looks like steel/silver (S), the 3rd ring copper (C), and then as follows: 4-B, 5-S, 6-C, 7-B, 8-S, 9-C, 10-B, 11-C, 12-S, 13-B. These identifications are only a guess and are derived from an examination of the photos with a printer's manigifier. TJB.

Each antenna ring is made from a different metal. What the metals are was not revealed to me. When I asked why different metals were used, I was told by Serge that they were chosen in connection with the different planetary positions. Although I would not guarantee that I am right, I have taken a studied guess. The outermost ring, the C, is made of brass, the second ring, a C Sharp, of a light rustproof metal, the third of copper, the fourth of brass, the fifth of a light rustproof metal, the sixth of copper, the seventh of brass, the eighth of a light rustproof metal, the ninth of copper, the tenth of brass, the eleventh of copper, the twelfth of a light rustproof metal, and the thirteenth of brass.

There are bracing wires running from the innermost to the outermost ring, which keep the antenna rings the correct distance apart.

However, existing photographs of the MWO show antennas with different numbers of rings. I saw one with twelve rings, while Serge's MWO had thirteen with the innermost ring for the bracing wires.

I do not know whether the thirteenth ring belongs to the antenna, but it seems very probable.

SECRECY

According to Serge, his father's MWO does not

work when the moon is full, or when it is enclosed in a Faraday Cage.

The rings of the antenna are held together by means of a string, and energy does not flow between them by conduction but by radiation. The antenna is thus capable of radiating gigantic quantities of energetic energy.

The higher and more powerful the energetic field, the faster illnesses and degenerative processes are positively affected. The outermost ring, the C ring, is directly connected to the coil on both sides.

The reply to my request for a peek into the sanctum of the MWO was a definite no. Nevertheless, I hope that Serge will eventually give his permission because the technology involved is naturally of great interest to us all, and because I feel that his father's work should be open to the view of everyone who is open to it.

It seems to me that Serge's fear that his father's techniques would be misused can be ruled out, for there are few people around today who are capable of dealing with this type of energy.

When Serge demonstrated the MWO, two spark gaps could be seen. There is a large coil behind each of the two antennas, which are brought into resonance with each other. The whole technique is based on oscillation and resonance!!

The sound of the two spark gaps is very stable and serene. No sparks jump from one antenna ring to another, as occurs with the Bergstresser and Beck antennas.

It is quite safe to come very close to the antenna rings with a car key, although sparks begin to jump continuously from a distance of about six centimeters. This does not cause an unpleasant sensation though. This indicates an extremely high voltage, high frequency and extremely rapid pulse behavior through the spark gap, and I suspect that the MWO contains a rotating mechanical spark gap.

The electricity needed to operate the MWO is supplied from a wall socket, which causes a fair degree of interference in the public electricity supply. This is something which was permitted in the past, but which is actually no longer allowed. Due to such interference, alarm systems, computers, answering machines and telephone systems etc. could suffer damage, or start to lead a life of their own.

It was only possible to operate the MWO for a short period of time, about five minutes, or else it would overheat.

The device is grounded through the mains. It may be that this was done in order to enable the feed cable connected to the wall socket to be used as a (capacitor). This works even when an earth connection is not present.

Serge did not want to answer my question concerning the relationship between his father, George Lakhovsky, and Nikola Tesla; a brief silence followed. We know from available infor-

mation that the two worked together, and that Tesla was also involved in the development of the MWO. Nikola Tesla had more than 1,000 patents to his name, and was the discoverer of alternating current, and induction motors.

A month after my visit to Serge, he sent me the Radio Cellular Oscillator, a device that George Lakhovsky developed before he started on the MWO. The RCO is a simple, subtle but effective instrument, which relaxes you rapidly and gives you a rosy feeling, especially in your head and body. The device is a boon for the relief of tension aches and it stimulates the circulation; for example, cold feet disappear like snow in the sun. Its effect is based on the same resonance principles as those of the MWO, only it is more subtle and the unit is driven by a vacuum tube.

CURRENT MWO RESULTS AND FINDINGS

The enormous interest that has arisen for MWO techniques and results is a clear indication that a new era has dawned. And I would like to share my knowledge of the current state of the MWO technique with you. A technique that is used both in alternative and regular health-care circles, and here and there in high-level scientific research. In the Netherlands, doctors, dentists, therapists, dermatologists, veterinaries, internists and private individuals etc. use the MWO.

Outside of the Netherlands, I know of therapists, doctors and private individuals in Belgium, Germany, Switzerland, Italy and Africa who are familiar with the device. I have also learned that MWO's are built in Italy and Belgium, albeit on a smaller scale than in the Netherlands.

When I received the design for the MWO from Ralph Bergstresser, I decided to carry out a thorough study of whether, with current technology, it was possible to achieve results similar to those achieved by George Lakhovsky during the first four decades of this century.

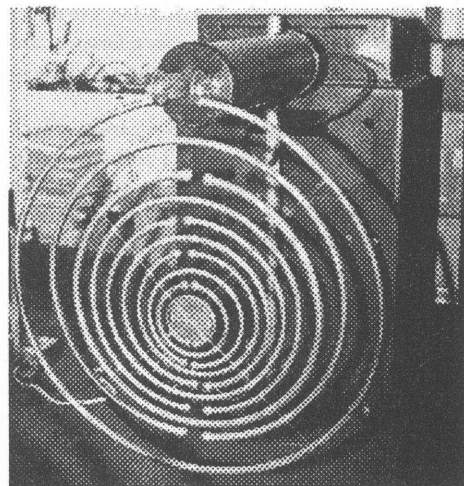

Photo showing front view of Lakhovsky Multiple Wave Oscillator antenna. The suspension in air provides for a tonal ringing.

Of course, much has changed since then. There is more pollution than in Lakhovsky's time: electrostress, stress, different eating behavior, lower quality food, environmental pollution, lighting and double-glazing which distort the laws of nature, sufficient reason to leave well enough alone concerning Lakhovsky's research.

After a number of years of research and many technical improvements of the MWO, we are now able to state that we have achieved results comparable with those of Lakhovsky.

I do suspect however, that it takes more time for the positive effects to be felt nowadays due to increased pollution and different living conditions.

Lakhovsky's device was exceptionally powerful; I do not think anyone builds them as powerful as that anymore. From various sources, I was able to learn that if you operate a Lakhovsky MWO at full power, you could damage living tissue. And other experts have told me that a magnetic field stronger than 10 Gauss can also damage enzymes.

The old devices were rated at 220 V or 110 V and were capable of causing considerable interference on radios and television sets. The MWO's I am allowed to build use a small 12-volt battery, which provides sufficient power for approximately four hours of use. A second battery can be built in, which gives you eight hours of use. They are housed in a doubly insulated plastic suitcase and are portable. Another important feature is that they need far less power than older versions.

The battery-powered version is to be greatly preferred to the 220-V and 110-V versions; there is so much electrical pollution in the public electricity supply that I consider it absolutely essential to use the cleaner energy that a battery supplies. Furthermore, many of our clients take the MWO with them when they travel or on vacation.

New versions of the device have become more effective despite the fact that they use much less power. They do not cause interference and can be operated continuously without overheating.

I build two models, a Bergstresser/Beck system and a Lakhovsky system. The Bergstresser/Beck system has a single Tesla coil and an antenna, a mat to sit on, and a lamp. The Lakhovsky model has a double Tesla coil with a flat primary coil in the middle. This flat primary coil provides the MWO with enormous power and effectiveness, much more than the cylindrical coil.

To the secondary coils, I have connected two antennas, which obtain their power on the outermost ring. The resulting power is radiated to the innermost rings, which in turn brings both antennas into resonance. The effectiveness of these resonant antennas is many times greater than a single sparking antenna. With this model, I deliver two mats to sit on, and a lamp.

I have positioned the spark gap in front of the primary coil; see the diagrams of Peter Lindemann and Lakhovsky. This costs the least amount of energy and provides the widest frequency spectrum as they are not damped by the capacitors

The MWO's I build are not grounded, and I have the feeling that they work better and generate more energy as a result. The person or animal being treated is already in contact with the earth, and, as far as I am concerned, provides the earth contact. Moreover, the middle of the coil, which is where the secondary coils begin, is not grounded either.

The coils are connected to each other, which means that they have a floating neutral point where the flat primary coil is positioned.

When someone takes up a position between both antennas, and does not sit exactly in the middle, or one side of the body requires more energy than the other, the energy supply stays in balance automatically and the resonance of the antennas is improved.

With a ground in the middle, at the beginning of both coils, the system is less flexible and more forced.

Another important consideration is that the area in which the MWO operates should be energetically well furnished, with crystals for example, or a large plate or tray filled with sand (sand has a crystal structure containing silicic acid and silicon; the chips of a computer contain silicon) and is a perfect conductor. The area should not form a Faraday Cage, and it should be possible to open a window.

It is not inconceivable that the glass of the windowpanes filter certain energies. Ultraviolet light is filtered out by glass (except quartz glass or plexiglass). It is very important to correct for the energy that ultraviolet light contains due to its frequency. In this regard, read 'Health and Light' by John N. Ott, and 'Into the Light' by W.C. Douglas.

The MWO needs optimal surroundings because it takes (cosmic) energy from the earth's environment. If this process is hindered, or prevented, the device will be less effective. In my opinion, the electrostatic and electromagnetic field developed by the MWO is a carrier of cosmic/energetic energy.

At Special Energy Products, so much data is coming in concerning the effects of the more than 120 devices we were able to build in 1992 and 1993, and concerning the many thousands of people who have been treated with them, that we cannot doubt the exceptional nature of this instrument.

We are receiving similar feedback from America, and think that we will soon be able to build devices that are even more effective.

The essence of the technique is neither a strong electromagnetic or electrostatic field, but a wide frequency spectrum, with all its harmonics and extremely high voltages. When correctly

applied, this allows you to generate enormous quantities of energetic (cosmic) energy.

Energetic energy is the principal factor in restoring balance and harmony at a mental and physical level. This transmits the correct vibration and polarity to matter, which enables you to recover very quickly and even to regenerate damaged cells.

The ionization that takes place between the antennas, and the ozone (both very rich in oxygen) that is created by the antennas or antenna, and especially by the lamp, are absolutely indispensable positive energies.

The MWO enables you to create order out of chaos allowing energetic energy to flow again, and allowing you to function as an energetic antenna once more. For we are all energetic antennas; we only obtain a fraction of the energy we need from our food. The rest of the energy we need is obtained elsewhere.

You can also store this form of energy in pure matter. I have carried out extensive research with these energy methods. By means of electro-acupuncture (dermatron) measurements, you can clearly demonstrate its effect on people, visually too. The MWO method can be used in a great many ways, for example, to enhance the effect of homeopathic medicines by providing more energetic energy in equivalent volumes.

You can polarize water with it and thus detoxify dissolved contaminants (even though they can still be measured). If you add a drop of the energized water (preferably distilled water) to fluids with many additives for example, such as coloring agents and preservatives, you can taste the difference in taste within a few seconds.

The taste of wine becomes fuller, that of coffee smoother. In general, you could say that it takes the rough edges off the taste. The addition of a few drops of water makes plants grow faster, produce more beautiful flowers, and bear fruit more quickly. They also suffer less from insect pests.

Treating a small quantity of sharp sand with the MWO also produces good results. Sprinkle this sand or mix it with the earth at the base of plants in the garden or flower pot. This form of energy can thus be used to completely or partially polarize (neutralize) poisonous substances.

What else do people use the MWO for? They treat plants with it, as well as animals, with astonishingly good results. They purify water with it, and clean the energy of rooms and objects.

People treat vegetables and fluids in order to neutralize toxins. In addition, the taste of the products improves. A number of people treat their makeup or beauty products with the MWO in order to prevent allergic reactions, or to optimize their products.

People who have been treated with the MWO describe the experience as similar to that of being in an energy shower. They feel light and pleasant, as if a burden has dropped from their

shoulders.

The MWO has been used to treat a large number of ailments and illnesses. Here are just a few:

*Arrythmia has often disappeared after a few treatments. The intended amputation of limbs usually becomes unnecessary.

*Rapid relief is often experienced from pain caused by arthritis, arthrosis and rheumatism, and in many cases the sicknesses disappear after a number of treatments.

*Bone fractures heal in a fraction of the normal time, as do wounds. And scars fade, often vanishing completely.

*Tension aches and facial neuralgia often disappear after a single treatment.

*Various people have been cured of leukemia and cancer partly as a result of treatment with the MWO. This has also been confirmed in the regular health-care circuit. Many people who have undergone chemotherapy and have been treated with the MWO at the same time have stated that they did not experience any side-effects from the chemotherapy, such as hair loss or hemoglobin decomposition (iron level).

*People who have been exposed to radiation and then treated with the MWO have suffered almost no tissue or cell-tissue damage, or other side-effects. Doctors call it a mystery.

*Migraine and tension headaches usually disappear after a few treatments and some people have even regained their memory. The memory of one person, who had a 15-minute recall, showed increasing improvement after a couple of treatments. One woman, who was treated for arthritis, also regained her memory.

*A woman who was to undergo an operation for a cyst, was completely free of the cyst after ten days of treatment with the MWO.

*Various people with tinnitus were relieved of their ailment after a single treatment.

*One man whose left hand had been virtually paralyzed after an operation, and which was swollen with fluid, was relieved of his paralysis after a single treatment, the arm returning to its normal size.

*The condition of a 13-year-old boy, whose blood-cell count had been too low since he was three, became critical when it fell below 10,000 — a count of 125,000 is considered normal. It was eventually decided to treat him with the MWO and within a week, his blood-cell count had climbed to 40,000. The youngster had an attack of influenza and it was not possible to measure the platelets because their shape was too irregular. Once the attack of influenza has passed, his blood-cell count was 125,000. From being a sickly boy, he grew to be a strong young man, without a problem in the world. He fell recently, seriously damaging his knee which bled profusely. His parents feared the worst. The bleeding stopped within a quarter of an hour.

*A few people have partially or completely regained the head of hair they once had. Their

hair had not fallen out due to illness or medicines.

*A man with incurable prostate cancer, was treated with the MWO by a doctor for a number of months. His cancer began to disappear and he is now completely cured. The doctor is of the opinion that the cure can be completely attributed to the MWO, because every other treatment had failed.

In the Netherlands alone, there are currently thousands of people who have been successfully treated with the MWO, by doctors, therapists, homeopaths, private individuals etc.

A high level of medical supervision is important of course, and minerals and vitamins in high doses are an absolute necessity. When undergoing treatment, the body's reserves are immediately mobilized by the MWO and sent to those locations where they are needed.

If we all, including members of the regular medical and scientific establishment, want to get to grips with degenerative illnesses, cancer, leukemia, aids etc., we would do well to realize that this device is probably the answer we have been looking for.

In my opinion, treatment would be even more effective were it to be based on a combination of the MWO and Ultraviolet Blood Irradiation. In this regard, read 'Into the Light' by W.C. Douglas.

At the moment, there are various highly qualified doctors, therapists and other scientists working with and researching energetic methods of treatment in order to perfect them and to make the resulting data available for statistical analysis.

Practice has shown that not every practitioner succeeds with these methods. If a person does not experience any reactions when treating him- or herself (something that occurs sporadically), the treatment does not have an effect when used on his or her patients.

However, when a person is sceptical, or is not open to the matter, but is treated by someone who is open to it, that person will definitely experience positive effects.

Dear friends, keep thinking positively, keep up the good work.

Hessel Hoornveld
Founder and director of:
Special Energy Products
Postbus 15
8374 ZN Kuinre
The Netherlands
Telephone: 00-31-5273-2999
Fax: 00-31-5273-2985

Reprinted from
BORDERLANDS 3RD QTR 1994

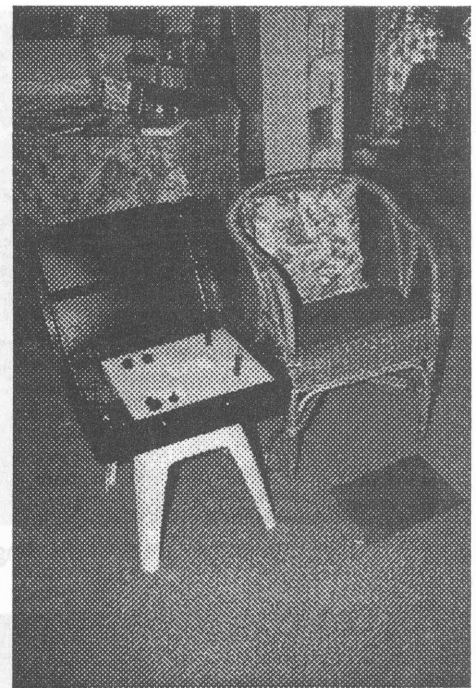

"Bergstresser/Beck-style" MWO unit with single antenna and footplate, built by Hessel Hoornveld.

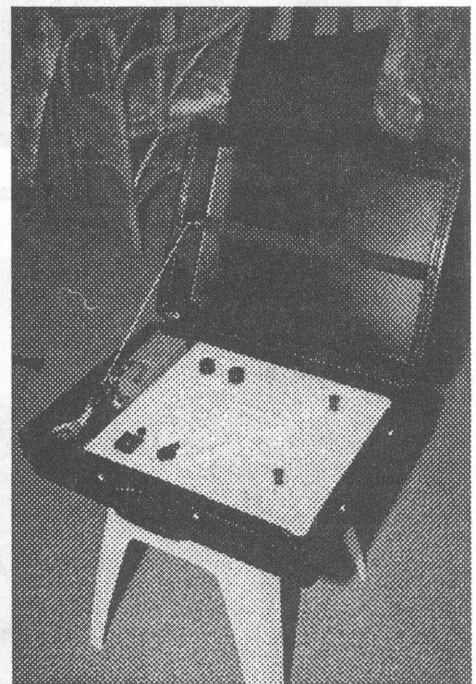

Closeup of MWO front panel.

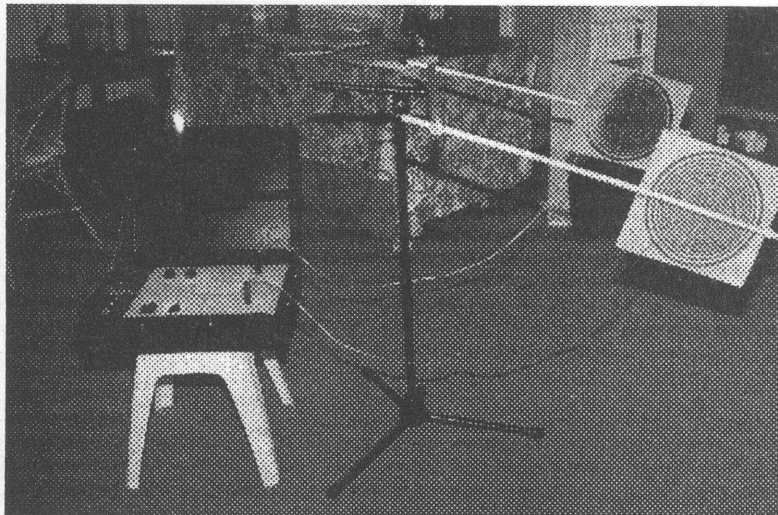

"Lakhovsky-style" MWO showing two antennas on stands.

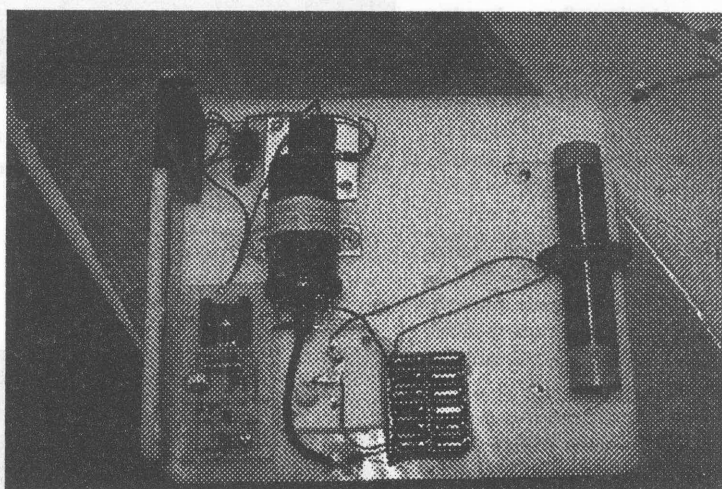

Interior circuitry of experimental "Lakhovsky-style" MWO.

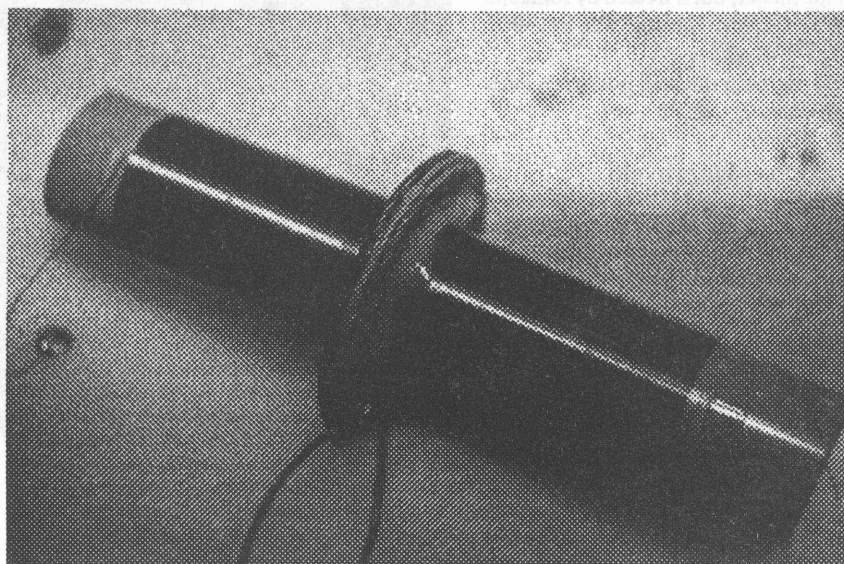

Double Tesla coil with a flat primary coil used "Lakhovsky-style."

SPECIAL LATE BREAKING LAKHOVSKY NEWS!!!!

Longtime Borderlander John Cjeka has provided us with a video of a *Popular Science* newsreel from the early 1940's by Paramount Pictures which shows a Lakhovsky MWO in action. The subject sits facing one antenna with the other to her back and a nurse holds a curious rod-like device. The handle in her hand is wooden and the rod and coil are a single piece of metal. As the nurse waves the rod in front of the subject 8" to 10" sparks fly to it from the antenna. Then the rod is waved about the body and then the coil is placed on the stomach and a small knob is facing the antenna. Next a violet ray-type glass tube coil with handle is placed on the subject. It is not connected, but is energized by the ambient field of the MWO. This provides us the detail of the report of Ron Crossley wherein (Jan-Feb 1991 JBR) he reported that when Georges Lakhovsky demonstrated the unit to him there was a rod or device used along with it. Will wonders never cease? And for a while everybody thought the MWO was just a big old spark box (some of them are, but not the real ones). Perhaps at some time in the future get video clips available in our regular magazine publication BORDERLANDS so that researchers can work to reproduce these curious accoutrements. I shows that we have been on the right track all along!

TJB

BORDERLANDS 1ST QTR 1994

OLD ELECTROTHERAPEUTIC DEVICES

By Jorje Resines

In the "good old days" (before WWII, after which the AMA and its branches at the different "banana republics" dictated what must be done and what is not to be done in the realm of Medicine and Healing) the enterprising scientists of the world dared to intrude into this field and worked hand-in-hand with the MDs to implement better healing devices, even if these left a lot to wish in terms of efficiency. From the article "Electroterapia" of the 1929 issue of the "Enciclopedia Espasa-Calpe" (The Spain-originated equivalent of the "Encyclopedia Britannica") I have extracted the basics of those machines. More complicated devices are only a combination of the features herein presented.

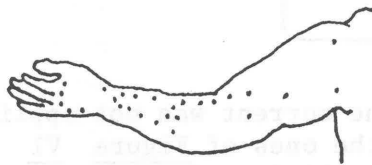

Figure I

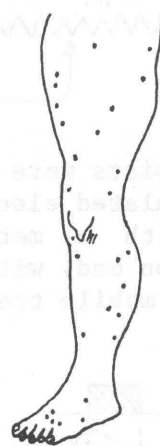

Figure II

The old electrotherapists began by first determining those points of the body that were sensible to electrical discharges. They did so without frying the prospective patient through the usage of Wimshurst-type electrostatic machines. The results (shown partially in Figures I and II) were "points of electrical resonance" that produced the contraction of a certain muscle/organ of the body that had no visible physical connection with them. Not unsurprisingly some of these points fall into Acupuncture meridians and some of them are directly acupuncture points, but the electrotherapists--lacking the proper data from China--failed to identify them.

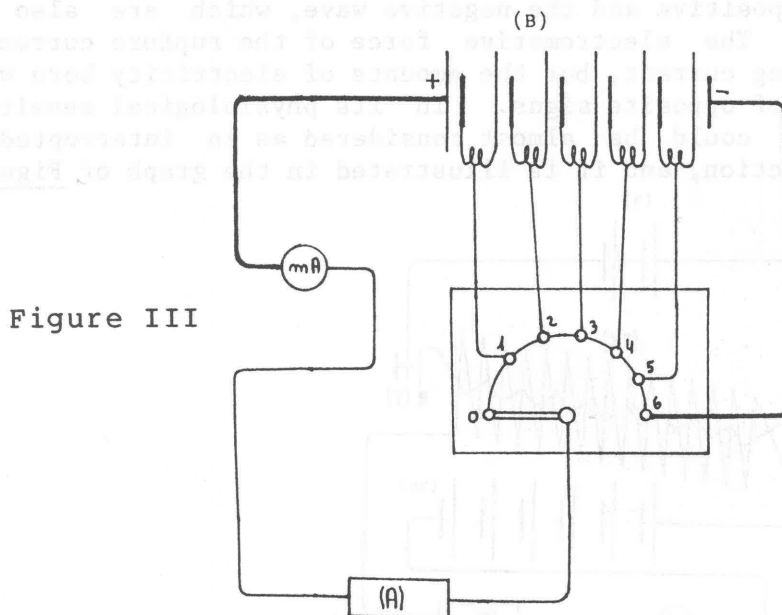
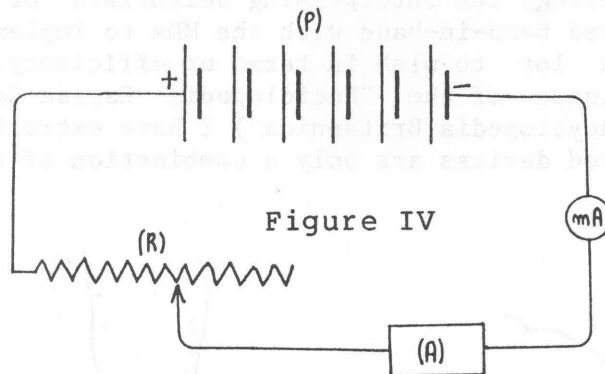
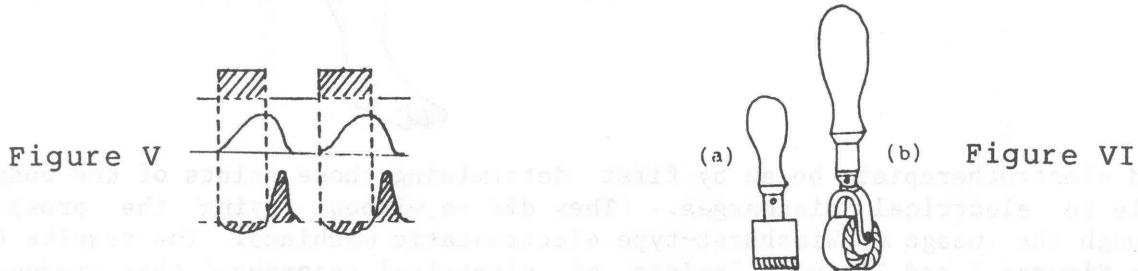

Figure III

The treatment of maladies began by the electrification of the affected zone in an indirect way and began with "galvanic devices", such as the one of Figure III, that delivered a galvanic current into the affected spot. It consisted of a grouping of (usually) Leclanche batteries (B) connected to a milliammeter (mA) and a point-by-point knob graduated from 0 to 5 (in this specific case) whose output was given to the patient (A). Another embodiment of the same principle is shown in Figure IV where a resistor (R) was added to regulate the power being delivered.



As the electrotherapists were very careful, the current was not applied directly to the skin but through insulated electrodes such as the ones of Figure VI which have a wood handle connected with a metal shaft to a cylinder of compacted carbon that was coated (at the application end) with a layer of leather. The electrodes could be for fixed application (a) or mobile treatment (b).



If galvanic current was not enough, then Faradic current was tried. Faradic currents are due to induction phenomena and are different from other currents both in shape and physiological effects. Though they are actually alternate currents they do show a difference between the positive and the negative wave, which are also separated by a certain time interval. The electromotive force of the rupture current is much greater than that of the closing current, but the amounts of electricity born within the induced circuit are equal and of opposite signs. In its physiological sensitivity and motor effects Faradic current could be almost considered as an interrupted current travelling towards a same direction, and it is illustrated in the graph of Figure V.

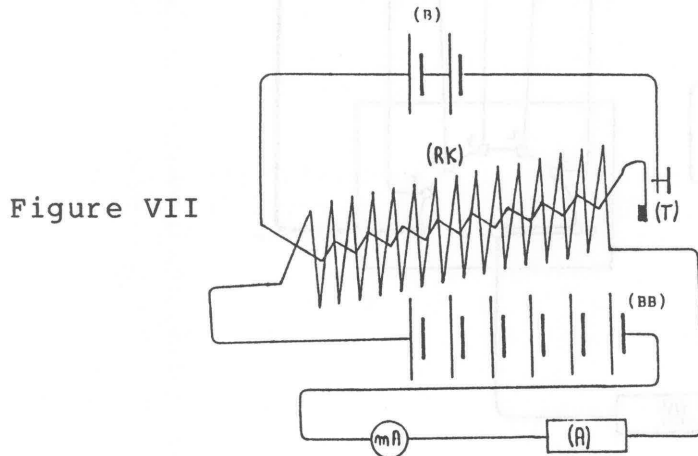

The best way to generate a Faradic current was to employ a Leclanche battery and a Rumkhorff coil connected to the electrodes of Figure VI, but the electrotherapists saw it better to combine the two kinds of treatment into the galvano-faradic apparatus of Figure VII where (B) is the battery that feeds the Rumkhorff Coil (RK), (T) a make-and-break device, (BB) the Leclanche battery-grouping for galvanic treatment, (mA) a milliammeter and (A) the patient to be treated.

Sometimes the MDs used Tesla-type treatment devices but because of the nature of the Tesla waves (that cross through matter without producing ill-effects) the (in his time) world-renowned Dr. Arsene D'Arsonval thought that the high voltage necessary to generate the field in the primary of the Tesla device was too dangerous for it could affect through resonance the human body if they were coupled with the energies of the secondary, hence he proceeded to re-design the devices and thus produced a large (1.5 meter in diameter and about 2.5 meters high) helical coil that was wrapped around a metallic cage but electrically insulated from it, the coil being fed (with suitable spark-gaps or spark-quenchers) current of the sinusoidal kind which is graphed in Figure VIII.

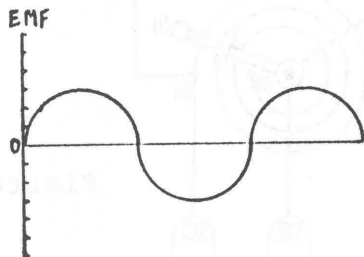

Figure VIII

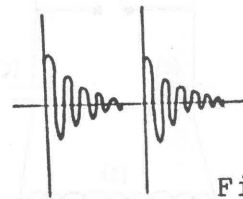

Figure IX

The generator of sinusoidal currents is that of Figure X. It consists of a Gramme ring that has, at one end, the usual collector with its brushes (B-B') and at the other end two insulated metallic shafts that communicate, respectively, with each side of the ring by two intakes of current upon the inducted section and at 180 degrees (K-K'), the ring turns inside a magnetic field created by an independent current that goes through the inductor (M) along the wires (T) - marked in positive and negative polarities at the illustration - that lead into the coils (C).

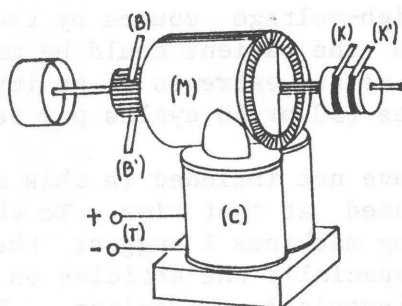

Figure X

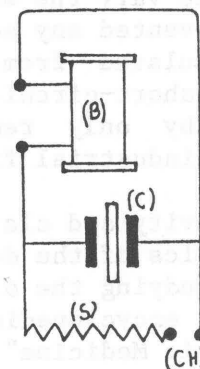

Figure XI

If the ring is activated mechanically from the outside you will collect on one side (B-B') a direct current and at the other (K-K') a sinusoidal alternate current; the usual maximal electromotive force will be indicated by an ordinary voltmeter of DC connected to the respective brushes (B-B'). Because of the influence exerted by Dr. D'Arsonval most of the high-frequency devices of his time were based upon the combination of the following components: (a) An electrical source of high potential (either a Wimshurst-type machine or a Rumkhorff Coil with an interrupter), (b) Two or more condensers, (c) A spark-gap, (d) A circuit with a certain self-induction, and (e) A

circuit induced by the former; though this is taken directly from the ideas of Dr. Nikola Tesla, they nevertheless produce damped waves such as the ones of Figure IX, and to do so use the circuits illustrated in Figures XI and XII, where (B) is a Runkhorff Coil, (C-C') condensers, (S) a solenoid, (CH) a spark-gap, (mA) a milliammeter and (A) the patient to be treated. The circuit can be altered to that of Figure XIII, including a spiraling antenna that goes from (A) to (B) whose length is tuned by rotating a handle (H) that has a cursor in it capable of sliding upon the antenna, this generates a self-induction into the devices which is maximal when the cursor is at (A) and the minimum is at (B). All other elements are similar to the ones already considered save for the glass handles (M-M') which are connected through the terminals (T-T') to the healing device.

Figure XII

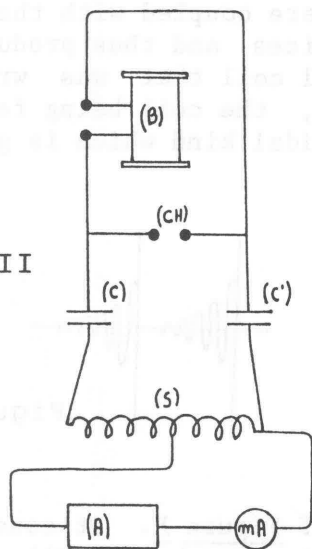
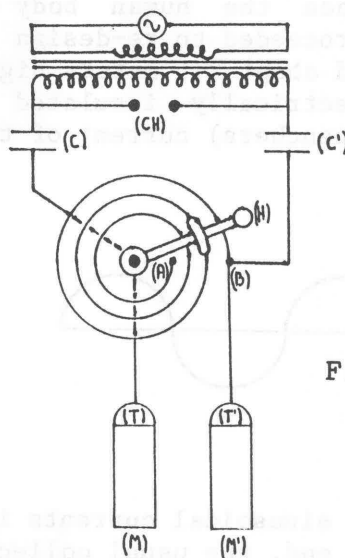

Figure XIII



This apparatus allows work with very short wavelengths, which eliminates any possibility of Faradic currents being within the circuit during the applications. The power utilized to treat an organism was of about 300 watts with an overall efficiency of 45%. The apparatus had a small volume and the only thing to do during applications was to turn the handle (H) to vary the wavelength employed, and the insulation between primary and secondary prevented any accidental connection between the ground and the patient who is also insulated from the high-voltage source by the double series of condensers and even if a short-circuit existed the patient could be maintained isolated from the power source by only remaining at the extremes of an impedance/resistance circuit that are nil for industrial frequencies (50 or 60 cycles per second).

For the sake of brevity and clarity I have not included in this article more ample references to the schematics of the devices used at that time. To those interested in pursuing the matter of studying the old healing machines I suggest the reading of (if you can find them) old encyclopedias and specially the articles on "Electrotherapy", "Electromedicine", "Electric Medicine", "Electrical Healing Devices" and/or "Electricity". Of course other articles can contain interesting material and it is only a matter of reading as much as possible of them.

As the situation of libraries in general is VERY BAD in Argentina, I am not sure if it there exists some sort of a "Electrotherapy History Book" that details the different electrical healing devices that have existed in the past and their evolution through the further radionic machines and present day apparatuses of this kind, therefore I will refrain from suggesting a given bibliography (unlike what I would like to do) for fear of leading the amiable readership of this Journal into false trails.

HIGH FREQUENCY OSCILLATORS FOR ELECTRO-THERAPEUTIC AND OTHER PURPOSES*

by Nikola Tesla

Some theoretical possibilities offered by currents of very high frequency and observations which I casually made while pursuing experiments with alternating currents, as well as the stimulating influence of the work of Hertz and of views boldly put forth by Oliver Lodge, determined me some time during 1889 to enter a systematic investigation of high frequency phenomena, and the results soon reached were such as to justify further efforts towards providing the laboratory with efficient means for carrying on the research in this particular field, which has proved itself so fruitful since. As a consequence alternators of special design were constructed and various arrangements for converting ordinary into high frequency currents perfected, both of which were duly described and are now — I assume — familiar.

One of the early observed and remarkable features of the high frequency currents, and one which was chiefly of interest to the physician, was their apparent harmlessness which made it possible to pass relatively great amounts of electrical energy through the body of a person without causing pain or serious discomfort. This peculiarity which, together with other mostly unlooked-for properties of these currents I had the honor to bring to the attention of scientific men first in an article in a technical journal in February, 1891, and in subsequent contributions to scientific societies, made it at once evident, that these currents would lend themselves particularly to electro-therapeutic uses.

With regard to the electrical actions in general, and by analogy it was reasonable to infer that the physiological effects, however complex, might be resolved in three classes. First the statical, that is, such as are chiefly dependent on the magnitude of electrical potential; second, the dynamical, that is, those principally dependent on the quality of electrical movement or current's strength through the body, and third, effects of a distinct nature due to electrical waves or oscillations, that is, impulses in which the electrical energy is alternately passing in more or less rapid succession through the static and dynamic forms.

Most generally in practice these different actions are coexistent, but by a suitable selection of apparatus and observance of conditions the experimenter may make one or other of these effects predominate. Thus he may pass through the body, or any part of the same, currents of comparatively large volume under a small electrical pressure, or he may subject the body to a high electrical pressure while the current is negligibly small, or he may put the patient under the influence of electrical waves transmitted, if desired, at considerable distance through space.

While it remained for the physician to investigate the specific actions on the organism and indicate proper methods of treatment, the various ways of applying these currents to the body of a patient suggested themselves readily to the electrician.

* Read at the eighth annual meeting of The American Electro-Therapeutic Association, Buffalo, N. Y., Sept. 13 to 15, 1898

As one cannot be too clear in describing a subject, a diagrammatic illustration of the several modes of connecting the circuits which I will enumerate, though obvious for the majority, is deemed of advantage.

The first and simplest method of applying the currents was to connect the body of the patient to two points of the generator, be it a dynamo or induction coil. Fig. 1 is intended to illustrate this case. The alternator G may be one giving from five to ten thousand complete vibrations per second, this number being still within the limit of practicability. The electromotive force — as measured by a hot wire instrument — may be from fifty to one hundred volts. To enable strong currents to be passed through the tissues, the terminals T T, which serve to establish contact with the patient's body should, of course, be of large area, and covered with cloth saturated with a solution of electrolyte harmless to the skin, or else the contacts are made by immersion. The regulation of the currents is best effected by means of an insulating trough A provided with two metal

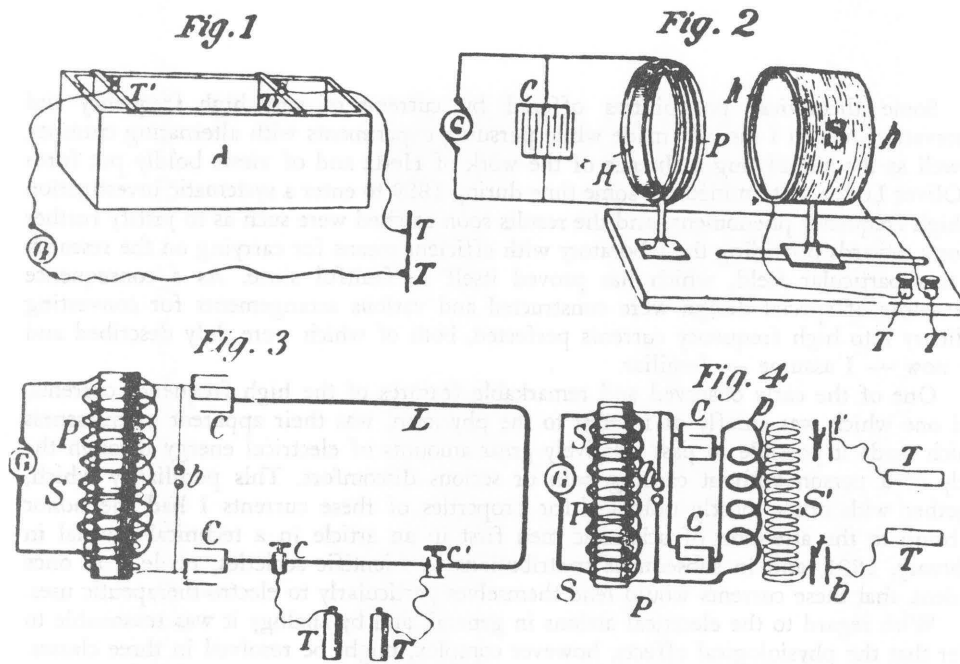

Figs. 1, 2, 3, 4.

terminals T T of considerable surface, one of which, at least, should be movable. The trough is filled with water, and an electrolytic solution is added to the same, until a degree of conductivity is obtained suitable for the experiments.

When it is desired to use small currents of high tension, a secondary coil is resorted to, as illustrated in Fig. 2. I have found it from the outset convenient to make a departure from the ordinary ways of winding the coils with a considerable number of small turns. For many reasons the physician will find it better to provide a large hoop H of not less than, say, three feet in diameter and preferably more, and to wind upon it a few turns of stout cable P. The secondary coil S is easily prepared by taking two wooden hoops h h and joining them with stiff cardboard. One single layer of ordinary magnet wire, and not too thin at that, will be generally sufficient, the number of turns necessary for the particular use for which the coil is intended being easily ascertained by a few trials. Two plates of large surface, forming an adjustable condenser, may be used for the

purpose of synchronizing the secondary with the primary circuit, but this is generally not necessary. In this manner a cheap coil is obtained, and one which cannot be easily injured. Additional advantages, however, will be found in the perfect regulation which is effected merely by altering the distance between the primary and secondary, for which adjustment provision should be made, and, furthermore, in the occurrence of harmonics which are more pronounced in such large coils of thick wire, situated at some distance from the primary.

The preceding arrangements may also be used with alternating or interrupted currents of low frequency, but certain peculiar properties of high frequency currents make it possible to apply the latter in ways entirely impracticable with the former.

One of the prominent characteristics of high frequency or, to be more general, of rapidly varying currents, is that they pass with difficulty through stout conductors of high self-induction. So great is the obstruction which self-induction offers to their passage that it was found practicable, as shown in the early experiments to which reference has been made, to maintain differences of potential of many thousands of volts between two points — not more than a few inches apart — of a thick copper bar of inappreciable resistance. This observation naturally suggested the disposition illustrated in Fig. 3. The source of high frequency impulses is in this instance a familiar type of transformer which may be supplied from a generator G of ordinary direct or alternating currents. The transformer comprises a primary P, a secondary S, two condensers C C which are joined in series, a loop or coil of very thick wire L and a circuit interrupting device or break b. The currents are derived from the loop L by two contacts c c', one or both of which are capable of displacement along the wire L. By varying the distance between these contacts, any difference of potential, from a few volts to many thousands, is readily obtained on the terminals or handles T T. This mode of using the currents is entirely safe and particularly convenient, but it requires a very uniform working of the break b employed for charging and discharging the condenser.

Another equally remarkable feature of high frequency impulses was found in the facility with which they are transmitted through condensers, moderate electromotive forces and very small capacities being required to enable currents of considerable volume to pass. This observation made it practicable to resort to a plan such as indicated in Fig. 4. Here the connections are similar to those shown in the preceding case, except that the condensers C C are joined in parallel. This lowers the frequency of the currents, but has the advantage of allowing the working with a much smaller difference of potential on the terminals of the secondary S. Since the latter is the chief item of expense of such apparatus and since its price rapidly increases with the number of turns required, the experimenter will find it generally cheaper to make a sacrifice in the frequency, which, however, will be high enough for most purposes. However, he only needs to reduce proportionately the number of turns or the length of primary p to obtain the same frequency as before, but the economy of transformation will be somewhat reduced in so doing and the break b will require more attention. The secondary S' of the high frequency coil has two metal plates t t of considerable surface connected to its terminals, and the current for use is derived from two similar plates t' t' in proximity to the former. Both the tension and volume of the currents taken from terminals T T may be easily regulated and in a continuous manner by simply varying the distance between the two pairs of plates t t and t' t' respectively.

A facility is also afforded in this disposition for raising or lowering the potential of one of the terminals T, irrespective of the changes produced on the other terminal, this making it possible to cause a stronger action on one or other part of the patient's body.

The physician may find it for some or other reason convenient to modify the arrangements in Figs. 2, 3 and 4 by connecting one terminal of the high frequency source to the ground. The effects will be in most respects the same, but certain peculiarities

will be noted in each case. When a ground connection is made it may be of some consequence which of the terminals of the secondary is connected to the ground, as in high frequency discharges the impulses of one direction are generally preponderating.

Among the various noteworthy features of these currents there is one which lends itself especially to many valuable uses. It is the facility which they afford for conveying large amounts of electrical energy to a body entirely insulated in space. The practicability of this method of energy transmission, which is already receiving useful applications and promises to become of great importance in the near future, has helped to dispel the old notion assuming the necessity of a return circuit for the conveyance of electrical

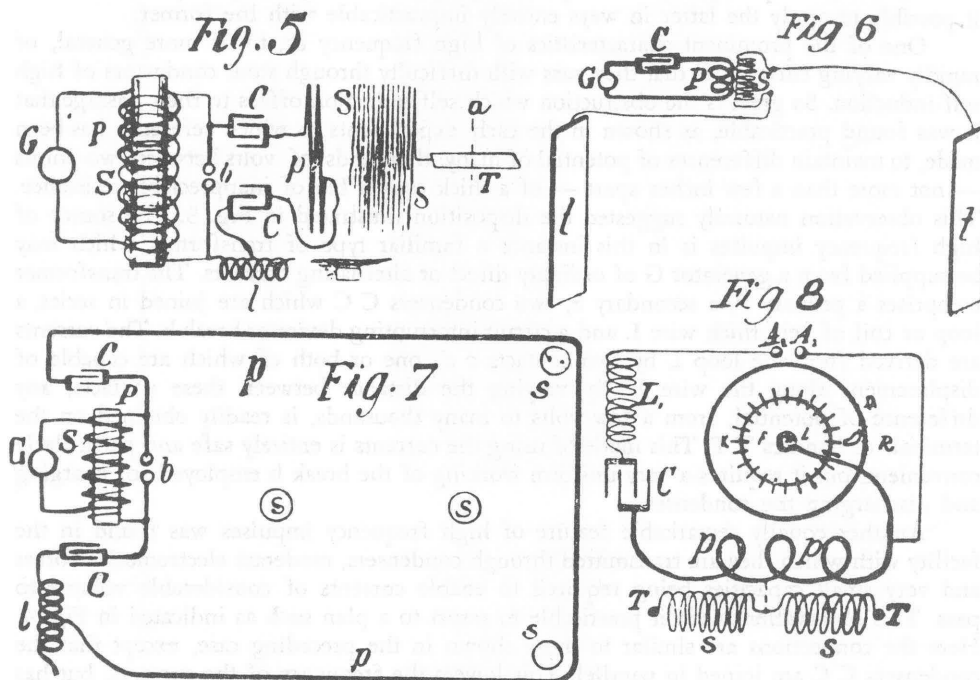

Figs. 5, 6, 7, 8.

energy in any considerable amount. With novel appliances we are enabled to pass through a wire, entirely insulated on one end, currents strong enough to fuse it, or to convey through the wire any amount of energy to an insulated body. This mode of applying high frequency currents in medical treatment appears to me to offer the greatest possibilities at the hands of the physician. The effects produced in this manner possess features entirely distinct from those observed when the currents are applied in any of the before mentioned or similar ways.

The circuit connections as usually made are illustrated schematically in Fig. 5, which, with reference to the diagrams before shown, is self-explanatory. The condensers *C C*, connected in series, are preferably charged by a step-up transformer, but a high frequency alternator, static machine, or a direct current generator, if it be of sufficiently high tension to enable the use of small condensers, may be used with more or less success. The primary *p*, through which the high frequency discharges of the condensers are passed, consists of very few turns of cable of as low resistance as possible, and the secondary *s*, preferably at some distance from the primary to facilitate free oscillation, has one of its ends — that is the one which is nearer to the primary — connected to the ground, while the other end leads to an insulated terminal *T*, with which the body of the patient is

connected. It is of importance in this case to establish synchronism between the oscillations in the primary and secondary circuits p and s respectively. This will be as a rule best effected by varying the self-induction of the circuit including the primary loop or coil p , for which purpose an adjustable self-induction e is provided; but in cases when the electromotive force of the generator is exceptionally high, as when a static machine is used and a condenser consisting of merely two plates offers sufficient capacity, it will be simpler to attain the same object by varying the distance of the plates.

The primary and secondary oscillations being in close synchronism, the points of highest potential will be on a part of terminal T , and the consumption of energy will occur chiefly there. The attachment of the patient's body to the terminal will in most cases very materially affect the period of oscillation in the secondary, making it longer, and a readjustment of the primary circuit will have to be made in each case to suit the capacity of the body connected with terminal T . Synchronism should always be preserved, and the intensity of the action varied by moving the secondary coil to or from the primary, as may be desired. I know of no method which would make it possible to subject the human body to such excessive electrical pressures as are practicable with this, or of one which would enable the conveying to and giving off from the body without serious injury amounts of electrical energy approximating even in a remote degree those which are entirely practicable when this manner of applying the energy is resorted to. This is evidently due to the fact that action is chiefly superficial, the largest possible section being offered to the transfer of the current, or, to say more correctly, of the energy. With a very rapidly and smoothly working break I would not think it impossible to convey to the body of a person and to give off into the space energy at the rate of several horse power with impunity, while a small part of this amount applied in other ways could not fail to produce injury.

When a person is subjected to the action of such a coil, the proper adjustments being carefully observed, luminous streams are seen in the dark issuing from all parts of the body. These streams are short and of delicate texture when the number of breaks is very great and the action of the device b (Fig. 5) free of any irregularities, but when the number of breaks is small or the action of the device imperfect, long and noisy streams appear which cause some discomfort. The physiological effects produced with apparatus of this kind may be graduated from a hardly perceptible action when the secondary is at a great distance from the primary, to a most violent one when both coils are placed at a small distance. In the latter case only a few seconds are sufficient to cause a feeling of warmth all over the body, and soon after the person perspires freely. I have repeatedly, in demonstrations to friends, exposed myself longer to the action of the oscillations, and each time, after the lapse of an hour or so, an immense fatigue, of which it is difficult to give an idea, would take hold of me. It was greater than I experienced on some occasions after the most straining and prolonged bodily exertion. I could scarcely make a step and could keep the eyes open only with the greatest difficulty. I slept soundly afterward, and the after-effect was certainly beneficial, but the medicine was manifestly too strong to be used frequently.

One should be cautious in performing such experiments for more than one reason. At or near the surface of the skin, where the most intense action takes place, various chemical products are formed, the chief being ozone and nitrogen compounds. The former is itself very destructive, this feature being illustrated by the fact that the rubber insulation of a wire is destroyed so quickly as to make the use of such insulation entirely impracticable. The compounds of nitrogen, when moisture is present, consist largely of nitric acid which might, by excessive application, prove hurtful to the skin. So far, I have not noted injuries which could be traced directly to this cause, though on several occasions burns were produced in all respects similar to those which were later observed and attributed to the Röntgen rays. This view is seemingly being abandoned, having not been substantiated by experimental facts, and so also is the notion that these rays are

transverse vibrations. But while investigation is being turned in what appears to be the right direction, scientific men are still at sea. This state of things impedes the progress of the physicist in these new regions and makes the already hard task of the physician still more difficult and uncertain.

One or two observations made while pursuing experiments with the apparatus described might be found as deserving mention here. As before stated, when the oscillations in the primary and secondary circuits are in synchronism, the points of highest potential are on some portion of the terminal T. The synchronism being perfect and the length of the secondary coil just equal to one-quarter of the wave length, these points will be exactly on the free end of terminal T, that is, the one situated farthest from the end of the wire attached to the terminal. If this be so and if now the period of the oscillations in the primary be shortened, the points of highest potential will recede towards the secondary coil, since the wave-length is reduced and since the attachment of one end of the secondary coil to the ground determines the position of the nodal points, that is, the points of least potential. Thus, by varying the period of vibration of the primary circuit in any manner, the points of highest potential may be shifted accordingly along the terminal T, which has been shown, designedly, long to illustrate this feature. The same phenomenon is, of course, produced if the body of a patient constitutes the terminal, and an assistant may by the motion of a handle cause the points of highest potential to shift along the body with any speed he may desire. When the action of the coil is vigorous, the region of highest potential is easily and unpleasantly located by the discomfort or pain experienced, and it is most curious to feel how the pain wanders up and down, or eventually across the body, from hand to hand, if the connection to the coil is accordingly made — in obedience to the movement of the handle controlling the oscillations. Though I have not observed any specific action in experiments of this kind, I have always felt that this effect might be capable of valuable use in electro-therapy.

Another observation which promises to lead to much more useful results is the following: As before remarked, by adopting the method described, the body of a person may be subjected without danger to electrical pressures vastly in excess of any producible by ordinary apparatus, for they may amount to several million volts, as has been shown in actual practice. Now, when a conducting body is electrified to so high a degree, small particles, which may be adhering firmly to its surface, are torn off with violence and thrown to distances which can be only conjectured. I find that not only firmly adhering matter, as paint, for instance, is thrown off, but even the particles of the toughest metals are torn off. Such actions have been thought to be restricted to a vacuous inclosure, but with a powerful coil they occur also in the ordinary atmosphere. The facts mentioned would make it reasonable to expect that this extraordinary effect which, in other ways, I have already usefully applied, will likewise prove to be of value in electro-therapy. The continuous improvement of the instruments and the study of the phenomenon may shortly lead to the establishment of a novel mode of hygienic treatment which would permit an instantaneous cleaning of the skin of a person, simply by connecting the same to, or possibly, by merely placing the person in the vicinity of a source of intense electrical oscillations, this having the effect of throwing off, in a twinkling of the eye, dust or particles of any extraneous matter adhering to the body. Such a result brought about in a practicable manner would, without doubt, be of incalculable value in hygiene and would be an efficient and time-saving substitute for a water bath, and particularly appreciated by those whose contentment consists in undertaking more than they can accomplish.

High frequency impulses produce powerful inductive actions and in virtue of this feature they lend themselves in other ways to the uses of the electro-therapeutist. These inductive effects are either electrostatic or electrodynamic. The former diminish much

more rapidly with the distance — with the square of the same — the latter are reduced simply in proportion to the distance. On the other hand, the former grow with the square of intensity of the source, while the latter increase in a simple proportion with the intensity. Both of these effects may be utilized for establishing a field of strong action extending through considerable space, as through a large hall, and such an arrangement might be suitable for use in hospitals or institutions of this kind, where it is desirable to treat a number of patients at the same time.

Fig. 6 illustrates the manner, as I have shown it originally, in which such a field of electrostatic action is established. In this diagram G is a generator of currents of very high frequency, C a condenser for counteracting the self-induction of the circuit which includes the primary P of an induction coil, the secondary S of which has two plates t t of large surface connected to its terminals. Well known adjustments being observed, a very strong action occurs chiefly in the space between the plates, and the body of a person

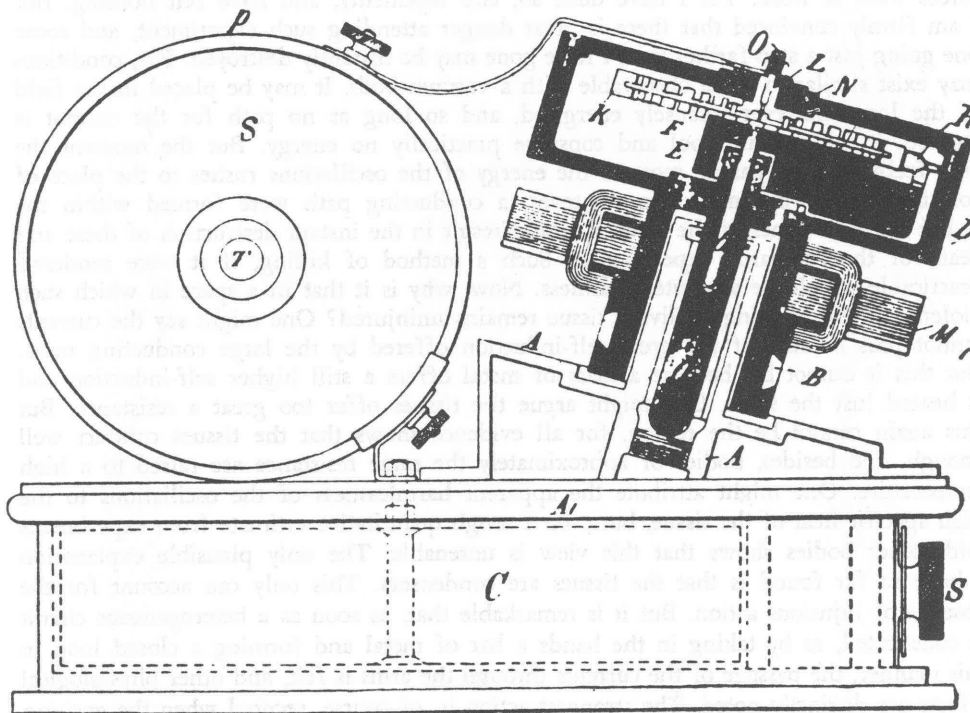

Fig. 9.

is subjected to rapid variations of potential and surgings of current, which produce, even at a great distance, marked physiological effects. In my first experiments I used two metal plates as shown, but later I found it preferable to replace them by two large hollow spheres of brass covered with wax of a thickness of about two inches. The cables leading to the terminals of the secondary coil were similarly covered, so that any of them could be approached without danger of the insulation breaking down. In this manner the unpleasant shocks, to which the experimenter was exposed when using the plates, were prevented.

In Fig. 7 a plan for similarly utilizing the dynamic inductive effects of high frequency currents is illustrated. As the frequencies obtainable from an alternator are

When I first observed these astonishing actions, I was interested to study their effects upon living tissues. As may be assumed, I proceeded with all the necessary caution, and well I might, for I had the evidence that in a turn of only a few inches in diameter an electromotive force of more than ten thousand volts was produced, and such high pressure would be more than sufficient to generate destructive currents in the tissue. This appeared all the more certain as bodies of comparatively poor conductivity were rapidly heated and even partially destroyed. One may imagine my astonishment when I found that I could thrust my hand or any other part of the body within the loop and hold it there with impunity. More than on one occasion, impelled by a desire to make some novel and useful observation, I have willingly or unconsciously performed an experiment connected with some risk, this being scarcely avoidable in laboratory experience, but have always believed, and do so now, that I have never undertaken anything in which, according to my own estimation, the chances of being injured were so great as when I placed my head within the space in which such terribly destructive forces were at work. Yet I have done so, and repeatedly, and have felt nothing. But I am firmly convinced that there is great danger attending such experiment, and some one going just a step farther than I have gone may be instantly destroyed. For, conditions may exist similar to those observable with a vacuum bulb. It may be placed in the field of the loop, however intensely energized, and so long as no path for the current is formed, it will remain cool and consume practically no energy. But the moment the first feeble current passes, most of the energy of the oscillations rushes to the place of consumption. If by any action whatever, a conducting path were formed within the living tissue or bones of the head, it would result in the instant destruction of these and death of the foolhardy experimenter. Such a method of killing, if it were rendered practicable, would be absolutely painless. Now, why is it that in a space in which such violent turmoil is going on living tissue remains uninjured? One might say the currents cannot pass because of the great self-induction offered by the large conducting mass. But this it cannot be, because a mass of metal offers a still higher self-induction and is heated just the same. One might argue the tissues offer too great a resistance. But this again cannot be the reason, for all evidence shows that the tissues conduct well enough, and besides, bodies of approximately the same resistance are raised to a high temperature. One might attribute the apparent harmlessness of the oscillations to the high specific heat of the tissue, but even a rough quantitative estimate from experiments with other bodies shows that this view is untenable. The only plausible explanation I have so far found is that the tissues are condensers. This only can account for the absence of injurious action. But it is remarkable that, as soon as a heterogeneous circuit is constituted, as by taking in the hands a bar of metal and forming a closed loop in this manner, the passage of the currents through the arms is felt, and other physiological effects are distinctly noted. The strongest action is, of course, secured when the exciting loop makes only one turn, unless the connections take up a considerable portion of the total length of the circuit, in which case the experimenter should settle upon the least number of turns by carefully estimating what he loses by increasing the number of turns, and what he gains by utilizing thus a greater proportion of the total length of the circuit. It should be borne in mind that, when the exciting coil has a considerable number of turns and is of some length, the effects of electrostatic induction may preponderate, as there may exist a very great difference of potential — a hundred thousand volts or more — between the first and last turn. However, these latter effects are always present even when a single turn is employed.

When a person is placed within such a loop, any pieces of metal, though of small bulk, are perceptibly warmed. Without doubt they would be also heated — particularly if they were of iron — when embedded in living tissue, and this suggests the possibility of

not as high as is desired, conversion by means of condensers is resorted to. The diagram will be understood at a glance from the foregoing description. It only need be stated that the primary p, through which the condensers are made to discharge, is formed by a thick stranded cable of low self-induction and resistance, and passes all around the hall. Any number of secondary coils s s s, each consisting generally of a single layer of rather thick wire, may be provided. I have found it practicable to use as many as one hundred, each being adjusted for a definite period and responding to a particular vibration passed through the primary. Such a plant I have had in use in my laboratory since 1892, and many times it has contributed to the pleasure of my visitors and also proved itself of practical utility. On a latter occasion I had the pleasure of entertaining some of the members with experiments of this kind, and this opportunity I cannot let pass without expressing my thanks for the interest which was awakened in me by their visit, as well as for the generous acknowledgment of the courtesy by the Association. Since that time my apparatus has been very materially improved, and now I am able to create a field of such intense induction in the laboratory that a coil three feet in diameter, by careful adjustment, will deliver energy at the rate of one-quarter of a horse power, no matter where it is placed within the area inclosed by the primary loops. Long sparks, streamers and all other phenomena obtainable with induction coils are easily producible anywhere within the space, and such coils, though not connected to anything, may be utilized exactly as ordinary coils, and what is still more remarkable, they are more effective. For the past few years I have often been urged to show experiments in public, but, though I was desirous to comply with such requests, pressing work has so far made it impossible. These advances have been the result of slow but steady improvement in the details of the apparatus which I hope to be able to describe connectedly in the near future.

However remarkable the electrodynamic inductive effects, which I have mentioned, may appear, they may be still considerably intensified by concentrating the action upon a very small space. It is evident that since, as before stated, electromotive forces of many thousand volts are maintained between two points of a conducting bar or loop only a few inches long, electromotive forces of approximately the same magnitude will be set up in conductors situated near by. Indeed, I found that it was practicable in this manner to pass a discharge through a highly exhausted bulb, although the electromotive force required amounted to as much as ten or twenty thousand volts, and for a long time I followed up experiments in this direction with the object of producing light in a novel and more economical way. But the tests left no doubt that there was great energy consumption attendant to this mode of illumination, at least with the apparatus I had then at command, and, finding another method which promised a higher economy of transformation, my efforts turned in this new direction. Shortly afterward (some time in June, 1891), Prof. J. J. Thomson described experiments which were evidently the outcome of long investigation, and in which he supplied much novel and interesting information, and this made me return with renewed zeal to my own experiments. Soon my efforts were centered upon producing in a small space the most intense inductive action, and by gradual improvement in the apparatus I obtained results of a surprising character. For instance, when the end of a heavy bar of iron was thrust within a loop powerfully energized, a few moments were sufficient to raise the bar to a high temperature. Even heavy lumps of other metals were heated as rapidly as though they were placed in a furnace. When a continuous band formed of a sheet of tin was thrust into the loop, the metal was fused instantly, the action being comparable to an explosion, and no wonder, for the frictional losses accumulated in it at the rate of possibly ten horse power. Masses of poorly conducting material behaved similarly, and when a highly exhausted bulb was pushed into the loop, the glass was heated in a few seconds nearly to the point of melting.

surgical treatment by this method. It might be possible to sterilize wounds, or to locate, or even to extract metallic objects, or to perform other operations of this kind within the sphere of the surgeon's duties in this novel manner.

Most of the results enumerated, and many others still more remarkable, are made possible only by utilizing the discharges of a condenser. It is probable that but a very few — even among those who are working in these identical fields — fully appreciate what a wonderful instrument such a condenser is in reality. Let me convey an idea to this effect. One may take a condenser, small enough to go in one's vest pocket, and by skilfully using it he may create an electrical pressure vastly in excess — a hundred times greater if necessary — than any producible by the largest static machine ever constructed. Or, he may take the same condenser and, using it in a different way, he may obtain from it currents against which those of the most powerful welding machine are utterly insignificant. Those who are imbued with popular notions as to the pressure of static machines and currents obtainable with a commercial transformer, will be astonished at this statement — yet the truth of it is easy to see. Such results are obtainable, and easily, because the condenser can discharge the stored energy in an inconceivably short time. Nothing like this property is known in physical science. A compressed spring, or a storage battery, or any other form of device capable of storing energy, cannot do this; if they could, things undreamt of at present might be accomplished by their means. The nearest approach to a charged condenser is a high explosive, as dynamite. But even the most violent explosion of such a compound bears no comparison with the discharge or explosion of a condenser. For, while the pressures which are produced in the detonation of a chemical compound are measured in tens of tons per square inch, those which may be caused by condenser discharges may amount to thousands of tons per square inch, and if a chemical could be made which would explode as quickly as a condenser can be discharged under conditions which are realizable — an ounce of it would quite certainly be sufficient to render useless the largest battleship.

That important realizations would follow from the use of an instrument possessing such ideal properties I have been convinced since long ago, but I also recognized early that great difficulties would have to be overcome before it could replace less perfect implements now used in the arts for the manifold transformations of electrical energy. These difficulties were many. The condensers themselves, as usually manufactured, were inefficient, the conductors wasteful, the best insulation inadequate, and the conditions for the most efficient conversion were hard to adjust and to maintain. One difficulty, however, which was more serious than the others, and to which I called attention when I first described this system of energy transformation, was found in the devices necessarily used for controlling the charges and discharges of the condenser. They were wanting in efficiency and reliability and threatened to prove a decided drawback, greatly restricting the use of the system and depriving it of many valuable features. For a number of years I have tried to master this difficulty. During this time a great number of such devices were experimented upon. Many of them promised well at first, only to prove inadequate in the end. Reluctantly, I came back upon an idea on which I had worked long before. It was to replace the ordinary brushes and commutator segments by fluid contacts. I had encountered difficulties then, but the intervening years in the laboratory were not spent in vain, and I made headway. First it was necessary to provide for a circulation of the fluid, but forcing it through by a pump proved itself impractical. Then the happy idea presented itself to make the pumping device an integral part of the circuit interrupter, inclosing both in a receptacle to prevent oxydation. Next some simple ways of maintaining the circulation, as by rotating a body of mercury, presented themselves. Then I learned how to reduce the wear and losses which still existed. I fear that these statements, indicating how much effort was spent in these seemingly insignificant details will not

convey a high idea of my ability, but I confess that my patience was taxed to the utmost. Finally, though, I had the satisfaction of producing devices which are simple and reliable in their operation, which require practically no attention and which are capable of effecting a transformation of considerable amounts of energy with fair economy. It is not the best that can be done, by any means, but it is satisfactory, and I feel that the hardest task is done.

The physician will now be able to obtain an instrument suitable to fulfil many requirements. He will be able to use it in electro-therapeutic treatment in most of the ways enumerated. He will have the facility of providing himself with coils such as he may desire to have for any particular purpose, which will give him any current or any pressure he may wish to obtain. Such coils will consist of but a few turns of wire, and the expense of preparing them will be quite insignificant. The instrument will also enable him to generate Röntgen rays of much greater power than obtainable with ordinary apparatus. A tube must still be furnished by the manufacturers which will not deteriorate and which will allow to concentrate larger amounts of energy upon the electrodes. When this is done, nothing will stand in the way of an extensive and efficient application of this beautiful discovery which must ultimately prove itself of the highest value, not only at the hands of the surgeon, but also of the electro-therapist and, what is most important, of the bacteriologist.

To give a general idea of an instrument in which many of the latter improvements are embodied, I would refer to Fig. 9, which illustrates the chief parts of the same in side elevation and partially in vertical cross-section. The arrangement of the parts is the same as in the form of instrument exhibited on former occasions, only the exciting coil with the vibrating interrupter is replaced by one of the improved circuit breakers to which reference has been made.

This device comprises a casting A with a protruding sleeve B, which in a bushing supports a freely rotatable shaft a. The latter carries an armature within a stationary field magnet M and on the top, a hollow iron pulley D, which contains the break proper. Within the shaft a, and concentrically with the same, is placed a smaller shaft b, likewise freely movable on ball-bearings and supporting a weight E. This weight being on one side and the shafts a and b inclined to the vertical, the weight remains stationary as the pulley is rotated. Fastened to the weight E is a device R in the form of a scoop with very thin walls, narrow on the end nearer to the pulley and wider on the other end. A small quantity of mercury being placed in the pulley and the latter rotated against the narrow end of the scoop, a portion of the fluid is taken up and thrown in a thin and wide stream towards the centre of the pulley. The top of the latter is hermetically closed by an iron washer, as shown, this washer supporting on a steel rod L a disk F of the same metal provided with a number of thin contact blades K. The rod L is insulated by washers N from the pulley, and for the convenience of filling in the mercury a small screw o is provided. The bolt L forming one terminal of the circuit breaker is connected by a copper strip to the primary p. The other end of the primary coil leads to one of the terminals of the condenser C, contained in a compartment of a box A, another compartment of the same being reserved for switch S and terminals of the instrument. The other terminal of the condenser is connected to the casting A and through it to pulley D. When the pulley is rotated, the contact blades K are brought rapidly in and out of contact with the stream of mercury, thus closing and opening the circuit in quick succession. With such a device it is easy to obtain ten thousand makes and breaks per second and even more. The secondary a is made of two separate coils and so arranged that it can be slipped out, and a metal strip in its middle connects it to the primary coil. This is done to prevent the secondary from breaking down when one of the terminals is overloaded, as it often happens in working Röntgen bulbs. This form of coil will withstand a very much greater difference of potential than coils as ordinarily constructed.

The motor has both field and armature built of plates, so that it can be used on alternating as well as direct current supply circuits, and the shafts are as nearly as possible vertical, so as to require the least care in oiling. Thus, the only thing which really requires some attention is the commutator of the motor, but where alternating currents are always available, this source of possible trouble is easily done away with.

The circuit connections of the instrument have been already shown and the mode of operation explained in periodicals. The usual manner of connecting is illustrated in Fig. 8, in which A_1 A_2 are the terminals of the supply circuit, L, a self-induction coil for raising the pressure, which is connected in series with condenser C and primary P P. The remaining letters designate the parts correspondingly marked in Fig. 9 and will be understood with reference to the latter.

THE MAGNETIC-ARC INSTRUMENT OF S.S. KNIGHT

by Mark L. Gallert

Reprinted from

NEW LIGHT ON THERAPEUTIC ENERGIES, 1976

Mr. Knight, a chemical and electrical engineer of Walnut Creek, California, was impressed with the severity and persistence of pain suffered in certain types of cancer. Realizing that pain is a sensation representative of an electrical phenomenon of excessive nerve-current flow, he decided to experiment to see if there was some way of interfering with that nerve flow through artificial impulses, in the effort to stop or alleviate the pain.

Towards this end, he developed an instrument combining several features of electro-therapy:

1. A wave pulsed at 90 times per minute, taking advantage of data obtained from experience with the older types Faradic machines.

2. A rest interval exceeding 75% of the duration of each pulsing cycle - enhances the beneficial effect.

3. Breaking the treatment by mechanical opening of contacts in such a way as to create an arc at each of the pulsing intervals. An arc produces a very wide band of frequencies, from those of very low frequency, to the highest that can be measured. The multiplicity of frequencies seems to play a part in masking or interrupting the sensation of pain.

4. A unique feature of the Knight instrument is that the arc is broken in a strong magnetic field produced by a large, powerful, permanent magnet. This introduces what is called the "Zeeman effect", that is, a magnification of the arc impulses, and a spreading of frequencies.

5. Use of very low power output - below 1/100 of a watt, so that there will be no perceptible heating of tissue when the complex of impulses from the instrument are fed to the patient through electrodes applied to the skin.

Experiments on cases which had been declared terminal cancer by medical doctors, showed that this device not only brought outstanding relief of pain in the majority of instances, but also produced some surprising "remissions" characterized by shrinking of tumour masses, and restoration of general health to the patient.

Dr. C.P. Bryant of Seattle, Washington, who used these instruments extensively in his practice over a period of years, declared that with their use he was able to restore to health 75% of all cancer cases which had not undergone surgery, X-ray or radium, and 25% of those cancer cases which had been subjected to surgery, X-ray or radium.

The Knight family has never represented these instruments as a "cancer cure". The original aim was to find some way to relieve the pain of cancer. Reports from doctors of apparent cures through use of the instruments were received with interest, as well as reports of benefits

from the application of the instrument to conditions other than cancer.

Mr. S.S. Knight, a man with pronounced humanitarian ideals, made the circuit of the instrument available to all inquirers and encouraged the building of instruments by anyone who wished to copy his circuit and specifications. He was keenly disappointed when reports reached him of failure, or lack of therapeutic effect from instruments constructed by others. It developed that adjustments were quite critical, particularly concerning the making and breaking of the arc. Mr. Knight could tell by looking at the arc and listening to it, when it was "right". It was difficult to develop objective criteria for adjustment of the equipment.

A puzzling circumstance, was that the maximum effect from Mr. Knight's instruments was obtained when they were new; after a few weeks of use the effect began to diminish; after some months it was perceptibly weaker, and after a year or more, of very little use. Several years ago, the reason for the lessening of effect was determined. The isolation transformer used to block the direct flow of the arc frequencies from the electric line supply (an isolation required to eliminate radio interference) was being saturated by the magnetism from the large magnet surrounding the arc. The more saturated the transformer became, the less electricity it passed. The equipment was re-designed to place the transformer out of range of the field of the magnet.

The instrument can be classed with experimental devices, as there have not been sufficient tests made under controlled conditions to establish with certainty the percentage of cases of various types of cancer that can be alleviated, arrested, and perhaps cured, but the tests to date indicate at least that this is a promising approach, which should be explored further.

An imitation instrument has been marketed by others, using an electro-magnet instead of a permanent magnet. Mr. Knight was opposed to this substitution, having a number of reasons for believing that the permanent magnet was preferable. Other changes have also been made in constructing these imitation instruments, including the type of electrodes. So far as your compiler has been able to determine, the instruments using electro-magnets have some value in relieving pain in a variety of conditions, but the effect on cancer seems to be slower and less pronounced than that obtained from the genuine Knight instruments when the latter are functioning properly and are in adjustment.



FIG. 1.—Balanced planar equiangular or logarithmic spiral-slot antenna (left) radiates a broad circularly polarized beam on each side of, and perpendicular to, the plane of the antenna.

Frequency-Independent Antennas

SURVEY OF DEVELOPMENT

Antennas now provide continuous coverage of large portions of the frequency spectrum. These very-wide-band antennas offer a challenge to the systems engineer to design equipment that will match bandwidths now available

By JOHN D. DYSON
University of Illinois,
Urbana, Illinois

THE NECESSITY of providing continuous coverage of large portions of the electromagnetic frequency spectrum for defense purposes has exerted great pressure on the antenna engineer to produce antennas that could be used over wider and wider bands of frequencies. Such requirements have led to an important breakthrough in the antenna field. The conception of the frequency-independent antennas at the University of Illinois and their development at this and at other laboratories has produced advances in the state of the art that now puts pressure on the electronics and system engineer to design equipment that will match the available antenna bandwidths. The purpose of

FIG. 2.—Balanced conical logarithmic spiral antenna (left) with feed cable carried along one arm; wire version of balanced conical logarithmic spiral antenna (right), fed with coaxial line and balun, along axis of cone.

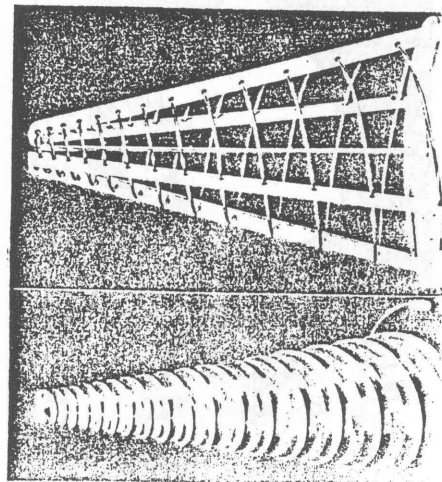

bandwidth cannot be extended.

The general philosophy behind the frequency-independent antennas is to design a radiating structure such that successive applications of a scaling factor result in structures identical with the original, or which, at most, differ by some rotation about an axis through the origin of the original structure. Although the structure must be infinite in size to fulfill the scaling condition of exact equivalence, forms based upon the equiangular or logarithmic spiral curve may be truncated to a finite size and still retain, over an extremely wide range of frequencies, characteristics associated with the infinite structure.

A second breakthrough occurred in 1955 when R. H. Du Hamel proposed to force radiation from otherwise angular structures by periodic discontinuities. This led to a linearly polarized antenna with pattern and impedance characteristics that repeat periodically with the logarithm of frequency.¹¹⁻¹³ Although these logarithmic-periodic antennas scale exactly at only certain discrete frequencies, they can be designed so that the radiation characteristics do not change appreciably over the period between these frequencies. Hence they also exhibit nearly frequency-independent characteristics.

Many versions of the log-spiral and log-periodic antennas have been developed. The planar log-spiral antenna shown in Fig. 1 is bidirectional, radiating a broad circularly polarized beam on each side of, and perpendicular to, its antenna plane.¹⁴ This spiral antenna may be made unidirectional and hence more useful, by an orthogonal projection of the balanced spiral arms upon the surface of a cone (see Fig. 2 left).¹⁵⁻¹⁷ For included cone angles less than about 45 degrees, radiation is confined to one broad circularly polarized lobe with maximum radiation of the apex of the cone. The antenna is balanced, with the feed voltage applied between the two arms at the apex of the cone. This feed voltage may be supplied by a conventional balanced line carried along the axis of the cone, or by a coaxial line and balun.

The characteristics of equiangular

electronic

configuration produced forms that had stable pattern and impedance characteristics over bandwidths up to 10 to 1.¹⁸⁻²⁰

Arrays of the Archimedes spiral antenna provide variable polarization of the radiated field²¹ and beam scanning by simple rotation of the antennas.²²⁻²⁴

In 1954 a major breakthrough occurred when V. H. Rumsey suggested that an infinite length structure based upon the equiangular or logarithmic spiral could be specified completely in terms of angles, and hence it should have characteristics independent of frequency. A study of balanced planar antennas based on these curves disclosed the equiangular spiral antenna to be the first antenna of practical size that had characteristics associated with an infinite structure.²⁵ This structure became the first of a class now called frequency-independent antennas.²⁶

This descriptive term is applied to antennas set apart from the usual concepts of operating bandwidth. The upper and lower frequencies at which these antennas may be operated are determined by independent parameters, and hence the bandwidth over which the radiation pattern and input characteristics are essentially constant is theoretically unlimited. Actually, the bandwidth is limited only by practical considerations of construction, and such antennas have been built to operate over a bandwidth of more than 42 to 1. There is no fundamental reason why this

this survey is to outline the development of these antennas.

As of 1945, antenna research and development had led to a few structures that operated over a 2 to 1 or slightly greater range of frequencies, with acceptable radiation and impedance characteristics. In a majority of cases, it was the radical changes in the radiation pattern with changes in operating frequency which limited the usefulness of antennas to somewhat less than this 2 to 1 range, since antennas had been developed with an input impedance that remained relatively constant with a change in frequency.

The disc antenna²⁷ introduced in 1946 was one of the first antennas that could be used over approximately a 4-to-1 range of frequencies. Advances during the next 7 or 8 years were limited, mainly, to increasing the bandwidth of existing antennas by a few percent. The one exception during this period was a modified helical antenna.²⁸ These unbalanced conical helical structures, fed against a ground plane, had acceptable pattern bandwidths of 4 or 5 to 1.

The spiral antenna introduced in 1953 was a major step forward in wide band antenna design. This construction consists of two flat, narrow, constant-width metallic arms, wound in an Archimedean spiral.²⁹ Fed at the center in a balanced manner, it radiates a broad circularly polarized lobe on each side of the plane of the antenna. Subsequent development of this

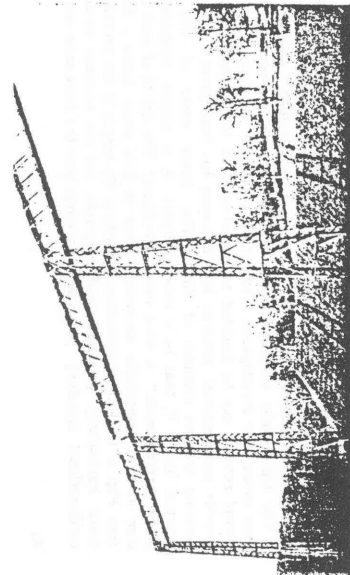

FIG. 3.—The University of Illinois radio telescope. The local line array, 155 feet above the 400-by-600-foot parabolic reflector, is visible below the wooden truss.

ture produces a wave substantially radiated toward the feed point with characteristics that vary little as the operating frequency is varied over extremely wide bandwidths.

A general consideration of the log-periodic zig-zag antennas and the conical log-spiral antennas as locally periodic, slow wave structures has led to a better understanding of their operation and to some useful design criteria.¹⁰⁻¹¹

This survey has covered the work of many people. It has been impossible to acknowledge the work of many others, however an extensive list of references has been included. The original work on logarithmic spiral and logarithmic periodic antennas was conducted at the University of Illinois, sponsored by the Aeronautical Systems Division, Wright Air Development Division under contracts AF33(616)-3220 and AF33(616)-6079.

This article is based upon a paper by the author published in the Journal of Research of the National Bureau of Standards, Section D, January 1962.

The theoretical problem of the log-spiral antenna has received considerable attention. This problem has been attacked by calculating the fields due to a logarithmic spiral filament,¹² and the fields produced by an infinite number of planar logarithmic spiral filaments.¹³⁻¹⁵ An approximate analysis for the radiation patterns of a filamentary log-spiral antenna with an assumed current distribution has been published.¹⁶⁻¹⁸

A recent comprehensive analysis of the log-periodic dipole array has been reported.¹⁹ A new and promising approach considers the log-periodic antenna as a locally periodic structure whose period varies slowly, increasing linearly with distance to the origin or apex.²⁰ This approach indicates that the basic ingredients for a frequency-independent antenna are a slow-wave transmission medium and a series of radiating elements, satisfying the similarity condition, coupled to the transmission medium at points spaced in geometric progression. Such a struc-

ture produces a wave substantially radiated toward the feed point with characteristics that vary little as the operating frequency is varied over extremely wide bandwidths.

A general consideration of the log-periodic zig-zag antennas and the conical log-spiral antennas as locally periodic, slow wave structures has led to a better understanding of their operation and to some useful design criteria.¹⁰⁻¹¹

This survey has covered the work of many people. It has been impossible to acknowledge the work of many others, however an extensive list of references has been included. The original work on logarithmic spiral and logarithmic periodic antennas was conducted at the University of Illinois, sponsored by the Aeronautical Systems Division, Wright Air Development Division under contracts AF33(616)-3220 and AF33(616)-6079.

This article is based upon a paper by the author published in the Journal of Research of the National Bureau of Standards, Section D, January 1962.

The theoretical problem of the log-spiral antenna has received considerable attention. This problem has been attacked by calculating the fields due to a logarithmic spiral filament,¹² and the fields produced by an infinite number of planar logarithmic spiral filaments.¹³⁻¹⁵ An approximate analysis for the radiation patterns of a filamentary log-spiral antenna with an assumed current distribution has been published.¹⁶⁻¹⁸

A recent comprehensive analysis of the log-periodic dipole array has been reported.¹⁹ A new and promising approach considers the log-periodic antenna as a locally periodic structure whose period varies slowly, increasing linearly with distance to the origin or apex.²⁰ This approach indicates that the basic ingredients for a frequency-independent antenna are a slow-wave transmission medium and a series of radiating elements, satisfying the similarity condition, coupled to the transmission medium at points spaced in geometric progression. Such a struc-

mounted sinusuous structure, fed by a waveguide, has been studied,²¹ and a balanced zig-zag antenna has been proposed.²² A vertically polarized log-periodic zig-zag antenna is shown in Fig. 7. The teeth bent parallel to the ground plane serve as a delay line to phase the vertical radiating portions.

Tapering structures, not constructed in a logarithmic periodic manner, have led to antennas of appreciable bandwidth. One tapered helix antenna²³⁻²⁵ consists of symmetrical elements excited by a balanced line. In addition long slot, tapered feed, structures that can be used over a 10-to-1 bandwidth have been proposed.²⁶ A radiating horn with side walls of periodically spaced wires²⁷ when fed from a rigid waveguide, can be operated over a 4-to-1 range of frequencies.

The frequency-independent antennas have opened up a new era in wide-band antennas. However, in view of their complex geometry, the experimental and empirical development of these antennas have outstripped their theoretical analysis.

The frequency-independent antennas have opened up a new era in wide-band antennas. However, in view of their complex geometry, the experimental and empirical development of these antennas have outstripped their theoretical analysis.

The frequency-independent antennas have opened up a new era in wide-band antennas. However, in view of their complex geometry, the experimental and empirical development of these antennas have outstripped their theoretical analysis.

The frequency-independent antennas have opened up a new era in wide-band antennas. However, in view of their complex geometry, the experimental and empirical development of these antennas have outstripped their theoretical analysis.

REFERENCES

(16) J. R. Donnellan, and R. T. Close, A Spiral-Grating Array, *IRE Trans., AP-8*, p. 11, 1960.

(17) J. R. Donnellan, A Spiral-Doublet Scanning Array, *IRE Trans., AP-9*, p. 276, 1961.

(18) J. D. Dyson, The Equiaxial Spiral Antenna, *Proc. Fifth Symp. on the USAP Log-Spiral Omnidirectional Circularly Polarized Antenna*, URSI-IRE Spring Meeting, May 1959, p. 10.

(19) J. D. Dyson, P. R. Mayes, and J. D. Dyson, Circularly Polarized Frequency Independent Antennas with Conical Beam or Omnidirectional Radiation, Report No. 86, Contract AF33(616)-3220, Dept. of Electrical Engineering, Univ. of Ill., July 1960.

(20) J. D. Dyson, Multi-Mode Logarithmic Antennas, *Proc. National Electronic Conf.*, p. 206, Oct. 1961.

(21) J. D. Dyson, The Log-Spiral Antenna in Simple Arrays, *Proc. of the Eleventh Symposium, USAF Antenna Research and Development*, Monticello, Ill., Oct. 1961.

(22) E. M. Turner, The Scimitar Antenna, *IRE Nat. Conv. Electronica Conf.*, 1956.

(23) H. B. Riblet, A Broadband Spherical Satellite Antenna, *Proc. JEE*, 48, p. 631, 1958.

(24) J. D. Dyson, Non-Planar Logarithmically Periodic Antenna Structures, *Proc. Aeronautical Systems Division, Wright Air Development Division, Oct. 1957*. Also, Antenna Laboratory Technical Report No. 10, Feb. 1958.

(25) R. H. DuHamel, and F. E. Ore, Logarithmically Periodic Antenna Design, *IRE Nat. Conv. Electronica Conf.*, p. 138, 1958.

(26) R. H. DuHamel, and D. G. Barry, *IRE WESCON Conf. Rec.*, 3, Part 1, p. 161, 1958.

(27) R. H. DuHamel, and F. E. Ore, Log Periodic Feeds for Lens and Reflector, *IRE Nat. Conv. Rec.*, 7, Part 1, p. 128, 1962.

(28) R. H. DuHamel, and D. G. Barry, (42) R. H. DuHamel, and D. G. Barry,

Medical Aspects of Ultra Short Waves

By C. H. West
U. S. Public Health Service

Mr. West here describes some of the effects and also some of the dangers of subjecting the human body to powerful ultra short wave fields

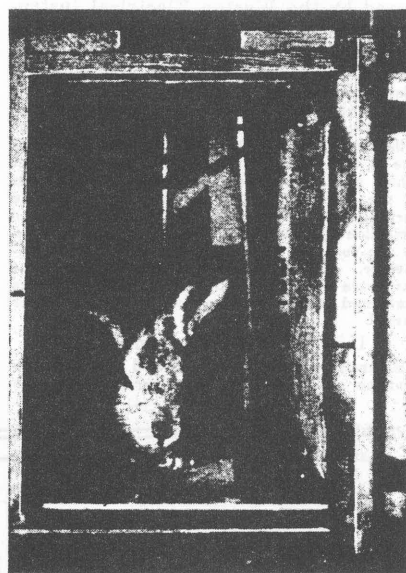
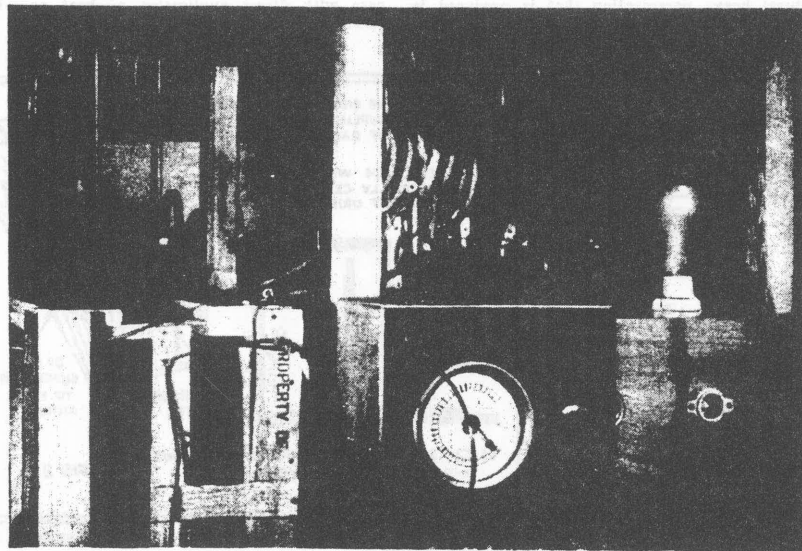

Photos courtesy J. G. Francis, U. S. Public Health Service, Member R. P. S.

Above—A rabbit about to be exposed to a powerful ultra short wave field; the sides as well as the top and bottom linings of the cabinet are of metal.

At left—The appearance of the ultra short-wave apparatus built and tested by Mr. West in his experiments.

● IT SEEMS that the general public is once again taking to radio and the art of building as a pastime. The amateurs are busy developing the five meter band, while the engineers are devoting a goodly portion of their time

to dabbling in the mysteries that the ultra short waves have created.

On the other hand, medical-scientific personages are making use of their medical knowledge, plus a large portion of electronics, in efforts to make the world a better place to live in with less aches and pains to bother us.

Many engineers employed in large electrical laboratories have made valuable use of their knowledge pertaining to the ultra short waves, and have constructed oscillators of high power for the purpose of producing fever in the human body at will. It is a known fact that fever is nature's doctor to a certain degree. If it can be produced in cases where there is no cause for a high fever, the patient's chance for recovery and cure is far better than combatting disease by injection of malaria germs, etc., which may produce reactions worse than the disease itself.

Unknown Qualities

However, the production of fever by an oscillator is a simple procedure, but the application of these high wave speeds to the human body is an entirely different matter. Secondly, the output or radiation of an ultra high frequency oscillator has never been completely identified.

It seems that for every known element discovered there are many others within—undiscovered. An illustration of this fact was brought to light very recently, in which the writer witnessed a demonstration of photo-electric cell work.

A double-cell apparatus manufactured by the Weston Electrical Instrument Corporation produced readings in foot-candles from the output of a 10 k. w. X-ray tube in which the cells were completely covered by 3/4 inch lead sheet.

The roentgen rays do not penetrate lead, and as the tube was quite a distance from the cells, the reaction in the sensitive meter was not due to heat waves, but simply a current output which registered through the lead upon the faces of the cells. The X-ray is noted for producing very bad burns if not handled properly, and the deflection from the target is called and identified as the roentgen ray after the name of the discoverer. How does science know whether the burns are caused from this additional element as registered in foot candles, for want of a better name?

U. S. W. "Fever" Apparatus

Recently, the writer constructed and put into practice an ultra short wave oscillator for the

production of fever or temperature. This apparatus consisted of two UX-852 tubes arranged in push-pull, but with the "back-to-back" arrangement of *Messy-Valuri*. It is a persistent oscillator and is capable of running long hours on wavelengths from 2 to 10 meters.

An auxiliary cabinet was constructed with two leads to couple across the plate inductance. This cabinet has one adjustable side; the top and bottom being one lead, and the two sides the other and forming a large condenser.

Rabbits were used in experiments and their temperature reached 41 degrees (Centigrade) from the usual 38 degrees (normal). However, after a few weeks severe burns were noticed. Since that time research has been carried on by other factions in an effort to ascertain the direct cause of the burns, which do not seem to be due to collections of moisture, or from coming in contact with the condenser plates.

This brings to mind that experiments by the writer with the very short waves disclose the fact that some sort of a photo-electric ray could be produced and would highly expose small dental films. It is believed this elementary action was first discovered by Mr. John Reinartz, the noted radio amateur, who perceived a bluish glow within an auxiliary indicator at a certain frequency.

Before any actual application to humans may be applied, it is our duty to ascertain accurately whether other elements are prevailing. To all indications there are many, and one of them is severe burns, which may be caused by an unidentified element.

Constructional Data and Summary

As will be noted in the photographs, the apparatus is entirely enclosed and surrounded by glass sides to better view the "works" in case things tend to go the "hay-wire" route. The lower portion of the cabinet contains the necessary plate and filament transformers, which operate direct from the 110 volt, 60 cycle line. The plate power is raw A. C. at a potential of 2600 volts, the filament transformer being the customary 10 volt affair. Inductances are removable; the ones shown are at present used for 30,000 kc. work. The circuit is shown in Fig. 1, which is the conventional push-pull method.

However, the auxiliary cabinet is for purpose of holding an animal within the field and without strapping him and causing discomfort. The condenser plates are of sheet metal and insulated, the schematic diagram appearing in Fig. 2.

When a rabbit is placed in this pen and the power applied, he fails to react immediately; but as he "warms" up to the situation the veins in the ears show dilation, and in 20 minutes his temperature starts to rise and keeps going. It is only at a much later date that burns are noticed.

From the foregoing it would hardly seem advisable to subject a human to any lengthy treatment, at least, for the present; but the value of high frequency in various forms have proved essential in many cases. Secondly, the natural heavy perspiration that is produced is essential in one degree in opening the pores

(some of which have probably never been opened before) and allowing the natural poisons of the body to escape more quickly than could have been accomplished with potent medicines.

The majority of high frequency apparatus produces this result. In the case of pulsating currents, which produce a series of reactions or "jumps" within the muscular system, this often is very beneficial in activating those muscles which could not have been manipulated manually without a great degree of pain.

Probably the first reaction noticed with reference to the ultra high frequencies were from early experimenters while conducting transmission tests with high power. It was noticed that the body temperature tended to rise at various times, due entirely to their proximity to a powerful oscillator. Science has been looking for a long time for some method to raise the temperature in the human body quickly. Ultra high frequency oscillators have solved that problem but have brought many other matters to light. Secondly, to produce the desired results the patient must be enclosed between two or more condenser plates of large proportions. The oscillator must be of high power, capable of delivering 500 watts output and the patient must be wrapped in a suitable covering to prevent his contact with any portion of the charged plates.

Various research workers who have volunteered their services as "trial patients" have received a goodly portion of burns as compensation, and are quite satisfied that ultra high frequency currents are "hot stuff!" Where heat is concerned, one could get equivalent results by setting on a hot steam radiator. The writer knows this to be true, and has experienced many a painful burn which he would have been willing to trade for a shock from a quarter kw. closed-core transformer.*

It could hardly seem probable that burns would prevail where the body is not in contact with any metallic object; but an examination under darkness of a large condenser tapped from the oscillator, will disclose a bluish aurora between the two elements, which is similar to that noted in Tesla coil experiments. Within this bluish discharge there can be many components not yet identified, which have a tendency to attack tender portions of the body and produce an internal burn, which does not come to the surface for identification until some days have passed.

It is open to discussion whether one-half of the electrical apparatus in present use actually cures the patient of pains, or whether it is the psychology of the matter in which the patient is surrounded by many cabinets of mysteries, of which he knows absolutely nothing. What cures one man does not seem to cure another with the identical complaint.

*Yes—but it is generally understood we believe, that the high frequency currents or field causes heat to be developed inside the body; even in organs such as the liver, etc., without heating up the whole body, which is not the case with direct application of heat as when seated on a hot radiator, etc.—Editor.

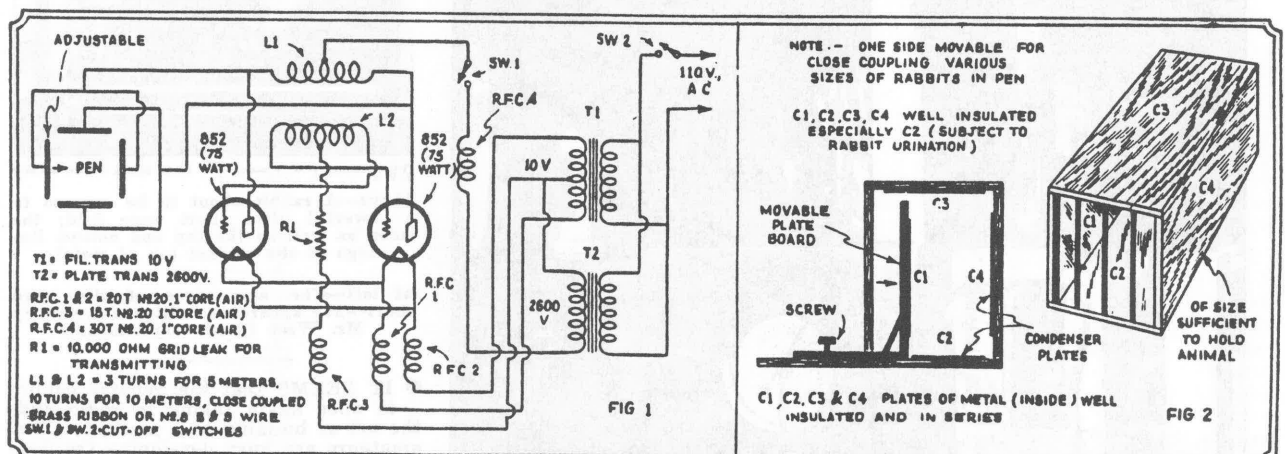

The drawings above provide details of the circuit used by Mr. West in building his ultra short-wave physiological apparatus, together with details of the apparatus itself.

reprinted by Lindsay Publications, Box 12, Bradley IL 60915-0012

Short Waves in Medicine

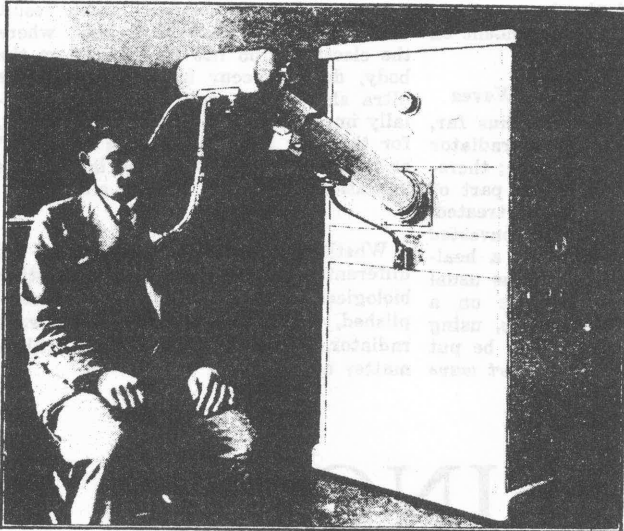

ULTRA SHORT WAVES IN MEDICINE

By DR. FRITZ NOACK
(Berlin)

PROFESSOR ESAU, of the University of Jena, the well-known pioneer in the field of ultra short waves, was the one who nearly two years ago pointed out that very evidently the ultra short wave exercised beneficial medicinal effects.

For further investigation of this effect, small mice were put between the condenser plates of the sender; and Lo! after some time the mice fell victims to a sort of tetanus, which eventually led to death. The result of this fact was that Prof. Esau resolved to commission a physician to make a further study of the physiological effect of these ultra short waves. Naturally the serious investigation of medicinal effects requires experience in physical measurements, likewise an apparatus operating in a constant and easily controlled manner.

Siemens and Halske Interested

It is gratifying that a manufacturer which already possesses very great experience in constructing electro-medical apparatus and which also has the requisite experience in physical measurements, the prominent firms of Siemens and Halske took up the matter. Now this company has manufactured a first ultra-short wave radiation apparatus and recently exhibited it to a picked group of scientists and to the press.

The pictures show the new set which, of course, has to be considered as the first of an evolutionary series. There will still be necessary all sorts of experiments to produce the set in such form that it will correspond to all the needs of the medical profession. The present set will, for the time being, be used for the further study of the physiological effect of ultra short waves. It will be the problem of the doctors to

One of the "fair sex" receiving a treatment through the knee by ultra-short waves. Several treatments are given for the average ailment.

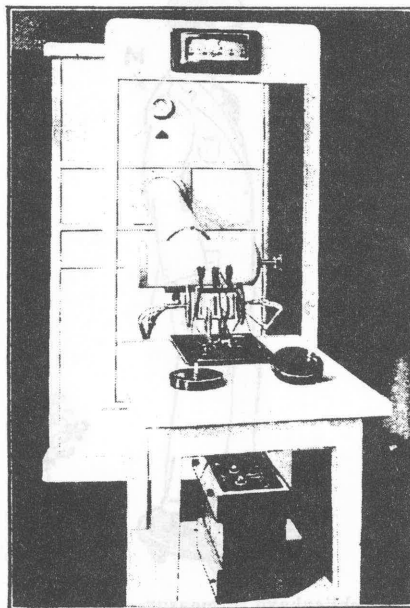
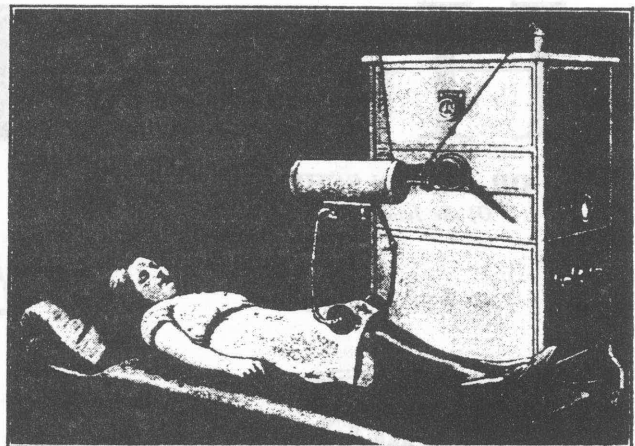

The ultra-short wave medical apparatus with its electrode arm adjusted to permit the waves passing through a solution for experiment.

investigate the fields of use and the conditions under which the set may be used.

Arrangement of U. S. W. Generator

In the large shielded box are the real ultra short wave generator—(actually resembling a radio transmitter) and the parts needed for its operation. The generator can work on two waves, four and eight meters. The wavelength is adjusted by inserting the proper tuning coils. The arm which projects out of the apparatus has inside it two lead wires which convey the oscillations outward; they are led to the two electrodes, which are placed at the ends of the two visible supports.

In the cross-beam at the end of the arm is a "tuning" device, which tunes the electrode oscillatory circuit exactly to the wavelength of the generator. The exact tuning can be read on a meter, which is above the arm on the box; this shows the direct plate current of the transmitter, which, with correct tuning of the electrode circuit, adjusts to a minimum; the value then indicated by the meter gives, after calibration of the a value for the electrode energy.

To be able to adjust the electrodes, as is necessary from one case to an-

other, the electrode arms are set in ball-joints. To ascertain whether oscillations are actually present in the electrode oscillatory circuit, there is on one electrode arm a little glow lamp (Neon tube), which lights up in the presence of oscillations.

Electrodes Swing on Giant Arm

The arm projecting out of the apparatus can be swung in all directions, for the better use of the whole unit. To accomplish this, it is fixed to the box in a universal joint. The end cross-piece of the arm can furthermore be turned, so that the electrodes can assume any desired direction. The right side wall of the box contains the main current switch, as well as a resistor with which the filaments of the tubes are regulated. The apparatus is in fact constructed just like a vacuum tube radio transmitter. The electrodes may take various forms;

in accordance with the most recent experiences, they are so shaped that they do not have to be put firmly against the body, but exercise their effect even in the presence of a layer of air between body and electrode. At the same time, the remarkable fact may be determined, that the thickness of the layer of air and the "depth effect" are dependent on each other.

Advantages of Ultra Short Waves

According to all experiences thus far, the medicinal ultra-short wave radiator is a sort of diathermal apparatus; therefore it serves to conduct to the part of the body, or the organ to be treated, electric wave energy, which is converted into heat and thereby exercises a healing effect. As compared with the usual diathermal sets (which operate on a wavelength of about 600 meters, using leaden electrodes, which have to be put right on the body), the ultra-short wave

set offers a considerably better control of the direction in which the heat is to be applied, so that one can better reach any desired organ than was possible before. Furthermore, by changing the wavelength, one can also adjust for a definite deep-lying stratum. Unpleasant accompanying phenomena, which result with the usual diathermal sets, where the electrodes do not rest firmly on the body, do not occur in the case of the ultra short wave radiator. It is especially important to note that one can now, for the first time, perform a "therapy" or treatment directly on the head. The operation of the set is very simple.

Whether, besides the warming of the different strata in the body, still other biological effects occur or can be accomplished, with the new ultra short wave radiator, is, at the present time, still a matter of question.

HUMAN BEINGS as ANTENNAS

By DR. ERWIN SCHLIEPHAKE, M.D.
Of the Jena University Medical Clinic

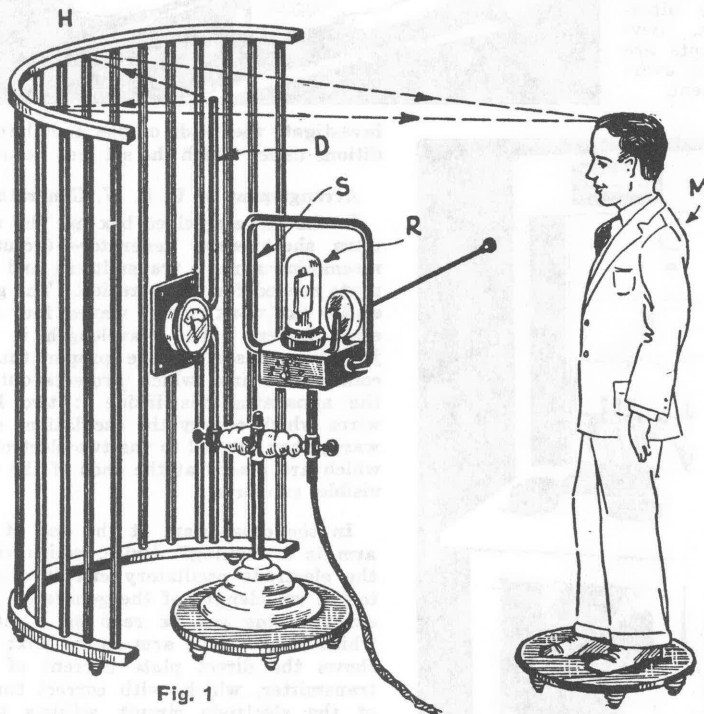

Fig. 1

Arrangement of the apparatus used by Dr. Schliephake in measuring and observing the effects of short waves on the human body, absorption, et cetera. H, parabolic reflector formed of wires; D, antenna, charged inductively by the coil S; vacuum tube at R, and beside it wave changing condenser; subject at M.

IF human beings remain in the vicinity of powerful radio transmitters, they are exposed to a very strong electromagnetic field. One must therefore ask what significance these radiations have for the internal organs, and how the body reacts to them. This question is justified by the fact that all other kinds of electromagnetic rays influence the human body more or less strongly.

The character, however, of the reaction is different, according to the wavelengths. Radium rays and X-rays, for example, because of the extraordinary shortness of the waves and the high effectiveness of energy under these conditions, exercise a very strong effect on the structure of atoms; so that serious injuries to the organism can arise (for instance, under certain conditions, cancer). Less serious are the effects of light rays which, however, in the ultra-violet part of the spectrum, can still occasion serious injuries; while the visible light which we perceive is of too low a frequency to injure healthy persons. There are, however, subjects, made sensitive by illness, who suffer serious affections of the skin from strong illumination. Above the optical spectrum, there follow the infra-red and heat waves, whose effect on atoms is relatively slight; in the case of still longer waves only molecular effects are to be expected. Here we are entering

the range of the Hertzian waves, electric waves in the stricter sense. Of these, the shortest are about half a millimeter (.02-inch) long, and therefore just above the heat radiations.

From direct analogy, it is to be assumed that the shortest of these waves must be absorbed by human bodies, as in the case of heat rays, and

DO YOU KNOW —

¶ What effect short waves have on the hair and scalp in general?

¶ Whether the current in the exciting antenna increases or decreases when a person stands in its field? Why?

¶ If the person stoops will this affect the reading of the antenna current meter?

¶ Whether "cold" or "heat" is produced inside the body by an overdose of the high frequency waves?

¶ The effect of short waves on the nervous system?

this absorption can be actually demonstrated.

Absorption of Radio by the Body

With specially-built transmitters, especially such as those which have been described by Kohl, electric waves only a few centimeters in length can be produced; these waves can be reflected by mirrors, exactly like light rays. If one puts the antenna in the focus of a concave mirror, then there is formed a parallel beam of radiation which can be concentrated again in another concave mirror. By means of a lens placed in the course of the radiation, the ray is made very sharp. If a person steps into this path, reception ceases. Since no reflection by the human body or only a very slight one is demonstrable, absorption of the radiation must have occurred; this effect is, moreover, demonstrable in the case of other organic substances or water. Unfortunately, not much can yet be said about the physiological effects of these radiations; the power of the transmitters of extremely short waves is still too low to produce perceptible changes.

It is otherwise with the wavelengths from three meters up, to the production of which powers of several kilowatts can be applied. Here the above described optical phenomena cannot be so well demonstrated, because the diffraction is much greater; but absorption by the human body can be very well shown.

When an antenna is inductively coupled to a 3-meter transmitter, the oscillations can be indicated by a detector even at a considerable distance away. If however, a person puts himself in the place of the antenna, the detector responds much more weakly, although the power consumed by the transmitter remains the

same. Accordingly, a part of the power must have been used up in the body. The same phenomenon can be demonstrated as follows: a closed or open oscillation circuit is inductively coupled with the transmitter (see Fig. 1). The ammeter in the circuit shows a definite current strength. If a person places himself on an insulating stool beside it, the current in the oscillation circuit is reduced. This withdrawal of energy, however, depends on the length of the body; for if the subject stoops, or changes to a sitting position, the current in the other circuit increases (Fig. 2). Therefore, it appears as though, by the tuning of the subject, to about half the wavelength, the power transmitted to him becomes much greater.

Concentrating Power by Means of a Reflector

By means of a large concave mirror one can also collect the transmitted power to a focus. Such a mirror need consist only of parallel wires stretched between two wooden frames. Its height must be equal to the wavelength, the opening one and one-half times the wavelength. It is best to use elliptical reflectors, with the transmitting antenna at one focus; then the reflected radiation is at the other focus of the ellipse. With a "dipole" ("Hertzian" antenna) containing an ammeter, especially strong concentration of energy at this point can be demonstrated. Here a lessening of the current in the dipole is instantly shown if a person steps into the vicinity. Since the human body is to be regarded essentially as an electrolytic system, with regard to the electric wave, and I have tried to demonstrate the effect in the following manner in a model experiment.

A glass tube, of half the wave's length, was filled with an 0.5% sodium chloride

(salt) solution, to which gelatine was added to prevent convection. In this jelly the temperature was measured, at different places, by thermo-elements. It was shown that the heating was greatest in the middle and least at the ends; being half as strong at the quarter points of entire length as it was in the middle. Since the maximum strength of the current is at the middle, the greatest heating is therefore connected with this.

Physiological Effect of Short Waves

Especially noteworthy, also, was a feeling of vibration, which was particularly evident if the hand was raised in front. We could establish this sensation only at our transmitter, which is operated with 50-cycle alternating current. There must be, therefore, a direct influence on the nervous system. Here too we have, therefore, another proof that the ultra-short radio waves exercised an effect on the nerves.

These vibrations are also felt if the hand is placed in a condenser's field. Many persons who remain close to the transmitter also experience remarkable sensations on the head, near the roots of the hair; these are like a peculiar prickling, the hair likewise standing up a little. In many subjects we could also observe slight increases in bodily temperature, which however did not exceed 0.5 of a degree, Centigrade (0.9 degree Fahrenheit). Since the body contains extremely fine regulators, by which the temperature is always kept constant, and since also the amounts of energy which can be conveyed into the body, even by powerful radio transmitters, give (when translated into heat units) only a relatively low number of calories, this increase in heat is probably not attributable to the received energy alone. As is to be shown later, nervous effects may play an important part in this.

The effect on the nervous system is

Fig. 2.
One of the most interesting effects of placing a human being in the field of a short wave (high frequency) oscillator is that of absorption. The antenna "D" is excited by the power tube and loop circuit at the left. Do you think the antenna current is increased or decreased by bending the body?

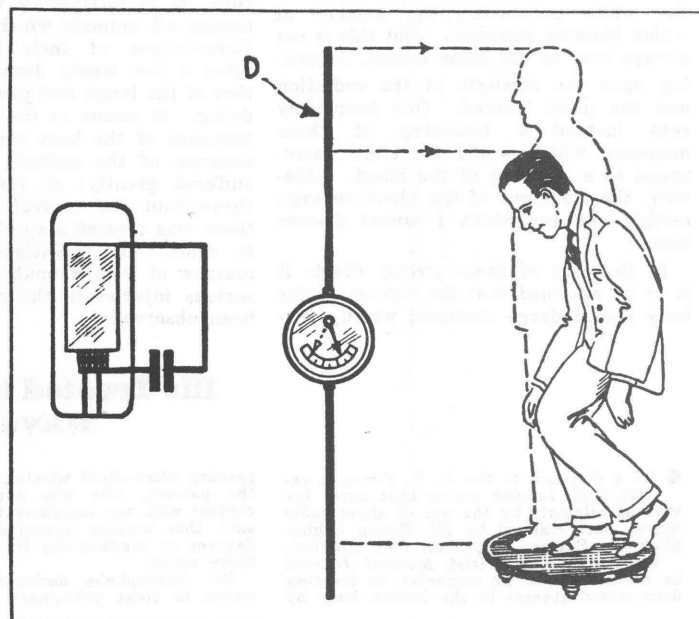

plainly felt by all persons who work a fairly long time with short waves. The sensations are different with the individuals; there are persons who are relatively insensitive, and others who very soon complain about the disturbances of their health. Usually there is first an increasing sleepiness; they are very tired by day, but at night they sleep badly. Several times a night they start out of their sleep, and they are tired and sleepy in the morning.

These phenomena increase more and more. Often there are also intensive headaches, particularly covering the back of the head. Many persons complain of digestive disturbances and pressure on the stomach. Most of them are furthermore easily excited and irritated, being inclined to complaining and to violence. This increased excitability of the nervous system can also be shown by electrical tests of the nerves.

Effects of the Electrostatic Field

It is much easier to study these changes by using the condenser field. Here it is not the electromagnetic wave which is used, but the electrostatic field, which always accompanies it. Here, however, the effect may be much more strongly concentrated. I have generally used plates four inches in diameter, between which the parts of the body in question were treated. The field between these plates suffices to heat 100 cc. of a 0.5% sodium chloride (salt) solution 5 degrees C. (90° F.) in one minute. If parts of the human body are introduced into this field, and the blood is then taken from some part of the body (for instance, from the earlobe) on investigation obvious changes are found.

The number of red corpuscles per cubic millimeter is very greatly increased; i. e., if they formerly amounted to 5 million, the number has risen to 6 million. The same is true of the haemoglobin (a constituent of the blood) and the white corpuscles, the number of which likewise increases. But this is not always true to the same extent, depending upon the strength of the radiation and the place treated. One frequently sees instead a lessening of these amounts, which would therefore correspond to a thinning of the blood. Likewise, the albumens of the blood undergo certain changes which I cannot discuss here.

In the case of these strong effects it is to be assumed that the tissues of the body also undergo changes; which, how-

Human Beings As Antennas

By Dr. Erwin Schliephake, M.D.

ever, cannot be directly proved in a subject.

Results of Experiments on Animals

In experiments with animals, on the contrary, such changes are plainly recognizable. They occur particularly strong in projecting parts of the animals, such as in the ears and tips of the tails; since there the electric field is distorted. Very often, one sees, some time after the treatment, that the parts in question are dying and falling off. In the case of a rabbit whose leg had been too strongly exposed to the electrostatic field, I noticed a complete disintegration of the flesh in a ring-shaped region, so that only the bone remained; but then, after a while, that also fell off.

That the nervous system of the animals is also influenced is shown by the fact that many of them shudder on the switching on or off of the field, at a time when there can be no question of a strong heating effect.

Also very interesting are the disturbances of the internal heat regulation, which one can produce in animals. If the region of the neck and the back of the head of a rabbit are exposed to a limited capacitative field and the temperature is afterward measured, one can soon note a permanently increased temperature, which often lasts for some weeks. If a very powerful dose of "irradiation" is administered the opposite can occur: the bodily heat falls more and more, often below 35 degrees C. (95° F.), until these low temperatures are no longer compatible with life. At the same time, it is interesting to observe that almost all animals which have had such disturbances of their heat regulation after a few weeks developed inflammation of the lungs and pleurisy, afterward dying. It seems as though, by the disturbance of the heat regulation, the resistance of the animals to disease had suffered greatly; so that in this path throughout the central nervous system there was created a special susceptibility to colds. On investigating the spinal marrow of such animals microscopically, serious injuries to the nerve cells have been observed.

Ills Treated by Short Waves

● IN a dispatch to the N. Y. Times, a report from London states that cures for various ailments by the use of short radio waves were claimed by Dr. Erwin Schliephake, a German physician and scientist. Writing in the *British Medical Journal* he described how he succeeded in treating deep-seated abscess in the human body by

passing ultra-short wireless waves through the patient, who was not in immediate contact with any instrument. He found, he said, that various tissues exhibit different degrees of conductivity in the presence of these waves.

Dr. Schliephake declared he has used waves to treat pulmonary abscesses after

Dangers and Beneficial Possibilities

After these experiences, I have not dared to expose entire human beings to a condenser field and in this way produce artificial rises in temperature. The responsibility seemed too great. At the same time, effective heating of the body can be accomplished equally well in other ways; such as with the well-known Apostoli "condenser bed," which can be connected to any diathermal apparatus. With the method previously described, only serious dangers for the patients treated would have been conjured up, without the possibility of producing a fundamentally new effect.

On the other hand, the disturbances of the physical health, which we could observe in the field of free radiation of powerful transmitters, have never been serious. After a period of recovery of a few weeks, with no irradiation, all effects have been observed to vanish. For four years now, I have almost daily worked for several hours at a transmitter with 1½ kw. plate dissipation; and the effects, often very unpleasant, have always gone back to normal on stopping the work.

In these things the wavelength is also certainly of importance, and in fact we have the impression that the disturbances to health became stronger as the wave was shortened. Anyway, the unpleasant sensations appear much quicker with a three-meter wave than with longer ones.

From all these experiences, it is at any rate clear that treatment with electric waves can in no way be regarded as always harmless for the human body. It is plain that their incorrect use can cause serious injuries to health. Certainly such injuries are to be expected only when the frequencies are very high; that is, with ultra-short waves; even then there is nothing to fear except with fairly high transmitter power.

On the other hand, with proper use, the short electric waves seem to be a valuable means of treatment. According to our experiments to date, with bacteria cultures and infected animals, the germs of disease can be killed. There is the added point that certain defensive processes are stimulated in the body. I have also already repeatedly treated human beings; and, in about a hundred cases, I have been able to attain an extraordinarily quick cure of suppuration (pus formation).

pneumonia, in pleural empyema, pneumonic tuberculosis, in certain forms of peritonitis, in migraine and acute tonsillitis.

Dr. Willis R. Whitney, research director of the General Electric Company, revealed in April, 1930, that he had developed a radio type of apparatus for killing bacteria in the body.

CHAPTER V.

DISTRIBUTED SERIES CAPACITY.

43. The capacity of a transmission line, cable, or high-potential transformer coil is shunted capacity, that is, capacity from conductor to ground, or from conductor to return conductor, or shunting across a section of the conductor, as from turn to turn or layer to layer of a transformer coil.

In some circuits, in addition to this shunted capacity, distributed series capacity also exists, that is, the circuit is broken at frequent and regular intervals by gaps filled with a dielectric or insulator, as air, and the two faces of the conductor ends thus constitute a condenser in series with the circuit. Where the elements of the circuit are short enough so as to be represented, approximately, as conductor differentials, the circuit constitutes a circuit with distributed series capacity.

An illustration of such a circuit is afforded by the so-called "multi-gap lightning arrester," as shown diagrammatically in Fig. 90, which consists of a large number of metal cylinders, p, q, \dots , with small spark gaps between the cylinders, connected between line L and ground G . This arrangement, Fig. 90, can be represented diagrammatically by Fig. 91. Each cylinder has a capacity C_0 against ground, a capacity C against the adjacent cylinder, a resistance r ,—usually very small,—and an inductance L .

The series of insulator discs of a high voltage suspension—or strain—insulator also forms such a circuit.

If such a series of n equal capacities or spark gaps is connected across a constant supply voltage e_0 , each gap has a voltage $e = \frac{e_0}{n}$. If, however, the supply voltage is alternating, the voltage does not divide uniformly between the gaps, but the potential difference is the greater, that is, the potential gradient steeper the nearer the gap is to the line L , and this distribution of potential becomes the more non-uniform the higher the frequency; that is, the greater the charging current of the capacity of the cylinder against the ground. The charging currents against ground, of all

354

DISTRIBUTED SERIES CAPACITY

355

the cylinders from q to the ground G , Figs. 90 and 91, must pass the gap between the adjacent cylinders p and q ; that is, the charging current of the condenser represented by two adjacent

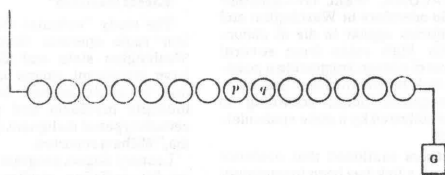

Fig. 90. Multi-gap lightning arrester.

cylinders p and q is the sum of all the charging currents from q to G ; and as the potential difference between the two cylinders p and q is proportional to the charging current of the condenser

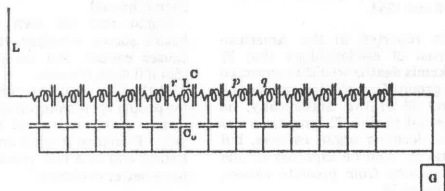

Fig. 91. Equivalent circuit of a multi-gap lightning arrester.

formed by these two cylinders, C , this potential difference increases towards L , being, at each point proportional to the vector sum of all the charging currents, against ground, of all the cylinders between this point and ground.

The higher the frequency, the more non-uniform is the potential gradient along the circuit and the lower is the total supply voltage required to bring the maximum potential gradient, near the line L , above the disruptive voltage, that is, to initiate the discharge. Thus such a multi-gap structure is discriminating regarding frequency; that is, the discharge voltage with increas-

ing frequency, does not remain constant, but decreases with increase of frequency, when the frequency becomes sufficiently high to give appreciable charging currents. Hence high frequency oscillations discharge over such a structure at lower voltage than machine frequencies.

For a further discussion of the feature which makes such a multi-gap structure useful for lightning protection, see A. I. E. E. Transactions, 1906, pp. 431, 448, 1907, p. 425, etc.

44. Such circuits with distributed series capacity are of great interest in that it is probable that lightning flashes in the clouds are discharges in such circuits. From the distance traversed by lightning flashes in the clouds, their character, and the disruptive strength of air, it appears certain that no potential difference can exist in the clouds of such magnitude as to cause a disruptive discharge across a mile or more of space. It is probable that as the result of condensation of moisture, and the lack of uniformity of such condensation, due to the gusty nature of air currents, a non-uniform distribution of potential is produced between the rain drops in the cloud; and when the potential gradient somewhere in space exceeds the disruptive value, an oscillatory discharge starts between the rain drops, and gradually, in a number of successive discharges, traverses the cloud and equalizes the potential gradient. A study of circuits containing distributed series capacity thus leads to an understanding of the phenomena occurring in the thunder cloud during the lightning discharge.*

Only a general outline can be given in the following.

45. In a circuit containing distributed resistance, conductance, inductance, shunt, and series capacity, as the multi-gap lightning arrester, Fig. 90, represented electrically as a circuit in Fig. 91, let r = the effective resistance per unit length of circuit, or per circuit element, that is, per arrester cylinder; g = the shunt conductance per unit length, representing leakage, brush discharge, electrical radiation, etc.; L = the inductance per unit length of circuit; C = the series capacity per unit length of circuit, or circuit element, that is, capacity between adjacent arrester cylinders, and C_0 = the shunt capacity per unit length of circuit, or circuit element, that is, capacity between arrester cylinder and

* See paper, "Lightning and Lightning Protection," N.E.L.A., 1907. Reprinted and enlarged in "General Lectures on Electrical Engineering," by Author.

DISTRIBUTED SERIES CAPACITY

357

ground. If then f = the frequency of impressed e.m.f., the series impedance per unit length of circuit is

$$Z = r + j(x - x_c); \tag{1}$$

the shunt admittance per unit length of circuit is

$$Y = g + jb, \tag{2}$$

where

$$\left. \begin{aligned} x &= 2\pi fL, \\ x_c &= \frac{1}{2\pi fC}, \\ b &= 2\pi fC_0; \end{aligned} \right\} \tag{3}$$

or the absolute values are

$$\left. \begin{aligned} z &= \sqrt{r^2 + (x - x_c)^2} \\ y &= \sqrt{g^2 + b^2}. \end{aligned} \right\} \tag{4}$$

If the distance along the circuit from line L towards ground G is denoted by l , the potential difference between point l and ground by E , and the current at point l by I , the differential equations of the circuit are *

$$\frac{dE}{dl} = ZI \tag{5}$$

and

$$\frac{dI}{dl} = YE. \tag{6}$$

Differentiating (5) and substituting (6) therein gives

$$\frac{d^2E}{dl^2} = YZE. \tag{7}$$

Equation (7) is integrated by

$$E = A_1 e^{-\alpha l} + A_2 e^{+\alpha l}, \tag{8}$$

where

$$\alpha = \sqrt{YZ} = \alpha + j\beta, \tag{9}$$

and

$$\left. \begin{aligned} \alpha &= \sqrt{\frac{1}{2} \{yz + gr - b(x - x_c)\}} \\ \beta &= \sqrt{\frac{1}{2} \{yz - gr + b(x - x_c)\}}. \end{aligned} \right\} \tag{10}$$

* Section III, Chapter II, paragraph 7.

Substituting (10) in (8) and eliminating the imaginary exponents by the substitution of trigonometric functions,

$$E = A_1 e^{-\alpha t} (\cos \beta l - j \sin \beta l) + A_2 e^{+\alpha t} (\cos \beta l + j \sin \beta l). \quad (11)$$

46. However, if $n =$ the total length of circuit from line L to ground G , or total number of arrester cylinders between line and ground, for $l = n$,

$$E = 0, \quad (12)$$

and for $l = 0$,

$$E = e_0 = \text{the impressed e.m.f.} \quad (13)$$

Substituting (12) and (13) into (11) gives

$$0 = A_1 e^{-\alpha n} (\cos \beta n - j \sin \beta n) + A_2 e^{+\alpha n} (\cos \beta n + j \sin \beta n)$$

and

$$e_0 = A_1 + A_2;$$

hence,

$$\left. \begin{aligned} A_1 &= \frac{e_0}{1 - \epsilon^{-2\alpha n} (\cos 2\beta n - j \sin 2\beta n)}, \\ A_2 &= -A_1 \epsilon^{-2\alpha n} (\cos 2\beta n - j \sin 2\beta n), \end{aligned} \right\} \quad (14)$$

and the potential difference against ground is

$$\frac{E = e_0 \epsilon^{-\alpha t} (\cos \beta l + j \sin \beta l) - \epsilon^{-\alpha(2n-l)} [\cos \beta(2n-l) - j \sin \beta(2n-l)]}{1 - \epsilon^{-2\alpha n} (\cos 2\beta n - j \sin 2\beta n)} \quad (15)$$

From equation (5), substituting (15) and (9), we have

$$I = -\sqrt{\frac{Y}{Z}} e_0 \frac{\epsilon^{-\alpha t} (\cos \beta l - j \sin \beta l) + \epsilon^{-\alpha(2n-l)} [\cos \beta(2n-l) - j \sin \beta(2n-l)]}{1 - \epsilon^{-2\alpha n} (\cos 2\beta n - j \sin 2\beta n)} \quad (16)$$

Reduced to absolute terms this gives the potential difference against ground as

$$e = e_0 \sqrt{\frac{\epsilon^{2\alpha t} + \epsilon^{-2\alpha(2n-l)} - 2\epsilon^{-2\alpha n} \cos 2\beta(n-l)}{1 + \epsilon^{-4\alpha n} - 2\epsilon^{-2\alpha n} \cos 2\beta n}} \quad (17)$$

DISTRIBUTED SERIES CAPACITY

the current as

$$i = e_0 \sqrt{\frac{Y}{Z}} \sqrt{\frac{\epsilon^{-2\alpha t} + \epsilon^{-2\alpha(2n-l)} + 2\epsilon^{-2\alpha n} \cos 2\beta(n-l)}{1 + \epsilon^{-4\alpha n} - 2\epsilon^{-2\alpha n} \cos 2\beta n}} \quad (18)$$

and the potential gradient, or potential difference between adjacent cylinders, is

$$e' = x_c i = e_0 x_c \sqrt{\frac{Y}{Z}} \sqrt{\frac{\epsilon^{-2\alpha t} + \epsilon^{-2\alpha(2n-l)} + 2\epsilon^{-2\alpha n} \cos 2\beta(n-l)}{1 + \epsilon^{-4\alpha n} - 2\epsilon^{-2\alpha n} \cos 2\beta n}} \quad (19)$$

For an infinite length of line, $n = \infty$, that is, for a very large number of lightning arrester cylinders, where $\epsilon^{-2\alpha n}$ is negligible, as in the case where the discharge passes from the line into the arrester without reaching the ground, equations (17), (18), (19) simplify to

$$e = e_0 \epsilon^{-\alpha t}, \quad (20)$$

$$i = e_0 \sqrt{\frac{Y}{Z}} \epsilon^{-\alpha t}, \quad (21)$$

and

$$e' = e_0 x_c \sqrt{\frac{Y}{Z}} \epsilon^{-\alpha t}, \quad (22)$$

that is, are simple exponential curves.

Substituting (4) and (3) in (21) and (22) gives

$$e' = e_0 \epsilon^{-\alpha t} \sqrt{\frac{C_0^2 + \left(\frac{Y}{2\pi f}\right)^2}{C^2 \{1 - (2\pi f)^2 CL\}^2 + (2\pi fCr)^2}} \quad (23)$$

and

$$i = 2\pi f C e'; \quad (24)$$

or, approximately, if r and g are negligible, we have

$$e' = e_0 \epsilon^{-\alpha t} \sqrt{\frac{C_0}{C \{1 - (2\pi f)^2 CL\}}} \quad (25)$$

and

$$i = 2\pi f e_0 \epsilon^{-\alpha t} \sqrt{\frac{CC_0}{1 - (2\pi f)^2 CL}} \quad (26)$$

47. Assume, as example, a lightning arrester having the following constants: $L = 2 \times 10^{-8}$ henry; $C_0 = 10^{-12}$ farads;

$C = 4 \times 10^{-11}$ farads; $r = 1$ ohm; $g = 4 \times 10^{-6}$ mho; $f = 10^8 = 100$ million cycles per second; $n = 300$ cylinders, and $e_0 = 30,000$ volts; then from equation (3), $x = 12.6$ ohms, $x_c = 39.7$ ohms, and $b = 62.8 \times 10^{-6}$ mhos;

from equation (1),

$$Z = 1 - 27.1 j \text{ ohms};$$

from equation (2),

$$Y = (4 + 62.8 j) 10^{-6} \text{ mho};$$

from equation (4),

$$z = 27.1 \text{ ohms and } y = 62.9 \times 10^{-6} \text{ mho};$$

from equation (10),

$$\alpha = 0.0021 \text{ and } \beta = 0.0412;$$

from equation (17),

$$e = 35,500 \sqrt{\epsilon^{-0.0042 t} + 0.08 \epsilon^{+0.0042 t} - 0.568 \cos(24.72 - 0.0824 t)};$$

from equation (18),

$$i = 54 \sqrt{\epsilon^{-0.0042 t} + 0.08 \epsilon^{+0.0042 t} + 0.568 \cos(24.72 - 0.0824 t)},$$

and from equation (19),

$$e' = 2140 \sqrt{\epsilon^{-0.0042 t} + 0.08 \epsilon^{+0.0042 t} + 0.568 \cos(24.72 - 0.0824 t)}.$$

Hence, at $t = 0$, $e = 30,000$ volts, $i = 61.6$ amperes, and $e' = 2560$ volts; and at $t = 300$, $e = 0$, $i = 57.5$ amperes, and $e' = 2280$ volts.

With voltages per gap varying from 2280 to 2560, 300 gaps would, by addition, give a total voltage of about 730,000, while the actual voltage is only about one-twenty-fourth thereof; that is, the sum of the voltages of many spark-gaps in series may be many times the resultant voltage, and a lightning flash may pass possibly for miles through clouds with a total potential of only a few hundred million volts. In the above example the 300 cylinders include 7.86 complete wave-lengths of the discharge.

Los Angeles Times

Jan 3, 1988

Ham Radio Operators' High Cancer Rate Poses a Puzzle

TACOMA, Wash. (AP)—Amateur radio operators in Washington and California appear to die at abnormally high rates from several forms of cancer, suggesting a possible link between cancer and electromagnetic fields, according to data collected by a state epidemiologist.

Others cautioned that evidence of such a link has been inconsistent and that other factors may be involved.

Dr. Samuel Milham Jr. of the Washington Department of Social and Health Services studied the deaths of 2,485 Washington and California ham operators between 1979 and 1984.

He reported in the American Journal of Epidemiology that 29 leukemia deaths would be expected in a group of people that size, but he found 36 deaths. Statistically, he expected to find 72 lymphatic and blood-forming organ cancers, but found 89. And he expected to find 67.6 deaths from prostate cancer, but found 78.

'Excess Mortality'

The study "indicates that amateur radio operator licensees in Washington state and California have significant excess mortality due to acute myeloid leukemia, multiple myeloma and perhaps certain types of malignant lymphoma," Milham reported.

Leonard Sagan, program manager for radiation studies at the Electric Power Research Institute in Palo Alto, Calif., warned that studies like Milham's can be misinterpreted. Milham's findings could be simple associations that have nothing to do with cancer causes among people who work with electricity, he said.

Sagan said his own research hasn't shown whether electricity causes cancer. But he predicted that if it does, it's rare.

"I think it would be unfortunate for people with children to become overly concerned about this," he said. "Evidence is weak and inconsistent and in a few years we will have better evidence."

Here's something to consider while using a Multi Wave Oscillator. Just "any old" radio frequency broadcast energy may not be desirable. Use this handbook in your detective work to discover Lakhovsky's secret.