

The Motionless Electromagnetic Generator, Extracting Energy from a Permanent Magnet with Energy-Replenishing from the Active Vacuum

from Thomas E. Bearden, Ph.D. James C. Hayes, Ph.D. James L. Kenny, Ph.D. Kenneth D. Moore, B.S.
Stephen L. Patrick, B.S.

*"..This one works beautifully and produces **COP=5.0...**" has said Tom Bearden*

Created on 10-06-00 - *JLN Labs* - Last update 04-08-02

All informations in this page are published free and are intended for private/educational purposes and not for commercial applications

The MEG diagrams published in these pages are currently under test by JL Naudin and may be subject to modifications after that they have been published on this site. They are the result of some attempts of a private and fully independent replication by the author. These diagrams are not the original MEG diagrams being tested by the Bearden's teamwork or some accredited labs.

Disclaimer: The author assumes no liability for any incidental, consequential or other liability from the use of this information. All risks and damages, incidental or otherwise, arising from the use or misuse of the information contained herein are entirely the responsibility of the user. Although careful precaution has been taken in the preparation of this material, I assume no responsibility for omissions or errors in the diagrams or measurement datas published here.

United States Patent

6,362,718

Patrick , et al.

March 26, 2002

NEW! US Patent 6,362,718 : **Motionless Electromagnetic**
Generator **NEW!**

See the [full MEG patent with diagrams \(15 pages \)](#)

Abstract

An electromagnetic generator without moving parts includes a permanent magnet and a magnetic core including first and second magnetic paths. A first input coil and a first output coil extend around portions of the first magnetic path, while a second input coil and a second output coil extend around portions of the second magnetic path. The input coils are alternatively pulsed to provide induced current pulses in the output coils. Driving electrical current through each of the input coils reduces a level of flux from the permanent magnet within the magnet path around which the input coil extends. In an alternative embodiment of an electromagnetic generator, the magnetic core includes annular spaced-apart plates, with posts and permanent magnets extending in an alternating fashion between the plates. An output coil extends around each of these posts. Input coils extending around portions of the plates are pulsed to cause the induction of current within the output coils.

Inventors: **Patrick Stephen L; Bearden Thomas E.; Hayes James C.; Moore Kenneth D.; Kenny James L.**

Appl. No.: **656313**

Filed: **September 6, 2000**

4 July, 2001 : Message from Tom Bearden (Circulate Widely)

This review by Myron Evans is fantastic, and it places EM energy from the vacuum very solidly into the literature. It will be published in the forthcoming three volumes of M.W. Evans, ed., Modern Nonlinear Optics, Second Edition, Wiley, 2001.

I have the permission of Myron Evans to post the paper until the publication of the book toward the end of this year.

Cheers,

Tom Bearden

[The Link Between the Sachs and O\(3\) Theories of Electrodynamics by M.W. Evans](#) (PDF document 409 Kb)

Website address: <http://www.cheniere.org/references/index.html>

Foundations of Physics Letters, Vol. 14., No. 1, 2001

[EXPLANATION OF THE MOTIONLESS ELECTROMAGNETIC GENERATOR WITH 0\(3\) ELECTRODYNAMICS](#)

P. K. Anastasovski, T. E. Bearden, C. Ciubotariu, W. T. Coffey, L. B. Crowell, G. J. Evans, M. W. Evans, R. Flower, A. Labounsky, B. Lehnert, M. Mészáros, P. R. Molnar, J. K. Moscicki, S. Roy, and J.P. Vigier.

Institute for Advanced Study, Alpha Foundation - Institute of Physics, 11 Rutafa Street, Building H - Budapest, H-1165, Hungary

[The MEG paper : Extracting Energy from a Permanent Magnet with Energy-Replenishing from the Active Vacuum](#), a PDF document (69 pages 1,29 MB), by T.E. Bearden

[MEG patent status, manufacturing update. Literature update.](#) October 30, 2001

- [The Motional Electromagnetic Generator \(MEG \)](#) from Thomas Bearden
- [Don't confuse COP with efficiency](#), an explanation by Tom Bearden (25 Feb 2002)
- [Information letter from Tom Bearden](#) (posted on 12-10-00)

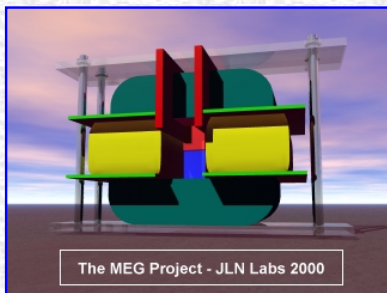

• [The MEG project](#) by J-L Naudin (updated 03-27-02)



- [Good advices for the MEG builders : The MEG Notes](#) by *Jon Flickinger*
- [The MEG v4.0 with the cross-flux magnetic gates setup](#) by *JL Naudin*
- [Thoughts about the MEG principle \(part1 \)](#) by *Cyril Smith* (updated 11-01-00)
- [Thoughts about the MEG principle \(part 2 \)](#) by *Cyril Smith* (updated 11-12-00)
- [The MEG, Why its works, The simple explanation...](#) by *Dave Squires* (updated 11-09-00)

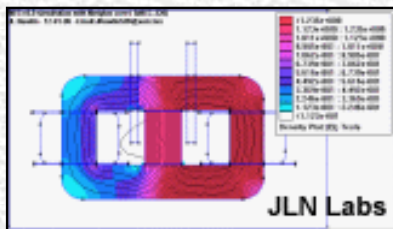

- [The Magnetic Transistor Theory](#) by *Dave Squires* (updated 11-05-00)
- [The Magnetic Amplifier Experiment v1.0](#) by *J-L Naudin*

Interesting papers and documents about the project :

- [The MEG paper : Extracting Energy from a Permanent Magnet with Energy-Replenishing from the Active Vacuum](#), a PDF document (69 pages 1,29 MB), by *T.E. Bearden*
- [The MEG paper](#) by *T.E. Bearden* (alternate site)
- [Giant Negentropy from the Common Dipole](#) By *T. E. Bearden* (PDF Format 86 KB)

- [On Extracting Electromagnetic Energy from the Vacuum](#) By T. E. Bearden (PDF Format 160 KB)

Link to the main Tom Bearden Web site : <http://www.cheniere.org/>

The Worldwide MEG replications (03-29-02)

Interesting patents to explore which have some similarities or interesting characteristics :

- [Electromagnetic switches by A.T.Starr \(1957\) : US2802170](#)
- [Magnetic frequency changer by H.T.Mortimer \(1959\) : US2883604](#)
- [Flux switching transformer by D.S Toffolo \(1963\) : US3087108](#)
- [Transformer in combination with permanent magnet by C.S.Garron \(1968\) : US3368141](#)
- ["Dispositif statique générateur de courant électrique" by P. Galley \(1975\) : FR2312135](#)
- [Electromagnetic generator by E.V. deRivas \(1977\) : US4006401](#)
- [Electromagnetic convertor with stationary variable-reluctance members by F.B.Richardson \(1978\) : US4077001](#)
- [Procedures and devices for energy production by H. Kunel \(1982\) : DE3024814](#)
- [Energy converter having a magnetic-core intermediate store by W. Volkrodt \(1986\) : DE3501076](#)
- [Magnetic Amplifier by D.Bramanti \(1987\) : US4675615](#)
- [Apparatus for release of Magnetostatic Energy of permanent magnets by A.Boday \(1997\) : CA2172240](#)
- [Static magnet dynamo generating electromotive force based on changing flux density of an open magnetic path by A.Keiichiro \(1999\) : US5926083](#)

METHODS FOR CONTROLLING THE PATH OF MAGNETIC FLUX FROM A PERMANENT MAGNET AND DEVICES INCORPORATING THE SAME

<http://l2.espacenet.com/dips/viewer?PN=WO0007285&CY=ep&LG=en&DB=EPD>

Patent Number: [WO0007285](#)

Publication date: **2000-02-10**

Inventor(s): FLYNN CHARLES J

Applicant(s):: [MAGNETIC REVOLUTIONS LIMITED L \(US\)](#)

Abstract : A permanent magnet device (110) includes a permanent magnet (112) having North and South pole faces with a first pole piece (114) positioned adjacent one pole face thereof and a second pole piece (116) positioned adjacent the other pole face thereof so as to create at least two potential magnetic flux paths (130, 132). First control coils (122, 124) are positioned along one flux path (130) and second control coils (126, 128) is positioned along the other flux path (132), each coil being connected to a control circuit (not shown) for controlling the energization thereof. The control coils (122, 124, 126, 128) may be energized in a variety of ways to achieve desirable motive and static devices, including linear reciprocating devices, linear motion devices, rotary motion devices and power conversion.

[Link to the Flynn's web site](#) : About the [Flynn's Parallel Path Technology](#)

January 20th, 2001 : Interesting papers and patents :

- **["Overunity device installed in Minuteman Missile - patented by Westinghouse"](#) by Tom Bearden**
- **H. Andreatta, "High Power Switching Amplifier Wherein Energy is Transferred to a Tuned Circuit During Both Half Cycles," [U.S. Patent No. 3,239,771, Mar. 8, 1966](#);**
- **Tom L. Dennis, Jr., "Highly Efficient Semiconductor Switching Amplifier," [U.S. Patent No. 3,239,772, Mar. 8, 1966](#);**
- **Heber J. Morrison, "Square Wave Driven Power Amplifier," [U.S. Patent No. 3,815,030, June 4, 1974](#).**



Email : JNaudin509@aol.com



Return to the [JLN Labs home page](#)

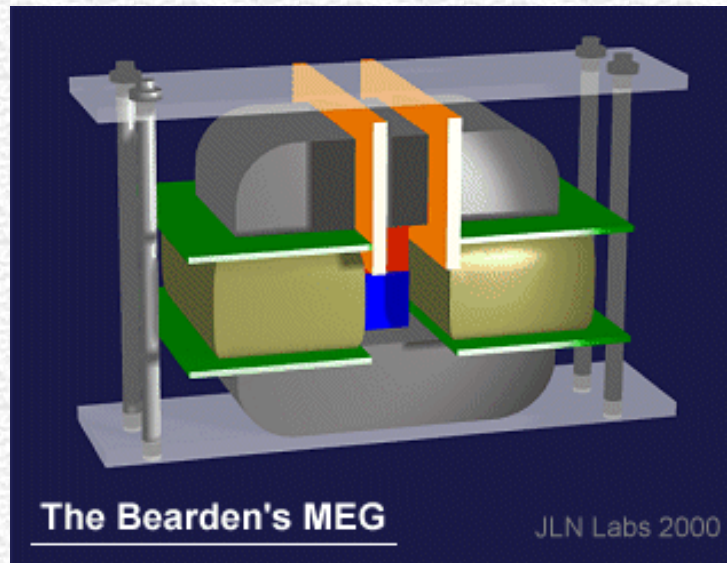

The Motionless Electromagnetic Generator,
Extracting Energy from a Permanent Magnet with Energy-Replenishing from the Active Vacuum

from Thomas E. Bearden, Ph.D. James C. Hayes, Ph.D. James L. Kenny, Ph.D. Kenneth D. Moore, B.S. Stephen L. Patrick, B.S.

*"..This one works beautifully and produces **COP=5.0...**" say Tom Bearden*

Created on 10-06-00 - *JLN Labs* - Last update 06-27-01

Sujet : The Motionless Electromagnetic Generator

Date : 06/10/00 07:54:41

From: xxxxxxxxxxxx (Tom Bearden)

Dear Jean-Louis,

Information on our Motionless Electromagnetic Generator has now been publicly released, in the form of our paper, "The Motionless Electromagnetic Generator: Extracting Energy from a Permanent Magnet with Energy-Replenishing from the Active Vacuum," carried on public DoE website

<http://www.ott.doe.gov/electromagnetic/papersbooks.html> .

Thus you may furnish the information to whomever you wish, since it is now publicly released and can be freely downloaded. It is a long paper (69 pages) and does take a little time to download.

*We are encouraging web site managers who so wish, to place a pointer to the paper if they wish to. As you are aware, **this one works beautifully and produces COP=5.0**. Our patent application has been filed and so full patent coverage is retained; we have been in patent-pending status for some time prior to the public release. We expect to force the patent by direct demonstration and independent government-certified test laboratory testing and certification to NIST, IEEE, and U.S. Government test standards.*

The system uses an extension to the work-energy theorem: In a replenishing potential environment, when energy is removed from the potential in a different form, the potential is simply replenished by the giant entropy process (my paper on the giant negentropy process is on the same DoE website). Use of a permanent magnet simply uses its magnetostatic scalar potential to evoke and sustain the giant negentropy mechanism. This sustains the continuous flow of the magnetic vector potential, and the device separates the magnetic B-field from the magnetic vector potential A.

The giant negentropy mechanism continuously replenishes the A-potential as fast as energy is extracted from it. Thus it is rather like dipping bucket after bucket of water from the same spatial volume in a rushing river, with the river instantly filling the hole up each time a dip is made. In this case we must pay only for the switching costs, since the giant negentropy mechanism continually replenishes the magnetic dipole sustaining the magnetic vector potential energy flow. Note that we do not destroy the source dipole, as every conventional closed current loop electrical system does. As Whittaker showed in 1903, once the dipolarity is established, the giant negentropy process continues so long as the dipole exists. Dipoles in original matter, e.g., have been pouring out copious energy by this process for some 15 billion years, so the energy is absolutely inexhaustible and copious.

There are 23 illustrations in the Magnetic Energy Ltd. paper on the DoE website.

*Very best wishes,
Tom Bearden*

You may download the MEG document at : <http://www.ott.doe.gov/pdfs/MEGpaper.pdf> (now removed)

Note (10-26-00) : The MEG Paper has been removed from the DoE site, but you may download it :

- <http://www.cseti.org/bearden/MEGpaper.pdf>

Note (11-21-00) : The MEG Paper has been removed from the Cseti web site, but you may also download it at :

- [The Motionless Electromagnetic Generator: Extracting Energy from a Permanent Magnet with Energy-Replenishing from the Active Vacuum](#), a PDF document (69 pages 1,29 MB), explanations and test results by T.E. Bearden ([Alternate site](#))

[The MEG paper : Extracting Energy from a Permanent Magnet with Energy-Replenishing from the Active Vacuum](#), a PDF document (69 pages 1,29 MB), by T.E. Bearden

[The MEG paper](#) by T.E. Bearden (alternate site)

If you don't have the Adobe Acrobat reader you may download it freely at :

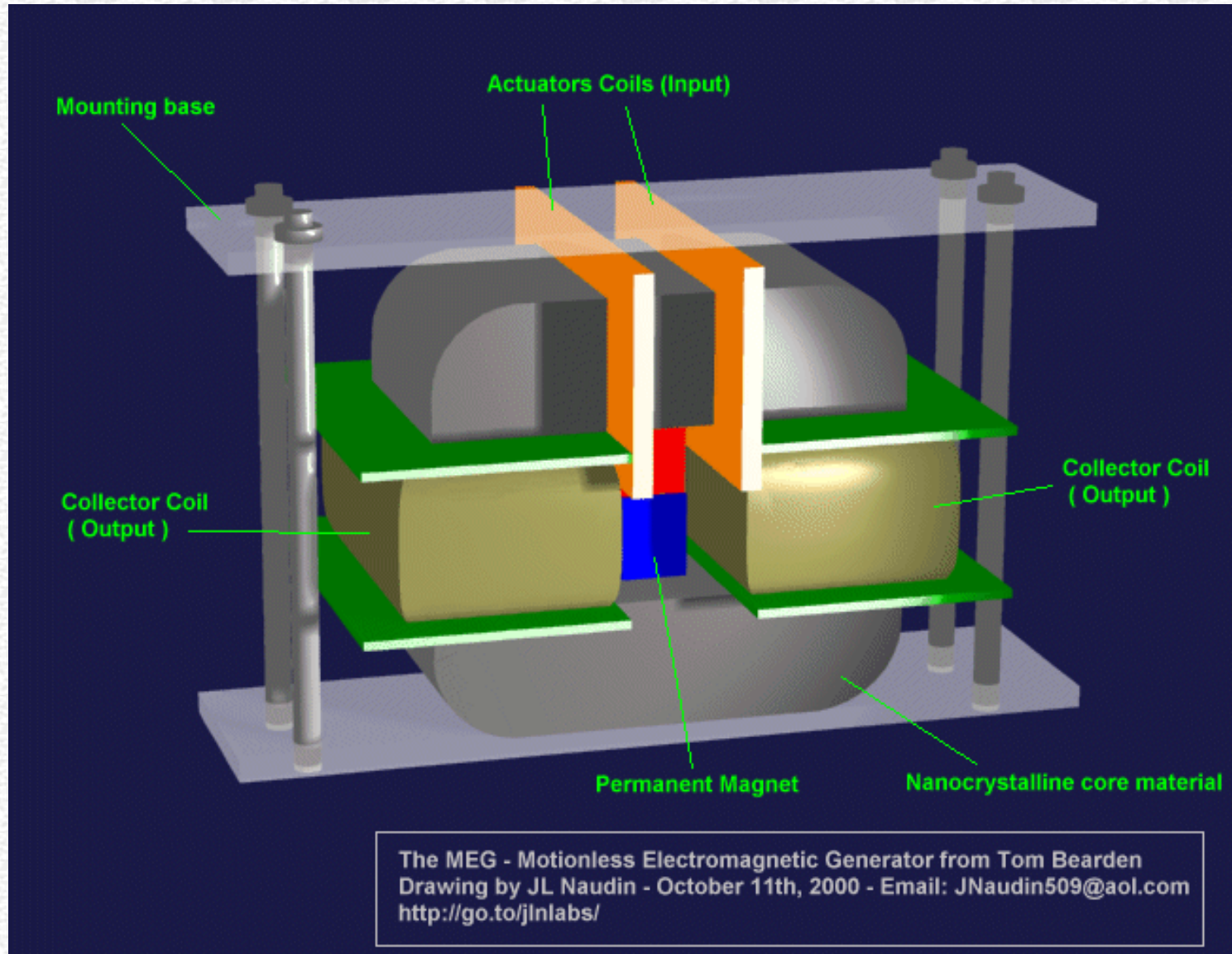

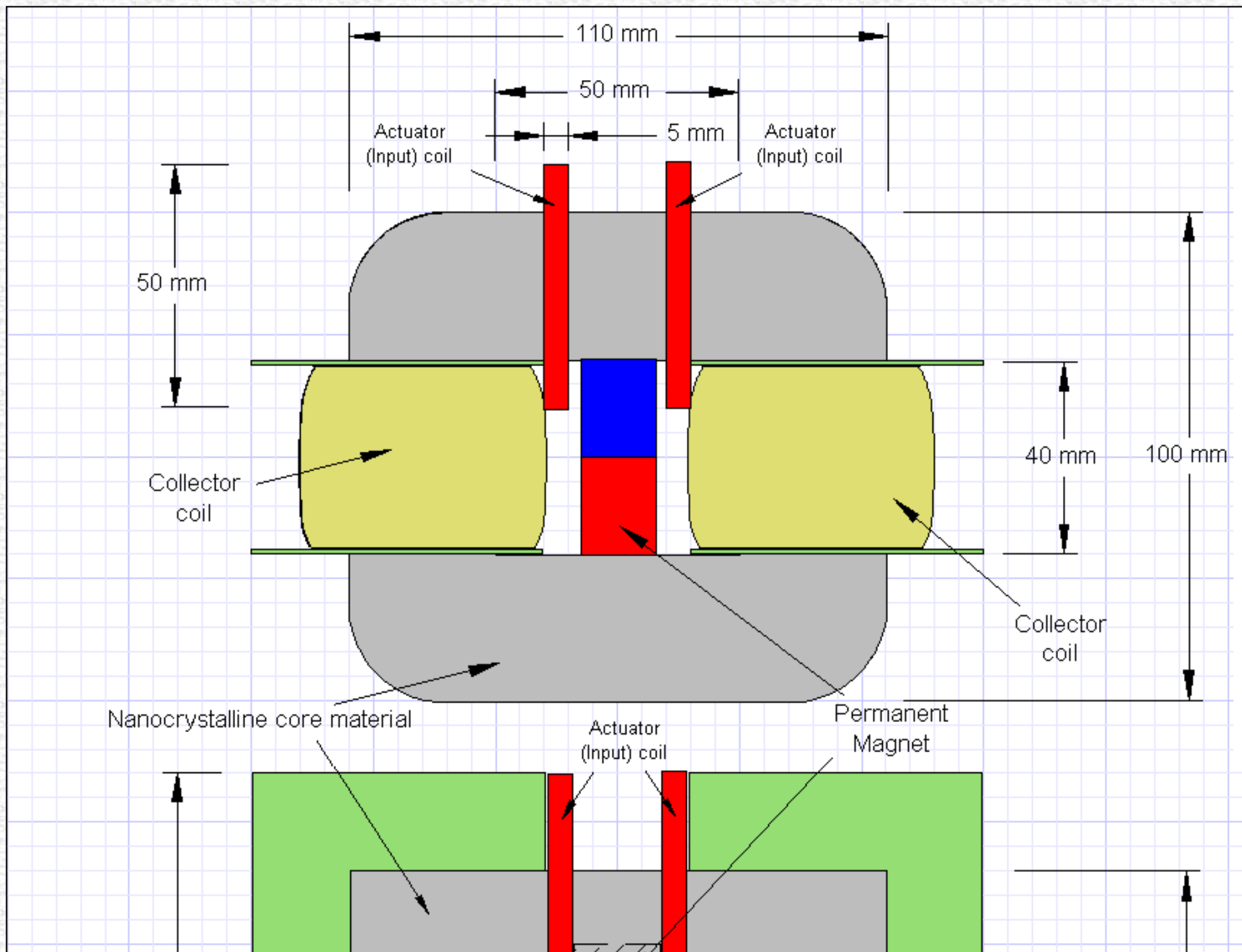

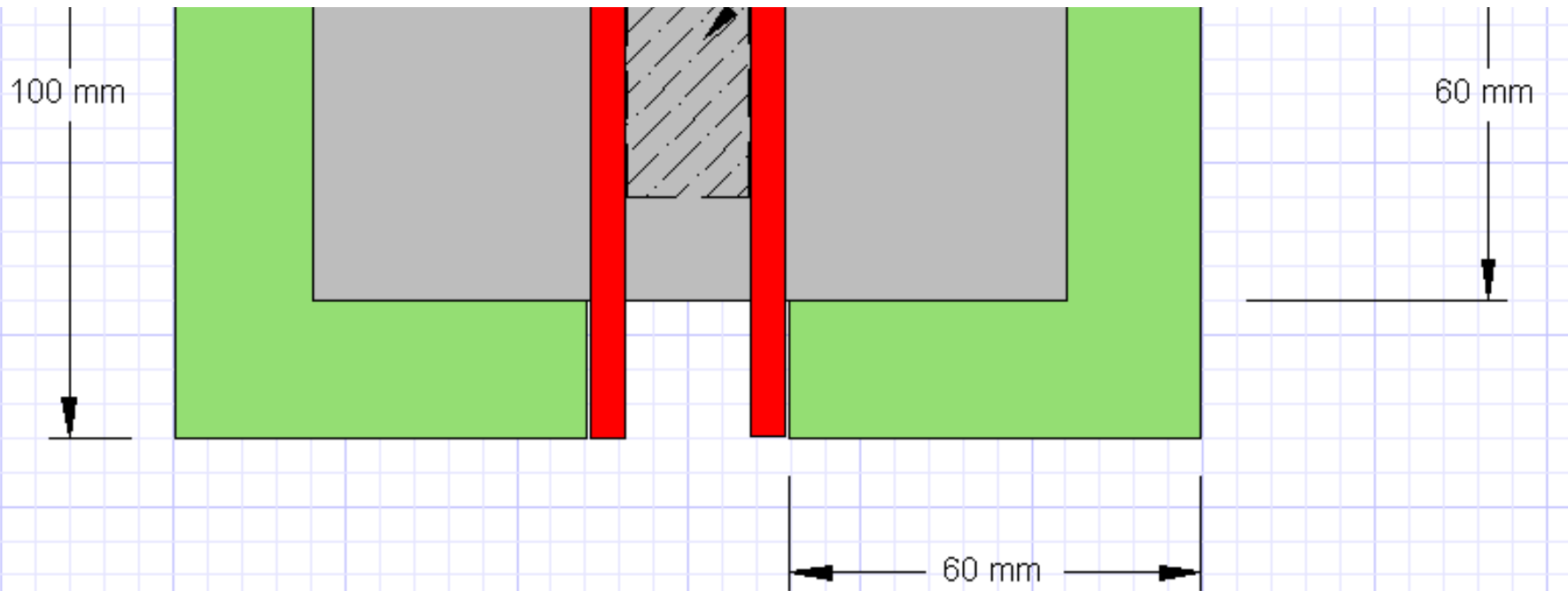

The MEG - Motionless Electromagnetic Generator from Tom Bearden (rel v1.00 - 10-11-00)
Drawing by JL Naudin and based on the Fig16 from the paper published on Oct 6th, 2000
" The Motionless Electromagnetic Generator: Extracting Energy from a Permanent Magnet
with Energy-Replenishing from the Active Vacuum " from Thomas Bearden
Email: JNaudin509@aol.com - Web site : <http://go.to/fjnlabs/>

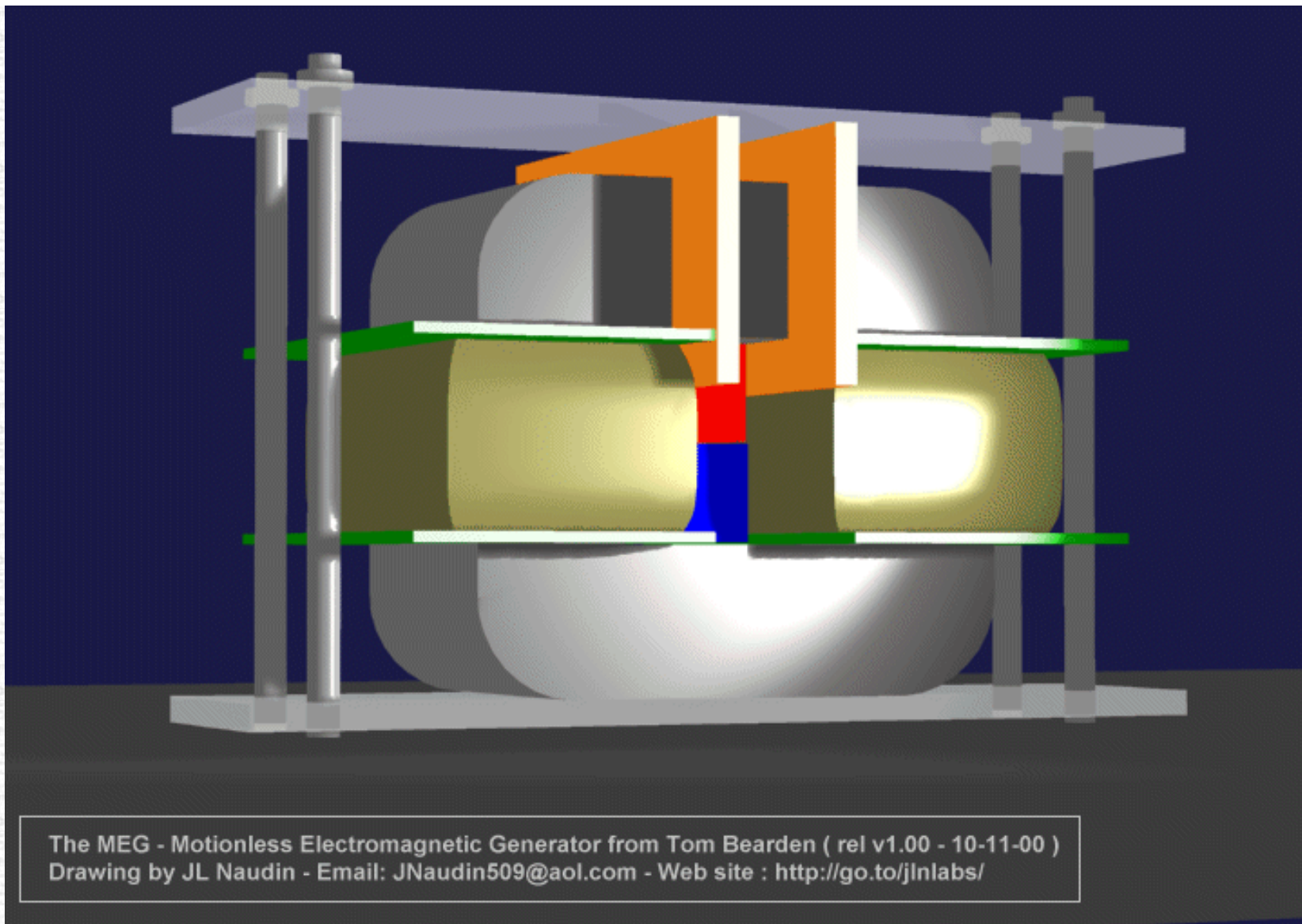

Some technical infos :

Fe-based Nanocrystalline Toroidal Core for Current Transformers :

Characteristics: Nanocrystalline alloy has similar features of high initial permeability and temperature stability, less gravity and packing factor than that of Permalloy. Under the same conditions of core size and performance, it is lighter (about 1/3 lighter) and cheaper than that of Permalloy.

Nanocrystalline Magnetic Core :

Characteristics: High saturation magnetic induction (1.25T), high permeability, high inductance (ten times higher than that of ferrite), low loss, small volume, light in weight, high electric interference resistance, good frequency performance and high temperature stability.

For more infos about the Nanocrystalline material see :

- [NANOCRYSTALLINE SOFT MAGNETIC ALLOYS FOR APPLICATION IN ELECTRICAL AND ELECTRONIC DEVICES](#) by V.R. Ramanan ABB-
Electric Systems Technology Institute

Nanocrystalline magnetic material suppliers :

- BFiOTiLAS : [Magnetics Components: Softcores material](#)
- MAGNETEC : Tape wound core based on the new nanocrystalline softmagnetic material called [NANOPERM](#)

Interesting patents to explore which have some similarities or interesting characteristics :

- [Electromagnetic switches by A.T.Starr \(1957\) : US2802170](#)
- [Magnetic frequency changer by H.T.Mortimer \(1959\) : US2883604](#)
- [Flux switching transformer by D.S Toffolo \(1963\) : US3087108](#)
- [Transformer in combination with permanent magnet by C.S.Garron \(1968\) : US3368141](#)
- [Electromagnetic generator by E.V. deRivas \(1977\) : US4006401](#)
- [Electromagnetic convertor with stationary variable-reluctance members by F.B.Richardson \(1978\) : US4077001](#)
- [Procedures and devices for energy production by H. Kunel \(1982\) : DE3024814](#)
- [Energy converter having a magnetic-core intermediate store by W. Volkrodt \(1986\) : DE3501076](#)
- [Magnetic Amplifier by D.Bramanti \(1987\) : US4675615](#)
- [Apparatus for release of Magnetostatic Energy of permanent magnets by A.Boday \(1997\) : CA2172240](#)
- [Static magnet dynamo generating electromotive force based on changing flux density of an open magnetic path by A.Keiichiro \(1999\) : US5926083](#)



4 July, 2001 : Message from Tom Bearden (Circulate Widely)

This review by Myron Evans is fantastic, and it places EM energy from the vacuum very solidly into the literature. It will be published in the forthcoming three volumes of M.W. Evans, ed., Modern Nonlinear Optics, Second Edition, Wiley, 2001.

I have the permission of Myron Evans to post the paper until the publication of the book toward the end of this year.

Cheers,

Tom Bearden

[The Link Between the Sachs and O\(3\) Theories of Electrodynamics by M.W. Evans](#) (PDF document 409 Kb)

Website address: **<http://www.cheniere.org/references/index.html>**

Foundations of Physics Letters, Vol. 14., No. 1, 2001

[EXPLANATION OF THE MOTIONLESS ELECTROMAGNETIC GENERATOR WITH O\(3\) ELECTRODYNAMICS](#)

P. K. Anastasovski, T. E. Bearden, C. Ciubotariu, W. T. Coffey, L. B. Crowell, G. J. Evans, M. W. Evans, R. Flower, A. Labounsky, B. Lehnert, M. Mészáros, P. R. Molnar, J. K. Moscicki, S. Roy, and J.P. Vigier.

Institute for Advanced Study, Alpha Foundation - Institute of Physics, 11 Rutafa Street, Building H - Budapest, H-1165, Hungary

[The MEG paper : Extracting Energy from a Permanent Magnet with Energy-Replenishing from the Active Vacuum](#), a PDF document (69 pages 1,29 MB), by T.E. Bearden

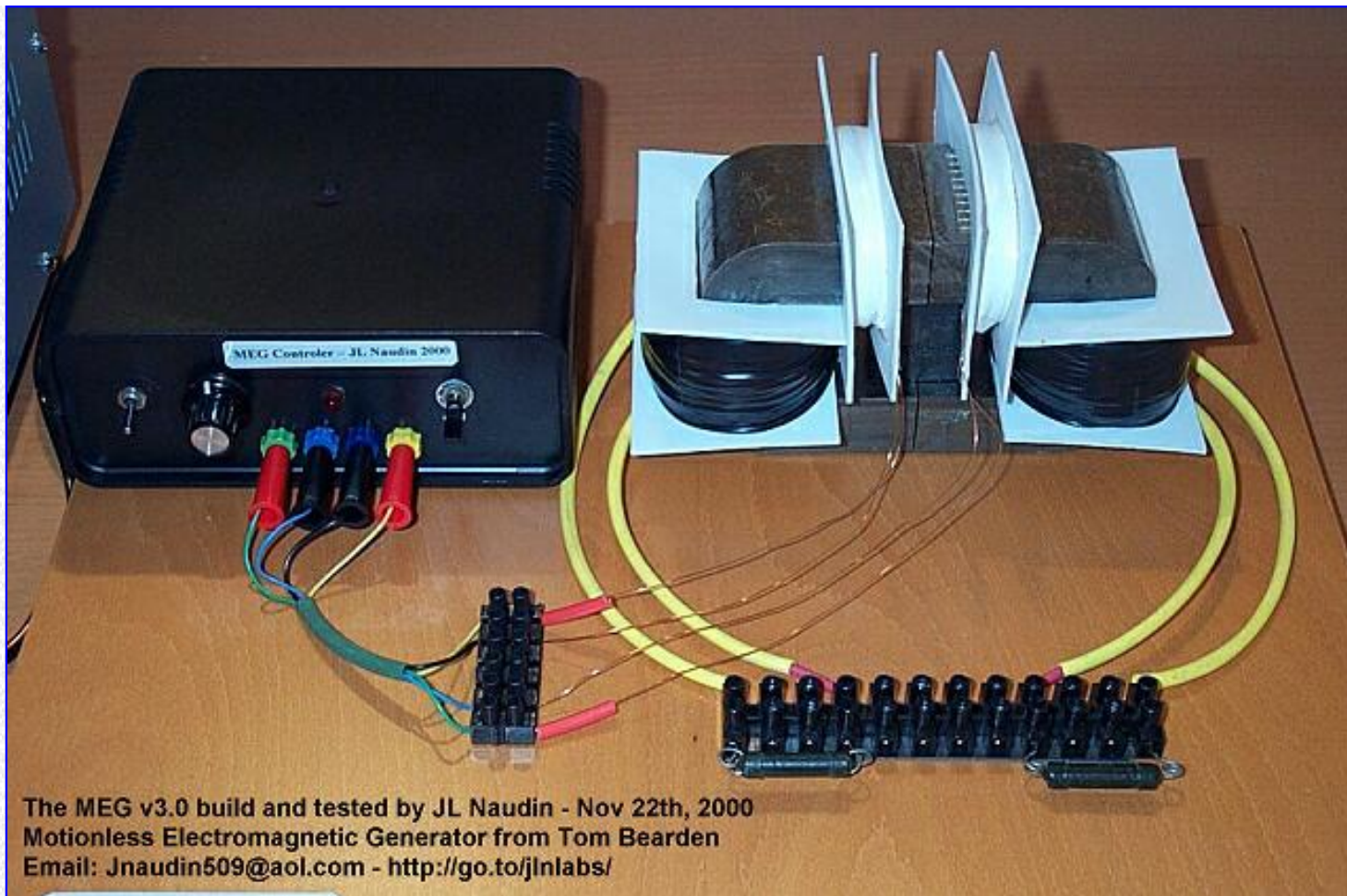

The MEG v3.0 build by JL Naudin - November 22th, 2000

See : [The MEG v3.0](#) build by J-L Naudin, with *diagrams and tests reports*

Return to the [MEG project](#) home page

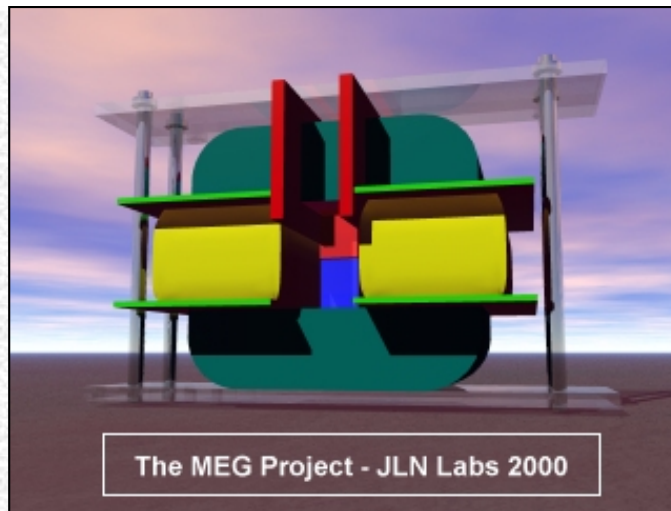

The Motionless Electromagnetic Generator Project

The MEG Project

*"..This one works beautifully and produces **COP=5.0...**" has said Tom Bearden*

Created on 11-18-00 - *JLN Labs* - Last update 03-27-02

All informations in this page are published free and are intended for private/educational purposes and not for commercial applications

The MEG diagrams published in these pages are currently under test by JL Naudin and may be subject to modifications after that they have been published on this site. They are the result of some attempts of a private and fully independant replication by the author. These diagrams are not the original MEG diagrams being tested by the Bearden's teamwork or some accredited labs.

Disclaimer: The author assumes no liability for any incidental, consequential or other liability from the use of this information. All risks and damages, incidental or otherwise, arising from the use or misuse of the information contained herein are entirely the responsibility of the user. Although careful precaution has been taken in the preparation of this material, I assume no responsibility for omissions or errors in the diagrams or measurement datas published here.

United States Patent

Patrick , et al.

6,362,718

March 26, 2002

US Patent 6,362,718 : Motionless Electromagnetic Generator (MEG)

☞ See the [full MEG patent with diagrams \(15 pages \)](#)

Abstract

An electromagnetic generator without moving parts includes a permanent magnet and a magnetic core including first and second magnetic paths. A first input coil and a first output coil extend around portions of the first magnetic path, while a second input coil and a second output coil extend around portions of the second magnetic path. The input coils are alternatively pulsed to provide induced current pulses in the output coils. Driving electrical current through each of the input coils reduces a level of flux from the permanent magnet within the magnet path around which the input coil extends. In an alternative embodiment of an electromagnetic generator, the magnetic core includes annular spaced-apart plates, with posts and permanent magnets extending in an alternating fashion between the plates. An output coil extends around each of these posts. Input coils extending around portions of the plates are pulsed to cause the induction of current within the output coils.

Inventors: **Patrick Stephen L; Bearden Thomas E.; Hayes James C.; Moore Kenneth D.; Kenny James L.**

Appl. No.: **656313**

Filed: **September 6, 2000**

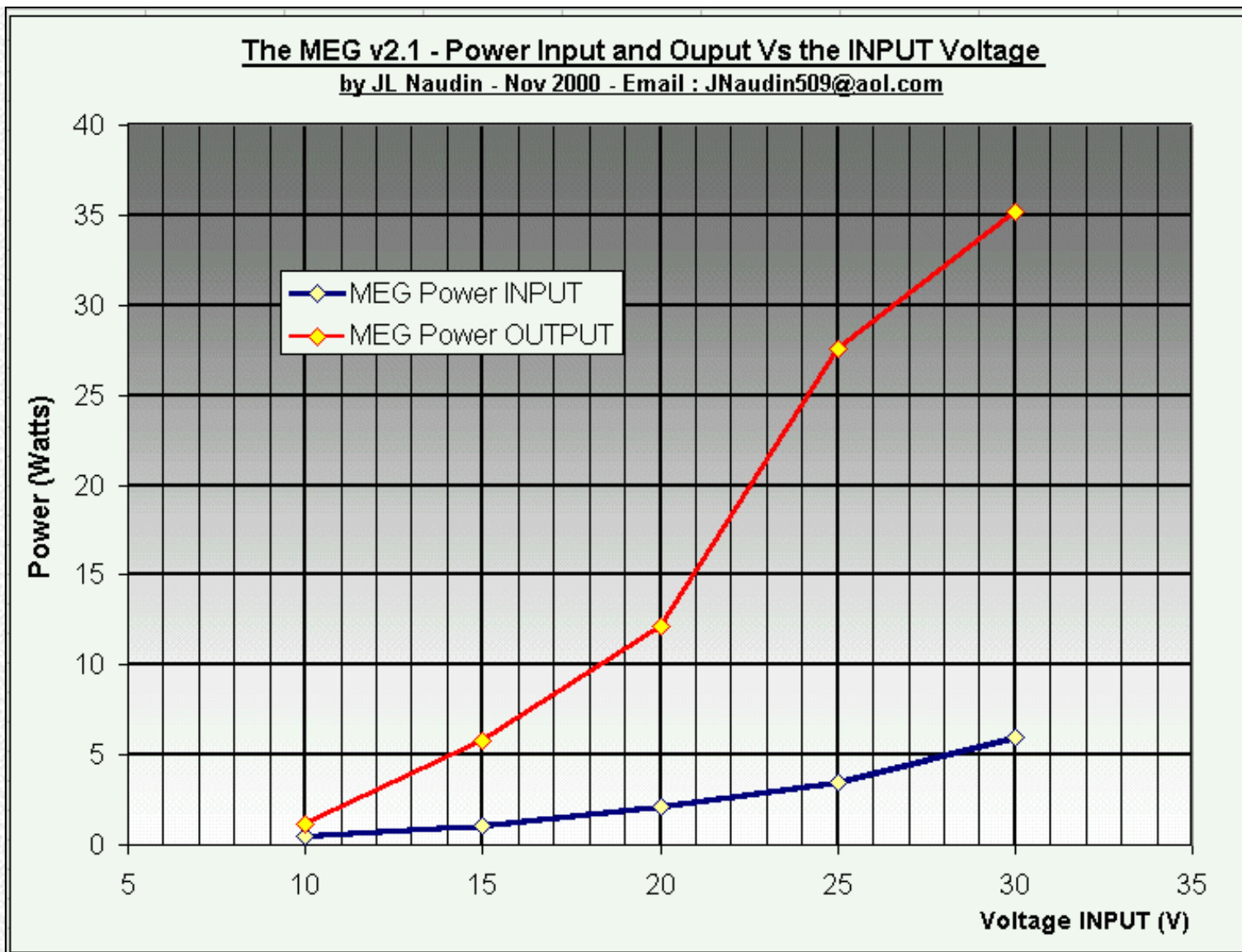

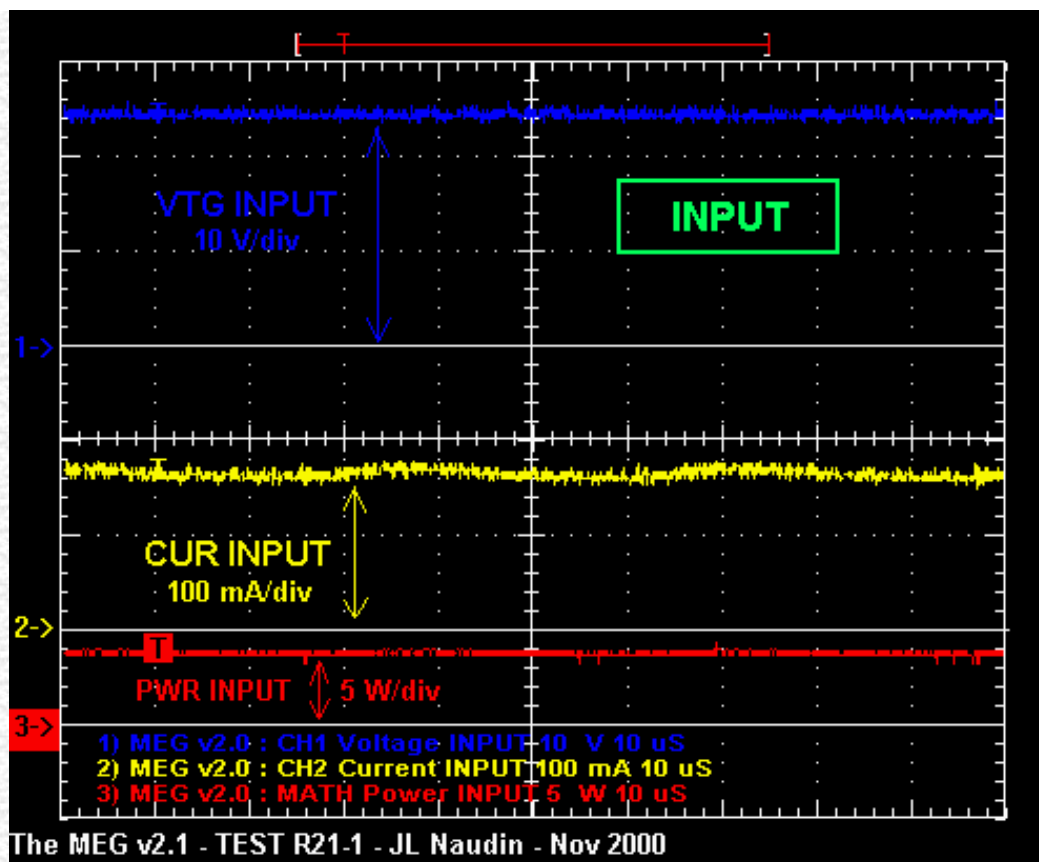

The TOTAL MEG INPUT at the DC input of the control board

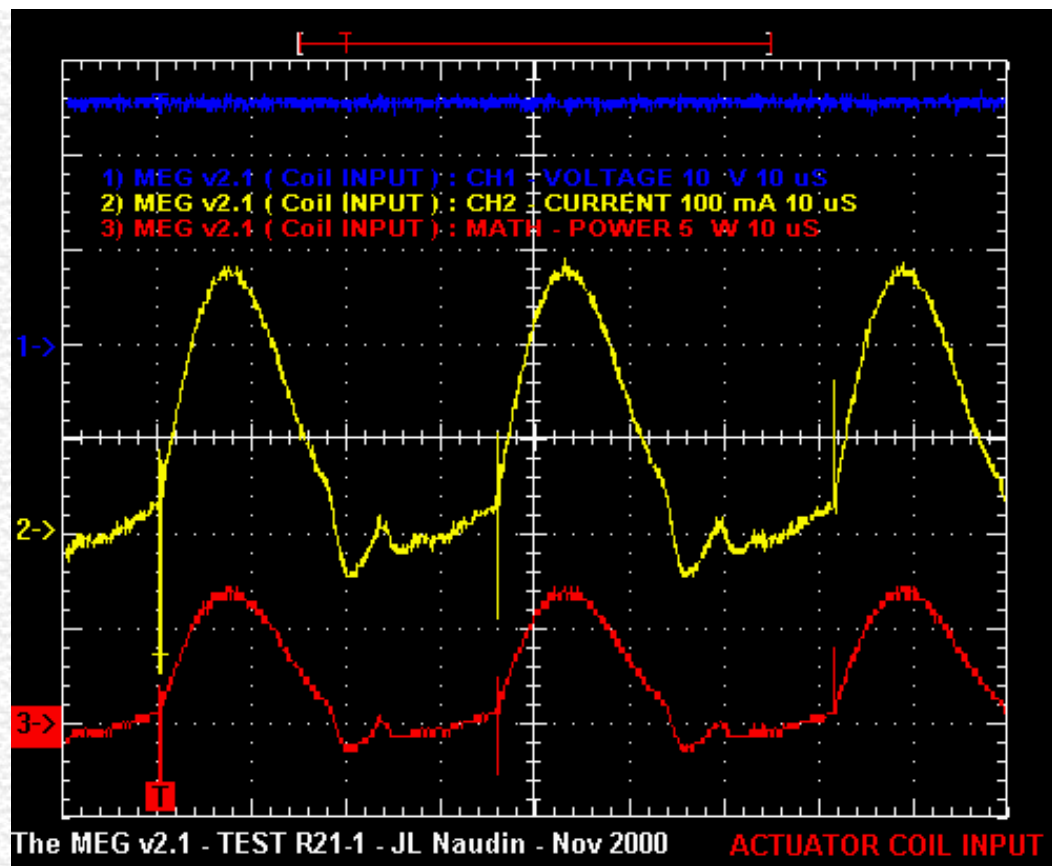

The ACTUATOR COIL INPUT (Primary coil)

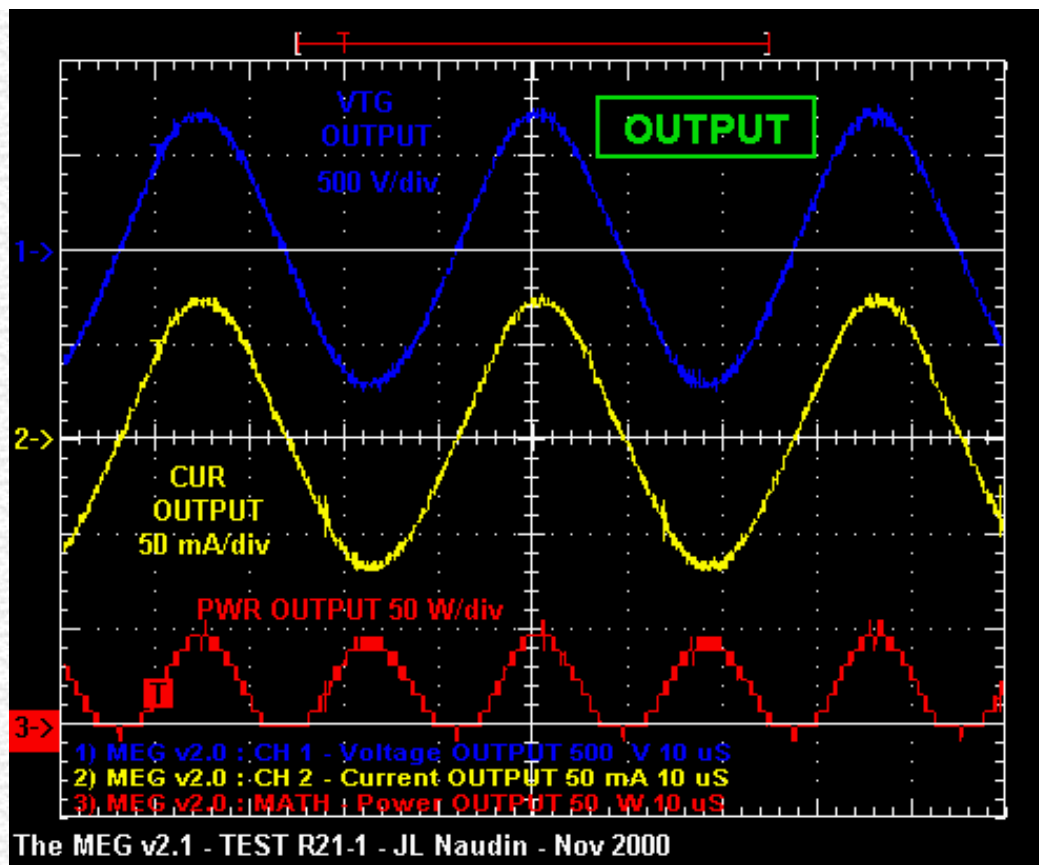

Above : The MEG v2.1 OUTPUT (Secondary coil)

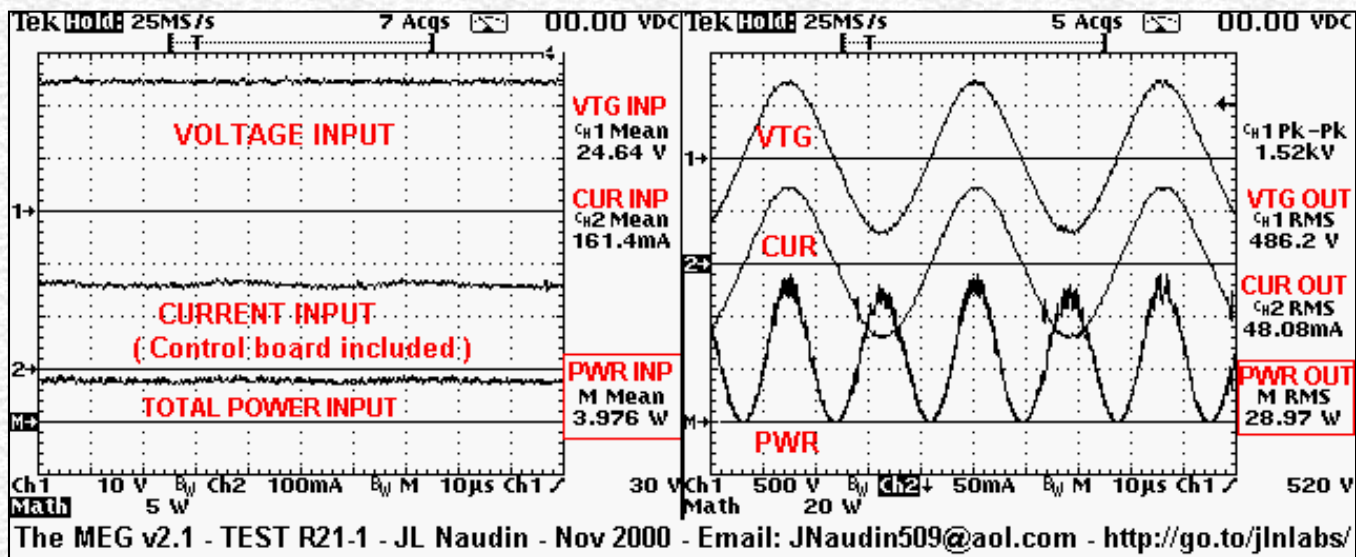

On the Left : The Voltage, the Current and the **Power INPUT** (measured at the DC input of the MEG control board)

On the Right : The Voltage, the Current and the **Power OUTPUT**

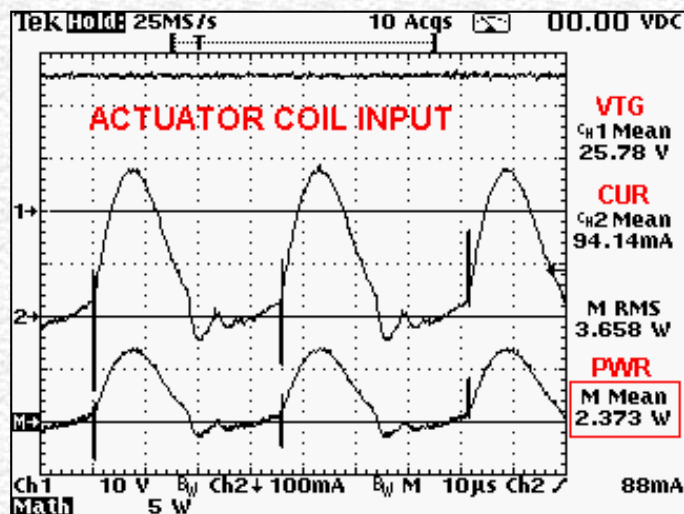

The ACTUATOR COIL INPUT

Note from Jean-Louis Naudin : The current has been measured with a 10 ohms ceramic and non inductive resistor (with a Tektronix THS720P oscilloscope, the probe used is a 1/10 and scope setup for the CH2 is 1000mA/V), the same resistor and the same method of measurement has been used for input and also the output.

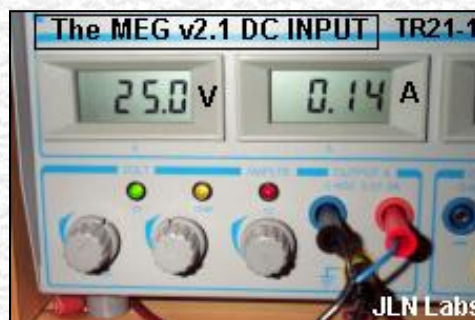

Above :The MEG v2.1 Input at the DC power supply

See : [The MEG v2.1 diagram](#)

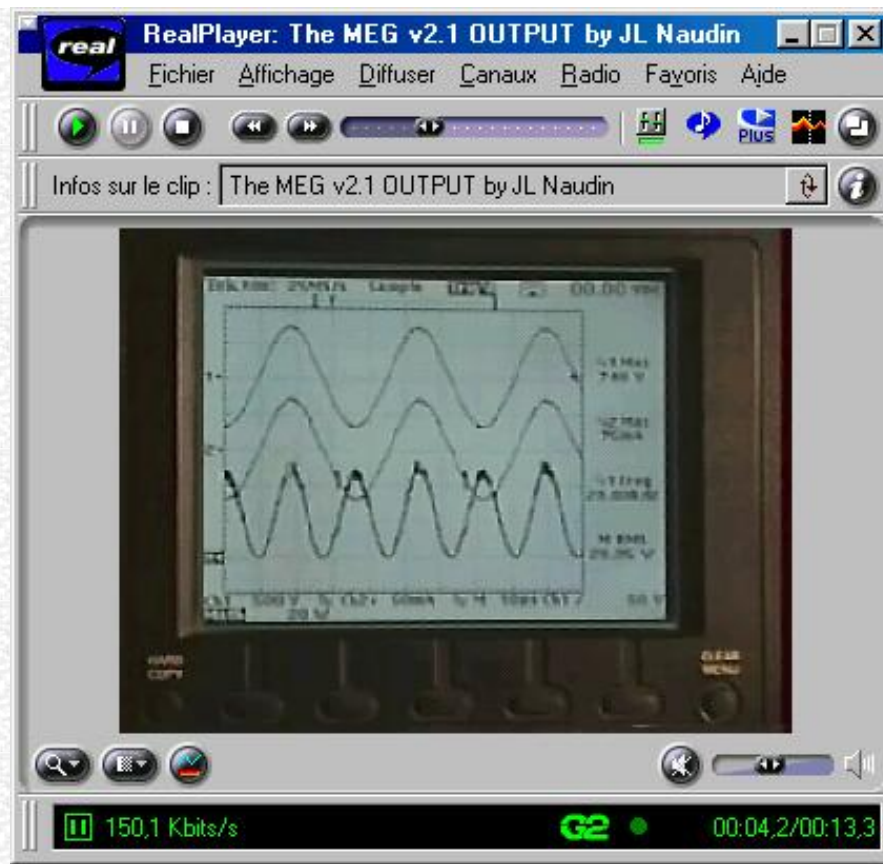

[Video of the test done on 11-16-00 \(228 Kb \)](#), you need to have



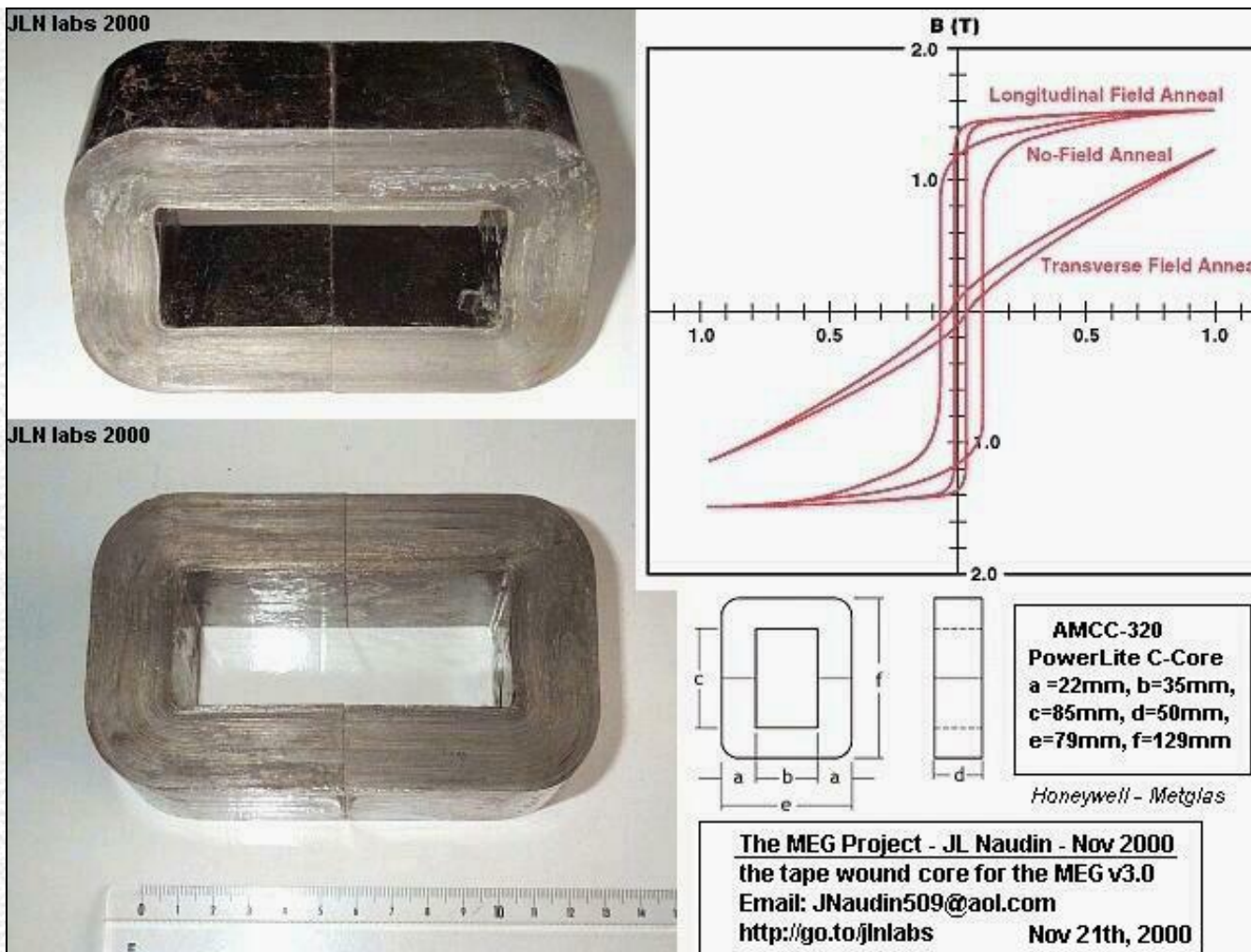

The [PowerLite™ C-Cores](#) (*Honeywell*) are manufactured with the METGLAS amorphous alloy.

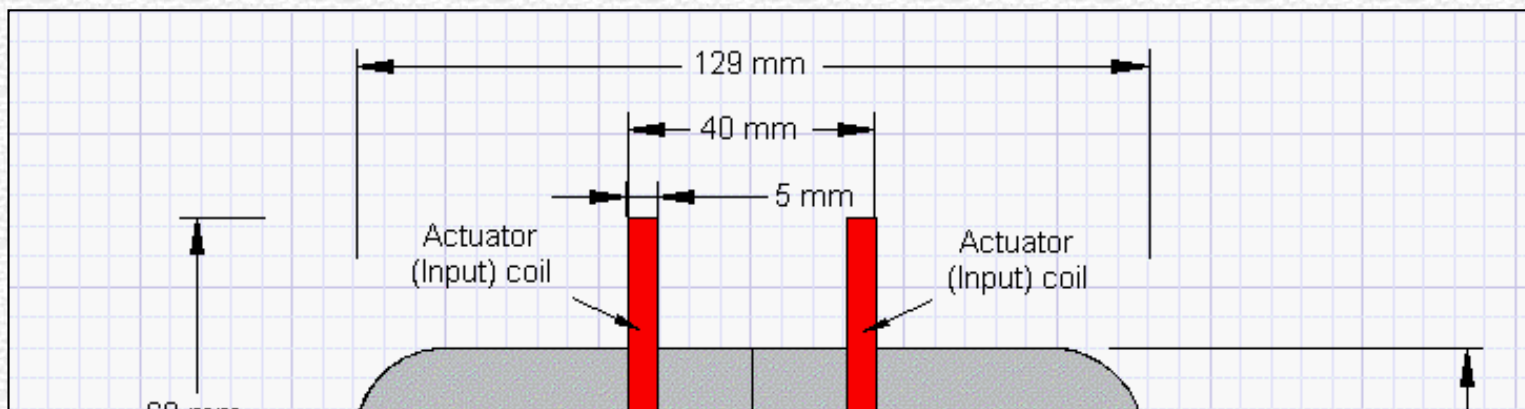

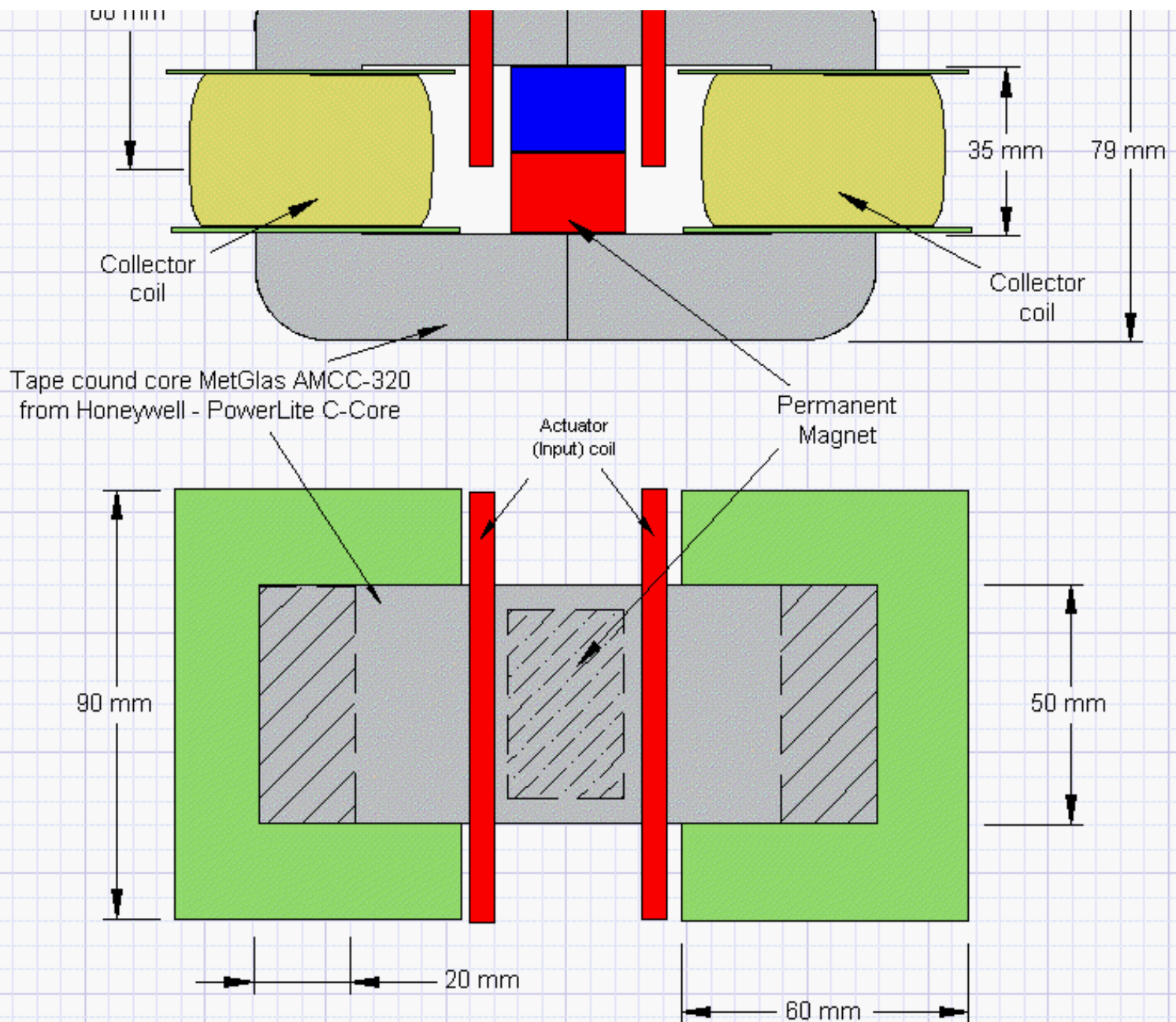

The MEGv3.0 - Motionless Electromagnetic Generator (rel v3.00 - 10-21-00)
based on the MEG from Thomas Bearden
Email: JNaudin509@aol.com - Web site : <http://go.to/jnlabs/>
This diagram is published free and intended for private/educational purposes only and not for commercial applications

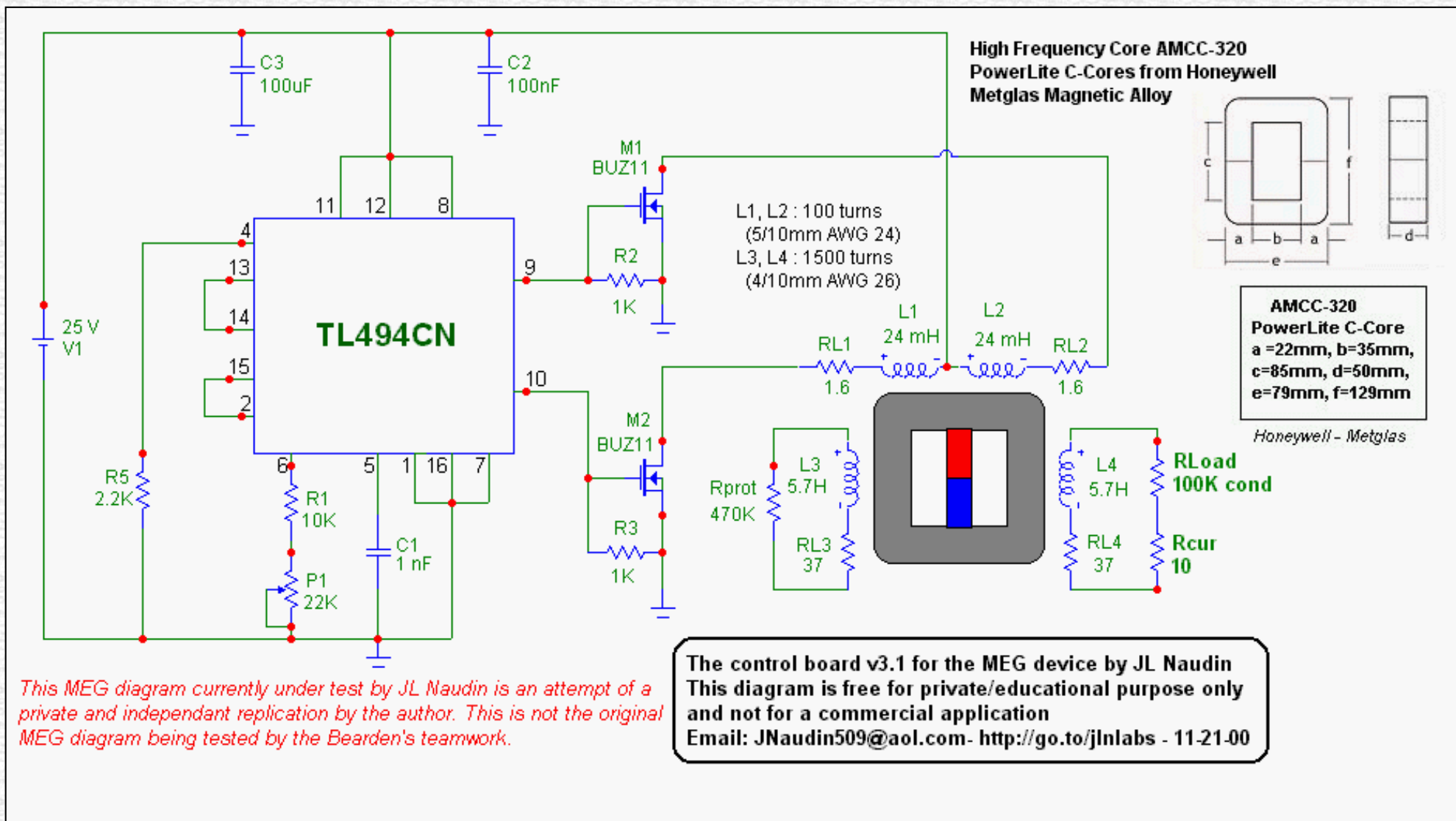

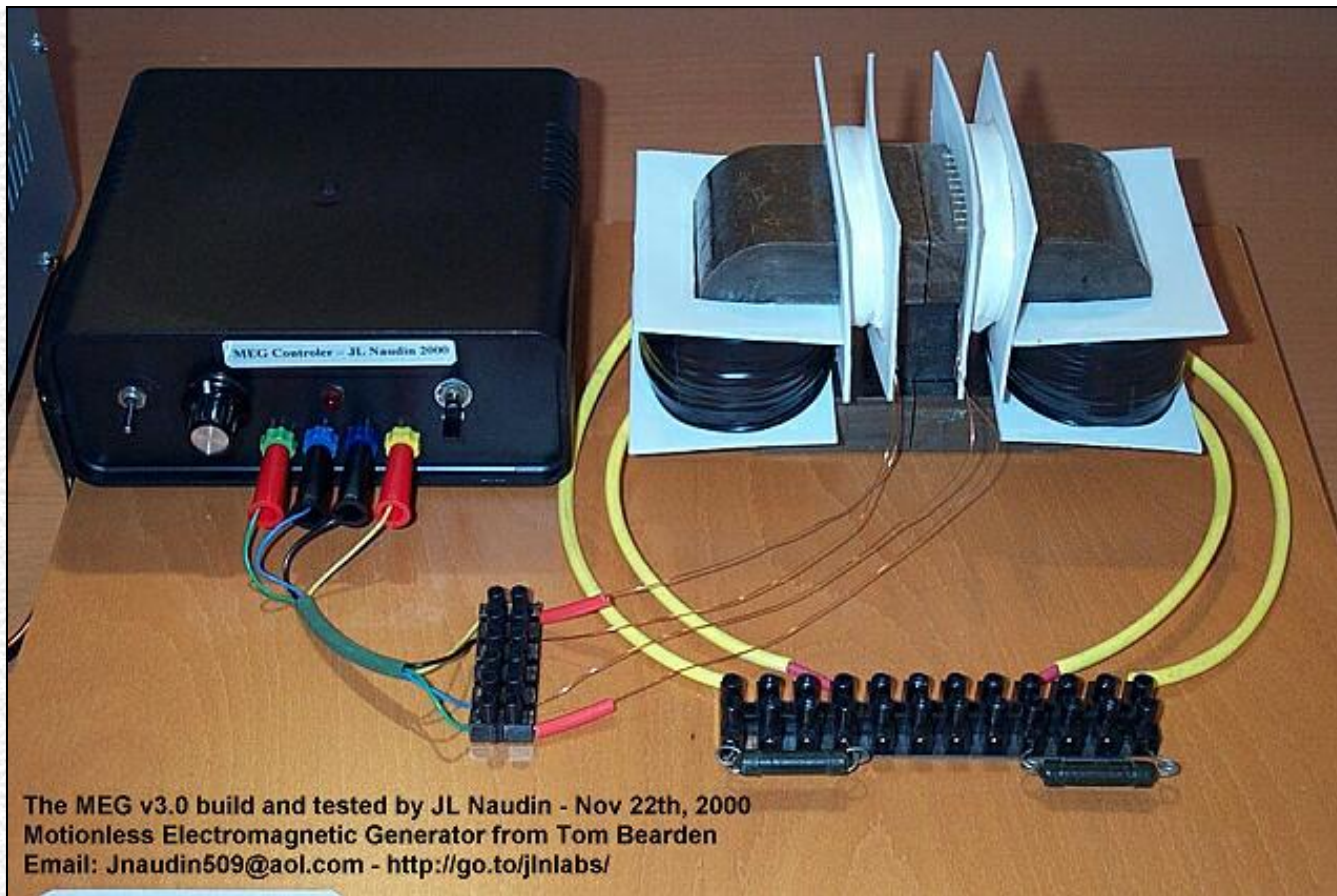

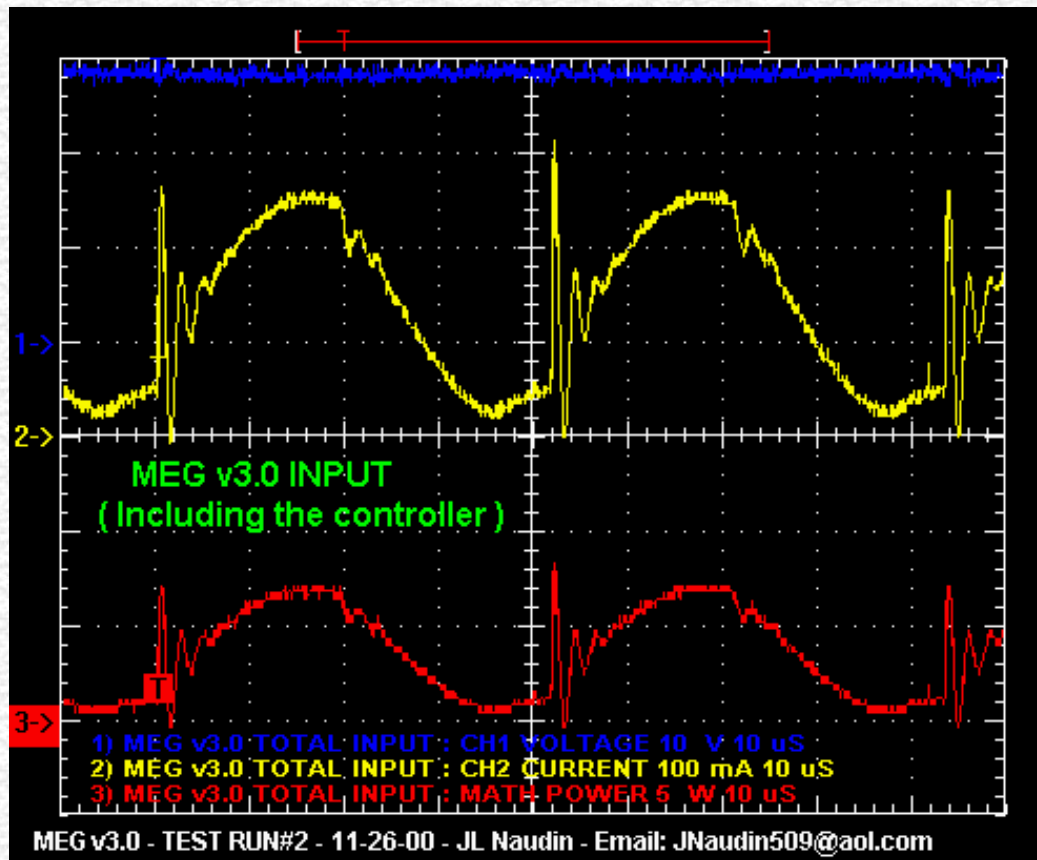

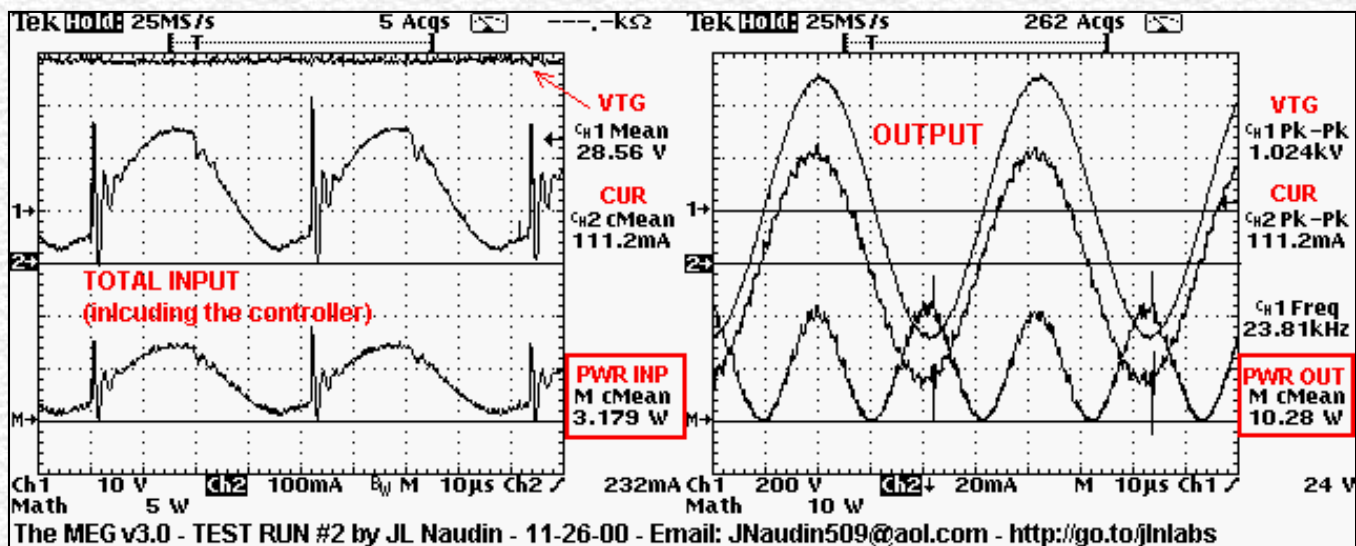
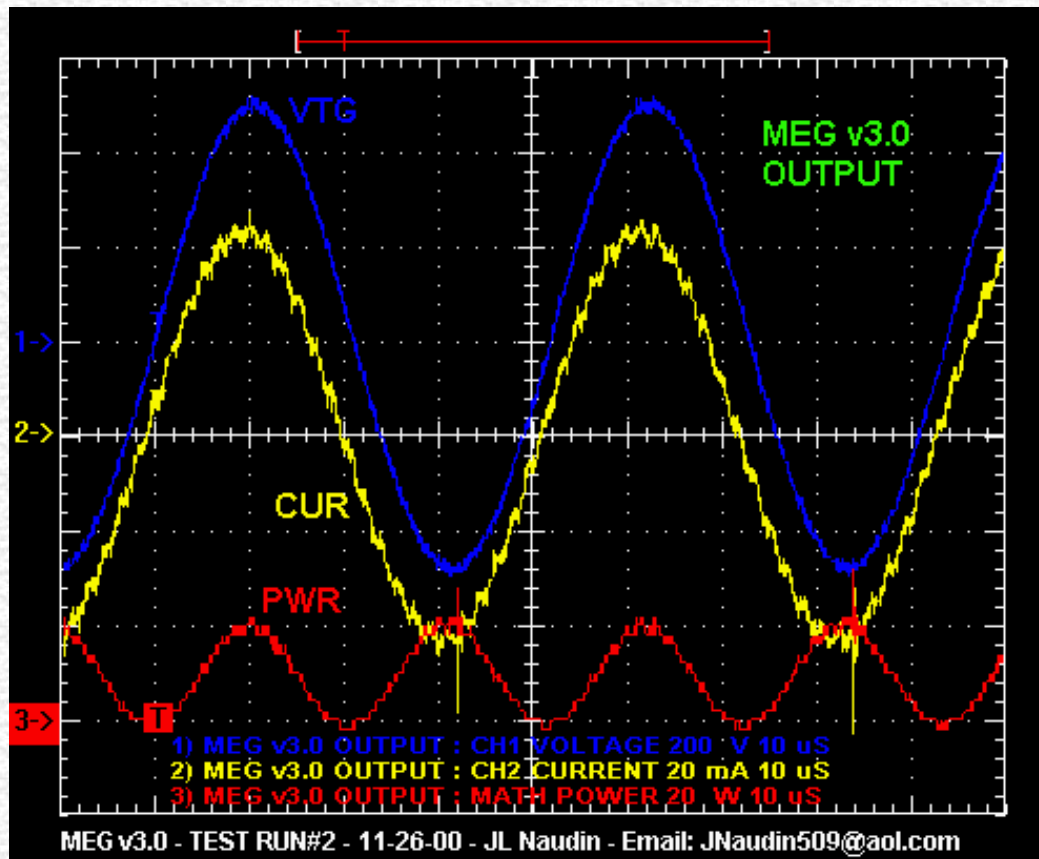

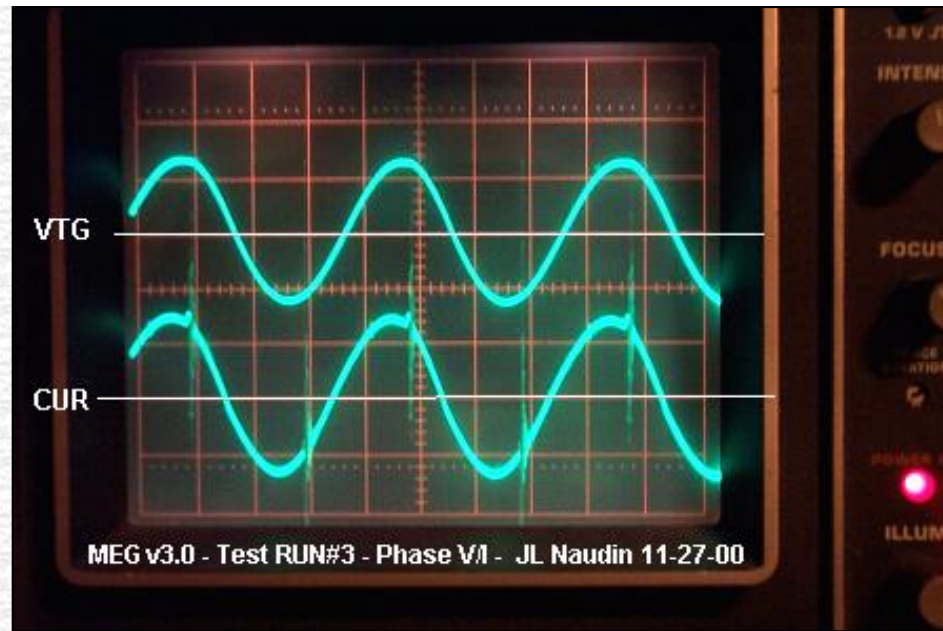

The phase between Voltage and Current at the MEG Output has also been checked with an analog oscilloscope (PM3215 2x50 Mhz Philips).

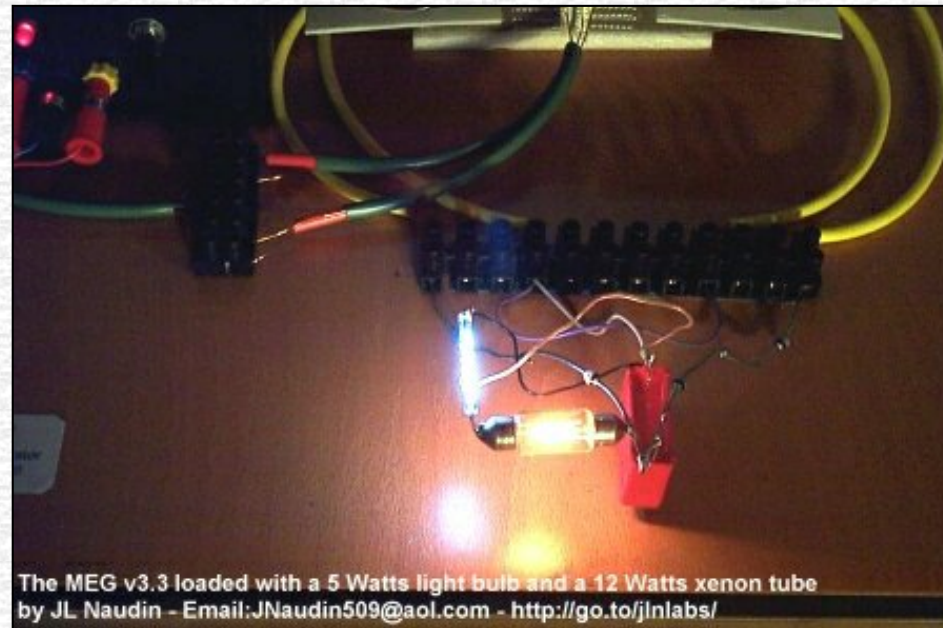

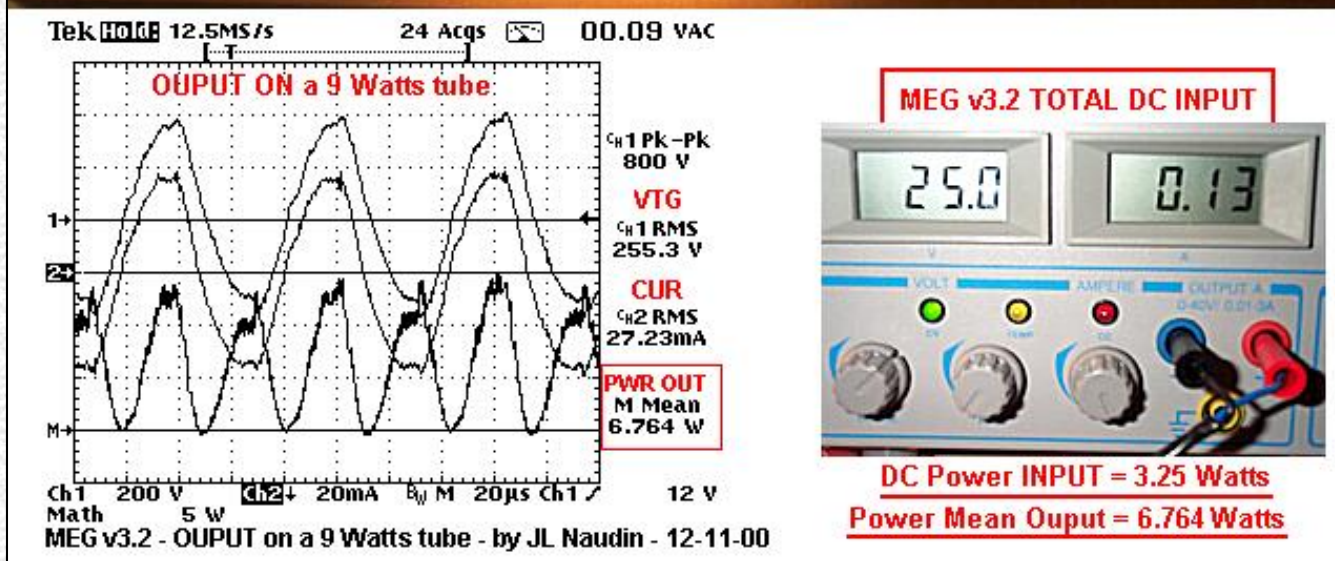
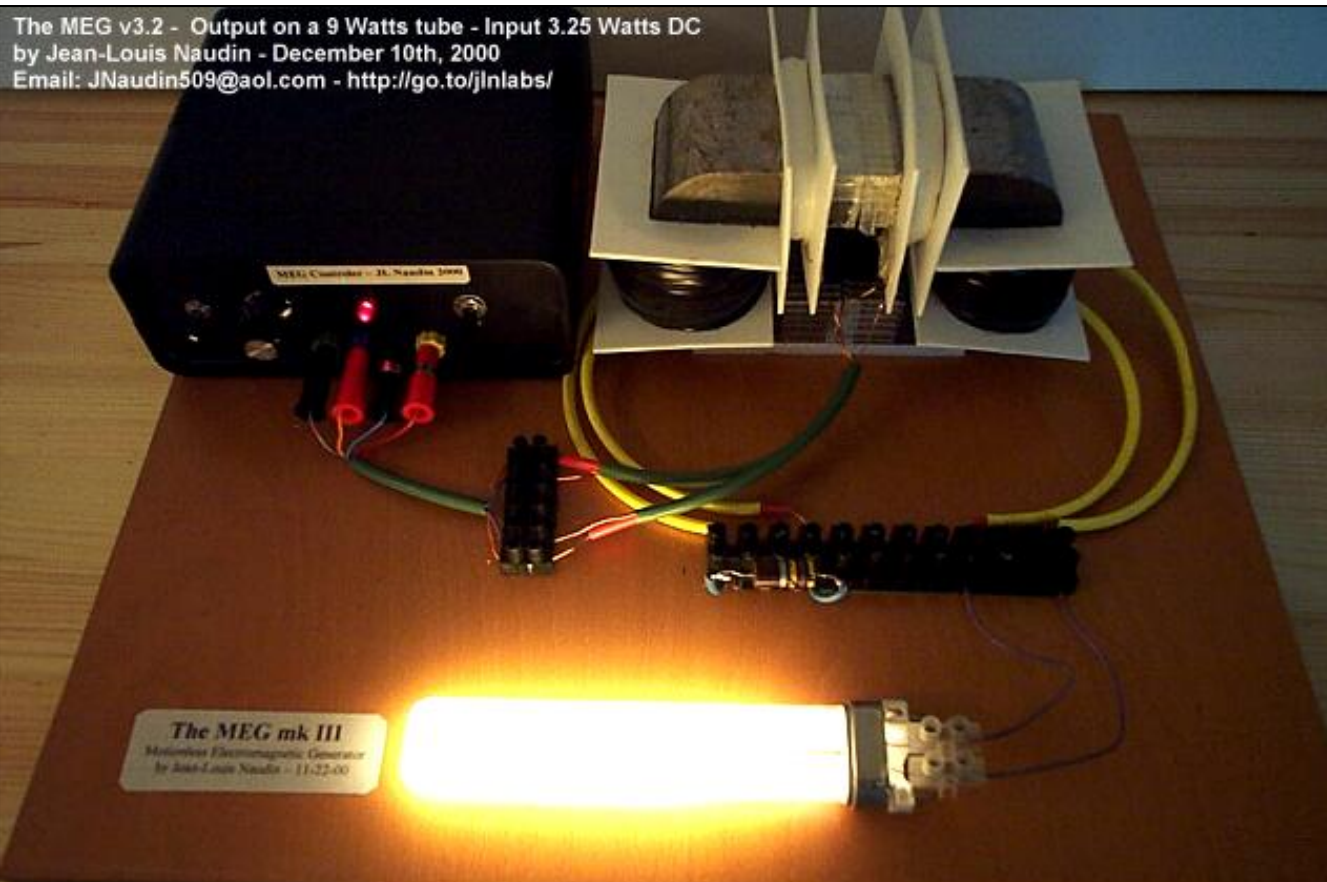

Notes : It is interesting to notice that the measured power required by the MEG electronic control board (TL494, BUZZ11, LED...) is 1.75 Watts (without

a load connected at the MEG Outputs). When the output is loaded with the 9 W lamp, the DC power input is 3.25 Watts. So, the real power used by the lamp is $3.25 - 1.75 = 1.5$ Watts at the INPUT with a measured OUTPUT = 6.76 Watts

MEG Project status (by JLN on 12-06-00) :

You will find below the only facts about my MEG units that I am able to say today :

- The Output (V/I) signals are really measured by the scope and this has also been checked by various methods (analog and digital scopes and multimeters), but unfortunately measurement artifacts remain possible,
 - the voltage and current are in phase as shown in my scope pictures above,
 - a "**conditionned**" RLoad (100 Kohms, non inductive carbon, 5Watts) or a MOV (Metal Oxide Varistor) is REQUIRED for getting the output datas measured above,
 - the working frequency and the output voltage must be high (about 20kHz and >1KV peak-to-peak loaded) ,
 - the working frequency must be tuned so as to get a pure sine wave and the max amplitude at the output (>1KV peak-to-peak loaded),
 - the switching signal is a squared pulse at 50% DTC,
 - the two primary coils must be switched alternatively (see the MEG animated simulation).
 - I have used ferrite magnets and an interesting effect that I have observed is :
when the magnet is added and with actuators coils set in the cross-flux magnetic gates configuration, the output signal increases significantly,
 - the RLoad warms up quikly when the MEG is switched on,
 - in most of cases the "apparent" power measured seems greater than the heat dissipated by Joule's effect in the RLoad, most of the power is radiated in EM form :
 - * With an electronic Teslameter, I have measured 2.8 milli-Tesla (at 16KHz) with the probe very close to the RLoad,
 - * With an E-Field Strength meter in AC mode, the E-Field = 1250 V/m at 50 cm far from the RLoad,
 - * With a gamma counter : No gamma radiation has yet been detected
- So be carefull if you work close to the MEG transformer because of the strong EM generated.

Not yet checked :

- core saturation effect by the magnet,
- flipping of the hysteresis curves by the actuator coils,
- calorimetric output measurements on the RLoad Vs the Input but in the most of case the "apparent" power measured seems greater than the heat dissipated by Joule's effect in the RLoad and this makes me pessimistic about the calorimetric tests results.

Conclusion (on 12-06-00) :

My MEG replication seems to be really close to the original device presented in the Bearden's MEG paper and I think that I have been able to replicate and measure the same signals at the Input/Output of the device. I have not used the original electronic and core diagrams from the Bearden's teamwork (because I don't have them..), so may be there are some important differences between the setups. The purpose of this project seems to be achieved : the replication of the MEG signals measured at its output is in line with the original papers and the inventors claims.

Now, the BEST verification to do is to convert the "apparent" power measured in useable power such as : light, heat, mechanical energy (in motors).... and also, of course, to close the loop... This has not yet been done today.

 **Good advices for the MEG builders :** [The MEG Notes](#) by *Jon Flickinger*

Technical datasheets :

- **[The TL494, Pulse-Width-Modulation \(Pwm\) Control Circuit from Texas Instrument](#)**
[The BUZ11 MosFet N-Channel transistor from Intersil](#)
- **[AMORPHOUS METALS Magnetic Materials METGLAS®](#)**
Magnetic Alloy 2605SA1 (Iron-based) Longitudinal Field Anneal Typical Core.
http://metglas.com:80/products/page5_1_2_4_1.htm
http://metglas.com:80/products/page5_1_2.htm
http://metglas.com:80/products/page5_1_2_4.htm

See also the :

- **[Previous tests results about the MEG v2.0](#)**
- **[The Motional Electromagnetic Generator \(MEG \)](#)** *from Thomas Bearden*

January 20th, 2001 : Interesting papers and patents :

- **["Overunity device installed in Minuteman Missile - patented by Westinghouse"](#)** *by Tom Bearden*
- **H. Andreatta, "High Power Switching Amplifier Wherein Energy is Transferred to a Tuned Circuit During Both Half Cycles," [U.S. Patent No. 3,239,771, Mar. 8, 1966](#);**
- **Tom L. Dennis, Jr., "Highly Efficient Semiconductor Switching Amplifier," [U.S. Patent No. 3,239,772, Mar. 8, 1966](#);**
- **Heber J. Morrison, "Square Wave Driven Power Amplifier," [U.S. Patent No. 3,815,030, June 4, 1974](#).**

Interesting papers and documents about the project :

- **[The MEG paper : Extracting Energy from a Permanent Magnet with Energy-Replenishing from the Active Vacuum](#)**, *a PDF document (69 pages 1,29 MB), by T.E. Bearden*
- **[Giant Negentropy from the Common Dipole](#)** *By T. E. Bearden (PDF Format 86 KB)*
- **[On Extracting Electromagnetic Energy from the Vacuum](#)** *By T. E. Bearden (PDF Format 160 KB)*

Some technical infos :

Fe-based Nanocrystalline Toroidal Core for Current Transformers :

Characteristics: Nanocrystalline alloy has similar features of high initial permeability and temperature stability, less gravity and packing factor than that of Permalloy. Under the same conditions of core size and performance, it is lighter (about 1/3 lighter) and cheaper than that of Permalloy.

Nanocrystalline Magnetic Core :

Characteristics: High saturation magnetic induction (1.25T), high permeability, high inductance (ten times higher than that of ferrite), low loss, small volume, light in weight, high electric interference resistance, good frequency performance and high temperature stability.

For more infos about the Nanocrystalline material see :

- [NANOCRYSTALLINE SOFT MAGNETIC ALLOYS FOR APPLICATION IN ELECTRICAL AND ELECTRONIC DEVICES](#) by V.R. Ramanan ABB-Electric Systems Technology Institute

Magnetic material suppliers :

- The [PowerLite™ C-Cores](#) (*Honeywell*) are manufactured with the METGLAS amorphous alloy.
- BFiOTiLAS : [Magnetics Components: Softcores material](#)
- MAGNETEC : Tape wound core based on the new nanocrystalline softmagnetic material called [NANOPERM](#)

For more informations, please contact : JNaudin509@aol.com

Return to the [MEG project](#) home page

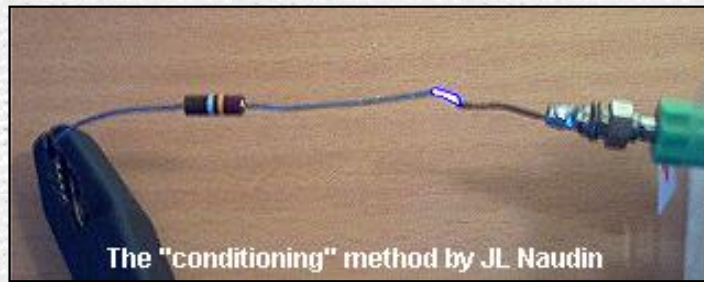

Method for "conditioning" a carbon resistor

by *Jean-Louis Naudin*

Created on 11-24-00 - *JLN Labs* - Last update 12-08-00

You will find below a method for building yourself a non-linear resistor with a common old carbon composite resistor. This component has some interesting characteristics such as a high resistance in DC and a low resistance at AC High Voltage (>1KV)....

Material required :

- A brand new pure carbon and non inductive resistor, the value must be greater than 100 Kohms or more.
- A 20kV pulsed DC HV power supply (at 80 KHz) (see the diagram at the bottom)

Procedure :

1. Connect one side of this brand new carbon resistor on the 0 Volt side and the other side at about 6 mm from the HV output so as to get a spark gap,
2. Switch on the HV power supply and adjust the spark gap so as to get the max spark distance,
3. You will observe that the yellow color bar will began progressively orange, this indicate the warm up of the resistor,
4. You will notice that the spark will vanish after about 1 minutes,
5. Switch off the power supply and check the value of this conditioned RLoad, the value must be now about 300 K... If this is not the case run the step 2 again,
6. Your "conditioned resistor" is now ready to be used for your tests...

In the pictures below, I have used a 220K 1/2 carbon resistor for a demonstration purpose, but I recommend you to use a 100 Kohms 5 Watts carbon resistor for your testing.

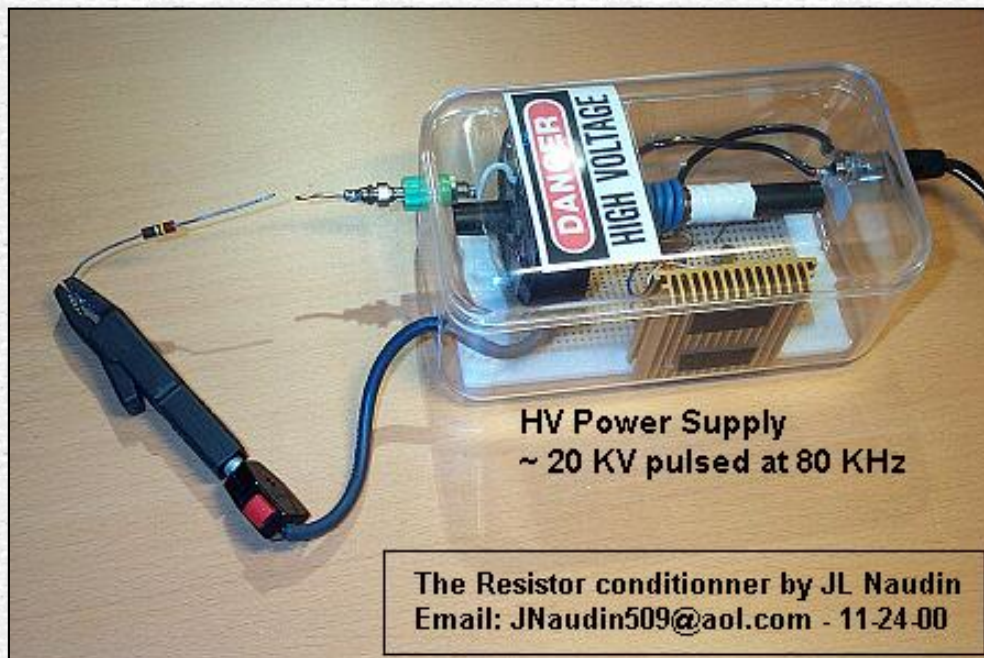

The HV power supply arrangement used as the resistor conditioner

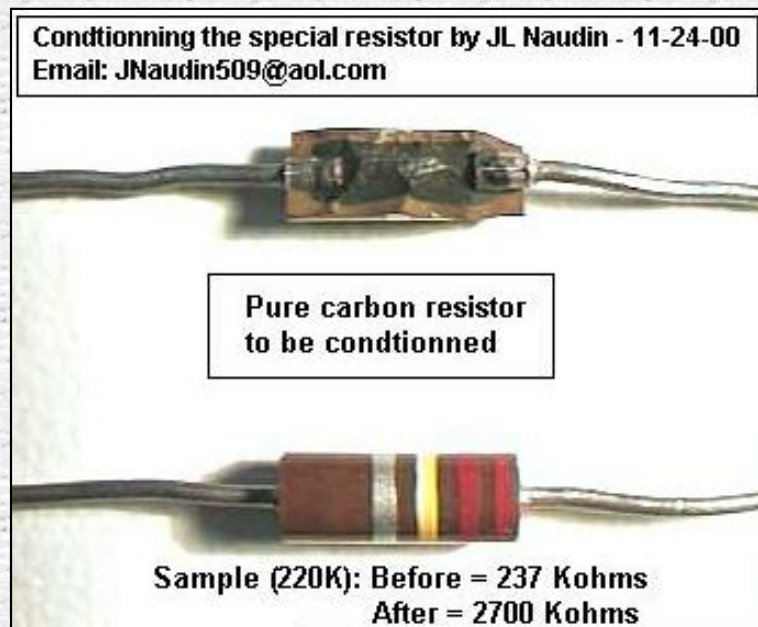

Above, you see that the resistor is made with carbon (no wire)

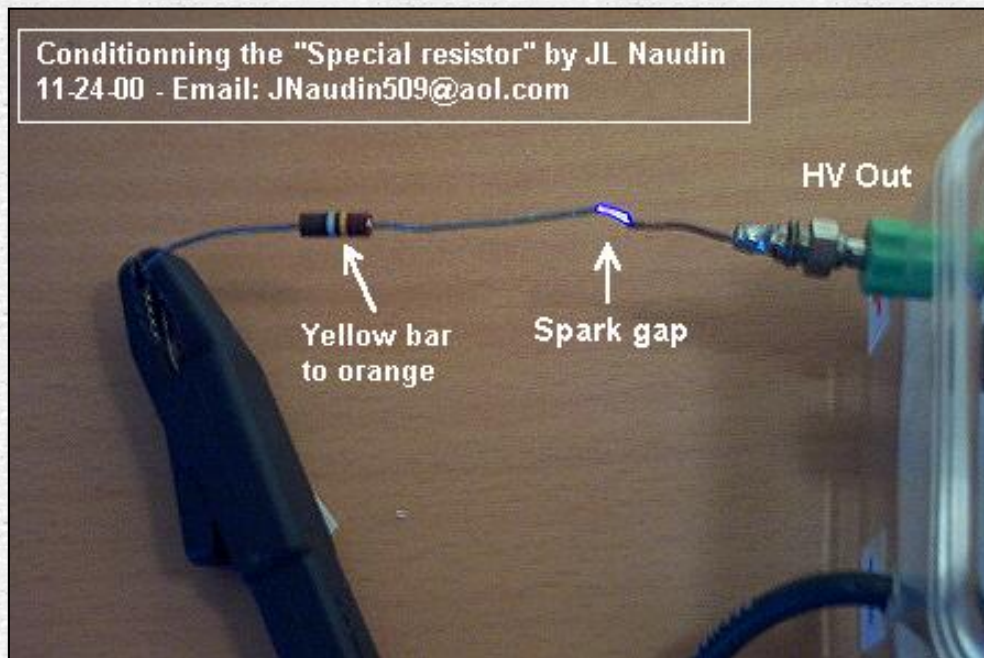

The "conditionning process", you may notice the spark and the change of the color bar of the resistor.



The pictures above see the change of the resistor value after the process

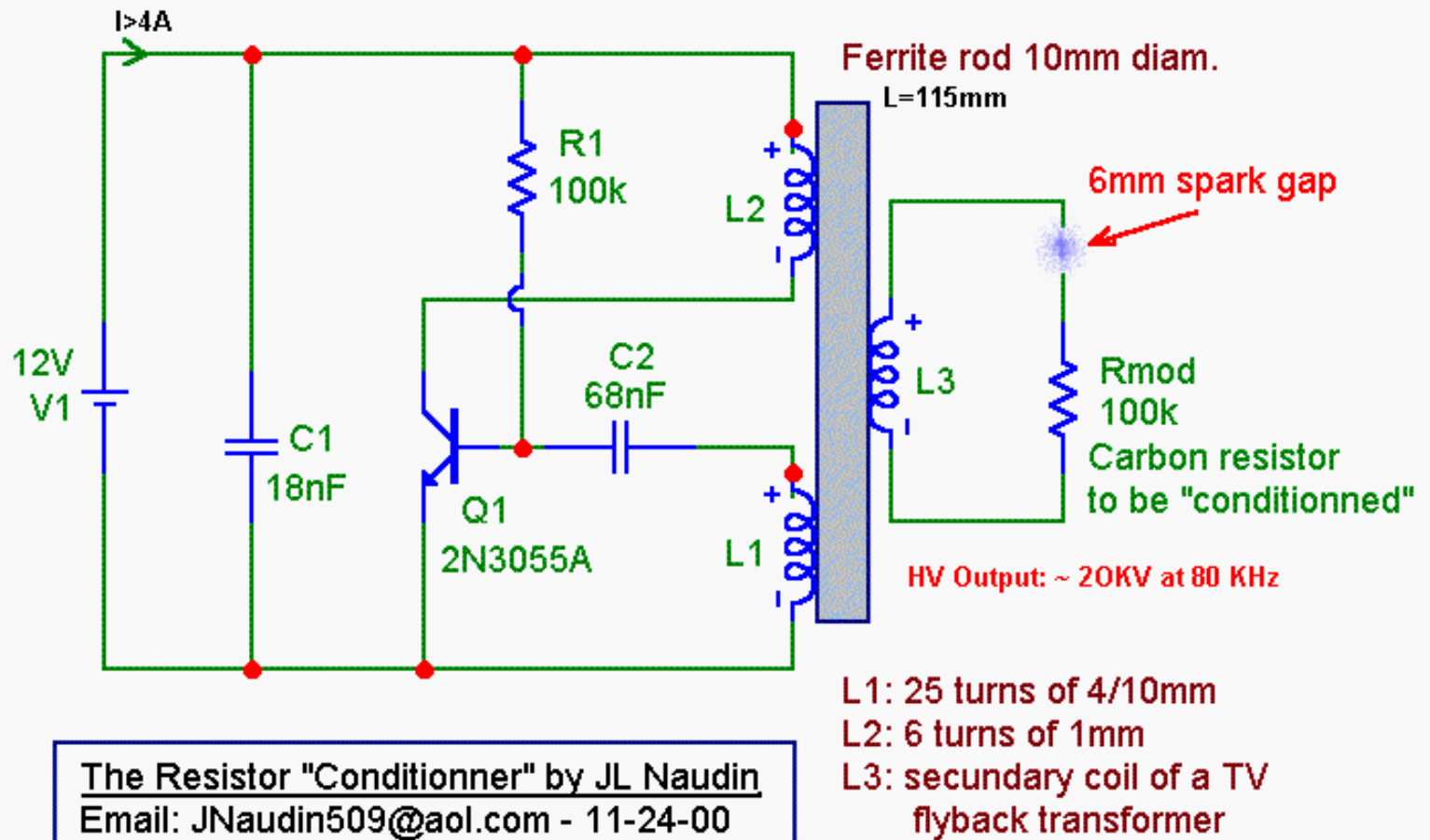

For more informations, you may write me directly at : Jnaudin509@aol.com

All informations in this page are published free and are intended for private/educational purposes and not for commercial applications

Disclaimer: The author assumes no liability for any incidental, consequential or other liability from the use of this information. All risks and damages, incidental or otherwise, arising from the use or misuse of the information contained herein are entirely the responsibility of the user. Although careful precaution has been taken in the preparation of this material, I assume no responsibility for omissions or errors in the diagrams or measurement datas published here.

Return to the [MEG project](#) home page

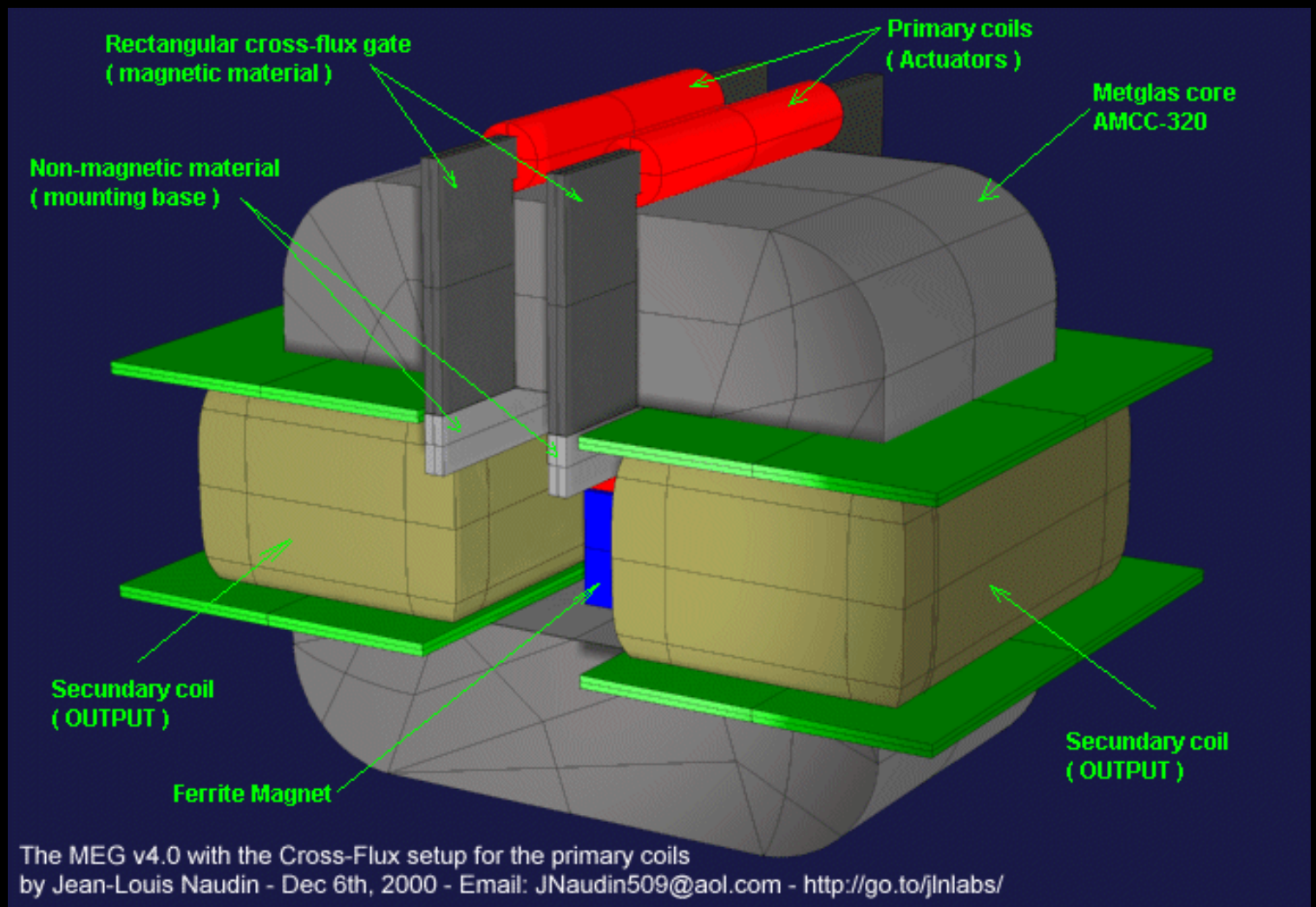

MEG v4.0 - Cross Flux magnetic gates setup

Simulation by JL Naudin - Dec 6th, 2000 - Email: JNaudin509@aol.com

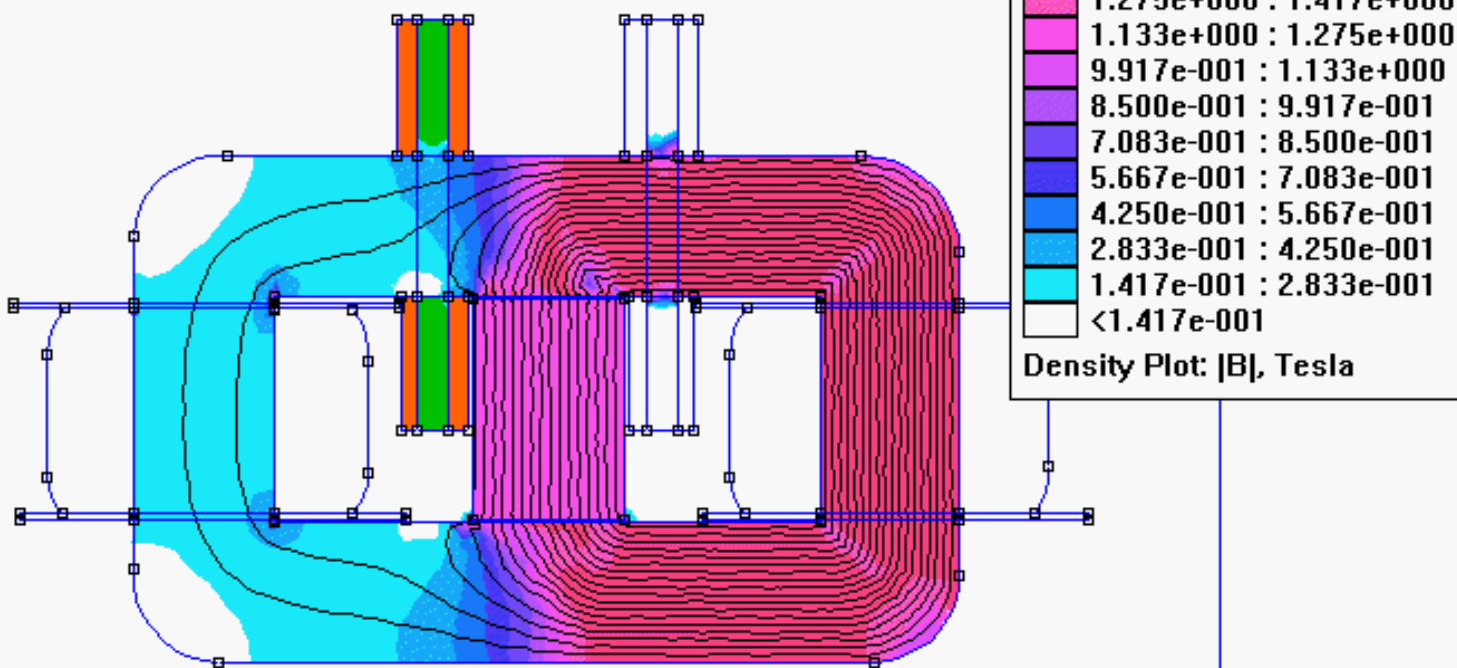

[The MEG v4.0 with the Cross-Flux magnetic gates setup](#)

[Return to the MEG project page](#)

--- In jlnlabs@y..., Jon Flickinger <jonfli@i...> wrote:
To All,

This information is to all those presently involved in or thinking about an attempted MEG replication. I'm expressing opinions that I've come to from the results I've obtained after spending many lab hours with many variations in topology and circuitry. In no way am I de-potentializing the MEG (pun intended) but simply trying to share what I've learned about the device for the good of the whole!

IMHO, it is a waste of time to attempt power measurements of the MEG standard load resistors (that is, any linear resistive device) if one expects to see any excess energy. The output loads must be resistive (non-reactive) and nonlinear. The resistance must decrease with increasing voltage and the power must be calculated from the output voltage and current. Those of you powering up your MEG for the first time with pure resistive loads, will find the waveforms do not match Bearden's nor JLN's! Only with nonlinear loads and a properly "tuned" MEG will you see the near half sine current waveform in your primary coils.

With nonlinear loads and a properly setup MEG, you will measure COP's >1 with the proper measurement tools and techniques. In general, the MEG seems to like voltage build up in the secondary windings before supplying current to the load!

If so, this would seem to align with Tom Bearden's public disclose of this device! The problem now lies in the utilization of this excess power to do some useful work. **It would appear to me that the MEG can be run with lower secondary voltages and properly designed loads and still yield COP's >1.** In fact, this should be a focal point for anyone doing this project.

Suggestions-

1) A common nonlinear load device to try would be various voltage rated MOV's or transient absorbers.

I used Panasonic ZNR10K621U's for **COP's ranging from 1.75 to 5** depending on coil turns and supply voltage. Ask JLN how he "conditioned" his carbon load resistor as I don't know. (*JLN Answer, see at : <http://jnaudin.free.fr/html/negres.htm>)*

2) Use a higher spec'd device for Vds than the BUZ11. With only a 50 v rating for Vds, this device avalanches on the primary turn off flyback phase and results in abnormal heating. Use a device with a Vds >200 volts and an Id >4 amps.

3) The power supply can also be a constant current source and will actually provide some measure of safety if disaster strikes in the switching circuitry!

4) I can't stress strongly enough the safety issues regarding the high output voltages one will encounter on the secondaries! USE CAUTION! Be sure your measurement devices connected to any portion of the secondaries are capable of withstanding the voltages you will encounter.

5) NEVER POWER UP A MEG WITHOUT LOADS CONNECTED AS THE OPEN CIRCUIT VOLTAGES CAN BE LETHAL AND DESTRUCTIVE!

I can now understand why the MEG presents certain problems in achieving a self-running state and it may not be necessary as Tom Bearden has recently tried to point out!

If anyone should experience valid COP's >1 with standard linear loads, please speak out!

Regards,

Jon Flickinger

--- End forwarded message ---

Return to the [MEG project](#) home page

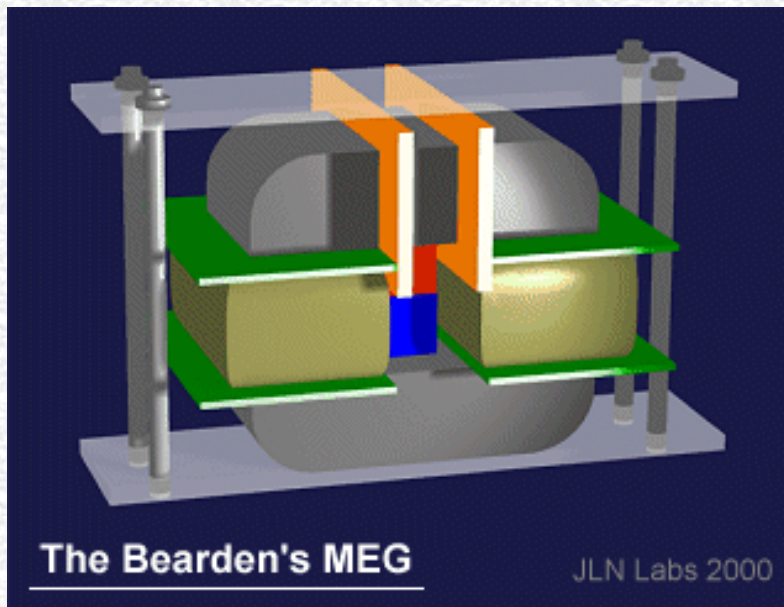

The Motionless Electromagnetic Generator Project

The MEG v2.0 built by JL Naudin

Created on 10-29-00 - *JLN Labs* - Last update 11-17-00

All informations in this page are published free and are intended for private/educational purposes and not for commercial applications



[See the latest test results of MEG v2.1](#)

The new tests on the enhanced MEG control board v2.0 are very encouraging because I have been able to reproduce the **exact waves shapes used in the original Bearden's MEG** presented in his technical paper : "[The Motionless Electromagnetic Generator: Extracting Energy from a Permanent Magnet with Energy-Replenishing from the Active Vacuum](#), a PDF document (69 pages 1,29 MB), explanations and tests results by T.E. Bearden *see page 67...*

The new MEG control board v2.0 is now **fully in line with the original Bearden's MEG** comparing to [my previous version \(see the test of the v 1.0\)....](#)

MEG v2.0 : TEST RUN#1 (11-07-00)

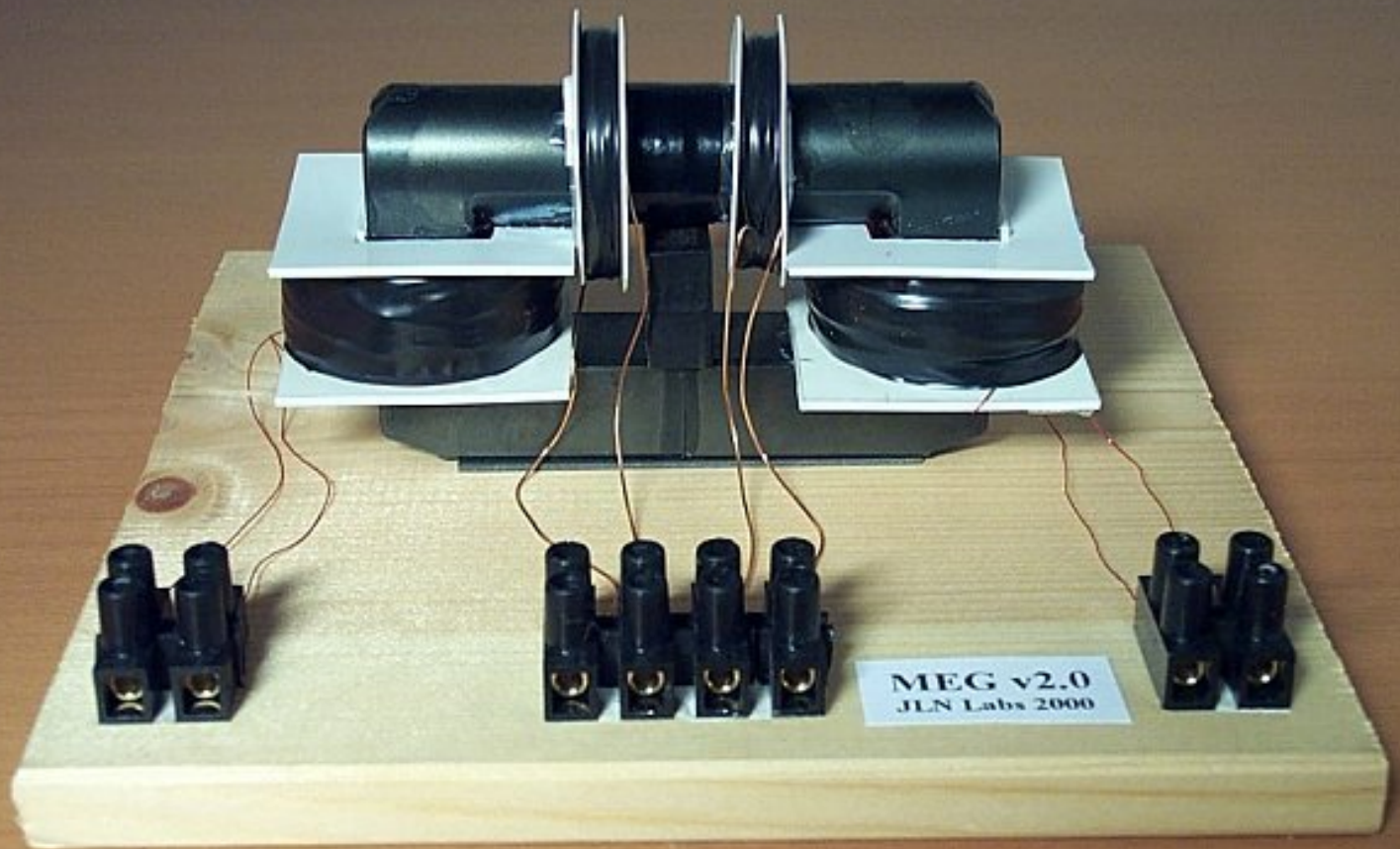

The MEG v2.0 built by JL Naudin - JLN Labs - Nov 2000
Email: Jnaudin509@aol.com - <http://go.to/jlnlabs>

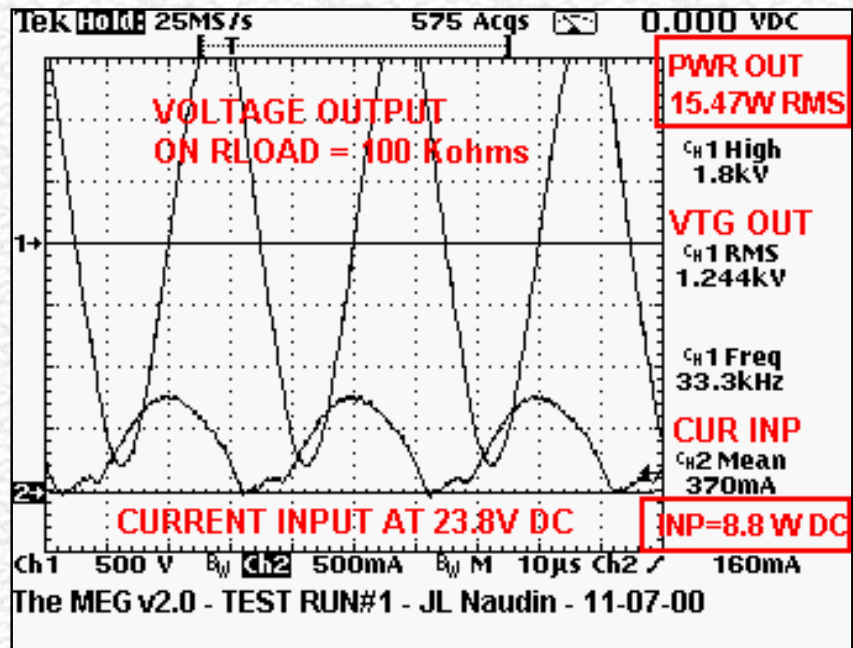

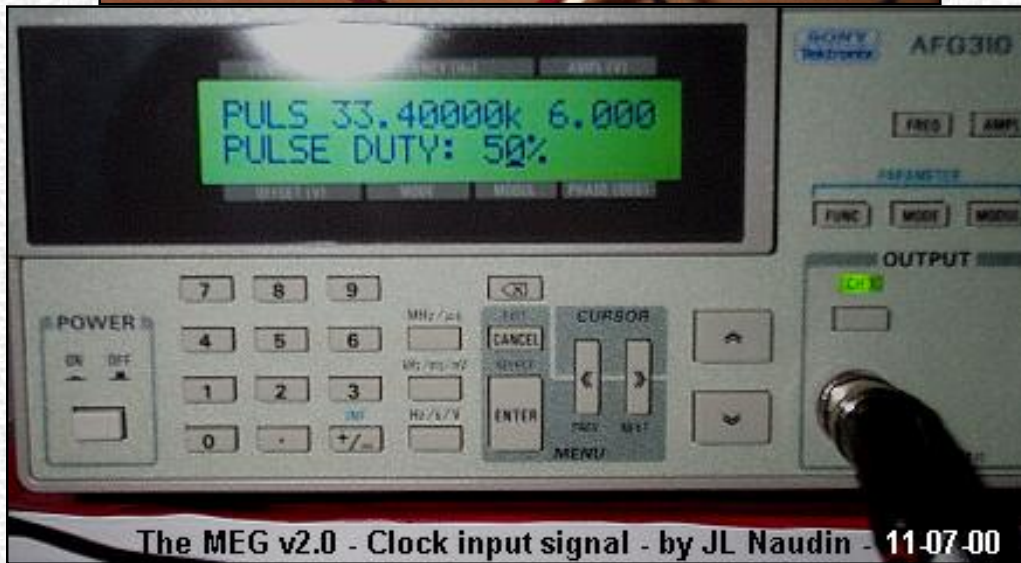
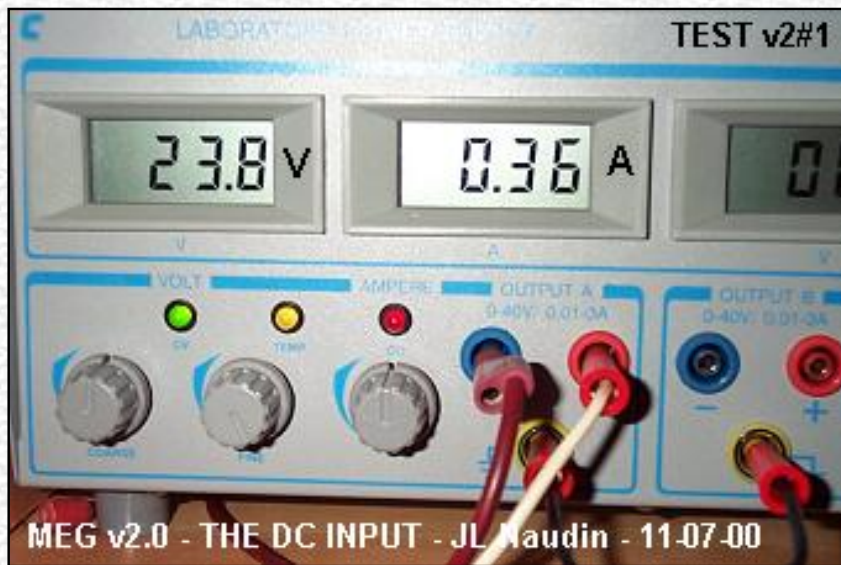

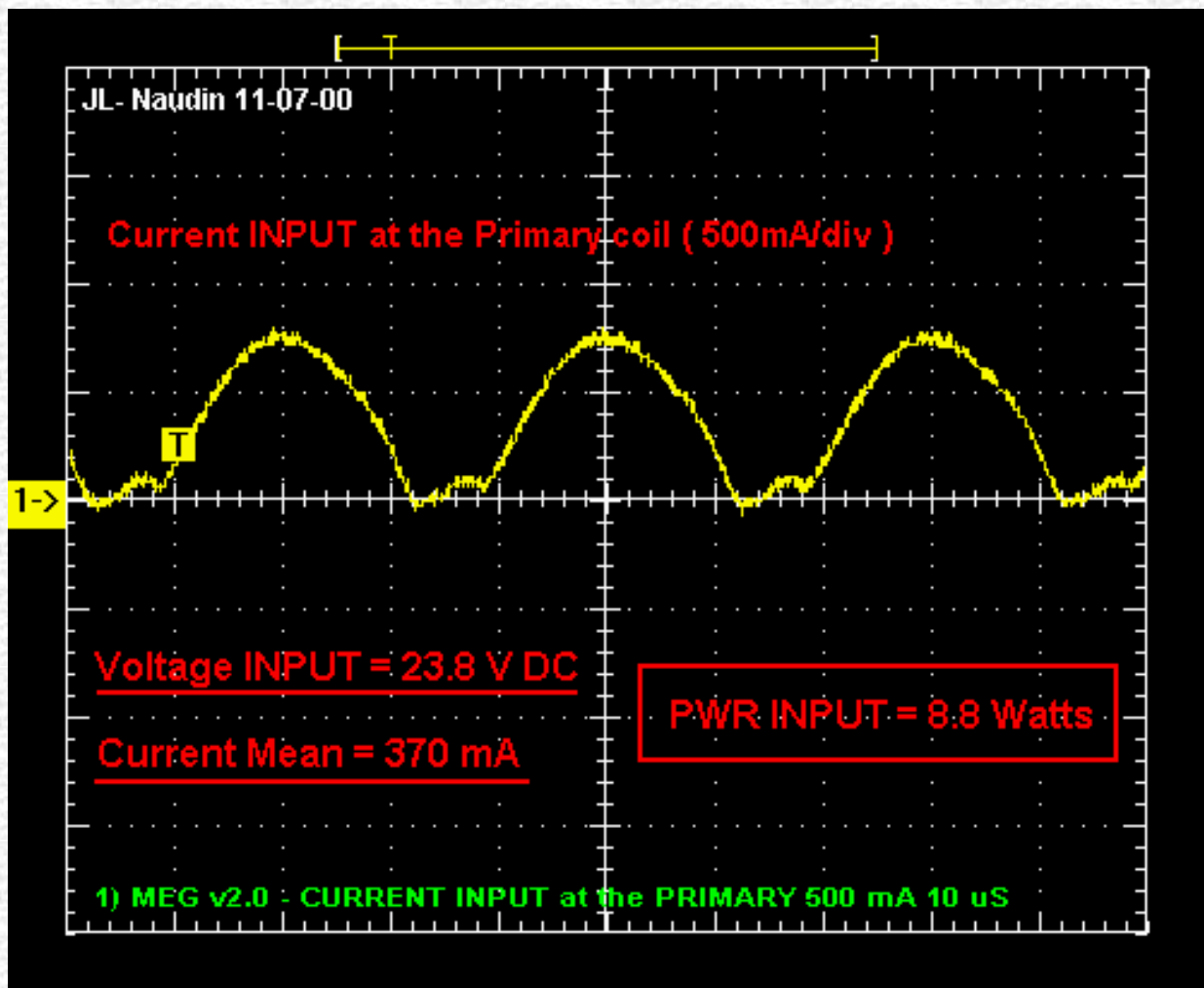

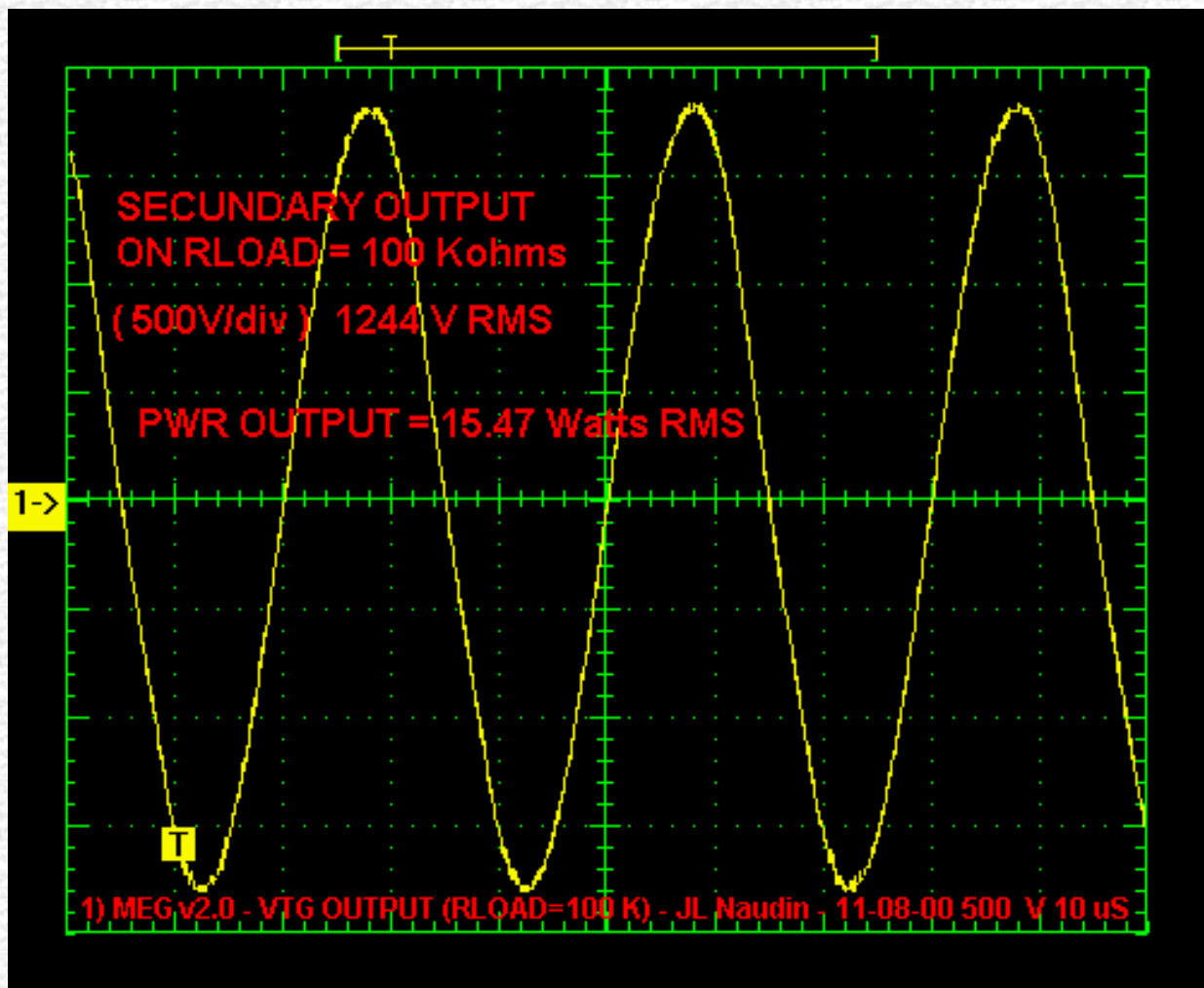

The measured COP is 1.75

Additional Notes 11-08-00 : After some tests about different MEG v2.0 setup, I have found that the Maximum power output can be obtained quickly by simply connecting one side of the secondary coil to ground. So, with one side of the output coil grounded, the COP reach its maximum instantaneously (about 1.75) when the power is swichted on (**this avoid that the RLoad carbon resistor connected at the output begins too hot**).

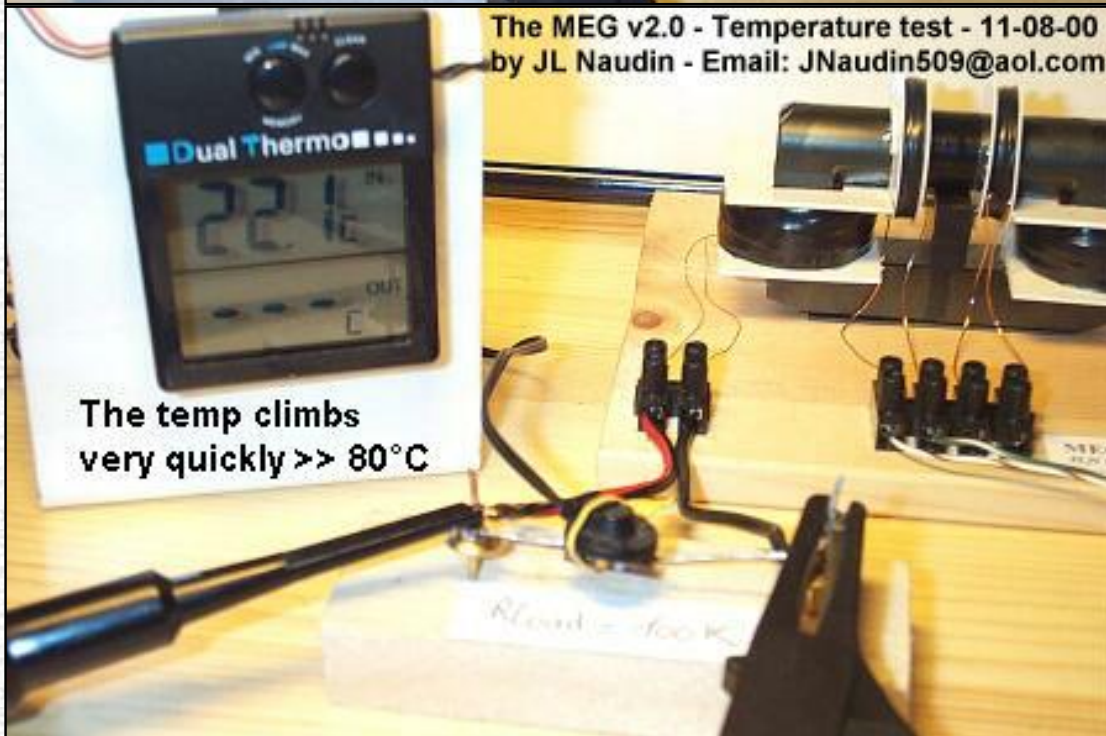
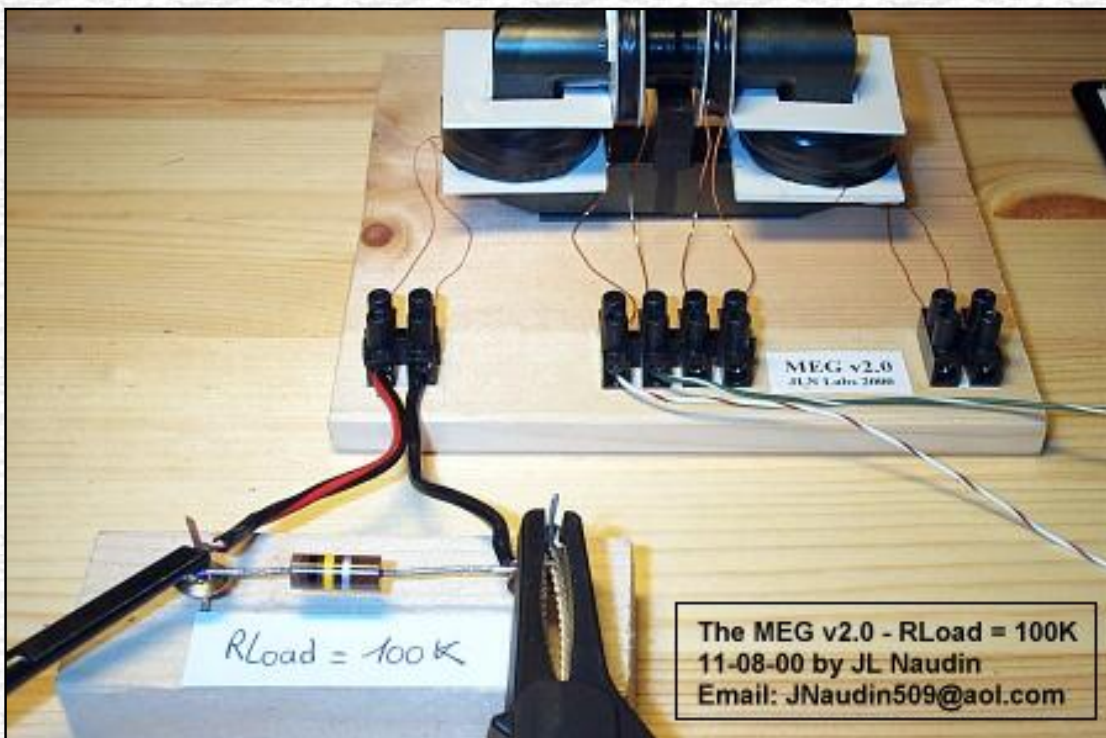



[Video of the test done on 11-09-00](#) (983 Kb), you need to have



MEG Project update (11-13-00) : I am trying to close the loop, but at this moment, I have not yet succeed in this way. There are many losses during the step-down phase of the output voltage and thus the device stops after a while...

Important note (11-16-00) : After many tests at long run period, the two secondary coils have been broken due to some sparks inside the windings generated by the presence of the High Voltage. Its seems that the High Voltage output climbs very quickly at a high value (> 3KV) at certain frequencies. So, be carefull if you do some tests. I am also currently searching for a Nanocrystalline tape wound core for the next version of the MEG v3.0.

Reference document :

- **[The Motionless Electromagnetic Generator: Extracting Energy from a Permanent Magnet with Energy-Replenishing from the Active Vacuum](#)**, a PDF document (69 pages 1,29 MB), by T.E. Bearden (**Removed from the CSeti site on 11-21-00** -> **[Alternate site](#)**)

See also :

- [Next tests results of the MEG_v2.1](#)
 - [Previous tests results of the MEG_v1.0](#)
-



Email : JNaudin509@aol.com

or send email to the JLN Lab's eGroup at : jlnlabs@egroups.com if you are a [team member](#).

Return to the [MEG project](#) home page

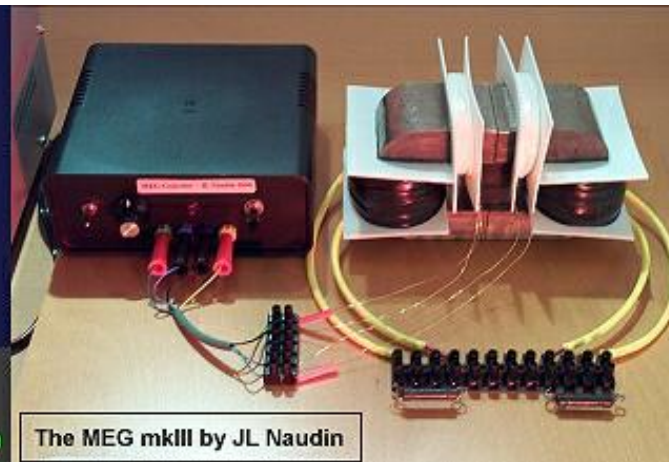
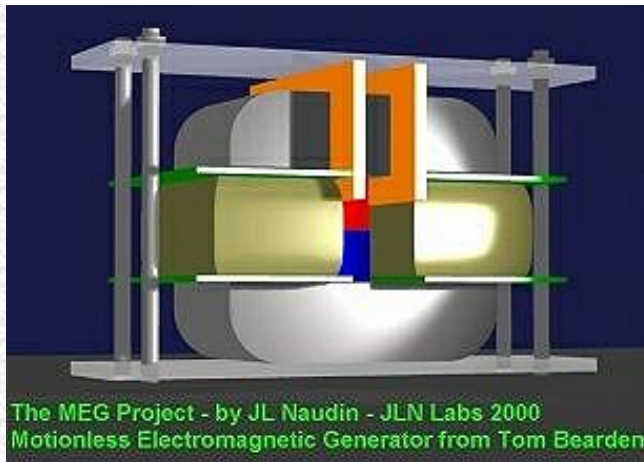

The Motionless Electromagnetic Generator Project

The MEG v1.0 built by JL Naudin
Created on 10-29-00 - *JLN Labs* - Last update 11-07-00

All informations in this page are published free and are intended for private/educational purposes and not for commercial applications



[See the latest results : TEST #5 \(11-05-00 \) on MEG v1.0f](#)



[See the MEG v2.0 tests results](#)

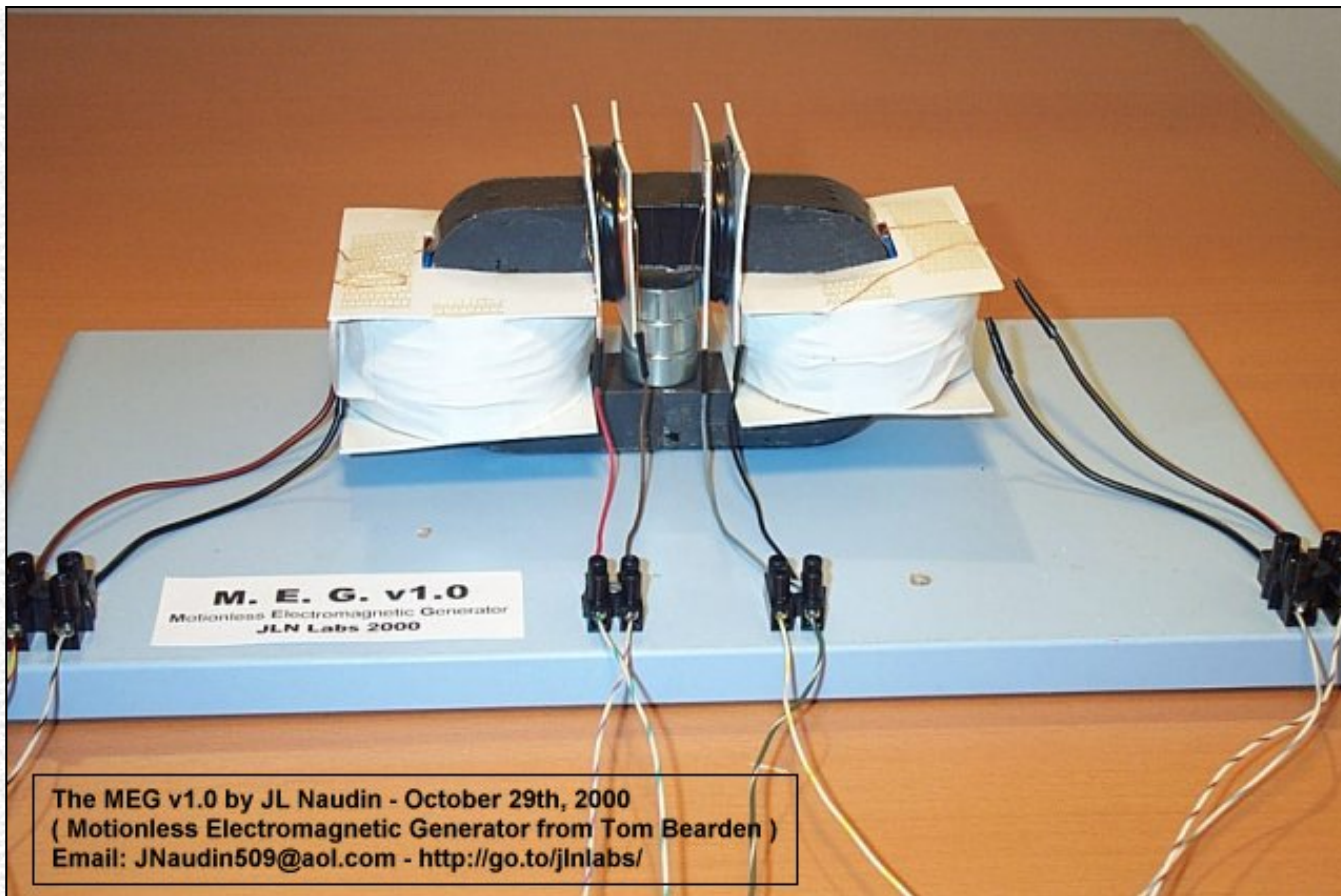

The MEG v1.0 build by JL Naudin - October 29th, 2000

MEG Project - The MEG controller (v1.0c)

by JL Naudin - 10-30-2000 - Email: Jnaudin509@aol.com

web site : <http://go.to/jlnlabs>

This diagram is free for private use only and non commercial use

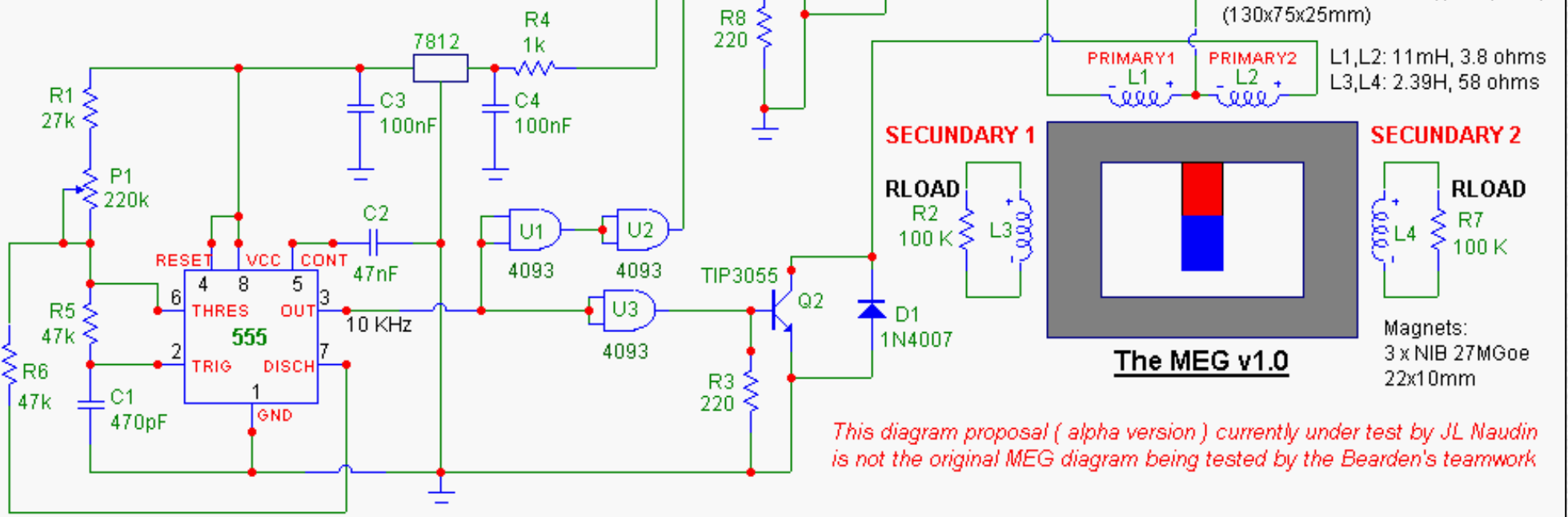

L1, L2 : 200 turns of 4/10
 L3, L4 : 2700 turns of 4/10
 Core section : 20x25 mm
 Grain-oriented silicon steel
 tape wound core (30/100)
 Silicore Isolectra Z25 type C(FA30)
 (130x75x25mm)

L1,L2: 11mH, 3.8 ohms
 L3,L4: 2.39H, 58 ohms

*This diagram proposal (alpha version) currently under test by JL Naudin
 is not the original MEG diagram being tested by the Bearden's teamwork*

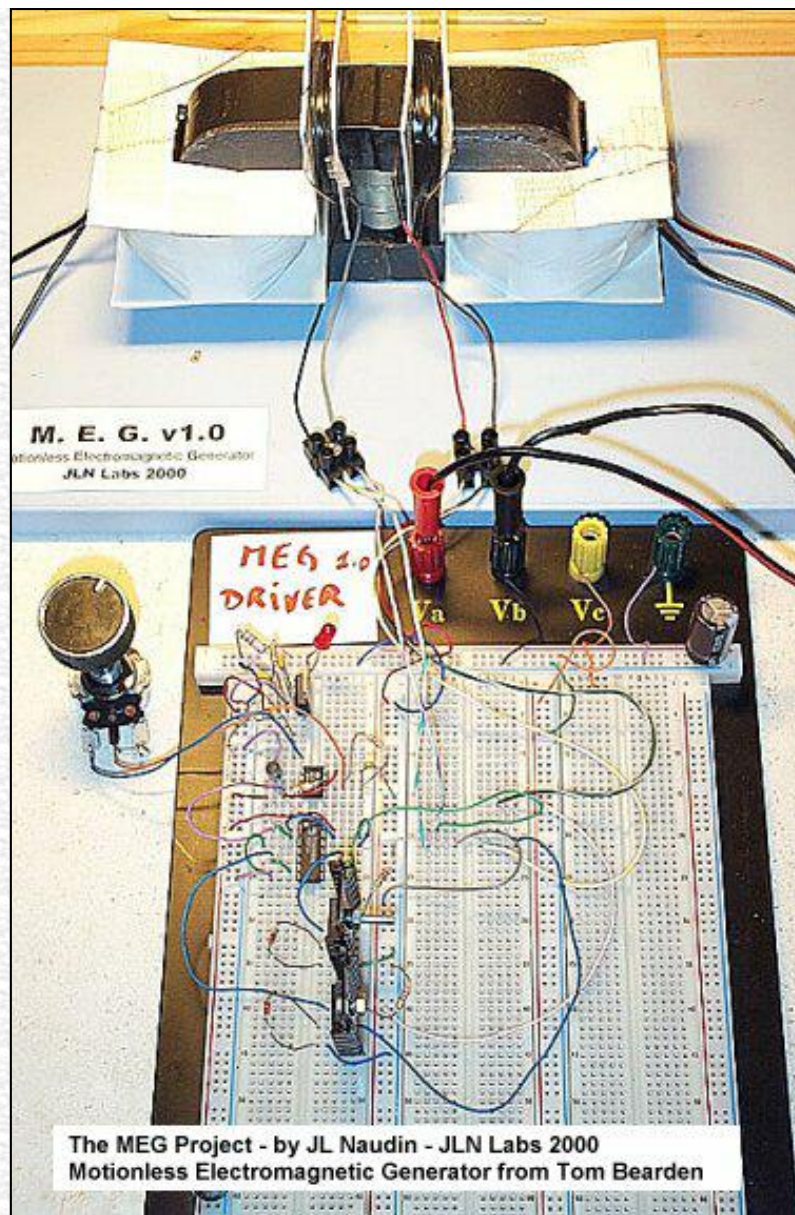

TEST #1 (11-01-00) :

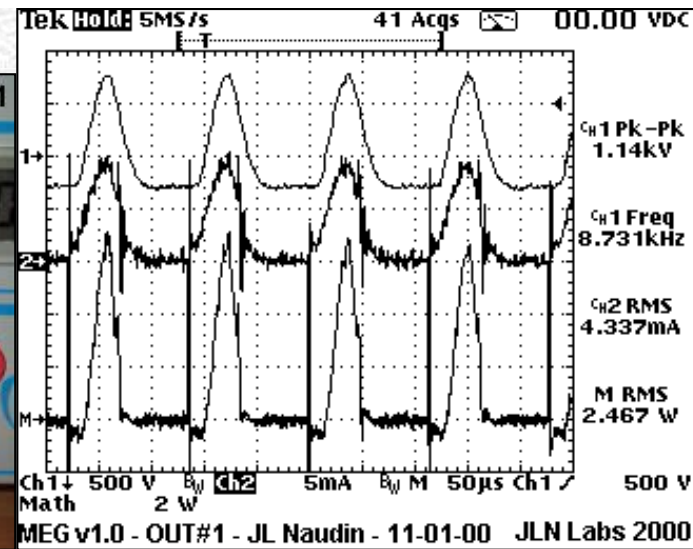
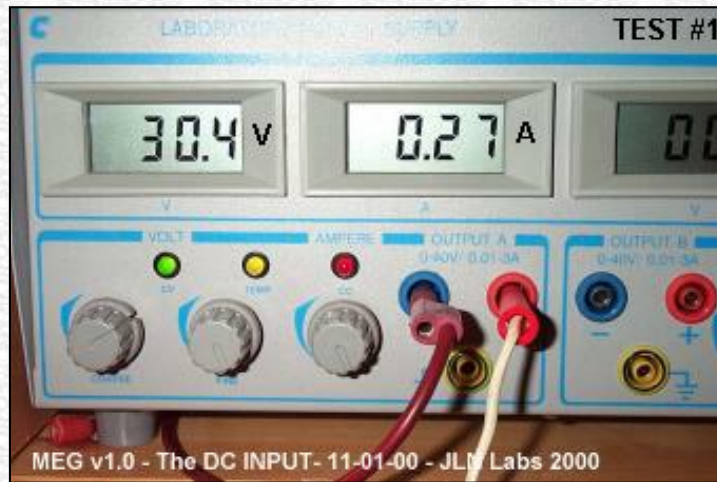

TEST #2 (11-01-00) : I have replaced the 555 oscillator by a programmable function generator, for a fine tuning of the clock pulse (period and duty cycle). The primary coils are now used in free run mode.

MEG Project - The MEG controller (v1.0d)

by JL Naudin - 11-01-2000 - Email: Jnaudin509@aol.com

web site : <http://go.to/jlnlabs>

This diagram is free for private use only and non commercial use

This diagram proposal (alpha version) currently under test by JL Naudin is not the original MEG diagram being tested by the Bearden's teamwork

L1, L2 : 200 turns of 4/10
 L3, L4 : 2700 turns of 4/10
 Core section : 20x25 mm
 Grain-oriented silicon steel
 tape wound core (30/100)
 Silicore Isolectra Z25 type C(FA30)
 (130x75x25mm)

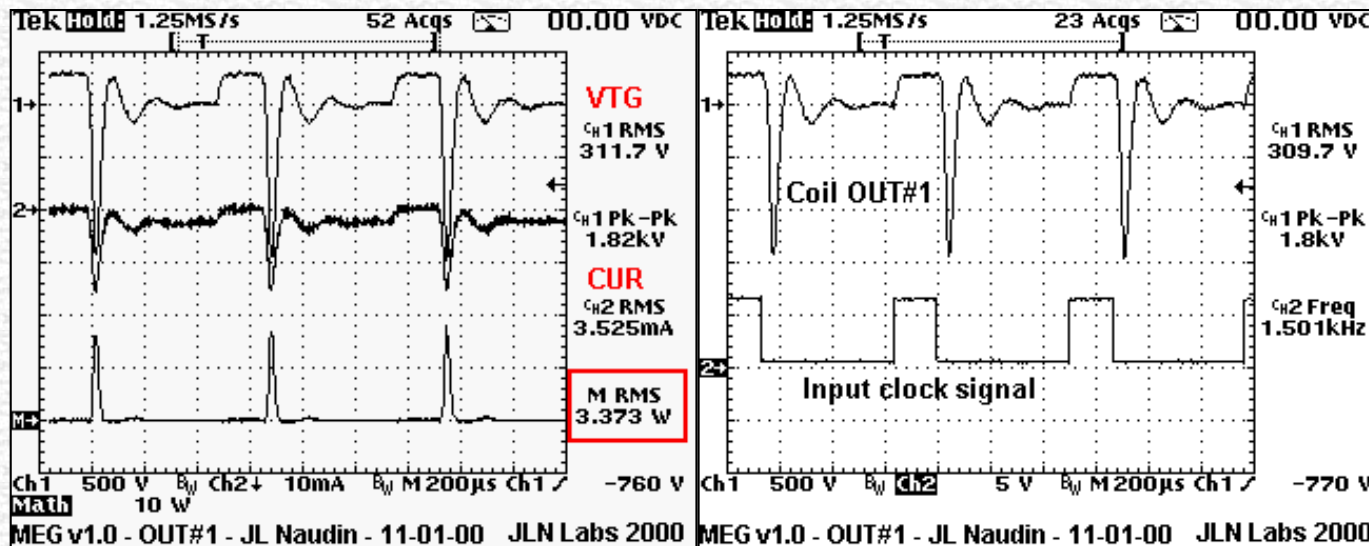
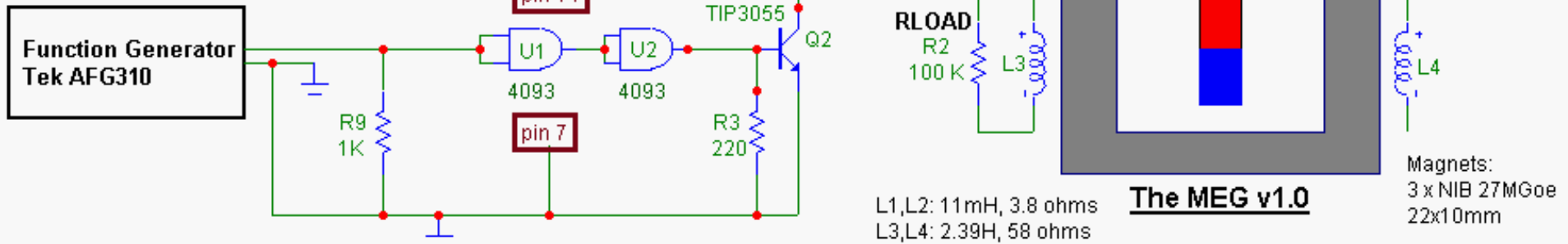



Total Power Input : 3.64 Watts (DC)

JLN's Comments : Now, the MEG circuit v1.0d begins to be interesting comparing to the previous version used in the TEST #1. The total power input measured at the DC power supply is now 3.64 Watts, while the power OUTPUT is 3.37 Watts RMS, this gives an efficiency of **93%**... The working frequency is now 1.5KHz Vs the 40KHz used on the original Bearden's MEG. This major difference is due to the use of grain oriented silicon steel material Vs to the Nanocrystalline material used for the core. The latest results are now encouraging, and worth to be explored deeply. May be a COP >1 can be reach with a fine tuning....More to come.

TEST #3 (11-02-00) on MEG v1.0d

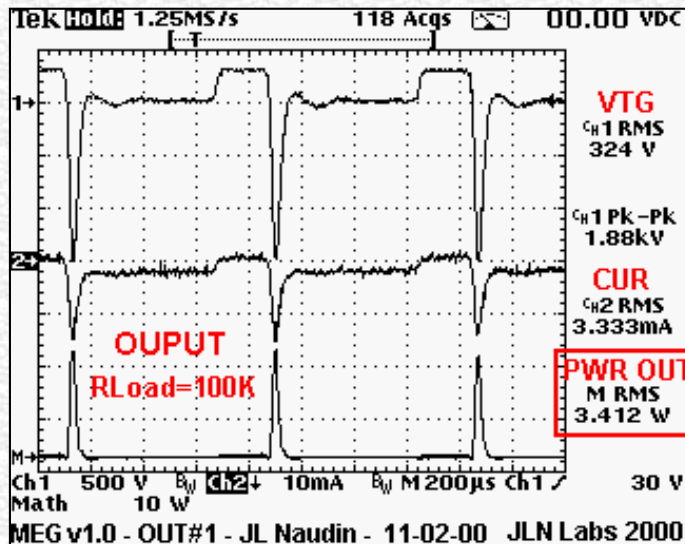

The RMS Power OUTPUT is 3.412 Watts (clock set at 1.3 KHz, squared pulse, duty cycle: 25%)



Total Power Input : 3.04 Watts (DC)

TEST #4 (11-02-00 and 11-04-00) on MEG v1.0e

The MEG v1.0e has the same design of the 1.0d version, only the resonant capacitors C5 (100nF) and been changed to $C5=100\text{nF}+10\text{nF}=110\text{nF}$, this allow to reduce the working frequency for a better transition of the Weiss domains in the grain-oriented silicon steel core. Now, the working frequency has dropped to 890 Hz. The primary coil #2 (L2) and the secondary coil #2 (L4) have not been used during the tests #3 and #4. This is the best setup (frequency, duty cycle) that I have found today.

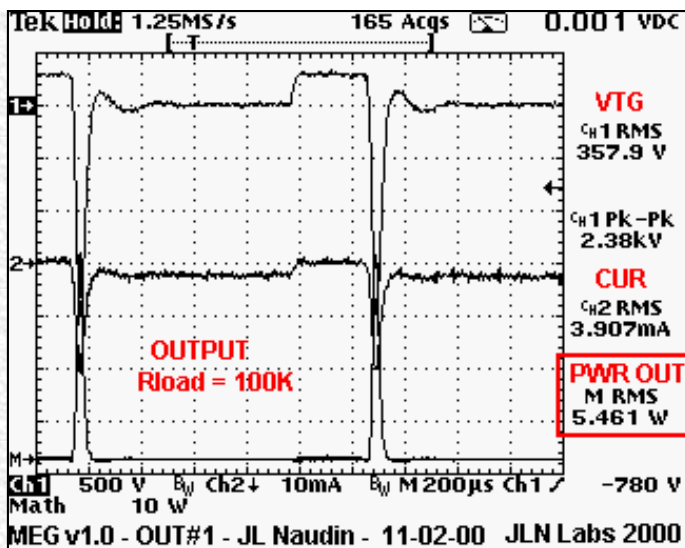

The RMS Power OUTPUT measured is 5.461 Watts (clock set at 890 Hz, squared pulse, duty cycle: 25%)

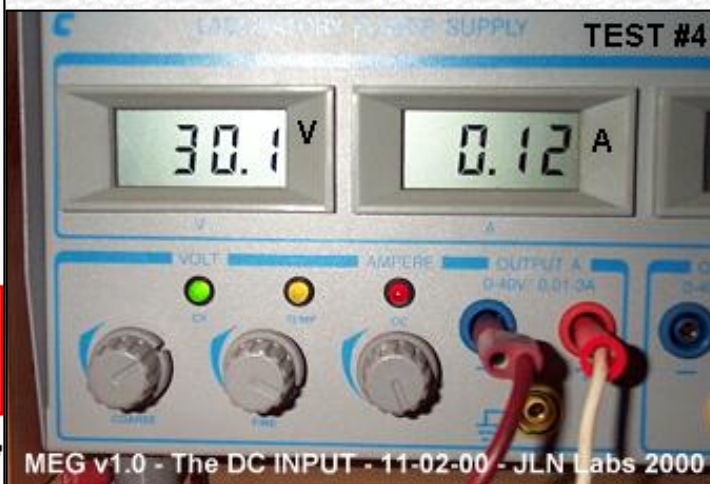
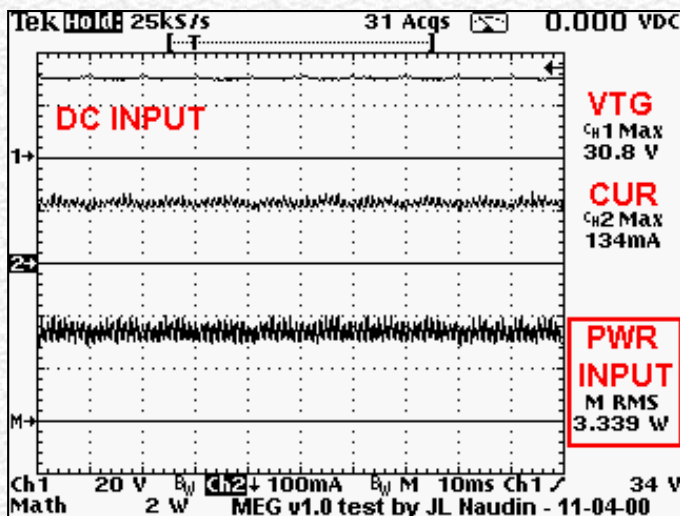

Total Power Input : 3.612 Watts (DC) measured at the power supply control panel and 3.339 Watts RMS (DC) measured at the input of the MEG controller with the scope



The 5W Load Resistor warm up quickly (44.4°C) during the test.

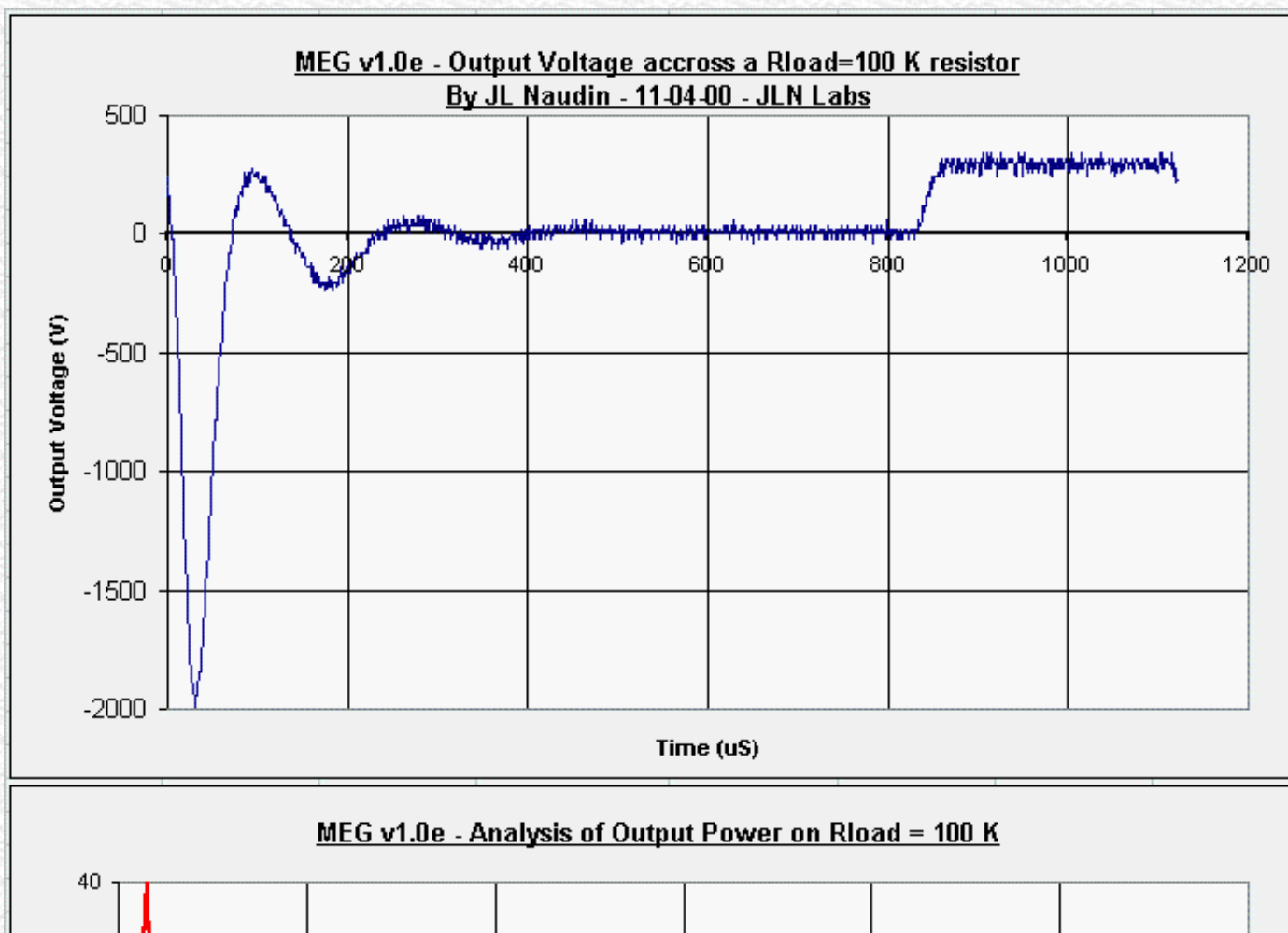

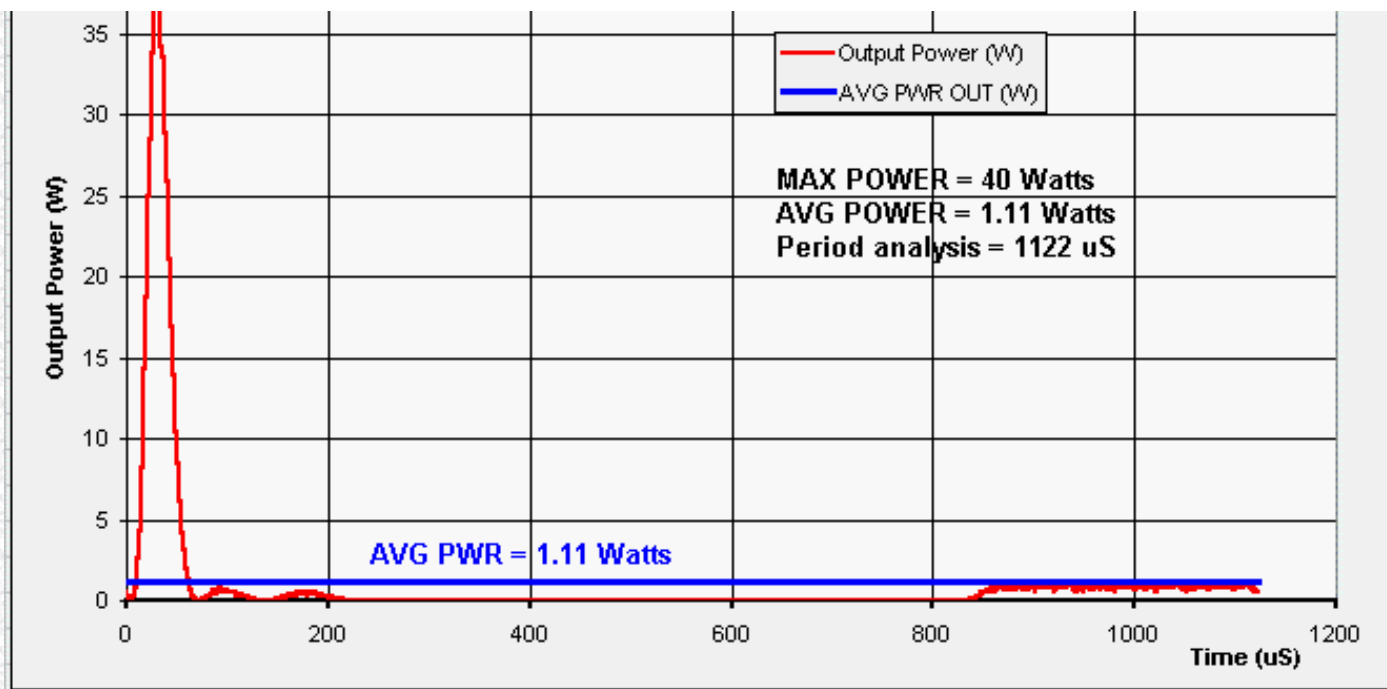

TEST #5 (11-05-00) on MEG v1.0e

The new tests on the enhanced MEG control board v1.0f are very encouraging because I have been able to reproduce the exact waves shapes used in the original Bearden's MEG presented in his technical paper : "[The Motionless Electromagnetic Generator: Extracting Energy from a Permanent Magnet with Energy-Replenishing from the Active Vacuum,](#)" page 67...

See below the scope signal measured at the actuator coil (Primary) and also at a loaded output coil (Secondary).

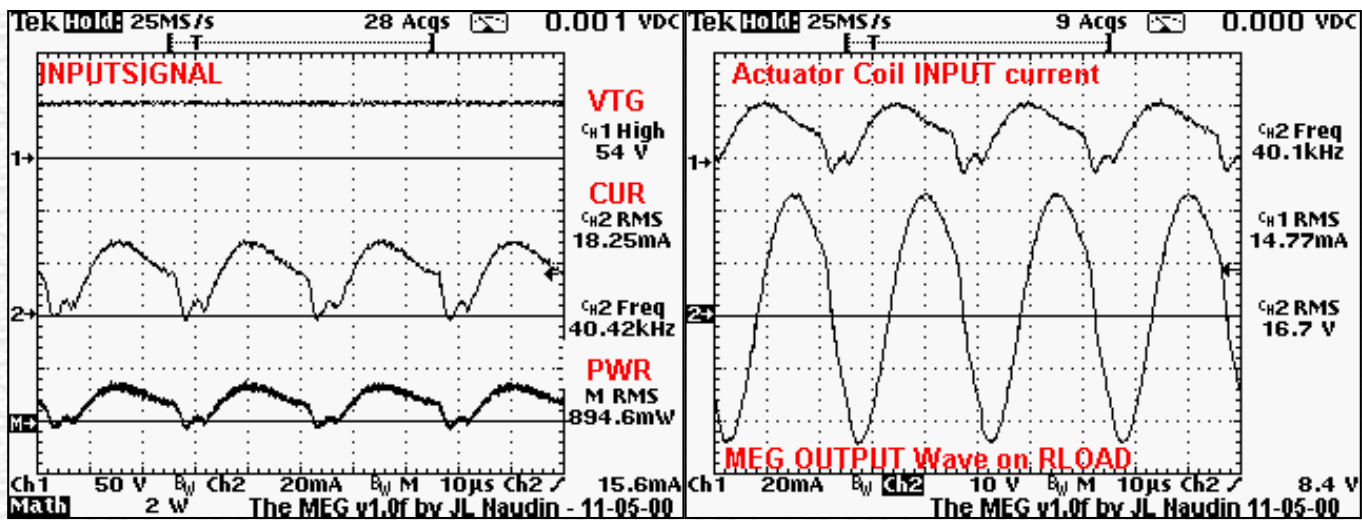

The Actuator Waves Shapes and the Output Waves signal on the MEG v1.0f

The new MEG control board v1.0f seems now **fully in line with the original Bearden's MEG** comparing to my previous version... Now, this electronic control board v1.0f must be improved for giving more power output....



[See the MEG v2.0 tests results](#)

Email : JNaudin509@aol.com
or send email to the JLN Lab's eGroup at : jlnlabs@egroups.com if you are a [team member](#).

Return to the [MEG project](#) home page

Posted on 12-10-00

Dear All,

You will find below some informations sent by Tom Bearden.

Best Regards

Jean-Louis Naudin

Sujet :	Information
Date :	Sat, 9 Dec 2000 01:36:27 -0600
From:	xxxxxx (Tom Bearden)
To:	Jnaudin509@aol.com (Jean-Louis Naudin)

Dear Jean-Louis:

Some fellows in your discussion groups raised the question of my use of energy flow (Poynting diverged component versus Heaviside nondiverged component) but made an error in their questioning. The correction is important for the free energy researcher, for it reveals a gigantic source of free energy around every little EM circuit, once we pay a little to get the circuit in operation. In other words, scientists should have harnessed more of that already enormous energy flow right under their noses around every circuit anyway, and should have given us free, cheap, clean electrical power.

To understand EM energy flow around EM circuits, I strongly suggest one put aside the textbooks' interpretations until one checks the original applicable papers of Heaviside and of Poynting, who independently and essentially simultaneously discovered the flow of energy through space in the 1880s. The concept of the flow of energy through space was not present in physics until then. Also note that Maxwell was already dead, having passed on from stomach cancer in 1879. Several of my papers (e.g., Dark Matter or Dark Energy?, published in Journal of New Energy) give the appropriate references one should check.

First, there is an enormous energy flow (trillions of times greater than what you input to the shaft of a generator, and than the chemical energy in a battery) pouring out of the terminals of every generator or battery. The enormity of this energy flow is easily shown, and measurements can be made of actual collection of energy from it by intercepting charges placed in it. Particularly see John D. Kraus, Electromagnetics, Fourth Edn., McGraw-Hill, New York, 1992, Figure 12-60, a and b, p. 578. Kraus shows a good drawing of the huge energy flow filling all space around the two conductors of a transmission line, with almost all of that energy flow not intercepted by the circuit at all and thus not diverged into the circuit to power it, but just "wasted."

Kraus also shows the "equi-divergence" contours in this energy flow, with measurements of the energy flow that can be collected by (diverged around) a unit point static charge placed at any point on each contour. So yes, that vast energy flow filling all space surrounding the circuit is real, it is known, but it

has been arbitrarily discarded from accountability in energy measurements in circuits because no one has been able to explain the source of it before. We explain it in "Giant Negentropy from the Common Dipole", published in Journal of New Energy.

Note that, at any point in one of Kraus' contours, if you place 100 unit point static coulombs of intercepting charge at that same point instead of the unit point static charge that is "standard", you will diverge continuously around that charge some 100 times as much energy flow as the magnitude shown by Kraus. In short, then you multiply the value of energy interception at each point on that contour by 100. Since we are describing a steady state condition, this means that now we are collecting 100 times as much energy "statically" (actually "continuously and steadily") at each point in the divergence zone around the charge.

You can do that sort of thing at each and every point in space surrounding the circuit, out to an almost infinite radius. None of that vast energy flow that is in that surrounding space is hitting the circuit and entering it. Also, you really can collect energy from that wasted but enormous energy flow.

Only a tiny, tiny portion of that surrounding external energy flow moves right along the surface of the conductors, strikes the surface charges in the circuit conductors and components, and is thereby diverged into the conductors to power up (potentialize) the Drude electrons and the circuit. That tiny "diverged" portion of the energy flow that enters the circuit is the Poynting component, not the losses. The respondent thus got it exactly reversed. Here is Poynting's own words:

"This paper describes a hypothesis as to the connexion between current in conductors and the transfer of electric and magnetic inductions in the surrounding field. The hypothesis is suggested by the mode of transfer of energy in the electromagnetic field, resulting from Maxwell's equations investigated in a former paper ("Phil. Trans.," vol. 175, pp. 343-361, 1884). It was there shown that according to Maxwell's electromagnetic theory the energy which is dissipated in the circuit is transferred through the medium, always moving perpendicularly to the plane containing the lines of electric and magnetic intensity, and that it comes into the conductor from the surrounding insulator, not flowing along the wire." [J.H. Poynting, "On the connexion between electric current and the electric and magnetic inductions in the surrounding field," Proc. Roy. Soc. Lond., Vol. 38, 1984-85, p. 168].

So your respondent was in error when he spoke of that little "dip" in the flow as what was "wasted" and the "losses". He got it exactly reversed.

Here is the straightforward way to deal with it. Simply separate the entire energy flow vector into two vector components: a very large component vector parallel to the conductor and a very small vertical component vector pointing vertically into the wire from outside. The combination (the sum vector) is the entire energy flow that is almost parallel to the wires but not quite (see quote from Heaviside). The parallel flow component vector is the Heaviside energy flow that completely misses the conductors and roars off into space and is lost. The tiny vertical flow component is the Poynting energy flow component that enters the circuit and powers it by potentializing the Drude electrons, and then being dissipated by the excited electrons in the circuit's loads and losses. This small vertical component is the tiny energy flow portion that Poynting assumed from the outset, and he never even considered the enormous parallel

component.

The problem was that, if one estimated the magnitude of the sum vector energy flow or the Heaviside parallel component, the startling amount of energy pouring out of the terminals was so vast that it staggered the imagination. In the 1880s, if you tried to state that a "one watt nominal circuit" actually was pouring out trillions of joules per second, almost all of which missed the circuit entirely and roared off into space and was lost, you would have been tarred and feathered and drummed out of science as a total lunatic. Heaviside had not the slightest notion of what could possibly be furnishing such a mind-staggering energy flow! So Heaviside -- who did include that NONDIVERGED vast component in his theory (while Poynting completely omitted it), was extremely cautious and spoke only of the "angle" of the energy flow and the "angles" of the components. Here are his exact words:

"It [the energy transfer flow] takes place, in the vicinity of the wire, very nearly parallel to it, with a slight slope towards the wire... . Prof Poynting, on the other hand, holds a different view, representing the transfer as nearly perpendicular to a wire, i.e., with a slight departure from the vertical. This difference of a quadrant can, I think, only arise from what seems to be a misconception on his part as to the nature of the electric field in the vicinity of a wire supporting electric current. The lines of electric force are nearly perpendicular to the wire. The departure from perpendicularity is usually so small that I have sometimes spoken of them as being perpendicular to it, as they practically are, before I recognized the great physical importance of the slight departure. It causes the convergence of energy into the wire." Oliver Heaviside, Electrical Papers, Vol. 2, 1887, p. 94.

As you can see, that slight "dip" is due to the vertical convergence of the Poynting energy component into the wire, and that is of course known in electrodynamics and appears in the texts.

Now when you measure energy in circuits, you actually measure energy dissipation. All the energy that is dissipated from or in a circuit, must have entered the circuit in the first place. So if you measure all the energy that a circuit dissipates, that is equal to all the energy that actually entered the circuit via the Poynting component. In short, we always "measure" Poynting's entering energy component as it is exiting, in the many places and components where it exits, etc.

We are NEVER measuring the remaining vast energy flow component, which Heaviside exposed and which the Kraus diagram illustrates very well.

And there the matter rested until Lorentz (the greatest electrical scientist of his day) entered the picture. Lorentz understood both components, but he also had not the foggiest notion of where on earth such an enormous energy flow could be coming from. He also would have been attacked and destroyed if he had actually advocated that huge "Heaviside" nondiverged component.

Unable to solve the vexing problem, Lorentz simply got rid of it. He reasoned that Heaviside's vast parallel component was "physically insignificant" (Lorentz's term) since it did not interact with the circuit and did not power anything, and therefore it could just be arbitrarily discarded from all accountability. So Lorentz simply integrated the entire energy flow vector around an assumed closed surface surrounding any volume element of interest. Voila! The Heaviside nondiverged component of

the energy flow vector passes straight through, positive (let us say) going into the surface and thus negative coming out of it. Hence the Lorentz closed surface integration procedure discards the enormous Heaviside nondiverged component. It does not eliminate the actual huge energy flow, but just arbitrarily discards any further accountability of it. On the other hand, the Lorentz procedure does retain the DIVERGED component, so it retains Poynting's component.

Electrodynamicists have just continued that very practice to this day, and have never resolved the "Heaviside component" problem. They do not usually bring it out as clearly as has Kraus, but even Kraus does not point out the startling fact that this proves that the shaft input to a generator cannot possibly be producing all that energy flow. Electrodynamicists continue to avoid the Heaviside flow component problem, because their model eliminates the vacuum interaction with the source dipole formed in the generator. Energy extracted from the vacuum by the broken 3-symmetry of that source dipole is what pours out both the Heaviside and Poynting energy flow components, as I discuss in my paper, "Dark Matter or Dark Energy?" in Journal of New Energy.

However, this integration procedure has caused the great confusion that some electrodynamicists and particularly many engineers are unaware that there is a dramatic difference between the entire EM "energy flow" per se that is connected with the circuit, and the Poynting energy flow component that is connected with the circuit. About half think those are one and the same thing, including authors of some of the textbooks.

Anyway, my paper, "Giant Negentropy of the Common Dipole", just published in Journal of New Energy, points out the rigorous and surprising solution of the Heaviside-Lorentz problem, and gives the precise source and of the enormous size of that discarded but still present nondiverged EM energy flow around every EM circuit.

In an AIAS group paper, Anastasovski, P. K; Bearden, T. E; Ciubotariu, C; Coffey, W. T.; Crowell, L. B; Evans, G. J; Evans, M. W; Flower, R; Jeffers, S; Labounsky, A; Lehnert, B; Meszaros, M; Molnar, P. R; Vigier, J P; Roy, S. "Classical electrodynamics without the Lorentz condition: Extracting energy from the vacuum," Physica Scripta 61(5), May 2000, p.513-517, I gave several ways of possibly extracting (diverging into the circuit and using) more of that Heaviside energy flow. The simplest and proven way (COP = 18) is the Bohren experiment which simply places the intercepting "unit point charge" into resonance. Thus the Bohren resonating charge sweeps out a greater geometrical reaction cross section area in the impinging energy flow, and collects more of the otherwise "missing a static charge" energy flow adjacent to a static collecting charge.

If -- after it has passed the circuit -- you retroreflect the Heaviside energy flow component back across the same circuit, you will get an additional Poynting collection by the surface charges, and get more energy. If you iterate this retroreflection, you get an overunity process, IF you do not use the common closed current loop circuit which uses half of the collected energy to destroy the dipole faster than one can power the load. Instead, one might adapt Tesla's "one wire circuit" between two widely separated capacitors connected by a long conductor. The best way, of course, is Letokhov's "negative absorption of the medium" which is excess emission from optically active, highly scattering media.

In the Physica Scripta you may also be interested in some of the more than a dozen ways suggested for extracting energy from the vacuum.

*Best wishes,
Tom Bearden*

Return to the [MEG Project page](#)

Thoughts about the MEG principle

By Cyril Smith

created on 11-01-00 - *JLN Labs* - last update on 11-01-00

Subject :	MEG thoughts
Date :	30/10/00 22:49:12 Paris, Madrid
From:	cyrilsmith@camelot64.fsnet.co.uk (Cyril Smith)

Hi All,

I have re-read Bearden's paper in the light of the latest information.

There are some aspects I agree with, sort of. Like his decomposition of any scalar potential into a set of harmonic EM wavepairs travelling in opposite directions, one being the phase conjugate of the other. Anyone who has studied transmission lines, and in particular standing waves, will appreciate this. However my views on EM waves as bunches of sub photon particles leads me to the view that the scalar potential at a point in space comes from these particle beams arriving from opposite directions, carrying the EM wave pattern: even DC as in electrostatics involves a non random pattern. The pattern is imposed by the boundary conditions. But even with no pattern the particles are there in random fashion, and I see this as the giant negentropy source.

Bearden emphasises the different fields, the B field in the core and the A field outside it. He then talks about the coil extracting energy separately from these fields, as though the two forms of extraction are different. But in my book the only way the coil can extract energy from the B field is via the A field, Bearden does not seemed to have made that link. So I have misgivings about Bearden's explanation, but I am prepared to believe that the device does work.

Having given some thought to the way the new exotic materials behave as giant Barkhausen jumps, tiny input H creates giant B change by way of all the dipoles in the sample reversing direction, and the way the domain wall travels through the material at some relatively low velocity (cf the velocity of light), I have come up with a suggestion for a magnetic OU device which might be similar to the MEG.

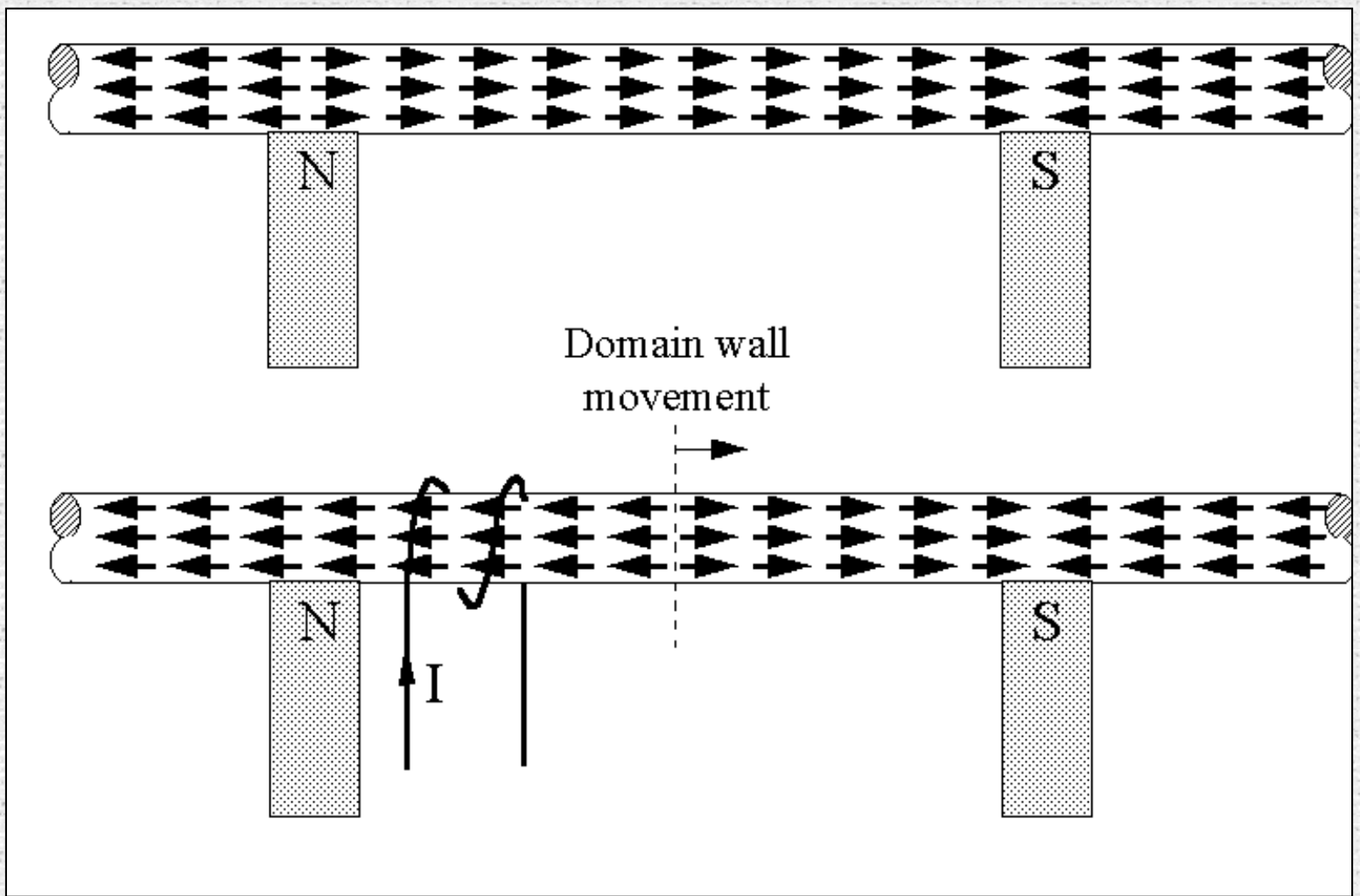

In the first gif the top drawing shows the MEG core straightened out, the arrows showing the atomic dipole orientations due to the PM. The bottom drawing shows the dipoles switching polarity as a result of current in the drive coil on the left. There is a domain wall travelling left to right. When it reaches the magnet on the right the core is completely magnetised in the one direction, the inductor is fully charged. We could discharge the inductor and regain the input energy, but we are interested in OU so we want some form of reflected wavefront to augment the discharge. Unlike EM waves which can travel through each other without interference, we cannot have domain walls travelling in opposite directions in the same sample. So let's try two samples.

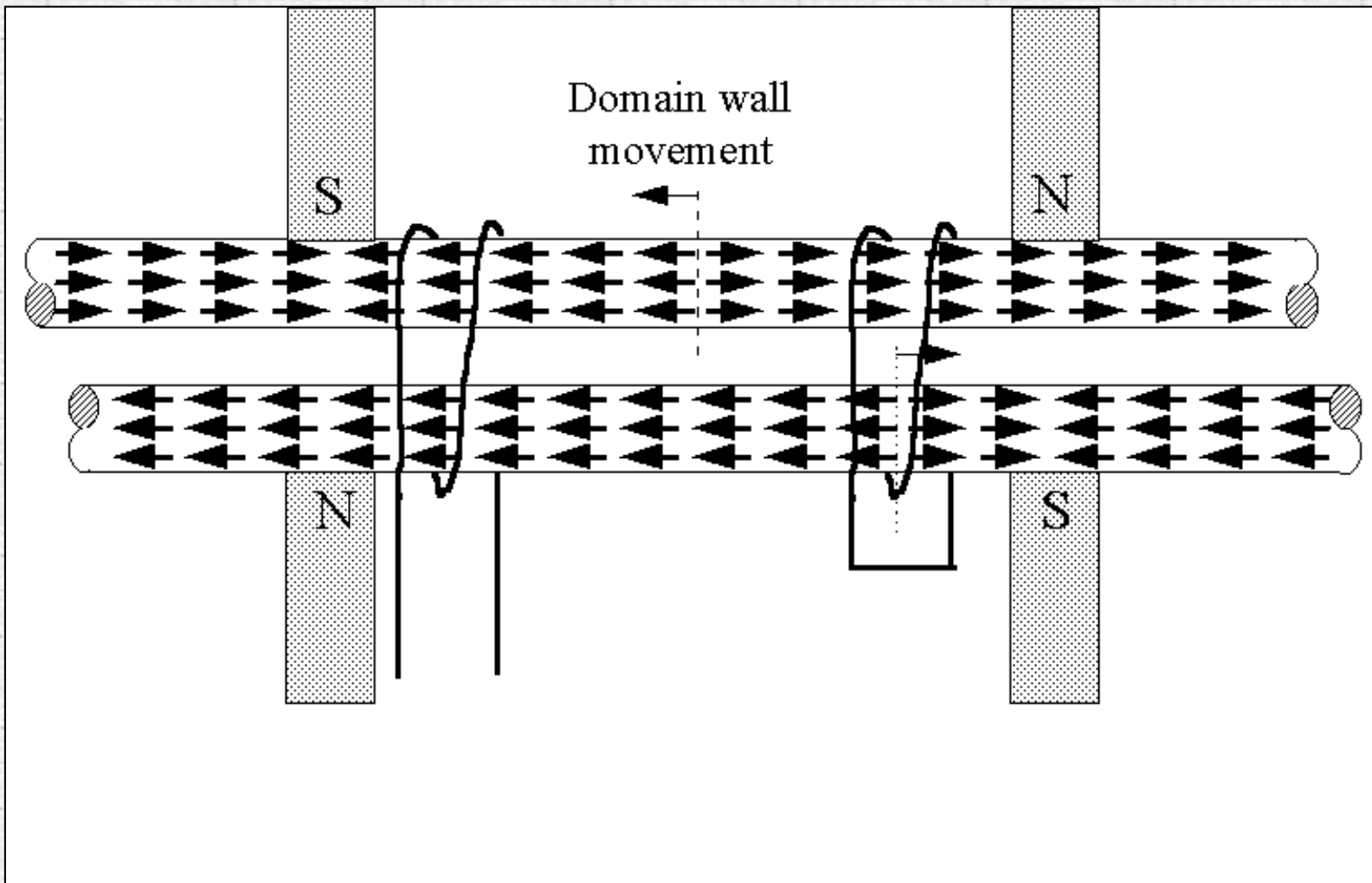

The second gif shows two cores with coils wound round both. Current in the coil on the left sends the wavefront down one core only because the other is already saturated in that polarity. The wavefront is shown having reached the other coil. When this wavefront reaches the shorted coil on the right the Lenz reaction from induced currents causes the dipoles in the other core to switch, thus sending a domain wall wavefront back along the second core. If the first coil is discharged in synchronism with the arrival of the return wavefront the energy extracted will be greater than the energy input, since there will be greater flux change.

Although shown as long rods, the same argument applies to the ring core MEG situation, you just have to juggle the manner in which coils wound on each segment are interconnected.

Any comments?

Cyril Smith

Sujet :	MEG
Date :	01/11/00 17:40:55 Paris, Madrid
From: <i>cyrilsmith@camelot64.fsnet.co.uk (Cyril Smith)</i>	
To: <i>JNaudin509@aol.COM</i>	

Hi All, Jean Louis,

I have looked at the magnetic vector potential at a fixed point on a core, and how it changes when a domain wall is approaching.

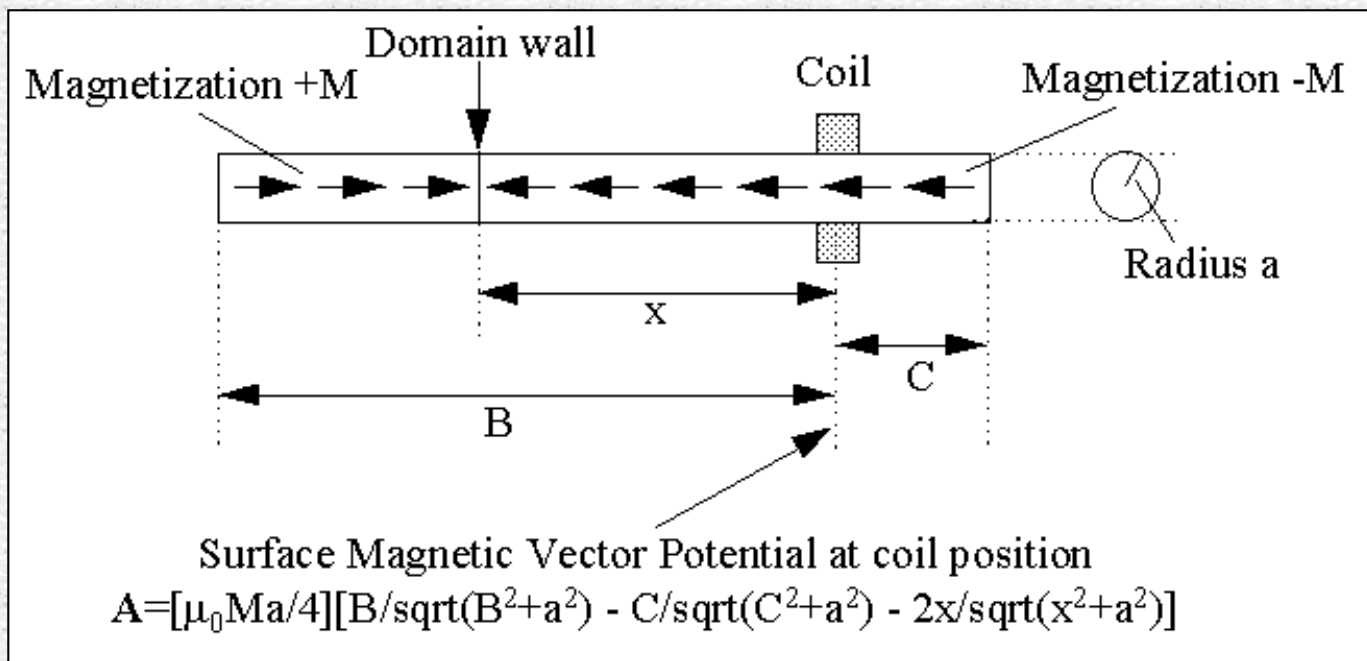

The gif above shows a cylindrical core of radius a and length $B+C$, with a coil positioned at station C from one end. A domain wall is at distance x from the coil. I give the formula for calculating vector magnetic potential A at the coil position, and of course the A field lines form closed circles around the core. It is a simple matter to increment the wall along at the wall velocity to produce a plot of A v. time, then to differentiate A to get E whose closed line integral is the induced voltage. The formula ought to apply to a ring core using arc dimensions in place of the linear ones.

I have played with this on a spreadsheet to plot the induced voltage impulse. A core whose radius is small cf its length gives a narrow impulse something like a gaussian pulse. The 1/2 amplitude width of the gaussian is approximately $4a/v$ seconds where v is the domain velocity. An interesting observation, increasing the radius a increases the width of the pulse, but the peak voltage remains constant.

Regards

Cyril Smith

 cyrilsmith@camelot64.fsnet.co.uk

[Read the next paper from Cyril Smith](#)

Return to the [MEG project](#) home page

Thoughts about the MEG principle (Part 2)

By Cyril Smith

created on 11-12-00 - *JLN Labs* - last update on 11-12-00

Subject :	MEG Theory and thoughts
Date :	12/11/00 11:28:51 Paris, Madrid
From :	cyrilsmith@camelot64.fsnet.co.uk (Cyril Smith)

Hi All,

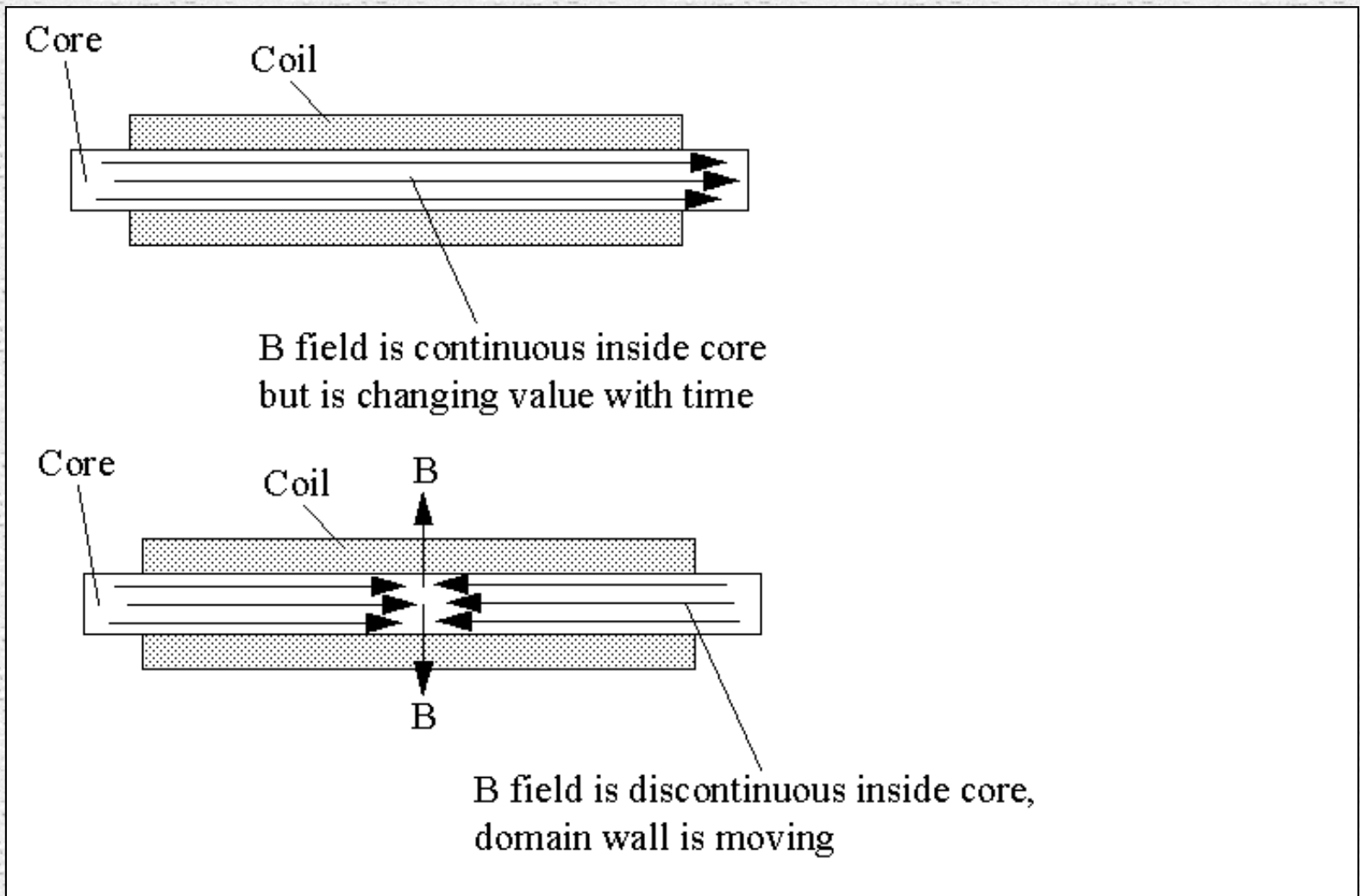

Cross Flux MEG. I can't see how cross flux will work with the exotic nanoperm and metglas materials. In my simple mind these get their terrific BH characteristics because they are highly anisotropic, the atomic dipoles are all aligned in the one direction. Thus they would have no useful BH characteristic in the cross flux direction, they would simply look like air. There is no internal mechanism for cross flux control. Statements like Fred has turned up "when a material is saturated in one direction it is not saturated in other orthogonal directions" are true only for isotropic materials. Remember the atomic magnetic dipoles are fixed in the crystal lattice, they do not wiggle about. They

can and do flip polarity and it is this feature which accounts for permeability. Imagine say 360 co-located dipoles each one aligned 1 degree different to its neighbour. We have a net dipole moment of zero. Now apply a slowly increasing magnetising force along say the 0 degree axis. First the 180 degree dipole will switch, then the 179 and 181 degree ones, then the 178 and 182 ones and so on. You will see that the net magnetisation gradually increases until saturation is reached where there are no more dipoles available. Plot magnetisation* μ_0 against magnetising force and you have B v. H , in the chosen 0 degree direction.

There will be no magnetisation in the 90 degree direction. Now apply a slowly increasing magnetising force in this new direction, keeping the original 0 degree H force present. Again you will see dipoles switching direction to give 90 degree magnetisation, but some of these were contributing to the 0 degree magnetisation, so this value will fall. Thus you can only get the 90 degree magnetisation at the expense of 0 degree magnetisation. This is the cross flux control mechanism. If all the dipoles are fixed in the one alignment there is no cross flux control available. GO steel will not be highly anisotropic, so here there will be some cross flux control.

Now to the non cross flux MEG. Something Dave D said about flux lines leaving the core rang some bells. It strikes me that flux lines can and must leave the core, even a complete magnetic circuit like a ring core. In the MEG the flux lines from the magnet do so. And it is obvious to me that if you wound two identical coils on opposite limbs of a ring core, passed current through these in cancelling mode, you would have flux lines leaving the core. This would simply be two banana shaped electromagnets placed in parallel, the ring core would have N and S poles opposite each other.

And going back to my description of the domain wall moving along the core, opposite sides of the wall have opposite polarity, so the wall is a magnetic pole. The flux must escape radially from the core at this point. This raises an interesting debate concerning transformer action. In the attached gif the top picture shows the usual interpretation for transformer induction. The B lines through the core are continuous, they change with time to induce voltage in the coil. This is the induction theory we all love or hate. My second picture shows what I believe is happening inside an anisotropic core like metglas, nanoperm and others. I show here just one domain wall because that is what happens in the MEG. The B field can not be continuous through the core because the magnetisation each side of the wall is of opposite polarity. So the B lines escape. Now to get the voltage induced in the core we need something different from our usual formulae. Maybe this is the route to understanding ou.

I gave a formula for the A field due to a domain wall, and this could be used for the induced voltage if the domain velocity is known (you would have to integrate over the length of the coil). The domain velocity can be controlled by the driving waveform (after all it is possible for the wall to be held stationary with suitable DC, it doesn't just move by itself). So at low frequencies, and for coils wound over significant lengths of the core (which you would normally do for power transformers), the B induction would be seen to obey normal transformer rules. But at higher frequencies there will be a velocity limit set by the material. I have seen on Aspden's site an analysis for the Hans Coler machine where he equates domain velocity to stress waves (acoustic velocity) in the material. I bow to Aspden's superior knowledge, and would point out that the 40kHz frequency for Bearden's MEG is not

unreasonable for this velocity.

Finally I have available some ferrite ring and C cores. Some of the ring cores are square loop (with the magnetostriction effect which can shatter the core if driven at mechanical resonance). Others are not. I will experiment with the MEG coil configuration, and with the core placed between my two big slab magnets. When I get time, which will probably be into December.

Best regards

Cyril Smith



cyrilsmith@camelot64.fsnet.co.uk

Sujet :	MEG
Date :	12/11/00 11:28:07 Paris, Madrid
From :	cyrilsmith@camelot64.fsnet.co.uk (Cyril Smith)

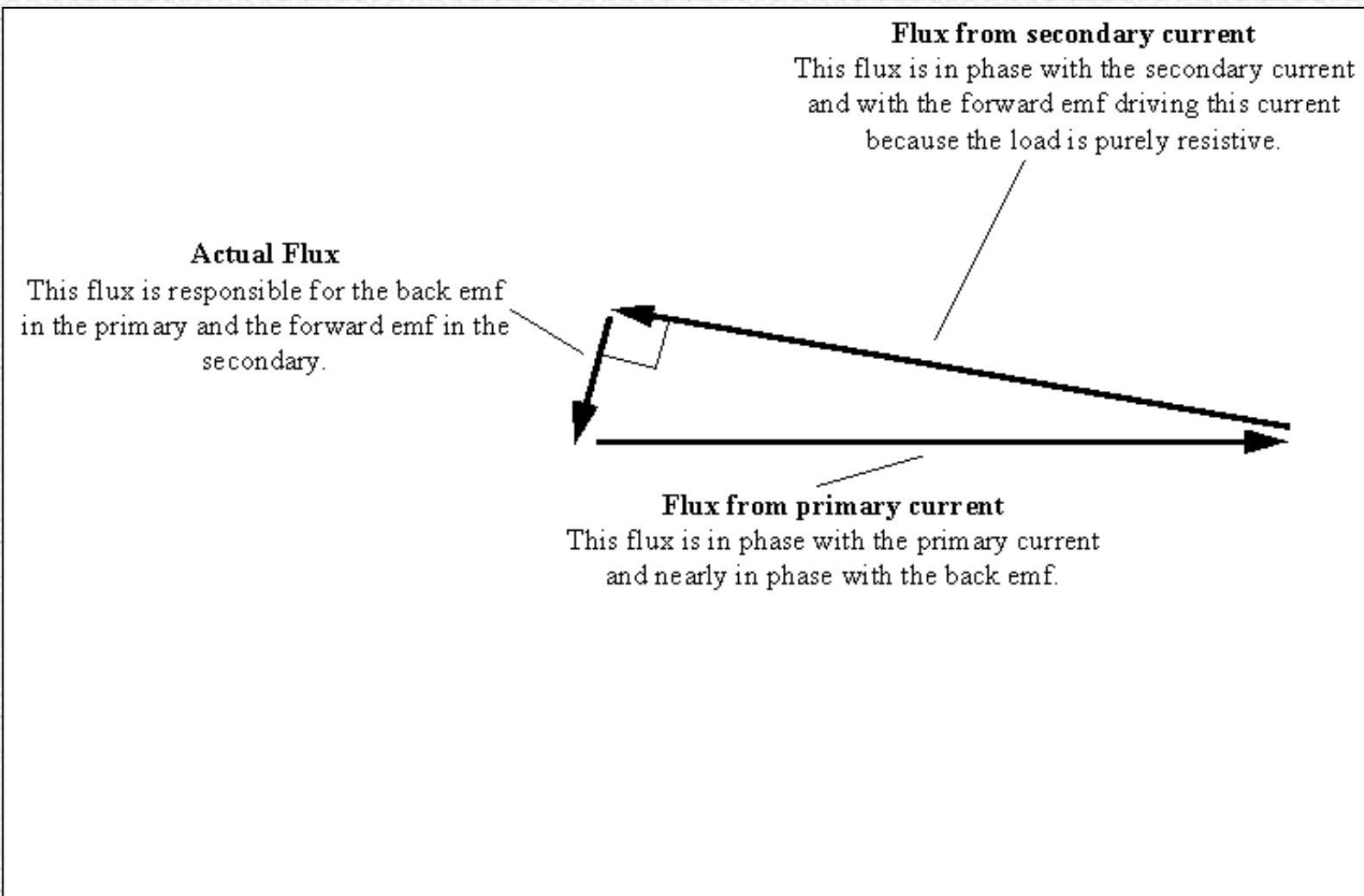

The gif above shows the phasor diagram for a transformer. The fluxes from the primary and secondary currents almost cancel, but not quite. What remains is the actual flux in the core which drives the emf's. The secondary current (and flux vector) is in phase with the induced emf (because the load is

resistive). The primary current (and flux vector) is almost in phase with the induced emf, so the primary impedance as seen by the input source is almost resistive: the small phase angle here is the inductive component needed to "create" the actual flux. As you reduce the load resistance you get greater primary and secondary current, so these two flux vectors get bigger (assuming the source can drive the increased power). But you can't do this ad infinitum. The power transfer limit is reached, not by the core's ability to carry the flux (for a given voltage the flux swing is constant, independent of the power transferred), but by the copper losses.

The above is for classical transformer design. With the MEG, I am not so sure that classical procedures apply, as you will see from my other mails.

Regards

Cyril Smith



cyrilsmith@camelot64.fsnet.co.uk

[Read the previous paper from Cyril Smith](#)

Return to the [MEG project](#) home page

MEG Theory

Why it Works, The Simple Explanation

By [Dave Squires](#) 11-08-2000

Consider the physical layout of the MEG. You have a stack of neodymium magnets in the center of a rectangular toroidal core. The magnets touch each side of the core on the inside. We have no coils on the core yet.

What does the magnet flux do?

The flux from the magnets will divide equally between each leg of the core. So we have half the flux flowing on the right and half on the left. See picture below of an FEMM simulation of this.

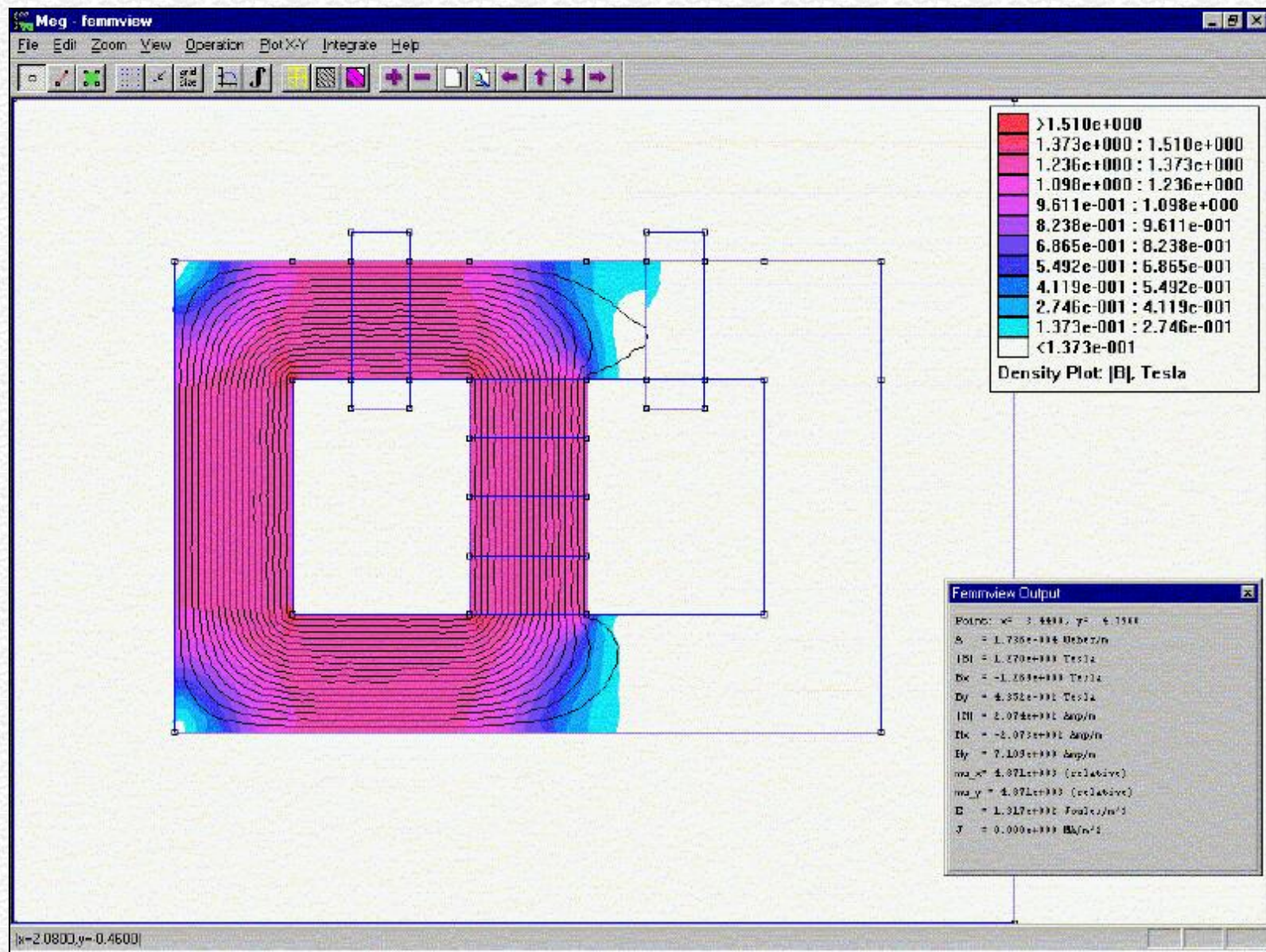

We now place coils on this core. We use two control coils on the top on each side of the magnet stack. And we wind two output coils on each vertical leg on opposite sides. The output coils are not shown on the FEMM simulation pictures.

OK, it is set up. Now we want to switch all the magnet flux to one side by opposing the magnet flux with the opposite control coil. How much flux will the coil need to generate to do this? Well, the answer of course is half the magnet flux since that is what is flowing in that leg. The other control coil is in the off condition, and open circuited, so no current can be induced in it and hence no back-flux generated. The core must not be allowed to reach magnetic saturation or more energy will be

required to force the flux to the other side.

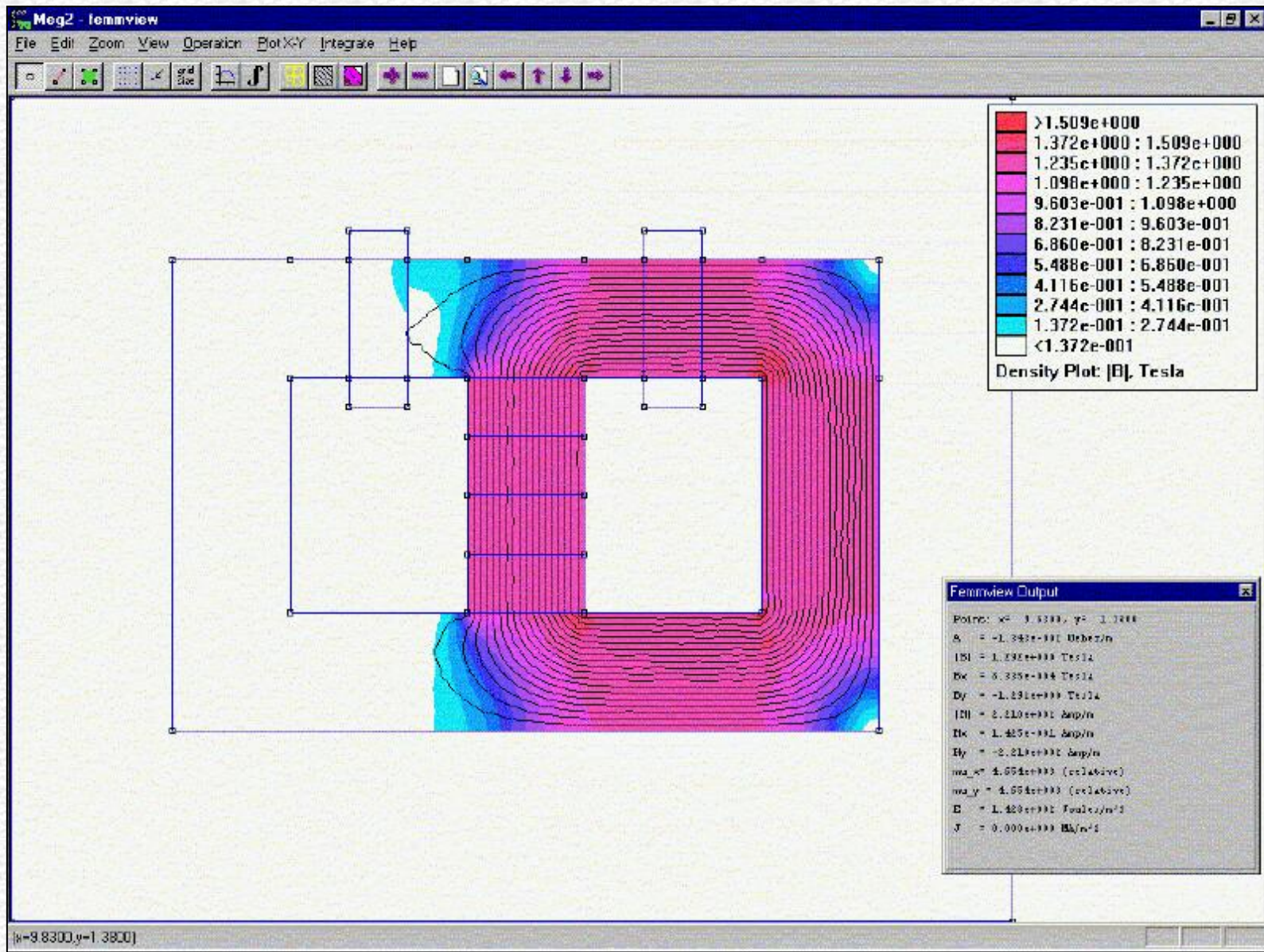

Then we turn off the control coil and what happens?

Remember both control coils are now off. The magnet flux will return to its original starting condition of half the flux flowing on each side as in the first picture. Does the magnet need any help to do this? No, of course not. When we did this we also removed half the magnet flux from the other leg when the control coil was on. The first half cycle we only see half the normal induction level in each output coil because at the start we only switch half the magnet flux into one leg and out of the other. So the total change is $B_{mag}/2$.

Now on subsequent cycles we let the magnet flux return to its original steady state and let the magnet do the work. Both control coils are off while this happens. Just when the magnet flux reaches its equilibrium point we turn on the other coil and keep the flux change going the other way. Each coil only needs to always switch half the magnet flux not all of it. After the first half cycle we see a 100% change of the magnet flux in each output coil on each cycle for an input power that is half the output. This assumes that we are activating the control coils for half of each cycle. This means we have a theoretical maximum COP of 2.0. We are using the magnet stack as a flux battery and "letting" it do half the work. See the next picture for the second half cycle. These FEMM pictures model the settled state after switching is complete at the zero crossing of the output sinewave.

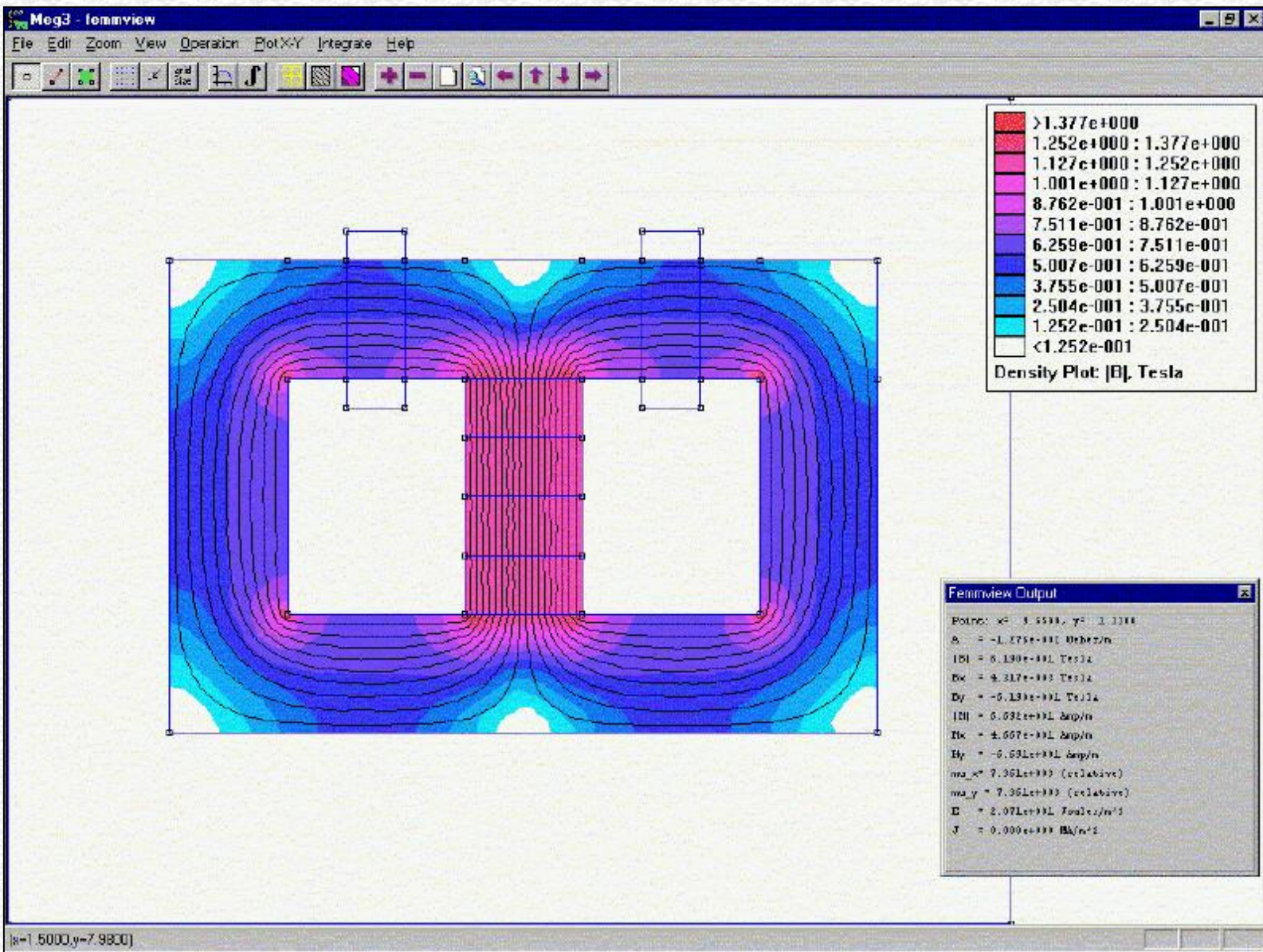

Now how can we improve it further? Faster switching using more exotic core materials could help. The higher the rate of change of the flux (dB/dt) the more output we get. So higher frequency operation is favored. The Bearden MEG claimed a COP of 5.0. It is very possible that the use of the particular nano-crystalline core material and operating at 40Khz can give a COP of 5.0. Also, changing the duty cycle might help to reduce the input power.

Jean-Louis Naudin has seen a COP of 1.75 using standard grain oriented silicon steel. This tends to confirm my hypothesis above. Core losses might prevent reaching a COP of 2.0 with this material. So at minimum, so far, you can get an OU solid state generator with a gain of 1.75. Just this alone could allow you to reduce your utility bill by about half if you put these devices between your breaker panel and your appliances. You could cascade them also to use 100 watts to get 15KW. It would only take about 9 stages to do this. What Jean-Louis has shown will do the job all by itself with no refinement. You just need bigger magnets, core section, and coils.

Power Gain Factors When Cascading Stages

This table is generated assuming you start with 100 watts input to stage 1 and size each stage appropriately to handle the power generated.

Stage Power Gain Power Output

1	1.75	175watts
2	3.06	306watts
3	5.36	536watts
4	9.38	938watts
5	16.41	1,641watts
6	28.72	2,872watts
7	50.27	5,027watts
8	87.96	8,796watts
9	153.94	15,934watts

What this means is you could create a power system to provide all your household power needs with only 100 watts drawn from the power grid. The only real reason to use the power grid is for the right frequency for all your present appliances. Done with an oscillator you could use a battery or hand crank generator to start it up and then run off a capacitor bank for the first stage. If the magnetic transistor idea proves out then one stage or two stages might be sufficient.

 *Dave Squires* (11-08-00) <mailto:djsquires@plix.com>

Return to the [MEG project](#) home page

Magnetic Transistor Theory

By [Dave Squires](#)

Date: 11-03-2000

To make any transistor you need a material region where you can control a great amount of the flow of something with a small amount of something. This gives gain or amplification. For a magnetic amplifier the goal would be to use a small amount of input current to switch a large amount of magnetic flux into an output coil. A strong rare earth permanent magnet would be used to serve as a magnetic battery or permanent source of magnetic flux.

If any core material the amount of coil flux required to switch the magnet flux would be equal to the magnet flux. The H or magnetic potential required to reach this flux level is determined by the permeability, the shape of the BH curve, the number of coil turns, the coil length, and the coil current. The equation is stated as follows.

$H = NI/L$ -- where N is the number of turns, I is the coil current and L is the coil length in meters.

The magnetic flux density, B, is written as:

$B = \mu_a H$; where μ_a is the permeability and H is the magnetomotive force or potential as shown above.

μ_a here is the absolute permeability and not the relative permeability.

Relative permeability is expressed as,

$\mu_r = \mu_a / \mu_0$ where μ_0 is the permeability of vacuum

So the absolute permeability we need is:

$$\mu_a = \mu_r \mu_0$$

Substituting in the equation for B we get,

$$\mathbf{B} = \mu_r \mu_0 \mathbf{H}$$

Then substituting for H we get,

$$\mathbf{B} = \mu_r \mu_0 \mathbf{NI/L}$$

For the case where we will be switching a constant magnetic flux from a permanent magnet the magnetic flux density B will then be constant as long as the same core cross section is maintained.

Now let's assume that we will use two different core materials in the magnetic circuit. We will use a core material of relative permeability μ_{r1} for one core and μ_{r2} for the other core. Also, let's assume that N and L could be different for the general case. So we have N_1 , N_2 , L_1 , and L_2 .

Now since the magnetic flux density B will be constant we can set two equation equal to each other as follows.

$B_1 = B_2$ and then substituting the expanded formulas for each we get,

$$\mu_{r1} \mu_0 N_1 I_1 / L_1 = \mu_{r2} \mu_0 I_2 / L_2$$

If we then solve for I_2 we get

$$I_2 = \frac{\mu_{r1} \mu_0 N_1 I_1 / L_1}{\mu_{r2} \mu_0 N_2 / L_2} = \frac{\mu_{r1} \mu_0 N_1 I_1 L_2}{\mu_{r2} \mu_0 N_2 L_1}$$

As you can see μ_0 will cancel out and the result for the general case reduces to,

$$I_2 = I_1 \frac{\mu_{r1} N_1 L_2}{\mu_{r2} N_2 L_1}$$

So it can be seen that if the number of coil turns and the coil lengths were equal the output current would be the ratio of the control coil relative permeability μ_{r1} to the output coil core permeability μ_{r2} times the input current. The equation for this special case would reduce to,

$$I_2 = I_1 \frac{\mu_{r1}}{\mu_{r2}}$$

Now we must keep in mind that we need a changing magnetic field to cause any induction in the output coil. So the control coils in a magnetic transistor device must be constantly switched with a periodic waveform of some kind. The rate of change of the flux or dB/dt must be as fast as possible to get the maximum output from the output coil. Also, the cores must never go much past the saturation point. The material can be made to traverse its BH curve just up to the knee of the curve for the material, but should remain on the steep slope portion so that extra H is not wasted with little change in B. Even going around the knee of the curve would waste energy with little benefit unless the knee is sharp.

It can also be seen from the above special case that if the material is uniform in permeability that there is no gain and you have a 1:1 transformer. Of course this is the ideal case where core losses are not taken into account. When core losses are subtracted the output current is less than the input current by some small amount of 1% to 5%.

The objective is to use as small as possible an input control current to control a large flux from a strong permanent magnet. It is obvious we need to match the magnet's B field for the given core cross section to be able to switch the magnet flux completely. The control coil would operate in blocking mode with opposing flux to do this. It would then have its permeability approach 1 and look like an air gap. To get the smallest H to do this we need the highest permeability material we can find with a high enough saturation induction level capability. We also need a square loop BH curve with a small sharp knee to the curve. The more vertical the curve the better. Metglas 2605SA1 material from Honeywell Amorphous Metals fits this bill nicely. For the rest of the core we can use cheap M1 grain oriented silicon electrical steel. Metglas is expensive, but fortunately

we only need a small amount for the coil core.

One other item is that we must make sure that there is no coil wound on the same high permeability material that is allowed to conduct when switching the magnet flux with the control coil. If this is allowed then the Lenz's Law back flux reaction (counter EMF) will oppose the control coil equally with lower current and destroy the gain we want. Any power extracting coil must be wound on the lower permeability material so that higher current and power can be extracted to generate the equivalent Lenz's Law back reaction to the changing flux from the magnet.

It should be easy to see that saturation of any of the cores must be avoided. Otherwise flux will be lost outside the core. If this happens the required H is lowered and the gain will be reduced. Therefore it is desirable to keep all the flux contained inside the core at all times. Flux leakage will be detrimental to maximum efficiency.

Summary and Conclusions

1. A magnetic transistor can be made by using materials in the magnetic circuit that have widely differing relative permeabilities.
2. The gate or control area should use the highest permeability material so that a lower magnetomotive force H is required to generate the same magnetic flux density B in the magnetic circuit core. Lowered H means lower coil current and lower input power.
3. A constant cross section of core material for the control section and the lower permeability section should be maintained.
4. Magnetic saturation should be avoided in all core sections. The control gate core can be taken right up to saturation, but should not be pushed beyond it because the H requirement goes up rapidly and energy will be wasted lowering the efficiency.
5. The BH curves of the core materials should have square loop characteristics with low hysteresis. This means that a small H is required to get a large B field density.
6. The control coil section operates to oppose the magnet flux. When not required it must be open circuited and no current allowed to flow. It does not need be used to generate attractive mode flux to favor the magnet flux flow. There is no need to do this. The off core simply completes the magnetic circuit for the magnet through the control core.
7. The gain realized is the ratio of the control coil core relative permeability divided by the output coil core relative permeability.
8. Since the control coil current is so much lower small power MOSFETs or medium power bipolar transistors can be used for the switching controller.

Why this Should Work in the MEG

Lenz's Law back reaction says this must work.

Consider that the magnet flux is constant through all portions of the magnetic circuit. We just need a lower H value to switch the magnet flux because of the very high permeability material in the control coil core. We assume we must create a B field in the control coil core equal in magnitude to the magnet's B field in order to block it completely. Now we have switched the magnet flux into a different magnetic circuit by blocking the magnet flux and allowing it to flow into the opposite leg. The control coil there is off and no Lenz's Law back reaction is allowed from the "off" state control coil. One hundred percent of the magnet flux is switched to the opposite leg of the circuit. Now Lenz's Law says that while the flux in the output core is changing there will be a back reaction to oppose the change in flux that will be equal in magnitude. This assumes that maximum current is allowed to flow in the output coil. To get a B field of equal magnitude to the magnet flux you will need a much larger value of H due to the much lower permeability of the output coil core. A larger value of H means a larger current must be generated in the output coil to create this amount of back flux. So Lenz's Law is responsible for the OU gain we can achieve. OU factors in the range of 30x to 50x should be easily attainable. These are efficiencies of 3000% to 5000% minus some small core and copper losses. And the whole unit would be solid state increasing the reliability tremendously.

Dave Squires (11-03-00) djsquires@plix.com

Return to the [MEG project](#) home page

Thoughts about the MEG principle

The Magnetic Amplifier Experiment

By Jean-Louis Naudin

created on 11-03-00 - *JLN Labs* - last update on 11-03-00

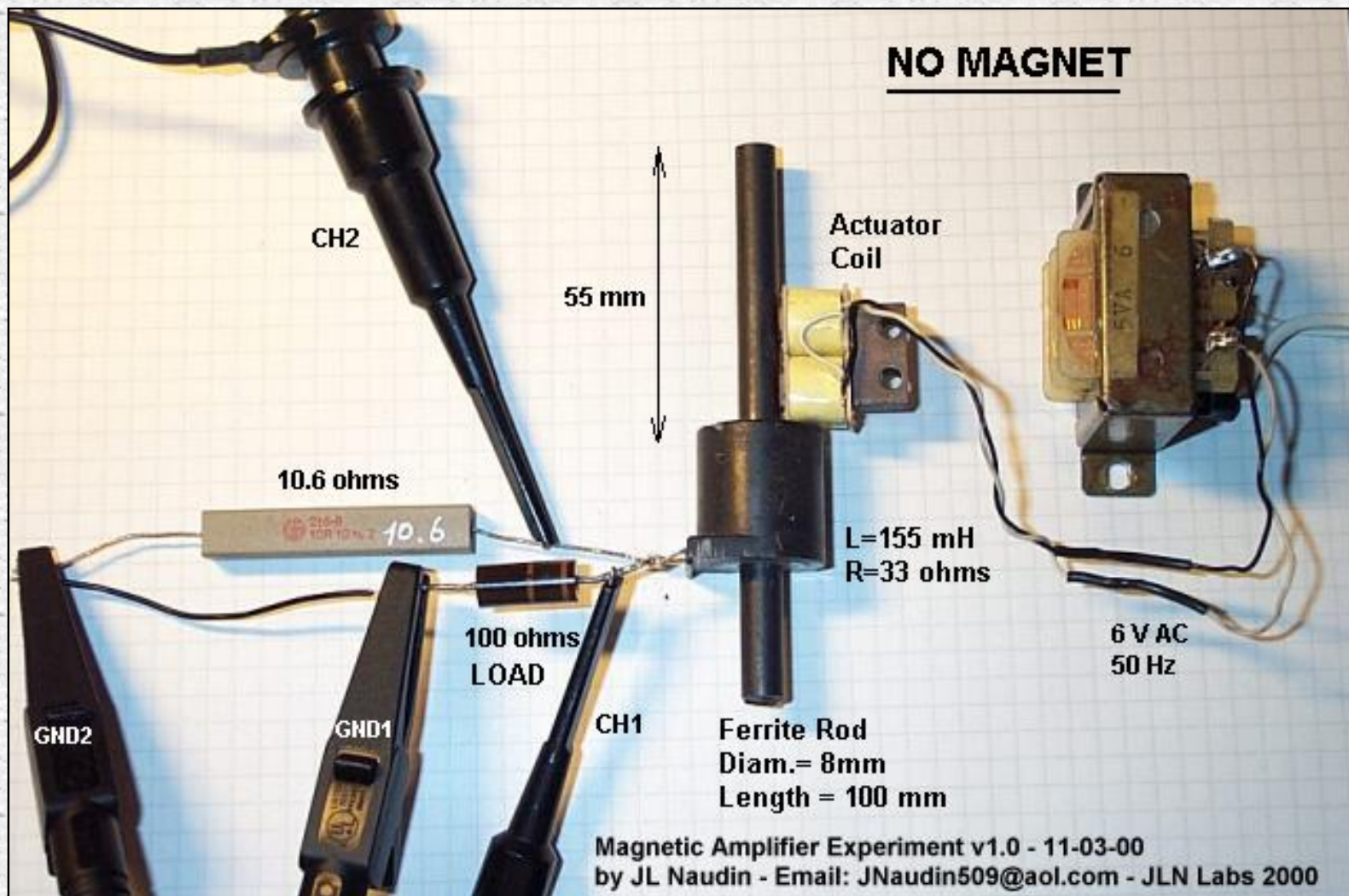

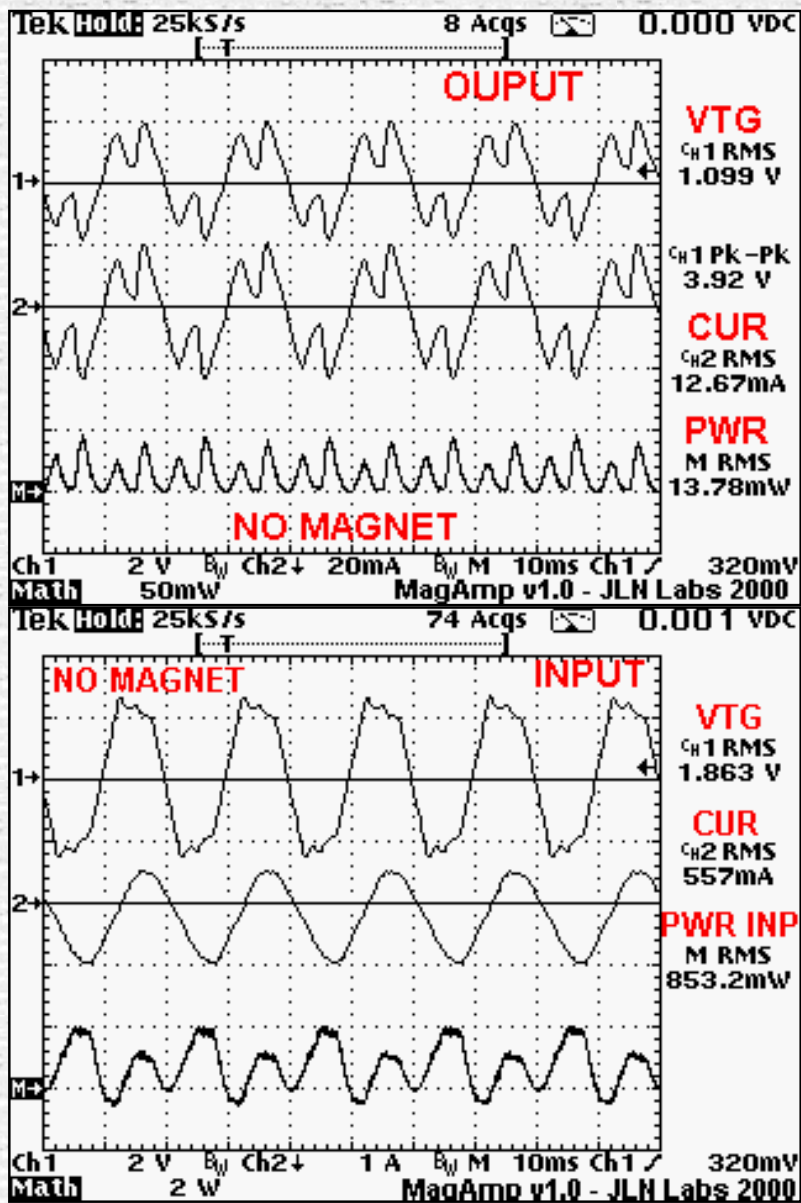

The power **OUTPUT** on a 100 ohms resistor is **13.78mW** without magnet
The power **INPUT** is **853.2mW** without magnet

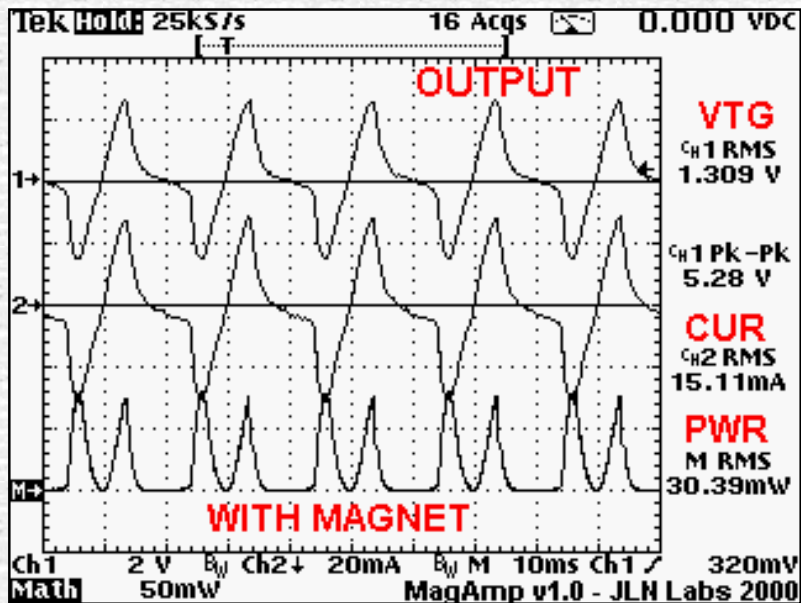
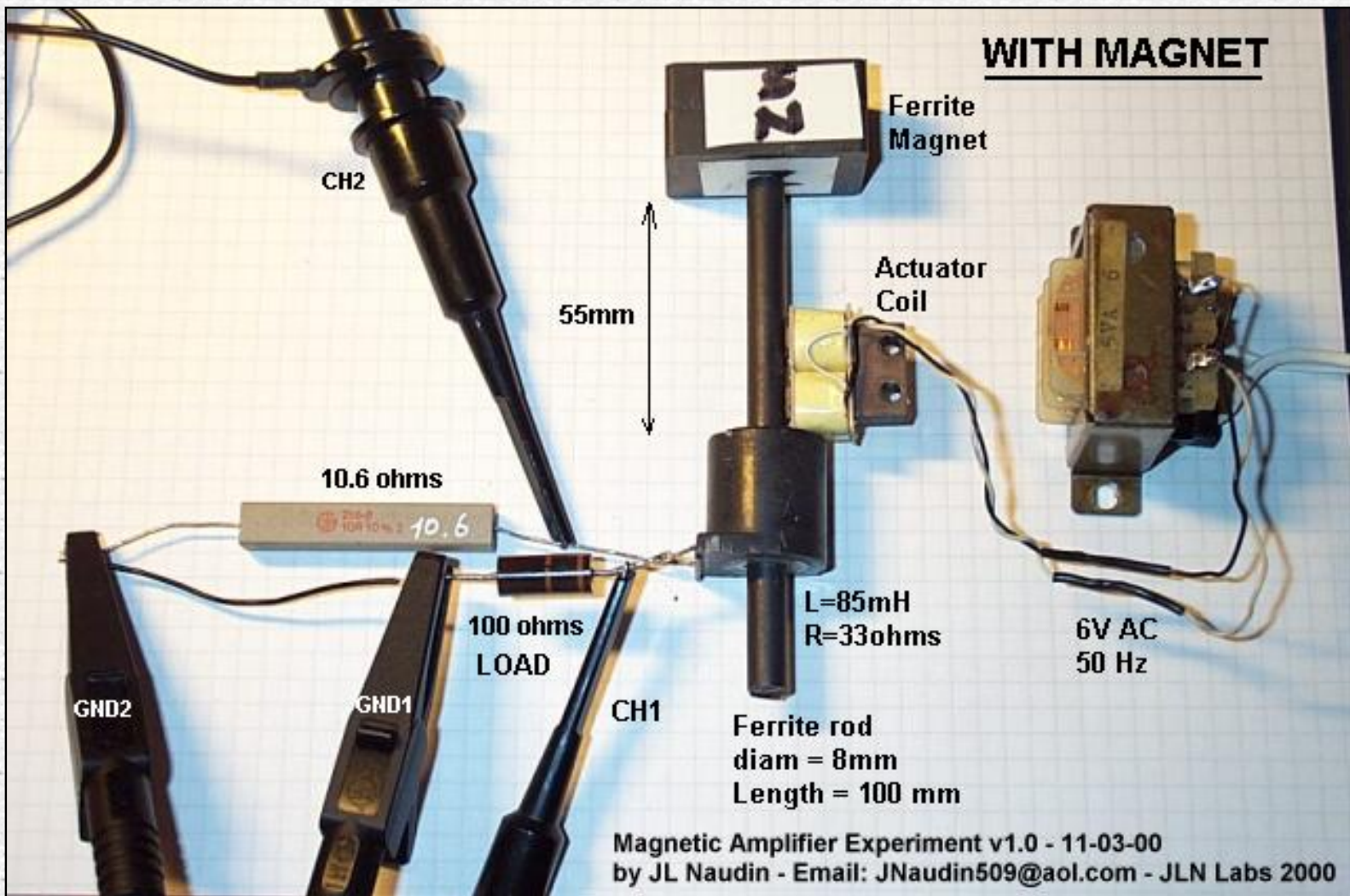

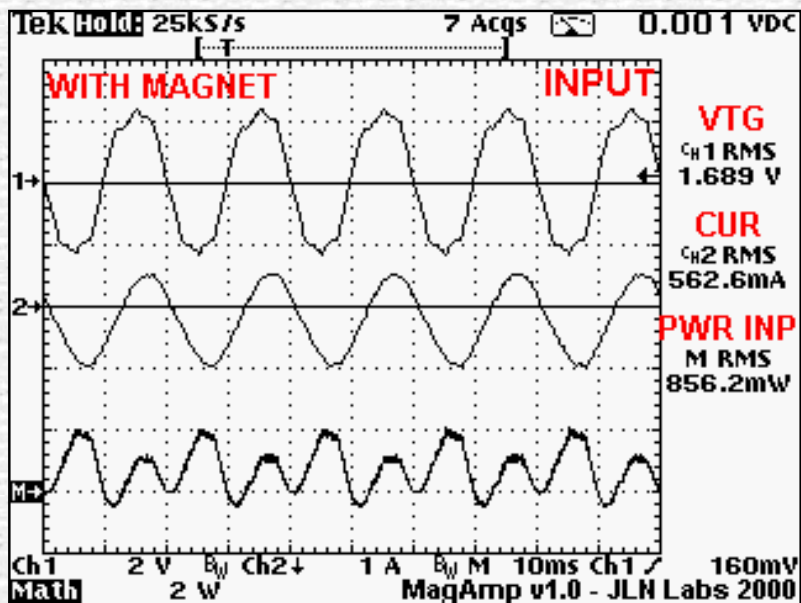

The power output on a 100 ohms resistor is **30.39mW** with the magnet
The power INPUT is **856.2mW** with the magnet

The **power OUTPUT** increase of **53.6%** while the **power INPUT** increase of **0.35%**
when the magnet is added at one side of the ferrite rod...

There is NO Overunity here, but only some food for thinking...

Return to the [MEG project](#) home page

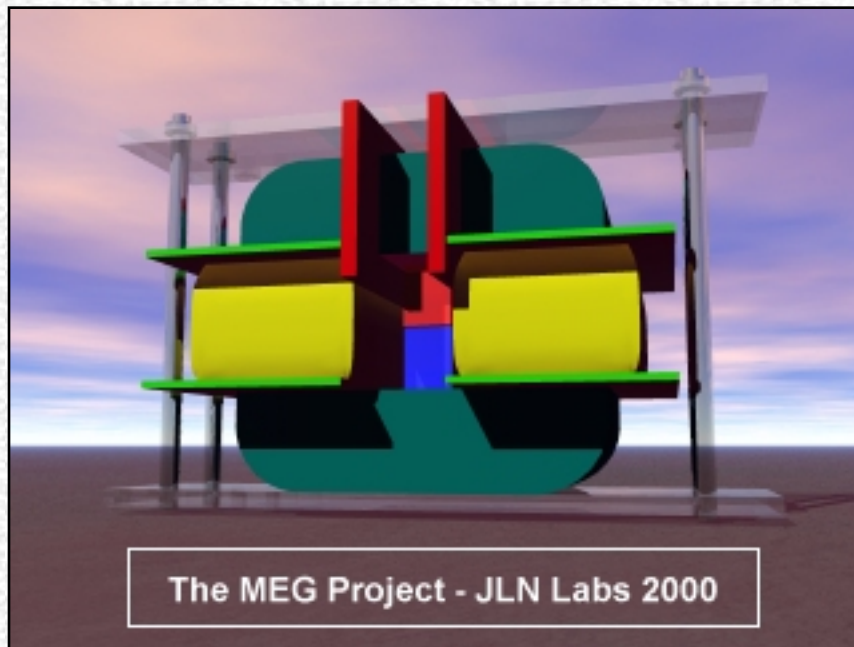

The Worldwide MEG replications



created on March 28, 2002 - JLN Labs - Last update March 29, 2002

All informations in this page are published free and are intended for private/educational purposes and not for commercial applications

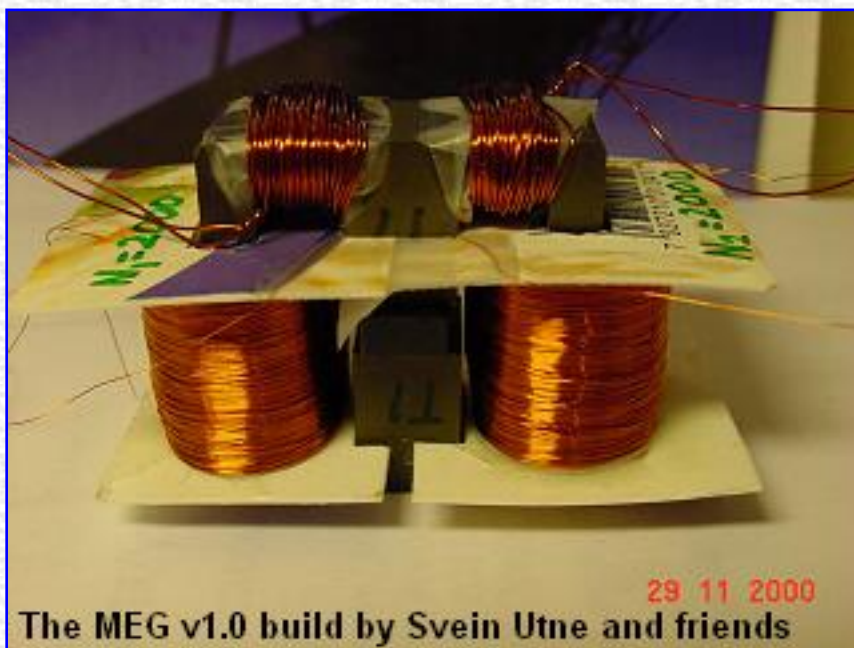

The MEG v1.0 build by

Svein Utne an friends

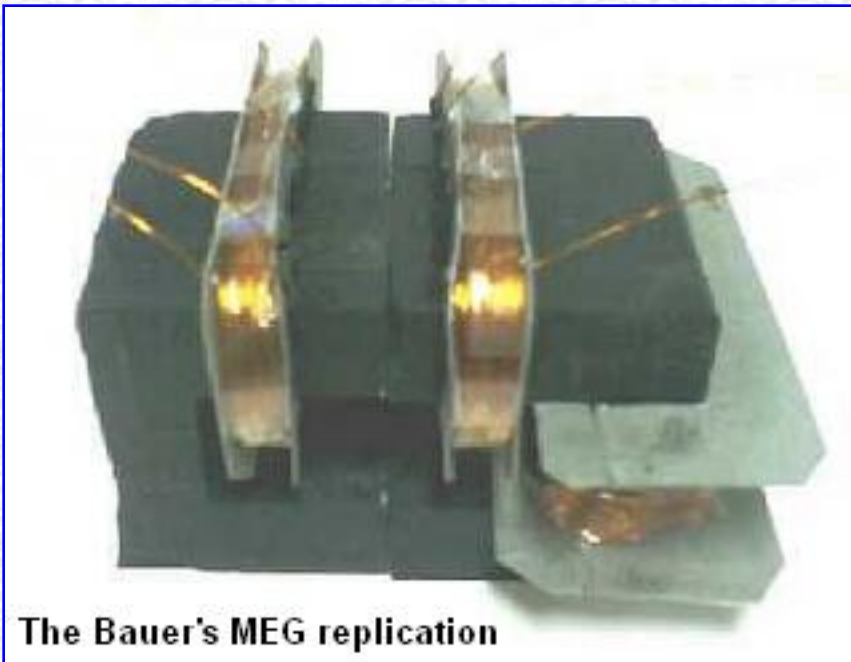

The Bauer's MEG replication

[Manfred Bauer](#)

[The MEG v1.0 build by](#)



Meg 1 by Ben Thomas

[Thomas](#)

[The MEG v1.0 build by Ben](#)

Return to the [MEG project](#) home page

USPTO PATENT FULL-TEXT AND IMAGE DATABASE

[Home](#) [Quick](#) [Advanced](#) [Pat Num](#) [Help](#)
[Bottom](#) [View Cart](#)

Searching 1996-2002...

Results of Search in 1996-2002 db for:

6362718: 1 patents.

Hits 1 through 1 out of 1

PAT. NO.	Title
1 6,362,718	Motionless electromagnetic generator

[Top](#) [View Cart](#)
[Home](#) [Quick](#) [Advanced](#) [Pat Num](#) [Help](#)

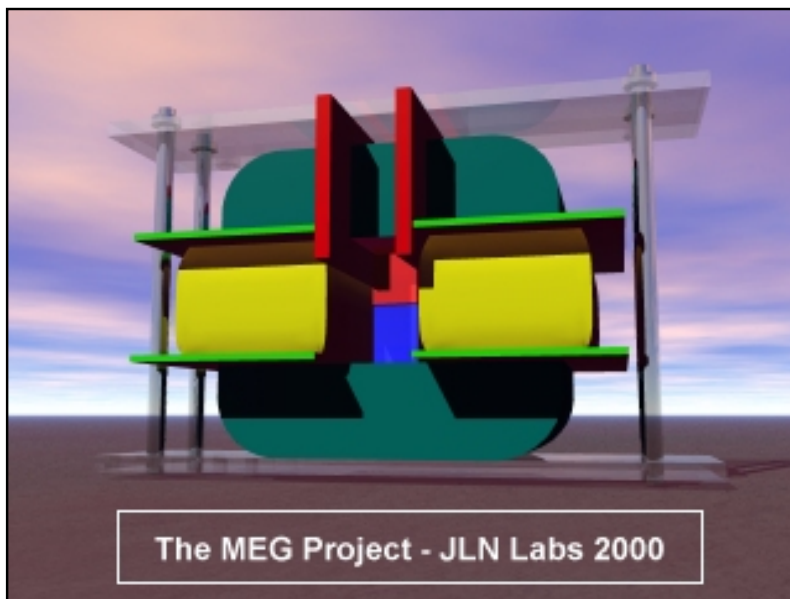

(This artwork is from Jean-Louis Naudin's Web)

The Motionless Electromagnetic Generator Project

The MEG Project

*"..This one works beautifully and produces **COP=5.0...**" say Tom Bearden - (COP=5 is equal to an efficiency of 500%)*

The MEG v1.0 build by [Svein Utne](#) and friends

Created on 19. November 2000 - Last updated 30. juli 2001

[California Institute for Physics and Astrophysics](#)

An Introduction to Zero-Point Energy

Quantum physics predicts the existence of an underlying sea of zero-point energy at every point in the universe. This is different from the cosmic microwave background and is also referred to as the electromagnetic quantum vacuum since it is the lowest state of otherwise empty space. This energy is so enormous that most physicists believe that even though zero-point energy seems to be an inescapable consequence of elementary quantum theory, it cannot be physically real, and so is subtracted away in calculations.

A minority of physicists accept it as real energy which we cannot directly sense since it is the same everywhere, even inside our bodies and measuring devices. From this perspective, the ordinary world of matter and energy is like a foam atop the quantum vacuum sea. It does not matter to a ship how deep the ocean is below it. If the zero-point energy is real, there is the possibility that it can be tapped as a source of power or be harnessed to generate a propulsive force for space travel.

Casimir Effects and the Quantum Vacuum Energy

There is growing interest in the nature of, and possibly even the manipulation of, the quantum vacuum. The vacuum stress predicted by Casimir in 1948 between conducting plates due to modification of the electromagnetic zero-point fluctuations has been confirmed by experiments. Agreement with theory at the five percent level has been obtained in a micron-range cavity (Lamoreaux, *Phy. Rev. Lett.*, 78, 5, 1997; see also [Lamoreaux, 1999](#)). Thermodynamic analysis has also shown that it is apparently possible, in principle, to extract energy from the quantum vacuum. More specifically, no violation of thermodynamics appears to result from such a process involving the ZPF. Although numerous unsubstantiated claims of ZPF energy tapping gadgets may be found on the internet, no one has yet devised any radically new means to extract such energy on a practical scale. Only a very minute and impractical level may be achieved using Casimir plates (which is nonetheless important as a proof of principle; see for example the article "Extracting electrical energy from the vacuum by cohesion of charged foliated conductors" by Robert Forward, *Phys. Rev. B*, Vol. 30, 1700, 1984; for more recent theoretical analyses see [Cole, 1999, Amer. Inst. Physics Conf. Proc. No. 458, 960, 1999](#) and Cole & Puthoff, *Phys. Rev. E*, 48, 1562, 1993).

[Fran De Aquino: Superparticles from the Initial Universe and deduction of the Fine Structure Constant and Uncertainty Principle directly from the Gravitation Theory. \(updated 30-03-01 \)](#)

Fran De Aquino - Physics Department, Maranhao State University,
S.Luis/MA, Brazil.

All information's in this page are published free and are intended for private/educational purposes and not for commercial applications

The MEG diagrams published in these pages are currently under test by JL Naudin and soon also by Svein Utne and may be subject to modifications after that they have been published on this site. They are the result of some attempts of a private and fully independent replication by the author. These diagrams are not the original MEG diagrams being tested by the Bearden's teamwork or some accredited labs.

Disclaimer: The author assumes no liability for any incidental, consequential or other liability from the use of this information. All risks and damages, incidental or otherwise, arising from the use or misuse of the information contained herein are entirely the responsibility of the user. Although careful precaution has been taken in the preparation of this material, I assume no responsibility for omissions or errors in the diagrams or measurement data published here.

Tom Bearden made shockwaves when he published his MEG in October 2000. The result was so unbelievable, that it was difficult to take it serious. Then JL Naudin tried to duplicate the result, and in the beginning of November Naudin started to get results that could be over unity. That is more power getting out then what is put

in to the system.

On 17. November, Naudin got results that showed 29 Watt out from less then 4 Watt in. The public interest was so over whelming that Naudin was drowning in emails and all sorts of questions, so he had to stop his open posting of his results, and also reduce his email activity. Now his latest results are restricted to only people that is taking an active part in MEG testing, and can share results from their own experiments.

With close contacts with people at SINTEF and The University of Trondheim we hope to be able to duplicate the results of Tom Bearden and JL Naudin, and we will share the result with you as the project develop.

One of the problem at the moment is to be sure there is no error in the measurements of power going in to the MEG and of that coming out. The input is DC between 10-30 Volt, so it should be possible to measure with high accuracy. The output is AC at high voltage of 500 till 1500 Volt (depending on input). At the moment there are still room for some error in this measurements, so it is inconclusive until some better test has been made.

Some researchers that we have contacted (that would like to be anonymous at present time) after more close study of the work done and published by Naudin is starting to believe Naudin is really getting over unity.

The final proof will be when there will be a closed loop. So the MEG is powered by its own output power, and still got some extra power. We are all waiting for Naudin to make this final step very soon.

We have sent Naudin some examples on how the step-down transformer can be built

You may look at it here: [Page1](#) [Page 2](#) [Page 3](#) and [Page 4](#) (about 80KB)

Can you find the error on page 4?

The MEG we are building in Trondheim has the following characteristics:

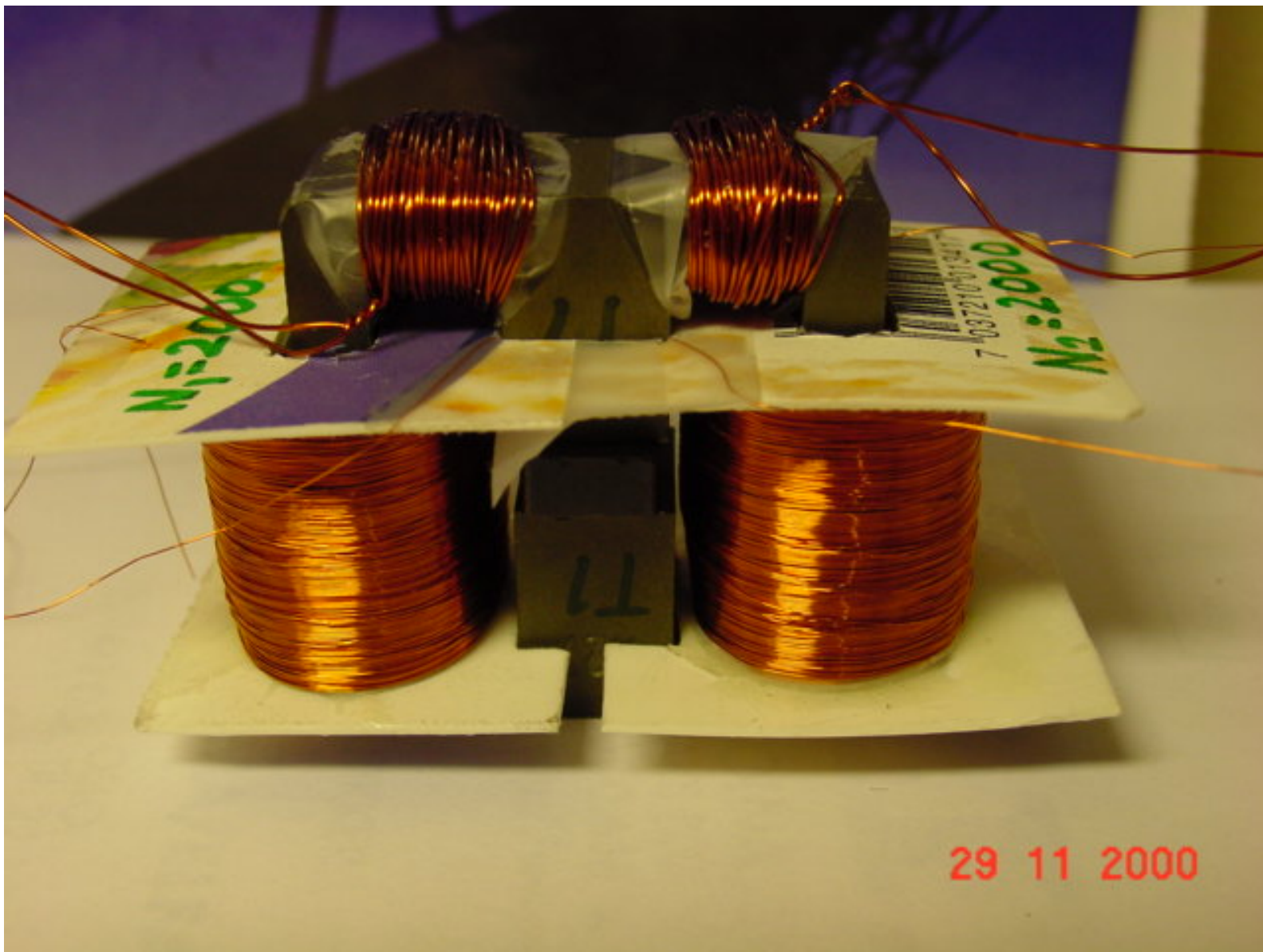

If you want to look at some [pictures of the MEG](#) parts before assemble

Primary coils 50 turns and the secondary coils 2000 turns

$N_2/N_1 = 2000/50 = 40$ The secondary coils wire is reduce to size 0.15mm to get more turns.

Now we have to make the electronics. I hope it will be done this weekend.

R_p =Primary resistance R_s =Secondary resistance

DC resistance [ohm]:

$R_{p1}=0.3$ $R_{p2}=0.3$

$R_{s1}=130$ $R_{s2}=133$

We started testing 3. December, and have already more then 90% efficiency.

We have already broken two transistors. Let it be a warning to others. We have up to 60VOLT coming back in the primary coils. In the pictures below you will see some results with one transistor broken.

On the next picture you will see this back current that oscillate and die out. We are using only 50 turns in the primary coils. If we will make an other I think we will use 200 in the primary coil, to see if this (green line) will be more nice.

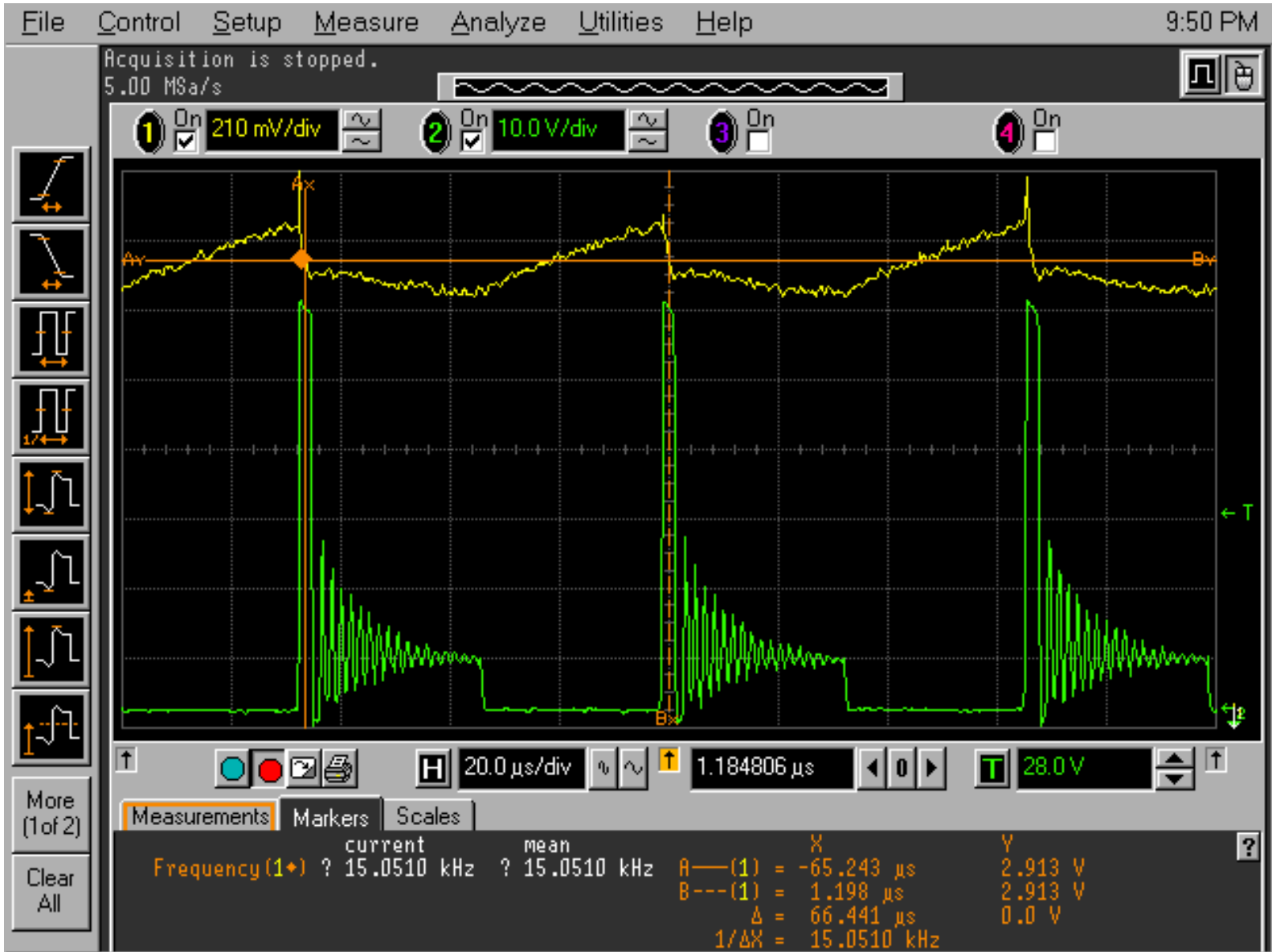

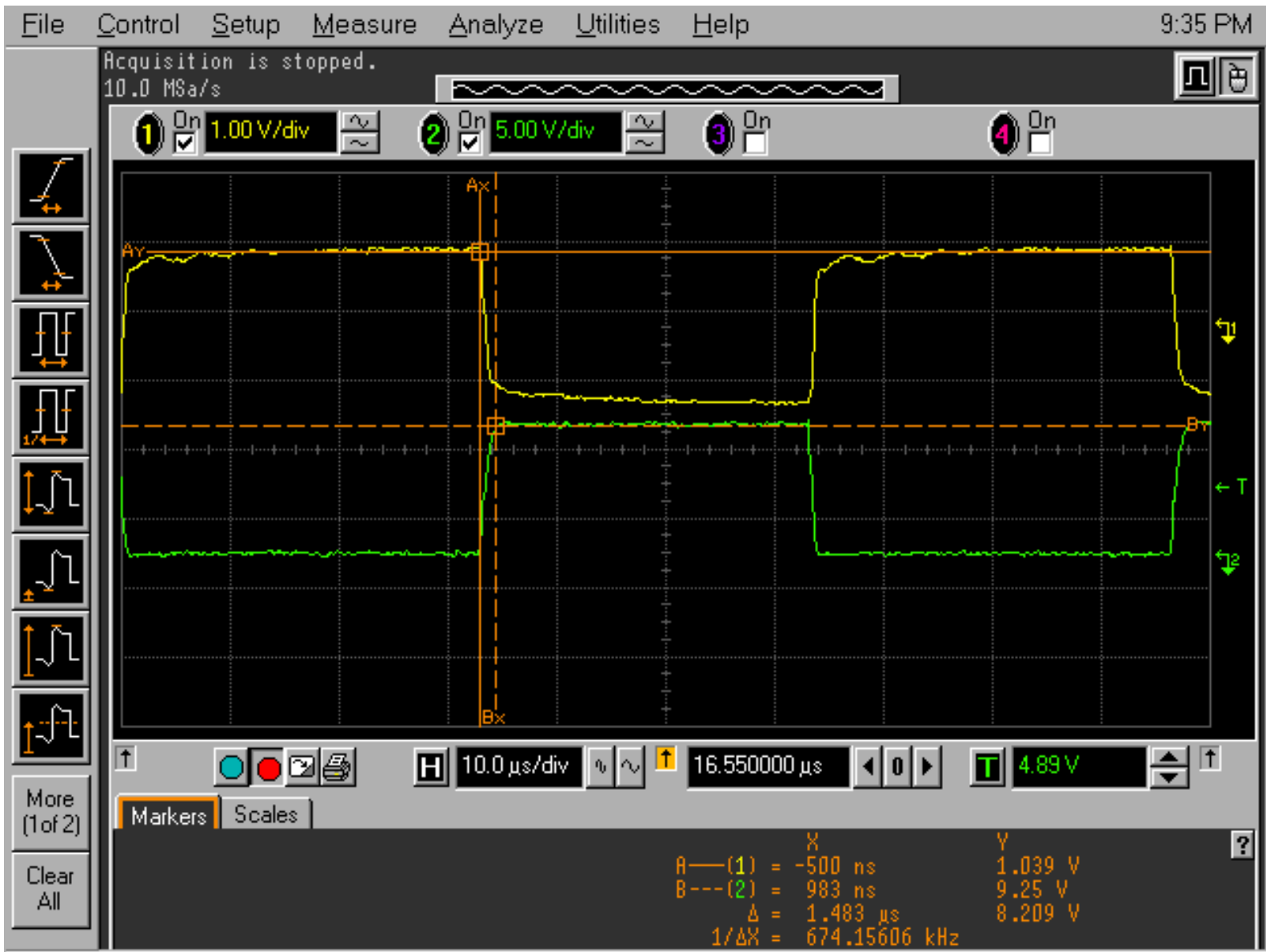

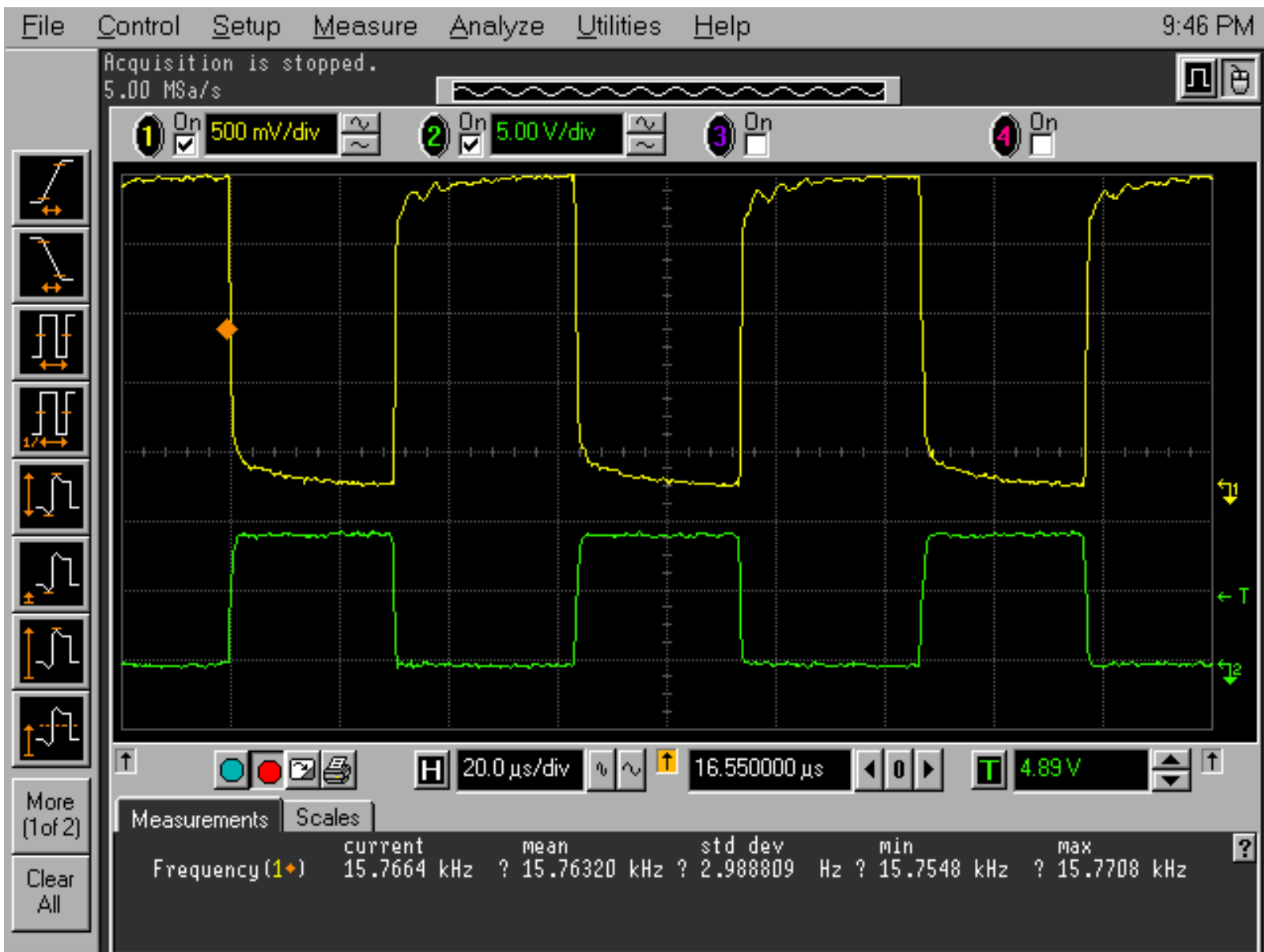

- [Core and magnet information](#)
- [Some tips on how to wind the secondary coils to avoid sparking](#)

Interesting papers and documents about the project :

You may download the MEG document at : <http://www.ott.doe.gov/pdfs/MEGpaper.pdf>

Note (10-26-00) : The MEG Paper has been removed from the DoE site, but you may download it :

- <http://www.cseti.org/bearden/MEGpaper.pdf>

Note (11-21-00) : The MEG Paper has been removed from the Cseti web site, but you may also

download it at :

- [**The Motionless Electromagnetic Generator: Extracting Energy from a Permanent Magnet with Energy-Replenishing from the Active Vacuum**](#), a PDF document (69 pages 1,29 MB), explanations and test results by T.E. Bearden ([Alternate site](#))

If you don't have the Adobe Acrobat reader you may download it freely at :



- [**Giant Negentropy from the Common Dipole**](#) By T. E. Bearden (PDF Format 86 KB)
- [**On Extracting Electromagnetic Energy from the Vacuum**](#) By T. E. Bearden (PDF Format 160 KB)
- [**Thoughts about the MEG principle \(part1 \)**](#) by Cyril Smith
- [**Thoughts about the MEG principle \(part 2 \)**](#) by Cyril Smith
- [**The MEG, Why its works, The simple explanation...**](#) by Dave Squires

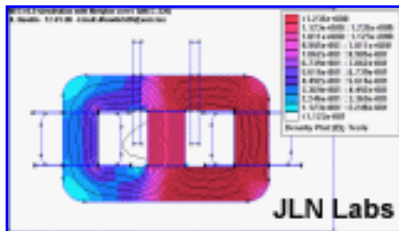

- [**MEG : See an animation with a simulated model**](#)

- [**The Magnetic Transistor Theory**](#) by Dave Squires
- [**The Magnetic Amplifier Experiment v1.0**](#) by J-L Naudin
- [**QuickField Flux Density Simulation Animation of the MEG**](#) (25. November)
- [**The MEG v3.1 with 9Watts light bulb**](#)
- [**The MEG v4.0 made by Naudin with the Cross-Flux magnetic gates setup**](#) (8. December)
- [**The Sweet's Vacuum Triode Amplifier**](#)

Mag Resonance of Elements at certain B

Some interesting info about resonant frequency of elements at a certain magnetic field strength.

<http://bmrl.med.uiuc.edu:8080/periodic/>

<http://bmrl.med.uiuc.edu:8080/MRITable/>

<http://bmrl.med.uiuc.edu:8080/MRITable/nmrcalc.html>

[Links to some other devices that might extract energy from the vacuum](#)

Some technical infos :

Fe-based Nanocrystalline Toroidal Core for Current Transformers :

Characteristics: Nanocrystalline alloy has similar features of high initial permeability and temperature stability, less gravity and packing factor than that of Permalloy. Under the same conditions of core size and performance, it is lighter (about 1/3 lighter) and cheaper than that of Permalloy.

Nanocrystalline Magnetic Core :

Characteristics: High saturation magnetic induction (1.25T), high permeability, high inductance (ten times higher than that of ferrite), low loss, small volume, light in weight, high electric interference resistance, good frequency performance and high temperature stability.

For more infos about the Nanocrystalline material see :

- [NANOCRYSTALLINE SOFT MAGNETIC ALLOYS FOR APPLICATION IN ELECTRICAL AND ELECTRONIC DEVICES](#) by V.R. Ramanan ABB-Electric Systems Technology Institute

Nanocrystalline magnetic material suppliers :

- **BFiOTiLAS** : [Magnetics Components: Softcores material](#)
- **MAGNETEC** : Tape wound core based on the new nanocrystalline softmagnetic material called [NANOPERM](#)

Interesting patents to explore which have some similarities or interesting characteristics :

MEG Project status (by JLN on 12-06-00) :

You will find below the only facts about my MEG units that I am able to say today :

- The Output (V/I) signals are really measured by the scope and this has also been checked by various methods (analog and digital scopes and multimeters), but unfortunately measurement artifacts remain possible,
 - the voltage and current are in phase as shown in my scope pictures above,
 - a "conditionned" RLoad (100 Kohms, non inductive carbon, 5Watts) is REQUIRED for getting the output datas measured above,
 - the working frequency and the output voltage must be high (about 20kHz and >1KV peak-to-peak loaded) ,
 - the working frequency must be tuned so as to get a pure sine wave and the max amplitude at the output (>1KV peak-to-peak loaded),
 - the switching signal is a squared pulse at 50% DTC,
 - the two primary coils must be switched alternatively (see the MEG animated simulation).
 - I have used ferrite magnets and an interesting effect that I have observed is :
when the magnet is added and with actuators coils set in the cross-flux magnetic gates configuration, the output signal increases significantly,
 - the RLoad warms up quickly when the MEG is switched on,
 - in most of cases the "apparent" power measured seems greater than the heat dissipated by Joule's effect in the RLoad,
most of the power is radiated in EM form :
 - * With an electronic Teslameter, I have measured 2.8 milli-Tesla (at 16KHz) with the probe very close to the RLoad,
 - * With an E-Field Strength meter in AC mode, the E-Field = 1250 V/m at 50 cm far from the RLoad,
 - * With a gamma counter : No gamma radiation has yet been detected
- So be carefull if you work close to the MEG transformer because of the strong EM generated.

Not yet checked :

- core saturation effect by the magnet,
- flipping of the hysteresis curves by the actuator coils,
- calorimetric output measurements on the RLoad Vs the Input but in the most of case the "apparent" power measured seems greater than the heat dissipated by Joule's effect in the RLoad and this makes me pessimistic about the calorimetric tests results.

Conclusion (on 12-06-00) :

My MEG replication seems to be really close to the original device presented in the Bearden's MEG paper and I think that I have been able to replicate and measure the same signals at the Input/Output of the device. I have not used the original electronic and core diagrams from the Bearden's teamwork (because I don't have them..), so may be there are some important differences between the setups. The purpose of this project seems to be achieved : the replication of the MEG signals measured at its output is in line with the original papers and the inventors claims.

Now, the BEST verification to do is to convert the "apparent" power measured in useable power such as : light, heat, mechanical energy (in motors).... and also, of course, to close the loop... This has not yet been done today.

[A New Magnetic-Electric Device Can Power Home From Near Free Energy Source](#)

[THE POWER SOURCE OF THE FUTURE](#)

[ENERGY-EFFICIENT ELECTRICAL POWER ANYWHERE IN THE WORLD...](#)

[The Speed of Gravity - What the Experiments Say](#)

[There is no gravitational *pull* . . . only a *push*!](#)

The popular belief is that neutrinos pass through matter without affecting it, but is there a way we might be able to take some of the energy in neutrinos, and converting it back to electricity?

This might also be of interest:

- [JLN Labs - Jean-Louis Naudin](#)
- [LaFonte Research Group](#)
- [Electrogravity](#)
- [The Fran De Aquino Website](#)
- [The System-G from Fran De Aquino](#)
- [Engineering The Warp Drive](#)
- [The Self Accelerating Plasma Tube](#) or (SAP Tube) by Stefan Marinov
- [Professor Stefan Marinov: Famous Free Energy researcher \(photo & "A Test of Marinov's Electrostatics"\)](#)
- [Thestatica Machine](#) go to PROTOTYPES
- [Thestatica Machine ORIGINAL PHOTOS \(takes a long time to load\)](#)
- [Free Energy page with pictures of Finsrud's perpetual 'sculpture'](#)
- [Searl Effect Generator \(SEG\)](#)
- [Links related to Energy](#)
- [List of URLs](#)
- [Nucleon](#)
- [California Institute for Physics and Astrophysics](#)
- [The Disclosure Project](#)

Reset July 30



Motionless Electromagnetic Generator

[Send me an email at mbauer@execpc.com](mailto:mbauer@execpc.com) Last update 12/30/00

QUICK LINKS:

[Back to my home page...](#)

[MEG replication efforts by JLNlabs](#)

[MEG relication efforts by Svein Utne](#)

12/7/00

The core material I am using for my replication is a ferrite from FROST.

[ATC-FROST choke cores](#)

The cross sectional area is approximately 1 inch by 1 1/8 inches.

The magnet is a stack of rare earth grade 27 NIB magnets from Edmund Scientific.

[Edmund Scientific](#)

Many different primary and secondary windings have been wound with various turn ratios. Experiments have been performed using different combinations of windings, magnet orientations, load resistances, drive pulse timing and frequency, and drive voltage. Waveforms are monitored with several Tektronix oscilloscopes. Input power is monitored with digital volt/ammeters.

[Photo of experimental breadboard](#)

The control board is a close copy of the control circuit offered by J Naudin on his website. Several changes were incorporated for variable dead time control and different Mosfet driver transistors. Components are available from [Digikey.com](#) More circuit changes are forthcoming to fix the exponential decay of the drive voltage at the input of the Mosfet drivers. Currently, the TL494 PWM generator chip is not configured for active pulldown of the gate input of the Mosfet. With a Ciss of 1800 pf for the IRL540 Mosfets, and a pull down resistance of 1Kohm, a delay of several microseconds occurs between the PWM pulse turnoff and the Mosfet turnoff. By using the variable dead time control of the PWM chip, correct pulse width can be obtained, but that is only a temporary fix.

[Schematic of original control board](#)

The optimum configuration I have been able to obtain is 1200 Vpp output across a 100 Kohm resistive load. The output voltage is a pure sine wave. The primary is 100 turns, and a single secondary of 500 turns. Power supply input is 25.0 Vdc @ 130 Ma., not including the control board power. Operating frequency is 55 Khz, with minimum dead time control. *This is without magnets in the core.*

Power input is 3.25 watts. Output power is calculated at 1.80 watts. Efficiency is therefore 55%. No overunity seen yet.

Yes, an unloaded secondary produces several thousand volts and arcs over in the windings. This has been verified.

When magnets are added, slightly higher output voltage is obtained in one orientation, and slightly less output in the other orientation. Still no overunity seen. Efficiency still below 100%.

Price quotes for Metglas cores used by several replication efforts can be found at Eastern Components. The latest prices quoted for the AMCC-320 Honeywell metglas core is \$162.00 US. The AMCC-125 core is \$87.25 US. Single quantity, shipping extra. Off the shelf cores.

[Eastern components](#)

I will utilize the present ferrite cores I have to explore the theories proposed, and to develop procedures for constructing a newer version.

12/9/00

New information from J Naudin about cross flux switching of the permanent magnet.

[Cross flux switching from JLNlabs](#)

I am in the process of changing my design to incorporate the cross flux primary switch. I will try using a silicon steel transformer core as a starting point. The core was cut on a milling machine to fit across the ferrite core I am using. I'll try various winding configurations to optimize the performance.

12/12/00

I used a high speed cutoff wheel to cut the silicon steel core to the rough shape to fit over the ferrite core I am using. Brass hardware is used to hold the stack of plates together for finishing. Then, using a bench grinder, I was able to slowly widen the gap to fit snugly over the ferrite core. Here, I am using a scrap piece of ferrite as a width gauge during final grinding.



In this picture, here's how the bare cross flux cores fit over the ferrite cores. Note, the ferrite is very brittle and corners break off easily. These ferrite cores are only being used for show.

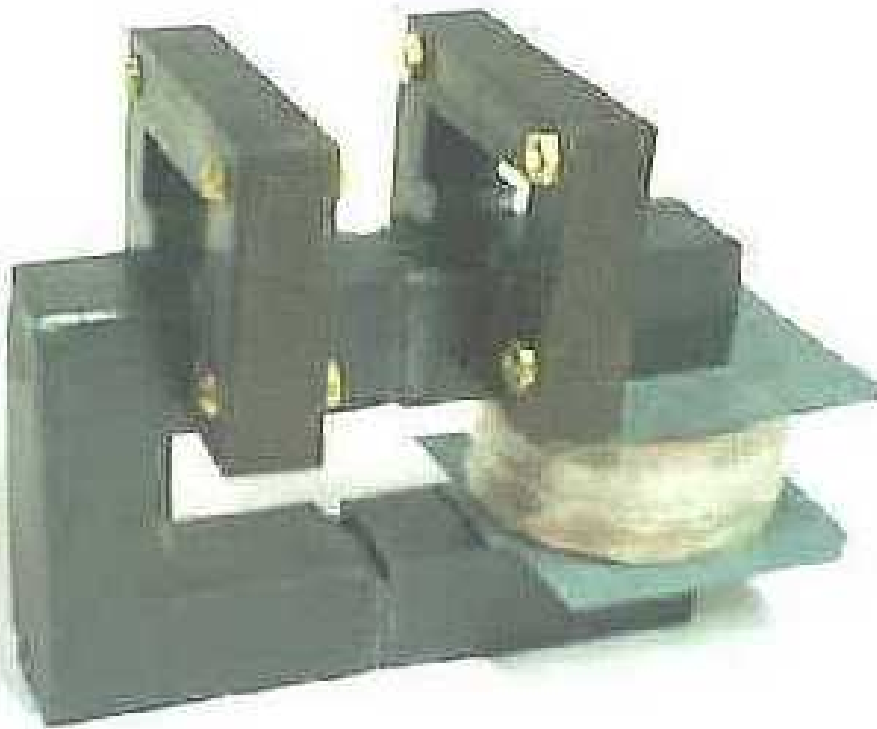

As a starting point for testing, I am using 250 turns of #22 gauge wire on each cross flux primary. This secondary coil only has 500 turns. Future experiments will use one of my other secondaries previously wound with more turns from other test runs.

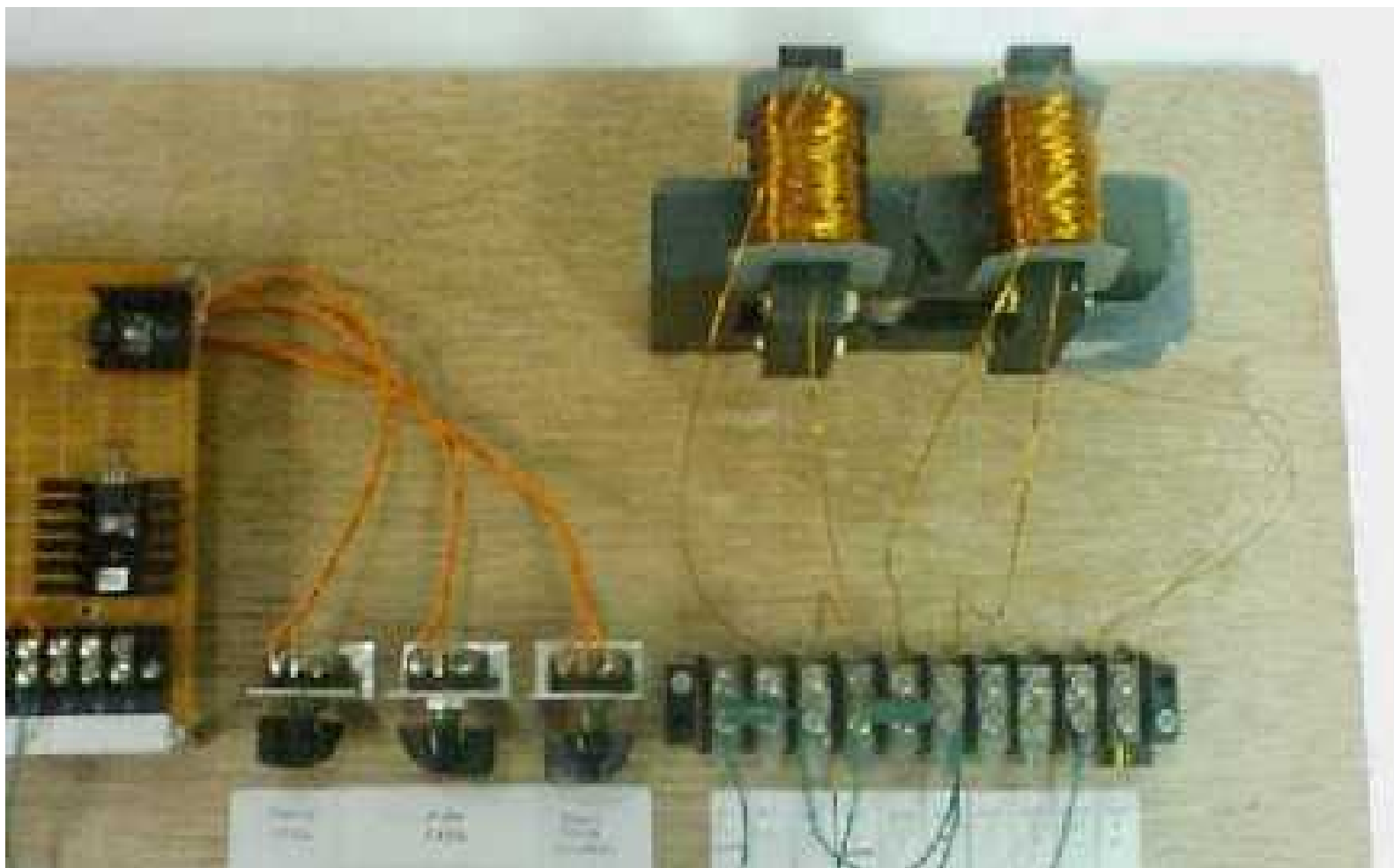

12/16/00

The cross flux principle seems to be a dead end for me at the moment. I did prove that the cross flux method almost got rid of the inductive coupling between primary and secondary windings. Secondary output was reduced from 1200 Vpp to 20 Vpp due to reduced coupling. The output didn't change with the magnet in the core or when it was out. So no permanent magnet flux switching occurred. It may be a problem with the core material being incorrect. I am resuming experimentation with the normal primary winding configuration, and try to get magnet flux switching to occur there.

12/19/00

The control board has had some improvements made. A transistor circuit to drive the mosfets has been added for better control of mosfet turnoff time. Additional noise suppression has been added to reduce measurement errors. Larger diameter wires in the interconnect harness were added to reduce resistance and switching losses.

The actual MEG unit itself fails to produce positive results due to lack of magnet flux switching. The magnet stack I use is the same diameter as the core material. (1 inch) Part of the permanent magnet flux seems to short circuit through the air rather than taking the long path through the core material. I will explore using a triple wide core (3 inch wide), with a 1 inch diameter magnet stack. This is to increase the core area to reduce the possibility of localized saturation. New primary and secondary coils will be needed.

[Updated MEG control board schematic](#)

12/23/00

A triple wide core of the same ferrite material is used with new windings. A secondary of 500 turns of #24 is used, with dual primaries of 100/150/200/250 turns. Multiple taps were used for trying different amp/turn investigations. Initial test without magnets, 25 vdc at 24 ma, gives 500 Vpp output into 100 Kohm. Optimum operating frequency is 50 Khz.

Here are a few pictures of the wider ferrite core and dual primary windings.





MEG Version 1.0

By

Ben Thomas

L3-L4 Laminectomy mid April, bitch, starting to get back on feet. I will get back to the PP amplifier as soon as I can work in my shop. Hang Loose

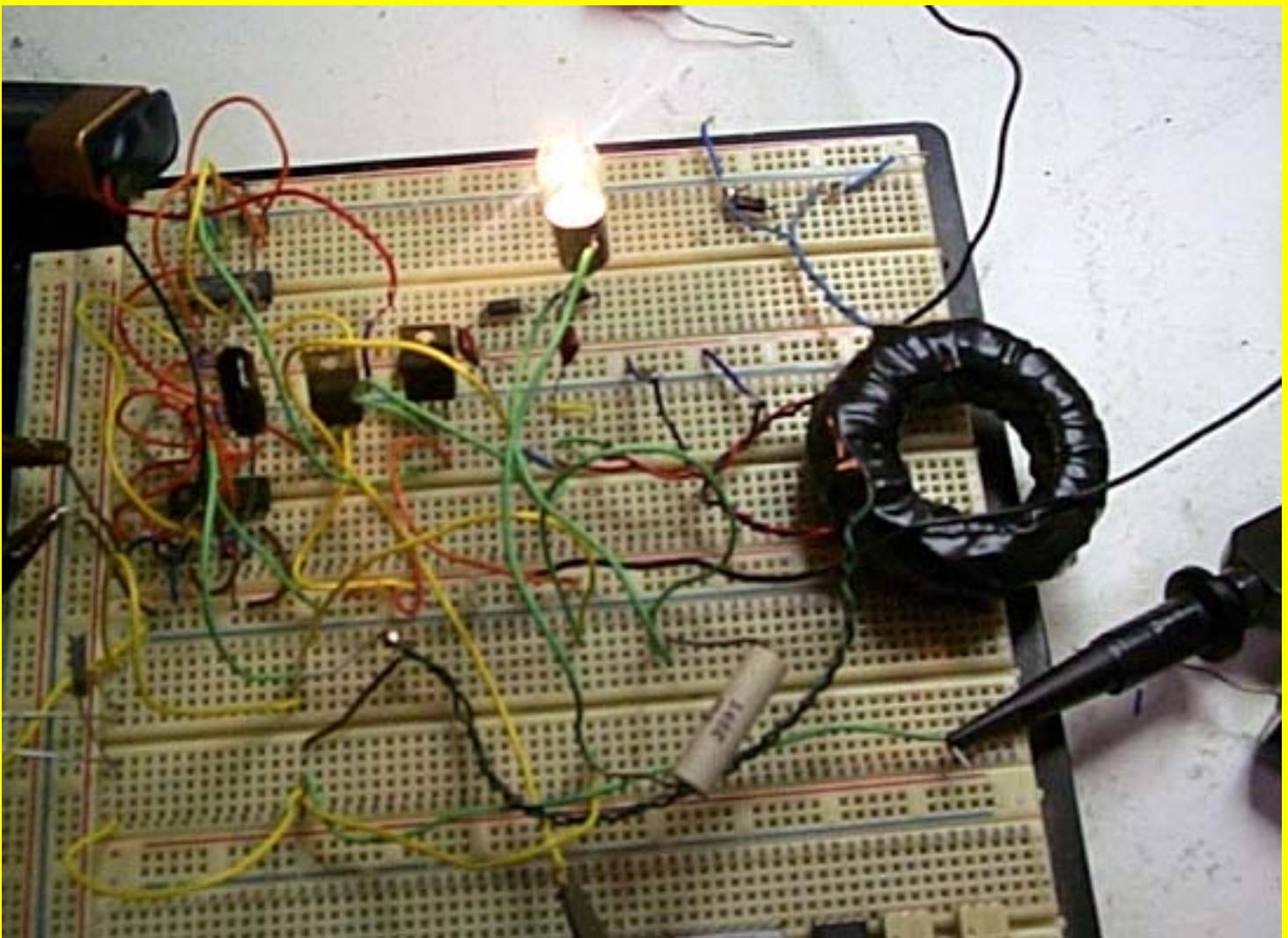

 **Whats next! Parallel Path pictures tonight. 04-04-02**

 **Results up to now 3-31-02**

 **The Coil**

 **Test Rig and Results so far!**

 **The "Over Efficient" Amplifier? Inside the MEG**

 **Graphs, More Coming**

 **MEG Version 2.0 Using Ferrite, Coil construction, Bobbin, etc.**

 **04113**

What's Next?

By

Ben Thomas

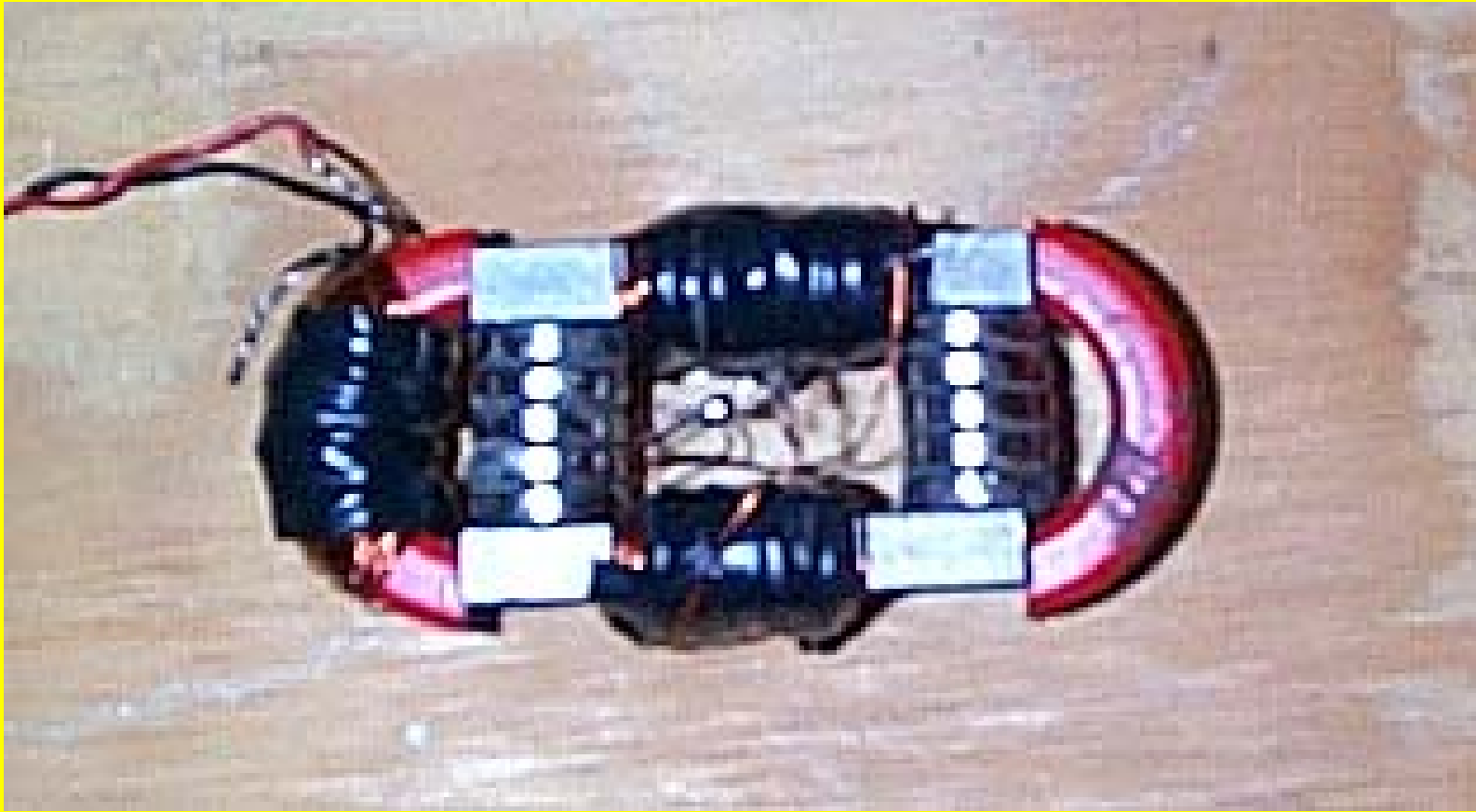

This is what I'll be working with next week. I'm not sure you can get gain in an active system (AC.) The fields in the magnets fight the fields in the electromagnets and reduce the gain to <1 no matter what you do. I must do some more tests to be sure but that is the first indication that I got from the first several test. I'll make no claims or until I can document what I say. Hang with me till I know for sure. I hope I'm wrong.

It's still fun

Ben K4ZEP

Power in vs. Power out

You make the call.

MEG V 1.0 is NOT Over Efficient in any conditions up to 10VDC. I suffer from the same problem most experimenters do in that they do NOT think out their instrumentation and properly document the results. Math will eat you up, poor memory is almost as bad. Couldn't sleep last night and re-thought out what was going on. Made the measurements and this is the result. I forgot how to do a PP to rms conversion and my "over efficient" enthusiasm took over. YOU MAKE THE CALL. Arrrghhhh.

Information:

All AC measurements were made on calibrated scope. Load resistor is a 5-watt precision film 100-ohm resistor. Frequency of device is 113 kHz. Lamp is 6 VDC 150 Ma.

Formulas used:

DC watts. $P=EI$, DC power from the supply using the voltage and the current as indicated.

AC watts- $P=AC=1/2 PP \times .707 =$ equivalent DC volts = $P=E \times E/R$ (E squared/R)

If you have 10V PP, it is equal to 3.53 Volts DC in a power equation.

Or 3.53 Volts DC will put the same heating power into a 100-ohm resistor as 10V PP AC.

Not shown is the loss in the core. Measured current without load and off resonance was linear as expected and could be lowered using a better core. At 10 VDC, the power into the core was

100 ma or about 1 Watt.

First comes the graph that you make your own decision about. The second picture is the scope of the device with the AC power into the 100-ohm resistor. The third picture is the device driving a LAMP. Calculated power shows this device is

only about 40% efficient driving that type of load. I might run a graph on it later but its problem is that it is NON linear in its response to a linear AC waveform so it would appear to distort the indicated power calculations. A graph will be helpful to see what is going on in a lamp. I'll post it later if it is applicable to this discussion. The brilliance of the lamp, referenced to a similar DC situation would indicate more out than in but looks are a lousy way to make a living.

Note also I am only running this device up to 10 volts at this time due to lack of good heat sinks on the power FET's. Oh yes, Purple is AC power, Black is DC power.

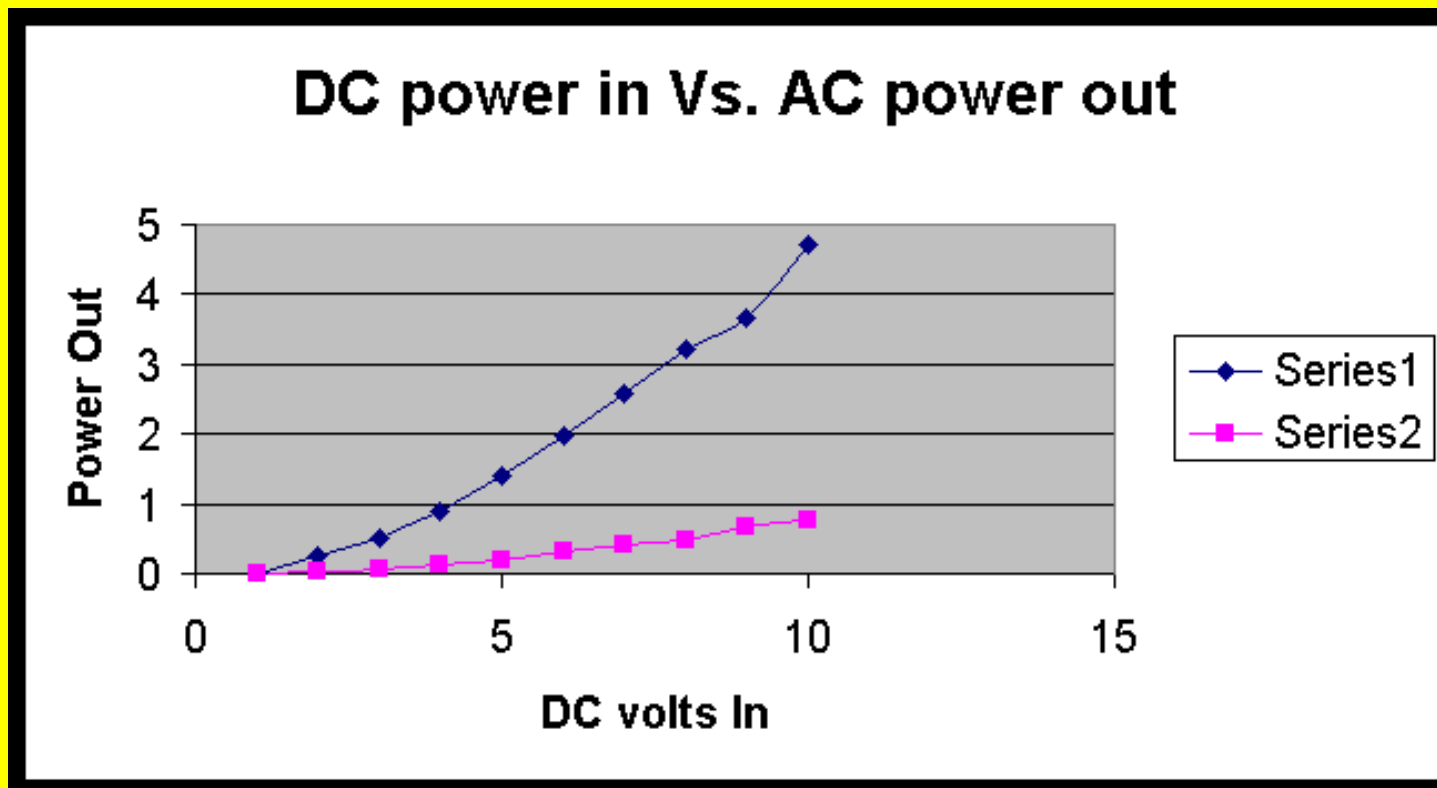

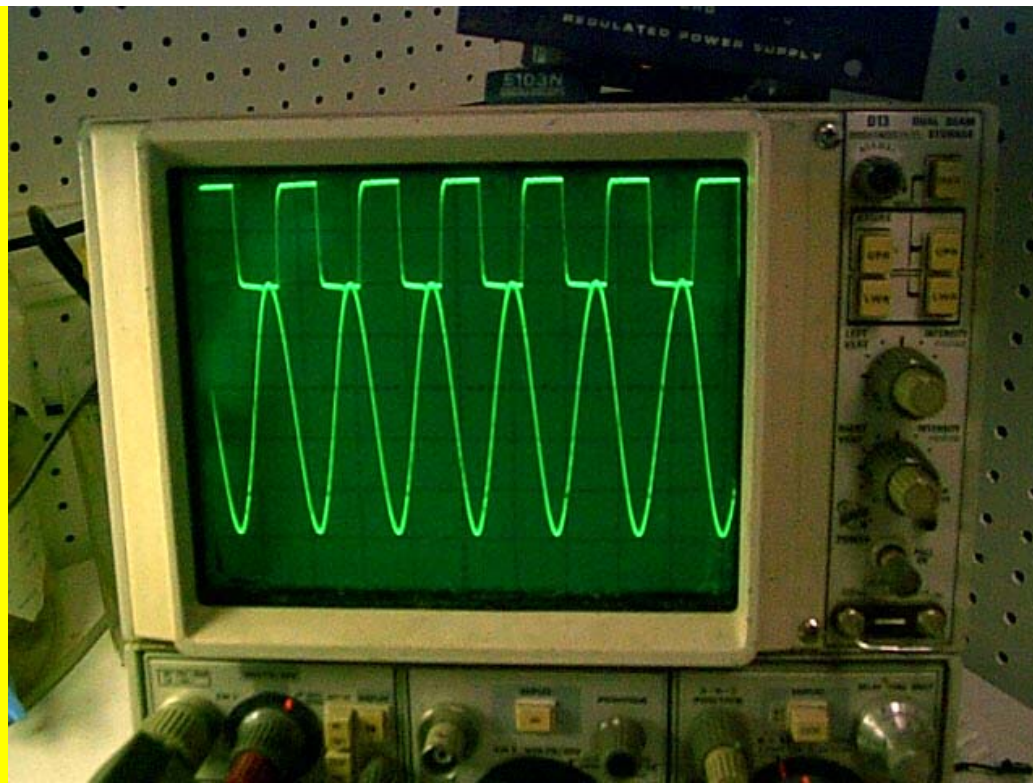

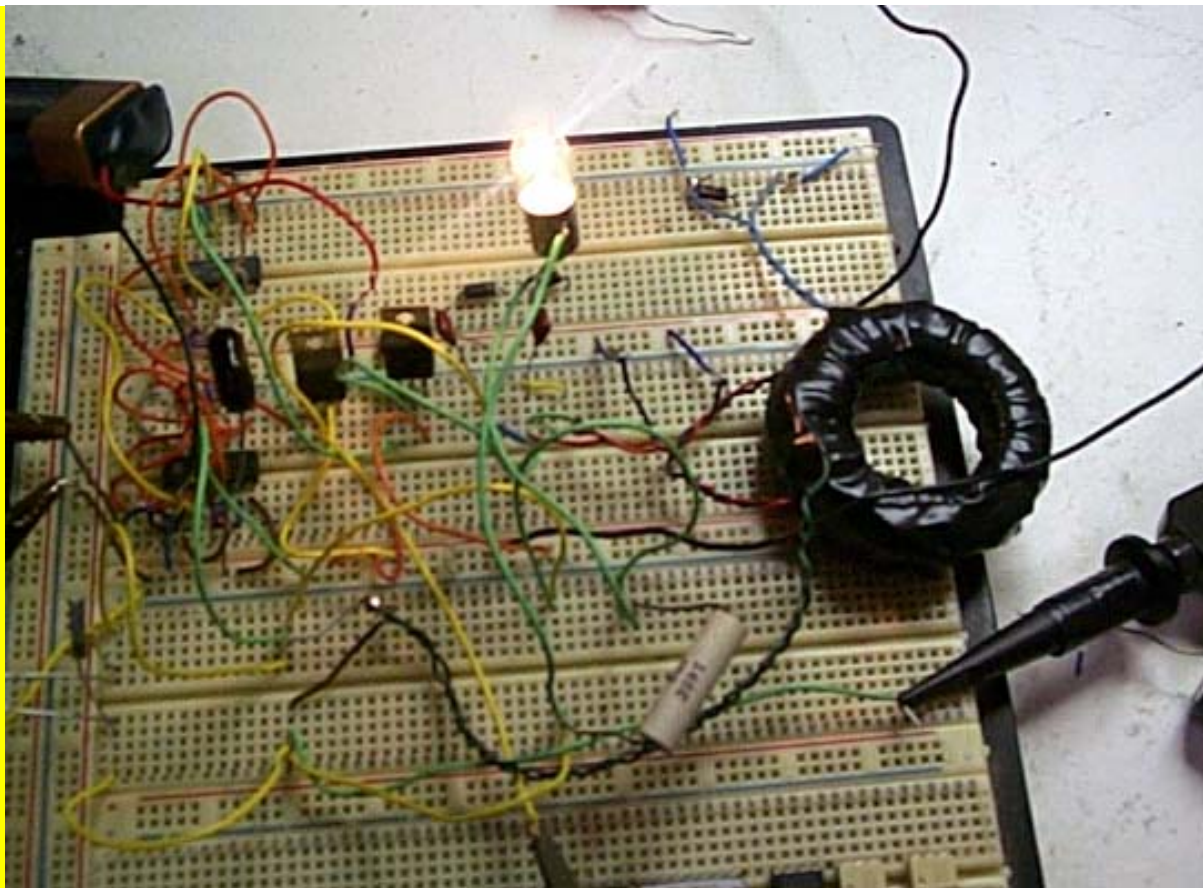

I'll post a decent schematic and drawing later. This should be able to be duplicated by any good electronics person. The patent information is NOT enough to do it. Some of the things I stumbled upon, some I thought out. Electronically there are some things you have to do, not complicated that makes it work properly. I will pass them along with the schematic. It will take a few days to do as I have to get up to speed on a new schematic editor. Please be patient. What a difference a day makes.

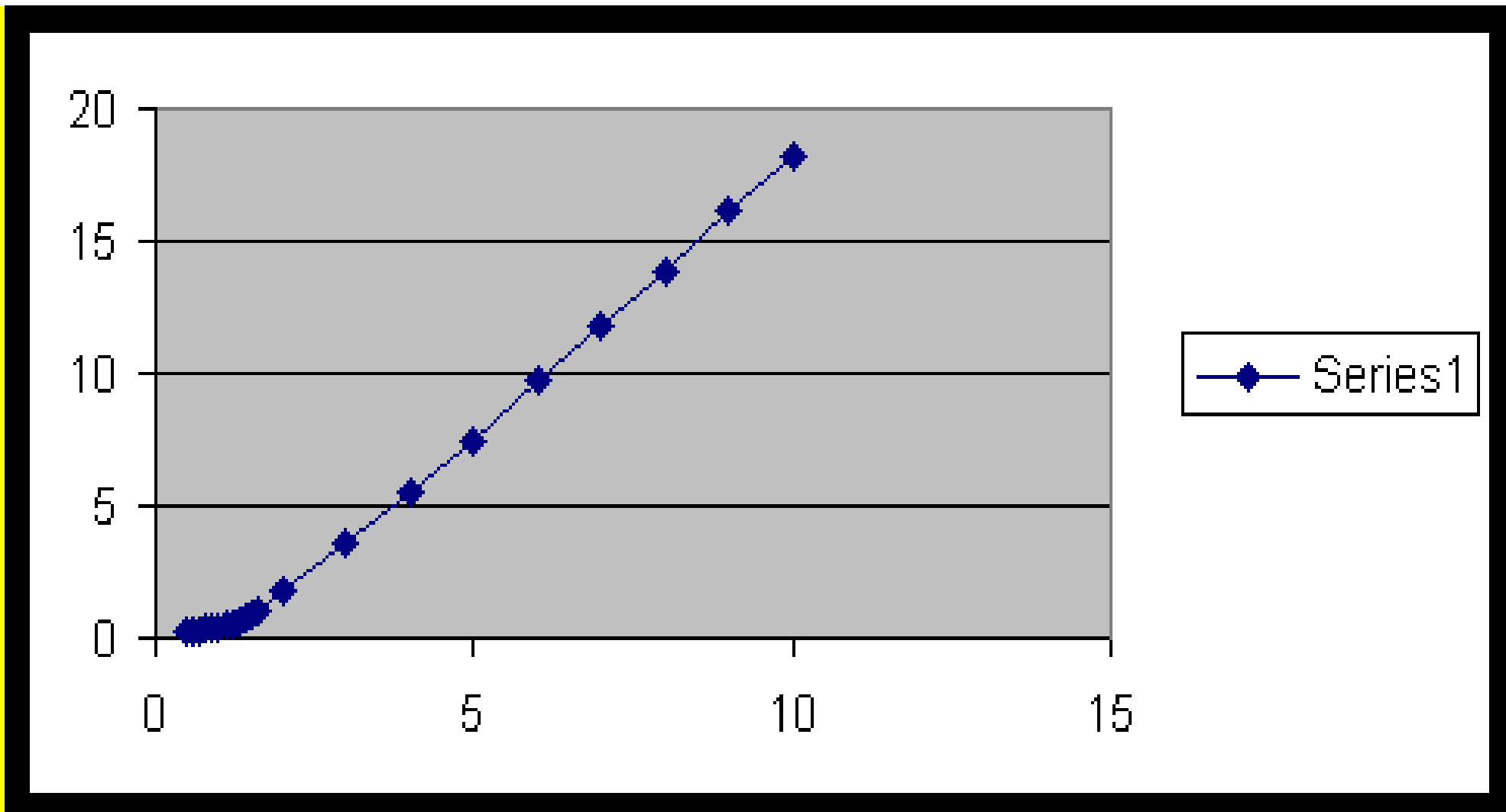

This is a graph of the Voltage in DC (measured to 3 places) vs AC Peak to Peak out, note it is absolutely linear! I have a poor transformer! ARrrggghhh.

Thanks

Ben K4ZEP

The Coil



The coil toroid form is available from :

http://www.antennex.com/palomar/page_7.htm There are 4 coils on this Torroid coil form.

2 EA, driver coils, 40 turns each of #26 enamel wire, .30 Ohms DC.

1 LV coil of 20 turns each of #26 enamel wire, .15 Ohms DC.

1-HV coil of 60 turns of #26 enamel wire, .45 Ohms DC.

The core form has a slot cut through it (bandsaw) the width of the magnet you plan to use, the magnet is then epoxy glued into place. Excitation windings are

the wound on the toroid all in the same direction using a home made bobbin to wind the specified number of turns on the form. If there is any interest, I'll put pictures of how I made the coil, the bobbin, etc.

The Test Board

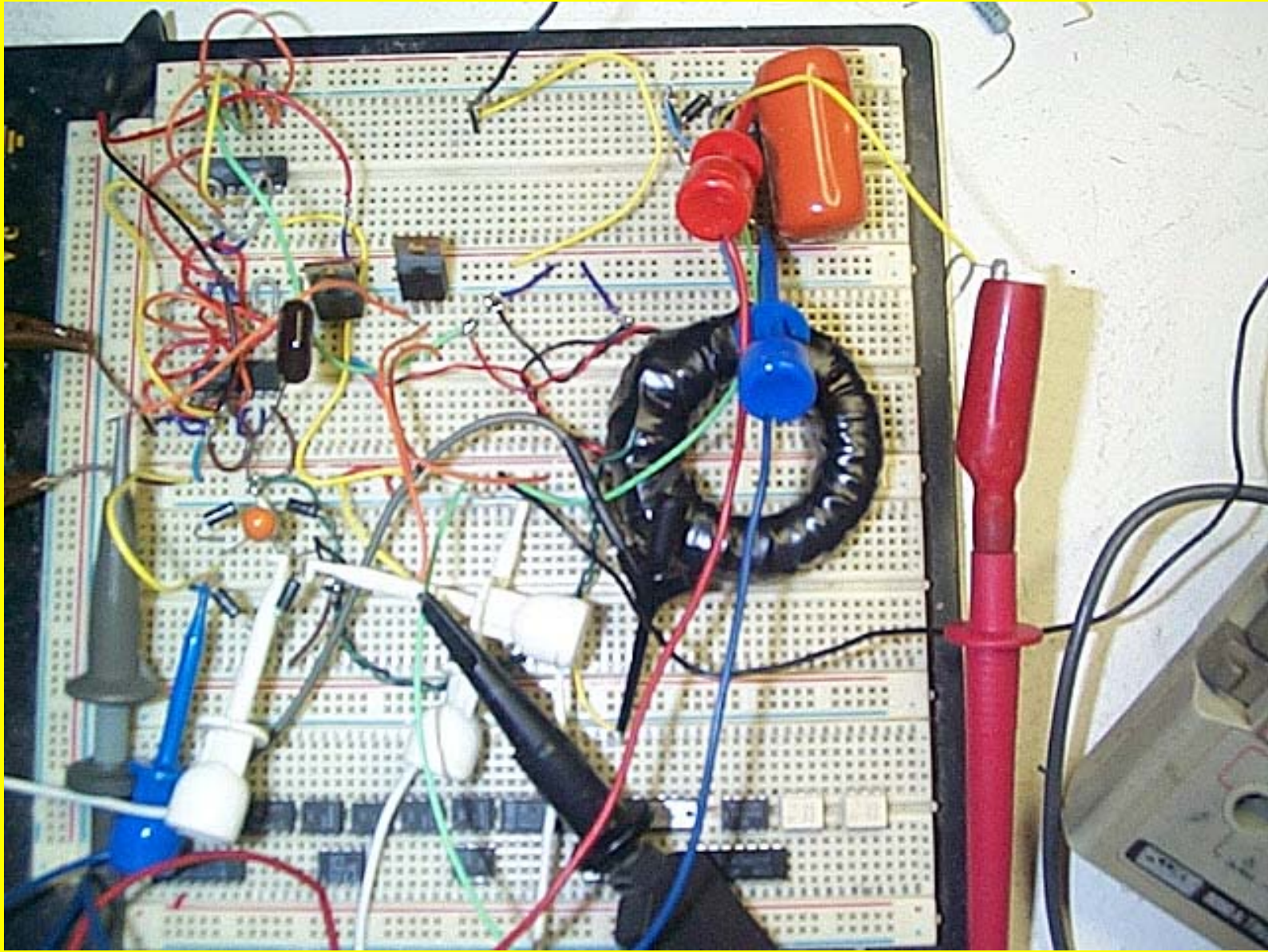

11:00 p.m. This is the test board so far today. The coil is in the mid-right, the two IRF 840's are in the center. The two chips above and below the Power FETS are the drivers. I am using quad sections to get the speed to drive the FET's with a rise time of about 20ns/volt. The device is VERY sensitive to frequency. My unit seems to work best with the frequency of 306Khz. I am driving the device with an external HP3310B function generator. The drive circuit pulls 2.6 Ma while running. I have run the output up to 10VDC to the drive coils. At this voltage, I pull .28Amps or 2.8 watts DC into the power fets . The two power supplies give the following output at that voltage. The low voltage supplies with a 4Kohm load, 3.2VDC at .7 Ma out. The high voltage supply puts out 11.87 VDC with a 15Kohm load or about .7 Ma out. Not much to brag about right

now but it is working as expected.

Things to do tomorrow.

1. Heat sink on the power FET's.
2. Self-run the driver section should occur at around 30 VDC into the output. This is where the turn selection was calculated. Power in the FETS has to be watched CAREFULLY! The circuit is so simple that there is no room for error. Got to look a lot more at the waveforms and try different combos on the switching coils.
3. Gradually work up to 75VDC on the output. Care must be taken to keep from blowing the outputs. Never turn off the drive with output drive connected in this configuration as one FET will be ON! Smoke!

Going to bed.

The Super Efficient Amplifier

By

Ben Thomas

Well gang, I have put about 20 hours on the bench building this MEG circuit. I have learned a lot and I'll try to pass on some of what I have learned.

First, let me say, what is shown in Patent #, 6,362,718 B1 is incomplete and does not work as shown. It is a good place to start but not a good place to finish. A lot of important information is left out such as (and I'm being picky!):

1. How do you convert the **VERY HIGH VOLTAGE** down to a usable source?
2. On sheet 3 of 5 of the drawings, how does the voltage get from a square wave in the primary to a nice sine wave as shown in Fig 6 E, F!
3. Also note, Fig 6G and 6 H show a problem in the switching and filtering circuit because of the artifact on the current trace.
4. Fig. 6 C does **NOT** address the high voltage spike (back EMF) developed in the circuit and which when it is operating correctly goes a **LOT** higher than indicated.

As I worked with the circuit, I slowly learned to appreciate what is going on! Lets start of with some general observations.

- A. To make power, it **TAKES** power. Quit thinking about Ma and 10-30 volts. Start thinking **AMPS** an **> 50** volts.
- B. Think of the **AC** resistance of the coils; **DO** not worry about the **DC** resistance of the coils this is an **ACTIVE** device.
- C. Think the circuit either works at any ratio of turns or it won't work at all.
- D. **THINK RESONANCE IN THE SECONDARY! THAT IS WHERE THE**

SINE WAVES AND SUPER EFFECIENCY COMES FROM! When the secondary is at resonance the current drops in the primary, there is less heat in the primary circuit and the sucker starts to purrrrrr.

- E. THINK OF WAYS TO USE THE BACK EMF pulse, this improves the circuit efficiency.
- F. My device is almost 100% efficient (22 watts in, 21 watts out) at 22VDC @ 1.12 amps input, 103 kHz, 60VDC @ .35 amps DC out. It powers the driving circuitry with no fuss or bother with a simple regulator. Just as a afterthought I tried a standard 30 W. desk lamp I have on my workbench as a load and it drives it to about one half normal brightness. I can only test for a few seconds due to heating in the FET's. I fully expect it to go SUPER EFFICIENT (a term I have coined) at about 25VDC input and about 1.25 Amps into the INPUT coils. For the next few days, I am stalled till I can borrow from work a 40VDC 10 Amp. Programmable supply, A few dozen changes to the circuitry, add heat sinks to the power FETS and rewind the input coils with larger wire (I used #26 wire) as I had no idea what was required at the start. In the meantime, I'm going to add an on board square wave VCO. I have discovered a simple way to control the output by controlling the frequency around resonance.

First, some basic data:

Voltage to drivers=9vdc battery start, regulator run in complete circuit.

Current in drive circuit approximately. 3ma.

Voltage to driver coils 10VDC.

Current in driver coils about .36Amp/ 50% duty cycles each coil.

Voltage in 20-turn output coils 34VPP Sine wave AC. 103 kHz. No load.

Voltage into the 100 ohm resistive load is 20V/PP.

The voltage and current seem to be linear in the input coils in a non-resonance condition. The voltage in the output coils is NOT linear but slightly logarithmic when resonance. I have a hunch the curve is indicative of the efficiency of the magnet/core/coil combination.

Note: If you do NOT have a load on the output coil, the voltage will rise to abnormal levels. Also, note, at 10VDC, the efficiency is low. It really takes off and the efficiency goes up dramatically at about 18-20 VDC input. The patent shows that the device is always "Super Efficient" I find that not to be the fact in my unit and there is (should be) a cross over point where it goes into this condition. I am using only 10VDC to the coils for this test as everything is stable and I don't have to use heat sinks on the FET's. I noted in someone's evaluation of the MEG and the patent that it was said, "you can't get a patent" unless you have a working model. NOT TRUE! I have seen more patents that obviously

did NOT, could NOT work than Carter has liver pills! I feel sorry for the suckers using a 450 turns on the output coils! The voltage there must be astronomical without a very controlled load! Arc over and shorting would be a very common affair. Oh well. Now to the pictures.

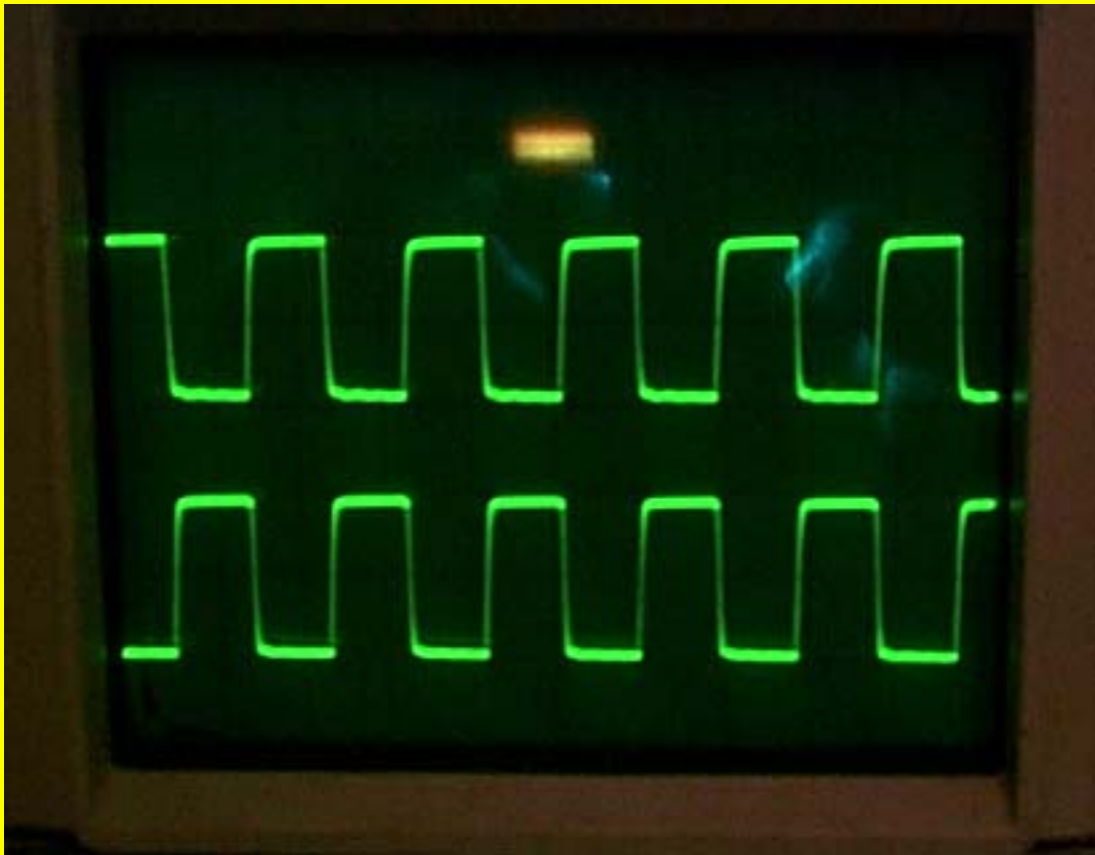

Wave1

This is the waveform to the gates of the FET's

5V/Div, 2us/div

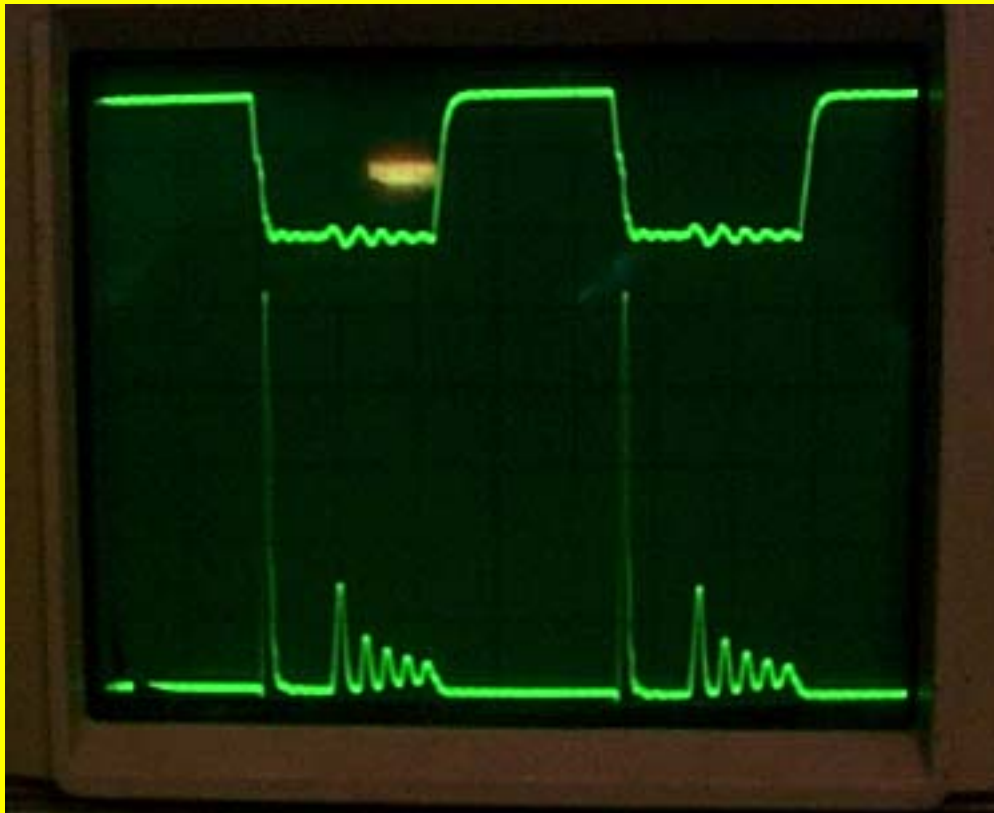

Wave2

This is the waveform to the gate at top and the waveform at the junction of the FET and Coil. Note the 260 V Back EMF Pulse!

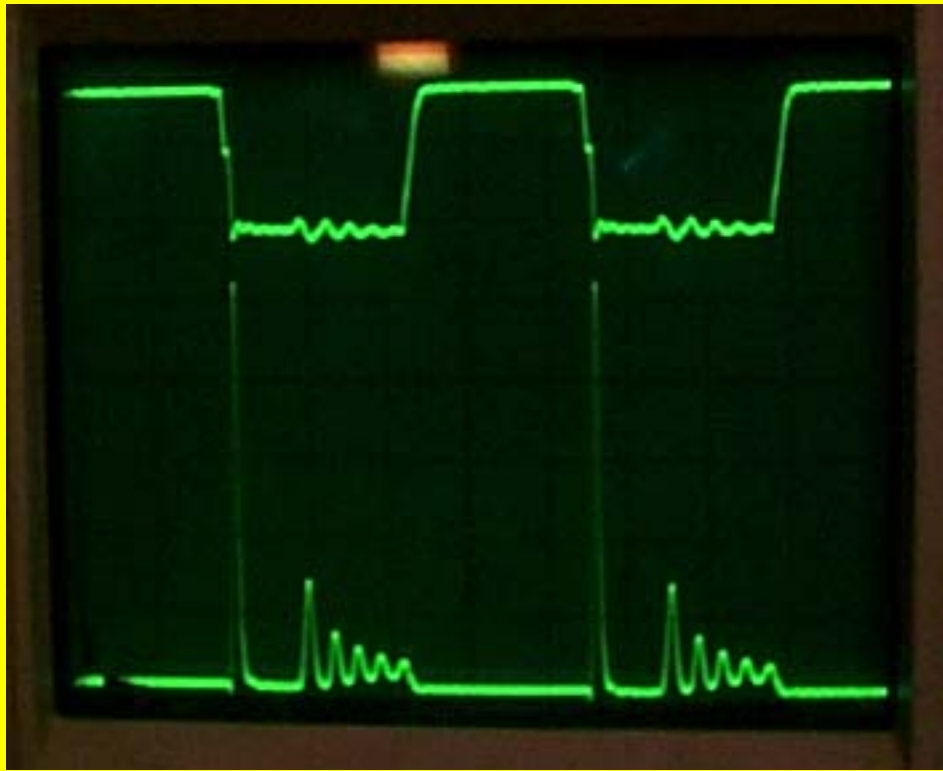

Wave 3

This is the same waveform on the second FET.



Wave 4

This is both junctions with reference to the first gate.

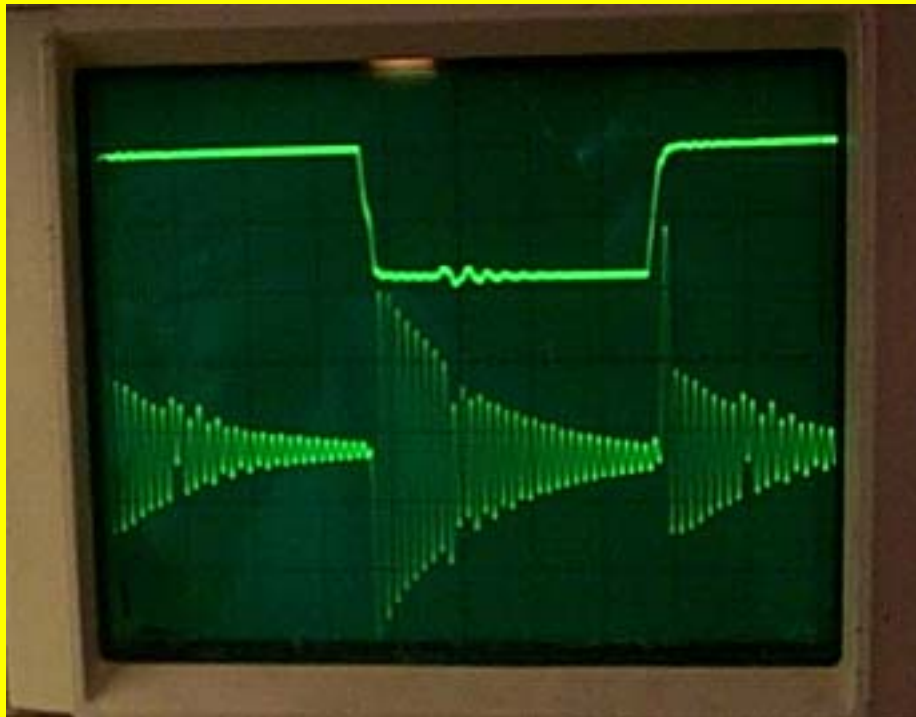

Wave5

First FET gate reference, frequency way low, note the ringing in the secondary coil!

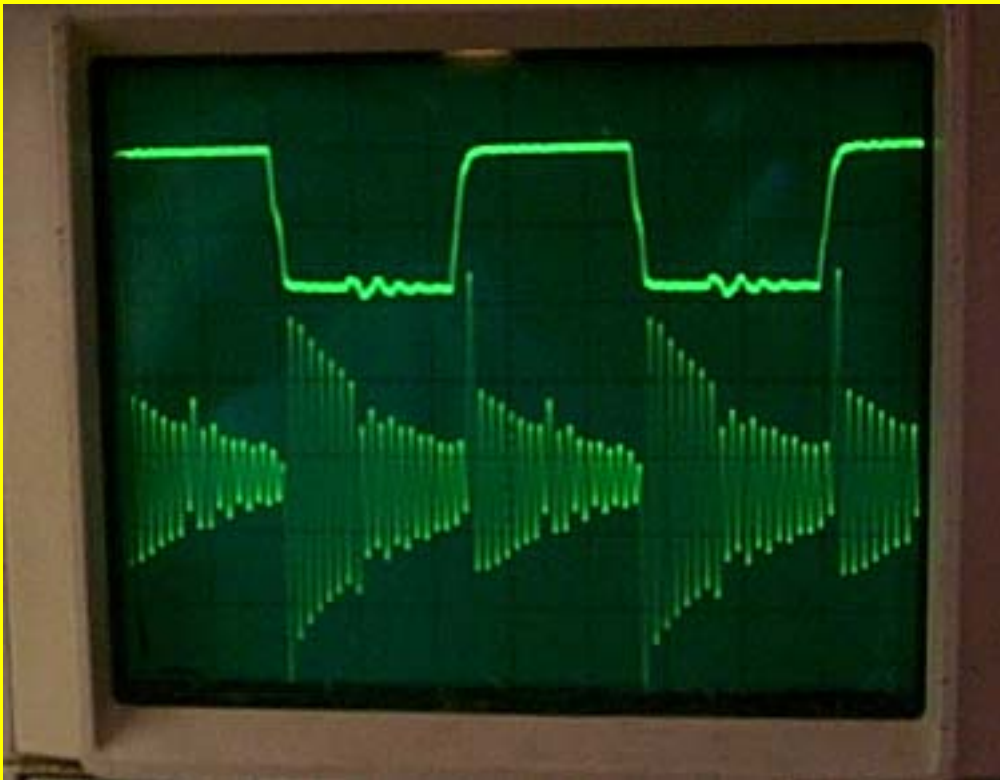

Wave6

This is at junction of FET and output coil no resonance cap.

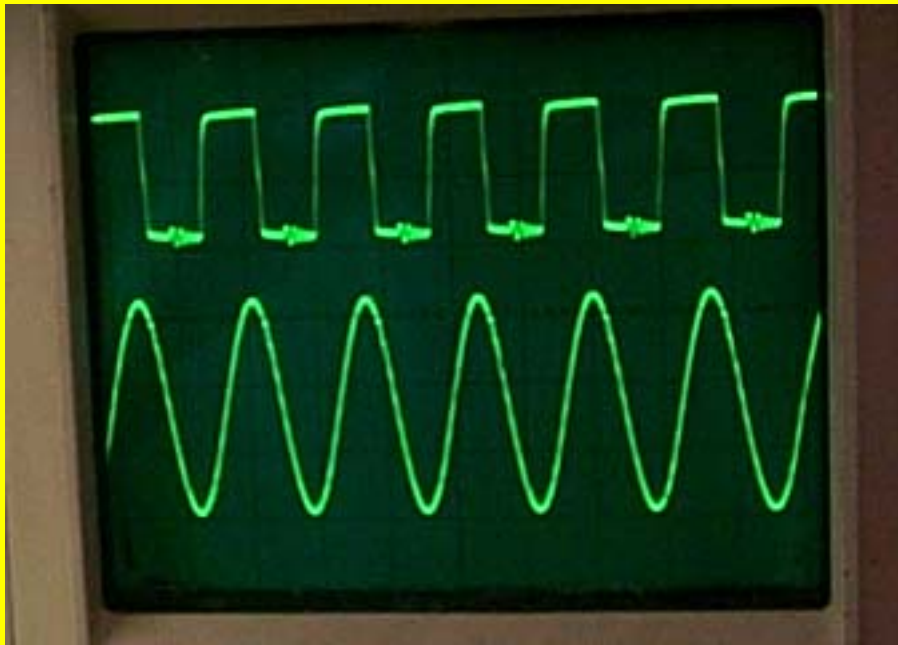

Wave7

This is output coil with Cap at resonance with virtually no load (scope probe only).

10V/div 34p/p no load.

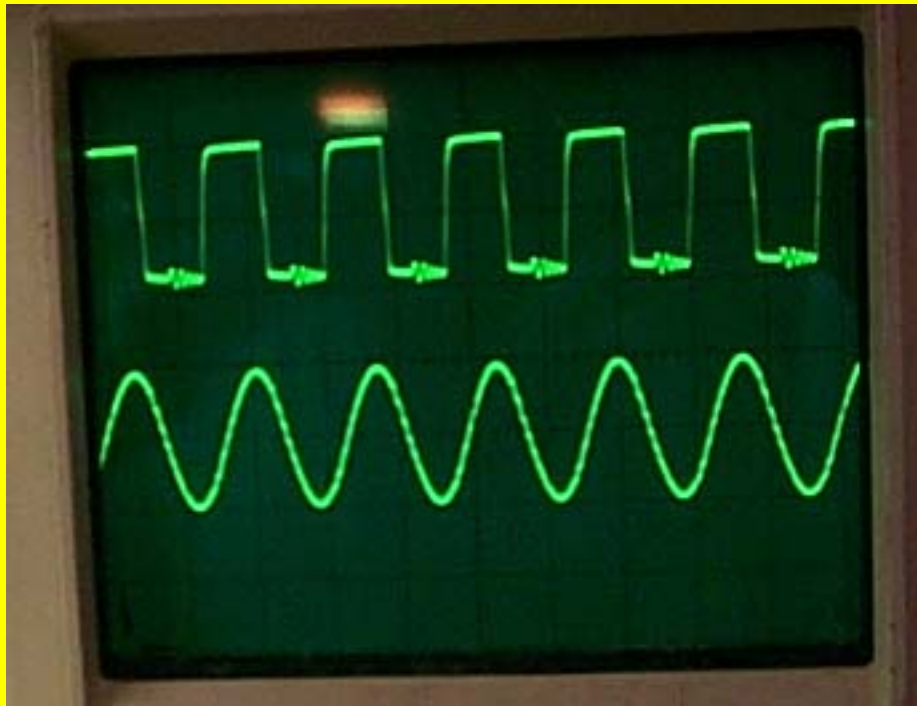

Same as above with 100 Ohm load. 20V/pp.

Well gang that's it for tonight. I'll post more in a few days. I'm kinda burnt out right now. When I have it in the self-run mode I will post schematics, etc. Things change so much every time I change something a schematic is not worth drawing.

Ben K4ZEP

Graphs

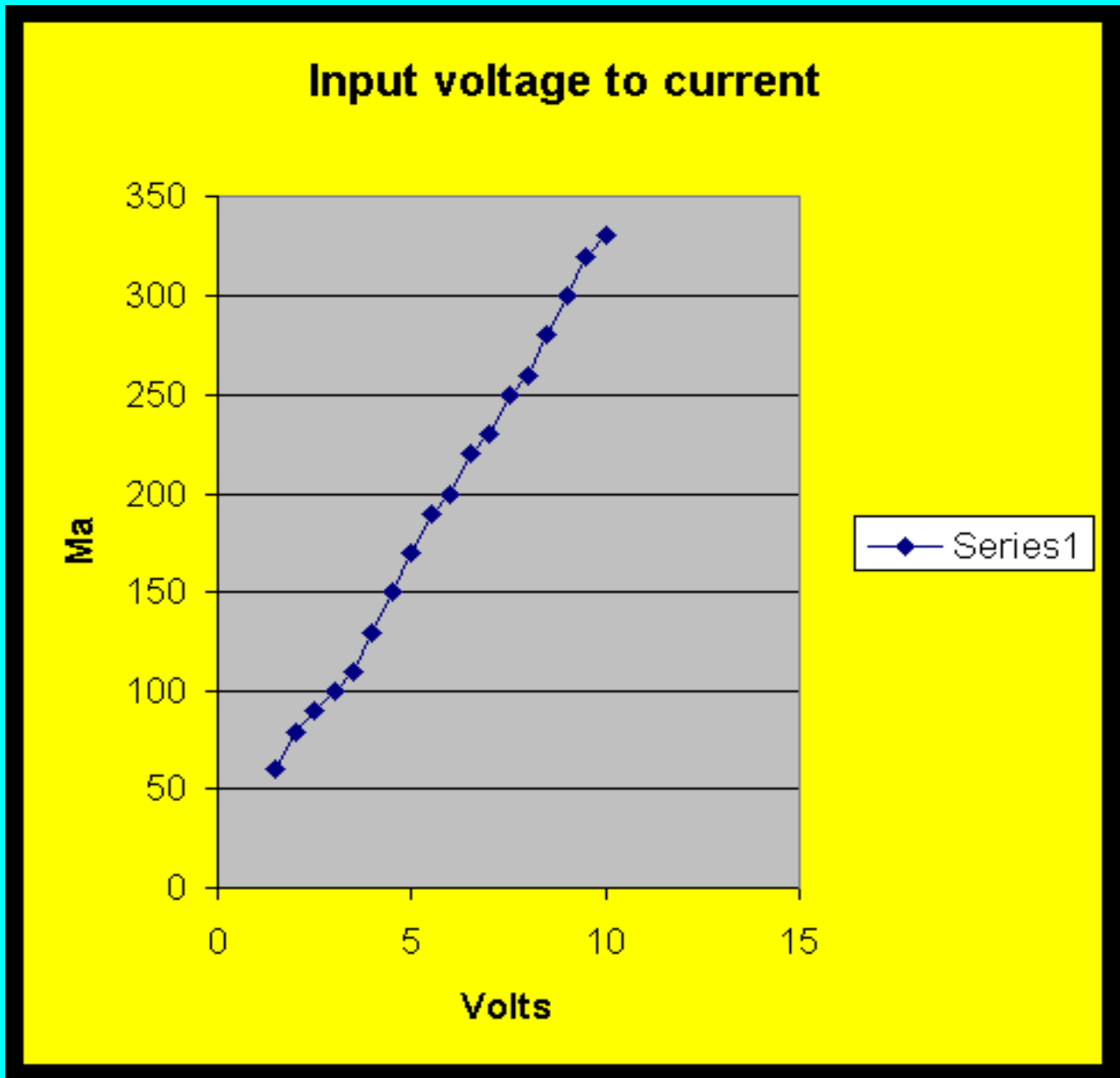

This is the input voltage to the coils vs. the input current. Note there is a little shift in the data due to the fact that the meter on the power supply is only accurate to 10Ma. But it obviously is linear!

Graphs

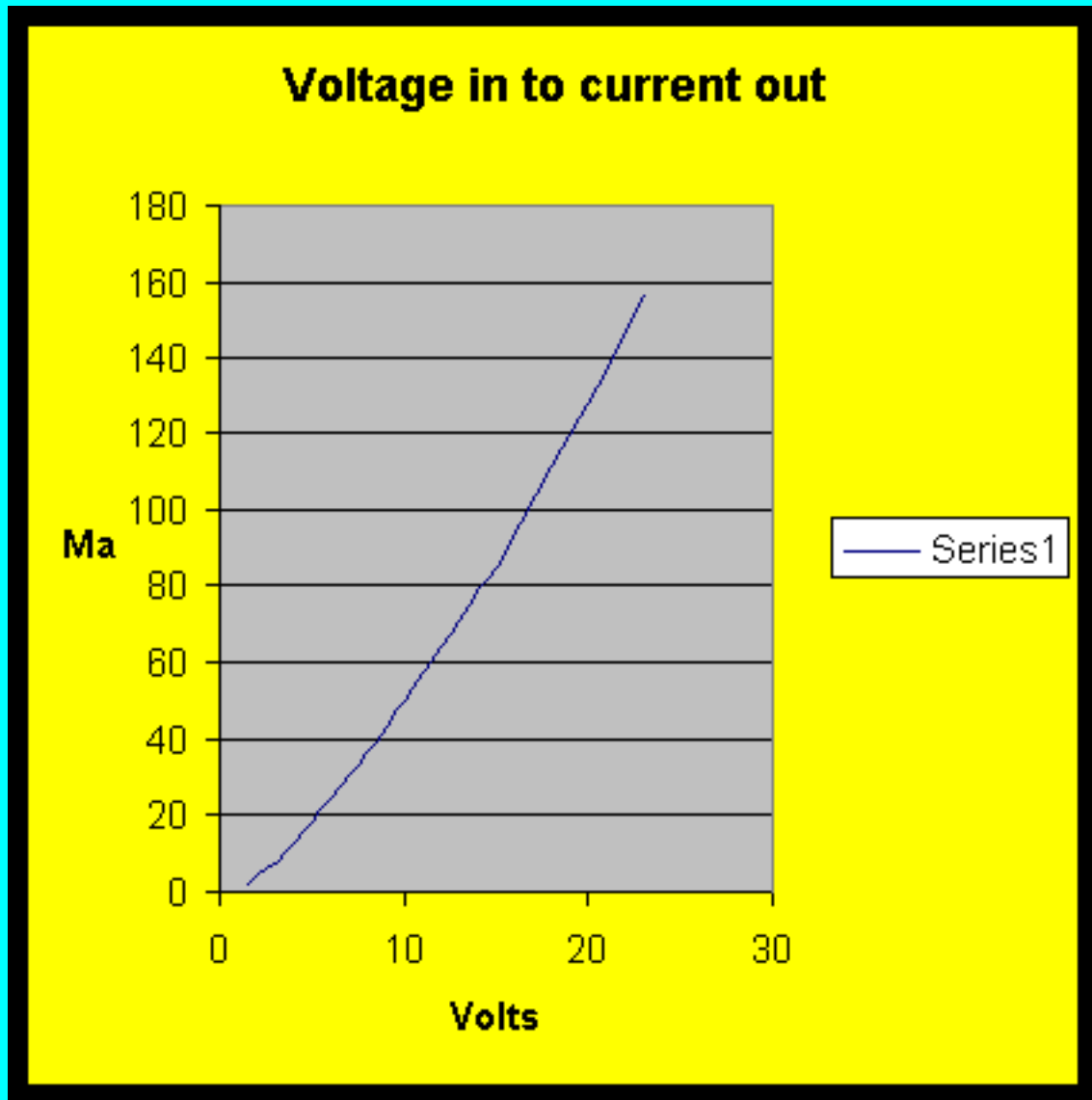

This is the graph of the output coil current after rectification with the shunt resistor in the meter being the load. It shows the same curve into a 100-ohm resistive load. NOTE IT IS NOT LINEAR and is starting to kick in at 26 volts.

The MEG Version 2.0

By

Ben Thomas

It will be a few days before I can get my heat sinks and power supply. To further my knowledge of what is going on, I am going to wind a new coil using a weak ferrite magnet to see how it responds to the same number of turns on the excitation side and the same number of turns on the secondary. I am not going to add a second HV secondary coil, as I do not need it to obtain the data I need.

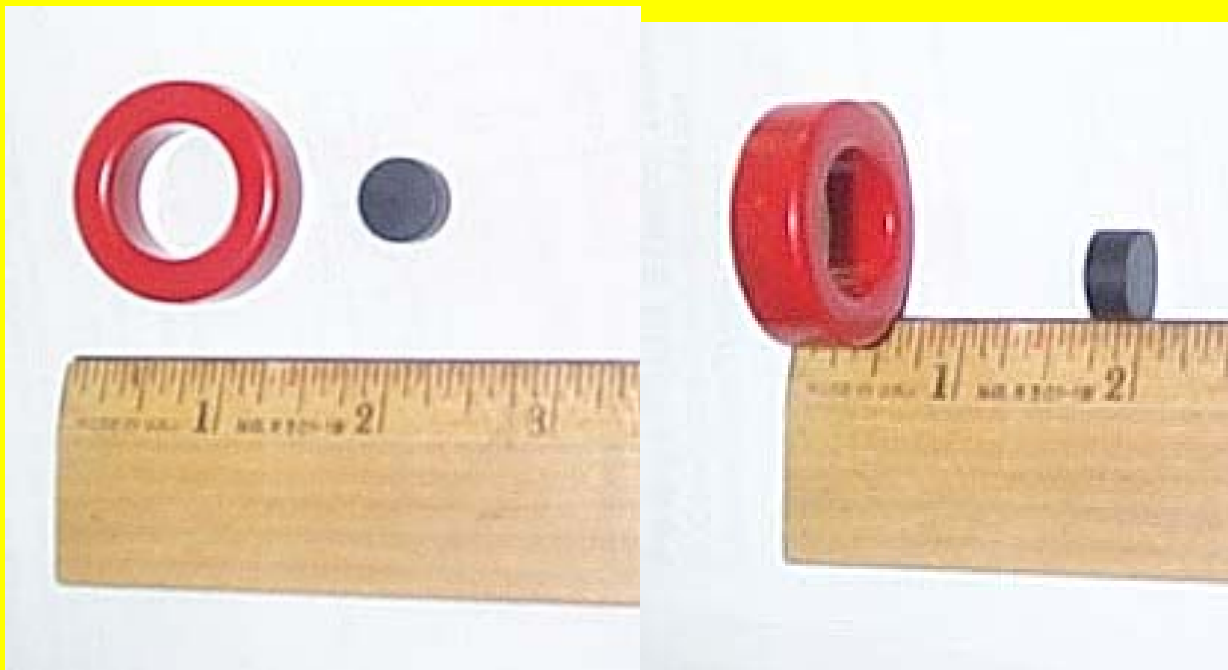



Here is the progression of building a coil. The notch is cut on a band saw and then dressed up with a file for a snug fit and the magnet is then ready to be glued with epoxy into place.

Data:

Coil form is a **Core Size T130-2 available from:** http://www.antennex.com/palomar/page_7.htm

Primary is # 26 AWG, 40 turns each coil on each side of the magnet.

Secondary is #26 AWG, 40 turns wound single layer on the rest of the form.

A MEG COIL IS BORN

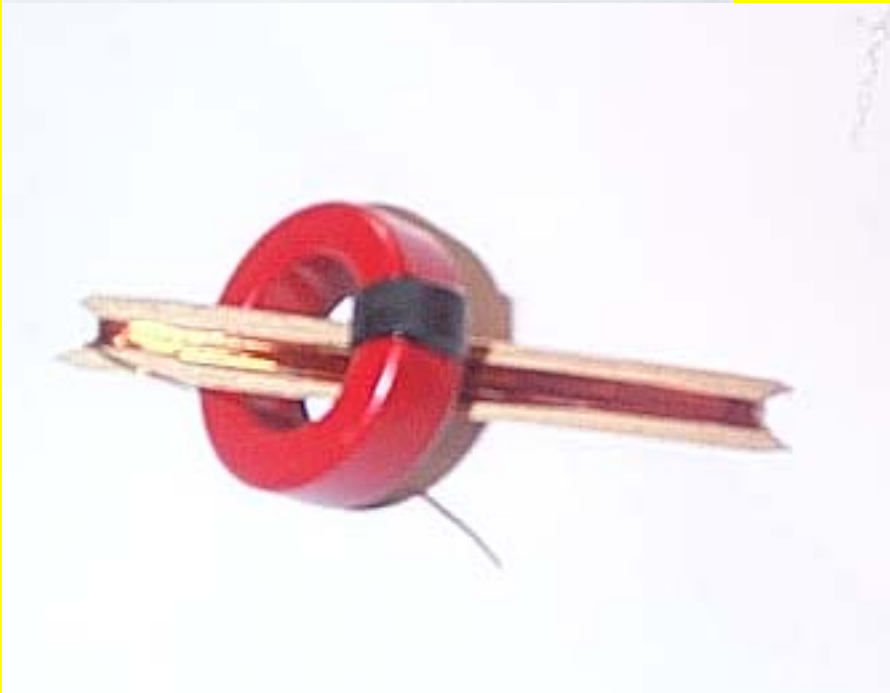

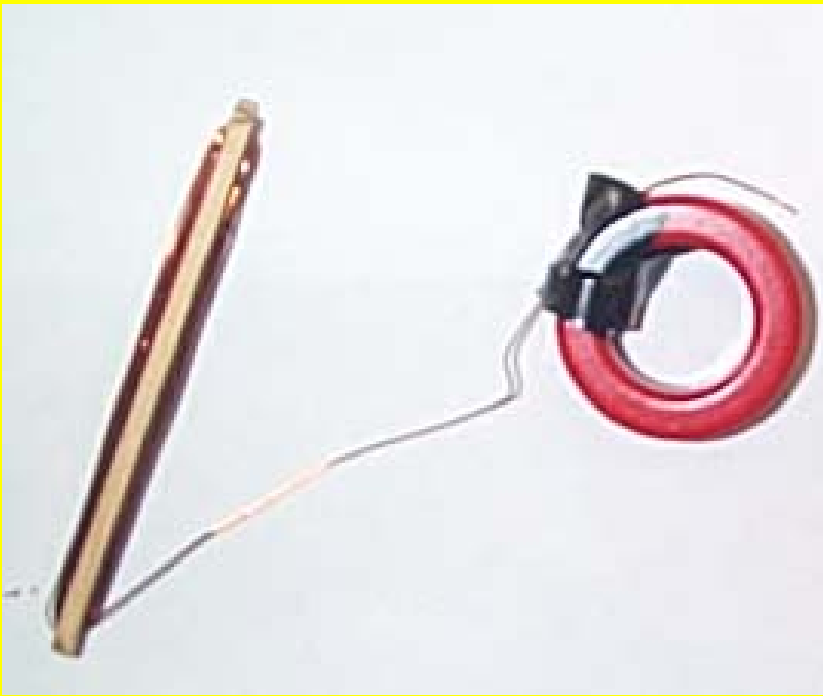

From left to right, you see the bobbin used to hold the wire you will put on the Torroid and the left shows a piece of tape holding the wire so you can wind the coil.





Here you have the second driver coil wound, and then it is taped up in preparation for the wires to be soldered on to it.



Here you have the finished driver coils on the left and the wound but not bound output coil on the right.



The finished coil, about 2 hours work counting putting it on the Web page.

Lets see if it works!

Ferrite SUCKS, I'll document it tomorrow, 3-31-02, I'm pooped, going to bed.

Ch. 6

Dup. for your files

THE LINK BETWEEN THE SACHS AND O(3) THEORIES OF ELECTRODYNAMICS

M. W. EVANS

CONTENTS

- I. Introduction
- II. The Non-Abelian Structure of the Field Tensor
- III. The Covariant Derivative
- IV. Energy from the Vacuum
- V. The Curvature Tensor
- VI. Generally Variant 4-Vectors
- VII. Sachs Theory in the Form of a Gauge Theory
- VIII. Antigravity Effects in the Sachs Theory
- IX. Some Notes on Quaternion-Valued Metrics

Acknowledgments

References

I. INTRODUCTION

In this volume, Sachs [1] has demonstrated, using irreducible representations of the Einstein group, that the electromagnetic field can propagate only in curved spacetime, implying that the electromagnetic field tensor can exist only when there is a nonvanishing curvature tensor $\kappa_{\mu\nu}$. Using this theory, Sachs has shown that the structure of electromagnetic theory is in general non-Abelian. This is the same overall conclusion as reached in O(3) electrodynamics [2], developed in the second chapter of this volume. In this short review, the features common to Sachs and O(3) electrodynamics are developed. The $\mathbf{B}^{(3)}$ field of O(3) electrodynamics is extracted from the quaternion-valued $\mathbf{B}^{\mu\nu}$ equivalent in the Sachs theory; the most general form of the vector potential is considered in both theories, the covariant derivatives are compared in both theories, and the possibility of extracting energy from the vacuum is considered in both theories.

II. THE NON-ABELIAN STRUCTURE OF THE FIELD TENSOR

The non-Abelian component of the field tensor is defined through a metric q^μ that is a set of four quaternion-valued components of a 4-vector, a 4-vector each of whose components can be represented by a 2 x 2 matrix. In condensed notation:

$$q^\mu = (q^{\mu 0}, q^{\mu 1}, q^{\mu 2}, q^{\mu 3}) \quad (1)$$

and the total number of components of q^μ is 16. The covariant and second covariant derivatives of q^μ vanish [1] and the line element is given by

$$ds = q^\mu(x) dx_\mu \quad (2)$$

which, in special relativity (flat spacetime), reduces to

$$ds = \sigma^\mu dx_\mu \quad (3)$$

where σ^μ is a 4-vector made up of **Pauli** matrices:

$$\sigma^\mu = \left(\left[\begin{array}{cc} 1 & 0 \\ 0 & 1 \end{array} \right], \left[\begin{array}{cc} 0 & 1 \\ 1 & 0 \end{array} \right], \left[\begin{array}{cc} 0 & -i \\ i & 0 \end{array} \right], \left[\begin{array}{cc} 1 & 0 \\ 0 & -1 \end{array} \right] \right) \quad (4)$$

In the limit of special relativity

$$q^\mu q^{\nu*} - q^\nu q^{\mu*} \rightarrow \sigma^\mu \sigma^\nu - \sigma^\nu \sigma^\mu \quad (5)$$

where * denotes reversing the time component of the quaternion-valued q^μ . The most general form of the non-Abelian part of the electromagnetic field tensor in conformally curved spacetime is 1

$$F^{\mu\nu} = \frac{1}{8} QR(q^\mu q^{\nu*} - q^\nu q^{\mu*}) \quad (6)$$

To consider magnetic flux density components of $F^{\mu\nu}$, Q must have the units of weber and R , the scalar curvature, must have units of inverse square meters. In the flat spacetime limit, $R = 0$, so it is clear that the non-Abelian part of the field tensor, Eq. (6), vanishes in special relativity. The complete field tensor $F^{\mu\nu}$ vanishes [1] in flat spacetime because the curvature tensor vanishes. These considerations refute the Maxwell-Heaviside theory, which is developed in flat spacetime, and show that O(3) electrodynamics is a theory of conformally curved spacetime. Most generally, the Sachs theory is a closed field theory that, in principle, unifies all four fields: gravitational, electromagnetic, weak, and strong.

There exist generally covariant four-valued 4-vectors that are components of q^μ , and these can be used to construct the basic structure of O(3) electrodynamics in terms of single-valued components of the quaternion-valued metric q^μ . Therefore, the Sachs theory can be reduced to O(3) electrodynamics, which is a Yang-Mills theory [3,4]. The empirical evidence available for both the Sachs and O(3) theories is summarized in this review, and discussed more extensively in the individual reviews by Sachs [1] and Evans [2]. In other words, empirical evidence is given of the instances where the Maxwell-Heaviside theory fails and where the Sachs and O(3) electrodynamics succeed in describing empirical data from various sources. The fusion of the O(3) and Sachs theories provides proof that the $\mathfrak{g}^{(3)}$ field [2] is a physical field of curved spacetime, which vanishes in flat spacetime (Maxwell-Heaviside theory [2]).

In Eq. (5), the product $q^\mu q^{\nu*}$ is quaternion-valued and noncommutative, but not antisymmetric in the indices μ and ν . The $\mathbf{B}^{(3)}$ field and structure of O(3) electrodynamics must be found from a special case of Eq. (5) showing that O(3) electrodynamics is a Yang-Mills theory and also a theory of general relativity [1]. The important conclusion reached is that Yang-Mills theories can be derived from the irreducible representations of the Einstein group. This result is consistent with the fact that all theories of physics must be theories of general relativity in principle. From Eq. (1), it is possible to write four-valued, generally covariant, components such as

$$q_x = (q_x^0, q_x^1, q_x^2, q_x^3) \quad (7)$$

which, in the limit of special relativity, reduces to

$$\sigma_x = (0, \sigma_x, 0, 0) \quad (8)$$

Similarly, one can write

$$q_y = (q_y^0, q_y^1, q_y^2, q_y^3) \rightarrow (0, 0, \sigma_y, 0) \quad (9)$$

and use the property

$$q_x q_y^* - q_y q_x^* \rightarrow \sigma_x \sigma_y - \sigma_y \sigma_x \quad (10)$$

in the limit of special relativity. The only possibility from Eqs. (7) and (9) is that

$$\begin{array}{ccc} q_x^1 q_y^{2*} & q_y^2 q_x^{1*} = 2iq_z^3 & \\ & \downarrow & \\ \sigma_x \sigma_y & \sigma_y \sigma_x = 2i\sigma_z & \end{array} \quad (11)$$

where q_x^1 is single valued. In a 2×2 matrix representation, this is

$$q_x^1 = \begin{bmatrix} 0 & q_x^1 \\ q_x^1 & 0 \end{bmatrix} \rightarrow \sigma_x = \begin{bmatrix} 0 & 1 \\ 1 & 0 \end{bmatrix} \quad (12)$$

Similarly

$$q_y^{2*} = \begin{bmatrix} 0 & -iq_y^2 \\ iq_y^2 & 0 \end{bmatrix} \rightarrow \sigma_y = \begin{bmatrix} 0 & -i \\ i & 0 \end{bmatrix} \quad (13)$$

$$q_z^3 = \begin{bmatrix} q_z^3 & 0 \\ 0 & -q_z^3 \end{bmatrix} \rightarrow \sigma_z = \begin{bmatrix} 1 & 0 \\ 0 & -1 \end{bmatrix} \quad (14)$$

Therefore, there exist cyclic relations with $O(3)$ symmetry

$$\begin{aligned} q_x^1 q_y^{2*} - q_y^2 q_x^{1*} &= 2iq_z^3 \\ q_y^2 q_z^{3*} - q_z^3 q_y^{2*} &= 2iq_x^1 \\ q_z^3 q_x^{1*} - q_x^1 q_z^{3*} &= 2iq_y^2 \end{aligned} \quad (15)$$

and the structure of $O(3)$ electrodynamics [2] begins to emerge. If the space basis is represented by the complex circular $((1),(2),(3))$ then Eqs. (15) become

$$\begin{aligned} q_x^{(1)} q_y^{(2)*} - q_y^{(2)} q_x^{(1)*} &= 2iq_z^{(3)} \\ q_y^{(2)} q_z^{(3)*} - q_z^{(3)} q_y^{(2)*} &= 2iq_x^{(1)} \\ q_z^{(3)} q_x^{(1)*} - q_x^{(1)} q_z^{(3)*} &= 2iq_y^{(2)} \end{aligned} \quad (16)$$

These are cyclic relations between single-valued metric field components in the non-Abelian part [Eq. (6)] of the quaternion-valued $F^{\mu\nu}$. Equation (16) can be put in vector form

$$\begin{aligned} \mathbf{q}^{(1)} \times \mathbf{q}^{(2)} &= i\mathbf{q}^{(3)*} \\ \mathbf{q}^{(2)} \times \mathbf{q}^{(3)} &= i\mathbf{q}^{(1)*} \\ \mathbf{q}^{(3)} \times \mathbf{q}^{(1)} &= i\mathbf{q}^{(2)*} \end{aligned} \quad (17)$$

where the asterisk denotes ordinary complex conjugation in Eq. (17) and quaternion conjugation in Eq. (16).

Equation (17) contains vector-valued metric fields in the complex basis $((1),(2),(3))$ [2]. Specifically, in $O(3)$ electrodynamics, which is based on the

existence of two circularly polarized components of electromagnetic radiation [2]

$$\mathbf{q}^{(1)} = \frac{1}{\sqrt{2}} (\mathbf{i}\mathbf{i} + \mathbf{j}) \exp(i\phi) \quad (18)$$

$$\mathbf{q}^{(2)} = \mathbf{k}(-\mathbf{i}\mathbf{i} + \mathbf{j}) \exp(i\phi) \quad (19)$$

giving

$$\mathbf{q}^{(3)*} = \mathbf{k} \quad (20)$$

and

$$\mathbf{B}^{(3)} = \frac{1}{8} QR\mathbf{q}^{(3)} \quad (21)$$

Therefore, the $\mathbf{B}^{(3)}$ field [2] is proved from a particular choice of metric using the irreducible representations of the Einstein group [1]. It can be seen from Eq. (21) that the $\mathbf{B}^{(3)}$ field is the vector-valued metric field $\mathbf{q}^{(3)}$ within a factor $\frac{1}{8} QR$. This result proves that $\mathbf{B}^{(3)}$ vanishes in flat spacetime, because $R = 0$ in flat spacetime. If we write

$$B^{(3)} = \frac{1}{8} QR \quad (22)$$

then Eq. (17) becomes the B cyclic theorem [2] of O(3) electrodynamics:

$$\mathbf{B}^{(1)} \times \mathbf{B}^{(2)} = iB^{(0)}\mathbf{B}^{(3)*} \quad (23)$$

..

Since O(3) electrodynamics is a Yang-Mills theory [3,4], we can write

$$\mathbf{q} = q^{(1)}\mathbf{i} + q^{(2)}\mathbf{j} + q^{(3)}\mathbf{k} \quad (24)$$

from which it follows [5] that

$$D^\mu(D_\mu\mathbf{q}) = \mathbf{0}; \quad D_\mu\mathbf{q} = \mathbf{0} \quad (25)$$

Thus the first and second covariant derivatives vanish [1].

The Sachs theory [1] is able to describe parity violation and spin-spin interactions from first principles [6] on a classical level; it can also explain



several problems of neutrino physics, and the Pauli exclusion principle can be derived from it classically. The quaternion form of the theory [1], which is the basis of this review chapter, predicts small but nonzero masses for the neutrino and photon; describes the Planck spectrum of blackbody radiation classically; describes the Lamb shifts in the hydrogen atom with precision equivalent to quantum electrodynamics, but without renormalization of infinities; proposes grounds for charge quantization; predicts the lifetime of the muon state; describes electron-muon mass splitting; predicts physical longitudinal and time-like photons and fields; and has built-in P , C , and T violation.

To this list can now be added the advantages of $O(3)$ over $U(1)$ electrodynamics, advantages that are described in the review by Evans in Part 2 of this three-volume set and by Evans, Jeffers, and Vigier in Part 3. In summary, by interlocking the Sachs and $O(3)$ theories, it becomes apparent that the advantages of $O(3)$ over $U(1)$ are symptomatic of the fact that the electromagnetic field vanishes in flat spacetime (special relativity), if the irreducible representations of the Einstein group are used.

III. THE COVARIANT DERIVATIVE

The covariant derivative in the Sachs theory [1] is defined by the spin-affine connection:

$$D^p = \partial^p + \Omega^p \quad (26)$$

where

$$\Omega_\mu = \frac{1}{4}(\partial_\mu q^p + \Gamma_{\tau\mu}^p q^\tau) q_p^* \quad (27)$$

and where $\Gamma_{\tau\mu}^p$ is the Christoffel symbol. The latter can be defined through the reducible metrics $g_{\mu\nu}$ as follows [1]:

$$\Gamma_{\mu\alpha}^p = \frac{1}{2} g^{\rho\lambda} (\partial_\mu g_{\lambda\alpha} + \partial_\alpha g_{\mu\lambda} - \partial_\lambda g_{\alpha\mu}) \quad (28)$$

In $O(3)$ electrodynamics, the covariant derivative on the classical level is defined by

$$D_\mu = \partial_\mu - igA_\mu = \partial_\mu - ig\mathbf{M}^a A_\mu^a \quad (29)$$

where \mathbf{M}^a are rotation generators [2] of the $O(3)$ group, and where a is an internal index of Yang-Mills theory. The complete vector potential in $O(3)$ electrodynamics is defined by

$$\mathbf{A} = A^{(1)}\mathbf{e}^{(2)} + A^{(2)}\mathbf{e}^{(1)} + A^{(3)}\mathbf{e}^{(3)} \quad (30)$$

where $e^{(1)}, e^{(2)}, e^{(3)}$ are unit vectors of the complex circular basis ((1),(2),(3)) [2]. If we restrict our discussion to plane waves, then the vector potential is

$$\mathbf{A}^{(1)} = \frac{A^{(0)}}{\sqrt{2}} (\mathbf{i} - \mathbf{j}) \exp(i\phi) \quad (31)$$

where ϕ is the electromagnetic phase. Therefore, there are O(3) electrodynamics components such as

$$A_X^{(1)} = \frac{iA^{(0)}}{\sqrt{2}} e^{i\phi}; \quad A_Y^{(1)} = \frac{A^{(0)}}{\sqrt{2}} e^{i\phi} \quad (32)$$

In order to reduce the covariant derivative in the Sachs theory to the O(3) covariant derivative, the following classical equation must hold:

$$-igA_\mu = \frac{1}{4} (D_\mu q^\rho) q_\rho^* \quad (33)$$

This equation can be examined component by component, giving relations such as

$$-igA_X^{(1)} = -\frac{1}{4} (D_X q_Y^{(1)}) A_Y^{(1)} \quad (34)$$

where we have used

$$q_Y^{(1)} = -iq_X^{(1)} \quad (35)$$

Using [2]

$$g = \frac{\kappa}{A^{(0)}} \quad (36)$$

we obtain

$$i\kappa q_X^{(1)} = \frac{1}{4} (D_X q_Y^{(1)}) q_Y^{(1)} = -\frac{i}{4} (D_X q_Y^{(1)}) q_X^{(1)} \quad (37)$$

so that the wavenumber κ is defined by

$$\kappa = -\frac{1}{4} D_X q_Y^{(1)} \quad (38)$$

Therefore, we can write

$$D_X q_Y^{(1)} = D_1 q^{1(1)} = \partial_1 q^{1(1)} + \Gamma_{\lambda 1}^1 q^{\lambda(1)} \quad (39)$$

and the wavenumber becomes the following sum:

$$\kappa = -\frac{1}{4}(\Gamma_{11}^1 q^{1(1)} + \Gamma_{21}^1 q^{2(1)}) \quad (40)$$

Using the identities

$$q^{1(1)} = q_x^{(1)} = \frac{i}{\sqrt{2}} e^{i\phi} \quad (41)$$

$$q^{2(1)} = q_y^{(1)} = \frac{1}{\sqrt{2}} e^{i\phi} \quad (42)$$

the wavenumber becomes

$$\kappa = -\frac{1}{4} \left(\frac{i\Gamma_{11}^1}{\sqrt{2}} e^{i\phi} + \frac{\Gamma_{21}^1}{\sqrt{2}} e^{i\phi} \right) \quad (43)$$

Introducing the definition (28) of the Christoffel symbol, it is possible to write

$$\begin{aligned} \Gamma_{11}^1 &= \frac{1}{2} g^{1\lambda} (\partial_1 g_{\lambda 1} + \partial_1 g_{1\lambda} - \partial_1 g_{11}) \\ &= \frac{1}{2} g^{13} \partial_z g_{11} + \dots \end{aligned} \quad (44)$$

so that

$$\kappa = -\frac{i}{8\sqrt{2}} g^{13} \partial_z g_{11} e^{i\phi} + \dots \quad (45)$$

This equation is satisfied by the following choice of metric:

$$g_{11} = \frac{1}{2}; \quad g^{13} = -8\sqrt{2} e^{-i\phi} \quad (46)$$

Similarly

$$\begin{aligned} \Gamma_{21}^1 &= \frac{1}{2} g^{1\lambda} (\partial_2 g_{\lambda 1} + \partial_1 g_{2\lambda} - \partial_\lambda g_{12}) \\ &= \frac{1}{2} g^{13} \partial_z g_{12} + \dots \end{aligned} \quad (47)$$

so that the wavenumber can be expressed as

$$\kappa = \frac{iK}{8\sqrt{2}} g^{13} g_{12} e^{i\phi} \quad (48)$$

an equation that is satisfied by the following choice of metric:

$$g_{12} = \frac{i}{2}; \quad g^{13} = -8\sqrt{2} e^{-i\phi} \quad (49)$$

Therefore, it is always possible to write the covariant derivative of the Sachs theory as an O(3) covariant derivative of O(3) electrodynamics. Both types of covariant derivative are considered on the classical level.

IV. ENERGY FROM THE VACUUM

The energy density in curved spacetime is given in the Sachs theory by the quaternion-valued expression

$$En_d = A^\mu J_\mu^* \quad (50)$$

where A^μ is the quaternion-valued vector potential and J_μ^* is the quaternion-valued 4-current as given by Sachs [1]. Equation (50) is an elegant and deeply meaningful expression of the fact that electromagnetic energy density is available from curved spacetime under all conditions; the distinction between field and matter is lost, and the concepts of “point charge” and “point mass” are not present in the theory, as these two latter concepts represent infinities of the closed-field theory developed by Sachs [1] from the irreducible representations of the Einstein group. The accuracy of expression (50) has been tested [1] to the precision of the Lamb shifts in the hydrogen atom without using renormalization of infinities. The Lamb shifts can therefore be viewed as the results of electromagnetic energy from curved spacetime.

Equation (50) is geometrically a scalar and algebraically quaternion-valued equation [1], and it is convenient to develop it using the identity [1]

$$q_\gamma q^{\kappa*} + q^\kappa q_\gamma^* = 2\sigma_0 \delta_\gamma^\kappa \quad (51)$$

with the indices defined as

$$\gamma = \kappa = \mu \quad (52)$$

to obtain

$$q^\mu q_\mu^* = \sigma_0 \delta^\mu \quad (53)$$

Using summation over repeated indices on the right-hand side, we obtain the following result:

$$q^\mu q_\mu^* = 4\sigma_0 \quad (54)$$

In the limit of flat spacetime

$$q^\mu q_\mu^* \rightarrow \sigma^\mu \sigma_\mu = 4\sigma_0 \quad (55)$$

where the right-hand side is again a scalar invariant geometrically and a quaternion algebraically.

Therefore, the energy density (50) assumes the simple form

$$A_\mu J_\mu^* = 4A_0 J_0^* \sigma_0 \quad (56)$$

A_0 and J_0^* are magnitudes of A^μ and J_μ^* . In flat spacetime, this electromagnetic energy density vanishes because the curvature tensor vanishes. Therefore, in the Maxwell-Heaviside theory, there is no electromagnetic energy density from the vacuum and the field does not propagate through flat spacetime (the vacuum of the Maxwell-Heaviside theory) because of the absence of curvature. The $\mathbf{B}^{(3)}$ field depends on the scalar curvature R in Eq. (21), and so the $\mathbf{B}^{(3)}$ field and O(3) electrodynamics are theories of conformally curved spacetime. To maximize the electromagnetic energy density, the curvature has to be maximized, and the maximization of curvature may be the result of the presence of a gravitating object. In general, wherever there is curvature, there is electromagnetic energy that may be extracted from curved spacetime using a suitable device such as a dipole [7].

Therefore, we conclude that electromagnetic energy density exists in curved spacetime under all conditions, and devices can be constructed [8] to extract this energy density.

The quaternion-valued vector potential A^μ and the 4-current J_μ^* both depend directly on the curvature tensor. The electromagnetic field tensor in the Sachs theory has the form

$$F_{\mu\nu} = \partial_\mu A_\nu^* - \partial_\nu A_\mu^* + \frac{1}{8} QR(q_\mu q_\nu^* - q_\nu q_\mu^*) \quad (57)$$

where the quaternion-valued vector potential is defined as

$$A_\nu = \frac{Q}{4} q_\nu^* \int (\kappa_{\rho\lambda} q^\lambda + q^\lambda \kappa_{\rho\lambda}^+) dx^\rho \quad (58)$$

The most general form of the vector potential is therefore given by Eq. (58), and if there is no curvature, the vector potential vanishes.

Similarly, the 4-current J_μ^* depends directly on the curvature tensor $\kappa_{\rho\lambda}$ [1], and there can exist no 4-current in the Heaviside-Maxwell theory, so the 4-current cannot act as the source of the field. In the closed-field theory,

represented by the irreducible representations of the Einstein group [1], charge and current are manifestations of curved spacetime, and can be regarded as the results of the field. This is the viewpoint of Faraday and Maxwell rather than that of Lorentz. It follows that there can exist a vacuum 4-current in general relativity, and the implications of such a current are developed by Lehnert [9]. The vacuum 4-current also exists in O(3) electrodynamics, as demonstrated by Evans and others [2,9]. The concept of vacuum 4-current is missing from the flat spacetime of Maxwell-Heaviside theory.

In curved spacetime, both the electromagnetic and curvature 4-tensors may have longitudinal as well as transverse components in general and the electromagnetic field is always accompanied by a source, the 4-current J_μ^* . In the Maxwell-Heaviside theory, the field is assumed incorrectly to propagate through flat spacetime without a source, a violation of both causality and general relativity. As shown in several reviews in this three-volume set, Maxwell-Heaviside theory and its quantized equivalent appear to work well only under certain incorrect assumptions, and quantum electrodynamics is not a physical theory because, as pointed out by Dirac and many others, it contains infinities. Sachs [1] has also considered and removed the infinite self-energy of the electron by a consideration of general relativity.

The O(3) electrodynamics developed by Evans [2], and its homomorph, the SU(2) electrodynamics of Barrett [10], are substructures of the Sachs theory dependent on a particular choice of metric. Both O(3) and SU(2) electrodynamics are Yang-Mills structures with a Wu-Yang phase factor, as discussed by Evans and others [2,9]. Using the choice of metric (17), the electromagnetic energy density present in the O(3) curved spacetime is given by the product

$$En_d = \mathbf{A} \cdot \mathbf{j} \quad (59)$$

where the vector potential and 4-current are defined in the ((1),(2),(3)) basis in terms of the unit vectors similar to those in Eq. (2), and as described elsewhere in this three-volume set [2]. The extraction of electromagnetic energy density from the vacuum is also possible in the Lehnert electrodynamics as described in his review in the first chapter of this volume (i.e., here, in Part 2 of this three-volume set). The only case where extraction of such energy is not possible is that of the Maxwell-Heaviside theory, where there is no curvature.

The most obvious manifestation of energy from curved spacetime is gravitation, and the unification of gravitation and electromagnetism by Sachs [1] shows that electromagnetic energy emanates under all circumstances from spacetime curvature. This principle has been tested to the precision of the Lamb shifts of H as discussed already. This conclusion means that the electromagnetic field does not emanate from a "point charge," which in general relativity can be present only when the curvature becomes infinite. The concept of "point

charge” is therefore unphysical, and this is the basic reason for the infinite electron self-energy in the Maxwell-Heaviside theory and the infinities of quantum electrodynamics, a theory rejected by Einstein, Dirac, and several other leading scientists of the twentieth century. The electromagnetic energy density inherent in curved spacetime depends on curvature as represented by the curvature tensor discussed in the next section. In the Einstein field equation of general relativity, which comes from the reducible representations of the Einstein group [1], the canonical energy momentum tensor of gravitation depends on the Einstein curvature tensor.

Sachs [1] has succeeded in unifying the gravitational and electromagnetic fields so that both share attributes. For example, both fields are non-Abelian under all conditions, and both fields are their own sources. The gravitational field carries energy that is equivalent to mass [1 1], and so is itself a source of gravitation. Similarly, the electromagnetic field carries energy that is equivalent to a 4-current, and so is itself a source of electromagnetism. These concepts are missing entirely from the Maxwell-Heaviside theory, but are present in $O(3)$ electrodynamics, as discussed elsewhere [2,10]. The Sachs theory cannot be reduced to the Maxwell-Heaviside theory, **but** can be reduced, as discussed already, to $O(3)$ electrodynamics. The fundamental reason for this is that special relativity is an asymptotic limit of general relativity, but one that is never reached precisely [1]. So the **Poincaré** group of special relativity is not a subgroup of the Einstein group of general relativity.

In standard Maxwell-Heaviside theory, the electromagnetic field is thought of as propagating in a source-free region in flat spacetime where there is no curvature. If, however, there is no curvature, the electromagnetic field vanishes in the Sachs theory [1], which is a direct result of using irreducible representations of the Einstein group of standard general relativity. The empirical evidence for the Sachs theory has been reviewed in this chapter already, and this empirical evidence refutes the Maxwell-Heaviside theory. In general relativity [1], if there is mass or charge anywhere in the universe, then the whole of spacetime is curved, and all the laws of physics must be written in curved spacetime, including, of course, the laws of electrodynamics. Seen in this light, the $O(3)$ electrodynamics of Evans [2] and the homomorphic $SU(2)$ electrodynamics of Barrett [12] are written correctly in conformally curved spacetime, and are particular cases of Einstein’s general relativity as developed by Sachs [1]. Flat spacetime as the description of the vacuum is valid only when the whole universe is empty.

From everyday experience, it is possible to extract gravitational energy from curved spacetime on the surface of the earth. The extraction of electromagnetic energy must be possible if the extraction of gravitational energy is possible, and the electromagnetic field influences the gravitational field and vice versa. The field equations derived by Sachs [1] for electromagnetism are complicated, but

can be reduced to the equations of O(3) electrodynamics by a given choice of metric. The literature discusses the various ways of solving the equations of O(3) electrodynamics [2,10], analytically, or using computation. In principle, the Sachs equations are solvable by computation for any given experiment, and such a solution would show the reciprocal influence between the electromagnetic and gravitational fields, leading to significant findings.

The ability of extracting electromagnetic energy density from the vacuum depends on the use of a device such as a dipole, and this dipole can be as simple as battery terminals, as discussed by Bearden [13]. The principle involved in this device is that electromagnetic energy density $A^\mu J_\mu^*$ exists in general relativity under all circumstances, and electromagnetic 4-currents and 4-potentials emanate from spacetime curvature. Therefore, the current in the battery is not driven by the positive and negative terminals, but is a manifestation of energy from curved spacetime, just as the hydrogen Lamb shift is another such manifestation. A battery runs down because the chemical energy needed to form the dipole dissipates.

In principle, therefore, the electromagnetic energy density in Eq. (50) is always available whenever there is spacetime curvature; in other words, it is always available because there is always spacetime curvature.

V. THE CURVATURE TENSOR

The curvature tensor is defined in terms of covariant derivatives of the spin-affine connections Ω_p , and according to Section (III), has its equivalent in O(3) electrodynamics.

The curvature tensor is

$$\begin{aligned} \kappa_{p\lambda} &= -\kappa_{\lambda p} = \Omega_{p;\lambda} - \Omega_{\lambda;p} \\ &= \partial_\lambda \Omega_p - \partial_p \Omega_\lambda + \Omega_\lambda \Omega_p - \Omega_p \Omega_\lambda \end{aligned} \quad (60)$$

and obeys the Jacobi identity

$$D_\gamma \kappa_{p\lambda} + D_p \kappa_{\lambda\gamma} + D_\lambda \kappa_{\gamma p} \equiv 0 \quad (61)$$

which can be written as

$$D_\mu \tilde{\kappa}^{\mu\nu} \equiv 0 \quad (62)$$

where

$$\tilde{\kappa}^{\mu\nu} = \frac{1}{2} \varepsilon^{\mu\nu\rho\sigma} \kappa_{\rho\sigma} \quad (63)$$

is the dual of $\kappa_{\rho\sigma}$.

Equation (4) has the form of the homogeneous field equation of O(3) electrodynamics [2,10]. If we now define

$$\begin{aligned}\kappa^{\rho\lambda} &= \Omega^{\rho;\lambda} - \Omega^{\lambda;\rho} \\ &= (\partial^\lambda + \Omega^\lambda)\Omega^\rho - (\partial^\rho + \Omega^\rho)\Omega^\lambda\end{aligned}\quad (64)$$

then

$$\begin{aligned}D_\rho \kappa^{\rho\lambda} &= (\partial_\rho + \Omega_\rho)((\partial^\lambda + \Omega^\lambda)\Omega^\rho - (\partial^\rho + \Omega^\rho)\Omega^\lambda) \\ &\equiv L^\lambda \neq 0\end{aligned}\quad (65)$$

has the form of the inhomogeneous field equation of O(3) electrodynamics with a nonzero source term L^λ in curved spacetime.

The curvature tensor can be written as a commutator of covariant derivatives

$$\begin{aligned}\kappa_{\mu\nu} &= -\kappa_{\nu\mu} = -[D_\mu, D_\nu] = -[\partial_\mu + \Omega_\mu, \partial_\nu + \Omega_\nu] \\ &= \Omega_{\mu;\nu} - \Omega_{\nu;\mu}\end{aligned}\quad (66)$$

and is the result of a closed loop, or holonomy, in curved spacetime. This is the way in which a curvature tensor is also derived in general gauge field theory on the classical level [11]. If a field ϕ is introduced such that

$$\phi'(x) = S\phi(x) \quad (67)$$

under a gauge transformation, it follows that

$$\delta\phi = \Omega_\mu dx^\mu \phi \quad (68)$$

and that

$$\partial_\mu \phi' = S(\partial_\mu \phi) + (\partial_\mu S)\phi \quad (69)$$

The expression equivalent to Eq. (68) in general gauge field theory is [11]

$$\delta\psi = igM^a A_\mu^a dx^\mu \psi \quad (70)$$

where M^a are group rotation generators and A_μ^a are vector potential components with internal group indices a . Under a gauge transformation

$$(\partial_\mu + \Omega'_\mu)\phi' = S(\partial_\mu + \Omega_\mu)\phi \quad (71)$$

leading to the expression

$$\Omega'_\mu = S\Omega_\mu S^{-1} - (\partial_\mu S)S^{-1} \quad (72)$$

The equivalent equation in general gauge field theory is

$$A'_\mu = SA_\mu S^{-1} - \frac{i}{g} (\partial_\mu S) S^{-1} \quad (73)$$

Equations (72) and (73) show that the spin-affine connection Ω_μ and vector potential A_μ behave similarly under a gauge transformation. The relation between covariant derivatives has been developed in Section III.

VI. -GENERALLY COVARIANT 4-VECTORS

The most fundamental feature of O(3) electrodynamics is the existence of the $\mathbf{B}^{(3)}$ field [2], which is longitudinally directed along the axis of propagation, and which is defined in terms of the vector potential plane wave:

$$\mathbf{A}^{(1)} = \mathbf{A}^{(2)*} \quad (74)$$

From the irreducible representations of the Einstein group, there exist 4-vectors that are generally covariant and take the following form:

$$\begin{aligned} B_1^\mu &= (B_X^{(0)}, B_X^{(1)}, B_X^{(2)}, B_X^{(3)}) \\ B_2^\mu &= (B_Y^{(0)}, B_Y^{(1)}, B_Y^{(2)}, B_Y^{(3)}) \\ B_3^\mu &= (B_Z^{(0)}, B_Z^{(1)}, B_Z^{(2)}, B_Z^{(3)}) \end{aligned} \quad (75)$$

All these components exist in general, and the $\mathbf{B}^{(3)}$ field can be identified as the B_3^μ component. In O(3) electrodynamics, these 4-vectors reduce to

$$\begin{aligned} B_1^\mu &= (0, B_X^{(1)}, B_X^{(2)}, 0) \\ B_2^\mu &= (0, B_Y^{(1)}, B_Y^{(2)}, 0) \\ B_3^\mu &= (B_Z^{(0)}, 0, 0, B_Z^{(3)}) \end{aligned} \quad (76)$$

so it can be concluded that O(3) electrodynamics is developed in a curved spacetime that is defined in such a way that

$$\mathbf{B}^{(3)} = -ig\mathbf{A}^{(1)} \times \mathbf{A}^{(2)} \quad (77)$$

In O(3) electrodynamics, there exist the cyclic relations (23), and we have seen that in general relativity, this cyclic relation can be derived using a particular choice of metric. In the special case of O(3) electrodynamics, the vector

$$B_3^\mu = (B_Z^{(0)}, B_Z^{(1)}, B_Z^{(2)}, B_Z^{(3)}) \quad (78)$$

reduces to

$$B_3^\mu = (B_Z^{(0)}, 0, 0, B_Z^{(3)}) \quad (79)$$

Similarly, there exists, in general, the 4-vector

$$A; = (A_Z^{(0)}, A_Z^{(1)}, A_Z^{(2)}, A_Z^{(3)}) \quad (80)$$

which reduces in O(3) electrodynamics to

$$A_3^\mu = (A_Z^{(0)}, 0, 0, A_Z^{(3)}) \quad (81)$$

and that corresponds to generally covariant energy-momentum.

The curved spacetime 4-current is also generally covariant and has components such as

$$\begin{aligned} j_1^\mu &= (j_X^{(0)}, j_X^{(1)}, j_X^{(2)}, j_X^{(3)}) \\ j_2^\mu &= (j_Y^{(0)}, j_Y^{(1)}, j_Y^{(2)}, j_Y^{(3)}) \\ j_3^\mu &= (j_Z^{(0)}, j_Z^{(1)}, j_Z^{(2)}, j_Z^{(3)}) \end{aligned} \quad (82)$$

which, in O(3) electrodynamics, reduce to

$$\begin{aligned} j_1^\mu &= (0, j_X^{(1)}, j_X^{(2)}, 0) \\ j_2^\mu &= (0, j_Y^{(1)}, j_Y^{(2)}, 0) \\ j_3^\mu &= (j_Z^{(0)}, 0, 0, j_Z^{(3)}) \end{aligned} \quad (83)$$

The existence of a vacuum current such as this is indicated in O(3) electrodynamics by its inhomogeneous field equation

$$D_\mu G^{\mu\nu} = J^\nu \quad (84)$$

which is a Yang-Mills type of equation [2]. The concept of vacuum current was also introduced by Lehnert and is discussed in his review (first chapter in this volume; i.e., in Part 2).

The components of the antisymmetric field tensor in the Sachs theory [1] are

$$\begin{aligned} B^3 &= F^{21} = -F^{12} = (B_Z^{(0)}, B_Z^{(1)}, B_Z^{(2)}, B_Z^{(3)}) \\ B^1 &= F^{32} = -F^{23} = (B_X^{(0)}, B_X^{(1)}, B_X^{(2)}, B_X^{(3)}) \\ B^2 &= F^{13} = -F^{31} = (B_Y^{(0)}, B_Y^{(1)}, B_Y^{(2)}, B_Y^{(3)}) \\ E^1 &= F^{01} = -F^{10} = (E_X^{(0)}, E_X^{(1)}, E_X^{(2)}, E_X^{(3)}) \\ E^2 &= F^{02} = -F^{20} = (E_Y^{(0)}, E_Y^{(1)}, E_Y^{(2)}, E_Y^{(3)}) \\ E^3 &= F^{03} = -F^{30} = (E_Z^{(0)}, E_Z^{(1)}, E_Z^{(2)}, E_Z^{(3)}) \end{aligned} \quad (85)$$

each of which is a 4-vector that is generally covariant. For example

$$B_Z^\mu B_{\mu Z} = \text{invariant} \quad (86)$$

So, in general, in curved spacetime, there exist longitudinal and transverse components under all conditions. In $O(3)$ electrodynamics, the upper indices $((1),(2),(3))$ are defined by the unit vectors

$$\begin{aligned} \mathbf{e}^{(1)} &= \frac{1}{\sqrt{2}}(\mathbf{i} - \mathbf{j}) \\ \mathbf{e}^{(2)} &= \frac{1}{\sqrt{2}}(\mathbf{i} + \mathbf{j}) \\ \mathbf{e}^{(3)} &= \mathbf{k} \end{aligned} \quad (87)$$

which form the cyclically symmetric relation [2]

$$\begin{aligned} \mathbf{e}^{(1)} \times \mathbf{e}^{(2)} &= i\mathbf{e}^{(3)*} \\ &\dots \end{aligned} \quad (88)$$

where the asterisk in this case denotes complex conjugation. In addition, there is the time-like index (0) . The field tensor components in $O(3)$ electrodynamics are therefore, in general

$$\begin{aligned} F^{01} = -F^{10} &= (0, E_X^{(1)}, E_X^{(2)}, 0) \\ F^{02} = -F^{20} &= (0, E_Y^{(1)}, E_Y^{(2)}, 0) \\ F^{03} = -F^{30} &= (E_Z^{(0)}, 0, 0, E_Z^{(3)}) \\ F^{21} = -F^{12} &= (B_Z^{(3)}, 0, 0, B_Z^{(3)}) \\ F^{13} = -F^{31} &= (0, B_Y^{(1)}, B_Y^{(2)}, 0) \\ F^{32} = -F^{23} &= (0, B_X^{(1)}, B_X^{(2)}, 0) \end{aligned} \quad (89)$$

and the following invariants occur:

$$\begin{aligned} B_Y^{(1)} B_Y^{(2)} + B_Y^{(2)} B_Y^{(1)} &= B^{(0)2} \\ B_X^{(1)} B_X^{(2)} + B_X^{(2)} B_X^{(1)} &= B^{(0)2} \\ E_Y^{(1)} E_Y^{(2)} + E_Y^{(2)} E_Y^{(1)} &= E^{(0)2} \\ E_X^{(1)} E_X^{(2)} + E_X^{(2)} E_X^{(1)} &= E^{(0)2} \\ B_Z^{(0)2} - B_Z^{(3)2} &= E_Z^{(0)2} - E_Z^{(3)2} = 0 \end{aligned} \quad (90)$$

From general relativity, it can therefore be concluded that the $\mathbf{B}^{(3)}$ field must exist and that it is a physical magnetic flux density defined to the precision of the Lamb shift. It propagates through the vacuum with other components of the field tensor.

VII. SACHS THEORY IN THE FORM OF A GAUGE THEORY

The most general form of the vector potential can be obtained by writing the first two terms of Eq. (57) as

$$F_{\rho\gamma,1} = \partial_\rho A_\gamma^* - \partial_\gamma A_\rho^* \quad (91)$$

The vector potential is defined as

$$A_\gamma^* = \frac{Q}{4} \int (\kappa_{\rho\lambda} q^\lambda + q^\lambda \kappa_{\rho\lambda}^+) q_\gamma^* dx^\rho \quad (92)$$

and can be written as

$$A; = Sg; \int (\kappa_{\rho\lambda} q^\lambda + q^\lambda \kappa_{\rho\lambda}^+) dx^\rho \quad (93)$$

In order to prove that

$$\int g; dx^\rho = g; \int dx^\rho \quad (94)$$

we can take examples, giving results such as

$$\begin{aligned} q_Z^* &= (-q_Z^{(0)}, q_Z^{(1)}, q_Z^{(2)}, q_Z^{(3)}) \\ &= (-q_Z^{(0)}, 0, 0, q_Z^{(3)}) \end{aligned} \quad (95)$$

$$\int q_Z^* dX = q_Z^* \int dX$$

because q_Z^* has no functional dependence on X. The overall structure of the field tensor, using irreducible representations of the Einstein group, is therefore

$$F_{\rho\gamma} = C(\partial_\rho q_\gamma^* - \partial_\gamma q_\rho^*) + D(q_\rho q_\gamma^* - q_\gamma q_\rho^*) \quad (96)$$

where C and D are coefficients. This equation has the structure of a quaternion valued non-Abelian gauge field theory. The most general form of the field tensor

and the vector potential is quaternion-valued. If the following constraint holds

$$\frac{D}{C^2} \equiv -ig \quad (97)$$

the structure of Eq. (96) becomes

$$F_{\rho\gamma} = \partial_\rho A_\gamma^* - \partial_\gamma A_\rho^* - ig[A_\rho^*, A_\gamma^*] \quad (98)$$

which is identical with that of gauge field theory with quaternion-valued potentials. However, the use of the irreducible representations of the Einstein group leads to a structure that is more general than that of Eq. (98). The rules of gauge field theory can be applied to the substructure (98) and to electromagnetism in curved spacetime.

VIII. ANTIGRAVITY EFFECTS IN THE SACHS THEORY

Sachs' equations (4.16) (in Ref. 1)

$$\begin{aligned} \frac{1}{4} (\kappa_{\rho\gamma} q^\lambda + q^\lambda \kappa_{\rho\lambda}^+) + \frac{1}{8} R q_\rho &= k T_\rho \\ -\frac{1}{4} (\kappa_{\rho\gamma}^+ q^{\lambda*} + q^{\lambda*} \kappa_{\rho\gamma}) + \frac{1}{8} R q_\rho^* &= k T_\rho^* \end{aligned} \quad (99)$$

are 16 equations in 16 unknowns, as these are the 16 components of the quaternion-valued metric. The canonical energy-momentum \mathbf{T}_ρ is also quaternion-valued, and the equations are factorizations of the Einstein field equation. If there is no linear momentum and a static electromagnetic field (no Poynting vector), then

$$\mathbf{T}_\rho = (\mathbf{T}_\rho^0, 0, 0, 0) \quad (100)$$

so we have the four components $\mathbf{T}_0^0, \mathbf{T}_1^0, \mathbf{T}_2^0,$ and \mathbf{T}_3^0 . The \mathbf{T}_0^0 component is a component of the canonical energy due to the gravitoelectromagnetic field represented by q_0^0 . The scalar curvature R is the same with and without electromagnetism, and so is the Einstein constant k .

Considering \mathbf{T}_0^0 In Eq. (99), we obtain

$$k\mathbf{T}_0^0 = \frac{1}{8} R q_0^0 + \frac{1}{4} (\kappa_{0\lambda} q^\lambda + q^\lambda \kappa_{0\lambda}^+) \quad (101)$$

and if we choose a metric such that all components go to zero except q_0^0 , then

$$k\mathbf{T}_0^0 \rightarrow \frac{1}{8} R q_0^0 \quad (102)$$

However, R also vanishes in this limit, so

$$\mathbf{T}_0^0 \rightarrow 0 \quad (103)$$

So, in order to produce antigravity effects, the gravitoelectromagnetic field must be chosen so that only q_0^0 exists in a static situation. Therefore, antigravity is produced by q_1^0 , q_2^0 , and q_3^0 all going to zero asymptotically, or by

$$q_0^0 \gg (q_1^0 \approx q_2^0 \approx q_3^0) \quad (104)$$

This result is consistent with the fact that the curvature tensor $\kappa_{0\lambda}$ must be minimized, which is a consistent result. The curvature is

$$\kappa_{p\lambda} = -\kappa_{\lambda p} = \Omega_{p;\lambda} - \Omega_{\lambda;p} \quad (105)$$

and is minimized if

$$\Omega_{p;\lambda} \approx \Omega_{\lambda;p} \quad (106)$$

If $p = 0$, then $\Omega_{0;\lambda} \approx \Omega_{\lambda;0}$. This minimization can occur if the spin-affine connection is minimized. We must now investigate the effect of minimizing $\kappa_{0\lambda}$ on the electromagnetic field

$$F_{p\gamma} = Q \left[\frac{1}{4} (\kappa_{p\lambda} q^\lambda q_\gamma^* + q_\gamma q^{\lambda*} \kappa_{p\lambda} + q^\lambda \kappa_{p\lambda}^+ q_\gamma^* + q_\gamma \kappa_{p\lambda}^+ q^{\lambda*}) + \frac{1}{8} (q_p q_\gamma^* - q_\gamma q_p^*) R \right] \quad (107)$$

We know that $R \rightarrow 0$ and $p = 0$, so

$$F_{0\gamma} = Q \left[\frac{1}{4} (\kappa_{0\lambda} q^\lambda q_\gamma^* + \dots) \right] \quad (108)$$

and the $F_{0\gamma}$ component must be minimized. This is the gravitoelectric component. Therefore, the gravitomagnetic component must be very large in comparison with the gravitoelectric component.

IX. SOME NOTES ON QUATERNION-VALUED METRICS

In the flat spacetime limit, the following relation holds:

$$q^\mu q^{\nu*} - q^\nu q^{\mu*} \rightarrow \sigma^\mu \sigma^\nu - \sigma^\nu \sigma^\mu \quad (109)$$

where

$$\sigma^\mu = \left(\begin{bmatrix} 1 & 0 \\ 0 & 1 \end{bmatrix}, \begin{bmatrix} 0 & 1 \\ 1 & 0 \end{bmatrix}, \begin{bmatrix} 0 & -i \\ i & 0 \end{bmatrix}, \begin{bmatrix} 1 & 0 \\ 0 & -1 \end{bmatrix} \right) \quad (110)$$

Therefore, the quaternion-valued metric can be written as

$$q^\mu = \left(\begin{bmatrix} q^{\mu 0} & 0 \\ 0 & q^{\mu 0} \end{bmatrix}, \begin{bmatrix} 0 & q^{\mu 1} \\ q^{\mu 1} & 0 \end{bmatrix}, \begin{bmatrix} 0 & -iq^{\mu 2} \\ iq^{\mu 2} & 0 \end{bmatrix}, \begin{bmatrix} q^{\mu 3} & 0 \\ 0 & -q^{\mu 3} \end{bmatrix} \right) \quad (111)$$

with components

$$\begin{aligned} q^0 &= \left(\begin{bmatrix} q_0^0 & 0 \\ 0 & q_0^0 \end{bmatrix}, \begin{bmatrix} 0 & q_0^1 \\ q_0^1 & 0 \end{bmatrix}, \begin{bmatrix} 0 & -iq_0^2 \\ iq_0^2 & 0 \end{bmatrix}, \begin{bmatrix} q_0^3 & 0 \\ 0 & -q_0^3 \end{bmatrix} \right) \\ q_x &= \left(\begin{bmatrix} q_x^0 & 0 \\ 0 & q_x^0 \end{bmatrix}, \begin{bmatrix} 0 & q_x^1 \\ q_x^1 & 0 \end{bmatrix}, \begin{bmatrix} 0 & -iq_x^2 \\ iq_x^2 & 0 \end{bmatrix}, \begin{bmatrix} q_x^3 & 0 \\ 0 & -q_x^3 \end{bmatrix} \right) \\ q_y &= \left(\begin{bmatrix} q_y^0 & 0 \\ 0 & q_y^0 \end{bmatrix}, \begin{bmatrix} 0 & q_y^1 \\ q_y^1 & 0 \end{bmatrix}, \begin{bmatrix} 0 & -iq_y^2 \\ iq_y^2 & 0 \end{bmatrix}, \begin{bmatrix} q_y^3 & 0 \\ 0 & -q_y^3 \end{bmatrix} \right) \\ q_z &= \left(\begin{bmatrix} q_z^0 & 0 \\ 0 & q_z^0 \end{bmatrix}, \begin{bmatrix} 0 & q_z^1 \\ q_z^1 & 0 \end{bmatrix}, \begin{bmatrix} 0 & -iq_z^2 \\ iq_z^2 & 0 \end{bmatrix}, \begin{bmatrix} q_z^3 & 0 \\ 0 & -q_z^3 \end{bmatrix} \right) \end{aligned} \quad (112)$$

In the flat spacetime limit

$$\begin{aligned} q^0 &\rightarrow \sigma^0 = \left(\begin{bmatrix} 1 & 0 \\ 0 & 1 \end{bmatrix}, 0, 0, 0 \right) \\ q_x &\rightarrow \sigma_x = \left(0, \begin{bmatrix} 0 & 1 \\ 1 & 0 \end{bmatrix}, 0, 0 \right) \\ q_y &\rightarrow \sigma_y = \left(0, 0, \begin{bmatrix} 0 & -i \\ i & 0 \end{bmatrix}, 0 \right) \\ q_z &\rightarrow \sigma_z = \left(0, 0, 0, \begin{bmatrix} 1 & 0 \\ 0 & -1 \end{bmatrix} \right) \end{aligned} \quad (113)$$

This means that in the flat spacetime limit

$$\begin{aligned}
 q_0^0 &\rightarrow 1; & q_0^1 &\rightarrow 0; & q_0^2 &\rightarrow 0; & q_0^3 &\rightarrow 0 \\
 q_X^0 &\rightarrow 0; & q_X^1 &\rightarrow 1; & q_X^2 &\rightarrow 0; & q_X^3 &\rightarrow 0 \\
 q_Y^0 &\rightarrow 0; & q_Y^1 &\rightarrow 0; & q_Y^2 &\rightarrow 1; & q_Y^3 &\rightarrow 0 \\
 q_Z^0 &\rightarrow 1; & q_Z^1 &\rightarrow 0; & q_Z^2 &\rightarrow 0; & q_Z^3 &\rightarrow 1
 \end{aligned} \tag{114}$$

Checking with the identity:

$$q_\gamma q^{\kappa*} + q^\kappa q_\gamma^* = 2\sigma_0 \delta_\gamma^\kappa \tag{115}$$

then

$$\begin{aligned}
 q_X q^{X*} + q^X q_X^* &= 2\sigma_0 \delta_X^X = 2\sigma_0 \\
 (q_X^0)^2 + (q_X^1)^2 + (q_X^2)^2 + (q_X^3)^2 &= \sigma_0
 \end{aligned} \tag{116}$$

which is a property of quaternion indices in curved spacetime. In flat spacetime:

$$(q_X^1)^2 = \sigma_0 \tag{117}$$

that is

$$\begin{pmatrix} 1 & 0 \\ 0 & 1 \end{pmatrix} = \begin{pmatrix} 1 & 0 \\ 0 & 1 \end{pmatrix} \tag{118}$$

The reduction to O(3) electrodynamics takes place using products such as

$$\begin{aligned}
 q_X q_Y^* - q_Y q_X^* &= \begin{bmatrix} 0 & q_X^1 \\ q_X^1 & 0 \end{bmatrix} \begin{bmatrix} 0 & -iq_Y^2 \\ iq_Y^2 & 0 \end{bmatrix} - \begin{bmatrix} 0 & -iq_Y^2 \\ iq_Y^2 & 0 \end{bmatrix} \begin{bmatrix} 0 & q_X^1 \\ q_X^1 & 0 \end{bmatrix} \\
 &= \begin{bmatrix} iq_X^1 q_Y^2 & 0 \\ 0 & -iq_Y^2 q_X^1 \end{bmatrix} \\
 &= i \begin{bmatrix} q_Z^3 & \mathbf{1} \\ 0 & q_Z^3 \end{bmatrix}
 \end{aligned} \tag{119}$$

that is

$$q_Z^3 = q_X^1 q_Y^2 \tag{120}$$

In flat spacetime, this becomes

$$1 = 1 \quad (121)$$

If the phases are defined as

$$q_X^1 = e^{i\phi}; \quad q_Y^{2*} = e^{-i\phi} \quad (122)$$

then the $B^{(3)}$ field is recovered as

$$B^{(3)} = \frac{1}{8} QR \quad (123)$$

Applying Eq. (99), it is seen that T^μ has the same structure as q^μ :

$$T^\mu = \left(\left[\begin{array}{cc} T^{\mu 0} & 0 \\ 0 & T^{\mu 0} \end{array} \right], \left[\begin{array}{cc} 0 & T^{\mu 1} \\ T^{\mu 1} & 0 \end{array} \right], \left[\begin{array}{cc} 0 & -iT^{\mu 2} \\ iT^{\mu 2} & 0 \end{array} \right], \left[\begin{array}{cc} T^{\mu 3} & 0 \\ 0 & -T^{\mu 3} \end{array} \right] \right) \quad (124)$$

Therefore, the energy momentum is quaternion-valued. The vacuum current is

$$j_\gamma = \frac{Q\kappa'}{4\pi} (T_\rho^{:\rho} q_\gamma^* - q_\gamma T_\rho^{:\rho*}) \quad (125)$$

where Q and $\kappa'/4\pi$ are constants. We may investigate the structure of the 4-current j_γ by working out the covariant derivative:

$$T_\rho^{:\rho} = \partial^0 T_0 + \partial^1 T_1 + \partial^2 T_2 + \partial^3 T_3 + \Gamma_{0\rho}^\rho T^0 + \Gamma_{1\rho}^\rho T^1 + \Gamma_{2\rho}^\rho T^2 + \Gamma_{3\rho}^\rho T^3 \quad (126)$$

The partial derivatives and Christoffel symbols are not quaternion-valued, so we may write

$$T_\rho^{:\rho} = (\partial^0 + \Gamma_{0\rho}^\rho)T_0 - (\partial^1 + \Gamma_{1\rho}^\rho)T_1 - (\partial^2 + \Gamma_{2\rho}^\rho)T_2 - (\partial^3 + \Gamma_{3\rho}^\rho)T_3 \quad (127)$$

Therefore the vacuum current in general relativity is defined by

$$j_\gamma = \frac{Q\kappa'}{4\pi} \left(((\partial^0 + \Gamma_{0\rho}^\rho)T_0 - (\partial^1 + \Gamma_{1\rho}^\rho)T_1 - (\partial^2 + \Gamma_{2\rho}^\rho)T_2 - (\partial^3 + \Gamma_{3\rho}^\rho)T_3) q_\gamma^* + q_\gamma ((\partial^0 + \Gamma_{0\rho}^\rho)T_0 + (\partial^1 + \Gamma_{1\rho}^\rho)T_1 + (\partial^2 + \Gamma_{2\rho}^\rho)T_2 + (\partial^3 + \Gamma_{3\rho}^\rho)T_3) \right) \quad (128)$$

This current exists under all conditions and is the most general form of the Lehnert vacuum current described elsewhere in this volume, and the vacuum

current in O(3) electrodynamics. In the Sachs theory, the existence of the electromagnetic field tensor depends on curvature, so energy is extracted from curved spacetime. The 4-current j_μ contains terms such as

$$\begin{aligned} j_{\gamma,0} &= \frac{Qk'}{4\pi} ((\partial^0 + \Gamma_{0\rho}^{\rho})T_0 q_\gamma^* + q_\gamma (\partial^0 + \Gamma_{0\rho}^{\rho})T_0) \\ &= \frac{Qk'}{4\pi} (\partial^0 + \Gamma_{0\rho}^{\rho}) \left(\begin{bmatrix} T_0^0 & 0 \\ 0 & T_0^0 \end{bmatrix} q_\gamma^* + q_\gamma \begin{bmatrix} T_0^0 & 0 \\ 0 & T_0^0 \end{bmatrix} \right) \end{aligned} \quad (129)$$

We may now choose $\gamma = 0, 1, 2, 3$ to obtain terms such as

$$\begin{aligned} j_{0,0} &= (\partial^0 + \Gamma_{0\rho}^{\rho}) \left(- \begin{bmatrix} T_0^0 & 0 \\ 0 & T_0^0 \end{bmatrix} \begin{bmatrix} q_0^0 & 0 \\ 0 & q_0^0 \end{bmatrix} + \begin{bmatrix} q_0^0 & 0 \\ 0 & q_0^0 \end{bmatrix} \begin{bmatrix} T_0^0 & 0 \\ 0 & T_0^0 \end{bmatrix} \right) = 0 \\ j_{1,0} &= -(\partial^0 + \Gamma_{0\rho}^{\rho}) \left(\begin{bmatrix} T_0^0 & 0 \\ 0 & T_0^0 \end{bmatrix} \begin{bmatrix} 0 & q_1^1 \\ q_1^1 & 0 \end{bmatrix} + \begin{bmatrix} 0 & q_1^1 \\ q_1^1 & 0 \end{bmatrix} \begin{bmatrix} T_0^0 & 0 \\ 0 & T_0^0 \end{bmatrix} \right) \\ &= -(\partial^0 + \Gamma_{0\rho}^{\rho}) (q_1^1 T_0^0 (\sigma_X + \sigma_0)) \\ &\neq 0 \end{aligned} \quad (130)$$

There are numerous other components of the 4-current density j_γ that are nonzero under all conditions. These act as sources for the electromagnetic field under all conditions. In flat spacetime, the electromagnetic field vanishes, and so does the 4-current density j_γ .

A check can be made on the interpretation of the quaternion-valued metric if we take the quaternion conjugate:

$$q^{\mu*} = \left(- \begin{bmatrix} q^{\mu 0} & 0 \\ 0 & q^{\mu 0} \end{bmatrix}, \begin{bmatrix} 0 & q^{\mu 1} \\ q^{\mu 1} & 0 \end{bmatrix}, \begin{bmatrix} 0 & iq^{\mu 2} \\ iq^{\mu 2} & 0 \end{bmatrix}, \begin{bmatrix} q^{\mu 3} & 0 \\ 0 & -q^{\mu 3} \end{bmatrix} \right) \quad (131)$$

which must reduce, in the flat space-time limit, to:

$$\sigma^\mu = \left(\begin{bmatrix} 1 & 0 \\ 0 & 1 \end{bmatrix}, \begin{bmatrix} 0 & 1 \\ 1 & 0 \end{bmatrix}, \begin{bmatrix} 0 & -i \\ i & 0 \end{bmatrix}, \begin{bmatrix} 1 & 0 \\ 0 & -1 \end{bmatrix} \right) \quad (132)$$

This means that the flat spacetime metric is

$$\begin{bmatrix} -1 & 0 & 0 & 0 \\ 0 & 1 & 0 & 0 \\ 0 & 0 & 1 & 0 \\ 0 & 0 & 0 & 1 \end{bmatrix} = -g^{\mu\nu} \quad (133)$$

which is the negative of the metric $g^{\mu\nu}$ of flat spacetime, that is, Minkowski spacetime.

If we define

$$q^{\mu*} = \left(\begin{bmatrix} q^{\mu 0} & 0 \\ 0 & q^{\mu 0} \end{bmatrix}, -\begin{bmatrix} 0 & q^{\mu 1} \\ q^{\mu 1} & 0 \end{bmatrix}, -\begin{bmatrix} 0 & -iq^{\mu 2} \\ iq^{\mu 2} & 0 \end{bmatrix}, -\begin{bmatrix} q^{\mu 3} & 0 \\ 0 & -q^{\mu 3} \end{bmatrix} \right) \quad (134)$$

then we obtain

$$\varepsilon_{\mu\nu} \equiv g_{\mu\nu} = \begin{bmatrix} 1 & 0 & 0 & 0 \\ 0 & 0 & -1 & 0 \\ 0 & -1 & 0 & 0 \\ 0 & 0 & 0 & -1 \end{bmatrix} \quad (135)$$

in the flat spacetime limit. This is the usual Minkowski metric

To check on the interpretation given in the text of the reduction of Sachs to O(3) electrodynamics, we can consider generally covariant components such as

$$\begin{aligned} q_X &= (q_X^0, q_X^1, q_X^2, q_X^3) \rightarrow (\sigma^0, \sigma^1, \sigma^2, \sigma^3) \\ q_Y &= (q_Y^0, q_Y^1, q_Y^2, q_Y^3) \rightarrow (\sigma^0, \sigma^1, \sigma^2, \sigma^3) \\ q_Y^* &= (-q_Y^0, q_Y^1, q_Y^2, q_Y^3) \rightarrow (-\sigma^0, \sigma^1, \sigma^2, \sigma^3) \end{aligned} \quad (136)$$

It follows that

$$q_X q_Y^* - q_Y q_X^* \rightarrow \sigma_X \sigma_Y - \sigma_Y \sigma_X = 2i\sigma_Z \quad (137)$$

and that:

$$\begin{aligned} \sigma_X &= (0, \sigma_X, 0, 0) \\ \sigma_Y &= (0, 0, \sigma_Y, 0) \end{aligned} \quad (138)$$

Note that products such as $\sigma_X \sigma_Y$ must be interpreted as single-valued, because products such as

$$[0 \ \sigma_X \ 0 \ 0] \begin{bmatrix} 0 \\ 0 \\ \sigma_Y \\ 0 \end{bmatrix} = \begin{bmatrix} 0 & 0 & 0 & 0 \\ 0 & 0 & 0 & 0 \\ 0 & 0 & 0 & 0 \\ 0 & 0 & 0 & 0 \end{bmatrix} \quad (139)$$

give a null matrix. Therefore, the quaternion-valued product $q_X q_Y^*$ must also be interpreted as

$$q_X q_Y^* - q_Y q_X^* \rightarrow \sigma_X \sigma_Y - \sigma_Y \sigma_X = 2i\sigma_Z \quad (140)$$

as in the text.

Acknowledgments

The U.S. Department of Energy is acknowledged for its Website: <http://www.ott.doe.gov/electromagnetic/>. This website is reserved for the Advanced Electrodynamics Working Group.

References

1. M. Sachs, 1st chapter in Part 1 of this three-volume set.
2. M. W. Evans, 2nd chapter in this volume (i.e., Part 2 of this compilation).
3. M. W. Evans, *O(3) Electrodynamics*, Kluwer Academic, Dordrecht, 1999.
4. T. W. Barrett and D. M. Grimes, *Advanced Electromagnetism*, World Scientific, Singapore, 1995.
5. A demonstration of this property in O(3) electrostatics is given by Evans and Jeffers, 1st chapter in Part 3 of this three-volume set; see also Ref(s).—by Vigier in Bibliography at end of that chapter.
6. M. W. Evans, J. P. Vigiér, and S. Roy (eds.), *The Enigmatic Photon*, Kluwer Academic, Dordrecht, 1997. Vo. 4.
7. T. E. Bearden, *Energy from the Active Vacuum*. World Scientific, Singapore, in press.
8. T. E. Bearden, 1st and 12th chapters in this volume (i.e., Part 2).
9. M. W. Evans and S. Jeffers, 1st chapter in Part 3 of this three-volume set; see also Ref(s).—by Vigier listed in that chapter.
10. T. W. Barrett, in A. Lakhtakia (Ed.), *Essays on the Formal Aspects of Electromagnetic Theory*, World Scientific, Singapore, 1993.
11. L. H. Ryder, *Quantum Field Theory*, 2nd ed., Cambridge Univ. Press, Cambridge, UK, 1987.
12. T. W. Barrett, *Apeiron* 7(1), (2000).
13. T. E. Bearden et al., *Phys.Scripta* 61, 513 (2000).

The Tom Bearden Website

*Foundations of Physics Letters, Vol. 14., No. 1,
2001*

EXPLANATION OF THE MOTIONLESS ELECTROMAGNETIC GENERATOR WITH 0(3) ELECTRODYNAMICS

- [Page 1](#)
- [Page 2](#)
- [Page 3](#)
- [Page 4](#)
- [Page 5](#)
- [Page 6](#)
- [Page 7](#)
- [Page 8](#)

**EXPLANATION OF THE MOTIONLESS
ELECTROMAGNETIC GENERATOR WITH 0(3)
ELECTRODYNAMICS**

P. K. Anastasovski (1), T. E. Bearden (2), C. Ciubotariu (3), W. T. Coffey (4), L. B. Crowell (5), G. J. Evans (6), M. W. Evans (7, 8), R. Flower (9), A. Labounsky (10), B. Lehnert (11), M. Mészáros (12), P. R. Molnar (12), J. K. Moscicki (13), S. Roy (14), and J.P. Vigier (15)

*Institute for Advanced Study, Alpha Foundation
Institute of Physics, 11 Rutafa Street, Building H
Budapest, H-1165, Hungary*

Also at:

(1) Faculty of Technology and Metallurgy, Department of Physics, University of Skopje, Republic of Macedonia; (2) CTEC Inc, Huntsville, Alabama; (3) Institute for Information Technology, Stuttgart University, Stuttgart, Germany; (4) Department of Microelectronics and Electrical Engineering, Trinity College, Dublin 2, Ireland; (5) Department of Physics and Astronomy University of New Mexico, Albuquerque, New Mexico; (6) Ceredigion County Council, Aberaeron, Wales, United Kingdom; (7) former Ed-

ward Davies Chemical Laboratories, University College of Wales, Aberystwyth SY32 INE, Wales, United Kingdom; (8) sometime JRF, Wolfson College, Oxford; United Kingdom; (9) Applied Science Associates and Temple University Center for Frontier Sciences, Philadelphia, Pennsylvania; (10) The Boeing Company, Huntington Beach, California; (11) Alfvén Laboratory, Royal Institute of Technology, Stockholm, S-100 44, Sweden; (12) Alpha Foundation, Institute of Physics, 11 Rutafa Street, Building H, Budapest, H-1165, Hungary; (13) Smoluchowski Institute of Physics, Jagiellonian University, ul Reymonta 4, Krakow, Poland; (14) Indian Statistical Institute, Calcutta, India; (15) Laboratoire de Gravitation et Cosmologie Relativistes, Université Pierre et Marie Curie, Tour 22-12, 4^{ème} étage, 4 Place Jussieu, 7525 Paris, Cedex 05, France.

Received 3 December 2000; revised 12 December 2000

Recently, Bearden *et al.* developed a device which is known as a motionless electromagnetic generator (MEG) and which produces a coefficient of performance (COP) far in excess of unity. The device has been independently replicated by Naudin. In this communication, the fundamental operational principle of the MEG is explained using a version of higher symmetry electrodynamics known as O(3) electrodynamics, which is based on the empirical existence of two circular polarization states of electromagnetic radiation, and which has been developed extensively in the literature. The theoretical explanation of the MEG with O(3) electrodynamics is straightforward: Magnetic energy is taken directly ex vacua and used to replenish the permanent magnets of the MEG device, which therefore produces a source of energy that, in theory, can be replenished indefinitely from the vacuum. Such a result is incomprehensible in U(1) Maxwell-Heaviside electrodynamics.

Key words: motionless electromagnetic generator, O(3) electrodynamics, energy from the vacuum.

1. INTRODUCTION

Bearden *et al.* [1] recently produced a device which they describe as a motionless electromagnetic generator (MEG), which outputs more energy than is input by the operator, and therefore produces a coefficient of performance (COP) well in excess of unity. The device has been replicated independently by Naudin [2] and is therefore reproducible and repeatable, meeting the requirements of scientific rigor. In this communication, a qualitative theoretical explanation is offered for the MEG using a version of higher-symmetry electrodynamics known as O(3) electrodynamics [3,4]. The latter theory has been developed from an empirical basis: the existence of two-circularly polarized states of electromagnetic radiation. In O(3) electrodynamics, there exists a vacuum current and vacuum energy [3,4]

$$E_n = \frac{1}{\mu_0} \int \mathbf{B}^{(3)} \cdot \mathbf{B}^{(3)} dV, \quad (1)$$

$$En = \frac{1}{\mu_0} \int \mathbf{B}^{(3)} \cdot \mathbf{B}^{(3)} dV, \quad (1)$$

where μ_0 is the vacuum permeability in S.I. units, and where $\mathbf{B}^{(3)}$ is a longitudinally directed and phaseless magnetic flux density which propagates in vacuum with the plane wave $\mathbf{B}^{(1)} = \mathbf{B}^{(2)*}$ in such a way that

$$\mathbf{B}^{(1)} \times \mathbf{B}^{(2)} = iB^{(0)}\mathbf{B}^{(3)*}, \quad \text{et cyclicum}, \quad (1a)$$

where $B^{(0)}$ is the scalar magnitude of $\mathbf{B}^{(3)}$ [3,4]. In this notation, $\mathbf{B}^{(3)}$ is a three vector and the dot denotes the usual scalar product, with the

upper star denoting the usual complex conjugate. In Sec. 2, Eq. (1) is derived from the field equations of O(3) electrodynamics, which are in turn derivable from fiber bundle theory, and have the structure of Yang-Mills field equations. In Sec. 3, the fundamental operational principle of the MEG is explained straightforwardly using Eq. (1).

2. DERIVATION OF EQ. (1)

The homogeneous and inhomogeneous field equations of O(3) electrodynamics are, respectively, [3,4]:

$$D_\mu \tilde{\mathbf{G}}^{\mu\nu} \equiv 0, \tag{2}$$

$$D_\mu \mathbf{H}^{\mu\nu} = \mathbf{J}^\nu, \tag{3}$$

where $\tilde{\mathbf{G}}^{\mu\nu}$ is an O(3) field tensor, and D_μ is the O(3) covariant derivative. In Eqs. (2) and (3), the Greek indices assume the standard values of 0, 1, 2, 3. In Eq. (3), the bold symbol \mathbf{J}^ν denotes a charge current twelve vector defined as:

$$\mathbf{J}^{\nu(i)} := (\rho, \mathbf{J}^{(i)}/c), \quad i = 1, 2, 3 \tag{4}$$

where c is the speed of light [3]. In O(3) electrodynamics, the field tensor $\mathbf{G}^{\mu\nu}$ is defined in the internal space ((1), (2), (3)) as the sum of three components [3]:

$$\mathbf{G}^{\mu\nu} := G_{\mu\nu}^{(1)} \mathbf{e}^{(1)} + G_{\mu\nu}^{(2)} \mathbf{e}^{(2)} + G_{\mu\nu}^{(3)} \mathbf{e}^{(3)}. \tag{5}$$

The field tensor $\mathbf{H}^{\mu\nu}$, which is a generalization of $\mathbf{G}^{\mu\nu}$ that includes magnetization and polarization, is similarly defined as:

$$\mathbf{H}^{\mu\nu} := H^{\mu\nu(1)} \mathbf{e}^{(1)} + H^{\mu\nu(2)} \mathbf{e}^{(2)} + H^{\mu\nu(3)} \mathbf{e}^{(3)}, \tag{6}$$

and the charge current 12-vector as

$$\mathbf{J}^\nu := J^{\nu(1)} \mathbf{e}^{(1)} + J^{\nu(2)} \mathbf{e}^{(2)} + J^{\nu(3)} \mathbf{e}^{(3)}, \tag{7}$$

where $\mathbf{e}^{(1)}, \mathbf{e}^{(2)}, \mathbf{e}^{(3)}$ are unit vectors in the basis ((1), (2), (3)). There-

where $\mathbf{e}^{(1)}, \mathbf{e}^{(2)}, \mathbf{e}^{(3)}$ are unit vectors in the basis $((1), (2), (3))$. Therefore $O(3)$ electrodynamics is a Yang-Mills gauge field theory [3] with internal space $((1), (2), (3))$. For further details, see Refs. 3 to 8.

These equations are Yang-Mills equations and as such, are derivable from fiber bundle theory [5]. They form an extended Lie algebra [5] and as such, constitute a valid Lie algebra, meeting all the criteria of such an algebra. An extended Lie algebra is defined [5] as

$$E := L \oplus V, \tag{8}$$

where L and V are two Lie algebras in different spaces.

In vacuum (in the absence of matter), one can develop a special case of Eq. (3):

$$\partial^\mu \mathbf{G}^{\mu\nu} = 0, \quad \mathbf{J}^\nu = g\epsilon_0 \mathbf{A}_\mu \times \mathbf{G}^{\mu\nu}, \quad (9)$$

where \mathbf{J}^ν is a conserved vacuum current. Here, the tensors $\mathbf{G}^{\mu\nu}$ and $\tilde{\mathbf{G}}^{\mu\nu}$ are dual to each other:

$$\partial^\mu \mathbf{G}^{\mu\nu} = 0, \quad (10a)$$

$$\tilde{\mathbf{G}}^{\mu\nu} = \frac{1}{2} \epsilon^{\mu\nu\sigma\rho} \mathbf{G}_{\sigma\rho}. \quad (10b)$$

This concept is absent from Maxwell-Heaviside electrodynamics, in which the only vacuum current is the Maxwell displacement current. However, Lehnert [6] has developed a theory of electrodynamics based on a concept similar to \mathbf{J}^ν and has replicated the existence $\mathbf{B}^{(3)}$ [6] as one component out of many possible longitudinal components in vacua. Empirical evidence for the the $\mathbf{B}^{(3)}$ field is revised elsewhere [3-5], where it is demonstrated that $O(3)$ electrodynamics explains anomalies that are not explicable with $U(1)$ electrodynamics.

Equation (1) is arrived at by developing Eq. (9) as follows. The vacuum charge-current twelve-vector \mathbf{J}^ν is a physical charge-current density that gives rise to the energy

$$En = - \int \mathbf{J}^\nu \cdot \mathbf{A}_\nu dV, \quad (11)$$

where V is the radiation volume [3,4]. This equation represents the electromagnetic energy in the vacuum generated by the vacuum current J^3 in a volume V [3] and, when written out in full, is

$$En = - \int \mathbf{J}^\nu \cdot \mathbf{A}_\nu dV, \quad (12)$$

$$\mathbf{J}^\nu = J^{\nu(1)} \mathbf{e}^{(1)} + J^{\nu(2)} \mathbf{e}^{(2)} + J^{\nu(3)} \mathbf{e}^{(3)}, \quad (12a)$$

$$\mathbf{J}^\nu = J^{\nu(1)}\mathbf{e}^{(1)} + J^{\nu(2)}\mathbf{e}^{(2)} + J^{\nu(3)}\mathbf{e}^{(3)}, \quad (12a)$$

$$\mathbf{A}_\nu = A_\nu^{(1)}\mathbf{e}^{(1)} + A_\nu^{(2)}\mathbf{e}^{(2)} + A_\nu^{(3)}\mathbf{e}^{(3)}. \quad (12b)$$

The analogous term in U(1) electrodynamics is the starting point for the derivation [3] of the Lamb shift in H .

The three-vector magnetic field $\mathbf{B}^{(3)}$ is defined fundamentally in O(3) electrodynamics [3] as

$$\mathbf{B}^{(3)*} := -ig\mathbf{A}^{(1)} \times \mathbf{A}^{(2)}, \quad (13)$$

where g is a proportionality coefficient defined as

$$g = \frac{\kappa}{A^{(0)}}, \tag{14}$$

where κ is the wave-vector and $A^{(0)}$ is the scalar magnitude of $\mathbf{A}^{(1)} = \mathbf{A}^{(2)*}$. For more details, see Refs. 3 and 5.

The energy term can therefore be developed as follows. In Eq. (12b), $A_\nu^{(1)}$, $A_\nu^{(2)}$ and $A_\nu^{(3)}$ are each four-vectors:

$$A_\nu^{(1)} = (\phi^{(1)}, -c\mathbf{A}^{(1)}), \tag{15}$$

$$A_\nu^{(2)} = (\phi^{(2)}, -c\mathbf{A}^{(2)}), \tag{16}$$

$$A_\nu^{(3)} = (\phi^{(3)}, -c\mathbf{A}^{(3)}). \tag{17}$$

From Eq. (9), it follows that:

$$\mathbf{J}^{(1)*} = -ig\epsilon_0 \mathbf{A}_\mu^{(2)} \times \mathbf{G}^{\mu\nu(3)}, \tag{18}$$

$$\mathbf{J}^{(2)*} = -ig\epsilon_0 \mathbf{A}_\mu^{(3)} \times \mathbf{G}^{\mu\nu(1)}, \tag{19}$$

$$\mathbf{J}^{(3)*} = -ig\epsilon_0 \mathbf{A}_\mu^{(1)} \times \mathbf{G}^{\mu\nu(2)}. \tag{20}$$

Equation (11) for the energy is therefore

$$En = -ig\epsilon_0 \int \mathbf{A}_\nu^{(2)} \times \mathbf{G}^{\mu\nu(3)} \cdot \mathbf{A}_\nu^{(1)} dV + \dots \tag{21}$$

We now use the vector identity

$$\mathbf{F} \cdot \mathbf{G} \times \mathbf{H} = \mathbf{G} \cdot \mathbf{H} \times \mathbf{F} \tag{22}$$

to obtain the non-zero result

$$En = -i\theta\epsilon_0 \int \mathbf{G}^{\mu\nu(3)} \cdot \mathbf{A}_\nu^{(1)} \times \mathbf{A}_\nu^{(2)} dV + \dots \tag{23}$$

$$En = -ig\epsilon_0 \int \mathbf{G}^{\mu\nu(3)} \cdot \mathbf{A}_\nu^{(1)} \times \mathbf{A}_\mu^{(2)} dV + \dots, \quad (23)$$

which can be developed as

$$En = c^2 \epsilon_0 \int \mathbf{B}^{(3)} \cdot \mathbf{B}^{(3)} dV \quad (24a)$$

$$= \frac{1}{\mu_0} \int \mathbf{B}^{(3)} \cdot \mathbf{B}^{(3)} dV \quad (24b)$$

where ϵ_0 is the vacuum permittivity in S.I. units, defined by

$$c^2 = \frac{1}{\mu_0 \epsilon_0}. \tag{25}$$

We therefore arrive at Eq. (1), which is the energy from the vacuum due to the vacuum current \mathbf{J}^ν , a current which is absent from Maxwell-Heaviside electrodynamics. The concept is however present in general relativity as shown by Sachs [7]. It has been shown [8] that the structure of the Sachs theory reduces to that of O(3) electrodynamics using a particular choice of metric. Therefore, there exists a foundation for O(3) electrodynamics in general relativity, and O(3) electrodynamics is a theory of conformally curved space-time. The Maxwell-Heaviside theory, on the other hand, is a theory of flat spacetime, in which there is no curvature tensor. Sachs has shown that in the theory of general relativity, the electromagnetic field cannot propagate through the vacuum. This result refutes the Maxwell-Heaviside theory, in which the field is assumed to propagate in a vacuum which is structurally equivalent to flat space-time.

3. QUALITATIVE EXPLANATION OF THE MEG, USING EQ. (24A)

The qualitative explanation of the MEG from Eq. (24a) is that the magnetic energy (24a) is transferred into the magnetic energy

$$En_s = \frac{1}{\mu_0} \int \mathbf{B} \cdot \mathbf{B} dV, \tag{26}$$

where \mathbf{B} is the permanent magnetic field of the core of the MEG [1]. Therefore, the energy (Eq. 26) is continuously replenished from the vacuum, so that in the theory, the MEG takes energy from the vacuum, which is effectively an infinite source of energy. The MEG is therefore an important prototypical device for outputting more power than is inputted by the circuit. The independent replication by Naudin [2] demonstrates that the MEG meets the requirements of reproducibility and repeatability, and so is a working device that cannot be refuted

demonstrates that the MEG meets the requirements of reproducibility and repeatability, and so is a working device that cannot be refuted theoretically. It must be explained theoretically, as suggested for example in Sec. 2 of this communication. The fundamental principle of the MEG is that energy is drawn from a permanent magnet and converted into an electric current. The permanent magnetic energy (26) is not depleted because it is continuously replenished by the vacuum magnetic energy (24a).

This description is a simplified synopsis of the MEG, which is fully described elsewhere [1], but suffices to show that a coefficient of productivity much greater than unity can be produced if it is realized

that the energy [1] exists in the vacuum itself, and that electromagnetic energy can be taken from the vacuum. There is no vacuum current J^ν in the Maxwell-Heaviside theory, and therefore there is no equivalent of the energy (24a) in that theory. The current J^ν is conserved, and so Noether's theorem is not violated by the explanation offered in this communication. In order for the MEG to operate in conventional Maxwell-Heaviside electrodynamics, a source of electromagnetic energy would have to be inputted into the MEG by this source, and the coefficient of performance could not exceed unity. In a higher-symmetry electrodynamics such as $O(3)$ electrodynamics, or in the electrodynamics developed by Lehnert [6], there is energy inherent in the vacuum *itself*, so no source, or transmitter, is needed in order for the MEG to output current indefinitely. The energy given to the core magnet of the MEG is taken from Eq. (1), and the MEG operates indefinitely in principle, and does not deplete, or run down, as an ordinary battery depletes. In higher symmetry electrodynamics, the positive and negative terminals of a battery act as a receiver of vacuum energy, and an ordinary battery runs down because the chemical energy needed to produce the positive and negative terminals is dissipated.

The MEG does not rely on such chemical energy, and in principle can take energy from the vacuum, via Eq. (1), indefinitely, and without a source, or transmitter, being present. The MEG does not violate Noether's theorem because the current J^ν is conserved and acts as a reservoir of energy. The MEG therefore utilizes this energy in the same way as water is drawn from a faucet.

Acknowledgments. The U.S. Department of Energy is thanked for the web site <http://www.ott.doe.gov/electromagnetic>, which is reserved for the advanced electromagnetic working group.

REFERENCES

1. T. E. Bearden, in M. W. Evans, ed., and the Royal Swedish Academy, *Contemporary Optics and Electrodynamics*, a special topical issue in three parts of I. Prigogine and S. A. Rice, series eds., *Advances in Chemical Physics* 114(2) (Wiley, New York, 2001), 2nd edn. of M. W. Evans and S. Kielich, eds., *Modern*

eds., *Advances in Chemical Physics* 114(2) (Wiley, New York, 2001), 2nd edn. of M. W. Evans and S. Kielich, eds., *Modern Nonlinear Optics*, a special topical issue in three parts of I. Prigogine and S. A. Rice, series eds., *Advances in Chemical Physics* 85 (Wiley, New York, 1992, 1993, 1997).

2. Communicated in Ref. 1.
3. M. W. Evans, in Ref. 1, Vol. 114(2).
4. M. W. Evans, J. P. Vigi er, and S. Roy, *The Enigmatic Photon, Volume 4* (Kluwer Academic, Dordrecht, 1997).
5. M. W. Evans, *The Enigmatic Photon, Volume 5: O(3) Electrodynamics* (Kluwer Academic, Dordrecht, 1999).

6. B. Lehnert, in Ref. 1, Vol. **114**(2). B. Lehnert and S. Roy, *Extended Electromagnetic Theory* (World Scientific, Singapore, 1998).
7. M. Sachs, in Ref. 1, Vol. **114**(1) and in T.W. Barrett and D. M. Grimes, eds., *Advanced Electromagnetism* (World Scientific, Singapore, 1995).
8. M.W. Evans, in Ref. 1, Vol. **114**(2).

The Motionless Electromagnetic Generator: Extracting Energy from a Permanent Magnet with Energy-Replenishing from the Active Vacuum

Thomas E. Bearden, Ph.D.
James C. Hayes, Ph.D.
James L. Kenny, Ph.D.
Kenneth D. Moore, B.S.
Stephen L. Patrick, B.S.

Magnetic Energy Limited
Huntsville, AL 35801

Special Note: Posting of this document on a DoE website does not imply approval or disapproval by the Department of Energy. This work is made available to illustrate innovative energy research by multiple researchers involving new concepts. Scientific method requires replication and independent test and verification, and an additional research prototype build-up for those purposes is presently underway by the authors.

BACKGROUND

Introduction

For about 10 years the inventors have been working together as a team, and exploring many avenues whereby electromagnetic energy might be extracted from various sources of potential, and eventually from the active vacuum itself. This has been very arduous and difficult work, since there were no guidelines for such a process whereby the electrical power system becomes an open dissipative system in the manner of Prigogine's theoretical models {17-19} but using determinism instead of statistics. There was also no apparent precedent in the patent database or in the scientific database.

Since the present "standard" U(1) electrodynamics model forbids electrical power systems with $COP > 1.0$, we also studied the derivation of that model, which is recognized to contain flaws due to its 136-year old basis. We particularly examined how it developed, how it was changed, and how we came to have the Lorentz-regauged Maxwell-Heaviside equations model ubiquitously used today, particularly with respect to the design, manufacture, and use of electrical power systems.

Our approach was that the Maxwell theory is well-known to be a material fluid flow theory, since the equations are hydrodynamic equations. So in principle, anything that can be done with fluid theory can be done with electrodynamics, since the fundamental equations are the same mathematics and must describe consistent analogous functional behavior and phenomena. This means that EM systems with "electromagnetic energy winds" from their external "atmosphere" (the active vacuum) are in theory quite possible, analogous to a windmill in a wind.

The major problem was that the present classical EM model excluded such EM systems. We gradually worked out the exact reason for the *arbitrary* exclusion that resulted in the present restricted EM model, where and when it was done, and how it was done. It turned out that Ludvig Valentin Lorenz {55} symmetrically regauged Maxwell's equations in 1867, only two years after Maxwell's seminal publication in 1865, and Lorenz first made the arbitrary changes that limited the model to only those Maxwellian systems in equilibrium in their energy exchange with their external environment (specifically, in their exchange with the active vacuum). This is not a law of nature and it is not the case for the Maxwell-Heaviside theory prior to Lorenz's (and later H. A. Lorentz's) alteration of it. Thus *removing* this symmetrical regauging condition {31, 34-38} is required—particularly during the discharge of the system's excess potential energy (the excitation) in the load.

Later the great H. A. Lorentz, working independently and apparently unaware of Lorenz's previous 1867 work, independently regauged the Maxwell-Heaviside equations so they represented a system that was in equilibrium with its active environment.

Implications of the Arbitrarily Curtailed Electrodynamics Model

Initially an electrical power system is *asymmetrically* regauged by simply applying potential, so that the system's potential energy is nearly instantly changed. The well-known gauge freedom principle in gauge field theory assures us that any system's potential—and hence potential energy—can be freely changed in such fashion. In principle, this potential energy can then be freely discharged in loads to power them, without any further input from the operator. In short, there is absolutely no theoretical law or law of nature that prohibits $COP > 1.0$ electrical power systems—else we have to abandon the successful modern gauge field theory.

But present electrical power systems do no such thing. However, all of them do accomplish the initial asymmetrical regauging by applying potential. So all of them do freely regauge their potential energy, and the only thing the energy input to the shaft of a generator (or the chemical energy available to a battery) accomplishes is the creation of the potentializing entity—the source dipole.

It follows that something the present systems perform in their discharge of their nearly-free¹ regauging energy must prevent the subsequent simple discharge of the energy to power the loads unless further work is done on the input section. In short, some ubiquitous feature in present systems must self-enforce the Lorentz symmetry condition (or a version of it) whenever the system discharges its free or nearly free excitation energy.

Lorentz's curtailment of the Maxwell-Heaviside equations greatly simplified the mathematics and eased the solution of the resulting equations, of course. But applied to the design of circuits—particularly during their excitation discharge—it also discarded the most interesting and useful class of Maxwellian systems, those exhibiting $COP > 1.0$.

¹ In real systems, we have to pay for a little switching costs, e.g., but this may be minimal compared to the potential energy actually directed or gated upon the system to potentialize it.

Consequently, Lorentz² unwittingly discarded all Maxwellian systems with "net usable EM energy winds" during their discharge into their loads to power them. Thus all present systems—which have been designed in accord with the Lorentz condition—cannot use the electromagnetic energy winds that freely arise in them by simple regauging, due to some universal feature in the design of every power system that prevents such action.

We eventually identified the ubiquitous closed current loop circuit as the culprit which enforces a special kind of Lorentz symmetry during discharge of the system's excitation energy. With this circuit, the excitation-discharging system must destroy the source of its EM energy winds as fast as it powers its loads and losses, and thus faster than it actually powers its loads.

Also, as we stated and contrary to conventional notions, batteries and generators do not dissipate their available internal energy (shaft energy furnished to the generator, or chemical energy in the battery) to power their external circuits and loads, but only to restore the separation of their internal charges, thereby forming the source dipole connected to their terminals. Once formed, the *source dipole* then powers the circuit {16, 22}.

Some Overlooked Principles in Electrodynamics

We recovered a major fundamental principle from Whittaker's {1} profound but largely ignored work in 1903. Any scalar potential is *a priori* a set of EM energy flows, hence a set of "electromagnetic energy winds" so to speak. As shown by Whittaker, these EM energy winds pour in from the complex plane (the time domain) to any x, y, z point in the potential, and pour out of that point in all directions in real 3-space {1, 26, 43}.

Further, in conventional EM theory, electrodynamicists do not actually calculate or even use the *potential itself* as the unending set of EM energy winds or flows that it actually is, but only calculate and use its *reaction cross section with a unit point static charge at a point*. How much energy is diverged around a single standard unit point static coulomb, is then said to be the "magnitude of the potential" at that point. This is a non sequitur of first magnitude.³

E.g., just as the small "swirl" of water flow diverged to stream around an intercepting rock in a river bottom is not the river's own flow magnitude, and certainly is not the "magnitude of the river", neither is the standard reaction cross section of the potential a measure of the potential's actual "magnitude". Indeed, the potential's "magnitude" with respect to any local interception and extraction of energy from it, is limited only by one's ability to (1) intercept the flow and (2) diverge it into a circuit to power the circuit. The energy flows identically comprising the potential {1} replenish the withdrawn energy as fast as it can be diverged in practical processes, since the energy flows themselves move at the speed of light.

² Although Lorentz did this first, such was H.A. Lorentz's prestige that when he advanced symmetrical regauging, it was rather universally adopted by electrodynamicists, and is still used by them today. E.g., see J.D. Jackson, Classical Electrodynamics, 2nd Edition, Wiley, New York, 1975, p. 219-221; 811-812.

³ E.g., just replace the assumed unit point static charge assumed at each point with n unit point static charges, and the collected energy around the new point charge will be n times the former collection. If the former calculation had yielded the actual magnitude of the potential at that point, its magnitude could not be increased by increasing the interception. But since the potential is actually a flow process, increasing the reaction cross section of the interception increases the energy collection accordingly.

Work-Energy Theorem In a Replenishing Potential Environment

We also came to better understand the conservation of energy law itself. Particularly, the present work-energy theorem assumes only a "single conversion" of energy into a different form, where such "conversion in form" due to a converting agent is what is considered "work" upon that agent. No "replenishing by a freely flowing energy river or process" is considered.

On the other hand, in a replenishing potential environment, a conversion in the form of the energy may increase the energy (e.g., the kinetic energy of an electron gas) of the converting agent, but all the field energy and potential energy input to that converting agent may be replenished, so that a *free regauging* occurs. In that case, the original energy can be changed—e.g., into field energy form, which is not the kinetic energy of the electron gas—and yet a joule of work can have been done upon the electron gas to alter its potential energy by as much work as was done on it. Thus the work performed by this change in energy form with simultaneous replenishment of the original form, may increase the energy of the medium while retaining as much field energy and potential energy as was input, but just in different form.

This is a profound change to the implicit assumptions used in applying the work-energy theorem. In short, the present work-energy theorem (without replenishment) was found to be a special case of a much more general and extended *energy-conversion-of-form-with-intermediate-work-performed-upon-the-converter* process. *Conversion of the form of energy* is rigorously what we call *work*. The energy is not consumed in the process, nor need it be "lost" in doing work upon the converter. So to speak, the well-established principle of gauge freedom has been arbitrarily overlooked in the conventional view of the work-energy theorem. As a short way of stating what we found, *the conventional form of the work-energy theorem applies only when there is no simultaneous regauging/replenishment involved*.

This extension of the work-energy theorem to a more general case has profound implications in physics. With the energy replenishing environment involved, the work-energy theorem becomes an energy-amplifying process. Energy can be freely amplified at will—anywhere, anytime—by invoking the extended energy-work process, if regauging accompanies the process simultaneously. Indeed, one joule of field energy or potential energy can do joule after joule of work on intermediary converters, increasing the kinetic energy etc. upon the converter medium, while retaining joule-for-joule of the input energy in differing field or potential forms. In this extended process, always after each joule of work on the converting agent there still remains a joule of field energy or potential energy of altered form.

The Extended Principles Permit COP>1.0 Electrical Power Systems

Gradually we realized that (1) electrodynamics without the arbitrary Lorentz regauging did permit asymmetrically self-regauging electrical power systems, freely receiving and converting electrical energy from their vacuum environment, (2) present systems are designed unwittingly to guarantee the re-imposition of symmetry during their excitation discharge, (3) this excitation symmetry is what must be and can be broken by proper system design, and (4) a magnetic system "powered" by a permanent magnet dipole's ongoing active processes {1, 26, 43} could readily be adapted so that the source dipole of the permanent magnet was not destroyed by the

circulating magnetic flux. We experimented on various buildups and prototypes, in this vein, for some years.

Patenting and Discovery Activity

In 1997 we filed a provisional patent application on the first prototype of real interest. We filed another formal patent application in 2000 after several years of experimentation in which we used multiple extraction of energy from the magnetostatic scalar potential formed between the poles of a permanent magnet. Here we reasoned that, in so doing, we would deplete the magnetic dipole, and our experiments sometimes seemed to indicate that a very slow depletion might indeed be happening.

Since our last formal patent application filing in 2000, additional build-ups and experiments have led us to the conclusion that it is not necessary to deplete the magnetic monopole. Instead, if one draws the energy *directly from the potentials* (primarily, from the magnetic vector potential) furnished by the magnetic dipole of the permanent magnets, one can essentially draw as much energy as desired, without affecting the dipole itself. And again, we found that any amount of energy can be withdrawn, so long as it is changed in form in the withdrawal. A giant negentropy mechanism—recently uncovered by Bearden {26} and further investigated by Evans and Bearden {43}— is associated with the magnet dipole, and in fact with any dipole as shown by Whittaker {1}. This negentropy mechanism {1, 26, 43} will replenish the magnetic vector potential energy to the permanent magnet dipole as fast as energy is withdrawn from it and into the circuit.

We hit upon the stratagem of using a highly specialized magnetic core material, nanocrystalline in nature and in special tape-wound layered structure, to try to extract the energy from the magnetic vector potential (**A**-potential) as a magnetic **B**-field (curl of the **A**-potential) that is locally restricted to the special nanocrystalline material which forms a closed magnetic flux path closed on both poles of the permanent magnet dipole. It turned out that the nanocrystalline material,⁴ because of its nature and also its tape-wound layered construction, actually will perform this separation of **B**-field and **A**-potential energy which is heretofore unheard of in such a simple magnetic core mechanism and flux path material.

We point out that a tightly wound, very long coil does a similar thing, as does a good toroid, and these effects of separating **A**-potential from **B**-field are known. But to our knowledge, such effects have not previously been utilized in magnetic core materials themselves, in a flux path through space. Our experimental measurements showed the magnetic field to be missing in the space surrounding the closed-path flux-path material, but the **A**-potential was indeed present and did interact with coils in normal manner. We also showed that the **B**-field and associated magnetic flux were rigorously confined internally to the nanocrystalline material flux path.

This then led to very novel ramifications and phenomenology, which we have been intensely exploring since filing the previous patent when we were depleting the magnetic dipole of the permanent magnet or seemed to be. Now we have no depletion of the magnetic dipole, and also

⁴ Obtained off-the-shelf as a commercial product from Honeywell.

we can now explain where the continuous "magnetic energy wind" comes from, what triggers and establishes it, and how to apply the resulting principles.

Consequently, rapid progress in non-depleting versions of our previous invention, as a full extension to both the previous invention and also to the previous process utilized (depletion of stored potential energy), has been accomplished.

Results of the Research

It is now clear—by fluid flow analogy and actual experiment—that we have found the perfect magnetic mechanism for (a) producing "magnetic energy winds" at will, furnished freely by nature in natural dipole processes only recently recognized {26} and clarified {43} in the literature, (b) producing a magnetic "windmill", so to speak, that freely extracts energy from these free winds provided by nature from these newly-understood processes, and (c) creating positive energy feedforward and feedback iterative interactions in a coil around a core, resulting from dual energy inputs to the coil from (1) actions in the core inside the coil (2) actions in the surrounding altered vacuum containing a continuously replenished field-free magnetic potential \mathbf{A} , and hence comprising a separate source of energy that will react with a coil.

The *iterative* interactions occurring between the two interactions in the coil, add a third increase of energy from the resulting convergent energy gain (asymmetrical self-regauging) series. The additional amplification of the energy is given by the limit of the resulting convergent series for energy collection in the coil. In this novel new usage, the net result is that the coil is an *energy amplifying* coil, freely and continuously fed by excess input energy from an external active source.

It turns out that a multiplicity of such positive energy feedforward and feedback loops occur and exist between all components of the new process. The system becomes a true open system receiving excess energy from the free flow of energy established in its vacuum environment by the subprocesses of this invention's system process.

Consequently, we have experimentally established this totally new process and field, and also have experimentally established that it is not necessary to deplete the permanent magnet dipole after all. Now, direct replenishment energy from the active vacuum can readily be furnished to the permanent magnet with the new techniques being utilized.

THREE IMPORTANT PRINCIPLES AND MECHANISMS

We explain three very important principles/mechanisms necessary to comprehend the new process in a replenishing potential environment:

- (1) The conservation of energy law states that *energy cannot be created or destroyed*. What is commonly not realized is that energy can be and is reused (changed in form) to do work, over and over, while being replenished (regauged) each time. If one has one joule of energy collected in one form, then in a replenishing potential environment one can change all that joule into a different form of energy, thereby performing one joule of work. However, one still has a replenished joule of energy remaining, by the conservation of energy law in such an environment, since the first joule was removed in different form. If one collects and holds

that remaining joule in its new form, and then changes the form of it yet again in the replenishing environment, one does another joule of work—and still has a joule of energy left, just in a yet different form. The process is infinitely repeatable, limited only by the ability to hold the changed form of the energy each time it is changed.

Further, only two energy forms are needed for endless iterative shifting of form—say, form **A** and form **B**, since **A** changed totally into **B** performs work upon the transforming medium equal to **A** energy dissipation, but yields **A**-equivalence amount of energy still remaining because of replenishment. The **B**-form energy can then be changed back from **B** to **A** yet again, wherein the same amount of work is done upon the transforming medium for the second time, and one *still* has a joule of energy remaining because of replenishment, now back in the original form. This process can be iterated. We call this the ping-pong principle and use the iterative work done by each replenished change of energy form to continually increase the excitation energy of a receiving entity, the Drude electron gas in the coil and its attached circuit. We accent that this is also a novel way to directly utilize free regauging energy.

Cyclic transform of the energy by "ping-pong" between two different forms of energy or energy states with replenishment, is all that is required to produce as much work as one wishes in the intermediary, from a single joule of operator-input energy, limited only by one's ability to hold the new form of energy after each transformation and not lose it (or not lose all of it). By letting this iterative ping-pong work be done upon the Drude electron gas, the energy of that gas is excited much more than by the energy we input, if the input energy were only used once to perform work (if its form were only changed once).

We stress that present electrical power systems deliberately use their collected energy only once, and do not take advantage of energy regauging by free replenishment from the potential environment. So engineers are totally unfamiliar with the ping-pong mechanism and do not apply it. In short, they simply do not use the ping-pong effect to dramatically increase the energy in the Drude electron gas in the external circuits connected to the generator or battery.

- (2) The **A**-potential and the **B**-field are extraordinarily useful for just such "ping-pong" iterative change of energy form, from **B**-field energy to **A**-potential energy and vice versa, back and forth, repeatedly. That is precisely what happens in each coil of the process of the invention, and this results in dual inputs of energy—one in curl-free **A** form and one in **B** form—simultaneously to the coil. Quite simply, one can extract the energy from a volume of **A**-potential, in **B**-field form where the **B**-field energy is removed from the volume, and the **A**-potential beyond will instantly (at least at the speed of light) simply refill the volume, but with curl-free **A**-potential.

A similar effect is also demonstrated by the well-known Aharonov-Bohm effect {13, 15}, but only in very small effects, without the ping-pong effect, and not used in power systems. By analogy, we may compare this iterative process to "dipping several buckets of water in succession" from a mighty rushing river; the river refills the "hole" immediately after each dipping. We can continue to extract bucket after bucket of water from the same spatial

volume in the river, because of the continual replenishment of the extracted water by the river's flow.

Any change of **B**-field energy in the center of the coil, interacts with the coil magnetically since the coil's magnetic field is at its greatest strength in its precise center, and the center of the coil is in the center of the core flux path material. This magnetic interaction between core and coil produces voltage and current in the coil and therefore in a closed external loop containing the coil, and simultaneously produces an additional equal energy outside the coil in the form of field-free **A**-potential, which is absolutely permitted since the magnetic energy in **B**-form was "dissipated" (transformed) into **A**-potential energy, thereby causing the electrons in the wires to flow by doing work that built voltage and current, which was a change of form of the **B**-field energy. Simultaneously, the current electrons produce the **A**-potential energy around the coil and outside it, which is absolutely permissible since a change in form of the energy is again involved.

Since these changes in energy form occur at the speed of light, in a local coil they appear "instantaneous" though in reality they are not quite instant, but just very rapid. However, the work produced by each change of form of the energy in that rapid "ping-pong" between the several energy states, continually produces *work upon the Drude electrons*, producing momentum and motion in the Drude gas, thus resulting in voltage and current. In this way, the increased momentum and motion—involved in the currents flowing in the voltage drop of the coil and external loop—result in increased stored kinetic energy in the moving Drude gas, which is electromagnetic energy of different form.

As can be seen, because of the speed of the ping-pong energy state transformations, with each transformation doing work in the Drude electron gas to increase that gas's excitation and energy, a continuous "collection" of excess energy—caused purely by the change of form of the energy and not by "loss" or "disordering" of the energy—occurs in the Drude electron gas, resulting in increased voltage and current in the circuit containing the coil. This is simply a mechanism for a "regauging" or change of potential energy of the Drude electron gas system. The Drude electron gas system's increased excitation energy can then be dissipated "all at once" in conventional fashion in the external load, providing more energy dissipated as work in the load than was input to the coil originally.

Hence there is generated an *energy amplifying* action of the coil and its multiplicity of processes. There is no violation of the energy conservation laws, of the laws of physics, or of the laws of thermodynamics since this is an open system far from equilibrium with its source of potential energy (the magnetic dipole of the permanent magnet), which in turn continuously receives replenishment energy from the vacuum by a giant negentropy process only recently uncovered by one of the inventors {26} and clarified by Evans and Bearden{43}.

- (3) The dissipation of the final collected regauging energy within the load can permissibly be greater than what we ourselves initially input⁵, because of the iterative change of form of the energy with replenishment. Therefore the iterative interactive work done on the Drude electron gas provides more than one joule of work done on the gas—thereby increasing its potential energy by more than one joule—for each joule of energy input by the operator to the system process. The cumulated potential energy in the Drude electron gas is then discharged in loads in normal fashion. Note that, even here, the energy is not lost when dissipated from the load and outside the system, but just flows out of the load in a different form (e.g., as heat radiated from a resistor load). Again, this is no different from a windmill in a wind.

The various asymmetrical regaugings violate Lorentz's arbitrary symmetrical condition—specifically in the discharge or change of form of the energy. Hence, this process restores to electrodynamics one group of those missing Maxwellian systems arbitrarily discarded by first Lorenz and later Lorentz, more than a century ago.

THE PROCESS IS THEORETICALLY SUPPORTED

Several rigorous scientific papers {27-40} by the Alpha Foundation's Institute for Advanced Study (AIAS) have been published or are in the publication process, fully justifying that energy currents (energy winds) can readily be established in the vacuum, and that such energy winds do allow the extraction of EM energy from the vacuum.

Also Cole and Puthoff {54} have previously shown that there is no prohibition in thermodynamics which prevents EM energy being extracted from the vacuum and utilized to power practical systems.

In electrochemistry it has long been known {21} that there can be no current or movement in electrodes without the appearance of excess potential (regauging) called the *overpotential*.

Further, in the most advanced model in physics—gauge field theory—the freedom to change gauge (in electrodynamics, to change the potential) at will and freely, is an axiom of the theory. If we freely change the potential of a physical power system, we freely change its potential energy (in a real system, we may have to pay for a little switching energy losses).

It follows that we can also freely change the excess potential of that system—regauge it—yet again, by any means we choose, including discharging that excess potential energy in a load to do work. Thus gauge field theory has for decades already axiomized the rigorous basis for COP>1.0 electrical power systems—but the Maxwellian systems necessary to do it have remained neglected due to their arbitrary discard by the ubiquitous use of Lorentz symmetrical regauging.

That such COP>1.0 electrical power systems have not been previously designed or built is therefore not due to a prohibition of nature or a prohibition of the laws physics at all, but is due

⁵ See references 9-11. Actually, the standard calculation of the Poynting energy flow is not the calculation of the total EM energy flow at all, but only a calculation of how much of the energy flow is intercepted by the surface charges of the circuit and thereby diverged into the conductors to power the Drude electrons.

to a characteristic used to design and build the systems themselves. Because of their ubiquitous closed current loop circuits, conventional power systems use half their collected energy to destroy their own source dipoles, which destroys any further use of energy from "the potential between the ends of the dipole" since both dipole and potential vanish. The potential of the source dipole, after all, is what potentializes the external circuit with additional excitation energy, to be utilized to power the system. In present systems, half that excitation energy is dissipated to destroy the dipole along with the source potential, and less than the remaining half is used to power the load. This rigorously limits such systems to $COP < 1.0$.

In the present invention, we do not destroy the potentializing source dipole, which is the magnetic dipole of the permanent magnet. We include the vacuum interaction with the system, and we also include the broken symmetry of the source dipole in that vacuum exchange—a broken symmetry proven and used in particle physics for nearly a half century, but still inexplicably neglected in the conventional Lorentz-regauged subset of the Maxwell-Heaviside model.

Consequently, our work and this novel process are rigorously justified in both theory and experiment, but the principles and phenomenology are still not incorporated in the classical electrodynamics theory utilized to design and produce electrical power systems. These principles are indeed included in the new $O(3)$ electrodynamics being developed by AIAS^{6,7} that extends the present $U(1)$ electrodynamics model, as shown by some 90 scientific papers carried by the U.S. Department of Energy on one of its scientific websites in *Advanced Electrodynamics*, and by an increasing number of publications in *Foundations of Physics*, *Physica Scripta*, *Optik*, etc.

We thus have invented a process which indeed is well-founded and justified, but the basis for it is not yet in the texts and university courses. It is our belief that this absence will be rapidly rectified in the universities, in both the physics and electrical engineering departments, upon the advent of practical self-powering electrical power systems freely regauging themselves and extracting energy from the magnetic dipole of a permanent magnet, with the energy being continuously replenished to the dipole from the active vacuum via the new giant negentropy {26, 43} process.

CONSIDERING THE PROCESS

A-Potential and Field-Free A-Potential

This invention relates generally to the field of electromagnetic power generation. Specifically it relates to a totally new field of extracting additional electromagnetic energy in usable form from a permanent magnet dipole's potential energy, in addition to the electromagnetic energy extracted from its magnetic field energy, wherein the excess potential

⁶ The Alpha Institute's Institute for Advanced Study (AIAS).

⁷ A private communication from Dr. Myron Evans, 30 Sept. 2000, rigorously confirms that the magnitudes of the vector potential and the 4-current do in fact provide EM energy from the vacuum, and determine its magnitude as well.

energy taken from the magnet dipole is continuously replenished to the permanent magnet dipole from the active vacuum that is a curved spacetime with an ongoing giant negentropy flow process {26, 43}.

With respect to the electrostatic scalar potential, electrodynamicists are familiar with the fact that unlimited energy can be extracted from a potential. The very simple equation

$$W = \emptyset q \quad [1]$$

gives the amount of energy W in joules, which is collected at any given point x, y, z from the electrostatic scalar potential—whose reaction cross section is given by \emptyset , in joules collected per point coulomb—by charges q in coulombs and located at point x, y, z . Note that as much intercepting charge q as desired can be used at any point to increase the energy collection at the point, and collection can be accomplished at as many points x, y, z as is desired.

So any amount of energy can be collected from any nonzero scalar potential, no matter how small the potential's reaction cross section, if sufficient intercepting charge q and collecting points x, y, z are utilized. In short, one can intercept and collect energy from a potential indefinitely and *in any amount*, and *in any form taken by the interaction*, because the potential is actually a set of EM energy flows in longitudinal EM wave form, as shown by Whittaker {1} in 1903 and further expounded by Bearden {24, 26}. Subsequently, Evans and Bearden {43} have more rigorously interpreted Whittaker's {1} work and extended the principle into power systems. Thus any energy diverged and "withdrawn" from the potential in a given local region of it, is immediately replenished to the potential and to that region from the complex plane (the time domain) by the potential's flowing EM energy streams {1, 26, 43}, as rapidly as the energy is deviated and withdrawn.

For the magnetic vector potential, some preliminary comments are necessary. First, for over a hundred years it has been erroneously advanced that the magnetic vector potential \mathbf{A} is "defined" by the equation

$$\mathbf{B} = \nabla \times \mathbf{A} \quad [2]$$

This is easily seen not to be a definition at all, since an equation says nothing about the nature of anything on its right or on its left, but merely states that the entire right side has the same magnitude as does the entire left side. For an expression to be a *definition*, it must contain an identity (\equiv) sign rather than an equal ($=$) sign. Hence in seeing what is attempted to be defined, we rewrite equation [2] as

$$\mathbf{B} \equiv \nabla \times \mathbf{A} \quad [3]$$

Now it is seen that it is the magnetic field \mathbf{B} that is being defined as the curl of a swirling \mathbf{A} -potential, which swirling component we will call \mathbf{A}_C for the " \mathbf{A} circulating" component of \mathbf{A} . The curl of the circulating \mathbf{A} is a magnetic field \mathbf{B} , by identity [3]. There may of course be present additional \mathbf{A} -potential that has zero curl, but that additional longitudinal \mathbf{A}_L -potential or \mathbf{A}_L -current does not produce a magnetic field \mathbf{B} per se. However, it does interact with charges, which add the curl operator and produce \mathbf{B} -field.

In 3-dimensions, the field-free \mathbf{A}_L potential may be moving longitudinally, in which case it is identically an electrical potential " ϕ " that is moving longitudinally and hence no longer really a *scalar* potential ϕ but a vector potential Φ . If Φ translates without changing magnitude, there is no \mathbf{E} -field and hence Φ is a field-free vector potential. Identity [3] still does not define \mathbf{A} , but defines \mathbf{B} in terms of \mathbf{A} and the curl operator. Note particularly that, in identity [3], we may have additional Φ present as a curl-free, longitudinal magnetic vector potential \mathbf{A}_L and we shall refer to this additional curl-free magnetic vector potential as \mathbf{A}_L (for longitudinally translating \mathbf{A} component without swirl).

General Relativistic Considerations

Rigorously we are using the Sachs unified field theory view that energy of whatever form represents a curvature in spacetime (ST). We argue that how we then observe or "see" the energy effects and label them, depends on the factors of physical interaction with that ST curvature. Thus interaction with magnetic charge produces magnetic energy aspects, while interaction with electrical charge produces electrical energy aspects, etc. Motion of either of the interactions lets us also "see" some of the magnetic energy as electrical energy, and some of the electrical energy as magnetic energy, etc.

However, when \mathbf{A}_L interacts with electrical charge, the charge may swirl, in which case the swirling component of the Φ moving with the charge is an \mathbf{A}_C component, and this \mathbf{A}_C swirling component will produce a magnetic field \mathbf{B} by identity [3].

As we stated, in the unified field theory approach being used {42, 44-46}, in spacetime all energy is simply a special curvature of that spacetime, regardless of the form of the energy. Hence one can readily visualize the energy being changed from a vector potential to a scalar potential and vice versa, depending simply upon whether the potential is moving or stationary with respect to the frame of the observer (the laboratory frame).

It is also a well-known facet of general relativity that any change of energy density in spacetime *a priori* is associated with a curvature of spacetime.⁸ What has been neglected in general relativity (and arbitrarily discarded in electromagnetic theory long before general relativity was born) is the enormous EM energy flow filling the space around every EM circuit {24}, with almost all of it missing the circuit entirely, and not being intercepted and diverged into the circuit to power it.

This non-intercepted huge energy flow was recognized by Heaviside {10, 11}, not even considered by Poynting {9}, and arbitrarily discarded by Lorentz {51} as having "no physical significance" because it did not strike the circuit and power any part of it.⁹ It is still arbitrarily discarded today, using Lorentz's discard method.

⁸ That is, with the single exception of gravitational field energy, and even that exclusion has been challenged.

⁹ This is rather like discarding all the wind on the ocean except for that tiny component of it that strikes the sails of one's own sailboat. It is true that the wind missing one's own boat has no further significance for that one boat, but it may of course be captured in the sails of an entire fleet of additional sailing vessels to power them quite nicely. Hence the statement of "no physical significance" is a non sequitur; "no physical significance to that one specific

Also, it is still largely unrecognized in Western science that pure general relativity contains no energy conservation equations {47, 48} of the kind encountered in electrodynamics and mechanics. This is easily seen by considered the impact of gauge freedom, which allows the potential energy of any region of spacetime to be *freely* changed at will. But this is also a form of freedom of spacetime curvature, hence the notion of *fixed* accountability of energy replenishment and dissipation is completely voided by gauge freedom.

The great scientist Hilbert {48} first pointed out this remarkable absence of energy conservation laws from general relativity, not long after Einstein published his theory.

It also appears that the ultimate energy interaction is the transduction of energy-form between the time-domain (complex plane) and 3-space. In fact, *all 3-spatial EM energy actually comes from time-like EM energy currents after 3-symmetry breaking* {1, 26, 43}.

Indefiniteness Is Associated with the A-Potential

A magnetic vector potential \mathbf{A} produced by a current-carrying coil not tightly wound or closed (or very long), must possess both a swirl component \mathbf{A}_C (from the circling of the coil in each turn of the coil) and a longitudinal component \mathbf{A}_L from the longitudinal advance of the current between coils, since a coil is actually a helix and not a set of circles. It will also possess a magnetic field, both inside the coil and outside it.

Hence, considering both curled and curl-free types, the actual magnitude of \mathbf{A} is always indefinite—and in fact the indefinite nature of the potential together with the freedom to change it at will is universally recognized by electrodynamicists {7, 14}. However, the prevailing argument that change of potential does not affect the system is a non sequitur.

Further, in 1904 E. T. Whittaker {2} showed that any electromagnetic field, wave, etc. can be replaced by two scalar potential functions, thus initiating that branch of electrodynamics called *superpotential theory*. Whittaker's two scalar potentials were then extended by electrodynamicists such as Bromwich, Debye {3}, Nisbet {4} and McCrea {5} and shown to be part of vector superpotentials {6}, and hence connected with \mathbf{A} .

Applying the Giant Negentropy Mechanism

So let us consider the \mathbf{A} -potential most simply as being replaced with such a Whittaker {1, 2} decomposition. Then each of these scalar potentials—from which the \mathbf{A} potential function is made—is decomposable into a set of harmonic phase conjugate wavepairs (of longitudinal EM waves). If one takes all the phase conjugate half-set, those phase conjugate waves are converging upon each point in the magnetic vector potential \mathbf{A} from the imaginary plane (from the time domain). At that same point in \mathbf{A} , the other waveset—comprised of the harmonic set of longitudinal EM waves in 3-space—is outgoing. The 4-conservation of EM energy requires that the incoming energy to the point from the complex plane is being transformed at the point (by the assumed unit point charge at that point) into real EM 3-space

circuit" is better—but even then is incorrect if additional "sails" (interceptors) are added to catch more of the available energy wind and diverge more of it into the circuit.

energy, and radiating outward from that point as real EM energy, in this case in the form of the magnetic vector potential \mathbf{A} without curl since the curl operator is absent.

We have previously pointed out {22, 24, 26, 43} that this energy flow input from the complex plane to every point in the potential, with its output in real 3-space, is a more fundamental symmetry than is the usually assumed 3-symmetry in EM energy flow. Further, it is a giant negentropy and a continuous, sustained reordering of a fraction of the vacuum energy, and the reordering continues to expand in space at light speed so long as the source dipole for the potential exists.

What this means is that the \mathbf{A} potential—in either of its components \mathbf{A}_L and \mathbf{A}_C —is not to be thought of as having "fixed energy" since it consists of and identically is a myriad energy flow processes ongoing between the time-energy domain (the complex plane) and the real energy domain (real 3-space).

As is any potential including the electrostatic scalar potential ϕ between the poles of an electric dipole and the magnetostatic scalar potential \emptyset between the poles of a permanent magnet, the \mathbf{A} -potential is an ongoing set of longitudinal EM energy flows between the time domain (imaginary plane) and real 3-space {1, 26, 43}.

We stress that the EM energy flows comprising the so-called "scalar" potential and all "vector" potentials, violate 3-flow symmetry in energy conservation, but rigorously obey 4-flow symmetry. There is no law of nature that requires that energy be conserved in 3-space! If we work in 4-space as is normal, then the laws of nature require that energy be conserved in 4-space, as is done by the potential. Imposing the arbitrary additional requirement of 3-flow energy conservation imposes a 3-symmetry-restoring operation which destroys or nullifies the giant negentropy 4-process¹⁰ of the dipole {26} and results in system 3-equilibrium with the active vacuum. It results in design and production of electrical power systems exhibiting only COP<1.0. The ubiquitous closed current loop circuit design produces a circuit that deliberately (though unwittingly) re-imposes the 3-flow symmetry, kills the dipole and the giant negentropy process, requires at least as much continuous input energy by the operator as was utilized to kill the dipole, and has generated the gigantic burning of hydrocarbons and the pollution of the biosphere.

A Negative Resistance Process

Because of its giant negentropy process {26, 43}, any potential is an open EM energy flow system, freely receiving energy from the complex plane in its active vacuum environment, transducing that received reactive power (in electrical engineering terms) into real power, and outputting real EM energy flow in space in all directions at the speed of light {26, 43}.

The vacuum-dipole energy exchange process is negentropic {26, 43}, since there exists total 1:1 correlation between the inflowing longitudinal EM waves in the complex plane and the

¹⁰ Which in turn destroys the ability of any observable to exist (in time). An observable is *a priori* a 3-space fragment of an ongoing 4-space interaction, torn out at one frozen moment of time. The fact that observables do not persist in time has profound impact upon the foundations of physics, but its implications remain to be explored.

outflowing EM waves in real 3-space {1, 26, 43}. The potential then may rigorously be regarded as a novel kind of *negative resistor*, constituting an automatic ongoing negative resistance process. By *negative resistance process* we mean that the spatial points occupied by the potential continuously

- (1) receive EM energy in unusable form (in the form of longitudinal EM waves input from the complex plane, which is the continuous receipt of reactive power),
- (2) transduce the absorbed/received energy into usable form (real energy in 3-space), and
- (3) output the received and transduced EM energy as usable EM energy flow in 3-space.

Thus associated with and comprising any potential and any dipolarity—including the dipolarity of a permanent magnet—we have a novel, free source of EM energy from the vacuum's complex plane (reactive power input, in electrical engineering terms, with real power output). That is true whenever we have a potential of any kind, either \mathbf{A} or ϕ , or a dipole of any kind, either electrical or magnetic, or a polarization. Further, any energy we divert (collect) from this potential by and upon intercepting charges, and hold it in the localized vicinity of the charge, is an energetic excitation of the perturbing charges.

Modeling the Transduction Mechanism

Charges can be thought of as rotating 720° in one "full rotation", being 360° rotation in the complex plane followed by 360° rotation in real 3-space. The charges in the source dipole thus absorb the incoming reactive power while rotating in complex space and are excited therein, then re-radiate this absorbed EM excitation energy in real 3-space during their subsequent 360° rotation in that 3-space. Further, all the energy diverted from the energy flows comprising the potential, is immediately replenished by the vacuum to the source dipole, by the stated giant negentropy mechanism {26, 43}.

Replenishment Via Giant Negentropy

It follows that we may collect energy from an \mathbf{A} -potential of a permanent magnet by applying the curl operator to \mathbf{A} , then withdrawing and holding the resulting $\mathbf{B} = \nabla \times \mathbf{A}$ magnetic field energy in a localized material flux path. That is the withdrawal of \mathbf{A}_C energy from the overall \mathbf{A} potential in space, which is the withdrawal of \mathbf{A}_C energy from the magnetostatic potential outflow dynamics between the poles of the magnetic dipole of the permanent magnet. This withdrawal and sharp path localization of the \mathbf{A}_C energy from the permanent magnet dipole's outpouring \mathbf{A} -potential energy will be continuously replaced at light speed by the giant negentropy process {1, 26, 43} engendered in 4-space by the magnetic dipole of the permanent magnet. Hence an unlimited amount of energy may be withdrawn from the \mathbf{A} -potential in space around the magnet in this fashion, and the withdrawn energy will be continuously replaced at light speed from the active vacuum via the giant negentropy process {1, 26, 43}. In real systems, the materials and components will impose physical limits so that only a finite amount of excess energy flow can be accomplished, but in real materials these limits still permit system $COP \gg 1.0$ {24}.

The foregoing discussion shows that, in a magnetic apparatus or process functioning as part of an overall electromagnetic power system, we may have one subprocess which continuously withdraws energy from the curled portion of \mathbf{A} (i.e., holds and localizes the magnetic field \mathbf{B} and confines it to a given path), and in that case the source (in this case the permanent magnet) of the \mathbf{A} -potential will simply replenish—at light speed—all the \mathbf{A} energy that was withdrawn and localized. The replenished \mathbf{A} energy will not be localized, since under a given set of conditions only so much energy is withdrawn and held in the localized condition.

The principle is that, as energy is drawn from the vector potential and then contained and circulated in field form in a localized material region or path, the withdrawn \mathbf{A} -potential energy in space outside that localized path is continually replenished from the permanent magnet dipolarity to the space surrounding the localized \mathbf{B} -field energy path as the real EM energy flow output of the giant negentropy process {26, 43} engendered by the magnet dipole. Further, the energy drawn from the permanent magnet dipolarity is continually replenished from the surrounding vacuum by the input EM energy flow to the magnet dipolarity from the vacuum's complex plane in the ongoing giant negentropy process {1, 26, 43}.

Regauging Can Be Negentropic

Any increase of energy in the apparatus and process in the local spacetime constitutes (a) self-regauging by the process, whereby the process freely increases the potential energy of the system utilizing the process, and (b) concomitant curvature of spacetime and increase in that spacetime curvature due to the increase of local energy in the system process.

From the standpoint of gauge field theory, free asymmetrical regauging is permitted by gauge freedom and is rigorously allowed, in effect allowing the violation of classical equilibrium thermodynamics because the regauged system freely receives EM energy from an external active source, the active vacuum's complex plane in the evoked giant negentropy process.¹¹ From the standpoint of general relativity, the excess energy from spacetime is freely allowed, since all EM energy moves in curved spacetime {36, 39, 40, 41, 42, 45, 46} *a priori*, and simple conservation of EM energy as usually stated in classical equilibrium electrodynamics need not apply {47, 48} in a general relativistic situation.

Use of a Nanocrystalline "Energy-Converting" Material

A nanocrystalline material recently available on the commercial market was found and utilized in this process. When utilized as a closed flux path external to and closed upon the two poles of a permanent magnet, the special nanocrystalline material will contain all the $\mathbf{B} = \nabla \times \mathbf{A}$ field energy (curled potential energy) in the closed flux path containing the magnet itself, while the magnetic dipole of the permanent magnet continuously replenishes and maintains the

¹¹ It may be that we are defining the causative mechanism for gauge freedom as being pure entropy or pure negentropy, but we defer to the advanced theoreticians to determine the truth or falsity of such a question. If one considers Whittaker's process {1} in either direction—i.e., energy freely entering 3-space from the time-domain, and energy freely entering the time-domain from 3-space—the conjecture may have some merit.

external circulation of field-free **A**-potential energy filling the space around the nanocrystalline closed flux path containing the withdrawn magnetic field energy.

This performance can in fact be measured, since magnetic field detectors detect no magnetic field surrounding the flux path (or even around the magnet in the flux path at an inch or two away from it), and yet coils placed in the spatial flux path outside the core interact with the field-free **A**-potential that is still there. A coil placed around the flux path so that the flux path constitutes its core, interacts both with the field-free **A**-potential outside the material flux path core, and simultaneously interacts—via the magnetic field inside the coil—with the magnetic field flux energy inside the core.

Dual Interactions with Ping-Ponging Between Them

Further, the two simultaneous interactions also *iteratively* interact with each other, in a kind of iterative retroreflection and interception of additional energy, so that a net amplification of the electrical energy output by the dually interacting coil results. The fact that iterative retroreflection processes can increase the energy collection from a given potential and enable $COP > 1.0$ has been previously pointed out {31}. In addition, multiple coils placed around the closed material flux path forming a common core of each and all of them, all exhibit such gains and also mutual interaction with each other, leading to further gain in the energy output by the coils and their interaction processes.

In short, the novel process of this invention takes advantage of the previously unknown giant negentropy process {1, 26, 43} ongoing to and from the permanent magnet's dipole and between the complex plane of the vacuum energy and real 3-space energy flows comprising the magnetic vector potential and the magnetostatic scalar potential, to provide a gain in the total amount of electromagnetic energy being diverted from (drawn from) the permanent magnet by the attached circuit, components, and their processes.

The total collectable energy now drawn from the magnet is the sum of (a) the magnetic field energy (curled **A**-potential energy) flowing in the flux path, (b) the magnetic energy in the uncurled **A**-potential energy flowing in the surrounding space, and (c) a further iterative "ping pong" gain component of energy caused by mutual and iterative interactions {31} of the multiple coils and their multiply interacting processes. Further, (d) additional energy can be intercepted and diverged (collected) from the flowing uncurled **A**-potential energy flowing in the surrounding space, and converted into output electrical energy as the outputs of coils, by simply adding additional interceptors (such as coils, for example, or spinning charges, etc.).

We have thus discovered a process for amplifying the circuit's *available* output energy extracted from a permanent magnet dipole's energy outflow, where the dipolarity is an open system and a negative resistor, freely receiving excess energy from the surrounding active vacuum, transducing the received energy into usable form, and outputting the energy as a continuous flow of usable excess electromagnetic energy. Thereby, additional energy may be intercepted in a system employing this process, and the process can be used in practical EM power systems and EM power system processes having $COP > 1.0$ when used in open-loop mode, and self-powering when used in closed-loop mode.

Further, we may utilize a collector/interceptor (such as a common coil wound around the flux path through it so that said flux path constitutes a core) which interacts with both available components of energy flow and with iterative interactions mutually between the two basic interactions. Each turn of the coil constitutes a $\nabla \times$ operator, bathed by the flowing uncurled \mathbf{A} -potential outside the line material. Hence the charges in the coil intercept the uncurled \mathbf{A} -flow, and curl the energy intercepted to produce a curled \mathbf{A} -flow, thus producing additional magnetic field $\mathbf{B} = \nabla \times \mathbf{A}$. This magnetic field is at its maximum in the exact center of the coil, which is in the exact center of the nanocrystalline core material with its retained $\mathbf{B} = \nabla \times \mathbf{A}$ field energy. Hence the coil interacts with two components of energy flow, being (1) the internal $\mathbf{B} = \nabla \times \mathbf{A}$ field energy retained in the nanocrystalline material in the coil's core, and (2) the external uncurled \mathbf{A} -potential energy flow striking its outside surface charges and changed into additional magnetic field energy and into additional electrical current flowing in the coil and out of it. In addition, (3) iterative mutual interaction between the two basic interactions also occurs, increasing the energy gain and the coefficient of performance.

Any additional EM energy input into the core material and flux path increases the $\mathbf{B} = \nabla \times \mathbf{A}$ field energy flowing in the flux path, hence withdrawn from the vector potential \mathbf{A} around the flux path, hence replenished from the permanent magnet dipole, and hence replenished to the magnet dipole from the complex plane, via the giant negentropy process {26, 43}. This increased energy collection in the magnetic flux in the core material passes back through the permanent magnet (which is in the path loop and completes it), altering the effective pole strength of the magnet and thereby increasing the magnitude of the giant negentropy process associated with said dipole of the permanent magnet. In turn, this increases the outflow of \mathbf{A} -energy from the magnetic dipole, increasing both its output $\mathbf{B} = \nabla \times \mathbf{A}$ field energy in the flux path and its output uncurled \mathbf{A} -flow energy in space outside the flux path. This further increases the spacetime curvature of the local space surrounding the flux path material, since the energy density of said local spacetime has increased.

Varying the Pole Strength of a Permanent Magnet

Hence the process is the first known process that deliberately and interactively alters the pole-strengths of the poles of a permanent magnet, utilizing said alteration to vary and increase the pole strength and hence the magnitude of the energy density flowing in the giant negentropy mechanism {26, 43}. From the general relativity view, it is the first known process that deliberately increases and structures the local curvature of spacetime, by electromagnetic means, so as to alter and increase the pole strength of a permanent magnet, using said pole strength alteration to increase the flow of energy into and out of the local spacetime, thereby increasing the curvature of said local spacetime and the resulting EM energy extracted therefrom.

Any extra uncurled \mathbf{A} -flow energy increase outside the nanocrystalline flux path material, increases the interaction with this field-free \mathbf{A} -flow energy of any coil around the flux path, thereby increasing the magnetic \mathbf{B} -field flux inside the flux path, and so on.

Regenerative Energy Gain

In short, the mutual iterative interaction of each coil wound on the flux path of the special nanocrystalline material, with and between the two energy flows, results in special kinds of regenerative energy feedback and energy feedforward, and regauging of the energy of the system and the energy of the system process. This excess energy in the system and in the system process is thus a form of free and asymmetrical self-regauging, permitted by the well known gauge freedom of quantum field theory. Further, the excess energy from the permanent magnet dipole is continually replenished from the active vacuum by the stated giant negentropy process {1, 26, 43} associated with the permanent magnet's magnetic dipole due to its broken 3-symmetry {16} in its energetic exchange with the vacuum.

As a result, each coil utilized is an amplifying coil containing an amplifying regenerative process, compared to a normal coil in a normal flux path which does not hold localized the $\mathbf{B} = \nabla \times \mathbf{A}$ field energy within its core material, and does not simultaneously interact with both internal \mathbf{B} -field flux energy and external excess field-free \mathbf{A} -potential.

Open System Far from Equilibrium, Multiple Sub-processes, Curved Spacetime

The entire system process is thus a self-regauging regenerative system process and an energy-amplifying system process, where the excess energy is freely furnished from the local curved spacetime as energy flows from the magnetic dipole of the permanent magnet, and in turn freely replenished to the permanent magnet dipole by the giant negentropy process established in the active vacuum environment by the broken 3-symmetry of said magnetic dipole {16} and the concomitant locally curved spacetime.

The system process is thus an open electromagnetic process far from thermodynamic equilibrium {17-19} in its active environment (the active vacuum), freely receiving excess energy from said active environment via the broken 3-equilibrium of the permanent magnet dipole. In each coil, the coil is an open system freely receiving excess energy from its active environment (the active field-free \mathbf{A} -potential flowing through the space occupied by the coil and surrounding it, and creating a local curved spacetime by its extra energy density, while also receiving energy from its internal environment, the \mathbf{B} -field magnetic flux in the material flux path through the center of the coil and comprising its core, and also curving the local spacetime by means of the extra energy density of the local spacetime.

The system process is also a general relativistic process {38-42, 45, 46} whereby electromagnetic energy is utilized to curve local spacetime, and then the locally curved spacetime continuously acts back upon the system and process by furnishing excess energy to the system and process directly from the curved spacetime, with the excess energy being continually input to the system from the imaginary plane (time domain) {1, 26, 43}.

SUMMARY OF THE PROCESS FROM VARIOUS ASPECTS

We summarize the many aspects of the overall process as follows: Advantage is taken of the fact that:

1. The magnetic flux and magnetic vector potential \mathbf{A} are freely and continuously furnished by a permanent magnet to a material flux path, and where the material flux path holds all curled vector potential \mathbf{A} and thus all magnetic field inside the flux path, and where the permanent magnet freely furnishes additional field-free magnetic vector potential \mathbf{A} to replenish the \mathbf{B} -field (curled magnetic vector potential \mathbf{A}) energy that was confined to the interior of the material flux path, and where multiple intercepting coils and processes are utilized with mutual iterative positive feedforward and positive feedback between the collectors and subprocesses to increase the energy collected and hence increase the COP of the system and system process.

2. A previously unrecognized giant negentropy mechanism is used as shown unwittingly by Whittaker {1} in 1903 but unrecognized until recently understood by Bearden {26} and further clarified by Evans and Bearden {43}, and the active vacuum continuously replenishes all magnetic vector potential \mathbf{A} (both curled and field-free) that is continuously output by the permanent magnet into the material flux path and into space surrounding the material flux path. Further, the replenishment energy flow from the active vacuum is from the time-domain {1, 26, 43} and thus from the complex plane, constituting the continuous input of reactive power by the active vacuum environment via time-like energy flows. These time-like potentials and energy flows are known in extended electrodynamics {29, 30, 32, 33, 35, 36, 38, 39, 41} but have not previously been deliberately utilized in electromagnetic systems and particularly in electromagnetic power systems, even though shown by Whittaker {1} as early as 1903.

3. The field-free magnetic vector potential \mathbf{A} is continually replenished and remaining (due to replenishment by the vacuum to the permanent magnet dipole and thence replenished from the magnet dipole to the space surrounding the material flux path) when a material flux path is utilized wherein the magnetic field associated with a permanent magnet's flux, through the flux path, is held internally and entirely in the material flux path, with the field-free magnetic vector potential \mathbf{A} remaining in space surrounding the flux path.

4. A coil will interact with either a magnetic field (i.e., it will interact with the curl of the \mathbf{A} -potential which curl is a magnetic field), or an \mathbf{A} -potential where no magnetic field is present, or simultaneously with a combination of both a curled \mathbf{A} -potential (with magnetic field \mathbf{B}) and a field-free \mathbf{A} -potential (without magnetic field \mathbf{B}). Indeed, there is a "ping pong" reiterative interaction between the two processes, constituting positive feedforward from each to the other, and positive feedback from each to the other.

5. A simultaneous interaction of a coil with both a magnetic field (curl of \mathbf{A}) and a field-free \mathbf{A} potential produces electromagnetic energy in the form of voltage and current in an external circuit connected to the coil, and the net voltage and amperage (power) produced by the coil is a result of the summation of both simultaneous interactions with said coil and its Drude electrons and of the iterative "ping-pong" interactions between the two simultaneous interactions, and therefore the summation provides a greater coil output energy than is produced by the coil

from either the magnetic field (curled \mathbf{A}) separately or the field-free \mathbf{A} -potential separately. Further, the "ping-pong" iterative interaction adds additional energy collection and gain to the electrical power output of the coil.

6. Multiple coils are wound on the material flux path, where magnetic flux is input to the material flux path from a permanent magnet, and where the material flux path holds internally all curl of \mathbf{A} (magnetic field) from the permanent magnet's flux, so that magnetic field and magnetic flux from the permanent magnet are inside the closed material flux path, and so that no magnetic field is outside the closed material flux path, and so that a field-free magnetic vector potential \mathbf{A} replenishes the curled \mathbf{A} -potential held in the material flux path, and where the replenished field-free magnetic vector potential \mathbf{A} occupies the space outside the material flux path and flows through the surrounding space.

7. A broken 3-space symmetry exists of a magnetic dipole {16} of a permanent magnet, well-known in particle physics since 1957 but inexplicably not yet added into classical electrodynamics theory, wherein the broken symmetry of the magnetic dipole rigorously requires that the dipole continually absorb magnetic energy from the active vacuum in unusable form, and requires that the broken symmetry output (re-emit) the magnetic energy in usable form as real magnetic field energy in 3-space and real magnetic vector potential in 3-space. And where the receipt of unusable EM energy, transduction into usable form, and output of the usable EM energy, constitutes a true negative resistance process {26, 43} resulting from the ongoing giant negentropy process {26, 43} engendered by the broken symmetry of the magnetic dipole of the permanent magnet.

8. Whittaker's 1903 mathematical decomposition {1} of any scalar potential applies Whittaker decomposition to the magnetostatic scalar potential existing between the poles of the permanent magnet, revealing that the magnetostatic scalar potential of the permanent magnet is comprised of a set of harmonic longitudinal EM wavepairs, where each wavepair consists of a longitudinal EM wave and its phase conjugate replica wave.

9. The incoming half-set of Whittaker decomposition waves consists of the phase conjugate waves, which are all in the imaginary plane {26, 43} and continuously converging upon the magnetic charges of the permanent magnet dipole at the speed of light. The incoming, converging longitudinal EM waves are continuously absorbed from the imaginary plane by the magnetic charges (magnetic poles), so that the permanent magnet dipole is continuously replenished with time-like energy flow from the active vacuum environment, while continuously transducing the received time-like energy into 3-spatial energy, and outpouring real EM energy flow in the form of the longitudinal EM Whittaker waves {1} emitted in 3-space in all directions.

10. The other half-set of the Whittaker decomposition waves, consisting of outgoing real EM Whittaker longitudinal waves {1} in 3-space, is continuously and freely emitted from the permanent magnet dipole charges (poles) and continuously diverges outward in space in all directions from the permanent magnet dipole at the speed of light. Thus there is revealed and used a process for a natural, continuous source of magnetic energy from the vacuum: a continuous EM wave energy flow convergence of electromagnetic energy from the vacuum to the magnetic dipole, but in the imaginary plane and hence constituting a continuous energy input in the form of imaginary power {26, 43}, with the absorbed magnetic energy being transduced

into real power and re-emitted in real 3-space in all directions, whereby the absorption of energy from the vacuum from the imaginary plane (time domain) is in 4-flow equilibrium with the re-emission of the absorbed energy in 3-space, but not in 3-flow equilibrium, and where the outgoing real magnetic energy provides the surrounding magnetic field and the surrounding magnetic vector potential of the permanent magnetic dipole.

11. In this manner the broken 3-symmetry of the magnetic dipole (permanent magnet) allows the dipole to continuously receive reactive power from the vacuum's time domain, transduce the reactive power into real EM power in 3-space, and re-emit the absorbed energy as real magnetic energy pouring into space and consisting of both a magnetic field and a magnetic vector potential. Thus the permanent magnet, together with its Whittaker-decomposed {1} magnetostatic scalar potential between its poles, represents a dynamo and an energy transducer, continuously and freely receiving energy from an external source (the active vacuum) in the complex plane and transducing the received complex plane EM energy into real EM energy {26, 43}, and radiating the real EM energy into real space as real EM power. EM energy flow conservation in 3-space is permissibly violated due to the broken 3-symmetry of the magnetic dipole, but EM energy flow in 4-space is not violated and is rigorously conserved. There is no law of nature which requires energy conservation in three dimensions and 3-space; instead, energy conservation is required by the laws of nature and physics in 4-space. The additional condition usually assumed—that energy conservation is *also* always conserved in 3-space—is not required by nature, by physics, or by thermodynamics, and the additional 3-conservation requirement is removed by this process in any dipole, by the broken 3-symmetry of the dipole. It is this newly recognized giant negentropy process advanced by Bearden {26} and extended by Evans and Bearden {43} which is directly utilized by this new power system process, in conjunction with directing and interacting material flux paths, intercepting coils, separation of curl of the **A**-potential (i.e., the **B**-field) and the field-free **A**-potential (replenished from the vacuum), and interaction of a coil with a magnetic field and magnetic flux running through a material core through the coil, and with an external field-free magnetic potential reacting with the coil. The foregoing actions provide a magnetic system which receives—via the permanent magnet dipole—replenishment EM energy from the active vacuum to the dipole, and from the dipole to the circuit and the space surrounding it, to enable the permanent magnet to continuously furnish magnetic field and flux to a flux path in the process, and continuously furnish both the curl energy of the **A**-potential and the field-free energy of the **A**-potential replenished from the vacuum, and to have multiple coils interacting simultaneously with both curled **A**-potential and magnetic flux inside the coils, while also interacting simultaneously with field-free magnetic **A**-potential from the space in which the coil is embedded, such that excess energy is added to the interacting coils from the field-free **A**-potential in space, and where the field-free **A**-potential in space is continuously furnished by the permanent magnet dipole, and where the extra energy for the furnished field-free **A**-potential is continuously received by the permanent magnet dipole from the active vacuum exchange, via the process shown by Whittaker's decomposition {1}.

12. The difficulty heretofore experienced by designers, engineers, and scientists with using the magnetic energy continuously emitted to form the static field and magnetic scalar potential of a permanent magnet dipole, is that all schemes for using the magnetic energy have

relied on physical motion, or the input of energy to overcome the field of the permanent magnet, or other brute force methods. This invention provides a new process for a coil to extract excess EM energy from the magnetic vector potential energy in space from the permanent magnet, while simultaneously interacting with the magnetic field energy of the permanent magnet flowing through a flux path through the center of the coil but not in space surrounding the flux path. The Whittaker decomposition shows that when the system extracts EM energy from the magnetic vector potential \mathbf{A} and magnetostatic scalar potential ϕ , the energy to continuously form and maintain the magnetic vector potential's vector current is continuously replenished from the vacuum by the convergent reactive EM power being input from the imaginary plane (time domain). Evans and Bearden {43} have also shown that, in the most general form of the vector potential deduced from the Sachs unified field theory, electromagnetic energy from the vacuum is given by the quaternion-valued canonical energy-momentum. Further, the most general form of the vector potential—i.e., flowing EM energy in vector potential form—has been shown by Evans and Bearden {43} to contain *longitudinal and time-like components (energy currents)*, in agreement with the simpler Whittaker decomposition {1} as a special case, but much richer in available structure than Whittaker's decomposition. Evans and Bearden {43} have also shown that the scalar potential is in general a part of the quaternion-valued vector potential, and can be defined only through suitable choice of metric for a given experimental setup. They have shown the energy current in vacuum in this more advanced treatment in $O(3)$ electrodynamics, and it is this demonstrated vacuum EM energy current which continuously replenishes any excess energy drawn from the permanent magnet dipole's magnetostatic scalar potential to replenish the curl of the \mathbf{A} -potential (the magnetic \mathbf{B} -field energy) held inside the material flux path powered by the magnet and also to replenish the field-free \mathbf{A} -potential filling space around the material flux path.

13. A special nanocrystalline material comprises the closed flux path powered by the permanent magnet, where the nanocrystalline material performs the highly special function of separating and retaining the curl energy of the \mathbf{A} -potential (i.e., retaining the magnetic field energy) inside the material flux path along with the magnetic flux. The nanocrystalline material consists of coiled flat "tape" layers of material, with the layers acting in the fashion of a perfect toroid to retain all magnetic field (curled \mathbf{A} -potential) inside the material, while having the curl-free \mathbf{A} -potential filling all space outside the nanocrystalline material.

14. This special nanocrystalline material may be further considered in the manner of a "layered" magnetic flux path material, wherein the "layers" are a molecule in thickness, and wherein essentially all eddy currents are eliminated or reduced to completely negligible magnitude, and wherein as a result the nanocrystalline material does not dissipate magnetic energy from the flux path, and wherein as a result said nanocrystalline material does not produce eddy currents, and wherein as a result the nanocrystalline material does not exhibit heating since heat is scattered and dissipated energy, and no such scattering or dissipating of the magnetic flux energy occurs in the nanocrystalline material. Thus the system process is able to process significant power and energy without heating of the core flux path material at all, and without requiring cooling of the core material, these being characteristics having a remarkable advantage over other core materials subject to eddy currents, substantial heating, and the need for cooling.

15. The magnetic flux from a permanent magnet provides a source of magnetic flux energy to and within the nanocrystalline material in a flux path, such that the nanocrystalline material holds the magnetic field component (curl energy of the vector potential \mathbf{A}) in the flux path while the flux path material itself is not further interacting with the field-free magnetic vector potential and its energy that fill the space around the closed material flux path, and where the field-free magnetic vector potential—in space external to the material flux path—geometrically follows the directions and turns of the material flux path but outside it.

16. Any coil immersed in the nanocrystalline material's magnetic vector potential in space, but not wound around a portion of said nanocrystalline flux path, will react to the magnetic vector potential and its energy. Each turn of a coil acts as a curl-operator, producing a magnetic field due to the received energy current from the magnetic vector potential. If an electrical current is passed through the coil, and if the magnetic flux produced by the electrical current in the coil is aligned with the magnetic flux that is produced by the coil's interaction with the magnetic vector potential from the nanocrystalline flux path material, then the two magnetic vector potentials will vectorially add, so that the magnetic field produced by the current through the coil will be augmented due to the curl-operation of the coil now acting upon an increased magnetic vector potential summation consisting of the vector sum of the curled magnetic vector potential and the field-free magnetic vector potential.

17. Any time-rate of change of a magnetic vector potential, either curled or curl-free, constitutes an electric field, which in an interacting pulsed coil produces pulsed voltage across the coil and pulsed current through the coil, and which produces current and power in a closed circuit loop consisting of the interacting coil and a connected external circuit. The excess magnetic energy is received by the circuit from the magnetic dipole of the permanent magnet (and replenished to the dipole from the time-like Whittaker energy currents from the active vacuum). The process transduces the excess magnetic energy into excess electrical energy, and outputs the excess electrical energy into electrical loads to power them, whereby the excess energy received and replenished from the active vacuum environment via the giant negentropy process of the permanent magnet dipole {26, 43} allows system COP to be greater than 1.0.

18. Further, with $COP > 1.0$, a fraction of the output electrical energy from the process and system can be extracted and positively fed back to the operator input of the system and process (such as the electrical energy fed to a driver coil), with governing and clamping control of the positive feedback energy magnitude, so that the system process becomes a self-powering process freely powering itself and its loads, receiving all the energy from an external energy source due to its broken symmetry in its vacuum exchange and the resulting giant negentropy process (26, 43) thereof, and thus constituting an open system far from thermodynamic equilibrium with its active environment, freely self-regauging and powering itself and its load simultaneously by dissipation of energy freely received from its active environment.

19. The dual-action effect is increased in an interacting coil if the coil is wound around a portion of the nanocrystalline flux path, due to the permeability of the flux path as a magnetic core and the input of flux from the permanent magnet. In this case, the increased magnetic field produced inside the coil also interacts with the magnetic flux path core in its center, producing an increased change in the magnetic flux in the nanocrystalline material itself.

The coil interacting in such dual fashion thus has *iterative* "energy feedforward and feedback" between the two simultaneous processes, one process proceeding outward from inside, and the other proceeding inward from outside. A convergent series of summing energy additions (regaugings) thereby occurs in the coil, thus producing *energy amplification* in the coil.

20. The combined aforementioned actions result in the coil increasing its energy output due to receiving and transducing extra energy from the magnetic flux of the permanent magnet, the magnetic field of the permanent magnet, and an extra field-free magnetic potential \mathbf{A} surrounding the flux path and continuously furnished by the permanent magnet. The production of one or more potentials is also the production of one or more regaugings. As is well-known from electrodynamics and from gauge field theory, gauge freedom is permitted freely and at will. In electrodynamics, regauging to change the potential of a system simultaneously changes (freely) the potential energy of the system. In the present process, this regauging is physically applied by (1) holding the curl of the \mathbf{A} -potential inside the special nanocrystalline flux path material, (2) furnishing additional field-free magnetic vector potential \mathbf{A} from the permanent magnet dipole, (3) continuously replenishing the potential and energy from the vacuum.

21. This process provides for a permissible gain in the magnetic energy output of the interacting coil(s) for a given amount of energy input by the (a) operator to the active coil (used similar to a "primary" coil in a transmitter), or (b) a clamped, governed positive energy feedback of a fraction of the energy output from one output coil back to the input coil. This additional magnetic field energy output is retained in the nanocrystalline flux path, and the additional magnetic vector potential energy output moves through space surrounding the coil. The system process of the invention thus is a new process for energy amplification, with the excess output energy being freely received from the vacuum and thence to the permanent magnet dipole, and thence from the permanent magnet dipole to the other parts of the system, via the giant negentropy process associated with the magnet dipole as shown by Evans and Bearden {43} and by Whittaker {1}.

22. Multiple coils wound around the special nanocrystalline material fluxpath will each and all exhibit regauging energy gain by the fore-described processes, with the energy continuously replenished from the vacuum to the source dipole and from the source dipole to process, via the process shown by Whittaker decomposition.

23. Any scalar potential such as the magnetostatic scalar potential between the poles of a permanent magnet, is a continually-replenished energy flow process {1, 26}, so that any system utilizing the output flow from the permanent magnet dipole and containing such permanent magnet dipole, is an open system far from equilibrium in the replenishing vacuum flux, as shown by the Whittaker decomposition {1} and more precisely expanded by Evans and Bearden {43}.

24. The entropy of any open system in disequilibrium with its vacuum environment, is *a priori* less than the entropy of the same system in equilibrium, and in fact the entropy of such an open system cannot even be computed, as is stated by Lindsay and Margenau {20} and as is well-known in physics.

25. This process, producing an open system in disequilibrium with a recognized continuous source of energy {17-19, 26, 43}, is permitted to perform any or several or all of five functions: (1) self-order, (2) self-oscillate, (3) output more energy than the operator inputs (the excess energy is freely received from the active environment), (4) power itself and its loads and losses (all the energy is freely received from the active environment), and (5) exhibit negentropy. The process specified by this invention permits all five functions. For example, by extracting some of the output energy from an output section (coil) used in a system employing the process, and feeding the extracted energy back to the input section (coil), the energy gain of the system permits it to become self-oscillating and hence self-powering, while obeying energy conservation, the laws of physics, and the laws of thermodynamics.

26. Multiple feedforward and feedback sub-loops exist between the various parts of a complete flux path loop and \mathbf{A} -potential flow loop, so that regenerative energy collection gains are developed in the various subprocesses of the overall process. The result is an overall feedback summation and overall feedforward summation, whereby the system process regauges itself with \mathbf{A} -potential flow energy from the magnetic dipole, and the regauged energy is continuously replenished and received from the active vacuum via the stated giant negentropy process.

27. The system process consists of a magnetic negative resistor process, where energy is received freely in unusable form (pure reactive power from the time domain of the spacetime vacuum), transduced into usable form, and output in usable form as real EM energy flow in 3-space {1, 26, 43}.

28. The system process is a permissible local energy gain process and a self-regauging process, freely increasing the process's and system's potential energy and receiving the regauging energy from the active vacuum via the giant negentropy process {26, 43}, and freely collecting and dissipating the excess regauging potential energy in loads.

29. The system process may be open-looped where the operator inputs some electrical energy and the system outputs more electrical energy than input by the operator, the excess energy being freely received from the permanent magnet dipole and from the vacuum to it via the giant negentropy process {26, 43}, with process transductions of the various energy forms between magnetic form and electrical form.

30. The system process may be close-looped and "self-powering", where a portion of the amplified energy output is extracted, rigidly clamped in magnitude, and positively fed back to the input. This replaces the operator input entirely, with all energy input to the system process being received from the vacuum through the permanent magnet dipolarity's Whittaker decomposition and constituting direct system application of the stated giant negentropy process {26, 43}.

31. The system process is a magnetic regenerative gain process, outputting more energy than the operator himself inputs, with the excess energy received from the active vacuum via the broken 3-symmetry of the dipole which initiates and sustains the giant negentropy process {26, 43}, whereby EM energy continuously flows into the system from the complex plane (time domain), is transduced into usable magnetic energy in real 3-space, and is then

transduced into ordinary electrical energy by the system process, thereby powering both the system and the loads.

32. In an embodiment using the process, all coils exhibit energy gain and increased performance, as does the overall system. All coils are energy amplifying coils, each with gain in energy output greater than 1.0 compared to the same coil without simultaneous but separate exposure to and interaction with separate inputs of field-free magnetic potential and magnetic field, and without iterative positive feedback between the two simultaneous interactions.

33. For power system processes, the combined process requires using at least one primary (active) coil in dual interaction with iterative feedback between the duals, and one secondary (passive) coil in dual interaction with iterative feedback between the duals, both on a common nanocrystalline flux path. The resulting "minimum configuration" embodiment produces a power system that is an open thermodynamic system, not in equilibrium with its external environmental energy source: to wit, the continuous inflow of EM energy from the complex plane of the active vacuum into the permanent magnet dipole, and the continuous outflow of real magnetic energy from the permanent magnet dipole, with the holding of the magnetic field energy and magnetic flux energy inside the nanocrystalline material in the closed magnetic flux path, and with excess field-free magnetic vector potential filling the surrounding space, as continuously furnished by the permanent magnet dipole and continuously replenished to the dipole by the active vacuum due to the dipole's broken 3-symmetry in its vacuum energy exchange and the giant negentropy 4-space energy flow operation {26, 43} initiated thereby.

34. This process permissibly violates 3-symmetry energy conservation, but rigorously obeys 4-symmetry energy conservation and thus is a process which has not previously been applied in electrical power systems. The basic excess energy input is received from an unusual source: the complex plane (time domain) of the locally curved and active spacetime (vacuum), as shown by the Whittaker decomposition {1} of the permanent magnet's magnetostatic scalar potential between its poles, and as further demonstrated in several AIAS papers {39-41, 43}, and as recognized by Bearden {26} and investigated more deeply by Evans and Bearden {43}. The energy into the nanocrystalline flux path material is input directly from the permanent magnet as magnet flux energy. From its dual interaction with two magnetic energy components, the active (driving) coil produces increased magnetic field flux in its center and thus in its interaction with the magnetic flux path and the magnetic flux in the flux path, and also produces increased magnetic flux back through the permanent magnet dipole, thereby altering the pole-strength of the permanent magnet, and also produces increased field-free \mathbf{A} -potential in space surrounding the permanent magnet and surrounding the nanocrystalline flux path, and flowing geometrically in the direction taken by the nanocrystalline flux path. From its dual interaction with two magnetic vector potentials as well as two magnetic field components superposed, the passive (driven) coil produces increased EM field energy in the form of current and voltage out of the coil and into any conveniently attached external load for dissipation in the load by conventional means.

35. The process in this invention uses and applies an open system process for receiving excess energy from an external source (the permanent magnet flux and the permanent magnet \mathbf{A} -potentials), and since the permanent magnet flux and permanent magnet \mathbf{A} -potentials

are continuously replenished from the vacuum via the broken 3-symmetry of the magnet dipolarity via its Whittaker decomposition {1}, the process is allowed to be adapted in systems to (a) produce $COP > 1.0$, and (b) be closed looped with clamped positive feedback from load output to input, so that the system powers itself and its load simultaneously.

36. The open system far from equilibrium process of this invention thus allows electromagnetic power systems to be developed that permissibly exhibit a coefficient of performance (COP) of $COP > 1.0$. It allows electromagnetic power systems to be developed that permissibly (a) power themselves and their loads and losses, (b) self-oscillate, and (c) exhibit negentropy.

37. No laws of physics or thermodynamics are violated in such open dissipative systems exhibiting increased efficiency, and conservation of energy laws are rigorously obeyed. Classical equilibrium thermodynamics does not apply and is permissibly violated. Instead, the thermodynamics of open systems far from thermodynamic equilibrium with their active environment—in this case the active environment—rigorously applies {17-19}.

38. This appears to be the first magnetic process deliberately utilizing and separating special energy flow processes—associated in a curved spacetime with the permanent magnet's dipolarity—to provide true magnetic energy amplification, receiving the excess energy freely from the permanent magnet dipole, with said energy being continually replenished to the dipole from the imaginary plane in spacetime by the giant negentropy process {26, 43}.

39. This appears to be the first power system process which in open-loop mode receives electrical energy input by the operator or outside normal source, wherein the electrical energy input is transduced into magnetic energy flows, and wherein curled \mathbf{A} -potential flow (magnetic field energy flow) is separated from field-free \mathbf{A} -potential flow, and where dual and iterative "ping-pong" interactions of feedforward and feedback of energy occur in each active component, and wherein the feedforward and feedback ping pong interactions create local energy gain in each active component, and wherein the magnetic potential energy of the system is self-regauged and increased (receiving the excess by giant negentropy replenishment from the active vacuum), and where the increased magnetic energy flow is then re-transduced into electrical energy and output to power loads, and wherein the output energy powering the loads is greater than the input energy provided by the operator.

40. The foregoing system functions as before described, wherein the system process positively feeds back a clamped fraction of its electrical output to its electrical input, resulting in a regenerative, energy-amplifying, self-regauging open system process which powers itself and its loads, the powering energy being freely received from the active vacuum curved spacetime via the giant negentropy process {1, 26, 43}.

41. The process therefore appears to be the first process for an electrical power system which permissibly violates electromagnetic energy conservation in 3-space, due to the use of the recognized and proven broken 3-symmetry of the dipole {16}, but while rigorously conserving electromagnetic energy in 4-space {26, 43}. It therefore appears to be the first electrical power system process which enables the use of a clamped positive feedback from output to input in an electrical power system having $COP > 1.0$ so that the system

continuously receives all the energy—to power its loads and losses—from the magnetic energy flow of a permanent magnet, with the energy flow being continually replenished to the permanent magnet by the energy circulation from the imaginary plane (as absorbed reactive power) and transduced into real power output by the magnet's dipole, and with the freely received magnetic flux energy from the dipole being separated into field energy and magnetic vector potential energy.

42. This appears to be the first $COP > 1.0$ electrical power system process that deliberately takes useful advantage of the fact that any amount of energy can be intercepted and collected from a potential, regardless of its magnitude, if sufficient intercepting charges (in this case, magnetic charges, or pole-strengths) are utilized. In this case, coils utilized around the special nanocrystalline core material interact with the field-free magnetic vector potential filling the space occupied by the electron spins in the Drude electron gas in the coils, while simultaneously the produced magnetic field in the coil due to its curl operation interacts with the localized magnetic field flux in the nanocrystalline flux path and core, and vice versa. In this way, effectively the energy interception and collection is multiplied beyond what is obtained by a coil with a core operating in normal magnetic field coupled to its magnetic vector potential in space.

43. This appears to be the first magnetic process that is a proven true negative resistance process, where "negative resistance process" is defined as a process whereby electromagnetic energy is continuously and freely received in unusable form, converted into usable form, and continuously output in usable form.

44. This appears to be the first power system process which deliberately uses energy to perform more than one joule of work per joule of energy, by transforming a given amount of energy into a different form, thereby performing work in the same amount upon a receiving medium while retaining the energy in its new form, then transforming that energy back into the first form again, thereby again performing work in the same amount upon the receiving medium again while retaining the energy back in its original form, and so on in "ping-pong" iterative fashion. The fraction of the energy that is retained from one transformation to the other determines the increase in energy of the medium receiving the work and thus being excited with kinetic energy, and thereby determines the energy gain of the power system in the multiplicity of such regenerative processes used in the system.

45. This appears to be the first magnetic process for EM power systems which deliberately creates and uses curved local spacetime to provide continuous energy and action upon the process's active components and subprocesses. Sachs' unified field model {44-46} as implemented by one of its important subsets— $O(3)$ electrostatics per Evans {40} and Vigier—is implemented in the system to provide several specific local curvatures of spacetime, with excess energy being thereby regauged into the system and used to power loads, including a self-powering system which powers itself and its loads simultaneously, and also including an open-loop system wherein the operator inputs a little EM energy and obtains more EM energy being dissipated as work in the load.

RELATED ART

There is believed to be no prior art in such true magnetic negative resistor processes for

- (1) utilizing curvatures of local spacetime to provide excess energy from spacetime input into the various active components of the system process,
- (2) receiving EM energy from the spacetime vacuum in unusable reactive power form,
- (3) having the permanent magnet dipole convert the received unusable EM energy into usable magnetic energy form,
- (4) splitting the magnetic energy output of the permanent magnet into separate magnetic field flux and both curled and uncurled magnetic vector potential current, each traveling in a different spatial pathway,
- (5) producing energy amplification by dual interaction of multiple simultaneous processes in a coil, with iterative feedforward and feedback between the simultaneous interactions,
- (6) producing driving and driven coils both in curved spacetime and with their magnetic flux inside a nanocrystalline core inside said coils and with a field-free magnetic vector potential in the space in which the coil is embedded, and
- (7) transducing the excess magnetic energy available for output, into electrical energy,
- (8) outputting the excess energy as ordinary electrical energy—consisting of voltage and current—to power circuits and loads,
- (9) permissibly exhibiting $COP > 1.0$ while rigorously obeying energy conservation, the laws of physics, and the laws of thermodynamics, and
- (10) being operated in either open-loop or closed loop operation, whereby in open-loop the operator inputs a lesser EM energy than is dissipated in the load, or whereby in closed loop operation a fraction of the output energy is positively fed back into the input to power the system and system process, while the remainder of the energy is dissipated in the load to power it.
- (11) Using and applying the extended work-energy theorem for a replenishing potential environment.

This appears to be the first process to take advantage of the above listings of operations, functions, processes, and facts, whereby no heating or eddy current dissipation is produced in the cores of coils utilized in embodiments of the process, and whereby said process and embodiments output electrical power in loads without the need to cool the process components.

The closest *somewhat* related work would appear to be the several patents of Raymond C. Gelinis {52} in that these patents use the curl-free magnetic vector potential. All the Gelinis patents deal with communications and receivers and transmitters, have no application to electrical power systems, do not use additional EM energy extracted from a permanent magnet and replenished by the vacuum, do not use curved local spacetime, do not use the giant negentropy process, do not function as open systems far from equilibrium in their vacuum

exchange, do not use iterative "ping-pong" feedforward and feedback in their various components to achieve gain, do symmetrically regauge themselves so that their excitation discharge is symmetrical and not asymmetrical, do not function as negative resistors, are not self-powering, cannot produce $COP > 1.0$, cannot self-operate in closed-loop form, and can and do produce only $COP < 1.0$. They therefore have no application to the field of the present invention.

DESCRIPTION OF THE FIGURES AND SYSTEM OPERATION.

The process in this invention is described in a description below and in the process gain block diagram cited below and attached as separate sheets, which are intended to be read in conjunction with the following set of drawings, which include (1) the background Lenz reactions, Poynting and Heaviside energy flow operations, Heaviside energy flow component, giant negentropy operation, Whittaker's decomposition of the scalar potential, and creation and use of curved local spacetime utilized in the invention, and (2) the principles, the functional block diagram, a physical laboratory test and phenomenology device, and the process operation of the invention as well as typical measurements of a laboratory proof-of-principle device.

Figure 1 graphically shows Whittaker's decomposition {1, 29, 30} of the scalar potential into a harmonic set of phase conjugate longitudinal EM wavepairs. The 3-symmetry of EM energy flow is broken {16, 26} by the dipolarity of the potential, and 4-symmetry in energy flow without 3-flow symmetry is implemented {1, 26}.

Figure 2 expresses this previously unexpected functioning of the scalar potential—or any dipolarity, including the magnetic dipole of a permanent magnet—as a true negative resistor {23}, receiving energy in unusable form, transducing it into usable form, and outputting it in usable form.

Figure 3 shows the startling ramifications of this previously unsuspected process: an ongoing, free, negentropic reordering of a fraction of the local vacuum energy {26}, spreading at the speed of light in all directions from the moment of formation of the dipole, and continuing as long as the dipole and its broken 3-symmetry exists. We have previously stated {22, 25} that the energy input to the shaft of a generator, and the chemical energy of the battery, have nothing to do with powering the external circuit connected to the battery or the generator. Other than dissipation in internal losses, the available internal energy dissipated by the generator or battery does not add a single joule/sec of energy flow to the external circuit. Instead, the available internal energy is dissipated internally and only to force the internal charges apart, forming the internal source dipole connected to the terminals. The input energy to a generator and expended by it, and the chemical energy available by a battery and expended by it, thus are expended only to continuously reform the source dipole that the closed current loop circuit continuously destroys.

Once established, the source dipole applies the giant negentropy process {26, 43} shown in Figures 1, 2, and 3. Energy is continuously received by the dipole charges from the surrounding active and negentropically reordered vacuum (curved spacetime), transduced into usable form, and output as real EM energy flow in 3-space. The receipt of this energy as reactive power freely received from the vacuum, does not yet appear in present classical electrodynamics

texts, which texts do not include the vacuum interaction, much less the broken symmetry of the source dipole in that vacuum exchange, even though such has been proven in particle physics since the 1950s. The present invention is believed to be the first applied process using this previously omitted process of easily extracting energy from the vacuum and outputting it in usable transduced form as real EM energy flow, via the giant negentropy process {26, 43}.

The transduced EM energy received from the vacuum by the source dipole, pours out of the terminals of the battery or generator and out through space surrounding the transmissions lines and circuits connected to the terminals (Figure 4) as shown by Kraus {53}. As is well-known, the energy flow (Figure 4) fills all space surrounding the external circuit conductors out to an infinite lateral radius away {53}. This is an *enormous* EM energy flow—when one includes the space-filling nondiverged component discovered by Heaviside {10, 11}. This neglected vast nonintercepted, nondiverged energy flow component was never even considered by Poynting {9}, and was arbitrarily discarded by Lorentz {51} as "of no physical significance".

Figure 5 shows that almost all that great EM energy flow pouring out of the terminals of the generator or battery and out through the surrounding space surrounding the transmission line conductors, misses the circuit entirely and is just wasted in conventional circuits having no iterative feedback and feedforward additional collection components and processes. In a simple circuit, for example, the arbitrarily discarded Heaviside nondiverged energy flow component may be some 10 trillion times in total rate of energy flow as the feeble Poynting component {9} that is intercepted by the surface charges in the circuit conductors and components, and diverged into the wires to power the Drude electrons and the loads and losses.

Figure 6 illustrates the negative resistor process diagrammatically. The source dipole and the associated scalar potential between its poles act as a true negative resistor, receiving enormous EM energy from the surrounding vacuum in unusable form (via the giant negentropy process shown in Figure 3). The charges of the dipole absorb this unusable energy and transduce it into usable EM energy form, then re-radiate it as usable EM energy. This of course is precisely a negative resistor process.

Figure 7 shows the integration trick which Lorentz originated to discard the perplexing and enormous Heaviside non-diverged energy flow component, while retaining the diverged (Poynting) energy flow component. In short, Lorentz's procedure—still utilized by electrodynamicists to discard the embarrassing richness of EM energy poured out of every dipole and not intercepted and used by the attached external circuit—for over a century has specifically and ubiquitously diverted electrodynamicists' attention away from the process described in this invention.

We strongly iterate the following point: We have designed the process of this invention and its embodiments by and in accord with Sachs' unified field theory and the Evans-Vigier O(3) electrodynamics subset of it. Consequently, all energy in mass-free spacetime is general relativistic in nature, modeling, and interpretation. The general relativity interpretation applies at all times, including for the electrodynamics. Hence any local delta energy in spacetime is precisely of one and only one nature: a curvature of that local spacetime. A traveling EM wave thus becomes identically a traveling oscillation of a specialized curvature of spacetime. Further, wherever the wave exists, its energy *a priori* curves that part of the spacetime. So EM waves,

fields, potentials, and energy flows always involve and identically are spacetime curvatures, structures, and dynamics. We also accent that time is always part of it, since what exists prior to observation is spacetime, not space. Hence "energy currents in time" and "electromagnetic longitudinal waves in the time domain" are perfectly rational expressions and facts, albeit strange to the 136-year old classical electrodynamics stripped of its integration with general relativity.

Figure 8 shows the relationship between a linearly moving magnetic vector potential \mathbf{A}_L , a swirling or circulating \mathbf{A}_C , the implementation of the $\nabla \times$ operator by the interacting coil and its moving charges, and the resulting magnetic field \mathbf{B} . \mathbf{A}_L can also be defined as the vector potential \mathcal{O}_L if desired, where \mathcal{O}_L is a vector potential and no longer the familiar scalar potential ϕ since \mathcal{O} is in motion. If the coil is wound very tight and is very long (or closed such as in a very tight toroid), then the magnetic field \mathbf{B} will be retained entirely inside the coil, while the field-free (curl-free) \mathbf{A}_C will remain outside the coil. This illustrates one of the major unrecognized principles of the potential (such as \mathbf{A}) being a flow process: What is usually considered to be the energy in the potential in a given volume of space, is actually the "reaction cross section" of the potential in that volume. Conventional electrodynamicists and electrical engineers do not calculate magnitudes of either fields or potentials, but only their *reaction cross sections*, usually for a unit point static charge assumed fixed at each point. We point out that this procedure calculates the divergence of energy from the potential, and hence the reaction cross section of the potential, but not the potential itself.

The energy so calculated—in this case, the curl of the \mathbf{A} flow, being the magnetic field \mathbf{B} —can in fact be diverted from the \mathbf{A} potential flow through a volume of space into another different volume of space. The magnitude of the \mathbf{A} potential flow will continue undiminished through the original volume of space, so long as the source dipole performing the giant negentropy process and thus providing the continuous EM energy flow represented by \mathbf{A} remain unchanged. In the case used in the process of this invention, we diverge the magnetic field energy from the \mathbf{A} -flow, while simultaneously retaining all the \mathbf{A} -potential energy flowing through the space outside the tightly wound coil. This is in fact an "energy collecting amplification" subprocess, and is no more mysterious than diverting a tiny flow of water from a nearly infinite river of flowing water, and having the river flow on apparently undiminished. In short, we may deliberately use the *energy flow nature* of the potential \mathbf{A} in order to simultaneously separate it into two flows of different energy form, curled and uncurled.

If we place a square pulse in the current of the coil in Figure 8, we also invoke the Lenz law reaction (Figure 9) to momentarily increase the current and hence the \mathbf{A}_C and the action of $\nabla \times \mathbf{A}_C = \mathbf{B}$, so that additional \mathbf{A}_C energy and additional \mathbf{B} energy are obtained. In this way, the energy gain is increased by the Lenz law effect—which is a regauging effect deliberately induced in the invention process by utilizing square pulse inputs. Then when the trailing edge of the pulse appears and sharply cuts off the pulse, a second Lenz law gain effect (Figure 9) is also produced, further increasing the energy gain in both \mathbf{A}_C and in \mathbf{B} . We use these two serial Lenz law effects to increase the potential energy of the system twice and also the collected field energy, thus allowing $\text{COP} > 1.0$ since during the regauging process the potential and the potential energy of the system are both increased freely, and so is the diversion of the increased

potential energy into **B**-field energy inside the coil. Both the changes increase the voltage drop across the coil and the current through it, translating the increased magnetic energy into usable electrical energy to power loads and losses.

Figure 10 shows the cross section of an input coil, one form of input device. The input can be from a separate signal generator, in which case the system runs "open loop" and requires continuous input power, but still provides $COP > 1.0$. Or, a portion of the output power can be extracted, clamped in magnitude, and positively fed back to the input, in which case the system runs "closed loop" and the operator need furnish no external power input. In either case, the system is an open system far from thermodynamic equilibrium with its active vacuum environment, freely receiving energy from said active environment to the dipole in the permanent magnet, and from the dipole out into the nanocrystalline material core in the form of magnetic field energy **B**, and in the space outside the core in the form of field-free **A**-potential. As can be seen, the **B** field energy is confined to the core material inside the coil, and the **A**-potential outside the core is field-free **A**. Any change in the **B**-field inside the core, is also a change in the **B**-field inside the coil and the coil interacts with it to produce current and voltage. Any change in the **A**-potential outside the core, also interacts with the coil which applies the $\nabla \times$ operator, thereby producing voltage and current in the coil and also producing additional **B**-field in the core material. In turn, this changes the **B**-field in the core, which produces more voltage and current in the coil and additional **A**-potential outside the coil, and so on. Hence there are dual iterative retroreflective interactions which increase the performance of the coil, making it an *energy amplifying* coil, and which also increase the COP of the system process. The output of the input coil is thus the alteration and increase of the **B**-field flux and energy in the core material, and an increase and alteration in the field-free **A**-potential surrounding the coil and moving around the circuit in the space surrounding the nanocrystalline core material flux path.

Figure 11 shows the cross section of a typical output coil for either open-loop or closed-loop operation. The operation is identical to the operation of the input coil, except this coil outputs energy in the form of voltage and current to an external circuit, external load, etc., and also outputs energy from its reaction with the **A**-potential outside the flux path to the nanocrystalline flux path material in its core. The output coil receives its energy input from the field-free **A**-potential outside the nanocrystalline material flux path as well as from the **B**-field energy and magnetic flux inside the nanocrystalline flux path through its core.

Further, the dual interaction processes and their mutual iterative interactions provide gain in both the **A**-potential energy outside the core material and the **B**-field energy and magnetic flux energy inside the core material.

Further, all coils on the core material thus serve as both output and input coils, and also have mutual iterative interactions with each other around the loop, coupled by the field-free external **A**-potential and the **B**-field and magnetic flux in the nanocrystalline material flux path acting as the cores of the coils. These interactions also provide gain in the kinetic energy produced in the Drude electron gas due to the iterative summation work performed upon the electrons to increase their energy.

Further, these mutual iterative feedback and feedforward energy gains also change the flux back through the permanent magnet, alternating it, so that the pole strength of the magnet

alternates and increases. This in turn increases the dipolarity of the permanent magnet, which in turn increases the magnitude of the associated giant negentropy process {26, 43}. In turn this results in more energy received from the active vacuum by the permanent magnet, and also more energy output by said permanent magnet dipole to the core material and to the coils.

Thus we have described a system and process having a multiplicity of iterative feedbacks and feedforwards from each component and subprocess, to every other component and subprocess, all increasing the energy collected in the system and furnished to the load. In open loop operation, this results in $COP > 1.0$ permissibly, since the excess energy is freely received from an external source. In closed loop operation, the COP concept does not apply except with respect to operational efficiency. In that case, the operational efficiency is increased because more energy is obtained from the broken symmetry of the permanent dipole, and therefore additional energy is provided to the loads, compared to what the same permanent magnet can deliver when such iterative feedback and feedforward actions in such multiplicity are not utilized. In closed loop operation, the system powers itself and its loads and losses simultaneously, with all the energy being freely supplied by the giant negentropy process of the permanent magnet dipole and the iterative asymmetrical self-regauging processes performed in the process.

Figure 12 is another view showing the major energy flows in an output coil section and subprocess, and the iterative dual inputs and interactions, of the basic scheme of operation of the process and its active component subprocesses.

Figure 13 is another view showing the major energy flows in an input coil section and subprocess, and the iterative dual inputs and interactions, of the basic scheme of operation of the process and its active component subprocesses.

Figure 14 is a diagrammatic block-diagram illustration of the components and processes in the system and system process, with the dual feedforward and feedbacks shown. It accents the overall system process gain due to the multiplicity of interactions and iterative interactions between the various system components and subprocesses, and further interactions with the dual local interactions and iterative feedforwards and feedbacks, thus providing a multiplicity of individual energy gain process and an overall energy gain process.

Figure 15 shows a type embodiment of the system and system process, perhaps at a home and powering a variety of home appliances and loads. The system as shown is "jump-started" initially in open-loop mode, and once in stable operation is disconnected from the jump starter (such as a battery) to run in closed-loop operational mode.

Figure 16 shows one of the former laboratory test build-ups embodying the process of the invention. This test prototype was used for proof-of-principle and phenomenology testing.

Figure 17 shows a simplified block diagram of a basic embodiment demonstrating the process. Many of these build-ups were built to test various core materials, observe phenomenology, etc. The "square C's" of the flux path halves right and left, as shown in this Figure 17, were actually made as "half-circle C-shaped flux path halves" right and left in Figure 16 above.

Figure 18 shows the measurement of the input to the actuator coil of the test unit of Figure 16 operated in open-loop mode.

Figure 19 shows the measurement of the output of one of the output coils of the test unit of Figure 16 operated in open-loop mode.

Figure 20 shows the output power in watts as a function of the input potential in volts, thus indicating the output versus potentialization sensitivity. The circles indicate actual measurements, and the curve has been curve-fitted to them.

Figure 21 shows the COP of a single output coil's power divided by the input power, as a function of input potentialization. The circles indicate actual measurements, and the curve has been curve-fitted to them. The second coil had the same power output and COP simultaneously, so the net unit COP of the unit is double what is shown in the figure.

Figure 22 shows the projected unit output power sensitivity versus voltage input, expected for the next prototype build-up now in progress.

Figure 23 shows the projected unit COP versus input potentialization, expected for the next prototype build-up now in progress. We expect this type of unit to easily operate at the COP = 30 or COP = 40 level, with multiple kilowatt output power.

RAMIFICATIONS

Importance of the Process and Its Sub-Processes

A process has been provided whereby useful electromagnetic energy may be extracted from the dipole of a permanent magnet, via the giant negentropy process {26, 43} associated with the magnetic dipole. In that process, an outflow of EM energy is continuously furnished by the magnet dipole in all directions in 3-space, and the energy to the dipole is freely furnished from the time-domain of the active vacuum {1, 26, 43}. Whittaker {1} unwittingly showed this giant negentropy mechanism in 1903, but failed to recognize its implications. Recent recognition of the mechanism and its implications for electrical power systems was accomplished by one of the inventors, Bearden {26} and then more deeply examined by Evans and Bearden {43}.

By using the principle that essentially unlimited energy can be withdrawn from (collected from) a potential, and the withdrawn energy will be replaced by the potential's negative resistor action using the giant negentropy mechanism {1, 26, 43}, a practical approach to free energy sources for self-powering and COP>1.0 electrical power systems anywhere in the universe is provided.

By using the principle that iterative transformation of its form energy in a replenishing potential environment can be repeatedly reused to do work, so long as the form of the energy resulting at the completion of each work phase is retained and reprocessed, one joule of energy can be utilized to do many joules of work, as precisely permitted by the conservation of energy law with regauging. This is a major change to the work-energy theorem of electrodynamics, which implicitly has assumed only a single change of form of the energy, followed by loss (escape from the system) of all the energy in the new form. In short, *the present work-energy*

theorem is only a special case valid under those assumed special conditions. The invented process takes advantage of the extended work-energy theorem where one joule of energy—accompanied by retention of the new form of energy resulting from work—can do multiple joules of work in a replenishing potential environment.

By using the principle that one joule in "iterative form changing mode with retention" can do many joules of work upon a component of a system—to wit, upon the Drude electron gas in an electrical circuit, where the potential energy is increased by the increased kinetic energy of the electrons having the work done upon them—the extended work-energy theorem can be utilized to overpotentialize the receiving Drude electron gas, thereby regauging the system to add excess energy by gauge freedom and outputting more electrical energy to the load than is input to the system by the operator.

By then dissipating in loads this excess energy collected in the Drude electron gas in the output circuit, the invented process provides greater energy to be dissipated in the load than is input by the operator. The combination of processes thus allows an electromagnetic system freely functioning as an open system not in equilibrium with its active vacuum (due to the giant negentropy mechanism {26, 43}), hence permitted to exhibit $COP > 1.0$. In this way, more work output can be accomplished by the system process than the work that the operator must perform upon the system to operate it.

By using the principle of governed, clamped positive feedback of a portion of the increased output back to the input, the system can be close-looped and can power itself and its load, with all the energy being furnished by self-regauging from the active vacuum as an external energy source, furnishing excess energy to the magnetic dipole's magnetostatic potential and associated magnetic vector potential, thereby replenishing energy withdrawn from said magnetic vector potential by the subprocesses in the overall system process.

One system operating in closed-loop mode can also have one fraction of its output devoted to "jump-starting" another such system in tandem, then switching the second system into self-powering closed-loop mode, then "jump-starting" another such system, which is then switched to self-powering, and so on. In that way, multiple systems can be "piggy-backed" so that an exceptionally large power system consisting of a group of such "piggy-backing" systems can be produced. In case of system failure, all can be started again in the same series, by furnishing only the initial small input required to jump-start the first system of the group. In this way, very large power systems such as necessary to power automobiles, trucks, ships, trains, etc. can be produced, and yet the back-up jump starting source—such as a storage battery—can be very small, e.g., a simple flashlight battery.

Implications for the Crisis in Oil Supplies Versus Energy Demands

The implications are that a total revolution in transportation, electrical power systems, backup power systems, etc. is at hand. In the process, the electrical power is obtained freely and cleanly from the vacuum, from permanent magnet dipoles continuously replenished from the active vacuum via the giant negentropy process.

A more significant fraction of the electrical power system can thus be decentralized, and degradation in case of system failure will be graceful and local. Yet full use can still be made of the existing power grids and power systems. As an example, arrays of self-powering electrical heater systems can be developed and used to heat the boilers in many standard power systems, thereby stopping the burning of hydrocarbons in those plants, and drastically reducing the pollution of the biosphere and the lungs of living creatures including humans. This would allow a graceful phase-in of new, clean, self-powering electrical power systems, reduction of hydrocarbon combustion for commercial electricity production, ready increase in electrical power to meet increasing world demands even in poor nations and developing countries, while capitalizing and using much of the present very large "sunk costs" investments in present large power systems. The core material fabrication is labor-intensive, so it is made in developing nations where such jobs are sorely needed and greatly benefit both the people and the nation. The dramatically increased use of and demand for these materials would thus stimulate substantial economic growth in those nations by providing many more jobs.

The conversion of power systems and replacement in a fraction of them, can proceed at a very rapid pace, since production and scale-up of systems utilizing this system process can be very rapid because, except for the cores, all fabrication, parts, techniques, tooling, etc. are simple and standard and very economical.

Particularly at this time of oil crisis and particularly a shortage of refining facilities, a very rapid and permanent solution to the oil crisis and the rapidly increasing demand for electricity—and also much of the problem of the present pollution of the biosphere by combustion byproducts, and of the present global warming enhancement by the emitted CO₂ from the hydrocarbon combustion—can be solved cheaply, economically, and quickly.

The steady reduction and eventual near-elimination of hydrocarbon combustion in commercial power systems and transport, and dramatic reduction in nuclear fuel rod consumption, etc. will result in cleaner, cheaper, more easily maintained power systems and a reduction in the acreage required for these power systems.

The gradual decentralization and localization of a substantial fraction of the presently centralized power grid will eliminate a significant fraction of power transmission costs, thereby lowering the price of electrical energy to the consumers.

The scale-up weight-per-kilowatt of systems using this system process will be sufficiently low to enable rapid development of electrically powered transport media such as automobiles etc. These will have weight about the same as now, carry a small battery as a back-up "jump-starter", and will have very agile performance suitable for modern driving in heavy traffic. With fuel costs zeroed, the cost to the citizens of owning and operating vehicles will be reduced. Costs to the trucking industry, e.g., will be dramatically reduced, since fuel is a major cost item. In turn, since most goods are moved via the trucking industry, the lower transport costs will mean more economical sales prices of the goods. These are very powerful and beneficial economic advantages of the new process.

Some Specific Advantages

The process allows electrical power systems having the following advantages:

1. The systems can have a high output power to weight ratio. Second generation equipment will have a very high output power to weight ratio.
2. The systems can be highly portable for mobile applications.
3. The size and output of the systems are easily scalable, and piggy-backing is simple.
4. The systems will be rugged and reliable for use in hostile environments where conventional generators would fail or be extremely difficult to sustain. The systems can easily be environmentally shielded.
5. The systems can function effectively in very wide operating temperature ranges and can be used where conventional batteries and fuel cells cannot function. As an example, it can power a resistance heater to keep its own immediate environment continuously warm. It can also power electrostatic or magnetic cooling devices to keep the unit and its immediate environment cool in higher temperature environments.
6. The system will have an extremely long life cycle and high reliability, allowing it to be placed where frequent maintenance is not possible.
7. The system uses no fuel or fuel transport, packaging, storage, and disposal systems and needs no intermediate refining facilities and operations. The resulting overhead and financial savings are vast and significant.
8. Use of the systems in a combined centralized and decentralized electrical power system provides survival of electric power and graceful degradation, rather than catastrophic collapse, of electrical power in the presence of damage and destruction. This is particularly important since the greatest threat to America is now the threat of terrorist attacks against our cities, or against our fuel supplies, electrical power grids, etc.
9. The systems produce no harmful emission, harmful or radioactive byproducts, hazardous wastes, or biospheric pollutants. As usage is phased in world wide, a significant reduction of environmental pollutants and hazardous wastes will result, as will a cleaner biosphere.
10. The systems can produce AC or DC power directly by simple electrical additions, and provide shaft power simultaneously. Frequency can be changed by frequency conversion.
11. Coupled with normal electric motors, the systems can provide attractive power system alternatives for automobiles, tractors, trucks, aircraft, boats, ships, submarines, trains, and other vehicles, again without exhaust emissions, pollutants or harmful waste products and without fuel costs.
12. The systems can be developed in small-system sizes, rugged and efficient, to replace the motors of hosts of small engine devices such as garden tractors, lawnmowers, power saws, leaf blowers, etc. which are presently recognized to be very significant biospheric polluters.

The above descriptions provide illustrations of some of the presently envisioned preferred embodiments of this invention.

Extension and Adaptation of the Process

The process can be extended . For example, we have mentioned piggy-backing arrays of such systems for easily assembled, very large power plants.

As another example, conversion to furnish either DC or AC, or combinations of either, at whatever frequencies are required, is easily accomplished by standard conversion techniques and add-on systems.

As another example:

The process uses a multiplicity of positive energy feedforwards and feedbacks, and iterative change of the form of the energy between multiple states in a replenishing environment, to provide iterative gain by "ping-pong". As the number of feedback and feedforward operations are increased, it is possible to advance the system process into a region where the regenerative feeds produce an exponentially *increasing* curve of regauging energy and potential energy increase, with concomitant exponentially increasing curve of output energy. Material characteristics, saturation levels of cores, etc. provide "plateaus" where the exponentially rising output curve is leveled off and stabilized. By using spoiling and damping, such exponential increase in energy density of the system can be leveled off at specifically desired plateau regions, which can be easily adjusted at will, either manually or automatically in response to sensor inputs. By this means, these systems enable automatically self-regulating, self-adapting power grids and power systems, which automatically adjust their state and operation according to the exact needs and conditions, changes of these needs and conditions, etc. without impact upon supporting fuel, transport, refining, storage, etc. These "exponential but plateau-curtailed" systems are capable of producing very large power-per-pound levels, and sustaining them without overheating, limited only by the saturation level of the core materials. Such new adaptations of the fundamental system process of this invention can be developed in straightforward manner in the second generation.

The adaptations and alterations of the process are limited only by the ingenuity of the engineer and the particular needs of a given application. The process uses the laws of nature in a novel and extended manner, such as using one joule of input energy to cause many joules of output work to be done in the load. Many alternative subprocesses, embodiments, modifications and variations will be apparent to those skilled in the art of conventional electrical power systems and magneto-electric generators.

REFERENCES:

1. E. T. Whittaker, "On the Partial Differential Equations of Mathematical Physics," Mathematische Annalen, Vol. 57, 1903, p. 333-355. Decomposes any scalar potential into a harmonic set of bidirectional EM longitudinal EM wavepairs, where each wavepair is comprised of a longitudinal EM wave and its phase conjugate replica wave. Dividing the

overall waveset into two half-sets, we have one half-set comprised of incoming longitudinal EM waves in the complex plane (the time domain) and a second half-set comprised of outgoing longitudinal EM waves in real 3-space. Hence the scalar potential represents a giant circulation of EM energy automatically established and maintained from the time-domain (complex plane) into the source dipole establishing the potential, with the absorbed complex energy being transduced and re-emitted by the dipole in all directions in 3-space as real longitudinal EM wave energy establishing the EM fields and potentials (and their energy) associated with the dipole.

2. “E. T. Whittaker, "On an Expression of the Electromagnetic Field Due to Electrons by Means of Two Scalar Potential Functions,” Proc. Lond. Math. Soc., Series 2, Vol. 1, 1904, p. 367-372. The paper was published in 1904 and orally delivered in 1903. Shows that all EM fields, potentials, and waves are comprised of two scalar EM potential functions. Whittaker’s method is well-known in the treatment of transverse electric and transverse magnetic modes of a cylindrical cavity or a waveguide. The Debye potentials and the Bromwich potentials are essentially radial components of the vector potentials of which Whittaker potentials are the real parts. Our further comment is that, since each of the scalar potentials used for the Whittaker functions has an internal Whittaker 1903 giant negentropic substructure and dynamics, then all present EM waves, fields, and potentials have—and are comprised of—vast internal longitudinal EM wave structures and dynamics.
3. P. Debye, Ann. Phys., Leipzig, Vol. 30, 1909, p. 57. Introduces a solution to Maxwell's equations in terms of two scalar potentials. These two scalar potentials are different from the two potentials utilized by E.T. Whittaker in 1904.
4. A. Nisbet, Physica, Vol. 21, 1955, p. 799. Extends the Whittaker and Debye two-potential solutions of Maxwell’s equations to points within the source distribution. This is a full generalization of the vector superpotentials (for media of arbitrary properties, together with their relations to such scalar potentials as those of Debye.
5. W. H. McCrea, Proc. Roy. Soc. Lond. A, Vol. 240, 1957, p. 447. Gives the general properties in tensor form of superpotentials and their gauge transformations. His treatment is more concise than that of Nisbet, but entirely equivalent when translated into ordinary spacetime coordinates.
6. Melba Phillips, “Classical Electrodynamics,” in Principles of Electrodynamics and Relativity, Vol. IV of Encyclopedia of Physics, edited by S. Flugge, Springer-Verlag, 1962. An excellent overview of superpotential theory.
7. J. D. Jackson, Classical Electrodynamics, Second Edition, Wiley, New York, 1975, p. 219-221; 811-812. In symmetrically regauging the Heaviside-Maxwell equations, electrodynamicists and gauge field theorists assume that the potential energy of any EM system can be freely changed at will (i.e., that the system can first be asymmetrically regauged, due to the principle of gauge freedom). The symmetrical regauging is actually two asymmetrical regaugings carefully chosen so that the net force field (emf)—available for excitation discharge of the excited system—is zero. In circuits, this means that the back emf (across the source dipole) is precisely equal and antiphased to the forward emf (across the

external circuit with its loads and losses). Jackson's book does not even address circuits, as he so states in J. D. Jackson, "Surface charges on circuit wires and resistors play three roles," American Journal of Physics, 64(7), July 1996, p. 855-870.

For operating EM systems, their initial potentialization (application of potential to the system to increase its potential energy available for further discharge) is asymmetrical *a priori* and universally used. Gauge field theory and its assumption of gauge freedom assures us of the validity of this theoretically work-free process of increasing the energy of the system. In real systems, a little switching cost etc. may be required, but minuscule in relation to the amount of extra potential energy that can be generated in the system at will.

As shown by Jackson 1975, for the conventional EM model electrodynamicists actually select only a subset of the Maxwellian systems and deliberately discard the remaining Maxwellian subset. Following Lorentz, the electrodynamicists arbitrarily select *two* asymmetrical regaugings but precisely such that none of the initial excess regauging energy—freely received in the system by its potentialization—can subsequently be dissipated to power loads without equally destroying the system potentialization represented by the source dipole. This inanity occurs because the *net force* is deliberately brought to zero, thus consisting of equal forward and back emfs—or mmfs in a magnetic circuit). This custom produces much simpler equations for that remaining *simpler* subset of Maxwellian systems which are in equilibrium in their exchange with the active vacuum during their dissipation of the free regauging energy.

Hence for more than a century it has been "customary" to *arbitrarily* discard all Maxwellian systems and subsystems which would *asymmetrically* regauge themselves during the discharge of their initial free excitation energy. This arbitrary, self-imposed condition is neither a law of nature nor a law of electrodynamics or thermodynamics. It is purely arbitrary.

It assumes that half the gauge freedom's excess potential energy be dissipated internally (against the source dipole's back emf) to destroy any further energetic activity of the system by destroying the source dipolarity (any excess potential on the system, and hence any excess potential energy).

The remaining half of the initial free gauge excitation energy is dissipated *usefully* in the system's external loads and losses. This means that the remaining half the excitation energy is dissipated *detrimentally* by the system to destroy its own energetic operation. Since any real system has losses, the net result is that *half* the gauge freedom potential energy of the excited system is used to destroy the source dipole itself and all potentialization of the system, and *less than half* is used to power the loads.

Since it requires as much additional energy to restore the source dipole as it required to destroy it, the operator then must furnish more energy to provide for continually restoring the dipole, than the system *permits* to be dissipated in the external loads.

The set of Maxwellian systems arbitrarily discarded by the ubiquitous Lorentz regauging are precisely those open dissipative Maxwellian systems not in thermodynamic equilibrium in their vacuum exchange. Those are precisely the Maxwellian systems which *do not* forcibly and symmetrically regauge themselves in accord with the Lorentz condition during their excitation discharge. Those *arbitrarily discarded* Maxwellian systems are thereby free

to dissipate their gauge freedom initial "free-excitation" energy primarily in the external loads and losses, with much less being dissipated in the source dipole to destroy it.

The performance of the *arbitrarily discarded* asymmetrically regauging Maxwellian systems is described by the thermodynamics of an open dissipative system not in equilibrium with its active environment, rather than by classical equilibrium thermodynamics. As is well-known in the thermodynamics of such systems (for which Prigogine received a Nobel Prize in 1977), such open dissipative systems—Maxwellian or otherwise—are permitted to (1) self-order, (2) self-oscillate or self-rotate, (3) output more energy (e.g., to do useful work) than the operator must input (the excess energy is freely received from the external environment, in this case the active vacuum), (4) power itself and its load(s) simultaneously (all the energy is freely received from the external environment, in this case the active vacuum), and (5) exhibit negentropy.

That our normal EM power systems do not exhibit $COP > 1.0$ is purely a matter of the arbitrary design of the systems. They are all designed with closed current loop circuits, which can readily be shown to apply the Lorentz symmetrical regauging condition during their excitation discharge in the load. Hence all such systems—so long as the current in the loop is unitary (its charge carriers have the same m/q ratio)—can only exhibit $COP < 1.0$ for a system with internal losses, or $COP = 1.0$ for a superconductive system with no internal losses.

8. Editorial, "The transfer of energy," The Electrician, Vol. 27, July 10, 1891, p. 270-272. This editorial points out that Poynting himself gave Heaviside priority for discovering EM energy flow through space.
9. J. H. Poynting, "On the transfer of energy in the electromagnetic field," Phil. Trans. Roy. Soc. Lond., Vol. 175, Part II, 1885, p. 343-361. Poynting got the direction of the flow wrong, which was later corrected by Heaviside. Further, Poynting considered only that very minor component of energy flow surrounding the circuit that actually strikes the circuit and enters it to power it. The enormous additional energy flow which is present but misses the circuit entirely and is usually wasted, was not considered by Poynting at all.
10. Oliver Heaviside, "On the Forces, Stresses, and Fluxes of Energy in the Electromagnetic Field," Phil. Trans. Roy. Soc. Lond., 183A, 1893, p. 423-480. This followed previous publications several years earlier by Heaviside; e.g. in The Electrician, beginning in 1885. Here Heaviside also credits Poynting with first discovering EM energy flow in space.
11. Oliver Heaviside, Electrical Papers, Vol. 2, 1887, p. 94. Quoting: "*It [the energy transfer flow] takes place, in the vicinity of the wire, very nearly parallel to it, with a slight slope towards the wire... . Prof. Poynting, on the other hand, holds a different view, representing the transfer as nearly perpendicular to a wire, i.e., with a slight departure from the vertical. This difference of a quadrant can, I think, only arise from what seems to be a misconception on his part as to the nature of the electric field in the vicinity of a wire supporting electric current. The lines of electric force are nearly perpendicular to the wire. The departure from perpendicularity is usually so small that I have sometimes spoken of them as being perpendicular to it, as they practically are, before I recognized the great physical importance of the slight departure. It causes the convergence of energy into the wire.*"

12. Sir Horace Lamb, Hydrodynamics, 1879, p. 210. Quoting: *"There is an exact correspondence between the analytical relations above developed and certain formulae in Electro-magnetism... Hence, the vortex-filaments correspond to electric circuits, the strengths of the vortices to the strengths of the currents in these circuits, sources and sinks to positive and negative poles, and finally, fluid velocity to magnetic force."*
13. Y. Aharonov and D. Bohm, Significance of Electromagnetic Potentials in the Quantum Theory," Physical Review, Second Series, 115(3), Aug. 1, 1959, p. 485-491. Quoting, p. 485: "...contrary to the conclusions of classical mechanics, there exist effects of potentials on charged particles, even in the region where all the fields (and therefore the forces on the particles) vanish." Indeed, since the field is usually defined as the force per unit charge, then the field as defined does not exist until after the causative "field as a separate entity" interacts with a charged mass. Hence the field as defined is an effect, never the cause. Further, being an effect and an observable as defined, it does not exist in spacetime as such, since no observable does. *A priori*, any observable is the output (effect) of a Δt operation upon LLLT, yielding an LLL "frozen snapshot" at an instant in time, which snapshot itself does not exist in time but was only a 3-space fragment of what was existing in the ongoing interaction at that point in time. The field-free 4-potential, together with its structure and its dynamics, provides the *causes* existing in spacetime prior to their interaction with intermediaries to produce effects.
14. Ingram Bloch and Horace Crater, "Lorentz-Invariant Potentials and the Nonrelativistic Limit," American Journal of Physics, Vol. 49, No. 1, Jan. 1981 Quoting p. 67: *"[It is usually] "...assumed that the magnitude of potential energy is irrelevant, being arbitrary to the extent of an additive constant."* Our comment: Note that this "standard" assumption in classical electrodynamics is totally wrong, particularly when one considers (1) conservation of energy, and (2) gravitational effects. We have previously nominated this arbitrarily discarded extra potential energy as a solution to the "dark matter" problem in astrophysics, and as being responsible for the extra gravity holding together the arms of the distant spiral galaxies. See T. E. Bearden, "Dark Matter or Dark Energy?", Journal of New Energy, 4(4), Spring 2000, p. 4-11. This paper is also carried on U.S. Department of Energy website <http://www.ott.doe/electromagnetic/papersbooks.html>.
15. S. Olariu and I. Iovitzu Popescu, "The Quantum Effects of Electromagnetic Fluxes," Reviews of Modern Physics, 57(2), Apr. 1985, p. 339-436. Full discussion of the Aharonov-Bohm effect and hundreds of references. According to Nobelist Feynman, it required 25 years for quantum physicists to clearly face the Aharonov-Bohm issue of the primacy and separate action of the force-field-free potential. It has then required another equal period before physicists would accept it, even though it was experimentally demonstrated as early as 1960.
16. T. D. Lee., Particle Physics and Introduction to Field Theory, Harwood, New York, 1981. A discussion by Nobelist Lee of particle physics and its findings, including broken symmetry which includes the broken symmetry of a dipole. Quoting p. 184: *"... the discoveries made in 1957 established not only right-left asymmetry, but also the asymmetry of the positive and negative signs of electric charge. In the standard nomenclature, right-left asymmetry is*

referred to as *P* violation, or parity nonconservation. The asymmetry between opposite signs of electric charge is called *C* violation, or charge conjugation violation, or sometimes particle-antiparticle asymmetry." And again, p. 184: "Since non-observables imply symmetry, these discoveries of asymmetry must imply observables." Simply put, Lee has pointed out the rigorous basis for asserting that the arbitrarily assumed Lorentz symmetry of the Maxwellian system is broken by the source dipole—and in fact by any dipole. In turn, such broken symmetry in the dipole's energetic exchange with the active vacuum is thus well-known in particle physics, but still is not included at all in classical electrodynamics, particularly the models used to design and build EM power systems. The proven dipole broken symmetry rigorously means that part of the dipole's received virtual energy—continuously absorbed by the dipole charges from the active vacuum—is transduced into observable energy and re-emitted in real (observable) energy form. That this has been well-known in particle physics for nearly a half century, but is still missing from the classical EM model, is scientifically inexplicable and a foundations error of monumental magnitude. Once made, it is the *source dipole* that powers the circuit.

17. I. Prigogine, "Irreversibility as a symmetry-breaking process," *Nature*, Vol. 246, Nov. 9, 1973, p. 67-71. Quoting, p. 70: "*Entropy ...cannot in general be expressed in terms of observables such as temperature and density. This is only possible in the neighbourhood of equilibrium... It is only then that both entropy and entropy production acquire a macroscopic meaning.*" Prigogine received a Nobel Prize in 1977 for his contributions to the thermodynamics of open systems, particularly with respect to open dissipative systems. What he is pointing out here is that, where equilibrium (and hence symmetry) is broken, the usual presumption of entropy and entropic production have no macroscopic meaning. For such systems, the often encountered challenge on classical equilibrium thermodynamics grounds is a non sequitur, and merely reveals the scientific ignorance of the challenger. In short, such a challenger would decry the windmill in the wind, denying that it can turn without the operator cranking it, because classical equilibrium thermodynamics forbids it. However, the windmill turns happily in the wind, without operator input at all, and in total violation of equilibrium thermodynamics because the windmill is not in equilibrium with its active environment, the active atmosphere. At the same time the windmill completely complies with the thermodynamics of open systems far from equilibrium, and energy conservation is rigorously obeyed. The windmill can "power itself and its load" since all the energy to power the windmill and power the load comes from the energy freely input by the wind.

It is usually not realized that Maxwell's equations are purely hydrodynamic equations and fluid mechanics rigorously applies {12}. Anything a fluid system can do, a Maxwellian system is permitted to do, *a priori*. So "electrical energy winds" and "electrical windmills" are indeed permitted {1, 26, 28, 29, 30, 31, 32, 33, 34, 35, 36, 37, 38, 39, 40, 41} in the Maxwell-Heaviside model, prior to Lorentz's regauging of the equations to select only that subset of systems which can have no net "electrical energy wind" from the vacuum. Specifically, this arbitrary Lorentz symmetrical regauging—while indeed simplifying the resulting equations and making them much easier to solve—also arbitrarily discards all Maxwellian systems not in equilibrium with their active environment (the active vacuum). In

short, it chooses only those Maxwellian systems which never have any net "electrical energy wind from the vacuum". Putting it simply, it discards that entire set of Maxwellian systems which interact with energy winds in their surrounding active vacuum environment.

18. G. Nicolis and I. Prigogine, Exploring Complexity, Piper, Munich, 1987. A technical exposition of the thermodynamics of dissipative systems far from thermodynamic equilibrium.
19. Gregoire Nicolis, "Physics of far-from-equilibrium systems and self-organization," Chapter 11 in Paul Davies, Ed., The New Physics, Cambridge University Press, Cambridge, 1989, p. 316-347. A good overview of the thermodynamics of dissipative systems far from thermodynamic equilibrium.
20. Robert Bruce Lindsay and Henry Margenau, Foundations of Physics, Dover, NY, 1963, p. 217. When a system departs from equilibrium conditions, its entropy must *decrease*. Thus the energy of an open system not in equilibrium must always be greater than the energy of the same system when it is closed or in equilibrium, since the equilibrium state is the state of maximum entropy. Thus, broken 3-equilibrium is a broken 3-symmetry between the active vacuum and material systems, and it is a *negentropic* operation.
21. J. O'M Bockris, "Overpotential: a lacuna in scientific knowledge," Journal of Chemical Education, 48(6), June 1971, p. 352-358. Essentially *the overpotential is a shift in the Fermi level necessary to allow the electron in the electrode metal to have energies overlapping with vacant acceptor levels in molecules adjacent to the electrode in the solution*. It enables the transfer of electrons via quantum transfer (tunneling). Quoting p. 356: "*Unless a system exhibits an overpotential, there can be no net reaction.*" [Emphasis in original]. We point out that an overpotential is an advantageous regauging (free change) of the potential energy of the local region where the overpotential appears.
22. T. E. Bearden, "On Extracting Electromagnetic Energy from the Vacuum," IC-2000 Proceedings, St. Petersburg, Russia, 2000 (in press). This paper is also published on Department of Energy website <http://www.ott.doe.gov/electromagnetic/papersbooks.html>
23. We define a *negative resistor* as any component or function or process that receives energy in unusable or disordered form and outputs that energy in usable, ordered form, where that is the *net* function performed. We specifically do not include "differential" negative resistors such as the tunnel diode, thyristor, and magnetron which dissipate and disorder more energy overall than they reorder in their "negative resistance" regimes.
24. T. E. Bearden, "Dark Matter or Dark Energy?", Journal of New Energy, 4(4), Spring 2000, p. 4-11. This paper is also carried on the aforementioned and listed U.S. Department of Energy website <http://www.ott.doe.gov/electromagnetic/papersbooks.html>.
25. T. E. Bearden, "The Unnecessary Energy Crisis: How to Solve It Quickly," Association of Distinguished American Scientists' Position Paper. This paper is also carried on Department of Energy website <http://www.ott.doe.gov/electromagnetic/papersbooks.html>.

26. T. E. Bearden, "Giant Negentropy from the Common Dipole," IC-2000 Proceedings, St. Petersburg, Russia, 2000 (in press). This paper is also carried on Department of Energy website <http://www.ott.doe.gov/electromagnetic/papersbooks.html>.
27. M. W. Evans, P. K. Anastasovski, T. E. Bearden *et al.*, "Spontaneous Symmetry Breaking as the Source of the Electromagnetic Field," accepted by Foundations of Physics Letters (in press).
28. T. E. Bearden, "Extracting and Using Electromagnetic Energy from the Active Vacuum," in M.W. Evans (ed.), Contemporary Optics and Electrodynamics, Wylie, 29001, 3 Vols. (in press), comprising a Special Topic issue as vol. 114, I. Prigogine and S. A. Rice (series eds.), Advances in Chemical Physics, Wylie, ongoing.
29. M. W. Evans, P. K. Anastasovski, T. E. Bearden *et al.*, "On Whittaker's Representation of the Classical Electromagnetic Field in Vacuo, Part II: Potentials Without Fields," submitted to Foundations of Physics, 2000 (in review).
30. M. W. Evans, P. K. Anastasovski, T. E. Bearden *et al.*, "On Whittaker's F and G Fluxes, Part III: The Existence of Physical Longitudinal and Timelike Photons," Journal of New Energy, 4(3), Special Issue, Winter 1999, p. 68-71.
31. M. W. Evans, P. K. Anastasovski, T. E. Bearden *et al.*, "Classical Electrodynamics Without the Lorentz Condition: Extracting Energy from the Vacuum," Physica Scripta, 61(5), may 2000, p. 513-517.
32. M. W. Evans, P. K. Anastasovski, T. E. Bearden *et al.*, "Vacuum Energy flow and Poynting Theorem from Topology and Gauge Theory," submitted to Physica Scripta, 2000 (in review).
33. M. W. Evans, P. K. Anastasovski, T. E. Bearden *et al.*, "The Effect of Vacuum Energy on the Atomic Spectra," Foundations of Physics Letters, 13(3), June 2000, p. 289-296.
34. M. W. Evans, P. K. Anastasovski, T. E. Bearden *et al.*, "Operator Derivation of the Gauge Invariant Proca and Lehnert Equations: Elimination of the Lorenz Condition," Foundations of Physics, 39(7), 2000, p. 1123 (in press).
35. M. W. Evans, P. K. Anastasovski, T. E. Bearden *et al.*, "Energy Inherent in the Pure Gauge Vacuum," submitted to Physica Scripta, 2000 (in review).
36. M. W. Evans, P. K. Anastasovski, T. E. Bearden *et al.*, "Electromagnetic Energy from Curved Space-Time," submitted to Optik, 2000 (in review).
37. M. W. Evans, P. K. Anastasovski, T. E. Bearden *et al.*, "Energy from the Vacuum," submitted to Physica Scripta, 2000 (in review).
38. M. W. Evans, P. K. Anastasovski, T. E. Bearden *et al.*, "The Aharonov-Bohm Effect as the Basis of Electromagnetic Energy Inherent in the Vacuum," submitted to Optik, 2000 (in review).
39. M. W. Evans, P. K. Anastasovski, T. E. Bearden *et al.*, "Longitudinal Modes in Vacuo of the Electromagnetic Field in Riemannian Spacetime," submitted to Optik, 2000 (in review).

40. M. W. Evans, P. K. Anastasovski, T. E. Bearden *et al.*, "O(3) Electrodynamics from the Irreducible Representations of the Einstein Group," submitted to Optik, 2000 (in review).
41. "O(3) Electrodynamics," a review of 250 pages in M. W. Evans (Ed.), Contemporary Optics and Electrodynamics, a special topical issue of I. Prigogine and S. A. Rice (series Eds.), *Advances in Chemical Physics*, Wiley, New York, 2001, vol. 114(2) (in press), preprint of sections available on U.S. DOE website <http://www.ott.doe.gov/electromagnetic/>.
42. M. W. Evans, precise statement on the importance and implications of O(3) electrodynamics as a special subset of Sachs' unified field theory, 2000. Quoting: *"With respect to O(3): In 1992 it was shown (Physica B, 192, 227, 237 (1992)) that there exists a longitudinal component of free space electromagnetism, a component which is phaseless and propagates with the transverse components. Later this was developed into a Yang-Mills theory of electromagnetism with O(3) Lagrangian symmetry. This theory is homomorphic with Barrett's SU(2) electrodynamics and has far reaching implications in field theory in general. Recently it has been recognized to be a sub theory of the Sachs theory of electromagnetism, based on the irreducible representations of the Einstein group of general relativity. The Sachs theory produces a non-Abelian structure for the electromagnetic field tensor. The O(3) electromagnetism also has implications for the potential ability of extracting energy from the vacuum, and its topological implications are currently being investigated by Ranada. The O(3) electromagnetism has been tested extensively against empirical data, and succeeds in describing interferometric effects and physical optical effects where the conventional Maxwell Heaviside theory fails. Implicit in both the O(3) and Sachs theories of electromagnetism is the ability to extract electromagnetic energy from curved space-time."*
43. M. W. Evans and T. E. Bearden, "The Most General Form of the Vector Potential in Electrodynamics," submitted to Optik, 2000 (in review).
44. Fragments of Science: Festschrift for Mendel Sachs, Michael Ram (Ed.), World Scientific, Singapore, 1999.
45. Mendel Sachs, General Relativity and Matter, Reidel, 1982. Provides a great generalization of general relativity and electrodynamics reaching from the quarks and gluons to the entire universe. O(3) electrodynamics forms a very important subset of Sachs' theory, which means that general relativistic effects such as curved spacetime and EM energy from the curved spacetime vacuum can be engineered electromagnetically. The present invention does engineer curved spacetime to obtain excess energy from the active vacuum.
46. Mendel Sachs, "Relativistic Implications of Electromagnetic Field Theory," in T. W. Barrett and D. M. Grimes, eds., Advanced Electromagnetism, World Scientific, 1995, p. 551.
47. A. A. Logunov and Yu. M. Loskutov, "Nonuniqueness of the predictions of the general theory of relativity," Sov. J. Part. Nucl., 18(3), May-June 1987, p. 179-187.
48. D. Hilbert, Gottingen Nachrichten, Vol. 4, 1917, p. 21. Quoting: *"I assert... that for the general theory of relativity, i.e., in the case of general invariance of the Hamiltonian function, energy equations... corresponding to the energy equations in orthogonally invariant theories do not exist at all. I could even take this circumstance as the characteristic feature"*

of the general theory of relativity." As Logunov and Loskutov pointed out, unfortunately this remark of Hilbert was evidently not understood by his contemporaries, since neither Einstein himself nor other physicists recognized the fact that in general relativity conservation laws for energy, momentum, and angular momentum are in principle impossible.

49. Henning F. Harmuth, "Extensions of Ohm's Law to Electric and Magnetic Dipole Currents," in Advanced Electromagnetism: Foundations, Theory and Applications, Eds. Terence W. Barrett and Dale M. Grimes, World Scientific, Singapore, 1995, p. 506-540.
50. J. R. Reitz, F. J. Milford, and R. W. Christy, "Foundations of Electromagnetic Theory, 3rd ed., Addison-Wesley, Reading, MA, 1980. For one thing, this book gives a thorough discussion of dipole currents, which is not covered well in most texts.
51. H. A. Lorentz, Vorlesungen über Theoretische Physik an der Universität Leiden, Vol. V, Die Maxwell'sche Theorie (1900-1902), Akademische Verlagsgesellschaft M.B.H., Leipzig, 1931, "Die Energie im elektromagnetischen Feld," p. 179-186. Figure 25 on p. 185 shows the Lorentz concept of integrating the Poynting vector around a closed cylindrical surface surrounding a volumetric element. This is the procedure which arbitrarily selects only a small component of the energy flow associated with a circuit—specifically, the small Poynting component striking the surface charges and being diverged into the circuit to power it—and then treats that tiny component as the "entire" Poynting energy flow. Thereby Lorentz arbitrarily discarded all the vast Heaviside energy transport component which does not strike the circuit at all, and is just wasted.
52. Raymond C. Gelinis, "Apparatus and Method for Demodulation of a Modulated Curl-Free Magnetic Vector Potential Field," U.S. Patent No. 4,429,280, Jan. 31, 1984; — "Apparatus and method for Modulation of a Curl-Free Magnetic Vector Potential Field." U.S. Patent No. 4,429,288, Jan. 31, 1984; — "Apparatus and Method for Transfer of Information by Means of a Curl-Free Magnetic Vector Potential Field." U.S. Patent No. 4,432,098, Feb. 14, 1984; — "Apparatus and Method for Determination of a Receiving Device Relative to a Transmitting Device Utilizing a Curl-Free Magnetic Vector Potential Field." U.S. Patent No. 4,447,779, May 8, 1984; — "Apparatus and Method for Distance Determination Between a Receiving Device and a Transmitting Device Utilizing a Curl-Free Magnetic Vector Potential Field," U.S. Patent No. 4,605,897, 12 Aug 1986; — "Josephson Junction Interferometer Device for Detection of Curl-Free Magnetic Vector Potential Fields," U.S. Patent No. 4,491,795, 1 Jan 1985. All these Gelinis patents are assigned to Honeywell. All deal with communications, have no application to electrical power systems, do not use additional EM energy extracted from a permanent magnet and replenished by the vacuum, do not use curved local spacetime, do not use the giant negentropy process, do not function as open systems far from equilibrium in their vacuum exchange, symmetrically regauge themselves so that their excitation discharge is symmetrical and not asymmetrical, and produce only COP<1.0.
53. John D. Kraus, Electromagnetics, Fourth Edn., McGraw-Hill, New York, 1992. Figure 12-60, a and b, p. 578 shows a good drawing of the huge Poynting energy flow filling all space around the conductors, with almost all of it not intercepted, not diverged into the circuit, but just "wasted."

54. Daniel C. Cole and Harold E. Puthoff, "Extracting Energy and Heat from the Vacuum," Physical Review E, 48(2), Aug. 1993, p. 1562-1565. Proves rigorously that there are no thermodynamics prohibitions against extracting and using energy from the active vacuum.
55. Ludvig Valentin Lorenz, "On the identity of the vibrations of light with electrical currents," Phil. Mag., Vol. 34, 1867, p. 287-301. In this paper Lorenz gave essentially what today is called the Lorentz symmetrical gauging.

FIGURES

The following figures (1-23) illustrate the major principles, process and subprocesses, functions, and test results of the process and its prototype embodiments.

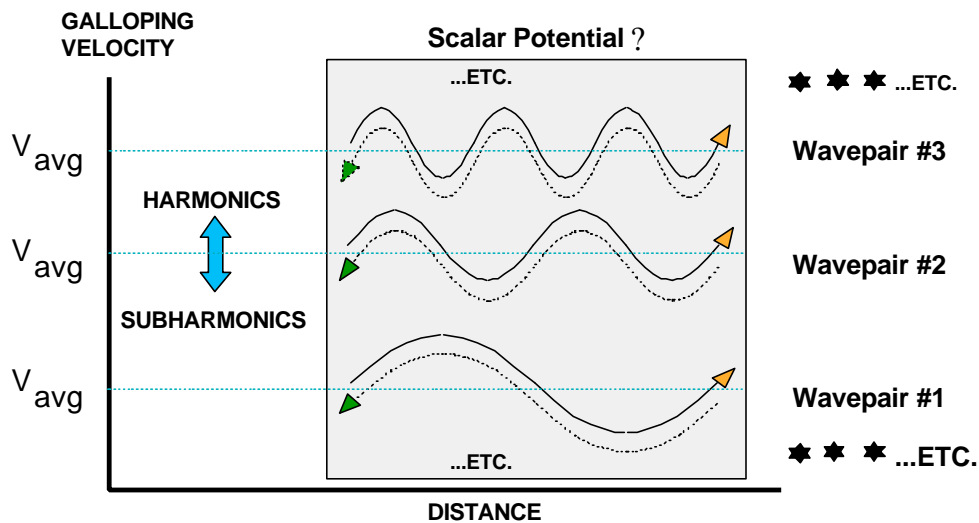

The Structure Is:

- A harmonic set of longitudinal wavepairs.
- In each wavepair the two waves superpose spatially, but travel in opposite directions. The two are phase conjugates and time-reversed replicas of each other.
- The convergent wave set is in the imaginary plane, and hence is not observable.
- The charge's spin is 720 degrees, 320 in the real plane and 320 in the imaginary plane.
- Hence the charge receives the complex convergent EM energy, transduces it into real EM energy, and emits enormous energy at the speed of light in all directions.
- This produces the fields and potentials from the "source charge."

Figure 1. The scalar potential is a harmonic set of phase conjugate longitudinal EM waves.

Note: Decompose the potential between the end charges of the dipole

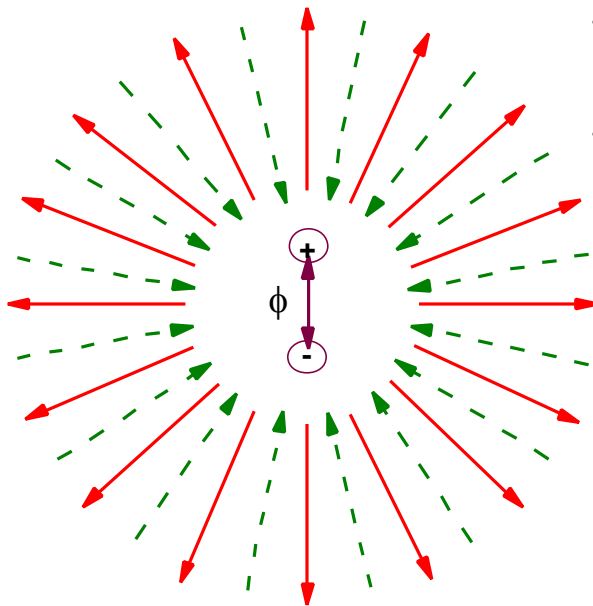

- Receives enormous EM energy in complex plane (similar to reactive power)
- Transduces it into real EM energy and emits it in all directions at the speed of light
- The emitted EM energy forms the fields and potentials and their energy, across space, from this "source dipole"

* Basis established by E.T. Whittaker, "On the Partial Differential Equations of Mathematical Physics," Math. Ann. 57, 333 (1903). Ignored since then.

LEGEND

→
Outgoing real EM energy

←
Incoming complex EM energy

Figure 2. The dipole is a true negative resistor.

Broken 3-space symmetry initiates jump to 4-space symmetry between complex plane and real plane. Energy flow is now conserved in 4-space, but not in 3-space. This is the true negative resistor effect, and a negentropic reordering of the vacuum.

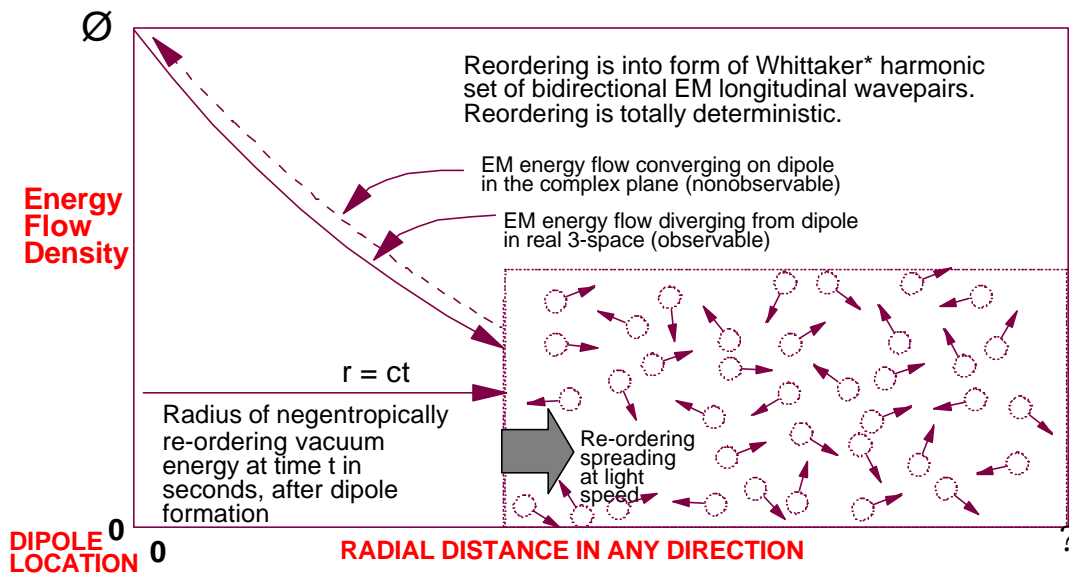

Figure 3. The dipole's broken 3-symmetry initiates a spreading giant negentropic reordering of a fraction of the vacuum's energy.

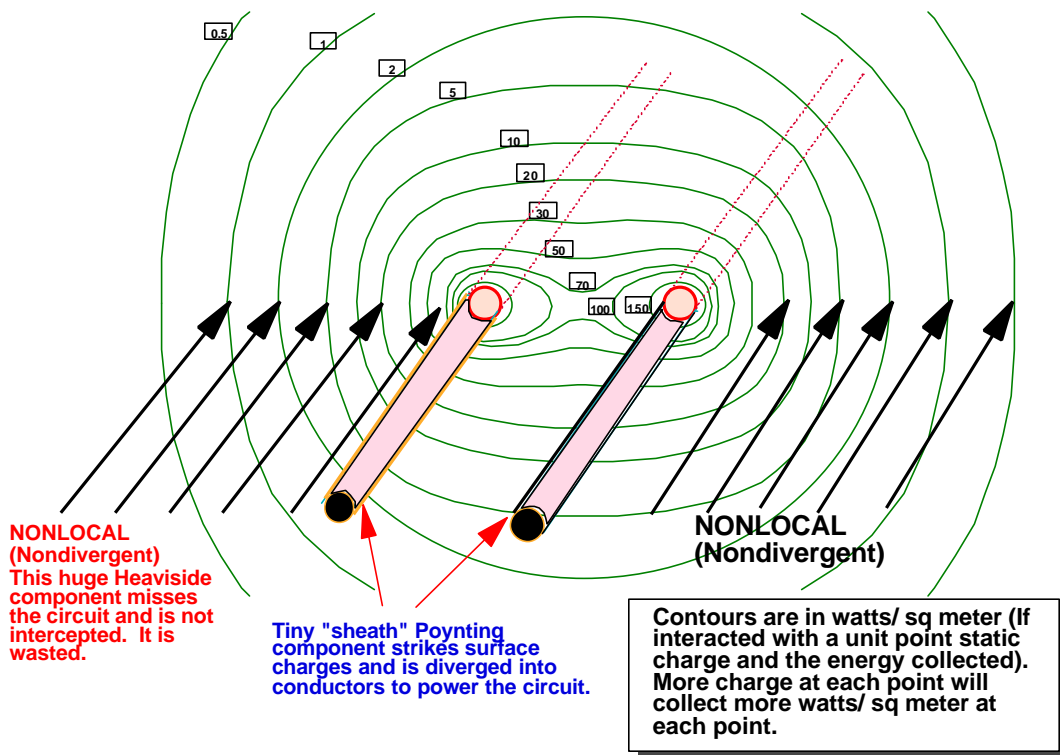

Figure 4. Energy flow contours surrounding a transmission line.

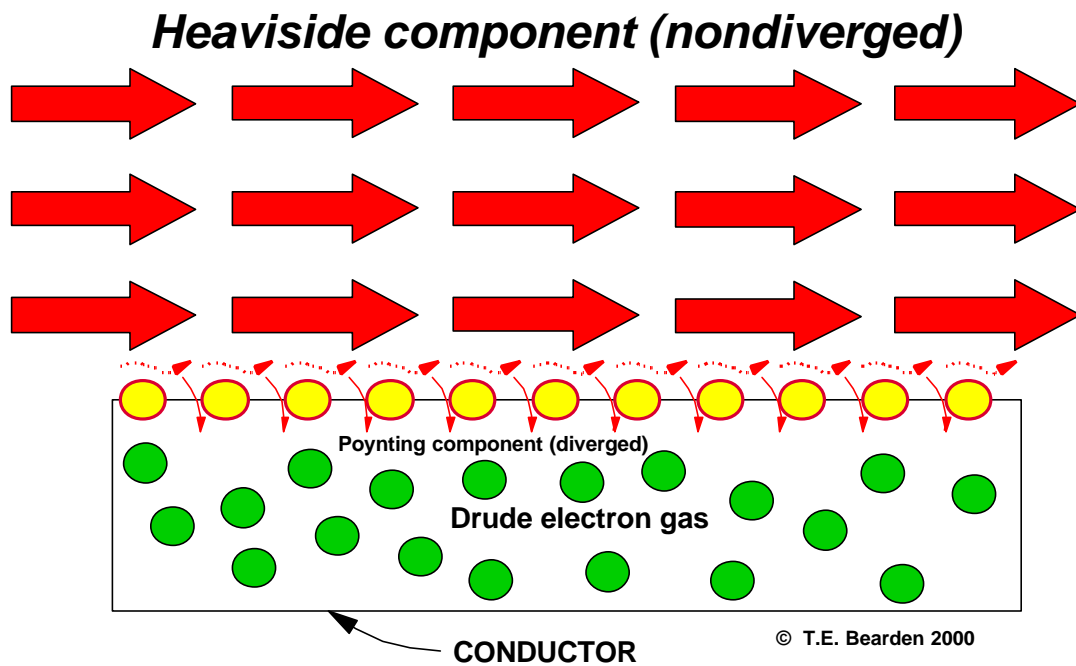

Figure 5. Heaviside and Poynting energy flow components. The Heaviside component is often 10 trillion times the Poynting component, but is simply wasted in ordinary single-pass energy flow circuits.

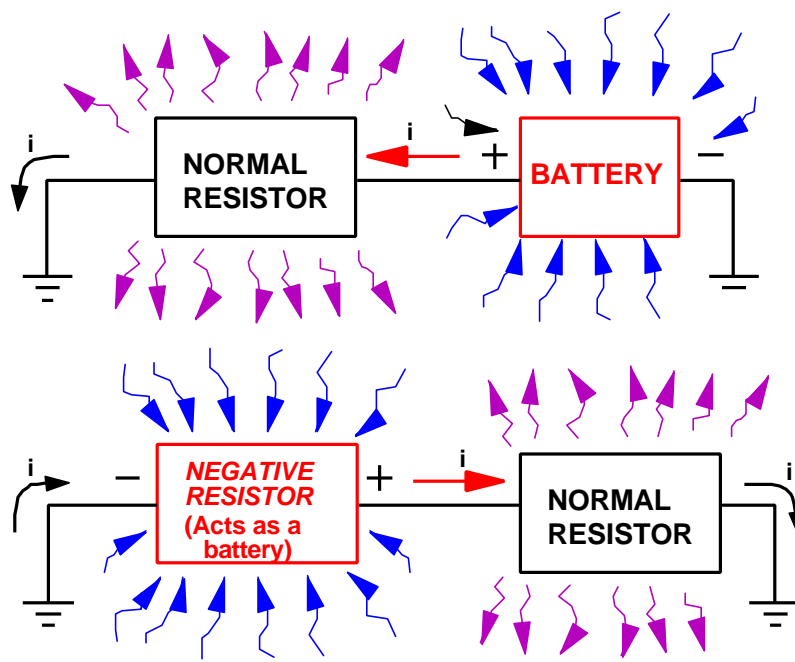
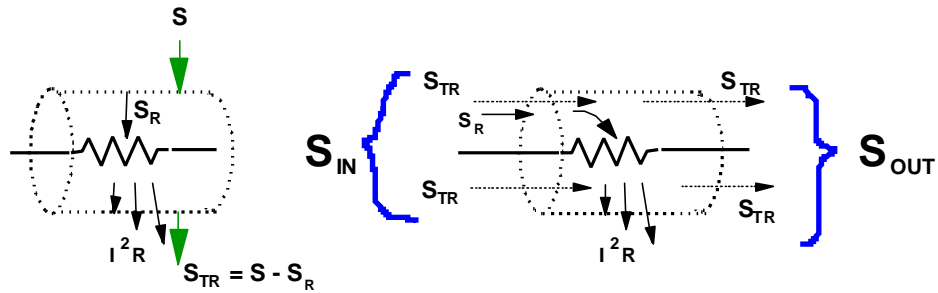

Figure 6. Negative resistance process vs. positive resistance process. A negative resistor receives energy in unusable form, transduces it, and outputs it in usable form. A positive resistor receives energy in usable form, and scatters it into unusable form.



1a. Lorentz surface integration.

1b. Actual S in and S out.

See Panofsky & Phillips,
Classical Electricity and
Magnetism, 2nd. edn.,
Addison Wesley, 1962,
p. 178-181.

Note: If the S-vector is integrated over the closed surface, then all nondiverged energy flow is zeroed, leaving only the very small component of the input S-flow that is powering the joule heating of the resistor. In short, only the small component of the S-flow that is equal in magnitude to the Poynting vector remains. This measures only the tiny portion of the S-flow that is intercepted and diverged into the conductors by their surface charges, powering the electrons and then dissipated out of the resistor as joule heating.

The Lorentz procedure arbitrarily discards the enormous Heaviside component that misses the circuit entirely and is wasted. This results in a non sequitur of first magnitude in energy flow theory .

Figure 7. Lorentz's integration trick to discard the enormous Heaviside non-diverged energy flow component.

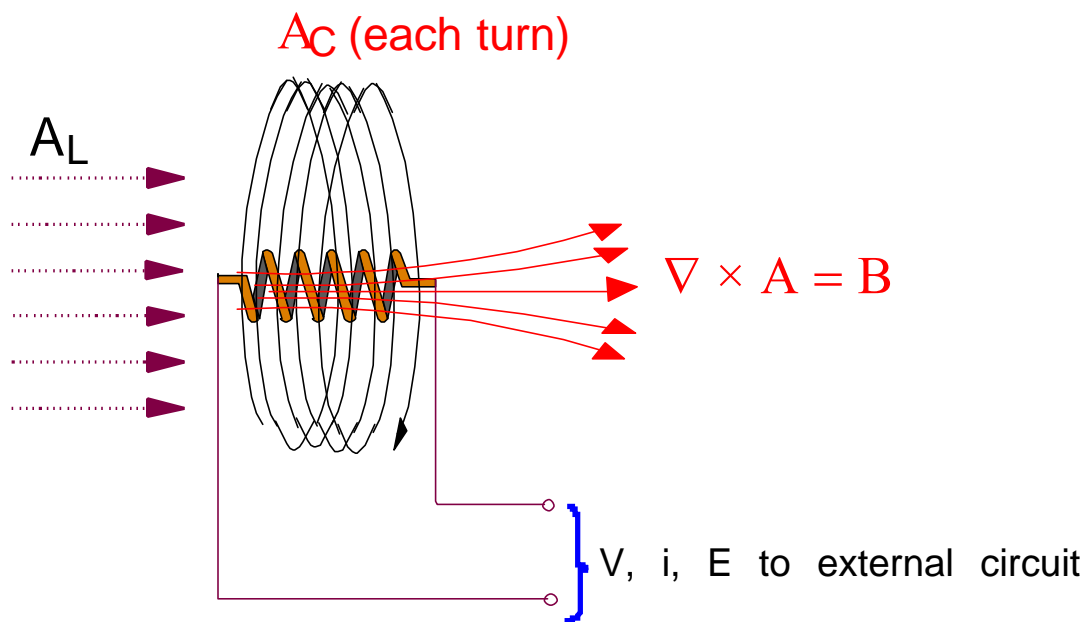
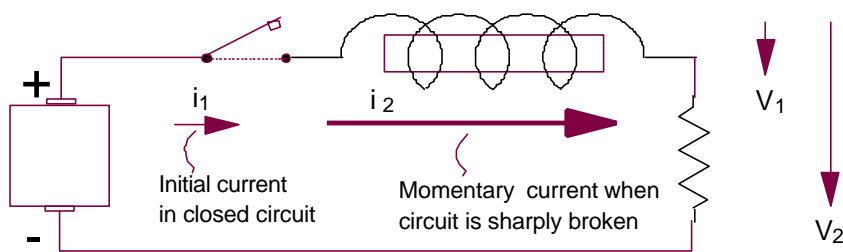
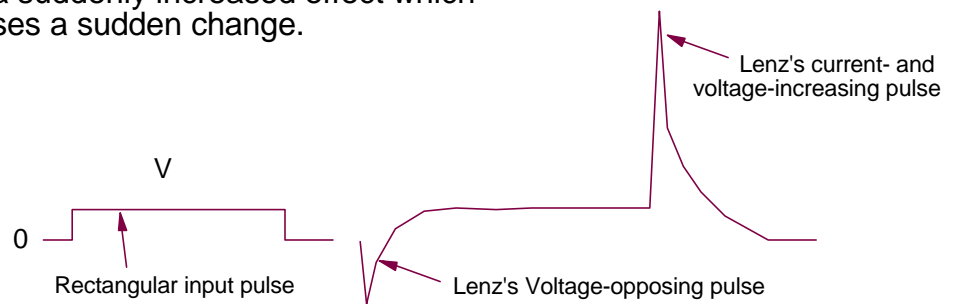

Figure 8. The A_L and A_C vector potentials, B-field, and $\nabla \times$ operator. The $\nabla \times$ operator operates on the A_C potential energy current, to produce normal B-field.

When a small current through the coil is suddenly broken, momentarily a surge of increased current and voltage ensues.



1a. Lenz's reaction is a suddenly increased effect which momentarily opposes a sudden change.



1b. Two successive Lenz's reactions to two interruptions by leading and trailing edges of a rectangular pulse.

Figure 9. Lenz's law reaction momentarily opposes a sudden change and increases the ongoing action which is to be changed.

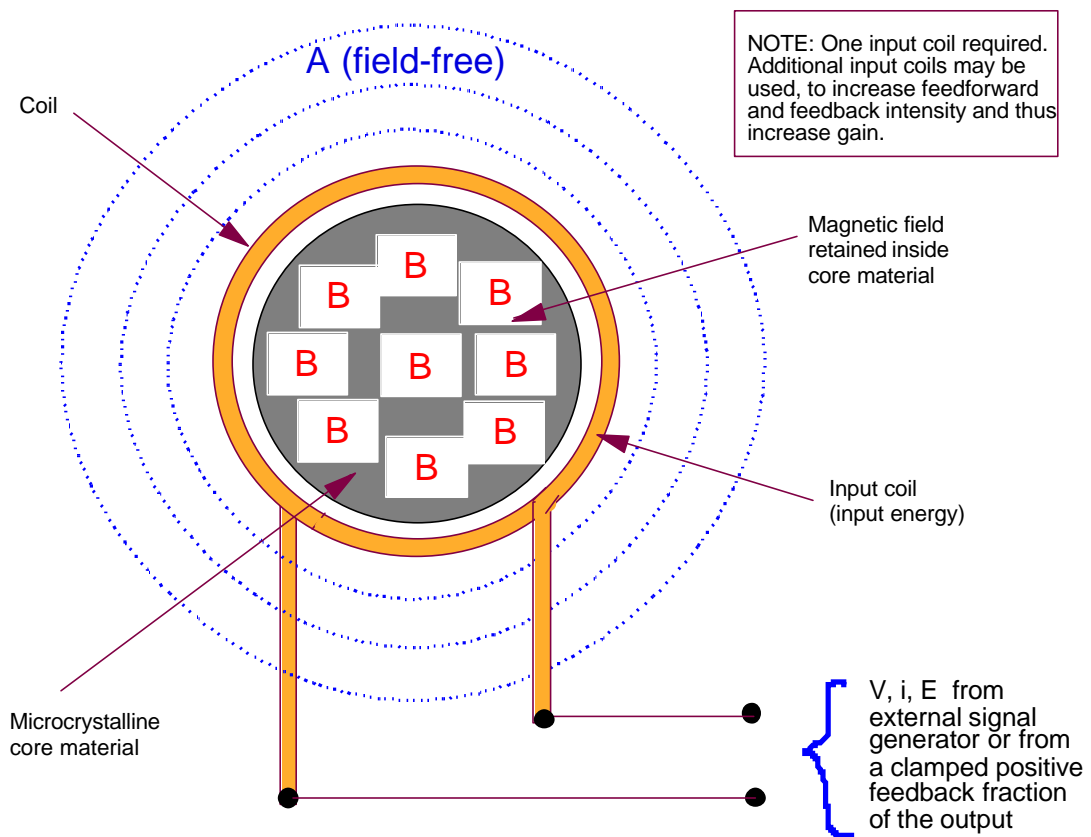

Figure 10. Input coil for either open-loop or closed-loop operation.

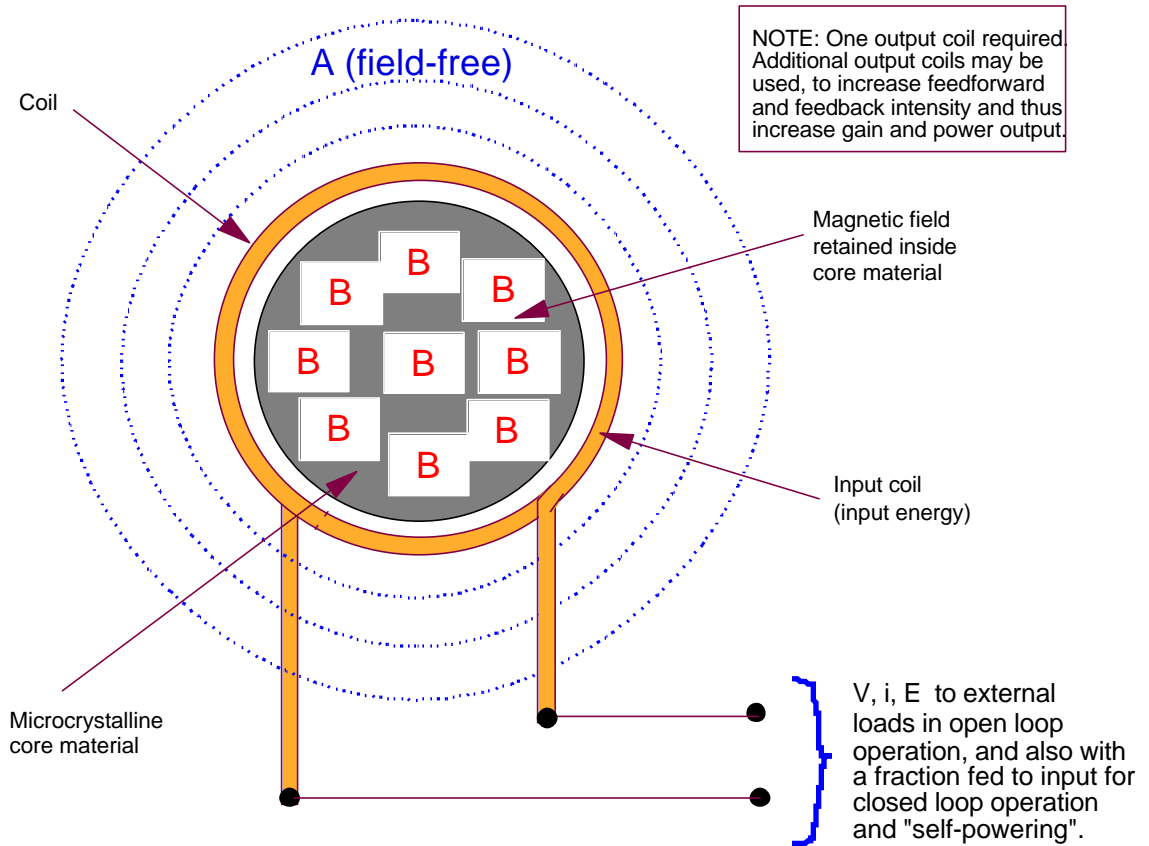

Figure 11. Output coil for either open-loop or closed-loop operation. Multiple output coils may be used in a variety of configurations.

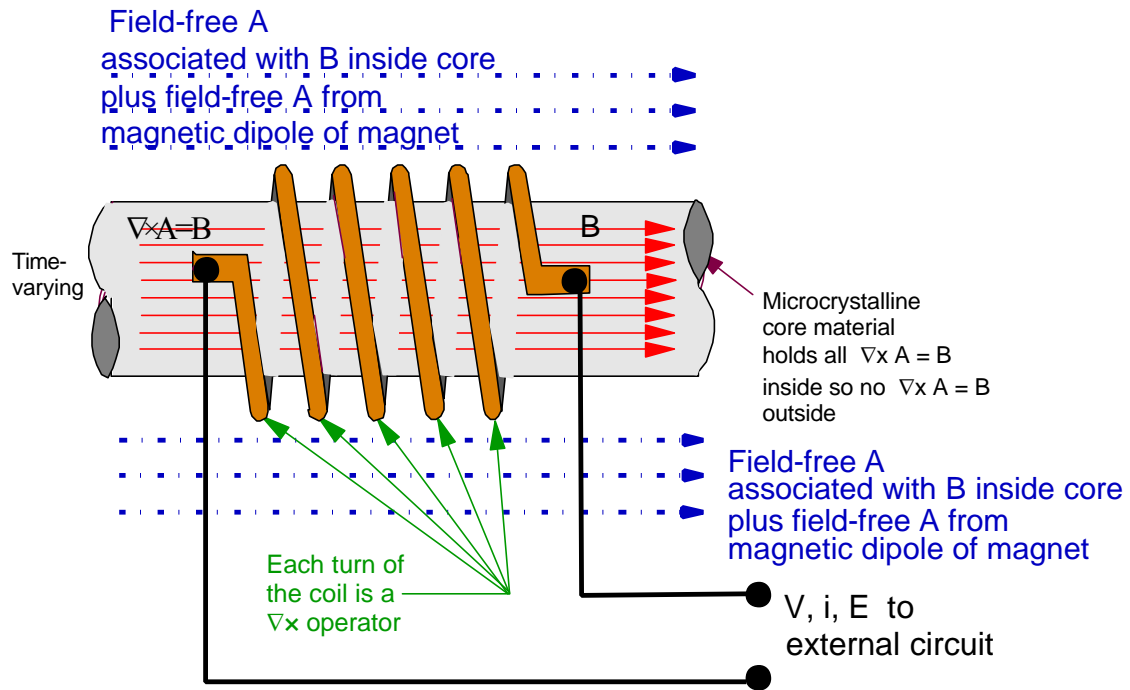

Figure 12. Basic scheme showing dual energy inputs and interactions with the coil. The output of each of these two interactions also "feeds forward" to the other interaction as an additional input to it, resulting in interactive "pingpong" of additional energy collection in the circuit, providing energy gain.

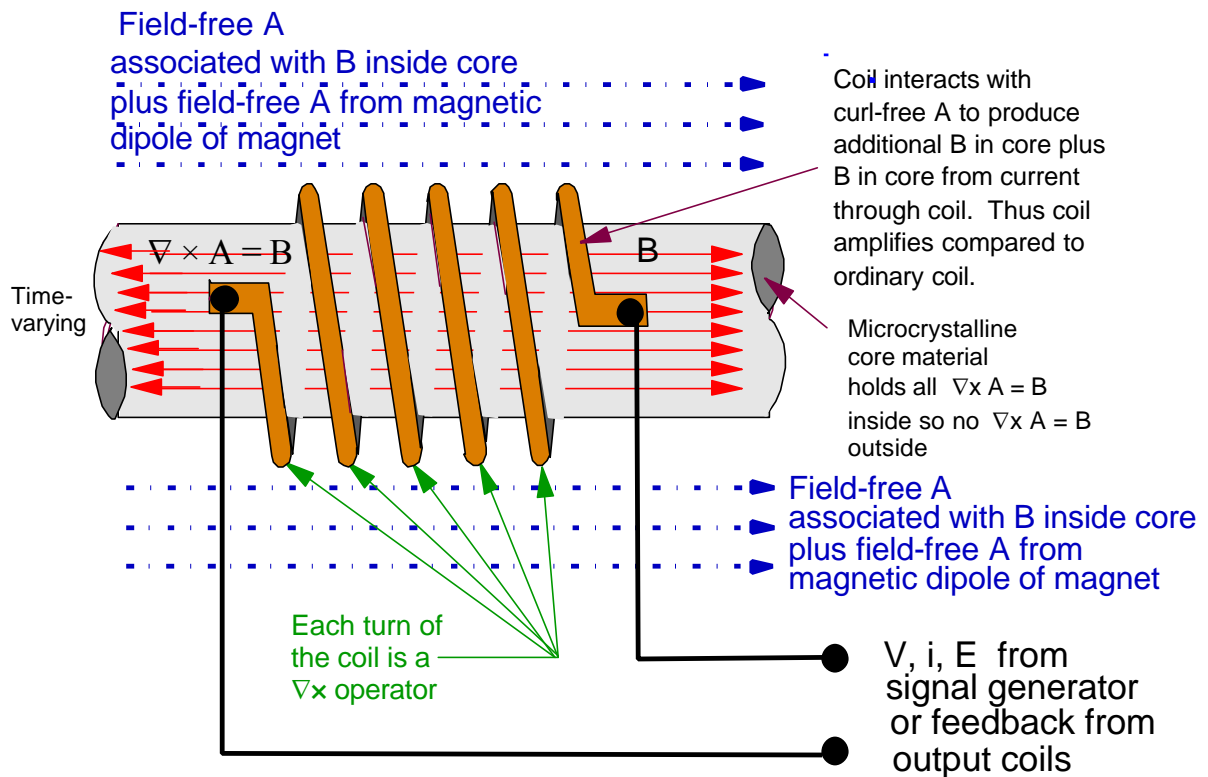

Figure 13. Dual energy inputs to the coil result in amplifying coil-core interaction. Not shown are the other feed loops providing extra curl-free A input from the surrounding space and extra B input in the core.

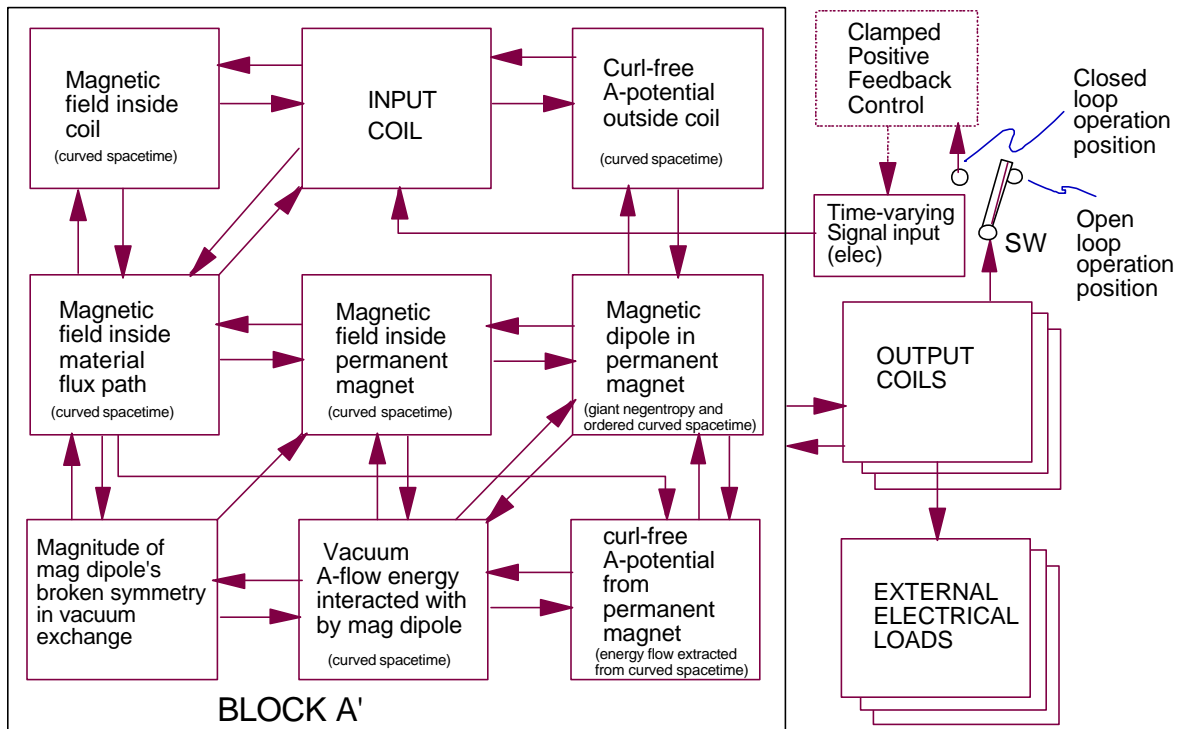

Figure 14. Energy gain process using feedforward and feedback subprocesses providing individual energy gain operations.

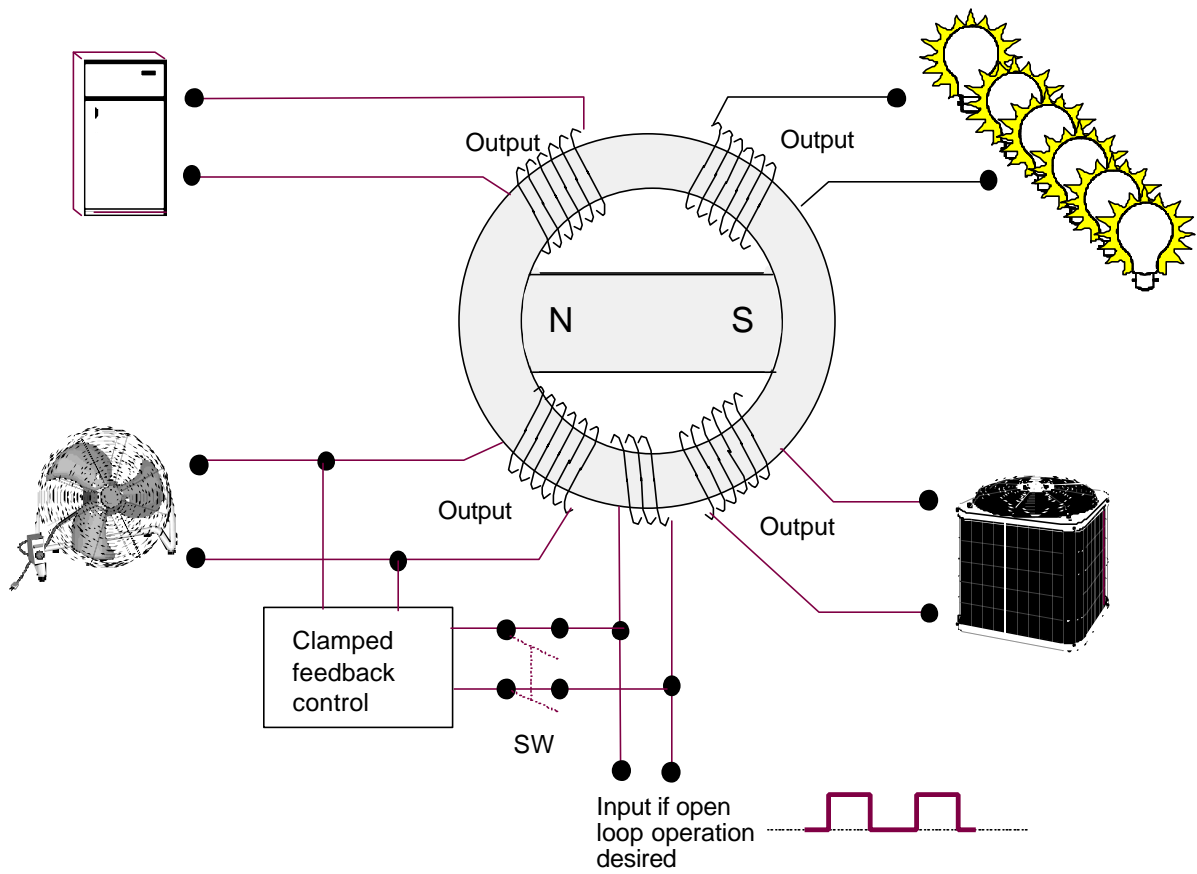

Figure 15. Typical embodiment system and application.

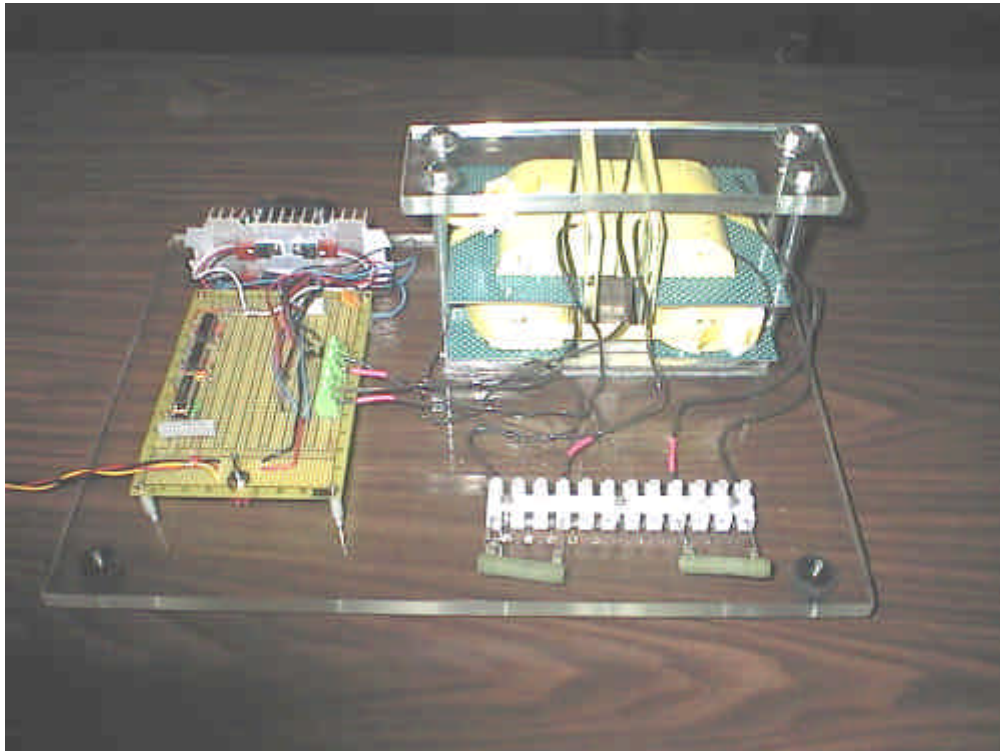

Figure 16. Motionless Electromagnetic Generator (laboratory experiment).

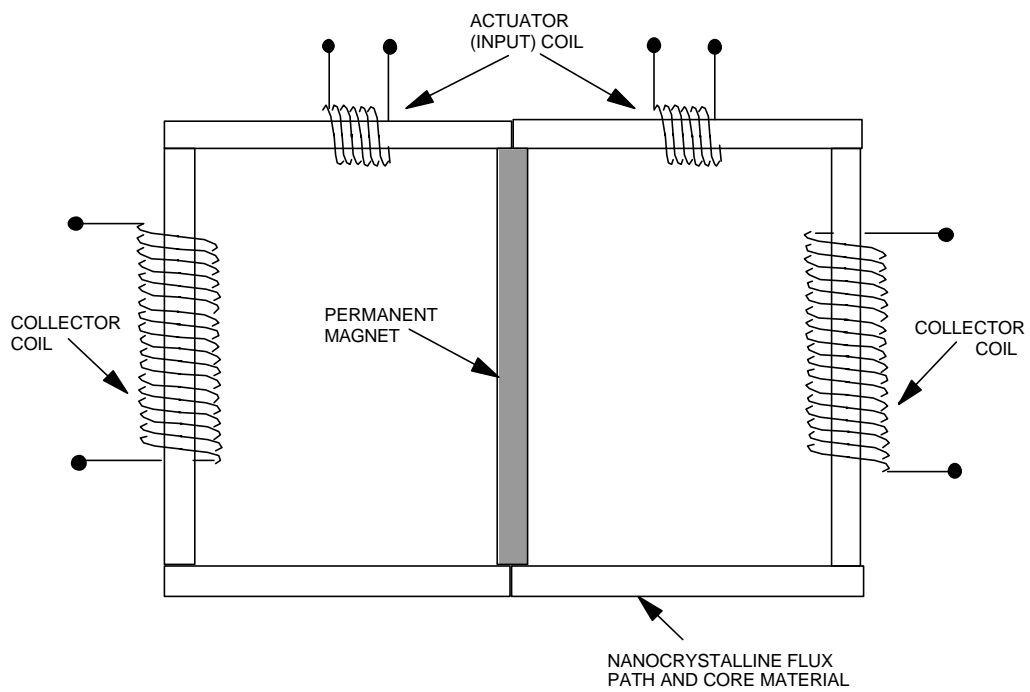

Figure 17. Diagram of laboratory test prototype.

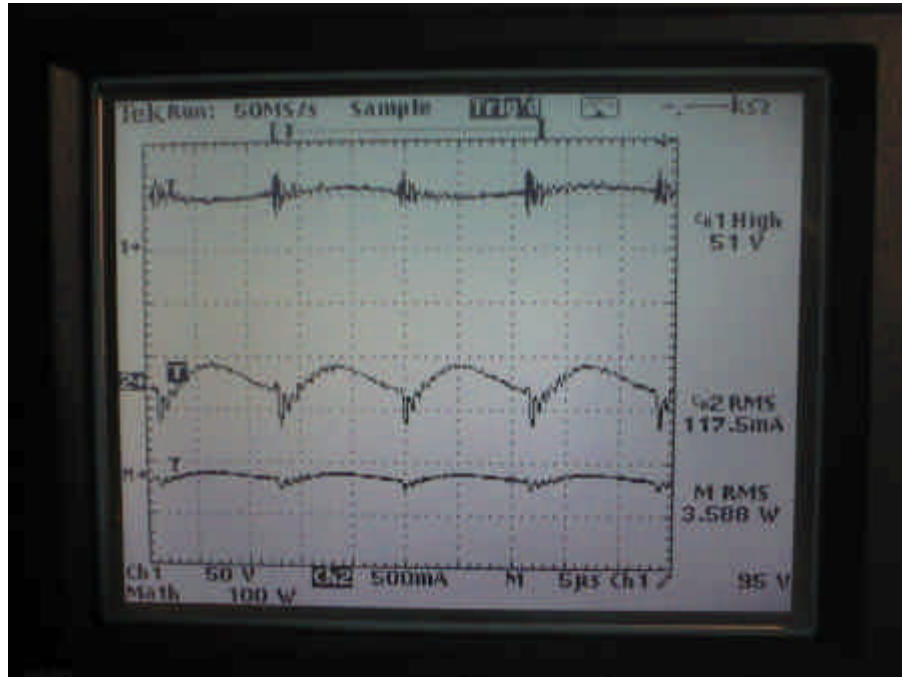

Figure 18. MEG Input measurements.

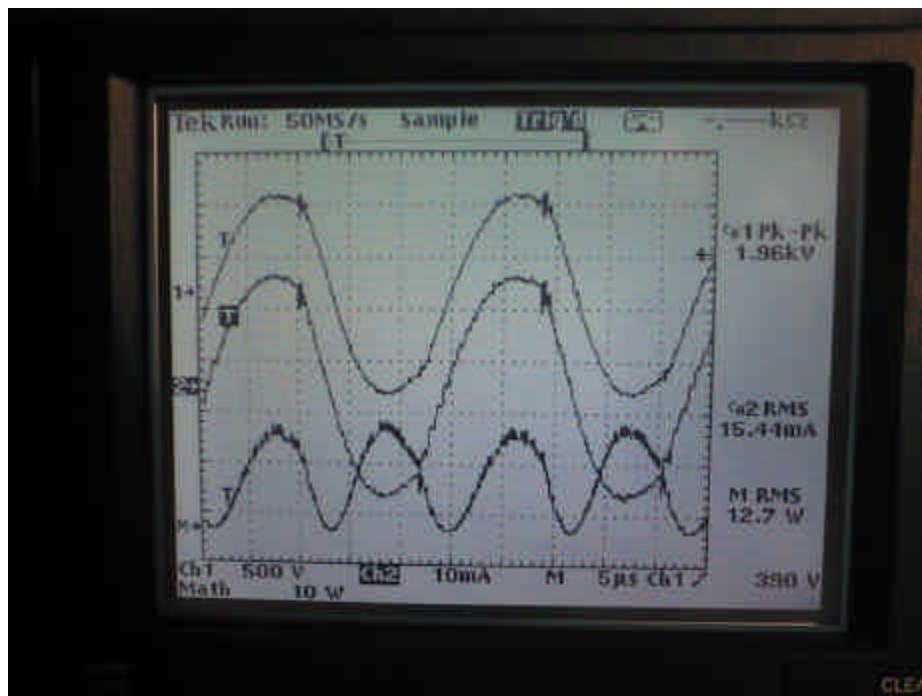

Figure 19. MEG output measurements.

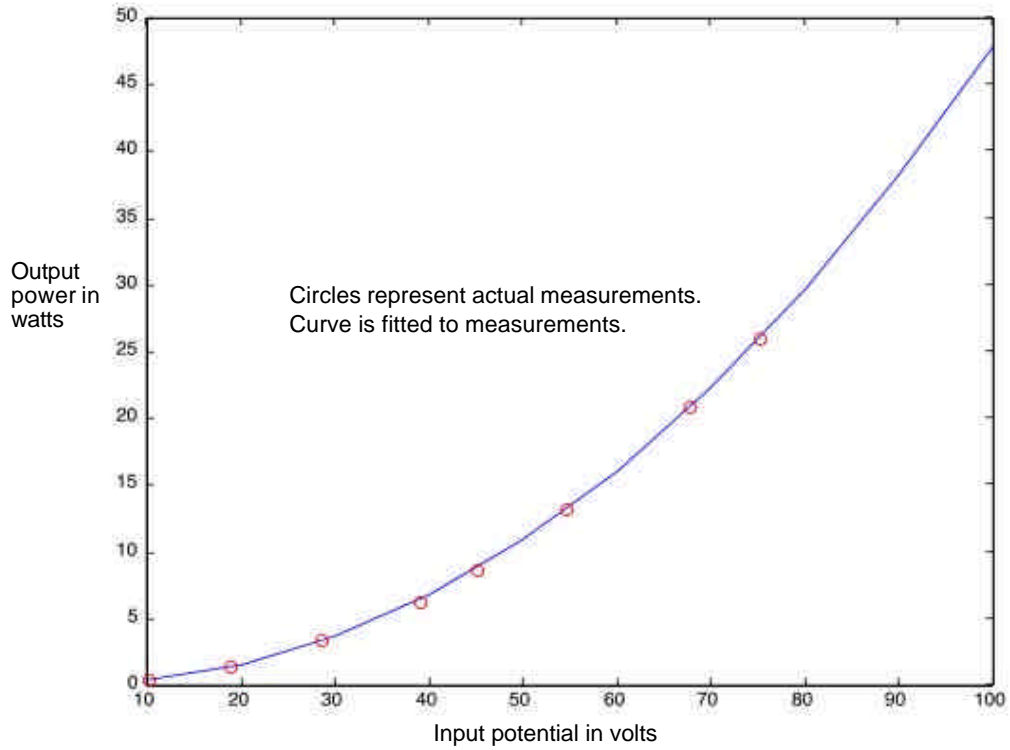

Figure 20. MEG prototype potentialization sensitivity.

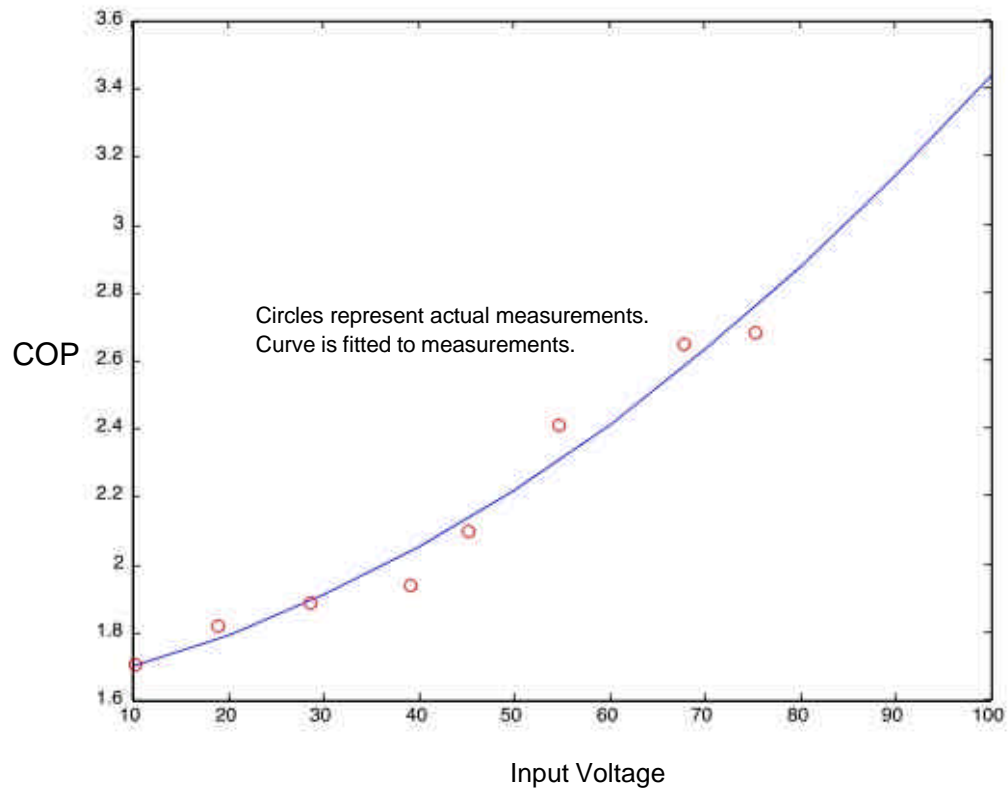

Figure 21. COP (power out versus power in), as a function of sensitivity (open loop prototype).

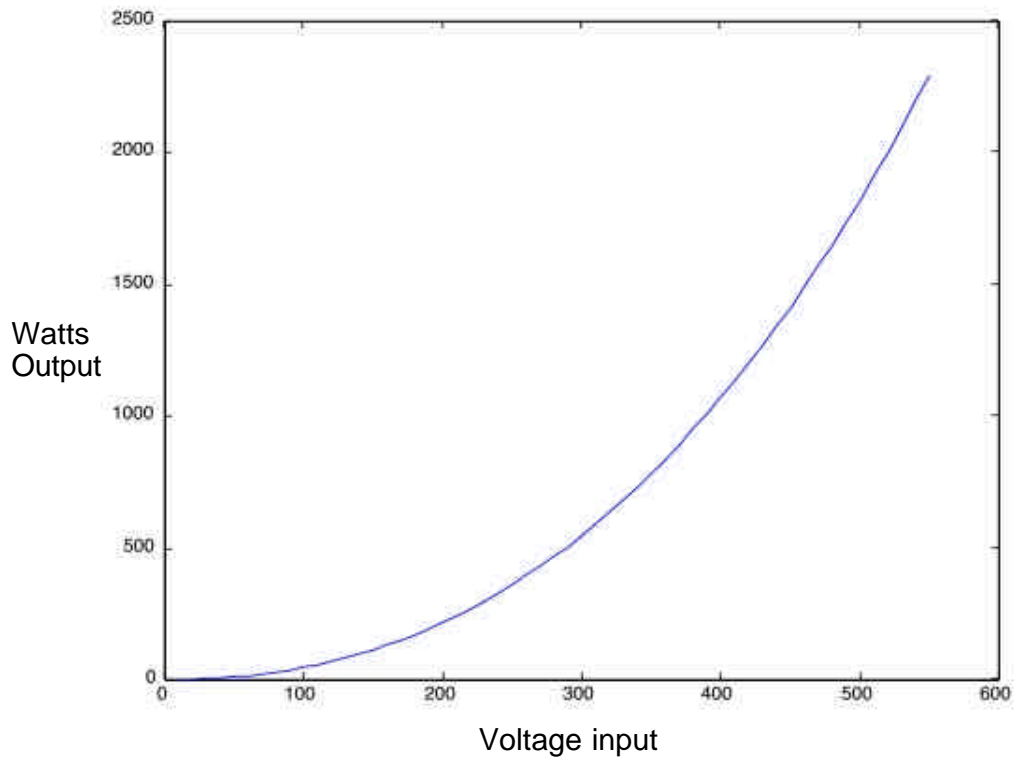

Figure 22. MEG projected sensitivity (test buildup in progress).

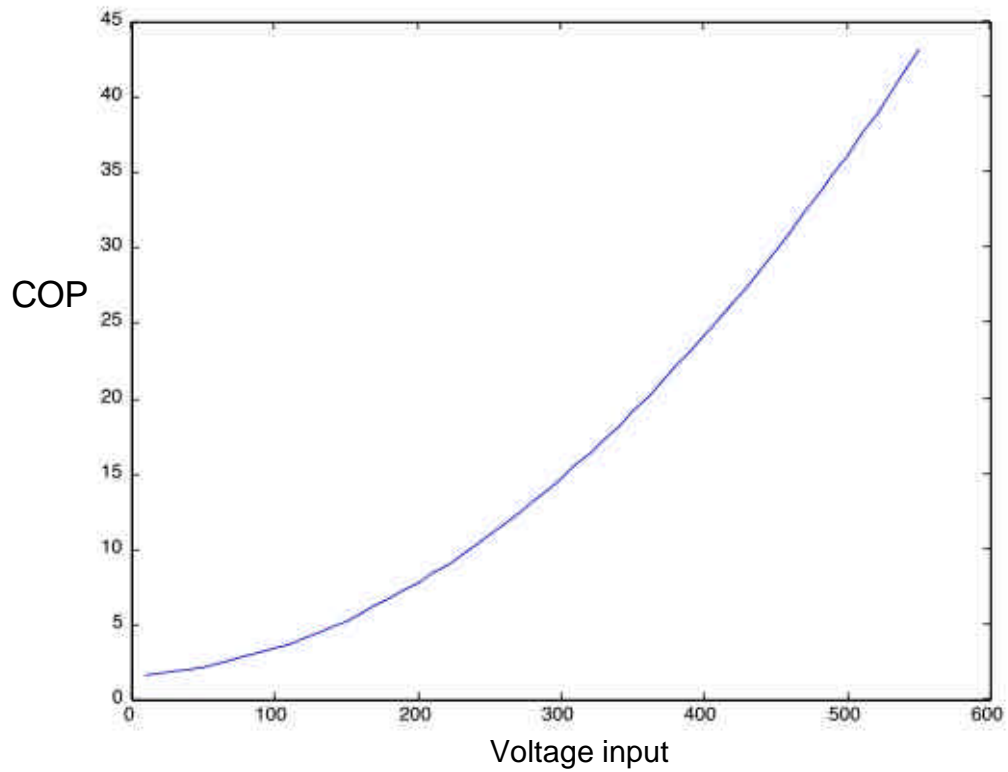

Figure 23. MEG projected COP versus input voltage (test buildup in process).



US006362718B1

(12) **United States Patent**
Patrick et al.

(10) **Patent No.:** **US 6,362,718 B1**
(45) **Date of Patent:** **Mar. 26, 2002**

(54) **MOTIONLESS ELECTROMAGNETIC GENERATOR**

(76) Inventors: **Stephen L. Patrick**, 2511 Woodview Dr. SE.; **Thomas E. Bearden**, 2211 Cove Rd., both of Huntsville, AL (US) 35801; **James C. Hayes**, 16026 Deaton Dr. SE., Huntsville, AL (US) 35803; **Kenneth D. Moore**, 1704 Montdale Rd., Huntsville, FL (US) 35801; **James L. Kenny**, 925 Tascosa Dr., Huntsville, AL (US) 35802

(*) Notice: Subject to any disclaimer, the term of this patent is extended or adjusted under 35 U.S.C. 154(b) by 0 days.

(21) Appl. No.: **09/656,313**

(22) Filed: **Sep. 6, 2000**

(51) **Int. Cl.**⁷ **H01F 27/24**

(52) **U.S. Cl.** **336/214**

(58) **Field of Search** 363/16, 24, 25, 363/26, 56.06, 56.08, 133, 134; 336/15, 110, 155, 177, 180, 213, 214, 221, 222

(56) **References Cited**

U.S. PATENT DOCUMENTS

2,153,378 A	4/1939	Kramer	171/95
2,892,155 A	6/1959	Radus et al.	324/117
3,079,535 A	2/1963	Schultz	317/201
3,165,723 A	1/1965	Radus	340/174
3,228,013 A	1/1966	Olson et al.	340/174
3,254,268 A	5/1966	Radus et al.	317/14
3,316,514 A	4/1967	Radus et al.	335/291
3,368,141 A	2/1968	Subieta-Garron	323/44
3,391,358 A	7/1968	Bratkowski et al.	335/21
3,453,876 A	7/1969	Radus	73/141
3,517,300 A	* 6/1970	McMurray	
3,569,947 A	3/1971	Radus	340/174
3,599,074 A	* 8/1971	Adams	
4,006,401 A	2/1977	de Rivas	323/92
4,077,001 A	2/1978	Richardson	323/92
4,366,532 A	12/1982	Rosa et al.	363/69
4,482,945 A	11/1984	Wolf et al.	363/129
4,554,524 A	11/1985	Radus	337/3

4,853,668 A	8/1989	Bloom	336/214
4,864,478 A	9/1989	Bloom	363/16
4,904,926 A	2/1990	Pasichinskyj	323/362
5,011,821 A	4/1991	McCullough	505/1
5,221,892 A	6/1993	Sullivan et al.	323/362
5,245,521 A	* 9/1993	Spreen	363/37
5,327,015 A	7/1994	Hackett	505/211
5,335,163 A	8/1994	Seiersen	363/126
5,694,030 A	* 12/1997	Sato et al.	323/282

OTHER PUBLICATIONS

Raymond J. Radus, "Permanent-Magnet Circuit using a 'Flux-Transfer' Principle," Engineers' Digest, 24(1-6) Jan.-Jun. 1963, p. 86.

Robert O'Handley, Modern Magnetic Materials, Principles and Applications, John Wiley & Sons, Inc., 2000, pp. 456-468.

Robert C. Weast, Editor, CRC Handbook of Chemistry and Physics, 1978-1979, p. B-50.

Honeywell.com web site, "amorphous metals".

* cited by examiner

Primary Examiner—Matthew Nguyen

(74) *Attorney, Agent, or Firm*—Norman Friedland

(57) **ABSTRACT**

An electromagnetic generator without moving parts includes a permanent magnet and a magnetic core including first and second magnetic paths. A first input coil and a first output coil extend around portions of the first magnetic path, while a second input coil and a second output coil extend around portions of the second magnetic path. The input coils are alternatively pulsed to provide induced current pulses in the output coils. Driving electrical current through each of the input coils reduces a level of flux from the permanent magnet within the magnet path around which the input coil extends. In an alternative embodiment of an electromagnetic generator, the magnetic core includes annular spaced-apart plates, with posts and permanent magnets extending in an alternating fashion between the plates. An output coil extends around each of these posts. Input coils extending around portions of the plates are pulsed to cause the induction of current within the output coils.

29 Claims, 5 Drawing Sheets

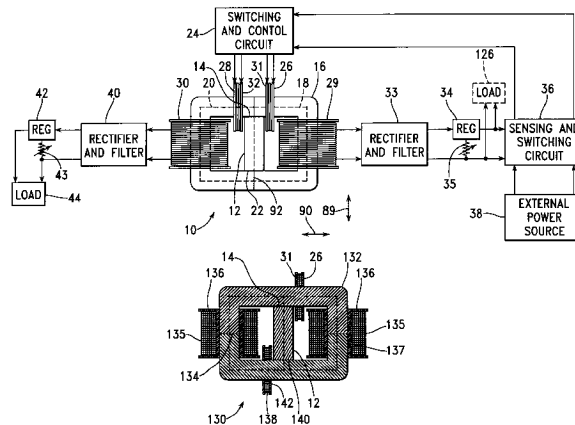

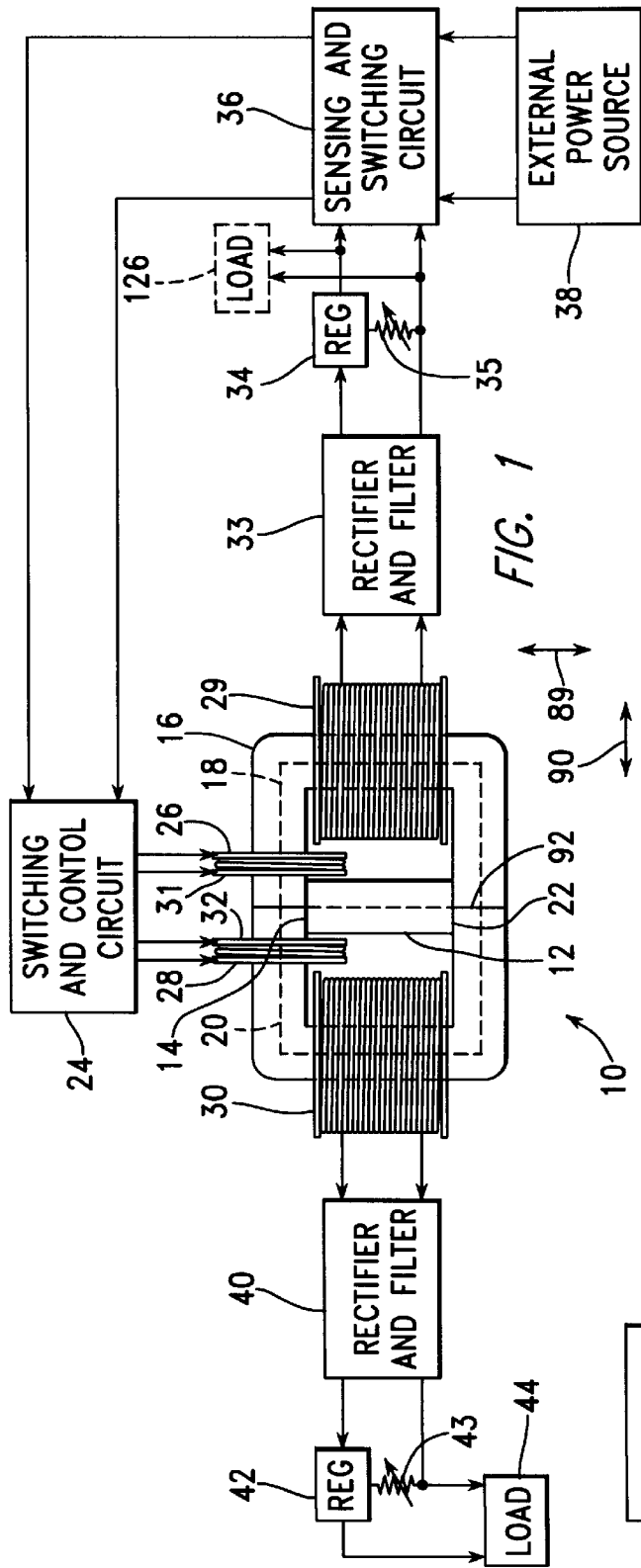

FIG. 1

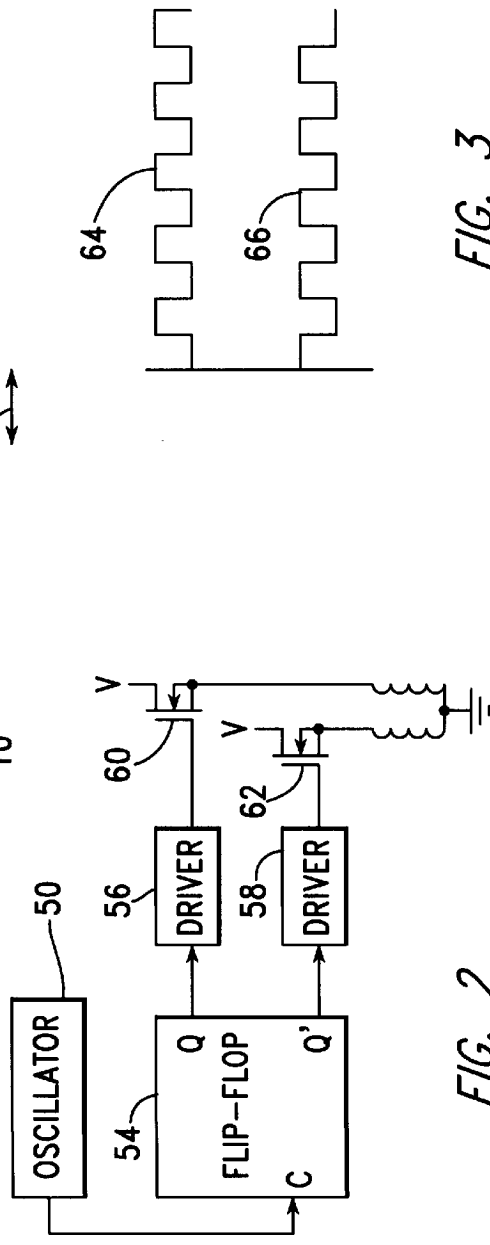

FIG. 2

FIG. 3

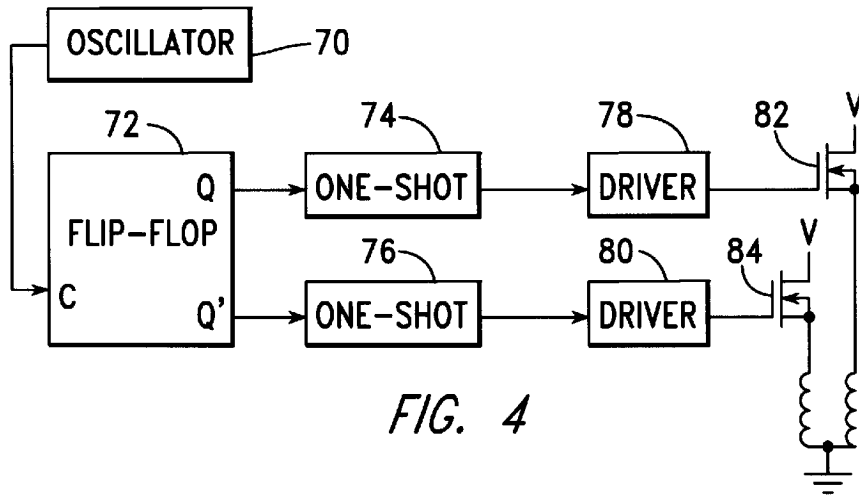

FIG. 4

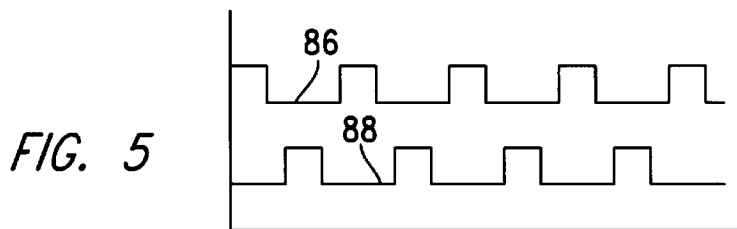

FIG. 5

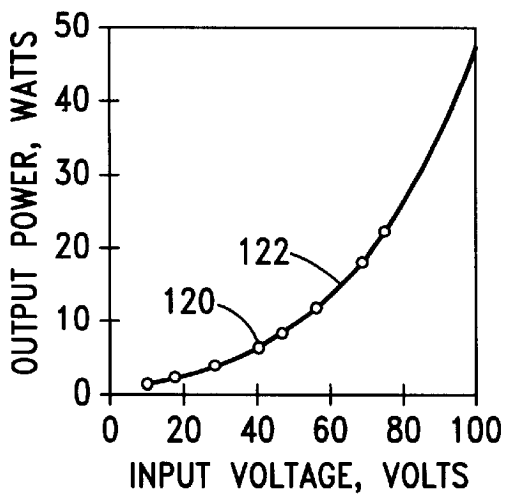

FIG. 7

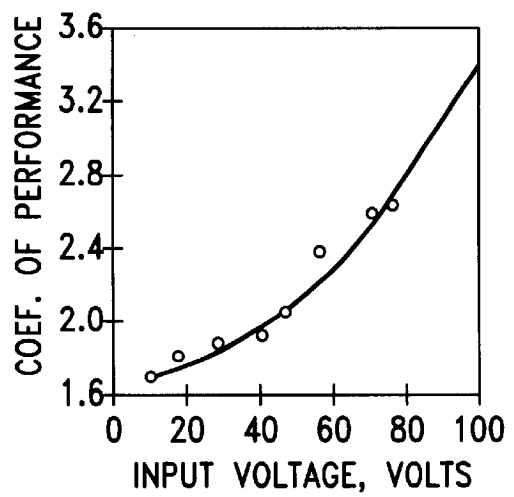

FIG. 8

FIG. 6A

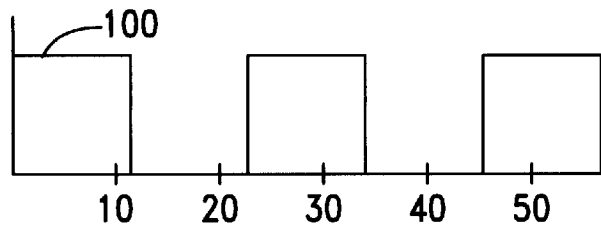

FIG. 6B

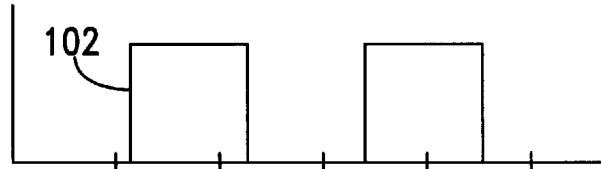

FIG. 6C

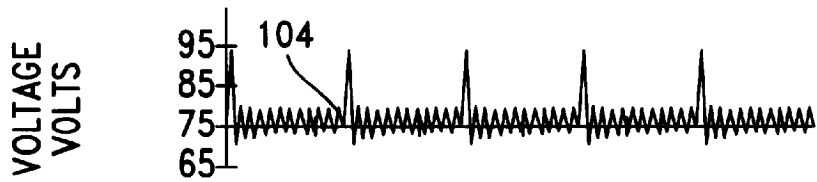

FIG. 6D

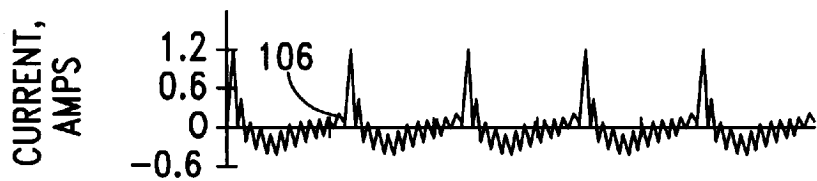

FIG. 6E

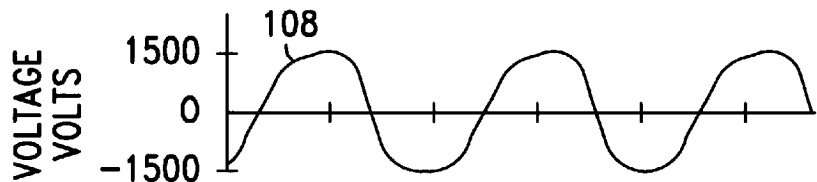

FIG. 6F

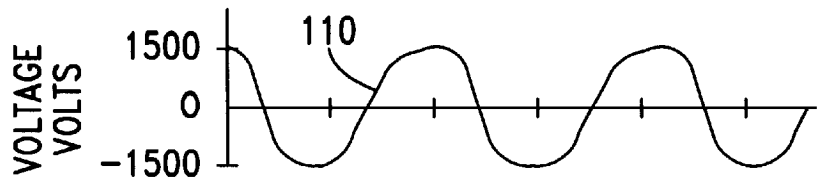

FIG. 6G

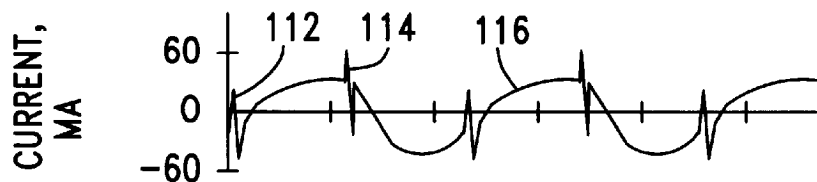
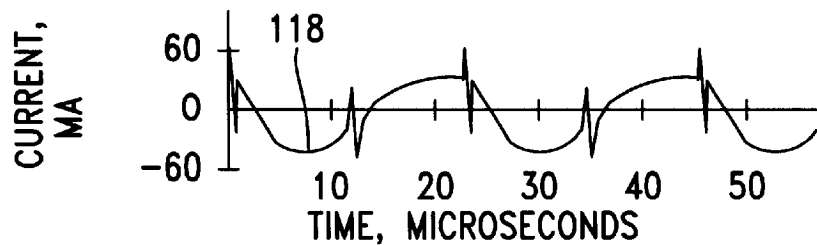

FIG. 6H



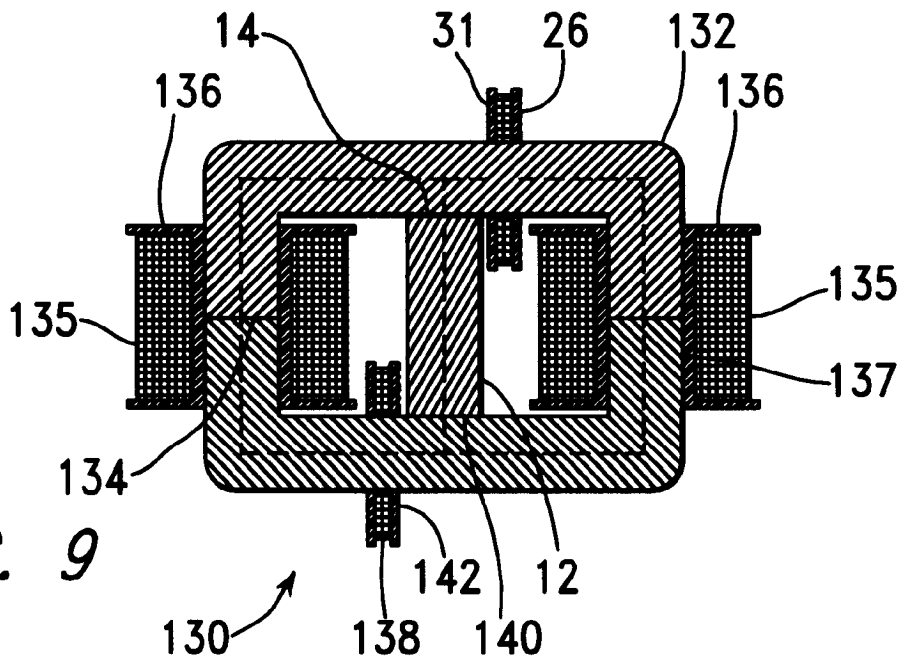

FIG. 9

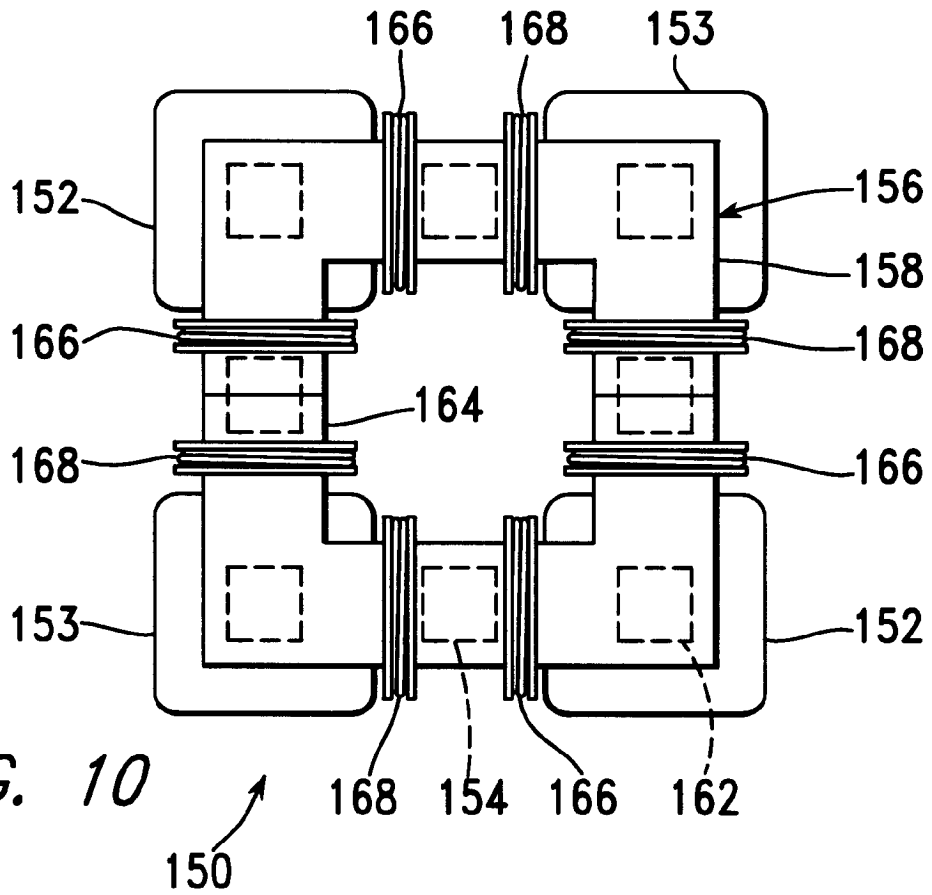

FIG. 10

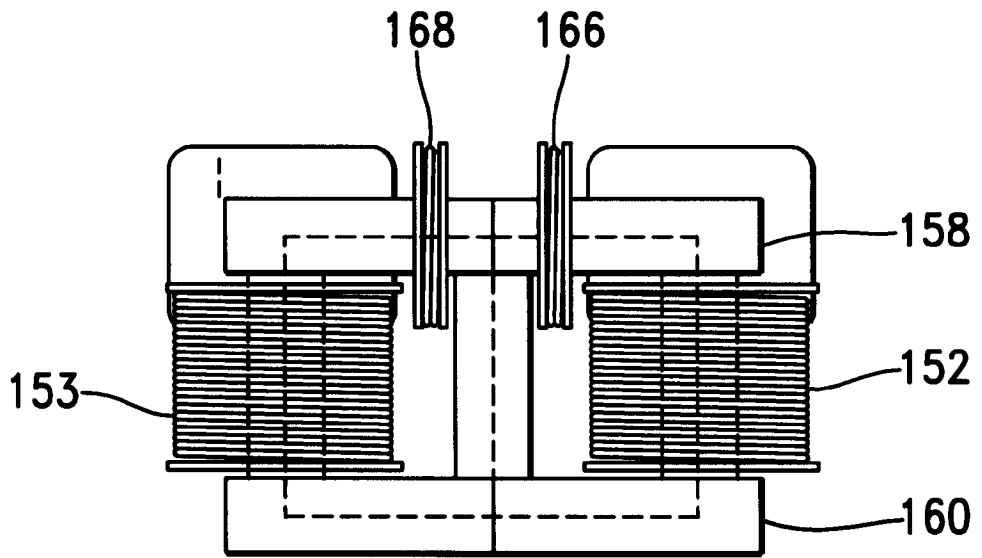

FIG. 11

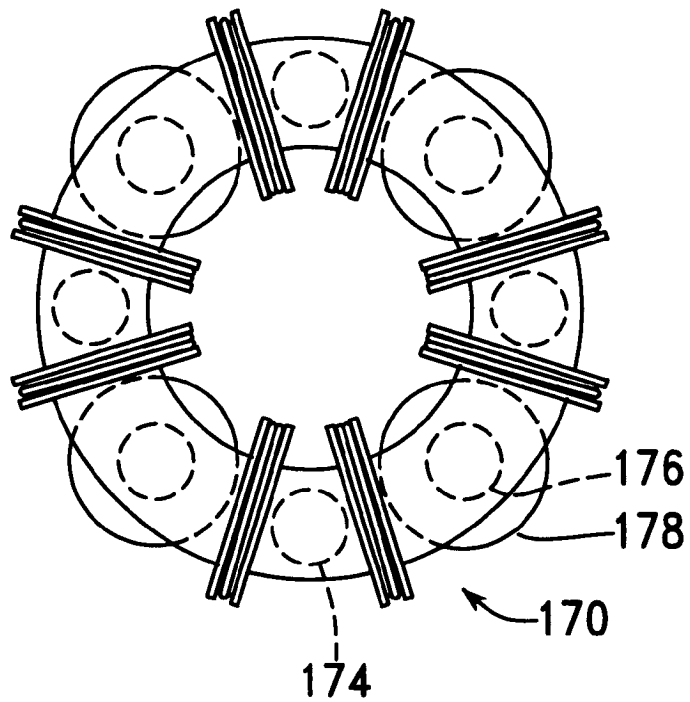
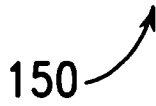

FIG. 12

MOTIONLESS ELECTROMAGNETIC GENERATOR

BACKGROUND INFORMATION

1. Field of Invention

This invention relates to a magnetic generator used to produce electrical power without moving parts, and, more particularly, to such a device having a capability, when operating, of producing electrical power without an external application of input power through input coils.

2. Description of the Related Art

The patent literature describes a number of magnetic generators, each of which includes a permanent magnet, two magnetic paths external to the permanent magnet, each of which extends between the opposite poles of the permanent magnet, switching means for causing magnetic flux to flow alternately along each of the two magnetic paths, and one or more output coils in which current is induced to flow by means of changes in the magnetic field within the device. These devices operate in accordance with an extension of Faraday's Law, indicating that an electrical current is induced within a conductor within a changing magnetic field, even if the source of the magnetic field is stationary.

A method for switching magnetic flux to flow predominantly along either of two magnetic paths between opposite poles of a permanent magnet is described as a "flux transfer" principle by R. J. Radus in *Engineer's Digest*, Jul. 23, 1963. This principle is used to exert a powerful magnetic force at one end of both the north and south poles and a very low force at the other end, without being used in the construction of a magnetic generator. This effect can be caused mechanically, by keeper movement, or electrically, by driving electrical current through one or more control windings extending around elongated versions of the pole pieces. Several devices using this effect are described in U.S. Pat. Nos. 3,165,723, 3,228,013, and 3,316,514, which are incorporated herein by reference.

Another step toward the development of a magnetic generator is described in U.S. Pat. No. 3,368,141, which is incorporated herein by reference, as a device including a permanent magnet in combination with a transformer having first and second windings about a core, with two paths for magnetic flux leading from each pole of the permanent magnet to either end of the core, so that, when an alternating current induces magnetic flux direction changes in the core, the magnetic flux from the permanent magnet is automatically directed through the path which corresponds with the direction taken by the magnetic flux through the core due to the current. In this way, the magnetic flux is intensified. This device can be used to improve the power factor of a typically inductively loaded alternating current circuit.

Other patents describe magnetic generators in which electrical current from one or more output coils is described as being made available to drive a load, in the more conventional manner of a generator. For example, U.S. Pat. No. 4,006,401, which is incorporated herein by reference, describes an electromagnetic generator including permanent magnet and a core member, in which the magnetic flux flowing from the magnet in the core member is rapidly alternated by switching to generate an alternating current in a winding on the core member. The device includes a permanent magnet and two separate magnetic flux circuit paths between the north and south poles of the magnet. Each of the circuit paths includes two switching means for alternately opening and closing the circuit paths, generating an alternating current in a winding on the core member. Each

of the switching means includes a switching magnetic circuit intersecting the circuit path, with the switching magnetic circuit having a coil through which current is driven to induce magnetic flux to saturate the circuit path extending to the permanent magnet. Power to drive these coils is derived directly from the output of a continuously applied alternating current source. What is needed is an electromagnetic generator not requiring the application of such a current source.

U.S. Pat. No. 4,077,001, which is incorporated herein by reference, describes a magnetic generator, or dc/dc converter, comprising a permanent magnet having spaced-apart poles and a permanent magnetic field extending between the poles of the magnet. A variable-reluctance core is disposed in the field in fixed relation to the magnet and the reluctance of the core is varied to cause the pattern of lines of force of the magnetic field to shift. An output conductor is disposed in the field in fixed relation to the magnet and is positioned to be cut by the shifting lines of permanent magnetic force so that a voltage is induced in the conductor. The magnetic flux is switched between alternate paths by means of switching coils extending around portions of the core, with the flow of current being alternated between these switching coils by means of a pair of transistors driven by the outputs of a flip-flop. The input to the flip flop is driven by an adjustable frequency oscillator. Power for this drive circuit is supplied through an additional, separate power source. What is needed is a magnetic generator not requiring the application of such a power source.

U.S. Pat. No. 4,904,926, which is incorporated herein by reference, describes another magnetic generator using the motion of a magnetic field. The device includes an electrical winding defining a magnetically conductive zone having bases at each end, the winding including elements for the removing of an induced current therefrom. The generator further includes two pole magnets, each having a first and a second pole, each first pole in magnetic communication with one base of the magnetically conductive zone. The generator further includes a third pole magnet, the third pole magnet oriented intermediately of the first poles of the two pole electromagnets, the third pole magnet having a magnetic axis substantially transverse to an axis of the magnetically conductive zone, the third magnet having a pole nearest to the conductive zone and in magnetic attractive relationship to the first poles of the two pole electromagnets, in which the first poles thereof are like poles. Also included in the generator are elements, in the form of windings, for cyclically reversing the magnetic polarities of the electromagnets. These reversing means, through a cyclical change in the magnetic polarities of the electromagnets, cause the magnetic flux lines associated with the magnetic attractive relationship between the first poles of the electromagnets and the nearest pole of the third magnet to correspondingly reverse, causing a wiping effect across the magnetically conductive zone, as lines of magnetic flux swing between respective first poles of the two electromagnets, thereby inducing electron movement within the output windings and thus generating a flow of current within the output windings.

U.S. Pat. No. 5,221,892, which is incorporated herein by reference, describes a magnetic generator in the form of a direct current flux compression transformer including a magnetic envelope having poles defining a magnetic axis and characterized by a pattern of magnetic flux lines in polar symmetry about the axis. The magnetic flux lines are spatially displaced relative to the magnetic envelope using control elements which are mechanically stationary relative to the core. Further provided are inductive elements which

are also mechanically stationary relative to the magnetic envelope. Spatial displacement of the flux relative to the inductive elements causes a flow of electrical current. Further provided are magnetic flux valves which provide for the varying of the magnetic reluctance to create a time domain pattern of respectively enhanced and decreased magnetic reluctance across the magnetic valves, and, thereby, across the inductive elements.

Other patents describe devices using superconductive elements to cause movement of the magnetic flux. These devices operate in accordance with the Meissner effect, which describes the expulsion of magnetic flux from the interior of a superconducting structure as the structure undergoes the transition to a superconducting phase. For example, U.S. Pat. No. 5,011,821, which is incorporated herein by reference, describes an electric power generating device including a bundle of conductors which are placed in a magnetic field generated by north and south pole pieces of a permanent magnet. The magnetic field is shifted back and forth through the bundle of conductors by a pair of thin films of superconductive material. One of the thin films is placed in the superconducting state while the other thin film is in a non-superconducting state. As the states are cyclically reversed between the two films, the magnetic field is deflected back and forth through the bundle of conductors.

U.S. Pat. No. 5,327,015, which is incorporated herein by reference, describes an apparatus for producing an electrical impulse comprising a tube made of superconducting material, a source of magnetic flux mounted about one end of the tube, a means, such as a coil, for intercepting the flux mounted along the tube, and a means for changing the temperature of the superconductor mounted about the tube. As the tube is progressively made superconducting, the magnetic field is trapped within the tube, creating an electrical impulse in the means for intercepting. A reversal of the superconducting state produces a second pulse.

None of the patented devices described above use a portion of the electrical power generated within the device to power the reversing means used to change the path of magnetic flux. Thus, like conventional rotary generators, these devices require a steady input of power, which may be in the form of electrical power driving the reversing means of one of these magnetic generators or the torque driving the rotor of a conventional rotary generator. Yet, the essential function of the magnetic portion of an electrical generator is simply to switch magnetic fields in accordance with precise timing. In most conventional applications of magnetic generators, the voltage is switched across coils, creating magnetic fields in the coils which are used to override the fields of permanent magnets, so that a substantial amount of power must be furnished to the generator to power the switching means, reducing the efficiency of the generator.

Recent advances in magnetic material, which have particularly been described by Robert C. O'Handley in *Modern Magnetic Materials, Principles and Applications*, John Wiley & Sons, New York, pp. 456-468, provide nanocrystalline magnetic alloys, which are particularly well suited forth rapid switching of magnetic flux. These alloys are primarily composed of crystalline grains, or crystallites, each of which has at least one dimension of a few nanometers. Nanocrystalline materials may be made by heat-treating amorphous alloys which form precursors for the nanocrystalline materials, to which insoluble elements, such as copper, are added to promote massive nucleation, and to which stable, refractory alloying materials, such as niobium or tantalum carbide are added to inhibit grain growth. Most of the volume of nanocrystalline alloys is composed of

randomly distributed crystallites having dimensions of about 2-40 nm. These crystallites are nucleated and grown from an amorphous phase, with insoluble elements being rejected during the process of crystallite growth. In magnetic terms, each crystallite is a single-domain particle. The remaining volume of nanocrystalline alloys is made up of an amorphous phase in the form of grain boundaries having a thickness of about 1 nm.

Magnetic materials having particularly useful properties are formed from an amorphous Co-Nb-B (cobalt-niobium-boron) alloy having near-zero magnetostriction and relatively strong magnetization, as well as good mechanical strength and corrosion resistance. A process of annealing this material can be varied to change the size of crystallites formed in the material, with a resulting strong effect on DC coercivity. The precipitation of nanocrystallites also enhances AC performance of the otherwise amorphous alloys.

Other magnetic materials are formed using iron-rich amorphous and nanocrystalline alloys, which generally show larger magnetization than the alloys based on cobalt. Such materials are, for example, Fe-B-Si-Nb-Cu (iron-boron-silicon-niobium-copper) alloys. While the permeability of iron-rich amorphous alloys is limited by their relatively large levels of magnetostriction, the formation of a nanocrystalline material from such an amorphous alloy dramatically reduces this level of magnetostriction, favoring easy magnetization.

Advances have also been made in the development of materials for permanent magnets, particularly in the development of materials including rare earth elements. Such materials include samarium cobalt, SmCo₅, which is used to form a permanent magnet material having the highest resistance to demagnetization of any known material. Other magnetic materials are made, for example, using combinations of iron, neodymium, and boron.

SUMMARY OF THE INVENTION

It is a first objective of the present invention to provide a magnetic generator which a need for an external power source during operation of the generator is eliminated.

It is a second objective of the present invention to provide a magnetic generator in which a magnetic flux path is changed without a need to overpower a magnetic field to change its direction.

It is a third objective of the present invention to provide a magnetic generator in which the generation of electricity is accomplished without moving parts.

In the apparatus of the present invention, the path of the magnetic flux from a permanent magnet is switched in a manner not requiring the overpowering of the magnetic fields. Furthermore, a process of self-initiated iterative switching is used to switch the magnetic flux from the permanent magnet between alternate magnetic paths within the apparatus, with the power to operate the iterative switching being provided through a control circuit consisting of components known to use low levels of power. With self-switching, a need for an external power source during operation of the generator is eliminated, with a separate power source, such as a battery, being used only for a very short time during start-up of the generator.

According to a first aspect of the present invention, an electromagnetic generator is provided, including a permanent magnet, a magnetic core, first and second input coils, first and second output coils, and a switching circuit. The permanent magnet has magnetic poles at opposite ends. The

5

magnetic core includes a first magnetic path, around which the first input and output coils extend, and a second magnetic path, around which the second input and output coils extend, between opposite ends of the permanent magnet. The switching circuit drives electrical current alternately through the first and second input coils. The electrical current driven through the first input coil causes the first input coil to produce a magnetic field opposing a concentration of magnetic flux from the permanent magnet within the first magnetic path. The electrical current driven through the second input coil causes the second input coil to produce a magnetic field opposing a concentration of magnetic flux from the permanent magnet within the second magnetic path.

According to another aspect of the present invention, an electromagnetic generator is provided, including a magnetic core, a plurality of permanent magnets, first and second pluralities of input coils, a plurality of output coils, and a switching circuit. The magnetic core includes a pair of spaced-apart plates, each of which has a central aperture, and first and second pluralities of posts extending between the spaced-apart plates. The permanent magnets each extend between the pair of spaced apart plates. Each permanent magnet has magnetic poles at opposite ends, with the magnetic fields of all the permanent magnets being aligned to extend in a common direction. Each input coil extends around a portion of a plate within the spaced-apart plates, between a post and a permanent magnet. An output coil extends around each post. The switching circuit drives electrical current alternately through the first and second pluralities of input coils. Electrical current driven through each input coil in the first plurality of input coils causes an increase in magnetic flux within each post within the first plurality of posts from permanent magnets on each side of the post and a decrease in magnetic flux within each post within the second plurality of posts from permanent magnets on each side of the post. Electrical current driven through each input coil in the second plurality of input coils causes a decrease in magnetic flux within each post within the first plurality of posts from permanent magnets on each side of the post and an increase in magnetic flux within each post within the second plurality of posts from permanent magnets on each side of the post.

BRIEF DESCRIPTION OF THE DRAWINGS

FIG. 1 is a partly schematic front elevation of a magnetic generator and associated electrical circuits built in accordance with a first version of the first embodiment of the present invention;

FIG. 2 is a schematic view of a first version of a switching and control circuit within the associated electrical circuits of FIG. 1;

FIG. 3 is a graphical view of drive signals produced within the circuit of FIG. 2;

FIG. 4 is a schematic view of a second version of a switching and control circuit within the associated electrical circuits of FIG. 1;

FIG. 5 is a graphical view of drive signals produced within the circuit of FIG. 3;

FIG. 6A is a graphical view of a first drive signal within the apparatus of FIG. 1;

FIG. 6B is a graphical view of a second drive signal within the apparatus of FIG. 1;

FIG. 6C is a graphical view of an input voltage signal within the apparatus of FIG. 1;

FIG. 6D is a graphical view of an input current signal within the apparatus of FIG. 1;

6

FIG. 6E is a graphical view of a first output voltage signal within the apparatus of FIG. 1;

FIG. 6F is a graphical view of a second output voltage signal within the apparatus of FIG. 1;

FIG. 6G is a graphical view of a first output current signal within the apparatus of FIG. 1;

FIG. 6H is a graphical view of a second output current signal within the apparatus of FIG. 1;

FIG. 7 is a graphical view of output power measured within the apparatus of FIG. 1, as a function of input voltage;

FIG. 8 is a graphical view of a coefficient of performance, calculated from measurements within the apparatus of FIG. 1, as a function of input voltage;

FIG. 9 is a cross-sectional elevation of a second version of the first embodiment of the present invention;

FIG. 10 is a top view of a magnetic generator built in accordance with a first version of a second embodiment of the present invention;

FIG. 11 is a front elevation of the magnetic generator of FIG. 10; and

FIG. 12 is a top view of a magnetic generator built in accordance with a second version of the second embodiment of the present invention.

DETAILED DESCRIPTION OF THE INVENTION

FIG. 1 is a partly schematic front elevation of an electromagnetic generator 10, built in accordance with a first embodiment of the present invention to include a permanent magnet 12 to supply input lines of magnetic flux moving from the north pole 14 of the magnet 12 outward into magnetic flux path core material 16. The flux path core material 16 is configured to form a right magnetic path 18 and a left magnetic path 20, both of which extend externally between the north pole 14 and the south pole 22 of the magnet 12. The electromagnetic generator 10 is driven by means of a switching and control circuit 24, which alternately drives electrical current through a right input coil 26 and a left input coil 28. These input coils 26, 28 each extend around a portion of the core material 16, with the right input coil 26 surrounding a portion of the right magnetic path 18 and with the left input coil 28 surrounding a portion of the left magnetic path 20. A right output coil 29 also surrounds a portion of the right magnetic path 18, while a left output coil 30 surrounds a portion of the left magnetic path 20.

In accordance with a preferred version of the present invention, the switching and control circuit 24 and the input coils 26, 28 are arranged so that, when the right input coil 26 is energized, a north magnetic pole is present at its left end 31, the end closest to the north pole 14 of the permanent magnet 12, and so that, when the left input coil 28 is energized, a north magnetic pole is present at its right end 32, which is also the end closest to the north pole 14 of the permanent magnet 12. Thus, when the right input coil 26 is magnetized, magnetic flux from the permanent magnet 12 is repelled from extending through the right input coil 26. Similarly, when the left input coil 28 is magnetized, magnetic flux from the permanent magnet 12 is repelled from extending through the left input coil 28.

Thus, it is seen that driving electrical current through the right input coil 26 opposes a concentration of flux from the permanent magnet 12 within the right magnetic path 18, causing at least some of this flux to be transferred to the left magnetic path 20. On the other hand, driving electrical current through the left input coil 28 opposes a concentration

of flux from the permanent magnet 12 within the left magnetic path 20, causing at least some of this flux to be transferred to the right magnetic path 18.

While in the example of FIG. 1, the input coils 26, 28 are placed on either side of the north pole of the permanent magnet 12, being arranged along a portion of the core 16 extending from the north pole of the permanent magnet 12, it is understood that the input coils 26, 28 could as easily be alternately placed on either side of the south pole of the permanent magnet 12, being arranged along a portion of the core 16 extending from the south pole of the permanent magnet 12, with the input coils 26, 28 being wired to form, when energized, magnetic fields having south poles directed toward the south pole of the permanent magnet 12. In general, the input coils 26, 28 are arranged along the magnetic core on either side of an end of the permanent magnet forming a first pole, such as a north pole, with the input coils being arranged to produce magnetic fields of the polarity of the first pole directed toward the first pole of the permanent magnet.

Further in accordance with a preferred version of the present invention, the input coils 26, 28 are never driven with so much current that the core material 16 becomes saturated. Driving the core material 16 to saturation means that subsequent increases in input current can occur without effecting corresponding changes in magnetic flux, and therefore that input power can be wasted. In this way, the apparatus of the present invention is provided with an advantage in terms of the efficient use of input power over the apparatus of U.S. Pat. No. 4,000,401, in which a portion both ends of each magnetic path is driven to saturation to block flux flow. In the electromagnetic generator 10, the switching of current flow within the input coils 26, 28 does not need to be sufficient to stop the flow of flux in one of the magnetic paths 18, 20 while promoting the flow of magnetic flux in the other magnetic path. The electromagnetic generator 10 works by changing the flux pattern; it does not need to be completely switched from one side to another.

Experiments have determined that this configuration is superior, in terms of the efficiency of using power within the input coils 26, 28 to generate electrical power within the output coils 29, 30, to the alternative of arranging input coils and the circuits driving them so that flux from the permanent magnet is driven through the input coils as they are energized. This arrangement of the present invention provides a significant advantage over the prior-art methods shown, for example, in U.S. Pat. No. 4,077,001, in which the magnetic flux is driven through the energized coils.

The configuration of the present invention also has an advantage over the prior-art configurations of U.S. Pat. Nos. 3,368,141 and 4,077,001 in that the magnetic flux is switched between two alternate magnetic paths 18, 20 with only a single input coil 26, 28 surrounding each of the alternate magnetic paths. The configurations of U.S. Pat. Nos. 3,368,141 and 4,077,001 each require two input coils on each of the magnetic paths. This advantage of the present invention is significant both in the simplification of hardware and in increasing the efficiency of power conversion.

The right output coil 29 is electrically connected to a rectifier and filter 33, having an output driven through a regulator 34, which provides an output voltage adjustable through the use of a potentiometer 35. The output of the linear regulator 34 is in turn provided as an input to a sensing and switching circuit 36. Under start up conditions, the sensing and switching circuit 36 connects the switching and control circuit 24 to an external power source 38, which is,

for example, a starting battery. After the electromagnetic generator 10 is properly started, the sensing and switching circuit 36 senses that the voltage available from regulator 34 has reached a predetermined level, so that the power input to the switching and control circuit 24 is switched from the external power source 38 to the output of regulator 34. After this switching occurs, the electromagnetic generator 10 continues to operate without an application of external power.

The left output coil 30 is electrically connected to a rectifier and filter 40, the output of which is connected to a regulator 42, the output voltage of which is adjusted by means of a potentiometer 43. The output of the regulator 42 is in turn connected to an external load 44.

FIG. 2 is a schematic view of a first version of the switching and control circuit 24. An oscillator 50 drives the clock input of a flip-flop 54, with the Q and Q' outputs of the flip-flop 54 being connected through driver circuits 56, 58 to power FETS 60, 62 so that the input coils 26, 28 are alternately driven. In accordance with a preferred version of the present invention, the voltage V applied to the coils 26, 28 through the FETS 60, 62 is derived from the output of the sensing and switching circuit 36.

FIG. 3 is a graphical view of the signals driving the gates of FETS 60, 62 of FIG. 2, with the voltage of the signal driving the gate of FET 60 being represented by line 64, and with the voltage of the signal driving FET 62 being represented by line 66. Both of the coils 26, 28 are driven with positive voltages.

FIG. 4 is a schematic view of a second version of the switching and control circuit 24. In this version, an oscillator 70 drives the clock input of a flip-flop 72, with the Q and Q' outputs of the flip-flop 72 being connected to serve as triggers for one-shots 74, 76. The outputs of the one-shots 74, 76 are in turn connected through driver circuits 78, 80 to drive FETS 82, 84, so that the input coils 26, 28 are alternately driven with pulses shorter in duration than the Q and Q' outputs of the flip flop 72.

FIG. 5 is a graphical view of the signals driving the gates of FETS 82, 84 of FIG. 4, with the voltage of the signal driving the gate of FET 82 being represented by line 86, and with the voltage of the signal driving the gate of FET 84 being represented by line 88.

Referring again to FIG. 1, power is generated in the right output coil 29 only when the level of magnetic flux is changing in the right magnetic path 18, and in the left output coil 30 only when the level of magnetic flux is changing in the left magnetic path 20. It is therefore desirable to determine, for a specific magnetic generator configuration, the width of a pulse providing the most rapid practical change in magnetic flux, and then to provide this pulse width either by varying the frequency of the oscillator 50 of the apparatus of FIG. 2, so that this pulse width is provided with the signals shown in FIG. 3, or by varying the time constant of the one-shots 74, 76 of FIG. 4, so that this pulse width is provided by the signals of FIG. 5 at a lower oscillator frequency. In this way, the input coils are not left on longer than necessary. When either of the input coils is left on for a period of time longer than that necessary to produce the change in flux direction, power is being wasted through heating within the input coil without additional generation of power in the corresponding output coil.

A number of experiments have been conducted to determine the adequacy of an electromagnetic generator built as the generator 10 in FIG. 1 to produce power both to drive the switching and control logic, providing power to the input

coils **26**, **28**, and to drive an external load **44**. In the configuration used in this experiment, the input coils **26**, **28** had 40 turns of 18-gauge copper wire, and the output coils **29**, **30** had 450 turns of 18-gauge copper wire. The permanent magnet **12** had a height of 40 mm (1.575 in. between its north and south poles, in the direction of arrow **89**, a width of 25.4 mm (1.00 in.), in the direction of arrow **90**, and in the other direction, a depth of 38.1 mm (1.50 in.). The core **16** had a height, in the direction of arrow **89**, of 90 mm (3.542 in.), a width, in the direction of arrow **90**, of 135 mm (5.315 in.) and a depth of 70 mm (2.756 in.). The core **16** had a central hole with a height, in the direction of arrow **89**, of 40 mm (1.575 mm) to accommodate the magnet **12**, and a width, in the direction of arrow **90**, of 85 mm (3.346 in.). The core **16** was fabricated of two "C"-shaped halves, joined at lines **92**, to accommodate the winding of output coils **29**, **30** and input coils **26**, **28** over the core material.

The core material was a laminated iron-based magnetic alloy sold by Honeywell as METGLAS Magnetic Alloy 2605SA1. The magnet material was a combination of iron, neodymium, and boron.

The input coils **26**, **28** were driven at an oscillator frequency of 87.5 KHZ, which was determined to produce optimum efficiency using a switching control circuit configured as shown in FIG. 2. This frequency has a period of 11.45 microseconds. The flip flop **54** is arranged, for example, to be set and reset on rising edges of the clock signal input from the oscillator, so that each pulse driving one of the FETS **60**, **62** has a duration of 11.45 microseconds, and so that sequential pulses are also separated to each FET are also separated by 11.45 microseconds.

FIGS. 6A–6H are graphical views of signals which simultaneously occurred within the apparatus of FIGS. 1 and 2 during operation with an applied input voltage of 75 volts. FIG. 6A shows a first drive signal **100** driving FET **60**, which conducts to drive the right input coil **26**. FIG. 6B is shows a second drive signal **102** driving FET **62**, which conducts to drive the left input coil **28**.

FIGS. 6C and 6D show voltage and current signals associated with current driving both the FETS **60**, **62** from a battery source. FIG. 6C shows the level **104** of voltage V. While the nominal voltage of the battery was 75 volts, a decaying transient signal **106** is superimposed on this voltage each time one of the FETS **60**, **62** is switched on to conduct. The specific pattern of this transient signal depends on the internal resistance of the battery, as well as on a number of characteristics of the magnetic generator **10**. Similarly, FIG. 6D shows the current **106** flowing into both FETS **60**, **62** from the battery source. Since the signals **104**, **106** show the effects of current flowing into both FETS **60**, **62** the transient spikes are 11.45 microseconds apart.

FIGS. 6E–6H show voltage and current levels measured at the output coils **29**, **30**. FIG. 6E shows a voltage output signal **108** of the right output coil **29**, while FIG. 6F shows a voltage output signal **110** of the left output coil **30**. For example, the output current signal **116** of the right output coil **29** includes a first transient spike **112** caused when the a current pulse in the left input coil **28** is turned on to direct magnetic flux through the right magnetic path **18**, and a second transient spike **114** caused when the left input coil **28** is turned off with the right input coil **26** being turned on. FIG. 6G shows a current output signal **116** of the right output coil **29**, while FIG. 6H shows a current output signal **118** of the left output coil **30**.

FIG. 7 is a graphical view of output power measured using the electromagnetic generator **10** and eight levels of

input voltage, varying from 10v to 75v. The oscillator frequency was retained at 87.5 KHZ. The measurement points are represented by indicia **120**, while the curve **122** is generated by polynomial regression analysis using a least squares fit.

FIG. 8 is a graphical view of a coefficient of performance, defined as the ratio of the output power to the input power, for each of the measurement points shown in FIG. 7. At each measurement point, the output power was substantially higher than the input power. Real power measurements were computed at each data point using measured voltage and current levels, with the results being averaged over the period of the signal. These measurements agree with RMS power measured using a Textronic THS730 digital oscilloscope.

While the electromagnetic generator **10** was capable of operation at much higher voltages and currents without saturation, the input voltage was limited to 75 volts because of voltage limitations of the switching circuits being used. Those skilled in the relevant art will understand that components for switching circuits capable of handling higher voltages in this application are readily available. The experimentally-measured data was extrapolated to describe operation at an input voltage of 100 volts, with the input current being 140 ma, the input power being 14 watts, and with a resulting output power being 48 watts for each of the two output coils **29**, **30**, at an average output current of 12 ma and an average output voltage of 4000 volts. This means that for each of the output coils **29**, **30**, the coefficient of performance would be 3.44.

While an output voltage of 4000 volts may be needed for some applications, the output voltage can also be varied through a simple change in the configuration of the electromagnetic generator **10**. The output voltage is readily reduced by reducing the number of turns in the output windings. If this number of turns is decreased from 450 to 12, the output voltage is dropped to 106.7, with a resulting increase in output current to 0.5 amps for each output coil **29**, **30**. In this way, the output current and voltage of the electromagnetic generator can be varied by varying the number of turns of the output coils **29**, **30**, without making a substantial change in the output power, which is instead determined by the input current, which determines the amount of magnetic flux shuttled during the switching process.

The coefficients of performance, all of which were significantly greater than 1, plotted in FIG. 8 indicate that the output power levels measured in each of the output coils **29**, **30** were substantially greater than the corresponding input power levels driving both of the input coils **26**, **28**. Therefore, it is apparent that the electromagnetic generator **10** can be built in a self-actuating form, as discussed above in reference to FIG. 1. In the example of FIG. 1, except for a brief application of power from the external power source **38**, to start the process of power generation, the power required to drive the input coils **26**, **28** is derived entirely from power developed within the right output coil **29**. If the power generated in a single output coil **29**, **30** is more than sufficient to drive the input coils **26**, **28**, an additional load **126** may be added to be driven with power generated in the output coil **29** used to generate power to drive the input coils **26**, **28**. On the other hand, each of the output coils **29**, **30** may be used to drive a portion of the input coil power requirements, for example with one of the output coils **26**, **28** providing the voltage V for the FET **60** (shown in FIG. 2), while the other output coil provides this voltage for the FET **62**.

Regarding thermodynamic considerations, it is noted that, when the electromagnetic generator **10** is operating, it is an

open system not in thermodynamic equilibrium. The system receives static energy from the magnetic flux of the permanent magnet. Because the electromagnetic generator **10** is self-switched without an additional energy input, the thermodynamic operation of the system is an open dissipative system, receiving, collecting, and dissipating energy from its environment; in this case, from the magnetic flux stored within the permanent magnet. Continued operation of the electromagnetic generator **10** causes demagnetization of the permanent magnet. The use of a magnetic material including rare earth elements, such as a samarium cobalt material or a material including iron, neodymium, and boron is preferable within the present invention, since such a magnetic material has a relatively long life in this application.

Thus, an electromagnetic generator operating in accordance with the present invention should be considered not as a perpetual motion machine, but rather as a system in which flux radiated from a permanent magnet is converted into electricity, which is used both to power the apparatus and to power an external load. This is analogous to a system including a nuclear reactor, in which a number of fuel rods radiate energy which is used to keep the chain reaction going and to heat water for the generation of electricity to drive external loads.

FIG. **9** is a cross-sectional elevation of an electromagnetic generator **130** built in accordance with a second version of the first embodiment of the present invention. This electromagnetic generator **130** is generally similar in construction and operation to the electromagnetic generator **10** built in accordance with the first version of this embodiment, except that the magnetic core **132** of the electromagnetic generator **10** is built in two halves joined along lines **134**, allowing each of the output coils **135** to be wound on a plastic bobbin **136** before the bobbin **136** is placed over the legs **137** of the core **132**. FIG. **9** also shows an alternate placement of an input coil **138**. In the example of FIG. **1**, both input coils **26**, **28** were placed on the upper portion of the magnetic core **16**, with these coils **26**, **28** being configured to establish magnetic fields having north magnetic poles at the inner ends **31**, **32** of the coils **26**, **28**, with these north magnetic poles thus being closest to the end **14** of the permanent magnet **12** having its north magnetic pole. In the example of FIG. **9**, a first input coil **26** is as described above in reference to FIG. **1**, but the second input coil **138** is placed adjacent the south pole **140** of the permanent magnet **12**. This input coil **138** is configured to establish a south magnetic pole at its inner end **142**, so that, when input coil **138** is turned on, flux from the permanent magnet **12** is directed away from the left magnetic path **20** into the right magnetic path **18**.

FIGS. **10** and **11** show an electromagnetic generator **150** built in accordance with a first version of a second embodiment of the present invention, with FIG. **10** being a top view thereof, and with FIG. **11** being a front elevation thereof. This electromagnetic generator **150** includes an output coil **152**, **153** at each corner, and a permanent magnet **154** extending along each side between output coils. The magnetic core **156** includes an upper plate **158**, a lower plate **160**, and a square post **162** extending within each output coil **152**, **153**. Both the upper plate **158** and the lower plate **160** include central apertures **164**.

Each of the permanent magnets **154** is oriented with a like pole, such as a north pole, against the upper plate **158**. Eight input coils **166**, **168** are placed in positions around the upper plate **158** between an output coil **152**, **153** and a permanent magnet **154**. Each input coil **166**, **168** is arranged to form a magnetic pole at its end nearest to the adjacent permanent magnet **154** of a like polarity to the magnetic poles of the

magnets **154** adjacent the upper plate **158**. Thus, the input coils **166** are switched on to divert magnetic flux of the permanent magnets **154** from the adjacent output coils **152**, with this flux being diverted into magnetic paths through the output coils **153**. Then, the input coils **168** are switched on to divert magnetic flux of the permanent magnets **154** from the adjacent output coils **153**, with this flux being diverted into magnetic paths through the output coils **152**. Thus, the input coils form a first group of input coils **166** and a second group of input coils **168**, with these first and second groups of input coils being alternately energized in the manner described above in reference to FIG. **1** for the single input coils **26**, **28**. The output coils produce current in a first train of pulses occurring simultaneously within coils **152** and in a second train of pulses occurring simultaneously within coils **153**.

Thus, driving current through input coils **166** causes an increase in flux from the permanent magnets **154** within the posts **162** extending through output coils **153** and a decrease in flux from the permanent magnets **154** within the posts **162** extending through output coils **152**. On the other hand, driving current through input coils **168** causes a decrease in flux from the permanent magnets **154** within the posts **162** extending through output coils **153** and an increase in flux from the permanent magnets **154** within the posts **162** extending through output coils **152**.

While the example of FIGS. **10** and **11** shows all of the input coils **166**, **168** deployed along the upper plate **158**, it is understood that certain of these input coils **166**, **168** could alternately be deployed around the lower plate **160**, in the manner generally shown in FIG. **9**, with one input coil **166**, **168** being within each magnetic circuit between a permanent magnet **154** and an adjacent post **162** extending within an output coil **152**, **153**, and with each input coil **166**, **168** being arranged to produce a magnetic field having a magnetic pole like the closest pole of the adjacent permanent magnet **154**.

FIG. **12** is a top view of a second version **170** of the second embodiment of the present invention, which is similar to the first version thereof, which has been discussed in reference to FIGS. **10** and **11**, except that an upper plate **172** and a similar lower plate (not shown) are annular in shape, while the permanent magnets **174** and posts **176** extending through the output coils **178** are cylindrical. The input coils **180** are oriented and switched as described above in reference to FIGS. **9** and **10**.

While the example of FIG. **12** shows four permanent magnets, four output coils and eight input coils it is understood that the principles described above can be applied to electromagnetic generators having different numbers of elements. For example, such a device can be built to have two permanent magnets, two output coils, and four input coils, or to have six permanent magnets, six output coils, and twelve input coils.

In accordance with the present invention, material used for magnetic cores is preferably a nanocrystalline alloy, and alternately an amorphous alloy. The material is preferably in a laminated form. For example, the core material is a cobalt-niobium-boron alloy or an iron based magnetic alloy.

Also in accordance with the present invention, the permanent magnet material preferably includes a rare earth element. For example, the permanent magnet material is a samarium cobalt material or a combination of iron, neodymium, and boron.

While the invention has been described in its preferred versions and embodiments with some degree of particularity, it is understood that this description has been

13

given only by way of example and that numerous changes in the details of construction, fabrication, and use, including the combination and arrangement of parts, may be made without departing from the spirit and scope of the invention.

What is claimed is:

1. An electromagnetic generator comprising:

- a permanent magnet having magnetic poles at opposite ends;
 - a magnetic core including first and second magnetic paths between said opposite ends of said permanent magnet, wherein said magnetic core comprises a closed loop, said permanent magnet extends within said closed loop, and said opposite ends of said permanent magnet are disposed adjacent opposite sides of said closed loop and against internal surfaces of said magnetic core comprising said closed loop;
 - a first input coil extending around a portion of said first magnetic path,
 - a second input coil extending around a portion of said second magnetic path,
 - a first output coil extending around a portion of said first magnetic path for providing a first electrical output;
 - a second output coil extending around a portion of said second magnetic path for providing a second electrical output; and
 - a switching circuit driving electrical current alternately through said first and second input coils, wherein said electrical current driven through said first input coil causes said first input coil to produce a magnetic field opposing a concentration of magnetic flux from said permanent magnet within said first magnetic path, and said electrical current driven through said second input coil causes said second input coil to produce a magnetic field opposing a concentration of magnetic flux from said permanent magnet within said second magnetic path.
2. An electromagnetic generator comprising:
- a permanent magnet having magnetic poles at opposite ends;
 - a magnetic core including first and second magnetic paths between said opposite ends of said permanent magnet, wherein said magnetic core comprises a closed loop, said permanent magnet extends within said closed loop, said opposite ends of said permanent magnet are disposed adjacent opposite sides of said closed loop, and a first type of pole of said permanent magnet is disposed adjacent a first side of said closed loop;
 - a first input coil, disposed along said first side of said closed loop, extending around a portion of said first magnetic path,
 - a second input coil, disposed along said first side of said closed loop, extending around a portion of said second magnetic path,
 - a first output coil extending around a portion of said first magnetic path for providing a first electrical output;
 - a second output coil extending around a portion of said second magnetic path for providing a second electrical output; and
 - a switching circuit driving electrical current alternately through said first and second input coils, wherein

14

- said electrical current driven through said first input coil causes said first input coil to produce a magnetic field opposing a concentration of magnetic flux from said permanent magnet within said first magnetic path, and additionally causes said first input coil to produce a magnetic field having said first type of pole at an end of said first input coil adjacent said permanent magnet, and
 - said electrical current driven through said second input coil causes said second input coil to produce a magnetic field opposing a concentration of magnetic flux from said permanent magnet within said second magnetic path, and additionally causes said second input coil to produce a magnetic field having said first type of pole at an end of said second input coil adjacent said permanent magnet.
3. An electromagnetic generator comprising:
- a permanent magnet having magnetic poles at opposite ends;
 - a magnetic core including first and second magnetic paths between said opposite ends of said permanent magnet, wherein said magnetic core comprises a closed loop, said permanent magnet extends within said closed loop, and said opposite ends of said permanent magnet are disposed adjacent opposite sides of said closed loop, a first type of pole of said permanent magnet is disposed adjacent a first side of said closed loop, and a second type of pole, opposite said first type of pole, of said permanent magnet is disposed adjacent a second side of said closed loop;
 - a first input coil extending around a portion of said first magnetic path, wherein said first input coil is disposed along said first side of said closed loop;
 - a second input coil extending around a portion of said second magnetic path wherein said second input coil is disposed along said second side of said closed loop;
 - a first output coil extending around a portion of said first magnetic path for providing a first electrical output;
 - a second output coil extending around a portion of said second magnetic path for providing a second electrical output; and
 - a switching circuit driving electrical current alternately through said first and second input coils, wherein said electrical current driven through said first input coil causes said first input coil to produce a magnetic field opposing a concentration of magnetic flux from said permanent magnet within said first magnetic path, and additionally causes said first input coil to produce a magnetic field having said first type of pole at an end of said first input coil adjacent said permanent magnet, and
 - said electrical current driven through said second input coil causes said second input coil to produce a magnetic field opposing a concentration of magnetic flux from said permanent magnet within said second magnetic path, and additionally causes said second input coil to produce a magnetic field having said second type of pole at an end of said second input coil adjacent said permanent magnet.
4. An electromagnetic generator comprising:
- a permanent magnet having magnetic poles at opposite ends;
 - a magnetic core including first and second magnetic paths between said opposite ends of said permanent magnet;

15

- a first input coil extending around a portion of said first magnetic path,
- a second input coil extending around a portion of said second magnetic path,
- a first output coil extending around a portion of said first magnetic path for providing a first electrical output;
- a second output coil extending around a portion of said second magnetic path for providing a second electrical output; and
- a switching circuit driving electrical current alternately through said first and second input coils, wherein said electrical current driven through said first input coil causes said first input coil to produce a magnetic field opposing a concentration of magnetic flux from said permanent magnet within said first magnetic path, and wherein said electrical current driven through said second input coil causes said second input coil to produce a magnetic field opposing a concentration of magnetic flux from said permanent magnet within said second magnetic path, wherein a portion of electrical power induced in said first output coil provides power to drive said switching circuit.
5. The electromagnetic generator of claim 4, wherein said switching circuit is driven by an external power source during a starting process and by power induced in said first output coil during operation after said starting process.
6. The electromagnetic generator of claim 2, wherein said magnetic core is composed of a nanocrystalline magnetic alloy.
7. The electromagnetic generator of claim 6, wherein said nanocrystalline magnetic alloy is a cobalt-niobium-boron alloy.
8. The electromagnetic generator of claim 6, wherein said nanocrystalline magnetic alloy is an iron-based alloy.
9. The electromagnetic generator of claim 2, wherein said changes in flux density within said magnetic core occur without driving said magnetic core to magnetic saturation.
10. The electromagnetic generator of claim 2, wherein said switching circuit drives said electrical current through said first input coil in response to a first train of pulses,
- said switching circuit drives said electrical current through said second input coil in response to a second train of pulses, alternating with pulses within said first train of pulses, and
- said pulses in said first and second trains of pulses are approximately 11.5 milliseconds in duration.
11. The electromagnetic generator of claim 2, wherein said permanent magnet is composed of a material including a rare earth element.
12. The electromagnetic generator of claim 11, wherein said permanent magnet is composed essentially of samarium cobalt.
13. The electromagnetic generator of claim 11, wherein said permanent magnet is composed essentially of iron, neodymium, and boron.
14. An electromagnetic generator comprising:
- a magnetic core including a pair of spaced-apart plates, wherein each of said spaced-apart plates includes a central aperture, and first and second pluralities of posts extending between said spaced-apart plates;
- a plurality of permanent magnets extending individually between said pair of spaced-apart plates and between adjacent posts within said plurality of posts, wherein each permanent magnet within said plurality of permanent magnets has magnetic poles at opposite ends,

16

- wherein all magnets within said plurality of magnets are oriented to produce magnetic fields having a common direction;
- first and second pluralities of input coils, wherein each input coil within said first and second pluralities of input coils extends around a portion of a plate within said spaced-apart plates between a post in said plurality of posts and a permanent magnet in said plurality of permanent magnets;
- an output coil extending around each post in said first and second pluralities of posts for providing an electrical output;
- a switching circuit driving electrical current alternatively through said first and second pluralities of input coils, wherein said electrical current driven through each input coil in said first plurality of input coils causes an increase in magnetic flux within each post within said first plurality of posts from permanent magnets on each side of said post and a decrease in magnetic flux within each post within said second plurality of posts from permanent magnets on each side of said post, and wherein said electrical current driven through input coil in said second plurality of input coils causes a decrease in magnetic flux within each post within said first plurality of posts from permanent magnets on each side of said post and an increase in magnetic flux within each post within said second plurality of posts from permanent magnets on each side of said post.
15. The electromagnetic generator of claim 14, wherein each input coil extends around a portion of a magnetic path through said magnetic core between said opposite ends a permanent magnet adjacent said input coil, said magnetic path extends through a post within said magnetic core adjacent said input coil, and driving electrical current through said input coil causes said input coil to produce a magnetic field opposing a concentration of magnetic flux within said magnetic path.
16. The electromagnetic generator of claim 14, wherein said switching circuit is driven by an external power source during a starting process and by power induced in said output coils during operation after said starting process.
17. The electromagnetic generator of claim 14, wherein said magnetic core is composed of a nanocrystalline magnetic alloy.
18. The electromagnetic generator of claim 2, wherein a portion of electrical power induced in said first output coil provides power to drive said switching circuit.
19. The electromagnetic generator of claim 18, wherein said switching circuit is driven by an external power source during a starting process and by power induced in said first output coil during operation after said starting process.
20. The electromagnetic generator of claim 3, wherein a portion of electrical power induced in said first output coil provides power to drive said switching circuit.
21. The electromagnetic generator of claim 20, wherein said switching circuit is driven by an external power source during a starting process and by power induced in said first output coil during operation after said starting process.
22. The electromagnetic generator of claim 3, wherein said magnetic core is composed of a nanocrystalline magnetic alloy.
23. The electromagnetic generator of claim 22, wherein said nanocrystalline magnetic alloy is a cobalt-niobium-boron alloy.

17

24. The electromagnetic generator of claim 22, wherein said nanocrystalline magnetic alloy is an iron-based alloy.

25. The electromagnetic generator of claim 3, wherein said changes in flux density within said magnetic core occur without driving said magnetic core to magnetic saturation.

26. The electromagnetic generator of claim 3, wherein said switching circuit drives said electrical current through said first input coil in response to a first train of pulses,

said switching circuit drives said electrical current through said second input coil in response to a second train of pulses, alternating with pulses within said first train of pulses, and

18

said pulses in said first and second trains of pulses are approximately 11.5 milliseconds in duration.

27. The electromagnetic generator of claim 3, wherein said permanent magnet is composed of a material including a rare earth element.

28. The electromagnetic generator of claim 27, wherein said permanent magnet is composed essentially of samarium cobalt.

29. The electromagnetic generator of claim 27, wherein said permanent magnet is composed essentially of iron, neodymium, and boron.

* * * * *