

On the Principles of Permissible Overunity EM Power Systems

T. E. Bearden

CEO, CTEC, Inc.

Fellow Emeritus, AIAS

28 July 2001

Abstract and Summary:

We develop the major principles of emerging overunity EM power systems as open systems far from thermodynamic equilibrium, freely receiving excess energy from the active vacuum. Such systems were arbitrarily omitted from Maxwell's theory by curtailment. Heaviside's reinterpretation and simplification of Maxwell's equations did retain such overunity EM systems as one major subset. Lorentz then regauged the Maxwell-Heaviside equations by arbitrary symmetrical regauging to provide still simpler equations and a further reduced subset of permissible Maxwell-Heaviside systems. Lorentz regauging erroneously discarded the entire class of Maxwellian EM systems not in thermodynamic equilibrium with the active vacuum.

Generators and batteries do not furnish energy to their external circuits. Instead, the source dipole, once formed, extracts energy from the vacuum via the broken 3-symmetry of its constituent charges. The generators and batteries only perform work upon their internal charges to separate them and form the source dipole. Hence one does not input energy to a conventional power source to *power the circuit*; instead, the input energy is only for the power source to *create its source dipole*. Once made, the broken symmetry of the dipole extracts usable EM energy from the vacuum and pours it out the terminals of the power supply ([Figure 1](#)). The extracted energy from the vacuum is in the form of Heaviside/Poynting energy flow, consisting of two components ([Figure 2](#)). The portion striking the circuit and diverged into the conductors to power the electron current is the Poynting component. The remaining Heaviside nondiverged component misses the circuit and is wasted. Every dipolar power supply is already a COP>1.0 EM *converter* system.

Closed current loop design of present power systems insures that Lorentz symmetrical regauging is self-applied by every system ([Figure 3](#)). The depotentialized electrons in the ground return line are forcibly rammed back through the back emf of the source dipole, scattering the dipole charges and destroying the source dipole. This kills the flow of energy being extracted from the vacuum by the former dipole. Such systems use their collected energy to destroy their free energy mechanism (the source dipole) and its extraction of energy from the vacuum, faster than they can power their loads.

Hence present EM power systems are self-crippling systems inherently self-limited to $COP < 1.0$.

Classical EM still erroneously assumes any charge as existing in an inert vacuum and creating—right out of nothing—all the EM energy flow it continuously pours out in all directions across the entire universe, providing the EM energy in the fields and potentials associated with the charge. This erroneous assumption that every charge is a pure source and a perpetual motion machine was resolved over 40 years ago in particle physics by the discovery of broken symmetry ([Figure 4](#)). However, classical electrodynamicists have never changed their century-old model to incorporate the proven active vacuum exchange.

For circuits, electrodynamicists presently do not calculate the entire associated EM energy flow, which is large. Instead, they calculate the small Poynting component of the flow—that component of the flow that strikes the surface charges in the circuit and is thereby diverged into the circuit to power the electrons ([Figure 2](#), [Figure 5](#)). The *nondiverged* energy transport (Heaviside) portion of the EM energy flow that misses the circuit is arbitrarily discarded. Following Lorentz's method { [\[1\]](#) }, electrodynamicists calculate the Slepian vector equivalent (i.e., the Poynting component) and erroneously label it the entire EM energy flow. Instead, it is the *energy dissipation flow* inside the circuit, not the entire EM energy flow associated with the circuit, both inside and outside it.

For a nominal circuit, the entire EM energy flow extracted by the source dipole from the vacuum may be on the order of 10^{13} times as great ([Figure 6](#)) as the Poynting component actually intercepted by the circuit { [\[2\]](#), [\[3\]](#) } and then used to produce the Slepian vector and power the losses and loads while also killing the source dipole. [\[1\]](#)

Examples of legitimate overunity systems and processes developed by scientists (Sweet, Kron, Lawandy, Letokhov, Chung, Mandel'shtam and Papaleksi) are briefly presented. The Bohren experiment is repeatable and produces $COP = 18$.

A summary of the major principles and characteristics of permissible EM power systems with $COP > 1.0$ is presented at the conclusion. The reader is directed to my website, <http://www.cheniere.org/>, for appreciable additional $COP > 1.0$ system information.

Introduction Beginning with Magnetics

Kinetic Magnets: Self-Oscillation in Magnetic Materials

The present author was for some years a colleague of inventor Floyd Sweet. In the 1980s and 1990s, the Sweet solid state vacuum triode amplifier { [\[4\]](#) } ([Figure 7](#)) produced ordinary, standard EM energy (6 watts in the first unit; 500 watts in later units) unless specially rigged to do antigravity. A retired electrical engineer proficient on the bench, Sweet's second power unit produced 500 watts with a $COP \approx 1.5 \times 10^6$. The system used barium ferrite permanent magnets whose materials were conditioned into self-oscillation at an initiated ELF frequency. Such a magnet is loosely referred to

as a "kinetic magnet".

Self-oscillation in permanent magnets is fairly well-known { [\[5\]](#) }, though not in electrical power system circles. Sweet's unique contribution was to stimulate self-oscillation at lower frequencies than what is ordinarily thought possible, and to do it more strongly than commonly found in the literature. The unit could also be rigged to do anti-gravity { [4](#) } ([Figure 8](#)), and would reduce its weight on the laboratory bench by 90%, but that is beyond the scope of this present paper.

It should be obvious to the reader that a permanent magnet with self-oscillating fields can be surrounded by conductors or coils in which the kinetic fields "cut" the conductors and induce currents freely. A resistor can be connected in a closed circuit with the coils, and the resistor will be powered by the kinetic magnet so that free work is continuously performed. In short, any competent university laboratory can produce such a demonstrable little overunity EM power system with a little effort from presently known self-oscillation in magnetic materials { [5](#) }. That alone is sufficient to prove that overunity EM power systems are permissible, since it only takes a single white crow to prove that not all crows are black.

Sweet activated his magnets by a proprietary process which he never fully revealed. Nevertheless, materials scientists competent in self-oscillation in magnetic materials can produce such an example magnet, which remains self-kinetic at somewhat higher frequency than the Sweet VTA for some period of time such as minutes, several hours, a day, or even a week.

Sweet's mentor was the great Gabriel Kron, [\[2\]](#) whose negative resistor we discuss later. Sweet greatly admired Kron and knew the details of Kron's negative resistor. A possible connection between Sweet's VTA and Kron's negative resistor cannot be ruled out.

The Researcher Must Be Aware Of Numerous Magnetic Effects { [\[6\]](#) }

Overunity researchers into magnetic approaches must progress beyond the simplified notion that a permanent magnet is just a blob of uniform material with a magnetic pole at each end. One must be aware of a wide range of odd and unusual effects in magnetic materials { [\[7\]](#) }, if one wishes to address unusual magnetic engines.

Multivalued magnetic potentials (MVMPs) [\[3\]](#) arise naturally in magnetic theory { [\[8\]](#) }, and such potentials can yield a nonconservative magnetic field. In that case, integration of $\mathbf{F} \cdot d\mathbf{s}$ around a rotation loop may permissibly be nonzero, producing an open system far from thermodynamic equilibrium, and permitting the system to exhibit $COP > 1.0$. The MVMP "potential self-jump" is an asymmetrical self-regauging. [\[4\]](#)

Many magnetic materials are also photorefractive, and readily produce nonlinear optical effects at various frequencies. As one example, multivalued phase conjugate reflection can occur { [\[9\]](#) }. Such effects did occur in the Sweet vacuum triode amplifier.

If the magnetics researcher doesn't know what a Wiegand wire { [\[10\]](#) } is or the Dromgoole { [\[11\]](#) }

effect is, or what the exchange force is, he needs to read the literature. The Wiegand effect occurs in a magnetic pulse wire which, in a magnetic field of a certain size, will self-reverse its dual magnetic state and deliver a very sharp, free magnetic pulse. By surrounding the wire with a coil of many fine turns, one can get a 12-volt pulse of electrical energy, for free. These assemblies are widely used as sensors and switching initiators.

The Dromgoole phenomenon is an interesting effect whereby a voltage placed on a solenoid wrapped around an iron wire may be increased up to 300 times as much by twisting the wire through 90 degrees.

The exchange force is a result of nearly instantaneous "spin flipping" of electrons in the magnetic material, producing a momentary sharp change in magnetic field, both in magnitude and orientation. [\[5\]](#) This exchange force momentarily may be more than a thousand times as strong as the normal **B**-field.

There are hundreds of other novel magnetic effects in magnetic materials, many of them involving unusual spin effects. The serious overunity magnetics researcher needs to laboriously compile a set of references on such topics. One never knows in advance when one may meet one or more of these phenomena in magnetic experiments with odd devices. About half the known magnetic phenomena are well understood; the remainder run the gamut from "somewhat understood" to "not understood at all".

A Caution on the Rare Production of Higher Polarization EM Energy

With great rarity, some novel uses of stresses and opposing forces in highly nonlinear electromagnetic circuits can produce and have produced "unusual" forms of EM energy. I am occasionally asked about these anomalous phenomena experienced by an experimenter encountering one or more of them. Let me explain these "unusual EM energies," at least what I understand of them from limited experience with them.

In quantum field theory { [\[12\]](#) } and quantum electrodynamics, there are four photon (EM energy) polarizations { [\[13\]](#) }. The x- and y- polarizations or any combination of the two are where the 3-space energy transported by the photon (or transported by a transverse EM wave comprised of such photons) is oscillating perpendicularly in 3-space to the line of propagation of the photon or wave.

If vibrations in the x- and y- directions are "frozen" so that the spatial energy cannot oscillate laterally, the transported energy will pulsate longitudinally like an accordion, back and forth along the propagation line of motion. That's called a "longitudinal" or "longitudinally polarized" photon (or EM wave). Most of the "unusual EM energy" effects produced in various nonlinear coils and other devices have involved the inadvertent production of such longitudinal EM waves (LWs). Irradiation by LWs can be detrimental to the body if too powerful. [\[6\]](#) Irradiation by weaker longitudinal EM radiation can make one ill { [\[14\]](#) }, while stronger LW radiation can maim or kill { [\[15\]](#) }, particularly if strongly pulsed.

In theory a purely longitudinal EM wave would have infinite velocity and infinite energy. In the real world, however, one can only make "partial" LWs, with some transverse wave residues. These "imperfect" LWs are known as *Undistorted Progressive Waves* (UPWs) { [16] }. In theory at least, a UPW can travel either slower than light (in which case it's called an *electromagnetic particle*) or faster than light (then it's a *superluminal wave*). Most major weapons laboratories of the world either have already discovered or are now discovering and using longitudinal EM waves.

But back to our basic longitudinal EM wave, for further development.

If we now "freeze" the z-direction as well, then the 3-space energy in the wave does not oscillate at all, but just moves along as a slug of spatial energy. However, photons carry not only a piece of *spatial energy*, but also a piece of *time*. Time is actually spatial energy compressed by the factor c^2 . With the spatial energy component "frozen", now the time component oscillates its magnitude. In short, that is called a "time-polarized" or "scalar" photon (or, if waves are used, a *time-polarized* or *scalar* EM wave.).

EM waves also carry not only spatial energy but also time-energy, since they transport photons. However, presently physicists just ignore and do not model the energetics of the time-component transported by the wave in spacetime (vacuum). They—usually unwittingly—portray only the 3-spatial intersection of the wave after observation.

Observation is a d/dt operator invoked on spacetime L^3T , destroying the T and leaving the L^3 . For that reason, all observation is spatial. No observable even "persists in time", since it is a frozen instant 3-snapshot of an ongoing 4-interaction. Rigorously, the "spatial" wave portrayed in the texts is the material force field wave in the detecting matter (as in the Drude electron gas in a detecting wire antenna). None of the dozens of texts checked shows the EM wave in *spacetime*, but only a broken consecutive series of frozen snapshots in 3-space. [7] That is not how the EM wave exists in space at all. (See [Figure 9](#)).

The conventionally unknown time-polarized EM wave is the most powerful of all EM waves, and in pulses or with any substantial power can have quite lethal effects upon anything living. Adroitly used, it can also have beneficial effects. Mind operations are totally electromagnetic, but consist of *time-polarized* EM wave and photon operations rather than *transverse*.

The Russians, e.g., have long since developed weapons utilizing time-polarized EM waves and generators for them. Russian forces tested such a time-polarized EM weapon in Afghanistan, on two occasions { [17] }. The Mujahedin thought this invisible "death ray" was some new kind of instant-acting nerve gas. A powerful pulse of time-polarized (scalar) waves instantly destroys all life of any kind in the struck area or object or zone. It does so by simply snapping the time-domain mind completely loose from the 3-spatial body, resulting in instant and total death (hence the name *mindsnapping*). Everything living, at cellular level or even much finer, has its own correlated "mind-part" in the time-polarized EM domain. So mindsnapping kills all living parts, from the finest level to the largest { [18] }.

Time can be taken to be spatial energy { [19] } compressed by a factor of at least c^2 . So it has at least the same energy density as mass. When one uses time-polarized EM waves, one is using the time-components of the EM waves and photons, hence the equivalent of extremely powerful nuclear energy—one where *all* the mass can be converted to spatial energy! So a little bit of transduction of time-energy into spatial energy can produce enormous spatial energy { [20] }.

We previously extended the conventional conservation of energy law—which conserves the net total of the spatial energy and the mass-energy—to include conserving the net total of the spatial energy, mass-energy, and time-energy { [21] } (Figure 10).

Usually researchers stumble into weak LW emission phenomena (hopefully only mildly!) when experimenting with something like opposing or biwound coils with cores of various materials (especially mixed organic material cores) or with plasmas irradiated by multiple EM waves where the difference frequencies can serve as extremely active radiation { [22] }. Under the right circumstances, the peculiar actions of the *difference* frequency are directly amplified by all the EM noise present { [23] }. Certain plasmas also transform transverse EM waves to longitudinal EM waves. The conglomerated results of such phenomena can be hazardous if powerful.

I advise anyone against experimenting with such, unless he is a *very* experienced researcher, takes extreme precautions, and *uses very little power*. Since LWs can affect nuclear detectors, one is also advised to have several different types of them closely on hand and monitoring. One experiments with such effects at one's own risk, and the risk can be substantial if other than minimal power is used. Neither this author nor the publishers of this volume are responsible for accidents or effects suffered by experimenters in this area, who experiment at their own volition and risk.

Unless rigged for antigravity (Figure 8), the Sweet device did not produce or radiate longitudinal EM waves. Otherwise I would no longer be among the living, because I was closely exposed to it many times for long periods.

A Heat Pump Can In Theory Be Close-Looped

The common home heat pump under ideal conditions has a COP = 4.0. Its maximum theoretical COP is 8.22, and probably a 6.0 heat pump could be designed for optimum conditions. The COP > 1.0 is made possible by the heat pump extracting excess energy from its external environment (the heat energy gleaned from compressing environmental gas and extracting the heat).

In theory, one can "close loop" a motor-generator-heat pump combination of some sort, where the system will provide electrical power output while also running itself, taking its energy from the ambient heat energy of the air. That doesn't violate conservation of energy; all the energy for the outputs and the losses are in fact extracted from the external environment by the heat pump's COP > 1.0 performance.

Of course the ambient air will usually not remain ideal. When the ambient air gets colder, its heat

energy content reduces appreciably. The efficiency of the heat pump drops precipitously, until one must switch to the resistive heating elements to provide the necessary heating at $COP < 1.0$. So close-looping the system isn't practical in most cases, and even when made practical by burying long air lines, etc. it is quite expensive. The complexity and maintenance also become burdensome. [8]

Overunity Systems Are Already Known

Overunity systems are quite ordinary. They are not fancy, and are conceptually similar to a waterwheel, a windmill, a sailboat, or a solar cell array. Or a little Seiko kinetic watch. The only difference is that we're trying to do it with EM power systems, and unwittingly facing the anathema of the closed-loop circuit which guarantees $COP < 1.0$. It follows that the first requirement is to produce an operation in the circuit which violates that "single closed-loop operation".

Overunity systems are already prescribed by physics and thermodynamics. They are already in the standard physics texts, and certain overunity processes are well-known in the literature—including some EM overunity processes which we've cited in many previous publications. The skeptic should refer to lasing without population inversion, the Lawandy patents, the Letokhov publications and processes, Letokhov's negative absorption of the medium (a medium can emit more energy than we input), negative resonance absorption (a particle can collect more energy than one would think impacts on it, and then emit that excess energy, as in the Bohren experiment), the fiber fuse, Russian parametric oscillator power systems of the 1930s, Kron's negative resistor, etc.

In short, *as in any field of physics, one must read the literature and find out what physics actually says and already contains about overunity processes that have been proven experimentally.* It's not as simple as just having an EE degree or graduating from an electronics and motor course. None of the material taught in conventional educational institutions will explicitly tell one that an overunity EM power system is even possible, much less show what the principles of such a device are, or how to go about building one. One will have to discover the principles and methods oneself; there are no handbooks and there are no great experts—the present author included!

Also, contrary to prevailing opinion, real overunity EM systems *have* been built, including by leading scientists, and suppressed or abandoned for one reason or another.

Gabriel Kron's Negative Resistor

Arguably one of the greatest electrical scientists of all time was Gabriel Kron. Working for GE, Kron built a true negative resistor in the 1930s, and it could power itself and the network analyzer at Stanford University, under a GE support contract with the U.S. Navy. Here is a direct quote from Kron { [24] } to show what we refer to:

"When only positive and negative real numbers exist, it is customary to replace a positive resistance by an inductance and a negative resistance by a capacitor (since none or only a few negative resistances exist on practical network analyzers.)"

In that sentence, Kron was required to insert the words "none or". In another quote, Kron { [25] } also revealed that he was not allowed to use the negative resistor to openly power the Network Analyzer. Quoting and reading through the spin-control:

"Although negative resistances are available for use with a network analyzer, in practice it is more convenient to use a second type of circuit, in which the positive and negative resistances are replaced by inductors and capacitors and the dc currents and voltages are replaced by ac currents and voltages of fixed frequency. The use of the second type of interpretation is equivalent to multiplying the wave equation by $i = \sqrt{-1}$."

In that quotation, one should just extract what is said in the first part of the first sentence: *"Negative resistances are available for use with a network analyzer."* And quoting Kron { [26] } from another publication as to what his overunity secret of the open path { [27] } was:

"...the missing concept of "open-paths" (the dual of "closed-paths") was discovered, in which currents could be made to flow in branches that lie between any set of two nodes. (Previously—following Maxwell—engineers tied all of their open-paths to a single datum-point, the 'ground'). That discovery of open-paths established a second rectangular transformation matrix... which created 'lamellar' currents..." "A network with the simultaneous presence of both closed and open paths was the answer to the author's years-long search."

Kron's secret has never been released by General Electric, Stanford University, or the U.S. Navy (the work was done under a Navy contract). It has never been deciphered { [28] } outside those groups { [29] }, with the possible exception of Floyd Sweet, who worked in General Electric with Kron (but not on the Network Analyzer project).

However, we will point out that Lorentz discarded all the "open circuit" or "Kron open path" Heaviside energy flow associated with a circuit, and energy flow that normally does not strike the circuit and power loads. It is a fact that this discarded energy flow is independent and open vis a vis the circuit ground and other parts. The entire "time current" domain is also independently an open path current that can move from one part of the circuit to another. We assure the reader that such time-currents do exist and are met with in both underunity and overunity EM circuits and systems. Every charge and dipole receives time-energy and converts it to 3-spatial EM energy, pouring that energy out in all directions. We personally believe the time-domain-induced energy currents account for at least a part or all of Kron's "open circuit path" discovery. Certainly there is enormous surplus EM energy flow there, in novel form, to be collected and used. It is there in every electromagnetic circuit, and it is presently just wasted and not even recognized.

The present scientific community simply will not allow funded research and publication in such "out of the box" energy research areas. No such "funded research packages" come from the National Science Foundation or the National Academy of Sciences, for research professors, post-docs, and graduate students to bid on. From time to time university scientists still try to work in overunity systems, but are viciously attacked and suppressed for their scientific impudence. Cold fusion research (involving transmutations at low spatial energy) is a primary example; there are many others. This is sad, because the Maxwell-Heaviside equations, *prior to Lorentz's symmetrical*

regauging circa 1886, include both $COP < 1.0$ and $COP \geq 1.0$ Maxwellian systems. Lorentz symmetrical regauging changed the equations so that the $COP > 1.0$ systems—which are *disequilibrium* systems a priori—were just arbitrarily discarded. Only equilibrium EM systems are retained in the Lorentz-regauged Maxwell-Heaviside Equations.

Chung's Negative Resistor

Professor Deborah Chung { [\[30\]](#) } at University of Buffalo also has invented a true negative resistor utilizing crossed carbon filaments, and thoroughly tested it. The university filed a patent application and moved toward licensing for commercial applications. However, the university's web site abruptly pulled off the University's offer of a technical package to companies signing nondisclosure and wishing to license the technology.

Chung's paper was submitted to a journal and after a protracted period in review was finally published. [\[9\]](#) It appears that the university has classified defense contracts, and the Chung negative resistor may have been classified or made totally proprietary for use on such programs.

However, J.-L. Naudin in France has replicated the Chung-type negative resistance experiment, as well as several versions which can be performed by experimenters much more readily. [\[10\]](#) The reader is referred to his website.¹⁰

Other Overunity Systems

Lawandy's Processes and Lasing Without Population Inversion

Lasing without population inversion is always overunity in optical gain. In COP it is underunity overall, so long as the stimulation input power remains externally provided. It does not take a genius to examine the latest experiments confining over 1,000 "random" photon interactions inside the optically active material—both in the forward time and time-reversed paths—to see that self-stimulation and self-oscillation are inherently possible. The simple Lawandy experiment { [\[31\]](#) } itself can be done in any university nonlinear optics laboratory, and the experiment works every time. Visually it is also quite spectacular ([Figure 11](#)). The related fiber fuse effect is also impressive ([Figure 12](#)). Why the Lawandy and related work—including his several patents { [\[32\]](#) } and marvelous results by others { [\[33\]](#) }—is not being explored for power system applications is a deep mystery. There is, however, a rapidly growing body of literature in this area.

A closely related phenomenon is the Bohren's experiment involving emission of excess energy from a stimulated medium due to resonant particles sweeping out a greater "reaction cross section area" in the prevailing Heaviside energy flow { [\[34\]](#) } ([Figure 12](#)). Another related experiment is the highly anomalous fiber fuse { [\[35\]](#) } ([Figure 13](#)).

Self-Powering Russian Overunity Parametric Oscillator Power Systems

In leading physics institutes and laboratories in the 1930s, the Russians built overunity parametric oscillators—and some pretty big ones. That work is fully documented { [\[36\]](#) } in the Russian scientific literature and in the French scientific literature. The devices were developed and tested in several physics institutes and laboratories. With linear loads the oscillators would progressively build to self-destruction. With nonlinear loads, the devices would stabilize and power themselves and their loads.

This work appears to have been deliberately suppressed by the Communist regime just prior to WW II. After the war all such technology passed under the ruthless control of the KGB, and into the special weapons research and development area, still highly classified and KGB-controlled to this day. We know of no similar work going on today in the West.

The Seiko Kinetic Wrist Watch

Rigorously, any overunity system—electrical or otherwise—must be an open thermodynamic system far from equilibrium. I wear such a little system on my wrist, in my wristwatch, which taps the mechanical energy in its dynamic environment (my arm movements) to move a little mass, which operates a little electrical generator, which charges a little capacitor, which powers a little motor operating the watch. It's a neat little watch and a clever design by Seiko. It exhibits a broken symmetry in its energy exchange with its active environment (my mechanical arm movements). Effectively it receives "free" energy and uses that to power itself and its load. [\[11\]](#)

Miscellaneous EM Overunity Power Systems

A solar cell is a perfectly valid EM overunity EM power system, as is any windmill-powered generator. Any receiving wire antenna of itself is a free energy "electrical" system whenever it freely receives EM energy arriving from space and then outputs its received signal to the circuit. It receives energy from its environment and outputs most of it, with some scattered as heat. A hydroelectric turbine-driven generator is also an overunity EM power system, as is a simple paddlewheel in a river.

The *operator himself* does not have to input energy to any of those systems. They are in fact all "energy converters", freely converting the form of some energy they freely receive from the environment, so that the output is electrical energy. More rigorously, they are open systems far from equilibrium in the energy exchange with their active environment.

However, those systems suffer from the common pandemic of modern EM power systems: the design of the external electrical circuit portion to so that it rigorously enforces Lorentz symmetry during excitation discharge into the load, by self-regauging itself to implement it. Hence these systems are not good solutions of the "energy crisis", nor do they solve the ever-increasing problem of polluting the biosphere with hydrocarbon combustion products and nuclear wastes.

The Mead-Nachamkin Zero Point Energy Converter

In 1996 Mead and Nachamkin { [\[37\]](#) } were granted a patent on an overunity EM power system

process for extracting zero-point energy of the vacuum. If one closely examines the patent wording, the device is patented as an energy converter and does not overtly state that it is a free energy system. It is, since the input energy is freely received.

Because energy cannot be created or destroyed, any "free" energy system *a priori* is a *converter*. It must receive the energy from its active environment, and convert that energy to a form usable to power its loads and losses. [\[12\]](#)

Open Systems Far from Thermodynamic Equilibrium

In any overunity system, the total of the *operator's* energy input and the *environmental* energy input is always equal to the total of the energy output in the load and the energy dissipated in the system's losses.

The thermodynamics of such systems has been well-known for decades { [\[38\]](#) }. As an example, Ilya Prigogine was awarded the Nobel Prize in chemistry in 1977 for his contributions to that kind of thermodynamics.

The tired old classical thermodynamics with its infamous second law—which only applies to a closed system or a system in equilibrium with its environment, [\[13\]](#) is all that the skeptics ever seem to have studied or know about. One would wish the arch skeptics would find out what has happened in physics and thermodynamics in the last 40 years! Classical thermodynamics does not apply unless the given system is *in equilibrium* with its active environment. It does not apply to any system *out* of equilibrium.

A common example of such a disequilibrium system is the windmill, or the waterwheel, or the sail boat—all used for thousands of years. Each of those three overunity systems rigorously obeys the conservation of energy law while it's doing free work. It just gets that free energy from its environment, and converts it to a form useful to its owner/operator. The operator does not have to furnish the input energy to it. He still has to pay to build it and maintain it, just as with any other system. The *energy* is free, but the *system and its maintenance* are not free.

The greatest of all overunity systems far from thermodynamic equilibrium, however, is the ubiquitous charge. Every electrical or magnetic charge in the universe is already an overunity EM power system, freely receiving a flux of virtual photon energy from its seething vacuum environment, converting a portion of that absorbed energy, and outputting that converted portion as an EM energy flow across the entire universe. Presently we crudely harness these natural free energy systems called "charges", in our rather inept power systems.

In the future we must learn to apply the free energy aspects of charges and dipoles in far more efficient ways. Presently we build only electrical power systems which kill the free "source dipole converters" faster than they power their loads.

That is really because we have never seriously tried to build anything else!

Energy Conservation and Its Relation to Work Obtainable

Much stuff and nonsense have been written about the conservation of energy in physics and electrical engineering.

The primary and master law of conservation of energy is this: *Energy cannot be created or destroyed*. But it certainly can be converted in form!

Let us be rigorous. We have great difficulty in trying to *define* energy. It isn't the "capacity to do work," because it isn't capacity. *Having* capacity and *identically being* capacity are two quite different statements!

Ultimately energy represents a change in a potential (potential state, condition, vacuum, whatever) which, however, is itself a collection of energy and thus just a form of energy. So, we can also reverse ourselves and interpret the potential as a change in the energy state. Regardless of how we proceed, effectively we just wind up stating that energy—whatever it might be—can always be changed in form. Perhaps the closest approach to defining energy can be taken from general relativity, where it can be argued on one hand that energy *is* a curvature in spacetime, and on the other hand that energy *causes* a curvature in spacetime, and on yet another hand that energy is *whatever acts* upon uncurved spacetime to curve it. And there is about where the matter rests. As Nobelist Feynman { [\[39\]](#) } stated,

" It is important to realize that in physics today, we have no knowledge of what energy is."

Along with Feynman, we have to admit that no one *really* knows what energy *is*, and this author does not claim to be an exception. We just know a lot of things that energy *does*. However, we do know what work is, once we assume energy as a given. *Work identically is the changing of the form of energy*, rigorously.

So a standard question I always ask new researchers is this: "Suppose we have one joule of collected energy. What is the maximum work we can do with that joule of energy?"

Almost invariably the answer is, "One joule of work." That is quite wrong.

If we change the form of all that joule of collected energy, we have done one joule of work. But afterwards we still have precisely one joule of energy remaining! It's just in a form differing from the form it was in when we started. *Energy is never consumed, and never destroyed*. Use it to do work, and we just have all of it left in a different form.

But we've done one joule of work from our original joule of energy, and we've still got one joule of energy remaining. If we then change the form of *that* joule of energy yet another time, we get yet another joule of work. And so on, as long as we can design an "energy-form changing" system that will not just let the energy completely escape after each transformation of the form of the energy.

[\[14\]](#)

In theory, a single joule of energy can do any number of joules of work, if we change its form repeatedly and if we continue doing that indefinitely.

In short, energy can be—and is—recycled and reused, over and over without end. [\[15\]](#)

In the prevailing Big Bang theory, every joule of energy in the universe was there shortly after the big bang began. Since then, every joule of that energy has been doing joule after joule of work. And all of it is still here, and still doing more work!

There is no conservation of work law! All that means is that there is no limit on the number of times a given joule of energy can be changed in form or "transduced". Run some energy through a resistor, and produce heat. Retroreflect all the heat somewhere into some chemicals, and change it all into chemical energy. Let that chemical energy do some more work on some plates, and get some more electrical energy. And so on. Such serial form-converting reactions producing more than one joule of work from one joule of energy do not violate the conservation of energy law, the laws of physics, and the laws of thermodynamics. *One is permitted indeed to get more than one joule of work from one joule of energy.* [\[16\]](#)

But not in a *single* energy-form conversion! In only one conversion, one can only get one joule of work from one joule of energy—but one also still has a joule of energy remaining . If one does not further convert that remaining joule, that's the end of it. In short, one then collects a joule of energy, does a joule of work with it, and then one wastes (dissipates) the joule of energy remaining in its different form.

Most of our professors in university were not quite clear on this subject, although at least some of them understood it. But many did not, and many still do not today.

A Surprising Thing About Thermodynamics and Reservoirs

It is quite fashionable to state that one cannot take energy from a reservoir at constant temperature. Well, that is not quite true as stated. More rigorously, we cannot take energy from a reservoir *in equilibrium* at constant temperature. We can indeed take energy from a reservoir at constant temperature but *not in equilibrium*. That is, from a nonhomogeneous reservoir at constant temperature.

We quote Hsu-Chieh Yeh { [\[40\]](#) } for a vivid statement of this fact:

From Planck's statement of the second law of thermodynamics it is generally inferred that it is impossible to construct an engine which produces work at the expense only of heat taken from the air or the ocean. ...[It is demonstrated that]... when the air and the ocean are combined as a nonhomogeneous reservoir of uniform temperature, it is possible to construct an engine which produces work by extracting heat from the said reservoir. This does not constitute a violation of the second law of thermodynamics,

rather than the "reservoir" in the Planck's statement must be clearly stated as being in equilibrium."

The proof and a schematic diagram of a machine to successfully do that energy extraction process is shown by Yeh { [41] }.

The "Final Word" On the Conservation of Energy Law

Some arch skeptics are fanatically die-hard—and a real pain in the neck as well.

To be absolutely precise, they have no leg to stand on, if they accept what physics ultimately says on the subject of energy conservation.

Before one gets too adamant about the universality of energy conservation, here's a most astonishing thing, but quite true: *In general relativity there is at basis no such thing as conservation of energy at all, unless one first makes some assumptions to inject it artificially so as to avoid facing the sheer terror of the collapse of energy conservation!*

The great Hilbert pointed this out shortly after the advent of Einstein's theory of general relativity. E. g., quoting from Logunov and Loskutov { [42] }, p. 179:

"In formulating the equivalence principle, Einstein actually abandoned the idea of the gravitational field as a Faraday-Maxwell field, and this is reflected in the pseudotensorial characterization of the gravitational field that he introduced. Hilbert was the first to draw attention to the consequences of this. In Ref. 2 [D. Hilbert, Göttingen Nachrichten, Vol. 4, 1917, p. 21] he wrote: 'I assert... that for the general theory of relativity, i.e., in the case of general invariance of the Hamiltonian function, energy equations... corresponding to the energy equations in orthogonally invariant theories do not exist at all. I could even take this circumstance as the characteristic feature of the general theory of relativity.' Unfortunately, this remark of Hilbert was evidently not understood by his contemporaries, since neither Einstein himself nor other physicists recognized the fact that in general relativity conservation laws for energy, momentum, and angular momentum are in principle impossible."

For situations where serious general relativity is not terribly involved, then we can legitimately speak of conservation of energy. Even so, one should not be too hasty to leap forth with the old *equilibrium* thermodynamics and pontificate that "there's no such thing as an overunity EM system because that would violate the infamous second law". If it's an open system far from equilibrium, classical thermodynamics and that second law do not even apply. The skeptic then objecting on the grounds of equilibrium thermodynamics is revealing that he doesn't know the difference between systems in equilibrium and open systems not in equilibrium. In short, he simply does not understand thermodynamics, and it is useless to argue with such a critic.

Before one gets overly confident about ordinary electrical and electronic circuits, and concludes that it's the rarest thing in all the world to have out-of-equilibrium operation in them, one should read the

literature carefully. To the contrary, in all sorts of circuits, equilibrium often is unexpectedly departed from, leading to chaotic operation and a highly increased degree of system complexity. E. g., quoting from Ogorzalek { [\[43\]](#) }, p. vii:

“All real systems are nonlinear in nature. This simple observation is true also for electrical and electronic circuits even though many of them are designed to perform linear transformations on signals. ...in many cases the designed circuit, when implemented, performs in a very unexpected way, totally different from that for which it was designed. In most cases, engineers do not care about the origins and mechanisms of the malfunction; for them a circuit which does not perform as desired is of no use and has to be rejected or redesigned....”

“...electrical and electronic circuits constitute a group of real physical systems in which observations and measurements are relatively easy to make. ..Such an ‘experimental comfort’ enabled thorough studies confirming the existence of strange unexpected behavior in almost every type of electronic circuit – oscillators, filters, instrumentation circuits, power supplies, PLLs, electric machines, microwave circuits, electro-optic systems, etc. The main problem remains in interpreting experimental data.”

In other words, normal circuits indeed do often depart from expected equilibrium behavior. Engineers just shrug and "fix the circuit where it doesn't do that". The scientists are aware of such occurrences, but have not yet fully deciphered all the ramifications or the wild phenomena that result. But they are working on it!

Seemingly Random Behavior Can Be Adaptively Controlled

One has to be extremely careful these days about many of the old statements that were drummed into us as axioms. Some of them no longer hold, or are even true. Others have to be modified from their "absolute" form.

Such a dead notion is the belief that randomness cannot be controlled. That is no longer true. In modern adaptive nonlinear control theory combined with nonlinear oscillation theory, random oscillations can indeed be brought under control and used.

We do not intend to belabor this fairly recent development, but just state that it casts a quite new eye on the notion in some quarters that random fluctuations of zero-point vacuum energy can certainly not be "controlled". That statement is no longer absolute, and must be modified in the light of new knowledge. In fact, we propose that the ordering by a charge of a portion of its received disordered or random virtual energy, is just such an adaptive control mechanism, "controlling" part of the disorder by adapting to it so as to cohere and integrate a portion of it into observable form.

We leave this interesting but complex subject by quoting from the very first scientific work successfully combining both nonlinear control theory and nonlinear oscillation theory. Quoting from

Fradkov and Programsky { [44] }, p. 8:

“In fact, the fields of nonlinear control and nonlinear oscillations were developed surprisingly independently. The present book is perhaps the first one to bring together these two important branches of nonlinear science.”

And again, quoting from Fradkov and Programsky { [45] }, p. 359-360:

“1. There is ... great benefit of using the modern nonlinear and adaptive control theory. ...2. There is no need to distinguish periodic and chaotic behavior. Accurate control is possible without accurate prediction. ...3. There is no need to define chaos in order to control it. ... 4. There is no need to use probability in order to control systems with seemingly random behavior.”

We must leave further investigation of this promising avenue to far better theorists than the present author! We mention it, however, because if the random perturbations of the vacuum energy interaction can be controlled, obviously one can extract EM energy from the vacuum. A simple charge or dipole already possesses the ability to do just that.

The Unresolved Problem of the Source Charge and Its Field Energy

But to return to the so-called "source charge". In the rigorous sense, there are no energy sources and there are no energy sinks. For example, quoting from Semiz { [46] }, p. 151:

"The very expression 'energy source' is actually a misnomer. As is known since the early days of thermodynamics, and formulated as the first law, energy is conserved in any physical process. Since energy cannot be created or destroyed, nothing can be an energy source, or sink. Devices we call energy sources do not create energy, they convert it from a form not suitable for our needs to a form that is suitable, a form we can do work with."

So there are "charge field-energy gates" and charge "field-energy converters", but there are no "source charges" and there are no energy sinks. [17]

However, one must keep one's sense of humor. Ironically, classical electrodynamicists may already be the most dedicated perpetual motion machine "advocates" in the world! In the overunity researchers' wildest nightmares, we could never begin to approach the vast scale of perpetual motion machines that the electrodynamicists already accept and prescribe.

It's that totally false concept of "source charge" that they advocate! They would have us believe that the source charge continually *creates right out of nothing* that enormous EM energy it continuously pours out across the universe in all directions. They would have us believe that a fearsome energy output is generated by the "source charge" without any input of energy from the

environment to that charge. Classical EM assumes the inert vacuum, and nothing at all furnishing the energy to that source charge.

Of course that violates the most sacrosanct conservation law of all: that energy cannot be created or destroyed. But many electrodynamicists just "hide" that little problem and seldom state it explicitly. When pressed, they do—as stated by Sen { [\[47\]](#) }— admit that

"The connection between the field and its source has always been and still is the most difficult problem in classical and quantum electrodynamics."

In short, the electrodynamicists haven't solved the "source charge problem" yet. My comment is a question: How many more decades should it take, just to read the solution already arrived at by the particle physicists, and accordingly change the flawed classical electrodynamics by adding in the required active vacuum and the broken symmetry of the source charge?

Classical EM seriously errs in ignoring the active vacuum. It's well known that no mass system can even *be* in equilibrium without the presence of the vacuum interaction. So just to observe a power system sitting in equilibrium on the floor, is to automatically "prove" that vacuum interaction is occurring with it.

Particle physicists solved that "source charge" problem over 40 years ago, but the electrodynamicists have not yet changed their 137-years-old { [\[48\]](#) } seriously flawed theory accordingly. One simply has to include the active vacuum exchange with the charge and the dipole, and the broken symmetry of the charge and of the dipole, since *a priori* any energy source is actually an *energy converter*.

Particle physicists proved (both theoretically and experimentally) that the vacuum is active, highly energetic, etc. Nobel prizes were awarded, such as to Lamb [\[18\]](#) and to Lee. [\[19\]](#)

The particle physicists also proved that any charge is a broken symmetry in the fierce virtual energy exchange between the seething vacuum and that charge. [\[20\]](#) The very definition of broken symmetry means that something virtual has become observable. In other words, *some* of that enormous virtual disordered energy that the charge absorbs from the vacuum, is *not* reradiated as virtual and disordered energy at all. Instead, that component is first organized by the charge (by its spin?) into observable size groupings. This component is reradiated as the energy flow pouring continuously out from that "source charge" across the entire universe in all directions, thereby providing the energy in the fields and potentials from that charge. [\[21\]](#) Again, every energy "source" is *a priori* an energy converter! So is an energy "sink".

The charge does not *create* the energy it continuously emits, but *gates* and organizes some of the energy it continuously receives from its vacuum exchange. It is not a source charge, but an *ordering and gating* charge.

The charge is thus an open system far from thermodynamic equilibrium. Since one has lots and lots of such charges in an EM power system, and every one of them is an open system freely

receiving and gating energy from the vacuum, *a priori* it should be possible to tame and use some of that observable EM energy flow that the charges freely pour out, to power loads and run the system, without the operator having to continually input additional energy to the system!

That we do not do so is not a commentary on nature's prohibitions, but a commentary on the inadequacy and wrong direction of our scientific research on EM power systems.

The Marvelous "Source Dipole" Overunity Power System

It follows that a dipole, being two separated charges, is also a broken equilibrium in the vacuum energy flux, and thereby it also gates out EM energy flow in all directions in 3-space, continuously. It too is an open system not in thermodynamic equilibrium. In short, it's a wonderful little overunity EM power system! It's one that every circuit contains, and may contain a very large number of them.

It is well-known that an open system not in thermodynamic equilibrium is permitted to perform five magical functions ([Figure 14](#)): It can (1) self-order, (2) self-oscillate, (3) output more energy than the operator inputs (the excess comes from the active environment, in this case the vacuum), (4) power itself and a load simultaneously (in this case all the energy comes from the active environment/vacuum, and the operator need not furnish any), and (5) exhibit negentropy. Every charge and dipole in the universe already does all five functions. Contributions to the theory of such open systems far from equilibrium with their active environment is what earned Prigogine a Nobel Prize. [\[22\]](#)

Perpetual Motion Debunkers Begrudgingly Recognize Overunity Systems

Note that even those determined fellows who make a career out of debunking overunity EM systems as "perpetual motion machines" (but never debunk *themselves* or the classical electrodynamicists advocating *charges* as perpetual motion machines on a breathtakingly large scale!) do admit that such overunity systems exist!

First, those ardent skeptics—who instantly label overunity EM systems as perpetual motion machines—assume an equilibrium system, which cannot exhibit $COP > 1.0$ anyway, and no legitimate researcher will contest that statement. They then classify perpetual motion machines by which law of equilibrium thermodynamics they say that the inventor claims to violate! So they classify their strawmen perpetual motion machines as perpetual motion machines of the first ([Figure 15](#)), second ([Figure 16](#)), and third ([Figure 17](#)) kinds.

They call *permissible* overunity systems *false or fictional perpetual motion machines*—because, they say, those systems are not closed systems { [\[49\]](#) } and are not equilibrium systems. They themselves *begrudgingly admit* that a proper open system, receiving and using energy freely furnished from its outside environment, can indeed produce $COP > 1.0$ and not violate any laws, manmade or natural. In short, the implied sum and substance of their vitriol is that you cannot break equilibrium in an

electromagnetic system, because the laws of nature prohibit it, and therefore in claiming overunity you are violating the laws of physics, thermodynamics, and nature. That is a non sequitur par excellence; it totally depends on the inventor claiming an equilibrium system but overunity COP nonetheless. If the inventor is not claiming a system in equilibrium with its active external environment, then the entire bombastic "perpetual motion" label is stuff and nonsense. We continue to be nonplussed at the naivete of scientific editors in publishing such non sequiturs as if something important and relevant to the problem of $COP > 1.0$ EM power system research had been stated.

We free energy researchers never said we have classical *equilibrium* systems! It's the *skeptics themselves* who keep setting up that tired old "closed system" strawman { [\[50\]](#) } and knocking it down—and that strawman has nothing at all to do with permissible overunity in *open EM systems far from thermodynamic equilibrium*. [\[23\]](#) In fact, the strawmen exist only in their own heads.

We in fact advocate the very kind of so-called "false perpetual motion machines" that the skeptics already admit can legitimately exhibit overunity COP and are permissible—and as is exhibited by every charge and dipole in the entire universe. As we said, the "classes" of perpetual motion machines the critics usually so importantly refer to, are simply strawmen set up for a proposed closed system or a system in equilibrium *violating its closed or equilibrium assumption*. In short, the cases are simple oxymorons ([Figure 14](#), [Figure 15](#), [Figure 16](#)).

So eerily, if one cuts through the jargon and lack of understanding exhibited by the "perpetual motion" accusers, that brand of skeptic unwittingly supports our position, though it may tear his vitals and he will never admit it in print. As we said, one must keep one's sense of humor. It's truly amazing how classical thermodynamics is used so ubiquitously to object to $COP > 1.0$ electrical systems, when such systems are open dissipative systems and not even described by that discipline! That's as bad as faulting relativity because it does not fit Newtonian mechanics!

Generators and Batteries Do Not Output Energy to the External Circuit

Now here's a real shocker: Generators and batteries—i.e., so-called "power sources"—do not furnish energy to their external circuits! (Again see [Figure 1](#)). Well, how could they! We already pointed out that there is no such thing as a source, but only a "gate" or transducer. No gadget or function *creates* energy, but only *transduces* it from one form to another. So rigorously, batteries and generators *must* be receiving and gating or transducing that energy from their "external environment". The gating for the energy furnished to the external circuit is from the source dipole converter. It receives the EM energy from the time domain, transduces it into 3-space, and outputs the flow of 3-space EM energy from the source dipole converter through all space surrounding the external circuit. The small flow component striking the system conductors, potentializes the surface charges in the conductors and components. Those surface charges serve as energy converters locally powering the Drude electrons. [\[24\]](#) The external circuit is powered by its own surface charge converters, freely receiving excess energy from the impinging EM energy flow existing in their immediate spatial environment.

To understand how the external circuit is powered, we must therefore pay attention to all the source charges (energy converters) in the circuit, receiving excess EM energy from their environment, converting it to usable energy form, and powering the elements of the circuit.

The external circuit itself can be nothing but a "receiver/converter" receiving, collecting, and converting some of that available EM energy flow in its immediate environment.

We reiterate: *Generators and batteries do not furnish energy to their external circuits!* If one does not know that, then one needs to go back and seriously reflect upon the processes inside batteries and generators, including what particle physics has to say about the source dipole's broken symmetry in its vacuum interaction. To fully analyze the performance of any EM system—and particularly any overunity EM system—one must include and analyze the *supersystem* (Figure 18). [25]

And one really needs to ponder what Lorentz [26] did (Figure 19) to mangle the EM energy flow theory, using the Poynting energy flow component to essentially substitute the tiny Slepian vector (for the energy flow dissipated in a circuit) for the monstrously large energy flow vector of the flowing energy in space surrounding (and associated with) the circuit—and treating the Poynting vector as the entire energy flow vector because all the rest was "physically insignificant" [27]. We note that Lorentz effectively discarded the other two components—curved local spacetime and its interactions with the system, and the local vacuum interaction and its dynamics—of the supersystem

Here's how a generator works, highly simplified (Figure 1). *It generates the source dipole converter!* As in Figure 1, consider a generator, e.g., one that is steam turbine-powered from a coal-fired boiler. We burn a little coal to heat the water in a boiler to form the steam to power the turbine to rotate the generator's shaft. With rotation, a magnetic field is formed in the generator. In that magnetic field, the negative charges are forced in one direction and the positive charges in the other, separating the internal charges inside the generator and forming the source dipole converter.

Now that's all a generator does. It performs work on its own internal charges, forcing the positive and negative charges apart to form that source dipole. It cannot do anything else except scatter and lose some extra energy in its other internal losses. It doesn't furnish *current* to the external circuit, because it doesn't furnish the electrons that form the current in the external circuit. Those electrons mostly come from the materials in that external circuit. In a copper wire, e.g., there is just about one electron free and bumping around like a gas molecule, per copper atom. Considered as a sort of gas, those free electrons from the circuit materials are referred to as the *Drude electron gas* { [51] }.

What comes out of the generator's source dipole—once it is formed—is the enormous EM energy that the dipole converter extracts from its broken symmetry in the vacuum interaction. *That's* where the energy flow component comes pouring out from and goes roaring out through all space surrounding our external circuit. It's gated from the vacuum by the source dipole converter, by the proven broken 3-symmetry of the dipole.

A battery dissipates chemical energy to accomplish the formation of its source dipole on the plates. We have to *pay* for the initial formation of the dipole, whether it's in a battery or a generator. But once made, the dipole converter will furnish energy continuously and indefinitely, so long as it exists, if we do not let it be perturbed. The energy for every EM circuit is taken straight from the active vacuum, classical electromagnetics and its mindset notwithstanding!

Once the source dipole is formed, particle physics assures us that the broken symmetry of that dipole, in its fiery exchange with the vacuum, orders and gates out a fierce flow of organized EM energy. This energy roars out through all space along (and generally parallel to) the external conductors attached to the generator terminals. (Again see [Figure 2](#) and [Figure 5](#)). John D. Kraus { [\[52\]](#) } shows a good drawing of how the *Poynting* component of the energy flow is actually withdrawn from surrounding space around the external conductors, by the surface charges as they absorb energy and move into the interior of the conductors radially, drawing in the immediate near-field portions of their fields extending out into space. Since the electrons can only move radially a small distance, almost all that huge energy flow in the space outside the conductor *is not* intercepted by the circuit (not drawn into the conductors) at all and thus is not diverged into the circuit to power it. Instead, most of the energy flow misses the circuit entirely and just roars on off into deep space and is "wasted."

The entire energy flow is enormous, filling all space surrounding that circuit, out to an infinite perpendicular radius away. *Both individual and collected charges modify the entire vacuum potential across the universe.* There's about 10^{13} times as much energy flow now zipping through space (for a nominal simple circuit) as the feeble little "sheath" of energy flow against the conductors. (See again [Figure 6](#)). This small "sheath of flow" strikes the circuit's surface electrons and thereby gets diverged into the circuit to power the electrons and form the Slepian vector $\mathbf{j}\phi$.

All the rest of that enormous *free* real EM energy flow extracted from the seething vacuum by the source dipole converter just passes on off into space and is lost.

Lorentz Arbitrarily Discarded All Overunity Maxwellian Systems

Lorentz found that enormous amount of energy—most of it missing the circuit and just wasted—to be very disconcerting! It was perhaps irritating to him that we build such puny "intercepting and collecting" electrical power systems. We build them with a laughable energy collection efficiency of some 10^{-13} or so ([Figure 6](#)). Hardly something to brag about!

If the truth hurts, or the facts contradict something one feels absolute about, it is often buried with a non sequitur. That is a human trait, and it applies to scientists as well as to lay persons. In modern times it's called "spin control".

So Lorentz fixed the problem with a little scientific spin control! He placed a little spherical surface mathematically around each element of those conductors, and integrated the EM energy flow vector

around that surface ([Figure 18](#)). Voila! All the Heaviside energy flow *missing* the circuit and therefore wasted, gets mathematically cancelled in that neat little mathematical trick { [\[53\]](#) }. It is not canceled in the *real world*, just in Lorentz's little mathematical trick. The result of the Lorentz surface integration of the EM energy flow vector is that only the tiny Poynting component of that energy flow—the component that struck the surface charges and got diverged into the circuit, creating the Slepian vector $\mathbf{j}\phi$, is retained mathematically and accounted.

All the rest is just *arbitrarily* discarded. It's "out of sight, out of mind!" Now there was no necessity to explain the source of that startlingly large Heaviside nondiverged energy flow component, because "it didn't even exist anymore".

Of course our instruments measure dissipation of energy. They indirectly measure how much energy is diverged into the circuit and collected (intercepted) there, because they measure the energy dissipation from the circuit. What is *dissipated from* an otherwise inert circuit must first have *entered* it. The instruments measuring the circuit do not measure anything of the non-intercepted, nondiverged Heaviside energy flow that does not enter the circuit but remains outside it.

So Lorentz's trick does retain how much energy is intercepted, diverged into the circuit, collected on the electrons to power them, and dissipated in the loads and losses. And that does match our instrumental measurements *in the circuit*. However, that *is not* the total EM energy flow connected with a circuit, but only a small component of it.

Classical electrodynamicists dutifully continue to follow Lorentz's little trick and call that Poynting component the "entire energy flow". Then they caution against thinking too deeply about the energy flow subject. [\[28\]](#)

As a result of this *faux pas* by Lorentz, physicists are politely debating even today about just what the "Poynting" vector really is, and what it should be, and questioning whether it is really the Slepian vector, and so on. [\[29\]](#) They've been quietly doing that in [American Journal of Physics](#), e. g., for more than 30 years now.

The Effect of Lorentz's closed Surface Integration of the EM Energy Flow Vector

Lorentz stated that all the rest of that wasted EM energy flow was "physically insignificant" (because it did not hit the circuit). Well, contrast this to the ocean wind on a sailing ship. ([Figure 20](#)). Lorentz's statement is analogous to arguing that the huge component of the wind that does not strike the ship's sails is "physically insignificant". However, if we put some more ships with "intercepting and collecting sails" alongside our ship, or at a distance, ([Figure 21](#)), they will be powered quite well with a little more of that "physically insignificant" wind. Lorentz's "physically insignificant nondiverged energy flow component" is insignificant only if we assume one and one only interceptor/collector charge which does not interact with it. For other interceptor/collector charges which do interact with it, the discarded flow is significant because it will then be diverged and do work. So in hiding the fact that the source dipole in a generator is a *negentropic overunity*

converter, Lorentz advanced a non sequitur of first order. That modern electrodynamicists continue to do it is inexplicable.

However, Lorentz thus avoided having to try to explain how the source dipole in every generator and battery outputs far more energy flow than the amount of shaft energy input to the generator, or chemical energy dissipated in the battery.

The electrodynamicists repeat that deceptive little Lorentz integration trick to this very day, in all the texts and all the papers {53}. As a result, most electrical engineers and even many electrical physicists have thoroughly confused electrical energy and energy flow with electrical energy dissipation and the flow of that dissipation energy component. A confusion in electrical engineering exists between EM work and EM energy, and every leading sophomore physics book shows this confusion. One cannot "draw power" from a generator, e.g. Power is the rate of doing work, and work is the change of energy form, so power is the rate at which the form of energy is being changed. *A priori*, that can only occur in the component where the form of the energy is actually being changed. The energy pouring from a generator's terminals has absolutely no "power" until it is intercepted and diverged or changed in form.

Let me put it this way. A flow of a trillion joules of energy per second, none of which is intercepted, diverged, or changed in form, rigorously has absolutely zero power. In the trillion joules per second example, no rate of change of the form of the energy is occurring, hence there is no power. However, one cannot logically ignore that it is still there as energy flow, as Lorentz did, even though it is not doing any work.

The textbooks will usually submit that the trillion-joule-per-second energy flow has a power of a trillion watts. Quite wrong. It has zero power {54}.

We do not "draw power" from a battery or generator. Power is ongoing right where the energy is being changed in form, in the component changing the energy's form and performing work. One cannot "draw it" from the source. One draws (receives) *energy* from the source dipole gating. But how tangled the lexicon for power systems has become, and how filled with non sequiturs!

Heaviside {55} and Poynting {57} independently and essentially simultaneously discovered the flow of EM energy through space, after Maxwell was deceased. We use Poynting's theory because Poynting published more prestigiously. However, to his credit Poynting always gallantly credited Heaviside with being first {56}. Also, Heaviside gallantly credited Poynting with being first.

From the beginning, Poynting considered only that component of the energy flow that actually enters the circuit {57}.

On the other hand, Heaviside pointed out that the diverged (Poynting) component was only a small component of the energy flow {58}. However, Heaviside could not explain what was producing such a startlingly large flow of energy from the terminals of the battery or generator. He thus spoke

cautiously [30] in terms of the "angles" the two components—diverged and nondiverged—made with some reference direction {58}. The Lorentz "solution" to the problem—just ignore all that extra nondiverged energy flow—matched the fundamental instrumental measurements in the dissipating circuit. So today all the texts and engineers calculate "*the* energy flow" as just that feeble little Poynting fraction of it caught by our circuits and dissipated in them { [59] }. That's a non sequitur of first magnitude which—*inexplicably!*—continues to be perpetuated throughout electrodynamics, and *particularly* throughout electrical engineering. The electrodynamicists actually calculate only a small component of the total energy flow already extracted—by the source dipole in our circuits—from the vacuum, and do not recognize the actual vacuum source for the energy that powers every electrical circuit. They continue to mistake the part for the whole, and continue to eliminate the active vacuum from their discipline, nearly half a century after the discovery of the interaction of the vacuum with that source dipole and the dipole's broken symmetry in it. Literally hundreds of texts and technical books, and thousands of scientific papers, contain these glaring foundations error. It is ironical that not a single electrical engineering department in the United States teaches how an electromagnetic circuit is actually powered.

This mangling of the energy flow theory also leads many physicists to puzzle as to how very small charges and dipoles (which have enormously powerful fields and thus extraordinarily powerful EM energy flow) can obey electromagnetics and not destroy the macroscopic universe. One example is the very, very tiny Lamb Shift. E.g., quoting Grandy { [60] }:

"...the energy density associated with the Lamb shift would produce a Poynting vector about three times the total power output of the sun, and a gravitational field disrupting the entire solar system!"

Grandy and other scientists have not recognized the importance of examining that very fact. One is faced with this dilemma: (i) the energy density of the Lamb shift and its associated EM energy flow are indeed of the order of magnitudes surmised by Grandy. Yet obviously the resulting net gravitational field does not disrupt the solar system. This much additional *positive* gravitation is produced by all that Poynting energy flow component, yet the *net* gravitation is nothing like that at all. It follows that some mechanism producing a very large amount of *negative* gravitation (antigravity) must also be involved, even though unrecognized! And so there is. The Bedini group and the MEG group have discovered that source and its mechanism in our overunity energy work, and Bedini and I have filed a patent on the transformation of that peculiar energy into ordinary electron current and energy to help power the system. This is the mechanism also generating the startling antigravity that is producing the acceleration of the expanding universe, which effect the astrophysicists have now validated. Since our foreign patent applications are not yet secured, the reader will have to wait for our forthcoming book { [61] } to obtain the answer to these riddles.

Scientists must think logically, and construct the theory logically. Else it isn't science.

There Is No Energy Problem, Just an Energy Intercepting and Using Problem

But back to our generator or battery. Once the source dipole converter is formed, the energy flow

along the circuit, powering the electrons, is for free. The energy is already freely extracted (actually *gushing in a torrent*) directly from the vacuum. We have never built anything *but* an electrical power system driven by electrical real EM energy flow extracted from the vacuum!

Yet following Lorentz, and considering an EM power system theory from which the active vacuum is excluded, most scientists continue to believe that it's *terribly difficult if not impossible* to extract electrical energy from the vacuum. What a colossal joke! None of our electrical power systems ever did anything else *but* extract and convert all the energy furnished to the external circuit, directly from the vacuum. And they actually extract and convert a great deal more EM energy that misses the circuit and is wasted. All we have ever built is an inherently free energy, overunity power system (if one accounts just the *energy conversion* process that is ongoing between the system and the other two components of the supersystem), once we paid to form the source dipole converter in the generator or battery. It is just that we have *crippled* every one of the myriad of free energy power systems we have ever built!

See [Figure 22](#). Here's how "difficult" it is to build a free energy flow generator. Take a charged capacitor. Lay it across a permanent magnet so that the "static" **E**-field of the capacitor is at right angles to the "static" **H** field of the magnet. That maximizes the generator's available EM energy flow, which is a dynamic flow expressed as $\mathbf{S} = k(\mathbf{E} \times \mathbf{H})$ by orthodox theory. That silly thing sits there and pours out energy indefinitely { [\[62\]](#), [\[63\]](#), [\[64\]](#) }. Substitute an electret for the capacitor, and you don't even have to recharge it. That's a *certified* free energy generator. The only problem is in how to *capture the steadily flowing energy and use it* { [\[65\]](#) }.

There is no *energy* problem per se! One can get all the *EM energy* one wishes, anywhere in the universe, directly from the vacuum's interaction with a source dipole, easily and simply. Just make a little dipole and pay peanuts for it. And have a developed technology that can catch a great deal of the resulting energy flow and use it effectively, without destroying that dipole.

The problem is only in how to (1) intercept and use an appreciable or useful bit of the free energy flow so easily gated from the active vacuum, and (2) dissipate the captured energy in loads (and some system losses) *without* using half of it to destroy the source dipole, as all our present circuits and power systems are designed to do.

There are two other associated problems: (3) the continuing advocating of a seriously flawed energy flow theory and electrical power system theory, and (4) the influence of very large international energy cartels with deeply vested economic commitment to the present course of power system research, development, and engineering. Still another related problem is (5) the resulting intense economic control of science and of energy research and policy, constraining it into "accepted" directions. In short, "thinking out of the box"—the present buzzword for highly innovative thinking—is almost ruthlessly excluded in the field of EM power system theory and technology.

How EM Power Systems Enforce Symmetrical Self-Regauging

So why do not our present "inherently free energy" power systems exhibit COP>1.0?

Quite simple. (See [Figure 3](#)). We are all trained to build the systems as closed current loop circuits, where all the spent electrons in the ground return line (from all loads and losses) are forcibly rammed right back through the source dipole charges in the generator or battery. That knocks the end charges every which way, scattering them and destroying the dipole converter—and thereby shutting off the free gating of energy from the vacuum.

It is easy to show that precisely one half the captured free energy in the circuit is utilized to continuously destroy the source dipole. The other half is distributed amongst the loads and losses. That means that less than half the captured free energy is available to do work in the loads. So the circuit kills its own source dipole faster than it powers its load.

In short, we only build symmetrically regauging Maxwellian EM power systems. We deliberately design them so that they *forcibly* self-regauge symmetrically.

We Pay the Power Company for a Sumo-Wrestling Match Inside Its Generators

One of the Lorentz asymmetrical self-regaugings in the EM power circuit is used to destroy the source dipole converter and shut off its gushing EM energy flow transduced and output from its vacuum interaction. The other Lorentz asymmetrical self-regauging is the dissipation of captured EM energy in the external system loads and losses. The two are equal, so the net regauging is symmetrical.

Again see [Figure 1](#). In the generator, once the source (gating) dipole converter is destroyed, we have to burn some more fuel to get the generator shaft rotated a bit more, making the magnetic field inside the generator and expending that magnetic energy to do work on the internal charges of both signs, to re-separate them and reform the dipole converter. Which the circuit promptly kills again, so we have to burn some more fuel to rotate the shaft to get the dipole converter reformed—and so on and so on. One gets the picture.

We pay the power company to engage in a giant and continuous Sumo wrestling match inside its own generators, and to *always lose* that wrestling match. Our universities proudly keep training our engineers to specifically design our power systems that way, so they proudly keep building them that way. And the power meter stays on the houses and factories, the gas pump meter stays on the gas pump, and we keep burning train loads of coal and oil from fleets of tankers to maintain this mess.

If it were not so tragic scientifically and responsible for the resulting gigantic pollution of the biosphere by hydrocarbon combustion byproducts and nuclear wastes, it would be a cosmic joke. For such an inane power system theory and technology, one is even tempted to paraphrase Tesla's { [\[66\]](#) } infamous statement—more a fervent hope—that

"...[I]n a short time it will be recognized as one of the most remarkable and inexplicable aberrations of the scientific mind which has ever been recorded in history."

Of course we do not wish to antagonize the electrodynamicists, but only wake them up to what has been done to all of us by the serious flaws and arbitrary changes implemented in their classical electrodynamics model. [31] After all, it is the electrodynamicists themselves whom we are urging to make the necessary corrections to the theory.

In a battery-powered system, the battery has to keep furnishing chemical energy to keep doing work on the internal charges to keep reforming the source dipole converter, that we ourselves design the circuit to keep destroying. Eventually the battery chemistry is all changed (e.g., the lead plate surface is all converted to lead oxide in a lead-acid battery) and the battery chemistry can no longer furnish chemical energy to do the work in separating the internal charges to reform the source dipole. So we must get a new battery, or if rechargeable we must send some current back through it to do work on that chemistry again to change it back (to reconvert the lead oxide back to lead). Since every system has some inefficiencies and losses, we will pay for more energy to recharge the battery than the work we get back in the load { [67] }.

So that's why we continue to universally build underunity power systems.

Off there in the distance, one can hear Lorentz laughing, and laughing, and laughing..... Meanwhile the strangling creatures in our biosphere now becoming a sewer, are crying, crying, crying.... and dying, dying, dying.....

What Lorentz Symmetrical Regauging Technically Is and Does

Lorentz was and remains one of the truly great scientists of all time, and his magnificent accomplishments in physics are renowned and well-known. Yet ironically he also gave us the two major changes to EM theory that for a century have prevented overunity EM power systems from being developed and utilized.

Lorentz's symmetrical regauging is a mathematical operation invoked on the Maxwell equations to simplify them. So what were Maxwell's *original* equations?

Maxwell's equations are some 20 quaternion and quaternion-like equations in 20 unknowns {48}. Heaviside changed them into what today are four equations, or in potential form are two equations with variables coupled. In that form the equations are referred to today as "Maxwell's equations".

Consider the potential form { [68] } of the equations. The Heaviside-Maxwell equations are difficult to solve in that coupled condition, and one must most often use numerical methods. So to mathematically produce equations with the variables decoupled, and therefore have equations far, far easier to solve, Lorentz just arbitrarily and symmetrically regauged them (changed the potentials). In short, he assumed that the potential energy of the system is arbitrarily and freely changed twice.

We should not criticize Lorentz too much! Everyone at the time believed that the potentials were not real anyway, but only mathematical conveniences { [69] }. So—it was universally thought—changing them mathematically was of no physical consequence, so long as the *real* EM causative

agents—thought to be the force fields—were not changed overall. In other words, if changes of the potential generated no *net* force when completed, it was believed that one could freely change potentials (and thus the system's potential energy) at one's whim, without changing the system. We know today that such a notion that the potentials have no physical significance is quite false, but eerily there is still great attachment to that very notion. For example, quoting p. 67 of Bloch and Crater { [\[70\]](#) }:

[It is usually] "...assumed that the magnitude of potential energy is irrelevant, being arbitrary to the extent of an additive constant."

Understand what is being said! It is being assumed that the potential energy of a system is irrelevant and arbitrary! Yet the entire notion of "powering a circuit" is to get some potential energy transferred to it, so that potential energy (collected energy, excitation energy) can be dissipated in the load to power it! The magnitude of how much energy we have available in a given system to discharge into loads and power them, is *most certainly not irrelevant!*

Again, quoting Goebel { [\[71\]](#) } p. 1137:

"[T]he zero of both scalar and vector electromagnetic potentials is irrelevant; the addition of a constant to an electromagnetic potential is of no consequence (so-called gauge invariance of the first kind).

Well, as a sort of "mental crutch" to see what regauging (change of potentials) entails, imagine this. We take an object with an electrostatic charge of 12 volts. We use a bias "ground" potential of 400 volts. Now between that "ground potential" and the electrostatic charge's potential, we have a potential of 412 volts. And we have not dissipated any energy yet, but there is now a whale of a lot of potential energy between that ground and that electrostatic charge potential.

So we have a "usable 412 volt potential". Suppose we have a circuit (one we've advocated before) ([Figure 23](#)) where instead of copper conductors we are using conductors made of copper doped with 2% pure iron, as a special alloy (it can be made in a metallurgical laboratory, in an inert atmosphere). Well, the electron relaxation time in those conductors is going to be something on the order of a millisecond. If we use very adroit and efficient switching, we can switch that 412 volts onto a circuit with those conductors (lots of them) connected across a capacitive load. And we can switch our voltage source away in, say, a microsecond, at the same time connecting a diode between ground and the 412 volt line of the circuit, so that current cannot flow except into the capacitor. Towards the end of that relaxation millisecond, the Drude electrons in those conductors will start to move, and the capacitor will then receive a charge. Yet during the charging, we will not even be connected to that circuit, which is now "on its own". We simply transferred energy (potential) without change of form. That is pure regauging, in theory with no cost whatsoever (in real life, we pay a little bit for the switching). Then the circuit itself "relaxes" to permit the charging of the capacitor. Then we separately discharge the capacitor through a resistive load. As can be seen (this is a gedanken experiment), regauging allows us to perform free work with the free potential energy transferred to the collecting "nonrelaxed" circuit. All we have to do with this approach is get enough energy involved in the transfer, charging of the capacitor, and discharge through the load, to be greater than the cost of switching. We gave a similar notion in a previous very solid paper { [\[72\]](#) }. This fairly simple experiment has unsuspected great importance for physics ([Figure 24](#)).

Lorentz used two simultaneous regaugings. Each regauging alone is *asymmetrical*; that is, it produces not only a free potential energy change (in the system, e.g.), but also a free new force (in the system) which could be used to dissipate that newly collected potential energy into a load, yielding overunity. Ah, but that would never do! So Lorentz simultaneously changed the other potential, but precisely selected the change *only just so* that the new free force was the exact equal and opposite of the first one. This zero-summed the two new free forces, so there were no *net* translation forces remaining. In short, the combination was and is a *symmetrical* regauging.

But the two net forces did not vanish; they are still there, as a "stress". So the two asymmetrical regauging forces fight each other to a Sumo wrestling draw. In the Lorentz symmetrical regauging view, it is proper to stress the system freely, adding all the stress energy one wishes, but heavens! Under no circumstances must one allow that extra free energy to be dissipated! In the view of the followers of Lorentz, there must always be a "balance" so that the dirty old user is not permitted to use any of that admittedly free regauging stress energy to power a load. For goodness sake! If they did not adhere to that "balance" and "symmetry", why the rascals would even begin to power their homes and automobiles for vanishingly small sums. And then where would the "high cabal" (Churchill's term) be, if there were no gas pump with a meter and no electric meter on one's house or factory. With Lorentz symmetrical regauging, there is no *net* translation force to do external work in the load. Hence the net effect is that the system has been *symmetrically* regauged { [73] }. It has also had its internal stress changed. In more colorful terms, the system has been murdered, strangled, thwarted, made into a self-suicidal system, etc. And this is what we teach all our electrical engineers who then go out and proudly design for us some more Lorentz-symmetrizing electrical power systems.

With the Lorentz symmetrical regauging, all the free system potential energy—the two changes of same—is thereby converted into extra stress energy inside the system, stressing the system but doing no external work! There is no net force left after Lorentz symmetrical regauging which can be used to dissipate that free regauging energy upon a load and do work for free.

In short, Lorentz retained only that very small subset of Heaviside-Maxwellian systems wherein all the systems are self-forced into thermodynamic equilibrium with their environment i.e., with the active vacuum. For those systems, classical equilibrium thermodynamics rigorously applies. Lorentz just arbitrarily and unwittingly discarded *all* the Heaviside-Maxwell systems in disequilibrium—the very Maxwellian systems which could exhibit $COP > 1.0$. He retained *only* those systems that are in equilibrium and can only exhibit $COP < 1.0$ (assuming a little internal losses for any real system).

He did that more than 100 years ago. Now the reader can understand why, in maintaining this century-old nonsense as the basis for all our electrical power systems, the scientific community itself is to blame for the energy crisis and also for the continued pollution of the planet by the waste products of such primitive electrical power systems and associated activities such as oil and gas production and transport, etc.

Sadly, the environmentalists have not yet even recognized *what* is wrong with the present power systems, and *who is to blame* for it.

For Overunity Systems, One Must First Undo the Lorentz Condition

The Heaviside-Maxwell equations do indeed include vast numbers of systems not in thermodynamic equilibrium, *before* Lorentz did his "symmetrical regauging" and arbitrarily changed those equations.

To simplify the mathematics and restore beautiful symmetry (which historically mathematicians worship), Lorentz arbitrarily discarded far more Maxwellian systems than he retained. He unwittingly taught electrodynamicists to simply discard and ignore all permissible overunity EM systems.

It follows that the very first thing we must do to an EM power system, to make it possible for the system to produce $COP > 1.0$, is arrange for the system to violate that arbitrary Lorentz condition. Actually, breaking the Lorentz condition is designing the system so that it does not forcibly pass all the "spent electrons" from the loads and losses, in the ground return line back through the primary source dipole converter, destroying it. The ramifications of doing this have been pointed out in a paper by the AIAS { [\[74\]](#) }.

Electrodynamicists already assume one can asymmetrically regauge any EM system—that is, freely change its potential energy, which in electromagnetics is just changing the voltage that is then applied to the charges. However, seemingly one is expected to love mathematics and symmetry so much more than the physics that one will (1) inane regauge that system again in a peculiarly restrained manner to "thwart" any ability of the system to discharge its excitation energy in the load without destroying its source dipole, and (2) carefully choose and apply a second regauging so that it precisely cancels out all "work-producing capability" of the first one.

Now other than mathematical convenience, why would anyone wish to destroy a perfectly good and already accepted free energy process, or cripple it so that the excess energy could not be utilized to do some free work? From a power system viewpoint, that is total insanity { [\[75\]](#) }.

Meanwhile, true to Lorentz our scientists and engineers have been building electrical power systems precisely so they symmetrically regauge themselves forcibly. And meanwhile the scientific community, environmental community, and governmental community have been decrying that we have a great energy problem in modern society and a great biosphere contamination problem. We do not, except as a secondary *result*. Instead, we have a formidable *scientific mindset* problem as the primary *cause*.

Hope for the Future: Poor but Growing

As the reader can see, there is a quite rigorous basis for overunity EM power systems. The gist of overunity operation—*asymmetrical self-regauging*—is already accomplished in every power system:. Unfortunately, the engineers have given us power systems (energy converters) that also

continually perform a *second* countering asymmetrical regauging, precisely designed to kill the useful results of first one. We will never produce overunity electrical power systems unless we design and build systems that deliberately violate symmetry (violate Lorentz regauging), and use *net asymmetrical* regauging.

Frankly, the scientific community still seems almost beyond hope on this, because it rather adamantly insists on upholding equilibrium systems and classical thermodynamics, behaving as if open disequilibrium EM systems do not exist (in the face of extensive published experimental proof that they do).

This may change, however, with continued pressure from the environmentalists and the coming decline of oil supplies in about year 2030 or so. [\[32\]](#) We can only fervently hope that the environmentalists wake up to the nature of the primary problem.

Also, hopefully there is now slowly rising an understanding of what Lorentz symmetrical regauging did to us, and what the real principles of permissible overunity power systems are. Particularly the younger university researchers, still not so brainwashed, are willing to look at the references themselves and see precisely what was done to the earlier Maxwellian EM models, and examine how the theory they have been taught to apply was actually derived.

Some of the Flaws in Foundations of Electrodynamics

As a parting thought, we leave the reader with this startling statement: No Western electrodynamicist—with the possible exceptions of Lorentz and Heaviside—appears to ever have calculated the magnitude of the scalar potential, even though every professor teaches "how to do it" and every text purports to show how to do it! We've all been taught to calculate the *reaction cross section* of the potential, not the magnitude of the potential itself { [\[76\]](#) }. The reaction cross section of the potential is a scalar value, but the potential itself *is not a scalar entity*, as shown by Whittaker 1903 and as so beautifully illustrated by Van Flandern's waterfall analogy.

Think of it closely. The so-called "magnitude" of the so-called scalar potential at a point, is defined as the joules of energy that will be *diverted from* the potential and thus "collect" upon and around a unit point static charge assumed to be located at that point. Sorry, but that's not the magnitude of the *potential* (which may occupy all spatial points); rigorously that is its reaction cross section at that point! So when we express this so-called "scalar potential" function which gives a scalar value at every spatial point, we are expressing the function that gives its reaction cross section at every spatial point.

The so-called "scalar" potential itself is not even a scalar entity, as rigorously shown by Whittaker { [\[77\]](#) } in 1903. Whittaker rigorously demonstrates that the potential is a harmonic bundle of bidirectional EM longitudinal wavepairs. Each wavepair is comprised of a longitudinal EM wave and its phase conjugate replica. So the so-called "scalar" potential is a bundle of special EM waves, going in both directions ([Figure 25](#)). It's an entire giant collection of EM energy flows in higher EM polarization form, reaching across the entire universe in all directions from that "source charge". It's

an ongoing change to the entire vacuum potential of the universe, across all space { [78] }. And it's a *multiwave, multivectorial* entity.

It's also a closed feedback loop. The vacuum feeds energy in different form to all the charges in the universe, and all the charges "feed" a mix of ordered and disordered energy back to the vacuum. This was beautifully expressed by Puthoff { [79] } as a *self-regenerative cosmological feedback cycle*.

At any spatial point, of course, the combined *reaction cross section* of all those composite waves is a scalar value—which has nothing at all to do with whether or not the potential itself is a vector or a scalar entity.

Again, we have to have a sense of humor! If the scalar potential were really a scalar entity, then when one set it onto a transmission line, it would just sit there like an old scalar boot. It doesn't do that at all, but takes off down the line like a scalded hog, revealing its vector nature. And if one sets it onto the middle of the transmission line, it takes off in both directions at once like two scalded hogs, showing its bidirectional vector nature.

Isn't it odd that such a simple gedankenexperiment alone proves instantly that the "scalar" potential isn't a scalar entity? Yet the electrodynamicists have not changed that horrible non sequitur in the textbooks in the nearly 100 years since Whittaker { [80] } clearly showed it with mathematical rigor.

It indeed often requires the Western scientific community from 40 to 100 years to do what should be done in four.

The amount of water one dips from a rushing river in a standard bucket, or diverts in a swirl around a fixed standard rock on the bottom, is not the magnitude of the river! What is collected from or diverted from something, is not the something but only a component of it. The part is not the whole.

From any "potential" that is nonzero (i.e., that has a nonzero cross section, no matter how small), one can collect as much energy as desired, at least in theory. The simple equation $W = Vq$, where W is the energy collected in joules from potential V (cross section V) upon charges q , covers the situation. As can be seen, from a microvolt potential (cross section) one can collect a trillion joules of energy, if one sets sufficient collecting charges into it where the cross section is one microvolt. And if one sets even more collecting coulombs in space occupied by that potential, one will collect another appropriate number of joules. Of course we would not use a microvolt as the "transfer potential" in a free energy system, but what about 1,000 volts? Then one does not need so much collecting charge, to have appreciable EM energy collected and ready to use to power loads.

In placing intercepting/diverging/collecting coulombs, one is placing interceptor/collectors in a myriad rushing bidirectional rivers of energy, fed by the entire energy of the universe (the simple potential is a change across the entire universe to the ambient vacuum potential). So the *actual* magnitude of any finite potential itself is so great that we may consider it infinite.

There are many other flaws in electrodynamics. The entire model needs a vigorous overhaul. To

quote Bunge { [81] }, p. 182:

"... the best modern physicist is the one who acknowledges that neither classical nor quantum physics are cut and dried, both being full of holes and in need of a vigorous overhauling not only to better cover their own domains but also to join smoothly so as to produce a coherent picture of the various levels of physical reality."

I'm pleased that Dr. Myron Evans { [82] }, President of the Alpha Foundation's Institute of Advanced Study (AIAS), and other AIAS advanced theorists such as Dr. L. B. Crowell { [83] }, together with other eminent theorists such as Barrett { [84] }, are now moving electrodynamics to a much more modern non-Abelian theory in higher gauge such as $O(3)$. Now the first major steps toward Sachs's unified field theory³¹ have also been taken { [85] }. While Evans himself cautions that this extended $O(3)$ electrodynamics is still not the final perfect step, it provides a dramatic new electrodynamics far superior to the $U(1)$ electrodynamics presently in vogue. And it can be used to directly engineer much of Sachs's unified field theory.

The AIAS theoreticians have also elegantly pointed out serious failures of the present $U(1)$ electrodynamics { [86] }, as have Barrett { [87] } and others { [88] }. Many of these shortcomings of the present electrodynamics are being rectified in the new $O(3)$ electrodynamics. We strongly point out that much of the present shortcomings can be rectified by instituting *supersystem* analysis²⁵ rather than system analysis. To analyze the supersystem, of course, requires a higher symmetry electrodynamics and extensive numerical methods.

In Summary

In closing, we summarize the bottom line for overunity EM power systems as the following list:

- (1) There already do exist overunity EM processes, recognized in physics and in the leading journals. That alone proves one can build overunity EM systems, since it only takes one white crow to prove that not all crows are black. Specifically, every charge and dipole in the universe is already a legitimate $COP > 1.0$ Maxwellian system.
- (2) Classical electrodynamics is thoroughly fouled, and actions have been performed decades ago to arbitrarily limit it to a small subset and exclude all overunity Maxwellian systems.
- (3) The Heaviside-Maxwell equations indeed prescribe and contain overunity EM systems, including overunity EM power systems, before Lorentz's arbitrary symmetrical regauging just to simplify the mathematical labor and thereby discard all the overunity systems.
- (4) The reduction of Maxwell's EM theory to a subset and the discarding of overunity EM systems is documented in the standard literature, once one comprehends what the curtailing actions actually represented in supersystem terms. One must keep a sense of humor and not treat classical electrodynamics and equilibrium thermodynamics as religious law brought

down from the mountain by Moses on his stone tablets.

(5) Any overunity system *a priori* is an open system far from thermodynamic equilibrium.

(6) If one wishes to build an overunity self-powering electrical power system, one must build the system so that it or some part of it violates Lorentz *symmetrical* self-regauging and uses net *asymmetrical* self-regauging. Then to close-loop the system requires special measures soon to be released (in 2002).

(7) The free change of the potential energy of a Maxwellian system is already assumed by all electrodynamicists to be possible at will. A priori this implies that the only "energy crisis" is in working out how to catch and use the energy to power loads, without destroying the function that is getting the free potential energy onto the system.

(8) Orthodox power systems are specifically designed to forcibly self-restore Lorentz symmetrical regauging by passing all the spent (depotentialized) electrons in the ground return line back through the primary source dipole converter to destroy it.

(9) It is radically easy and operationally simple to extract all the electrical energy one wishes, directly from the vacuum, anywhere in the universe. Just make a little dipole.

(10) Particle physics has proven the basis for the active vacuum and any dipole's broken symmetry in it for over 40 years, but classical electrodynamicists have not yet changed the classical EM U(1) model's assumption of an inert and empty vacuum, much less a broken symmetry in the ongoing vacuum exchange.

(11) Batteries and generators utilize their internal energy to continually restore their continually destroyed source dipole converters, but do not furnish energy to the external circuit including to the loads. Once formed, the source dipole converter receives vacuum energy and converts some of it to EM energy flow furnished to the external circuit and to all surrounding space.

(12) The external circuit itself contains a conglomerate of source charge converters called "surface charges". The surface charges intercept and receive energy from the immediate EM energy flow environment in space, converting it to circuit energy and powering the circuit elements.

(13) Any proficient electromagnetics laboratory can build a small demonstration self-oscillating permanent magnet via present thin film techniques and surround it with conductors to freely power a small load, thereby instantly establishing overunity EM power systems and extraction of usable EM energy from the active vacuum.

(14) Well-known scientists such as Kron have indeed previously built overunity power devices, such as negative resistors, and such as devices with stimulated media producing excess emission.

(15) Practical overunity EM power systems can be developed whenever sufficient funding for a carefully selected scientific team and a dedicated laboratory along the lines of this paper are provided—and whenever the research is allowed to proceed by the scientific community.

Epilog

In a strange sense we just wish to free the overunity EM power systems the orthodoxists already build and strangle, since they invariably design the systems to fight themselves to the death. There really is a hidden free energy genie in the "escalating energy crisis" bottle, waiting to be released.

See [Figure 26](#). In a more humorous vein, I recently checked with my friend Rajah, in India, who moves logs with elephants in his logging business. Rajah is an expert on asymmetrical self-regauging systems called "elephants". His elephants forage for their feed, freely taking on excess energy from their environment and storing it, thereby asymmetrically regauging themselves. Then Rajah takes one elephant (one net force with some regauging energy to expend) and uses it to lift and carry one or more logs. He has to pay a little to direct the elephant, of course, by hiring the trainer. But the elephant produces far more work output than the work done on the elephant by the trainer/rider. In fact, the elephant expends some of the free energy it has received from the environment in its foraging and asymmetrical self-regauging.

I discussed the problem of Lorentz symmetrical regauging with Rajah, and explained that in his business it would require that he always use his elephants in opposed matching pairs, straining fiercely one against the other. He exclaimed that such a scheme was utter nonsense, because then he himself would have to furnish the energy to drag both the struggling elephants and the logs to the loading dock! It was immediately obvious to him that such a proposed system was the worst of all possible solutions.

Rajah was astounded at my suggestion for such a thing, and asked me what on Earth prompted the Western scientists to make such a strange proposal. I explained to Rajah that all our own Western power systems were already built that way, and the electric companies were very proud of the fact that they therefore continually burned fuel by the trainloads to keep the Western "logging operations" and "paired elephants inside the generators" going furiously to move the loads.

Rajah looked at me intently for a long moment, saw that I was not joking even though my eyes were twinkling, then laughed uproariously for an extended period.

"That is very, very strange!" he exclaimed. "Never have I heard such a bizarre tale. I think that I will never understand your Western science and its insane way of trying to use its elephants!"

Rajah then asked a simple question, "How many logs have they moved with their elephants alone?"

And I replied, "Not a single one! They constantly drag two opposing elephants and their load of logs around at the same time, sweating and puffing and blowing and burning fuel to do so. And our universities continue to assure us that such is the will of God and the laws of nature."

When I left, Rajah was still laughing uproariously, as he approvingly watched his own elephants working steadily and efficiently in singles.

Note in closing: We have also added an informal appendix of several figures to further elucidate some of the matters discussed. See Figures 27-37.

Notes and References

[1] My calculation of the 10^{13} figure was admittedly very crude, but even if it is excessive by several orders of magnitude, the total amount of Heaviside energy flow in space around the conductors, not entering the circuit, is still formidable. We have nominated that nondiverged, unaccounted "dark" Heaviside energy as the agent producing the excess gravity in the arms of spiral galaxies and holding them together. See T. E. Bearden, "Dark Matter or Dark Energy?", Journal of New Energy, 4(4), Spring 2000, p. 4-11.

[2] A full bibliography of Kron's works is given in S. Austen Stigant, "Gabriel Kron on Tensor Analysis, A bibliographical record," BEAMA Journal, Aug. 1948. If one reads Kron's papers carefully, with the "supersystem" (to be discussed later) in mind, much of what Kron did in his negative resistor becomes apparent.

[3] A multi-valued magnetic potential has two values at a single point in space, one on the "right" and a different one on the "left". A rotor passing through the point thus sees a free and instantaneous change of magnetic potential, accompanied by a free and instantaneous change of magnetic force.

[4] We point out that the gauge freedom axiom in gauge field theory already assumes that the potential energy of an electromagnetic system can be freely changed at will, anytime, anywhere. It directly follows that, if we freely increase the potential energy of a system by asymmetrical regauging, the free nonzero force that results allows the excess regauging energy to be dissipated as free work in a load. That our present circuits do not do this, thus focuses attention that it is strictly a fault of the circuitry design. We speak more on this when we mention the concept of the "supersystem". Note that energy conservation requires that an energy transfer method exist for any such regauging under the gauge freedom axiom.

[5] For an introduction, Feynman, Richard P., Robert B. Leighton and Matthew Sands, The Feynman

Lectures on Physics, Addison-Wesley, New York, 1963, Vol. II, Chapter 37 covers magnetic materials including exchange forces, spins, and spin effects.

[6] This is because, unknown prior to 2000, the longitudinal EM wave in 3-space is always accompanied by a companion longitudinal EM wave in the time domain. Strong irradiation in the time-domain can interfere with body and cellular processes.

[7] See particularly Robert H. Romer, "Heat is not a noun," American Journal of Physics, 69(2), Feb. 2001, p. 107-109. This is an editorial discussion by the Editor of AJP of the concept of heat in thermodynamics. Heat is not a substance, not a thermodynamic function of state, and should not be used as a noun. In endnote 24, p. 109, he also takes to task "...that dreadful diagram purporting to show the electric and magnetic fields of a plane wave, as a function of position (and/or time?) that besmirch the pages of almost every introductory book. ...it is a horrible diagram. 'Misleading' would be too kind a word; 'wrong' is more accurate." "...perhaps then, for historical interest, [we should] find out how that diagram came to contaminate our literature in the first place." As one can see, even the illustration of an "EM wave in space" is totally ridiculous and wrong. Why such is not rooted out of the texts remains an enigma wrapped in a mystery, to adapt a phrase by Churchill.

[8] If one wishes to experiment with close-looping a heat pump, then underground installation of the lines should be utilized in order to stabilize the heat pump's COP at a high level.

[9] Shoukai Wang and D.D.L. Chung, "Apparent negative electrical resistance in carbon fiber composites," Composites, Part B, Vol. 30, 1999, p. 579-590. For related work, also see Deborah D. L. Chung, "Superconductor-metal laminates and method of making," U.S. patent no. 5,059,582, issued Oct. 22, 1991. A superconducting laminate having at least one layer of metal and at least one layer of superconducting material. The metal layer and the superconducting layer are bonded. The metal later may also include carbon fibers from various precursors. The superconductor may be a composite material. The invention also includes a method of making the laminates. Assigned to The Research Foundation of State University of NY, Albany, NY.

[10] For replication and tons of related technical information on Chung's negative resistor and negative resistors in general, see J.-L. Naudin's website at <http://jnaudin.free.fr/cnr/>. We carefully point out the difference between the "differential" negative resistor—which continuously "eats" more power than it provides to the circuit and therefore is a net load rather than a net source—and the *true* negative resistor, which furnishes excess power to the circuit and is a net internal source.

[11] We humorously wrote about this (and some other things) in T. E. Bearden, "Intriguing Novelties and Speculations: Part I of II," Explore 10(1), 2000, p. 40-48; Part II of II, Explore 10(2), 2001, p. 63-69. This was an article from my notes and reflections on intriguing items from my "oddities" files.

[12] Indeed, it turns out that all EM energy in 3-space comes from the time-domain, and the charge or dipole absorbs time-energy, converts it to 3-space energy, and emits it in 3-space in all directions. See T. E. Bearden, "Giant Negentropy from the Common Dipole," Journal of New Energy, 5(1), Summer 2000, p. 11-23. On DoE open website <http://www.ott.doe.gov/electromagnetic/papersbooks>.

[html](#) and <http://www.cheniere.org/>. After publication, we discovered very powerful additional support in Mandl and Shaw, Quantum Field Theory, Wiley, 1984, Chapter 5. Mandl and Shaw argue that the longitudinal and scalar polarizations of the photon are not directly observable, but only in combination, where they manifest as the "instantaneous" Coulomb (i.e., electrostatic) potential. Our comment is that this argument, translated from particle terminology to wave terminology, directly fits my re-interpretation of Whittaker's 1903 decomposition of the scalar potential. However, Mandl and Shaw fail to account for the interaction of the detecting/observing unit point charge (which is the "combining" mechanism), and thus fail to account for the absorption of the incoming time-polarized wave or photon, the transduction of that excitation energy of the charge into longitudinal EM wave/photon energy, and the subsequent emission of that excitation energy in 3-space. Thus they missed the time-excitation charging via absorption of the "coupled" time-polarized EM wave/photon, and the decay by emission of 3-space longitudinal EM wave/photon. This interaction has been erroneously omitted in physics prior to our recognition of it. So Mandl and Shaw do not account for photon (or wave) polarization transduction, where the "causal" time-polarized EM wave or photon comes in and is absorbed by the detecting charge or dipole, then re-emitted as the longitudinally polarized EM wave or photon in 3-space. Recognition of these missing facts allowed at last a solution to the long-vexing problem of the source charge, often called the greatest problem in both quantum and classical electrodynamics

[13] E.g., see Robert Bruce Lindsay and Henry Margenau, Foundations of Physics, Dover, New York, 1963. Quoting p. 213: "*Equilibrium states are the only ones that are capable of explicit analysis in thermodynamics...*" Quoting p. 217: "*Non-equilibrium conditions cannot be specified by variables of state, and their entropy cannot be computed. ...the condition of equilibrium is the condition of maximum entropy.*" It follows that (i) the disequilibrium state is an excited state, (ii) it has decreased its entropy and thereby increased its entropy, and (iii) classical thermodynamics does not and cannot describe systems which operate in disequilibrium with their active environment. It is very interesting that U(1) electrodynamics assumes the external environment of the Maxwellian system is inert, hence the system is in equilibrium. Accordingly, U(1) electrodynamics as developed and used in electrical engineering does not even apply to open dissipative systems, which are systems in disequilibrium with their active environment, in this case the active local vacuum and the active local curvatures of spacetime.

[14] And here is a great secret, known to Nikola Tesla: All you really must have is two entities or functions that change the energy's form back and forth between two states or types. The first entity receives the energy in form A, and changes it into form B, doing work, but also feeds the form B energy to the second entity. The second entity changes the B-energy back to form A, doing work, but then feeds this A-energy back to the first entity. And so on. If one could do that without "spilling" any of the energy from the reverberation process, one could simply create work continually and indefinitely, from any charge of energy. There is no conservation of work law, and the work-energy theorem has been arbitrarily interpreted only for one single change of form of the energy. The universe does this "iterative reuse" of energy; it is just that we've concentrated on changing the form of energy once in our circuits (i.e., in the load), and more or less letting it escape our system (the load) after that. Tesla surged the energy back and forth between special accumulators at the two ends of a single wire, to accomplish the necessary reverberation. This reuse of energy by reverberation between two states

was one of his secrets.

[15] And this specifically includes as the *primary* change, the change between time-energy and 3-space energy, and vice versa.

[16] Again, see my "Giant Negentropy" paper. The easiest thing in all the world to do, is to engineer negentropy, simply by making a little dipole. That blasts the daylight out of classical 3-equilibrium thermodynamics, because 3-symmetry of energy flow is broken by any dipole. Instead, 4-symmetry between inflow of time-energy and outflow of 3-space EM energy applies, and there is no 3-space EM energy input to the dipole at all.

[17] We have already pointed out that the notion of "energy source" hides a very special kind of energy and a very special kind of EM energy flow symmetry. The same is true for the notion of "energy sink", but this cannot be further discussed until certain patent applications in process of being filed are secured. We merely note that the gauge freedom principle of quantum field theory, applied to "source" and "sink" concepts, tells us already that we can change the form of the energy involved in a "sink" to the form of energy involved in a source". For the rest, one must wait for my forthcoming book, T.E. Bearden, Energy from the Vacuum: Principles and Concepts, World Scientific, 2002 (in process).

[18] For Lamb's work that led to his Nobel prize, see Willis E. Lamb, Jr. and Robert C. Retherford, "Fine structure of the hydrogen atom by a microwave method," Physical Review, 72(3), Aug. 1, 1947, p. 241-243. . Lamb received the 1955 Nobel Prize in physics jointly with Polykarp Kush for experiments measuring the small displacement later called the "Lamb shift" of 0+ne of the energy levels in atomic hydrogen. The reader should be advised that, even though this is a small effect, the *energy density* involved is greater than the surface energy density of the sun.

[19] In 1956, Lee predicted broken symmetry. In 1957, Wu et al. proved it experimentally, whereupon the Nobel Prize was awarded to Lee in the same year, 1957. Two charges of opposite sign, separated, do constitute such a broken symmetry in the vacuum flux. See T.D. Lee, "Question of Parity Conservation in Weak Interactions," Physical Review, 104(1), Oct. 1, 1956, p. 254-259; T. D. Lee, Reinhard Oehme, and C. N. Yang, "Remarks on Possible Noninvariance under Time Reversal and Charge Conjugation," Physical Review, 106(2), 1957, p. 340-345; T. D. Lee, "Weak Interactions and Nonconservation of Parity," Nobel Lecture, Dec. 11, 1957; C. S. Wu, E. Ambler, R. W. Hayward, D. D. Hoppes and R. P. Hudson, Experimental Test of Parity Conservation in Beta Decay," Physical Review, Vol. 105, 1957, p. 1413

[20] Consider the observable charge together with its clustering virtual charges of opposite sign. Take a differential piece of the charge, together with one of the virtual charges. That constitutes a dipole. So the charge can be treated as a set of composite dipoles. Each of the dipoles has a scalar potential between its ends. That potential then decomposes via Whittaker 1903. By correcting Whittaker's misinterpretation of the phase conjugate wave, immediately one has the solution to the source charge problem: the vacuum energy is input to the charge from the time domain (fourth Minkowski axis). The charge absorbs this time-energy, transduces it into excitation energy in 3-space, then remits its excitation energy as real EM energy flow in 3-space, in all directions.

[21] Note that one does not calculate "the magnitude of the field", but only the intensity of the field at a point occupied by it. The field itself may extend across all space, from its "source charge". Similarly one does not calculate the "magnitude of the potential", but only its intensity at a point occupied by it. Many electrical engineers are nonplussed to realize that they have never calculated the magnitude of either a potential or a field. They also are often startled to realize that, from any nonzero potential ϕ , one may intercept and collect any amount of energy W from ϕ by using sufficient intercepting charge q . The formula is $W = \phi q$. That is because both the field and the "static" or scalar potential actually involve continuous energy flow.

[22] See Ilya Prigogine (with G. Nicolis), Self-Organization in Non-Equilibrium Systems: From Dissipative Structures to Order through Fluctuations, Wiley, New York, 1977; Ilya Prigogine with D. Kondepudi, Modern Thermodynamics: From Heat Engines to Dissipative Structures, Wiley, Chichester, 1998.

[23] We also clear up another great misunderstanding that is widespread: the difference between efficiency and coefficient of performance. The efficiency of a system is determined by how much useful work it provides, or useful energy it outputs, divided by how much input energy it receives *from all sources*. No system, either in equilibrium or in disequilibrium, can exceed 100% efficiency. If it has any internal losses, etc., any EM system will always have efficiency less than 100%. However, coefficient of performance compares the useful work provided, or the useful energy the system outputs, to the operator's input of energy. Thus a system can indeed have a $COP > 1.0$, even if its efficiency $\xi < 100\%$. An example is the common home heat pump, which has a $COP = 4.0$ or so in ideal operating conditions, while at the same time having an efficiency of less than 50%.

[24] For the several functions played by the surface charges and their excitation energy, see J. D. Jackson, "Surface charges on circuit wires and resistors play three roles," American Journal of Physics, 64(7), July 1996, p. 855-870.

[25] More rigorously, we introduce the concept of the supersystem, which consists of three components: (i) the physical electrical system and its dynamics, (ii) the local active vacuum and its components, and (iii) the active local curvatures of spacetime and their dynamics. All three components of the supersystem interact with each other. No circuit analysis is actually complete until the supersystem has been analyzed. U(1) symmetry electrodynamics arbitrarily and falsely assumes that the local vacuum is inert, so that no broken symmetry with it exists, and falsely assumes that the local spacetime is flat. Hence it discards the two components of the supersystem that comprise the "active environment" of the physical electrical system. In such case, by assuming equilibrium with the active environment, U(1) electrodynamics arbitrarily discards all overunity electrical power systems, which a priori must be in disequilibrium with an active environment, receiving and using energy from that environment.

[26] To see the actual Lorentz procedure—which he did originally circa 1886—see H. A. Lorentz, Vorlesungen über Theoretische Physik an der Universität Leiden, Vol. V, Die Maxwell'sche Theorie (1900-1902), Akademische Verlagsgesellschaft M.B.H., Leipzig, 1931, "Die Energie im

elektromagnetischen Feld," p. 179-186. Figure 25 on p. 185 shows the Lorentz concept of integrating the EM energy flow vector around a closed cylindrical surface surrounding a volumetric element. This is the procedure which arbitrarily selects only the *diverged* component of the energy flow associated with a circuit—specifically, the small Poynting component striking the surface charges and being diverged into the circuit to power it—and then treats that tiny component as the "entire" EM energy flow. Thereby Lorentz arbitrarily discarded all the extra Heaviside *nondiverged* energy transport component which does not strike the circuit at all, and is just wasted.

[27] Lorentz's actual phrase, translated, was that the discarded nondiverged EM energy flow "has no physical significance." To falsify that statement, refer to Craig F. Bohren, "How can a particle absorb more than the light incident on it?" American Journal of Physics, 51(4), Apr. 1983, p. 323-327. See Endnote {34 }.

[28] E.g., see D.S. Jones, The Theory of Electromagnetism, Pergamon Press, Oxford, 1964, p. 52. Quoting: "*It is possible to introduce the Poynting vector S , defined by $S = E \times H$, and regard it as the intensity of energy flow at a point. This procedure is open to criticism since we could add to S any vector whose divergence is zero without affecting [the basic integration procedure's result].*" Obviously if we have such a nondiverged additional EM energy flow there, the diverged Poynting energy flow is not the *total* energy flow at all. Quoting J. D. Jackson, Classical Electrodynamics, Second Edition, Wiley, 1975, p. 237: "*...the Poynting vector is arbitrary to the extent that the curl of any vector field can be added to it. Such an added term can, however, have no physical consequences.*" Note that the divergence of a curled field is zero. So Jackson has also stated that a nondivergent energy flow accompanying the diverged Poynting component can have no physical significance. That is in error. It has no physical significance for the *specific diversion process by that specific diverger* that is intercepting and diverging the particular Poynting flow component. However, we may place an *additional* interceptor/diverger outside the functional region of that first divergence, and collect (diverge) additional EM energy from Jackson's (actually Lorentz's) "component that can have no physical significance". It can indeed have physical consequences for other divergers (other collection processes outside that volume inclosed by the little Lorentz surface where the energy flow vector is integrated).

[29] E.g., see C. J. Carpenter, "Electromagnetic energy and power in terms of charges and potentials instead of fields," IEE Proceedings A (Physical Science, Measurement and Instrumentation, Management and Education), (UK), 136A(2), Mar. 1989, p. 55-65. Carpenter advocates that $\mathbf{j} \cdot \mathbf{\phi}$ be used as the energy flow vector. For a refutation of Carpenter's argument, see J. A. Ferreira, "Application of the Poynting vector for power conditioning and conversion," IEEE Transactions on Education, 31(4), Nov. 1988, p. 257-264.

[30] Heaviside was self-taught and never attended university. Consequently, he was acutely aware of his lack of the formal Ph.D., and therefore his role as an outsider or near-hermit. Mathematicians had objected to some of the operational methods Heaviside originated, and attacked him resoundingly. Later, these methods were soundly justified and adopted. However, in the 1880s Heaviside was still a very cautious man around academics. He therefore did not plainly state how much larger the remaining component of the energy flow was, but merely referred to it obliquely in terms of angles to a reference. This way, he was not violently attacked as a "perpetual motion nut". In the 1880s,

neither the electron nor the atom had been discovered, there was no knowledge of an active vacuum since quantum mechanics was not born yet, and there was no knowledge of curved spacetime since neither special or general relativity had been born.

[31] And we also wish to alert them to the fact that the Sachs unified field theory provides an excellent framework to deal with and analyze the supersystem, which must be done to design and build overunity EM power systems. Further, higher symmetry electrodynamics is required rather than U(1) electrodynamics. The O(3) electrodynamics originated by Evans and Vigier, and further pioneered by Evans, is ideal for engineering such overunity systems and understanding them. Some pertinent papers and books are: M. W. Evans (Ed.), Modern Nonlinear Optics, Second Edition, Wiley, 2001, 3 vols. (in press), comprising a Special Topic issue as Vol. 114, I. Prigogine and S. A. Rice (series eds.), Advances in Chemical Physics, Wiley, ongoing. In that reference, particularly see M. W. Evans, "O(3) Electrodynamics," a review of some 250 pages; M. W. Evans, "The Link Between the Sachs and O(3) Theories of Electrodynamics," M. W. Evans, "Link Between the Topological Theory of Ranada and Trueba, the Sachs Theory, and O(3) Electrodynamics," T. E. Bearden, "Extracting and Using Electromagnetic Energy from the Active Vacuum," T. E. Bearden, "Energy from the Active Vacuum: The Motionless Electromagnetic Generator," Hal Fox, "Energy for the Future: High Density Charge Clusters," Mendel Sachs, "Symmetry in Electrodynamics: From Special to General Relativity, Macro to Quantum Domains," B. Lehnert, "Optical Effects of an Extended Electromagnetic Theory," Lawrence B. Crowell, "Non-Abelian Electrodynamics: Progress and Problems," S. Jeffers, J.-P. Vigier, and M.W. Evans, "Current Status of the Quantum Theory of Light," Petar K. Anastasovski and David. B. Hamilton, "The Superluminal Theory and Effects," and Terence W. Barrett, "Topological Approaches to Electromagnetism." Also see M. W. Evans, P. K. Anastasovski, T. E. Bearden *et al.*, "Explanation of the Motionless Electromagnetic Generator with O(3) Electrodynamics," Foundations of Physics Letters, 14(1), Feb. 2001, p. 87-94; — "Explanation of the Motionless Electromagnetic Generator with the Sachs Theory of Electrodynamics," Foundations of Physics Letters, 14(4), 2001, p. 387-393 (in press), — "Operator Derivation of the Gauge Invariant Proca and Lehnert Equation: Elimination of the Lorentz Condition," Foundations of Physics, 39(7), 2000, p. 1123-1130; — "Effect of Vacuum Energy on the Atomic Spectra," Foundations of Physics Letters, 13(3), June 2000, p. 289-296; — "Runaway Solutions of the Lehnert Equations: The Possibility of Extracting Energy from the Vacuum," Optik, 111(9), 2000, p. 407-409; — "Classical Electrodynamics Without the Lorentz Condition: Extracting Energy from the Vacuum," Physica Scripta 61(5), May 2000, p. 513-517. Particularly see M. W. Evans, P. K. Anastasovski, T. E. Bearden *et al.*, "The New Maxwell Electrodynamics Equations: New Tools for New Technologies. A Collection of 60 papers from the Alpha Foundation's Institute for Advanced Study. Published as a Special Issue of the Journal of New Energy, 4(3), Winter 1999. 335 p.

[32] The supply of cheap, low sulphur oil is declining *now*.

[1]. W. K. H. Panofsky and M. Phillips, Classical Electricity and Magnetism, Addison-Wesley, Reading, MA, 1962, 2nd edition, p. 181 shows the Lorentz closed cylindrical surface integration trick

that erroneously discards most of the available EM energy flow vector while retaining only that small component striking the circuit and being diverged into it—in short, the Poynting component of the Poynting vector that acts to produce the Slepian vector.

[2]. For a calculation of this nominal 10^{-13} factor, see T. E. Bearden, “Energy Flow, Collection, and Dissipation in Overunity EM Devices,” Proceedings of the 4th International Energy Conference, Academy for New Energy, Denver, CO, May 23-27, 1997, p. 5-51. In Figure 5, p. 16 the fraction of the energy flow that is intercepted and collected by the circuit—i.e., the Poynting component—is roughly shown to be on the order of 10^{-13} of the entire energy flow available. We welcome a more careful functional representation by skilled electrodynamicists!

[3]. Most of the energy flow filling space surrounding the circuit will miss the circuit entirely, and just roar on off into space and be wasted. For a view showing that the intercepted and diverged Poynting component actually enters the conductors from the surrounding space, see John D. Kraus, Electromagnetics, Fourth Edn., McGraw-Hill, New York, 1992, Figure 12-60a and 12-60b, p. 578.

[4]. Floyd Sweet and T. E. Bearden, "Utilizing Scalar Electromagnetics to Tap Vacuum Energy," Proceedings of the 26th Intersociety Energy Conversion Engineering Conference (IECEC '91), Boston, Massachusetts, p. 370-375.

[5]. For a good scientific book on the subject, see V. S. L'vov, Wave Turbulence Under Parametric Excitation: Applications to Magnets, Springer Series in Nonlinear Dynamics, Springer-Verlag, New York, 1994. This book covers self-oscillation in permanent magnets and magnetic materials. Professor L'vov is with the Department of Physics, Weizmann Institute of Science, Israel.

[6]. For an excellent advanced treatise on magnetic materials and the novel effects exhibited in them, see Robert C. O'Handley, Modern Magnetic Materials; Principles and Applications, Wiley, New York, 1999.

[7]. Here are two very good references: (1) B. D. Cullity, Introduction to Magnetic Materials, Addison-Wesley, Reading, MA, 1972. Out of print, but a classic—and wonder of wonders, it's written in clear English so one can actually understand it; (2) Harry E. Burke, Handbook of Magnetic Phenomena, Van Nostrand, New York, 1985; this is a one-of-a-kind, indispensable handbook on magnetic effects and magnetic phenomena.

[8]. For a discussion of multivalued magnetic potentials with appropriate references, see T. E. Bearden, “Use of Asymmetrical Regauging and Multivalued Potentials to Achieve Overunity Electromagnetic Engines,” Journal of New Energy, 1(2), Summer 1996, p. 60-78.

[9]. E.g., see S. Itoh *et al.*, "Simulational and experimental studies on anomalous reflectivity of phase conjugate wave," Ferroelectrics, Vol. 170, 1995, p. 209-217. The appearance of multivalued conjugate reflectivities produced by the photorefractive effect was investigated.

[10]. "Wiegand effect: A new pulse-generating option," Automotive Engineering, 86(2), Feb. 1978, p. 44-48; SAE paper 780208, "The Wiegand Effect and its Automotive Applications," by J. David Marks and Michael J. Sinko, The Echlin Manufacturing Co.; "The Wiegand Effect. Some Properties of Wiegand Wire under Asymmetric Sine Wave Drive," by R.C. Barker and J.H. Liaw, Dept. of Engineering and Applied Science, Yale University; D. Botnick, "Access control systems offer programming flexibility," Bank Systems and Equipment, 21(8), Aug. 1984, p. 66-68; J. Buj, "The 'Wiegand effect' enables various devices to be operated with the minimum of electric power," Revista Espanola de Electronica (Spain), 24(267), Feb. 1977, p. 14-17; Phillip E. Wigen, "Wiegand Wire: New Material for Magnetic-Based Devices," Electronics, July 10, 1975, p. 100-105.; Gerald M. Walker, "Wiegand's Wonderful Wires," Popular Science, May 1979, p. 102-104, 109; B. Dance, "The Wiegand effect – its applications," Electron (UK), No. 139, June 5, 1978, p. 23-24; H.J. Gevatter and W.A. Merl, "The Wiegand wire—a new magnetic sensor," Regelungstechnische Praxis (Germany), 22(3), Mar. 1980, p. 81-85 [In German]. See also Guenter H. Kuers, "Wiegand effect in theory and practice," Proceedings of SPIE, vol. 392, Proceedings of the 2nd International Conference on Robot Vision and Sensory Controls, Stuttgart, West Germany, Nov. 2-4, 1982, p. 123-132.

[11]. G. W. O. Howe, "Effect of Torsion on a Longitudinally-Magnetized Iron Wire," Wireless Engineer 29(344), May 1952, p. 115-117.

[12]. See F. Mandl and G. Shaw, Quantum Field Theory, Wiley, 1984.

[13]. For a good introduction to the four photon polarizations, see Lewis H. Ryder, Quantum Field Theory, Second Edition, Cambridge University Press, 1996, p. 147+.

[14]. As witnessed by some 60 ground workers who became ill, some permanently, while handling the debris of the Arrow DC-8 at Gander, Newfoundland which was killed with a Russian longitudinal EM wave interferometer on Dec. 18, 1985. The actual strike of the "ball of glowing EM energy" was witnessed. A photograph of the hole burned through the side of the right fuselage ahead of the engines was later published in Aviation Week & Space Technology. The struck parts of the aircraft were time-charged, and the decay of that charge produced longitudinal EM wave irradiation for some days. Ground crew exposed to that irradiation developed debilitating syndromes such as chronic and severe fatigue, nausea, dizziness, blood changes, chronic headaches, etc.

[15]. Several nations of the world appear to have secretly weaponized longitudinal EM wave weapons for more than two decades, and one of them (Russia) deployed such weapons as early as 1963. These weapons, e.g., have been tested to generate large earthquakes. For a confirmation of the quake-producing EM weapons and that they have been used, we cite the following statement by Secretary of Defense Cohen: *"Others [terrorists] are engaging even in an eco-type of terrorism whereby they can alter the climate, set off earthquakes, and volcanoes remotely through the use of electromagnetic waves... So there are plenty of ingenious minds out there that are at work finding ways in which they can wreak terror upon other nations...It's real, and that's the reason why we have to intensify our [counterterrorism] efforts."* Secretary of Defense William Cohen at an April 1997 counterterrorism conference sponsored by former Senator Sam Nunn. Quoted from DoD News Briefing, Secretary of Defense William S. Cohen, Q&A at the Conference on Terrorism, Weapons of Mass Destruction, and U.S. Strategy, University of Georgia, Athens, Apr. 28, 1997.

[16]. A good overview is given by W. A. Rodrigues, Jr. and J.-Y. Lu, "On the existence of undistorted progressive waves (UPWs) of arbitrary speeds $0 \leq v < \infty$ in nature," Foundations of Physics, 27(3), 1997, p. 435-508. A slightly corrected version is downloadable as hep-th/9606171 on the Los Alamos National Laboratory web site. It includes corrections to the published version. See also W. A. Rodrigues, Jr. and J. Vaz Jr., "Subluminal and Superluminal Solutions in Vacuum of the Maxwell Equations and the Massless Dirac Equation," Advances in Applied Clifford Algebras, Vol. 7 (S), 1997, p. 457-466.

[17]. See Yossef Bodansky, "Soviets testing chemical agents in Afghanistan," Jane's Defence Weekly, 1(3), Apr. 7, 1984, p. 508. The Mujahedin (freedom fighters) thought this was some strange new gas that killed instantly and silently, and called it "smerch" (wind of death) gas. I personally spent two hours in Washington, D.C. with the representative of the Mujahedin to the U.S. government. The Mujahedin saw the silently struck bodies just suddenly drop like limp dishrags, never making a single twitch thereafter. They were totally and instantly dead, down to every cell. The bodies did not decay in the desert sun during the 30 days required for the Mujahedin to fight their way back. No predators or bacteria or insects bothered the bodies where they lay. What the Mujahedin did not know was that the various particles of the struck bodies had been "time-charged" (see my "Giant Negentropy" paper) and a time-charge slowly decays, emitting longitudinal EM radiation. Any predator etc. approaching the bodies would sicken from the LW radiation, fall, and soon expire. The longitudinal EM radiation dies away slowly, the half-life depending upon the degree of initial time-charging. Hundreds of other cases of the use of LW weapons can be given.

[18]. T. E. Bearden, "Mind Control and EM Wave Polarization Transductions, Part I, Explore, 9 (2), 1999, p. 59; Part II, Explore, 9(3), 1999, p. 61, Part III, Explore (in publication).

[19]. This can be understood as follows: The fundamental units used in one's physical model are arbitrary and chosen for convenience. (The arbitrariness of the number of fundamental units utilized is shown by the example of the "natural" system of units used by physicists and having only a single fundamental unit, usually chosen to be mass.). So one can model physics in terms of a single fundamental unit—say, *energy*. In that model, all other entities are functions of energy, in which case time becomes a function totally of energy. The resulting model would be a nightmare for learning, visualizing, and calculating, but it would yield all the correct results. In such case, time turns out to be spatial energy compressed by c^2 , and thus has the same energy density (in the 4th Minkowski axis) as mass has in 3-space. To ease understanding, think of it this way: If I compress some spatial energy (say, EM energy in space) by the factor c^2 , and leave that highly compressed EM energy in 3-space, it is called *mass*. If I put the compressed spatial energy over into the fourth Minkowski axis, it is called *time*. One second of time, if "decompressed" and thereby turned back into 3-space energy, yields some 9×10^{16} joules of spatial energy. As can be seen, active spacetime hardly misses the time-energy extracted by even the largest electrical power plant.

[20]. Note that time and spatial energy in the photon are canonical; their product equals a constant. So the lower the spatial energy (the lesser the photon frequency), the greater the time component, which in energy equivalents is multiplied by nearly 10^{17} . Ironically, low frequency EM

waves and photons have far greater energy than the conventional "high energy" (high frequency) photons so valued by physicists. We have previously pointed out that the low (spatial) energy nuclear reactions (LENR) experienced in cold fusion experiments, are in fact extremely high energy interactions, of greater energy density than used in the most powerful supercollider, when the time-energy is taken into account. See T. E. Bearden, "EM Corrections Enabling a Practical Unified Field Theory with Emphasis on Time-Charging Interactions of Longitudinal EM Waves," Journal of New Energy, 3(2/3), 1998, p. 12-28.

[21]. T. E. Bearden, "Toward a Practical Unified Field Theory and a Deep Experimental Example," Proc. INE Symposium, Univ. Utah, Aug. 14-15, 1998; — "EM Corrections Enabling a Practical Unified Field Theory with Emphasis on Time-Charging Interactions of Longitudinal EM Waves," Explore, 8(6), 1998, p. 7-16.

[22]. E.g., see Owen Flynn, "Parametric arrays: A new concept for sonar," Electronic Warfare Magazine, June 1977, p. 107-112. Any two sine-wave frequencies as simultaneous drivers combine to produce a sine-wave difference frequency propagating in water (or in an isotropic nonlinear medium), essentially without sidebands or reverberations. Its pattern has a main lobe approximately equal to that of the high frequency drive, but devoid of sidelobes. The level of the propagating difference frequency is proportional to both the product of the two fundamental drive levels and to the square of the desired value of difference frequency.

[23]. M. I. Dykman *et al.*, "Noise-enhanced heterodyning in bistable systems," Physical Review E, 49(3), Mar. 1994, p. 1935-1942.

[24]. Gabriel Kron, "Numerical solution of ordinary and partial differential equations by means of equivalent circuits." Journal of Applied Physics, Vol. 16, Mar. 1945a, p. 173.

[25]. Gabriel Kron, "Electric circuit models of the Schrödinger equation," Phys. Rev. 67(1-2), Jan. 1 and 15, 1945, p. 39. See also S. Austen Stigant, "Gabriel Kron on Tensor Analysis, A Bibliographical Record," BEAMA Journal, Aug. 1948, for a full bibliography of Kron's outstanding publications.

[26]. Gabriel Kron, "The frustrating search for a geometrical model of electrodynamic networks," Journal unk, circa 1962, p. 114. See also Gabriel Kron, "Invisible dual (n-1) networks induced by electric 1-networks," IEEE Transactions on Circuit Theory, CT-12(4), Dec. 1965, p. 464-470.

[27]. John Bedini and I have filed a patent application on the flow of a novel kind of EM energy current between any two points at different potentials in an EM circuit. This also includes a process for converting that novel (and in an overunity system, detrimental) energy current into ordinary electrical current fed into the input section of the overunity system. Thus we are in patent pending status on the major method for close-looping a COP>1.0 EM system. Details cannot be provided until our foreign patent filings are secured. We will caution all overunity researchers that the simple-minded notion that ordinary clamped positive feedback can close-loop a COP>1.0 electrical power

system is naïve to the extreme. Unless one understands the supersystem (noted elsewhere in the footnotes), one cannot understand Kron's statement of his open path, and one cannot begin to understand close-looping an electrical power system for self-powering operation. This entire area is of the utmost importance to physics; e.g., it appears that the strange energy flow we discovered in overunity systems is responsible for the antigravity that is causing the acceleration of the expanding universe.

[28]. See P.L. Alger, Ed., The Life and Times of Gabriel Kron, or *Walking Around the World, and Tensors*, Mohawk Development Services, Inc., Schenectady, NY, 1969; Banesh Hoffman, "Kron's Non-Riemannian Electrodynamics," Reviews of Modern Physics, 21(3), 1949, p. 535-540; K. Kondo and Y. Ishizuka, "Recapitulation of the Geometrical Aspects of Gabriel Kron's Non-Riemannian Electrodynamics," Research Association of Applied Geometry, Memoirs of the Unifying Study of Basic Problems in Engineering and Physical Sciences by Means of Geometry, Gakujutsu Bunken Fukyu-kai, Tokyo, Vol. I, 1955, p. 185-239 (particularly see footnote 1, p. 222).

[29]. However, it may have involved multiply-connected spacetime, in which a single bit of energy can be in two different spatial locations (to the external observer) simultaneously. In short, the external observer sees a direct and unique "energy amplification" since he sees twice as much energy existing in his frame. In theory any number of spatial points in a normal frame can be multiply connected, similar to a quantum potential. Energy appearing at one MCS-point will simultaneously appear at every other, since in MCS all the points are superposed. For the connection to Kron's work, we quote J. W. Lynn and R.A. Russell, "*Kron has never published details of his method of making the polyhedron self-organizing, although his published results show that in this state it has some remarkable properties, associated with harmonic integrals on multiply connected spaces.*" [J.W. Lynn and R.A. Russell, "Kron's Wave Automaton," Journal unk, date unk., p. 131.]

[30]. For a skeptical reference, see K. C. Cole, "Experts Scoff at Claim of Electricity Flowing with 'Negative Resistance'," Los Angeles Times, July 10, 1998. I wrote a rebuttal to the editor, but it was not published. Professor Chung is a leading scientist in "smart materials" (materials that act similar to electronic circuits) in the United States and she is widely published.

[31]. Nabil M. Lawandy, M. Balachandran, A. S. L. Gomes and E. Sauvain, "Laser action in strongly scattering media," Nature, 368(6470), Mar. 31, 1994, p. 436-438. For a good lay article complete with color pictures, see Ivars Peterson, "Boosted light: Laser action in white paint," Science News, 145(15), Apr. 9, 1994, p. 228-229. See also P. Mandel, "Lasing without inversion: A useful concept?" Contemporary Physics, Vol. 34, 1993, p. 235; O. Kocharovskaya, "Amplification and lasing without inversion," Physics Reports, Vol. 219, 1992, p. 175.

[32]. For example, see Nabil M. Lawandy, "Optical Gain Medium Having Doped Nanocrystals of Semiconductors and Also Optical Scatterers," U.S. Patent No. 5,434,878, July 18, 1995. A pending co-patent application serial No. 08/210,710, filed Mar. 19, 1994 entitled "Optical Sources Having a Strongly Scattering Gain Medium Providing Laser-like Action" has also probably been granted.

[33]. Diederik Wiersma and Ad Lagendijk, "Laser Action in Very White Paint," Physics World, Jan. 1997, p. 33-37. A slight update of the article, along with other pertinent and updated

references is given on website <http://www.wins.uva.nl/research/scm/adlag/articles/dgain.htm>.

[34]. Craig F. Bohren, "How can a particle absorb more than the light incident on it?", American Journal of Physics, 51(4), Apr. 1983, p. 323-327. In the same issue, see independent confirmation of Bohren's work by H. Paul and R. Fischer, "Comment on 'How can a particle absorb more than the light incident on it?'," American Journal of Physics, 51(4), Apr. 1983, p. 327. Under nonlinear conditions, a particle can absorb more energy than is in the light incident on it. Metallic particles at ultraviolet frequencies are one class of such particles and insulating particles at infrared frequencies are another. Bohren shows an experiment that outputs 18 times as much energy as is input to it via "conventional" calculations. The absorbing particles are simply resonated, so they sweep out a greater reaction cross section than the static charge by which the field, potential, and field intensity is defined. So the resonant charges sweep past the normal Poynting-diverged" zone into the usually nondiverged Heaviside zone, and absorb additional energy—some 18 times as much, which is then re-emitted as real energy. This is a verifiable overunity process which any good university nonlinear optics laboratory can easily perform. Other pertinent references are V.S. Letokhov, "Laser Maxwell's demon," Contemporary Physics, 36(4), 1995, p. 235-243; — "Generation of light by a scattering medium with negative resonance absorption," Soviet Physics JETP, 26(4), Apr. 1968, p. 835-839; — "Double γ - and optical resonance," Physics Letters A, Vol. 43, 1973, p. 179-180.; — "Stimulated emission of an ensemble of scattering particles with negative absorption," ZhETF Plasma, 5(8), Apr. 15, 1967, p. 262-265. Pappalardo, R. and A. Lempicki, "Brillouin and Rayleigh Scattering in Aprotic Laser Solutions Containing Neodymium," Journal of Applied Physics, Apr. 1992, p. 1699-1708.

[35]. D. D. Davis and S. C. Mettler, "Experimental investigation of the fiber fuse." Summaries of Papers Presented at the Conference on Optical Fiber Communication, Vol. 8 1995 Technical Digest Series, Postconference Edition, 1995, p. 187-188. the fiber fuse is a phenomenon that results in catastrophic destruction of an optical-fiber core, occurring at laser propagation powers of a watt or more. The effect is accompanied by a bright white light propagating down the fiber, like a fuse burning toward an explosive, which led to the term "fiber fuse." The mechanism has been theorized to be self-propelled self-focusing, though some experiments have found evidence for thermal shock waves and chemical reactions. See D. P. Hand and P. St. J. Russell, "Solitary thermal shock-waves and optical damage in optical fibers," IEE Colloquium on 'Non-Linear Optical Waveguides', IEE Digest No. 88, London, England, 1988, p. 101-103; — "Solitary thermal shock waves and optical damage in optical fibers: the fiber fuse," Optics Letters, 13(9), Sep. 1988, p. 767-769. See particularly Pierre St. James Russell, "Power conservation and Field Structures in Uniform Dielectric Gratings," Journal of the Optical Society of America A, 1(30), Mar. 3, 1984, p. 293-299. In his analysis of the energetics, Russell has noted apparent violation of local conservation of energy. This is true if the vacuum-mass interaction is not taken into account, which Russell did not do. Russell's analysis supports the fact that (i) the vacuum-mass interaction is required, (ii) the fiber fuse does utilize some of its extra gated Heaviside vacuum energy, and therefore is an open system far from equilibrium, which can output more energy than was input by the operator. Interestingly, if the fiber fuse is then relit from the other end of an optical cable previously damaged by an earlier fiber fuse, the new fiber fuse will often march back down the cable, re-filling the previously melted holes!

[36]. E.g., see L. Mandelstam [Mendel'shtam, L. I.], N. Papalexii, A. Andronov, S. Chaikin and

A. Witt, "Report on Recent Research on Nonlinear Oscillations," Translation of "Expose Des Recherches Recentes Sur Les Oscillations Non Lineaires," Technical Physics of the USSR, Leningrad, Vol. 2, 1935, p. 81-134 [NASA Translation Doc. TT F-12,678, Nov. 1969]. See also A. Andronov, "The limiting cycles of Poincare and the theory of self-maintained oscillations," Comptes-Rendus, Vol. 189, 1929, p. 559; — and A. Witt, , "On the mathematical theory of self-excitations," Comptes-Rendus, Vol. 190, 1930, p. 256; — On the mathematical theory of self-excitation systems with two degrees of freedom," Zhurnal Tekhnicheskioi Fiziki, 4(1), 1934.

[37]. Franklin B. Mead and Jack Nachamkin, "System for Converting Electromagnetic Radiation Energy to Electrical Energy," U.S. Patent No. 5,590,031, Dec. 31, 1996.

[38]. E.g., see G. Nicolis and I. Prigogine, (1987), Exploring Complexity, Piper, Munich, 1987; — Exploring Complexity: An Introduction, Freeman, New York, 1989. For a good layman's treatise, see Gregoire Nicolis, "Physics of far-from-equilibrium systems and self-organization," Chapter 11 in Paul Davies, Ed., The New Physics, Cambridge University Press, Cambridge, 1989, p. 317-347. See particularly Ilya Prigogine, The End of Certainty: Time, Chaos, and the New Laws of Nature, Free Press, New York, 1996, 1997; — From Being to Becoming: Time and Complexity in the Physical Sciences, W.H. Freeman and Company, San Francisco, 1980.

[39]. Richard P. Feynman, Robert B. Leighton, and Matthew Sands, Lectures on Physics, Addison-Wesley, Reading, MA, Vol. 1, 1964, p. 4-2.

[40]. Hsu-Chieh Yeh, "Remark on the second law of thermodynamics," American Journal of Physics, 52(8), Aug. 1984, p. 720+.

[41]. *Ibid.*, p. 721.

[42]. A. A. Logunov and Yu. M. Loskutov, "Nonuniqueness of the predictions of the general theory of relativity," Sov. J. Part. Nucl., 18(3), May-June 1987, p. 179-187.

[43]. Maciej J. Ogorzalek, Chaos and Complexity in Nonlinear Electronic Circuits, World Scientific, New Jersey, 1997.

[44]. Alexander L. Fradkov and Alexander Yu. Pogromsky, Introduction to Control of Oscillations and Chaos, World Scientific Series on Nonlinear Science E, Series Editor Leon O. Chua, World Scientific, New Jersey, 1998, p. 8.

[45]. *Ibid.*, p. 359-360.

[46]. Ibrahim Semiz, "Black hole as the ultimate energy source," American Journal of Physics, 63(2), Feb. 1995, p. 151-156.

[47]. D.K Sen, Fields and/or Particles, Academic Press, London and New York, 1968, p. viii.

[48]. Maxwell's seminal EM paper was J. C. Maxwell, "A Dynamical Theory of the Electromagnetic Field," Royal Society Transactions, Vol. CLV, 1865, p 459. Read Dec. 8, 1864. Also in The Scientific Papers of James Clerk Maxwell, 2 vols. bound as one, edited by W. D. Niven, Dover, New York, 1952, Vol. 1, p. 526-597. In the latter, two errata are given on the unnumbered page prior to page 1 of Vol. 1. In this paper Maxwell presents his seminal theory of electromagnetism, containing 20 equations in 20 unknowns. His general equations of the electromagnetic field are given in Part III, General Equations of the Electromagnetic Field, p. 554-564. On p. 561, he lists his 20 variables. On p. 562, he summarizes the different subjects of the 20 equations, being three equations each for magnetic force, electric currents, electromotive force, electric elasticity, electric resistance, total currents; and one equation each for free electricity and continuity. In the paper, Maxwell adopts the approach of first arriving at the laws of induction and then deducing the mechanical attractions and repulsions.

[49]. E.g., see Stanley W. Angrist, "Perpetual Motion Machines," Scientific American, Vol. 218, Jan. 1968, p. 114-122. Angrist gives a typical critique using classical equilibrium thermodynamics. He calls *permissible* overunity systems (open dissipative systems receiving excess energy from an external source) *false perpetual motion machines*. See also Angrist's article, "Perpetual Motion," Encyclopaedia Britannica, Bicentennial Edition, Macropaedia Vol. 14, 1976, p. 102-105. Here he gives a very good summary of the subject as ordinarily posed, with precise definitions included for perpetual motion machines of the first, second, and third kinds and for fictitious perpetual motion machines. Unfortunately his argument is completely irrelevant to permissible overunity machines, which he already labels "fictitious perpetual motion machines" and admits they exist. The substance of his argument then is that systems in equilibrium cannot power themselves. That is quite true, but is a mere tautology and has no relation to an open system in disequilibrium, receiving excess energy. So he demolishes a dummy strawman, while ignoring the Statue of Liberty under his very nose.

[50]. Indeed, once the active vacuum is considered, there is no such thing as a "closed system" in all the universe. Every system is open, at least to the vacuum exchange. So the most that can be legitimately raised as a question is the matter of a system in equilibrium. Even so, the system is subject to individual fluctuations, and may thus be subject to nonlinear oscillations, chaotic operation, etc.

[51]. P. Drude, Ann. Physik, Vol. 1, p. 566; Vol. 3, 1900, p. 370, 869. Here Drude first developed a theory of conductivity in a metal based on the assumption that there is a gas of free electrons in the metal. This gas of conduction electrons is often referred to as the "Drude gas." Note that this was shortly after J. J. Thomson's discovery of the electron in 1897.

[52]. John D. Kraus, Electromagnetics, Fourth Edn., McGraw-Hill, New York, 1992, Figure 12-60, a and b, p. 578.

[53]. E.g., the trick can be seen in Wolfgang Panofsky and Melba Phillips, Classical Electricity and Magnetism, Second Edition, Addison-Wesley, Menlo Park, CA, 1962, third printing 1969, p. 181, or in W. Gough and J.P.G. Richards, European Journal of Physics, Vol. 7, 1986, p. 195.

[54]. As an example, the various dipoles in the human body extract from the vacuum and output an energy flow rate of about 10^{15} joules per second. However, the body's reaction cross section is about 10^{-13} , so it actually intercepts, collects, and utilizes about 100 joules per second. So its power output is about 100 watts, about like powering a room light bulb. If the body caught all of that energy, it would instantly explode like a huge bomb with a sudden surge of enormous power. So life as we know it could not exist unless that Poynting reaction cross section were very, very small—which it fortunately is.

[55]. Oliver Heaviside, "Electromagnetic Induction and Its Propagation," The Electrician, 1885, 1886, 1887, and later. A series of 47 sections, published section by section in numerous issues of The Electrician during 1885, 1886, and 1887. Nearly a decade later Heaviside also published prestigiously; see Oliver Heaviside, "On the Forces, Stresses, and Fluxes of Energy in the Electromagnetic Field," Phil. Trans. Roy. Soc. London, 183A, 1893, p. 423-480. Here Heaviside discusses the Faraday-Maxwell ether medium, outlines his vector algebra for analysis of vectors without quaternions, discusses magnetism, gives the EM equations in a moving medium, and gives the EM flux of energy in a stationary medium. On p. 443, he credits Poynting with being first to discover the formula for energy flow, with Heaviside himself independently discovering and interpreting this flow a little later by himself in an extended form..

[56]. Editorial, "The Transfer of Energy," The Electrician, Vol. 27, July 10, 1891, p. 270-272.

[57]. See J. H. Poynting, "On the transfer of energy in the electromagnetic field," Philosophical Transactions of the Royal Society of London, Vol. 175, Part II, 1885, p. 343-361. See also J. H. Poynting, "On the connexion between electric current and the electric and magnetic inductions in the surrounding field," Proc. Roy. Soc. Lond., Vol. 38, 1884-85, p. 168-172. Poynting got the direction of the energy flow wrong, and also only included the energy dissipation flow, eliminating the nonintercepted and nondiverged portion of the flow. [Heaviside corrected him.] Quoting Poynting from p.168: *"This paper describes a hypothesis as to the connexion between current in conductors and the transfer of electric and magnetic inductions in the surrounding field. The hypothesis is suggested by the mode of transfer of energy in the electromagnetic field, resulting from Maxwell's equations investigated in a former paper ("Phil. Trans.," vol. 175, pp. 343-361, 1884). It was there shown that according to Maxwell's electromagnetic theory the energy which is dissipated in the circuit is transferred through the medium, always moving perpendicularly to the plane containing the lines of electric and magnetic intensity, and that it comes into the conductor from the surrounding insulator, not flowing along the wire."*

[58]. Quoting Oliver Heaviside, Electrical Papers, Vol. 2, 1887, p. 94: *"It [the energy transfer flow] takes place, in the vicinity of the wire, very nearly parallel to it, with a slight slope towards the wire... . Prof. Poynting, on the other hand, holds a different view, representing the transfer as nearly perpendicular to a wire, i.e., with a slight departure from the vertical. This difference of a quadrant can, I think, only arise from what seems to be a misconception on his part as to the nature of the electric field in the vicinity of a wire supporting electric current. The lines of electric force are nearly perpendicular to the wire. The departure from perpendicularity is usually so small that I have sometimes spoken of them as being perpendicular to it, as they practically are, before I recognized the great physical importance of the slight departure. It causes the convergence of energy into the*

wire.”

[59]. Yet good electrodynamicists will caution one that the Poynting flow is not to be interpreted as "the" EM energy flow in space. E.g., quoting Wolfgang K. H. Panofsky and Melba Phillips, Classical Electricity and Magnetism, Second Edition, Addison-Wesley, Menlo Park, CA, 1962, third printing 1969, p. 180: "*Paradoxical results may be obtained if one tries to identify the Poynting vector with the energy flow per unit area at any point.*"

[60]. W. T. Grandy Jr., "The Explicit Nonlinearity of Quantum Electrodynamics." in The Electron: New Theory and Experiment, David Hestenes and Antonio Weingartshofer, Eds., Kluwer Academic Publishers, Boston, 1991, p. 149-164.

[61]. T. E. Bearden, Energy from the Vacuum: Principles and Concepts, World Scientific, Singapore, 2002 (in preparation).

[62]. Often naïve objections are vociferously raised that a "static field" or "static potential" cannot be or generate an ongoing continuous energy flow or sets of energy flows. To answer that, we refer to Jed Z. Buchwald, From Maxwell to Microphysics, University of Chicago Press, Chicago and London, 1985, p. 44. Quoting: "*[Poynting's result] implies that a charged capacitor in a constant magnetic field which is not parallel to the electric field is the seat of energy flows even though all macroscopic phenomena are static.*"

[63]. For an even more admirable explanation of what is meant by "static", see Tom Van Flandern, "The speed of gravity – What the experiments say," Physics Letters A, Vol. 250, Dec. 21, 1998, p. 1-11. Quoting p. 8-9: "*To retain causality, we must distinguish two distinct meanings of the term 'static'. One meaning is unchanging in the sense of no moving parts. The other meaning is sameness from moment to moment by continual replacement of all moving parts. We can visualize this difference by thinking of a waterfall. A frozen waterfall is static in the first sense, and a flowing waterfall is static in the second sense. Both are essentially the same at every moment, yet the latter has moving parts capable of transferring momentum, and is made of entities that propagate.*"

As this applies to gravitational fields for a fixed source, if the field were static in the first sense, there would be no need of aberration, but also no apparent causality link between source and target. If the field were static in the second sense, then the propagation speed of the entities carrying momentum would give rise to aberration; and the observed absence of aberration demands a propagation speed far greater than lightspeed.

So are gravitational fields for a rigid, stationary source frozen, or are they continually regenerated? Causality seems to require the latter."

[64]. Indeed, astronomy experiments have now verified that gravity's speed v_g is enormous, being $v_g \geq 2 \times 10^{10} c$. See Tom Van Flandern, *ibid.* Quoting Van Flandern, p. 10: "*To many, this result [astronomy's verification that gravity's speed $v_g \geq 2 \times 10^{10} c$] is so contrary to 'common sense'*"

in the light of relativity theory as to be absurd. But Thomas Kuhn has cautioned all scientists to avoid the trap of becoming so steeped in a prevailing paradigm that it starts to seem like common sense and makes other ideas sound and feel wrong. Eventually, even one's professional status can become linked to a prevailing paradigm."

[65]. And this illustrates what I believe to be so fundamentally wrong in the leadership of the scientific community. *Their own conventional electrodynamics assures them that one can easily make a "free energy generator", such as that electret with its E -field at right angles to that permanent magnet's H -field.* Do the scientific leaders not believe their own science? Here's a two-dollar device that just sits there and pours out EM energy in 3-space continuously and indefinitely, and you do not have to put any 3-space energy in there at all, ever again, once the thing is made and you pay for making it. Okay. *That is half the energy problem solved;* it's producing the energy, freely and indefinitely, once minimal front end costs to make the beast are paid. The second part is working out how to intercept, catch, and use some of it. So why are not our scientific leaders scrambling furiously to fund research into discovering how to catch and use that free energy flow without destroying that magnetic dipole and that electret dipole?

One way or another, it would seem that the American taxpayers are programs. Here is a "free source of EM energy flow", admitted as such in the textbooks, that is easy to build and will work indefinitely. It's a scientific fact, and it's certified by the scientific community itself. So what's the problem? Just because we old fellows never thought to struggle with this novel and demonstrable fact and learn how to use it, does not mean that the young fellows won't do it in fairly short order—if the scientific community will allow them to do the research and fund them to do it. Innovative ideas and experiments with this single "free energy generator" would be worth more than all the billions spent on energy research in other realms.

Once "catching and using" the energy is solved, this silly little experiment yields a permanent solution to the world's electrical energy problems, forever. The energy is environmentally clean and nonpolluting. No hydrocarbon residues. No nuclear wastes produced. No interference with the ozone layer. No contribution at all to global warming. No pollution of the streams, no killing the fish, and no despoiling the pristine wilderness.

Environmentalists, are you listening? Whatever happened to your native curiosity? Why are you not placing the blame for the energy crisis—and the continuing pollution of the biosphere to get electrical energy—where it belongs, squarely on the leaders of the scientific community?

[66]. Nikola Tesla, "The True Wireless," Electrical Experimenter, May 1919.

[67]. That is, unless we utilize the Bedini method for creating a negative resistor in the charging battery, and supercharging the battery while also powering the load. See T. E. Bearden, "Bedini's Method For Forming Negative Resistors In Batteries," Journal of New Energy, 5(1), Summer 2000, p. 24-38. The paper is also carried on <http://www.cheniere.org/> and also on DoE website <http://www.ott.doe.gov/electromagnetic/papersbooks.html> .

[68]. E.g., see J. D. Jackson, Classical Electrodynamics, Second Edition, Wiley, New York, 1975, p. 219-221.

[69]. But see (a) Y. Aharonov and D. Bohm, "Significance of Electromagnetic Potentials in the Quantum Theory," Physical Review, Second Series, 115(3), 1959, p. 485-491; (b) — "Further considerations on electromagnetic potentials in the quantum theory," Physical Review, 123(4), Aug. 15, 1961, p. 1511-1524. Quoting reference (a), p. 485: "...*contrary to the conclusions of classical mechanics, there exist effects of potentials on charged particles, even in the region where all the fields (and therefore the forces on the particles) vanish.*"

[70]. Ingram Block and Horace Crater, "Lorentz-Invariant Potentials and the Nonrelativistic Limit," American Journal of Physics, Vol. 49, No. 1, Jan. 1981, p. 67.

[71]. Charles J. Goebel, "Symmetry Laws," in McGraw Hill Encyclopedia of Physics, Sybal B. Parker, Editor-in-Chief, McGraw Hill, NY, 1983, p. 1137.

[72]. M. W. Evans, P. K. Anastasovski, T. E. Bearden et al., "Classical electrodynamics without the Lorentz condition: Extracting energy from the vacuum," Physica Scripta 61(5), May 2000, p. 513-517. Note that our "asymmetrical regauging" of extra potential energy onto the receiving system was actually a violation of the usual Lorentz symmetry condition.

[73]. One can see the Lorentz regauging and how it is done in J.D. Jackson, Classical Electrodynamics, Second Edition, Wiley, New York, 1975, p. 219-221; 811-812.

[74]. P. K. Anastasovski; T. E. Bearden; C. Ciubotariu; W. T. Coffey; L. B. Crowell; G. J. Evans; M. W. Evans; R. Flower; S. Jeffers; A. Labounsky; B. Lehnert; M. Meszaros; P. R. Molnar; J. P. Vigier; and S. Roy; "Classical electrodynamics without the Lorentz condition: Extracting energy from the vacuum," Physica Scripta 61(5), May 2000, p. 513-517. It is shown that if the Lorentz condition is discarded, the Maxwell-Heaviside field equations become the Lehnert equations, indicating the presence of charge density and current density in the vacuum. The Lehnert equations are a subset of the O(3) Yang-Mills field equations. Charge and current density in the vacuum are defined straightforwardly in terms of the vector potential and scalar potential, and are conceptually similar to Maxwell's displacement current, which also occurs in the classical vacuum. A demonstration is made of the existence of a time dependent classical vacuum polarization which appears if the Lorentz condition is discarded. Vacuum charge and current appear phenomenologically in the Lehnert equations but fundamentally in the O(3) Yang-Mills theory of classical electrodynamics. The latter also allows for the possibility of the existence of vacuum topological magnetic charge density and topological magnetic current density. Both O(3) and Lehnert equations are superior to the Maxwell-Heaviside equations in being able to describe phenomena not amenable to the latter. In theory, devices can be made to extract the energy associated with vacuum charge and current. More than a dozen potential methods of approaching the practical extraction of EM energy from the vacuum is presented.

[75]. We must admit that it may be insanity only in the view of the consumer and the environmentalist. It may be highly lucrative and desirable in the view of the "energy seller".

[76]. We also can do an analogous thing for the fields, but the discussion for the potential will

illustrate the point.

[77]. E. T. Whittaker, "On the Partial Differential Equations of Mathematical Physics," Mathematische Annalen, Vol. 57, 1903, p. 333-355.

[78]. I.e., for the scalar potential between the ends of a dipole that has been around (in original matter) since shortly after the Big Bang. For a source dipole or charge suddenly produced in the laboratory, the resulting potential is being created radially outward in space at the speed of light.

[79]. H. E. Puthoff, "Source of Vacuum Electromagnetic Zero-Point Energy," Physical Review A, 40(9), Nov. 1, 1989, p. 4857-4862.

[80]. Whittaker, Mathematische Annalen, *ibid.*

[81]. Mario Bunge, Foundations of Physics, Springer-Verlag, New York, 1967, p. 182.

[82]. M. W. Evans and S. Kielich., (eds.), Modern Nonlinear Optics, Vol. 85 of I. Prigogine and S.A. Rice (series eds.), Advances in Chemical Physics, Wiley, New York, 1992, 1993, and 1997. See also M.W. Evans et al., "A General Theory of Non-Abelian Electrodynamics," Foundations of Physics Letters, 12(3), June 1999, p. 251. See particularly the collection of more than 30 AIAS papers, in press, to be published shortly as a Special Issue of Journal of New Energy. Presently more than 90 AIAS papers are carried on a Department of Energy website (limited access) for ongoing discussions with DOE scientists.

[83]. E.g., Lawrence B. Crowell, "Generalized Heisenberg Uncertainty Principle for Quantum Fields in Curved Spacetime," Foundations of Physics Letters, 12(6), Dec. 1999, p. 585-591.

[84]. T. W. Barrett and D. M Grimes. [eds.], Advanced Electromagnetism: Foundations, Theory, & Applications, World Scientific, River Edge, New Jersey, 07661, 1995. See particularly T. W. Barrett, "Electromagnetic Phenomena Not Explained by Maxwell's Equations," in Lakhtakia, A. (ed.): Essays on the Formal Aspects of Electromagnetic Theory, World Scientific Publishing, River Edge, NJ, 1993, p. 6-86; T. W. Barrett, "Maxwell's theory extended: Part 1: Empirical reasons for Questioning the Completeness of Maxwell's Theory – Effects Demonstrating the Physical Significance of the A Potentials," Annales de la Fondation Louis de Broglie, 15(2), 1990, p. 143-183; Part II: Theoretical and Pragmatic Reasons for Questioning the Completeness of Maxwell's Theory." Annales de la Fondation Louis de Broglie, 15(3), 1990, p. 253-283.

[85]. L. B. Crowell and M. W. Evans, "SU(2) x SU(2) Electroweak Theory I: The B(3) Field on the Physical Vacuum," Foundations of Physics Letters, Vol. 12, 1999, p. 373; — "SU(2) x SU(2) Electroweak Theory II: Chiral and Vector Fields on the Physical Vacuum," Foundations of Physics Letters, Vol. 12, 1999, p. 475; M.W. Evans and L. B. Crowell, Classical and Quantum Electrodynamics and the B(3) Field, World Scientific, Singapore, 2001.

[86]. E.g., Evans *et al.*, "Inconsistencies of U(1) Gauge Field Theory in Electrodynamics: The

Inverse Faraday Effect," DOE web site; — "Interferometry in Higher Symmetry Forms of Electrodynamics and Physical Optics," Physica Scripta, 61(1), Jan. 2000, p. 79-82; — Inconsistencies in the U(1) Theory of Electrodynamics: Stress Energy Momentum Tensor," Foundations of Physics Letters, 12(2), Apr. 1999, p. 187; — "Empirical Evidence for Non-Abelian Electrodynamics and Theoretical Development," submitted to Annales de la Fondation Louis de Broglie; — "Equations of the Yang-Mills Theory of Classical Electrodynamics," Optik (in press).

[87]. E.g., see Terence W. Barrett, "Electromagnetic Phenomena Not Explained by Maxwell's Equations," in Lakhtakia, A. (ed.), Essays on the Formal Aspects of Electromagnetic Theory, World Scientific Publishing, River Edge, NJ, 1993, p. 6-86.

[88]. Such as Bunge (quoted in this paper), the great John Wheeler, Nobelist Richard Feynman, Cornille, Barrett, etc.

Slide Index

[Figure 1. How the power line is powered, when we turn the shaft of a generator.](#)

[Figure 2. The Heaviside and Poynting energy flow components \(circular\).](#)

[Figure 3. How the closed-current-loop circuit guarantees COP<1.0.](#)

[Figure 4. Table of how broken symmetry developed, etc. Word slide.](#)

[Figure 5. Side view of Heaviside and Poynting components, with P-component entering the circuit.](#)

[Figure 6. Slide with the \$10^{13}\$ estimate.](#)

[Figure 7. Sweet VTA.](#)

[Figure 8. Antigravity test results of Sweet VTA.](#)

[Figure 9. Slide with Romer's statement.](#)

[Figure 10. Extending conservation of energy to include time-energy.](#)

[Figure 11. The Lawandy experiment.](#)

[Figure 12. Bohren's experiment.](#)

[Figure 13. The highly anomalous fiber fuse.](#)

[Figure 14. Five magic functions.](#)

[Figure 15. Perpetual motion machine of the first kind.](#)

[Figure 16. Perpetual motion machine of the second kind.](#)

[Figure 17. Perpetual motion machine of the third kind.](#)

[Figure 18. The Supersystem concept.](#)

[Figure 19. Lorentz' trick to discard the Heaviside nondiverged component.](#)

[Figure 20. Lorentz's single ship illustration.](#)

[Figure 21. Multiple ships surrounding Lorentz's ship.](#)

[Figure 22. Poynting generator \(magnet and electret\). A certified free-energy-flow generator powered by the vacuum.](#)

[Figure 23. Special relaxation circuit using Fe-doped copper wire.](#)

[Figure 24. Importance to Physics of the Fe-doped copper wire experiment.](#)

[Figure 25. Whittaker's decomposition of the scalar potential.](#)

[Figure 26. Rajah's use of asymmetrical regauging systems.](#)

[Figure 27. My electrodynamicist's advice on regauging.](#)

[Figure 28. Some basic definitions of interest.](#)

[Figure 29. What really powers EM circuits and power systems.](#)

[Figure 30. The active vacuum and modern physics.](#)

[Figure 31. Four important symmetry groups.](#)

[Figure 32. Some aspects of strong local symmetry.](#)

[Figure 33. Other aspects of strong local symmetry.](#)

[Figure 34. Choice of fundamental units is arbitrary.](#)

[Figure 35. All EM energy in 3-space comes from the time-domain.](#)

[Figure 36. A dipole is a broken 3-symmetry in its vacuum energy exchange.](#)

[Figure 37. In the future we will more readily "burn time" as fuel for EM energy.](#)

[Figure 38. What the future holds.](#)

Generators make dipoles. They do not add one watt to the powerline.

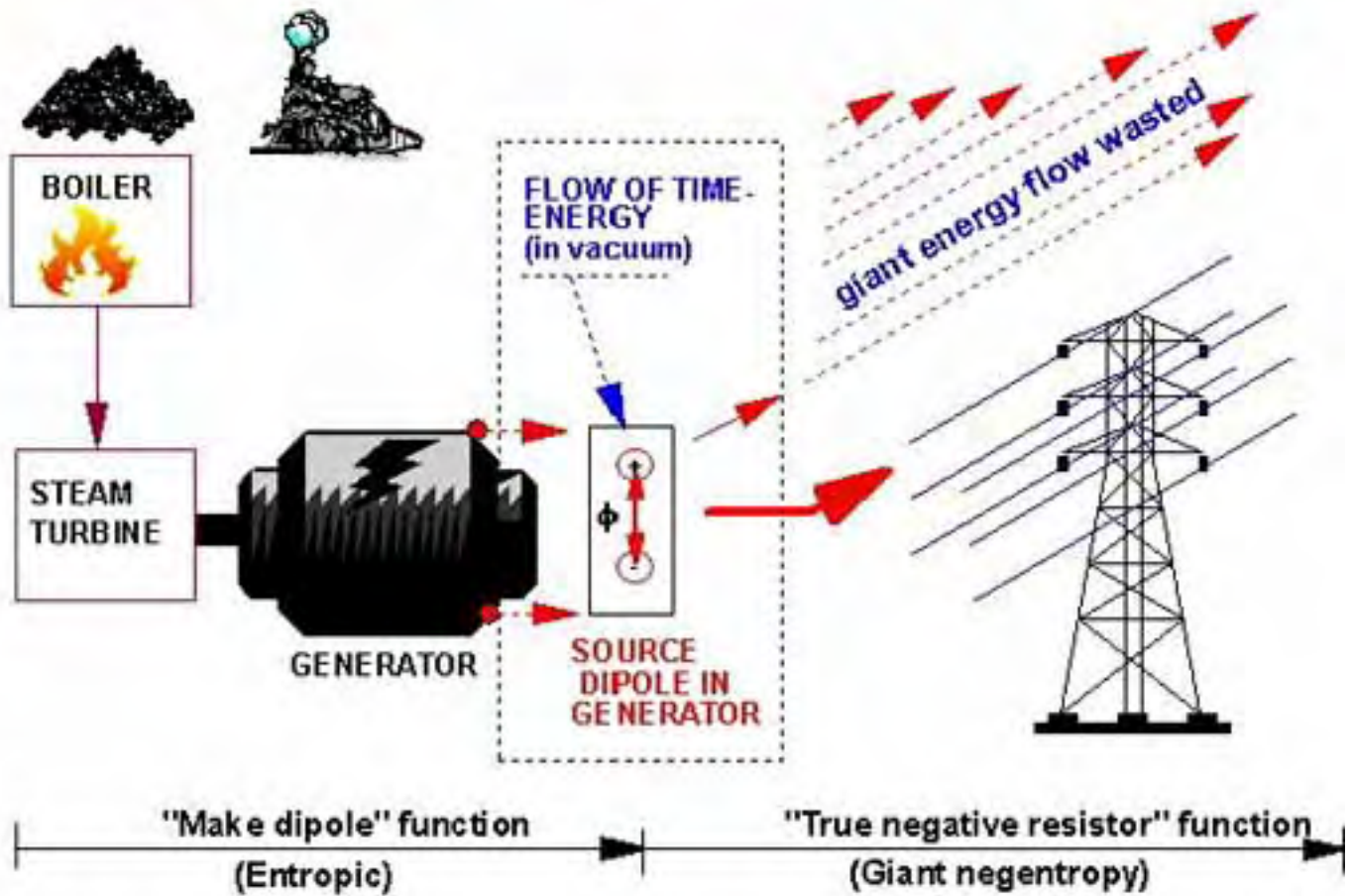

Figure 1. How the power line is powered when we turn the generator shaft.

Energy flow contours around a 2-conductor transmission line

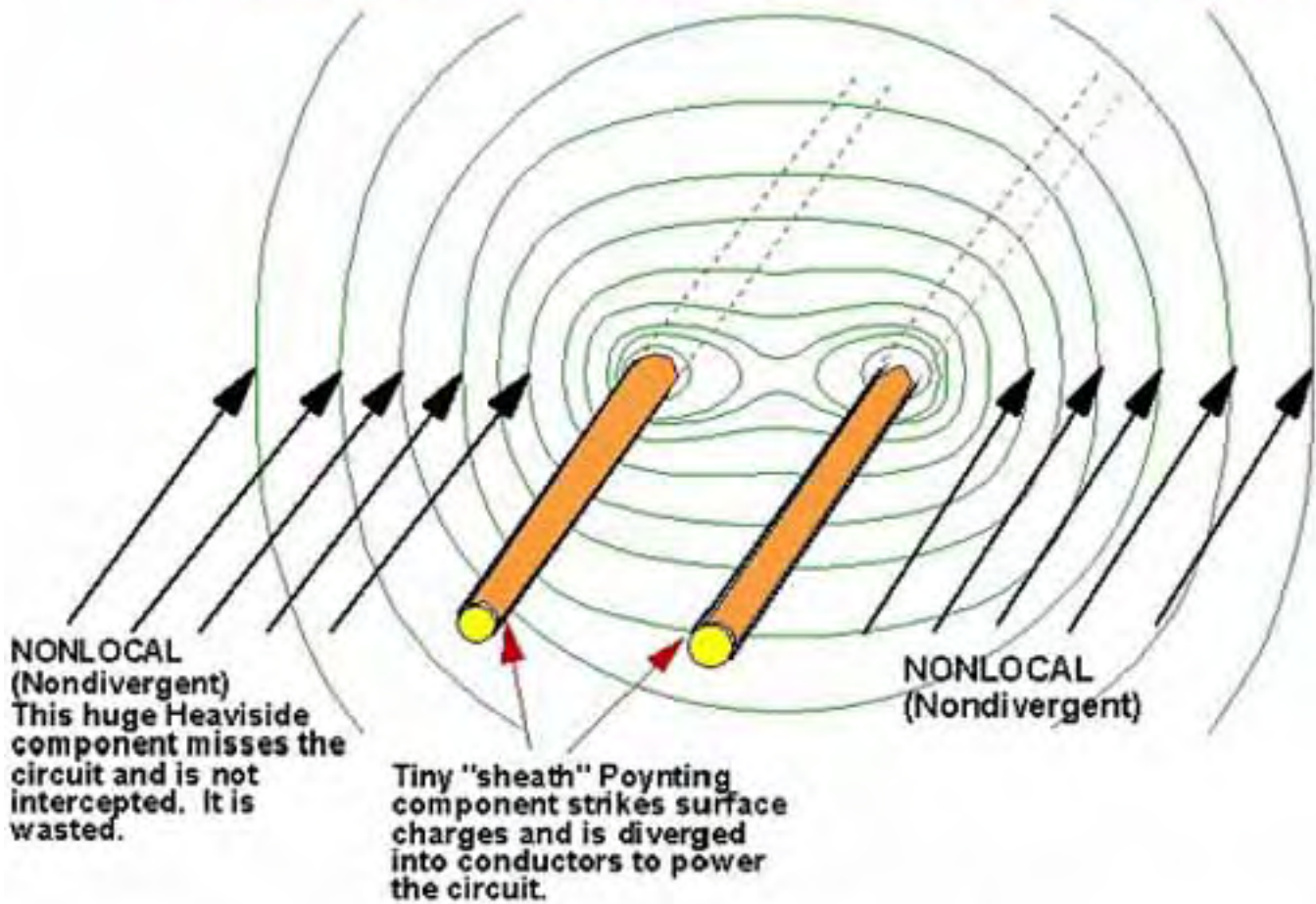
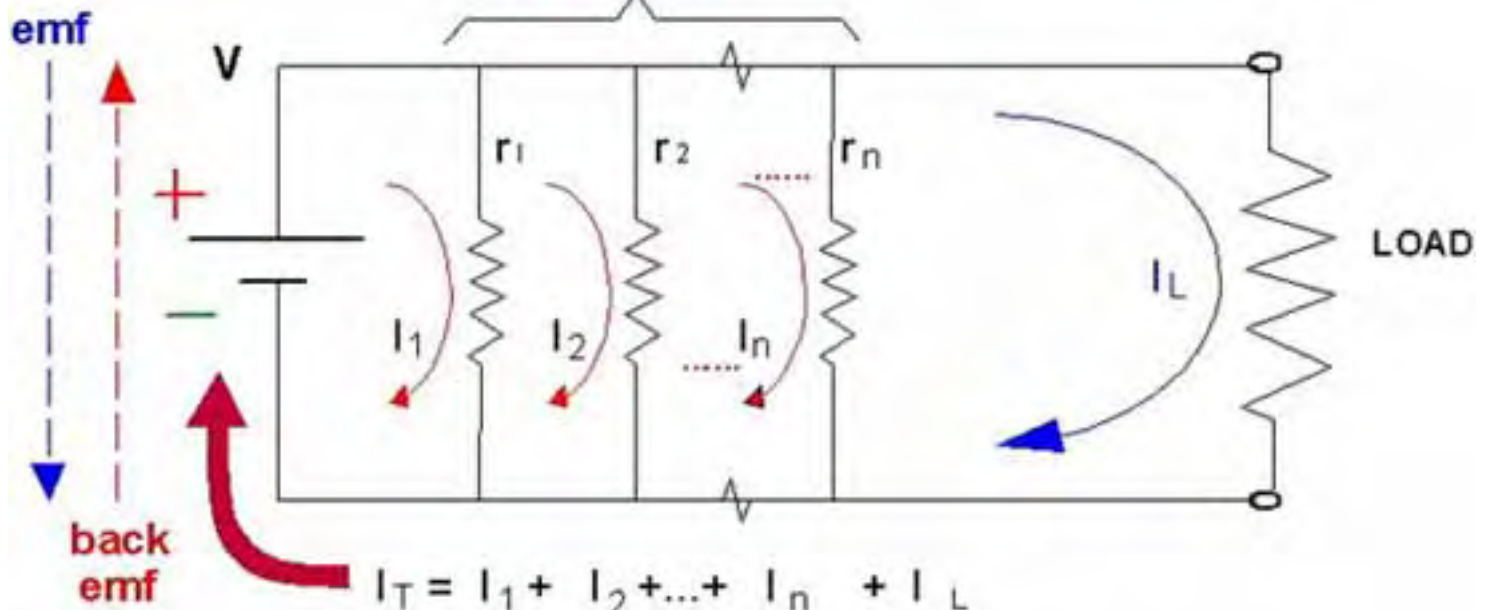

Figure 2. The Heaviside and Poynting energy flow components.

Dissipative power inside source = $V I_T$ and $V I_T > V I_L$

Other losses



$$I_T = I_1 + I_2 + \dots + I_n + I_L$$
$$COP = \frac{P_L}{P_T} = \frac{V \times I_L}{V \times I_T} = \frac{I_L}{I_T}$$

$$I_T > I_L \quad ; \text{ so COP} < 1.0$$

Figure 3. Why a closed-current-loop circuit gives COP<1.0.

Symmetry and Broken Symmetry



- Something is symmetrical if it remains unchanged under a certain operation
- A sphere is symmetric with respect to rotation about its center
- A cathedral arch is left and right symmetric about a vertical line through the center
- Laws of electricity are symmetric with respect to reversal of positive and negative charge.
- In 1956, Lee and Yang strongly predicted broken symmetry
- In early 1957, Wu et al. demonstrated broken symmetry experimentally, in the electroweak interaction
- In latter 1957, Lee and Yang were awarded the Nobel Prize
- A dipole reverses charge between its ends, hence is a broken symmetry.
- Among other things, this means that something virtual has become observable. The dipole absorbs virtual energy from the vacuum, and re-emits real observable EM energy.

Figure 4. Symmetry and broken symmetry.

Heaviside component (nondiverged)

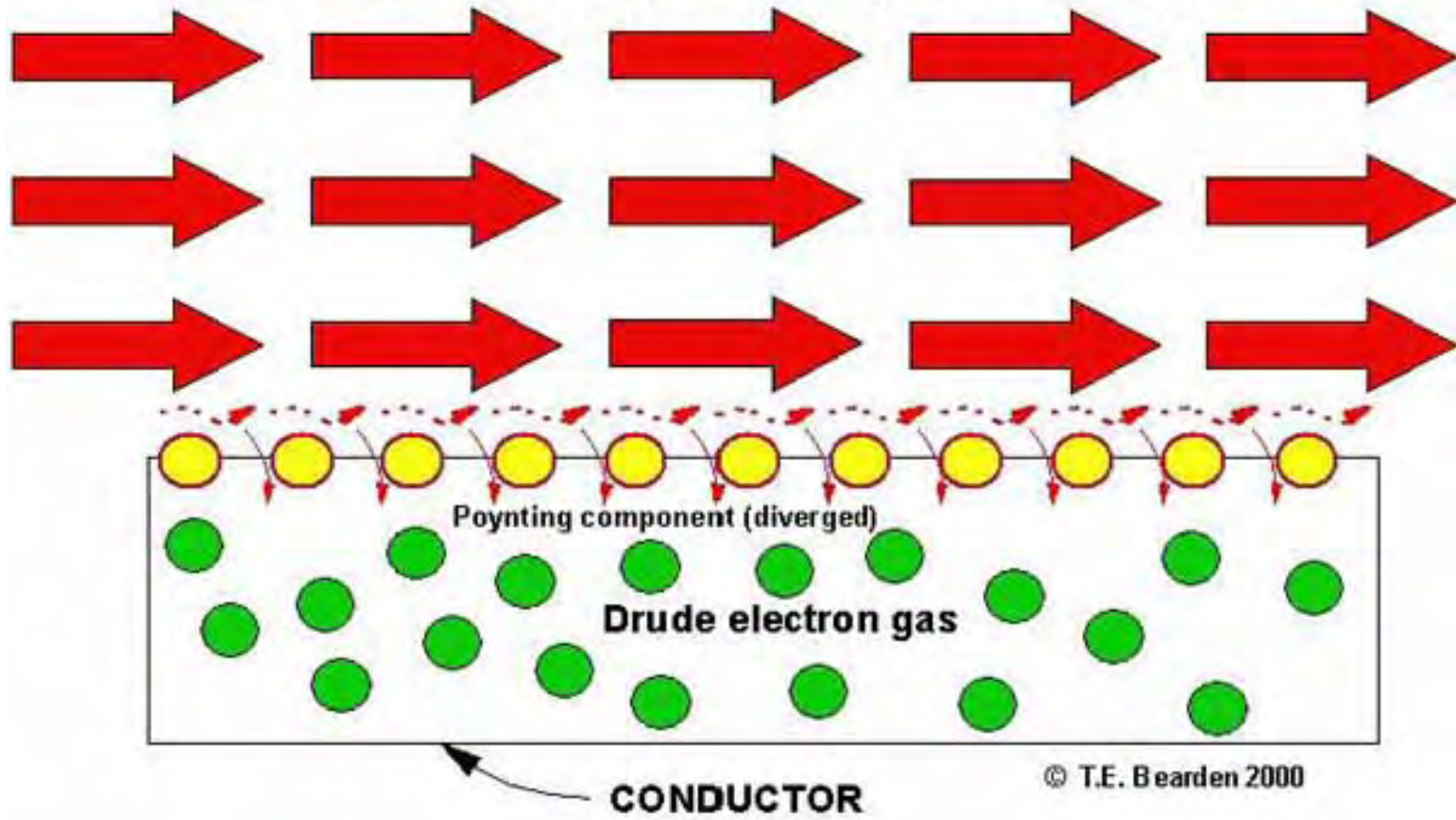
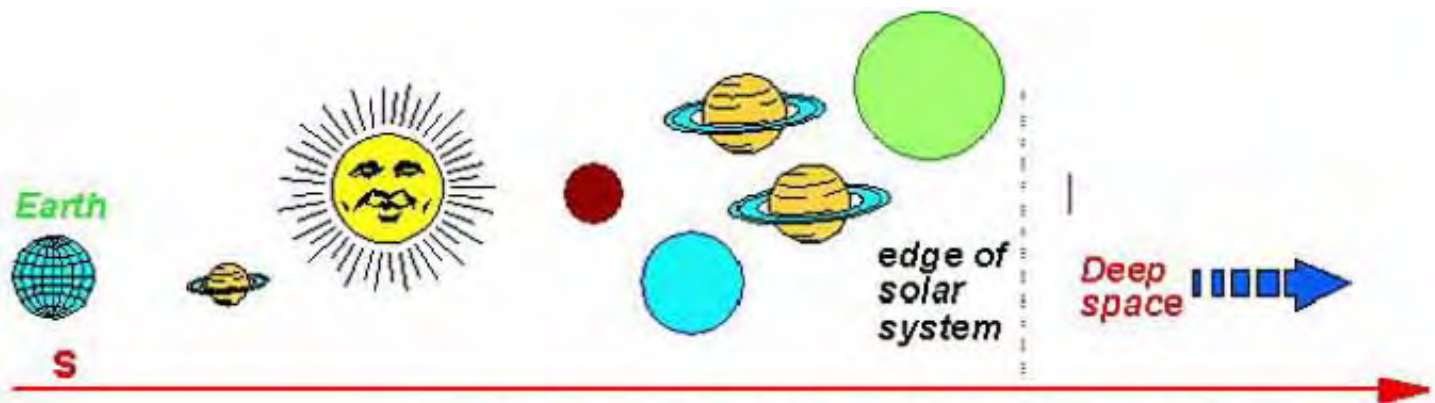

Figure 5. Heaviside and Poynting energy flow components (side view).



Distance traveled by S in one hour is 1.08×10^{12} meters.

Example: 1.3 amps flowing in DC circuit, 1.8 mm diameter copper wire. $J = 51 \text{ A/cm}^2$

S violently transports ϕ provided from the source.

J ϕ sluggishly transports the energy collected and dissipated in the circuit.

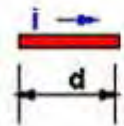

$d_j = 0.1368 \text{ meters}$

For the case discussed, the electron drift velocity in the circuit is about 3.8×10^{-5} meters/sec. So $J\phi$ moves about 0.1368 meters in one hour. Thus $J\phi$ has collected about 0.1368 meters of the ϕ -filled S-tube. During that same hour, the S-flow evoked by the power source will have traveled 1.08×10^{12} meters. The ϕ of both currents is the same. Both are involved in the same energy-filled tube. Thus S has provided and transported about 7.89×10^{12} times as much energy along the circuit in one hour as the $j\phi$ has been able to collect, transport, and dissipate as work in the circuit. This circuit provides about 10^{-13} collection efficiency (interaction cross section).

© 1995 T.E. BEARDEN

Figure 6. Rough estimate of ratio of Heaviside/Poynting components.

Floyd Sweet and his first vacuum triode amplifier (6 watts)

.....

- Two activated magnets facing
- Fields in self-oscillation
- Barium ferrite magnets
- Barium nuclei in self-oscillation
- Barium nuclei self-pumped
- Two coils in quadrature
- Load (lamps, 6 watts)
- Later made 500 watt VTA, then 5 kilowatt VTA

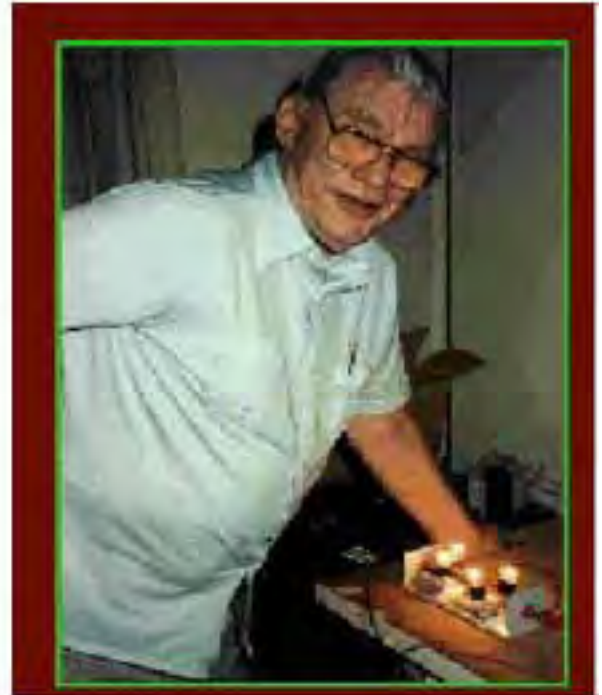

Figure 7. Sweet's first vacuum triode amplifier (6 watts).

Sweet VTA antigravity test results

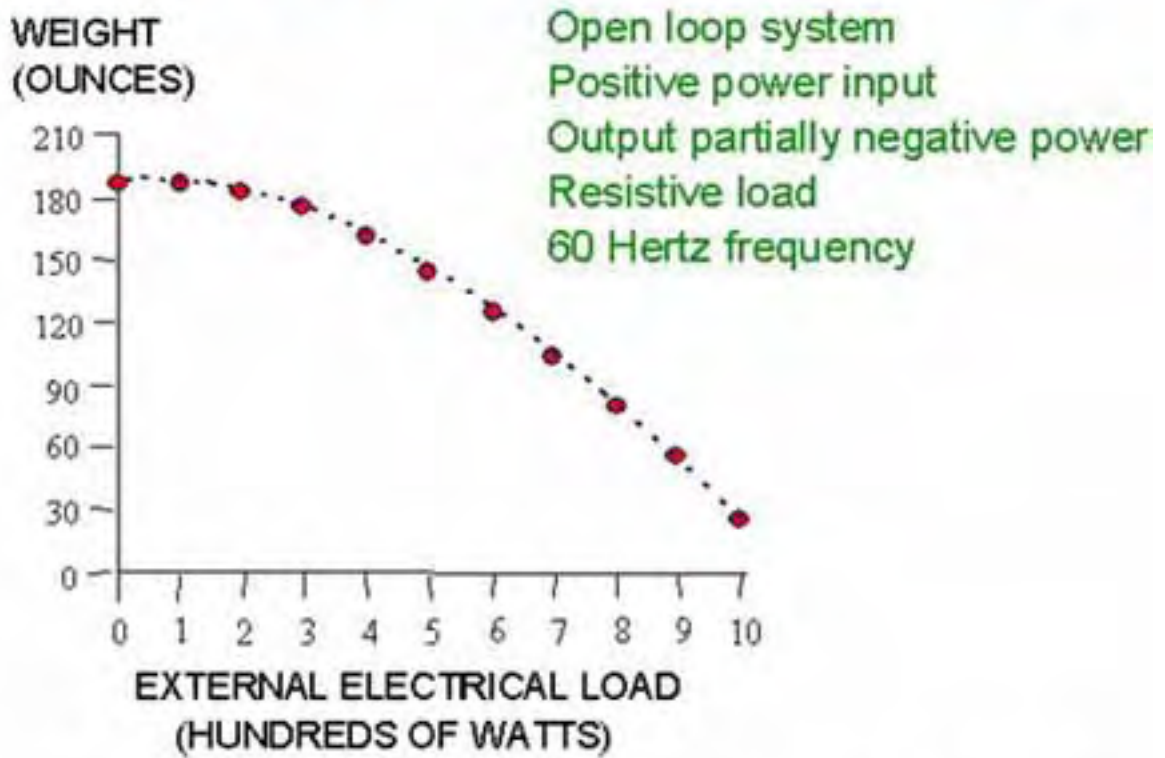

Figure 8. Results of Sweet vacuum triode amplifier antigravity tests.

Dr. Romer, AJP Editor:

- "That dreadful diagram purporting to show the electric and magnetic fields of a plane wave, as a function of position (and/or time?) that besmirch[es] the pages of almost every introductory book."
- "...it is a horrible diagram. 'Misleading' would be too kind a word; 'wrong' is more accurate."
- "...perhaps then, for historical interest, [we should] find out how that diagram came to contaminate our literature in the first place."



Figure 9. Dr. Romer on the conventional EM wave illustration.

Extended Conservation of Energy Law

- **Let**

- E_T = total energy
- E_E = ordinary energy
- E_M = mass energy
- E_t = time energy

- **Then**

$$E_T = E_E + E_M + E_t$$

$$(kE_t \rightarrow E_E > 0) \Rightarrow E_T > (E_M + E_E)$$

★ 1999 T.E. BEARDEN

Figure 10. Extended energy conservation law.

Note: Example of anti-Stokes radiation, where medium emits excess radiation and energy. In this case, energy is replenished directly from the vacuum's energetic interaction.

Nabil M. Lawandy et al,
"Laser action in strongly scattering media," *Nature, Letters*, 368(6470),
Mar. 31, 1994, p. 436-438.

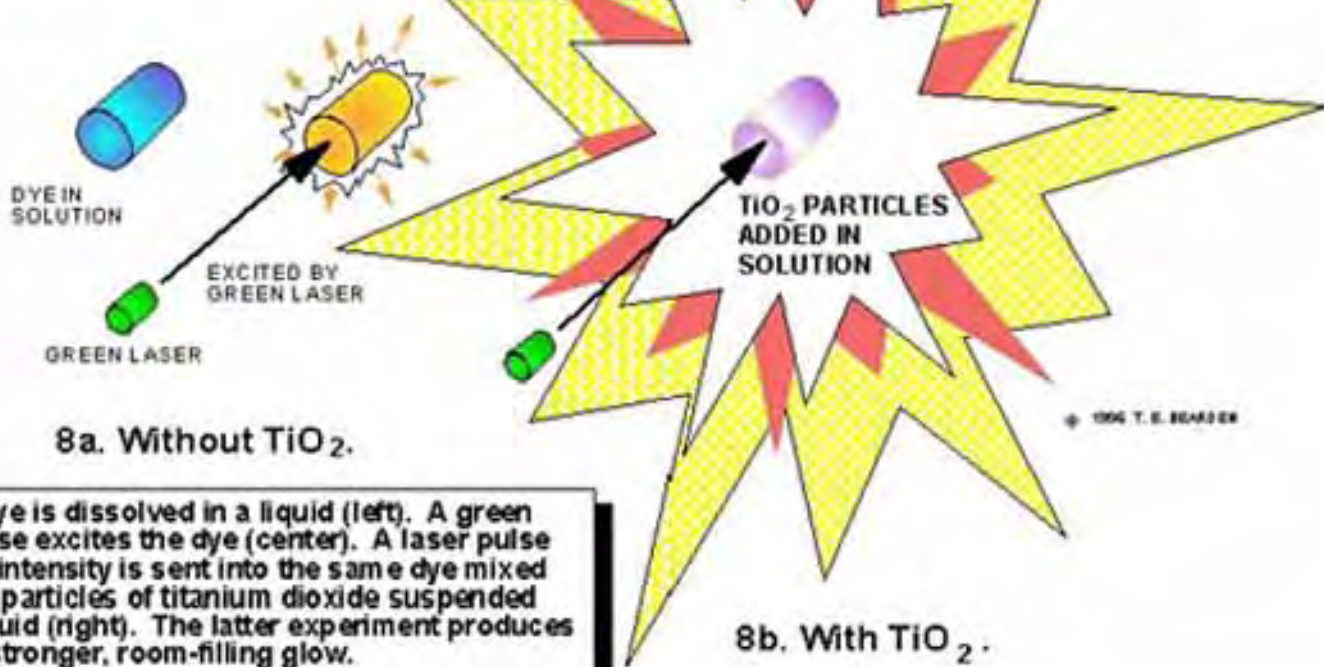

A pure dye is dissolved in a liquid (left). A green laser pulse excites the dye (center). A laser pulse of equal intensity is sent into the same dye mixed with tiny particles of titanium dioxide suspended in the liquid (right). The latter experiment produces a much stronger, room-filling glow.

Figure 11. Lawandy's experiment with multi-pass, multiple energy collection.

Geometrical Distortion of Poynting Energy Flow

At or near resonance frequency, in the case shown the energy collection fraction (reaction cross section) increases dramatically.

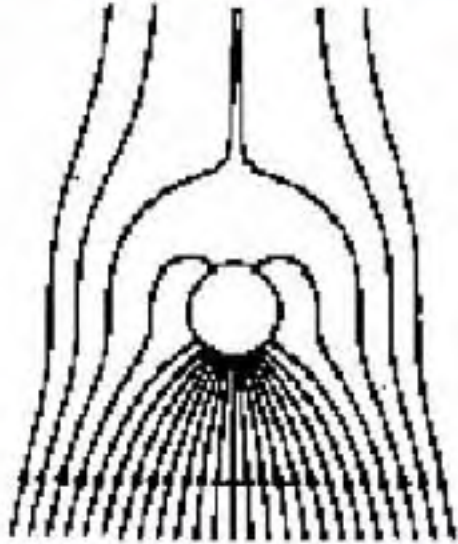

a. Around an aluminum sphere at light energy 8.8 eV.
Absorption efficiency = 18.00.

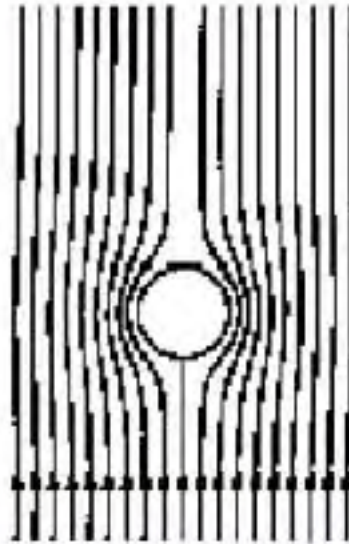

b. Around an aluminum sphere at light energy 5eV.
Absorption efficiency = 0.1.

Figures per Craig F. Bohren, "How can a particle absorb more than the light incident upon it?", American Journal of Physics, 51(4), Apr. 1983, p. 326.

Figure 12. Bohren's experiment gives COP = 18 as a transducer.

Fiber Fuse and Its Strange Anomalies

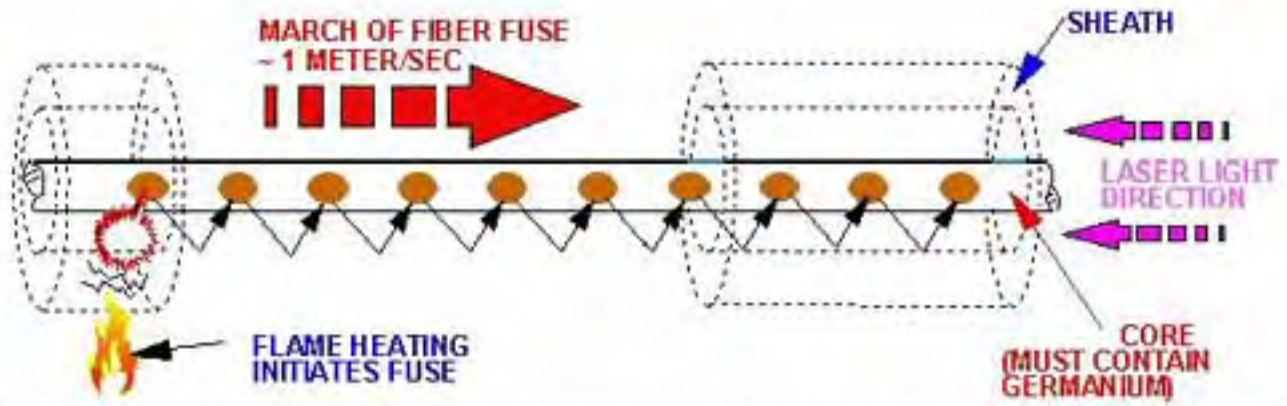

A. Fiber fuse destroys core of fiber optics cable of indefinite length, pitting core with holes.

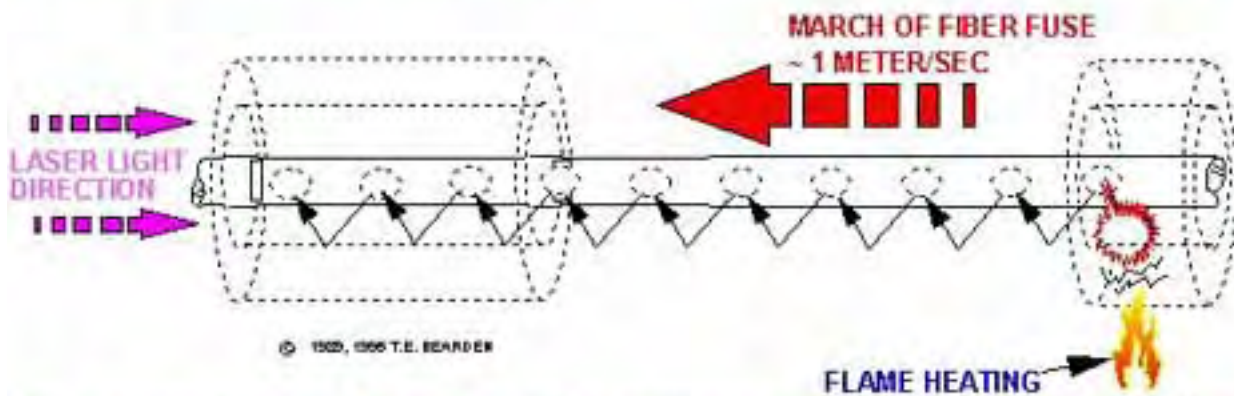

B. Reversed second fiber fuse often restores pitted core in cable, filling holes back up.

Figure 13. The fiber fuse phenomenon.

Five "magic" functions of an open disequilibrium system. It can:

- Self-order
- Self-rotate or self-oscillate
- Output more energy than the operator inputs (the excess is freely received from the active environment)
- Power itself and its load simultaneously (all the energy is freely received from the active environment)
- Exhibit negentropy

Figure 14. Five magic functions of open systems in disequilibrium with an active environment.

"First Kind" of Perpetual Motion Machine

First Kind:

- **"Violates the first law of thermodynamics (that energy can neither be created nor destroyed)."**

Comment:

- First law of thermodynamics has nothing to do with it.
- Neither a windmill nor a watermill violates the first law.
- Sets up illogical "strawman" and then knocks it down.
- Overunity EM system is an open system, freely receiving excess energy from an external source -- the vacuum.
- Since critics unwittingly defined perpetual motion machine as Newton's first law anyway, then this claim is that Newton's first law violates the first law of thermodynamics. Obviously that is false.

Figure 15. Perpetual motion machine of the first kind.

"Second Kind" of Perpetual Motion Machine

Second Kind:

- "Violates the second law of thermodynamics (that it is impossible to construct a heat engine that, operating in a cycle, produces no other effect than the absorption of thermal energy from a reservoir and the performance of an equal amount of work.)"

Comment:

- Second law of equilibrium thermodynamics has nothing to do with it.
- Overunity EM system is an open system, freely receiving excess energy from an external source - the vacuum.
- As such, it is in disequilibrium and equilibrium thermodynamics does not apply.
- Open systems in disequilibrium, receiving free energy from environment, can permissibly give $COP > 1.0$.

Figure 16. Perpetual motion machine of the second kind.

"Third Kind" of Perpetual Motion Machine

Third Kind:

- **Completely freed from the action of all nonconservative forces that irreversibly remove energy from a system.**

Comment:

- All Newtonian systems in constant motion violate that.
- Just states that the system isn't, for example, doing work.
- Overunity EM systems asymmetrically regauge, so receive excess energy freely, and an excess free force, which is a *nonconservative* force.
- Electrodynamics had to assume a second *nonconservative* force, equal and opposite, to obtain Lorentz condition and symmetrical regauging of Maxwell's equations.

Figure 17. Perpetual motion machine of the third kind.

The supersystem concept

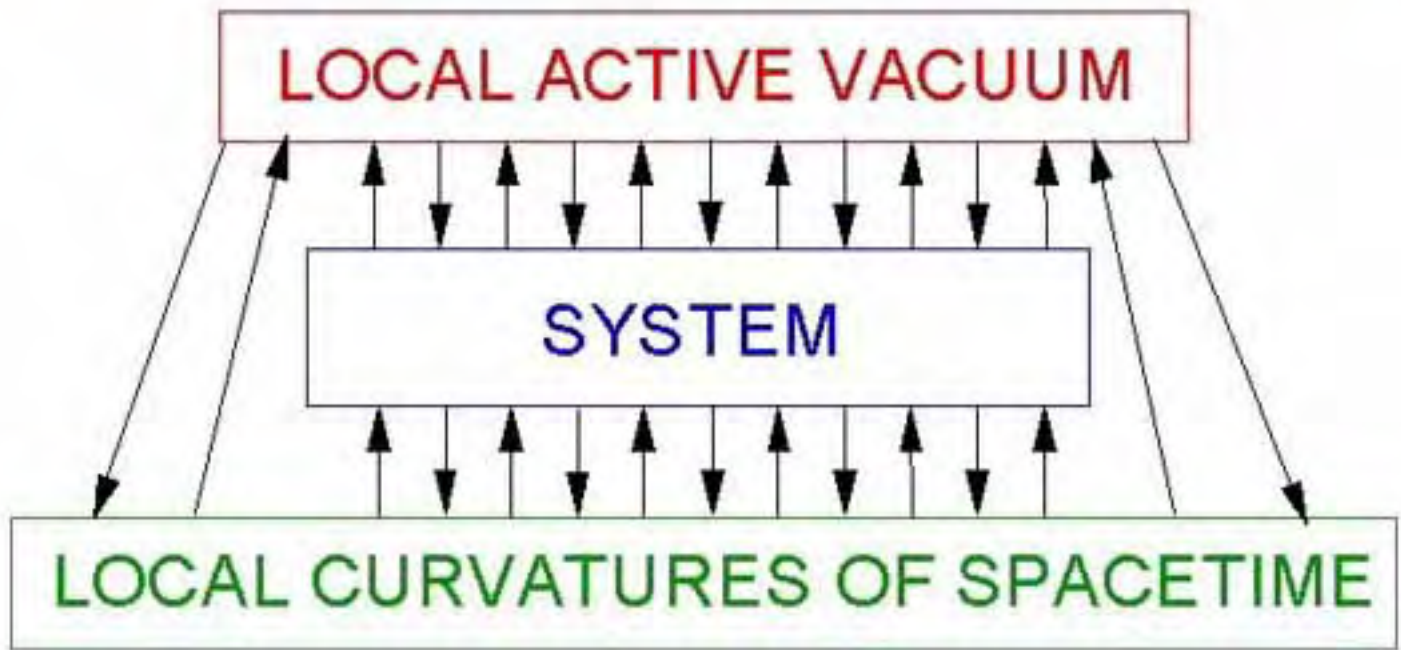
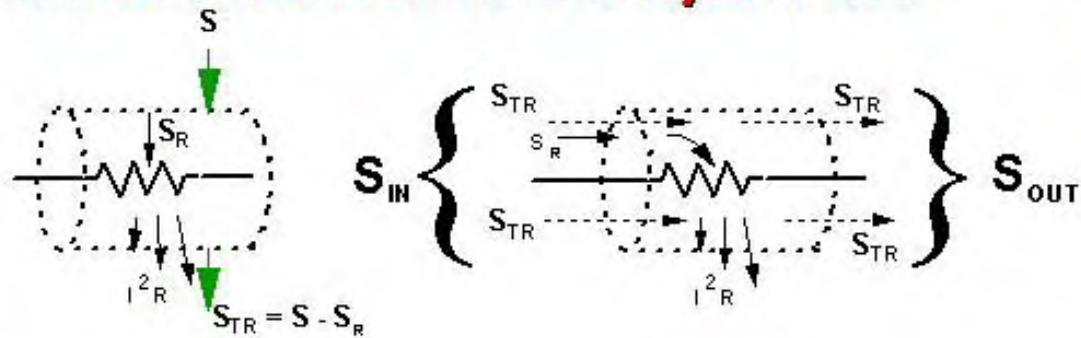

Figure 18. Concept of the supersystem and its interacting components.

Lorentz's trick to discard the enormous Heaviside Component



1a. Lorentz surface integration.

1b. Actual S in and S out.

See Panofsky & Phillips, Classical Electricity and Magnetism, 2nd. edn., Addison Wesley, 1962, p. 178-181.



Note: If the S-vector is integrated over the closed surface, then all nondiverged energy flow is zeroed, leaving only the very small component of the input S-flow that is powering the joule heating of the resistor. In short, only the small component of the S-flow that is equal in magnitude to the Poynting vector remains. This measures only the tiny portion of the S-flow that is intercepted and diverged into the conductors by their surface charges, powering the electrons and then dissipated out of the resistor as joule heating.

The Lorentz procedure arbitrarily discards the enormous Heaviside component that misses the circuit entirely and is wasted. This results in a non sequitur of first magnitude in energy flow theory.

Figure 19. Lorentz's trick to discard the large Heaviside energy flow component.

Lorentz Closed Surface Integration

Selects only the locally divergent portion of the Poynting energy flow that powers the component.



Figure 20. Lorentz's fundamental assumption.

Lorentz Closed Surface Integration

Selects only the locally divergent portion of the Poynting energy flow that powers the component.

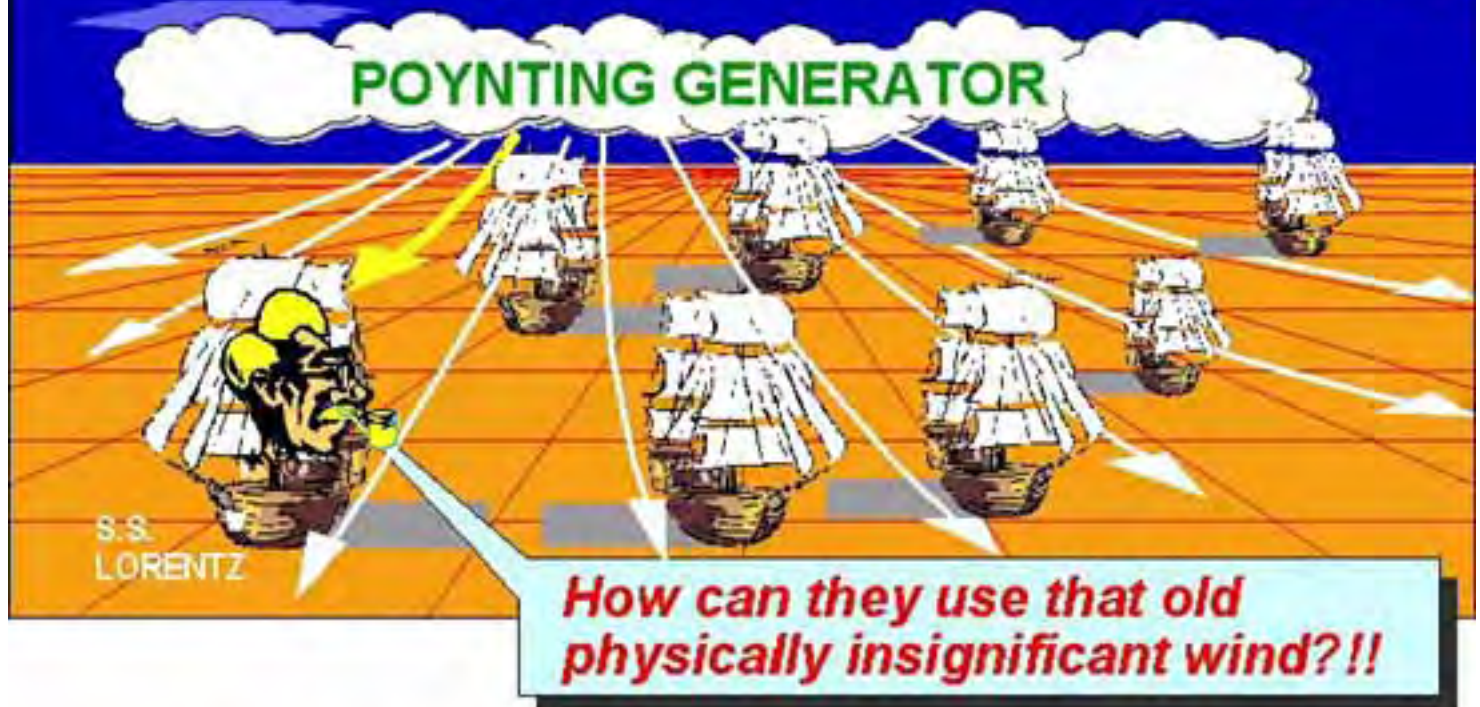
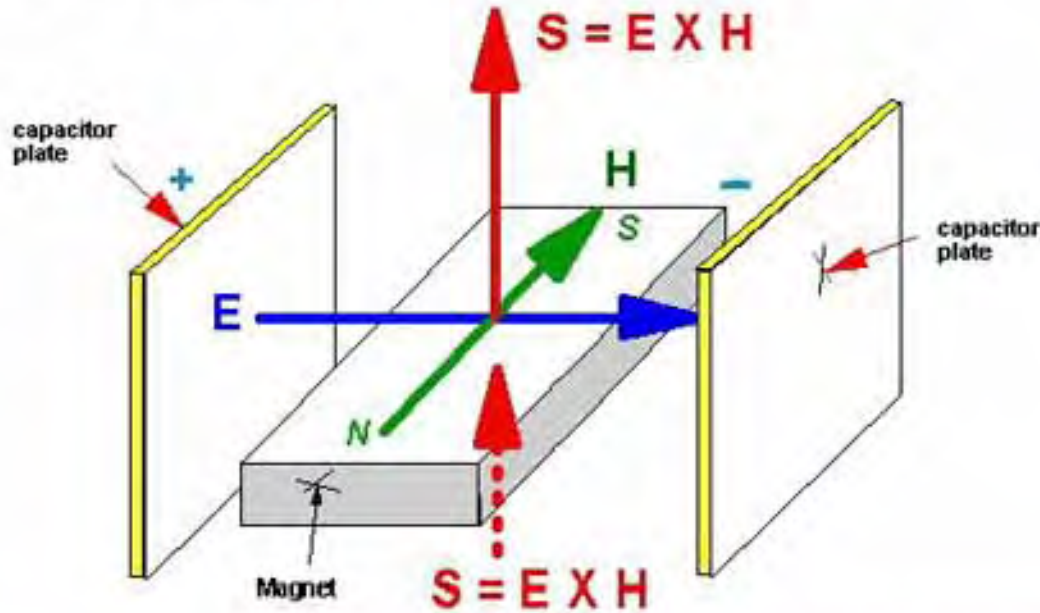

Figure 21. Showing Lorentz's assumption to be a non sequitur.

Free-energy-flow generator powered by the vacuum



The problem is not in extracting energy -- even enormous energy -- from the vacuum. The problem is collecting and using the energy to power loads, without destroying the source dipole.



EM energy continually flows from this "static" arrangement, without any further input of energy by the engineer.

Figure 22. A certified free-energy-flow generator powered by the vacuum.

Concept of bridging and free regauging

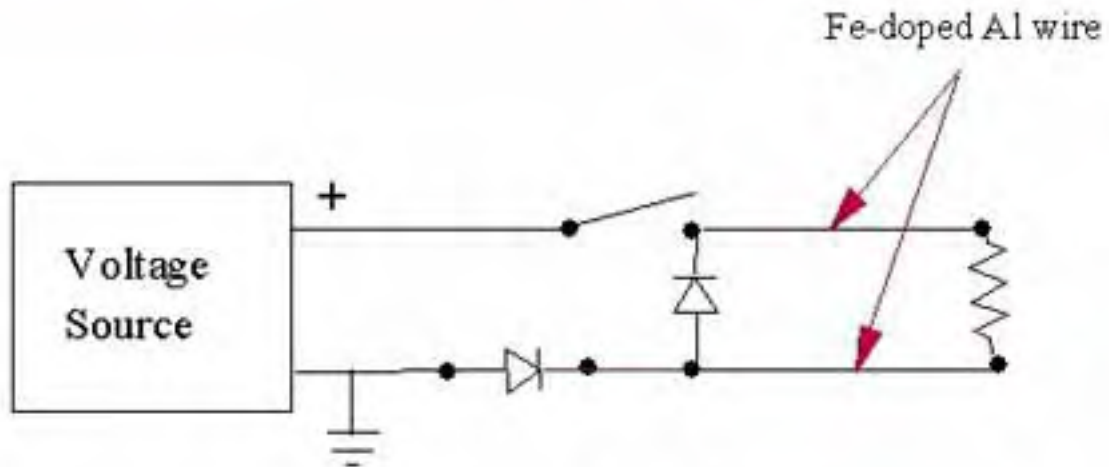

Note: May use many strands of Fe-doped Al wire instead of one, for each conductor

Figure 23. Special relaxation circuit using Fe-doped copper conductors.

Importance of experiment to test gauge freedom

- Gauge freedom requires that potential energy of circuit can be freely changed at will
 - Requires external active environment and mechanism of exchange
 - Otherwise, falsifies the entire conservation of energy law because energy then can be created and destroyed
- Successful test
 - Proves broken 3-symmetry of generator's source dipole
 - Proves giant negentropy of dipole (and charge)
 - Proves all EM energy in 3-space comes from time domain
 - Proves all EM circuits are powered by energy extracted from vacuum
 - Solves energy crisis permanently and leads to cleanup of biosphere
- Null test
 - Falsifies gauge freedom axiom in quantum field theory
 - Dramatically changes much of physics by falsifying energy conservation law

Figure 24. Importance of the special relaxation circuit experiment.

The "Scalar" potential is a harmonic set of biwaves

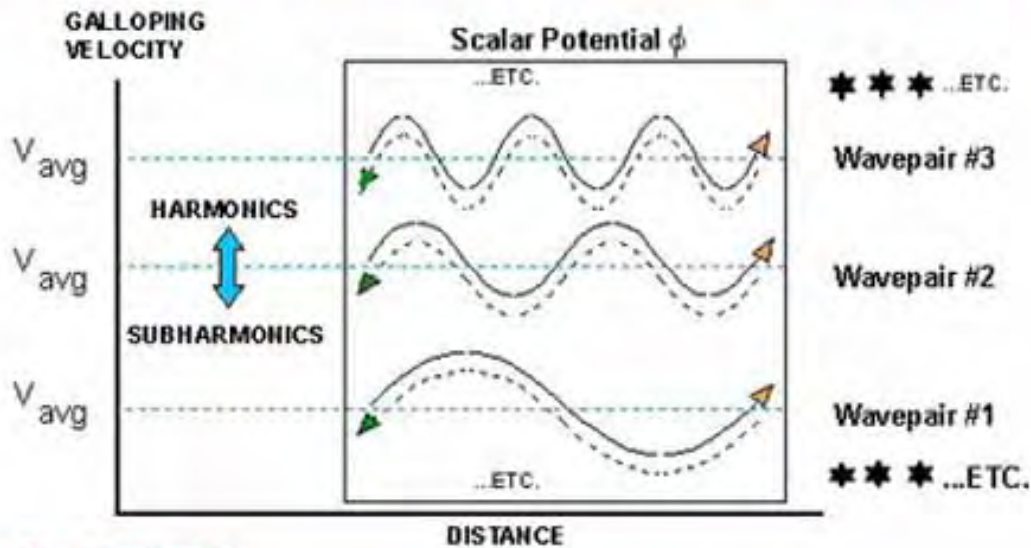

The Structure is:

- A harmonic set of longitudinal wavepairs.
- In each wavepair the two waves superpose spatially, but travel in opposite directions. The two are phase conjugates and time-reversed replicas of each other.
- The convergent wave set is in the imaginary plane, and hence is not observable.
- The charge's spin is 720 degrees, 360 in the real plane and 360 in the imaginary plane.
- Hence the charge receives the complex convergent EM energy, transduces it into real EM energy, and emits enormous energy at the speed of light in all directions.
- This produces the fields and potentials from the "source charge."

Figure 25. Whittaker's 1903 decomposition of the scalar potential.

Expert Advice in Asymmetric Regauging and Elephantine Maxwell's Demons



I asked advice of my friend Rajah, who is an expert in the use of elephantine Maxwell's demons. He uses them for logging operations.



Rajah always asymmetrically regauges only once, so that he has a single elephant "demon" with no other "demon" opposing it. This demon can do work.



© T.E. BEARDEN 1996

Rajah laughs uproariously when told my electrodynamicist insists on using two demons, equally strong, pitted against each other.

He asks, "*How many logs has he moved with his demons?*" I told him, "*Never a single one; he insists that I myself furnish the energy to move them.*"

Rajah exclaims, "*How strange!*"

Figure 26. Rajah's advice on regauging one's power system for doing work.



You really need a Maxwell's demon, to do some free work.



Your electrodynamicist says he can make one, by regauging.



He says he will do the regauging for you. Hey, what a swell guy!



He regauges twice, and makes two Maxwell's demons equal and opposite. They won't do any net work for you!



He disdainfully says, "We *always* do it that way! We *must* enforce local equilibrium and the second law of thermodynamics!".



You decide to have a little chat with your electrodynamicist! With friends like that, who needs enemies!

© T.E. BEARDEN 1996

Figure 27. My electrodynamicist's advice on regauging.

Basic Definitions

- **Free energy** - excess energy freely furnished to a device from an external source of energy, so that all one needs to do to use the energy is to gate, collect, and distribute it to a load or loads, without utilizing it to close the gating mechanism.
- **Free energy device** - a device that receives excess energy from an external source, gates it, collects it, and shuttles or shifts it to be distributed to one or more loads to perform work, without performing work to close the gating mechanism.
- **Coefficient of performance** - COP; the ratio of the work done in the load(s) powered by the machine or circuit, divided by the work done on it by the operator to operate it. Does not apply to a self-powering (closed loop) machine or circuit.
- **Efficiency** - ξ or the ratio of the work done in the loads (or the energy output of a converter), divided by the total energy input to the device from all sources. No system can have $\xi > 1.0$.



Figure 28. Some basic definitions of interest.



A Startling Fact

- Batteries and generators do not power their external circuits.
 - They dissipate their available internal energy to separate charges and make the source dipole.
- The source dipole:
 - Extracts enormous energy from the vacuum
 - Pours it out through the terminals, filling all space surrounding the external circuit
- The circuit surface charges catch a tiny bit of the energy flow (the Poynting component).
- Most (the Heaviside component) is wasted.
- All the hydrocarbons ever burned, fuel cells consumed, dams built, windmills built, and solar cells deployed, have not directly added a single watt to the power line.
- All the energy caught and used by the power line was extracted from the vacuum by the generator source dipole.

Figure 29. What really powers EM circuits and power systems.



Vacuum and Modern Physics*



- Missing symmetry of matter
- Symmetry only of mass and vacuum
- Vacuum excitation
- Vacuum structures
- Spontaneous symmetry breaking
- Interaction between matter and vacuum
- Possibility of vacuum engineering

*T. D. Lee, Particle Physics and Introduction to Field Theory,
Harwood Academic Publishers, NY, 1981, p. 378-390.

Figure 30. The active vacuum and modern physics

Four Important Symmetry Groups

- **Permutation symmetry**
 - Statistics
- **Permutation symmetry**
 - Translation
 - Rotation
 - Acceleration
 - Etc.
- **Discrete symmetries**
 - Space inversion
 - Time reversal
 - Particle-antiparticle conjugation
- **Unitary symmetries**



Figure 31. Four important symmetry groups.

Aspects of Strong Local Asymmetry

- If local asymmetry is strong, conservation laws may be appreciably violated
 - Energy
 - Charge
 - Spin
 - Momentum
 - Angular momentum

- Properties of an object may differ appreciably for
 - Different observers
 - Different detecting means
 - One time to another
 - One position to another



Figure 32. Some aspects of strong local asymmetry.

Other Aspects of Strong Local Asymmetry

- Local spacetime is curved
- Lorentz invariance of vacuum is violated
- May be a local "sink" or "source"
- Gravitational/inertial effects from EM
- Translation between virtual and observable
- Electrogravitational solitons
- Action at a distance
- Transmutation effects may exist
- Scalar/pseudoscalar field translation

energy!

energy!

Cold Fusion!

Figure 33. Other aspects of strong local asymmetry.

Fundamental units are arbitrary

- Choice of units is arbitrary
- Units are chosen
 - To simplify the equations
 - For ease of understanding
 - As a matter of custom
- Can use one unit -- e.g., the joule
 - Time then is a function of energy
 - Time is spatial energy compressed by c^2

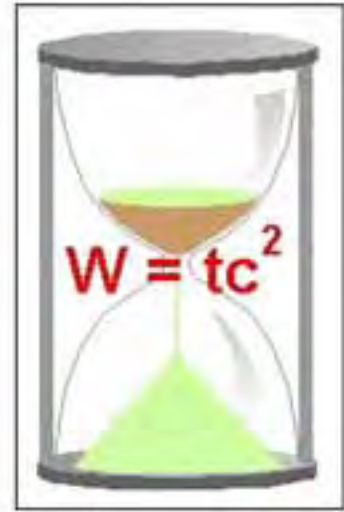

© 1998 T.E. BEARDEN

Figure 34. Choice of fundamental units is arbitrary.

All EM energy freely comes from the time domain

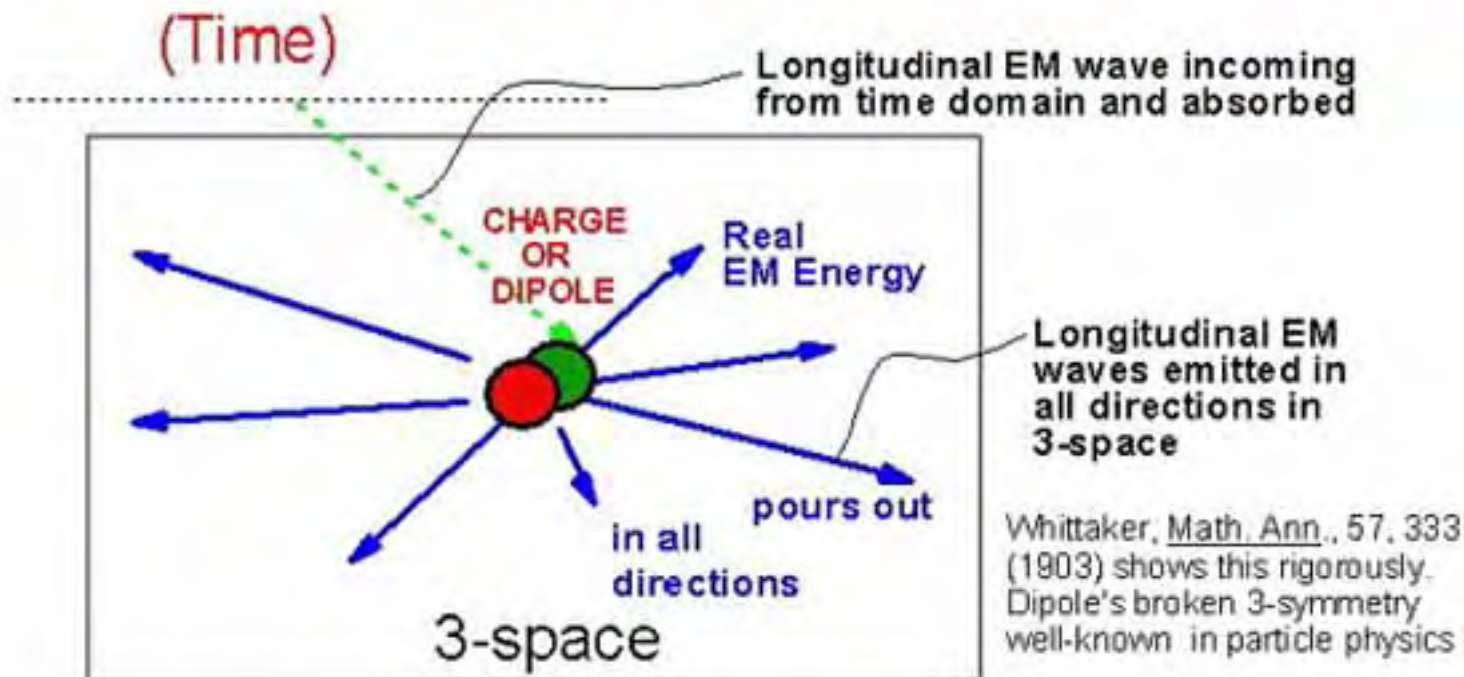

Note: Whittaker (and others) interpreted the phase conjugate half set of LWs after interaction with the charges of the dipole, and as a 3-space effect rather than the time-domain cause. This fundamental non sequitur has just been repeated since then.

Figure 35. All EM energy in 3-space comes from the time-domain.

A Dipole is a Broken Symmetry

- In 1950s, broken symmetry was discovered in particle physics*
- Any dipole is a broken 3-symmetry
 - In its seething energy exchange with the active vacuum
 - Basis now in particle physics for a half-century
 - Still not in electrodynamics
- The dipole receives energy from the vacuum in unusable form
 - Transduces it into usable, ordinary EM energy
 - Pours it out continuously in all directions
- The dipole is the ultimate negative resistor



**Nobel prizes were awarded to Lee and Yang*

Figure 36. A dipole is a broken 3-symmetry in its vacuum energy exchange.

"Burn time" as EM fuel



- Energy locked into time equals energy locked into matter
- Transduce 1 μ sec per second, and output is 9×10^{10} watts
- Equivalent to ninety 1000-MW electrical powerplants
- *Age a little slower also!*



© 1998 T. E. BEARDEN

Figure 37. In the future we will more readily "burn time" as fuel for EM energy.

In conclusion: The future holds:

- **Electrical energy from the time domain:**
Clean, cheap, simple, anytime, anywhere
 - Eliminate cost of fuel, refining, transportation
 - Provide a transportation revolution
 - Dramatically reduce stress on aging power grid
 - Substantial decentralization, failure resistant, graceful degradation
- **Unified science of all four forces in physics***
- ***Can meet increasing demands for electrical energy while dramatically cleaning the environment***



*Sachs'-Evans model (90 papers on DoE site, many published)

Figure 38. What the future holds.