

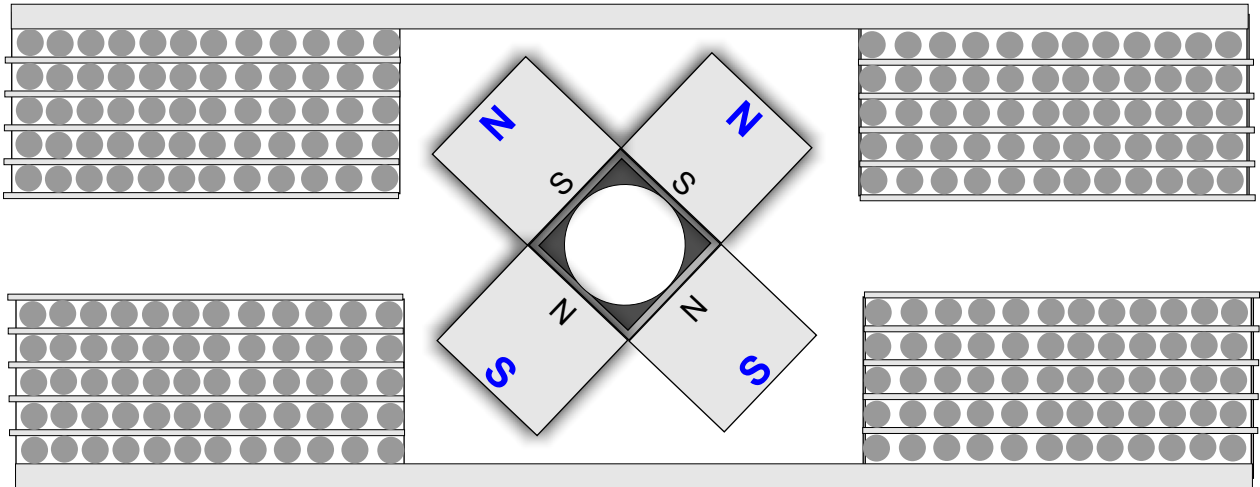

SPIRAL COIL GENERATOR PLANS



We use 4 magnets as an example only!



This is a cut away view of our Spiral Coil Generator

WARNING! - NOTICE!

We are not responsible for anything in these plans, you build at your own risk!

This **Generator** can **output** high voltages as well as **high amperages**. if you make skin contact with the **Generator output** you **could Be electrocuted (die!)**

High Voltage can kill! always wear rubber gloves, rubber shoes, rubber or plastic lab coat as well as eye protection. Label high voltage parts and work area with a High Voltage warning signs! Once your **Generator** is complete, encase **it** in a safe housing.

Encase all electrical parts. Since you are building a high voltage **Generator** do a professional job! Do not be sloppy.



Generator can have a box housing as well as a cylinder housing. Simply use plywood. Just like our fuelless engine model.



SPIRAL COIL GENERATOR PLANS

This is a cut away view of our Spiral Coil Generator

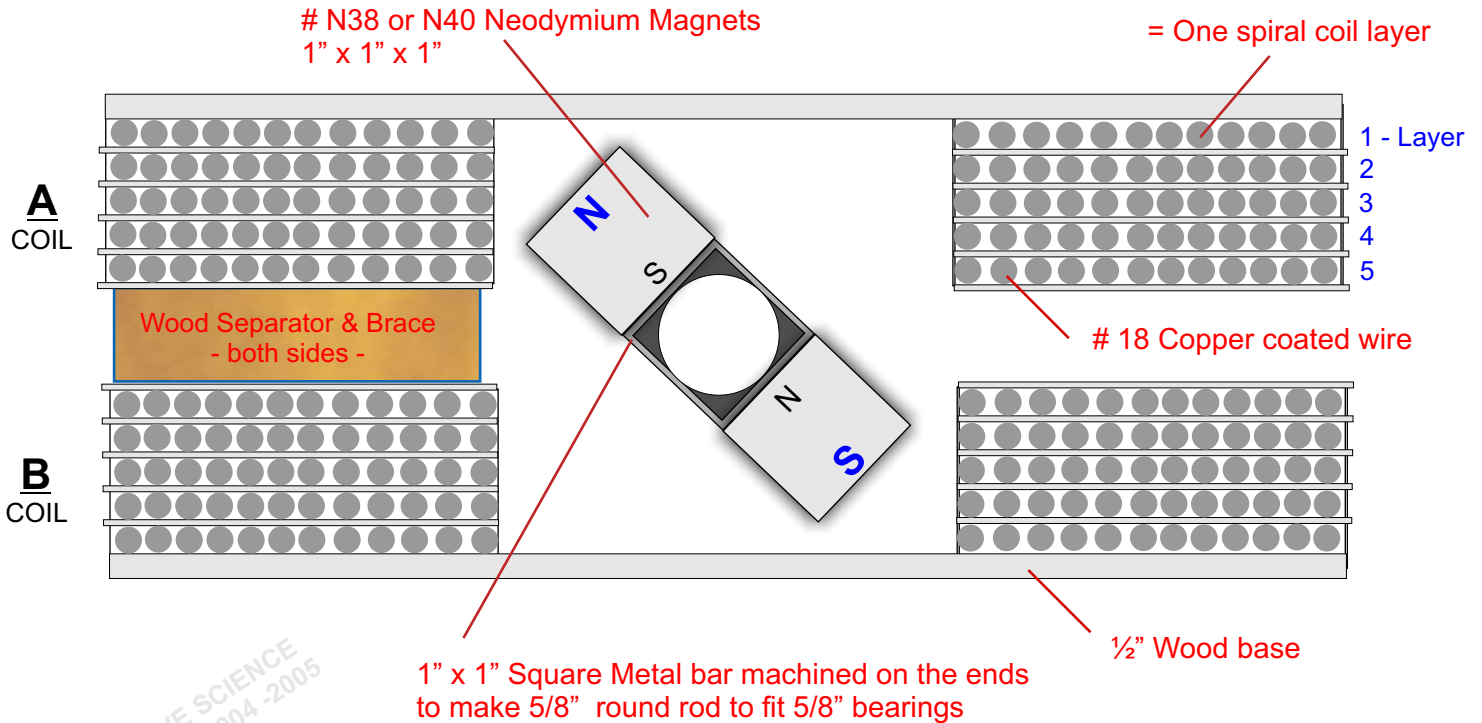

Each spiral coil layer is connected in series.

The Square edge shape is the best to use, it has a very high efficiency, but is very hard to make.

It is best to use an oval shape or round end design.

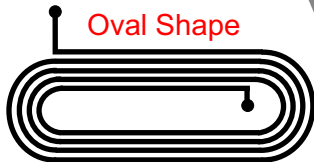

Layers can also be screen printed which we have full rights to.. Copyright and Patent pending If you wish to purchase manufacturing rights contact us.

Top View of one spiral coil #18 wire

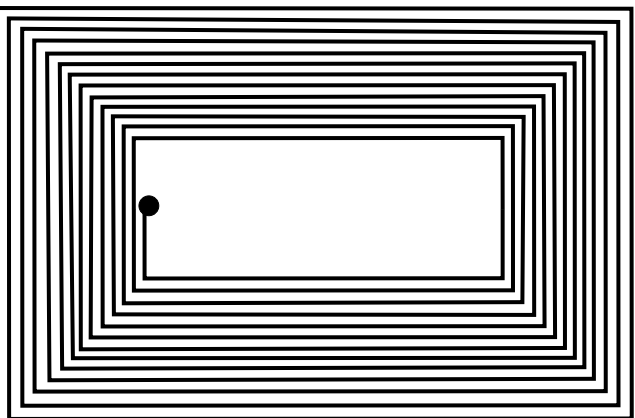

“ David Waggoner “



WARNING!

You can not copy or duplicate any part of these plans in any shape or form without the written permission from Creative Science & Research. You can not resell copy or give away these plans in any part. that includes photo's etc..

Our New Spiral Coil Technology!

These plans are for your eyes only, (excluding Family members and those who may want to help you build this device.) This device uses a new discovery which we discovered more than 2 to 3 years ago. It involves the use of spiral coil technology! Which we have Copyright and Patent pending on. We are selling manufacturing rights to this device only, if you are interested please contact us: sales@fuellesspower.com as well as sending us a letter by mail.. These coils can be screen printed as well....Copyright Patent pending 2004 - 2005

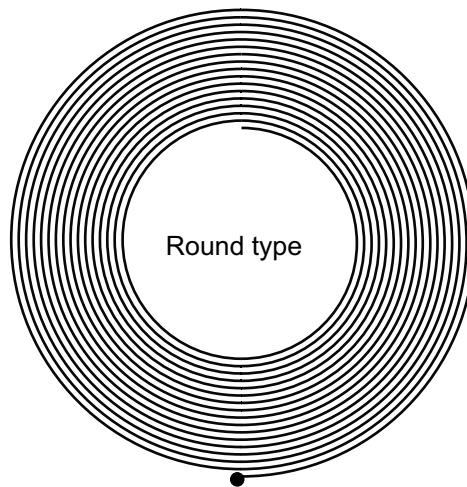

Copyright 2004 Fuelless Engine is simply a brand name as an example.

The Spiral Coil Generator Sp500

The **Generator** housing can be made using wood, or a square wood box or as seen here using laser cut 1/4" aluminum ends.

If you wish to manufacture our **Generator** you can buy the rights to do so. Please contact David Waggoner at

Creative Science & Research
PO BOX 557 New Albany IN 47151
sales@fuellesspower.com

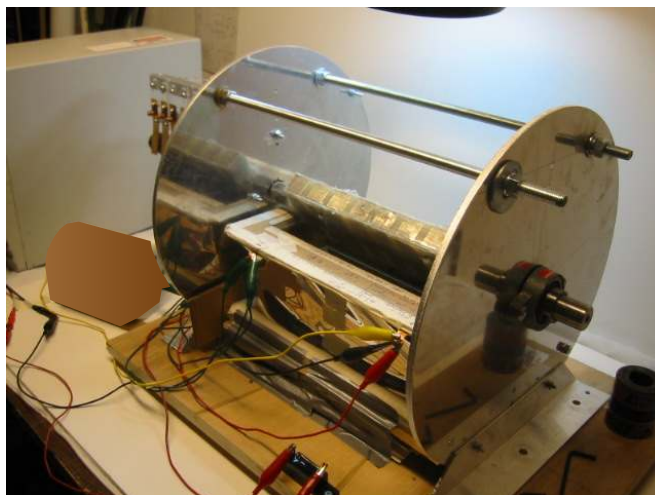

CREATIVE SCIENCE

#18 copper coated wire.
Layered like pancakes!

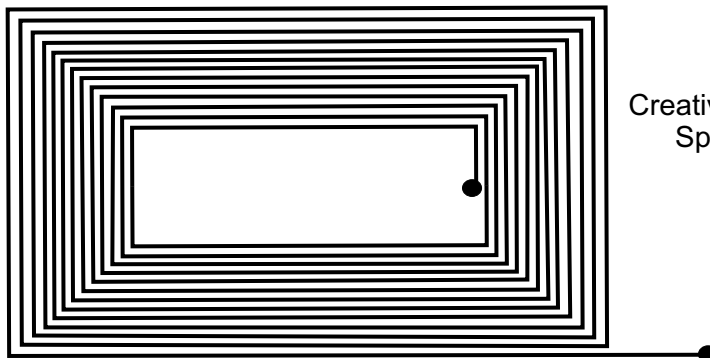

Creative Science & Research
Spiral Coil Technology

Very High Efficient

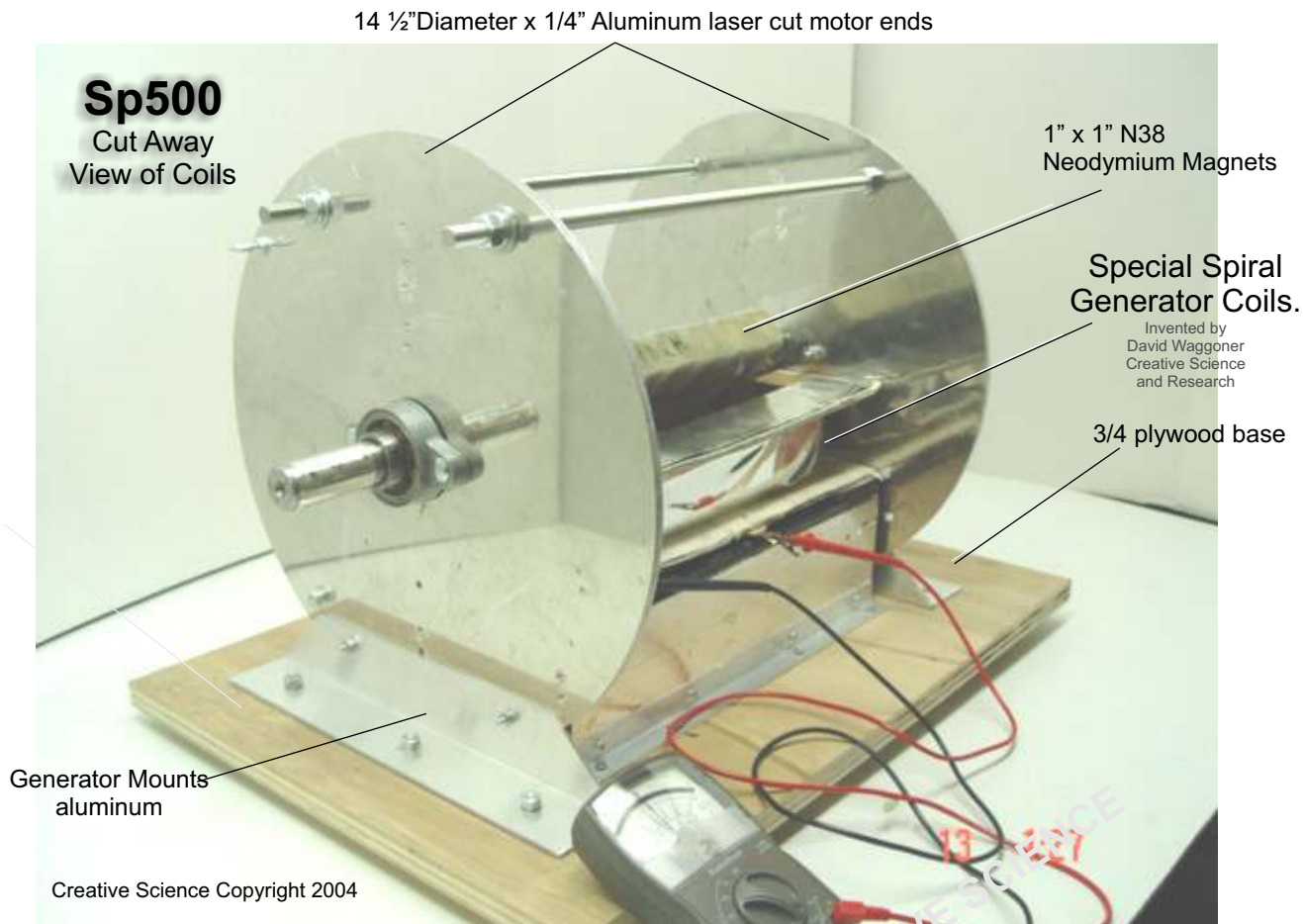

These photo's and plans are **CONFIDENTIAL** and can not be copied or sold in any way
Copyright 2004 Creative Science & Research

My special spiral coil designs play a very important part in this Generator. I like to consider these plans unlike any other set of plans you may have purchased in the past. Use these plans to build a working prototype but use them also as a building block to discover and research new and better ways to build this Generator!

You will be amazed after you get this Generator up and running. I am sure it will be like nothing you have ever experienced before! Connect our Fuelless Engine to the 1" Rotor Shaft or a gas motor. If you use a gasoline engine to turn the generator, you will need to use the right size pulley(s) to get the desired voltage. The faster you turn the magnet rotor the higher the voltage output. 115 vac x 60 Hz can be achieved.



Parts & Supplies

1. PVC Sheeting - 1/4" x 4 foot x 4 foot (White)
Supply Sources: Sign and or Screen printing shops near you. Internet. Sign supplies, screen printing supplies.

2. PVC Sheeting - 1/8" x 4 foot x 4 foot (White)
You can cut PVC with a sharp matt knife and a metal strait edge or metal ruler. Can also be cut using a fine table saw cutting blade.

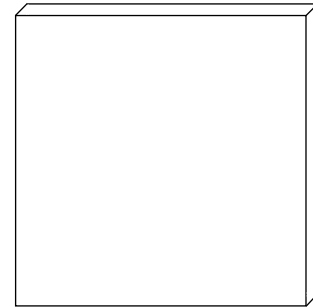

3. QTY-1 6 to 10 lb spool of copper coated wire.
Or sometimes called magnetic wire. size #18 AWG
Supply Sources: Internet, (use search engines)
MWS Wire Industires CA. 818-991-8553



- * This wire is for the spiral generator coil. Patent Pending
EIS Wire Company Louisville, KY
502-636-0384

Alphacore.com or Reawire.com

4. Qty-3 Wood Nuts 1/4" or other

- 4a. Qty-8 Wood Screws or dry wall type
2 1/4" L



Or Optional: Aluminum Tape





Parts & Supplies

5. 3M Spray Adhesive or other.
Must spray onto surface thick and very sticky.
Supply Sources: Local Art Supply stores, Internet,
Hardware stores.



6. PVC Glue
Supply Sources: Hardware stores, Internet, Plumber
supplies.



7. Qty-1 Lazy Susan Metal, ball bearing type.
Supply Sources: Hardware stores, Internet,
AceHardware.com



8. Qty-1 16" diameter plywood, 3/4" thick
Supply Sources: Lumber yards, Laser wood
cutting companies.

9. Qty-1 Aluminum tape 2"
Supply Sources: Hardware stores, Internet.



10. Qty-1 Hex Bar Cold Steel



Cut to 29" length. Do not use Aluminum!
Supply Source: Small Parts Inc. Wwww.SmallParts.com
or call 1-800-220-4242

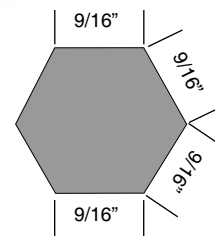

NOTICE: Optional 1" Hex Bar would be better and easier to place
the 1" N38 Neodymium magnets on. That would be 1" across
each flat. If you did decide to use 1" Hex bar you would need
to resize the PVC Bobbin in these plans. The center of bobbin
would need to be wider. **Or Option 2: Use 1" x 1" Square bar as seen on page 1**

11. Qty - 24 steel bolts 8-32 x 7/8" or 1" long, you will need nuts and washers
as well. Use lock washer on the brushes.



Parts & Supplies

12. Hex Bare

You will then need to get a machine shop to turn the ends for you to 1" D (Should only cost about \$25 - \$50)

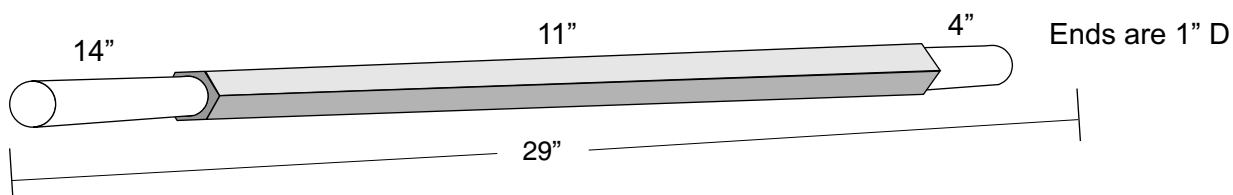
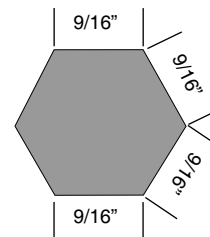

Again do not use aluminum Hex, must be steel, Once magnets are in place the entire rod will become like one big powerful magnet!



13. Generator ends

Must be aluminum, hard plastic (Nylon 6/6 Smallparts.com) or wood.

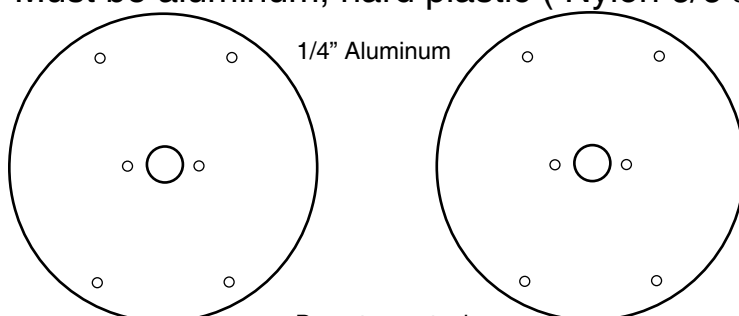

Do not use steel that attracts magnetic flux

14 1/2" Diameter x 1/4" or up to 1/2" thick. Center hole is 1.125" Diameter or we could say 1 1/8" D. This hole is for the rotor hex bar to go through which will be 1" in diameter and for the 1" Bearing(s). The top holes are for the long steel bolts. And the bottom holes are for the aluminum angle support.



Parts & Supplies

14. 2 Way Carpet Tape
Supplier: Hardware Stores, Internet.



15. 2-ton DEVON 2 part Epoxy



Suppliers: Hardware Stores
Internet,
www.Texaswoodcarvers.com
2 - 9oz bottles



16. N38 Neodymium Magnets QTY- 48
1" x 1" x 3/8" thick

Suppliers: Internet, www.Kjmagnetics.com

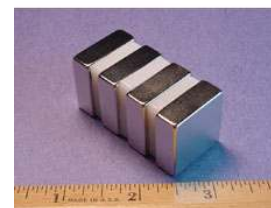

17. Aluminum Angle 2" x 2" x 24"
cut to 12 inch lengths.
Suppliers: Hardware stores, Internet.

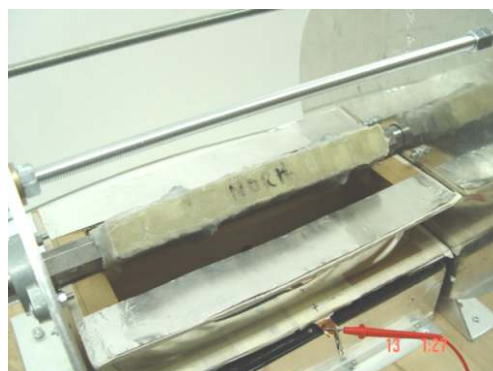



Parts & Supplies

18. 2 x 4 wood cut 2 pieces to 13 1/2" and
2 pieces to 5"

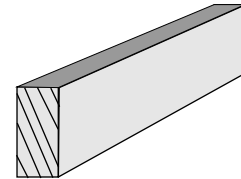

Supplier: Lumber yards, Hardware stores.

(Notice: USA 2 x 4's are actually 1.5" x 3 3/8" in size).

This will be used to make a bottom support base for your Generator coil.

19. QTY-2 Flange bearings for rotor and Generator end



Or



Supplier: Internet, Grainger.com , Hardware stores
If Hardware stores do not have it they can order it.

- 19-A. 1" Split Tapper Bushing or 1" Coller for flywheel.



20. Steel long bolts Qty-2 coarse thread 7/16" x cut to 18.75" long



21. Steel Nuts.....Qty-8 7/16" coarse thread

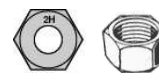

22. Steel washers.....Qty-8 7/16"



Or



23. Steel Lock washers.....Qty-4 7/16"

24. Steel Carriage bolts coarse thread Qty-4 5/16"

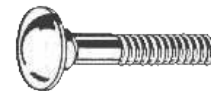

25. Steel Nuts coarse thread.....Qty-4 5/16"



26. Steel washersQty-4 5/16"



27. Steel Bolts coarse thread.....Qty-6 1/4" x 1 1/2" L w/ nuts & washers

28. Steel Bolts coarse thread.....Qty-4 1/4" x 1" L w/nuts & washers



Parts & Supplies

27. Plywood Generator base: 16 1/2" x 24" x 3/4" thick.
Suppliers: Lumber yards, Internet.

It is best to attach a sheet of 1/8" aluminum to the top of the plywood board, this helps collect free energy. (hard to explain) Connect the aluminum sheet to the wood using wood screws.



Cherry Wood

28. Thick Copper Foil Adhesive tape for output contacts



29. Soldering Gun and Solder to solder contacts.



Soldering Gun

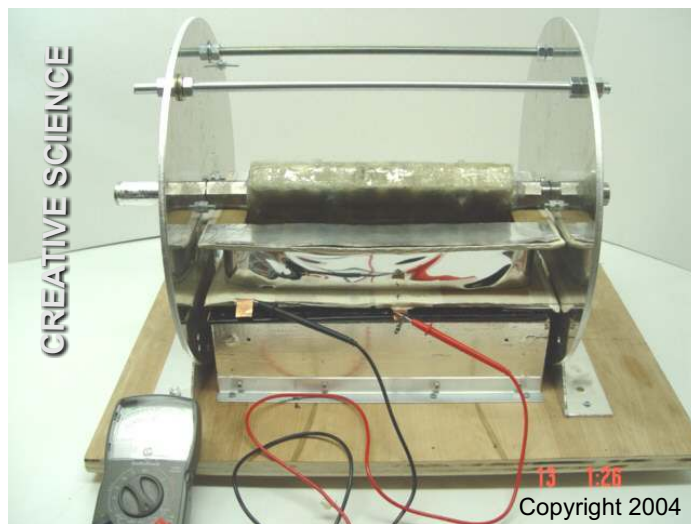
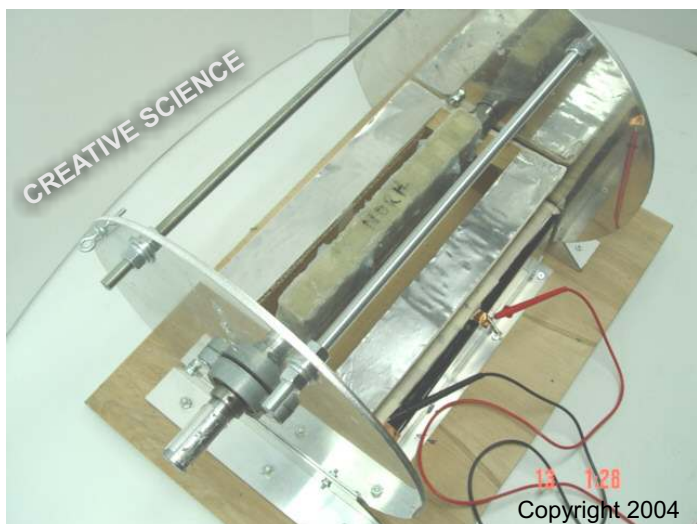

Generator coils use #18 Gauge Copper coated wire for the spiral coils!
The bottom coils are **B** the top coils (Not shown) is **A**.



N38 Neodymium Magnets
1" x 1" x 3/8" thick

Creative Science & Research
Spiral Coil & Spiral Coil Pancake Technology

Top View

Example of just one coil layer

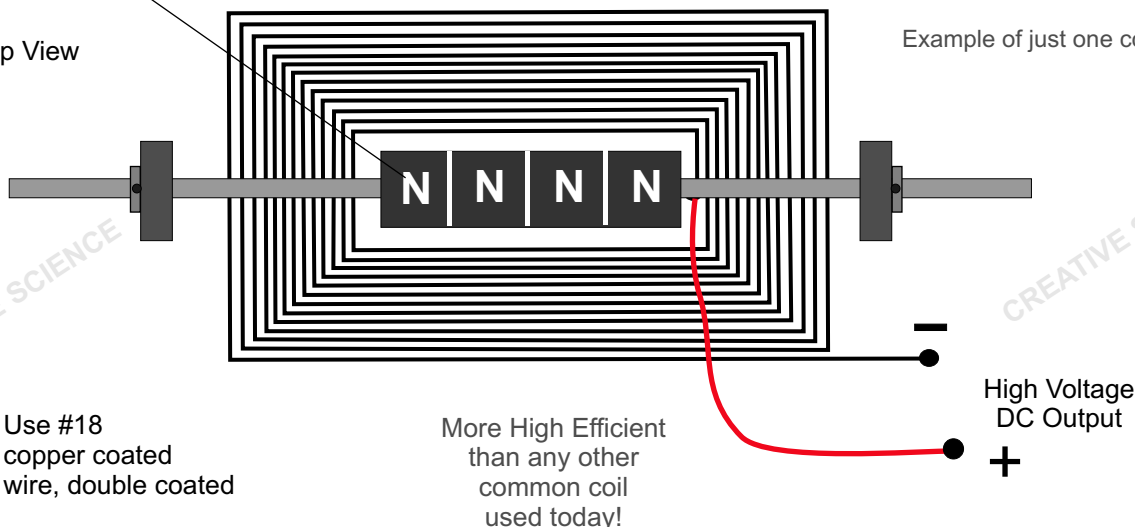

The above drawing is an example of just one spiral coil layer. The coil is very high efficient! By stacking many coils one on top of the other and connecting them in series you will greatly multiply the Voltage and Amperage output! These are very powerful generator coils. Extremley High Efficient! Patent pending!

Again, this will be very time consuming but it will be well worth it. The above spiral coil drawing is just an example, there is no spaces in between the wires. The coating on the wire will act as the separator. The above shape is perfect and will give you the best results but is hard to make. It is much easier to make long oval shape spiral coils.

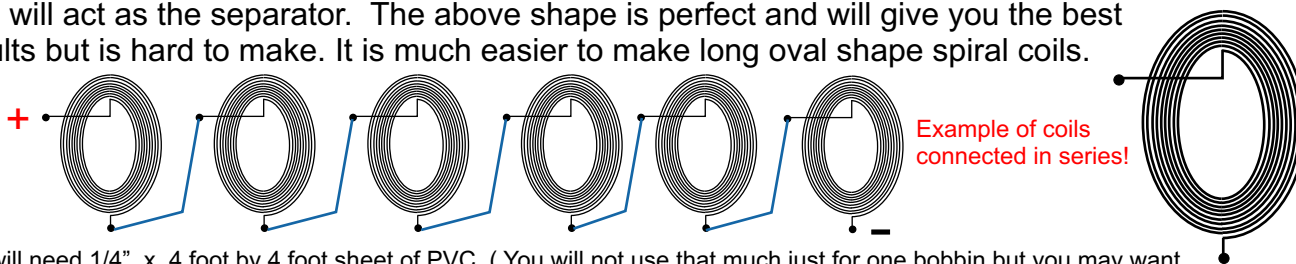

You will need 1/4" x 4 foot by 4 foot sheet of PVC, (You will not use that much just for one bobbin but you may want to make more bobbins later and experiment with different coils for fun). You can buy PVC sheeting at any Local sign or screen printing shop in your area or if you can not get it there search the internet for PVC supplies or sign supply companies, Check your local phone book first. You must use PVC, you can not use Metal or Aluminum. You will also need: Qty -1 10 lb spool of #18 gauge copper coated wire, (Double coated) you can also find this on the internet as well search for copper coated wire, tell them you need it for a magnetic generator. You may have copper wire suppliers in your local area, if you can't find them in your phone book check with a local electric motor repair shop in your area and they can sell you copper wire or tell you were you can buy some. You will also need a large spray can of 3M spray adhesive as well as very thick paper. You will be building the **Generator Coil PVC Bobbin**. You can use regular PVC glue to glue all your PVC joints. You can find this at any hardware store or on the internet, this glue is commonly used for gluing PVC pipe fittings together. You will also need to purchase a Lazy Susan or a small bench top drill press to place your PVC bobbin on so you can rotate it little by little while you turn and place the wire onto the PVC bobbin base. A small metal Lazy Susan works great for this, use a round 3/4" plywood board and attach the Lazy Susan to the bottom of the board. AceHardware.com carries them. Metal ball bearing type.



Generator Operation

Basic Generator Operation:

When the north pole N of the rotor magnet is pointing toward the 1:00 position and begins to turn within the spiral coil it creates a very high voltage generator effect into the front Emf and the Back Emf of the Generator Coils.

The voltage output and the amperage output depends on the size of wire being used, the number of spiral coil layers and the magnet rotor speed.

The more spiral coil layers you use the less rpms will be needed to generate the higher voltages. In these plans we are using #18 wire but if you use smaller wire (#15) you will gain more amperage output, but in turn the rpms will go up. To lower the rpms needed to get the desired voltage you want simply add more spiral coil layers.

The nice thing about this generator is that it's simple! You do not need commutator brushes as you do in many other DC or AC generators.

With this generator the voltage output will be AC= alternating current. The Hz will depend on the speed of the magnet turning within the coils. If High Voltage DC is desired then simply add a high voltage diode rated at 2 times the amperage output of the generator and 2 times the voltage output of the generator. This generator is very high efficient and can be turned using Wind power, Water power, The Fuelless Engine's (as seen on our web sites or catalog) or a gasoline type engine.

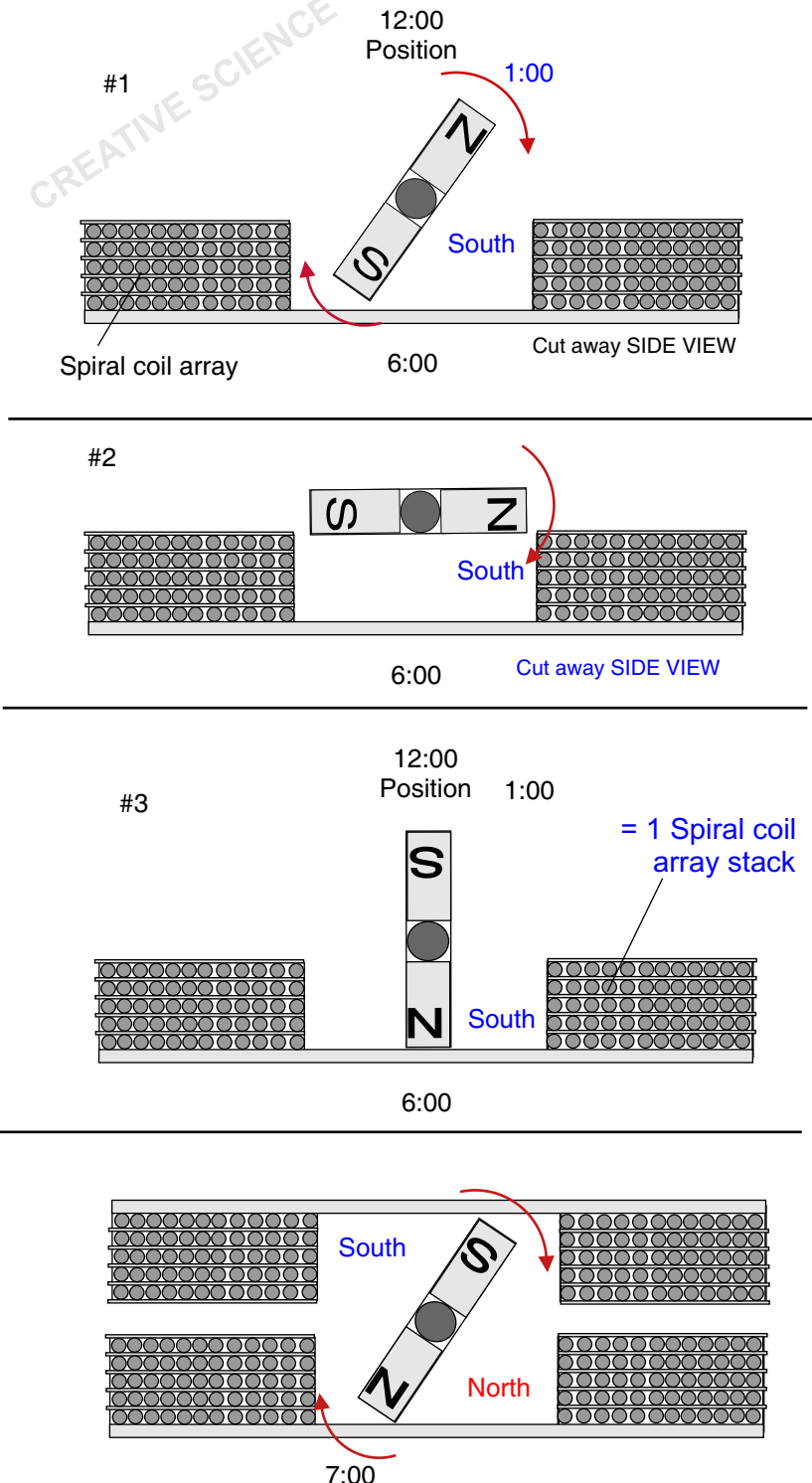

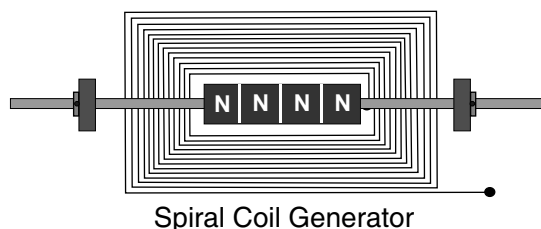

Spiral Coil Generator

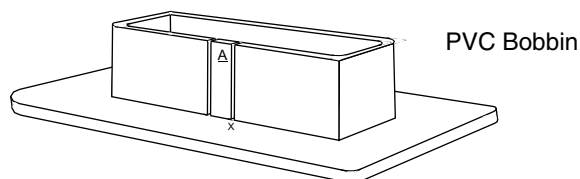

PVC Bobbin

If you carefully study the **generator coil** and rotor magnet design you will see that it is very different from any other generator that is manufactured today! Most all generators today use copper coated wire wrapped around a soft iron core. As you can see we DO NOT use a soft iron core. Again as you can see we simply replaced the soft iron core which is stationary and common in all generators today and replaced it with a movable neodymium magnet core, Which is far better and more high efficient than using the stationary non movable soft iron cores. There is much more that we can explain as far as how our spiral generator coils work and function as well as there highest potentials, but for the sake of protecting our trade secretes we will keep this info to ourselves. Anyway you do not need to know all the details to make this generator work! Simply study and follow the plans.

The spiral coil pancake array (generator coils) are made up of many layers of **#18 copper coated wire** and are connected in series. Our first prototype coils were soldered in series, we soon found many better ways to connect the coils in series than soldering them. we found that it is best to simply make one long array using one wire, no need to cut the wire.

To start: Spin your first spiral coil layer, coat it with PVC glue or best to use 2 part epoxy, allow it to dry 2 hrs if you use epoxy, then prepare a thick paper that is the same thickness as the wire. We then spray the top of the first coil layer with 3M spray adhesive and then the back of the paper separator, let stand for 2 to 3 minutes and then apply the paper to the top of the first coil layer. The paper will have a small slit in it so the 2nd layer lead wire can be sent through it, back through the center PVC bobbin and back out to start another 2nd layer spiral coil. This may seem confusing, but I am telling you this now just to give you an idea of what I will show you later. Before you can start spinning your spiral coil layers a PVC bobbin must be made. As well as a Bobbin coil turn table. For small coils we use our special homemade drill press as a coil spinner, we use a 90 vdc motor with controller to control the speed. But with these large of coils you can not use a drill press coil winder the coil bobbins are to big, so a large round wooden table with a Lazy Susan connected to the bottom must be used. The PVC bobbin will be taped with 2 way carpet tape to the top of the wooden Lazy Susan, and you will need to turn the entire structure by hand. Which is a very slow process. If you are good at making things it is best to automate it. You will want to use a 90 VDC conveyer belt motor with controller and a rubber wheel so the lazy Susan can be driven automatically. The lazy Susan should be about 16" in diameter and placed on a work table top.



Spiral Coil Construction

PVC Bobbin: If you are not very good at building things very accurately it maybe best for you to build the magnetic rotor first, and then build the PVC Spiral coil bobbin around it. So you make sure the rotor magnet will not hit the PVC bobbin or Copper wire loops that will be on the inside walls. Use a matt knife or a table saw with a fine blade to cut the PVC pieces or You can make it square cornered and then add round PVC or wood to the ends. There will be 6 pieces A - F, F is the largest and the bottom of the PVC bobbin. A & B can be glued as one piece and then cut later. Cut and glue as square pieces, not round edges as drawing shows. Drawing is just an example. You can round the corners later. Cut and use the drawing measurements as your guide. **Note: You can also make your open slits on side C as well to keep out of magnets reach.**

Top View of PVC Spiral Coil Bobbin

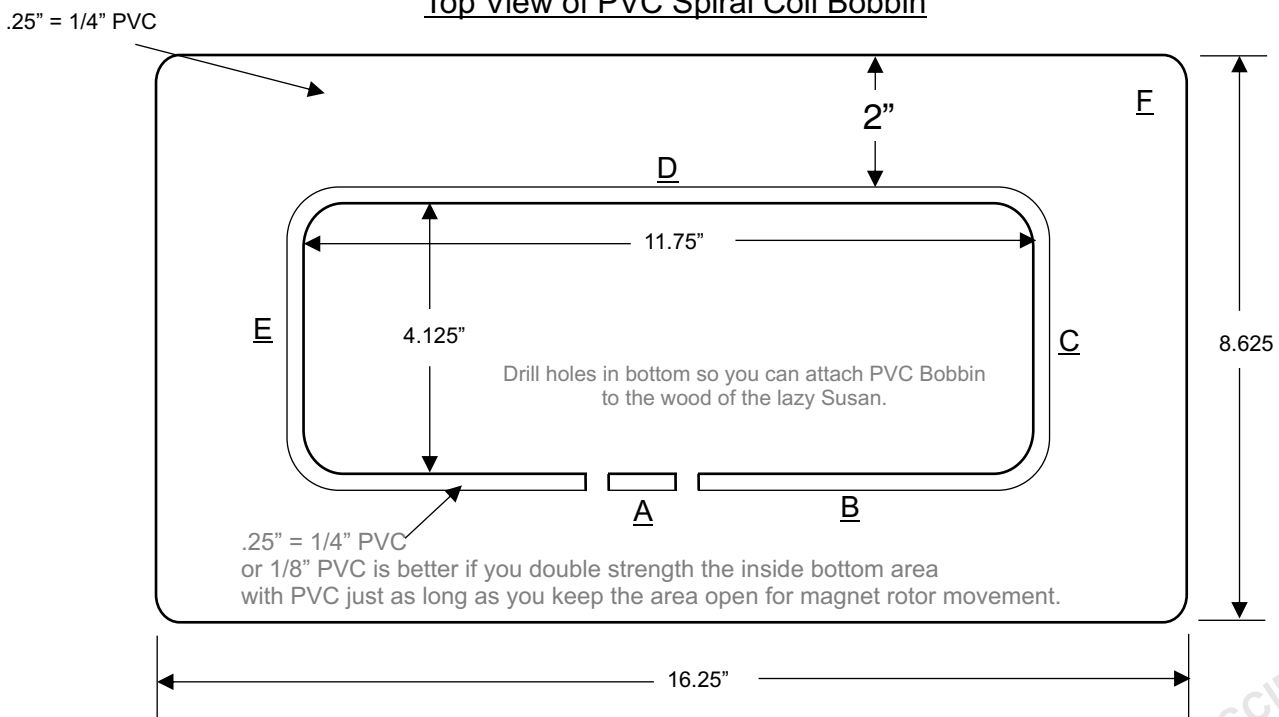

3D Side View

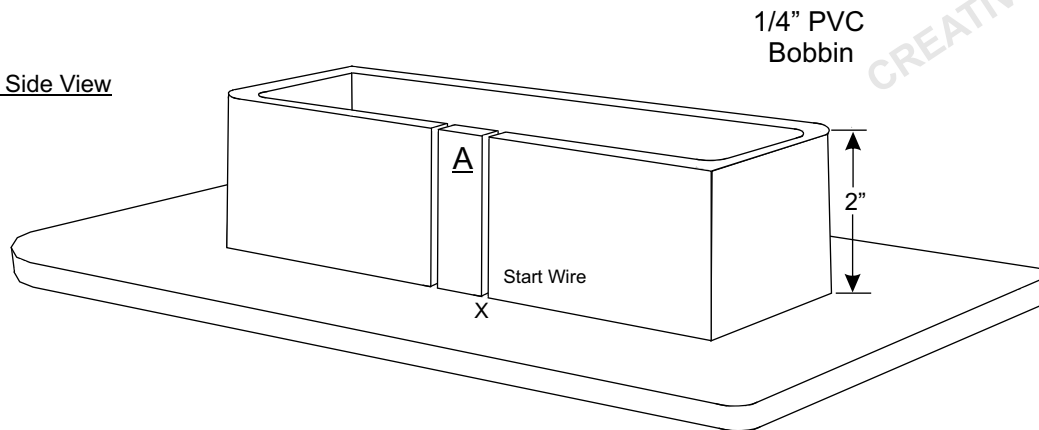

Part # A The bottom will be glued the bottom of PVC bobbin, but you may still want to use tape and stiff cardboard or wood at the top of a while you work the wire. Best to use small wood blank and to small spring loaded clamps.



Optional Oval Bobbin

Optional PVC Bobbin: The prototype you see in the photo's and in these plans do not use the oval shaped Bobbin below. This is a much easier way to spin the copper wire around the center of air core bobbin. The wire works much better this way, but there is a small loss in magnetic flux. If you do it this way you will need to extend the generator size. But we are not going to provide plans for that, it's not that hard, simply move the generator's ends outward to make more room for the longer PVC Bobbin coil. First build the rotor magnet assembly and then the PVC Oval Spiral Coil Bobbin and then the generator ends etc...

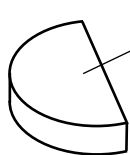
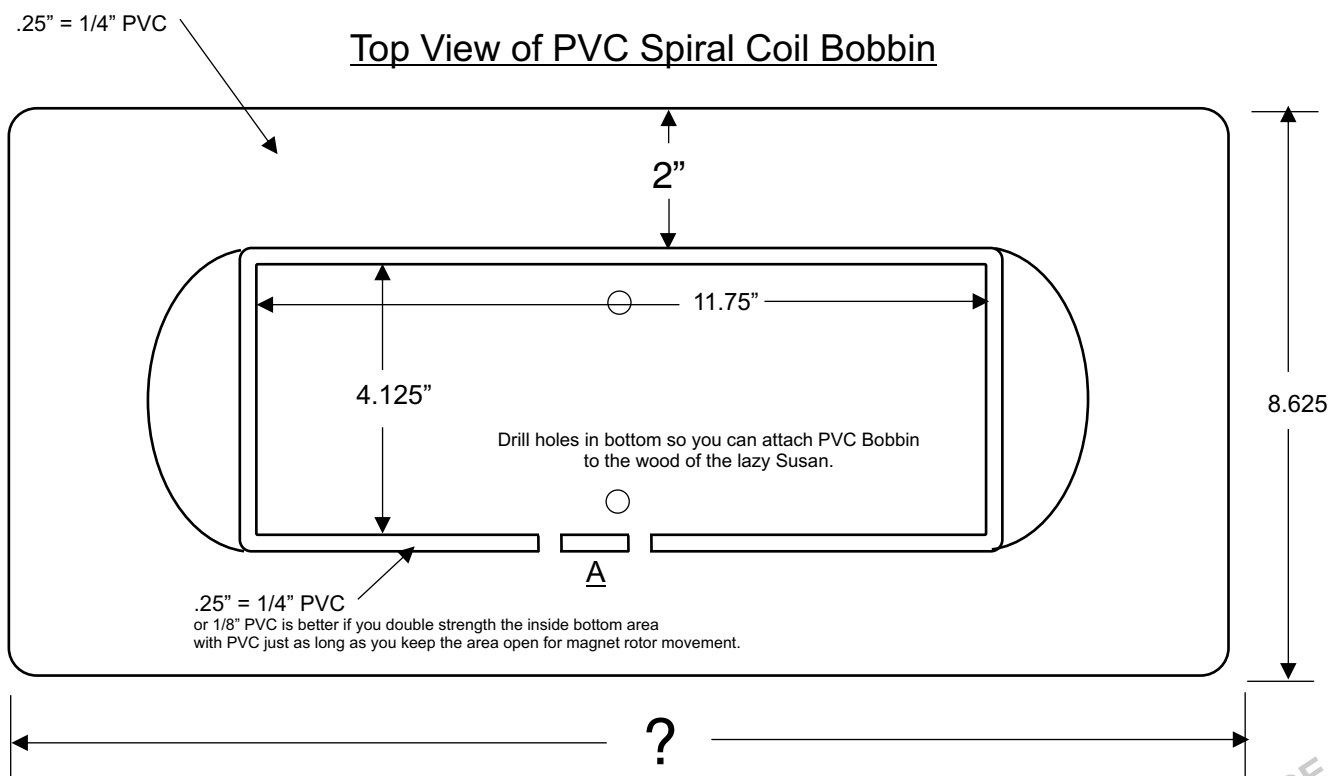

Example of one piece of PVC 1/4" cut as many as you will need to reach the top of bobbin, glue the first one to the bottom base of bobbin as well as to the center PVC bobbin piece. Glue each one,-- one on top of the other. Use PVC glue.

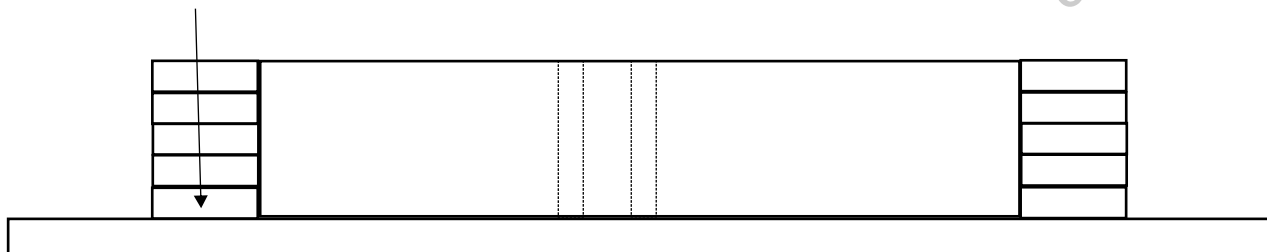

Side View



Spiral Coil Construction

ASSEMBLY: Spiral Coil Assembly. Your PVC Bobbin should now be done and been allowed to dry for about 24 hrs. You will now need to make a cardboard slip cover for the center of the PVC bobbin, so when you spray the bottom of the PVC the center will be protected. Place your slip cover over the center of PVC bobbin, (WARNING! Spraying should be done in a well ventilated area!) Now spray the top of the bottom of the PVC bobbin with 3M spray adhesive #77. Make sure to spray every inch of it. Let it dry for about 2 minutes and apply a 2nd coat. Let dry another 2 to 3 minutes and then remove the center slip cover and place the entire PVC bobbin on the center of your wooden Lazy Susan using 2 way tape or Velcro. Your #18 copper coated wire spool should be on a wood metal rod holder so it can be easily unrolled. You can make a wire spool holder out of 2 x 4's or plywood. (Or use 2 way carpet tape).

Now it's time to begin turning the wire onto the PVC Bobbin. Place the beginning of the wire in the start hole area, allow about 12" to come through the hole and tape it inside of the center of bobbin using masking tape. Now use a small plastic knife and push the wire down onto the sticky surface of the PVC bobbin and at the same time the wire should be pushed snug up against the wall of the center of the bobbin. pull the wire with your right hand / applying a small force and sliding the plastic knife across the copper wire at the same time. Your applying force so it will stick to the sticky surface. If it does not then you purchased bad spray adhesive. If you find you have taking to long to spin the wire and the Adhesive has dried half way into it, then you will need to cover and protect the wire you have already laid down and place the Slip cover back over the center (Do not cut the wire, take the spool of wire with you to your spray booth area) Then re-apply more 3M spray adhesive. Remove protective covers and finish the first spiral coil layer. Leave 1/8" space all around the end of the coil to the end of the PVC bobbin bottom. Now it is time to prepare for the 2nd layer. The top of the first spiral coil layer wire should be coated with PVC glue (which dries fast) or a 2 part epoxy which is best but take hours to dry. Use a stiff but thin piece of card board or plastic to lay down the glue or epoxy onto the top surface. Use it like you would a putty knife make it as smooth and as even as you can. If you use 2 part epoxy you can wait 10 to 20 minutes and then apply your Die electric thick paper spacer. The Die electric spacer will go right on top of the spiral layer and epoxy. Again the die electric spacer can be thick paper or plastic mylar, Make sure what ever you use that it is the same thickness as the #27 copper coated wire. The Die electric spacer must have a slit in it and be lined up with the left side of the A bobbin slit so the wire can be guided on top of first spiral coil and back through the center of PVC bobbin so the whole process can be repeated again.

NOTICE!

With each turn of wire there should be no space in between the wire making up the spiral coil.

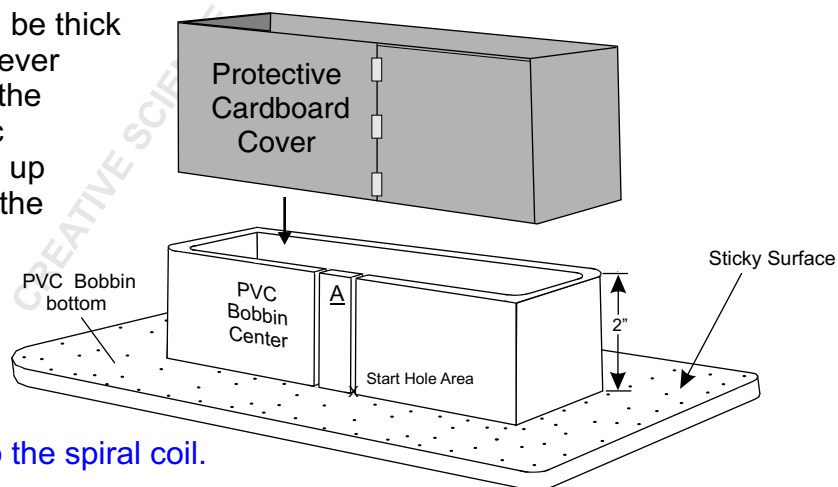



Notice: Optional - You can use a thin layer of 2 part epoxy on top of your finished spiral layer and then apply your thick paper on top and then a 3/4 plywood weight and let dry overnight!

Spiral Coil Construction

Use 2 way carpet tape or Velcro on the bottom of the PVC bobbin to attach it to the top of the wooden Lazy Susan so the bobbin will not move as you are spinning your spiral coil. A optional drag brace can be used to go through one side of the wood to keep the Lazy Susan from moving to freely.

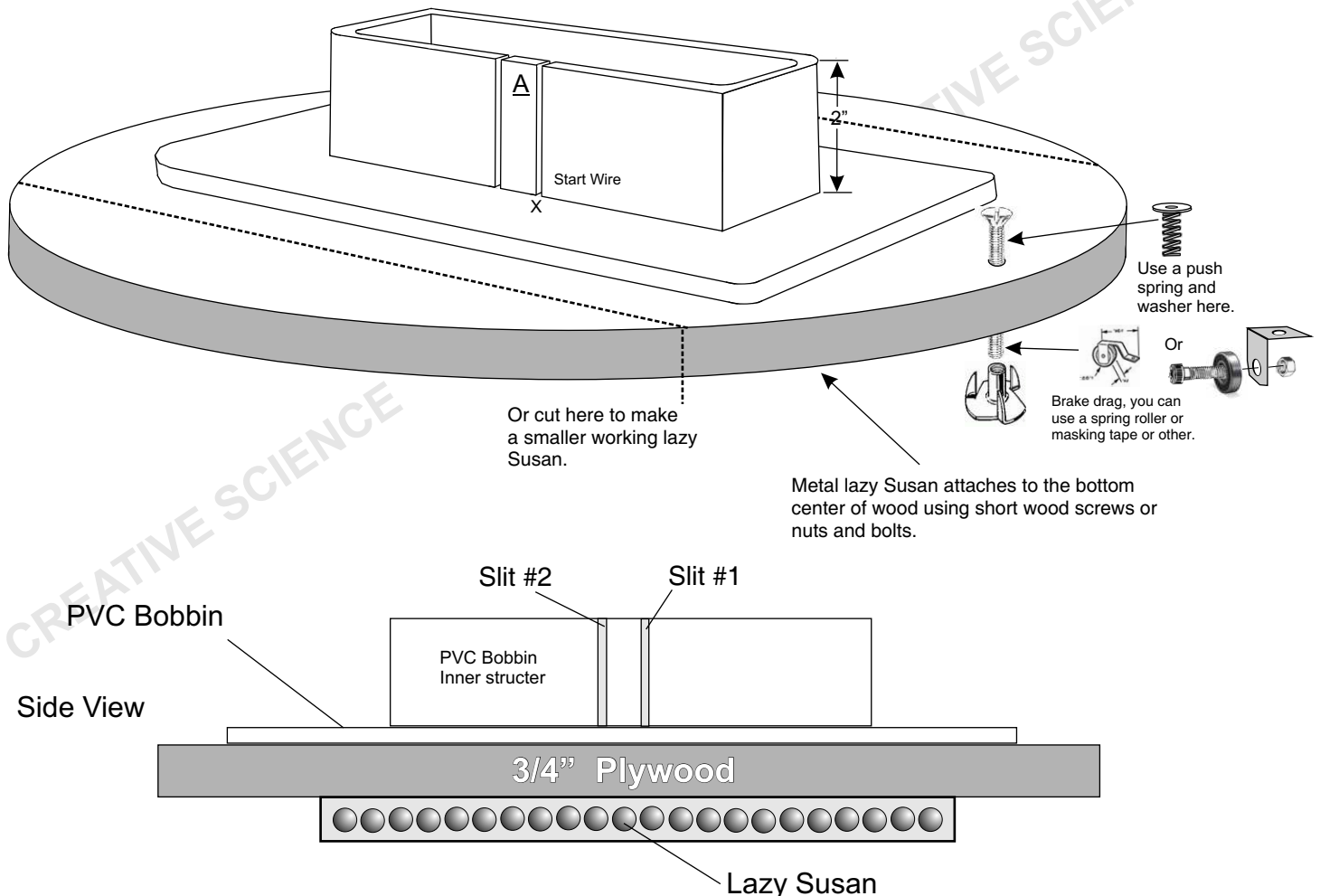

Once you have spined your first layer coil and applied the epoxy and paper and you have allowed it to dry about 2 hrs you will now want to spray the top of the thick paper so you can restart another layer, repeat what you did before when you made your first layer. Remember the Thick paper must fit perfectly and snug around the inner bobbin structure of it's outer walls so the copper coated wire will not slip through any cracks between the paper and the PVC. TROUBLE SHOOTING: If adhesive spray is not working use 2 way carpet tape, we have used both before. Spray adhesive is great for small wire.



Spiral Coil Construction

EPOXY OPTION: If you decide to use a 2 part epoxy to apply over each layer of your spiral coils, then it is best to use a 3/4" plywood or 1/4" metal weight to lay on top of the coil and thick paper separator during the 45 to 65 minute drying time. (Epoxy dries to handle in 2 hrs.) The epoxy should be getting hard and sticky in about 45 to 65 minutes. The weight will help the coil to stay flat and help keep the thick paper flat against the coil and epoxy and will insure that the thick paper sticks to the coil surface area. The result will be a very flat and uniform coil and paper layer, each layer should be done this way. **Make the 3/4" plywood or 1/4" metal weight the same size and dimensions as the thick paper separator!**

* NOTE: You can stick the thick paper separator on top of the coil and fresh epoxy at about 5 to 10 minutes into the drying time.

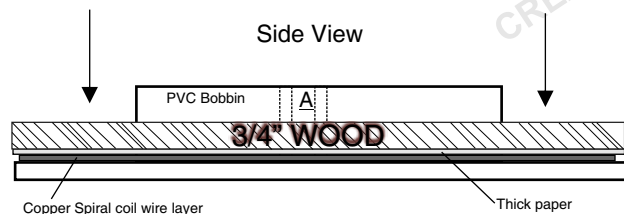

Use 3/4" plywood as a weight during drying time to press the coil and paper flat.

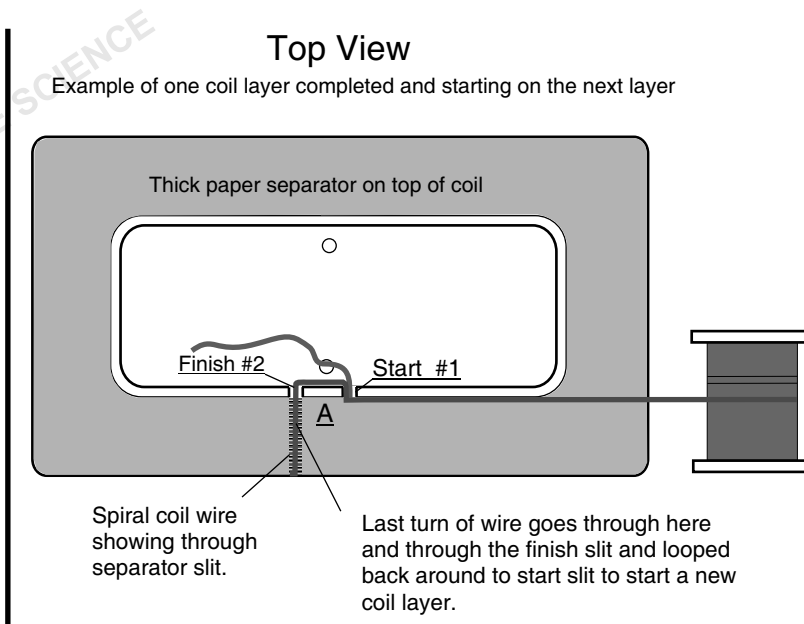

The thick paper separator can be drawn using Corel Draw or any other drawing and layout computer program. Design the layout to 100% size. And then print out on a printer. Most people only have a printer that can print 8 1/2 x 11" paper, so what you should do is to print out each half on 8 1/2 x 11" past or tape it together and go to a copy center that has a copy machine which can print on 11" x 17" thick paper. Or better yet draw and layout the paper separator by hand on a master sheet of 11" x 17" thick paper copy it with a copier or cut it out and make a drawing templet and trace all the rest using the master templet. The finished paper separators must be cut very accurately just to a perfect fit for the center bobbin. If you have a space between the paper and the PVC bobbin the wire will slip into that space and that is not good. I would say for me making a very accurate templet would be the best way to go. (Another option would be to get a sign shop with a good sign machine that can draw the templet for you or the actual paper separators themselves, I have not checked but it should not cost much at all to have them do this for you.)



Spiral Coil Construction

Step One

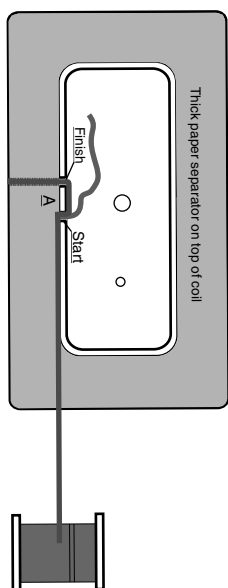

Step Two

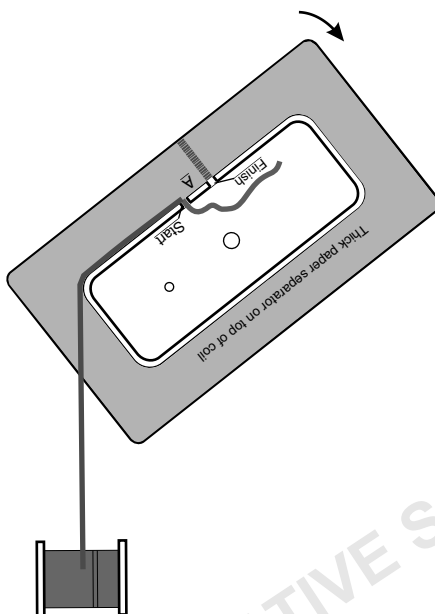

Step Three

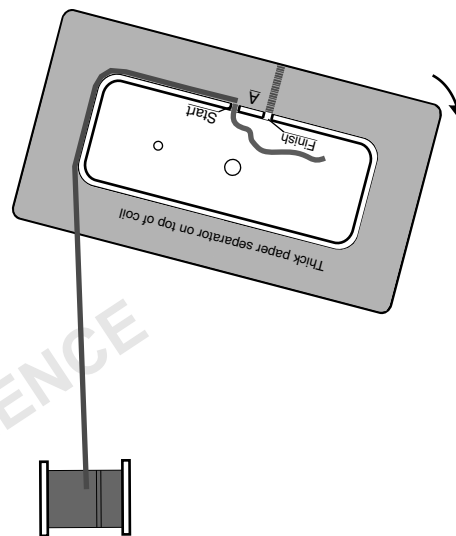

Step Four

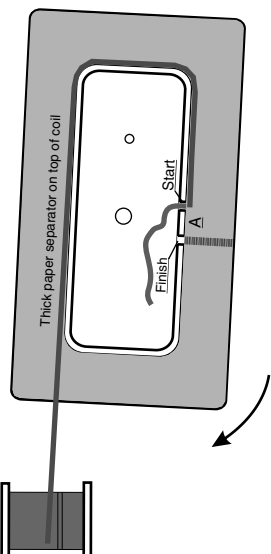

Step Five

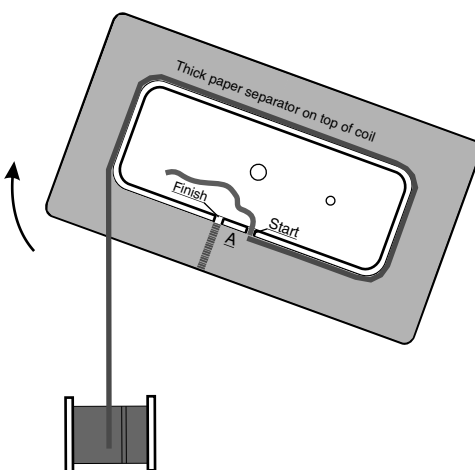

Step Six

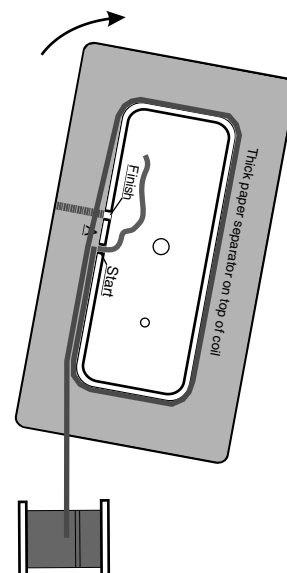

Continue until you have a full and complete spiral coil, leave about 1/4" to 1/2" space on end of last turn, between the last wire turn and the PVC bobbin bottom edge. Again after done, apply thin layer of epoxy on top of wire, let dry about 10 minutes, place thick paper on top of that, then 3/4" plywood weight. Let dry 2 hrs then remove weight, to start 3rd layer coil, loop wire through slits #1 and #2 and repeat again. (Remember the thick paper must be the same thickness as the wire you are using or in this case #27 AWG copper coated wire. Repeat layers until you reach the top of bobbin).



Spiral Coil Construction

Thick paper separator TOP VIEW

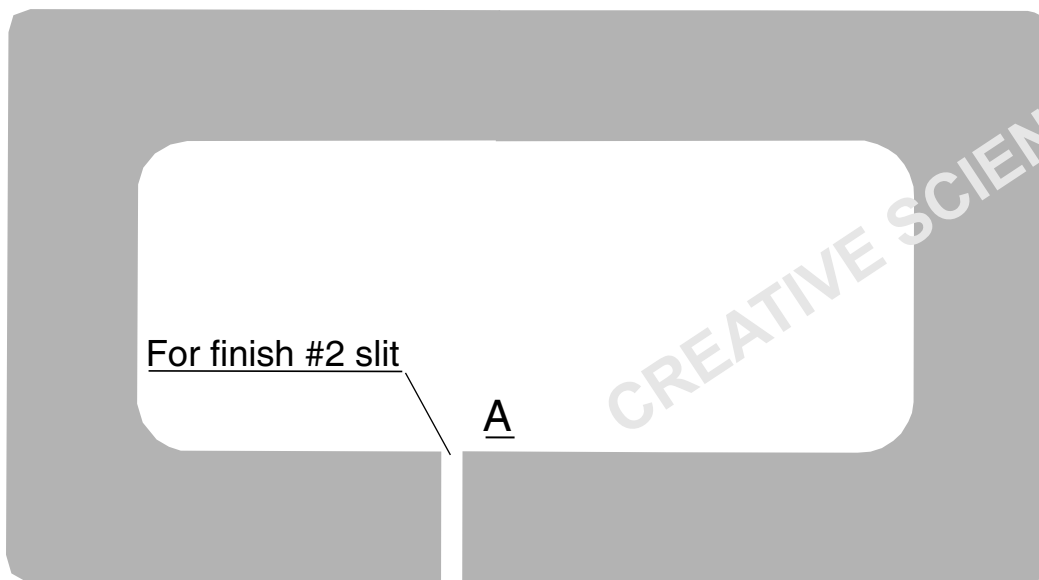

Note: Paper must be as thick as the copper coated wire you are using to make your spiral coils. Art supply stores carry many different types of thick paper.



Close up SIDE VIEW of paper slit for PVC slit #2, wire fits in between paper slit.

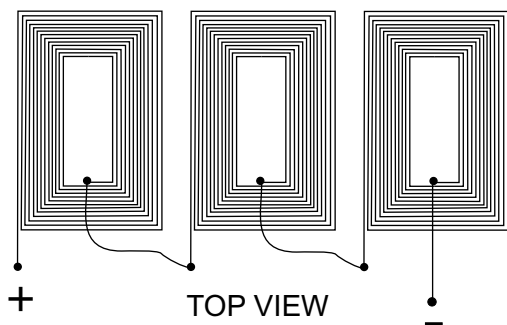

Example of electrical connections. You do not need to solder each coil together, there is no soldering needed using our coil winding loop method.

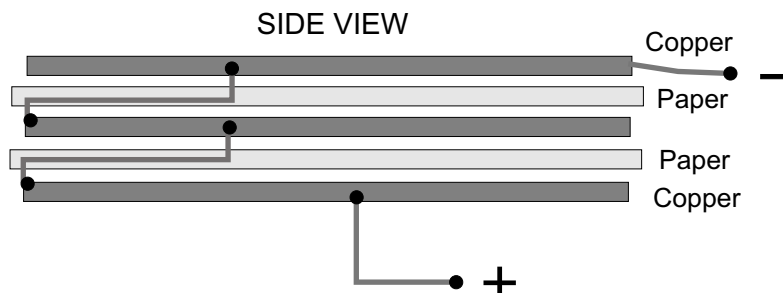



Now that you have successfully completed your generator spiral coil array it would be a very good idea to test it. Using a volt meter with ohms and capacitance capabilities take an ohms resistance reading and write the results on top of the paper of the spiral coil, next take a capacitance reading and do the same. You will now need to weigh the entire spiral coil array and write that down as well. The height that we gave you should be enough to output a great deal of electricity and current. The coils will output AC current. If you need DC current simply add a diode rated at high amperage and 2 times the output voltage amount connected to one of the wire legs of the output of the coil. If you desire more voltage simply add more layers.

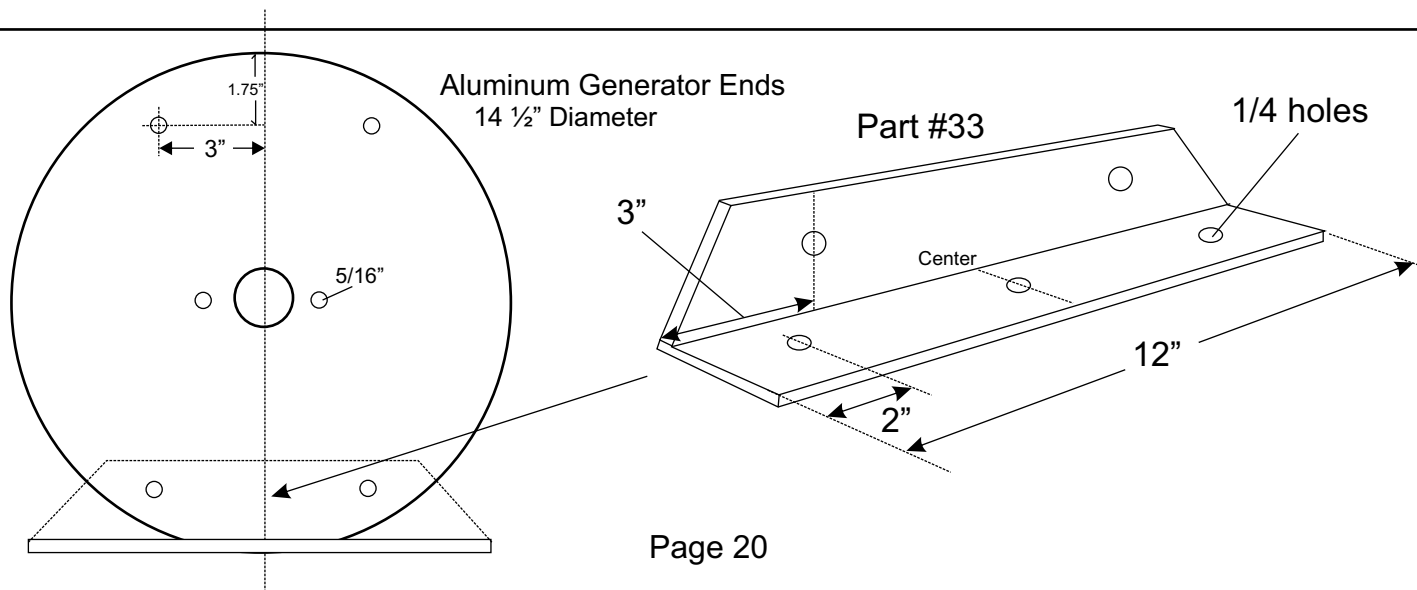
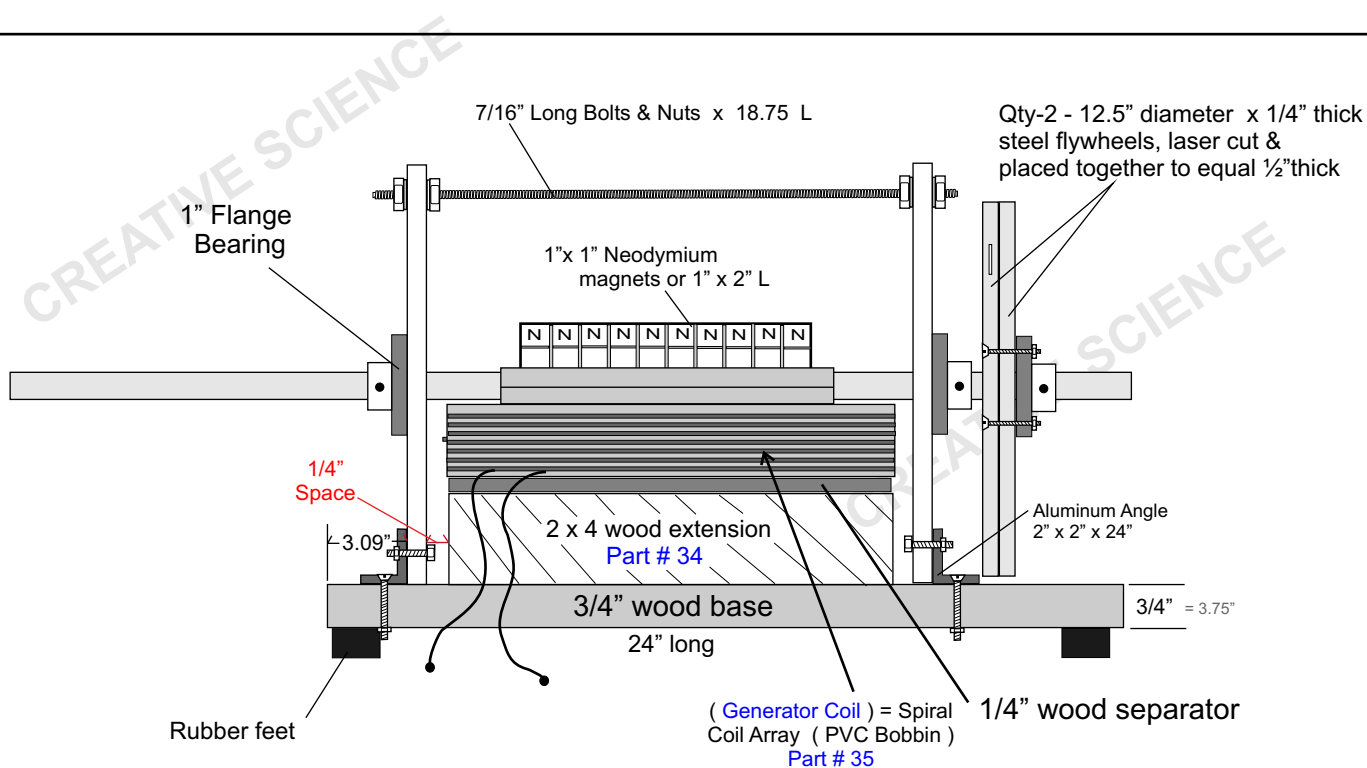

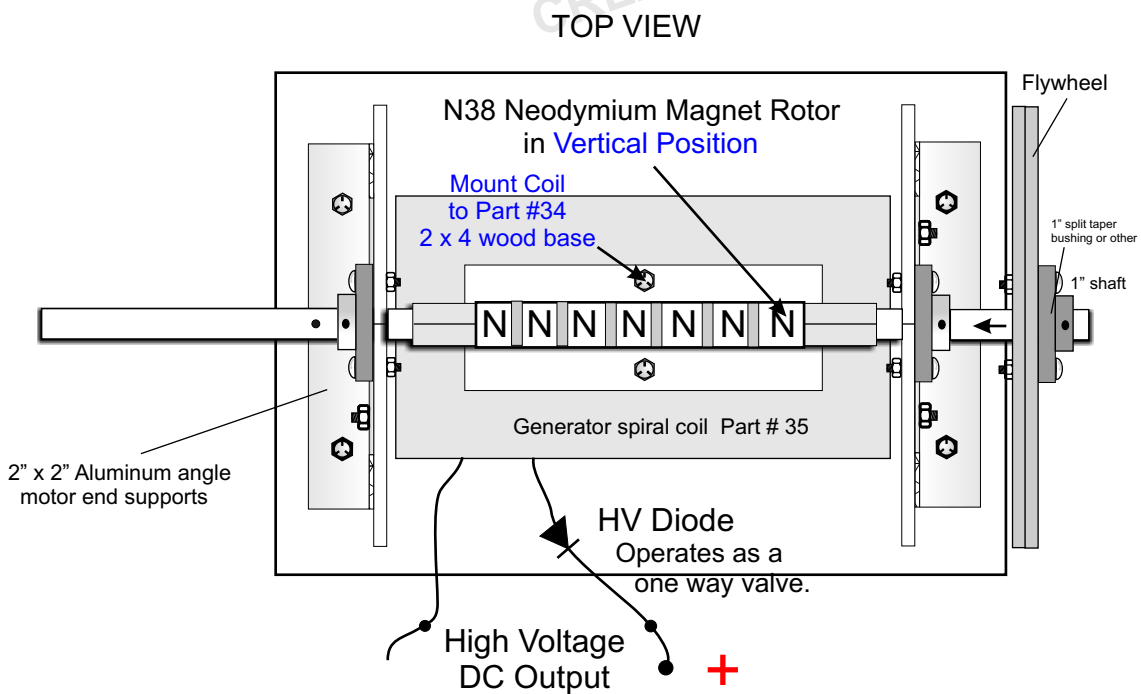
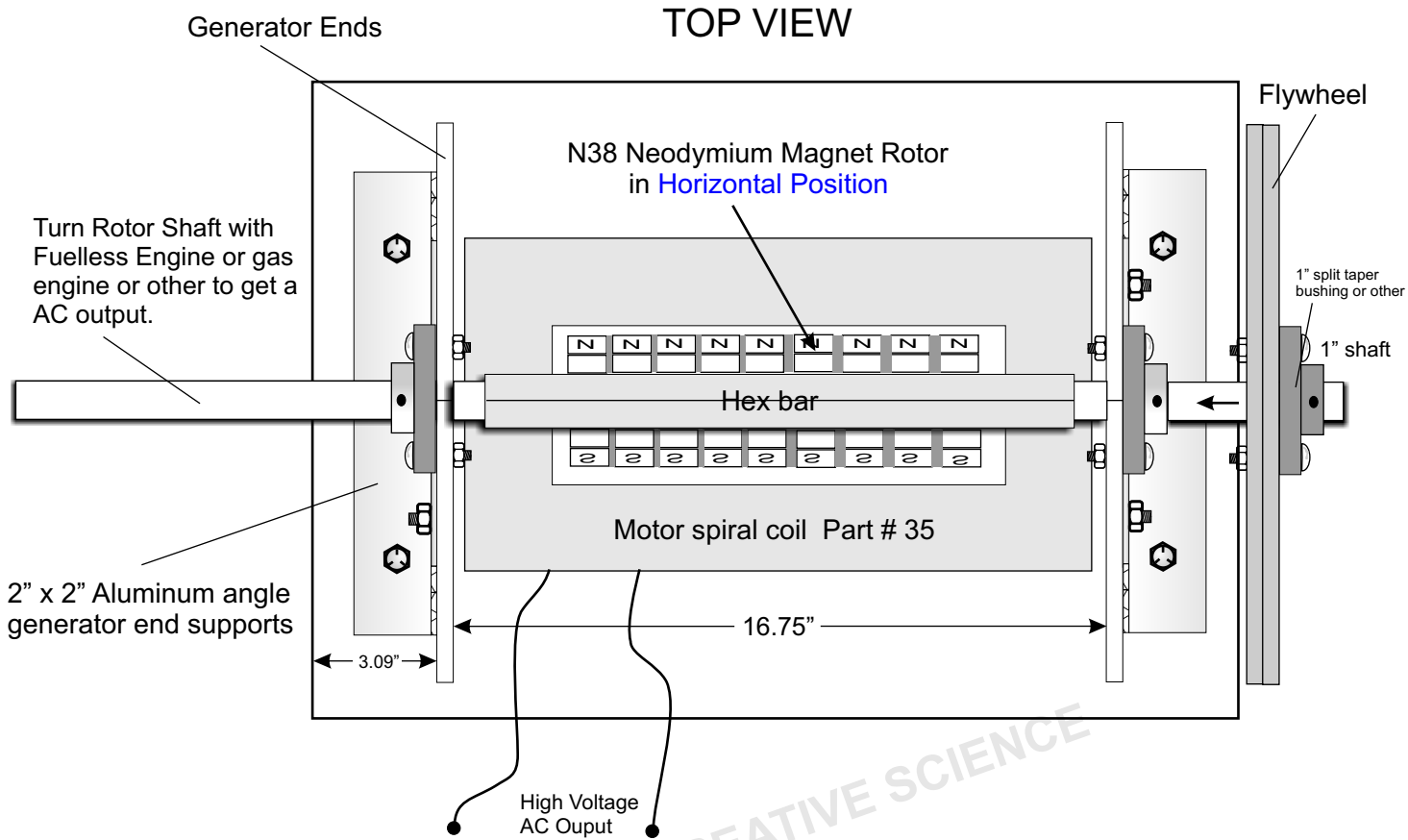



Assembly

Using wood screws or bolts connect rubber feet onto the bottom of 3/4" plywood base. Drill qty-2 7/16" holes in the top portion of each aluminum generator ends or you can use fine cherry 3/4" plywood instead of laser cut aluminum. (14.25 D. Laser cut Aluminum can be expensive if you go to the wrong laser cutting shop). Place your 1" rotor hex shaft in the 1.10" D holes in the center of generator ends, now place your 1" bearings on the 1" rotor hex shaft on the outside (see drawings). Spread the ends 16.75" apart and mark the shaft with a black permanent marker where the center generator end starts onto the shaft. The center hole must be bigger so 1" Diameter -shaft will not rub up against the aluminum while the motor is running. you also want to get the shaft in perfect center of the 1.10" center hole of the ends so you can mark your flange bearing bolt holes with a black fine point marker. To get the 1" shaft in dead center use tape to fill in the space. Apply the tape to the rotor hex shaft itself and place through holes, they must fit tightly. Now mark your bolt holes and remove everything, the flange bearing and generator ends from shaft. Remove tape from rotor shaft. You will now need to drill all your holes. The flange bearing bolt holes must be dead center. Find the center of the circles you made. *Some flange bearings come with square bolt hole areas this is for Carriage bolts.* It is best to use a large flat bed drill press to drill your holes or you could let a machine shop do it, If not lay the ends on a flat table and use a small starter drill bit first to make sure you drill dead center. It is important that you get the 1" bearing in perfect center of the 1.10" hole(s). If you do not think you can do it then make your holes bigger so you can move the bearing around and adjust it by hand and tighten the bolts. If you use lock washers the bearings should not move after hundreds of hours of motor operation. Now take your 3/4 cherry plywood motor base and mark center lines on it. Now mark center lines on the aluminum motor ends as well as the aluminum 2" angles. Mark 3" from the left side of the 3/4" plywood base (the left side would be the side that the commutator is on). Now mark 1/4" after that, that's for the 1/4" thick generator end, now mark 16.75" = 16 3/4" (Coil area see drawings). Now mark all drill holes that will be needed to mount the 2" x 2" aluminum angle (part #33) to the ends and 3/4" plywood base. Make sure you make everything as dead center and as accurate as you can get. Generator ends must be parallel with each other or the Rotor will drag. The top of generator rotor can be adjusted with the long bolts to eliminate drag. Now attach your 2" aluminum angle to the 3/4" Plywood base using 1/4" x 1 1/2" bolts and nuts. Now bolt the left generator end to the left 2" aluminum angle. Place the 1" hex shaft into center hole. Connect flange bearings to both ends, do not tighten bolts all the way yet. Place the right generator end onto the right end of rotor shaft, bolt the both ends to the 2" angles using 1/4" x 1" bolts, washers and nuts. You can use lock washer also if you like. Tighten the left side of generator end first and then adjust and measure the right end to the left generator end so they are perfectly parallel with each other. Place the long bolts and nuts in the top (see drawings). Tighten all bolts and adjust top long bolts until the 1" hex rotor shaft moves freely! Drill holes for your flywheel mounts. *Flywheels must be laser cut.* Mount flywheels onto the right side of rotor shaft using 1" split taper bushings or 1" collars. Taper bushings can be purchased at grainger.com. Part # 3A147, (4" steel pulleys can be used to attach to flywheels also, but you will need to drill holes to make them work.



2 X 4 wood extension frame part #34

Used to hold up and brace the generator coil. (Spiral coil array part #35). You will need a table saw (best to use) or other to cut the 2 x 4 " frame. 2x4" wood is a US wood size. The wood is not really 2" x 4" thick is less. Anything you have close to it will work as long as it is sturdy, you could even use thick aluminum, (NO Steel) Again please note we are just showing you somewhat how to build our prototype model do not let that limit your artistic thinking. No doubt you could improve on it_(we already have).

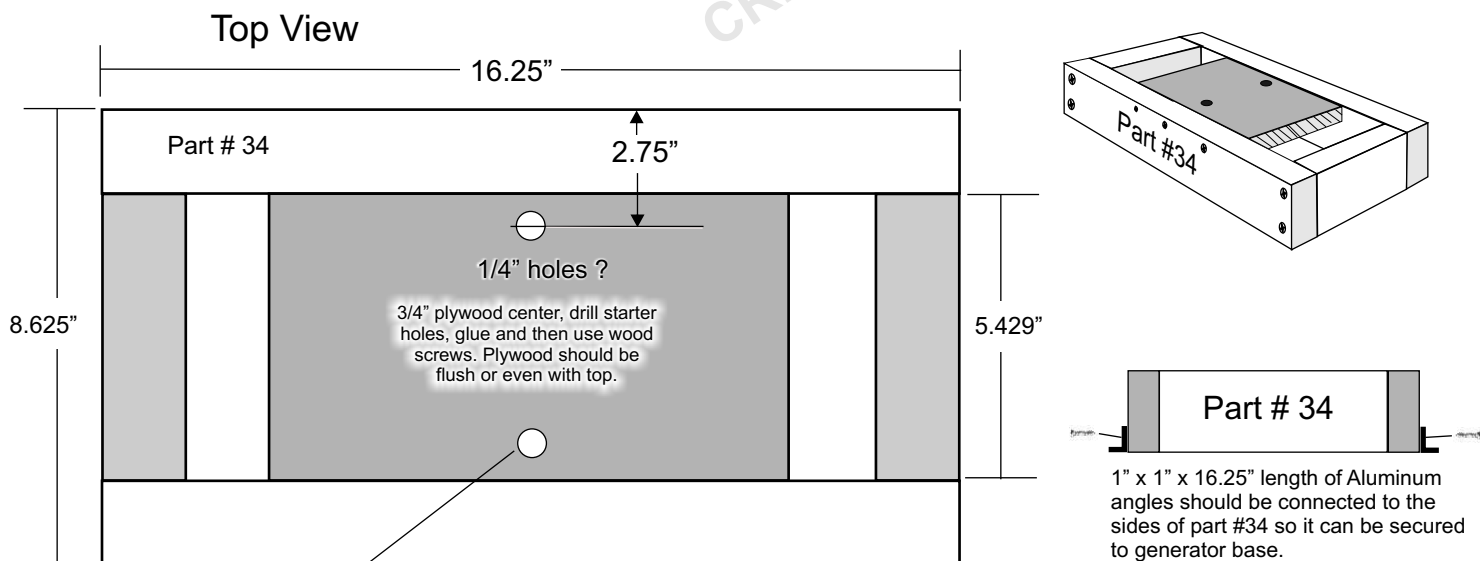

1/4" woodnuts?

These wood nuts are hammered behind the hole and through it. I am not sure of the hole size. So buy the nut first and then size it up and drill your bolt holes. These wood nuts can be purchased at most hardware stores or on the internet. Try www.AceHardware.com

Drill holes in bottom of 1/4" PVC part #35 spiral coil bobbin. Drill the holes a hair bit larger so the coil can be adjust to fit around the rotor magnets. Or drill this type, but still make width of hole a hair bit larger than bolts.

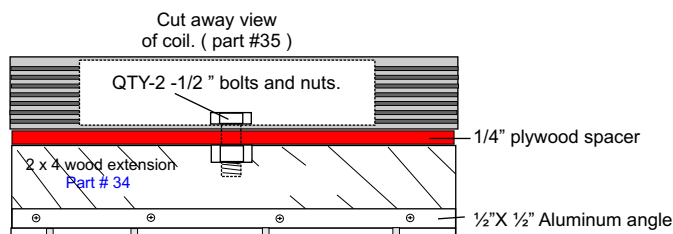

Line up part #35 and Part # 34 one on top of the other and attach 1/2" holding bolts and nuts. Use short wood screws to attach to 3/4" wood motor base. Use 1/2"x 1/2"aluminum angle. Assembly option: In order as so, 1st Left generator end and bearings, 2nd-Part #'s 34 & 35, 3rd rotor magnet assembly (when done), 4th right motor end assembly.



Rotor Shaft & Magnet Assembly

Now it's time to assemble the hex rotor shaft and magnet assembly. You will work on the north pole side of the rotor shaft first. You can find the north pole of the magnets by using a compass. Use a very fine point permanent marker and mark each magnet with a small N. Care must be taken when handling these magnets! read all safety instructions your Neodymium magnet supplier gives you. Use protective eye wear. These magnets are hard to handle so you must take your time. It is a slow day by day process. It is easier to use a 1" flats hex bar, the magnets fit right onto it. If you decide to use a 1" hex bar (that's 1" across the flats) you will need to resize and design the spiral coil air core bobbin. (the rotor assembly will be wider). We use N38 Neodymium magnets, it's best to use N40 but they are much more expensive and harder to work with. Neodymium magnets are the most powerful permanent magnets in the world! 1" x 2" magnets can be used as a 2nd option. You will be using 2 part Devon epoxy. (a 2nd option is to glue magnets with professional magnet motor glue and then epoxy the air spaces. Special glue is called LOCTITE 7649 and LOCTITE 326 it is a 2 part as well. We did NOT use this on our first prototype and motor is running very well so far). The hex bar ends must be taken to a machine shop and lathed down to 1" (see parts and supplies.) Sand the hex metal were the magnets will be glued to. Clean with a Lacquer thinner or other. Hands and work area must be very clean! Mark the area's were the magnets will be placed. Each magnet will have a 3/8" space in between each one. Use metal washers as seen in the pictures. No need to glue the bottoms of the magnets just place them in place and apply glue to the bottom side areas first. You will want to clamp the hex bar down or tape it so it will not move. **Placing the magnets:** Use both hands, left hand on your right wrist, right hand holding magnet and slowly come at the hex bar were magnet will lay, Come in at an angle, you do not want the magnets to snap to the surface with all the magnets force, you must hold back some of that force and help slide it into place. Magnets can break and shatter! Start with your first magnet, line it up dead center and glue it very well with epoxy, (glue sides only at this time Not the front were washer spacer will be). Let dry 2 hrs and tape plastic or cardboard on top of the magnet so when you start your next magnet the next magnet will not try and attract to the north side of the first magnet, if this happens simply slide the magnet off side ways and try again.

Use 5 washers to equal a 3/8" thickness (as a spacer, make qty-6 of these)... Place 2nd magnet onto hex bar and glue sides. Repeat until you get one whole row of 8 magnets in line. Now you can glue the air spaces in between the magnets. Let dry overnight and then start your 2nd row, until you have 3 rows of 8 stacked on each other and glued very well. Always keep in mind the rotor must be as well balanced as you can make it. The rotor will be turning at very high rpms, if it is off balanced the entire generator will vibrate and can vibrate parts loose. See the following pictures on the next pages. The pictures are self explanatory. Study this page well as well as the pictures before you try and attempt to glue the magnets into place. Use tape as wall molding to keep the 2 part epoxy in. Make sure there are no holes in tape or the epoxy will leak out. Once you have finished the north pole side use masking tape and card board to protect it from damage or other magnets coming in contact with it when you start the south pole side.



Rotor Shaft & Magnet Assembly

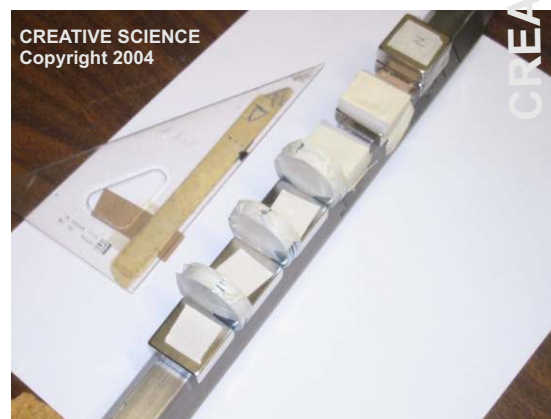
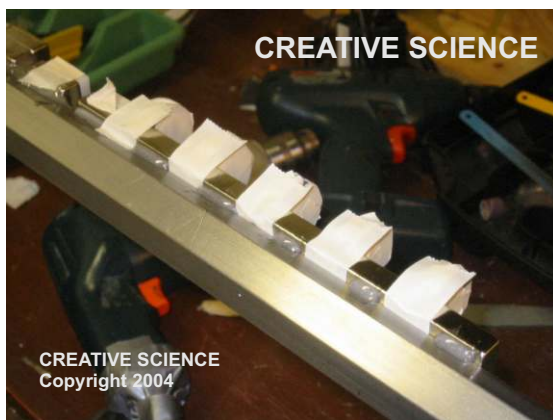
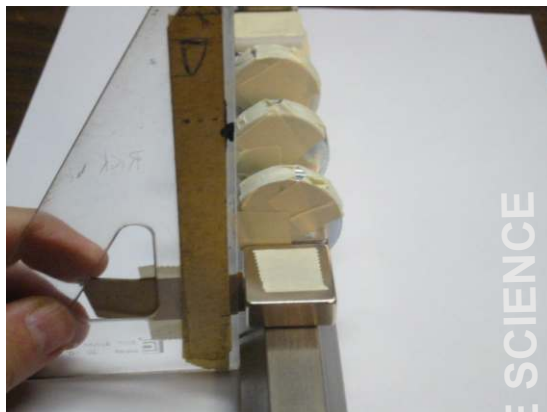
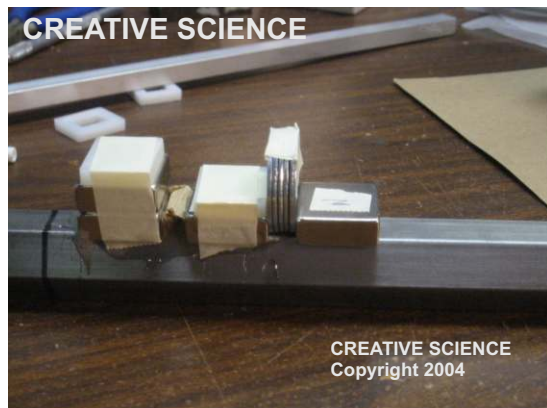



Rotor Shaft & Magnet Assembly

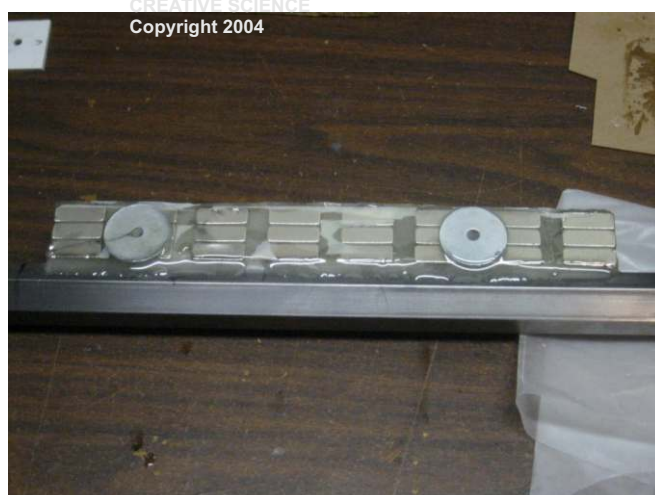
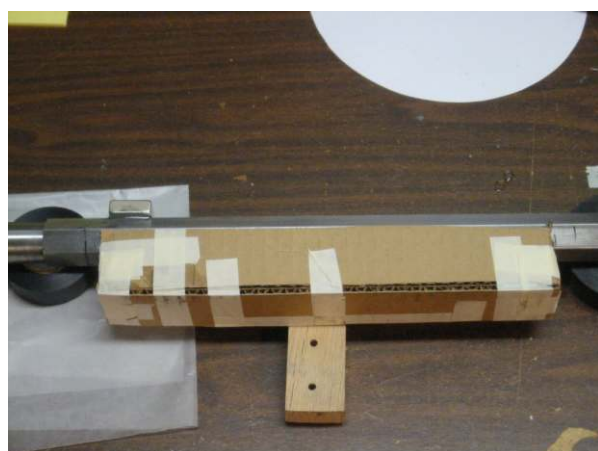
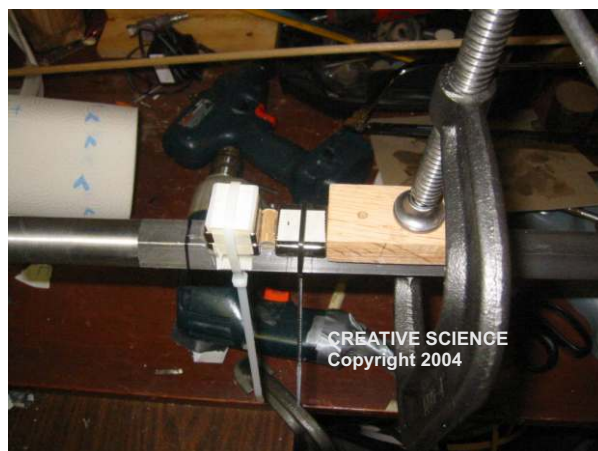



As an example here is a small round disk type spiral coil being turned and assembled. I wish we had the bigger coils to show you but we do not have assembly photo's. The photo to the right shows the PVC pipe in center and 1/8" PVC pipe sheeting on the bottom under the thin paper. The paper is glued onto PVC sheet using 3M spray adhesive. The light brown paper is covering the PVC pipe so we can spray the top of the paper and not get any over spray on the PVC pipe. Of course the PVC pipe is already glued to the PVC 1/8" thick sheeting using PVC glue.

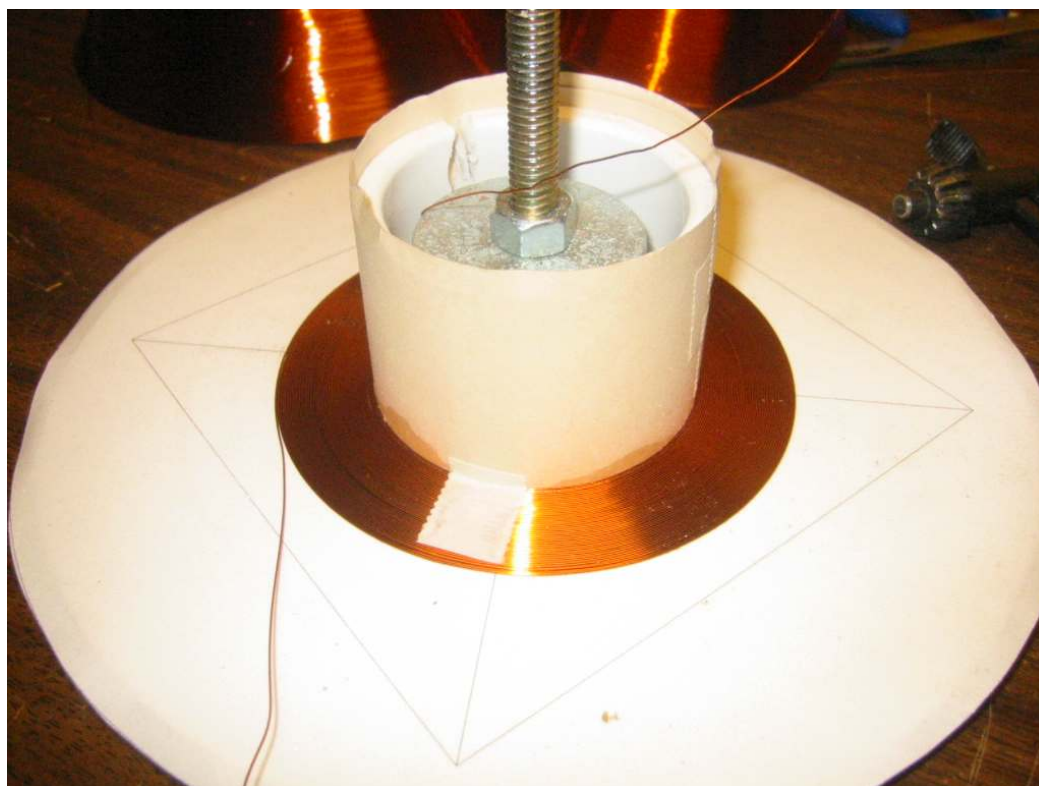
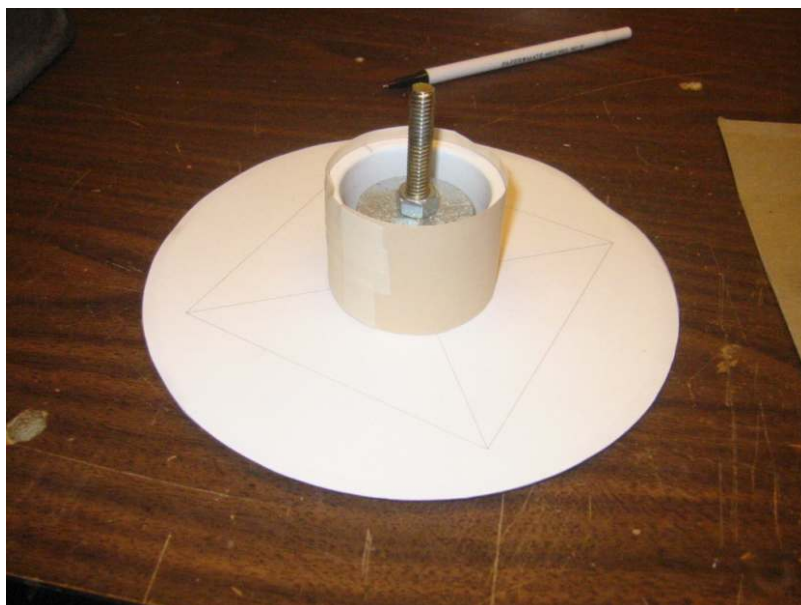

#27 Copper coated wire being wound on top of the sticky paper.



Spiral Coil Technology / Copyright - Patent Pending

For added protection,(so the wire does not come up) we use small peices of masking tape to keep the wire in place.

The center bolt is connected to a small low rpm drill press, but because we are using smaller wire we turn the drill press pulley with our right hand (manually) as we guide the wire in place using a thin plastic or metal object and press down on the wire as we turn the drill press so the wire will stick to the sticky surface of the paper.

Using bigger wire such as #15 or #18 awg is much better to work with and is great for generator use.

Please keep in contact and tell us how you are doing. Please send us photo's by mail or by e-mail, we would love to hear from you. If you need any technical help please send us an e-mail to:

Sales@Fuellesspower.com

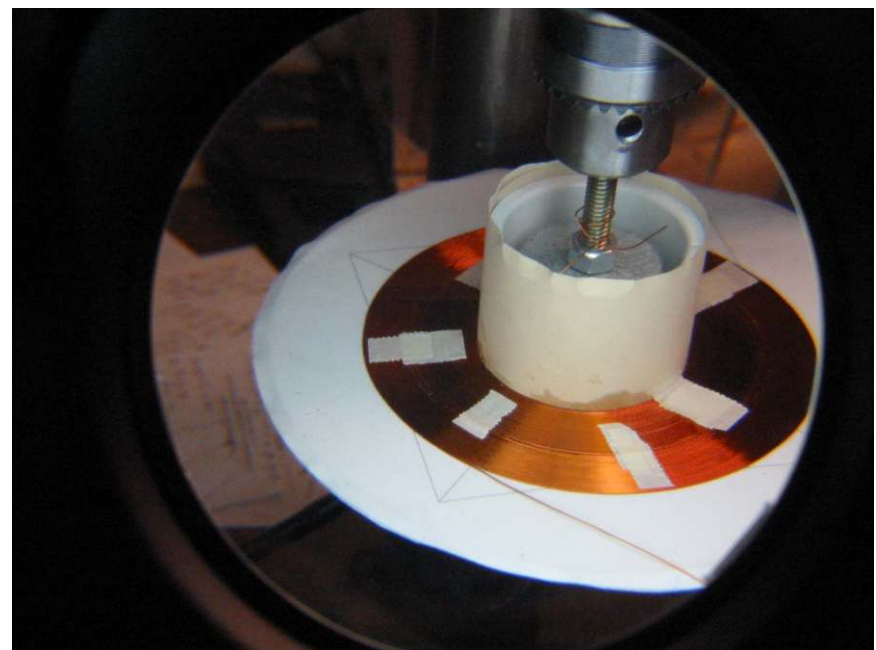
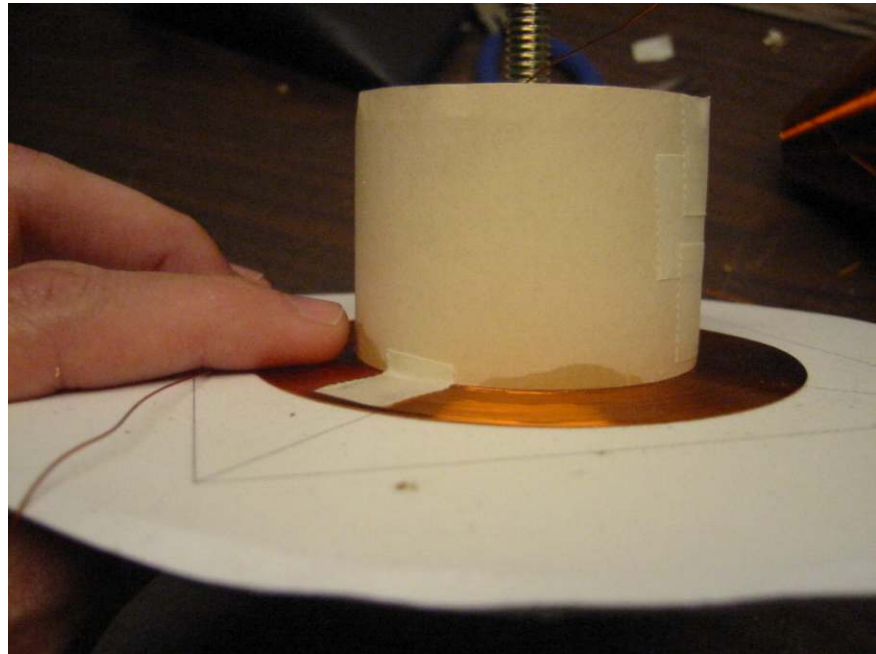

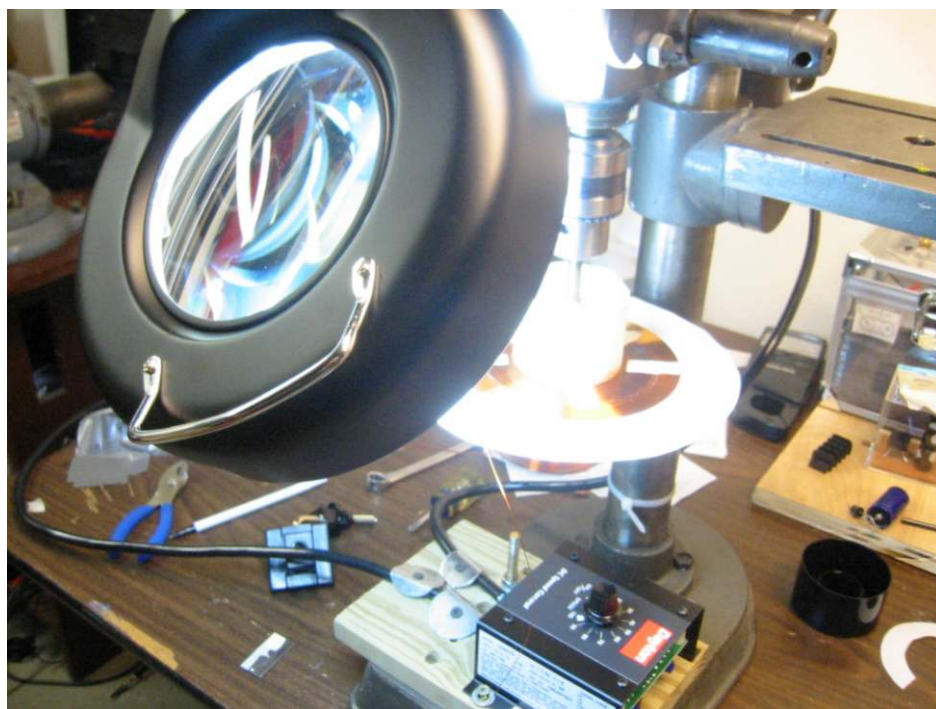
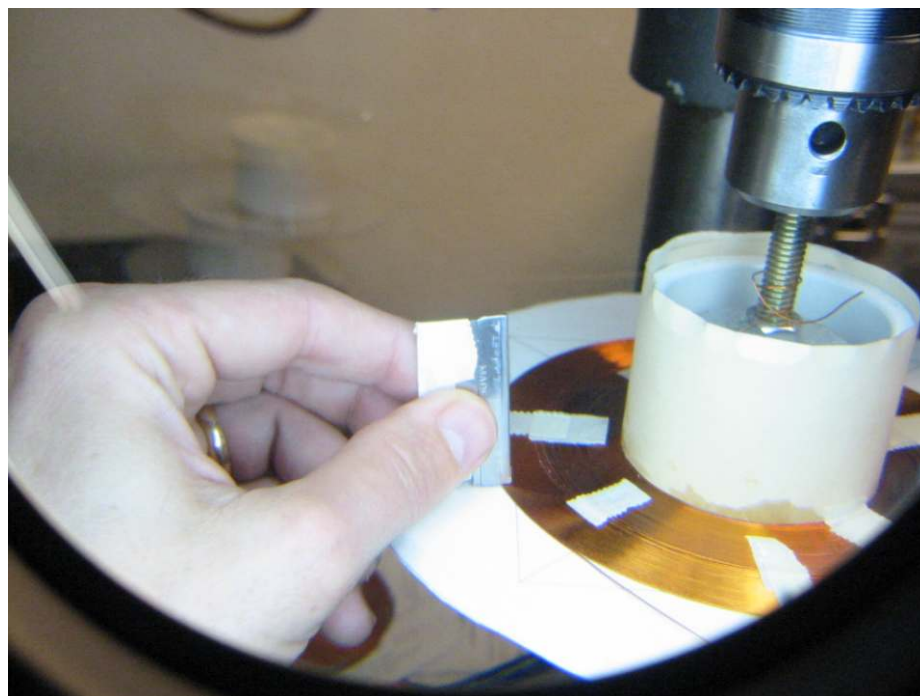



WARNING! CONFIDENTIAL INFORMATION

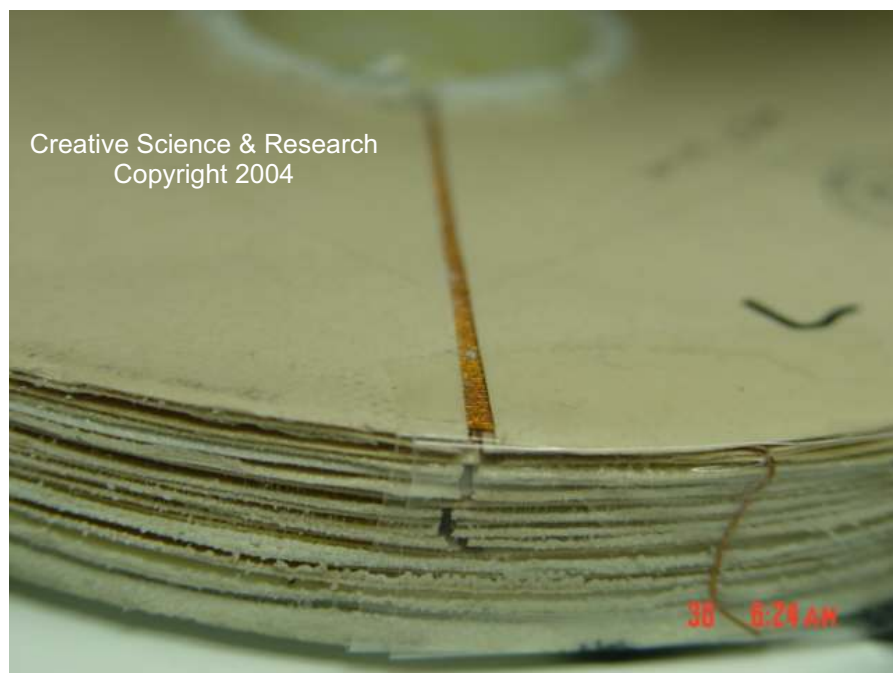

One of smaller prototypes used paper instead of Mylar



WARNING! DO NOT COPY

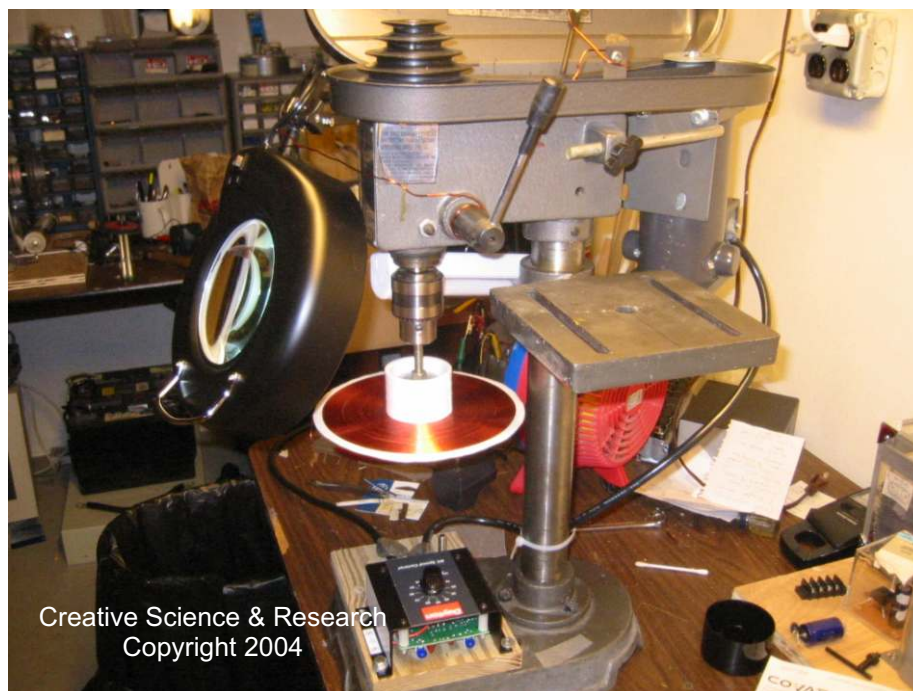



New Sp500 Generator Upgrade Invented by David Waggoner

This is a better way of getting more power out of the coils than using only one spinning magnet array. Here we are using 2. **A** magnets spin at the opposite time as **B** magnets. If the worm gears and timing of the magnets are done correctly, the generator will have very little (no load) resistance.

By using 2 sets of spinning magnets the electrical output of the generator coil is doubled (and could be more than that!) And the amperage is doubled as well. This is a very high efficient way of producing electricity.

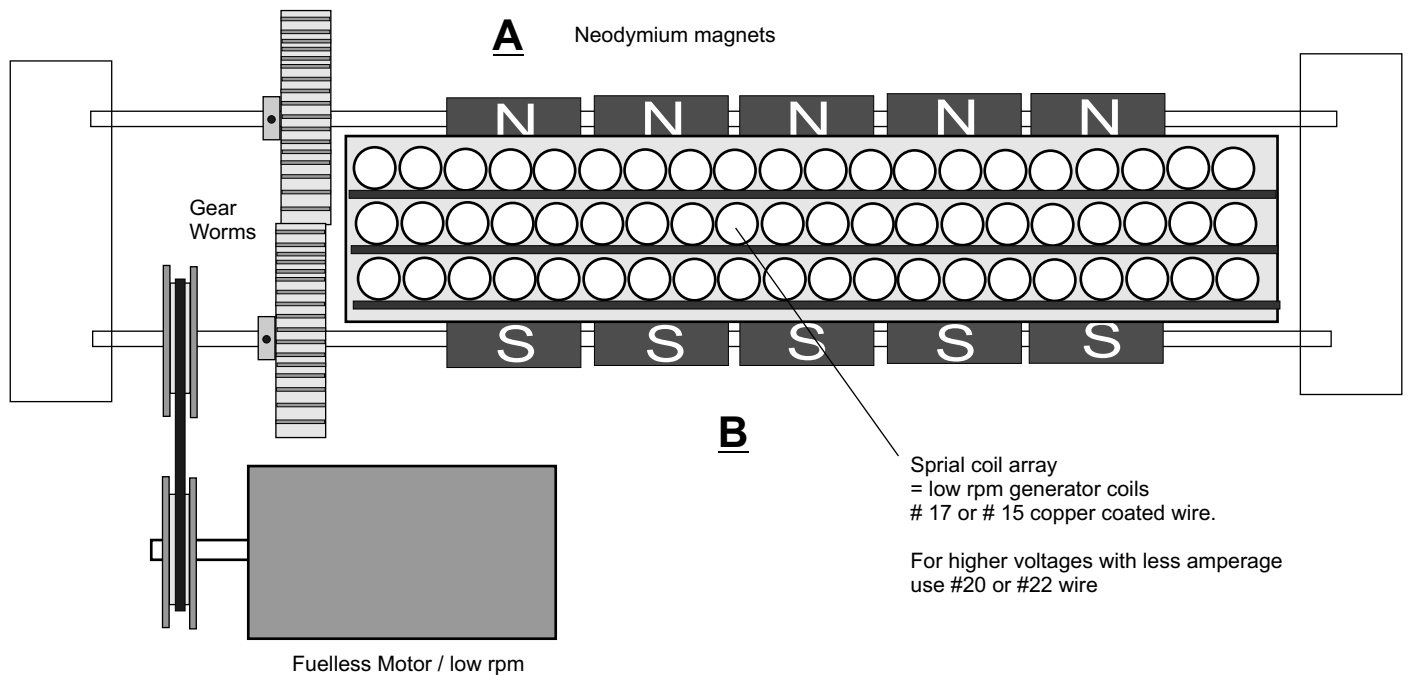

It maybe possible to stack more on top of each other to increase the power and voltage. But gears would have to be timed just right. This should not be a problem. **To Time:** loosen each hex bolt on the gears connected to shafts. Allow all magnets to alien with each other, then tighten the hex bolts on each gear and the magnets and shafts should be perfectly timed. If they are not **timed just right** a magnetic resistance will occur causing more power to be needed to turn the shaft **B**

The generator can be stacked with many coil sections! Imagine a 4 foot high generator array. Very low rpm and a very high output with a very high efficiency output.

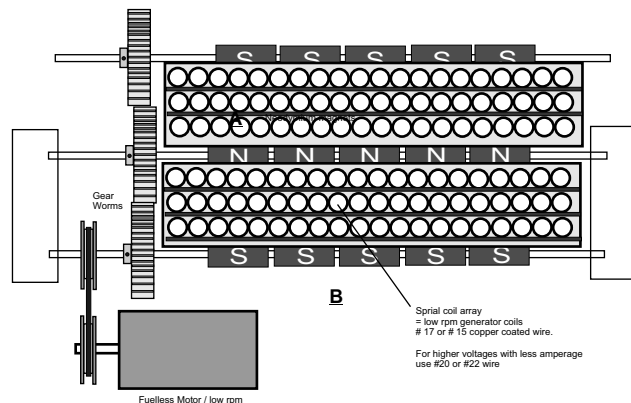



Model # 3 Low Rpm Generator

Invented by David Waggoner Creative Science & Research 2000 to 2004

This type of generator is very high efficient as well.

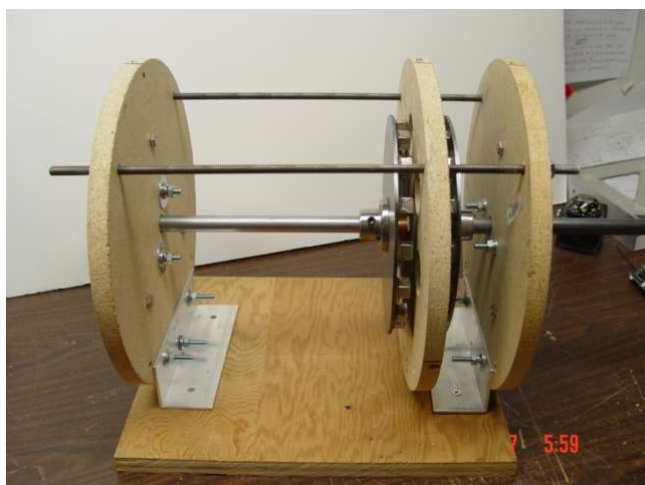

This is a small prototype that we built which worked very well. Best to use large disk shaped N38 or N40 neodymium magnets.



The photo to the left is one of the 1/4" x magnet disks being prepared for the magnets. We drilled holes all the way around the top of disk so epoxy will fill and bond magnets into place better. Mark lines by scratching with exacto knife. Prepared a paper templet on computer.



Invented by David Waggoner Creative Science & Research 2000 to 2004

Model # 3 Low Rpm Vortex Generator



1/2" wood, for holding generator coils

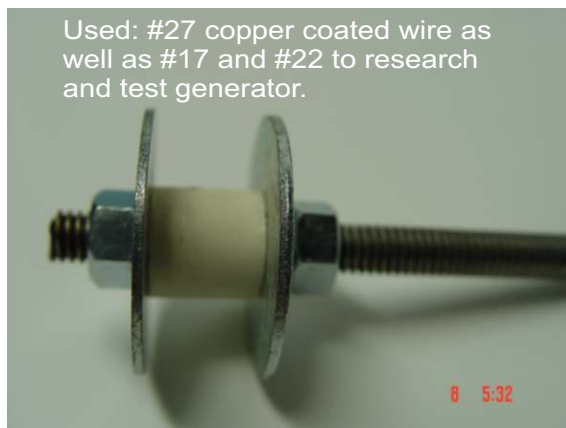

Used: #27 copper coated wire as well as #17 and #22 to research and test generator.

Coil winder removable bobbin. For manual turning on a drill press. Epoxied each layer.



#17 copper coated wire air coil with 2 part epoxy. Coils are then epoxied into wood holes.

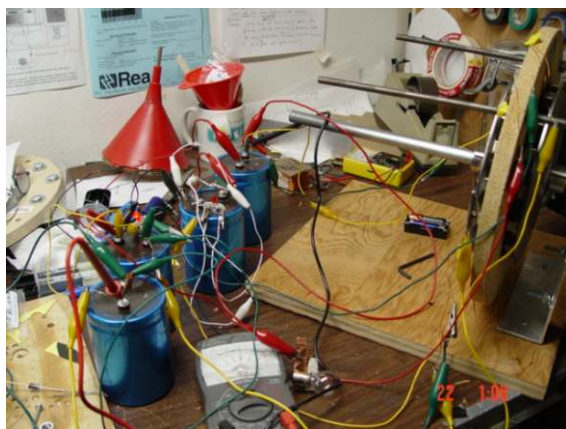



Invented by David Waggoner Creative Science & Research 2000 to 2004

Model # 3 Low Rpm Vortex Generator

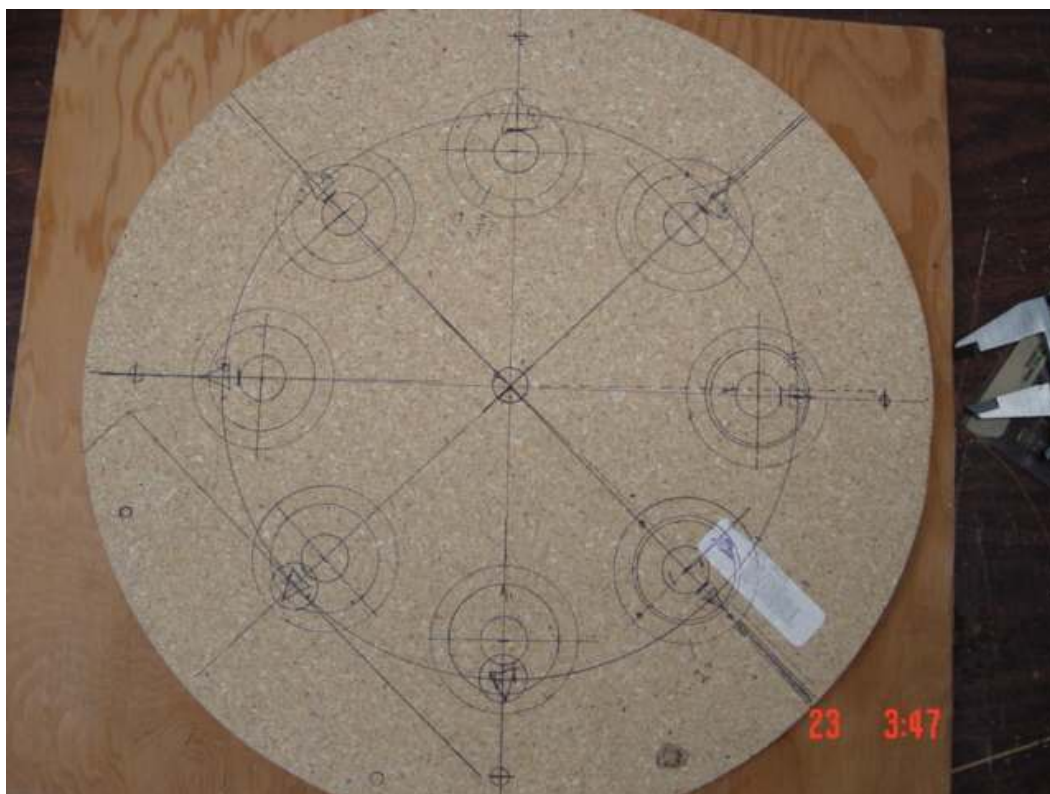



Invented by David Waggoner Creative Science & Research 2000 to 2004

Model # 3 Low Rpm Vortex Generator

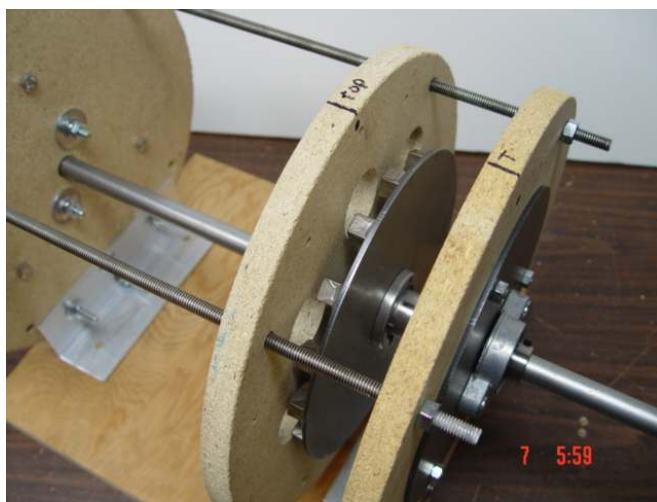
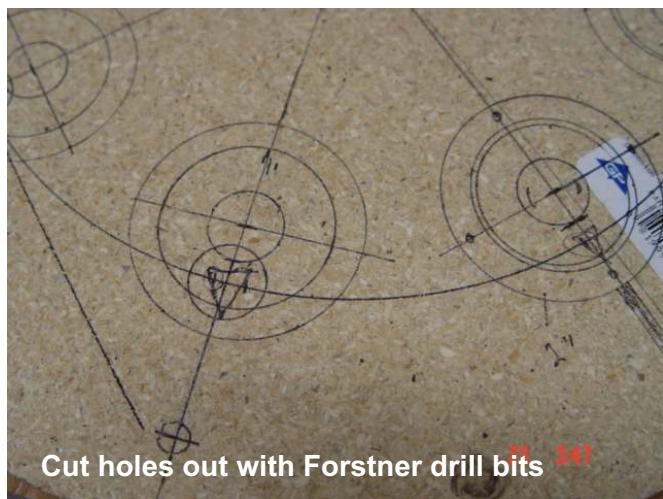

Use wax paper and adhesive spray for Bobbin end pieces, so epoxy will not stick to bobbin when winding wire and applying epoxy. # 3, use wax paper and heavy weights to flatten coil while epoxy is drying.

Model # 3 Low Rpm Vortex Generator

Invented by David Waggoner 2000 to 2004

Exploded view

Stator generator coils

Up to 8 coils per stator. There can more than one stator on one shaft as well as disk magnets.

Use a very low watt red led as a indicator that caps are energized to 3 v or more.

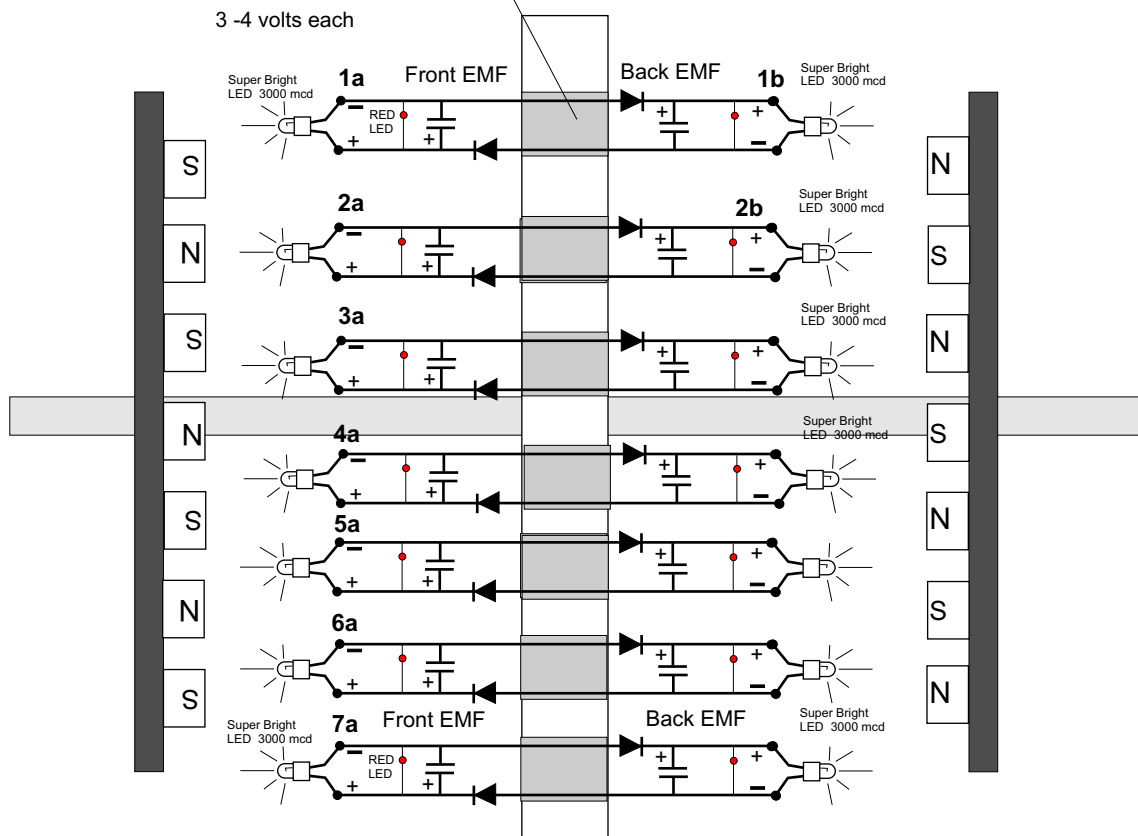

Great as outdoor or indoor super high efficient lighting. Up to 16 lights or the back emf of 1b can be redirected to charge 2a, and 2b can be directed to charge 3a etc.. This would help speed up the charge time of the large caps. I am using 5 volt x 150,000 MF powercap type 85D 99y-8430 made in USA made by NATIONAL CAPACITOR Garden grove california. I am using zenior diodes I am not sure of the voltage rating or amperage rating. (maybe 1 amp diodes ?)

The Rotor disks can be ran by a small fuelless engine 10 ma x 1200 ? This would make for a great way to provide super cheap indoor or outdoor emergency lighting. The whole system could last for 70 years. Another use would be to use this generator to help run a fuelless engine. The white LED lights would be removed and the caps connected in series to bring the voltage up to 15 to 20 volts. This can then be directed back to the 12 volt deep cycle battery which runs a 70 watt inverter that in turns runs the HV multiplier 1200 v which runs fuelless engine. The fuelless engine maybe able to be made to run at 100% unity or over unity if the back EMF of motor is used to turn the south pole after the north pole is turned by the front EMF. The back EMF can be timed and switched on using a 2nd SW commutator. Use a diode and capacitor to collect the bak EMF to charge cap, then discharge cap into coil using a 2 n d d i o d e .



Invented by David Waggoner Creative Science & Research 2000 to 2004

Model # 3 Low Rpm Vortex Generator

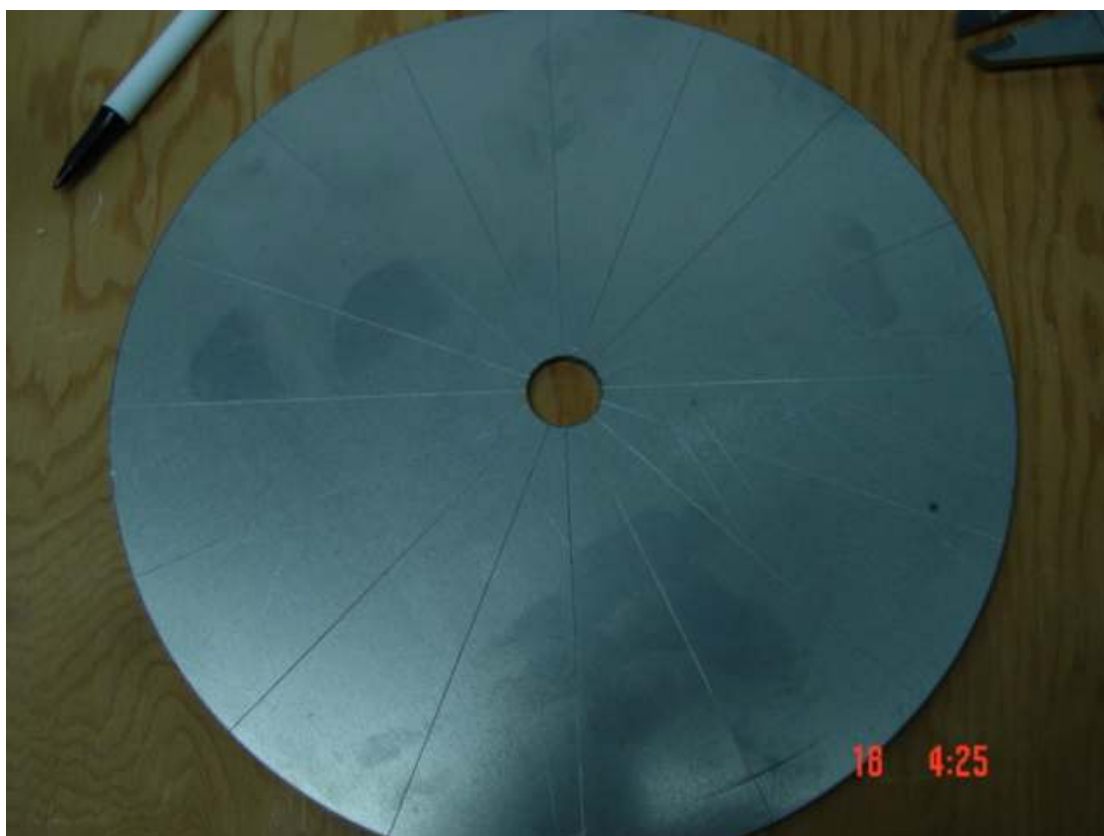
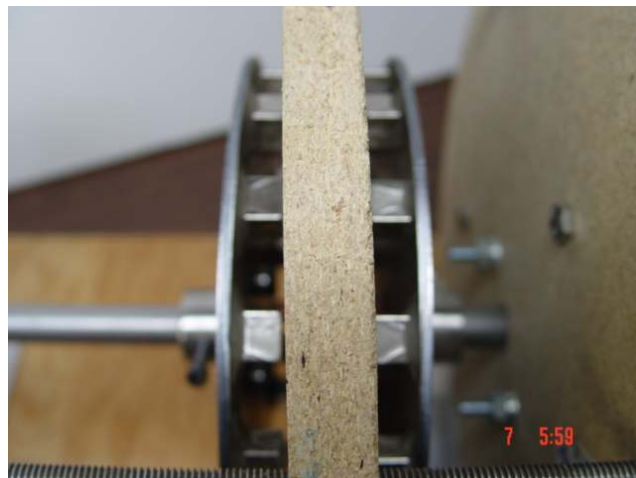



Invented by David Waggoner Creative Science & Research 2000 to 2004

Model # 3 Low Rpm Vortex Generator

By using multi coils and mutli magnet disks makes this a very powerful low rpm generator. Each coil will have its own capacitor and diode. Researching the best diode and capacitor to use still needs to be done. I am using N38 neodymium magnets (cube type) $\frac{1}{2}$ "x $\frac{1}{2}$ ". By using aluminum disks for the double back to back magnets gives greater flux as each magnet strengthen the other which creates more electricity and amperage.

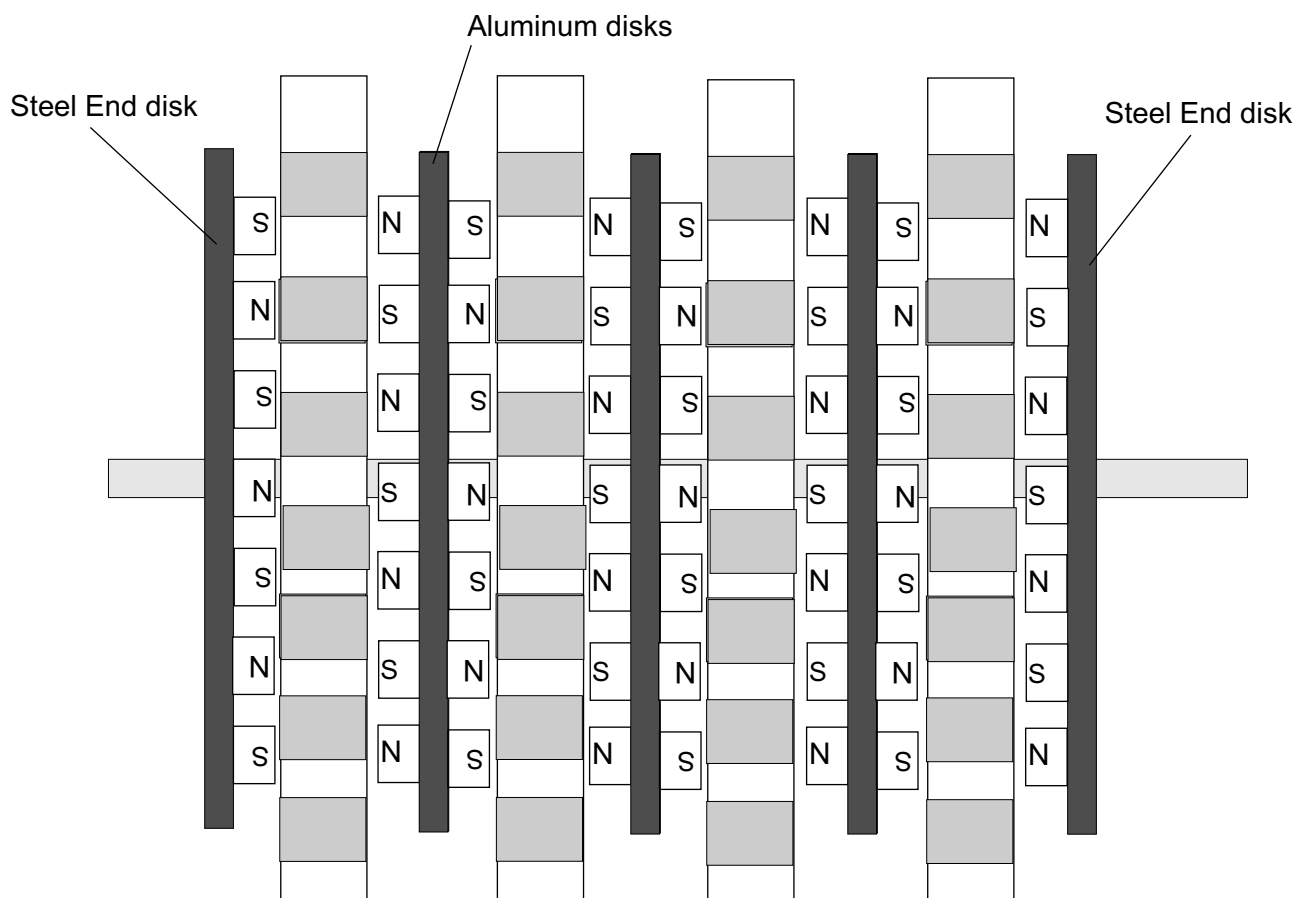

By using a round disk magnet n38. The same size diameter as the coils. Will give a far better output of power and electrical energy!



Invented by David Waggoner Creative Science & Research 2000 to 2004

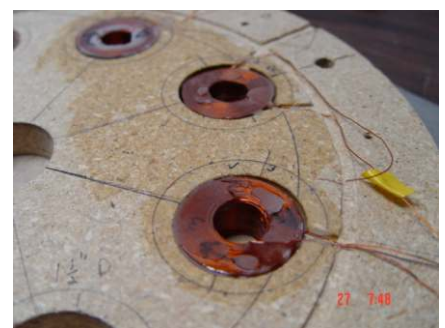
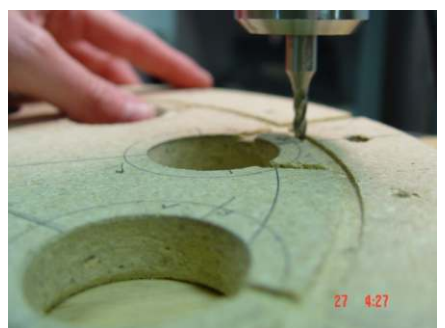
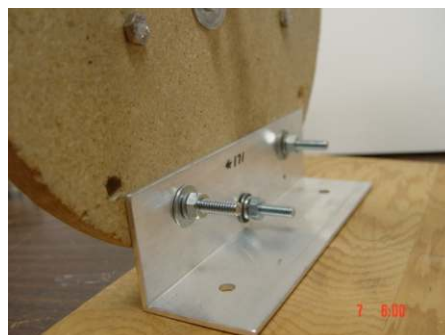



Invented by David Waggoner Creative Science & Research 2000 to 2004

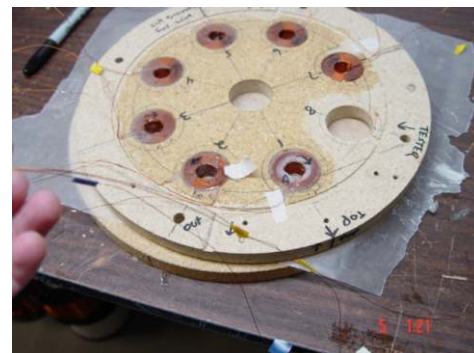
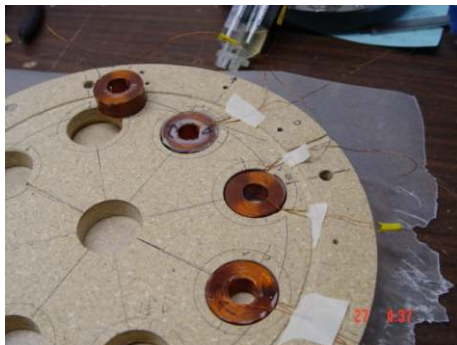

Click on magnifier + in Adobe Reader to get a closer view.

