

# NU ENERGY TECHNOLOGIES

Your Energy Source for the New Millennium



## Radiant Energy Power Generation

revised millennium edition

Information in this document is subject to change without notice and does not represent a commitment on the part of Bruce A. Perreault. The information described in this document is furnished under a license agreement or nondisclosure agreement. The information may be used or copied only in accordance with the terms of the agreement. It is against the law to copy this information on magnetic tape, disk, or any other medium for any purpose other than the purchaser's personal use.

## **LICENSE AGREEMENT**

IMPORTANT – By reading the pages to follow and/or by using the enclosed information, you agree to be bound by the terms set-forth herein by Bruce A. Perreault (BAP). BAP grants you a limited, non-exclusive, non-transferable, royalty-free license for the use of one copy of the enclosed information. BAP retains all title and all ownership rights to this information. All rights not expressly granted are reserved to BAP. You shall not rent, lease, sell, sub-license, assign, or otherwise transfer the information. You shall not decompose or disassemble the information except to the extent that this restriction is expressly prohibited by law. Your license for the use of the information shall commence upon your receipt of it. The license shall continue until terminated in writing by the author or his estate. The information is deemed accepted by you. In no event shall Bruce A. Perreault be liable for any consequential, incidental, direct, indirect, special, punitive, or other damages whatsoever arising out of this agreement or the use of or inability to use the information, except to the extent that this limitation is prohibited by law.

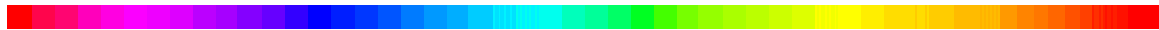

## **Copyright Information**

Unless otherwise noted, all materials (including without limitation all text, graphics, instructions, and demonstrations) are copyrighted, ©1999, 2000, July 2001 & November 2001 by Bruce A. Perreault. The material available through this publication may be freely used for attributed **noncommercial educational** purposes only. Due credit is hereby requested and notification is to be given to the author.

All materials may not be reproduced, stored in any retrieval system, or used in any way for commercial purposes without the express prior written permission of the copyright holder.

**ISBN 1-930216-01-7**

# Dedication

Dr. Thomas Henry Moray, of Salt Lake City, Utah, was probably the first to use Radiant Energy as a source of power. His tireless effort, to gain recognition for this work, has been an inspiration to me.

The original concepts presented by the late Dr. Thomas Henry Moray, of Salt Lake City, between the years 1909 to 1974, have paved a road to our energy independence. He made history by drawing the attention of the scientific community to certain discoveries of far-reaching importance. His research involved the direct application of Radiant Energy, to the ultimate electric particles of the atoms and molecules of the Universe. Dr. Moray's discoveries, when demonstrated, convinced large numbers of scientific men who had witnessed them in action. However, there were a few scientists in high places who prevented the commercial success of this technology.

If these eminent men, the supposed leaders of the scientific community, had the privilege of studying under Dr. Moray; they would have understood his discoveries and applauded them. But in their ignorance of Radiant Energy, they refused to believe or even listen politely to the facts that he often demonstrated.

One of his prototypes measured about 42 x 26 x 22 inches and weighed no more than sixty pounds. It generated around four kilowatts of electrical power and was demonstrated in front of scores of witnesses. Unfortunately, these few people, knowing nothing of the truth, have done incalculable damage to Moray's discoveries over the years.

In its' widest form, Radiant Energy can be said to be the "Holy Grail of Free Energy." Those who wish to study this exciting subject will do well to give serious attention to Dr. Moray's original discoveries and to my recent research.

It should be as easy to accept the fact that a device can be built to receive radiation from its surroundings as it is to accept a radio that receives broadcast waves. One device transforms radio energy coming from a transmitter to sound while the other transposes electrical particles into heat, light, or power. The fundamentals are the same in radio and in the Radiant Energy (R. E.) device. The radio receiver receives transmitted energy waves out of the air; the R. E. device receives energy waves from atomic ions and converts them into electricity. As in the reception of radio waves, the Radiant Energy circuit is tuned to respond to the natural energy that is emitted from certain intermolecular reactions.

# Table of Contents

<b>BOOK DEDICATION</b>	<b>ii</b>
<b>LIST OF FIGURES</b>	<b>iv</b>
<b>INTRODUCTION</b>	<b>v</b>
<b>S E C T I O N 1</b>	
<b>ATOMOSPHERIC ELECTRICITY</b>	<b>1</b>
<b>S E C T I O N 2</b>	
<b>THE WIRELESS TELEGRAPHIC CONNECTION</b>	<b>3</b>
<b>S E C T I O N 3</b>	
<b>MORAY'S CIRCUITRY</b>	<b>7</b>
<b>S E C T I O N 4</b>	
<b>EARLY DEMONSTRATIONS</b>	<b>10</b>
<b>S E C T I O N 5</b>	
<b>MY RADIANT ENERGY RESEARCH</b>	<b>31</b>
<b>S E C T I O N 6</b>	
<b>ION VALVE TECHNOLOGY EXPLAINED</b>	<b>35</b>
<b>S E C T I O N 7</b>	
<b>EDWIN GRAY'S ENERGY SYSTEM</b>	<b>39</b>
<b>S E C T I O N 8</b>	
<b>TREATISE ON MATTER &amp; ENERGY</b>	<b>41</b>
<b>S E C T I O N 9</b>	
<b>ALPHA FUSION</b>	<b>47</b>
<b>S E C T I O N 10</b>	
<b>THE TRUTH ABOUT NUCLEAR SCIENCE</b>	<b>53</b>
<b>R E F E R E N C E P A T E N T</b>	
<b>HERMANN PLAUSON - JUNE 9, 1925 - 1,540,998</b>	<b>56</b>

# List of figures

<b>Number</b>	<b>Page</b>
Figure 1 - EARLY RADIANT ENERGY CIRCUIT	7
Figure 2 - SOURCES OF RADIANT ENERGY	8
Figure 3 - PROOF OF CONCEPT	34
Figure 4 - ION VALVE	35
Figure 5 - RADIANT ENERGY GENERATOR CONCEPT DEVICE	37
Figure 6 - EDWIN GRAY ENERGY SYSTEM	40

**R**adiant Energy is emitted as charged particles from all bodies at a constant rate. The mystery surrounding it will unlock untold amounts of energy. Under the proper conditions, it can be rendered susceptible to the most incomprehensible changes caused by the oscillations, pulsation and surging throughout the Universe.

It was discovered by the Curie's that all matter is radioactive. It can be shown that radium, barium, uranium, thorium, polonium, vanadium, cerium, molybdenum, zinc, aluminum, etc... will imprint radiographs on sensitive photographic paper.

The Sun's explosions hurl intense surges of Radiant Energy at the Earth. The atmosphere absorbs these particles, shielding all life on the planet from deadly harm. Electrical charge is induced into the clouds that form in the lower atmosphere. This is due to the fact that clouds are in constant motion and travel parallel to the highly charged upper atmosphere. Once enough charge is built up in a cloud, it discharges to the ground as lightning. Static charge is thus transformed into kinetic oscillations. The Earth's magnetic field quivers in response to these surgings. Is it too far fetched to reason that we can duplicate this natural process to obtain electrical power?

If an oscillating tank circuit has the correct impedance, reactance and inductance it will absorb energy from an external oscillating electrical source. Energy is captured. The tank oscillations can be kept alive by establishing resonance with the external source. Therefore, energy is not drawn from the transformer that powers the tank circuit. In the case of the Radiant Energy Receiver, it becomes possible to harness the atomic electrons that are generated within specially constructed energized plasma tubes.

What I have just revealed here is the "Holy Grail of Energy." The implications of this discovery are far and wide. Is humankind ready for such a revelation? What will be explained in the pages to follow is nothing more than a glorified radio receiver, one that is designed to oscillate with the oscillations of the Universe. It locks onto the very wheelwork of nature. This Radiant Energy receiver should last for many years with very little maintenance, no more than for a good radio.

**"Electric power is everywhere present in unlimited quantities and can drive the world's machinery without the need of coal, oil, gas, or any other of the common fuels."**

*-Nikola Tesla*

# Atmospheric Electricity

*We have succeeded in penetrating many secrets of Nature. Because of this we have an obligation to honor her abundant miracles with care and respect.*

Since the time of Benjamin Franklin and his famous kite experiments not much has been learned about the nature of atmospheric electricity and how to convert it into useful power. Certain people have discussed this form of energy to some extent. Some theoretical papers in the so-called "free energy" field have been written. Many of these theorists deny that our ionized atmosphere can be utilized to produce usable amounts of electrical power. They are determined to cling to their wild unproven theories.

Nevertheless, I have taken it upon myself to find a solution to converting ionized particles into useful electrical currents. The properties of radioactive matter have shown me that large quantities of energy can be collected and converted. I have found that with the right circuits and components, rivers of high-voltage static electricity can be efficiently transformed into a lower practical voltage. It is my desire to be able to furnish irrefutable proof of this process, in this new millennium. However, there are still more questions that need to be answered. The utilization of the atmospheric electricity on completely new ground has to first take place.

The production and utilization of atmospheric electricity for the well being of humankind has been the goal of scholars and researchers for countless years now. However, the implementation of a real working device has remained a pious desire until today. This is because well-intentioned researchers turn away from the simple fact that there is free electricity in the atmospheric air just waiting to power our appliances. Only in the last year have I realized through new experiences and investigations that atmospheric electricity may be drawn into an electronic device in usable quantities to be converted into useful power.

Many researchers after investigating atmospheric electricity become astonished when they realize that there is nothing new in the World. They find out that the features of atmospheric electricity have been with us for a very long time, before the knowledge of electricity. The wisdom of the effects and utilization of atmospheric electricity dates back many thousands of years, as we can infer from the biblical texts. We read in the first book of Moses, that the all-holiest temple of Jehovah housed the Ark of the Covenant. With the exception of the high priests, this Ark would kill anyone getting too close to it. Furthermore, we read that 40 priests dared to approach the Ark, in the absence of Moses and Aaron. Lightning issued out from it, killing all 40 priests.

It is written in the second book of Moses, Chapter 25 verses 10-11:

10. Frame an ark of acacia-wood; the length whereof shall be of two cubits and a half (45 inches): the width, a cubit and a half (27 inches): the height, likewise a cubit and a half.
11. And thou shall overlay it with the purest gold within and without (exactly like a capacitor).

The biblical text cited here indicates that the Ark was made out of a noble wood that acted as a good electrical insulator and that gold was to be laid inside and out. Thereby, all conditions were just right for creating a good electrical capacitor. From the description we can tell that Moses and Aaron knew how to collect electrostatic energy from the atmosphere. This Ark of the Covenant could only have been a very large capacitor with a huge capacity. It was charged by atmospheric electricity from the accounts given. The fact that it remained fully charged with this electricity must be attributed to the dry climate in Palestine. Knowledge of this energy was a coveted secret kept by Moses and the high priests of Egypt. They were the first connoisseurs of atmospheric electricity.

When the study of meteorology first began there was a big interest in atmospheric electricity. Many in this field thought to use it. This is revealed through the patents of the time. The first relevant patent was granted to inventor Dr. Heinrich Rudolph of St. Goarshausen according to the German Patent Office; D.R.P. No. 98180 January 19, 1897.

Benjamin Franklin in America made a few attempts to utilize atmospheric electricity. He once built a motor that implied a commercially significant amount of energy might be derived from the Earth's atmosphere. It has been observed that a potential gradient of 150 volts per meter of height is always available on average.

There are three major causes of atmospheric ionization shown in **Figure 2**. The first one is due to the cosmic rays and the second cause is due to the solar winds. The solar winds consist of 96% protons and the remaining percentage is atoms of tritium. There are other particles but they are relatively unimportant. Almost all of these high-energy particles are absorbed by the Earth's upper atmosphere causing it to become ionized. This is how the ionosphere is created. However, the area where the reaction between the solar wind and the magnetosphere takes place is far outside of the Earth's atmosphere. The charged solar wind particles rattle our planet's magnetic cage long before its gas envelope neutralizes them. The third cause of atmospheric ionization is due to the content of radioactive gasses contained in the air we breathe. In the ground radioactive substances such as radium, thorium and actinium are spread throughout the soil. These elements generate gaseous radioactive emanations that spread in the air and ionize its molecules. The actinium-emanation generated from the decay of U235 plays a major role because of its brief radioactive half-life of 3.9 seconds.

## **Radio Ionics**

There are not enough charged ions in the air to be converted into electrical power. This on the surface appears to be a correct calculation and assumption. There simply are not enough of them. However, what has been overlooked is the fact that these ions are in a state of constant surging motion. This is the mechanism to obtain power from this sea of energy! It is not the charge that should be looked at. These ions are in motion like magnets are in motion in a generator. Can you see the correlation here? It is the motion of the ions that **induce** electrical current. By means of properly tuned radio ionic circuit rests a possible solution to harnessing this source of energy. Hermann Plauson was successful in converting atmospheric energy into useful electrical currents. He was granted a patent titled "Conversion of Atmospheric Electric Energy" – U.S. Patent No. 1,540,998. In this patent he states that "St. Elmo's fire and the northern lights can be more or less absorbed in the same way as a receiver in wireless telegraphy absorbs waves coming from a far distance." This patent has been added to the end of this book for your study. It begins on page 59.



# The Wireless Telegraphic Connection

Radio in the early years was called "wireless telegraphy." Beginning around the year 1913, amateur wireless telegraph stations were set up in trees and housetops. Aerials and masts dotted the countryside. It is estimated that there was almost "a quarter of a million stations." They were used to send and receive wireless telegraph signals, not voice. Vacuum tubes were not yet widely known. These stations had to rely on spark gaps.

It was the energy spikes, or surges put out by the spark-gap transmitters that first caught T. H. Moray's attention back in 1903. In 1909 Moray devised a circuit that would draw electricity from these surges of energy that traveled through the ground. By the fall of 1910 he obtained enough electrical energy from the ground to power a miniature arc lamp. During the Christmas holidays of 1911 he was able to power an old type 16-candle carbon arc lamp at about half of its brightness.

In 1912 while Henry Moray was on mission with the Mormon Church in Uppsala, Sweden, his passion for crystal radios got him started in his research in the science of radiant energy. Every spare moment he searched for a mineral that could possibly work as a radio detector. Moray had found two specimens that worked well as radio detectors. The material found in the hillside could have very well been a type of **argenti-zinciferrous-galena**. This type of galena is highly sensitive to radio waves that allowed his receiver to function without a battery. I make this assumption because a galena type synthetic formula can be found in Moray's Electrotherapeutic Apparatus – U.S. Patent No. 2,460,707. This material using only the power transmitted from a local wireless station could drive a small horn speaker as reported by Moray.

The other detector material was a white, powdery, stone-like material that he found in a railway car, located in Abisko, Sweden. From military records we know for certain that this white material was "**fused silica**." Silica is the chemical name for the simple oxide of silicon, silicon dioxide ( $\text{SiO}_2$ ). Mineralogists call this compound **quartz**. This is normally found in nature in its crystalline form. Finding this mineral in a fused state can only mean one thing. That, what Moray found was **metamict quartz**. A metamict is a crystalline mineral that loses its crystal structure due to radioactive destruction. For this to occur the quartz had to have contained trace amounts of uranium and/or thorium, which is why it was found in a "fused" state, in a more or less amorphous state, the so-called metamict state, owing to radiation damage from  $\alpha$ -decay of these impurities. "Over the course of hundreds of millions of years,  $\alpha$ -decay doses as high as  $10^{19}$  decays/g can occur, which may lead to the complete amorphization"<sup>(1)</sup> of the quartz structure.

Moray's rare mineral find became known as the "Swedish stone." He was able to light a standard 100-watt General Electric light bulb in June of 1925 with this Swedish stone. By August 1925 he was able power an electric flat iron along with the 100-watt bulb. Therefore, bringing the total power consumed to 655 watts. People would quite often demand that he would draw too much power from his device and the white, stone-like material would overheat and burn up.

A problem of drawing power from telegraph stations appeared when the Federal Radio Commission on Nov. 11, 1928 limited the amount that could be transmitted. The transmitted frequency also had to be well defined. Spark-gap transmitters simply could not meet these requirements. Scores of spark gap driven telegraph stations had to be dismantled and in effect had been given death sentences. This spelled disaster for Moray. He could still draw energy from the background radio noise produced by the great cosmos but the amount of power that he could obtain was severely limited. Originally, Moray's source of power was drawn from the local spark gap radio transmitting stations through the ground. Moray could draw power from the radio frequencies generated by nature but unfortunately only very low power could be had from this source. This forced Moray to develop a more favorable detector material. It was not too long before he got the inspiration to add radioactive dopants to his Swedish stone material and to other types of semiconductive materials. This occurred shortly after the Radio Allocation Act of 1928 when Moray's detectors were no longer able to receive steady incoming power. His Radiant Energy receiver could produce power but it only came in regular pulses. It was not constant without the added radioactive material. The addition of radioactive dopants to semiconductors allowed his receiver to produce a steady flow of energy.

### **Radiant Energy Early Definition**

Professor Langley showed that out of the total amount of radiation coming from the Sun, only the visible portion of the spectrum represents only 19%. He presented the theory that there is only one kind of energy radiated from sunlight. That, heat, and chemical effects depend entirely upon the state or condition which radiant energy may happen to fall on matter.

Professor Langley wrote that up until 1872 it was almost universally believed that there were three different kinds of **entities**—actinic, luminous, and thermal, represented in the spectrum. There is only one radiant energy that appears to us as 'actinic,' or 'luminous,' or 'thermal' radiation, according to the way we observe it. Heat and light, therefore, can not be things in themselves, but separate sensations to our bodily sensors. They are merely effects of this mysterious thing called "radiant energy."

The Italian physicist Melloni stated that, "light is merely a series of caloric indications sensible to the organs of sight, or vice versa, the radiation of obscure heat are veritable invisible radiation of light." Melloni wrote this in 1843, but it was not adopted until Langley by his elaborate researches, more refined and complex, proved it. The great physicists of society then adopted the doctrine of one radiant energy.

Only a few researchers know the immediate effect of radiant energy: electromagnetic. The results of two centuries of observation all point to this conclusion. When a mighty tongue of white-hot matter darts across the abyss of a large spot or cavern on the Sun, the equilibrium of the Earth's magnetic field is disturbed and the effect is a magnetic storm. The needles of magnetographs throughout the world quiver and oscillate. The vibrations take place on opposite sides of our planet, the impulse passes from the Sun to the side nearest of the Earth and then to the most distant side, whether through or around the Planet's surface.

After centuries of investigation from Gilbert to Tesla, this most wonderful research still holds admiration and mystery for all that study this vast science; electrodynamics. Power is cut out of the seemingly emptiness of space, and the hurrying waves are caught and chained to servitude in artificial light and electric appliances. The Sun, being electromagnetic, emits waves that carry

power, which beat and surge against the Earth. A magnetic field is space that surrounds a magnet. This space might be filled with air, wood, stone, glass, or might be a vacuum. But the waves are not quenched. They flow through all of these things. A freely suspended magnet in a magnetic field will move, and the Earth's surface is surrounded by a magnetic field, that is acted upon by the Sun's magnetic field. Suspend a sewing needle by a silk fiber in the Earth's magnetic field and it will come to rest parallel to the field's north and south poles. Now, if this field becomes disturbed, that is; if it becomes stronger or weaker, the needle will move. This is a magnetic storm. When a gas jet is hurled across a spot on the Sun the disturbance reaches the Earth in the same time that light does. So, radiance traveling at 186,000 miles per second is reaching the Earth in eight minutes and nineteen seconds.

The most memorable magnetic storm occurred on November 17, 1882. This was one of the most violent recorded. The daily press was burdened with accounts of widespread magnetic disturbance. In some places telegraphic communication was suspended. The turbulence filled that great quadrilateral from New York to Yankton, Nashville and Winnipeg. In Milwaukee, the carbons in the electric lamps were lighted, rendered incandescent by currents of electricity flowing on the wires. At other locations, switchboards in telegraph offices were set on fire and sending keys were melted, while electric balls were seen hovering on the telegraph lines in Nebraska.

The Earth's aurora holds the key to harnessing the Sun's daily pulsation. An aurora is the visible effect of obscure undulations from the Sun, as they come dashing on the Earth with a speed of 186,000 miles per second. In a six-month winter, say at the North Pole of the Earth, the Sun is far south of the equator, and none of its rays can shine on the Earth's northern pole. However, the aurora is very bright. It displays many colors, and these flash and glow with rapid variations. The light, although caused by the Sun, does not come direct. It is caused by the turbulence set up in the Earth's magnetic field by electromagnetic upheaval on the Sun. The field of the Earth is "tuned" with the Sun's field, as was the coherer in the days of wireless telegraphy and telephony. The aurora is known to be electrical, for magnets and compass needles on ships are always affected. Could the coherer of the days of old teach us something new?

No magnet can be placed near a "current" of electricity, or a static charge without making an oscillation. Every oscillation sends out a wave, like a stone falling in water. An electromagnetic wave from the Sun disturbs the Earth's magnetic field in the same way that an induction coil used in wireless telegraphy does. The Earth and coherer are both doing the same thing with the same kind of electromagnetic waves. The coherer in a distant receiving station will react to natural electromagnetic wave fronts from the Sun. It will likewise react to the artificial wave fronts coming from the induction coil. The electromagnetic wave makes the loose particles of metal between the knobs in the glass tube coherer generate dots and dashes.

Making a device "oscillate with the oscillations of the Universe" may not be too far off the mark in obtaining energy. Perhaps a radon-powered diode (ion valve) will act as a one way gate to this energy? This type of specialized diode offers zero resistance to electrical current. It is also an ion gate that can function in the million-volt range. Today's state of the art high voltage diodes will not meet our requirement. This is because as more are added in series the greater the electrical resistance becomes. I believe that Moray's Swedish stone met our requirements utilizing only a trace amount of radon generating material.

Moray found that semiconductive materials doped with radioactive impurities have an increased sensitivity. One such satisfactory formula included a triboluminescent zinc mixture consisting of

pure zinc sulfide, radioactive impurities and pure germanium metal. He also found that "artificial radiation" could be used in place of the radioactive impurities. For example, by exposing bismuth to wavelengths of energy emitted from one of his unique vacuum tubes, he was able to create "active bismuth," today known as Polonium-210. This is what Moray called "artificial radiation." When added to the zinc sulfide, it would glow a bluish-green. When this glowing material was then doped into ultra-pure germanium it made an excellent emitter of secondary electrons. This synthetic substance was called "fission material" by Moray. This transistor type material is said to be superior even to what is available today.

"The Moray germanium mixture gives certain unique results in functioning as in a valve and or booster (amplifier). Made in form of rounded stones or pellets compressed under high pressure and fused. Combination contains **radium chloride, thorium, uranium, and pure germanium metal-triboluminescent zinc.** Some pellets fastened to envelop with pure tin in place of solder. Bismuth pellets fused to side. Germanium mixture pellets float between other pellets but making firm, needlepoint-like contact. Have used silicon too, which has some of the properties of germanium. Germanium works best when impurities are introduced. Care must be taken when alloyed with other substances, as too much other mixture added worsens conductivity and germanium loses its properties." \* T.H. Moray, 5th edition, *The Sea of Energy in Which the Earth Floats* (1978), p. 71.

I had often asked myself: what ever became of Moray's radiant energy tubes? Wouldn't it be nice to run some tests on them? These questions have been put to rest because these very tubes are now in my possession. It was communicated to me that the widow of T. H. Moray gave these tubes and his notebook to a man named Stan Mahurin. This man knew Moray and his wife quite well.

Mr. Mahurin passed the tubes onto a close friend because he had no clue as to their function but insisted on keeping the notebook. The next owner of the tubes had no clue either. These tubes remained in storage for over twenty-five years. I was contacted because of my passion for Radiant Energy research and was given the opportunity to purchase them. I promptly replied and have had the honor to inspect them first hand. Upon inspection of these tubes there does not appear to be any radioactive material in them. However, this does not mean that it was never in the tubes. Moray stated that he was using what he called "artificial radiation." From his notes we know that he created this artificial radioactive material by attracting radon gas to a metal by giving it a negative charge. We also know that radon decays to lead-210, a beta emitter with a half-life of around 22 years. This would mean that Moray's source of induced radioactive material would eventually burn itself out. This would explain why Moray did not have a running prototype in his later years.

My own research is now nearly complete. My next project is to build a radiant energy generator that will demonstrate a few hundred watts of excess power above what the circuits require to be self-sustaining. The final step will be for me to develop a commercial unit for general use. Through this millennium edition of my book, the shroud of mystery surrounding this old source of energy may now be lifted.

1) Miami University, Herbert Jaeger Physics

## Moray's Circuitry

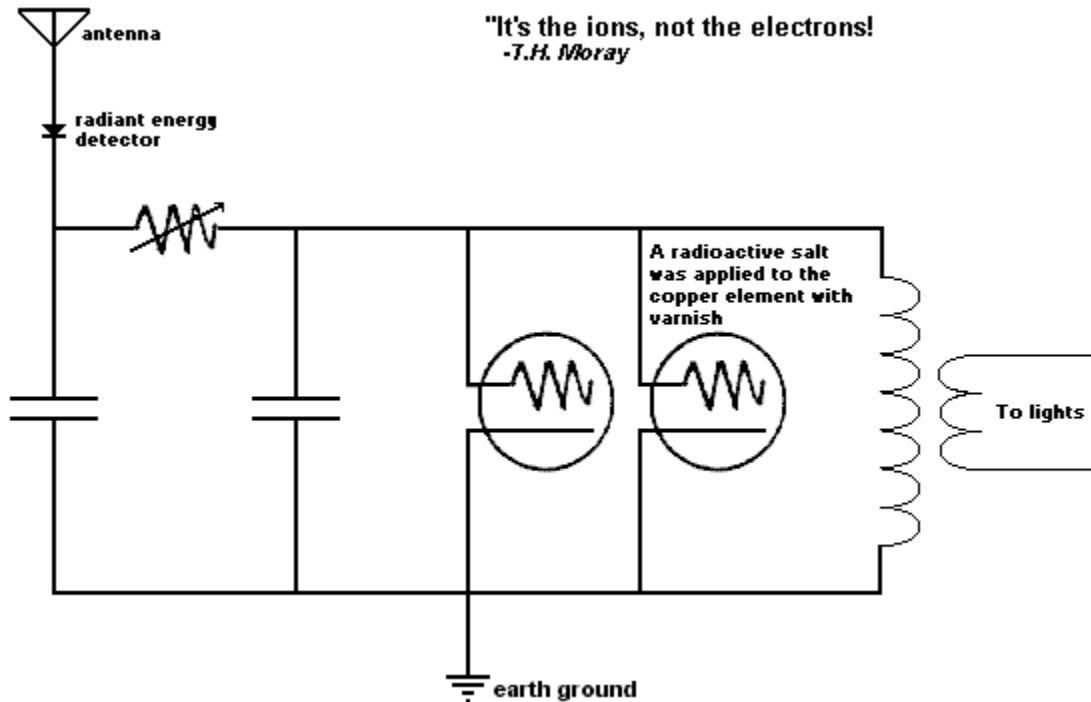

**Early Radiant Energy Circuit - Figure 1**

It is assumed that the average reader of this publication is familiar with the elementary principles of radio transmission. Granting this, it is of course reasonable to believe that such readers will understand how an oscillating current is set up in a circuit comprising an inductance or coil of wire, a capacitor and a spark gap. The capacitor is charged with a high tension current from any convenient source such as a transformer or induction coil. When the potential stored in the capacitor reaches a critical value, the air in the gap between the spark gap electrodes can no longer stand the strain. The capacitor discharges across the gap in a succession of crashing sparks. As the current from the capacitor crosses the gap in one direction, it literally over-reaches itself just as a pendulum will swing past the neutral point when given a push by hand. After the first rush of current passes in one direction, a reversal of the cycle occurs and a second rush in the opposite direction occurs. This operation is repeated many thousands of times per second. The discharge gradually dies down as all the energy is either completely radiated or used up in heat or performing work. The oscillations cease once the potential across the capacitor has been lowered so that the spark can no longer jump the air gap. The capacitor immediately takes a fresh charge from the

transformer and the entire cycle of operations is repeated. It will be understood that all of this passes in an infinitesimal fraction of a second. The charge and discharge of the capacitor takes place so rapidly that the observer can detect no change in the solid spark that appears continuously to fill the gap. It should also be understood that if the oscillating tank circuit has the correct impedance, reactance and inductance, it would absorb energy from an external oscillating electrical source. Energy is therefore **captured**. The tank oscillations can be kept alive by establishing resonance with the external source. In the case of Moray's early radiant energy receiver, the capacitor was charged through a material that acted like a high voltage diode. This material he called "Swedish stone." Electrons (electricity) were actually generated in the discharge tubes and fed back to the antenna and ground circuitry. This mode of energy generation is explained in more detail on pages 37 to 38.

What has been explained here is the Holy Grail of energy. The implications of this discovery are far and wide. Is humankind ready for such a revolutionary design? This receiver locks onto the very wheelwork of Nature. This device should last for many years with very little maintenance, no more than for a good radio.

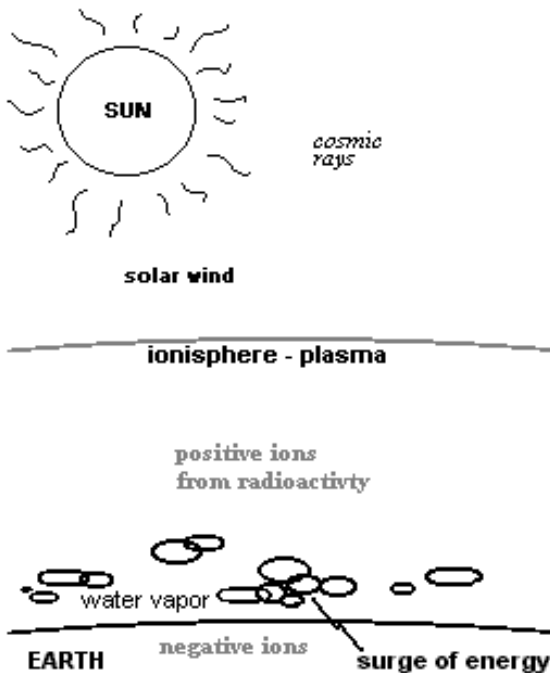

### SOME FACTS TO THINK ABOUT

1. Cosmic particles are hurled at the Earth from outer space.
2. The Sun emits ionized **protons** and **tritium** atoms that are carried to the Earth by the solar winds 24 hours each and every day.
3. The Earth's upper atmosphere absorbs the charge carried by the particles in the solar winds causing it to become ionized.
4. The Earth's ionized atmospheric region is called the "ionosphere." It is sort of a half gas and half plasma.
5. Water vapor (clouds) become charged by induction as they travel parallel to the ionosphere.

### Sources of Radiant Energy - Figure 2

6. When clouds become sufficiently charged they will discharge according to Pupin's theory of capacitive discharge. The energy is released in the form of light and electrical oscillations.
7. There is a cloud discharge about one hundred times each second that is randomly located somewhere on the planet, generating a tremendous amount of oscillating electrical energy. The total energy per discharge is approximately "**two million-million watts.**" Now multiply this by one hundred and you have an unbelievable amount of unleashed energy.
8. The facts presented are Nature's process of generating oscillating electrical energy.

## Moray's Radiant Energy Detector Tube

T.H. Moray invented a very unique vacuum tube. He called this discovery, the "Moray-valve." It functioned as a high-voltage, high frequency, minute capacitance detector tube. It included solid-state semiconductors mounted "under ideal conditions."

This Radiant Energy valve contained Moray's fission material. It replaced the original Swedish Stone. Its anode acted as a collector made with a molybdenum disulfide rod. The metal case served as a parabolic reflector to concentrate and focus the secondary ions that were expelled from the fission material.

Radiant Energy in Moray's detector comes to us in waves of separate and distinct units called photons. There are definite relationships between the energies of these particles and the zinc sulfide (triboluminescent zinc) germanium mixture, contained in Moray's fission material. The zinc sulfide in the mixture is highly sensitive to the photons generated from the fission material. The sulfide transforms the high frequency photons into lower frequency photons. These photons then **impinge** upon the germanium. The germanium being sensitive to these lower frequency photons emit secondary photo ions. The hemisphere that contains the active materials was filled with a low-pressure water vapor and was comparatively simple in construction.

Thomas H. Moray successfully demonstrated an electrical device, weighing less than sixty pounds, that extracted enormous amounts of energy: 4,000 watts. This unconventional source of energy is abundant day or night throughout the year. To understand how this device generates energy, you must carefully read the material contained in this book. I have compiled this information to assist you in understanding radiant energy power generation without giving away the entire contents of my discoveries.

On the introduction page in the "The Sea of Energy in Which the Earth Floats," 4<sup>th</sup> edition, Moray explains that radiant energy is kinetic in nature. It is rendered sensible by conversion of its energy. He states that "this is the phenomenon of the transducer fueled by a fission reaction. In the final analysis, radiant energy is a means of using the energy released by the fissionable reactions taking place in the stellar crucibles of the universe." Moray in his 2<sup>nd</sup> edition, on page 61, describes the "universe" as being both stellar and atomic. The final clue to the inter-most secret of Moray's energy device can be found on page 33 in this same edition; "It is an accepted fact that when various substances are bombarded with alpha particles they are found to give off **electrons.**" How much clearer could he have made this? He further states; "just as sodium, potassium, cesium, rubidium, barium and strontium react to visible light or wavelengths within a certain range, might not certain other substances react to oscillations from the Cosmos or artificially produced radiation?" Moray's **fission material** clearly fits this description. How could we not know from this description how Moray's "detector" functioned? He also states; "the universe is analogous to a radio transmitting station. It is continually emitting energy, only of a greater range of wavelengths." Is it this type of statement that has confused people seeking answers? I say that this is a certainty.

What is revealed within this publication should clear a path to the understanding of Moray's radiant energy device for the reader. It will be understood that ionic recombination can be directed to produce intense surges of electromagnetic energy. More clearly, ionic energy is converted into electromagnetic energy. The conversion from ionic to electromagnetic energy can then be transformed into useful electrical power by conventional radio circuitry.

## **Electronics vs. Ionics**

The Earth's electric field that exists between the surface and the ionosphere is charged to about 360,000 volts. It is estimated that the stored energy ranges from about one million to a billion kilowatts. This field provides a low current at high voltage and will not power today's appliances because they use high current, low voltage electromagnetic power. In 1748, Benjamin Franklin was the first to invent an electrostatic motor that could run on the earth's energy field. Did this scientist of yesteryear point us in the right direction?

At the Paris Electrical Exhibition of 1881, Professor Amos Dolbear successfully demonstrated his electrostatic transducer for the telephone. He obtained US Patents No. 239,742 and No. 240,578 for this invention.

Thomas Edison's 1880 discovery of thermionic emission, the current of electron flow in a vacuum tube, created the first electronic device. Sir William H. Preece called this the "Edison Effect." Edison had discovered the fundamentals of the electron tube and was granted US Patent No. 307,031. Its' basic principle was to be used in radio communication for many years to follow.

In 1887 Dolbear was forced to go to court against Alexander Graham Bell to establish that he was the inventor of the telephone. Dolbear lost this infringement case. The judge consequently ruled that Bell was the inventor of the telephone. This decision was the pivotal point of our electrical development. Because of this one decision by a court, inventors moved in the direction of electromagnetic driven components.

Conventional radio tubes to this day are based on electron emission. Electron flow through a vacuum tube is where we get the word "electronic." If science had gone the way of ionic emission instead of electron emission in radio tubes I believe that our technology would be drastically different today.

I have designed radio tubes that carry an ion current instead of electrons. Vacuum tubes that carry electrons are called "electron valves." My tubes carry ions and therefore are called "ion valves." This changes everything about inductance and capacitance in any circuitry. Capacitance then becomes the real key element in electron transfer through associated wires and circuitry. It may be of interest to you that "ohm's law" only applies to conventional electron tubes. In a conventional electron tube the mean velocity of an electron is about 1 cm per second. In my ion tube charge transfer is much faster. When using an ion tube as a rectifier or oscillator this changes the whole mathematical equation on the electrodynamics of the associated electrical circuits.

I believe that T. H. Moray's tube oscillators were actually ion valves. This is what allowed them to run cold. This is the Holy Grail of energy that can be used to tap into the sea of energy that is all around us. We are bathed in this sea of ions at all times. This is not just a wild dream. The circuits given in this publication are proof positive that a new technology is just on the horizon.

With the release of this publication, there can now be no doubt that we are at the dawn of a revived energy revolution. I have given a great gift to science. All I ask for in return is that you shout from your rooftops the information gleaned and to please give me the credit for what I have earned.



## Early Demonstrations

What follows are accounts given by observers of the T. H. Moray radiant energy device that utilizes the vast stores of energy in the Universe without mechanical force, but through **ionic oscillations**. The statements have been edited for clarity without changing the meaning being conveyed.

### A brief description of the device

A brief description of what the device has done will be given. Also, successful demonstrations will be described like those that have been made in the presence of hundreds of reliable witnesses, many of whom are highly trained and hold degrees in physics and electrical engineering. There will be a brief description of why the device works based on the oscillations of condensers. I do not believe in perpetual motion. I have no quarrel with those that may; the operation of the Moray device is **not** perpetual motion. It utilizes energy that exists and transforms it into useful forms. An electrical generator is not really a generator, as it creates nothing. The generator does not make electricity. It is merely pumped. From that standpoint, an electric generator might be referred to as an electron pump. The Moray energy device might be called an **electric siphon**, or high speed-oscillating turbine.

T. H. Moray's device was enclosed in a box 10 x 10.5 x 26 inches, one wire leading from the device to a special balanced antenna. Another wire was connected to a balanced ground connection.

In my version, a special tube ion is used. The switch of the device is simply turned on. The device is adjusted so that a synchronized resonance is established. Once it is operating, the device "siphons" energy. A specially constructed high frequency transformer is used to control the output so that any desired voltage may be obtained.

On page 17 of the "Nature of the World and of Men" (compiled by the technical staff, Chicago Institute of Technology), we learn that our planet is receiving energy from the Sun continuously at the rate of 160,000 horsepower per inhabitant.

In the "Physical Review," Dr. Gunn of the U. S. Navy Research Laboratories states that the Earth itself is a huge dynamo, producing 200,000,000 amperes of electrical current. For more detail, read pages 334 to page 344, "Physical Review," July 15, 1939.

The Aurora Borealis is definitely considered to be an electrical phenomenon produced by the passage of electric charges through the rarefied gases of the higher atmosphere.

The conversion of matter to energy in the stars is now generally accepted as fact. During radioactive disintegration energy waves are radiated. Thus, we may conclude that energy waves of very high frequency are sent out from the stars, one of which is our Sun.

Similar to the reception of radio waves, the Moray circuit is resonance tuned by the right arrangement of inductance, capacities and oscillators. These components respond to the particular wave frequency

"oscillations" of energy from the Cosmos. Moray used a special valve to prevent return of the power to the outer circuit and forced it to go through the power application circuit.

All that is necessary to put the device in operation is to start electric oscillations in the circuit due to a difference of potential between ground and atmosphere.

The frequency of the current is extremely high, as is shown by the brush discharge when either the antenna lead or the ground wire is disconnected from the machine. Certain difficulties of insulation inherent in high frequency currents are avoided by the ingenious operations of the oscillator tubes that reduce the frequency on the output side.

Standard electric light globes become exceedingly hot in one spot about the size of a dime when operated on this current. This is due to the fact that the gas in the globes becomes incandescent under the influence of the very high frequency current. Also, the luminosity of the incandescent gas is much higher and whiter than with ordinary current. A variation of the Tesla, high frequency, button type globe would be ideal for use with this device.

Ordinarily, when a potential is applied to the terminals of a condenser, a full charge is acquired almost instantaneously. The filling up of Moray's oscillator tubes is similar to water being poured into a bucket. That is, the longer the voltage is applied the greater the charge that is taken, up to the maximum capacity for a given potential and frequency.

R.E. experiments have been made at different places, many miles from all power lines. One experiment occurred more than 50 miles from any power lines and 26 miles from even a farmer's telephone. The locations for these experiments were selected by those making the test and not by the inventor. These locations were not prearranged but selected as they drove along in their own car, not the auto of the inventor.

In an endurance test, the device was operated under seals for a total of 157 hours and 55 minutes. Then the seals were broken and the device was put under severe strain and tests for about another hour and then shut off.

Close examination of the device, showed that all parts were in perfect shape and could have been run indefinitely. During the entire test the light burned evenly and brightly without flickering. There was no change in the brilliance from day to day.

The quantity of current passing through the secondary of the transformer, experts have asserted, is sufficient to burn up similar wire if ordinary current was used. Yet, there is no heating of the transformer, even though cooling air was not present, as it is completely enclosed. All parts of the machine run absolutely cool regardless of the length of time operated.

It makes no difference whether one 50-watt lamp is used or whether fifty of them are connected to the machine; the current is adapted to the load.

This current has another physical characteristic as seen in photographs of light bulbs operated by the radiant energy (R.E.) device. The photographic images of such bulbs are extremely bright. So, the emulsion density in the area of the bulb image is extremely low, virtually zero. If one takes a photograph of the original print the resulting film has the same characteristics. Prints made from this second film have these same characteristics as well. The light bulb images have such extreme low density that one has to reduce the exposure of other parts of the image in order to get a satisfactory picture. Yet the light

from the R. E. device is whiter and less harsh, even to stressed eyes. Here is further evidence that this current is different from any coming from conventional sources in use today.

There is no sound coming from the machine when in operation, there being no moving parts, electrical oscillations or prime mover operations.

The current cannot be derived from batteries, as it can be seen. Doctors of Physics have pronounced this current to be high frequency. Only an alternating current has these properties. Batteries provide only direct current.

It cannot be induction from adjacent power lines, as an induced current is always the same frequency as the inducing current. There is no power line on Earth carrying current of these frequencies. This current cannot be caused by radio signals. These are much too weak. To operate a loud speaker, it is necessary to amplify a radio signal many times, to say nothing of lighting a lamp or heating a flat iron. Also, the frequency of the incoming current is higher than radio signals.

Moray gave a demonstration for a nationally known physicist, a professor in one of the greatest universities of this country. The physicist made these observations:

Moray states that when the oscillators are connected to the circuit the condensers fill slowly. The longer the current is applied the greater the charge they take, up to their maximum for the applied voltage. This is similar to filling a bucket by pouring the water into it. The condensers do not take the charge instantaneously, as is ordinarily the case.

Moray has also stated that the size of wire in the transformer could not carry the amperage passing through it without burning up if ordinary current were used. Yet the wires remained absolutely cool no matter how long the machine operated.

The above points show these currents to be entirely out of the ordinary. They cannot be accounted for by induction from existing power lines or current from batteries.

#### **Another short account follows**

Today Mr. Judd, Mr. Adams and attorney Nebeker visited the inventor's laboratory. After the "radiant energy" device was packed into the attorneys' auto, we drove away. The three above-mentioned gentlemen began to discuss where they should go to make the test experiment. The inventor did not want to have any say in where the test was made. He wanted the test to be made at a place selected by them. At last, the three men decided to go up Emigration Canyon, as there are no power lines there. After driving about four miles up the canyon they selected a place. Then they changed their minds, selecting another place a few hundred feet further up the canyon.

Mr. Judd stayed in the car because of an injured foot, while Mr. Nebeker and Mr. Adams put up the antenna and ground. The inventor then took the device out of the car and connected it to the "antenna and ground." The switch on the device was opened and closed many times as in all former experiments, but no light appeared. The device was then "tuned in" as Mr. Judd had witnessed in previous tests. Then the switch was closed and the lights came on. The "antenna wire" was momentarily disconnected. The lights went out but came back on when the "antenna" was again connected to the device. The same thing happened when the "ground wire" was disconnected and then reconnected. All this with Mr. Judd hopping around on one foot, he having gotten out of the car when the tuning process was started. All

three gentlemen were very well satisfied and pleased with what they saw. It was dusk when they left the canyon.

**The following is a letter describing a similar test performed at a different location**

Dear Mr. Cooley,

This letter is being written for your information. It is a record of the electrical demonstration made October 29th, 1926, by inventor T. H. Moray for Attorney Judd, Mr. Knight and myself.

As prearranged, I met Moray and Judd at the Moray laboratory about 7:10 a.m. on October 29th, 1926. We carried the electrical equipment in my car and left Mr. Judd's car in the Moray parking lot.

I remember that the odometer registered 19 miles at Charleston and 26 miles as we left the last electric power line near the mouth of Daniel's Canyon. It registered 52 miles when we stopped to do the demonstration. Thus, we were 26 miles from the nearest power line and also 26 miles from the nearest one wire rural telephone line.

Moray requested that we select a place near a stream of water so that the ground pipe could be sunk in its bed to be more effective. The ground in the mountains, at this time of year, was frozen. We stopped at a place about 10 miles southeast of the Daniel's Strawberry summit and about 200 yards west of the main road to Duchesne. This location was almost due east from what Mr. Knight called Haystack Mountain. It was perhaps  $\frac{3}{4}$  of a mile east of Strawberry Lake on a little stream that made a zigzag course through a gently sloping grassy flat.

The antenna wire was put up without any aid or instructions whatever from Moray, as it had been "balanced." Moray did suggest that the wire be stretched tighter to prevent so much sag at its' center. This was done and the wire then appeared to clear the ground by 7 or 8 feet at its lowest point.

Operation of the R.E. device;

The balanced ground rod was pointed at the end to make it easier to drive into the ground.

The antenna wire was insulated from the poles with two quartz glass insulators about six inches long. A piece of wire about two feet long connected each insulator to the poles. The lead-in wire was fastened to the antenna at a point about 10 or 15 feet from the east pole. I helped Moray solder the connection where the lead-in wire was fastened onto the antenna wire. I also helped him solder the ground wire to the rod. I stepped the distance between the two antenna poles and estimated it to be 87 feet as I took 29 steps intended to be three feet each.

Moray took his electrical equipment out of the automobile and placed it on the running board of the car. Two dry boards were laid on the ground and a rubber mat from my office was placed on the boards for Moray to stand on. This was as a precaution against electric shocks. The running board was hardly large enough for the equipment so we took the seat cushion out of the front seat and placed it on the mat. Moray transferred the equipment to the seat cushion and connected it up there.

Very light snowflakes fell occasionally and a tarpaulin was hung over the top of the auto doors to protect the equipment from getting wet. When all of the wire connections were made and the device synchronized in resonance by Moray. It was just 1:05 PM by my watch. Before "tuning in" he closed the switch but no light appeared. After "tuning in" for slightly more than 10 minutes the switch was closed

and the light appeared immediately. It was slightly after 1:15 PM by my watch. Moray closed the switch two or three times before and during the tuning operation but no light appeared until perfect "balance" was established.

While the lights were burning the antenna lead-in wire was disconnected from the apparatus. The lights went out. When reconnected again, the lights reappeared. Moray disconnected the "ground wire" and the lights went out. He then reconnected it and the lights appeared again.

E. C. Johnson of Salt Lake City, Utah signed the above letter.

**Mr. Nelton Welling wrote this letter, describing yet another test**

Your interest in the Moray invention to take electrical energy from the "air" and make it usable for light, heat and power purposes is the reason for this letter. It describes a demonstration that I saw of his device on Saturday, February 21.

A dozen people were present, including Paul Harsh, Mark Yuri and Mr. Ferguson.

I first witnessed a demonstration of this device three months ago. Since then, the cabinet containing the machine has been simplified and improved. It was quite apparent that there was no possible faking of the power produced.

The tuning device was improved. The time required to bring in the energy was shortened from five minutes to less than a minute.

The operation was as simple as tuning in a well-equipped radio set. A lady who witnessed the demonstration for the first time also performed this tuning. She operated the device as easily as Dr. Moray himself did. This was after she had seen him "tune in" the energy.

A pilot light on the cabinet first became illuminated. The switch was then closed, connecting a light rack with the current. Instantly thirty 50-watt lamps and five 100-watt lamps were brilliantly lit.

A regular, Hot Point flat iron was then connected without dimming the lights in the least. The inventor stated that the result would have been the same had one hundred lamps been used in place of the 35 on the light rack.

The lights and iron together were consuming more than four-horse power of electric energy.

On account of the brilliancy of the lights it was apparent that much more than ordinary voltage was going into them. The excessive heat, which developed in one spot, made me feel that they would soon burn out, but they did not.

I confidently believe Dr. Moray is on the threshold of perfecting one of the most amazing fundamental inventions of history.

Very sincerely yours,

Nilton H. Welling

**The next document is a lengthy report written by T. J. Yates to the Secretary of Utah about Morays work**

Dear Secretary of the State of Utah,

Many men of science have come from foreign countries and from the East and the West and have been shown demonstrations. Not one of them has been able to find any fault with what they have seen or heard. Names of these men will be furnished upon request. These men have had the device opened for their inspection. They have pronounced the experiments to be wonderful, that the current is high frequency, the color of the light different, that the device carries many times as much current without even getting slightly warm. Any other electrical device of like construction, known to man, would burst into flame if it were carrying that much current. They state that the "tubes used are far more powerful than anything known to science today." The drawings, circuits and theory have been pronounced by leading men of science as scientifically, electrically, mechanically sound and correct.

It is generally accepted now by science. Moray's device proves there is energy coming from somewhere, that such a field of energy surrounds the Earth.

As Moray explains it, the oscillator tubes pick up electrical oscillations through the circuit of the device itself. As stated, the Moray device picks up these surgings or oscillations of energy coming and returning to the Universe. It is tuned to oscillate in harmony (sympathetically) with the oscillations of the Universe just as musical instruments can be made to vibrate together. Every oscillation, whether large or small, is completed during the same interval of time, the heartbeats of life. The oscillations of the Universe are governed by the same eyelet of time and are completed during the same interval of time. As Moray stated years ago, these waves of energy have a regular beat note of time, coming and going like the waves of the sea. They are in a very definite mathematical order of time, coming to the Earth from every direction. They are stronger in the day time than at night, but always coming with a regular beat note that might be referred to as the Father of Time; the Sire of Gravitation.

This energy has a definite elastic rigidity and density, which is subject to displacement and strains. When the strain is removed, this medium will spring back to its old position and beyond, surging back and forth as the waves of the sea. It will continue to oscillate until the original pressure is used up. If the internal impedance is too great, there will be no oscillations. It will merely slide back in a dead beat to its unrestrained state. By cutting down the resistance to the minimum and by synchronous resonance (sympathy) of the device with that of the Universe, recovery will be quicker and quicker. Finally inertia will assert itself and lengthen the time of final recovery by carrying the recoil beyond the natural oscillation. Thus, the vibrations are prolonged by oscillation. When the recovery is distinctly oscillatory, resonance sets in. The oscillations will go on forever because they come from the Universe. These electric oscillations are not simple ones, but surges with a definite beat note.

One will ask, how can you get steady energy from such surging? Since there is a great amount of energy at such a terrific potential could not a steady flow of water be obtained from the surging of the sea?

The operation of the condensers need not be repeated here as they have been fully explained in the enclosed account.

It is not claimed that all of Moray's theory is proven. But it is claimed that the device works. The results are certain. In the absence of better explanations, Moray's theories are as good as any.

Moray explained his theory to a well-known and noted American scientist, who said, "You go in your theory back to the law of gravitation."

In this day and age, anything is possible. What was done with radiant energy has been called "radical." Nevertheless, of the great number of learned men who have seen and heard of Moray's work, not one has been able to disprove his claims, theories or discoveries. Some of these men are amongst America's foremost in science. They have spent from five hours to many days on the theory and claims and made test experiments. Hence, these further explanations of the Moray theory, on which he has spent his time from boyhood.

Fully realizing that whatever the difficulties in discovering new truths, there are still greater obstacles in getting them recognized. As Mark Twain once said, "It takes many years to get a new idea fixed in the human mind." One should not be long surprised at the attacks of some or at the exasperation of a certain number of worthy people. Not surprising is the silence of a greater number of the scholars who have heard of these experiments. It is hard for the average human mind to rid itself of inherited ideas, which so completely and unconsciously control our line of thought. Franklin, Faraday, Cavendish and others were unable to always express themselves so that their peers understood their inner meaning. They gave to the World their ideas in a form unintelligible to others of their day. Yet their ideas have since become known facts.

The theory described here is not new in the main, nor is it contrary to ideas that science has accepted today. It is however original with Moray in application. When Moray first advanced them years ago they were "killed" by those who heard of them before they got very far. Be that as it may, Moray has studied "radiant energy" and found a means of using it. Heat, light, power and energy are not things in themselves. They are sensations, or effects produced by this "cosmic power," directly or indirectly.

**"ASTRONOMY," by Robert H. Baker, P.H. D. Professor of Astronomy, University of Illinois**

**Page 303:**

Another problem relates to the apparent lavish expenditure of this radiation. Of all the energy that pours forth from the Sun, the planets and their satellites intercept less than one part in 200 million. The remainder spreads through interstellar space with little chance, so far as we know, of being recovered. The suggestion that the Sun shines only in the direction of material that can intercept it, may appeal from the point of view of economy, but appears to have little else to recommend it. It would seem that Nature is squandering its resources of energy so prodigally that it must end in bankruptcy. But we doubtless have at present, an imperfect account of the situation.

**"FOUNDATIONS OF THE UNIVERSE," by M. Luckiesh, D. SS. Director of Lighting Research Laboratory, General Electric Company printed in 1925**

**Page 5:**

In the far-off stellar crucibles, we see the same laws being obeyed as in our laboratories. Tracing down, to the almost infinitesimal constituents of the extremely minute atom, we find that apparently it does not exist at all. It is not even as the realistic matter that we have supposed it to be. There at its very foundation, it seems to consist of electric charges that probably simulate the motions of celestial bodies. It is becoming more and more certain that the apparent complexity of Nature is due to our lack of knowledge. As the picture unfolds, it promises a marvelous simplicity.

### **Pages 41-43:**

The great success of the atomistic principle relating to the kinetic theory of matter, is one of the wonders of the modern scientific age. As expected, it has found other applications equally fascinating and promising. It is now being pressed further into the service of explaining the structure of matter.

### **Maxwell's Theory**

When Maxwell (1873) propounded the electromagnetic theory of light (radiation), his achievement was epochal. The exact manner in which the radiant energy traversed space was not known. The next epochal event was the founding by Planck (1900) of the quantum theory. Here we have the atomistic principle applied to energy instead of being confined to the material of the Universe as it had been. In other words, in the quantum theory, we have the atomistic idea applied to physical processes. We now have the atom of matter, the atom (electron) of electricity and the atom (quantum) of action (a product of energy and time). Planck assumed the emission of radiation (from the Sun, a lamp filament, etc.), to occur discontinuously. He conceived elements of energy of equal magnitude; analogous to the equality of electrons, or atoms of a given element. Radiant energy is emitted at various wavelengths or frequencies that must be taken into account in the laws of radiation. Now, the physicist uses quanta as commonly as he does electrons and atoms and molecules. Bodies are built of molecules, the molecules of atoms, and the atoms of electrons (and protons). Here we see the atomistic principle applied to "material" (matter) and then to electricity (what shall we call it)? Finally, a physical process, the radiation emitted by the electrons, is divided into quanta. With such pictures of the Universe being constructed, we may cease to be surprised at anything, but our interest and admiration will grow.

One of the most marvelous relationships that has ever been revealed in the entire science of physics is that between light and electricity. Knowing now how to view the structure of atoms, this relationship is not quite so surprising. Half century ago, there was a total absence of knowledge, pertaining to the existence of electrons in atoms of matter. So, the sudden revelation, that light (and radiation in general) is an electrical phenomenon, was very startling and revolutionary. Even today those persons, who are unfamiliar with fundamental physics, find it difficult to believe that energy traveling from yonder star to the eyes, is electromagnetic in nature. But that has been amply proved. It is the atoms in those distant stellar crucibles that possess moving electrons that are emitting electromagnetic waves of many wavelengths or frequencies. Here on Earth, we have many 'receiving stations' that are tuned to certain ranges of wavelengths.

### **"RADIANT ENERGY," by Edgar Lucien Larkin (1903)**

### **Pages 17-18:**

Radiant here means proceeding from a center in straight lines in every direction. Energy is internal and inherent.

Professor Barker, "Physics," page 4, says: "Energy is defined as a condition of matter in which any definite portion may effect changes in any other definite portion." This was written in 1892 and discoveries since confirm it. Energy then, is a state of matter. Or rather, is it the result of a particular state in which matter may be when any observed phase of energy appears?



These two notions, matter and energy, or possibly one, are the sum total of all that has been found during three centuries of incessant research? This search has been in that portion of the Universe visible in a forty-inch telescope, armed with the most powerful spectroscope ever made.

It is the belief of the writer that all this space is saturated with inconceivably minute corpuscles. J. J. Thomson recently discovered these. These are doubtless either electricity in its ultimate refinement, or very closely allied to it, or its immediate carriers. The smallest particle of hydrogen has long been thought to be the smallest mass of any known particle of matter. But the corpuscles detected by Thomson have only one-thousandth the mass of the hydrogen atom. The Earth and Sun, all suns and dark bodies in space, all granular matter, moves through the primordial cosmic mass of electrical corpuscles as would a wire screen through water. The wide spaces in diamond, glass, steel, flint, or anything else, allow these "bodies smaller than atoms," as Thomson calls them, to pass through.

### **Larkin's Theory on the transmission of energy**

From the definition of energy, it is the potential of the Universe. When matter is in a phase allowing it to be active, it affects other quantities of matter at a distance. The method of transfer is known to be by means of wave motion. Each impulse moves from the emitting to the receiving mass on a rigorously straight line. One continuous set of oscillations in this straight line is called a ray. Each negative or Thomsonian corpuscle makes a double vibration to and fro like a pendulum straight across the direction of the ray – i.e., at right angles to it. The corpuscle moves over and returns to the original position it had before the excursion. The corpuscles are negative and can be drawn out of their original straight path by the action of magnetism. So, the entire wave motion of the Universe is electromagnetic. This is what Maxwell prophesied forty years ago. Thomson fulfilled the prophecy.

After one corpuscle makes an oscillation across the direction of the ray and returns, the next does likewise and the next and so on. After the first corpuscle makes a swing, another distant from it 186,000 miles in the same straight line, will also make a vibration at the end of the first second of time.

**"ATOMS AND RAYS," by Sir Oliver Lodge, Fellow of the Royal Society of Science and holder of five or six Doctors degrees from colleges, with honors from a score more. He has held offices of President in a dozen or more Scientific Societies. Printed in 1924**

The term 'light' strictly speaking, means that kind of ethereal radiation which is able to affect the eye. But it is common knowledge that there are many other wavelengths of radiation besides those that effects the eye. It is not clearly known why the eye is sensitive to some kinds of ethereal radiation and not to others. That, no doubt, is a question for physicists and physiologists in collaboration. But the eyes of animals, insects and man, all appear to be sensitive to a limited range of ethereal radiation, which is therefore called light. Some kinds of radiation can affect a photographic plate. Other kinds can stimulate the chemical actions going on in the leaves of plants and thereby supply the energy needed for vegetable growth. Another kind, a rather deeper harmony as it were, supplies everything on Earth with warmth and by evaporating water contributes to most of the phenomena of weather. Other kinds, again, are omitted when individual electrons, traveling at a high speed in a vacuum, encounter the obstruction of a target. These kinds of invisible radiation are called x-rays. And, at the opposite end of the scale, great antennas emit another kind of radiation. These are the Hertzian waves employed in radio.

If describing these kinds of radiation as different, we are not speaking quite accurately. They differ only as treble notes differ from bass notes. They differ in rapidity or rate, or vibration or wavelength. They do not differ in any other essential particular. The longest waves are telegraphic ones, which may be a mile

long. Much, much shorter are the x-rays, whose wavelength is actually smaller than atoms, and only expressible in billionths of an inch. This whole range of waves, travel at precisely the same speed. This is the only speed at which the ether is able to transmit energy. They are all of the same electromagnetic character. They are all subject to the same optical laws of interference, of reflection and polarization, which have long been studied in departments of physics.

**Moray would qualify the above by saying there are speeds greater than the speed of light**

Whatever an electric charge is, or is not, it is certainly a focus of energy. Imagine an ether vortex, containing the known mass of the electron and circulating with the velocity of light. The energy of this vortex would be equal to that of the electric field in the space surrounding the electron. This coincidence, if it were a coincidence, can hardly fail to have some meaning. Some thinkers are beginning to view the whole material Universe as being built up of ether in various states of self contained or intrinsic motion. These adjectives are intended to discriminate between rotary motion, like that of a top or a whirlpool and ordinary locomotion, or whiffing from place to place. Locomotion has not been attributed to the ether, which is the most stationary thing we know. It is perhaps the only stationary thing that exists, but it may be full of what is sometimes called "stationary motion." This is a paradoxical term, appropriate to the condition of a sleeping top.

Those who hold this view of the Universe are strengthened in their position by Einstein's expression of energy in general. It is well known that all ordinary energy, such as the motion of railway trains, or croquet balls, etc, is merely relative to the Earth, or to some other piece of matter. There is nothing absolute about it. But Einstein gives an expression for what could be called absolute energy, in which the only relevant velocity is that of light. All the phenomena of Nature, at any rate in inorganic Nature may be due to, this great ethereal velocity. It must appear in a form that enables it to appear to our animal derived senses. For the spinning motion itself is impalpable and beyond the ken of our instruments. It can be detected only when it partially exhibits itself as transmitted waves in the form of radiation.

All the light that we experience can be resolved into vibrations or tremors in the ether. That is how we first knew about the ether. But all electric and magnetic phenomena and therefore, all chemical activity are likewise known to be modes of manifestation of the ether of space. The complete manner and meaning of which have still to be worked out.

So the question arises, What is matter? Is that too a manifestation of some peculiar properties in the ether? We know now that matter is built up of protons and electrons. But analyzing these into their fundamentals, we find far more than a hint that they are but special modifications in the all-pervading ether. They are essentially resolvable into ethereal energy of a specific kind. Hence, we are beginning to think that matter itself is a form of energy.

Energy is one thing in the physical universe that directly appeals to us. We apprehend it under a great variety of forms. And it is becoming provable that what we call matter is one of those forms. Most of the known forms of energy are convertible one into another. The energy of motion turns into heat, as does the energy of electric currents, unless it is converted into the energy of chemical separation or electric charge. Conversion from one form to another, without loss, is the sign-natural of energy. The proof that matter is a form of energy will not be clinched until it can be demonstrated that matter too is convertible into other forms of energy.

Such a process has not yet been performed in our laboratories, or has it? Though it is believed to be occurring in the giant stars. The interior of stars is at an altogether exceptional temperature and pressure.

This constitutes a laboratory where results can be beyond the scope of our present manipulation. In the light from those stars we see some small residual outcomes of this production of energy at the expense of matter. In their motions, we probably see the same thing. That, which we ordinarily recognize as the locomotive energy of bodies, seems now to be overflow or surplus of the violent constitutional energy within. This energy, at present seems inaccessible to us, but is possessed in enormous amount by the very constitution of the atoms of matter. Fortunately, a few of those atoms have given us the hint. They have spontaneously emitted their energy. We call it radioactivity. It is only the heavy atoms of fission material and other substances at that end of the series, which still retain the property of spontaneous disintegration. The other more familiar atoms seem to have lost that power, and settled down into apparent stability and quiescence. These atoms show no obvious sign of possessing any such power. But to the eye of science, it is there. Means have been sought for getting at it.

Combination of atoms into molecules and the interaction of molecules generally have long been known to give rise to various forms of energy. Witness ordinary combustion and the power of explosives. **Simple atoms like those of hydrogen, can be packed together so as to form the more complex atoms of higher elements. This process will liberate vast stores of energy, much greater than could be obtained from ordinary kinds of chemical combination.** It is highly unlikely that this will go on spontaneously or uncontrollably or dangerously, under such conditions, as we are familiar with on Earth. They may be violent enough under the conditions in the interior of stars, including perhaps our Sun. But here, on Earth, they are traceable, guided and controllable. They will not run rampant and do damage, except by reason of bad or malevolent arrangements and then only on a relative small scale.

How soon energy of this kind may become commercial, no one can say. The practical way is by using energy from the cosmos; i.e., not by so-called fission material.

### **Another Testimonial**

TO WHOM IT MAY CONCERN,

This is to certify that on the evening of March 16, 1929, along with Dr. Wilkinson, of Cedar City, I witnessed a demonstration at the laboratory of T. Henry Moray, Salt Lake City, Utah.

Dr. Moray claims to have invented an apparatus that will produce electrical energy without the use of a prime mover. This apparatus was demonstrated on this occasion.

#### 1. Description of the Apparatus

The apparatus uses an antenna specially balanced or an aerial capacitor and a special ground wire. These were connected to the terminals of a switch. Two wooden boxes were placed on a table. On one of these boxes was a high-frequency transformer. In the other box were two sets of condensers, ten large ones in one set and ten small ones in the other set. There were two composition cylinders, each about 1 – 1/8 inches in diameter and four inches long. Each of these cylinders weighed about three or four ounces. In addition, there was another box approximately hemispherical in shape, about two inches in diameter and weighing about two ounces. There were also coils of wires and other equipment. These pieces of apparatus were connected by a number of wires.

Two of these wires were led out to the switch. One was attached to the blade of the switch and the other its' jaw. When the switch was closed, the antenna, lead-in, apparatus in the boxes and ground wire, were all in series.

The other wires leading out of the box were connected to six 100-watt lamps connected in multiple during part of the demonstration. A flat iron was connected during part of the demonstration, as well.

## 2. Demonstration

During the demonstration the apparatus was connected in series as above described, except that a small switch connected in series with the coil was left open.

Dr. Moray energized and synchronized the device in three or four minutes. The lamps were lighted and remained bright as long as the switch was left closed, which was about 60 minutes. He then connected an electric flat iron. In a short time, the iron was hot. When the "ground wire" was disconnected and then the lead-in was disconnected, the lights went out.

## 3. Objections people have made

- I. That there is a hidden wire from the electric lighting current obtains the power.
- II. That the power is obtained from batteries.

## 4. Tests

Before and after the demonstration I closed the big switch that connects or shorts the antenna and ground. I also made other tests. If the antenna or lead-in were connected to the lighting circuit this would have produced a short circuit. I further tested the device by closing and opening the switch several times to see if any sparks appeared. But there were no sparks. I placed my wet finger between the blade and the jaws of the switch and could not feel any electricity. I touched my hand to both sides of the switch and the wall to check for ground but could not feel anything. We turned the table over and examined it carefully for hidden wires but found none. With the apparatus all connected as when operating the lights the contacts with the switch were moved but produced no arcing. This indicates that the circuit was dead.

While the demonstration was being conducted and the lamps were receiving energy through the apparatus, the main switch, that controls the lights in the building, was opened. All lights on the house circuit went out but the lights on the Radiant Energy circuit were not altered. They were neither brighter nor dimmer at that time. Thus the lights could not have received their power from that source.

The condensers were thoroughly tested. The terminals were shorted, the positive to the negative. If they had been batteries they would have showed a spark. But no sign of spark appeared. I connected them to the electric terminals then tested them. After being charged, the large condensers gave a vigorous discharge, showing a brilliant strong arc and a loud sound. They showed a sudden discharge as condensers are supposed to do and batteries never do.

The small condensers were less vigorous in discharging. They displayed the same snappy discharge of a condenser and not how a battery discharges. These tests proved positively that condensers and not batteries were in the cases. Besides no batteries of such size, could produce such power. The boxes were completely emptied thus leaving no possible place for batteries to be stored. Besides the boxes were not large enough in order to hide batteries.

During the time that the lights were burning the connections with the big switch were moved along the switch and vigorous arcing occurred. Thus, proving that electrical energy was passing through this apparatus.

## 5. Conclusions

The electric lamps received energy from some source. During the demonstration, which lasted for more than an hour, the lights were brilliant at all times, just as bright at the end as at the beginning of the demonstration.

The lights were a different color and brighter and whiter than those on the house circuit. The electric energy that lighted the lamps and heated the flat iron was not received from the house circuit.

One is therefore forced to the conclusion that the electric energy was received from some other source. As difficult as it is to understand, with our present knowledge, the only conclusion that can be drawn from the demonstration is that the energy was received by and through the apparatus as claimed by Dr. Moray.

T. J. YATES, KE N.E.

### **This next letter is from Murray O. Hayes Ph.D.**

To all whom it may concern,

It is now more than two years since I first became acquainted with Dr. T. H. Moray and the work he is carrying on. In that time he has demonstrated inventive ability of an exceptional order.

Perhaps the most wonderful of his inventions is a device whereby he is able to draw electric power from the Cosmos. This energy is not derived by induction from power lines, as has been suggested by some, nor is it derived from radio stations. This has been demonstrated by taking the apparatus more than 50 miles from the nearest power line and over a hundred miles from the nearest radio station. At this location it operated just as well as anywhere else. This device was subjected to an endurance test in which it was operated continuously for a week. During this test a 100-watt lamp was lighted simultaneously along with the heating of a 575-watt standard Hot Point flat iron, making a total of 675-watts. It is very evident that no batteries could sustain such a current drain as this. Besides the current is high frequency.

He has also invented a very sensitive sound detector whereby it is possible to hear conversations carried on in an ordinary tone of voice, at a distance of several blocks.

He has also worked out numerous radio designs that eliminate many of the parts now considered necessary for good reception. Yet, there was no apparent diminution in quality or volume. In fact, there was a notable elimination of interference from static when some of these designs were used.

He has devised a means for measuring with some degree of accuracy the energy evolved during mental activity. His device shows variable deflections of a sensitive galvanometer needle that appeared to be related to the rigor of mental activity.

There are a great many other equally remarkable things that he has done. For example, reducing old rubber from truck tires to the state of a viscous fluid. This fluid is readily vulcanized without the addition of a smoke sheet as is necessary with other processes. He also created a high frequency therapeutic device and numerous other devices, which show great ingenuity.

Murray O. Hayes Ph.D.

**This letter is addressed to Mr. Lovesy is from Murray O. Hayes, Ph.D.**

Dear Mr. Lovesy,

As promised during our recent discussion, I am writing about my acquaintance with the construction and operating principles of the Moray device for utilizing cosmic energy.

You are already aware that I have seen many demonstrations of what this mechanism will do. Also, I have seen the parts of which it is built. Recently Dr. Moray has shown to me the wiring diagram of the device. I can find no inconsistencies in it, not anything that does not appear to be logical and sound. While this device appears to be very complicated, when looking at the machine, it is in reality very simple in essence. It is based on reorganized laws of electricity, when all is explained. There are many features which appear to be incidental, but they are in reality of basic importance.

He has also shown to me and explained the detector that his device uses. In this he has applied a fundamental principle of electric circuits which, I believe, would not have been noticed unless pointed out by him. This detector also has numerous features which appear incidental but are the heart of the matter and of first importance.

In my own home he connected his detector into a crystal set for receiving radio in place of the crystal. The reception was better than with the Erla crystal, though the antenna was merely one of the bell type. He also took a lump of lead treated according to a process of his own. He used in its place of the crystal and got wonderful reception of radio signals. They were loud enough, in fact, to operate an old fashion horn speaker of the type put out of RCA about 1923.

I was recently present when an electrical engineer representing the Russian government was given a demonstration of the energy machine. He at first said that the amplification of radio waves accounted for the output energy. However, it would be a real achievement to amplify such waves sufficiently to light six one hundred-watt lights at one time. This is in addition to heating a flat iron of the standard five hundred seventy-five-watt type. When engineer saw the inside of the device, he admitted that it could not have been radio waves. He remarked many times, "It is very interesting."

This machine has been operated in my presence so many times, under so many different conditions of weather and of Season that I am positively convinced that it is what its' inventor claims it to be. I also believe that its' commercial adaptation is feasible. I believe that Dr. Moray has explained everything to me without reservation. I am sure that this is a revolutionary and epoch making invention.

Sincerely yours,

Dr. Murray O. Hayes

## **Patent Correspondence**

Dear Henry,

For your information, I wish to report on the matter of your radiant energy machine since coming here.

We arrived here Friday, July 10. On Monday, July 13, I spent the whole day in the search room of the Patent Office. I examined every patent issued by the U. S. on devices for the reception of radiant energy. Most of them were so obviously dissimilar to your invention that they did not consume much time. Not one is there which shows, on reading, even the remotest resemblance to your radiant energy machine. Not one mentions such an idea.

Neither is there any patent that suggests anything like your oscillator tubes. I feel perfectly safe in saying that there is not one chance in a hundred thousand that the examiner will find any disclosures that will restrict your claims. I have always felt certain that you would obtain broad protection on your radiant energy invention. But now I know it for certain.

You may use this letter in any way that you see fit.

Very truly yours,

Murray O. Hayes

## **Thomas J. Yates, E.E., M.E, wrote this notarized letter**

TO WHOM IT MAY CONCERN,

I witnessed a demonstration of the apparatus invented by Dr. T. H. Moray by which he produces electrical energy. A report of that visit has already been made.

I now have, about two years later, witnessed a second demonstration of the same device; some changes in the apparatus were noted. A great improvement was made in the performance. The condensers, coils and other parts, noted at the previous test, were now in one small box about 10 x 10 x 30 inches. A safer and better means of starting the device has been devised. Once the apparatus is put in operation, it will continue to charge itself.

The lamp rack that formerly held six 100-watt lamps has been replaced. The new rack is larger and holds thirty-two 50-watt lamps, three 100-watt lamps and a receptacle to receive an extension plug and cord. On the other end of this cord a 575-watt electric iron was connected. During this test, all of the electric lamps were lighted at one time. Their light was whiter and more brilliant than other lights in the room, which were supplied from the house circuit. When the lights were on bright, the electric iron was plugged in. There was no noticeable blinking or sudden diminution of the lights as in the usual house lighting systems when an electrical iron is turned on. The lights were as bright as before the iron was plugged in. The iron heated quite rapidly. In about 2½ minutes it was hot enough to be used for ironing.

I made a thorough and careful examination of the entire system to see if electricity could have been introduced from some other source. I inspected every part of the system, all wires were checked; the switch was removed and examined. Leads from the switch to the box containing the condensers and coils

were checked. The box itself was lifted and examined. The leads from the box to the lamp rack were inspected. The lamp rack was lifted and examined, as was the ground wire from the switch to the water pipe on which it was grounded. Not an inch of space was overlooked where there might be any metal that would carry the power. I am prepared to say that no such connection existed from which power could be had from any other system.

A crystal radio set was connected to the lead-in wire from the antenna on one side and to the ground wire on the other. Perfect reception was had. If there had been power from other sources on the antenna or lead-in wire radio reception would not have been possible. Instead a loud humming sound would be produced. This was demonstrated that by connecting the radio set to the house lighting system.

When Moray's system was working, the lights were burning bright. The terminal attached to the antenna was disconnected. A vigorous arcing occurred and the sparks jumped over an air gap as long as eighteen inches. This would indicate that the power was high voltage. The nature of the sparks indicated a high frequency current.

I do not understand the principle by which Dr. Moray's device produces the electric energy. The condensers and the coils of wire are common. The cylinders called "oscillators" and the small conical shell called the "detector" are the only things not commonly known, but the system works. It produces electric power in abundance and does all that Dr. Moray claims for it.

I do not own any stock or interest in Moray's work. My only purpose in issuing this statement is in the interest of the advancement of science. I consider this development a great advance in the science of producing electrical energy.

Very truly yours,

In witness to the above I hereunto sign my name.

(Signed) Thomas J. Yates, E.E., M.E.

STATE OF UTAH COUNTY OF SALT LAKE

Thomas J. Yates, being first duly sworn, deposes and says that he has read the foregoing statement and acknowledges that he wrote and signed the same as above set up.

(SEAL)

Thomas J. Yates

Subscribed and sworn to before me this 18th day of December 1930.

My Commission expires R. J. Chapman May 7, 1934 Notary Public – residing at Salt Lake City, Utah.



**This is a letter addressed to Moray from W. H. Lovesy**

Dear Henry,

I have handed you the original letter from Murray O. Hayes, in which he described being shown and having explained to him the wiring diagram of your R.E. device. Also the fundamentals of the detector were explained to him. In that letter he stated plainly these fundamentals would not have been noticed unless pointed out by you. At the same time, he had become familiar with all of the details of the construction of your device for utilizing cosmic energy. He added that you had applied only fundamental principles of electric circuits.

There is attached a second letter containing details of Mr. Hayes educational record.

I made the memorandums on the face of these two original documents at the time I was consulting with Murray O. Hayes in my office. At the time he definitely advised me of being shown every detail of your invention. Mr. Hayes stated that he could make one of the machines himself from the information that had been given him.

Murray O. Hayes made similar statements to me several times. I have made repeated requests that he makes these declarations. Namely that he had been shown every detail of the invention. Perhaps these repeated requests gave him the impression that I had a doubt about the invention.

Personally, I have never had a doubt. But I thought that only you held the real detailed secrets of the invention. I had a conference in New York with Dr. Harvey Fletcher and Dr. Carl Eyring at the Bell laboratories. I agreed with them to ask you to give the details of your invention to Murray O. Hayes. The purpose was to determine if he could duplicate your machine. In every instance his answer was emphatic and to the effect that he could do so.

Yours truly, W. H. Lovesy

**This letter is from Geo. R. Pyper**

To Whom It May Concern,

I have worked in electricity all my life. I was with the Utah Power and Light Company for thirteen years and worked in all departments including sub-stations. I have been with the Kearns Corporation for over seventeen years. I have been in charge of all the electrical work for the Tribune and Telegram Publishing Company and in the Kearns and Tribune Buildings.

In last December I witnessed a demonstration at Dr. Moray's laboratory of his electrical marvel box. He let me see inside this box. There was a H. F. transformer, some of his cold tubes and some condensers. Dr. Moray connected this box to a special balanced aerial and ground wire from outside the building. Two of us held a counter poise antenna attached to glass insulators in the room. When he connected the box to this counter poise antenna, I saw the same results as with the external aerial.

During this demonstration and while the lamp and appliances were operating, I shorted the aerial and ground wires. There was no spark; it just turned off the power from the box. I then took hold of both of these wires and felt nothing, they were both cold.

He then took a larger box, about 18 x 30 x 15 inches and connected it to the outside aerial and ground wire. From this box he lighted about fifty 100-watts, 120-volt lamps, ran a small motor specially wound at great speed, an original electric iron and a 500-watt glow heater.

Dr. Moray then disconnected the appliances and lamps and attached two long wires to the box. We pulled the main line, Utah Power and Light Company service switch for his building. We attached the wire from the box to the building side of the switch. He lighted his building and heated iron heaters. In fact, he did everything the Utah Power and Light Company service would do except run motors that I understand have to be specially wound.

Standard globes were used. They seemed to give a softer whiter light that was more like daylight.

I am satisfied from my experience in electricity that there was no fake of any kind such as concealed batteries or wires. Everything was in the open so I could see every operation. I did not see the inside of the larger box.

It was a very remarkable demonstration and one that I will always remember.

Geo. R. Pyper

## **SECTION SUMMARY**

Whenever a fairly large amount of oppositely charged ions coexist within a small volume of space extensive recombination occurs. The resulting accumulative radiation can add up to an intense, constant wide-band frequency. This phenomenon prevails around many stars in our own galaxy and is concentrated around nebulas and star clusters. Indeed, this is a very old source of energy. All we have to do is attach our machines to this "wheelwork of nature."

## **SECTION REFERENCES**

### **"The Sea of Energy In Which The Earth Floats" by T. H. Moray, 5<sup>th</sup> Edition 1978**

The Eyring Research Institute, before Henry Moray died, was working on "Direct Energy Conversion Systems." This involves using radioactive material in conjunction with the quartz junction. p. 89

In 1942, shortly after World War II began for the United States, Henry Moray attempted to rebuild a radiant energy device. He used the remaining bit of what was known as the "Swedish Stone." This material limited the amount of power that his device could draw. Consequently, in the larger unit, he developed a second detector that forced him into extensive research involving nuclear materials and radioactive reactions. He became deeply involved in the study of synthetic radioactivity as described by Gustave LeBon in his book, "The Evolution of Matter." p. 186

Others may discover Direct Energy Conversion Systems using synthetic radioactive materials. Bell laboratories have made millions of dollars from semiconductors, though no credit has been given to Henry Moray. p. 190

**This is from a speech given by T. H. Moray on Jan. 23, 1962 at the Valley State College Northridge, California**

It is now estimated, because of present advances in dielectrics that a 100-lb. unit can be made to deliver 300KW. That is gross weight, not net weight. p. 11

**"The Sea of Energy In Which The Earth Floats" 4th Edition 1960, by T. H. Moray**

Nikola Tesla was not referring to so-called atomic energy or nuclear energy but to the energy that is continually bombarding the Earth from outer space. Call it cosmic, or what one will. p. 1

Enough energy is coming to the Earth to light 1,193,600 one hundred-watt lamps for every human being alive today. No fuel of any kind will be taken. Energy can be "picked-up" directly by great ocean liners, railroads, airplanes, automobiles or any form of transportation. In addition, heat, light and power can be available for use in all kinds of buildings. p. 1

Electrons are spontaneously being emitted from the nuclei found in Nature. Every new discovery on the subject bears out the claim that all "space" is filled with energy containing millions of amperes at very high voltages. p. 89

In the case of R. E. devices, a different effect is established. The oscillations from the Universe are trapped by the R. E. valve and continue to enter the circuit as the waves of the sea beat upon the shore. p. 92

Pellets were made of a mixture of the **Moray lead** that withstands heat over 1800°F. Using pure germanium mixed with bismuth, iron sulfide, triboluminescent zinc and certain other impurities **including the Moray fission material**, he obtained a substance that had wonderful properties as a detector or valve for radio signals. p. 128

With this germanium combination alloy used as a detector, it was found that radios would operate without batteries or any source of power other than that obtained from the **radio transmitting station**. p. 128

To make this special R. E. energy valve, he used a lump of lead (Moray lead). It was treated according to the process that he has discovered and got wonderful reception on a radio. p. 129

**"Radiant Energy" 3rd edition by T. H. Moray, 1945**

This energy, or as Dr. Moray explains it, these oscillations of energy, are picked up by the device through the oscillators, or neutron bombardment. p. 8

In reference to electrons, neutrons, protons and ions: It is my theory, in using these terms, that they are the energy of the Universe. p. 17

My device oscillates because of the oscillations of the Universe caused by the disintegration of matter. p. 18

## **Radiant Energy 2<sup>nd</sup> edition by T. H. Moray, 1931**

As far as atomic energy is concerned for heat, light and power, it is and always will be nothing more or less than an expensive, dangerous, glorified steam plant or an equally dangerous thermoelectric device. The process involves breaking into the lines of force of the radiation field that surrounds the reactor to capture energy. Such a plant, no matter how efficient, never is the complete answer to the World's energy problems. Costs and weight will always be a great problem.

Any nuclear fuel, even the most "super nuclear pile reactor," or what have you, is, and always will be, just another way to operate an energy plant from any heat, light and power viewpoint. p. 1

**When Moray used the word "Universe" he was often referring to the atom. Moray refers to cosmic energy that relates to both "stellar space" as it does to "atomic space." p. 61**

The facts involved are the same in both the radio receiving set and this device. The nature of the mechanism, however, in one differs greatly from the other. The radio receiving set receives transmitted energy waves out of the air and transposes them into sound waves. The R.E. device receives oscillations from the Universe, and transposes them into electricity. p. 13

If the frequency is raised high enough, molecules will separate and the atoms are freed. Raise the vibration of the atoms still higher and higher and they will resolve themselves into the original elements of which all matter is constituted. p. 15

Cosmic rays are constantly creating radioactive carbon. The fusion of small atoms together to make larger ones gives off more energy than so-called "splitting" of the larger uranium or plutonium atoms. The uranium energy release ratio is only 1 to 1000 – that is only 1/1000 of the heavy atoms are changed in the uranium "atom splitting" process of the atomic pile. p. 60

11 April 1990

Arthur Glenn Foster  
Principal Engineer wrote:

There are some interesting side details. "We" (a group of us in government and industry, loosely coupled) were pursuing "Project X". We had a contract to process some of the Moray "valve," fine-ground, "Swedish Stone" into pressed "detector" pellets. The pellet material was doped with a tiny amount of unpurified radium reduced from U238 yellow cake.

The pellets were subjected to a huge number of millibars of pressure by a tetrahedral press used for manufacturing artificial diamonds. This technique was developed and patented by Dr Tracy Hall after he left GE. When a certain critical pressure was reached "something" in the material "flashed." The electric pulse produced was so violent that it burned out the 2000-amp carbon-die heater power supply, blew the main breakers in the building and blew the power line transformer on the outside power pole!

## My Radiant Energy Research

Whenever radiation from a radioactive substance ionizes atoms, electrons are emitted. The electrons almost immediately recombine with the positively charged atoms that expelled them in the first place. Charge equilibrium occurs at the exact moment of recombination, along with electromagnetic oscillation. A by-product of this phenomenon is called **ionic oscillation**. Radioactive particles will again separate the newly recombined atom. In fact, any electrically neutral atom will lose electrons when exposed to radioactive matter. The atom that is left behind becomes a positive ion. This process of ionization and recombination is a continuous cycle as long as the atom is exposed to a source of ionizing radiation.

Whenever a fairly large amount of oppositely charged ions coexist within a small volume of space, the accumulative radiation from recombination can add up to an intense, constant wide-band frequency. This phenomenon prevails around many stars in our own galaxy and is concentrated around nebulas and star clusters. Indeed, this is a very old source of energy. All we have to do is attach our machines to this "wheelwork of nature."

What has just been revealed to you here is the final secret to harnessing the very wheelwork of nature. Ionic recombination of the decay products of radioactive isotopes will produce intense surges of electromagnetic energy. More often the wavelengths created are in the infrared (thermal) range. However, the wavelengths generated can also manifest within the radio frequency range or even far into the **gamma** end of the electromagnetic spectrum. They can even be made to manifest as free electrons. What does the decay of radioactive matter teach us about the nature of energy?

Under the right conditions, radioactive particles can be made to generate intense surges of energy in the radio frequency range. Tune into this energy with a tank circuit that will resonate with it and you have yourself a powerful source of electrical power.

To the best of my knowledge no person has ever harnessed radioisotopic energy using the process that I have just explained, with the exception of T. H. Moray and myself. There is not a patent to be found that even closely resembles it. Radio astronomy only gives us hints about these "**ionic oscillations**."

Many radioactive isotopes could be used to generate electrical power. However, the real power behind these isotopes is the radon gas that they release. I have pointed this out many times in my writings, lectures and articles. Polonium can be cheaply manufactured by bombarding the metal bismuth with a source of neutrons.

In United States Patent 2,728,867, it is stated that each gram of nuclear fuel that is undergoing fission gives off around twenty watts of power. In comparison, one gram of **polonium** will generate about one hundred and forty watts of power. This is **seven times** more energy than what is available from a conventional nuclear reactor!

If polonium is made to generate surges of intense electron oscillations then it becomes a powerful source of radio energy. A simple **ion valve**, or call it what you will, can be used to generate these oscillations. They in turn can be directly converted to electrical power. This unique valve is shown in **Figure 4**. Before it can function it must be connected to a source of high-voltage. In order for electrical energy to be extracted, it must also be connected to a proper circuit. One such circuit is detailed in **Figure 5**. The electronic circuit shown is basically what is required for this conversion. Many additional stages can be added for more power. Many other circuit and component configurations can also be used but the fundamental conversion principle will remain the same. The circuit and components shown in this book will give you the general idea of the principles involved.

The actual mechanics and electronics of building and validating a radiant energy prototype are relatively simple. It is fun and easy. Moray's devices used a detector that was ionized by radioactive impurities. However, radioactive material need not be used, from what we now know.

Those involved in building prototypes, must first confront some serious issues before beginning. I will try to enumerate a few pitfalls and make descriptions as clear as I can. This will fortunately and blessedly push some of you into action, but for others it will be viewed as an impossible challenge.

#### **What are the most important assets for beginning my research?**

1. Dedication
2. Motivation
3. Passion
4. Do instead of just theorizing.

#### **What is the second most important thing?**

The lone wolf researcher will need a lot of skills if their project is to be successful. Among the most valuable skills are those involving electronics technology. Plus, some familiarities with machine shop practice and materials. A good sense of organization is important. Being able to stand-back and observe the big picture, along with a lot of plain, good old common sense; are necessary skills to have. The "hands-on-imperative" must be at the very core of your efforts.

#### **What if I have few tools and skills but have the dedication?**

Then you need to have some cash, the green stuff. You will have to buy the skills, knowledge and time of others. You can farm out electronics and machining chores but it will be expensive. The more that you can do for yourself the better off it will be for you in the long run.

A fully equipped, skilled, advanced amateur radiant energy experimenter might slip by for about \$300.00 for everything. If you have only a few tools hanging around then a proof of concept prototype might cost you around \$500.00 because of the extra tools that you will have to purchase. Later you can build a more powerful prototype to replace the proof of concept design. Your basic working design will not have to be replaced. You can add more components as your research progresses. Simple dedication goes a long way. Watching, paying attention to details and doing it right the first time; are all very important. With this borne in mind, you could complete a powerful prototype for around \$5,000.00 that could provide power for the average home. However, it is not

now my intention to instruct you on how to build a home power unit. This book was written so that you may validate the technology; refinements still have to be made.

### **Are there any dangers involved?**

Yes, of course there are! There are a number of ways to wind up in an early grave! Most of the lethal dangers can be avoided with **skills**. Read first and do second. Reference books and a solid, broad-based scientific library are your true assets. Access to the Internet would also be very helpful. Know the danger zones in the various disciplines that you are going to come across in your research endeavors.

The radiant energy circuitry is connected to an antenna and ground. A lightning strike could fry the device and burn down your house to boot. I take no responsibility for this. You build these circuits at your own risk. Take the time to install lightning protection on the antenna and ground leads. It could save you a lot of grief in the long run.

Some specific dangers include:

1. Crushed and mangled hands of the unwary or metal splinters in the eyes or skin.
2. There are burn and eye damage hazards.
3. Imploding glass bell jars, power valves, can scatter glass splinters at high velocity into face and body. Always use glass enclosures that can withstand the vacuum that is being applied.

### **Do you have what it takes to go the distance?**

If you have what it takes and there is a burning passion for this research then you are probably ready to begin. This is not a place for a wimpy mentality. If you become frustrated or fail in your experiments, have the courage and good grace to realize how this came about. Make the effort to find out where you made your mistakes.

More than likely, you are going into this research with learning from books that have been written to hide certain facts from you. Do not expect results over night. Learn all that you can by careful observation, educate yourself, search out the truth first and let Nature be your guide.

There are political powers in this World that would not like to see us succeed in getting radiant energy power implemented. They know quite well that this energy source will liberate the global community. This mode of power generates not only power, but it will also generate hope for our decaying World.

### **Fundamental Validation Test Circuit**

First of all, let me say, there is no fringe science involved with radiant energy power generation. This is a very old source of energy being extracted and harnessed in a unique, new way. I do not claim to have discovered anything new in nature. What I do claim is an improved method to convert radiant energy (atomic ions) into useful electrical power. Think of the radiant energy receiver as a type of electronic heat pump, only it is pumping ions, not heat. No laws of physics are being violated. No new laws are being implied.

## Energy from the Dissociation of Matter

It is no secret that electrical current can be obtained by utilizing a couple of dissimilar metals. You can plunge a dissimilar couple into an electrolyte to obtain electrical current. This is called electrochemical energy. You can heat the junction of a pair of dissimilar wires that have been twisted together at their ends to generate electrical potential. This is called "thermoelectricity." However, what is not generally known is that you can also generate electrical current with plasma or a glow discharge as your medium between two dissimilar electrodes. This effect is the result of "triboelectricity." All these forms of electrical energy are caused by the dissociation of matter. This dissociation of matter is called "radioactivity" by the scientific world. All electrical phenomenon is the result of this radioactive decay.

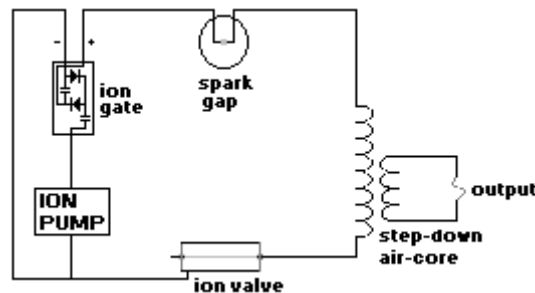

**Proof of Concept - Figure 3**

- The "ion gate" in this circuit uses two .001mfd/20kvdc capacitors and two 20kv, 100-nanosecond diodes.
- There are varieties of electronic circuits that can be built to serve as ion pumps. The circuit used was designed by Robert E. Iannini and can be found on my website at: <http://www.nuenergy.org/plasma.htm>
- The ion valve in the above proof of concept prototype consists of a standard aluminum electrical conduit that is six inches in length. Its center wire is a 60  $\mu\text{m}$  diameter tungsten wire secured with two half-inch PVC end caps.

### **Preliminary Ion Valve Validation**

1. The output at the ion gate reads around 5KVDC using an analog high voltage test probe without the ion-regulator valve in the circuit. With the ion valve in circuit a 20KVDC reading is obtained with at least a 25% reduction in current being drawn to power the circuit.
2. The apparent energy gain in the above ion valve appears from the fact that when negative ions produced at the surface of the inner cylinder bombard the center wire secondary negative ions are generated. The negative ions, when accelerated with sufficient voltage are capable of dislodging (dissociation) other negatively charged ions by from the target against which they impinge upon; and a significant result is that the number of secondary ions may be several times greater than the number of primary ions. This has the effect of reducing power drain from the power supply. A.W. Hull observed this effect in a thermionic tube – HULL, Proc. I.R.E., 6, 5, 1918.
3. The ion valve can be used as a quenching (regulator) device that can provide clean sinusoidal currents to the output current.



# Ion Valve Technology

## Explained

An ion valve that has been preconditioned with radon gas will uniquely add electrons to an applied high-voltage source. Inputted energy can be converted to a higher wattage electrical output. Using an ion valve in this embodiment the basic design has an axial, negatively charged cathode wire that extends the length of the cylinder. The anode is made out of an aluminum cylinder that is positively charged. Its cathode is a tungsten wire or rod that is negatively charged.

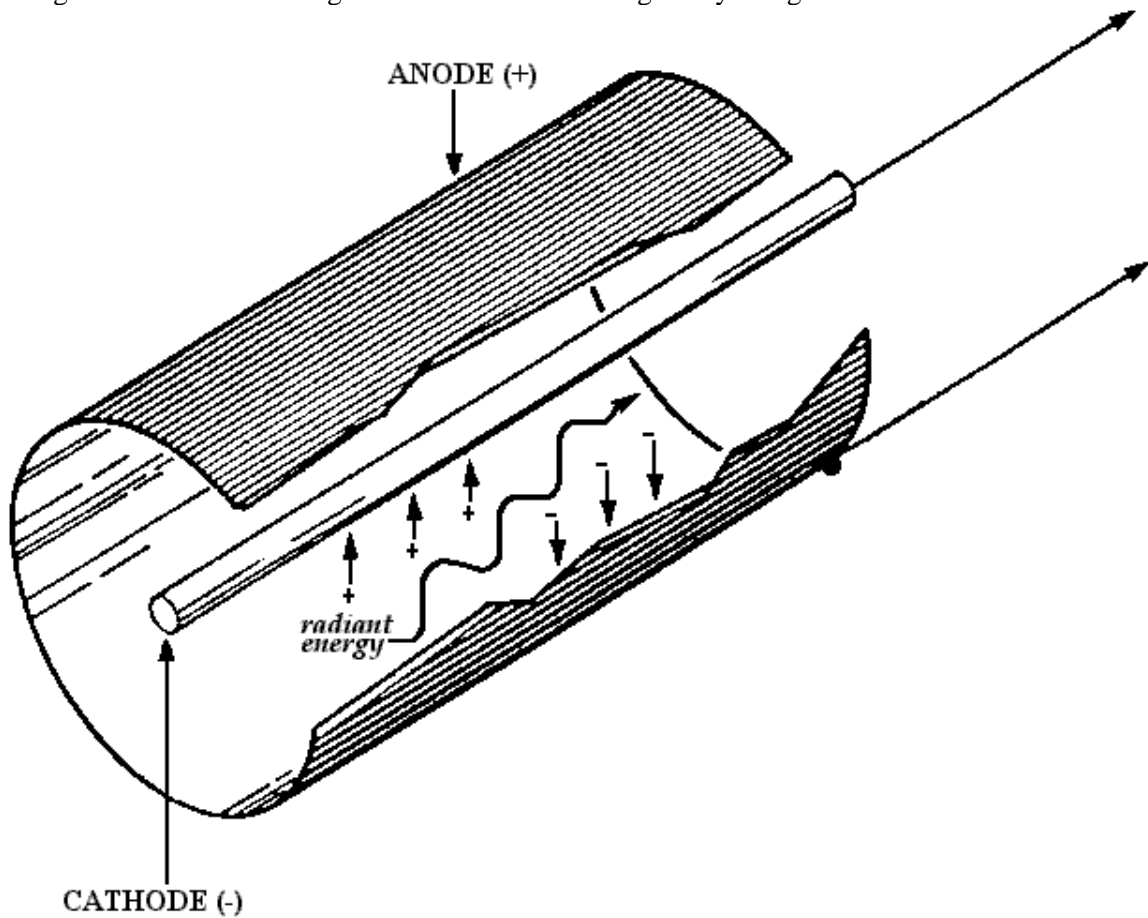

**Ion Valve - Figure 4**

In the diagram shown here negatively charged ions are formed at the surface of the center cathode wire. Positively charged ions are formed on the inner surface of the anode cylinder.

When a surge of ions flows through the valve they are added to the negative ions that sit on the cathode. They are now attracted to the positive anode cylinder. A few milliseconds later the positive ions on the surface of the inner cylinder are attracted to the negatively charged onrushing

ions. When these negative and positive charges collide they neutralize each other generating electromagnetic oscillation. This characteristic has the effect of suppressing any **inductive kick back** seen from the loads that would normally flow back towards the power supply. Feedback from the loads to the power supply will result in wasteful heat losses.

I am fully convinced that my ion valve is a refined version of Edwin Gray's conversion tube described in his US Patents No. 4,595,975 and No. 4,661,747. **Chauncey J. Britten** also describes a similar component in his US Patent No. 1,826,727. Mr. Britten's component appears to be a prior variation of my ion-regulator valve design. Britten's valve was said to have lit up his home in 1930 according to a local newspaper article of that time period. Russian scientist **Alexander Chernetski** experimented with what appears to have been a type of ion-regulator valve. It is said that he got up to five times more energy out of his device than what he put into it. Plans were made to commercialize the invention but like the Moray, Gray and Britten devices it never became a commercial product.

The ion valve is not to be confused with a current rectifier. The ion valve prevents ions from flowing back to the power source. It is an 'energy dam' for the lack of a better description. Both negative and positive ions can flow through this component. The valve has a charge blocking effect. This is why Moray stated that "the valves are not rectifiers in the sense that they operate as radio valves in changing AC or HF to DC. Ion valves have an actual valve action in stopping the 'flow' of energy in one direction. Its function may be thought of as an oscillatory action similar to the waves of the sea, without rectification, from returning to the outer circuit." p. 209, *The Sea of Energy*, 5th edition. This rather cryptic language now makes more sense seeing first hand how my ion valve works.

The metal atoms in the cathode wire are bonded to each other through electron sharing. In another embodiment, to break these bonds the wire is given a positive charge and the cylinder is given a negative charge. The negative charge on the cylinder negatively ionizes any gas that contacts it. These ions rush towards the positive cathode. When an ion that carries an excess electron hits head on with a positively charged metal atom the electron combines with the metal atom. The absorbed electron passes along its kinetic energy onto the metal atom causing it to break its bonds with the atoms that were joined to it. This generates an intense burst of free electrons. The "sea electron" model helps to explain this effect. It is where metal atoms are bathed in a "sea" of valence electrons. If this model is taken one step further it can be shown that when metallic atoms are dissociated from each other excess electrons are released as pure electrical energy. This occurs because the electrons no longer take part in the intermolecular binding force that existed before the dissociation took place. The freed electrons will add amperage to the output circuit to which it is connected. Henceforth, the equation  $I \times E = P$  holds true in this system. Where, "I" represents electrons (amperage), "E" electromotive force (ionic voltage) and "P" is the power generated.

The ion-regulator valve is an important component to the radiant energy converter. Add a grid to this valve and you then have an ion driven oscillator component. The ion-regulator valve can be used as a rectifier by heating its cathode. Electric motors can be made to draw less current from the power supply. Communication systems that take advantage of the ion valve as an oscillator could make present day radio transmission obsolete. Electrical power transmission and its generation could also receive a fresh new start. The possibilities are refreshing. It is an honor to offer humankind this technology. It is my goal to build and bring devices to market that will introduce new products that will better the quality of our lives.

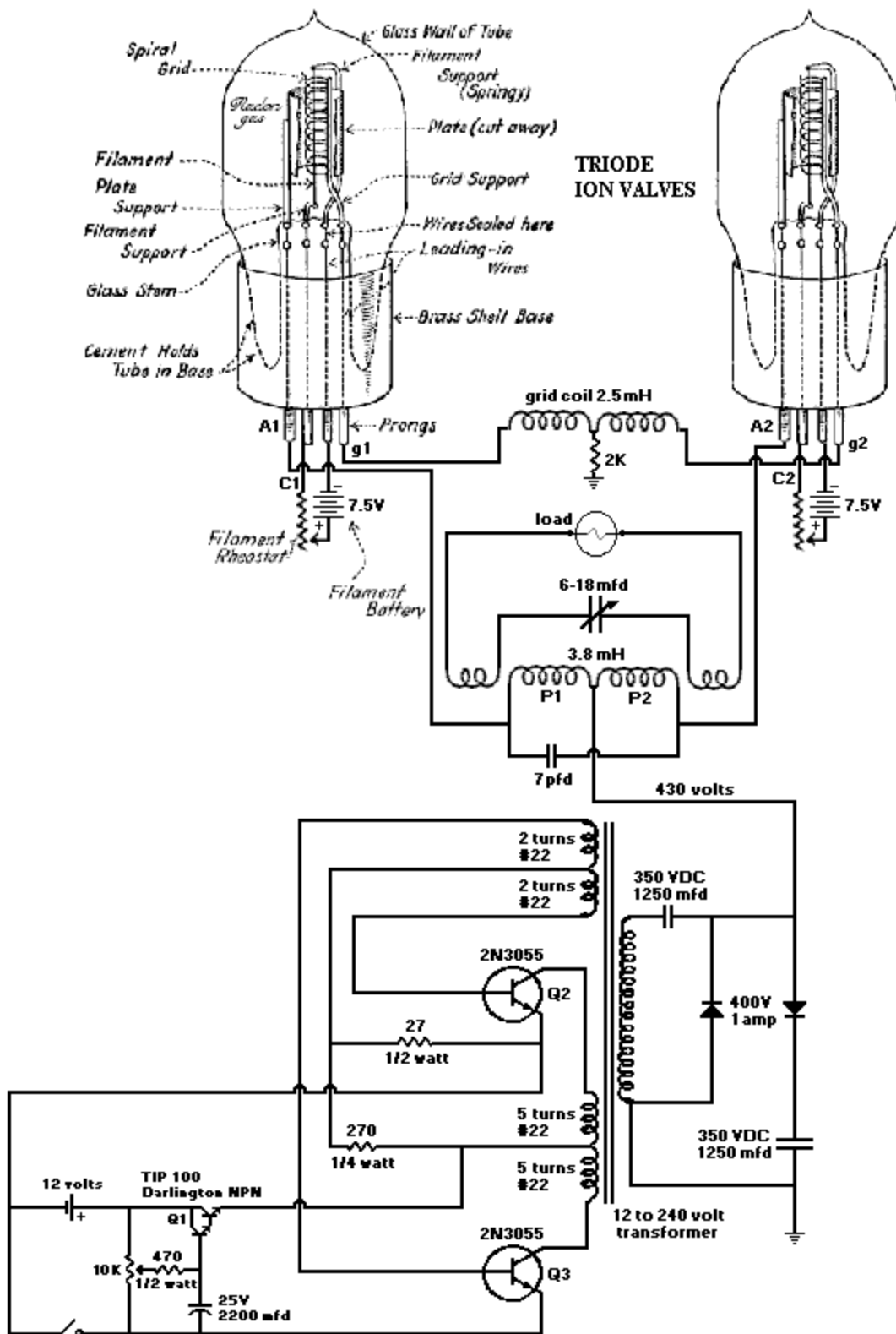

**Radiant Energy Generator Concept Device - Figure 5**

To activate an ion valve a vacuum is pulled, radon gas is introduced and a negative charge is applied to the cathode wire. The radon decays and deposits lead-210. This is a beta emitter and will supply electrons without the need for filament current.

**T55 Taylor electron tubes** were used in the above public demonstration device due to nuclear regulatory restrictions. Other radio vacuum tubes may be substituted. The energy output of this device does not give the slightest shock when the hands are in direct contact with it. Voltage meters will not respond to this type of energy. A 100-watt light bulb placed across the output will be brighter than if powered by conventional current. The filament within the light bulb can be seen to glow a cherry red and the gas is excited throughout. It is not a form of electricity that we are accustomed to experiencing. This type of electrical current should not be confused with what powers the circuitry of **Figure 5**.

The source of energy that drives the circuit is a wavelength of energy that T. H. Moray loosely called "radiant energy." To obtain power from this energy source a receiver must be built that will oscillate in harmony with it. This particular type of radiant energy possesses great powers of penetration, exceeding, in fact, the penetrating powers of ordinary x-rays. These rays have been proven to be harmless and may be used, if desired, to produce clear radiographs. They are antiseptic, germicidal, and are good tissue builders possessing wonderful healing powers. They will also effect photographic plates, produce phosphorescence in certain substances, render the surrounding air conductive to electricity and can produce heat in some materials.

### **WARNING!**

Electricity is EXTREMELY DANGEROUS and caution should always be used when working around it. Please take the time to educate yourself sufficiently. If you don't understand something, investigate further before attempting it. Take liberal advantage of encyclopedias, science books, and other reference materials. This book was compiled for information purposes only. I do not control the materials used in construction, the methods of construction, nor the applications of the construction, therefore; I AM NOT RESPONSIBLE FOR DANGEROUS OR UNDESIRABLE RESULTS. Always use rubber gloves when working with high-voltages.

### **ALL SAFETY PROCEDURES MUST BE CAREFULLY OBSERVED** **MEASURING HIGH VOLTAGE IS NOT RECOMMENDED**

**Disclaimer:** *The author assumes no liability for any incidental, consequential or other liability from the use of this information. All risks and damages, incidental or otherwise, arising from the use or misuse of the information contained herein are entirely the responsibility of the user. Although careful precaution has been taken in the preparation of this material, no responsibility is assumed for omissions or errors.*

## Edwin Gray's Energy System

**Thomas H. Moray invented a high efficiency 6,000-hertz power supply. It turns out that Edwin Gray's power supply also produced this same frequency. Gray claimed that electrical equipment such as solid state radio; television and light bulbs would operate on this type of current.**

The overall efficiency of the Gray device was said to be extremely high. From one of his company press releases we are told that it will power loads four times longer in comparison to a standard DC to AC inverter power supply. This particular press statement indicates that he was planning to market a device that put out a 6Khz frequency, as compared to the standard 60Hz frequency coming from the public utility power grid.

Both the Moray and Gray energy systems harnessed a very old source of energy in very unique ways. They could be the solution to our power needs by using an inexpensive renewable energy. The advantages over other systems are many. The World is indeed moving at a suicidal pace, we need this technology more than ever. It will light lights, run motors and electrical appliances.

When you put a high potential current across two separate elements, ionization will occur between them. The high voltage elements **12** & **34** develop a pre-discharge plasma glow between them. The charge polarity given to the tube **14** in the Gray circuit puts it into an **impulse mode**. When a glow pre-discharge is present in this mode no current flows. The tube **14** functions pretty much like a Geiger radiation detection tube waiting for an electromagnetic surge to trigger it into conduction.

Discharge occurs across the spark gap **62** once the capacitor **16** charges to the gaps' breakdown voltage. Once the arc is broken the capacitor **16** recharges, the cycle repeats and the cycle repeats so long as the batteries remain charged. This discharge current flows along the red wire shown in **Figure 6**.

Consider an electron moving through a magnetic field, whose lines of force are at right angles to its direction of motion. It is known that the electron is constrained to move in a circular path. In fact, if the field is made strong enough the electron may be forced to revolve in a circular orbit whose diameter is smaller than the field. If a magnetic field is applied transversely to the motion of the electrons, they may be deflected to such an extent as to prevent them from reaching the plate. Thus they are constrained to return to the cathode. A.W. Hall of the General Electric Co. was the first to use this principle in a highly efficient vacuum tube converter that he called a magnetron. The sudden discharge through the element **12** generates an intense electromagnetic field that collapses very abruptly. This discharges the energy stored in capacitor **38** in series with the load **36** and capacitor **16**. During this discharge cycle capacitors **16** & **38** recharge and in the same moment a powerful surge of electrical oscillations flows through the load **36**. The collapsing magnetic field in conjunction with the reappearance of the pre-glow discharge instantly generates a pulse train of electrical oscillations. This surge of power runs Gray's unique high frequency motor. The motor

functions with extreme efficiency because DC resistance is reduced to a minimum and wasteful heat loss is practically non-existent in this system.

**FIG. 1**

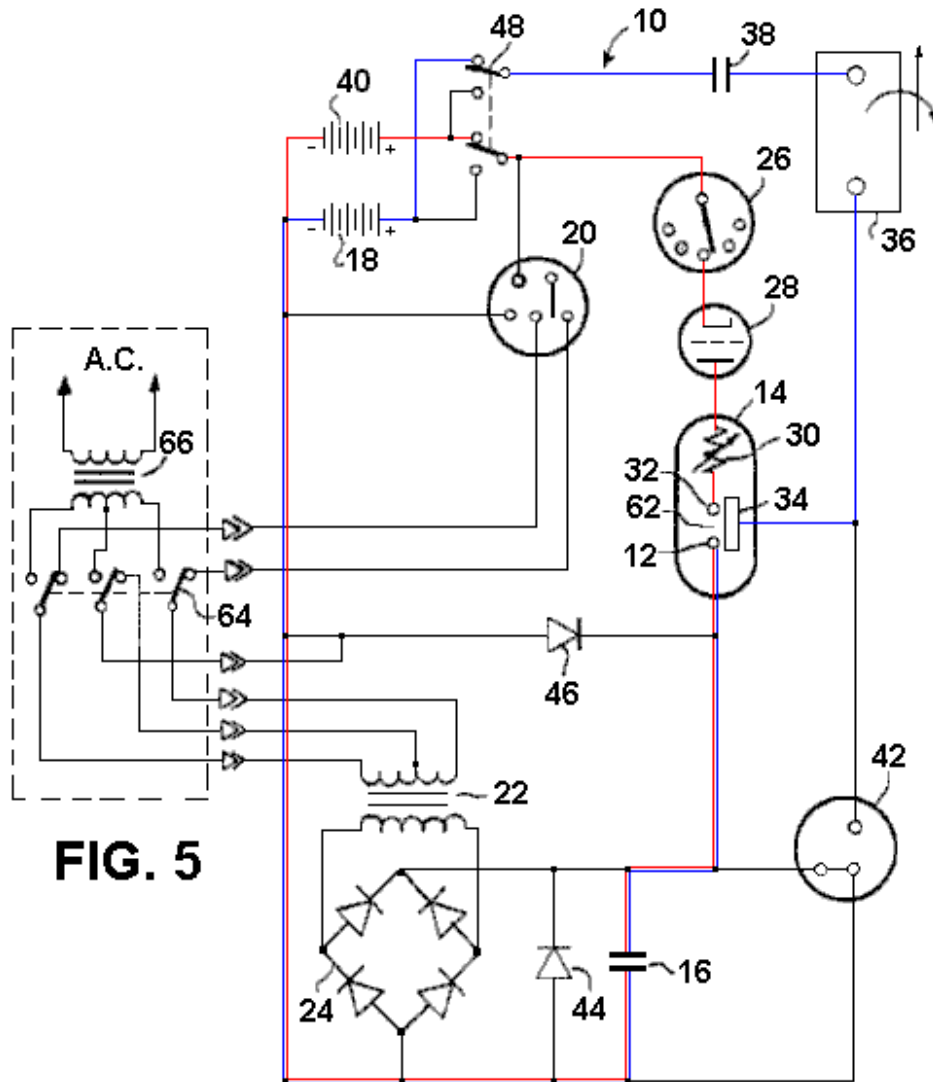

**FIG. 5**

**Edwin Gray Energy System - Figure 6**

1. The blue wires represent the high frequency current path that powers the load 36.
2. The red wires represent the current discharge path that occurs when the spark gap in the Gray conversion tube 14 fires. Storage batteries 40 and 18 alternately recover the discharge energy through a double-poled switch 48.
3. When the capacitor 16 discharges an intense oscillating high frequency electromagnetic field is generated through the "switching tube" and load circuit.

# Treatise On Matter & Energy

*Matter and Energy are one and the same...*

## **Three Primary Particles**

Atomic theory does not predict every reaction created by the various states of matter and of energy. There are principles in Nature yet to be revealed. Something has been missing from the over-all atomic picture of matter and energy. There are three primary particles that bring the elements into existence. Just as the colors red, green and blue combine to give us the entire rainbow, the same holds true of the three primary particles: protons, neutrons and electrons. The combination of these three basic primary particles is what gives physical mass to an element and its' unique characteristics. Its physical size, its mass, gives it a signature. This signature is given an "elemental" name.

If a given element is not in a kinetic state then it is said to be at complete rest. It is cold. The external forces acting upon it determine a particle's energy level. When struck by another particle, it becomes kinetic. It is this kinetic activity that we call heat. This heat or kinetic energy level may be raised by particles which impinge upon it that have higher kinetic energy levels. The "heat" of an element may be lowered by other elements that impinge upon it that have lower kinetic energy levels. This will cause the element to lose some of its heat. It is therefore "cooled." However, the elements fundamental make up is not changed. An element may acquire the kinetic energy level of visible light and still retain its fundamental properties. Its' signature is not changed.

## **Gamma Radiation**

An atom that absorbs or expels neutron particles will ring like a bell. It emits gamma energy. Whenever an atom gains or loses neutron energy it generates gamma energy. Gamma energy is a disturbance phenomenon.

The only difference between natural and artificial gamma energy levels is their origins. Natural gamma rays are emitted from the nucleus of a radioisotope. Artificial gamma energy is generated outside the atom. Gamma rays and x-rays are often called photons. They have no mass and no charge and may be considered to be energy disturbances in space.

## **Wavelength**

The kinetic energy level of the radiating element determines the wavelength of energy. A low kinetic level is represented by a long wavelength on the chart. A high kinetic level represents a short wavelength on the chart. The "speed of light" is therefore a relative term. Energy is contingent upon the matter that it impinges upon.

The x-rays begin at about the middle of the ultraviolet portion of the spectrum. These are called soft x-rays. Those that extend into the lower portion of the gamma range are called hard x-rays. Beyond this range, they are cosmic rays. These energy disturbances are called "photons." They are not particles. They are disturbances caused by the kinetic states of particles in motion. This energy spectrum proceeds in order of decreasing wavelength: sound, thermal, visible light, ultraviolet, gamma, and the cosmic rays.

### **Pair Production**

If a photon has sufficient energy, its energy may be absorbed by atoms. The photon interacts with electrons. This gives rise to a process called "pair production," in which the energy of the photon is absorbed by the atom.

### **Photo Disintegration – Gamma Energy**

Atoms can absorb high-energy x-ray photons, those with energies above 10 MeV (Million electron Volts). Here, the electrons within atoms are raised to an excited state and instantaneously emit high-energy gamma radiation. This makes the atom receptive to nuclear transformation. This process is called "photo-disintegration."

### **1.02 MeV Energy Barrier**

It has been calculated that when one electron pairs with another, 0.51 MeV of photon energy results. Since two electrons are involved in a pair production event, a photon must have at least 1.02 MeV of energy to separate them. A photon with less than 1.02 MeV will not produce a pair production event. Any energy in excess of 1.02 MeV is distributed equally between the two electrons.

### **Electrical Energy – Electron Cloud**

An atom is negatively ionized when it gains electrons. The atom is positively ionized when it loses electrons. How can it be then that a helium particle expelled from radioactive decay is charged to millions of volts positive? This observation can mean only one thing, that the electron shells are really an abstract thought for mathematical calculations, when concretely the atom is a mixture of electrons, neutrons and protons. The electron cloud consists of thousands of actual electrons. It must be noted that an electron is approximately 1,830 times smaller than the mass of a proton. The scientific community has ignored this little fact. As an example it will take around 1,830 electrons to equal the mass of one proton in the hydrogen atom. So, it is said that there is one proton and one electron in the hydrogen atom. What really should be said is that there is one proton and approximately 1,830 electrons. However, it is much easier to state that there is one electron in the hydrogen atom for simplicity. The mathematical electron shell theory need not be modified to fit this reality. It is convenient to use the square root of the actual number of electrons that surround each nucleus, for day to day chemical formulations.

When electrons or negative ions rush towards a positively charged atom in order to reach equilibrium, it is said that an electric current is generated. This current is created by a particular energy state called "voltage." If a metallic conductor has electrical current flowing in one direction one end of the conductor has an excess of electrons. The opposite end has a deficit of electrons. All "electric oscillations" are a result of this phenomenon. Battery power, direct current generators,



alternating current alternators, radio, microwaves, radar, electronic oscillators, metallic coils and condensers, electron-tubes, ion-tubes and transistors, magnetrons, klystrons, lasers, masers and molecular transitions; all carry these oscillations.

So then, what is electricity? This question has eluded the most able intellects throughout human history. Could this be because science ignored the fact that the electron in an atom is actually representing more than one thousand electrons, not just one? As observation shows, two states of energy exist, one "negative" and the other "positive." How could it be that there are two states, identical in their properties, opposite in character, both clinging to matter, both attracting and yet completely neutralizing each other? From this analogy, it is safe to say that electron differences create the effects of electricity.

### **Chemical Cohesion**

Atoms are attracted by virtue of their differing kinetic phase relationships. Matter stays together because of this principle. Atoms are continually expanding and contracting in unison with their kinetic frequencies. Expanding particles are attracted to contracting ones and visa-versa. "Gravitation" might turn out to be a grand display of this phenomenon. Atoms will repel atoms only if they are in the state of coherent kinetic vibration. This occurs when atoms are vibrating in phase with each other. Coherence will raise energy levels. Differing elements will form "compounds" when their fundamental frequencies are in accord with each other. They must ring harmoniously.

### **Ultra Chemistry**

The first law of thermodynamics describes the principle of the conservation of energy. It states that "energy is not created or destroyed; it merely changes form." The fact is that the creation or destruction of energy is a result of matter being broken down or built up. They both go hand in hand.

I strongly believe that the three primary particles were created at the beginning of the Universe and that they can not be destroyed. However, the good news is that to serve our needs we can artificially alter the elements, (cosmic soups) of these three particles, protons, neutrons and electrons).

I will dare to further state that neutrons not only reside in the "nucleus," but they also exist throughout the atom as a homogenous mix with the other primary particles. The most simplistic expression of the Perreault Atom involves the bold statement that neutrons reside in balance with the protons and electrons in the atoms. This concept applies throughout the entire Periodic Chart of the Elements.

### **Isotopes**

Three hydrogen elements (isotopes) are known to exist that are chemically similar but have different weights. The three weigh differently due to neutron content. These are all hydrogen atoms. However, it is the neutron count in the atomic shell that determines the isotope.

It is clearly established that triple weight hydrogen (tritium) decays to helium-3. In this particular transformation a charged normal weight hydrogen element (protium) carries an excess electron in

its shell. It can react with tritium and emit an electron as a by-product of the reaction. At this moment the electron is emitted at an accelerated rate and is seen as beta energy. This model will not alter the way we view chemistry, however, it should change how nuclear changes are viewed.

### **Gravitation**

Each individual atom is at the center of it's own universe and has a unique resonant frequency that is representative of it's specific mass. Lithium for an example has a greater mass than the hydrogen atom and will vibrate at a lower frequency in comparison. Therefore, we may say that it is caught by earth's gravitational pull more readily and has more weight. This may help to explain how physical objects are attracted to the Earth.

### **Stored Nuclear Energy**

Have you ever wondered about spontaneous radioactive decay? Is there a super charged state of matter? If an atom becomes ionized by either gaining or by losing electrons then why can there not be a nuclear ionization too? I hypothesize that atoms do become ionized on the nuclear level by gaining or losing neutrons. This may appear incidental but could be at the very heart of an ultra-chemistry. I say that it is highly likely that this very phenomenon is behind natural spontaneous radioactive decay and explains many unanswered questions in nuclear science.

Atoms can gain or expel neutron particles, some to a greater or lesser degree. Thorium can readily be transformed into a fissile isotope of uranium by absorbing neutrons. It is a known fact that thorium stores more energy than uranium, coal, oils and all other fuels combined. This represents a tremendous amount of stored energy. Transformed thorium could be our most economic source of energy. It is almost as abundant as the element lead.

It is only by passing from one state of equilibrium to another that matter can lose or gain energy, consequently emitting radiation. The notion that radioactivity originated in a peculiar chemical process was adopted and defended by Rutherford. "Radioactivity," says he, "is due to a succession of chemical changes." Research has found that this "succession" is due to neutron transformation.

### **Nuclear Transformation**

Elements that absorb neutrons and become unstable are called "radioisotopes." When an atom absorbs neutrons it is seen as a "fusion" reaction. When an atom loses neutrons, it is seen as a "fission" reaction. All elements can "transform" into a radioisotope and visa-versa. Radioactive isotopes are unstable and will transform into stable elements. A radioactive isotope will eventually revert back to the original element on it's own accord. Radioisotopes are nature's storehouses of energy. We need not look any farther for our energy needs. Nature holds an inexhaustible supply.

### **Induced Radioactivity**

When bismuth is exposed to radium, initially it becomes several hundred times more active than the radium. This is due to emanation that clings to the surface of the bismuth. Emanation is widely known as radon gas that will eventually decay to polonium. It releases more energy than any single natural element ever discovered.

If beryllium is exposed to radium, neutrons are generated. These neutrons will have penetrating power several times that of the most energetic gamma energies. This activity is due, not to an alteration of the inactive matter itself, but to an admixture of a very small quantity of intensely active matter. Is this the neutron? Could it be that a neutron is actually an inert monatomic gas? This would certainly explain a few gaps in accepted atomic theory.

I have found that "radioactive" matter can be electronically synthesized. I find that radioactive matter is simply in an atomically charged state. It has been recognized that when an atom gains or loses electrons, it becomes "charged." However, I have taken this one step further by suggesting that matter will also become super charged when it gains or loses neutrons. This super charge that the atom acquires depends largely on its energy state and the type of radioactive gas that it reacts with at the moment of contact.

### **Strange Nuclear Facts**

Primary neutron particles and gamma energy levels are generated in nuclear transformations. This results in the atom becoming super charged.

A "chain-reaction" in radioactive matter is due to the concentration of excess neutrons. The greater the concentration of excess neutrons, the more accelerated the decay process becomes.

For example, if beryllium metal is added to radium metal, neutrons are expelled. These neutrons can be used to cause secondary nuclear reactions in fissile material. The beryllium becomes the nuclear trigger.

The energy released by the transformation of beryllium is estimated to be at around 50 MeV and that of boron nearly as large. The excess neutrons generated can be used to super charge atoms thus transforming them into radioisotopes.

### **Cold Fusion**

Here is a "cold fusion" reaction to consider. Radon gas (a pure alpha emitter) generated from the decay of radium is deposited onto a beryllium wire. Beryllium will react with an excited alpha particle that will generate a "cold fusion" reaction without the need for excessive heat, as is the case for "hot fusion." The reaction that results is: the  ${}_4\text{Be}^9 + {}_2\text{He}^4 \rightarrow {}_6\text{C}^{12} + {}_0\text{n}^1$  (cold fusion) mentioned above. This secondary neutron energy now can effect a reaction in nuclear fuels. Atoms need not be fragmented in this reaction. Therefore, this reaction is "clean." There are other examples but this formula will give you a general idea.

Alpha fusion is actually cold fusion. The end result generates neutrons from the production of fusion by alpha particle collision. A simple equation where mass squared by it's speed equates to temperature. This equation can be applied to a kinetically energetic alpha particle in my model. Simply stated, a fusion reaction occurs when there is a temperature differential between the alpha particle and the target that it impinges upon. It must also be noted that no new neutrons will result because the reaction consumes what it releases. This is cold fusion.

The over all reaction is 'cold' in the general sense; in contrast to reactions that produce excess residual heat. To site a cross correlation; a thermal heat pump will absorb hot particles right out of the cold air of winter. The average temperature is cold. This analogy can be applied to the alpha

fusion reaction just cited. The particles involved are in the midst of relatively cool ones. The average temperature is cold. This is my justification for dubbing it a "cold fusion" reaction. You may still consider the reaction to be hot. In fact, it is in every real sense of the word. Even so, the term 'cold fusion' is a non-mathematical one. We can use it to denote the difference between reactions that result from a CERN particle reactor and those that are naturally directed by ultra chemical reactions. As you can see, I do not buy into what the textbooks say about what constitutes the nuclear versus chemical reaction. All reactions are chemical in my point of view. The cited alpha reaction is an ultra extension of chemistry. The textbooks have over complicated the "nuclear reaction" in my assessment and in doing so have fogged the truth in many instances.

So-called "cold fusion" researchers have overlooked the fact that the electrodes that they are using contain traces of naturally occurring radioisotopes. Alpha particle emitters such as Pt190 & Pt192 are two examples. What is an alpha particle anyway? It is a super charged helium atom is it not? Couldn't you also say that it is the atomic ash of nuclear decay? That is exactly what researchers are finding in their experimental cold fusion setups. Neutrons may also be generated as a result of a cold fusion reaction but we might not always detect them. If the neutrons generated equal the neutrons absorbed in the reaction there is nothing left to detect. In my opinion this is the signpost of a clean nuclear reaction.

### **Some Ignored Uranium Facts**

1. U235 emits ultraviolet light. Galen Winsor<sup>1</sup>
2. U238 expels electrons most readily when exposed to a wavelength of 3000 Angstroms in the ultraviolet spectrum. H. C. Renschler<sup>2</sup>
3. The UV light wavelength of 254 nanometers (nm) is a catalyst to oxidation processes.
4. The 254 nm frequency of light kills viruses, molds and other pathogens by rendering their DNA inactive. It therefore disinfects drinking water.
5. The human skin is reddened (erythema) and is most sensitive to the wavelength of 3000 Angstroms (254 nm range). Hauser and Vahle<sup>3</sup>

### **SECTION SUMMARY**

Bombardment by alpha or beta particles does not "disintegrate" atoms. Rather, this bombardment goes beyond normal chemical changes. Energy is transformed by neutron absorption or by neutron emission.

What other discoveries await us? The future is indeed a glorious jewel to behold. Will we continue to follow the path that leads us further away from this great storehouse of energy?

## Alpha Fusion

The Department of Energy (DOE) has hindered the development of this technology by holding fast to its' bogus restrictions on radioactive materials. I allege that they fear a miniature, clean atomic power source that will deny the Department of Defense its supply of weapons-grade plutonium.

The DOE's 45-year old H-bomb fusion program sucks up all government fusion funding. The DOE's fusion projects are located at the Princeton University Plasma Physics Lab. These projects are top-secret, cold-war research projects using fusion for massive production of plutonium and tritium for nuclear weapons.

The Princeton fusion reactor burns tritium, a radioactive fuel that produces deadly **neutron** radiation, 80% of its total output of energy. This reactor, if used in conjunction with a breeder reactor, is capable of "breeding" 100 times more plutonium than can be produced by a conventional utility reactor. This is a fuel machine for nuclear weapons of destruction.

Congressman George Brown, Chairman of the Science, Space and Technology Committee, had introduced a new bill, in early May of 1994. This bill would have allowed for clean, compact, "neutron-less" fusion energy technologies that would compete with the DOE's weapons program. This bill was never passed!

In spite of resistance from the DOE against clean atomic reactions, the "Fusion Energy Research and Development Act" (Brown's bill) would have created an Office for Alternative Fusion Energy and a separate budget for Alternative Fusion Technologies.

A neutron free, atomic device could generate electricity at minimal cost. It would compete with any petroleum-based fuels. This would mean no more oil spills, among many other benefits that I have already outlined.

Dr. Bogdan Maglich was the driving force behind the neutron free technology and the alternative fusion bill. He discovered the **omega meson** and other particles. In 1961, his omega meson discovery won him and three associates, a citation from President John F. Kennedy.

Dr. Maglich invented the "Migma," a miniature reactor that demonstrated the principle of a non-radioactive nuclear reaction in a 6-cubic-inch volume. While most fusion reactions are radioactive, Dr. Maglich's reactor utilizes a design that is virtually non-radioactive. In 1984, Dr. Maglich planned to demonstrate the magmas' energy capabilities. The tests were to be done in cooperation with nuclear labs in Russia, under the State Department's "Conversion of Peaceful Nuclear Research" program for Russian scientists.

Dr. Maglich had flown supporters with him to Washington to persuade the Congress to give the project an affirmative vote. The DOE and the nuclear-industry lobbyist defeated the vote. Humanity was on the brink of an energy technology that would have been compact, safe and almost zero residues except for the electricity that it produced.

A space shuttle full of moon dust would contain enough helium-3 to meet all the energy needs of the U.S. for an entire year. Dr. Maglich pointed out that nine grams of helium-3 are the equivalent of 1,000 barrels of crude oil. A Migma reactor could breed helium-3 from seawater. You do not need to go to the moon.

The Bechtel Corporation in 1989 subcontracted with Dr. Maglich to produce an engineering design of a clean nuclear reactor slated for a space power station. Dr. Maglich at the time was about ready to publish his completed design. The Defense Department (DOD) at this point stepped in and classified the plans before he could utter one word. DOD called his reactor "export controlled," a classification forbidding any written or verbal presentation of this invention to anyone except for government officials. This clearly violated an international agreement that forbids withholding information on controlled nuclear reactions. The agency justified this classification by saying that this type of research contains "ground-breaking work."

The bottom line is that **neutron free** atomic reactions do not generate weapons fuel. The DOE would stand to lose its funding for nuclear weapons fuel if non-radioactive reactors were to be commercialized. These groundbreaking designs would threaten all nuclear power plants.

In the final analysis, it is relatively simple. The alpha particle proves to be an effective energy source in inducing fusion when combined with the right material. We can safely come to the conclusion that through the proper conditions that the alpha particle can provide incredible amounts of power for our use.

### **Energy Released by Alpha Fusion vs. Uranium Fission**

"Alpha fusion" is an amazing process. Here is a comparison of the energy released per atom of uranium that undergoes fission versus alpha fusion via neutron absorption.

U235 fission=161,000 kWh/kg ( $2 \times 10^8$  BTU/lb.)

vs.

Alpha fusion= $1.68 \times 10^{11}$  kWh/kg ( $2.6 \times 10^{14}$  BTU/lb.)

The potential implication of this alpha fusion formula staggers the imagination. There is room for unlimited innovation and creativity. Imagine having a device that could safely provide power for several decades without recharging. Sounds almost like science fiction you say? It is a scientific fact! Plutonium-238 is a non-fissile isotope that decays by **alpha particle** emission with essentially zero associated gamma emissions. This type of plutonium spontaneously produces about one kilowatt of energy for two kilograms of mass. This reaction will release alpha particles that can

only travel a short distance before they are stopped. This process decreases slowly over time. After ten years the energy production is about 92 percent of the initial value. Even after 87 years the material produces half as much energy as it did when was first started.

When positively charged helium atoms (alpha particles) collide with the **electron cloud** that envelops another atom the positive charge is eventually canceled by these collisions. This is called "absorption." Atoms ring like a bell when impinged upon by alpha particles. This ringing state generates **x-rays**. The wavelength of this generated x-ray depends on the charge of the alpha particle and what type of atom it hits. If the x-ray generated has an energy level that exceeds 10MeV, atoms absorb it. In this case, the neutrons are raised to an excited state. They may be broken loose from the shells of an element or a neutron may be added to a shell. Gaining or losing neutrons via this process may create isotopes. We can efficiently do this by exposing atoms to alpha particles. This model clearly demonstrates that energy is transformed from one state to another. It is neither created nor is it destroyed.

Generally, the formation of a chemical compound is accompanied by the release of a definite amount of heat per unit mass of the substance formed. The burning of a fuel is a chemical reaction in which oxygen is consumed. The quantity of heat released when a unit of fuel is burned with oxygen is called the "heat of combustion." For the average coal, this value is from 7,000 to 8,000 calories per gram or 12,000 to 14,000 BTUs per pound.

In contrast, **radioisotopic** transformation is accompanied by the release of enormous energy when compared to conventional oxygen – electron oxidation. However, this does not justify the theory advanced that neutrons occupy the center of atoms. It is my hypothesis that neutrons reside in the orbital shells of elements and not within the nucleus. To envision this atomic structure one only has to look at our own solar system to see this on a grand scale. Isotopic oxidation (neutron oxidation) simply involves the neutrons. However, the energy involved is much greater because the neutrons represent neutral charge and therefore the binding energy of the elemental shells is of a greater magnitude.

When the unstable isotope of an element reverts back to its original stable state energy is released in the transformation. Now, consider that incident electrons are impinging upon, for example, the naturally occurring element U235. Assuming its absorption wavelength is correct, according to the resonant frequency of this element, then excess energy can be released. This may be done with any isotope. However, U235 will "self-fission" and under the right conditions, will not require any source of energy other than what it emits. Excess energy is released only after enough neutrons are captured to cause the transformation of the U235 atom. This is called the "break even" point, beyond which excess energy is released to effect a "chain-reaction."

We are not limited to the U235 isotope to use as a fuel source. This element is used in a commercial nuclear reactor because it undergoes self-fission and requires no additional catalyst in order to "burn." The public does not generally know that the U238 in a commercial reactor does not undergo fission. The only reason for its presence is to capture neutrons that transform it into weapons grade plutonium (Pu<sup>239</sup>).

U238 will "fission" via fast neutrons generated by the alpha fusion process. However, there is one small hitch to the alpha fusion process. A nuclear fusion fuel material is needed along with the U238 alpha emitter. This material generates the required fast neutrons for this type of fission. All that is needed is the right type of spark to speed up the decay rate. Radium or radiothorium could

also be used as the alpha source. Beryllium, boron, or carbon can be used as the fusion catalyst. Any of the elements below periodic number fifteen feasibly could be utilized. However, these three elements sited pack the most wallop. My process uses alpha fusion formulas that show the way to a simple and economical method. No excess neutrons result to create a toxic waste problem. Fully depleted U238 could be used that does not contain U235. Instead of making nuclear bullets, like the ones used in the Gulf War, we could be using our reserves of depleted uranium as a beneficial fuel source.

Plutonium is not feasible at this time, so plain old, natural, untreated uranium will also work. One pound of "yellow-cake" ( $U_3O_8$ ) is equivalent to 31 barrels of oil or 10 tons of coal. At the moment yellow cake costs only \$12.50 per pound.

Radon gas from naturally occurring radio emissive uranium or thorium ores can be directly converted into electricity. The case surrounding these materials will provide adequate shielding. These devices can be designed to be compact so that a lightweight unit could be built. It has been estimated that for every pound of fuel, that, one kilowatt of power can be generated.

For political reasons' people, organizations and government agencies have strongly opposed the use of all forms of nuclear energy. These people have made the general population paranoid of any and all radioactive materials. Despite this strong opposition and threats against it's development, work continues with the dream of harnessing transformations safely. The atom makes energy available to us. I have proposed a radical atomic theory to explain the nuclear energy process. Conventional atomic theory has many flaws. It does not completely explain the energy created by a nuclear reaction. Does this mean that the nuclear reactor does not completely create energy? No matter what theory you wish to use in explaining atomic power, the fact still remains that energy is transformed.

James Chadwick discovered the neutron in February 1932. Later, further studies were made to discover what effects would be produced by bombarding different materials with this new particle. Researchers for the next several years bombarded every known element with neutrons and recorded hundreds of new radioactive isotopes. My own research in this area has revealed many secrets of the vast reservoirs of energy contained within the atom.

### **The First Neutron Initiator**

The initiator for the first plutonium weapon was composed of polonium coated onto beryllium. The polonium came from the Radium Chemical Company.

### **Electronically Activated Neutron Source**

In the winter of 1996, I applied a 90,000-volt negative charge to a carbon rod. This carbon rod was surrounded with radioactive ore in a closed container. Under these conditions, the radon gas emitted from the ore was attracted and absorbed into the charged rod. This began my research into electronically assisted atomic transformations.

"It must be first remarked that helium is a gas which accompanies all radioactive minerals. It was from these bodies that it was first obtained – a catalyst with an interesting effect."



"This derivation from radium is a **special helium** since it appears to possess the property of spontaneously vanishing. Its' only resemblance to ordinary helium seems to consist of the momentary presence of some spectral rays." \* The Sea of Energy, 5<sup>th</sup> edition, pages 229-230.

### **Breeding U234**

Mix a dilute solution of uranium nitrate and finely divided carbon together. The solution is boiled for about half an hour. Radon is united with the carbon. After which the carbon is filtered out. To unite the radon with the carbon, the two are exposed to a strong source of **gamma radiation**. This is the **catalyst** that accelerates nuclear (ultra-chemical) reactions.

The reaction is as follows:  $C^{12} + Rn^{222} \rightarrow U^{234}$  (uranium "X") +  $e\uparrow$

To concentrate the U234 the excess carbon can be removed by burning.

The results of my life-long research have opened a doorway that could lead to electronically induced nuclear fusion. I originally named this process "alpha fission" to connote the electronically induced atomic reaction. The term was chosen so as to cause the least adverse social reaction to this discovery, due to the fact that the public has been duped into a state of paranoia by its global governments. Later, this term was changed to alpha fusion, as this is a more accurate term than the original chosen term.

Conventional nuclear reactors generate deadly toxic radioactive wastes as by-products. These reactors are even more deadly than anyone realizes. Fuel rods in the reaction process are extremely hot and are subjected to enormous internal pressure. You can not tell me that untold amounts of deadly radon gas are not leaking into our environment. The fact of the matter is that a special detector would be required to detect this leakage. Scintillation, Geiger and Alpha counters will not detect this gas because the mass of the radon gas can not penetrate the sensors on these meters. We must take a close look at clean nuclear processes before it is too late (if it isn't already).

With the advent of electronically triggered neutrons, a self-sustaining chain reaction can be obtained and may be highly controlled. I find this especially true if **thorium ore** is used. Thorium emits **thoron** ( $Rn^{220}$ ). Owing to its extremely short half-life, thoron by itself can not be used as a source of strong radiation. However, in conjunction with its parent substance radiothorium, it can indeed be used as a strong source of radioactivity.

Thoron has a short half-life of 54.5 seconds. On the other hand Radon-222 has a considerably long half-life of 3.5 days making it a hazard. Thoron is safe and convenient to work with because there are no long-lived products in its disintegration chain. Therefore, there is minimal danger of permanent contamination. The parent substance, radiothorium, may be obtained from thorium solutions in the manner described next.

Radiothorium is generally used as a parent source of thoron. Radiothorium has a conveniently long half-life of nearly two years. Extractions of radiothorium can be obtained in a highly emanating state. A small quantity of iron chloride is added to a thorium solution and precipitated as hydroxide by ammonia or as oxalate by oxalic acid. The precipitate, the hydroxide or oxalate of iron, is washed very carefully and dried at room temperature. This precipitate should have a high activity rate. It will not lose more than 20% of its initial activity rate for many months. This radiothorium

preparation may be spread into a thin layer in a shallow brass tray placed at the bottom of a small lead-shielded container. The active deposit thorium can be collected on a negatively charged wire, insulated with respect to the container. The emanated **thoron** gas may also be absorbed into various materials.

Many radioactive isotopes could be used to generate electrical power. However, the power behind these isotopes is really with the radon gas. I have pointed this out many times in my writings, lectures and articles. Simply by bombarding bismuth, we can create polonium. In United States Patent 2,728,867, it is stated that the available energy of a commercial nuclear fuel rod is around twenty watts of power per gram. In comparison, **polonium** will generate one hundred and forty watts of power per gram. This is **seven times** more energy than is available from the conventional fission process!

The atomic ions emitted from radioactive isotopes can be directly converted to electrical power. My conversion method shown in Section 5, **Figure 4** can be used to convert this source of radiant energy. Additional stages can be added for more power. The circuit shown gives a general idea of how such an energy conversion device can function. By no means is this technology limited to this one circuit or configuration.

### **Radon Fuel**

My research has revealed that the energy devices of T. H. Moray, Alfred Hubbard, Reverend Antonio d'Angelo, Joseph Papp, and others all contained a source of **radon gas**. They may or may have not realized that this was what they were using as their fuel. We will never know this for sure. However, what we do know for certain is that they all used radium in their energy devices. When my prototype is ready to be demonstrated I too will show how radon can be used to generate electricity. Demonstrations will have to be performed in private until my device obtains an exemption from government restrictions.

The facts show beyond doubt that radon gas was the fuel source that has powdered many so-called "free energy" devices. You can say that these devices ran on the energy of the cosmic rays. It is these rays that created radioactive thorium and uranium that we find in the ground. High-energy cosmic rays are really neutrons as Nikola Tesla had discovered. When a cosmic particle reacts with either thorium or uranium a radioisotope is created. This is why you see a consistent percentage of U235 all over the planet. This percentage represents an accumulation of cosmic ray bombardment over the lifetime of our world. Nature offers us this fuel that can be used to obtain electrical power with no moving parts and it is out there free for the taking. We do not have to split atoms to harness this storehouse of energy. Nature has already safely done this for us.

In order for clean nuclear power generation to enter into public use, high-grade radioactive ores must be secured without restrictions. Recent attempts to obtain these ores have been blocked by the United States Government. Once these ores are obtained I will build a high wattage radiant energy converter. Through my writings, lectures and published articles I have attempted to explain my research. Over the years I have made my research available to the public and have asked for little in return. I am asking you at this to help me to get this technology implemented, within the constraints of the law. As a former United States President once stated: "Sometimes when we reach for the stars, we fall short but we must press on."

*President Ronald Reagan*

## The Truth about Nuclear Science

Present day alternative energy researchers find hope in that, one day, power will be obtained from the energy that runs the Cosmos. In reality, this dream has only proved to be a lure to its followers, beyond the limits of credibility. A quagmire of unsubstantiated hypotheses exists that are bottomless and lack reality. The facts of many newly conceived energy concepts are wholly inadequate, lacking justification, and incapable of throwing any light on the promise of inexpensive, abundant sources of energy.

The Earth is indeed bathed in a sea of cosmic and solar energies. Can a device be built that can transform these energies into usable power? I believe that T. H. Moray did build such a device. This has inspired me to conduct my own research and to build my own prototypes. How the radiant energy device really worked might shock a few people once the facts become realized.

Nature is my best teacher. Within one of her classrooms there are mineral samples that give out pure electrical energy. They are the radioactive rocks. If radioactive matter from these rocks derives its energy elsewhere, this must be of a type entirely different from any presently known. It is capable of penetrating, without loss, hundreds of feet of solid rock.

Nikola Tesla's investigations brought him to the conclusion that the Earth was being showered with "tiny particles, each carrying so small a charge that we are justified in calling them neutrons." He stated that "...they move with great velocity, exceeding that of light."

Dr. Thomas Moray called into existence the concept of unlimited radiant energy (the cosmic ray), permeating all space and all matter, unimpeded. Such a view, at first glimpse, merges perfectly with the continuous and permanent activity of radium extracted from certain rocks. This activity seems to last for an indefinite time. There appears to be no rational reason why radioactivity, however intense and powerful, should decay or diminish with the passage of time. Yet, radiant matter (radioactivity) does decay. The demonstrated "half-life" values have proven that the stored energy within radiant matter will eventually be depleted.

At some point in my own research, I had to ask myself three important questions:

- 1) Is there anything opposed, either to reason or to probability, to the view that the energy evolved from radium is actually derived from an existing previously unsuspected internal process within the atom?
- 2) Within the decay process does the element experience a transformation into other elements?
- 3) How is it that such enormous stores of energy in matter have remained so long unknown?

In my experience, a specimen of radium chloride is dissolved in water and the liquid is then evaporated. Bringing this compound back to its dry state, as the result of this very simple operation,

the radium has lost the greater part of its radioactivity. The penetrating beta and gamma rays completely disappear. The remaining non-penetrating alpha rays will be only one quarter as powerful as they were initially. Then a strange thing happens. Left alone, the radium will spontaneously recover its lost activity. Little by little, day by day, until at the end of a month, it will be no less active than it was before it went into solution. This appears to be in direct conflict with the zealous statement that "radioactivity of radium cannot be affected by any known process." On studying this experiment carefully, we will find that when radium chloride is dissolved in water something escapes into the air. This "something" is intensely radioactive. It diffuses in the air, but will remain if contained within a gas-tight, closed vessel. In short, this "something" is a gas possessing the property of radioactivity to a very intense degree. This gas was called "emanation" in days of old. Today it is called **RADON-222**. It has a half-life of around 3.8 days. This radon gas is highly radioactive. Thorium releases **RADON-220** that is intensely radioactive and has a half-life of around 55.6 seconds. Uranium emits **RADON-219**, the most intensely radioactive substance, having a half-life of only 3.96 seconds.

Radon that has been separated from its parent source will rapidly decay. It is easy enough to conclude from this experiment that energy is stored within the radium atom. This accounts for the comparatively rapid decay of the activity of the generated radon gas. This gas is depleting its internal store of energy so rapidly that it is soon exhausted. On the other hand how is the gradual recovery of the radioactivity of the parent radium explained? This question is the golden key to unlocking the secret of its power.

If it is true that energy comes from within, as large as the store of energy within the atom must be to explain its radioactivity, yet it cannot be infinite. Therefore, it is expected that the activity will slowly decay with the passing of time. Two radioactive bodies, one much more radioactive than the other, are compared together. It is expected that the activity of the more powerful body will decay faster than that of the other. A time will come for both of these substances, when the internal stores of energy are exhausted, that the radioactivity will come to an end. Therefore, radium, a substance containing the store of energy, can no longer be radium when the energy is lost. Coal is not coal after it is burnt. When energy is obtained from matter, the matter changes. Before it can be restored to its former state, the energy evolved must be put back. In no case, is it possible for matter to part with its store of chemical energy and remain the same, otherwise perpetual motion could be easily constructed.

We conclude that, if the energy is stored in the radium, it must be within the atom. Therefore, if radium changes, it must be a change of the atom and of the element itself. This change would be its ultra-chemical reaction. This is a more fundamental and deep-seated change than the normal chemistry or any known kind of material change. Until the discovery of radioactivity, such changes certainly had never been observed. If the energy of radium comes from within, then it must be subjected to this ultra-chemistry that has eluded the chemist. This process of ultra-chemistry must be understood as a special extension of chemistry. It is not some vaguely possible, transcendental nuclear condition in the Sun and stars. Once this is understood, the answers will become as sure as the nose on your face.

Imagine that a month has passed. The radium chloride is once again dissolved in water and evaporated down to dryness exactly as before. Once more you will find in the process, that the radium has lost the same large proportion of its radioactivity. Again it gains a new amount of radon gas no less than before it went into solution. Repeat this experiment as often as you like. You will find the result always the same. The radon that you separate from the radium is decaying away from

day to day. But the radium will also generate a spontaneous fresh new batch of radon. In order to make sense of this, we have to answer these nagging questions; "from where does the energy of radium come?" Does it come from nowhere, or is it being newly created out of nothing? This is a view that is not acceptable for a plausible twenty-first-century physical science.

If our doctrines of energy are true, then there are only two possible answers to consider. Either the energy must be derived from within the radium, or it must be supplied from elsewhere. This simple narrowing down of all the possible answers may appear to you somewhat simplistic, but in reality, it carries with it far more than appears on the surface. Being a minute property of the element, radioactivity is therefore a property of the atom. If we say that the energy comes from within, this means that there must exist an enormous and not previously suspected store of energy in matter, or at least in radioactive matter.

Dr. Moray often advanced the theory that radium acts merely as a transforming mechanism, that it converts the cosmic rays into electrical particles. He states that it retransmits energy in a form that we recognize. Tesla also entertained this view. There are electrical transformers dotted all over our country receiving transmitted but dangerous high-tension currents from the central power station. These are "transformed" into comparatively safe, low-tension currents for your house. Are the atoms of radium acting as the transformers of a mysterious and unknown source of external energy, first receiving it and then delivering it up again in a form that can be recognized? It may be said that so vague a view, postulating the existence of limitless and mysterious supplies of omnipresent energy, cannot be directly disproved. One thing is for certain; this view provides a way of escape from some of the more distasteful "logical" assertions, namely that all forms of energy are stored within the atoms and molecules.

If radium owes its activity to an energy source outside itself, one has only to isolate it. We have seen that to quench radioactivity, or to modify it in any way is one of the things mainstream science cannot do.

An experiment has proven that even in its natural state in the mine, hundreds of feet deep down in the Earth, pitchblende exhibits its normal radioactivity. Over 100 years ago, scientists concluded that some sort of radiation must exist in the atmosphere. This conclusion arises because under all circumstances, air is found to have a slight positive concentration of ionized particles. The atoms are minus an electron. This radiation is constantly much stronger at high altitudes than at the Earth's surface. This leads us to conclude that such radiation does not originate on this planet but rather from somewhere in the outer regions of space. The fact that the intensity of this radiation does not increase during daylight hours eliminates the sun as its source. Also, the intensity does not decrease during the day or increase by night, therefore it cannot be a result of any particular group of stars.

### **Spontaneous Decay**

Does not the "free emanating" state of a salt of radium teach anything about its decay mechanism? Results obtained by Dr. Alois Gaschler and Otto Hahn in the 1920's proved conclusively that when radium becomes finely divided, it most readily emits radon. This teaches us that radioactive change is effected by confinement. How many scientists have paid attention to this all-important lesson? Is it actually the true mechanism behind what is being called "fission?"

It is in my humble educated opinion that the seat of radioactivity is due to radon gas trapped within the lattice of certain heavy metals. The best comparison that I can think of is coal and the stored

hydrogen gas within its lattice. Its stored hydrogen reserve reacts with oxygen transforming these two gasses into H<sub>2</sub>O with the release of heat. The carbon contained in the coal also reacts with oxygen when a high enough heat is generated from the hydrogen reaction and combustion occurs, transforming the carbon and oxygen into CO<sub>2</sub>. Pretty much the same fundamental principle must occur when radon gas is released from its heavy metal prison. The reactant in this later case is a neutron from a previous radon gas emission. Radon reacts with a metal, losing a neutron to it. When this occurs, the radon becomes highly unstable, emitting alpha particles and rapidly transforming into stable lead. From this reaction it is clear that radon is not as inert as we were lead to believe. In fact, I say that radon is at the very foundation of nuclear reactions.

Since the discovery of radium by Madame Curie, the fundamental method of its extraction has not changed. The process utilizes the same methods that were instituted by Madame Curie and M. Debiere. Radioactive ores are first treated with a warm solution of hydrochloric acid that dissolves the metals. The addition of sulfuric acid precipitates the insoluble barite's that are always present, carrying along with them all the radium as barium sulfate. It is necessary that barium is present in the process. If the solution does not contain a sufficient quantity, then some barium has to be added. It is said that the barium acts as a "carrier" to the radium. Can there be any other explanation? It never made much sense to me why the radium would not precipitate out without the barium. I simply could not accept the notion that it acted as the carrier. The answer to this problem becomes relatively simple if you let Nature be your teacher. Forget what the textbooks tell you. We know from her lessons that radiation can be induced into non-radioactive elements, do we not? Could it be then, that something in the separated hydrochloric solution is transforming the barium into what we call radium? Ala-ka-zam, low and behold, there sure is, it is called **URANIUM-235**.

### **Nu Radium Formula**

Radium may be synthetically manufactured by fusing dry uranium nitrate mixed with about 0.5% of dry barium nitrate. This is done in the heat of an electric arc. The mass is then treated with nitric acid, water and sulfuric acid, successively. Radioactive barium sulfate, possessing all the physical properties of the "element" discovered by Madame Curie, is obtained by this formula. This material will emit ultra-violet rays, x-rays, excite phosphor screens and cause air to conduct electricity. The chloride and the carbonate of radium may also be created by using uranium chloride or uranium carbonate respectively and will have the same properties.

Uranium nitrate typically contains about 0.72 per cent **U235**. The barium reacts with the U235 creating pure radium. Take note here that this is an ultra-chemical reaction and that the barium is not a carrier as has been believed. Best results are obtained when 0.72 per cent barium is added, making it equal or less than the amount of U235 contained in the nitrate. If sulfuric acid is added after the reaction takes place, then radium sulfate is precipitated. This material can now be filtered for removal from the solution. The synthetically created radium radioisotope results when barium reacts with **RADON-219**. It can not come into being otherwise. **All other radioisotopes may be called into existence by using U235 as the source of energy transformation.** There are other processes involved but this will be discussed in a future paper. Radioisotopes created by ultra-chemical processes will have far reaching ramifications, if and when it is taken under the wing of mainstream science. Radioisotopes could be made to order literally in a jar. These findings indicate that all radioactive substances originate from the U235 atom. Now the question arises; where did the U235 atom originate? I can only speculate at this point that it is created when a cosmic ray hits a stable U238 atom head-on. If my conclusions turn out to be correct, then the energy stored in radiant matter is a product of an external cosmic force and an internal force without contradiction.

## Clean Nuclear Reactors

Mother Nature offers us a clean nuclear process to supply the World with energy. My reasoning is based upon her process that leaves behind a clean, non-toxic ash. You have seen it in children's balloons at birthday parties. The inert gas that I am referring to here is called "helium." When I shine ultraviolet light onto a radioactive ore, the trapped helium gas will fluoresce a lime-green. The only ash, left behind by Nature's process, is what is seen under the ultraviolet lamp. There are no deadly radio toxins like the ones found in the commercial reactor. It makes all the difference in creation how the reaction is carried out and for what purpose. I will also tell you that eating radium, like the women did who painted the glow-in-the-dark watch and clock dials will create serious health problems. A little common sense goes a long way.

The commercial nuclear reactor releases excessive amounts of neutrons. This is a direct result of the reaction of **RADON-219** with the zircalloy fuel rod casing. It is highly likely that we can design reactors that will release only pure electrical particles in place of the toxic radioisotopes created by stray neutrons. Why not build clean reactors that do not generate excessive neutron release? Maybe it is because this is not presently perceived by mainstream science? Knowing the true facts makes it a relatively simple matter to acquire a cleaner burning reaction. The only major modification in reactor design is to find a more suitable fuel rod casing. Eliminate the excess neutrons and you will have a clean burn.

## Are Neutrons What Really Cause Fission?

1. Alpha bombardment of any element with atomic numbers from **1** through **15** will generate a new and stable element that will release one excess neutron from the reaction.
2. Neutron bombardment of any stable element from **16** and above will generate a new and unstable element by capturing neutrons. One or more neutrons are released from the reaction. The targeted element will gain the weight of the absorbed neutrons.
3. Neutron bombardment of an unstable element generates one helium-4 atom from each reaction. The atomic weight of the targeted element loses the weight of one helium-4 atom as a result of the reaction.

From these three facts, it is not too hard to figure out that the "moderator" in a commercial nuclear reactor is actually what initially supplies the required neutrons for a "fission reaction." The excess neutrons created are what react with a "fissile fuel" that creates a secondary reaction. The release of thermal energy is a by-product. Scientists of yesteryear had these facts straight. Why are present day nuclear theories so off course? It will only be when these facts resurface that advances will be made in the way we obtain energy.

## CONCLUSION

The devices that I have presented at public tests do not contain radioactive materials for obvious reasons. However, the underlying principles have been adequately demonstrated. I have used star-mode electrodes in the past to slowly discharge the capacitors in a prototype device. Advanced discharge systems are now being utilized. In 1995 I discovered ion valve circuits that are now being used in my most recent prototype. Even though these public tests have not contained radioactive material, my research has been validated.

Funding has not permitted me to build a device that can power a home or electric car. However, my prototypes have proven beyond doubt that with the proper funding this can be accomplished. It is my hope, through the publication of my findings, that funding will be forthcoming. At this point in time, it is most important to me that I receive credit for my work and that my research discoveries do not fall on deaf ears.

Public tests are performed as necessary to validate the technologies. These demonstrations are deemed as research and development tests only. No power claims are expressed or implied.

For almost fifteen years now I have carried out many experiments. The fruits of this research are ripening. Many fruits are within grasp but they are not yet quite ripe for the picking. The intent of revealing my progress to the World is to insure that this work is not done in vain. Through my writings I have attempted to explain the many facets of "radiant energy" and how it is possible to draw useable power from it. If radiant energy can be given to the World then humankind will have the potential to reach heights not yet dreamed or conceived. Today, I freely give to you the results of my life's work. Together we can reclaim our independence!

## **REFERENCES**

**Winsor**, "Nuclear Scare Scam" – lecture

**"Radiations from Radioactive Substances"** by  
**Sir E. Rutherford, J. Chadwick, and C. D. Ellis** 1930

**Rentschler**, A. I. E. E. 1930, p. 49 & p. 576

**Hauser and Vahle, Strahlentherapie**, 1921, p. 13 & p. 41

"The Interpretation of Radium and the Structure of the Atom" by **Frederick Soddy, M.A., F.R.S.** 1920

Annual Report of the Smithsonian Institution (1899) "An Experimental Study of Radio-active Substances"  
p.162

United States Patent No. 1,644,370 **A. Gaschler** – Oct. 3, 1927

United States Patent No. 1,655,184 **Otto Haun** – Jan 3, 1928

### **HISTORICAL COMMENTARY**

Tesla's last ten years of his life, 1933 - 1943, contrary to popular belief, were his most productive years in his private laboratory located on Canadian soil. This was communicated to me through his last known living assistant, Arthur H. Matthews, E.E., and B.Sc. before he passed away in 1986. He also revealed to me that special primary batteries with replaceable zinc electrodes powered Tesla's electric car. This car also had a "fluid transmission" and could travel at 90 miles per hour. The electric motor could run on the batteries for three hundred miles before you had to pull over and attend to the batteries and then you were on your way for another three hundred miles. Matthews claimed that there were enough spare parts in the trunk to run the car for one year! The performance of this vehicle seems to be impossible. However, the characteristics of Tesla's unidirectional electrical current can generate short duration high-energy that will generate high frequency oscillations when dumped through an inductive coil. This unique principle makes possible many seemingly impossible innovations. It was this principle that was at the very heart of Tesla's Magnifying Transmitter, also known as his "DC transformer" to his assistant Arthur H. Matthews.



H. PLAUSON

CONVERSION OF ATMOSPHERIC ELECTRIC ENERGY

Filed Jan. 13, 1921

12, Sheets-Sheet 1

Fig. 1.

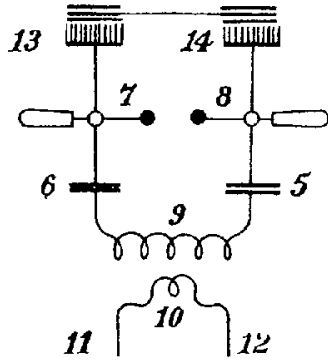

Fig. 2.

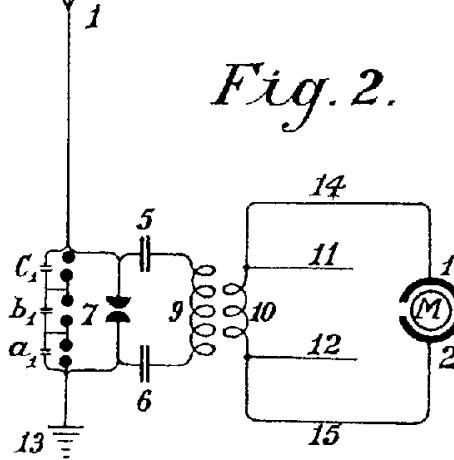

Fig. 3.

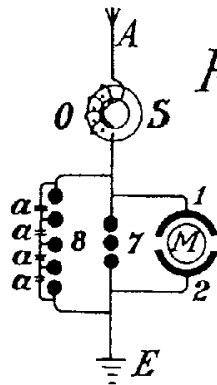

Fig. 4.

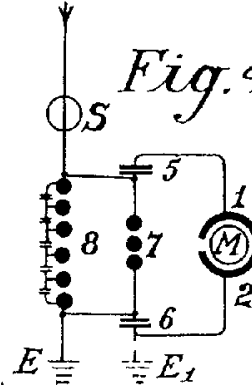

Fig. 5.

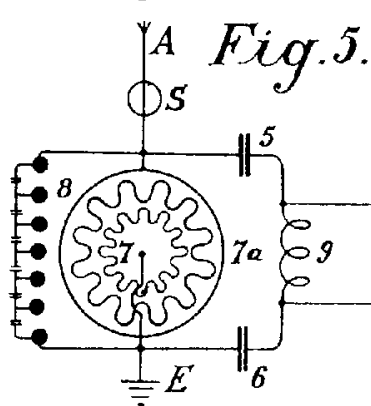
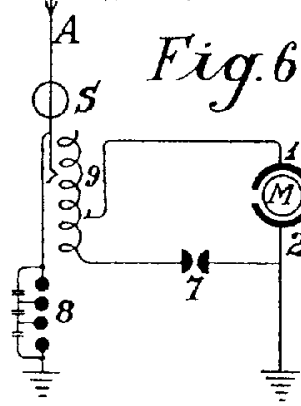

Fig. 6.



Iq Vegtor  
Hermann Plauson

by Knight Bros  
attorneys

Filed Jan. 13, 1921

12 Sheets-Sheet 2

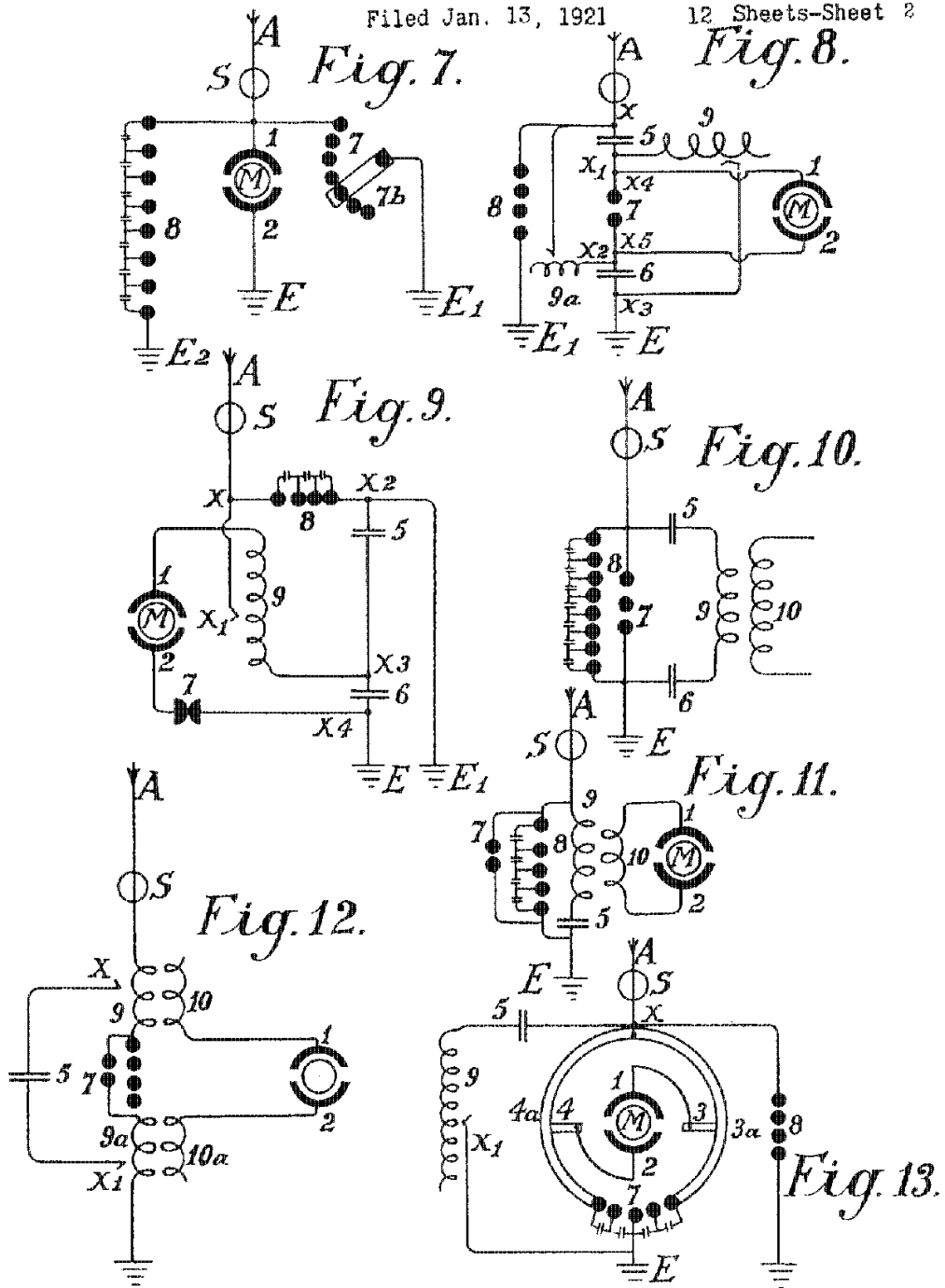

Inventor  
 Norman Plauson  
 by Knight Price  
 attorney

H. PLAUSON

CONVERSION OF ATMOSPHERIC ELECTRIC ENERGY

Filed Jan. 13, 1921 12 Sheets-Sheet 3

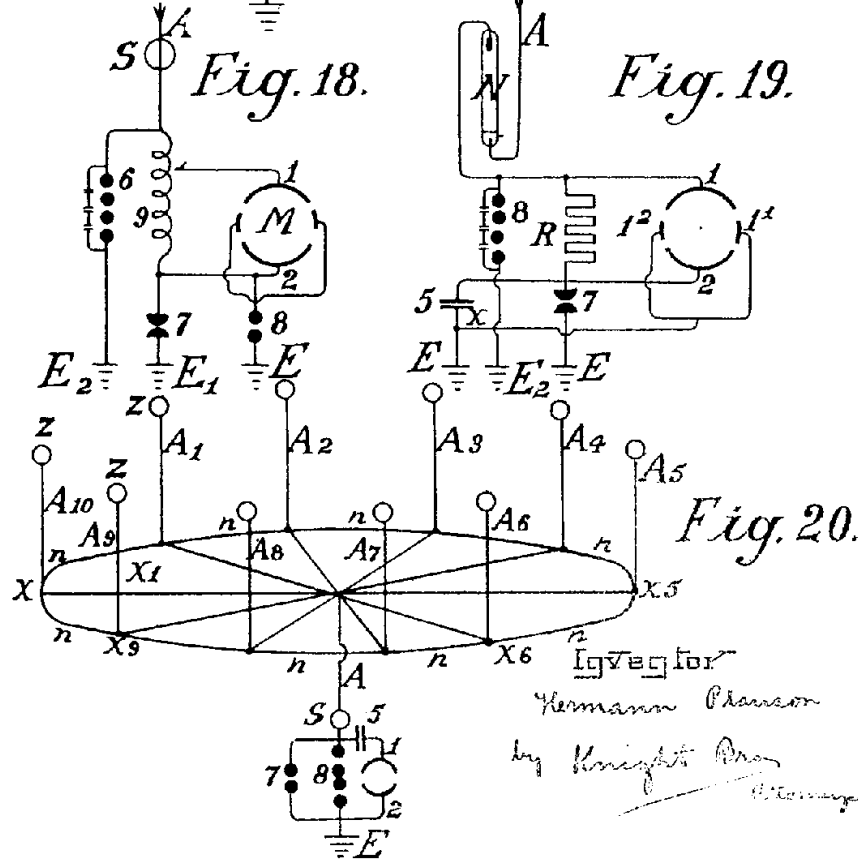
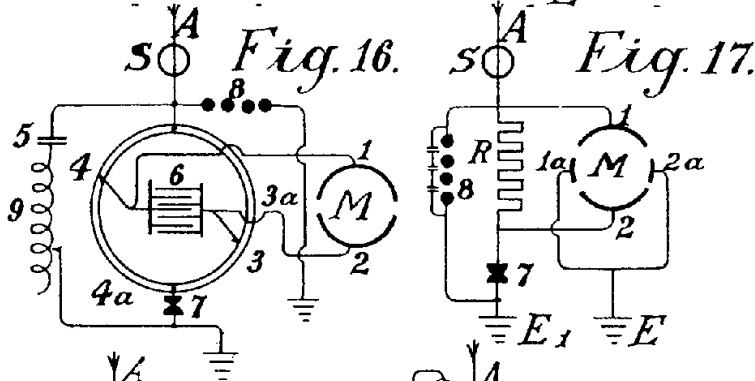
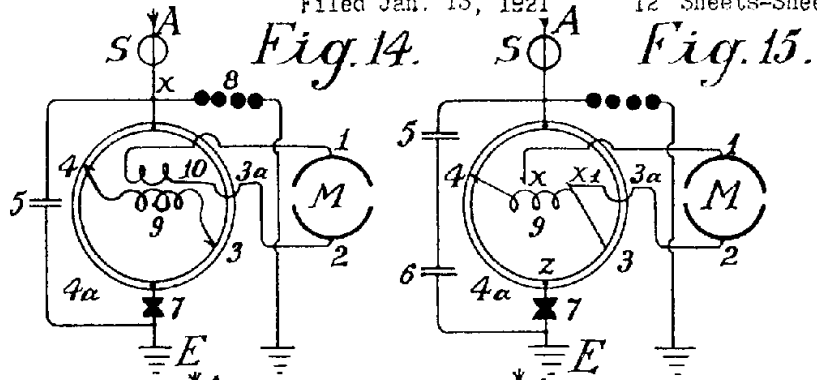

Inventor  
 Hermann Plauson  
 by *Knight's Patent*  
*Attorneys*

June 9, 1925.

1,540,998

H. PLAUSON

CONVERSION OF ATMOSPHERIC ELECTRIC ENERGY

Filed Jan. 13, 1921

12 Sheets--Sheet 4

Fig. 22.

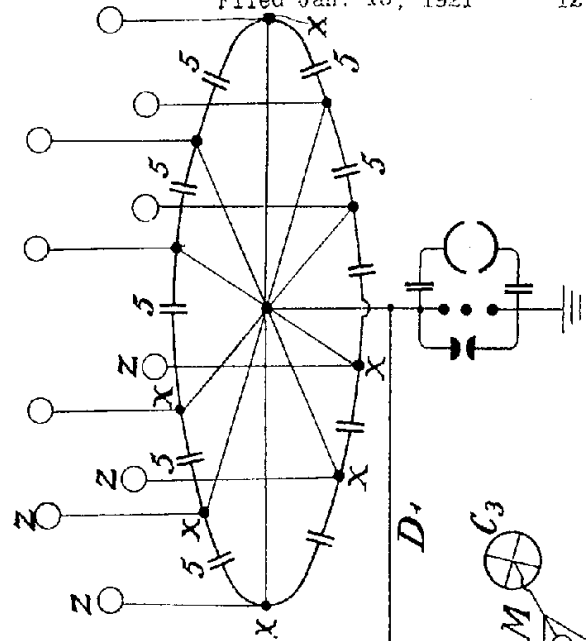

Fig. 21.

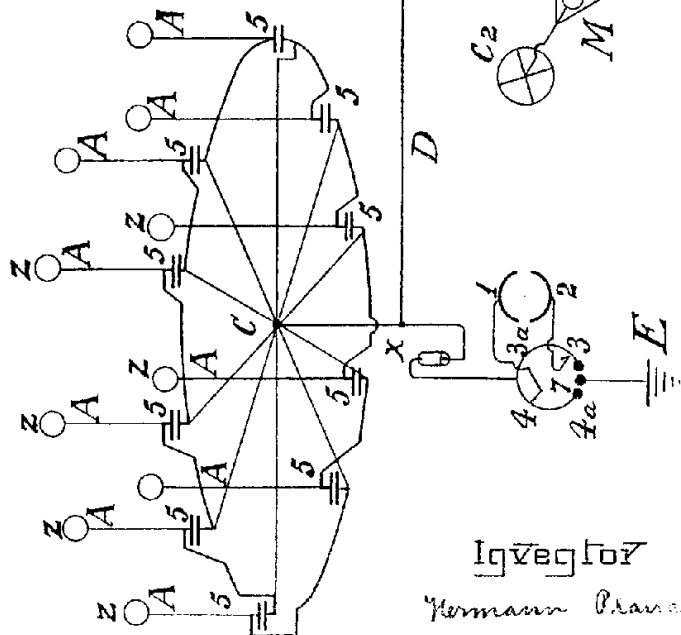
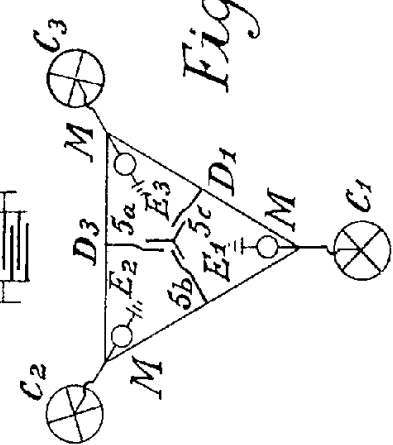

Fig. 23.



Inventor  
 Hermann Plauson  
 by Knight B. [unclear]  
 Attorney

June 9, 1925.

1,540,998

H. PLAUSON

CONVERSION OF ATMOSPHERIC ELECTRIC ENERGY

Filed Jan. 13, 1921

12 Sheets-Sheet 5

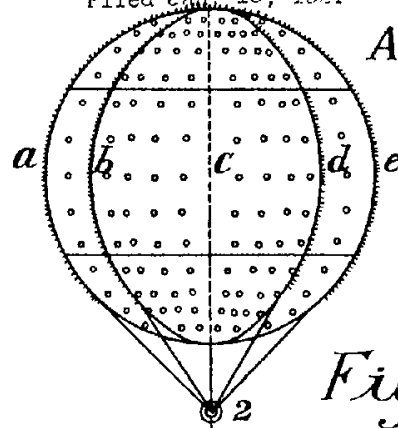
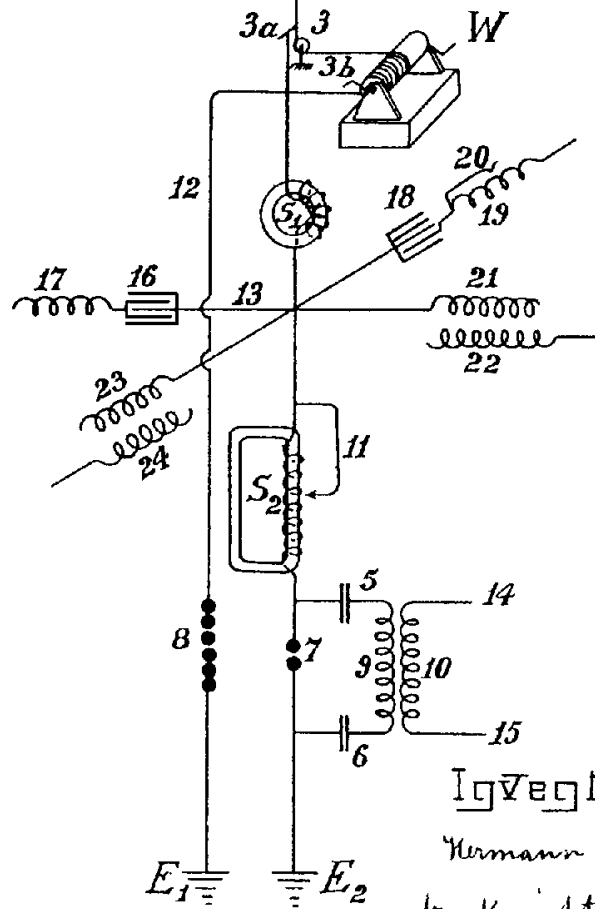

Fig. 24.



Inventor

Hermann Plauson

by Knight Bros

Attorneys

June 9, 1925.

1,540,998

H. PLAUSON

CONVERSION OF ATMOSPHERIC ELECTRIC ENERGY

Filed Jan. 13, 1921

12 Sheets-Sheet 6

Fig. 25.

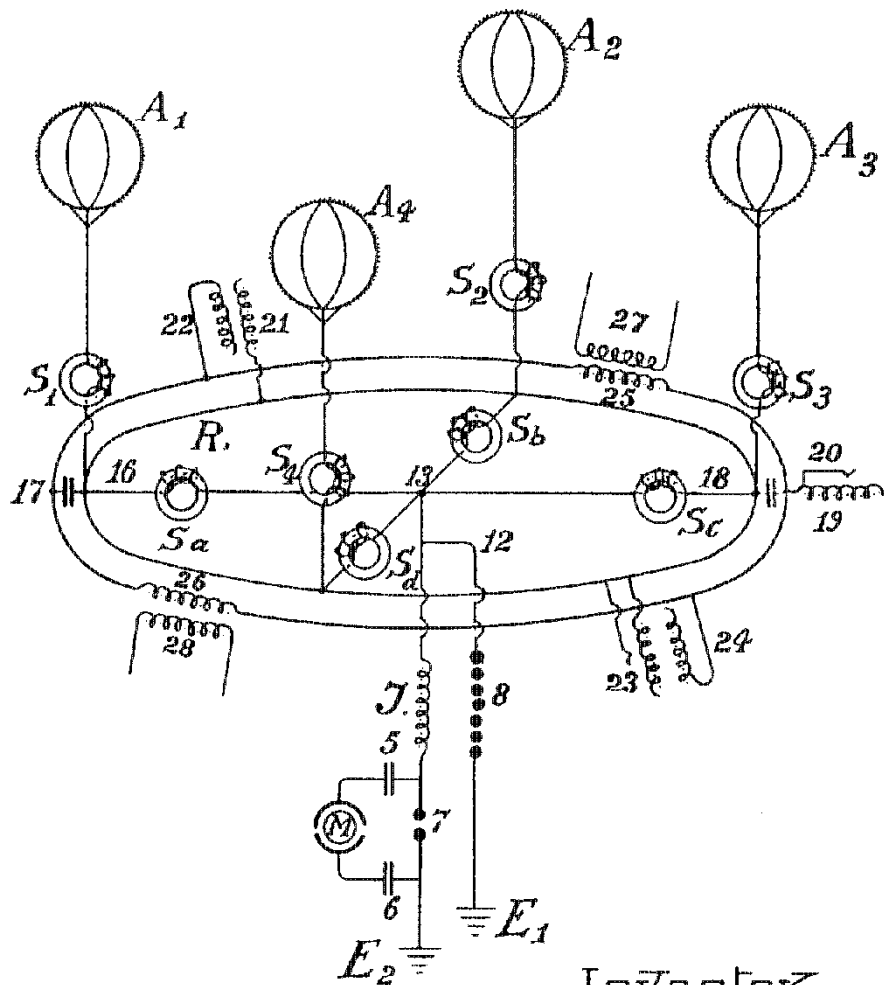

Iqvegtor

Hermann Plauson

by Knight Bros  
attorneys

June 9, 1925.

1,540,998

H. PLAUSON

CONVERSION OF ATMOSPHERIC ELECTRIC ENERGY

Filed Jan. 13, 1921,

12 Sheets-Sheet 7

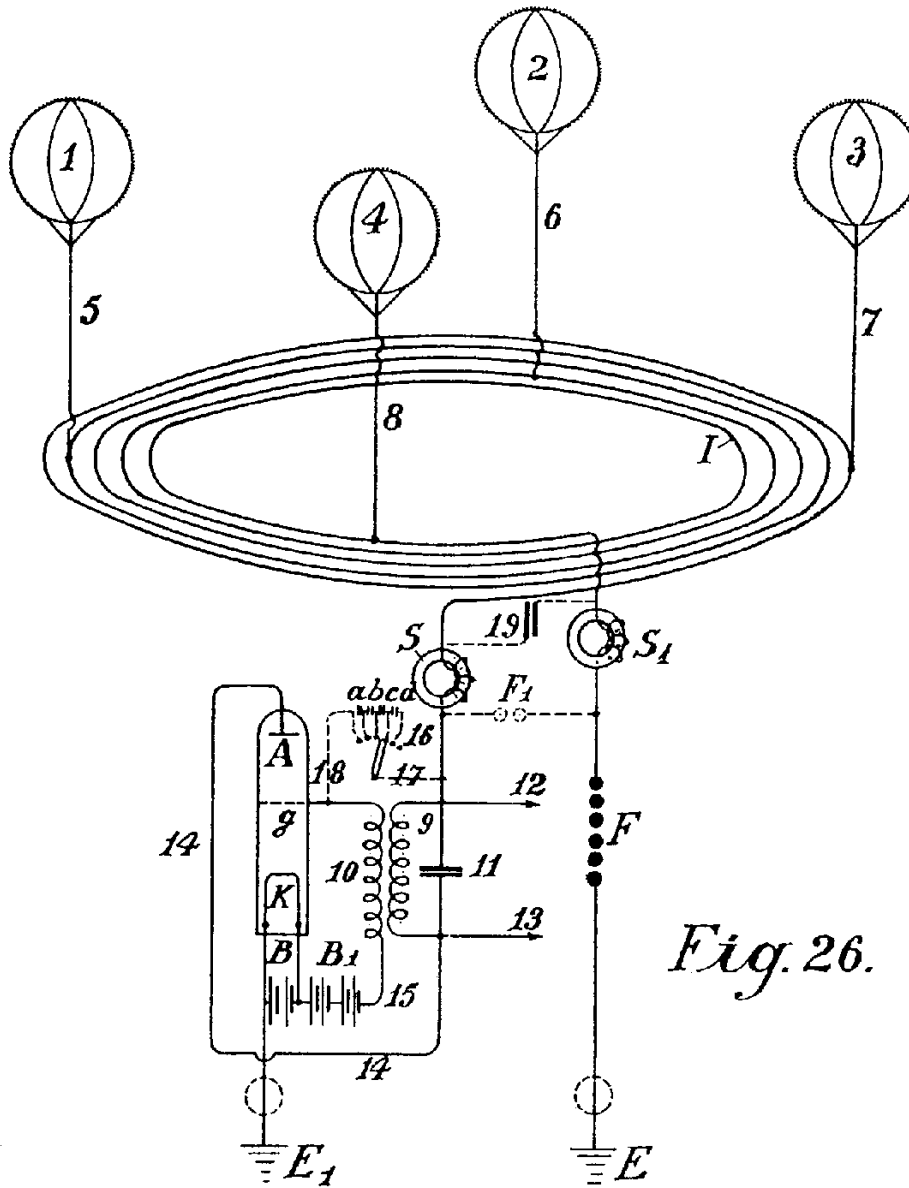

Fig. 26.

Игъеггог

Hermann Plauson

by Knight Bros  
Attorneys

June 9, 1925.

1,540,998

H. PLAUSON

CONVERSION OF ATMOSPHERIC ELECTRIC ENERGY

Filed Jan. 13, 1921.

12 Sheets-Sheet 8

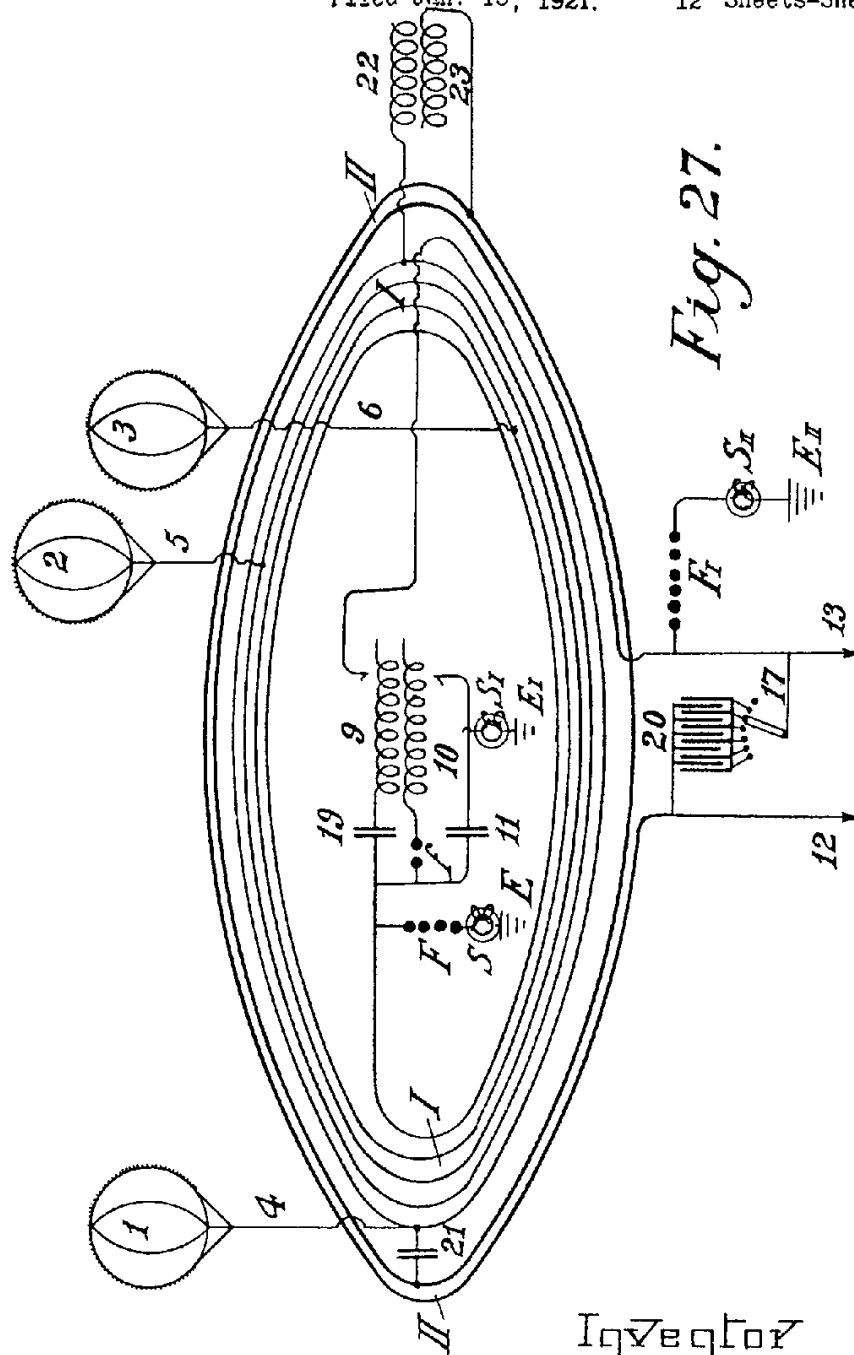

Игъеглор

Hermann Plauson

by Knight  
Attorney



June 9, 1925.

1,540,998

H. PLAUSON

CONVERSION OF ATMOSPHERIC ELECTRIC ENERGY

Filed Jan. 13, 1921

12 Sheets-Sheet 9

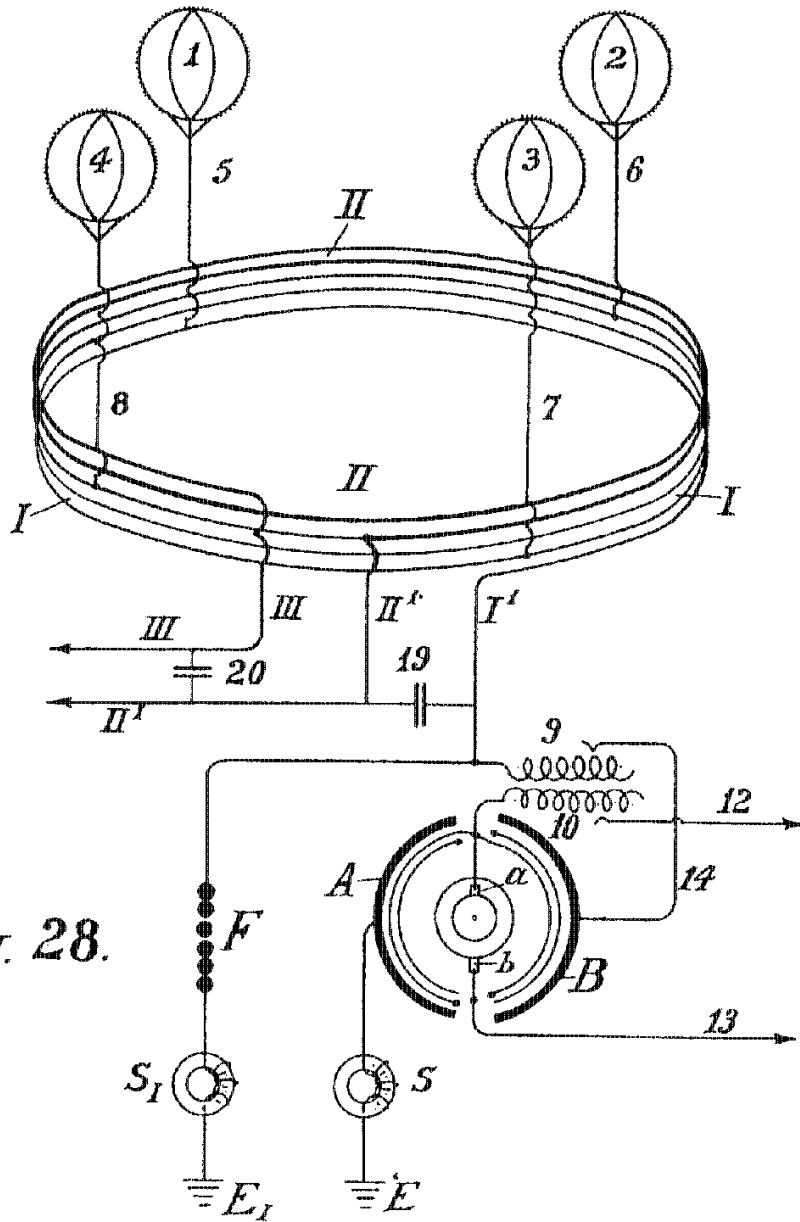

Fig. 28.

Iqvegor

Hermann Plauson

by Kniepitz Ben  
attorneys

June 9, 1925.

1,540,998

H. PLAUSON

CONVERSION OF ATMOSPHERIC ELECTRIC ENERGY

Filed Jan. 13, 1921.

12 Sheets-Sheet 10

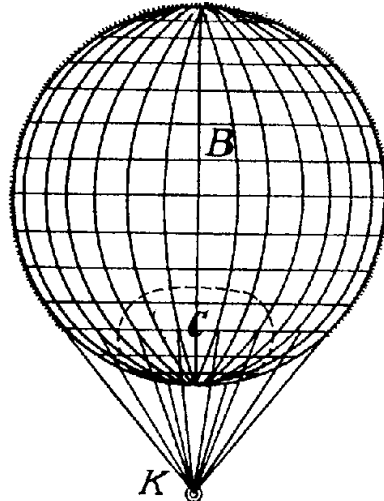

Fig. 29.

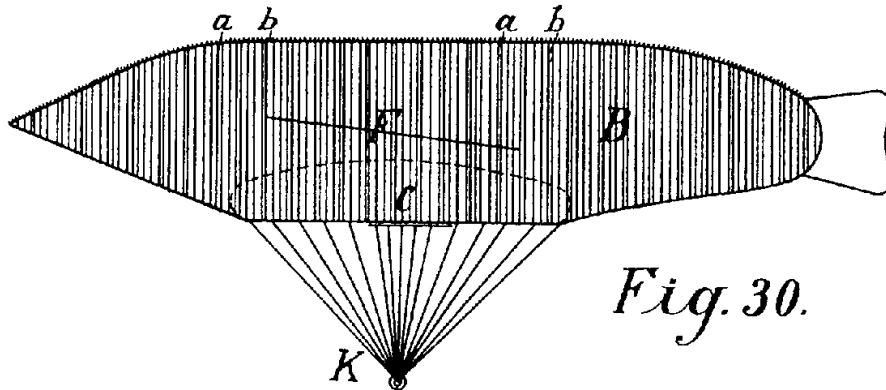
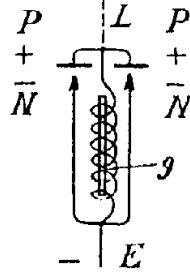
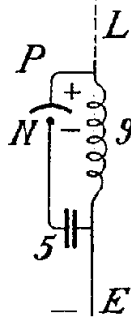

Fig. 30.



Извѣстїи  
Германн Плаусон

by  
Knight Bros  
Attorneys

June 9, 1925.

1,540,998

H. PLAUSON

CONVERSION OF ATMOSPHERIC ELECTRIC ENERGY

Filed Jan 13 1921 12 Sheets-Sheet 11

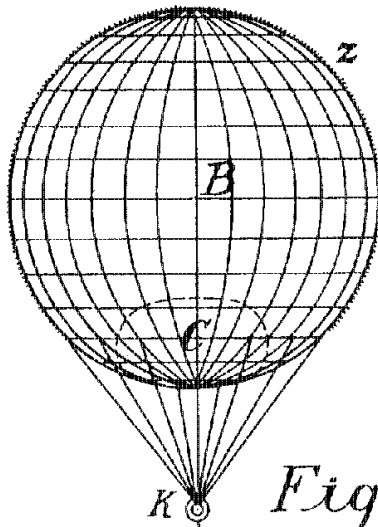

Fig. 31.

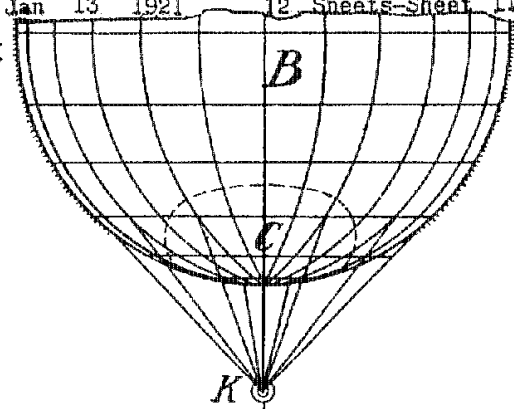
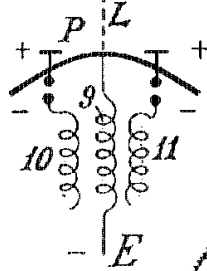

Fig. 32.

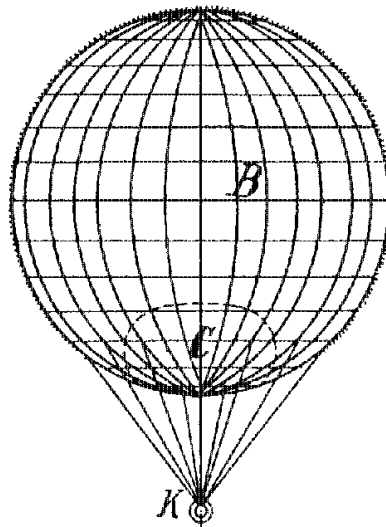
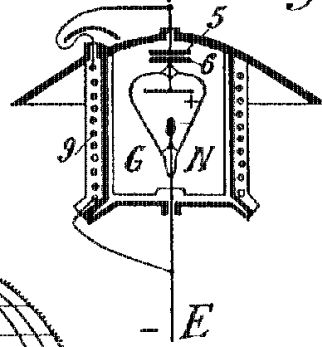
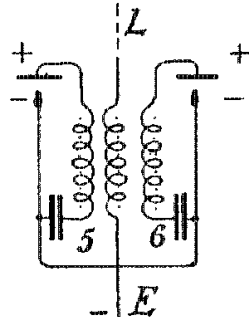

Fig. 33.



Изобретение  
 Hermann Plauson  
 by Knight Bros  
 Attorneys

June 9, 1925.

1,540,998

H. PLAUSON

CONVERSION OF ATMOSPHERIC ELECTRIC ENERGY

Filed Jan. 15, 1921

12 Sheets-Sheet 12

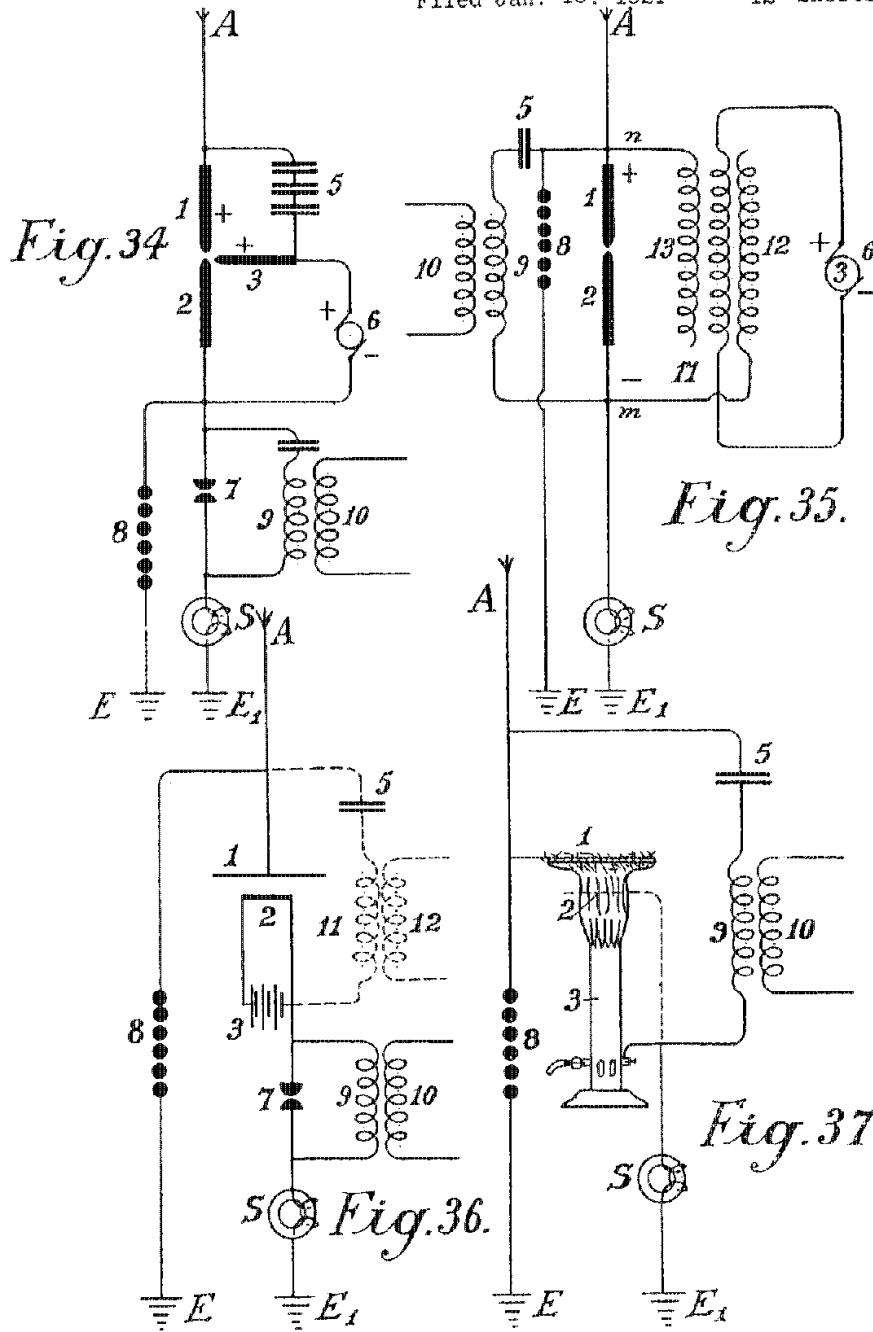

Игъеглоръ

Herman Plauson

by Knight B. Attorney

# UNITED STATES PATENT OFFICE.

HERMANN PLAUSON, OF HAMBURG, GERMANY.

CONVERSION OF ATMOSPHERIC ELECTRIC ENERGY.

Application filed January 13, 1921. Serial No. 437,107.

*To all whom it may concern:*

Be it known that I, HERMANN PLAUSON, Esthonian subject, residing in Hamburg, Germany, have invented certain new and useful Improvements in the Conversion of Atmospheric Electric Energy, of which the following is a specification.

Methods of obtaining atmospheric electricity by means of metallic nettings set with spikes which are held by means of ordinary or anchored kite balloons made of fabrics and filled with hydrogen, are in theory already known. Atmospheric electricity obtained in this way has been suggested to be used in the form of direct current for the charging of accumulators. This knowledge however is at present only theoretical as the conversion in practice has hitherto been a failure. No means are known of protecting the apparatus from destruction by lightning. The balloons used for collecting the charge must also be made of very large size in order to be able to support the weight of the metallic netting and the heavy cable connections.

Instead of using heavy metallic netting as collectors attached to single air balloons of non-conducting materials which are liable to be torn and are permeable to the gas, it is proposed to use metallic balloon collectors which have the following important advantages—

(a) The metallic cases are impenetrable to helium and hydrogen; they also represent large metallic weather-proof collecting surfaces.

(b) Radio active means and the like may be easily applied internally or externally; whereby the ionization is considerably increased and therewith also the quantity of atmospheric electricity capable of being collected.

(c) Such balloon collectors of light metal do not require to be of large size as they have to carry only their own moderate weight, and that of the conducting cable or wire.

(d) The entire system therefore offers little surface for the action of storm and wind and is resistant and stable.

(e) Each balloon can be easily raised and lowered by means of a winch so that all repairs, recharging and the like can be carried out without danger during the operation.

It is further proposed to use a collecting aerial network of several separate collectors spread out in the air above the earth, which collectors are interconnected by electrical conductors.

According to this invention charges of atmospheric electricity are not directly converted into mechanical energy, and this forms the main difference from previous inventions, but the static electricity which runs to earth through aerial conductors in the form of direct current of very high voltage and low current strength is converted into electro-dynamic energy in the form of high frequency vibrations. Many advantages are thereby obtained and all disadvantages avoided.

The very high voltage of static electricity of a low current strength can be converted by this invention to voltages more suitable for technical purposes and of greater current strength. By the use of closed oscillatory circuits it is possible to obtain electromagnetic waves of various amplitude and thereby to increase the degree of resonance of such current. Such resonance allows various values of inductance to be chosen whereby again the governing of the starting and stopping of machines driven thereby by simply tuning the resonance between coils of the machine and the transformer circuit forming the resonance can easily be obtained. Further, such currents have the property of being directly available for various uses, even without employing them for driving motors, of which there may be particularly mentioned, lighting, production of heat and use in electro-chemistry.

Further, with such currents a series of apparatus may be fed without direct current supply through conductors and also the electro-magnetic high frequency currents may be converted by means of special motors adapted for electro-magnetic oscillations into mechanical energy, or finally converted by special machines into alternating current of low frequency or even into direct current of high potential.

The invention is more particularly described with reference to the accompanying diagrams in which:—

Figure 1 is an explanatory figure.

Figure 2 is a diagrammatic view of the simplest form.

Figure 3 shows a method of converting atmospheric electrical energy for use with motors.

Figure 4 is a diagram showing the use of protective means.

Figure 5 is a diagram of an arrangement for converting large current strengths.

Figure 6 is a diagram of an arrangement including controlling means.

Figure 7 shows means whereby the spark gap length can be adjusted.

Figure 8 shows a unipolar connection for the motor.

Figure 9 shows a weak coupled system suitable for use with small power motors.

Figures 10, 11 and 12 show modified arrangements.

Figure 13 shows a form of inductive coupling for the motor circuit.

Figure 14 is a modified form of Figure 13 with inductive coupling.

Figure 15 is an arrangement with non-inductive motor.

Figure 16 is an arrangement with coupling by condenser.

Figures 17, 18 and 19 are diagrams of further modifications.

Figure 20 shows a simple form in which the aerial network is combined with special collectors.

Figure 21 shows diagrammatically an arrangement suitable for collecting large quantities of energy.

Figure 22 is a modified arrangement having two rings of collectors.

Figure 23 shows the connections for three rings of collectors.

Figure 24 shows a collecting balloon and diagram of its connection of condenser batteries.

Figures 25 and 26 show modified collector balloon arrangements.

Figure 27 shows a second method of connecting conductor for the balloon aeri-als.

Figure 28 shows an auto-transformer method of connection.

Figure 29 shows the simplest form of construction with incandescent cathode.

Figure 30 shows a form with cigar shaped balloon.

Figure 31 is a modified arrangement.

Figure 32 shows a form with cathode and electrode enclosed in a vacuum chamber.

Figure 33 is a modified form of Figure 32.

Figure 34 shows an arc light collector.

Figure 35 shows such an arrangement for alternating current.

Figure 36 shows an incandescent collector with Nernst lamp.

Figure 37 shows a form with a gas flame.

Figure 1 illustrates a simple diagram for converting static electricity into dynamic energy of a high number of oscillations. For the sake of clearness in the drawings an influence machine is assumed to be employed

and not an aerial antenna. 13 and 14 are combs for collecting the static electricity of the influence machine. 7 and 8 are spark discharging electrodes, 6 and 5 condensers, 9 an inductive primary coil, 10 secondary coil, 11 and 12 ends of conductors of the secondary coil 10. When the disc of the static influence machine is rotated by mechanical means, the combs collect the electric charges one the positive and the other the negative, and charge the condensers 5 and 6 until such a high potential is formed across the spark gap 7—8, that the spark gap is jumped. As the spark gap 7—8 forms a closed circuit with condensers 6 and 5, and inductive resistance 9, as is well known, waves of high frequency electromagnetic oscillations will pass in this circuit.

The high frequency of the oscillations produced in the primary circuit induces waves of the same periodicity in the secondary circuit. Thus in the primary circuit electromagnetic oscillations are formed by the passage of the spark over the spark gap and these waves are maintained by fresh charges of static electricity.

By suitably selecting the ratio between the number of the coils in the primary and secondary circuits with regard to a correct application of the co-efficients of resonance (capacity, inductance, and resistance) the high voltage of the primary circuit may be suitably converted into low voltage and high current strength.

When the oscillatory discharges in the primary circuit becomes weaker or entirely cease, the condensers are charged again by the static electricity until the accumulated charge again breaks down the spark gap. All this is repeated as long as electricity is produced by the static machine by employing mechanical energy.

An elementary form of the invention is shown in Figure 2 in which two spark gaps in parallel are used one of which may be termed the working gap 7 in Figure 2, whilst the second serves as a safety device for excess voltage and consists of a larger number of spark gaps than the working section, which gaps are arranged in series and are bridged by very small capacities as is illustrated in  $a_1, b_1, c_1$ , Figure 2 which allow of uniform sparking in the safety section.

In Figure 2 A is the aerial antenna for collecting charges of atmospheric electricity. 13 is the earth connection of the second part of the spark gap, 5 and 6 are condensers, 9 a primary coil. Now when through the aerial A the positive atmospheric electricity seeks to combine with the negative charge to earth, this is prevented by (the air gap between) the spark gaps. The resistance of the spark gap 7 is, as shown in the drawings, lower than that of the other safety section which consists of three spark gaps connected in

series, and consequently a three times greater air resistance is offered by the latter.

So long therefore, as the resistance of the spark gap 7 is not overloaded, so that the other spark gaps have an equal resistance with it the discharges take place only over spark gap 7. Should however the voltage be increased by any influences so that it might be dangerous for charging the condensers 5 and 6 or for the coil insulation 9 and 10 in consequence of break down, by a correct regulation of this spark gap the second spark gap can discharge free from inductive effects direct to earth without endangering the machine.

Without this second spark gap, arranged in parallel having a higher resistance than the working spark gap it is impossible to collect and render available large quantities of electrical energy.

The action of this closed oscillation circuit consisting of spark gap 7, two condensers 5 and 6, primary coil 9, and also secondary coil 10 is exactly the same as the one described in Figure 1 with the arrangement of the static induction machine with the only difference that here the second spark gap is provided. The electromagnetic high frequency alternating current obtained can be tapped off from the conductors 11 and 12 for lighting and heating purposes. Special kinds of motors adapted for working with these peculiar electrical charges may be connected at 14 and 15 which can work with static electricity charges or with high frequency oscillations.

In addition to the use of spark gaps in parallel a second measure of security is also necessary for taking off the current. This precaution consists according to this invention, in the introduction of and method of connecting certain protective electromagnets or choking coils in the aerial circuit as shown by S in Figure 3.

A single electromagnet only having a core of the thinnest possible separate laminations is connected with the aerial.

In the case of high voltages in the aerial network or at places where there are frequent thunder storms, several such magnets may however be connected in series.

In the case of large units or plants several electromagnets can be employed in parallel or in series parallel.

The windings of these electromagnets may be simply connected in series with the aerals. In this case the winding preferably consists of several thin parallel wires, which make up together, the necessary section.

The winding may be made of primary and secondary windings in the form of a transformer. The primary winding will be then connected in series with the aerial network, and the secondary winding more or less short-circuited over a regulating resist-

ance or an induction coil. In the latter case it is possible to regulate to a certain extent the effect of the choking coils. In the further description of the connecting and constructional diagrams the aerial electromagnet choke coil is indicated by a simple ring S.

Figure 3 shows the simplest way of converting atmospheric electricity into electromagnetic wave energy by the use of special motors adapted for high oscillatory currents or static charges of electrical energy. Recent improvements in motors for working with static charges and motors working by resonance, that is to say, having groups of tuned electromagnetic cooperating circuits render this possible but such do not form part of the present invention.

A motor adapted to operate with static charges will for the sake of simplicity be diagrammatically indicated by two semi-circles 1 and 2 and the rotor of the motor by a ring M. (Figure 3.) A is a vertical aerial or aerial network. S the safety choke or electromagnet with coil O as may be seen is connected with the aerial A. Adjacent the electromagnet S the aerial conductor is divided into three circuits, the circuit 8 giving the safety spark gap, the circuit 7 with the working spark gap, and then a circuit including the stator terminal 1, the rotor and stator terminal 2 at which a connection is made to the earth wire. The two spark gaps are also connected metallically with the earth wire. The method of working these diagrams is as follows:

The positive atmospheric electric charge collected tends to combine with the negative electricity (or earth electricity) connected with the earth wire. It travels along the aerial A through the electromagnet S without being checked as it flows in the same direction as the direct current. Further, its progress is arrested by two sparks gaps placed in the way and the stator condenser surfaces. The stator condenser surfaces are charged until the charge is greater than the resistance of the spark gap 7, whereupon a spark springs over the spark gap 7 and an oscillatory charge is obtained as by means of the motor M, stator surfaces 1 and 2, and spark gap 7, a closed oscillation circuit is obtained for producing the electromagnetic oscillations. The motor here forms the capacity and the necessary inductance and resistance, which, as is well known, are necessary for converting static electricity into electromagnetic wave energy.

The discharges formed are converted into mechanical energy in special motors and can not reach the aerial network by reason of the electromagnet or choke. If, however, when a spark springs over the spark gap 7 a greater quantity of atmospheric electricity tends to flow to earth, a counter voltage is

induced in the electromagnet, which is greater the more rapidly and strongly the flow of current direct to the earth is. By the formation of this opposing voltage a  
 5 sufficiently high resistance is offered to the flow of atmospheric electricity direct to earth to prevent a short circuit with the earth.

The circuit containing spark gap 8 having  
 10 a different wave length which is not in resonance with the natural frequency of the motor, does not endanger the motor and serves as security against excess voltage, which, as practical experiments have shown,  
 15 may still arise in certain cases, but can be conducted direct to earth through this spark gap.

In the diagram illustrated in Figure 4 the spark gap 7 is shunted across condensers 5  
 20 and 6 from the motor M. This construction affords mainly a better insulation of the motor against excess voltage and a uniform excitation through the spark gap 7.

In Figure 5 a diagram is illustrated for  
 25 transforming large current strengths which may be employed direct without motors, for example, for lighting or heating purposes. The main difference is that here the spark gap consists of a star shaped disc 7 which  
 30 can rotate on its own axis and is rotated by a motor opposite similarly fitted electrodes 7<sup>a</sup>. When separate points of stars face one another, discharges take place, thus forming  
 an oscillation circuit over condensers 5 and 6 and inductance 9 for oscillatory discharges.  
 35 It is evident that a motor may also be directly connected to the ends of the spiral 9.

The construction of the diagram shown  
 40 in Figure 6 permits of the oscillation circuit of the motor being connected with an induction coil. Here a regulating inductive resistance is introduced for counter-acting  
 excess voltages in the motor. By cutting the separate coils 9 (coupled inductively to the  
 45 aerial) in or out the inductive action on the motor may be more or less increased or variable aerial action may be exerted on the oscillation circuit.

In Figure 7 the oscillation circuit is closed  
 50 through the earth (E and E<sub>1</sub>). The spark gap 7 may be prolonged or shortened by more or fewer spark gaps being successively connected by means of a contact arm 7<sup>b</sup>.

Diagram 8 shows a unipolar connection of  
 55 the motor with the aerial network. Here two oscillation circuits are closed through the same motor. The first oscillation circuit passes from aerial A through electromagnet S, point  $\alpha$ , inductance 9<sup>a</sup> to the earth con-  
 60 denser 6 and further, over spark gap 7 to the aerial condenser 5 and back to  $\alpha$ . The second oscillation circuit starts from the aerial condenser 5 at the point  $\alpha'$  over the  
 inductance 9 to the earth condenser 6 at the  
 65 point  $\alpha''$  and through the condenser 6 over

the spark gap 7 back to  $\alpha'$ . The motor itself is inserted between the two points of the spark gap 7. From this arrangement slight-  
 70 ly damped oscillation wave currents are produced.

In the diagram illustrated in Figure 9 a  
 70 loosely coupled system of connections is illustrated which is assumed to be for small motors for measuring purposes. A indicates the aerial conductor, S the electromag-  
 75 net in the aerial conductor, 9 the inductance, 7 the spark gap, 5 and 6 condensers, E the earth, M the motor, and 1 and 2 stator connections of the motor. The motor is di-  
 80 rectly metallicly connected with the oscillation circuit.

In Figure 10 a purely inductive coupling  
 is employed for the motor circuit. The motor is connected with the secondary wire 10  
 85 as may be seen in Figure 11 in a somewhat modified diagram connection. The same applies to the diagram of Figure 12.

The diagrams hitherto described prefer-  
 90 ably allow of motors of small and medium strength to be operated. For large aggregates, however, they are too inconvenient as the construction of two or more oscillation  
 95 circuits for large amounts of energy is difficult; the governing is still more difficult and the danger in switching on or off is greater.

A means of overcoming such difficulties is  
 100 shown in Figure 13. The oscillation circuit here runs starting from the point  $\alpha$  over con- denser 5, variable inductance 9, spark gap 7 and the two segments (3<sup>a</sup> and 4<sup>a</sup>) form-  
 105 ing arms of a Wheatstone bridge, back to  $\alpha$ . If the motor is connected by brushes 3 and 4 transversely to the two arms of the bridge as shown in the drawings, electromagnetic  
 110 oscillations of equal sign are induced in the stator surfaces 1 and 2 and the motor does not revolve. If however, the brushes 3 and 4 are moved in common with the conduct-  
 115 ing wires 1 and 2 which connect the brushes with the stator poles a certain alteration or displacement of the polarity is obtained and  
 120 the motor commences to revolve.

The maximum action will result if one  
 115 brush 3 comes on the central sparking contact 7 and the other brush 4 on the part  $\alpha$ . They are however, usually in practice not brought on to the central contact 7 but only  
 120 held in the path of the bridge segments 4<sup>a</sup> and 3<sup>a</sup> in order not to connect the spark gaps with the motor oscillation circuit.

As however, the entire oscillation energy  
 can thereby not act on the motor it is better to carry out the same system according to the  
 125 diagram 14. The diagram 14 differs from the foregoing only by the motor not being directly metallicly connected with the seg-  
 130 ments of the commutator, but only a primary coil 9 which induces in a secondary coil 10, current which feeds the motor M and takes the place of the rotor. By this



arrangement a good transforming action is obtained, a loose coupling and also an oscillation circuit without a spark gap.

In Figure 15 the motor is not purely inductively as in 14, but directly metallicly branched off from the primary coil (at  $x$  and  $x'$ ) after the principle of the auto-transformer.

In Figure 16 instead of an inductance a condenser 6 is in similar manner, and for the same object inserted between the segments 3<sup>a</sup> and 4<sup>a</sup>. This has the advantage that the segments 3<sup>a</sup> and 4<sup>a</sup> need not be made of solid metal but may consist of spiral coils whereby a more exact regulation is possible and further motors of high inductance may be employed.

The arrangements of Figures 17, 18 and 19 may be employed for use with resonance and particularly with induction condenser motors; between the large stator induction condenser surfaces, small reversing pole condensers are connected, which, as may be seen from Figures 17, 18 and 19 are led together to earth. Such reversing poles have the advantage that with large quantities of electrical energy the spark formation between the separate oscillation circuits ceases.

Figure 19 shows a further method which prevents electromagnetic oscillations of high number of alternations formed in the oscillation circuit striking back to the aerial conductor. It is based on the well known principle that a mercury lamp, one electrode of which is formed of mercury, the other of solid metal such as steel allows an electric charge to pass in only one direction from the mercury to the steel and not vice versa. The mercury electrode of the vacuum tube N is therefore connected with the aerial conductor and the steel electrode with the oscillation circuit. From this it results that charges can pass only from the aerial through the vacuum tube to the oscillation circuit, but not vice versa. Oscillations which are formed on being transformed in the oscillation circuit cannot pass to the aerial conductor.

In practice these vacuum tubes must be connected behind an electromagnet as the latter alone affords no protection against the danger of lightning.

As regards the use of spark gaps, all arrangements as used for wireless telegraphy may be used. Of course the spark gaps in large machines must have a sufficiently large surface. In very large stations they are cooled in liquid carbonic acid or better still in liquid nitrogen or hydrogen; in most cases the cooling may also take place by means of liquefied low homologues of the metal series or by means of hydrocarbons the freezing point of which lies at between  $-90^{\circ}$  C. and  $-40^{\circ}$  C. The spark gap casing must also be insulated and be of

sufficient strength to be able to resist any pressure which may arise. Any undesirable excess super-pressure which may be formed must be automatically let off. I have employed with very good results mercury electrodes which were frozen in liquid carbonic acid, the cooling being maintained during the operation from the outside through the walls.

Figure 20 is one of the simplest forms of construction of an aerial network in combination with collectors, transformers and the like illustrated diagrammatically. E is here the earth wire, 8 the safety spark gap, 7 the working spark gap, 1 and 2 the stator surfaces of the motor, 5 a condenser battery, S the protective magnet which is connected with the coil in the aerial conductor, A<sup>1</sup> to A<sup>10</sup> aerial antennæ with collecting balloons, N horizontal collecting or connecting wires from which, to the centre a number of connections run.

The actual collectors consist of metal sheaths preferably made of an aluminium magnesium alloy, and are filled with hydrogen or helium and are attached to copper plated steel wires. The size of the balloon is selected so that the actual weight of the balloon and the weight of the conducting wire is supported thereby. On the top of the balloon aluminium spikes, made and gilded in a special manner hereinafter described, are arranged in order to produce a conductor action. Small quantities of radium preparations, more particularly polonium-ionium or mesothorium preparations considerably increase the ionization, and therewith the action of these collectors.

In addition to metal balloons, fabric balloons which are superficially metal coated according to Schoop's metal spraying process, may however also be employed. A metallic surface may also be produced by lacquering with metallic bronzes, preferably according to Schoop's spraying process or lacquering with metallic bronze powders in two electrical series of widely different metals, because thereby the collecting effect is considerably increased.

Instead of the ordinary round balloons, elongated cigar shaped ones may be employed. In order also to utilize the frictional energy of the wind, patches or strips of non-conducting substances which produce electricity by friction, may be attached to the metallized balloon surfaces. The wind will impart a portion of its energy in the form of frictional electricity, to the balloon casing, and thereby the collecting effect is substantially increased.

In practice however, very high towers (up to 300 metres is fully admissible) may be employed as antennæ. In these towers copper tubes rise freely further above the top of the tower. A gas lamp secured

against the wind is then lit at the point of the copper tube and a netting is secured to the copper tube over the flame of this lamp to form a collector. The gas is conveyed  
 5 through the interior of the tube up to the summit. The copper tube must be absolutely protected from moisture at the place at which it enters the tower and also rain must be prevented running down the walls  
 10 of the tower which might lead to a bad catastrophe. This is done by bell shaped enlargements which expand downwards, being arranged in the tower in the form of high voltage insulators of Siamese pagodas.  
 15 Special attention must be devoted to the foundations of such towers. They must be well insulated from the ground, which may be obtained by first embedding a layer of concrete in a box form to a sufficient depth  
 20 in the ground and inserting in this an asphalt lining and then glass bricks cast about 1 or 2 metres in thickness. Over this in turn there is a ferro-concrete layer in which alone the metal foot of the tube is  
 25 secured. This concrete block must be at least 2 metres from the ground and be fully protected at the sides by a wooden covering, from moisture. In the lower part of the tower a wood or glass house for the large  
 30 condenser batteries or for the motors may be constructed. In order to lead the earth connection to the ground water, a well insulated pit constructed of vitreous bricks, must be provided. Several such towers are  
 35 erected at equal distances apart and connected with a horizontal conductor. The horizontal connecting wires may either run directly from tower to tower or be carried on bell shaped insulators similar to those in use for high voltage conductors. The width  
 40 of the network may be of any suitable size and the connection of the motors can take place at any suitable places.

In order to collect large quantities of electricity with few aerials it is well to provide the aerial conductor with batteries of condensers as shown in two methods of construction in Figures 21 and 22. In Figure  
 45 21 the batteries of condensers 5 are connected on the one hand with the aerial electricity collectors Z by the aerial conductor A, and on the other hand interconnected in series with an annular conductor from which horizontal conductors run to the connecting points C to which the earth wire is  
 50 connected.

Figure 22 shows a similar arrangement. Should two such series of antennæ rings be shown by a voltmeter to have a large difference of potential (for example, one in the mountains and one in the plain) or even of different polarity these differences may be compensated for by connecting sufficiently large condenser batteries (5, 5<sup>a</sup>, 5<sup>b</sup>) by means  
 60 of Maji star conductors D and D<sup>1</sup>. In Fig-

ure 23 a connection of three such rings of collectors to form a triangle with a central condenser battery is illustrated.

The condenser batteries of such large installations must be embedded in liquefied  
 70 gases or in liquids freezing at very low temperatures. In such cases a portion of the atmospheric energy must be employed for liquefying these gases. It is also preferable to employ pressure. By this means the condenser surfaces may be diminished, and  
 75 still allow for large quantities of energy to be stored, secure against breakdown. For smaller installations the immersing of the condensers in well insulated oil or the like, suffices. Solid substances on the other hand cannot be employed as insulators.

The arrangement in the diagrams hitherto described was always such that the condenser batteries were connected with both  
 80 poles directly to the aerial conductors. An improved diagram of the connections for obtaining atmospheric electricity for the condenser batteries has however, been found to be very advantageous, this arrangement  
 85 consists in that they are connected by only one pole (unipolar) to the collecting network. Such a method of arrangement is very important, as by means of it a constant current and an increase of the normal working  
 90 pressure or voltage is obtained. If for example a collecting balloon aerial which is allowed to rise to a height of 300 metres, shows 40,000 volts above earth voltage, in practice it has been found that the working  
 95 voltage (with a withdrawal of the power according to the method hereinbefore described by means of oscillating spark gaps and the like) is only about 400 volts. If however, the capacity of the condenser surfaces be increased, which capacity in the above mentioned case was equal to that of the collecting surface of the balloon aerials, to double the amount, by connecting the condenser batteries with only one pole, the  
 100 voltage rises under an equal withdrawal of current up to and beyond 500 volts. This can only be ascribed to the favourable action of the connecting method.

In addition to this substantial improvement it has also been found preferable to insert double inductances with electromagnets and to place the capacities preferably between two such electromagnets. It has also been found that the useful action of  
 105 such condensers can be further increased if an induction coil be connected as inductive resistance to the unconnected pole of the condenser, or still better if the condenser itself be made as an induction condenser.  
 110 Such a condenser may be compared with a spring which when compressed carries in itself accumulated force, which it again gives off when released. In charging, a charge with reversed sign is formed at the  
 115

other free condenser pole, and if through the spark gap a short circuit results, the accumulated energy is again given back since now new quantities of energy are induced at the condenser pole connected with the conductor network, which in fact charges with opposite signs to that at the free condenser pole. The new induced charges have of course the same sign as the collector network. The whole voltage energy in the aerial is thereby however increased. In the same space of time larger quantities of energy are accumulated than is the case without such inserted condenser batteries.

In Figures 24 and 25 two different diagrams of connections are more exactly illustrated, Figure 24 shows a collecting balloon and the diagram of the connections to earth. Figure 25 four collecting balloons and the parallel connection of the condenser batteries belonging thereto.

A is the collecting balloon made of an aluminium magnesium alloy (electron metal, magnalium) of a specific gravity of 1.8 and a thickness of plate 0.1 to 0.2 mm. Inside there are eight strong vertical ribs of T shaped section about 10 to 20 mm. in height and about 3 mm. in thickness with the projecting part directed inwards (indicated by *a, b, c, d* and so forth); they are riveted together to form a firm skeleton and are stiffened in a horizontal direction by two cross ribs. The ribs are further connected with one another internally and transversely by means of thin steel wires, whereby the balloon obtains great power of resistance and elasticity. Rolled plates of 0.1 to 0.2 mm. in thickness made of magnalium alloy are then either soldered or riveted on this skeleton so that a fully metallic casing with smooth external surface is obtained. Well silvered or coppered aluminium plated steel wires run from each rib to the fastening ring 2. Further, the coppered steel hawser L preferably twisted out of separate thin wires (shown in dotted lines in Figure 24) and which must be long enough to allow the balloon to rise in the desired height, leads to a metal roller or pulley 3 and from thence to a winch W, well insulated from the earth. By means of this winch, the balloon, which is filled with hydrogen, or helium, can be allowed to rise to a suitable height (300 to 5,000 metres) and brought to the ground for recharging or repairs.

The actual current is taken directly through a friction contact from the metal roller 3 or from the wire, or even from the winch or simultaneously from all three by means of brushes (3, 3<sup>a</sup> and 3<sup>b</sup>). Beyond the brushes the conductor is divided, the paths being:—firstly over 12 to the safety spark gap 8, from thence to the earth conductor E<sup>1</sup>, and secondly over electromagnet S<sup>1</sup>, point 13, to a second loose electromagnet

having an adjustable coil S<sup>2</sup>, then to the spark gap 7 and to the second earth conductor E<sup>2</sup>. The actual working circuit is formed through the spark gap 7, condensers 5 and 6, and through the primary coil 9; here the static electricity formed by oscillatory discharges is accumulated and converted into high frequency electromagnetic oscillations. Between the electromagnets S<sup>1</sup> and S<sup>2</sup> at the crossing point 13, four condenser batteries are introduced which are only indicated diagrammatically in the drawings each by one condenser. Two of these batteries (16 and 18) are made as plate condensers and prolonged by regulating induction coils or spirals 17 and 19 while the two others (21 and 23) are induction condensers. As may be seen from the drawings each of the four condenser batteries 16, 18, 21, 23 is connected only by one pole to the aerial or to the collector conductor. The second poles 17, 19, 22, 24 are open. In the case of plate condensers having no inductive resistance an induction coil is inserted. The object of such a spiral or coil is the displacement of phase of the induction current by  $\frac{1}{4}$  periods, whilst the charging current of the condenser poles which lie free in the air, works back to the collector aerial. The consequence of this is that in discharges in the collector aerial the back inductive action of the free poles allows a higher voltage to be maintained in the aerial collecting conductor than would otherwise be the case. It has also been found that such a back action has an extremely favourable effect on the wear of the contacts. Of course the inductive effect may be regulated at will within the limits of the size of the induction coil, the length of the coil in action being adjustable by means of wire connection without induction (see Fig. 24, No. 20).

S<sup>1</sup> and S<sup>2</sup> may also be provided with such regulating devices in the case of S<sup>2</sup> (illustrated by 11). If excess voltage be formed it is conducted to earth through the wire 12 and spark gap 8 or through any other suitable apparatus, since this formation would be dangerous for the other apparatus.

The action of these condenser batteries has already been hereinbefore described.

The small circles on the collector balloon indicate places at which zinc amalgam or gold amalgam or other photoelectric acting metals in the form of small patches in extremely thin layers (.01 to .05 mm. in thickness) are applied to the balloon casing of light metal. Such metallic patches may also be applied to the entire balloon as well as in greater thickness to the conducting network. The capacity of the collector is thereby considerably strengthened at the surface. The greatest possible effect in collecting may be obtained by polonium amalgams and the like. On the surface of the

collector balloon metal points or spikes are also fixed along the ribs, which spikes serve particularly for collecting the collector charge. Since it is well known that the resistance of the spikes is less the sharper the spike is, for this purpose it is therefore extremely important to employ as sharp spikes as possible. Experiments made as regards these have shown that the formation of the body of the spike or point also plays a large part. For example, spikes made of bars or rollers with smooth surfaces, have a many times greater point resistance as collector accumulator spikes than those with rough surfaces. Various kinds of spike bodies have been experimented with for the collector balloons hereinbefore mentioned. The best results were given by spikes which were made in the following way. Fine points made of steel, copper, nickel, or copper and nickel alloys, were fastened together in bundles and then placed as anode with the points in a suitable electrolyte (preferably in hydrochloric acid or muriate of iron solutions) and so treated with weak current at 2 to 3 volts pressure. After 2 to 3 hours according to the thickness of the spikes or pins the points become extremely sharp and the bodies of the spikes have a rough surface. The bundle can then be removed and the acid washed off with water. The spikes are then placed as cathode in a bath consisting of solution of gold, platinum, iridium, palladium or wolfram salts or their compounds and coated at the cathode galvanically with a thin layer of precious metal, which must however be sufficiently firm to protect them from atmospheric oxidation.

Such spikes act at a 20 fold lower voltage almost as well as the best and finest points made by mechanical means. Still better results are obtained if polonium or radium salts are added to the galvanic bath when forming the protective layer or coating. Such pins have a low resistance at their points and even at one volt and still lower pressures have an excellent collector action.

In Figure 24 the three unconnected poles are not connected with one another in parallel. That is quite possible in practice without altering the principle of the free pole. It is also preferable to interconnect in parallel to a common collector network, a series of collecting aeri-als.

Figure 25 shows a diagram for such an installation.  $A^1, A^2, A^3, A^4$  are four metal collector balloons with gold or platinum coated spikes which are electrolytically made in the presence of polonium emanations or radium salts, which spikes or needles are connected over four electro-magnets  $S^1, S^2, S^3, S^4$ , through an annular conductor R. From this annular conductor four wires run over four further electromagnets  $S^a,$

$S^b, S^c, S^d$ , to the connecting point 13. There the conductor is divided, one branch passing over 12 and the safety spark gap 8 to the earth at  $E^1$ , the other over inductive resistance J and working spark gap 7 to the earth at  $E^2$ . The working circuit, consisting of the condenser 5 and 6 and a resonance motor or a condenser motor M, such as hereinbefore described, is connected in proximity round the sparking gap section 7.

Instead of directly connecting the condenser motor of course the primary circuit for high frequency oscillatory current may also be inserted.

The condenser batteries are connected by one pole to the annular conductor R and can be either inductionless (16 and 18) or made as induction condensers as shown by 21 and 23. The free poles of the inductionless condensers are indicated by 17 and 19, those of the induction condensers by 22 and 24. As may be seen from the drawings all these poles 17, 22, 19, 24 may be interconnected in parallel through a second annular conductor without any fear that thereby the principle of the free pole connection will be injured. In addition to the advantages already set forth the parallel connection also allows of an equalization of the working pressure in the entire collector network. Suitably constructed and calculated induction coils 25 and 26 may also be inserted in the annular conductor of the free poles, by means of which a circuit may be formed in the secondary coils 27 and 28 which allows current produced in this annular conductor by fluctuations of the charges or the like appearances to be measured or otherwise utilized.

According to what has been hereinbefore stated separate collector balloons may be connected at equidistant stations distributed over the entire country, either connected directly with one another metallically or by means of intermediate suitably connected condenser batteries through high voltage conductors insulated from earth. The static electricity is converted through a spark gap into dynamic energy of a high number of oscillations and may in such form be coupled as a source of energy by means of a suitable method of connecting, various precautions being observed, and with special regulations. The wires leading from the collector balloons have hitherto been connected through an annular conductor without this endless connection, which can be regarded as an endless induction coil, being able to exert any action on the whole conductor system.

It has now been found that if the network conductor connecting the aerial collector balloons with one another is not made as a simple annular conductor, but preferably short circuited in the form of coils over a

condenser battery or spark gap or through thermionic tubes or valves or audions, then the total collecting network exhibits quite new properties. The collection of atmospheric electricity is thereby not only increased but an alternating field may be easily produced in the collector network. Further, the atmospheric electrical forces showing themselves in the higher regions may also be directly obtained by induction. In Figures 26 and 28 a form of construction is shown on the basis of which the further foundations of the method will be more particularly explained.

In Figure 26 1, 2, 3, 4 are metal collector balloons, 5, 6, 7, 8 their metallic aerial conductors and I the actual collector network. This consists of five coils and is mounted on high voltage insulators in the air, on high voltage masts (or with a suitable construction of cable embedded in the earth). One coil has a diameter of 1 to 100 km. or more. S and S' are two protective electromagnets, F the second safety section against excess voltage, E its earth conductor and E' the earth conductor of the working section. When an absorption of static atmospheric electricity is effected through the four balloon collectors, the current in order to reach the earth connection E' must flow spirally through the collector network over the electromagnet S, primary induction coil 9, conductor 14, anode A of the audion tube, incandescent cathode K, as the way over the electromagnet and safety spark gap F offers considerably greater resistance. Owing to the fact that the accumulated current flows in one direction, an electromagnetic alternating field is produced in the interior of the collector network coil, whereby the whole free electrons are directed more or less into the interior of the coil. An increased ionization of the atmosphere is therefore produced. In consequence of this the points mounted on the collector balloon show a considerably reduced resistance and therefore increased static charges between the points on the balloon and the surrounding atmosphere are produced. The result of this is a considerably increased collector effect.

A second effect which could not be obtained otherwise is obtained by the electromagnetic alternating field which running parallel to the earth surface, acts more or less with a diminishing or increasing effect on the earth magnetic field, whereby in the case of fluctuations in the current a return induction current of reversed sign is always produced in the collector coil by earth magnetism. Now if, however, a constantly pulsating continuous alternating field is produced as stated in the above collector network I, an alternating current of the same periodicity is produced also in the collecting network coil. As the same alternating field is further transmitted to the aerial balloon, the resistance of its points is thereby considerably reduced, whilst the collector action is considerably increased. A further advantage is that positive electrons which collect on the metal surfaces during the conversion into dynamic current produce a so-called drop of potential of the collector area. As an alternating field is present, the negative ions surrounding the collector surfaces, when discharge of the collector surfaces takes place produce by the law of induction, an induction of reversed sign on the collector surface and so forth (that is to say again a positive charge). In addition to the advantages hereinbefore set forth, the construction of connecting conductors in coil form when of sufficiently large diameter, allows of a utilization of energy arising in higher regions also in the simplest way. As is well known electric discharges frequently take place at very great elevations which may be observed, such as St. Elmo's fires or northern lights. These energy quantities have not been able to be utilized up to now. By this invention all these kinds of energy, as they are of an electromagnetic nature and the direction of the axis of the collector coils stands at right angles to the earth's surface, can be more or less absorbed in the same way as a receiver in wireless telegraphy absorbs waves coming from a far distance. With a large diameter of the spiral it is possible to connect large surfaces and thereby to take up also large quantities of energy.

It is well known that large wireless stations in the summer months, and also in the tropics are very frequently unable to receive the signals in consequence of interruptions which are caused by atmospheric electricity, and this takes place with vertical coils of only 40 to 100 m. diameter. If on the contrary horizontal coils of 1 to 100 km. diameter be employed very strong currents may be obtained through discharges which are constantly taking place in the atmosphere. Particularly in the tropics or still better in the polar regions where the northern lights are constantly present, large quantities of energy may probably be obtained in this way. A coil with several windings should act the best. In similar manner any alteration of the earth magnetism should act inductively on such a coil.

It is not at all unlikely that earthquakes and spots on the sun will also produce an induction in such collector coils of sufficient size. In similar manner this collector conductor will react on earth currents more particularly when they are near the surface of the earth or even embedded in the earth. By combining the previous kind of current collectors so far as they are adapted for

the improved system with the improved possibilities of obtaining current the quantities of free natural energy which are to be obtained in the form of electricity are considerably increased.

In order to produce in the improved collector coil uniform current oscillations of an undamped nature so-called audion high vacuum or thermionic tubes of suitable connection are employed instead of the previously known spark gaps (Fig. 26, Nos. 9-18). The main aerial current flows through electromagnet S (which in the case of a high number of alternations is not connected here but in the earth conductor E<sup>1</sup>) and may be conveyed over the primary coils in the induction winding through wire 14 to the anode A of the high vacuum grid tube. Parallel with the induction resistance 9 a regulating capacity of suitable size, such as condenser 11 is inserted. In the lower part of the vacuum grid tube is arranged the incandescent filament or the cathode K which is fed through a battery B. From the battery B two branches run, one to the earth conductor E<sup>1</sup> and the other through battery B<sup>1</sup> and secondary coil 10 to the grid anode *g* in the vacuum tube. By the method of connections shown in dotted lines, a desired voltage at the grid electrode *g* may also be produced through the wire 17 which is branched off from the main current conductor through switches 16 and some small condensers (*a*, *b*, *c*, *d*) connected in series, and conductor 18, without the battery B<sup>1</sup> being required.

The action of the entire system is somewhat as follows:—

On the connecting conductor of the aerial collector network being short circuited to earth, the condenser pole 11 is charged and slightly damped oscillations are formed in the short circuited existing oscillation circuit formed of the condenser 11 and self inductance 9. In consequence of the coupling through coil 10, fluctuations of voltage take place in the grid circuit 15 with the same frequency, which, fluctuations in turn influence the strength of the electrode current passing through the high vacuum amplifying tube and thus produce current fluctuations of the same frequency in the anode circuit. A permanent supply of energy to the oscillation circuits 9 and 10 consequently takes place, until a condition of balance is set up, in which the consumed oscillation energy is equal to that absorbed. Thereby constant undamped oscillations are now produced in the oscillation circuits 9-11.

For regular working of such oscillation producers high vacuum strengthening tubes are necessary and it is also necessary that the grid and anode voltages shall have a phase difference of 180° so that if the grid is negatively charged, then the anode is

positively charged and vice versa. This necessary difference of phase may be obtained by most varied connections, for example, by placing the oscillation circuit in the grid circuit or by separating the oscillation circuit and inductive coupling from the anodes and the grid circuit and so forth.

A second important factor in this way of converting static atmospheric electricity into undamped oscillations is that care must be taken that the grid and anode voltages have a certain relation to one another; the latter may be obtained by altering the coupling and a suitable selection of the self induction in the grid circuit, or as shown by dotted lines 18, 17, 16 by means of a larger or smaller number of condensers of suitable size connected in series; in this case the battery B<sup>1</sup> may be omitted. With a suitable selection of the grid potential a glow discharge takes place between the grid *g* and the anode A, and accordingly at the grid there is a cathode drop and a dark space is formed. The size of this cathode drop is influenced by the ions which are emitted in the lower space in consequence of shock ionization of the incandescent cathodes K and pass through the grid in the upper space. On the other hand the number of the ions passing through the grid is dependent on the voltage between the grid and the cathode. Thus if the grid voltage undergoes periodic fluctuations (as in the present case) the amount of the cathode drop at the grid fluctuates and consequently the internal resistance of the tube correspondingly fluctuates, so that when a back coupling of the feed circuit with the grid circuit takes place, the necessary means are afforded for producing undamped oscillations and of taking current, according to requirements from the collecting conductor.

The frequency of the undamped oscillations produced is with a suitably loose coupling equal to the self frequency of the oscillation circuits 9 and 10. By a suitable selection of the self induction of the coil 9 and capacity 11 it is possible to extend from frequencies which produce electromagnetic oscillations of only a few metres wave length down to the lowest practical alternating current frequency. For large installations a suitable number of frequency producing tubes in the form of the well known high vacuum transmission tubes of .5 to 2 kw. in size may be connected in parallel so that in this respect no difficulty exists.

The use of such tubes for producing undamped oscillations, and also the construction and method of inserting such transmission tubes in an accumulator or dynamo circuit is known and also that such oscillation producing tubes only work well at voltages of 1,000 up to 4,000 volts, so that on the contrary their use at lower voltages is

considerably more difficult. By the use of high voltage static electricity this method of producing undamped oscillations as compared with that through spark gaps must be regarded as an ideal solution particularly for small installations of outputs of from 1 to 100 kw.

By the application of safety spark gaps, with interpolation of electro-magnets, not only is short circuiting avoided but also the taking up of current is regulated. Oscillation producers inserted in the above way form a constantly acting electromagnetic alternating field in the collector coil, whereby as already stated, a considerable accumulating effect takes place. The withdrawal wire or working wire is connected at 12 and 13, but current may be taken by means of a secondary coil which is firmly or movably mounted in any suitable way inside the large collector coil, i. e. in its electromagnetic alternating field, so long as the direction of its axis runs parallel with that of the main current collecting coil.

In producing undamped oscillations of a high frequency (50,000 per second and more) in the oscillation circuits 9 and 11, electromagnets S and S<sup>1</sup> must be inserted if the high frequency oscillations are not to penetrate the collector coil, between the oscillation producers and the collector coil. In all other cases they are connected shortly before the earthing (as in Figs. 27 and 28).

In Figure 27 a second method of construction of the connecting conductor of the balloon aeriels is illustrated in the form of a coil. The main difference consists in that in addition to the connecting conductor I another annular conductor II is inserted parallel to the former on the high voltage masts in the air (or embedded as a cable in the earth) but both in the form of a coil. The connecting wire of the balloon aeriels is indicated as a primary conductor and also as a current producing network; the other is the consumption network and is not in unipolar connection with the current producing network.

In Figure 27 the current producing network I is shown with three balloon collectors 1, 2, 3 and aerial conductors 4, 5, 6; it is short circuited through condenser 19 and inductance 9. The oscillation forming circuit consists in this diagram of spark gap f, inductance 10, and condenser 11; the earth wire E, is connected to earth over electromagnet S<sup>1</sup>. F is the safety spark gap which is also connected to earth through a second electromagnet S at E<sub>1</sub>. On connecting up the condenser circuit 11 this is charged over the spark gap f whereby an oscillatory discharge is formed. This discharging current acts through inductance 10 on the inductively coupled secondary 9, whereby in the producing network a modi-

fication of the potential of the condenser 19 is produced. The consequence of this is that oscillations arise in the coil shaped producer network. These oscillations induce a current in the secondary circuit II, which has a smaller number of windings and a less resistance, the voltage of which, according to the proportion of the number of windings and of the ohmic resistance, is considerably lower whilst the current strength is greater.

In order to convert the current thus obtained into current of an undamped character, and to tune its wave lengths, a sufficiently large regulatable capacity 20 is inserted between the ends 12 and 13 of the secondary conductor II. Here also current may be taken without an earth conductor, but it is advisable to insert a safety spark gap E<sup>2</sup> and to connect this with the earth over an electromagnet S<sup>2</sup>.

The producer network may be connected with the working network II over an inductionless condenser 21 or over an inductionless condenser 22, 23. In this case the secondary conductor is unipolarly connected with the energy conductor.

In Figure 28 the connecting conductor between the separate accumulator balloons is carried out according to the autotransformer principle. The collecting coil connects four aerial balloons 1, 2, 3, 4, the windings of which are not made side by side but one above the other. In Figure 28 the collector coil I is shown with a thin line, the metallicly connected prolongation coils II with a thick line. Between the ends I<sup>1</sup> and II<sup>1</sup> of the energy network I a regulating capacity 19 is inserted. The wire I<sup>2</sup> is connected with the output wire and with the spark gap F.

As transformer of the atmospheric electricity an arrangement is employed which consists in using rotary pairs of condensers in which the one stator surface B is connected with the main current, whilst the other A is connected with the earth pole. Between these pairs of short circuited condensers are caused to rotate from which the converted current can be taken by means of two collector rings and brushes, in the form of an alternating current, the frequency of which is dependent on the number of balloons and the revolutions of the rotor. As the alternating current formed in the rotor can act, in this improved method of connection described in this invention, through coils 10 on the inductance 9, an increase or diminution of the feed current in I can be obtained according to the direction of the current by back induction. Current oscillations of uniform rhythm thereby result in the coil shaped windings of the producer network.

As the ends of this conductor are short cir-



cuited through the regulatable condenser 19 these rhythms produce short circuited undamped oscillations in the energy conductor, the periodicity and wave lengths of which oscillations can be adjusted according to desire by altering the capacity 19 to a given wave length and therewith also to a given frequency. These currents may also be employed in this form directly as working current through the conductors II<sup>1</sup> and III. By inserting the condenser 20 a connection between these conductors may also be made, whereby harmonic oscillations of desired wave length are formed. By this means quite new effects as regards current distribution are obtained. The withdrawal of current can even take place without direct wire connection if, at a suitable point in the interior of the producing network (quite immaterially whether this has a diameter of 1 or 100 km.) a coil tuned to these wave lengths and of the desired capacity is firmly or movably mounted in the aerial conductor in such a way that its axial direction is in parallel with that of the collector coil. In this case a current is induced in the producing network, the size of which is dependent on the total capacity and resistance and also on the periodicity employed. A possibility is thereby afforded in future, of taking energy from the producer network by wireless means. As thereby in addition to atmospheric electricity also magnetic earth currents and the energy from the higher atmosphere (at least partially) may be simultaneously obtained, this last system for collecting the atmospheric energy is of particular importance for the future.

Of course everywhere instead of spark gaps suitable grid vacuum tubes may be employed as producers for undamped oscillations. The separate coils of the producer network with large diameters may be connected with one another through separate conductors all in parallel or all in series or in groups in series. By regulating the number of oscillations and also the extent of the voltage more or less large collector coils of this kind may be employed. The coils may also be divided spirally over the entire section. The coils may be carried out in annular form or also in triangular, quadrangular, hexagonal or octagonal form.

Of course wires may be carried from a suitable place to the centre or also laterally which serve the current waves as guides. This is necessary when the currents have to be conducted over mountains and valleys and so forth. In all these cases the current must be converted into a current of suitable periodicity.

As already hereinbefore mentioned separate collecting balloons may be directly metallicly interconnected at equidistant sta-

tions distributed over the entire country or may be connected by interpolation of suitable condenser batteries by means of high voltage conductors. The static electricity is converted through a spark gap into dynamic energy of a high number of oscillations, and could then in such form, with a suitable arrangement of the connections, observing various measures of precaution, be employed as source of energy after separate or special regulation.

According to this invention in order to increase the collecting effect of the balloon in the aerial collector conductor or in the earth wire, radiating collectors are employed. These consist either of incandescent metal or oxide electrodes in the form of vacuum grid tubes, or electric arcs (mercury and the like electrodes) Nernst lamps, or finally flames of various kinds may be simply connected with the respective conductor.

It is well known that energy can be drawn off from a cathode consisting of an incandescent body opposite an anode charged with positive electricity (vacuum grid tube). Hitherto however, a cathode was always first directly placed opposite an anode, and secondly the system always consisted of a closed circuit.

Now if we dispense with the ordinary ideas in forming light or flame arcs in which a cathode must always stand directly opposite an anode, and if we place an incandescent cathode opposite an anode charged to a high potential or another body freely floating in the air, or regard the incandescent cathode only as a source of unipolar discharge (which represent group and point discharges in electro-static machines similar to unipolar discharges), it may be ascertained that incandescent cathodes and less perfectly all incandescent radiators, flames and the like admit of relatively large current densities and allow large quantities of electric energy to radiate into the open space in the form of electron streams as transmitters.

The object of this invention is as described below, if such incandescent oxide electrodes or other incandescent radiators or flames are not freely suspended in space but connected metallicly with the earth so that they can be charged with negative terrestrial electricity, these radiators possess the property of absorbing the free positive electrical charges contained in the air space surrounding them (that is to say of collecting them and conducting them to earth). They can therefore, serve as collectors and have, in comparison to the action of the spikes, or points, a very large radius of action R; the effective capacity of these collector is much greater than the geometrical capacity ( $R_0$ ) calculated in an electro-static sense.

Now as our earth is surrounded as is well



known, with an electro-static field and the difference of potential

$$\frac{\delta V}{\delta h}$$

of the earth field according to the latest investigations, is in summer about 60 to 100 volts and in winter 300 to 500 volts per metre of difference in height ( $\delta h$ ), a simple calculation gives the result that when such a radiation collector or flame collector is arranged for example on the ground, and a second one is mounted vertically over it at a distance of 2,000 metres and both are connected by a conducting cable, there is a difference of potential in summer of about 2,000,000 volts and in winter even of 6,000,000 volts and more.

According to Stefan Boltzmann's law of radiation, the quantity of energy which an incandescent surface (temperature  $T$ ) of 1 sq. cm. radiates in a unit of time into the open air (temperature  $T_0$ ) is expressed by the following formula:

$$S = \epsilon (T^4 - T_0^4) \text{ watt/sq. cm.}$$

and the universal radiation constant  $\epsilon$  is according to the latest researches of Ferry (Annales de Chimie et de physique 17 page 267 (1909)) equal to  $6.30 \times 10^{-12}$  watt/sq. cm.

Now if an incandescent surface of 1 sq. cm. shows, as compared with the surrounding space a periodic fall of potential  $\delta V$  it radiates (independent of the current direction, that is to say of the sign) in accordance with the above formula, for example at a temperature of  $3725^\circ \text{C.}$  an energy of 1.6 kw. per sq. cm. per second. As for the radiation the same value can be calculated for the collection of energy, but reversed. Now as carbon electrodes at the temperature of the electric arc support on the current basis a current density up to from 60 to 65 amperes per sq. cm. no difficulties will result in this direction in employing radiating collectors as accumulators.

If the earth be regarded as a cosmically insulated condenser in the sense of geometrical electro-statics  $\alpha$  there results from the geometric (compare Ewald Rasch, "das elektrische Bogenlicht" (The electric arc light) page 169) capacity of the earth according to Chwolson:

For negative charging  $1.3 \times 10^6$  Coulomb  
 For negative potential  $V = 10 \times 10^8$  volts.  
 From this there results however,  $EJT \approx 24.7 \times 10^{24}$  watt/Sec. Now if it is desired to make a theoretic short circuit through an earthed flame collector this would represent an electric total work of about  $79,500 \times 10^{10}$  kilowatt years. As the earth must be regarded as a rotating mechanism which is thermo-dynamically, electromagnetically, and also kinematically coupled with the sun and stars system by cosmic radiations and

gravitation a diminution of the electric energy of the earth field is not to be feared. The energies which the incandescent collectors would withdraw from the earth field can only cause by the withdrawal of motor work a lowering of the earth temperature (temperature  $T_E = 300$ ) and reduce this to that of the world space ( $T = 0$ ) by using the entire energy. This is however not the case as the earth does not represent a cosmically entirely insulated system. On the contrary there is conveyed to the same according to the recent value corrected by Ferry for the solar constants through the radiation from the sun an energy of  $18,500 \times 10^{10}$  kw. Accordingly any lowering of the earth temperature ( $T_E$ ) without a simultaneous lowering of the sun's temperature ( $T_S$ ) would contradict Stefan Boltzmann's law of radiation.

$$S = \epsilon (T_S^4 - T_E^4).$$

From this it must be concluded that if the earth temperature ( $T_E$ ) sinks, the total radiation  $S$  absorbed by the earth increases, and further also that the secular speed of cooling of the earth is directly dependent on that of the sun and the other radiators cosmically coupled with the sun and is connected most closely with these.

The incandescent radiation collectors may, according to this invention, be employed for collecting atmospheric electricity if they (1) are charged with the negative earth electricity (that is to say when they are directly connected by means of a metallic conductor with the earth) and (2) if large capacities (metal surfaces) charged with electricity are mounted opposite them as positive poles in the air. This is regarded as the main feature of the present invention as without these inventive ideas it would not be possible to collect with an incandescent collector, sufficiently large quantities of the electrical charges contained in the atmosphere as technology requires; the radius of action of the flame collectors would also be too small, especially if it be considered that the very small surface density (energy density) ( $\epsilon$  about  $= 2 \times 7 \cdot 10^9$  St. E. per sq. cm.) does not allow of large quantities of charge being absorbed from the atmosphere.

$\alpha$ ) Calculated according to Poisson's calculation;

$\Delta V = -4\pi\delta$ ; as here the alteration of the potential or potential gradients only takes place in the direction of the normal, this calculation assumes the simple form

$$\delta = \frac{1}{4\pi} \times \frac{\delta^2 V}{\delta n^2}$$

It has indeed already been proposed to employ flame collectors for collecting atmospheric electricity and it is known that

their collecting effect is substantially greater opposite the points. It is however, not known that the quantities of current which could hitherto be obtained are too small for technical purposes. According to my experiments the reason for this is to be found in the too small capacities of the collector conductor poles. If such flame or radiating collectors have no or only small positive surfaces, their radius of action for large technical purposes is too small. If the incandescent collectors be constantly kept in movement in the air they may collect more according to the speed of the movement, but this is again not capable of being carried out in practice.

By this invention the collector effect is considerably increased by a body charged with a positive potential and of the best possible capacity being also held floating (without direct earth connection) opposite such an incandescent collector which is held floating in the air at a desired height. If for example, a collecting balloon of sheet metal or of metalized balloon fabric be caused to mount to 300 up to 3,000 metres in the air and as positive pole it is brought opposite such a radiating collector connected by a conductor to earth, quite different results are obtained.

The metallic balloon shell (with a large surface) is charged to a high potential by the atmospheric electricity. This potential is greater the higher the collecting balloon is above the incandescent collector. The positive electricity acts concentratedly on the anode floating in the air as it is attracted through the radiation shock ionization, proceeding from the incandescent cathode. The consequence of this is that the radius of action of the incandescent cathode collector is considerably increased and thereby also the collecting effect of the collecting balloon surface. Further the large capacity of the anode floating in the air plays therefore an important part because it allows of the taking of large charges, and thereby a more uniform current is obtained even when there is a large consumption: this cannot be the case with small surfaces.

In the present case the metallic collecting balloon is a positive anode floating in the air and the end of the earth conductor of this balloon serves as positive pole surface opposite the surface of the radiating incandescent cathode, which in turn is charged with negative earth electricity being conductingly connected to earth.

The process may be carried out by two such contacts (negative incandescent cathode and anode end of a capacity floating in the air) a condenser and an inductive resistance being switched on in parallel, whereby simultaneously undamped oscillations may be formed.

In very large installations it is advisable to connect two such radiating collectors in series. Thus an arc light incandescent cathode may be placed below on the open ground and an incandescent cathode which is heated by special electro-magnetic currents be located high in the air. Of course for this the special vacuum Liebig tubes with or without grids may also be employed. An ordinary arc lamp with oxide electrodes may be introduced on the ground and the positive pole is not directly connected with the collecting balloon, but through the upper incandescent cathode or over a condenser. The method of connecting the incandescent cathode floating in the air may be seen in Figs. 29-33.

B is the air balloon, K a Cardan ring (connection with the hawser) C the balloon, L a good conducting cable, P a positive pole, N negative incandescent cathode, and E earth conductor.

Fig. 29 represents the simplest form of construction. If electric oscillations are produced below on the ground by means of a carbon arc lamp or in other suitable way a considerably greater electric resistance is opposed to that in the direct way by inserting an electrical inductive resistance  $\rho$ . Consequently between P and N, a voltage is formed, and as, over N and P only an inductionless ohmic resistance is present, a spark will spring over so long as the separate induction coefficients and the like are correctly calculated. The consequence of this is that the oxide electrode (carbon or the like) is rendered incandescent and then shows as incandescent cathode an increased collecting effect. The positive poles must be substantially larger than the negative in order that they may not also become incandescent. As they are further connected with the large balloon area which has a large capacity and is charged at high voltage, an incandescent body which is held floating in the air and a positive pole which can collect large capacities is thereby obtained in the simplest way. The incandescent cathode is first caused to become incandescent by means of separate energy produced on the earth, and then maintained by the energy collected from the atmosphere.

Fig. 30 only shows the difference that instead of a round balloon a cigar shaped one (of metal or metalized fabric) may be employed and also a condenser  $\delta$  is inserted between the incandescent cathode and the earth conductor so that a short circuited oscillation circuit over P, N  $\delta$  and  $\rho$  is obtained. This has the advantage that quite small quantities of electricity cause the cathode to become incandescent and much larger cathode bodies may be rendered incandescent.

In this form of construction both the in-

candescent cathode and also the positive  
 electrode may be enclosed in a vacuum  
 chamber as may be seen in Fig. 32. A cable  
 L is carried well insulated through the  
 5 cover of a vessel and ends in a condenser  
 disc 5. The cover is arched in order to  
 keep off the rain. The vessel is entirely or  
 partially made of magnetic metal and well  
 insulated inside and outside. Opposite the  
 10 disc 5 another disc 6 and on this again a  
 metallic positive pole of the vacuum tube  
*g* with the incandescent cathode (oxide  
 electrode) N is arranged. The negative  
 15 electrode is on the one hand connected with  
 the earth conductor E, and on the other  
 hand with the inductive resistance 9 which  
 is also connected with the cable L with the

between the two poles 1 and 2. As the  
 cathode 2 is connected with the negatively  
 charged earth, and therefore always acts as  
 a negative pole, a form of rectification of  
 the alternating current produced by the  
 70 dynamo 3 is obtained, the second half of  
 the period is always suppressed. The work-  
 ing circuit may be carried out in the same  
 way as in Fig. 34; the working spark gap  
 7 may however be dispensed with, and in-  
 75 stead thereof between the points *n* and *m* a  
 condenser 5 and an induction resistance 9  
 may be inserted from which the current is  
 taken inductively.

Fig. 36 represents a form of construction 80  
 similar to Fig. 34 only that here instead of  
 an arc lamp a Neopent incandescent body

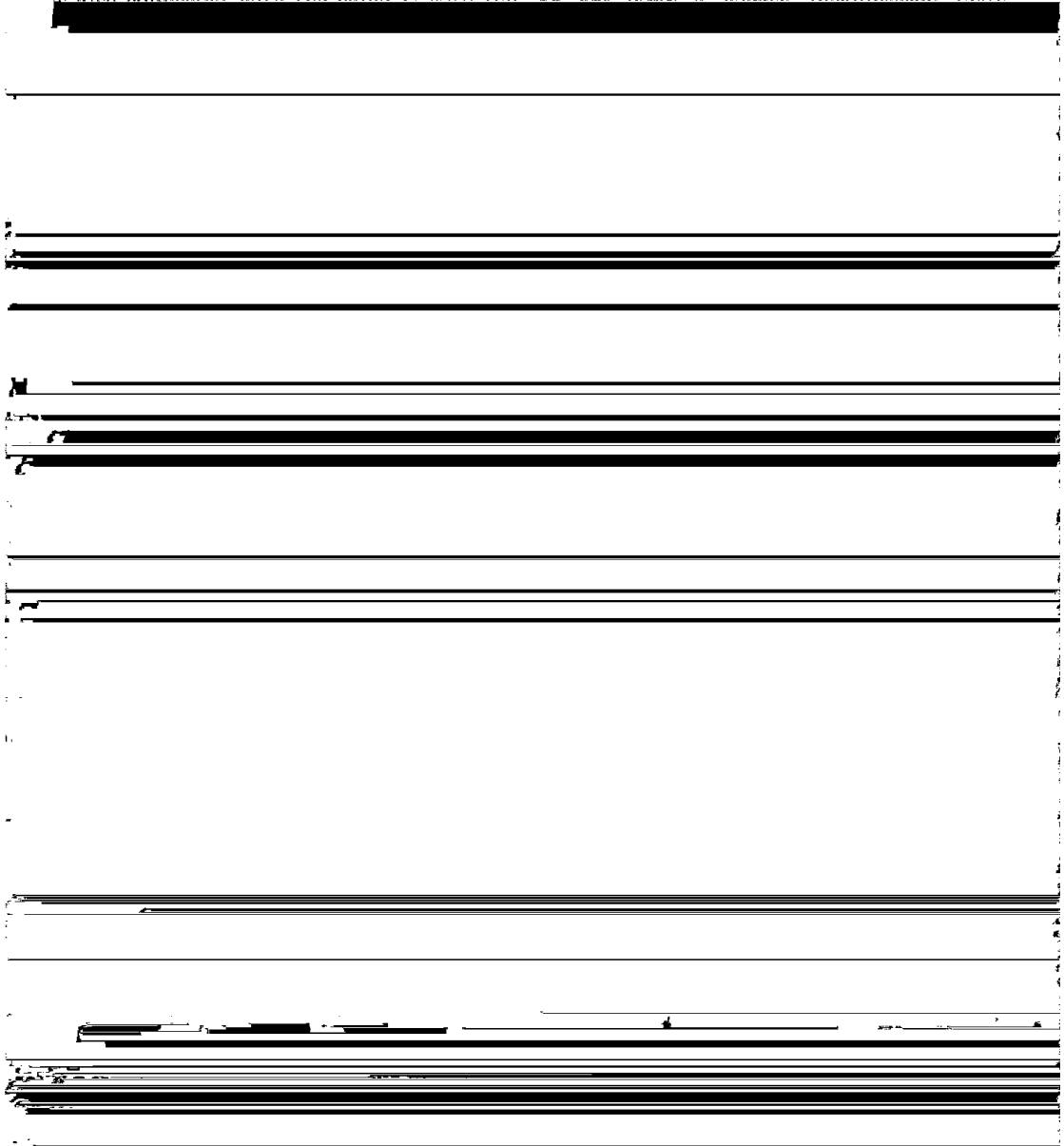

comprising a conductor, means to support same above the earth level, an inductance therein, a spark gap associated with said conductor, a second spark gap of much higher relative resistance in parallel therewith and an energy receiving circuit coupled with the spark gap of lesser resistance.

3. An electrical energy generating system comprising a collecting surface, means to support same above the earth level, a conductor connecting said collecting surface with the earth level, a choke in said conductor, an electromagnetic resistance converting electrostatic energy to electromagnetic energy, a safety higher resistance in parallel therewith and a net work coupled with the conversion resistance of lesser value.

4. An electrical energy generating system comprising electric conductors spaced above the earth to form electromagnetic oscillating circuits, conductors connecting to earth level, electrostatic to electromagnetic energy conversion means therein, a safety high electrostatic resistance in parallel therewith and means to alter the electromagnetic characteristic of the circuits.

5. An electrical energy generating system comprising in combination a static collecting surface arranged above the earth, conductors connecting to earth level, a pair of

spark gaps in parallel of different electrostatic resistance, a utilization net work shunted across the spark gap of lesser resistance and an electromagnetic choke in said conductors.

6. An electrical energy generating system comprising an open circuit energy collecting aerial, a pair of sparking gaps in parallel of widely different resistance, connected thereto and a closed electric oscillation circuit in shunt across the gap of lesser resistance.

7. An electrical energy generating system comprising an open circuit energy collecting aerial, a pair of sparking gaps in parallel of widely different resistance connected thereto, a closed electric oscillation circuit in shunt across the gap of lesser resistance, a plurality of electrostatic collecting surfaces, means to connect said collecting surfaces in parallel in groups and means to connect said groups symmetrically with said aerial.

In witness whereof, I have hereunto signed my name this 30 day of Dec., 1920, in the presence of two subscribing witnesses.

HERMANN PLAUSON.

Witnesses:

H. F. ARMSTRONG,  
W. H. BEESTON.



# Nu Energy Technologies

---

*A Leading Source for Clean & Economical Energy...*  
*powering our future with revolutionary radio ionic energy*

---

## **INVENTION AND DISCOVERY**

### **Radiant Energy Power Generation**

*Nuclear  
Science  
has been  
incorrect  
since the  
advent of  
the Atomic  
"chain  
reaction"*

It would be logical to expect that the discovery of fission was the authoritative answer to nuclear science. It would be normal also to expect that no single individual could really claim to be its "inventor," since it is a natural physical process. The efforts of hundreds of dedicated scientists were required to bring it into existence. Countless descriptions on the origin of atomic decay have been theorized. Since the advent of the atomic chain reaction nuclear science has been written into scientific law. However, this was based on atomic-bomb era mentality and is not correct according to what the author of this book has unveiled.

Mr. Bruce A. Perreault knows the truth about nuclear reactions. He is a catalyst who will ultimately lead humankind to the successful development of radiant energy power generators.

By any normal standard this man is the discoverer of a revised nuclear standard that promises to open new roads to invention and discovery.

---

Bruce A. Perreault, P. O. Box 22, Rumney, New Hampshire 03266-0022 USA  
Copyrighted © 1999, 2000 & 2001 All Rights Reserved

**Website: <http://www.nuenergy.org>**



**\$24.95 USD Retail**