

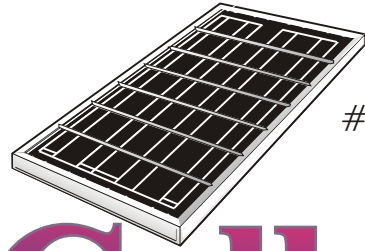

Homemade

Solar Cells



401P

© Copyright 2003

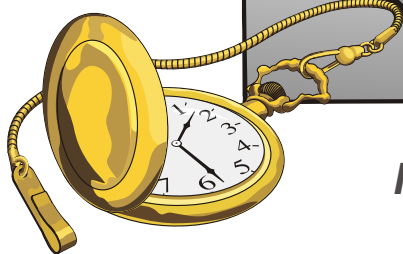
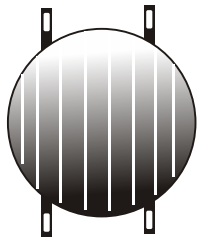
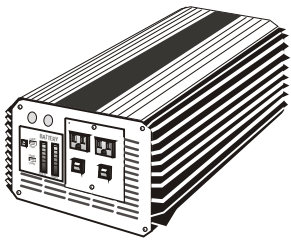

Time is running out

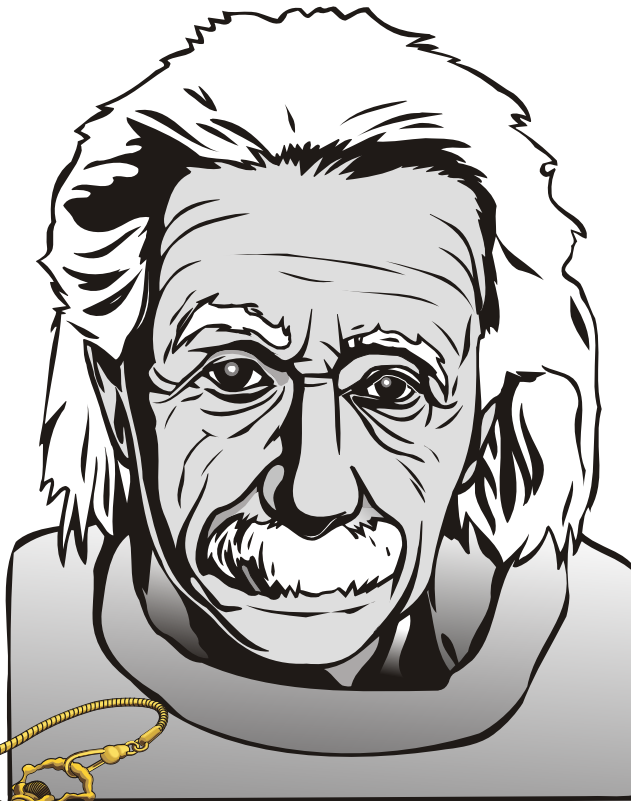

2003

FREE ENERGY

for



CREATIVE SCIENCE

www.fuelless.com

P.O. BOX 557 NEW ALBANY, IN. 47151

fuellesspower.com

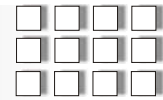

Thank you for buying these plans. It will help us in our research efforts and to tell the world about this suppressed technology.

Included is 3 different ways to make a home made solar cell:

The 1996 Japan Patent is by far the best and the most powerful. The Japan Patent uses a simple process that has been used for centuries, You simply screen print the negative and positive layers and the contact layers on to a piece of glass plate, it does not matter how thick the glass is. The layers can be sprayed on with a spray gun and an air compressor, but it is best to Screen print it. Screen printing each layer will make your solar cells last longer and they will be more efficient

If you do not know what screen printing is, you can learn about this very simple process from the Library. Also lots of info and supplies can be purchased at your local hobby store or art supply store. You can also buy supply's such as screens and such at a local Screen printing shop. or they can screen print it for you. Screen printing is very simple and cheap to do for you self right in your own home. It may take a little studying but it will be worth it. you can print up as many Solar Cells as you want for just pennies. (Cover your entire roof with them. You will have more energy than you will ever need. You can then make money selling electricity back to the electric company which should pay for it self in one to two years. The most expensive part is the deep cycle marine batteries and your inverters. Many are making a nice income every year from this, just by selling electricity back to the electric company, ask to see if your electric company has that type of program in your area. most states I heard do.

The Japan method is new and it is not limited to just a glass surface, you can also apply it right onto aluminum or copper sheeting. Look at the 1 st page, see the N type layer #2 this is what the Patent says to Print first. But if you want to print onto a metal surface the metal surface would be #5 then the 1 st print would be #4 then let it air dry and then bake at 600 degrees for 3 to 5 minutes.

(Each printed layer can be done this way.) Then your 2nd print would be #3, then you let air dry, then bake, then Print #2 Air dry/bake. Then you must print a Metal grid over #2 then let air dry, (you don't have to bake the metal print.) This will be your negative contact, #5 will be your Positive Contact, so what your doing is just simply reversing the printing layer steps. If you have never seen a solar cell the metal grid is like a metal door screen but with bigger spacing. You can buy a special metal printing ink or mix it your self as the patent says. The ink is simply made up of nickel or silver. Nickel is the cheapest and will work just fine.

Please Notice: You can not manufacture and sell the Japan Solar Cells with out there permission If you want to learn about Screen Printing we sell a VHS Video for only \$29.95

Please send \$4 for shipping.

The chemicals that are mentioned in the patent are very easy to get. You can buy them in any QTY from any Chemical supply company look one up in your yellow page phone book. Or check online, search for Chemical Supply Shops or companies.

About Photovoltaics

Photovoltaic (or PV, Solar Cells) systems convert light energy into electricity. The term "photo" is from the Greek "phos" which means light. "Volt" is named from Alessandro Volta (1745-1827, He was a pioneer in the study of electricity. So you could say that" Photo-voltaics is basically light electricity! And is most commonly known as Solar Cells. Solar cell systems are already a very important part of our lives. The simplest systems power many of the small calculators and wrist watches we use everyday. PV power is the cheapest form of electricity for powering these small devices. There are many ways to make solar cells, and one of the cheapest ways is to screen print them. There are many companies in the USA that are doing this. Many US Patents have been issued for screen printing solar cells and there are many different chemical inks that can be used. The Japanese Patent is one of many.

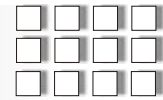

Turning Sunlight Into Electricity!

Solar Cells convert light energy into electricity at the atomic level. It was first discovered in 1839, the process of producing electric current in a solid material with the aid of sunlight wasn't truly understood for more than a hundred years.

Throughout the second half of the 20th century, the science has been refined and process has been more fully explained. As a result the cost of these devices has put them into the mainstream of modern energy producers. This was caused in part by advances in technology, where PV conversion efficiencies have been improved.

Solar Cell Materials

The most important parts of a solar cell are the semiconductor layers, this is where the electron current is created. There are a number of different materials available for making these semiconducting layers, and each has benefits and drawbacks. Unfortunately, there is no one ideal material for all types of cells and applications.

In addition to the semiconducting materials, solar cells consist of a top metallic grid or other electrical contact to collect electrons from the semiconductor and transfer them to the external load, and a back contact layer to complete the electrical circuit. Then, on top of the complete cell is typically a glass cover or other type of transparent encapsulant to seal the cell and keep weather out, and an anti-reflective coating to keep the cell from reflecting the light back away from the cell. A typical solar cell consists of a cover glass, an anti-reflective layer, a front contact to allow the electrons to enter a circuit and a back contact to allow them to complete the circuit, and the semiconductor layers where the electrons begin to complete their voyages!

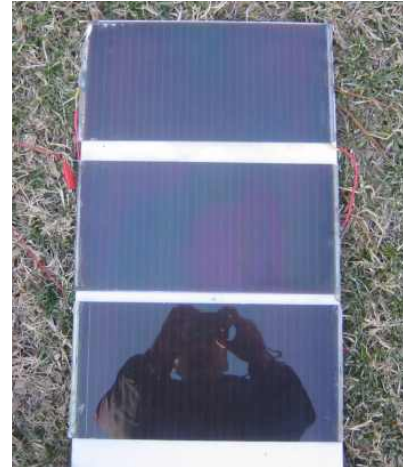

12" x 18" 12 vdc
Screen Printed Solar Cells

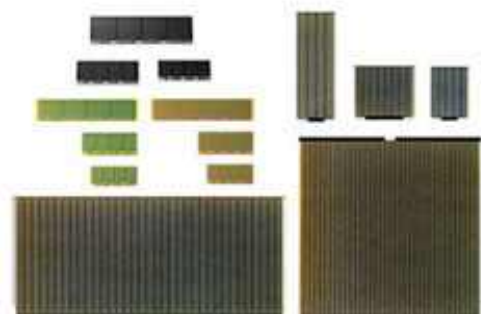

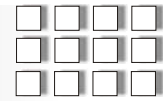

Scientists in Arizona are using screen-printing, a technique developed for printing fabrics, paper and to produce plastic, glass and metal solar cells.

The basic materials of a photovoltaic cell (solar cell) are inexpensive. The organic manufactured by Ghassan Jabbour and colleagues at the University of Arizona in Tucson have about 11/4 of the efficiency of commercial silicon solar cells, which turn 10-20 per cent of light energy into electricity. But, being cheap to produce, they can make up the loss in quantity what they lack in quality. Now the Japan screen printed solar cells are even better than that!

For more info contact: Matsushita Electric Industrial co. LTD, Osaka. Japan



A Screen printing press, the wood frame is the screen

In conventional Screen - printing, a taut piece of screen mesh fabric is stretched over a wood frame, you can buy the screens already made and the materials from any screen printing shop or screen printing supply company in your area or on the internet. Also you might want to check with your local art store, sometimes they have full kits etc...

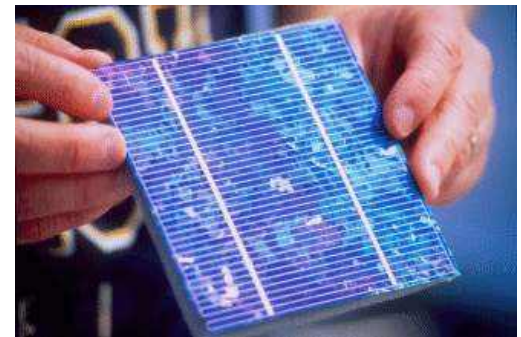

An example of a Silicon cell

The screen is then masked off using masking tape, For example: a 5" x 5" square area. the screen outside of the masking tape is then coated with a block out liquid or paint, this is so when you apply your semiconducting ink that you mix, it will go through just the area that you masked off when you apply a rubber squeegee to it. The screen can then be placed on any table top and hinges attached to the back of the wood frame and the table, this will insure the screen can move up and down. Then get a small wood paint stick and using a small nail, hammer one end to the front side of wood frame. This will be your kick leg and will help keep your screen in an upward position when needed. Take a 5" x 5" piece of glass and place it right under the open 5" x 5" area of the open screen mesh. When the leg is flipped back the screen comes down and you grab your rubber and wood handled squeegee and with the ink in front of your rubber squeegee pull toward you applying pressure so ink will go through screen, once you have passed by the 5" x 5" area then flip the screen back up and reverse squeegee to flood the screen for the next print.

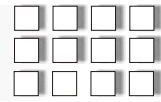

The Research group mentioned earlier, Jabbour's group, print very flat, thin cells, onto glass in a similar way. First they coat the glass with a transparent electrically conducting material (metal ink) that acts as one of the solar cell's electrodes. On top of this, they lay down a thin film of a polymer, which helps to gather current from the photovoltaic material.

Finally they deposit a blend of two organic compounds that convert light into electricity. One is a carbon-based molecule called a fullerene, it produces charged particles that carry an electrical current when light shines onto the molecules. The other is a polymer, it ferries the current to the electrodes on the top and the bottom of the solar cell.

Under blue light, these screen-printed solar cells have an efficiency of 4.3 per cent. And the Japanese cells are much greater than that! Many of the flexible solar cell panels that you see today are screen printed.

Now lets take a look at what The Dupont Company is doing with there solar cells. Dupont is involved in the development of solar cell metallisation since the 1970's. Although all PV cell manufacturers use different processes to make there solar cells, the metallisation of the rear and front sides is in many cases **DONE BY SCREEN PRINTING!** Which has shown itself to be one of the most economic way to produce solar cells.

Recently, Dupont achieved a real breakthrough in the formulation of front-side contacts for silicon solar cells that has resulted in customers, such as photowatt, to realize the screen printing efficiency by changing their anti-reflection technology from **titanium dioxide to silicon nitride**. This came at just the right time for the Photowatt solar cell company, Because they have been using there own past material for the front side metallisation since it first started manufacturing solar cells. The development of the metallisation from Dupont for the back side, (p-side). These pasty inks are either silver pastes containing Al, or pure Al pastes to secure a good ohmic contact with the p-side of the solar cell. We have told you all this to help you better understand and leam the screen printing solar cell process and what others are doing.

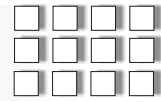

The Japan Solar Cell Patent

Note: You can Use an outside Grill to bake the Screen Printed layers. It is a good idea to make small cells, 8" x 10" or what ever. It is easier to fit into the Grill, We suggest Baking in side a large roasting pan and then put the roasting pan inside the preheated grill and shut the lid. It is suggested that you try and make 3 prototype cells first, Work out all the details, Test them, and then start on a large production of Solar Cells. It will all get much easier once you have done it. It is also suggested that you bake them out side. You don't want any fumes in the house, an outside grill is the best and most readily available oven there is and propane is cheap. I hear you may be able to make them without a Nitrogen atmosphere if not try special gas companies or make some yourself, it is supposed to be nonflammable.

Screen Printing: You start with a small 14" x 14" wood frame 2x2". Then a plastic or clothe screen is stretched over the frame tightly one side at a time, and then stapled down on all 4 sides, we suggest buying a yellow 200 mesh screen from a screen printing supplier, Then you put an image of what ever you want to print into the screen by photo emulsion or by cutting a lacquer or water film with an exacto knife. (see our Screen Printing Video) Once you have your image you place the finished screen onto a flat smooth table top, attach it to a 14" long 2" x 4" with 2 door hinges. using wood screws, then you attach the 2" x 4" on to the table so it and the screen will not move. the screen should only go up or down. you then put your 8" x 10" glass under the screen, register it, then lay the screen down over the glass and apply your ink and then with a small 12" rubber Squeegee, You pull the ink over the image and it is pushed thru the screen mesh and thru the image that you cut and smoothly is printed onto the glass.

SUPPLIERS;

Screen Printing Books and supplies; NDS 1-800-783-3883 Indianapolis, IN.
(See also Art Store's, Hobby Shop's, Arts and Crafts, Screen printing company's.)
They also sell copper sheeting.

Solar Cell Screen Print Chemicals: Search the web, simply type in the chemical you are looking for and many suppliers will pop up. Example: Cadmium Sulphide Supplier..... We have checked and you can find all the chemicals and info on them free on the web.

Also see: www.stanfordmaterials.com/semi.html

The Stanford Materials Company

1. Cadmium Sulphide in powder form = Cds (or if already thick liquid or ink OK.)
2. Cadmium Chloride + Cdcl 2 (Powder or liquid form)
3. Propylene glycol + pg in liquid form
4. Carbon Powder, if you can not find none make your own wood carbon powder?
5. Cadmium = Cd
6. Tellurium = Te

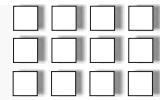

THE COPPER CHLORINE SOLAR CELL: Buy a roll of Thin Copper sheeting, cut a 1.5" diameter piece out with a pair of cutters, then sand polish the copper on both sides with some fine grade steel wool. then by using a propane torch heat the copper while gripping it with rubber handled pliers, and let the copper get red hot, until it glows, move the copper over the flame evenly for about 3 minutes then allow to cool slowly. Then once it is cooled dip it down in an acid solution of 1/2 water and 1/2 acid, **WARNING!** Never pour water into acid always pour acid into water. The acid that you can use is MURIATIC ACID (Hydrochloric Acid) you can buy it at any hardware store, or you can use a solution of nitric acid. REMEMBER TO WEAR PROTECTIVE GOGGLES OR OTHER SUITABLE EYE PROTECTION, AND WORK IN A WELL VENTILATED AREA. DO NOT SMELL THE FUMES OR MAKE CONTACT WITH YOUR SKIN, WEAR RUBBER GLOVES. THESE ACIDS CAUSE SEVERE BURNS. KEEP OUT OF THE REACH OF CHILDREN. NOTICE: WE ARE NOT RESPONSIBLE FOR ANYTHING IN THESE PLANS , YOU BUILD AND EXPERIMENT AT YOUR OWN RISK.

Keep it in the acid for only a half a minute or longer, the idea is to keep it dipped in the acid long enough for the black oxide to come off of the top layer, under that is the photo sensitive red cuprous oxide. Remember you should only have a dark bright red layer left. Note: do not leave it in to long it will eat away the red. once you have done that then it's O.K. to wash off the acid with water, do all of this outside or in your garage, make sure all of the acid is off. wash no less than 3 minutes, now look at the copper disk on one side you will have bright copper, this is the positive side, and on the other side you will have red this the negative side the side you face toward the sun. now mix a small solution of 95 water and 5 Clorox bleach, now take the red side and look for scratches if there are any you must paint them with enamel oil base paint, apply paint to any where on that side where copper is showing through, now glue a plastic lid on to red side, let it dry then drill a small hole in the top pour in Clorox bleach and water solution and then place a copper or steel wire through the hole and onto the bottom, wire must be submerged in the solution, now tape or glue the hole up with the wire in it. now tape Solar cell out into the sun and using a DC volt meter attach + to the copper back, and - to the steel wire coming out of hole. you will see the meter move showing a voltage, now block the sun with your hand and watch the voltage drop. make many of these for just pennies and put them in series or parallel to increase your voltage or amperage. These type of cells are only 5 of the japan cells.

I have heard that the Japanese cells are about 95 of the American made silicon cell that is a very expensive process. Screen printing them is the cheapest way to go and is easy, once you get the hang of it.

Chemicals: needed: 1. Cadmium Sulphide = cds 2. Cadmium Chloride == cdcl 2 (These can be in powder form) 3. Propylene Glycol = pg this is used to mix the powders into a pasty but screen printable liquid ink type. 4. Carbon powder, if you can not find it make some yourself out of burnt wood etc... 5. Cadmium = cd
6. Tellurium = Te

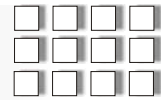

Copper Chorline Solar Cell

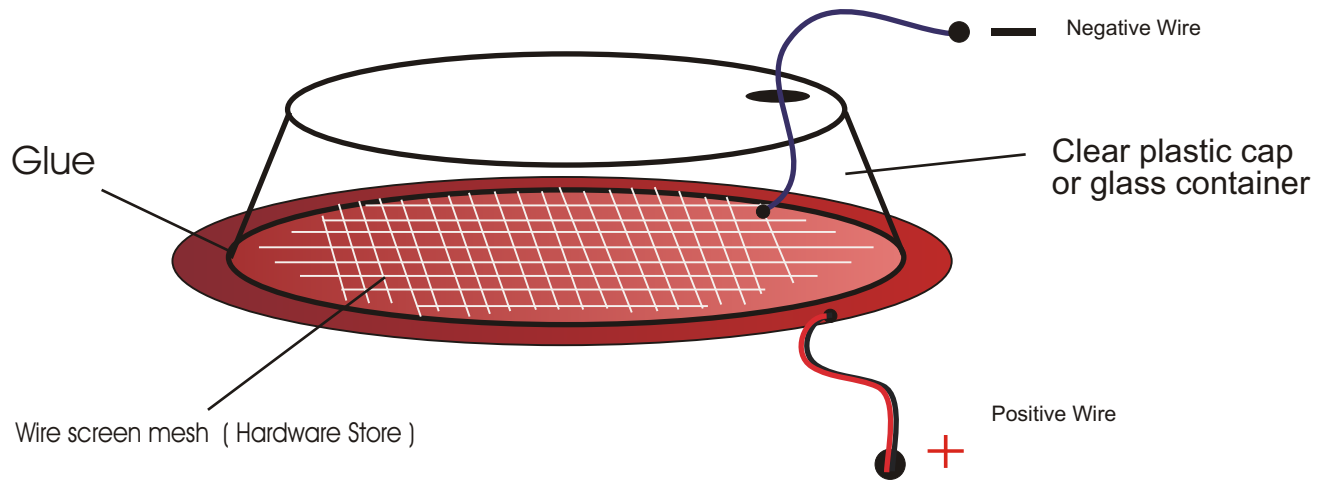

There are many different ways to construct these home made cells, the above drawing shows a wire screen mesh that you can buy at any hardware store. Using wire mesh makes a much more powerful cell, than just using one strand of wire. before assembly, attach the wire mesh to the red copper side. use a small weight in the center of the wire mesh and using clear silicon, glue down the edges, (make sure you don't get any glue in the area where the plastic cap is going to sit.) now let that sit over night, then glue on your clear plastic cap on to the red copper side of cell.

these also make a great science fair project as well as providing free electricity to your home. It's going to take some practice if you do any of these projects.

Knowledge is Power! Study this Patent well and read all you can from the free info on the internet as well about screen printing solar cells and the many different chemicals that can be used! The Japan Solar Cells are better to make and will last a long time!

Creative Science & Research: PO BOX 557 New Albany IN, 47151
www.fuelless.com www.fuellesspower.com

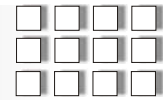

A More Simplified Copper Solar Cell

Similar to the Copper Chlorine Cells. We have found that if you use Conductive Nickle Paint you will get far better results. But start out using the screen mesh or the aluminum wire. You can buy Nickle Paint on the internet. Simply search for "Nickle Paint suppliers" on your search engine. You can do the same for finding thin copper sheeting. There is also a company in Louisville KY, that sells copper sheeting, see Conner Manufacturing 18th st. Louisville, KY. (502)-587-1387 Or Vendome Copper & Brass 729 Franklin St. Louisville, KY. 40202 (502)-587-1930



Warning: You build at your own risk!

Creative Science & Research PO BOX 557 New Albany, IN. 47150

Copyright 2003



The fabrication of a Modern solar cell is very complicated and a delicate process. In most cases, a large silicon ingot is grown from a small crystal in an extremely clean and sterile environment. Any dust or particle contamination even down to the atomic level during the growing process can completely ruin the ingot. Impurities must typically be kept to one part per billion.

The growing process itself is slow, and the very pure materials required are extremely costly. Because of this, a single ingot which is later sliced into thin cells approximately 0.05 centimeters thick often costs thousands of dollars to produce.

This fact coupled with the general inefficiency (7-14 typically) of even these modern cells has kept the price of photoelectric cells too high to be competitive with other sources of power.

Someday, lower cost production techniques together with higher efficiency will make widespread use of clean, renewable solar energy possible. Someday solar cells will be a very common Source of energy, the idea of deriving electricity directly from sunlight will continue to excite the inventor and experimenter.

It is well known that if even 1 of the Sahara desert were covered with the solar cells just described, it would more than supply our worlds current energy needs. We will briefly outline some of the processes and materials that are now being researched for converting the use of solar energy into electricity.

You should have no trouble building the cells that will be described in the following pages. Be cautious. Use good judgment and common sense in handling the chemicals and heating processes described. You'll find that a simple solar cell can be constructed by a persistent student, Solar cells that can make outstanding science fair projects.

The electrical output from the homemade copper cells in this article will be well below that of modern commercial cells, but the materials cost is also very low. Often a cell can be literally produced for pennies! The loss in efficiency is probably more than made up in the reduction of their price.

But again the Screen printed solar cells are far more powerful than the copper type solar cells.

COPPER SOLAR CELLS

A small, carefully made solar cell of approximately 2 1/2" diameter will produce around 5 milliamperes of current in direct sunlight. This is enough to drive a sensitive light meter or extremely sensitive relay. Banks of these cells have even been used to run small electric motors.

Experiment with the procedures described. You may stumble onto a method of producing even more efficient cells than we have. Just be sure to be very careful. The chemicals described can be dangerous if abused or mishandled. **You build at your own risk!** There are an estimated 80 trillion kilowatts of solar electrical energy available in the northern hemisphere.

Many Different types of Chemicals Have Photoelectric Properties!

There are a number of elements and chemical compounds that can be used to produce photoelectric power. They include titanium, selenium, thorium, cuprous oxide, and metals of the alkali group including sodium, potassium, rubidium, lithium, cesium and francium.

The two best substances for a homemade cells are, **selenium and cuprous oxide.**

An example of a complete Free Energy System, Using Solar cells in series and parallel to charge 12 volt deep cycle batteries, which in turn runs our 5,000 watt inverter to run your home on 120 vac x 60 Hz. We recommend replacing the solar panels with our Fuel less Engine connected to a 12 volt car alternator to keep up batteries. The lawn mower motor we use as a back up.

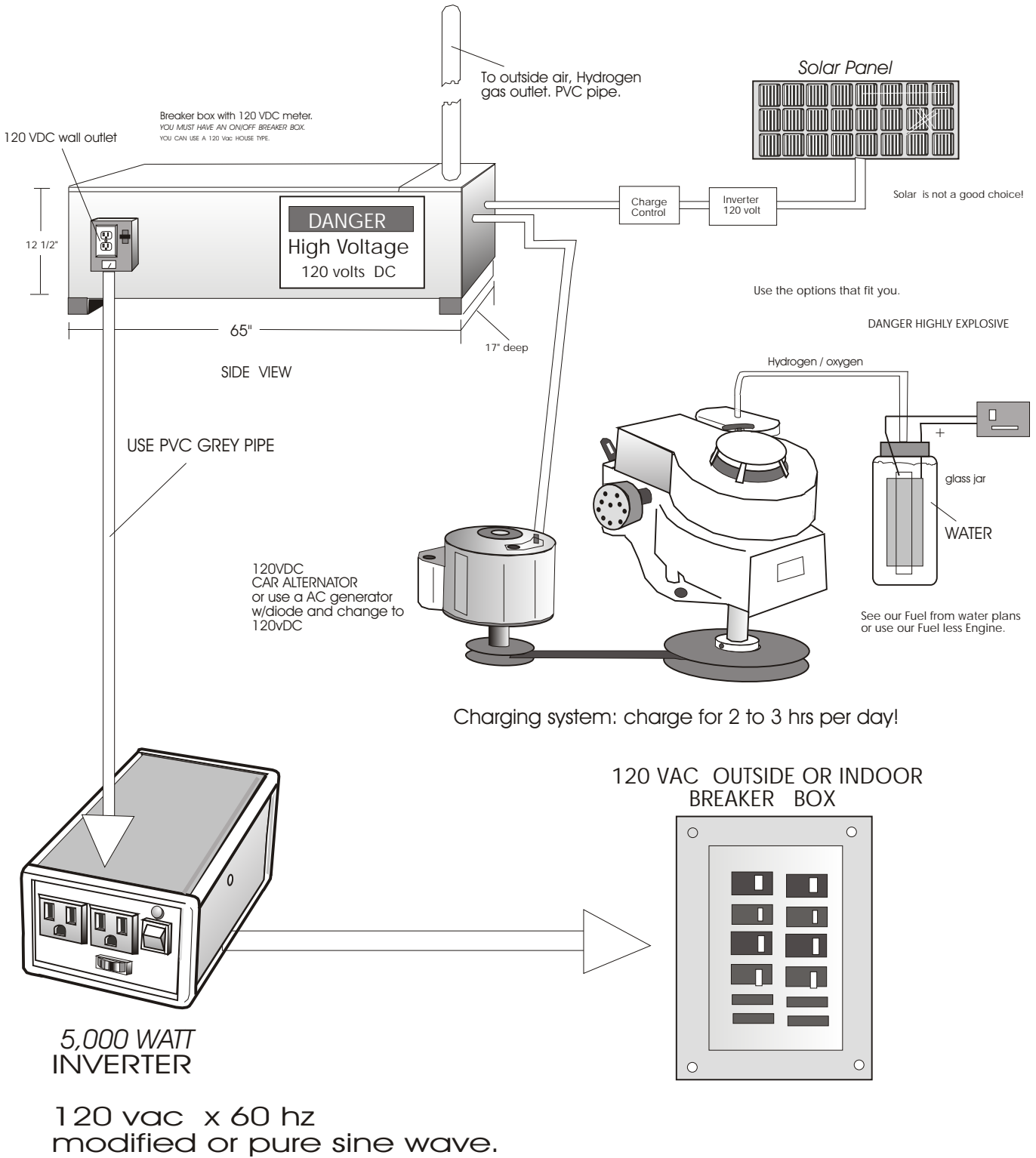

Selenium was extensively used in the production of commercial solar cells before silicon. Although it can be a somewhat difficult to find a supplier and it is a toxic heavy metal, it is relatively inexpensive and can often be found in old model radio sets, where it was used in the rectifier of the power supply. A selenium photocell is made from a metal plate (usually iron) with one side being covered with a layer of selenium. A very thin layer of silver or gold is spattered over the selenium layer forming a layer of current-carrying material that allows light to pass through it. This layer is called a transparent electrode. A metal electrode called a collector, rests on the gold or silver near the edge of it.

Wires are attached to the collector and the iron plate to deliver the electric current to the load. Although not as great an output as more modern cells, a selenium photocell can produce as much as eight milliamperes for each square inch of surface area exposed to bright sunlight.

Cadmium sulfide is probably the most promising low-cost solar cell second only to silicon.

If you have an interest in electronics, you will undoubtedly recognize cadmium sulfide (the common "CDS" cell) as the material used in light detecting circuits. Although inventors have realized for some time that a number of materials such as cadmium sulfide change their electrical resistance in the presence of light, it has only been in fairly recent times that it was realized they could also be used to generate power also.

The most important attribute of cadmium sulfide is that it could be mass-produced efficiently using a thin-film procedure wherein very thin layers of its photosensitive components are evaporated onto a base metal or screen printed.

Cadmium cells are fairly efficient (3-5 typical) making them a good rival for amorphous silicon cells.

An Experimental Cell With Cuprous Oxide

The best cell by far for the you to start with, is a cell made with cuprous oxide ($\text{Cu}^{\wedge}\text{O}$). Copper actually has two oxides, a red

oxide called cuprous oxide, and a black oxide called cupric oxide (CuO).

The dark red cuprous oxide has photoelectric properties but black cupric oxide does not. The black oxide that forms on the outside of your cell must be removed because it is opaque and will not allow light to reach the cell's active surface.

Building your solar Cell

Step 1. Cut a piece sheet copper into the size and shape you wish for your cell. Although .025 inch thick copper was used for the cells described here, just about any thickness will do.

Copper is a soft metal and can be cut with tin snips or even with an old pair of scissors.

Cut your cell with a diameter of 1 1/2 inches, we start with a smaller cell because it is much easier to work with. The larger the heat source the bigger the size copper you can use to create your solar cell. After you get the hang of it you can then build larger cells..

As you cut the copper, be sure to leave a "handle" so that you may grip the cell with pliers without marring the cell's active surface.

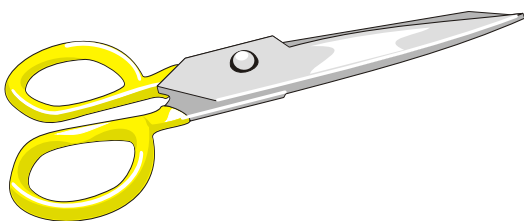

Thin Copper sheet

Step 2.

the surface of the cell must be made extremely clean. Prepare a solution of nitric acid by carefully mixing 20 parts nitric acid and 80 parts distilled water. Remember to wear protective goggles or other suitable eye protection and to work in a well ventilated area whenever you work with chemicals.

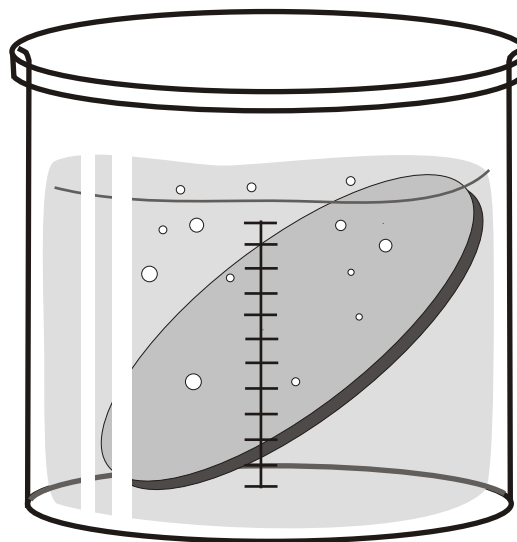

Copper disk, scoured & polished and dipped in acid.

IMPORTANT! ALWAYS ADD ACID TO WATER! NEVER ADD WATER TO ACID!

Begin by carefully polishing the face of the cell with a fine grade of steel wool until it shines brightly. Then place the cell with the shiny side up, in the solution of nitric acid.

Soon, tiny bubbles will form on the copper disk. Stir the solution occasionally. When the disk seems shiny and well cleaned, remove and rinse it under cool running water.

WARNING! Never to allow your skin to touch the acid, and that no acid remains on the cell.

The cell will sometimes work without the acid cleaning if it is simply well polished by the steel wool. However, we strongly recommend the acid cleaning.

Nitric acid and the other chemicals mentioned in the text can be easily ordered from a number of mail-order chemical houses such as found in the classified section of magazines such as Popular Science.

Step 3. Cuprous oxide is now formed on the disk by heating it over a Bunsen burner, or propane torch. A gas stove can be used, but results may be unpredictable.

The time the disk must be heated varies greatly depending on the heat of the torch, and the thickness and size of the copper piece. Using a standard propane torch from the hardware store and a disk of the described size, I found 2 minutes and 40 seconds to be ideal. If you heat it too long, you run the risk of burning off the oxides. Heating for too short a time may prevent the oxides from forming fully.

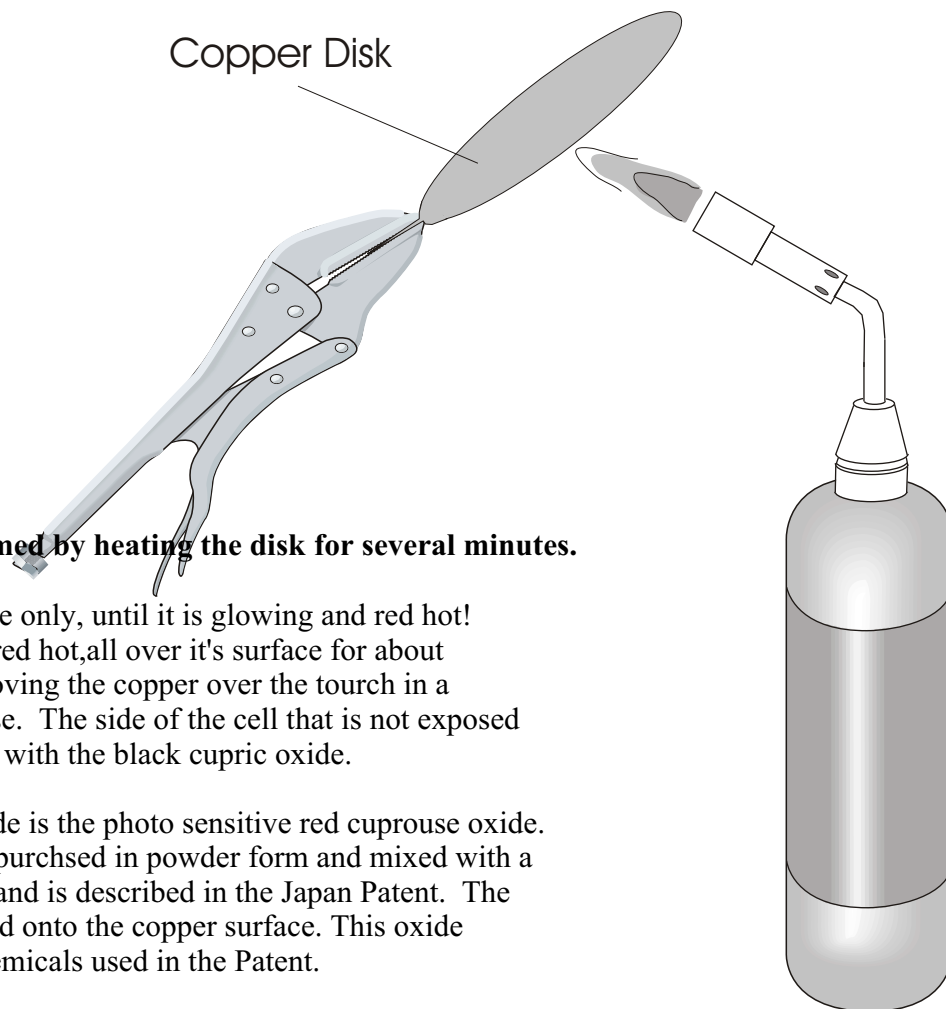

Photo sensitive oxides are formed by heating the disk for several minutes.

The Copper is heated on one side only, until it is glowing and red hot! copper must be kept at an even red hot, all over its surface for about 2 minutes and 45 seconds by moving the copper over the torch in a round motion, counter clock wise. The side of the cell that is not exposed to the flame will become coated with the black cupric oxide.

Now just beneath this black oxide is the photo sensitive red cuprous oxide. This red cuprous oxide can be purchased in powder form and mixed with a special solvent, which is clear, and is described in the Japan Patent. The Oxide can then be screen printed onto the copper surface. This oxide material is different than the chemicals used in the Patent.

After heating your cell for the prescribed time, it must be carefully cooled. There are two ways to go about this. You can cool the copper quickly by either placing it face down on a flat metal surface, or by waiting a few moments and then quenching it in cool water. The advantage to cooling the cell quickly is that the unwanted black cupric oxide will often flake off the cell due to the difference in contraction rates of the oxides. Unfortunately, I have had bad luck with this method despite extensive experimentation with different temperatures and procedures.

What has worked very well for me is to bring the cell's temperature down as slowly as possible making sure the black oxide does not crack at all. Once completely cool, the cell is immersed in the nitric acid bath. You must wait while the acid begins to dissolve the black oxide. Then you remove and rinse the cell.

A very weak solution of sodium cyanide can also be used with good results. However, you should be extremely careful when using it. Cyanide is an extremely poisonous chemical, and if accidentally mixed with an acid can create deadly fumes. At this point the black oxide covering the cell can be rubbed away with steel wool and a little elbow grease. After all of the Black oxide has been removed, your cell should have a uniform coating of deep red on one side.

black oxide has been removed, your cell should have a uniform coating of deep red on one side. Don't worry if the very outside edges of your cell don't have the coating, this is due to uneven cooling and is normal. Keep in mind that the red coating must not be scratched or scraped away to reveal the bare copper plate beneath. If this happens the cell might short in the final step and not work at all.

Testing: There are now several ways that you can test you solar cell even though it is not finished, it can generate power.

If you are building the cell for a science fair or other demonstration, you may want to stop and use the cell at this point while the cuprous oxide is still visible. If you hold the cell near a source of bright light, a current will be generated between the cuprous oxide coating and the copper plate. The copper will form the positive terminal and the cuprous oxide the negative.

Making contact with the copper portion of the disk is very easy. Simply sand a small bare spot on the back of the solar cell and attach a wire. Attaching the wire and making a good contact with the cuprous oxide is more difficult, it is hard to solder and attach anything, but it can be done by pressure gluing or other.

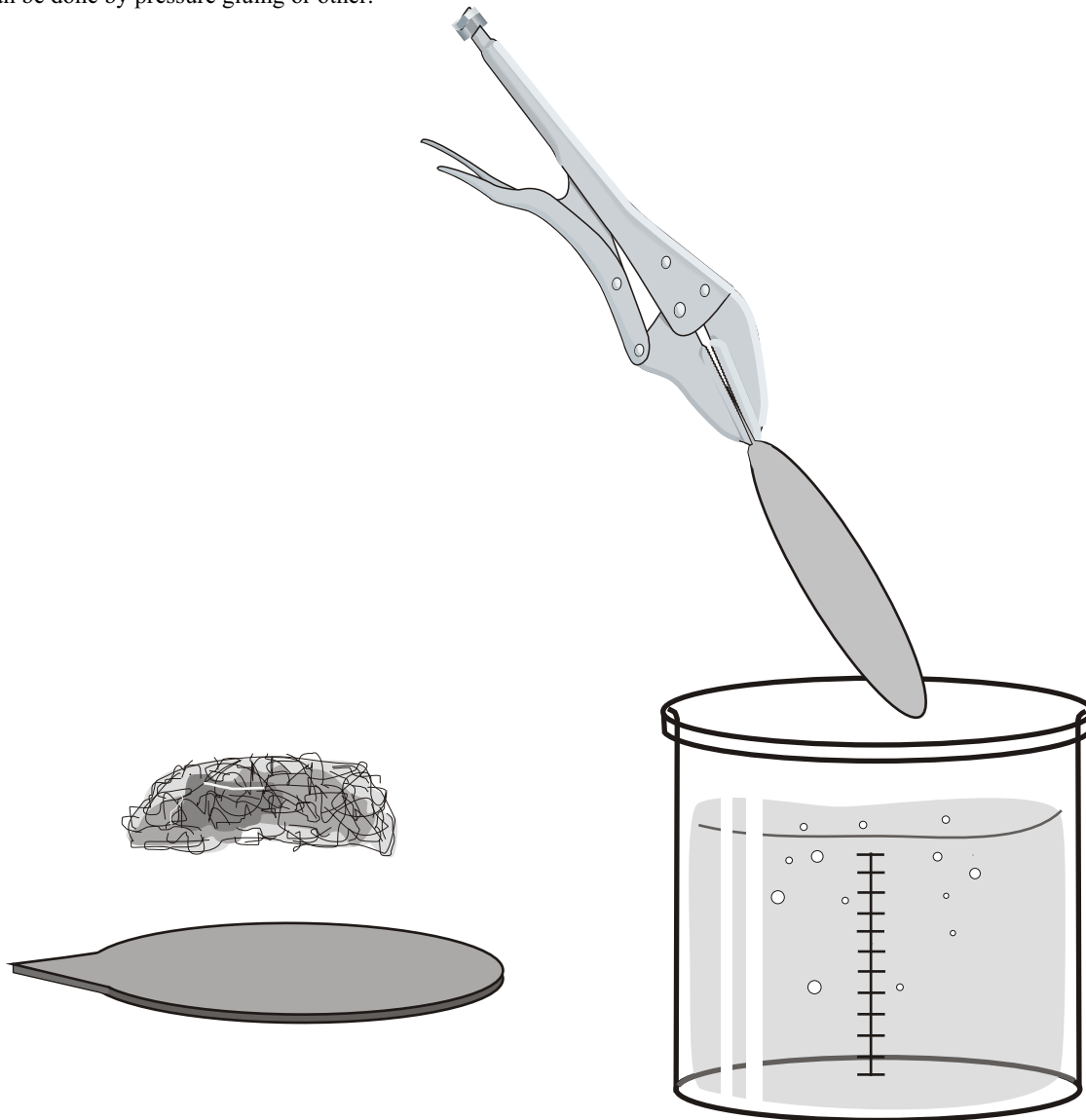

method of making a good contact with this large of a surface area, is by attaching a wire grid to it. A better way is to apply a very thin layer of silver or gold called a transparent electrode. An easily fabricated but temporary transparent electrode can be made from salt water. Or as seen in our Chlorine cells and a container glued to the cell and the liquid applied. A solution of salt or acid will conduct electricity and also pass light to the cell. Drip a small amount of salt water or your spit, on to the center of the cell. Make sure that the water rests only on the cuprous oxide and does not touch any of the solar cell's copper surface or it will short out and will not produce any free electrical energy at all.

Now, attach one wire from a galvanometer, digital voltmeter using the milliamp or low voltage setting to some exposed portion of the cell's copper surface. Usually the back or the edges have some exposed copper. Touch the other meter lead to the surface of the water. The meter will spring to life. Next, bring a bright source of light such as a 100 watt bulb near the cell. The meter should show a slightly smaller voltage as the light approaches. Your cell will produce best in sunlight! The cell is changing some of the light into electricity but is having to counteract the current generated by the saltwater, hence the drop in voltage. The salt water actually acts as an electrolyte and with the oxide generates its own current just as a small battery would. Another way that you can test your cell is by making a wire electrode for the surface. This is done simply by coiling some 30 gauge silver-plated wire or aluminum wire and by holding it against the (cells) cuprous oxide surface with a sheet of glass. A good way is to coil the wire around is to use a cone shaped dowel or other object first in order to make good even spirals. Make sure that the wire touches the cuprous oxide only, and none of the bare copper. You will always have some bare copper around the edges of the cell, so it is best to paint with enamel paint, let dry and then work with the cell.

By simply attaching one wire of your meter to the silver wire, and one to the cell's exposed copper, you will be able to register a small current when a light is brought near. In this form, the cell can be operated indefinitely and makes an excellent Science Fair Display.

Making The Silvering Solution: The final step in making your own solar cell will be to make a permanent transparent electrode. When properly applied, this will give your cell a beautiful semi-mirrored finish and allow you to make electrical contact with the whole cuprous oxide face of the cell. This step is probably the trickiest in the production of the cell.

But, just as with the last steps, it becomes somewhat easier with practice. Using distilled water, make ten percent solutions each of ammonia water, potassium hydroxide and potassium sodium tartrate in separate test tubes. A ten percent solution can be created by mixing 10 parts by weight of solute in 90 parts of water. Please remember that the test tubes can become warm or even hot when the water is first added, so be sure to use Pyrex glass test tubes. Also, make certain you have ample ventilation when mixing the ammonia solution. Dissolve in 1 oz. water a single crystal of silver nitrate. The crystal should be somewhat larger than the head of a match. Begin adding drops of the ammonia solution to the dissolved silver nitrate until the water first becomes brown, and then just begins to clear. Add a drop of potassium hydroxide to this solution. Then again begin adding drops of ammonia water until the solution just begins to clear. The solution will remain somewhat cloudy. Too much ammonia in the solution can dissolve the cuprous oxide coating and can damage or ruin the cell. Stir the mixture while adding a single drop of the potassium sodium tartrate solution. The mixture is now ready and should be used immediately.

Applying The Solution

Temperature and variations in the chemical mixture can dramatically change the time required to complete the silvering process. The best way to complete this step is by simple visual examination of the process as it proceeds.

With the cell on a flat surface, begin by carefully pouring the silvering mixture on to the center of the cell. Remember to avoid letting this mixture contact any exposed copper. A good trick is

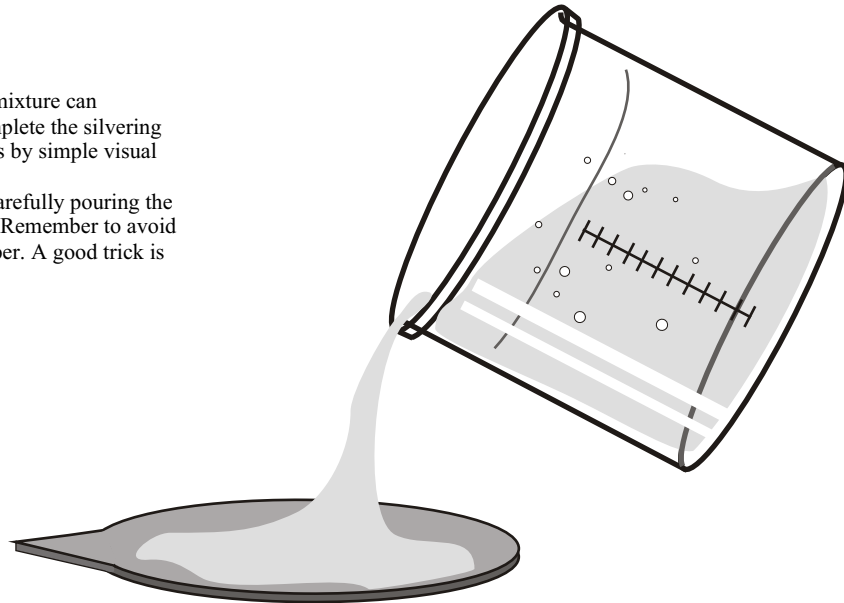

to cover with paint or lacquer any exposed copper surfaces on the face of the cell. Continue pouring until the liquid has covered as much of the surface as you can. If all the exposed copper on the surface has been properly protected with the lacquer, you can actually pour the solution until it comes right to the edge. Since water has an affinity for itself called "cohesion", it won't spill over the edge. Very soon, a thin film of silver will begin to form over the cell's surface. The liquid should be poured off when the red oxide is still slightly visible beneath the silver. allow the silvering process to go a little too long rather than not long enough since some of the silver coating can be polished away. You should now have a smooth silver coating through which the red oxide is barely visible.

Completing the Cell contact can now be made to the cuprous oxide face of the cell by means of a ring of lead or silver-coated wire which is slightly smaller in diameter than the disk itself. With the ring held firmly against the disk, a protective coating of thin lacquer can be applied. Make certain the lacquer does not come between the wire and the disk. With wires attached to the disk's copper back and the lead or silver ring, the cell is complete. The disk can now be housed behind glass, mounted to a sheet of plastic, cast in a clear resin or housed in any other enclosure you desire!

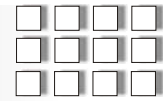

Screen Printing Supplies and Devices

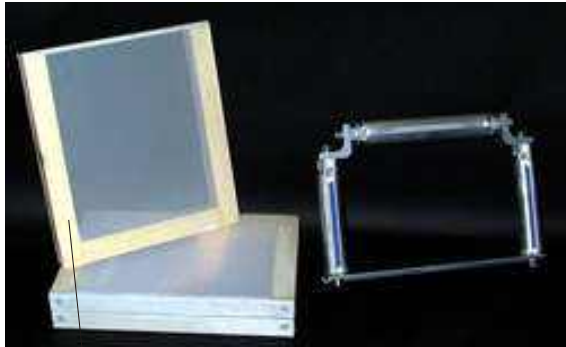

Wood Screen printing Frame(s)



Photo Emulsion / premixed for applying to back side of screen, (see our Screen Booklet.)



Wood and special rubber Squeegee

Photo emulsion aluminum screen coater



Wood and special rubber Squeegee for pulling the ink over the inside of the wood framed screen to print image.



Photo emulsion aluminum screen coater's for different size wood framed screens.



6 - color t-shirt & cap printing press. You do not need this to print solar cells, all you need is a flat and sturdy table top.

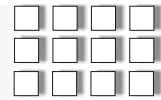

Cadmium Sulphide (CdS)

Crystal properties

Crystal growth method:	Seeded vapor phase growth
Crystal growth orientation	(0001)
Maximum size	Up to 50mm diameter
Variations:	Doped crystals (on request)

Crystallographic properties

Crystallographic structure:	Hexagonal a= 0.4135nm, c= 0.6749nm
Defects structure	Inclusions with < 10 μ m in size
Color:	Red

Physical properties

Density:	4.82 g/cm ³
Melting point:	1748 °C
Hardness:	4 Mohs
Thermal conductivity:	15.9 W m ⁻¹ K ⁻¹
Dielectric constant:	8.28 C, 8.64 I C
Band gap (@ 300 K):	2.53 eV
Specific resistivity:	~108 (Ohms cm)
Emmission wavelength:	600 nm @ 300 °K

Optical properties

Transmission range:	0.5 μ m -15 μ m (2mm thick)
Refraction index:	No = 2.517, Ne = 2.548

United States Patent [19]

Aramoto et al.

[11] Patent Number: **5,538,903**

[45] Date of Patent: **Jul. 23, 1996**

[54] **METHOD OF MANUFACTURING SOLAR CELL**

[75] Inventors: Tetsuya Aramoto, Osaka; Nobuo Nakayama, Hirakata; Kuniyoshi Omura, Higashiosaka; Mikio Murozono, Hirakata, all of Japan

[73] Assignee: Matsushita Electric Industrial Co., Ltd., Osaka, Japan

[21] Appl. No.: 342,445

[22] Filed: Nov. 18, 1994

[30] Foreign Application Priority Data

Nov. 18, 1993 [JP] Japan 5-314478

[51] Int. Cl.⁶ H01L 31/18

[52] U.S. Cl. 437/5; 136/260; 136/264; 136/265; 427/74; 427/76; 427/346; 437/9; 437/234

[58] Field of Search 437/5, 9, 234; 427/74-76, 346; 136/260, 264, 265

[56] References Cited

FOREIGN PATENT DOCUMENTS

47-5880 3/1972 Japan .
48-26976 8/1973 Japan 437/9

60-33278 2/1985 Japan
62-30318 2/1987 Japan
1-235116 9/1989 Japan
4-188623 7/1992 Japan .
5-154441 6/1993 Japan .

CREATIVE SCIENCE
P.O. BOX 8001
NEWARK, NJ 07102
437/9
437/9 7150

OTHER PUBLICATIONS

"Matsushita News", Feb. 1, 1983, pp. 1-5.
T. Arita et al, *Solar Energy Materials*, vol. 23, pp. 371-379 (Dec. 1991).

Primary Examiner—Aaron Weisstuch
Attorney, Agent, or Firm—Ratner & Prestia

[57] ABSTRACT

A method of manufacturing a solar cell, comprising the steps of forming a layer of n-type compound semiconductor, a layer of p-type compound semiconductor, and an electrode layer on a glass substrate, wherein at least one of said steps of forming a layer of compound semiconductor layer comprises preparing a paste by mixing a semiconductor raw material and a viscous agent, applying said paste to said substrate, drying said paste to harden it, and firing the dried paste, and vibrating said substrate during or after the application of the paste, to remove the bubbles in the paste, resulting in a semiconductor layer which is smooth, dense, and having good adhesion, thus realizing a solar cell with improved and uniform characteristics.

24 Claims, 3 Drawing Sheets

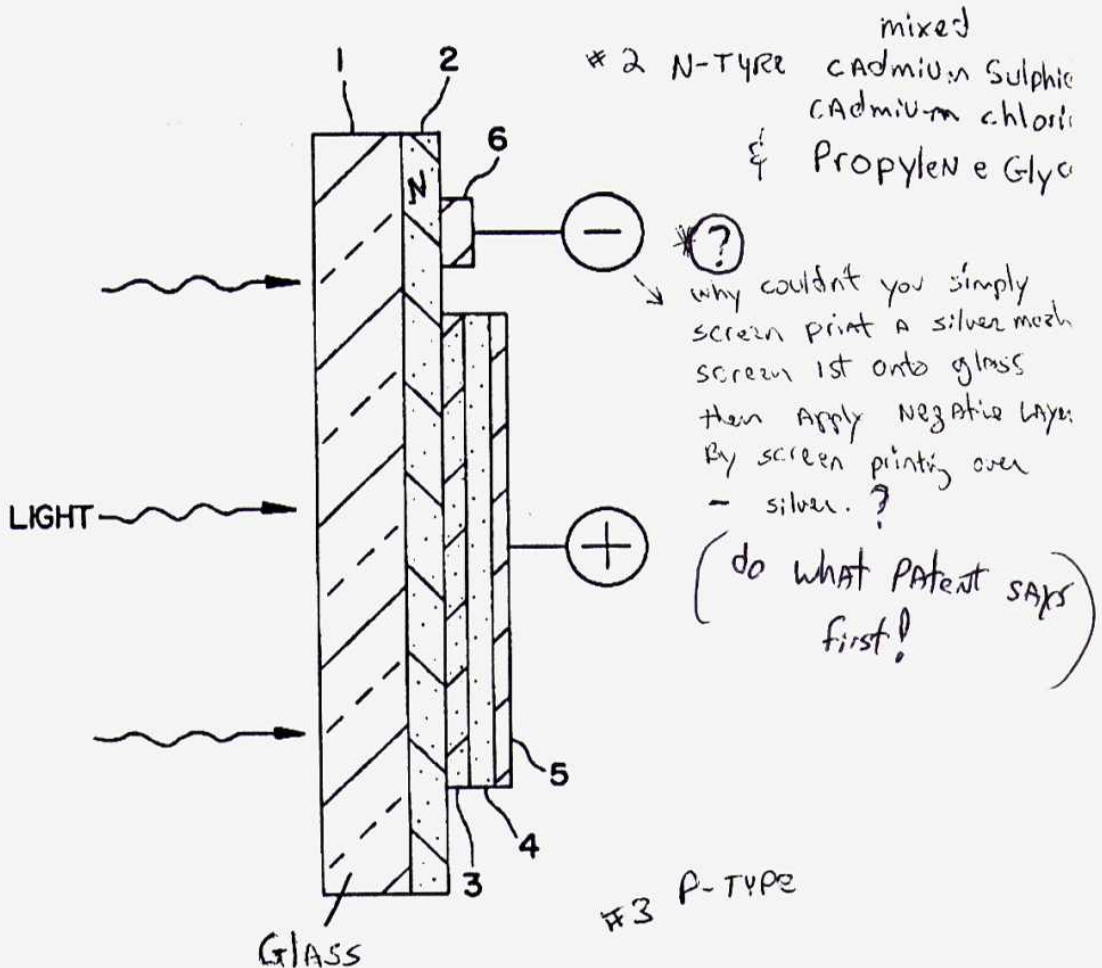

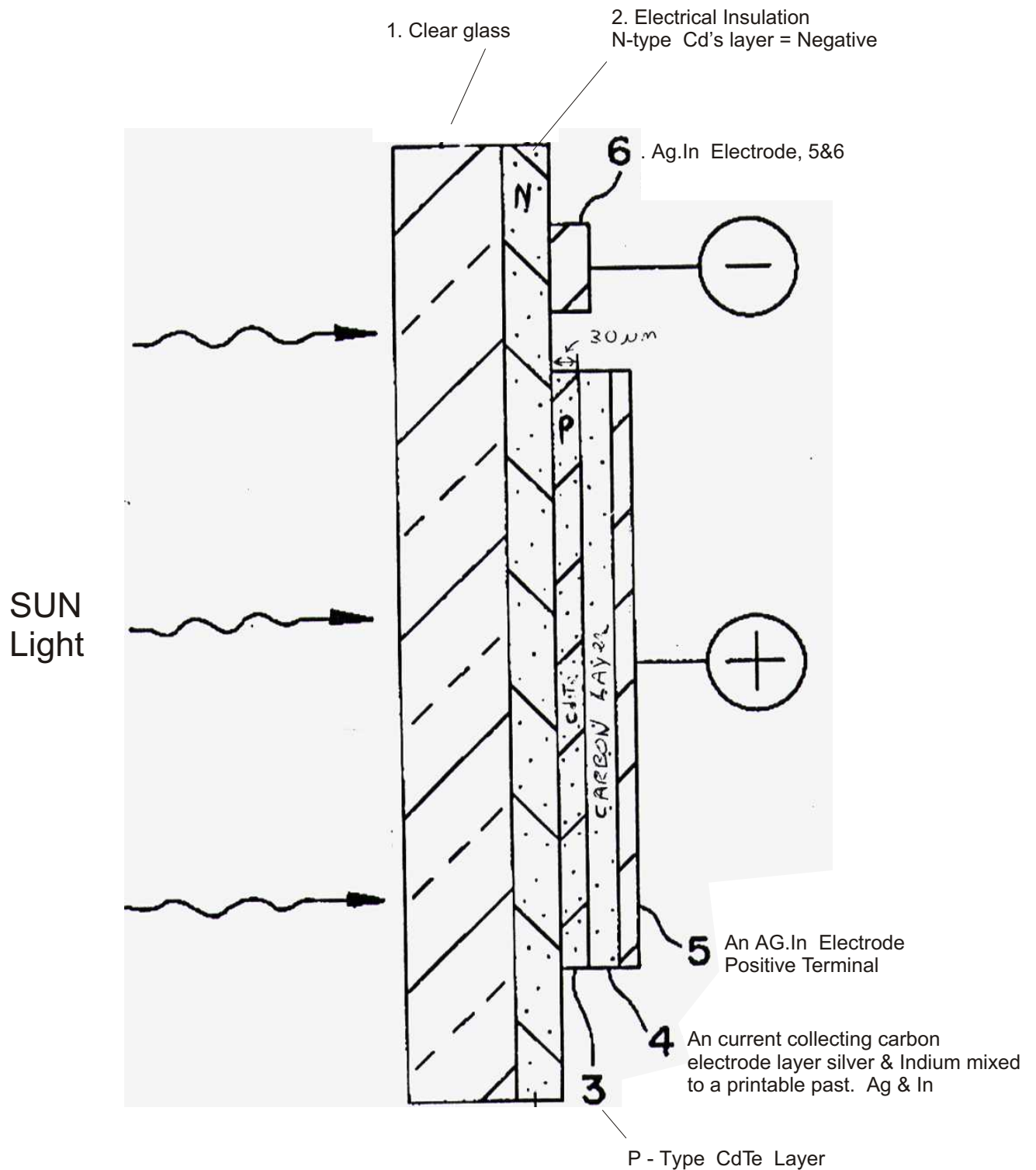

Double or triple print #2, to do this you print the first layer, let dry and then print the 2nd layer = 60 um thickness. #3 layer print only one layer using the same screen printing screen.

METHOD OF MANUFACTURING SOLAR CELL

BACKGROUND OF THE INVENTION

1. Field of the Invention

This invention relates to a method of manufacturing a solar cell of compound semiconductors by way of coating | and firing.

2. Description of the Prior Art

In recent years, expectations for solar cells as a clean energy source have been raised, in view of the global warming, acid rain, ozone layer destruction, and other such environmental destruction. For the wide usage of solar cells to occur, improvement of the photo-electric conversion efficiency and reduction of the cost are most important, that purpose, solar cells made of compound semiconductors of Group III-V materials such as GaAs, InP, Group II-VI materials such as CdS/Cu₂S, CdS/CdTe, and Group I-II-VIa materials such as CuInS₂, CuInSe₂, as well as crystalline and amorphous silicon solar cells, have been investigated in many countries of the world. Among these, solar cells made of compound semiconductor heterojunctions of n-CdS/p-CdTe have been produced commercially, with relatively low material cost, conversion efficiency as high as 10%, less deterioration over long time periods, and a relatively simple manufacturing process suitable for mass production consisting of printing, drying, firing (sintering or baking), resulting in a high density arrangement on a glass plate and realization of high voltage without outer wire connection, as well as large area cells.'

A typical solar cell of Group II-VI semiconductor, of which a sectional view is shown in FIG. 1, comprises a glass substrate 1 of high light transmittance and electrical insulation provided on one surface thereof with an n-type CdS layer 2, a p-type CdTe layer 3, a current collecting carbon electrode layer 4, an Ag-In electrode which is the positive terminal 5, and an Ag-In electrode which is the negative terminal 6 formed by laminating with printing and baking of each layer. Usually, although not shown in the figure, the thus prepared solar cell element is provided, on both the Ag-In electrodes, with a copper paste layer deposited, dried, and baked for easy soldering of lead wires. The cell is then covered all over with a passivation layer of a thermosetting resin such as epoxy and baked.

Light, including that of the sun, falls on the surface of the glass substrate 1 opposite to the surface having the above solar cell element layers, to generate electrical power by photo-electric conversion.

As the substrate, a heat-resistant barium borosilicate glass is employed which has a very low alkali metal content and a high softening point. 55

In the manufacturing of the compound semiconductor solar cell by the coating and firing method, it is important that each of the n-type compound semiconductor layer, p-type compound semiconductor layer, and electrode layer have uniform thickness, a smooth surface, and no pin holes! Especially if the n-type CdS semiconductor layer formed directly on the substrate is uniform, smooth and non-porous, the adherence of the Ito the substrate is improved, resulting in an increase of the light transmittance, decrease of the sheet resistance, and, further, an increase of the photo-current and improvement of the characteristics of the cell.

Conventionally, to obtain such a layer, a paste made of the powdered compound semiconductor or elements therefor, an electroconducting agent, and a viscous agent mixed together was kept under reduced pressure to remove bubbles therein and after the deposition, the substrate was held horizontally at about 50°C., which was lower than the drying temperature of the viscous agent, to reduce the viscosity of the viscous agent and uniformly precipitate the raw material powders in order to obtain a high density layer. However, if the bubbles were removed from the paste before coating, it sometimes happened in the coating process by screen printing that bubbles were introduced from the surrounding atmosphere, resulting in uneven deposition or pin-holes. Also, with the heat treatment only after coating, the raw material powders did not always uniformly precipitate and the bubbles were not sufficiently removed, resulting in the layer not being flat, or of uniform thickness. The pin-holes left after coating and firing of the layers caused an increase of the sheet resistance. Especially, if pin-holes were formed in the p-type CdTe layer, the carbon particles of the carbon electrode layer formed thereon penetrated into the pin-holes up to the CdS layer under the CdTe layer, causing internal short circuiting or current leakage, fatally damaging the solar cell performance.

SUMMARY OF THE INVENTION

It is an object of the present invention to provide a new method of manufacturing compound semiconductor solar cells comprising n-type and p-type compound semiconductors and electrode layers having improved performance, uniform characteristics, and low production cost, brought about by formation of the layers without pin-holes and with uniform thicknesses and smooth surfaces.

To obtain the above object, a method of manufacturing a solar cell according to the present invention comprises steps of forming a layer of an n-type compound semiconductor, a layer of a p-type compound semiconductor, and an electrode layer on a glass substrate, wherein at least one of said steps of forming a layer of compound semiconductor comprises preparing a paste by mixing a semiconductor raw material and a viscous agent, applying said paste to said substrate, drying said paste to harden it and firing said dried paste, and vibrating said substrate during or after the application of the paste.

BRIEF DESCRIPTION OF THE DRAWINGS

FIG. 1 is a schematic sectional view of a Group II-VI compound semiconductor solar cell of n-CdS/p-CdTe type.

FIGS. 2(A)-2(B) are microphotographs of sections of sintered CdS layers on a glass substrate.

FIGS. 3A-3D are graphs of the open circuit voltages, short circuit currents, fill factors, and intrinsic photoelectric conversion efficiencies of solar cells fabricated according to the present invention, as well as by the conventional method.

DETAILED DESCRIPTION OF THE INVENTION

An example of the method of manufacturing a Group II-VI compound semiconductor solar cell according to the present invention is now explained by referring to FIG. 1. A paste was prepared by mixing a fine powder of cadmium sulphide (CdS), cadmium chloride (CdCl₂), and propylene glycol (PG), the CdCl₂ being a flux, and the PG being a viscous agent.

The paste was applied to a substrate of barium borosilicate glass by screen printing to form a coating layer of 60 μm thickness.

The glass substrate was subjected to vibration of 20 μm amplitude and 28 kHz ultrasonic frequency by contacting the output end of a piezoelectric vibrator on the outer end of the substrate for 5 seconds, whereby the roughness of the deposited layer due to the screen net disappeared and the bubbles in the layer were removed. The substrate with the vibrated layer was then dried in the atmosphere at 120° C. (PG was removed by vaporization), and sintered at 690° C.

A comparison substrate coated with a CdS layer was fabricated by a similar method but without the application of vibration.

The light transmittance and sheet resistance of the two kinds of samples were then measured and microphotographs of sections thereof ($\times 500$) were taken. The results are shown in Table 1 and FIGS. 2(A)–2(B).

TABLE 1

	CdS layer formed according to the present invention	CdS layer formed without vibration
Light transmittance (%) ($\lambda = 0.7 \mu\text{m}$)	63 %	60 %
Sheet resistance (Ω/cm^2)	28	33

As is observed in FIG. 2(B), the CdS layer on the substrate prepared without vibration has projections and depressions on the surface, void spaces and/or pin-holes, and the thickness is not uniform. Moreover, it is not sufficiently adherent to the substrate. On the contrary, the CdS layer of the sample shown in FIG. 2(A) fabricated with vibration has few voids and/or pin-holes, uniform thickness, and a smooth surface, fully adherent to the substrate. Numerically, Table 1 indicates improvements of the light transmittance by 5% and reduction of the sheet resistance by 15%. Thus it is expected the CdS layer formed with the vibration would have superior characteristics as the window layer of a solar cell.

Next, CdTe paste was prepared by kneading (well) an equi-mol mixture of cadmium (Cd) and tellurium (Te) powders with addition of CdCl₂ and PG, and the paste was applied in a 30 μm thickness on the above CdS sintered layer by screen printing, dried in the atmosphere, and sintered at 620° C., to form a CdTe layer.

Then, a carbon paste, prepared by kneading carbon powder and a viscous agent made of a solution of a resin in an organic solvent was applied on the CdTe layer, to form an electricity collecting electrode 4 on the n-CdS/p-CdTe heterojunction.

Further, the carbon electrode layer 4 and the CdS layer 2 were provided with a positive terminal 5 and a negative terminal 6 of Ag₂In by depositing Ag₂In paste by screen printing and drying and baking, the Ag₂In paste being prepared by kneading of silver (Ag) and indium (In) powders with a viscous agent made of a solution of a resin in an organic solvent.

On the positive and negative electrodes 6 and 5 of Ag₂In, copper paste was applied by screen printing, and dried and baked. Further, on the other parts of the cell a passivation layer was likewise applied by printing, and dried and baked, to complete the cell. The sinterings or bakings in the above processes were made in a nitrogen atmosphere.

The following describes the effect of vibration given to the glass substrate when, in the above described manufac-

turing process of a compound semiconductor solar cell, the pastes made of the mixtures of the respective powdered n-type and p-type compound semiconductor materials, flux agent, and viscous agent were applied to form the n-type and p-type layers and electrode layers on the substrate.

A: A sample cell fabricated with the semiconductor and electrode layers dried and fired after the application of the paste on the substrate without vibration, i.e. according to the prior art.

B: A sample cell fabricated with vibration given to the substrate only after the application of CdS paste, i.e. no vibration during the other processes.

C: A sample cell fabricated with vibration given only after the application of CdTe, i.e. no vibration during the other processes.

D: A sample cell fabricated with vibration given only after the application of the carbon paste, i.e. no vibration during the other processes.

E: A sample cell prepared with vibration given to the substrate after application of the CdS paste, CdTe paste, and carbon paste, with further drying and firing.

The vibration was given at 20 μm amplitude and 22 kHz frequency for 10 seconds by contacting the output end of the ultrasonic oscillator to the reverse side of the glass substrate; the reverse side being the surface on which the semiconductor layers were not applied. The other conditions were the same.

For the solar cells of these samples, the open circuit voltage (Voc), short circuit current (Isc), fill factor (FF), and intrinsic photo-electric conversion efficiency (EFF) were measured, with the results shown in FIGS. 3A–3D as values relative to the values for sample cell A taken as 1.00.

From the measurements of the sample cell B as shown in FIGS. 3A–3D, it is seen that the vibration after the CdS application has caused, by removing the paste bubbles, smoothing the film surface, and by improvement of the adhesion between the CdS layer and the substrate, resulting in an increase in light transmittance, and a reduction in surface resistance, an improvement of Isc, and, through the reduction of the number of pin-holes at the junction, improvements of Voc and FF.

From the data for the sample cell C, it is seen that the vibration after the CdTe paste application has led to the improvement of Voc, Isc, and FF as a result of CdTe grain size or orientation or other improvement in the film quality.

The measurements of the sample cell D show the contribution of the vibration after the carbon paste application to the improvement of Isc, FF, and EFF. It is thought that the contact resistance between the carbon electrode layer and the CdTe layer is reduced by the vibration.

Lastly, from the data of the sample cell E, it is clear that an about 10% increase of EFF compared to sample cell A has been obtained by the combined effect of the vibrations after each of the applications of CdS, CdTe, and carbon pastes.

Thus, it is understood that the characteristics of the solar cells are improved by the simple measure of vibrating the glass substrate after the applications of the pastes, without requiring any significant change of the process or manufacturing installation.

The method of application of the various pastes is not confined to the screen printing as referred to in the above examples. Various other methods can be employed; nozzle printing of paste from a nozzle, including printing of a figure in a desired pattern on a glass substrate by adjusting the distance between the tip of the nozzle and the surface of the substrate to change the paint thickness; relief and intaglio

printing; and spray printing of paste with a spray gun while shielding the non-printed areas by a mask.

Table 2 shows how the spread of unevenness of the surface (the difference between the maximum thickness and the minimum thickness) and the yields in production change depending upon whether or not the ultrasonic treatment is employed on every layer of the cells. As is observed, by the vibration after the paste application similar effects can be obtained as with the screen printing.

TABLE 2

Printing	Without ultrasonic treatment		With ultrasonic treatment	
	Spread of unevenness (μm)	Yield (%)	Spread of unevenness (μm)	Yield (%)
Screen	35	92	8	95
Nozzle	15	85	9	89
Relief	21	72	4	82
Intaglio	26	82	9	90
Spray	18	74	12	91

Instead of vibrating the outer circumference or the outer surface after the application of the pastes as explained above, vibration during printing of the paste may have the same effects.

For the application of such ultrasonic vibration, 5 to 10 seconds are sufficient, so that the application of paste with the vibration and further vibration thereafter of a short time less than 5 seconds is sufficient; therefore substantial elongation of manufacturing time does not occur.

Although ultrasonic vibration given to the glass substrate during or after the pastes of the n-type and p-type compound semiconductor layers and electrode layer were applied was effective, vibration given during or after application of the pastes for the formation of the terminal or passivation layer did not bring about remarkable effects on the cell characteristics.

It is added that the method of the present invention, thus far explained with reference to CdS/CdTe compound semiconductor solar cells, can be applied to the formation of other compound semiconductor layers of solar cells including Group I-III-VI₂ compounds, for example CuInSe₂, in the place of CdTe, provided the layer is formed by coating and firing.

As explained above in detail, when a solar cell is fabricated by forming a laminate of n-type and p-type compound semiconductor layers and electrode layers on a glass substrate, the layers become free of bubbles, and the surfaces flat, if vibration is given to the glass substrate during or after the paste of the raw material and viscous agent for the layer are applied; and drying and firing thereafter provide dense layers of uniform thickness and in good contact with the next layer, and a solar cell with improved, uniform characteristics.

What is claimed:

1. A method of manufacturing a solar cell, comprising the steps of forming a layer of n-type compound semiconductor, a layer of p-type compound semiconductor, and an electrode layer on a glass substrate, wherein at least one of said steps of forming a layer of compound semiconductor comprises:

preparing a paste by mixing a powdered semiconductor raw material and a viscous agent, applying said paste to said substrate, drying said paste to harden it, and firing said paste, and vibrating said substrate during or after the application of the paste.

2. A method of manufacturing a solar cell according to claim 1, wherein said vibration is of an ultrasonic pulse form.

3. A method of manufacturing a solar cell according to claim 2, wherein the application of the paste is performed by a method selected from the group consisting of screen printing, nozzle printing, relief printing, intaglio printing, and spray printing.

4. A method of manufacturing a solar cell according to claim 3, wherein the powdered raw materials for the layers of n-type and p-type semiconductors comprise elements of groups II and VI or a compound thereof.

5. A method of manufacturing a solar cell according to claim 4, further comprising a step of forming a passivation layer of resin over said cell except for the positive and negative output terminals thereof.

6. A method of manufacturing a solar cell according to claim 3, wherein said n-type compound semiconductor layer comprises CdS, and said p-type compound semiconductor layer comprises one of CdTe and CuInSe₂.

7. A method of manufacturing a solar cell according to claim 6, further comprising a step of forming a passivation layer of resin over said cell except for the positive and negative output terminals thereof.

8. A method of manufacturing a solar cell according to claim 3, further comprising a step of forming a passivation layer of resin over said cell except for the positive and negative output terminals thereof.

9. A method of manufacturing a solar cell according to claim 2; wherein the powdered raw materials for the layers of n-type and p-type semiconductors comprise elements of groups II and VI or a compound thereof.

10. A method of manufacturing a solar cell according to claim 9, further comprising a step of forming a passivation layer of resin over said cell except for the positive and negative output terminals thereof.

11. A method of manufacturing a solar cell according to claim 2, wherein said n-type compound semiconductor layer comprises CdS, and said p-type compound semiconductor layer comprises one of CdTe and CuInSe₂.

12. A method of manufacturing a solar cell according to claim 11, further comprising a step of forming a passivation layer of resin over said cell except for the positive and negative output terminals thereof.

13. A method of manufacturing a solar cell according to claim 2, further comprising a step of forming a passivation layer of resin over said cell except for the positive and negative output terminals thereof.

14. A method of manufacturing a solar cell according to claim 1, wherein the application of the paste is performed by a method selected from the group consisting of screen printing, nozzle printing, relief printing, intaglio printing, and spray printing.

15. A method of manufacturing a solar cell according to claim 14, wherein the powdered raw materials for the layers of n-type and p-type semiconductors comprise elements of groups II and VI or a compound thereof.

16. A method of manufacturing a solar cell according to claim 15, further comprising a step of forming a passivation layer of resin over said cell except for the positive and negative output terminals thereof.

17. A method of manufacturing a solar cell according to claim 14, wherein said n-type compound semiconductor layer comprises CdS, and said p-type compound semiconductor layer comprises one of CdTe and CuInSe₂.

18. A method of manufacturing a solar cell according to claim 17, further comprising a step of forming a passivation layer of resin over said cell except for the positive and negative output terminals thereof.

19. A method of manufacturing a solar cell according to claim 14, further comprising a step of forming a passivation

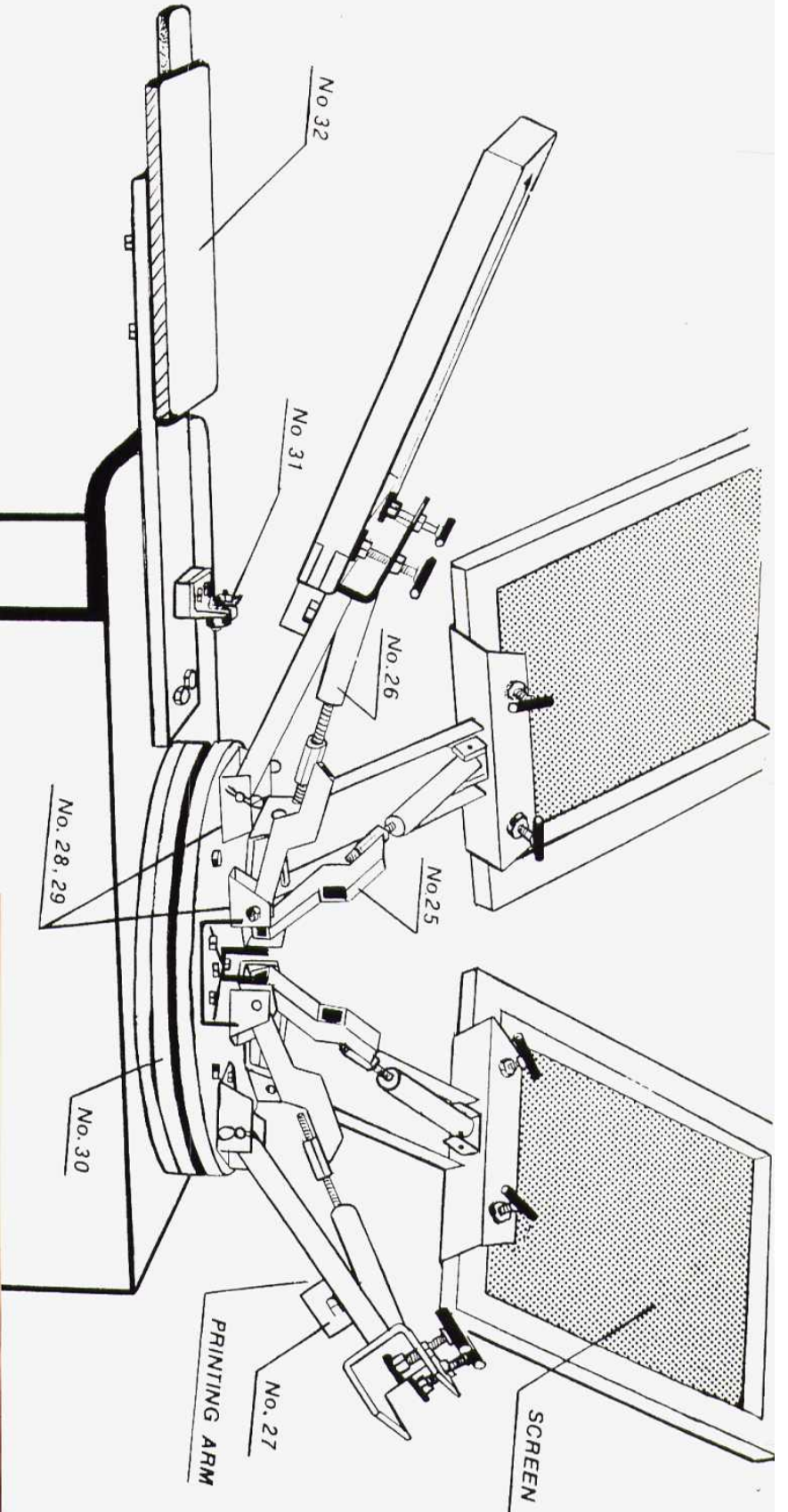

JC-M1

T-SHIRT PRINTER

© 1989 Creative Sign & Screen

PLANS \$19.95

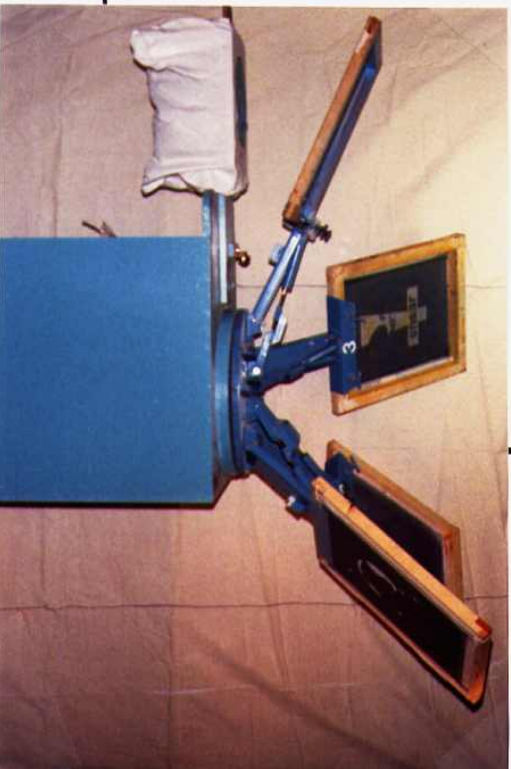

Screen Printing

Learn how to Screen Print. Screen printing is done all over the world by very large printing companies right down to the guy who does it at home in his basement. Screen printing was first discovered by the Chinese hundreds of years ago. It is a very simple process that anyone can do. The Chinese first used silk to use in there wood frames to print with, then as time went on better material was made to print with



See our Screen printing video or Screen printing booklet
Video only \$29.95 #402video, Booklet only \$9.95

Photowatt chooses Dupont's Solamet™ materials for its PV solar cells

For many years, Photowatt has been a European leader in the manufacture of photovoltaic (PV) solar cells. Since 1997, the company, based at Bourgoin-Jallieu, near Lyon, France, has been a part of ATS (Automation Tooling Systems), a large multinational concern with its headquarters in Toronto, Canada. ATS specializes in the fabrication of automated production lines for the automotive and electronics industries.

In 2001, the PV market grew by 39 per cent, based on power in megawatts (MWp), and Photowatt is well positioned to take advantage of this buoyant market. Like most large PV manufacturers, the company has increased capacity every year to cope with demand and, between 1995 and 2002, its production capacity has increased 10-fold, from 2 to 20 MW.

Photowatt has an advantage in the industry by being a vertically-integrated PV cell manufacturer with the capability to produce solar panels from silicon feedstock. It can therefore control all of the intermediate processing and manufacturing steps, including ingot casting, silicon wire sawing, solar cell metallisation, lamination and assembly.



Printing of Photowatt's front-side PV cells.

ATS's fully-automated solar cell lines

The company's parent, ATS, has a strong background in the automation of manufacturing processes. This has enabled Photowatt to install two new fully-automated high volume PV cell and module manufacturing lines which are shown in the photo on the right. These lines started operating in 2000 and can undertake the screen printing of the rear and front metallisation pastes, drying and firing of the pastes, deposition of the anti-reflective coating (ARC), sorting, ribbon soldering, lamination of the protective insulation layer and module assembly.

Today, the standard size of a multi-crystalline Si cell is 125 x 125 mm (5 inches square) with a thickness of 300 Mm. Using a titanium dioxide anti-reflective coating, Photowatt's solar cell efficiency was about 13 per cent. More recently, using new silicon nitride anti-reflective coating technology, this efficiency has been improved to over 15 per cent on the company's own multi-crystalline silicon. DuPont Microcircuit Materials has been

END

Homemade Solar Cells

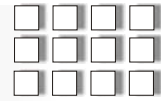

401

Learn How to Screen Print Start your own Business It's Easy!

Start Your Own Screen Printing Business Right in your Own Home!
Screen print T-Shirts, Caps, Jackets, Signs, Bumper Stickers, etc...

Start your Own Business, Be your own BOSS!
Make up to \$100,000 per year

Save money by building all homemade screens and special table top printer! Get started as low as \$70

Included is where to buy T-Shirts, Caps, Supplies etc... Wholesale!
Also great for Screen printing solar cells! Screen print as many Solar cells as you want for you and your friends, Screen printing Booklet teaches anyone to screen print in there own backyard it's easy to do! Print as many solar cells as you want for just pennies! Stop paying high electric bills. You may even want to start your own screen printing and sign business, printing t-shirts, caps, jackets, decals, and signs of all types, make big money, our video and booklet will show you how!

Screen Printing plans / bookletonly **\$9.95** # 402Book

Screen Printing Video (vhs)only **\$29.95** # 402Video

This video is packed full of information and shows you how to get started in screen printing and shows an actual 5-color t-shirt printing press being used, how to make and prepare a screen, what type of ink to buy, and where to buy your screen printing supplies, where to buy your t-shirts, jackets and caps at a low wholesale price.. Some companies sell small screen printing kit's for only \$28.

Build a 5/color T-Shirt Printing Press!

Start your Own Business, Be your own BOSS!
Make up to \$100,000 per year

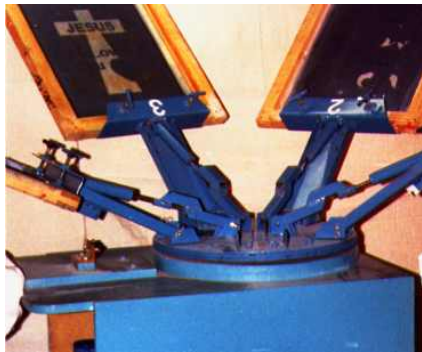

Plans only..... **\$19.95** # JC-M1..