

100 KV from a bike GENERATOR

#373

© copyright 2001

Make up to 100,000 volts of Earth Shaking Power, With just a turn of your fingers.

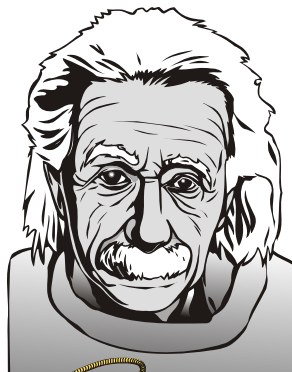
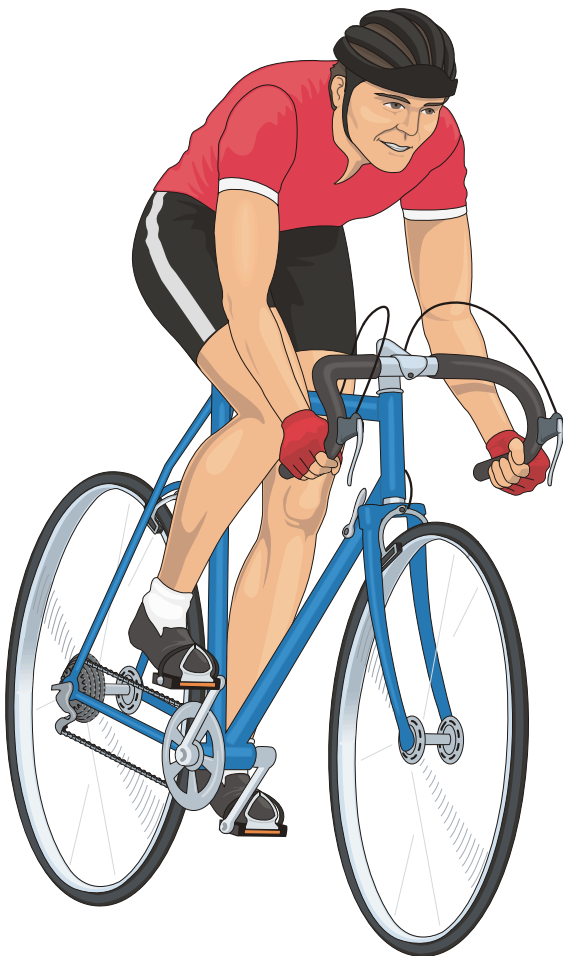

Time is running out



FOR RESEARCH PURPOSES ONLY- BUILD AT YOUR OWN RISK!

WARNING!

WARNING! High Voltage can kill you, always wear rubber gloves when working with high voltage. We are not responsible for anything in these plans, you build at your own risk. If you are a high Voltage nut like us, then you may like to learn how

Creative Science PO BOX 557 New Albany, IN. 47150

#373 cover



© 100 Kv from a Bike Generator

Copyright 2003 Creative Science & Research

Thank You for purchasing these plans, It will help us to further our research efforts so we can share free energy to the world. Someday free energy will be allowed in every home in the world. Free energy is a reality and I hope you enjoy all our plans. If you have any questions or comments please contacts us at: Tesla@FuellessPower.com

Thank you
David Waggoner
President



HOW TO GET 100 KV FROM A BIKE GENERATOR:

YOU CAN GET UP TO 100,000 VOLTS DC CURRENT FROM JUST A BICYCLE GENERATOR. A bike generator gives off alternating current (AC) which can be transformed into High Voltage AC or DC currant, Thru the use of a High Voltage Transformer or a Voltage doubler in this case a voltage multiplier. It's very simple but powerful. The capacitor creates the new amperage and high voltage thru the use of diodes This a fun science project and can be used in many experiments that involves high voltage.

With high Voltage you can do more than the world will ever know about, only a small few out of the billions of people in the world really know what you can do with high voltage,

Hopefully you have bought all our plans. You are going to need them if you are truly interested in free energy technology and building your own free energy device. The Bike generator is a fun way to get started in high voltage experiments. It somewhat safe and easy to do. If you know nothing about high voltage research this is a great experiment to get started with. We hope you enjoy these plans. If you have any input that we can use in these plans please send it by e-mail and we will give you the credit and which all our customers will see.





© 100 Kv from a Bike Generator

Copyright 2003 Creative Science & Research

Remember high voltage can kill you, Please wear rubber gloves and discharge all capacitors before touching them without gloves. Just because it's your project does not mean it is safe.

The 100 kv bike generator uses 20 volts volt capacitors rated at 200 to 300 uF , The diodes are rated at any were from 30 volts. all these parts can be purchased at your local radio shack or any other online electronic parts supplier. .

The diagram below shows a multiplier which you can multiply the incoming voltage as many times as you want or can afford., It is best to use a 15,000 volt neon transformer which you can buy at any sign or neon shop. Connect the transformer directly to the generator and you will eliminate the need for a voltage multiplier. (if you don't know what a step up transformer is, it's simply a regular wall transformer used backwards.) If you do not have any knowledge of basic electronics then we suggest you get a Radio Shack book on GETTING STARTED IN ELECTRONICS.

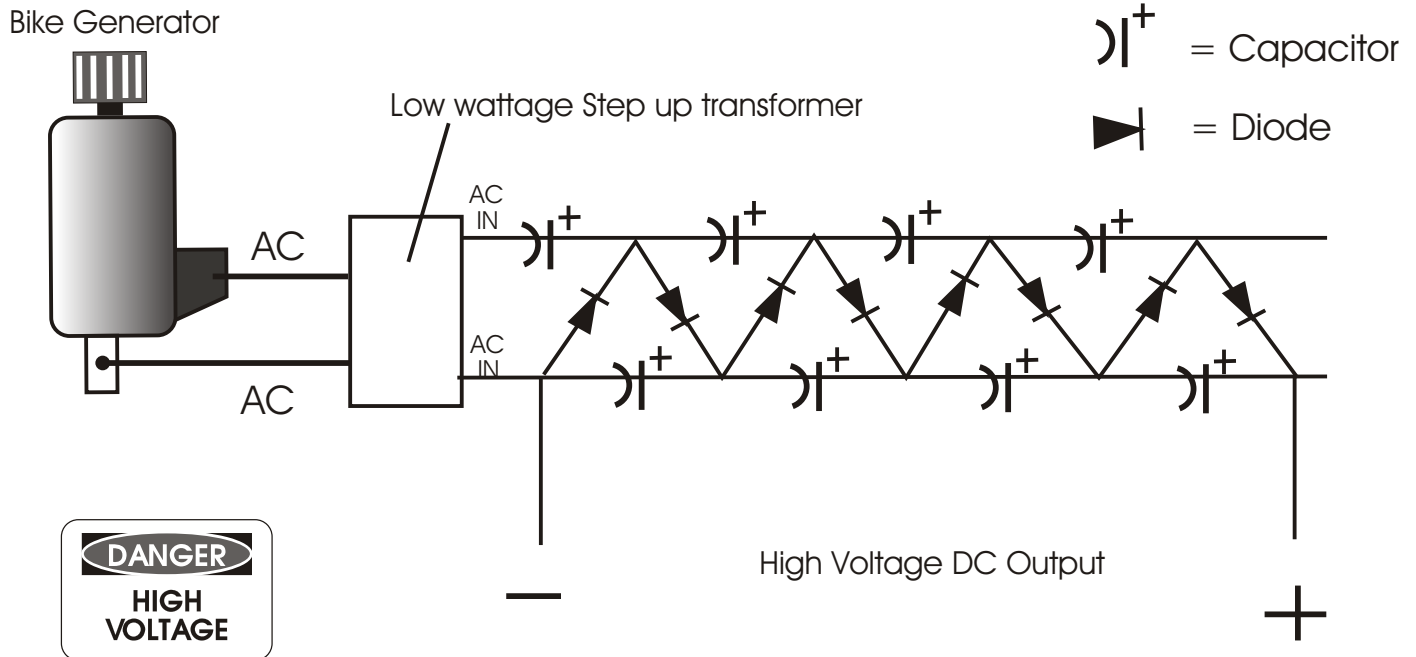

WARNING: High Voltage can kill you. If you are not a trained professional don't work on or around high voltage.

We are not responsible for these plans, you build at your own risk. so be careful.



©

100 Kv from a Bike Generator

Copyright 2003 Creative Science & Research



Low Voltage Capacitor



High Voltage Capacitors



15,000 V Neon Sign Transformer

Dog Shocker

Invented by: David Waggoner Copyright 2003

Here are just a couple of ideas you can use the high voltage for. Are you tired of going for a bike ride and having a dog try and bite your feet?

surprise fido with 3,000 volts DC or AC on his ugly face, The 3,000 volts will quickly stop the biggest dog right in there tracks.

Very simple to build and construct in one day or less. Consist of 1 or 2 bike generators, 1 capacitor bank and 4 - shock poles, your shock poles must be made of spring like metal. Keep children away from this. and place a high voltage warning sticker on the cap bank or pole area. your friends will be amazed!

It would be a great idea if you also included an off and on switch. If you use larger capacitor and charge them you could kill something so be careful, we suggest you use low uf capacitors. remember your not the A-Team so be very careful, high voltage can kill you. wear rubber gloves, and use a low uf cap bank.

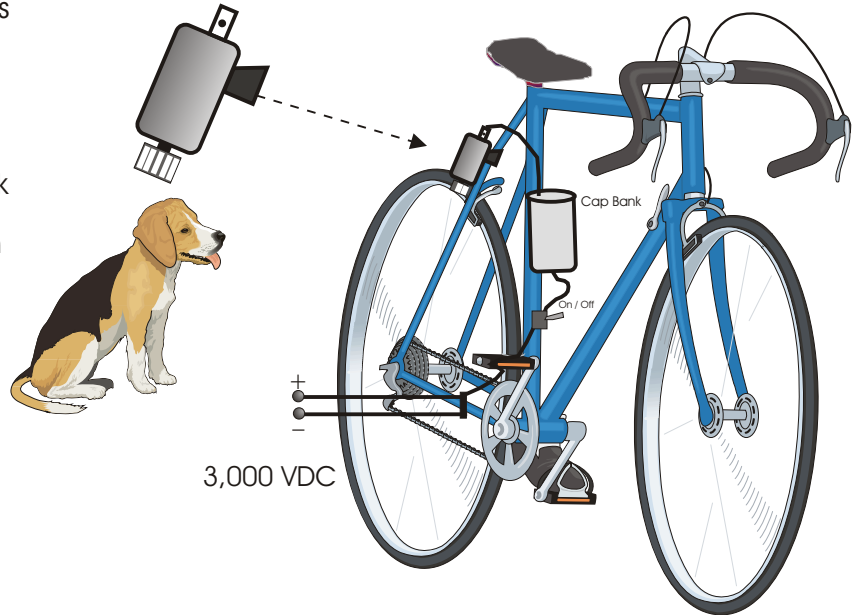

The NEON BIKE

Invented by: David Waggoner Copyright 2003

Neon uses pure AC current, Neons lites up as you ride. You may want to use 2 AC bike generators, one on the back and one on the front. and connect them to 2 - AC HV step up transformers. (The wire windings in these transformers should be as thin as possible) You can make one yourself by rewinding an old 2 amp wall transformer.

The Capacitor bank is not needed. You can get Neon Bulbs made very cheaply at any neon sign shop in your area.

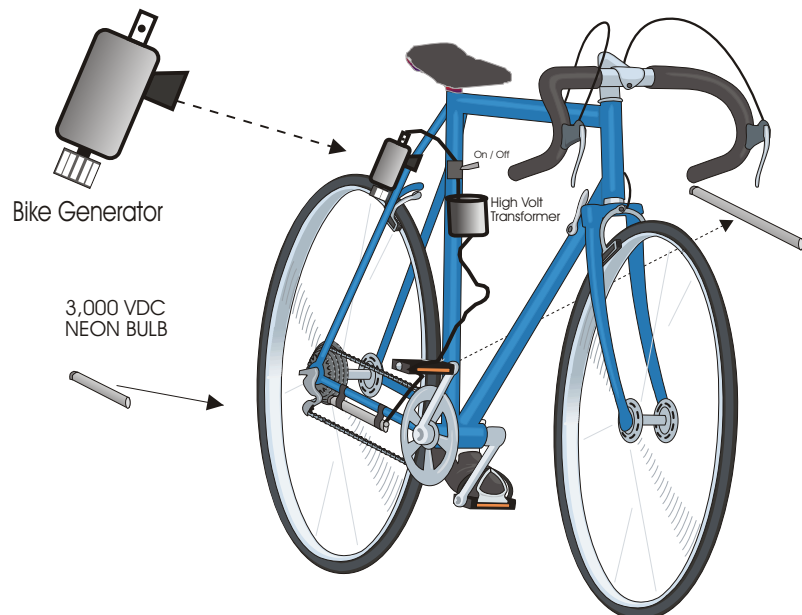

Creative Science PO BOX 557 New Albany, IN. 47151



© 100 Kv from a Bike Generator

Copyright 2003 Creative Science & Research

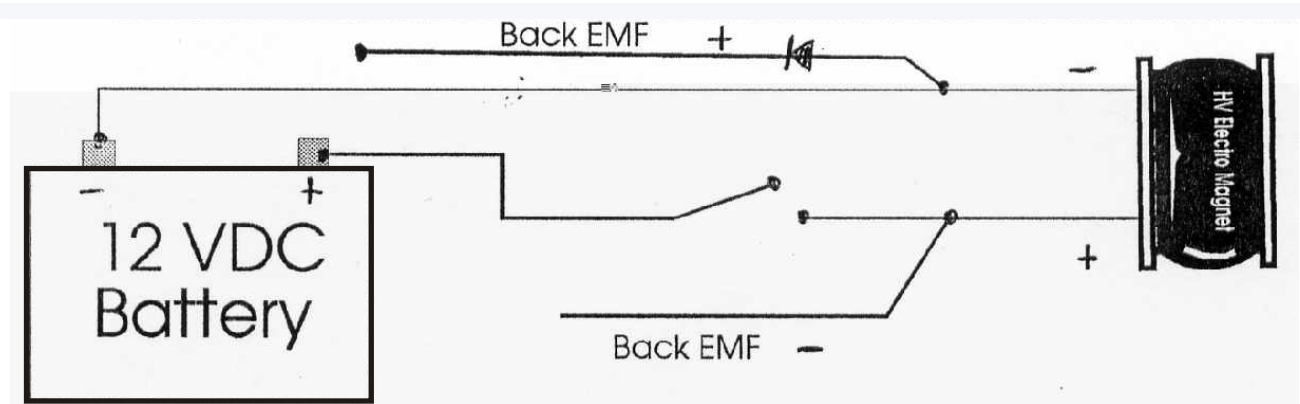

FREE ENERGY FROM A COLLAPSING MAGNETIC FIELD!

Collecting the back EMF from a motor coil or generator coil. Back Emf is free energy from a collapsing magnetic field generated in a coil of copper coated wire and collected to store or to apply back into the working apparatus or batteries.

So how do you collect the back EMF?

Lets start with the basic's. We start with a coil of copper coated wire which is used as an electromagnet or a generator coil. By applying 12 volts DC to the coil of wire you get a strong magnetic field, Polarity is forward and when that 12 vdc is turned off the coil produces a reversed polarity, in which the magnetic field changes also. But voltage will be lower because the 12 VDC must be pulsed (Switched on & off) at a high rate. The faster the better, So what is happening is you are getting FREE ENERGY FROM A COLLAPSING MAGNETIC FIELD. SEE fig, #1 You will need to use a diode to capture the back Emf.

Free News

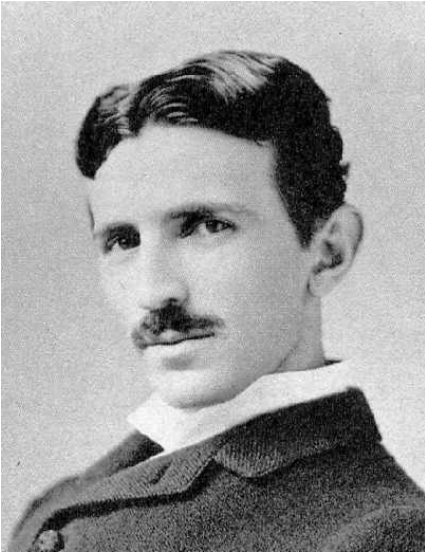

NIKOLA TESLA

TESLA

One afternoon in 1861, five-year-old Nikola Tesia was watching his mother cooking in their home in the village of Smiljan, Croatia.

"I spend so much time and energy beating these eggs," his mother complained. "By the time I'm finished, my wrists ache so."

"But, Mother," Nikola said, "what about the eggbeater you invented. Doesn't that make the work easier?"

Mrs. Tesia shrugged. "It's just two forks tied together. I still have to do all the work. Now if I could think of a way to get the forks to turn automatically ..."

Nikola didn't hear anything

more. In his mind a picture had formed, an image of his mother's eggbeater forks attached to a spinning cylinder. But what could he find to drive it? Day and night he thought about the problem.

Dreams and Inventions

Years passed, during which young Nikola invented a popgun and a new kind of bow and arrow that was so powerful and true all the kids in his village wanted one. He even experimented with flight. He jumped from the barn roof holding an open umbrella and nearly broke his neck in the process.

All that time, in the back of his mind was the problem of how to make a motor that would do work such as turning his mother's eggbeater.

Then one day when he was nine, Nikola rushed into the house flushed with excitement. "Mother!" he yelled. "I've done it! I've invented a real motor!"

Nikola quickly led his mother to the barn. When Mrs. Tesia saw what her son had done, she didn't know whether to hug him or scold him. The boy had rigged up a clever system of spinning wheels and pulleys, powered by sixteen wildly fluttering June bugs. Nikki had glued them one by one to slats on top of the apparatus.

"Nikki!" his mother cried. "This will never do!"

"I know, Mother," Nikola said hurriedly. "But if I double the number of bugs, it'll turn much faster."

Mrs. Tesia soon convinced Nikola that using live insects this way was not only unsanitary but also unkind. Nikola agreed to look for other ways to drive a motor.

This story has been told many times. Whether it's true or not, it shows the fire and originality

that made Nikola Tesia a great inventor.

In the years that followed, Tesia buried himself in the study of physics and electrical engineering. He amazed his teachers by discovering ways to improve electrical motors and generators.

When Tesia was a young man, inventors everywhere were trying to figure out how to make electric power available to everyone. There were two possible ways to do it: direct current (d.c.) and alternating current (a.c.). (See "Electrical Currents" on page 33.)

Working with Edison

In the United States, Thomas Alva Edison was just beginning a crusade to use d.c. to deliver electrical power to the big cities.

In the late 1800s, electricity was still mysterious and frightening to most people. And it was expensive. Edison and his engineers still hadn't found a way to make a direct current of electricity travel long distances through wires. Power plants had to be built close to the places that wanted electricity.

Tesia thought he saw a way to make alternating current work. With great ideas tucked away in his mind, Tesia arrived in the United States in 1884. Almost immediately, Tesia was hired by Thomas Edison himself, Tesia told Edison about his ideas. He wanted to make electricity available using a.c., which could deliver electricity over long distances—to wherever it might be needed.

But Edison did not want to hear anything about alternating current. "Ridiculous!" Edison would snap whenever Nikola mentioned his ideas. "Everybody knows a.c. is dangerous. Besides, my whole operation is set up for direct current."



© 100 Kv from a Bike Generator

Copyright 2003 Creative Science & Research

Amperage Meter



AC Bike Generator



High Voltage Capacitor Terminals



©

100 Kv from a Bike Generator

Copyright 2003 Creative Science & Research



Homemade HV Tesla Coil



100 Kv from a Bike Generator

Copyright 2003 Creative Science & Research

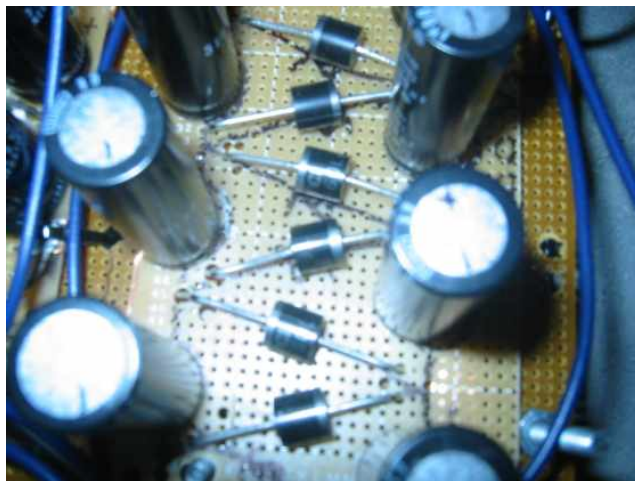
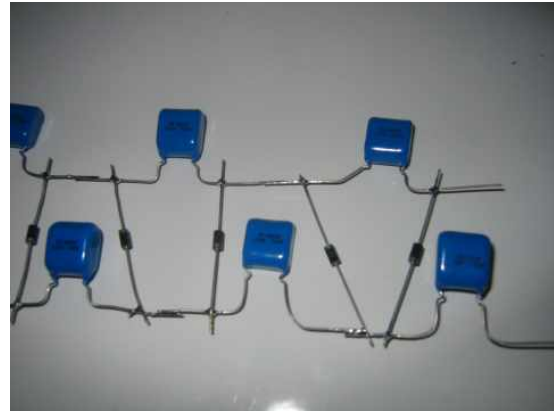

High Voltage, High Amperage Voltage Multiplier
We used flash capacitors and 6 amp diodes.