

Pythagoras, Plato and the Golden Ratio

The Golden Ratio and the Pentagram in the philosophy of the Pythagoreans

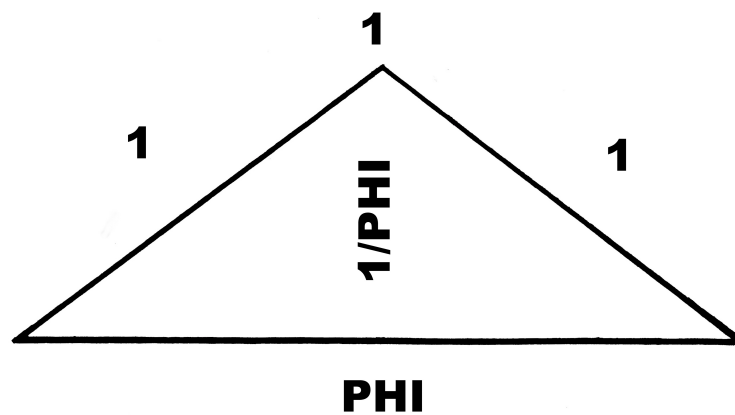
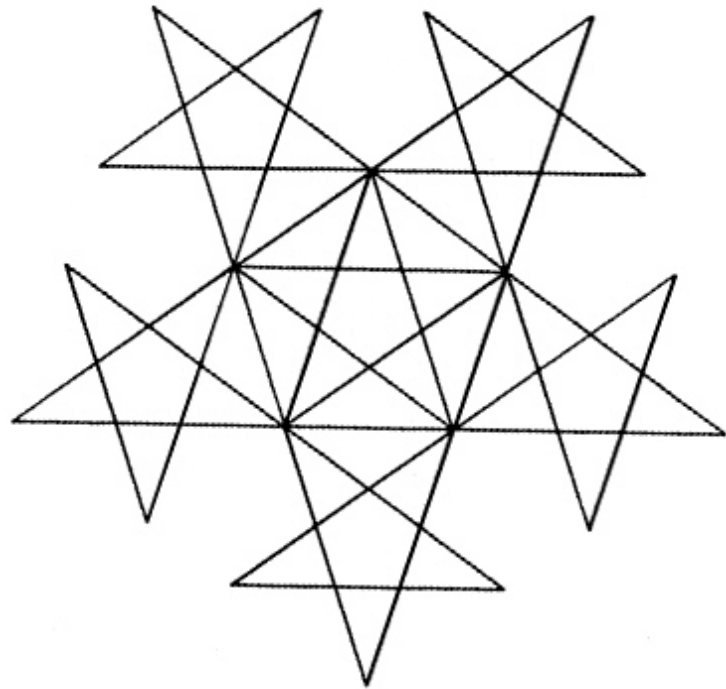

By: Ken L. Wheeler

Pythagoras, Plato and the Golden Ratio

The Golden Ratio and the Pentagram in the philosophy of the Pythagoreans

Author: Ken L. Wheeler

1st Edition 2005

All Rights Reserved. Copyright © Oct. 2005 DARKSTAR PUBLICATIONS

Printed on acid free paper for archiaval purposes.

No part of this book may be reproduced or transmitted in any form or by any means, graphic, electronic, or mechanical, including photocopying, recording, taping or by any information storage or retrieval system, without the permission in writing from Darkstar Publications

For information, please contact: Darkstar Publications, 533 Plainview Rd.,
Lexington, Ky 40517

Published by Darkstar Publications

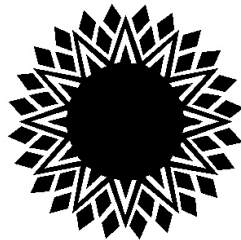

ISBN 0-9712541-5-X

\$15.00 U.S. Printed in the United States of America

Introduction

“The Pythagorean Philolaus says that the sun is a vitrescent body which receives the light reflected by the fire of the Cosmos, and sends it back to us, after having filtered them, light and heat; so that you might say that there are two suns, the body of the fire which is in the heaven, and the igneous light which emanates there from, and reflects itself in a kind of a mirror. Perhaps we might consider as a third light that which, from the mirror in which it reflects, and falls back on us in dispersed rays.” [FRAGMENTS OF PHILOLAUS From Boeckh 14. (Stob.Ecl.1:25:3:p.530)]

Pythagoras, Plato, and Plotinus after them were well aware, by their intense study of geometry and nature, the Golden section. The purpose of this very small but pithy book is to examine some key passages of Plato and the Phi incommensurability of the Pythagorean pentagram and unveil a heretofore unknown ‘secret’ rediscovered which links the Golden ratio, Pythagoras, the ontological preeminence of the pentagram, and the two most important passages in the Republic of Plato all together. I will show that the Emanationist philosophy/religion of the Platonists employed the Golden ratio into both a “Divided Line” analogy and the “Cave” symbolism to show the variant degrees of proportion and ratio between the visible (aisthetos) and intelligible (noetos) kosmos in a divine Logos (proportion) of which the Monad is Arche. Also I hope to demonstrate that the “Pythagorean oath”, the tetraktys was shown only inside a special ‘Pythagorean triangle’, the 1-1-Phi triangle which is not only the “triple intertwined triangle” of the pentagram, but also the 1-1-Phi-1/Phi analogy of Plato’s Cave and Divided line symbolism for the totality of all things.

The Logos (proportion) which comprises the visible and intelligible, I hope to show, formed the foundational doctrine of the Pythagoreans and Platonists who despised all who were “ignorant of geometry” to partake of their instruction, for “As above, so below”, the Platonists before and after understood the “third thing which unified” was a Logos of the Monad, geometrically and arithmetically represented by a power of Phi, which itself is the logoi of the necessary emanation of the Monad.

Phi is the ratio and relationship of the Monad to its increasingly phenomenal self-image in emanation. “But employing the objects of which the shadows below are resemblances in their turn as images” [Rep. 509]; thru the many ages of nature study the Pythagoreans understood that all nature exhibits a Logos (proportion) to a Principle (1), and this very special ratio was Phi (1 to 1.618033), and so being the case, the 2nd and 3rd Hypostases (the Nous and the Psyche tou pantos [world soul]), though noetic, MUST exhibit this same proportion. After who knows how long a time, the symbolism and analogies I mention below will spell out that which the Emanationists settled upon as the visible models for their knowledge of the ordered kosmos into powers and or proportions of Phi.

One very special triangle, its significance uncovered for the first time here in this book, serves as the model for the tetraktys, the pentagram, the Divided line, and the Cave analogies, and its geometries contain the seven sections of Platonic totality. The 1-1-Phi ‘Pythagorean triangle’, the 108-36-36 degrees isosceles triangle. At no time does this book affiliate its discussion with the bastardization of the pentagram in meaning and usage, or the theology of numbers with those groups as commonly denoted in the practice of the white-lighter new-age movement, but only to the root meaning and importance as taught by the Pythagoreans alone, of which the author is certain, is the only point of relevance or importance.

The Pythagoreans and Platonists were obsessive in mind and possessed by talk and models of harmony and proportions as pertains the noetic and visible kosmos is in no doubt, but what is of utmost importance is that Phi comprised the most important “oaths/secrets” of the Pythagoreans and which is the basis of the 5th Platonic solid which “represented the kosmos”. Phi is the ubiquitous logoi of the principle to things create in which the mind finds beauty in its ratio and which the entire kosmos is painted in. We know now that even DNA has a ratio of its width to full circle revolution of 1:Phi, as well as spiral galaxies and all things in between at all levels of the microcosmic to the macrocosmic, the great Greek minds of ages past were no less ignorant of these facts even though they didn’t possess the finer instrumentality of our modern world. Everything from rocks and plant growth, human and animal physical proportions, to aesthetics in art, and, as was reported, that Pythagoras discovered that the harmony of musical scales followed to the letter a Phi ratio. This grand discovery led the Pythagoreans and Platonists, who knew that from the smallest to the grandest the Golden ratio Phi was represented, with which they created models and analogies for Emanation, and to declare: “(We) are thinking not of these (geometers), but of the ideals which they resemble”.

For further specifics on Phi as it pertains to phenomena, art, and proportions in living things, there are several books worthy of purchase. The effort here however is to unravel the heretofore unmentioned ontological and philosophical principles which varying powers of Phi represented in the models, symbols, and analogies of the Pythagoreans and Platonists, and lastly, for the first time anywhere in print, to have provided a brief overview of what exactly the philosophical meaning of Phi represents, both on its own, and in the mind of the Platonists who never tired of cogitating upon ratios, harmonies, proportions and the Phi principle which underlies the very logoi of the Absolute, the Divine Monad.

“As there still remains one compound (the 5th Platonic solid, the dodecahedron) the fifth, which the Divine used it (as model/image) for the whole, brodering it with designs (images/forms)” [Plato, Timaeus, 55C]

“Pythagoras, seeing that there are five solid figures, of which the sphere of the universe was represented by the dodecahedron.” [Aetius, Placita, ii, 6.5 (Thomas, I,217)]

1. The Divided Line of Plato

“The vivific fountain of souls is comprehended under two intellects” [Thomas Taylor, Chaldean Oracles #91]

“The triad measures and bounds all things” [Thomas Taylor, Chaldean Oracles #76]

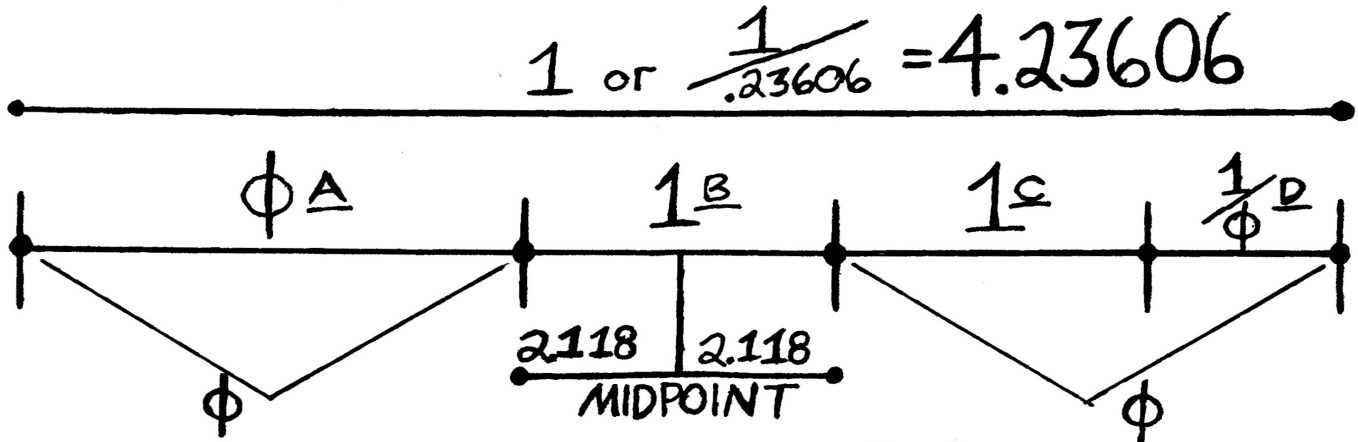

FIGURE 2

[The Divided Line; (Plato’s Republic 509d-511e)] Figure 2

You have to imagine, then, that there are two ruling powers, and that one of them is set over the intellectual world (**The One and Being-On [Phi]**), the other over the visible (**the ‘shadows’, the Mimesis of Nous and that of matter**). I do not say heaven, lest you should fancy that I am playing upon the name. May I suppose that you are making this distinction of the visible ([**1-Unity, also 1/Phi phenomenally**], or **Unity-Noetic ‘forms’, 1/Phi Mimesis [shape] and 1/Phi [matter] ‘shadow’ = The Lesser section**) and of the intelligible (**The One and Phi [1/phi, 1/phi, and Psyche .381967] = The Greater section**) fixed in your mind? I have.

Now take a line (**Totality, i.e. = 1, also = 4.236067, or 1/.236067 [primordial Dyadism of Unity of the Monad], Pan, Pentagram**) which has been cut into two unequal parts (**One and Phi ratio**), and divide each of them again in the exact same proportion (**which gives (1) Phi [1.618033], (2) One, (3) One, and (4) 1/Phi [1.618033]**), and suppose the two main divisions, one to the visible (**Lesser = Noetic forms [1-Unity], and ‘shapes’ [1/Phi] and matter-‘shadows’ [1/Phi]**) and the other to the intelligible (**Greater = Phi and the One**), and then compare the subdivisions in respect of their clearness and want of clearness, and you will find that the first section [**#3 and #4**] (**Noetic forms [1-Unity-1/Phi], mimesis [1/Phi], and matter, 1/Phi [1.618033]**) in the sphere of the visible consists of (noetic) images (**Kosmos Noetos, Nous-Eidos**). And by images I mean, in the first place, shadows (**shapes-Hyle-matter 1/Phi [1.618033]**) and in the second place, reflections (**noetic reflections-Mimesis, Kosmos Aisthetos**), in water and in solid, smooth and polished bodies and the like: Do you understand? Yes, I understand.

Imagine, now, the other section [**#1 and #2**] (**The Greater section, Being-Phi [1.618033] and Hen-the Absolute-1**), of which this (**the lesser section, the Noetic forms and ‘shadows and shapes’ i.e. matter**) is only the resemblance (**a mimesis of the 1st hypostasis and Being-On**), to include the animals (**animate life, all empirically ensouled Being-Zoe-Phi**) which we see, and everything that grows or is made. Very good. Would you not admit that both the sections of this division have different degrees of truth (**one being the Lesser section, the relative/image/semblance [Noetic forms and ‘shapes and shadows’ 1/Phi-matter], and the Greater section, the real, the genuine [Phi-Being and the One]**), and that the copy (**both matter-‘shadow’, noetic empirical shapes in union with the Psyche = Phi-On-Being, which is an Eikon of the Monad**) is to the original (**The One**), [i.e. that by ratio, **Phi is to One as One is to Phi**] as the sphere of opinion (**doxa, hypothesis [Phi] ratio to Gnosis [1, Nous]**) is to the sphere of true knowledge (**gnosis**)? Most undoubtedly.

Next proceed to consider the manner in which the sphere of the intellectual (**the One and hybrid of Being: Mimesis-Psyche-Hyle [Phi]**) is to be divided. In what manner? Thus: There are two subdivisions (**Mimesis-matter ‘body’ and Psyche-soul**) in the lower (**the lower part [Phi, which is inferior to The One] of the Greater Section**), or that of which the soul (**Psyche, the 3rd hypostasis, empirically conjoined with shapes, and ‘shadow’-matter-hyle**) uses (**assimilates**) the figures given by the former (**Mimesis-matter**) division (**of Being as composed of 2 sections**) as images; the enquiry can only be hypothetical, and instead of going upwards to a principle (**Hen, the One**), it (**Psyche**) descends to the other (**base, Phi**) end (**Proodos, emanation, which Plotinus uses from Plato as the entire foundation of Neoplatonism. That the Psyche uses the “figures” of Mimesis-matter to descend into the artifice of empirical Being**). In the higher of the two (**two souls, inferior-base-worldly, and the ‘higher’ noetic, the Aryan Soul**), the soul passes out of hypotheses, and goes up to a principle which is above hypotheses, making no use of images (**Mimesis-Hyle, instead “turns back” i.e. Epistrophe, or anamnesis**) as in the former case, but proceeding only in and through the ideas (**makes no use of the empirical**) themselves. I do not quite understand your meaning, he said. Then I will try again; you will understand me better when I have made some preliminary remarks.

You are aware that students of geometry, arithmetic, and the kindred sciences assume the odd and the even and the figures and three kinds of angles (**Pythagorean symbolic geometry**) and the like in their several branches of science; these are their hypotheses, which they and everybody are supposed to know, and therefore they do not deign to give any account of them either to themselves or others; but they begin with them, and go on until they arrive at last, and in a consistent manner, at their conclusion? Yes, he said, I

know. And do you not know also that although they make use of the visible forms and reason about them (**this is a commentary upon the Pythagorean usage of number and geometry as the principle contemplations for both ontology and being**), they are thinking not of these, but of the ideals which they resemble (**Noetic symbolism of First Principles**); not of the figures which they draw, but of the absolute square and the absolute diameter, and so on-- the forms which they draw or make, and which have shadows (**matter**) and reflections (**eidōs**) in water (**Zoe, life**) of their own, are converted by them into images (**Psyche, Phi**), but they are really seeking to behold the (**principle nature of**) things themselves, which can only be seen with the eye of the mind? That is true. And of this kind I spoke as the intelligible, although in the search after it the soul is compelled to use hypotheses (**number and geometers as ontological metaphors**); not ascending to a first principle, because she is unable to rise above the region of hypothesis, but employing the objects of which the shadows below are resemblances in their turn as images (**the 1/1/Phi geometer as “image and shadow” of the Monad and emanation itself**), they having in relation to the shadows and reflections of them a greater distinctness, and therefore a higher value. I understand, he said, that you are speaking of the province of (**Pythagorean**) geometry and the sister arts.

And when I speak of the other division of the intelligible (**The One, Hen, the Absolute**), you will understand me to speak of that other sort of knowledge which reason herself attains by the power of dialectic, using the hypotheses not as first principles, but only as hypotheses-- that is to say, as steps and points of departure into a world which is above hypotheses (**to use the geometer as hypothesis to direct the mind by anamnesis into Epistrophe, or mystical Oneing of the mind to the One**), in order that she may soar beyond them to the first principle of the whole; and clinging to this and then to that which depends on this, by successive steps she descends again without the aid of any sensible object, from ideas, through ideas, and in ideas she ends. I understand you, he replied; not perfectly, for you seem to me to be describing a task which is really tremendous; but, at any rate, I understand you to say that knowledge and being, which the science of dialectic contemplates, are clearer than the notions of the arts, as they are termed, which proceed from hypotheses only: these are also contemplated by the understanding, and not by the senses: yet, because they start from hypotheses and do not ascend to a principle, those who contemplate them appear to you not to exercise the higher reason upon them, although when a first principle is added to them they are cognizable by the higher reason. And the habit which is concerned with geometry and the cognate sciences I suppose that you would term understanding and not reason, as being intermediate between opinion and reason.

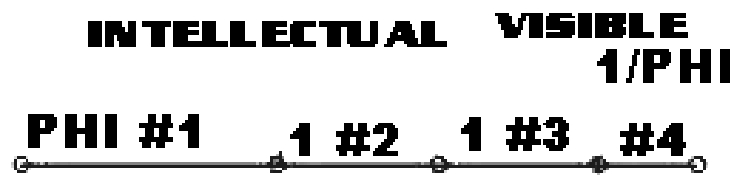

Other than Plotinus himself, there is no finer examination of Emanationism, starting from Pythagoras (from whom I'm certain this analogy originally came from) and ending with Proclus, than that of the 'Divided Line' symbol in Plato's Republic 509d. Certainly Plotinus himself must have seen this passage as the quintessential Pythagorean analogy for the proportioning and unity-ratio model of totality by which all things 'below' were a logos of the Monad. The phenomenal, and the three Hypostasis find measure within and between each other in the Divided line, as shown below, the middle of the Divided line is the middle of the Monad. All proportion of Phi from Phi to the power of -3 to Phi cubed are represented in the divided line, as well as the seven sections of totality, including the Monad, the Nous, the Psyche, matter, mimesis, eidōs, and agnōsis are represented in perfect arrangement, harmony and in conjunction as a coherent totality underneath the Divine Monad.

The "lesser" visible section is only "a resemblance, a mirage", or as Plotinus has said "a shadow of a mere reflection" (as pertains all empirical things in the 'visible kosmos'), not surprisingly enough one is reminded of the fractal metaphor for Totality, or the 'Holographic paradigm', or some of Bohme's writings on "wholeness". All "things old are new again" is certainly the case in light of science finding paradigms for 3000 year old analogies of the model of Emanationism which is the cornerstone of all Pythagorean, Platonic, Advaitin, and Neoplatonic belief. Sadly the only true religion, Emanation is an unknown to most who only know of the diametrically opposed and equally irrational and untrue antinomies of Creationism (God/Allah, etc.) and Nihilism (Atheism, anti-foundationalism).

$$A : B = C : D = (A + B) : (C + D) = (C + D) : (A + B + C + D)$$

$$\Leftrightarrow 1/\phi : 1 = 1 : \phi = (1/\phi + 1) : (1 + \phi) = (1 + \phi) : (1/\phi + 1 + 1 + \phi)$$

$$\Leftrightarrow 1/\phi : 1 = 1 : \phi = \phi : \phi^2 = \phi^2 : \phi^3$$

The Divided Line symbolism of the Pythagoreans (of which Plato only parrots in the Republic) is missed by altogether most (if not all) "Platonists" who fail to see the root meaning to be gleaned from the unity and proportions of totality (or, 'visible and noetic' Pan/Totality), the glaring example by which Emanation is a radiation from the Monad into images, forms, and unions which are both empirical multiples or lesser ratios to the Whole; the Divine 'sectoring' of the hypostases in both magnitude and space and their relationships and unions.

As said: "they are thinking not of these (geometers), but of the ideals which they resemble" that the Pythagoreans, knowing full well that all things ontological, empirical and otherwise are a Logos (proportion) of the Monad, these "geometers" are visible models of the higher noetics which the mind of man can use and employ to grasp the principle of Emanationism itself which is so abstruse to the rational and profane mind: "but employing the objects of which the shadows below are resemblances in their turn as images".

"(We) are really seeking to behold the (**principle nature of**) things themselves", the holy symbol of the Pythagorean triangle which constitutes the "oath, secret sign" and which laid out is the Divided line with its seven sectors was the "secret" which the

Pythagoreans held close as the visible model for Emanationism which Plotinus later perfected in elaborate detail in the Enneads, himself the “True (master) student of Plato”-Plotinus.

2. Plato’s Cave

“The Pythagoreans actually called procession (Proodos, emanation) Tolma (audacity)” [Proclus Alcibiades 104E, p. 60 Westerlink]

“The Monad is extended, which generates two (and so forth)” [Thomas Taylor, Chaldean Oracles #54]

“For the intellect (Nous) of the Divine said all things should be cut into three. His will assented, and immediately all things were cut” [Procl. In Parmenid. IV 1091, Morrow and Dillon, p. 439]

“Everything in this cave is analogous to things visible; the men, animals and furniture of every kind in it corresponding to the third, and the shadows in it, and the images appearing in mirrors, to the fourth section in the division of a line at the end of the preceding book. Things sensible also are imitations of things dianoetic, or, in other words, of the objects of scientific energy, which form the second section of Plato’s line.” [Thomas Taylor, notes to The Republic; p. 560. Vol. IX Taylor series, Prometheus Trust 1995]

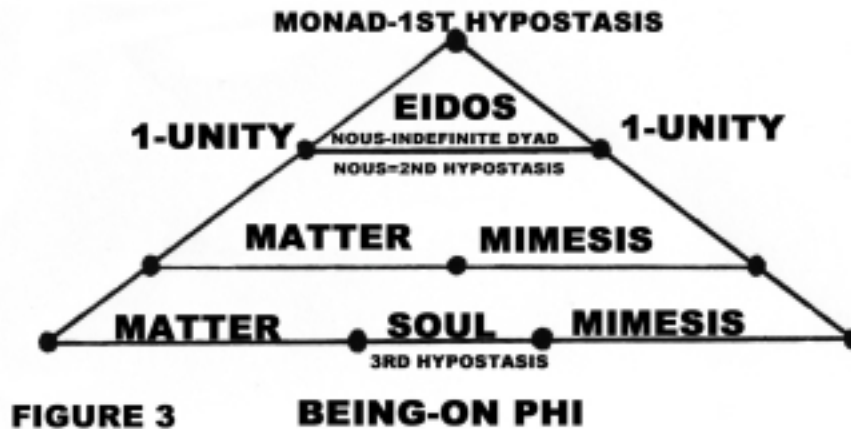

#1 Manifest puppets on cave wall, and the chained men = PHI [1.618033].

#2 The Sun = 1.

#3. The blazing fire = 1 = Nous, Kosmos Noetos

#4 The low wall, the puppets, the cave wall the prisoners face, the noetic shapes, shadows, and matter, Kosmos Aisthetos = 1/PHI [1.618033].

[The Cave (Plato’s Republic 514a-521b)] Figure 14 and 3

And now, I said, let me show in a figure (all of this is a model variant on the “Divided Line” analogy just prior) how far our nature is enlightened or unenlightened:--Behold human beings (#1, Phi, same as the manifest shadow puppets on the cave wall are, both are meant Phi. Both manifest puppet-shadows and the chained men are ensouled conglomerates of sentient noetic matter, living, though an unreal hybrid artifice of Nous and ‘shadow-matter’ in perfect ratio, Phi; one being the ensouled men-Psyche tou pantos, and the other being the puppets, ‘ensouled’ by the marionette players) living in a underground cavern (Kosmos Aisthetos), which has its mouth open towards the light (The Sun, Agathon, the One, #2) and reaching all along the cavern; here they have been from their childhood, and have their legs and necks chained so that they cannot move, and can only see what is directly before them, being prevented by the chains from turning their heads around. Above and behind them a fire is blazing at a distance (#3 Nous, [1-Unity, also Eide 1/Phi phenomenally], matrix of noetic forms, Kosmos Noetos), and between the fire and the prisoners there is a raised way (which blocks direct vision of the ontological Nous by corporeal Being, the Psyche tou pantos); and you will see, if you look, a low wall (#4, insentient matter-1/Phi, both the cave wall the chained men face and the noetic ‘puppets’ are 1/Phi, are both #4) built along the way, like the screen (barrier between the intelligible and the visible) which marionette players (unmanifest Psyche) have in front of them, over which they (noetic insentient and incorporeal beings) show their puppets (mimesis 1/Phi, noetic forms as yet unmanifest). I see.

And do you see, I said, men passing along the wall carrying all sorts of vessels, and statues and figures of animals made of wood and stone and various materials (matter-Hyle), which appear over the wall (insentient matter which has shape and the ‘men’, sentient unmanifest noetic ‘Beings’)? Some of them are talking, others silent. You have shown me a strange image, and they are strange prisoners. Like ourselves, I replied; is it not so that they see only their own shadows (Phi), or the shadows of one another, which the fire (Nous) throws on the opposite wall of the cave (the visible material cosmos, Kosmos Aisthetos)? True, he said; how could they see anything but the shadows if they were never allowed to move their heads? And of the objects which are being carried in like manner they would only see the shadows (of the puppets on the wall before them)? Yes, he said.

And if they were able to converse with one another, would they not suppose that they were naming only what was actually before them (**giving name only to sentient ratios of matter, noetic forms and Psyche, or to insentient objects**)? Very true. And suppose further that the prison had an echo which came from the other side, would they not be sure to fancy when one of the passers-by spoke that the voice which they heard came from the passing shadow? No question, he replied. To them, I said, the truth would be literally nothing but the shadows (**Phi**) of the images (**1/Phi, image of an image, the grand ignorance thereof as to reality**). That is certain. And now look again, and see what will naturally follow if the prisoners are released and disabused of their error. At first, when any of them is liberated and compelled suddenly to stand up and turn his neck round and walk and look towards the light, he will suffer sharp pains; the glare will distress him, and he will be unable to see the realities of which in his former state he had seen the shadows; and then conceive some one saying to him, that what he saw before was an illusion, but that now, when he is approaching nearer to (**true**) being and his eye is turned towards more real existence, he has a clearer vision, -what will be his reply?

And you may further imagine that his instructor is pointing to the objects as they pass and requiring him to name them, -will he not be perplexed? Will he not fancy that the shadows which he formerly saw are truer than the objects which are now shown to him? Far truer. And if he is compelled to look straight at the light, will he not have a pain in his eyes which will make him turn away to take and take in the objects of vision which he can see, and which he will conceive to be in reality clearer than the things which are now being shown to him? True, he would.

And suppose once more, that he is reluctantly dragged up a steep and rugged ascent, and held fast until he's forced into the presence of the sun (**The One, Hen**) himself, is he not likely to be pained and irritated? When he approaches the light his eyes will be dazzled, and he will not be able to see anything at all of what are now called realities. Not all in a moment, he said. He will be require to grow accustomed to the sight of the upper world. And first he will see the shadows (**Phi**) best, next the reflections of men and other objects in the water, and then the objects themselves; then he will gaze upon the light of the moon and the stars and the spangled heaven; and he will see the sky and the stars by night better than the sun or the light of the sun by day? Certainly. Last of he will be able to see the sun, and not mere reflections of him in the water, but he will see him in his own proper place, and not in another; and he will contemplate him as he is. Certainly. He will then proceed to argue that this is he who gives the season and the years, and is the guardian of all that is in the visible world, and in a certain way the cause of all things which he and his fellows have been accustomed to behold? Clearly, he said, he would first see the sun and then reason about him. And when he remembered his old habitation, and the wisdom of the den and his fellow-prisoners, do you not suppose that he would felicitate himself on the change, and pity them? Certainly, he would.

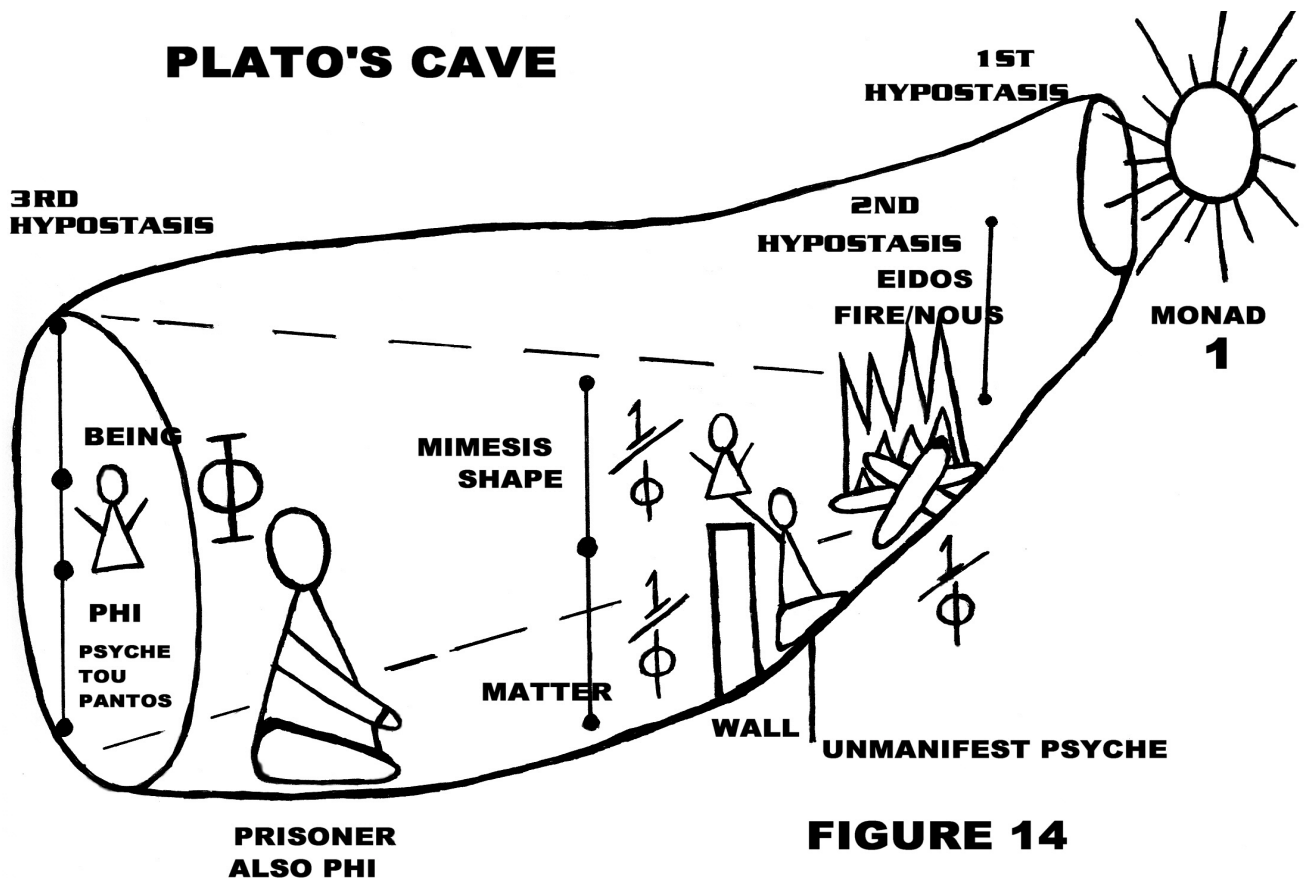

FIGURE 14

The cave analogy is certainly interesting, and well mentioned throughout the ages, however there are almost none who have grasped what its message is; as mentioned above, Thomas Taylor, though sparingly, understood to a degree that the Cave was nothing other than another symbolic representation of the noetic and visible realms of totality from the "Divided Line" Rep. 509d-511", and what positions they played in the cosmos (lower in the cave, higher up in the cave). The proportions and ratios the Nous-fire and of the

Monad in descending potency and increased sentience are well illustrated to the effect that the shadow (matter) puppets on the wall represent as much sentient beings as do the chained prisoners who are looking upon same.

The “marionette players” are none other than the noetic and incorporeal psyches which, by and thru the puppets they animate, are made manifest in corporeal and noetic proportions upon the wall or the visible cosmos where intelligible and sensible Being is manifest. Its absolutely no coincidence whatsoever that the analogy of the puppet is virtually a worldwide spiritual symbol for the dead corporeal husk of matter-mimesis which is ‘ensouled’, but which itself is utterly devoid of any soul, just as what is illuminated from afar itself possesses no light but is ‘En-lumined’ (illuminated). A proverbial Indian analogy in the same ilk would be: "Behold! That painted puppet this body, riddled with oozing sores, an erected façade. Diseased heap that fools fancy and swoon over. Spirit is not part of it! For the body befalls utter destruction.”[**Dhammapada. 147**]; also there are many countless examples of compounds of “mind (nous/will) made (animated) body” in the very same texts.

The Sun, obviously, is none other than the Divine Monad which the “freedman” works his way back to “with squinting eyes” by means of anamnesis, this “turning round” which is both Greek and Indian, for sati (anamnesis) as well, is a “turning round from phenomena to Subjective nature”. The enigmatic 2nd Hypostasis, the Nous, the fire which lies “between the Sun and the prisoners” and which gives shape to shapeless Eidetic forms and which is ultimately the producer of matter itself, and is the point of discussion of the majority of the “Cave” symbolism. This fire, the source of all individuation is a lesser and inferior copy of the static Monad above and outside of the cave of becoming. The noetic Unity of the Nous which is both One and “the indefinite dyad” [**5.4.2, Plotinus**] encompasses the entirety of the cave itself and “fills” its emanation with proportional Phi sections which are both ontological, empirical and arranged in such a ratio that blending is made possible for the 3rd Hypostasis to be manifest.

The chained prisoners, in this analogy, are identical in meaning to the puppets with which they are facing, both are empirical shapes animated by the hybrid Soul (pyshce tou pantos, vinnana, or in Sanskrit: Jivatman, literally “the living Soul”), are rational and ratio bound mixtures of the noetic and the “shadows” of matter and its 1/Phi mimesis shapes. With their “heads forever facing forward”, these men and puppets see “themselves” in ignorance, as this conglomerate which is doomed to separation and re-assimilation into another bodily form (palingenesia), doomed as the “prisoners of worldly phenomena”-Sankara, forever in identity with the unreal and ignorant of the “Noetic fire” which is “thy true Nature” (tat tvam asi, That thou art [not this form pre-fated to destruction]), and preeminently its Hypostasis, the Divine Monad of which all things, including the Nous, are proportional parts in harmony with the partless Monad and its emanations, both transient and eternal.

3. The 1-1-Phi Pythagorean triangle and its attributes

“The world is single; it began to form from the centre outwards. Starting from this centre, the top is entirely identical to the base; still you might say that what is above the centre is opposed to what is below it; for, for the base, lowest point would be the centre, as for the top, the highest point would still be the centre; and likewise for the other parts; in fact, in respect to the centre, each one of the opposite points is identical, unless the whole be moved.” [**FRAGMENTS OF PHILOLAUS From Boeckh 10. (Stob. Eclogl.1:5:7:p.360)**]

Now that which comes to be must be bodily, and so visible and tangible; and nothing can be visible without fire, or tangible without something solid, and nothing solid is without earth. Hence the Divine, when he began to put together the body of the universe, set about making it of fire and earth. **But two things alone cannot be satisfactorily united without a third**; for there must be some bond between them drawing them together. And of all bonds the best is that which makes itself and the terms it connects a unity in the fullest sense; and it is of the nature of a **continued geometrical proportion** to effect this most perfectly. For whenever of three numbers, the middle one between any two that are either solids (cubes) or squares is such that, as the first is to it, so is it to the last, and conversely as the last is to the middle, so is the middle to the first, then since the middle becomes first and last, and again the last and first becoming middle, in that way all will necessarily come to play the same part towards one another, and by doing so they will make a unity. Now it had been required that the body of the universe should be a plane surface with no depth, a single measure would have been enough to connect its companions and itself; but in fact the world was to be solid in form, and solids are always conjoined, not be one mean, but by two. Accordingly the Divine set water and air between fire and earth, and made them, so far as was possible, proportional to one another, so that as fire is to air, so is air to water and as air is to water, so is water to earth, and thus he bounded together the frame of a world visible and tangible. For these reasons and from such constituents, four in number, the body of the universe was brought into being, coming into concord by means of proportion, and from these it acquired Amity, so that coming into unity with itself it became indissoluble by any other save him who bound it together. [**Timaeus, 31b-32c, Plato's Cosmology: The Timaeus of Plato, Translated by Francis MacDonal Cornford, Bobbs-Merrill, Indianapolis, 1975:43-44**]

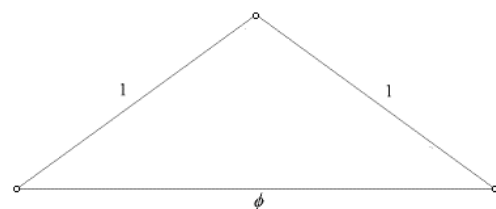
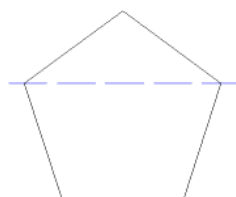
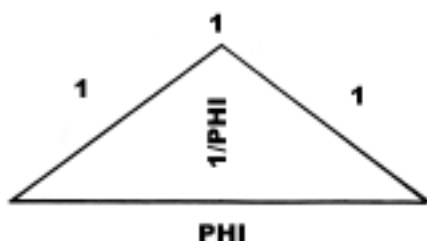

There is only one coherent geometric form which encompasses the four sectors of the Divided line analogy of Phi-1-1-1/Phi, and that is the Pythagorean triangle below in figures 6 and 10, which also by no coincidence is the same triangle “tripled” to form the Pythagorean pentagram. This is the very same proportional representation for Plato’s cave where the Phi Beings below are a proportional (logos) to the Nous above and the Monad on high. As seen in figure 10, the vertical encompasses the visible realm, and the periphery the noetic.

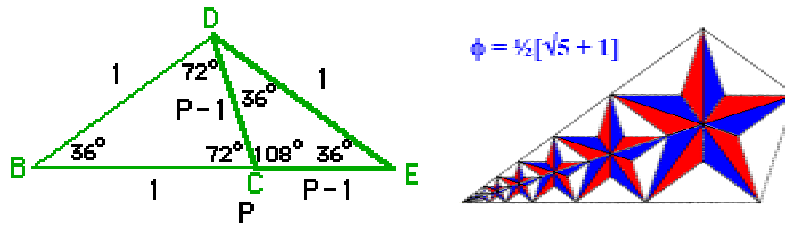

The “volume” reserved for the eidos, matter, and mimesis. Phi squared is the Unity of the two sloping angles plus their vertical from base, 1/Phi. A seemingly countless number of proportional relationships exist between (Figure 6) the bisections of A, B, and C relative to their separation and incommensurability and ratios of Phi. That the Pythagoreans chose this specific triangle as the basis for their pentagram and the model for Republic 509 and 514 symbolisms is no happenstance whatsoever. All seven sections of Phi cubed (the totality of the 4 sections of the divided line) can be found only in this geometric isosceles Pythagorean triangle. From the Psyche, C, the five constituents of empirical being extend. Ontologically, the entirety of C represents the Psyche, while its Phi baseline represents the Psyche tou pantos, or the ‘world soul’, also in periphery of the pentagram itself.

It’s personally quite surprising that nobody has seen the 1-1-Phi triangle before as the Pythagorean model of the cosmos, knowing for one that it is the basis of the Pythagorean pentagram as well as the dodecahedron of which we already know: “the universe was represented by the dodecahedron.” [Aetius, Placita, ii, 6.5 (Thomas, I,217)], and “the fifth solid, which the Divine used it (as model/image) for the whole, broidering it with designs (images/forms)” [Plato, Timaeus, 55C]. This is most certainly the premise and model by which the Divided line and Cave symbolisms employed the 1-1-Phi proportioning as the model for their philosophy of the Greater and Lesser in respects to the Demiurge and the divine monad, and an attempt to explain the indefinite dyads position.

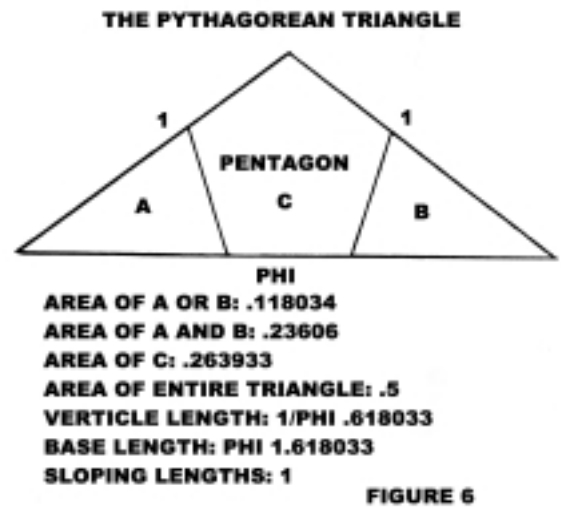
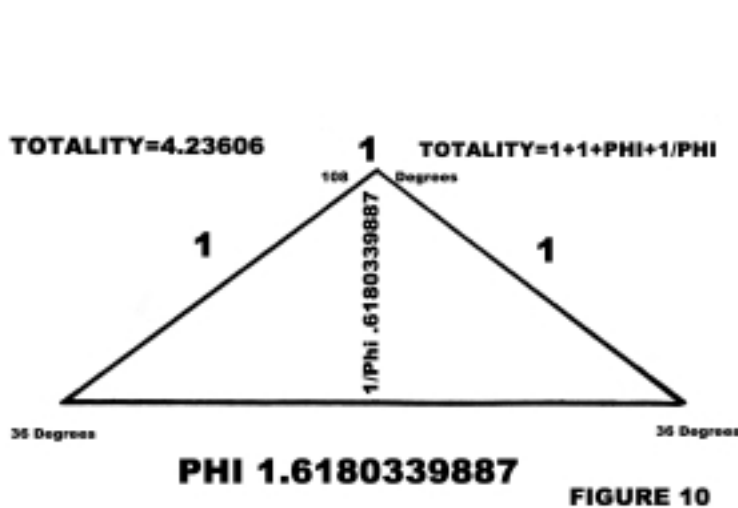

4. The Pythagorean Tetraktys

“Some called the Tetraktys the great oath of the Pythagoreans, because they considered it the perfect number, or even because it is the principle of wholeness; among them is Philolaus.” [Lucien, Pro. Laps. Inter. Salut. 5]

“The number 10 is complete at 4” [attributed to Pythagoras]

“To him that gave to our generation the Tetraktys, which contains the fount and root of all eternal nature” [Pythagorean oath]

“Arithmetic, geometric, and harmonics were the three principles by which the Divine Artifice proportioned out the world soul!” [Timaeus 36]

Number is the first principle, a thing which is undefined, incomprehensible, having in itself all numbers which could reach infinity in amount. And the first principle of numbers is in substance the first Monad, which is a male monad, begetting as a father all other numbers. Secondly, the Dyad is a female number, and the same is called by the arithmeticians even. Thirdly, the Triad is a male number; this the arithmeticians have been wont to call odd. Finally, the Tetrad is a female number, and the same is called even because it is female. Pythagoras said this sacred Tektractys is: 'the spring having the roots of ever-flowing nature.'.... the four parts of the Decad, this perfect number, are called number, monad, power and cube. And the interweavings and minglings of these in the origin of growth are what naturally completes nascent number; for when a power of a power; and a cube is multiplied on a cube, it is the power of a cube; and when a cube is multiplied on a cube, the cube of a cube; thus all numbers, from which arise the genesis of what arises, are seven: number, monad, power, cube, power of a power, power of a cube, and cube of a cube. [p.312] (Hippol., Phil., 2. Dox. 355, Pythagorean Sources & Fragments, Kenneth Sylvan Guthrie, Phanes Press, Grand Rapids, Michigan 1988:312)

“The Pythagoreans say that the triangle is the absolute principle of generation of begotten things, and of their form; that is why Timaeus says that the reasons of physical being, and of the regular formation of the elements are triangular; indeed, they have the three dimensions, in unity they gather the elements which in themselves are absolutely divided and changing; they are filled with the infinity characteristic of matter, and above the material beings they form bonds that indeed are frail. That is why triangles are bounded by straight lines and are [have] angles which unite the lines, and are their [ends].” [FRAGMENTS OF PHILOLAUS From Boeckh (Proclus, ad Euclid. Elem.I.33)]

The Pythagoreans considered the figure seven as the image and model of the divine order and harmony in nature. It was the number containing twice the sacred number three or the "triad," to which the "one" or the divine monad was added: $3 + 1 + 3$. As the harmony of nature sounds on the key-board of space, between the seven planets, so the harmony of audible sound takes place on a smaller plan within the musical scale of the ever-recurring seven tones. Hence, seven pipes in the syrinx of the god Pan (or Nature), their gradually diminishing proportion of shape representing the distance between the planets and between the latter and the earth--and, the seven-stringed lyre of Apollo. Consisting of a union between the number three the symbol of the divine triad with all and every people. (Theosophy, June 1880)

It's been falsely asserted that the Pythagorean tetraktys is arranged evenly inside an equilateral triangle without meaning or proportion which would certainly be outside the meaning of the Pythagoreans that totality (Pan) underneath the monad is evenly distributed without proportional meaning and harmony. However if proportionally arranged inside the Pythagorean isosceles triangle, a near endless series of harmonies and ontological statements are demonstrated which most certainly prove that the very Pythagorean triangle which "in conjoined triplet form the pentagram" is also one and the same triangle which is the skeleton for the tetraktys which the Pythagoreans made their oath by.

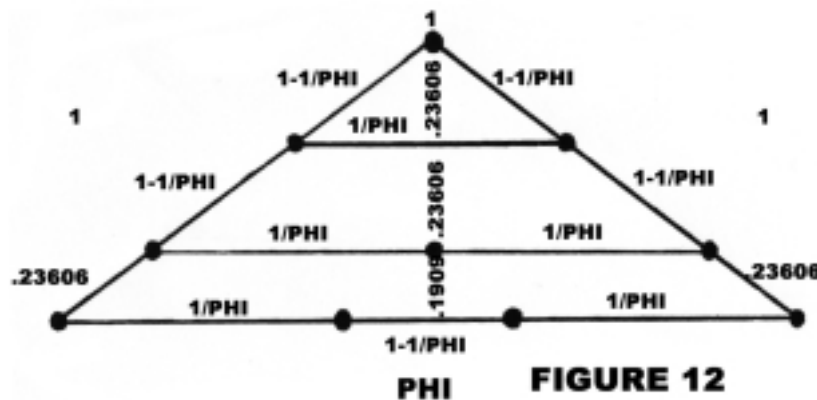

In figure 12 above and 1 below, two things stand out: #1. That $1/\text{Phi}$ (matter-eidos-mimesis) have five representations, as does $1-1/\text{Phi}$ (Soul, psyche), but Phi to the power of -3 (.23606) has only four, two of which serve as basis for separation of the Eidos from the Monad, and matter from the Eidos, and two of which serve as the foundation for the hybrid intelligible, or Being. This is discussed elsewhere that the reason for the 'missing .23606' is in and choate to the Monad itself, since .23606 is the indefiniteness which perpetuates emanation from the Monad and from the Nous to Being. Privative agnosis having no principle to itself but being a privation of Subjective self-gnosis is therefore the 'missing principle' or "cause before cause" as mentioned by many a Greek philosopher as well as countless hundreds of Indian philosophers.

#2. Logically so, if figure 12 is examined, $1/\text{Phi}$ is strictly the domain of matter-eidos-mimesis, or all things empirical and visible (Plato 509D), whereas the periphery is the domain of all things ontological, intelligible and akin to the Monad, with Unity (1-1) as slopes, Monad as principle above, and the psyche-hybrid as base below. The only exception where matter extrudes to the periphery is as being, where matter and shape are in union with the Soul as intelligible conglomeration, in this case forming Plotinus' 3rd hypostasis, the Psyche tou pantos.

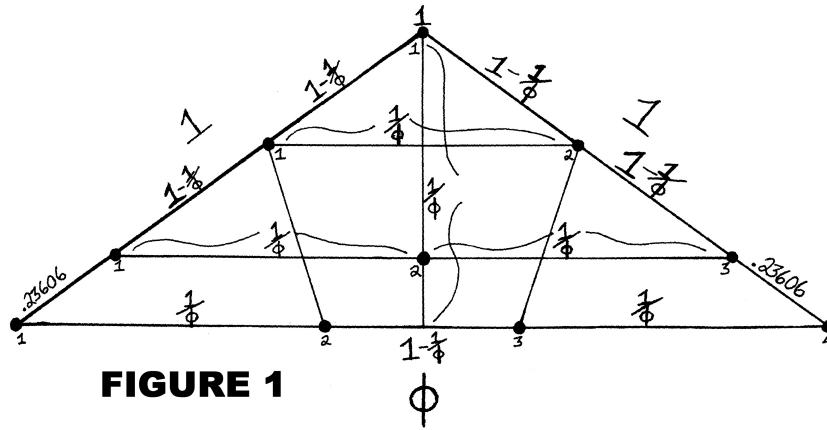

FIGURE 1

Looking at figure 3 below we see perfect harmony and proportion in Emanation, which is not found by placing the tetraktys inside of an equilateral triangle. Both proportional distances between all three hypostasis, their ontological peripheries and vertical separations are in perfect unison. There are 10 points in the tetraktys but only 7 sections, 2 for matter (one for visible and one for the intelligible), 2 for mimesis (same as prior), one for the Soul, one for the Eidos, and lastly the atemporal 'section' of the Monad. There is also only one point which lies within the Pythagorean triangle, and that is for the "shadows" of shapes and matter, even though the eidos is within the triangle, its points (basis) are as per the Nous, or Unity on the periphery.

That there are 5 sections of $1/\Phi$, 5 sections of $1-1/\Phi$, and 5 of Φ to the power of -3, or $5-5-5$ coincides perfectly with the both the pentagram and the harmonic means of the Decad itself being 5. The 'means' between which the Monad and empirical intelligible Being find place by matter-mimesis, in whose union the Subjective is able to gain self-gnosis, by the objective unification of the Subjective principle as the Psyche tou Pantos. Matter and mimesis must precede in time that of the Psyche tou pantos, otherwise the 3rd hypostasis would find no conjunction with its "empirical harmonies" thereby creating the intelligible being; although of course the soul of man is everso precedent to the shadows of matter, but not temporally so as the consubstantial soul. That the Pythagoreans, Plato and most intelligent of all, Plotinus, were Trinitarians is certainly in no doubt.

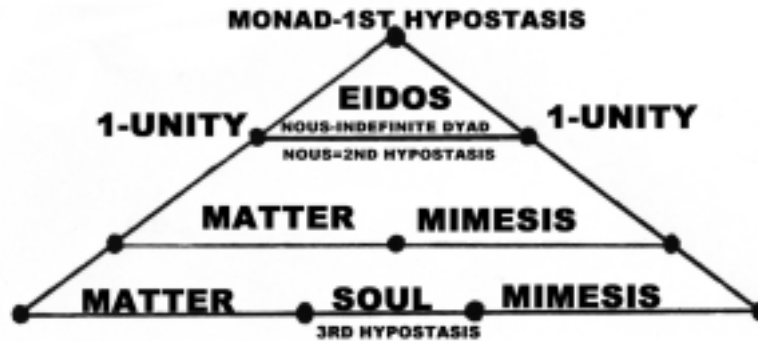
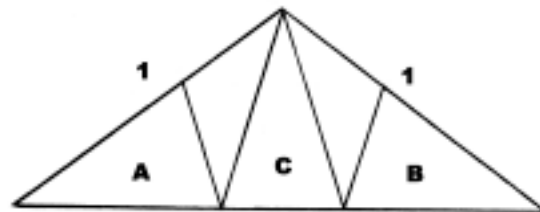

FIGURE 3 BEING-ON PHI

Looking at Figure 13 below we see that the ontological center of the Psyche from the monad, or C, is the same dimension and angle as that of the empirical sectors of A and B. $1-1/\Phi$ is to 1 as $1/\Phi$ is to Φ . That there is perfect harmonic proportion between matter-mimesis and that of the Psyche is what both Pythagoras and Plato in the Timaeus speak of as the "Oneing" of "two unlikes", being the "shadows" of matter and that of the Psyche in union as Phi, or Being.



PHI FIGURE 13

Finally, looking at figures 9 and 5 below, the question might be raised as to why the 3rd line and base is .1909 from the 2nd base and from the Monad to the Eidos and from the Eidos to matter-mimesis the separation is .23606 as vertical separation. The answer lies in the proportioning out of Being that the two sloping bases of Phi are .23606 and its vertical is one half of the Psyche, or .1909, but that the two verticals of Eidos and matter-mimesis from the monad and from each other is also .23606 or Phi to the power of -3 three. All section from Phi to the power of -3 thru to Phi cubed (4.23606) are covered in the tetraktys as laid out inside the Pythagorean triangle of 1-1-Phi-1/Phi.

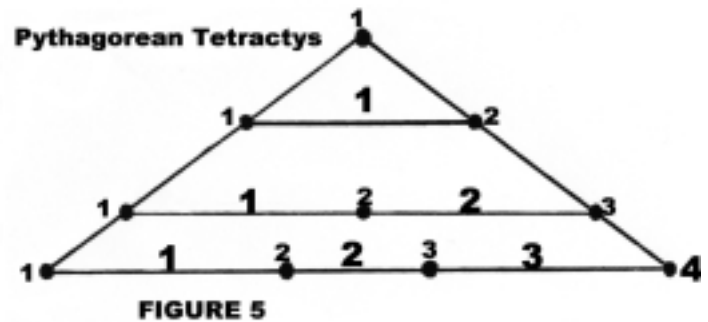
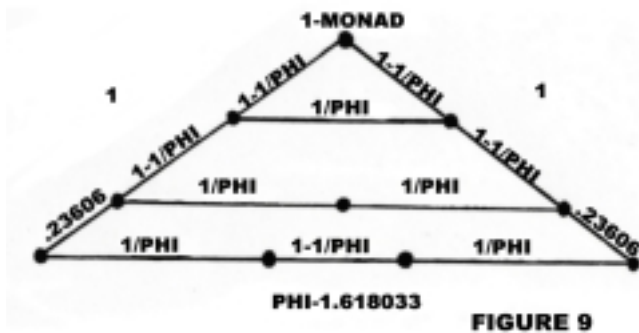

It is utterly unthinkable that the Pythagorean tetraktys can be placed in anything but the Pythagorean 1-1-Phi triangle and not the disproportional and unharmonious equilateral triangle as commonly conceived; if extended out into the pentagram further proportions are visible as to the tetraktys, namely to the effect that the 1-1/Phi becomes 1 to 1/Phi which becomes Phi as to the 4 elements and Aether (Psyche tou pantos). This as well as the ‘secret’ nature of the 5th Platonic solid, the dodecahedron, are but a part of the ‘unwritten doctrines’ which Plato does not speak about forthrightly for reasons that the Pythagoreans (of which Plato himself was) thought it unconscionable to discuss with the profane, uninitiated many folk, i.e. the common clod.

5. The Greek Pentagram, two points up

“The Logos (proportion) is the Divine in relationship to the create world...is at once the Cutter of the universe and the glue binding it together” [Heres 133, 146]

That the modern New-Age movement, the Templars, Satanists, Freemasons, and esoteric crystal-rubbing white-lighters have misappropriated the pentagram for their own ends, herein will be utterly ignored that we might get to the original meaning and ontological precedent by which Pythagoras and his sect saw the pentagram as the symbol of, Totality (4.23606). Foremost, it must be understood that the original Pythagorean pentagram was always two points up, always, the one point up pentagram most often seen today was not that of the Pythagoreans for several reasons. #1. that “triple intersecting triangle” [Lucian, “In Defense of a Slip of the Tongue in Greeting,” (5Lucian-Kilburn, 177); (Vogel, 1966, 46; Thomas, 1934, I, 225)] had 2 points up to represent the 1-1-Phi triangle as base-down for a reason, this represents the lower and empirical Phi, of Being. #2. That Air and Ether (Being, Phi) were to be represented at the top. #3. That the Monad apex must be at the top with the two-points-up representation. #4. The sole impetus for the periphery of becoming was the one-point-down, being fire.

The true Pythagorean pentacle was (and is) always two points up and was considered a Pentagrammon – ontological Being in the center, a pentagon (pentagonas) representing the Self, and the five points or blazing angles (pentalpha) represented the Pentemychos - inside the angles, and outside of them - every single line has meaning in this Master Glyph and none of it, not one bit of it, was latter day religious New Age garbage, Freemasonry, and general pagan rubbish.

Heinrich Cornelius Agrippa von Nettesheim had a drawing of a two points up pentacle where he informed the reader it is "Pythagorean," in his [Occult Philosophy, first published in 1533 AD]. He had other drawings, too, of pentacles one point up with a man inside, with astrological symbols. But for the two point up pentacle, he specifically informs us that he knew it was Pythagorean.

These coins represent successive issues probably struck on the occasions of recurrent religious festivals, chiefly perhaps connected with the worship of the Phoenician Kabeiri, of the Libyan Ammon (the Rams' heads and the Pentagram, his symbol on coins of Pitane So, the pentagram was also a symbol of the Ammon, which is Pan, or totality (Pali: sabba, “the All”). Meaning that the Pentagrammon was the symbolic representation for totality, the soul, matter, image, the Nous, the Monad, and all inter-relationships thereof.

Coin One: MYSIA, ca 4th Century BC, Head of "Zeus Ammon" / Pentagram. In some designs the head of Zeus Ammon is replaced with Head of Bacchante or omphalos entwined by a serpent (ouroboros).



Coin Two: Thrace, Cherronesos, circa 400-350 BC, AR Hemidrachm. Lion / Pentagram and VE monogram.



Coin Three: Lucania, Velia, ca 350-400 BC, Didrachm. Head of Athena, helmet shows griffin ornamentation / Pentagram.



Coin Four: Alexander III, The Great; 336-323 BC, AR Drachm. Head of Herakles, wearing the skin of the Nemean Lion, which he slew as one of his "12 Labours". / Zeus seated left, holding eagle and sceptre; ALEXANDROU (in Greek) to right, lion's head and the letter Phi (circle with line through) in field to left; pentagram under the throne of Zeus, i.e. that pentagram is the Godhead (seat of Zeus himself).



Coin Five: CAMPANIA, Teanum Sidicinum, circa 265-240 BC, Æ Obol. Laureate head of Apollo left; O (obol) behind / Man-headed bull standing right, being crowned by Nike who flies above; pentagram below.



Coin Six: Pentagram on reverse of a small bronze coin (AE10) from Pitane, Mysia, 4th-3rd cent, BC. Letters around the pentagram spell PITAN (Serpent), (ouroboros). The 'tail-devourer' is the symbolization of concepts such as completion, perfection and totality (4.23606), the endless round of existence, etc. It is usually represented as a worm or serpent with its tail in its mouth."



“Ouroboros was and is the name for the Great World Serpent, encircling the earth. The word 'Ouroboros' is really a term that describes a similar symbol which has been cross-pollinated from many different cultures. From "Ouroboros," there is the serpent or dragon gnawing at its own tail. The symbolic connotation from this owes to the returning cyclical nature of the seasons; the oscillations of the night sky; self-fecundation; disintegration and re-integration; truth and cognition complete; the Androgyne (see below); the primaeval waters; the potential before the spark of creation; the undifferentiated; the Totality; primordial unity; self-sufficiency, and the idea of the beginning and the end as being a continuous unending principle. It represents the conflict of life as well in that life comes out of life and death. 'My end is my beginning.' In a sense life feeds off itself, thus there are good and bad connotations which can be drawn. It is a single image with the entire actions of a life cycle - it begets, weds, impregnates, and slays itself, but in a cyclical sense, rather than linear. Thus, it fashions our lives to a totality more towards what it may really be - a series of movements which repeat. 'As Above, So Below' - we are born from nature, and we mirror it, because it is what man wholly is a part of.” **[Chris Aynesworth (The World Tree) "Of The Androgyne: The Serpent Ouroboros]**

The Ouroboros encircles the Universe; everything known and unknown is encompassed in its embracing coils, supporting and maintaining the earthly balance. It injects life into death and death into budding life. Its form suggests immobility with its locked jaws upon itself, yet at the same time it pushes the insistent message of perpetual movement through its twined coils. The first clues to this symbol go back as far as 1600-1700 BC in Egypt. Through the years the serpent moved on to the Phoenicians and the Greeks-who were what gave it the name "Ouroboros." The Greek translation means, "tail eater."

For the Indians the Ouroboros would be Samsara itself, i.e. Sam-carati, or “going round”, the perpetual cycle of birth, old age, death, rebirth, or the “wheel of becoming” which is “moved by the unmoved mover (the Absolute)”, wherein the fool finds himself living out and identifying himself with empirical existence rather than his true nature which is “opposite all antinomies”. This Ouroboros is Phi itself, the “self sufficient” logos of the Nous which is sentient and self-aware, but in ignorance is self aware only to the mere self, and not The Self, of which the divine beings and those who have assimilated by wisdom their nature are freed from.

From Plato’s *Timaeus*: "It had no need of eyes, for there was nothing outside it to be seen; nor of ears, for there was nothing outside to be heard. There was no surrounding air to be breathed, nor was it in need of any organ by which to supply itself with food or to get rid of it when digested. Nothing went out from or came into it anywhere, for there was nothing. Of design it was made thus, its own waste providing its own food, acting and being acted upon entirely with and by itself, because its designer considered that a being which was sufficient unto itself would be far more excellent than one which depended upon anything." **[Plato’s *Timaeus*-33 - The Construction of the World]**

6. The Pythagorean pentagram and its attributes

“The Monad is the image of the Divine which is single in its Unity and at the same time a pleroma” **[Heres 187]**

“Movement thanks to the dyad, and life thanks to the pentad” **[Iamblichus-Theology of Arithmetic]**

The Pythagoreans called the pentagram and the pentad Nemesis because it distributed (emanation) the “heavenly and the divine” (into totality/Pan). Also the pentad was deemed Athena because it “revealed the fifth essence, Aether (psyche)” **[Iamblichus-Theology of Arithmetic]**. The proportioning and incommensurability of the pentagram must have been noticed quite early on by the Pythagoreans and the tetraktys its primary triangle composed in triplicate, the pentagram thereof. Seemingly the only thing genuine to the Pythagorean pentagram still preserved by the white-lighter new age movement (whose favorite pastime is to adopt and pervert pure philosophical symbols) was the fact that the 5 apexes of the pentagram represent the four elements and the soul in the harmony of empirical being, with the 2 aerial sectors of air and the psyche tou pantos ‘above’; see figure 11 below. We know well from the symbolism of Greek coins and other written fragments that the pentagram unequivocally represents totality, sometimes shown being surrounded by the ouroboros the Phi-down Pythagorean triangle represented the partitioning up of the Nous, the image of the Monad, into various logos sectors and lastly in conjunction with matter, the hybrid soul is formed, the 5 elements, which both represent the 5 platonic solids, but also the 5 constituents of the kosmos, being air, earth, water, fire, and lastly the soul, but this “world soul” need be differentiated as both Plato and Plotinus did from the genuine unmanifest soul which is ever so connected with the Nous above.

This ‘world soul’, the 3rd Hypostasis of Plotinus **[5.2.1]**, is the basis for the aerial sector of the Pythagorean pentagram. The Indians were on equal footing with the Platonists in differentiating the consubstantial ‘world soul’, or Jivatman (Vinnana-consciousness in Pali) with that of the genuine psyche which “does not partake of the world and its forms” but only so in animation (reflection), or as per the symbolism that light doesn’t partake of its object of illumination, but illumines (life) same none the less.

What is apparent in the Pythagorean pentagram is the number of trinities by representation: mind-matter-union/hybrid, heavenly-worldly-spiritual, Monad-Nous-Psyche, Hen-Unity-dyad, Hen-Pan-On, Nous-psyche-psyche tou pantos (and so forth, etc.) [Fig. 7, 8, 11].

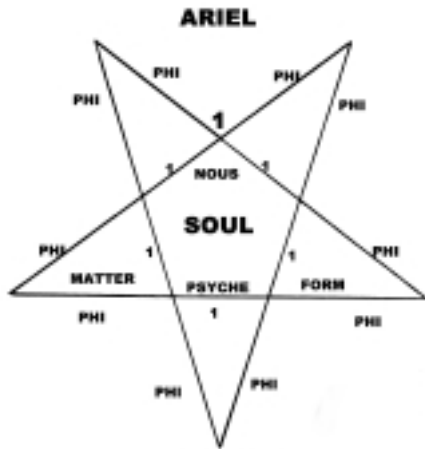

FIGURE 11 PHENOMENAL



FIRE FIGURE 7



FIRE FIGURE 8

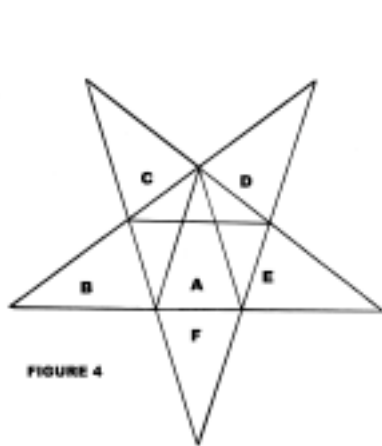

FIGURE 4

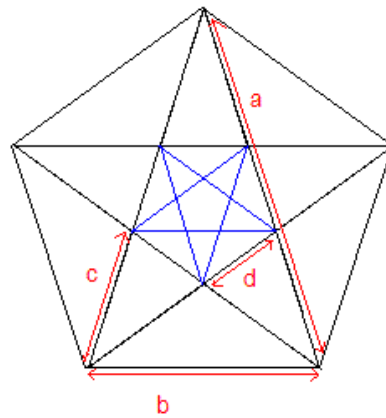
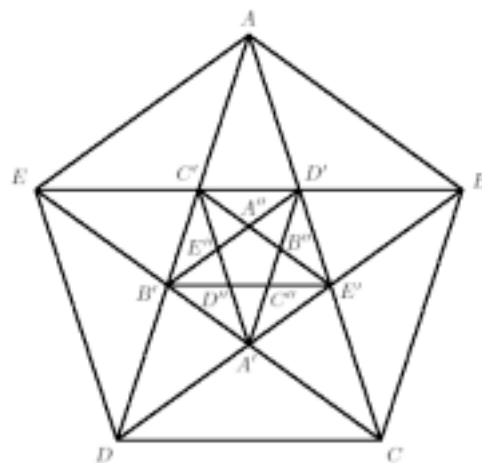
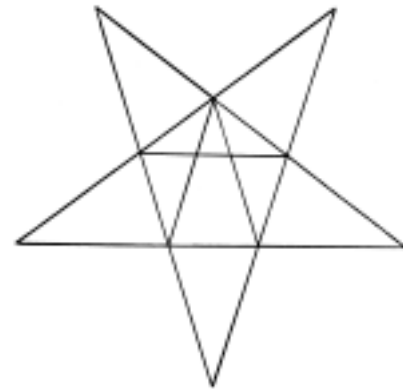

Figure 2



“The diameters of the pentagon form a new regular pentagon in the center, the diameters of this smaller pentagon will again form a regular pentagon, and so on in an infinite process. It is easy to see that in the pentagons produced in this way $AE = AB'$ and $B'D = B'E'$ and therefore $AD - AE = B'E'$, and likewise $AE = ED' = EA'$ and $B'E' = B'D = B'E$ and therefore $AE - B'E' = B'A'$, and so forth ad infinitum, or, in other words, that the difference between the diameter and the side of the greater pentagon is equal to the diameter of the smaller pentagon, and the difference between the side of the greater pentagon and the diameter of the smaller pentagon is equal to the side of the smaller pentagon, and again the difference between the diameter of the smaller pentagon and its side is equal to the diameter of the next smaller pentagon and so forth in infinitum. Since ever new regular pentagons are produced by the diameters it is

then evident that the process of mutual subtraction will go on forever, and therefore no greatest common measure of the diameter and the side of the regular pentagon can be found.”

[Kurt von Fritz, 'The discovery of incommensurability by Hippasus of Metapontum, *Annals of Mathematics*, 1945, pp. 242-264]

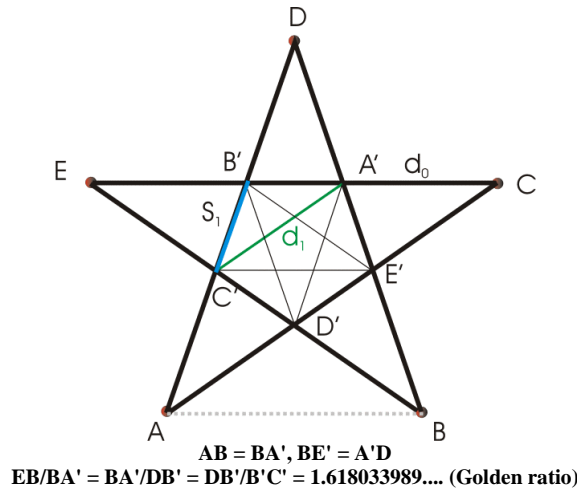

The Pythagoreans used the Pentagon star (Pentagram) formed by the five diagonals of a regular Pentagon as a symbol of their school. It was probably this reason that they studied its geometrical properties and that they discovered that this symbol contradicts their idea that everything can be expressed by integer numbers or ratio of integer numbers. Pentagram is a Greek word for “pentagrammes”, i.e. five lines. Sometimes it is called also a pentalpha, as it looks consisting of 5 rotated “A” symbols.

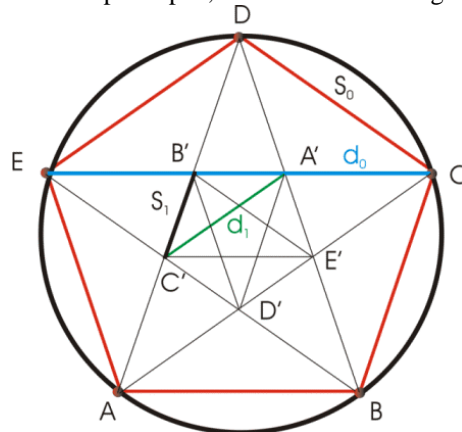

Consider the Pentagon ABCDE, the length of each side is s_0 and the length of the each diagonal (e.g. EC) d_0 . Consider that all sides of CDED' are of equal length and all the four sides of AC'A'D' also. Hippasus used a geometric analog of Euclid's algorithm to show that the ratio d_0/s_0 is an irrational number. From the Pentagon ABCDE and the diagonals a smaller pentagon A'B'C'D'E' can be formed with diagonal d_1 and side s_1 , and from this a smaller pentagon can be again constructed with a diagonal d_2 and side s_2 and so forth. One can find the following relations between the sides and the diagonals of these pentagons:

$$\begin{aligned} d_0 - s_0 &= d_1 < s_0, s_0 - d_1 = s_1 < d_1, \\ d_1 - s_1 &= d_2 < s_1, s_1 - d_2 = s_2 < d_2, \\ d_2 - s_2 &= d_3 < s_2, s_2 - d_3 = s_3 < d_3, \end{aligned}$$

Hippasus showed that the Euclid algorithm will never stop! Therefore it is impossible to express the ratio d_0/s_0 as a ratio of integers

7. The Indefinite Dyad-(.618033, 1/Phi, or Phi squared-Unity), Nous

“The Indefinite Dyad is the basis for multiplicity and differentiation” [Speusippus]

“The Dyad is not number (is not 2), nor an even number, because it is not actual” [Theology of Arithmetic by Iamblichus]

The Indefinite Dyad is not multiplicity but the very principle by which multiplicity and number is made feasible. Many foolish commentators have illegitimately claimed the Dyad to be numerical 2 and therefore the principle of multiplicity, but this is illogically not the case that the Dyad is twice the Monad. The Dyad itself is meant Proodos, or emanation, that both the nature and act of Monad in procession, to self-extension. “Some people, misled by numbers which are already countable and secondary, instruct us to regard the dyad as a system of two monads, which the result that if dissolved it reverts to these same monads. But if the dyad is a system of

monads, then the monads are generated earlier, and if the monad is half the dyad, then the existence of the dyad is necessarily prior. If their mutual relations are to be preserved for them, they necessarily co-exist, because double is double what is half, and half is half what is double, and they are neither prior nor posterior, because they generate and are generated by each other, destroy and are destroyed by each other.” [Theology of Arithmetic by Iamblichus]

The Dyad is the principle of duplicity, which when extended becomes phenomenalized and a product, the Dual, or number. That the very cosmos is full of indefinite and infinite antinomies (large/small, life/death, becoming/annihilation) is not in question by any, but the very principle by which the Monad is Dyadinous, or specifically an unceasing emanative Principle which proceeds out into temporality but which “itself is without change in the giving”-Plotinus, is the point of much Monistic philosophy. In Indian Monistic philosophy (Advaita, original Buddhism, Vedanta) the Indefinite Dyad is called primordial agnosis; that the accounting for procession itself is due to the privation of gnosis of and to the Monad itself. Contrary to Creationism which posits a 1st Perfect, a sentient self-aware God on his throne who creates by the whims of his will, the Emanationist philosophy of the Pythagoreans, Plato, Plotinus and that of Advaita Vedantic Monism places no intelligence within the sphere of the 1st hypostasis, rather if the monad in Emanation be compared to anything analogously at all, it would be a fire hydrant which “pours forth” all proportional things that are a Logos of itself but which “never depletes in the giving”-Plotinus, since what is given is not itself but something unreal to the 1st and an Eidetic mirage in ratio to itself within the Kosmos Noetos and Aisthetos.

The nature of duplicity proceeds number, or product (phenomena); the duplicitous nature and efflux of the Monad into time and space is the characteristic of the Monad itself that, as principle it is the creatrix of plethos, its self-privative identity, nature and “radiation”-Plotinus, this being the senseless Monad, the Arche. It ‘radiates’ in division various proportions of its own creations, and asserts itself by means of and principle as ananke, or necessity in efflux to other. As Meister Eckhart said: “God does not know what he is, for he is not a what”. This is the principle of emanation as taught by the Pythagoreans, Plato, and most intelligently so by Plotinus. Nature and activity by the Hen-Monad are indistinguishable as pertains the principle of all things create, of which the Logos, Phi squared and 1/Phi, is empirically manifest as a lesser and lesser potency of the One, but a greater and greater empirical reality by which and wherein the individuated psyche finds rest and identity, giving Being and sentience to the Psyche tou pantos which can contemplate and, by means of apophasis, proceed back to (Epistrophe) to the Monad.

The “cause before cause”, or as the Vedantists deemed, the primordial agnosis inherent to and choate with the Monad is the hyperborean privation of the very principle of the Absolute to itself, which as an absence, mediates the efflux of the Monad to other which is the source and contention of many thousands of years of debate to which is asked: “How from One, the many?”. “In short, the philosophers began only to speak of contrary principles; but above these elements they knew another superior one, as is testified to by Philolaus, who says that God has produced, and realized the finite and infinite, and shown that at the limit is attached the whole series which has a greater affinity with the One, and to Infinity, the one that is below. Thus, above these two principles they have posited a unifying cause, superior to everything which, according to Archenetus, is the cause before the cause, and, according to Philolaus, the universal principle.” [Archytas of Tarentum (400 B.C.) METAPHYSICAL FRAGMENTS].

The principle of unlimit as given name to the Kosmos Aisthetos and its endless myriad sensible and insentient phenomena, logically and by abductive reasoning, is the phenomenal logos of the primordial agnosis choate to the Monad, but which are specifically products of the Nous. The greatness and magnitude of actuality by the limit of Monad, in its efflux, is manifest in the visible cosmos as an unlimited magnitude of matter and noetic forms wherein the individuated Nous is consubstantially manifest as empirical Being. “As above so below”. The most telling aspect of what the indefinite dyad is, is that “Zeus is the monad and that the Dyad is Rhea (Nature, efflux, i.e. Emanation)” [Theology of Arithmetic by Iamblichus]; meaning that the very principle of Nature (Maya, Natura naturans, our “Mother Nature” [the “means” of all creation, divine or human, or “art” by which anything is made]).

The indefinite Dyad is not therefore the dual, but the principle of duplicity inherent to the Monad that it “doesn’t stay with and in itself, for itself, as itself, and by itself”-Plotinus. They say that Plato maintained that the One and the Dyad were the First Principles, of Sensible Things as well. He placed the Indefinite Dyad also among the objects of thought and said it was Unlimited, and he made the Great and the Small First Principles and said they were Unlimited, in his Lectures On the Good; Aristotle, Heraclides, Hestiaeus, and other associates of Plato attended these and wrote them down in the enigmatic style in which they were delivered [Barnes 1984: 2399]. Alexander says that “according to Plato the One and the Indefinite Dyad, which he spoke of as Great and Small, are the Principles of all things and even of the Forms themselves.” So Aristotle reports also in his books On the Good. One might also have got this from Speusippus and Xenocrates and the others who attended Plato's course On the Good [Simplicius on Aristotle's Physics 187a12, quoted in Kramer 1990: 203].

“Thinking to prove that the Equal and Unequal [other names for One and Indefinite Dyad] are first Principles of all things, both of things that exist in their own right and of opposites...he assigned equality to the monad, and inequality to excess and defect; for inequality involves two things, a great and a small, which are excessive and defective. This is why he called it an Indefinite Dyad - because neither the excessive nor the exceeded is, as such, definite. But when limited by the One the Indefinite Dyad, he says, becomes the Numerical Dyad” [Barnes 1984: vol. 2, 2398]. “Before, those who are earlier than we (partisans of Aristander, Pythagoreans) attempted to explain the nature of the soul mathematically by number, as some medium between the natural and supernatural; it is asserted by those who call the soul a number, that it consists of (these three) Unity (Nous-The One), as something indivisible (the Psyche), and of indefinite doubleness which his divisible (matter and mimesis-form). Others of them (Severus) conceive that soul as a geometric figure, that it consists of a point (Monad) and the divergence (sloping angles of triangle); of which the first is indivisible (Monad) and the second divisible (Unity)” [Works of Numenius, #46]. One must dismiss the duality of principles in Platonism. The Indefinite Dyad is merely the extrinsic side of absolute Unity, which has the consequence that the One is really responsible for everything.

In Plotinus [5.4.2], we are told that “the dyad is the Intellectual-Principle (Nous)”, or 1/Phi, the ontological Eidos by which all shapes and matter themselves are an empirical reflection of. In 5.1.1 of the Enneads the principle for the Souls descent is Tolma,

which is extremely well evidenced is the Pythagorean concept of the Indefinite Dyad [**Plotinus, Tolma, and the Descent of Being; N. Joseph Torchia. American University Studies; ISBN 0820417688**]. The Nous, as indefinite Dyad is a lesser potency of emanation relative to the Monad, in so being it brings to existence a Holon, a trinity of being, a perfect cosmic logos between hyle, psyche, and mimesis, respectfully matter, shape, and soul, of which in conjunction is a consubstantial soul, the Psyche Tou Pantos.

Lets examine a few passages of Plotinus which shed a great deal of light upon the nature of the Dyad, the Nous, 1/Phi, the principle by which all things empirical are an emanation of:

[**Plotinus 2.4.11-12**] A thing then need not have magnitude in order to receive form: it may receive mass with everything else that comes to it at the moment of becoming what it is to be: a phantasm of mass is enough, a primary aptness for extension, a magnitude of no content- whence the identification that has been made of Matter with The Void. But I prefer to use the word phantasm as hinting the indefiniteness into which the Soul spills itself when it seeks to communicate with Matter, finding no possibility of delimiting it, neither encompassing it nor able to penetrate to any fixed point of it, either of which achievements would be an act of delimitation. In other words, we have something which is to be described not as small or great but as the great-and-small: for it is at once a mass and a thing without magnitude, in the sense that it is the Matter on which Mass is based and that, as it changes from great to small and small to great, it traverses magnitude. Its very undeterminateness is a mass in the same sense that of being a recipient of Magnitude- though of course only in the visible object. In the order of things without Mass, all that is Ideal-Principle possesses delimitation, each entity for itself, so that the conception of Mass has no place in them: Matter, not delimited, having in its own nature no stability, swept into any or every form by turns, ready to go here, there and everywhere, becomes a thing of multiplicity: driven into all shapes, becoming all things, it has that much of the character of mass. 12. It is the corporeal, then, that demands magnitude: the Ideal-Forms of body are Ideas installed in Mass. But these Ideas enter, not into Magnitude itself but into some subject that has been brought to Magnitude. For to suppose them entering into Magnitude and not into Matter- is to represent them as being either without Magnitude and without Real-Existence [and therefore undistinguishable from the Matter] or not Ideal-Forms [apt to body] but Reason-Principles [utterly removed] whose sphere could only be Soul; at this, there would be no such thing as body [i.e., instead of Ideal-Forms shaping Matter and so producing body, there would be merely Reason-Principles dwelling remote in Soul.] The multiplicity here must be based upon some unity (**Nous and the Monad together**) which, since it has been brought to Magnitude, must be, itself, distinct from Magnitude. Matter is the base (**Phi**) of Identity to all that is composite: once each of the constituents comes bringing its own Matter with it, there is no need of any other base. No doubt there must be a container, as it were a place, to receive what is to enter, but Matter and even body precede place and space; the primal necessity, in order to the existence of body, is Matter.

[**Plotinus 2.4.10**] But how can I form the conception of the sizelessness of Matter? How do you form the concept of any absence of quality? What is the Act of the Intellect, what is the mental approach, in such a case? The secret is Indetermination. Likeness knows its like: the indeterminate knows the indeterminate (**that the agnosis of the Nous finds its likeness in the vessel of a phenomenal 'agnosis', being Hyle, matter**) . Around this indefinite a definite conception will be realized (**Being brought into actuality**), but the way lies through indefiniteness (**that the Nous is the Demiourgos for all things create**). What, then, is this indetermination in the Soul? Does it amount to an utter absence of Knowledge (**agnosis**), as if the Soul or Mind had withdrawn? No: the indeterminate has some footing in the sphere of affirmation (**that agnosis itself is the self-positing objectification of the Subjective Nous as manifest object**). The eye is aware of darkness as a base capable of receiving any colour not yet seen against it: so the Mind, putting aside all attributes perceptible to sense- all that corresponds to light- comes upon a residuum which it cannot bring under determination: it is thus in the state of the eye (**Nous**) which, when directed towards darkness (**matter**), has become in some way identical with the object (**subject empirically objectified, that matter is reflected in and upon the 'eye' of the Nous in that it directs its vision thereto**) of its spurious vision (**due to the agnosis of Subjectivity**)

[**Plotinus 2.4.15**] The Indeterminate in the Intellectual Realm, where there is truer being, might almost be called merely an Image of Indefiniteness (**that genuine indefiniteness is choate to and of the Monad, i.e. primordial subjective-agnosis**): in this lower Sphere where there is less Being (**Phi**), where there is a refusal of the Authentic, and an adoption of the Image-Kind, Indefiniteness is more authentically indefinite. But this argument seems to make no difference between the indefinite object (**1/Phi**) and Indefiniteness-essential (**.236067**). Is there none? In any object in which Reason and Matter co-exist we distinguish between Indeterminateness (**mimesis and matter**) and the Indeterminate subject (**Spirit, .381966**): but where Matter stands alone we make them identical, or, better, we would say right out that in that case essential Indeterminateness is not present; for it is a Reason-Principle and could not lodge in the indeterminate object without at once annulling the indeterminateness. Matter, then, must be described as Indefinite of itself, by its natural opposition to Reason-Principle. Reason is Reason and nothing else; just so Matter, opposed by its indeterminateness to Reason, is Indeterminateness and nothing else (**that matter is an empirical image of ontological agnosis, therein it is by its nature the phenomenal image of the foremost and preminent indefiniteness**).

[**Plotinus 5.4.2**] If the Intellectual-Principle were the engendering Source, then the engendered secondary, while less perfect than the Intellectual-Principle, would be close to it and similar to it: but since the engendering Source (**The One**) is above the Intellectual-Principle (**Nous**), the secondary can only be that principle. But why is the Intellectual-Principle not the generating source? Because [it is not a self-sufficing simplex]: the Act of the Intellectual-Principle is intellection, which means that, seeing the intellectual object towards which it has turned (**empirical ensouled Being**), it is consummated, so to speak (**sacrifices itself thereto**), by that object, being in itself indeterminate like sight [a vague readiness for any and every vision] and determined by the intellectual object. This is why it has been said that "out of the indeterminate dyad and The One arise the Ideas (**noetic forms**) and the numbers (**all things phenomenal**)": for the dyad is the Intellectual-Principle (Nous). Thus it is not a simplex; it is manifold; it exhibits a certain composite quality- within the Intellectual or divine order, of course- as the principle that sees the manifold (**that the Nous is objectively directed away from its subjective and better nature due to its indefiniteness** [.236067]).

[**Plotinus 3.7.6**] The phrase "He was good" [used by Plato of the Demiurge] refers to the Idea of the All; and its very indefiniteness signifies the utter absense of relation to Time: so that even this Universe has had no temporal beginning; and if we speak of something

"before" it, that is only in the sense of the Cause from which it takes its Eternal Existence. Plato used the word merely for the convenience of exposition, and immediately corrects it as inappropriate to the order vested with the Eternity he conceives and affirms.

[Plotinus 5.1.5] The Dyad (**being unmanifest and neither belonging to the One or to Number, it is 'Indefinite'. This is "cause before cause", i.e. primordial agnosis, which is meant emanation by definition**) is a secondary (**only to the Monad**); deriving from unity (**The Monad and the Dyad together**), it finds in unity the determinant needed by its native indetermination: once there is any determination, there is Number, in the sense, of course, of the real [the archetypal] Number. And the soul is such a number or quantity (**.381966**). For the Primals (**Unity**) are not masses or magnitudes; all of that gross order is later, real only to the sense-thought. Thus by what we call Number and the Dyad (**.236067**) of that higher realm, we mean Reason Principles and the Intellectual-Principle: but while the Dyad is, as regards that sphere, undetermined- representing, as it were, the underly of The One- the later Number [or Quantity]- that which rises from the Dyad [Intellectual-Principle] and The One (**Unity**)- is not Matter to the later existents but is their forming-Idea, for all of them take shape, so to speak, from the ideas rising within this. The determination of the Dyad is brought about partly from its object- The One- (**that the object of agnosis is the Subject itself**) and partly from itself, as is the case with all vision in the act of sight: intellection [the Act of the Dyad] is vision occupied upon The One.

[Plotinus 5.1.6] The One to be, how does anything at all come into substantial existence, any multiplicity, dyad, or number? Why has the Primal not remained self-gathered so that there be none of this profusion of the manifold which we observe in existence and yet are compelled to trace to that absolute unity? In venturing an answer, we first invoke the Divine Himself, not in loud word but in that way of prayer which is always within our power, leaning in soul towards Him by aspiration, alone towards the alone. But if we seek the vision of that great Being within the Inner Sanctuary- self-gathered, tranquilly remote above all else- we begin by considering the images stationed at the outer precincts, or, more exactly to the moment, the first image that appears. How the Divine Mind comes into being must be explained: Everything moving has necessarily an object towards which it advances; but since the Supreme can have no such object (**only the Nous can have said object in its vision**), we may not ascribe motion to it: anything that comes into being after it can be produced only as a consequence of its unfailing self-intention; and, of course, we dare not talk of generation in time, dealing as we are with eternal Beings: where we speak of origin in such reference, it is in the sense, merely, of cause and subordination: origin from the Supreme must not be taken to imply any movement in it: that would make the Being resulting from the movement not a second principle but a third: the Movement would be the second hypostasis

[Plotinus 5.5.4] the dyad has come into being, but the precedent monad still stands; and this monad is quite distinct within the dyad from either of the two constituent unities (**1 and 1 [1x1 is lesser than 1+1] Unity being both the Monad and the Nous together as 1 principle**), since there is nothing to make it one rather than the other: being neither, but simply that thing apart, it is present without being inherent. But how are the two unities distinct and how is the dyad a unity, and is this unity the same as the unity by which each of the constituents is one thing? Our answer must be that the unity is that of a participation in the primal unity with the participants (**lesser phenomenal noetic forms and empirical Being**) remaining distinct from that in which they partake (**as a baby suckles from its mother for its existence but is autonomous from same**); the dyad, in so far as it is one thing (**this is meant that the One is by nature and action emanative, i.e. that its efflux is temporalized and phenomenalized**), has this participation, but in a certain degree only; the unity of an army is not that of a single building; the dyad, as a thing of extension, is not strictly a unit either quantitatively or in manner of being. Are we then to take it that the monads in the pentad and decad differ while the unity in the pentad is the same as that in the decad? Yes, in the sense in which, big and little, ship is one with ship, army with army, city with city; otherwise, no.

8. The Phi sections and their ontological meaning

"He divided them (parts of the created world) in the middle and laid the pieces opposite each other...(this create world) as consisting of almost an endless series of opposites held together in harmony by the very creative impulse or agent which had originally separated them out from primitive and unformed matter by a series of bisections" [Philo Gen. 15.10]

8.1 Phi from the power of -3 to Phi cubed

"There are [in our existence] two things, one the authentic Self (psyche), and the other ever pursuing something other than itself...one that is ever for the sake of things that really are, the other that which having become for the sake of the former (psyche tou pantos)" [Philebus 53d]

The Phi framework proceeds from: 0.236067978 by increasing powers of Phi to produce the additive series: 0.381966011, 0.618033989, 1.00000000, 1.618033989, 2.618033989, 4.236067978 and so on. The totality of Emanation is encapsulated from the 7 figures proceeding from either side of the Monad, being Phi to the power of -3 to Phi cubed. Phi to -3 is the primordial agnosis which its choate to the Monad and forms the empirical basis and separation of the Nous, thereby creating "Unity" and all things in between (eidos-matter-mimesis). Perfectly in proportion to each other relative to the 1st Hypostasis, the Monad, the 2nd and 3rd Hypostasis are inverse squares of Phi, the Psyche being Phi to -2 and the Nous (Unity and vertical) being Phi squared. The Antinomy to Agnosis is totality (4.23606), of which the 1 divided by agnosis = 4.23606 (1/.23606 = Phi cubed). The remaining proportions belong to matter and Being, both of which share equal portions of shape and matter, with Being, the exceptional empirical hybrid of the empirical intelligible. Certainly this is another Pythagorean trinity of which Plato and his formers were well aware of. Also, certainly no coincidence, the 2nd and 3rd Hypostasis are both a distance of Phi from the Monad if the Monad is removed from both hypostasis.

Interestingly, there are 5 section of Phi to -3, Phi to -2, and Phi to -1, but only one section of Phi, Phi squared, and Phi cubed inside the 1-1-Phi Pythagorean triangle.

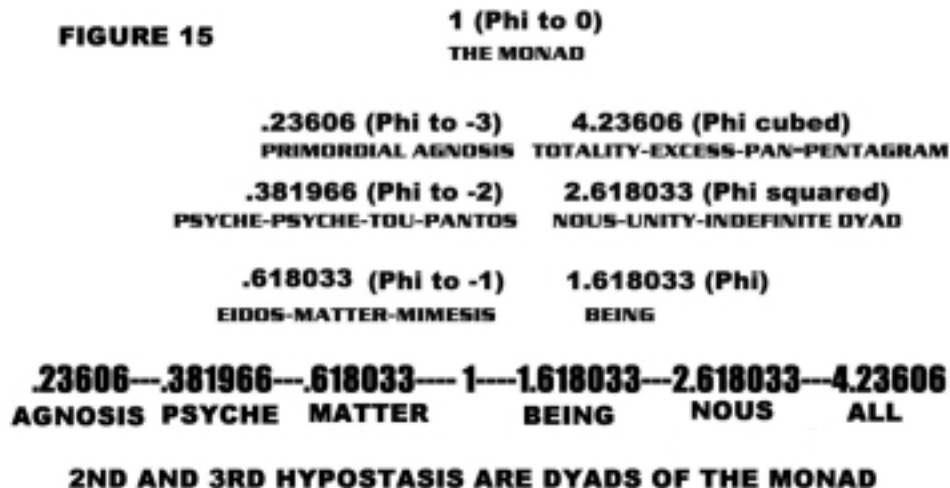

8.2 Agnosis-Emanation “cause before cause”, the basis of emanation .236067976, Phi to -3

“In short, the philosophers began only to speak of contrary principles; but above these elements they knew another superior one, as is testified to by Philolaus, who says that God has produced, and realized the finite and infinite, and shown that at the limit is attached the whole series which has a greater affinity with the One, and to Infinity, the one that is below. Thus, above these two principles they have posited a unifying cause, superior to everything which, according to Archenetus, is the cause before the cause, and, according to Philolaus, the universal principle.” [Archytas of Tarentum (400 B.C.) METAPHYSICAL FRAGMENTS].

.23606 is the privative principle by which the Monad, in image as Nous, is ‘dissected’ (The One itself always remains One, but is divided amongst all things temporal and which partake of its image “in radiation”-Plotinus). As we know: $1/.23606 = 4.23606$ Totality, this privative principle, which has no ontological actuality whatsoever is best seen as the ratio of radiation by which the Monad has its “image” or Logos in all phenomena. In reality, .23606, both mathematically in our Pythagorean triangle, and logically so, is the “seed” whereby 1/Phi and Phi are made manifest. Agnosis has the Subject (Monad, noetic) as its Object (visible), which is meant radiation, or Emanation. .23606 is the principle of all excess, therefore kakon, evil, is the ‘seed’ of noetic forms, empirical shapes, and of matter itself. Nous is separated from the one by .23606, as well as matter and forms from the nous, lastly as the basis for Phi, or Being itself.

In the strictest sense, .23606 is the Dyad itself, and not 1/Phi. The reconciliation that, obviously, the One is the “cause” for all things would negate the very stature of the Monad and its Principle, for the One cannot be moved, or it would be subordinate to what it moves to. This “dark principle” which itself uncaused, is the “cause of all things but which itself is without any cause”, is not the Monad by the very principle of duplicity which is not of the One, but what the Monad is not, being Self-assimilated to itself on the magnitude of Subjective-Gnosis. There can be no Creationistic 1st Perfect that we, lesser ‘Gods’ in the sphere of becoming can look above and declare a sentient Creator both aware of his minions but also of his own Nature. In a partless Perfect, self-gnosis is logically untenable. This absence, this “dark principle” leads to the establishment of a “Second God”-Numenius, being the Nous, which Plotinus calls the Dyad. But this “real Dyad”, also driven by Subjective-agnosis is the source for all things create. But before the Noetic Dyad which is “real” in the sense of being the basis for the Nous’ emanation to other, there exists agnosis to and of the One.

.23606 of the Monad is not a diminishment of the Ones potency, but an objective attribution of the subjective Monad that, of and within same there does not exist either self-awareness or sentience, which would imply a Creationist Theism, which Plotinus outright rejects: “there is no knowledge in the One”-Plotinus. We might as soon attribute reality to a privation, or absence in the example of darkness (that its being is not substantial but only a lack, a privation of light), as we would ascribe any existence, ontological or empirical to the privation of gnosis which exists from the very first through to the very last, except in the case of those “rare few who have assimilated to the Good”-Plato-Plotinus. If we were to apply the ignorant contention of the Creationists that “God made man in his own image”, then God is a completely ignorant fool who confuses phenomenal attributes with his noetic, uncreate, and eternal nature. The Gnosis which must “be made become” by the Being is something which is immanent but not imparted either by the Monad, the Nous, or lastly by the Psyche. The subjugation of becoming advocated is meant that .23606, or agnosis, be foremost recognized and lastly inverted through assimilation with the Good.

To say that the One is cause of anything would bring deficiency to the One that it be in need of anything, rather that which does not exist, agnosis, a pure absence, is opposite to that which is Self-inherent and Self-assimilated thereby nullifying Emanation. The ancient Advaitins and Vedanists were grand masters at debating the dialectic of the nature and meaning of “that which did not exist, but was the uncaused cause of all things which were made become”. Seemingly untenable, how is it that something which does not exist is the cause of anything? Just as if someone, analogously, were to land upon planet X which had no water, how might this person perish from what “doesn’t exist”? The answer is simple if viewed in this way. The “darkness of the Godhead” is that within it there is no Self-Gnosis, its nature is a pure unbridled actus of Emanation wherein Subject-gnosis must be “made become” by the person

who, in anamnesis, “wades back to the source” by various means of assimilation, such as apophasis (‘talking away’), the via negativa wherein all empirical objectivity is denied in order to give root to Subjective and noetic knowledge of the Godhead, the very principle which one is by Nature. This “turning round” (tat tvam asi) of the will (Nous) within man is the basis for the mystical epistrophe which Plato and Plotinus spoke of as Monistic mystics, advocating a “Oneing with the Principle of all things”. We can only talk of .23606 as being ‘real’ in the position of the second hypostasis, the Nous, as before this, it is merely an absence, a privation of which “nobody can make measure”-Plato, or “we cannot speak of something totally non-existent”- Proclus.

If we give light to the nature of .23606 and its nature, it is that of a multi-faceted mirror in which the unmoving, unchanging Monad is reflected as a plethora of noetic and phenomenal things, where all things are in proportion (Logos) to the One and to each other in perfect ratio either to the One or to each other in blending. $1/.23606 = 4.23606$. The area of the 2 far triangles A and B in figure 13, is .23606, meaning that quadrants of empirical excess are parcels of the Indefinite Dyad. C is also the same area as either A or B, and all three have the Psyche (.381966) as its base, but only C is the Psyche as the base of Being, or Phi. The Psyche (.381966) divided by .23606 = Phi.

Also in the Tetraktys, there are 5 examples of 1/Phi, 5 examples of 1-1/Phi, but there are only 4 examples of .23606, because one of them is ‘hidden’, which is meant the privation choate to the Monad, see figure 12. The Tetraktys itself is composed of 1-4 which total 10, or totality, but the last remaining section is .23606 or privation, being the impetus for Emanation, giving a total of 4.23606.

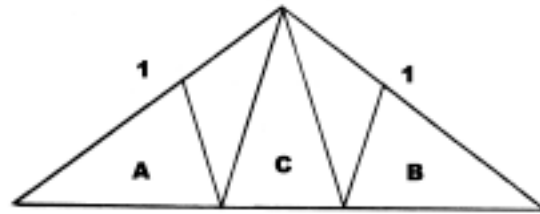

PHI FIGURE 13

8.3 The Psyche, the Soul 1-1/Phi .381966, Phi to -2

“How can that which is never self-same ‘be’ anything? For if it is ever self-same, it is evidently not at that time transient, and if it is always self-same and ‘itself’, how can it ever change or move without relinquishing its own form?” [Cratylus 439E]

Because bodies, according to their own nature, are changeable, inconstant, and infinitely divisible, and nothing unchangeable remains in them, there is evidently need of a principle that would lead them, gather them, and bind them fast together; and this we name Soul. If then the soul were a body of any kind of constitution, even if it were as small as (an atom,) what would then hold that together? For we said that every body needed some principle that would hold the body together, and so on into infinity, until we should reach the incorporeal.Should it be said, however, that because bodies have three dimensions, then must also the soul, as it penetrates the whole body, be of triple extension, and therefore in any case be a body, then would we have to answer that although every body has three dimensions, yet not everything that has three dimensions is a body. For quantity and quality, which in themselves are incorporeal, may under certain circumstances be reckoned quantitatively. Likewise the soul, which in itself is non-extensive, might be considered as tridimensional in case that by chance it had happened into something tridimensionalBefore those, who earlier than we have attempted to explain the nature of the soul mathematically as some medium between the natural and the supernatural, it is asserted by those who call the soul a number, that it consists of unity, as something indivisible, and of the indefinite doubleness (manifold) as something divisible. Others, however, who conceive of the soul as of a geometrical figure, insist that it consists of a point and the divergence (either a locus and the divergence of two lines, or a centre and the radius of a circle); of which the first is indivisible, and the second divisible. Of the first opinion are the partisans of Aristander, Numenius, and the majority of the expounders; of the second opinion is Severus. [The Neoplatonic Writings of Numenius, Collected and translated by Kenneth.Sylvan.Guthrie, Vol. VI, Great Works of Philosophy (ed. Ed. Robert Navon) Selene Books, Lawrence, Kansas 1987: 44-46]

Numerically, in terms of the Phi-Series planetary framework, the element "Aether" may be understood to be the ubiquitous value $\Phi^{-2} = 0.3181966$ which we already know to be the "Body," "Soul" and "Spirit" of the matter as discussed lightly in the previous Section. Specifically, this exact parameter occurs firstly as the "Body" (Distance) of Mercury ("Fire"), secondly as the "Soul" (Synodic Period) between Mercury and Venus (Venus "Philosophical"), and thirdly as the "Spirit" (Velocity) of Antimony (the Jupiter-Saturn Synodic Cycle, or Saturn "Philosophical"). It is therefore apparent that this constant is a central feature of Alchemy, for it also represents "Hermaphroditic Brass", Isaac Newton's aptly named "Quintessence," and more generally, the Fifth element "Aether". As for this element's all-inclusive nature, according to the "Theurgists" quoted by Proclus in his *Commentary on the Timaeus*: “All things receive inclosed on ev'ry side, In aether's wide ineffable embrace: Then in the midst of aether placed the heav'n; In which let earth of infinite extent, The sea, and stars, the crown of heav'n, be fixt. And when your power around the whole has spread A strong coersive bond, a golden chain, suspended from the aether.” .381966, in the Pentagram also represents a ration of 1 to 1/Phi on the 5 peripheries.

8.4 .618033 1/Phi, Phi to -1

“As there still remains one compound (the 5th Platonic solid, the dodecahedron) the fifth, which the Divine used it (as model/image) for the whole, broidering it with designs (images/forms)” [Plato, *Timaeus*, 55C]

1/Phi represents the Eide, matter, mimesis of the interior of the Pythagorean triangle, as well as the sloping angles of the 5 peripheries of the pentagram, or as in the Divided Line of Plato, represents all things empirical and material.

$$\frac{1}{\phi} = \phi - 1 = \frac{\sqrt{5} - 1}{2} \approx 0.618$$

8.5 The Monad, 1, Phi to 0

“The pentagram”: because the symbol secretly called the pentalpha was a recognition-symbol amongst the Pythagoreans, and they used it in their letters.” [Scholium to Lucian (Q.2), “In Defense of a Slip of the Tongue in Greeting,” 5 [Vogel, 1961, 181]

The Monad is enlarged, which generates Two. For the Dyad sits by him, and glitters with Intellectual Sections. And to govern all things, and to Order all things not Ordered. For in the whole World shineth the Triad, over which the Monad Rules. This Order is the beginning of all Section. For the Mind of the Father said, that all things can be cut into three, Governing all things by mind. And there appeared in it (the Triad) Virtue and Wisdom. And Multiscient Verity. This way floweth the Shape of the Triad, being præ-existent. Not the first (essence) but where they are measured. For thou must conceive that all things serve three principles. The first course is Sacred, but in the middle. Another the third, ærial; which cherished the Earth in Fire. And fountain of Fountains, and of all Fountains. The Matrix containing all things. Thence abundantly springs forth the Generation of multi various Matter. Thence extracted a prester the flower of glowing Fire, Flashing into the cavities of the World: for all things from thence. Begin to extend downwards their admirable Beams. [The Chaldean Oracles as Set Down By Julianus, {Latin: Francesco Patrizzi; English: Thomas Stanley} Heptangle Books, Gillette, New Jersey, 1939:3]

8.6 1.618033, Phi, Phi to 1

“Indeed the pentagram, the triple intersecting triangle which they used as a symbol of their sect, they called ‘totality’” [Lucian, “In Defense of a Slip of the Tongue in Greeting,” 5 Lucian-Kilburn, 177)]; [Vogel, 1966, 46; Thomas, 1934, I, 225]

$$\phi = \frac{\sqrt{5} + 1}{2} \approx 1.618$$

0.381966011 + 0.618033989 = 1 = Monad (ODD, MALE Number)
 0.381966011 + 1.618033989 = 2 = Dyad (EVEN, FEMALE Number)
 0.381966011 + 2.618033989 = 3 = Triad (ODD, MALE Number)
 element "Aether" may be understood to be the ubiquitous value $\text{Phi}^{-2} = 0.381966011$

Phi phi = 1 Phi - phi = 1 Phi + phi = $\sqrt{5}$	
Phi = 1.6180339..	phi = 0.6180339..
Phi = 1 + phi	phi = Phi - 1
Phi = 1/phi	phi = 1/Phi
Phi ² = Phi + 1	(-phi) ² = -phi + 1 or phi ² = 1 - phi
Phi = ($\sqrt{5} + 1$)/2	phi = ($\sqrt{5} - 1$)/2

In the Pythagorean triangle, Phi represents the union of matter-mimesis-psyche, thereby forming the 5 peripheries of the pentagram of the 4 elements and the world-soul

8.7 2.618033 Nous, Phi squared

“For the whole, the Divine used the dodecahedron” [The Didaskalikos of Albinus #13]

“Pythagoras, seeing that there are five solid figures, which are called the mathematical figures, says that the earth arose from the cube, fire from the pyramid, air from the octahedron, and the sphere of the universe from the dodecahedron.” [Aetius, Placita, ii, 6.5 (Thomas, I,217)]

See 7 above on the Indefinite Dyad.

8.8 Totality (“The All” or Pan) 4.236067976, Phi cubed

“In every world a triad shines forth, of which the Monad is the Principle” [Thomas Taylor, Chaldean Oracles #75]

“What the Pythagoreans intended to signify by ‘monad-duad-triad’, or Plato by ‘bound-infinite-that which is mixed from both’, or we by ‘One-the-many-the united’, that the oracles of the gods signify by ‘hyparxis-power-intellect’.” [Thomas Taylor, Chaldean Oracles #69]

4.2360679 is the Number for totality, or Pan as in Coin #1 in the section “The Greek Pentagram, two points up”. In some designs of this coin (whose reverse side is the pentagram) the head of Zeus Ammon (Pan) is replaced with an omphalos entwined by a serpent (ouroboros), also representing totality. Zen Ammon-Pentagram, or Totality sits upon the throne of the Monad. See figure 10.

4.23606 has many interesting connection with Phi and the other section of the 1-1-Phi Pythagorean triangle. In the “Divided Line” of Plato’s Republic 509d, all section total to 4.23606, of which the midpoint is in the center of the Monad at 2.118033, interestingly giving the analogy that totality is the resultant of the procession/emanation from the center of the Monad. The agnosis inherent to the Monad divided thereof gives totality, 4.23606, meaning that the nature and “cause before cause” which is meant the reason for the Monads emanation to other, results in the cosmic totality of 4.23606 which includes all things “visible” and “noetic” in the divided line section of Plato.

Below are just a few examples, of which many more can certainly be extrapolated:

- #1. $1/.23606 = 4.23606$
- #2. In the “Divided Line” of Plato’s Republic 509d: $A(\text{Phi}, 1.618033)+B(1)+C(1)+D(1/\text{Phi}, .618033) = 4.23606797$. Of which the midpoint is the middle of the Monad at 2.118033. One half of Agnosis is .118033. 2 is the indefinite dyad, or Nous, which is not numerical 2 but dyadinous Unity.
- #3. $4.23606 \times \text{Half agnosis} (.118033) = \text{Area of the 1-1-Phi Pythagorean triangle, or } .5$. Also, half the divided line $(2.118033) \times \text{agnosis} (.23606) = \text{Area of the 1-1-Phi Pythagorean triangle, or } .5$.
- #4. $4.23606/\text{Phi squared} = \text{Phi}$
- #5. $4.23606/\text{Phi} = \text{Phi squared}$
- #6. $\text{Phi cubed} = 4.23606$. This would apparently mean that the ‘Trinity’ of totality (4.23606) is = Phi cubed.
- #7. $4.23606 \times .23606 \text{ (agnosis)} = 1$
- #8. Total of the 1-1-Phi-1/Phi verticle of the Pythagorean triangle = 4.23606
- #9. Area of the triangle, .5 / its lesser section [either A or B section] (.118033) = 4.23606
- #10. Totality (4.23606) x Area of the Pentagram (.854102) = Circumference of the Pythagorean triangle (3.618033)
- #11. $4.23606 \times \text{Psyche} (.381966) = \text{Phi} (1.618033)$
- #12. (1) $1/\text{Phi}$ (Eidos, form) + (2) $1/\text{Phi}$ (matter) + (3) $1/\text{Phi}$ (mimesis, shape) = 1.854099, Plus (4) .381966 (Psyche tou pantos) = 2.23606, Plus (5) 1 (the Monad) = 3.23606, Plus (6) .23606 (Primordial agnosis) = 3.472132, Plus (7) Nous-Indefinite dyad (.76394, or 2X Psyche, [plus agnosis] = 1 = ‘Unity’)] = 4.23606797 i.e. Totality; all of which = 1, or the Monad in its Emanation.
- #13. $4.23606 \times \text{Psyche tou pantos} (.381966) = \text{Phi}$
- #14. 4.23606 = the sum of all things empirical and ontological, or Pan.
- #15. $4.23606 = 1 \text{ through } 4 \text{ (of the Pythagorean tetractys)} + \text{agnosis} (.23606) = \text{Totality}$
- #16. (1) Phi = Being 1.618033, (2) Phi squared = 2.618033 (Up to the Noetic and excess (matter and mimesis), (3) Phi cubed = Totality, or 4.23606
- #17. Unity (2) + the square root of 5 (2.23606 [all things phenomenal]) = Phi cubed, or 4.23606
- #18. $4.23606 = 1 + \text{Phi} + \text{Phi}$. Also as mentioned Phi cubed = 4.23606
- #19. $4.23606 \times 1/\text{Phi} = \text{Phi squared}$

9. Conclusion

“Pythagoras thought that his disciples should guard in silence the words they heard, saying that the man who disclosed (to the common man) the nature of incommensurability (of the Pentagram) to those unworthies was so hated that not only was he banned

from the (circle of the Pythagoreans) common association, but also while alive his gravestone was erected to signify that said (heretic) was dead (to the society). For he who revealed the structure of the dodecahedron, would perish in the sea like one who has committed sacrilege.” [Iamblichus, *On the Pythagorean Life*, chapter 34]

Number is the first principle, a thing which is undefined, incomprehensible, having in itself all numbers which could reach infinity in amount. And the first principle of numbers is in substance the first Monad, which is a male monad, begetting as a father all other numbers. Secondly, the Dyad is a female number, and the same is called by the arithmeticians even. Thirdly, the Triad is a male number; this the arithmeticians have been wont to call odd. Finally, the Tetrad is a female number, and the same is called even because it is female. Pythagoras said this sacred Tetractys is: 'the spring having the roots of ever-flowing nature.' The four parts of the Decad, this perfect number, are called number, monad, power and cube. And the interweavings and minglings of these in the origin of growth are what naturally completes nascent number; for when a power of a power; and a cube is multiplied on a cube, it is the power of a cube; and when a cube is multiplied on a cube, the cube of a cube; thus all numbers, from which arise the genesis of what arises, are seven: number, monad, power, cube, power of a power, power of a cube, and cube of a cube. [Hippol., *Phil.*, 2. Dox. 355, *PYTHAGOREAN SOURCES & FRAGMENTS*, Kenneth Sylvan Guthrie, Phanes Press, Grand Rapids, Michigan 1988:312]

The purpose of this small but pithy book was to re-illuminate a lost symbol of the Pythagoreans which formed the basis of their model for the kosmos, of their oath, the tetraktys and of the mark of their sect, the pentagram, all of which is based upon what I preferred to call the Pythagorean triangle which of its very nature contains a near endless (only the most important of which are mentioned here) list of proportions and analogies for the Absolute and the demiurge and the logos which exists between the Monad, the Nous, the Psyche, and the world soul and its empirical constituents of being.

As such, this book is little more than an introduction, in hopes that others may use it as a springboard for further investigation into this symbol, most especially knowing what we know of the Pythagoreans and Platonists who certainly entertained an insatiable desire to possess a geometer which served as perfect model for the kosmos on many many levels, and the relevant proportions and ratios contained therein which corresponded perfectly both to the Monad, to nature, to the soul, and the interrelationships of all as one harmonic totality underneath the One.

Certainly not comprehensive, but without excessive logomachy of which too many authors cant say in 1000 pages what others can say in 10, my best hopes are that the ubiquitous Pythagorean triangle in question was a “forest for the trees” problem these many years among other excuses, that this topic has not been brought to light before, that I or we may have better insight into the teachings of Pythagoras the models he employed.

10. Bibliography

- Michael F. Wagner (Editor). 2002. *Neoplatonism and Nature*: State University of New York Press
Kirk, G.S. and R.E. Raven. 1975. *The Presocratic Philosophers*. Cambridge: Cambridge University Press.
Sayre, Kenneth M. 1983. *Plato's Late Ontology: A Riddle Resolved*. Princeton: Princeton University Press.
Barnes, Jonathan, ed. 1984. *The Complete Works of Aristotle, vol. 2*. Princeton: Princeton University Press.
J.M. Rist, 1967. *Plotinus, The Road to Reality*, Cambridge University Press.
F.E. Peters, 1967. *Greek Philosophical Terms*, New York University Press
Scott A. Olsen, "The Indefinite Dyad and the Golden Section: Uncovering Plato's Second Principle", *Nexus Network Journal*, vol. 4, no. 1 (Winter 2002)
A.H. Armstrong, 1984. *Plotinus (In 7 Vols.)* Harvard University Press
Plato, *The Collected Dialogues*, Bollingen Series LXXI, Princeton, 1989
Robin Waterfield, 1988. *The Theology of Arithmetic*: Phanes Press
Herz-Fischler, Roger. 1987. *A Mathematical History of the Golden Number*. New York: Dover Publications.
Kenneth Guthrie, 1987. *The Neoplatonic Writings of Numenius*. Selene Books
Sir Thomas Heath, 1981. *A History of Greek Mathematics*. Dover Publications
Roger Herz-Fischler, 1987. *A Mathematical History of the Golden Number*. Dover Publications
H.E. Huntly, 1970. *The Divine Proportion*. Dover Publications.

