



Graham Priest  
**LOGIC**  
A Very Short Introduction

Indian Edition

OXFORD

## Logic: A Very Short Introduction

‘a delightful and engaging introduction to the basic concepts of logic. Whilst not shirking the problems, Priest always manages to keep his discussion accessible and instructive.’

Adrian Moore, St Hugh’s College, Oxford

‘an excellent way to whet the appetite for logic. . . . Even if you read no other book on modern logic but this one, you will come away with a deeper and broader grasp of the *raison d’être* for logic.’

Chris Mortensen, University of Adelaide

‘This new addition to the VSI series makes a splendid fist of warming up logic for the general palate. You still have to learn a few symbols, but the pleasure in following Priest’s mind-bending puzzles about dividing amoebas, or refuting, with his guidance, a famous refutation of the existence of time, will be worth it.’

*Guardian*

‘This elegant and beautifully written little book provides the novice with an excellent introduction to the general field of logic.’

Michael Detlefsen, University of Notre Dame

VERY SHORT INTRODUCTIONS are for anyone wanting a stimulating and accessible way in to a new subject. They are written by experts, and have been published in more than 25 languages worldwide.

The series began in 1995, and now represents a wide variety of topics in history, philosophy, religion, science, and the humanities. Over the next few years it will grow to a library of around 200 volumes – a Very Short Introduction to everything from ancient Egypt and Indian philosophy to conceptual art and cosmology.

### Very Short Introductions available now:

#### ANCIENT PHILOSOPHY

Julia Annas

#### THE ANGLO-SAXON AGE

John Blair

#### ANIMAL RIGHTS David DeGrazia

#### ARCHAEOLOGY Paul Bahn

#### ARCHITECTURE

Andrew Ballantyne

#### ARISTOTLE Jonathan Barnes

#### ART HISTORY Dana Arnold

#### ART THEORY Cynthia Freeland

#### THE HISTORY OF

ASTRONOMY Michael Hoskin

#### ATHEISM Julian Baggini

#### AUGUSTINE Henry Chadwick

#### BARTHES Jonathan Culler

#### THE BIBLE John Riches

#### BRITISH POLITICS

Anthony Wright

#### BUDDHA Michael Carrithers

#### BUDDHISM Damien Keown

#### CAPITALISM James Fulcher

#### THE CELTS Barry Cunliffe

#### CHOICE THEORY

Michael Allingham

#### CHRISTIAN ART Beth Williamson

#### CLASSICS Mary Beard and

John Henderson

#### CLAUSEWITZ Michael Howard

#### THE COLD WAR

Robert McMahon

#### CONTINENTAL PHILOSOPHY

Simon Critchley

#### COSMOLOGY Peter Coles

#### CRYPTOGRAPHY

Fred Piper and Sean Murphy

#### DADA AND SURREALISM

David Hopkins

#### DARWIN Jonathan Howard

#### DEMOCRACY Bernard Crick

#### DESCARTES Tom Sorell

#### DRUGS Leslie Iversen

#### THE EARTH Martin Redfern

#### EGYPTIAN MYTHOLOGY

Geraldine Pinch

#### EIGHTEENTH-CENTURY

BRITAIN Paul Langford

#### THE ELEMENTS Philip Ball

#### EMOTION Dylan Evans

#### EMPIRE Stephen Howe

#### ENGELS Terrell Carver

#### ETHICS Simon Blackburn

#### THE EUROPEAN UNION

John Pinder

#### EVOLUTION

Brian and Deborah Charlesworth

#### FASCISM Kevin Passmore

#### THE FRENCH REVOLUTION

William Doyle

#### FREUD Anthony Storr

#### GALILEO Stillman Drake

#### GANDHI Bhikhu Parekh

GLOBALIZATION  
     Manfred Steger  
 HEGEL Peter Singer  
 HEIDEGGER Michael Inwood  
 HINDUISM Kim Knott  
 HISTORY John H. Arnold  
 HOBBS Richard Tuck  
 HUME A. J. Ayer  
 IDEOLOGY Michael Freeden  
 INDIAN PHILOSOPHY  
     Sue Hamilton  
 INTELLIGENCE Ian J. Deary  
 ISLAM Malise Ruthven  
 JUDAISM Norman Solomon  
 JUNG Anthony Stevens  
 KANT Roger Scruton  
 KIERKEGAARD  
     Patrick Gardiner  
 THE KORAN Michael Cook  
 LINGUISTICS Peter Matthews  
 LITERARY THEORY  
     Jonathan Culler  
 LOCKE John Dunn  
 LOGIC Graham Priest  
 MACHIAVELLI  
     Quentin Skinner  
 MARX Peter Singer  
 MATHEMATICS  
     Timothy Gowers  
 MEDIEVAL BRITAIN  
     John Gillingham and  
     Ralph A. Griffiths  
 MODERN IRELAND  
     Senia Pašeta  
 MOLECULES Philip Ball  
 MUSIC Nicholas Cook  
 NIETZSCHE Michael Tanner  
 NINETEENTH-CENTURY  
     BRITAIN Christopher Harvie and  
     H. C. G. Matthew  
 NORTHERN IRELAND  
     Marc Mulholland  
 PAUL E. P. Sanders  
 PHILOSOPHY Edward Craig  
 PHILOSOPHY OF SCIENCE  
     Samir Okasha  
 PLATO Julia Annas  
 POLITICS Kenneth Minogue  
 POSTCOLONIALISM  
     Robert Young  
 POSTMODERNISM  
     Christopher Butler  
 POSTSTRUCTURALISM  
     Catherine Belsey  
 PREHISTORY Chris Gosden  
 PRESOCRATIC PHILOSOPHY  
     Catherine Osborne  
 PSYCHOLOGY Gillian Butler and  
     Freda McManus  
 QUANTUM THEORY  
     John Polkinghorne  
 ROMAN BRITAIN  
     Peter Salway  
 ROUSSEAU Robert Wokler  
 RUSSELL A. C. Grayling  
 RUSSIAN LITERATURE  
     Catriona Kelly  
 THE RUSSIAN REVOLUTION  
     S. A. Smith  
 SCHIZOPHRENIA  
     Chris Frith and Eve Johnstone  
 SCHOPENHAUER  
     Christopher Janaway  
 SHAKESPEARE Germaine Greer  
 SOCIAL AND CULTURAL  
     ANTHROPOLOGY  
     John Monaghan and Peter Just  
 SOCIOLOGY Steve Bruce  
 SOCRATES C. C. W. Taylor  
 SPINOZA Roger Scruton  
 STUART BRITAIN  
     John Morrill  
 TERRORISM Charles Townshend  
 THEOLOGY David F. Ford

Available soon:

- THE TUDORS John Guy  
TWENTIETH-CENTURY  
BRITAIN Kenneth O. Morgan  
WITTGENSTEIN A. C. Grayling  
WORLD MUSIC Philip Bohlman  
AFRICAN HISTORY  
John Parker and Richard Rathbone  
ANCIENT EGYPT Ian Shaw  
THE BRAIN Michael O'Shea  
BUDDHIST ETHICS  
Damien Keown  
CHAOS Leonard Smith  
CHRISTIANITY Linda Woodhead  
CITIZENSHIP Richard Bellamy  
CLASSICAL ARCHITECTURE  
Robert Tavernor  
CLONING Arlene Judith Klotzko  
CONTEMPORARY ART  
Julian Stallabrass  
THE CRUSADES  
Christopher Tyerman  
DERRIDA Simon Glendinning  
DESIGN John Heskett  
DINOSAURS David Norman  
DREAMING J. Allan Hobson  
ECONOMICS Partha Dasgupta  
THE END OF THE WORLD  
Bill McGuire  
EXISTENTIALISM Thomas Flynn  
THE FIRST WORLD WAR  
Michael Howard  
FREE WILL Thomas Pink
- FUNDAMENTALISM  
Malise Ruthven  
HABERMAS Gordon Finlayson  
HIEROGLYPHS  
Penelope Wilson  
HIROSHIMA B. R. Tomlinson  
HUMAN EVOLUTION  
Bernard Wood  
INTERNATIONAL RELATIONS  
Paul Wilkinson  
JAZZ Brian Morton  
MANDELA Tom Lodge  
MEDICAL ETHICS  
Tony Hope  
THE MIND Martin Davies  
MYTH Robert Segal  
NATIONALISM Steven Grosby  
PERCEPTION Richard Gregory  
PHILOSOPHY OF RELIGION  
Jack Copeland and Diane Proudfoot  
PHOTOGRAPHY Steve Edwards  
THE RAJ Denis Judd  
THE RENAISSANCE  
Jerry Brotton  
RENAISSANCE ART  
Geraldine Johnson  
SARTRE Christina Howells  
THE SPANISH CIVIL WAR  
Helen Graham  
TRAGEDY Adrian Poole  
THE TWENTIETH CENTURY  
Martin Conway

For more information visit our web site

[www.oup.co.uk/vsi](http://www.oup.co.uk/vsi)

Graham Priest

# LOGIC

A Very Short Introduction

**OXFORD**  
UNIVERSITY PRESS

# OXFORD

UNIVERSITY PRESS

YMCA Library Building, Jai Singh Road, New Delhi 110 001

Oxford University Press is a department of the University of Oxford.  
It furthers the University's objective of excellence in research, scholarship,  
and education by publishing worldwide in

Oxford New York

Auckland Bangkok Buenos Aires Cape Town Chennai  
Dar es Salaam Delhi Hong Kong Istanbul Karachi Kolkata  
Kuala Lumpur Madrid Melbourne Mexico City Mumbai Nairobi  
São Paulo Shanghai Taipei Tokyo Toronto

Oxford is a registered trade mark of Oxford University Press  
in the UK and in certain other countries

Published in the United States  
by Oxford University Press Inc., New York

© Graham Priest 2000

The moral rights of the author have been asserted  
Database right Oxford University Press (maker)

First published as an Oxford University Press Paperback 2000  
First Indian Edition 2006

All rights reserved. No part of this publication may be reproduced,  
stored in a retrieval system, or transmitted, in any form or by any means,  
without the prior permission in writing of Oxford University Press,  
or as expressly permitted by law, or under terms agreed with the appropriate  
reprographics rights organizations. Enquiries concerning reproduction  
outside the scope of the above should be sent to the Rights Department,  
Oxford University Press, at the address above

You must not circulate this book in any other binding or cover  
and you must impose this same condition on any acquirer

For sale in India, Bangladesh, Nepal, Srilanka  
and Myanmar only and not for export therefrom.

Not for sale in Pakistan

British Library Cataloguing in Publication Data

Data available

Library of Congress Cataloging in Publication Data

Data available

ISBN-13: 978-0-19-568262-5

ISBN-10: 0-19-568262-9

Typeset by RefineCatch Ltd, Bungay, Suffolk  
Printed in India by Rajshri Photolithographers, Delhi-110 032  
Published by Oxford University Press  
YMCA Library Building, Jai Singh Road, New Delhi 110 001

*This book is dedicated to all those who have ever thought about logic – or who ever will.*





# Contents

|    |  |      |
|----|--|------|
|    | Preface  | xi   |
|    | List of Illustrations  | xiii |
| 1  | Validity: What Follows from What?                            | 1    |
| 2  | Truth Functions - Or Not?                                    | 7    |
| 3  | Names and Quantifiers: Is Nothing Something?                 | 17   |
| 4  | Descriptions and Existence: Did the Greeks Worship Zeus?     | 24   |
| 5  | Self-Reference: What is this Chapter About?                  | 31   |
| 6  | Necessity and Possibility: What Will be Must be?             | 38   |
| 7  | Conditionals: What's in an <i>If</i> ?                       | 47   |
| 8  | The Future and the Past: Is Time Real?                       | 55   |
| 9  | Identity and Change: Is Anything Ever the Same?              | 63   |
| 10 | Vagueness: How do you Stop Sliding down a Slippery Slope?    | 70   |
| 11 | Probability: The Strange Case of the Missing Reference Class | 78   |
| 12 | Inverse Probability: You can't be Indifferent About it!      | 86   |
| 13 | Decision Theory: Great Expectations                          | 94   |

|    |   |     |
|----|---|-----|
| 14 | A Little History and Some Further Reading | 102 |
|    | Glossary                                  | 111 |
|    | Problems                                  | 117 |
|    | Bibliography                              | 121 |
|    | General Index                             | 123 |
|    | Index of Names                            | 127 |

# Preface

Logic is one of the most ancient intellectual disciplines, and one of the most modern. Its beginnings go back to the 4th century BC. The only older disciplines are philosophy and mathematics, with both of which it has always been intimately connected. It was revolutionized around the turn of the twentieth century, by the application of new mathematical techniques, and in the last half-century it has found radically new and important roles in computation and information processing. It is thus a subject that is central to much human thought and endeavour.

This book is an introduction to logic, as contemporary logicians now understand the subject. It does not attempt to be a textbook, however. There are numerous such books currently available. The point of this one is to explore the roots of logic, which sink deep into philosophy. Some formal logic will be explained along the way.

In each of the main chapters, I start by taking up some particular philosophical problem or logical puzzle. I then explain one approach to it. Often this is a fairly standard one; but in some of the areas there is no standard answer: logicians still disagree. In such cases, I have just chosen one that is interesting. Nearly all the approaches, whether standard or not, may be challenged. I finish each chapter with some problems for the approach that I have explained. Sometimes these problems are standard; sometimes they are not. Sometimes they may

have easy answers; sometimes they may not. The aim is to challenge you to figure out what you make of the matter.

Modern logic is a highly mathematical subject. I have tried to write the material in such a way as to avoid nearly all mathematics. The most that is required is a little high-school algebra in the last few chapters. It is true that you will need the determination to master some symbolism that may be new to you; but this is a lot less than is required to have a basic grasp of any new language. And the perspicuity that the symbolism gives to difficult questions makes any trouble one may have in mastering it well worth it. One warning, though: reading a book on logic or philosophy is not like reading a novel. There will be times when you will have to read slowly and carefully. Sometimes you may have to stop and think about things; and you should be prepared to go back and reread a paragraph if necessary.

The final chapter of the book is on the development of logic. In this, I have tried to put some of the issues that the book deals with in an historical perspective, to show that logic is a living subject, which has always evolved, and which will continue to do so. The chapter also contains suggestions for further reading.

There are two appendices. The first contains a glossary of terms and symbols. You may consult this if you forget the meaning of a word or symbol. The second appendix contains a question relevant to each chapter, with which you can test your understanding of its main ideas.

The book goes for breadth rather than depth. It would be easy to write a book on the topic of every single chapter — indeed, many such books have been written. And even so, there are very many important issues in logic that I have not even touched on here. But if you hang in there till the end of the book, you will have a pretty good idea of the fundamentals of modern logic, and why people find it worth thinking about the subject.

# List of Illustrations

- |   |                                  |    |    |  |     |
|---|----------------------------------|----|----|--|-----|
| 1 | <b>Tweedledum and Tweedledee</b> | 2  | 8  | <b><i>The Persistence of Memory</i> (Dali)</b>   | 61  |
|   | Mary Evans Picture Library       |    |    | The Museum of Modern Art, New York. Given anonymously.<br>Photograph © 2000 The Museum of Modern Art, New York |     |
| 2 | <b>Gottlob Frege</b>             | 10 | 9  | <b>Leibniz</b>   | 66  |
|   | Photo: AKG London                |    |    | © The Science Museum, London   |     |
| 3 | <b>Nobody</b>                    | 18 | 10 | <b>A bike-rider's dilemma</b>  | 71  |
|   | Mary Evans Picture Library       |    |    | © John Taylor  |     |
| 4 | <b>Bertrand Russell</b>          | 25 | 11 | <b>Sherlock Holmes</b>   | 79  |
| 5 | <b>A Möbius strip</b>            | 33 |    | Mary Evans Picture Library   |     |
|   | Photodisc. Photo: Nick Koudis    |    | 12 | <b>Whirlpool galaxy</b>  | 87  |
| 6 | <b>Aristotle</b>                 | 40 |    | Science Photo Library. Photo: Chris Butler   |     |
|   | Archivi Alinari, Florence        |    | 13 | <b>A devilish plan</b>   | 100 |
| 7 | <b>Jumping to conclusions</b>    | 51 |    | © John Taylor  |     |
|   | © John Taylor                    |    |    |  |     |

I

I

I

I

I

I

I

I

I

I

I

I

# Chapter 1

## **Validity: What Follows from What?**

Most people like to think of themselves as logical. Telling someone ‘You are not being logical’ is normally a form of criticism. To be illogical is to be confused, muddled, irrational. But what is logic? In Lewis Carroll’s *Through the Looking Glass*, Alice meets the logic-chopping pair Tweedledum and Tweedledee. When Alice is lost for words, they go onto the attack:

‘I know what you are thinking about’, said Tweedledum: ‘but it isn’t so, nohow.’

‘Contrariwise,’ continued Tweedledee, ‘if it was so, it might be; and if it were so, it would be: but as it isn’t, it ain’t. That’s logic.’

What Tweedledee is doing – at least, in Carroll’s parody – is reasoning. And that, as he says, is what logic is about.

We all reason. We try to figure out what is so, reasoning on the basis of what we already know. We try to persuade others that something is so by giving them reasons. Logic is the study of what counts as a good reason for what, and why. You have to understand this claim in a certain way, though. Here are two bits of reasoning – logicians call them *inferences*:



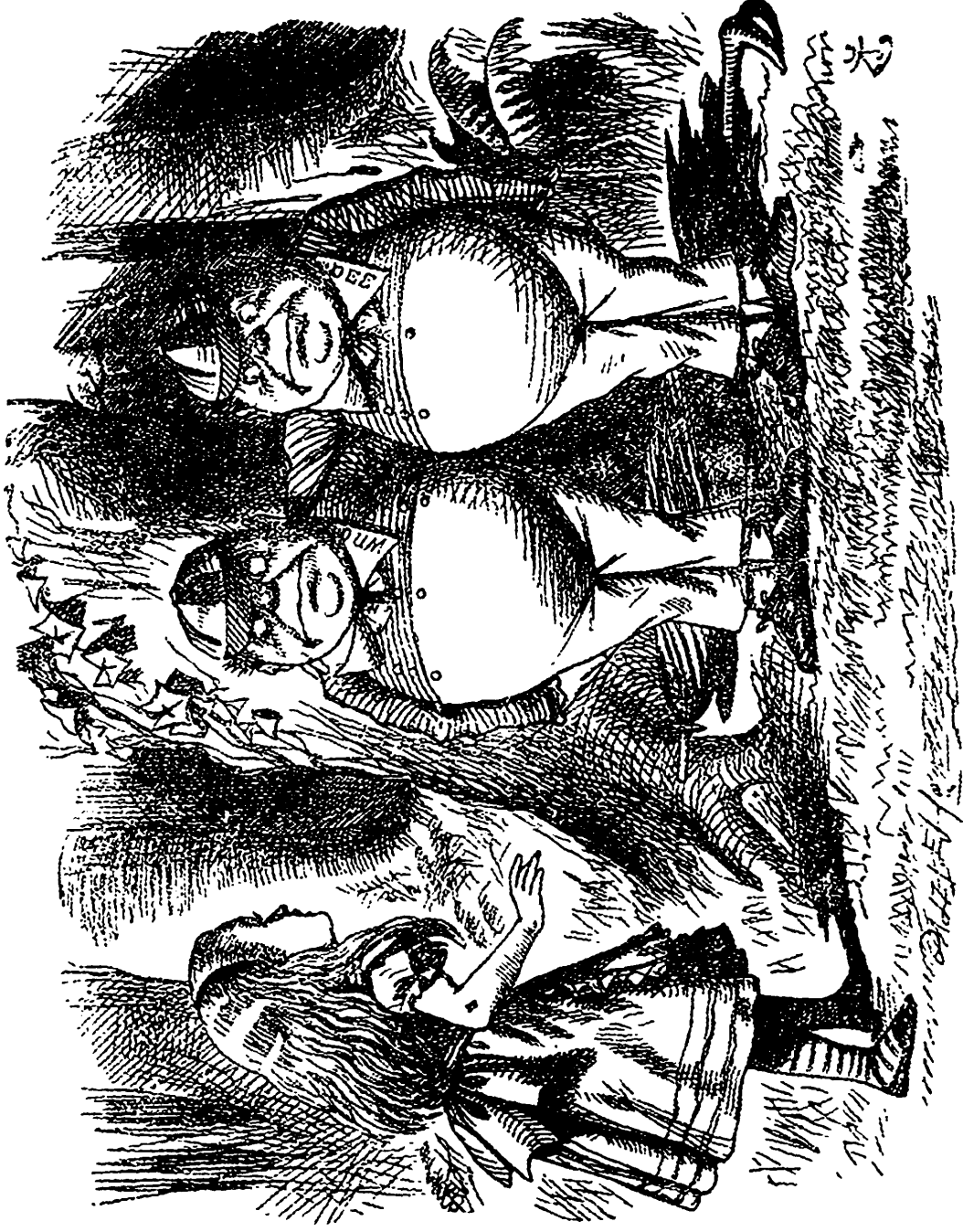

1. Tweedledum and Tweedledee debate the finer points of logic with Alice

1. Rome is the capital of Italy, and this plane lands in Rome; so the plane lands in Italy.
2. Moscow is the capital of the USA; so you can't go to Moscow without going to the USA.

In each case, the claims before the 'so' – logicians call them *premisses* – are giving reasons; the claims after the 'so' – logicians call them *conclusions* – are what the reasons are supposed to be reasons for. The first piece of reasoning is fine; but the second is pretty hopeless, and wouldn't persuade anyone with an elementary knowledge of geography: the premiss, that Moscow is the capital of the USA, is simply false. Notice, though, that if the premiss had been true – if, say, the USA had bought the whole of Russia (not just Alaska) and had moved the White House to Moscow to be nearer the centres of power in Europe – the conclusion would indeed have been true. It would have followed from the premisses; and that is what logic is concerned with. It is not concerned with whether the premisses of an inference are true or false. That's somebody else's business (in this case, the geographer's). It is interested simply in whether the conclusion follows from the premisses. Logicians call an inference where the conclusion really does follow from the premisses *valid*. So the central aim of logic is to understand validity.

Validity

You might think this a rather dull task – an intellectual exercise with somewhat less appeal than solving crossword puzzles. But it turns out that this is not only a very hard matter; it is one that cannot be divorced from a number of important (and sometimes profound) philosophical questions. We will see some of these as we go along. For the moment, let us get a few more of the basic facts about validity straight.

To start with, it is common to distinguish between two different kinds of validity. To understand this, consider the following three inferences:

1. If the burglar had broken in through the kitchen window, there

would be footprints outside; but there are no footprints; so the burglar didn't break in through the kitchen window.

2. Jones has nicotine-stained fingers; so Jones is a smoker.
3. Jones buys two packets of cigarettes a day; so someone left footprints outside the kitchen window.

The first inference is a very straightforward one. If the premisses are true, so must the conclusion be. Or, to put it another way, the premisses couldn't be true without the conclusion also being true. Logicians call an inference of this kind *deductively valid*. Inference number two is a bit different. The premiss clearly gives a good reason for the conclusion, but it is not completely conclusive. After all, Jones could simply have stained his hands to make people think that he was a smoker. So the inference is not deductively valid. Inferences like this are usually said to be *inductively valid*. Inference number three, by contrast, appears pretty hopeless by any standard. The premiss seems to provide no kind of reason for the conclusion at all. It is invalid – both deductively and inductively. In fact, since people are not complete idiots, if someone actually offered a reason like this, one would assume that there is some extra premiss that they had not bothered to tell us (maybe that someone passes Jones his cigarettes through the kitchen window).

Logic

Inductive validity is a very important notion. We reason inductively all the time; for example, in trying to solve problems such as why the car has broken down, why a person is ill, or who committed a crime. The fictional logician Sherlock Holmes was a master of it. Despite this, historically, much more effort has gone into understanding deductive validity – maybe because logicians have tended to be philosophers or mathematicians (in whose studies deductively valid inferences are centrally important), and not doctors or detectives. We will come back to the notion of induction later in the book. For the present, let's think some more about deductive validity. (It is natural to suppose that deductive validity is the simpler notion, since valid inferences are more cut-and-dried. So it's not a bad idea to try to understand this first. That,

as we shall see, is hard enough.) Until further notice 'valid' will simply mean 'deductively valid'.

So what is a valid inference? One, we saw, where the premisses can't be true without the conclusion also being true. But what does that mean? In particular, what does the *can't* mean? In general, 'can't' can mean many different things. Consider, for example: 'Mary can play the piano, but John can't'; here we are talking about human abilities. Compare: 'You can't go in here: you need a permit'; here we are talking about what some code of rules permits.

It is natural to understand the 'can't' relevant to the present case in this way: to say that the premisses can't be true without the conclusion being true is to say that in all situations in which all the premisses are true, so is the conclusion. So far so good; but what, exactly, is a situation? What sorts of things go into their makeup, and how do these things relate to each other? And what is it to be *true*? Now, there's a philosophical problem for you, as Tweedledee might have said.

These issues will concern us by and by; but let us leave them for the time being, and finish with one more thing. One shouldn't run away with the idea that the explanation of deductive validity that I have just given is itself unproblematic. (In philosophy, all interesting claims are contentious.) Here is one problem. Assuming that the account is correct, to know that an inference is deductively valid is to know that there are no situations in which the premisses are true and the conclusion is not. Now, on any reasonable understanding of what it is to be a situation, there are an awful lot of them: situations about things on the planets of distant stars; situations about events before there were any living beings in the cosmos; situations described in works of fiction; situations imagined by visionaries. How can one know what holds in *all* situations? Worse, there would appear to be an infinite number of situations (situations one year hence, situations two years hence, situations three years hence, . . .). It is therefore impossible, even

Validity

in principle, to survey all situations. So if this account of validity is correct, and given that we can recognize inferences as valid or invalid (at least in many cases) we must have some insight into this, from some special source. What source?

Do we need to invoke some sort of mystic intuition? Not necessarily. Consider an analogous problem. We can all distinguish between grammatical and ungrammatical strings of words of our native language without too much problem. For example, any native speaker of English would recognize that 'This is a chair' is a grammatical sentence, but 'A chair is is a' is not. But there would appear to be an infinite number of both grammatical and ungrammatical sentences. (For example, 'One is a number', 'Two is a number', 'Three is a number', . . . are all grammatical sentences. And it is easy enough to produce word salads *ad libitum*). So how do we do it? Perhaps the most influential of modern linguists, Noam Chomsky, suggested that we can do this because the infinite collections are encapsulated in a finite set of rules that are hard-wired into us; that evolution has programmed us with an innate grammar. Could logic be the same? Are the rules of logic hard-wired into us in the same way?

Logic

### Main Ideas of the Chapter

- A valid inference is one where the conclusion follows from the premiss(es).
- A deductively valid inference is one for which there is no situation in which all the premisses are true, but the conclusion is not.

# Chapter 2

## Truth Functions - or Not?

Whether or not the rules of validity are hard-wired into us, we all have pretty strong intuitions about the validity or otherwise of various inferences. There wouldn't be much disagreement, for example, that the following inference is valid: 'She's a woman and a banker; so she's a banker'. Or that the following inference is invalid: 'He's a carpenter; so he's a carpenter and plays baseball'.

But our intuitions can get us into trouble sometimes. What do you think of the following inference? The two premisses occur above the line; the conclusion below it.

The Queen is rich.      The Queen isn't rich.  
Pigs can fly.

It certainly doesn't seem valid. The wealth of the Queen – great or not – would seem to have no bearing on the aviatory abilities of pigs.

But what do you think about the following two inferences?

The Queen is rich.  
Either the Queen is rich or pigs can fly.

Either the Queen is rich or pigs can fly.      The Queen isn't rich.  
 Pigs can fly.

The first of these seems valid. Consider its conclusion. Logicians call sentences like this a *disjunction*; and the clauses on either side of the 'or' are called *disjuncts*. Now, what does it take for a disjunction to be true? Just that one or other of the disjuncts is true. So in any situation where the premiss is true, so is the conclusion. The second inference also seems valid. If one or other of two claims is true and one of these isn't, the other must be.

Now, the trouble is that by putting these two apparently valid inferences together, we get the apparently invalid inference, like this:

The Queen is rich.  
Either the Queen is rich or pigs can fly.      The Queen isn't rich.  
 Pigs can fly.

Logic

This can't be right. Chaining valid inferences together in this way can't give you an invalid inference. If all the premises are true in any situation, then so are their conclusions, the conclusions that follow from *these*; and so on, till we reach the final conclusion. What has gone wrong?

To give an orthodox answer to this question, let us focus a bit more on the details. For a start, let's write the sentence 'Pigs can fly' as *p*, and the sentence 'The Queen is rich' as *q*. This makes things a bit more compact; but not only that: if you think about it for a moment, you can see that the two particular sentences actually used in the examples above don't have much to do with things; I could have set everything up using pretty much any two sentences; so we can ignore their content. This is what we do in writing the sentences as single letters.

The sentence 'Either the Queen is rich or pigs can fly' now becomes 'Either *q* or *p*'. Logicians often write this as  $q \vee p$ . What of 'The Queen isn't rich'? Let us rewrite this as 'It is not the case that the Queen is

rich', pulling the negative particle to the front of the sentence. Hence, the sentence becomes 'It is not the case that  $q$ '. Logicians often write this as  $\neg q$ , and call it the *negation* of  $q$ . While we are at it, what about the sentence 'The Queen is rich *and* pigs can fly', that is, ' $q$  and  $p$ '? Logicians often write this as  $q \& p$  and call it the *conjunction* of  $q$  and  $p$ ,  $q$  and  $p$  being the *conjuncts*. With this machinery under our belt, we can write the chain-inference that we met thus:

$$\frac{\frac{q}{q \vee p} \quad \neg q}{p}$$

What are we to say about this inference?

Sentences can be true, and sentences can be false. Let us use  $T$  for truth, and  $F$  for falsity. After one of the founders of modern logic, the German philosopher/mathematician Gottlob Frege, these are often called *truth values*. Given any old sentence,  $a$ , what is the connection between the truth value of  $a$  and that of its negation,  $\neg a$ ? A natural answer is that if one is true, the other is false, and vice versa. Thus, if 'The Queen is rich' is true, 'The Queen isn't rich' is false, and vice versa. We can record this as follows:

- $\neg a$  has the value  $T$  just if  $a$  has the value  $F$ .
- $\neg a$  has the value  $F$  just if  $a$  has the value  $T$ .

Logicians call these the *truth conditions* for negation. If we assume that every sentence is either true or false, but not both, we can depict the conditions in the following table, which logicians call a *truth table*:

|     |          |
|-----|----------|
| $a$ | $\neg a$ |
| $T$ | $F$      |
| $F$ | $T$      |



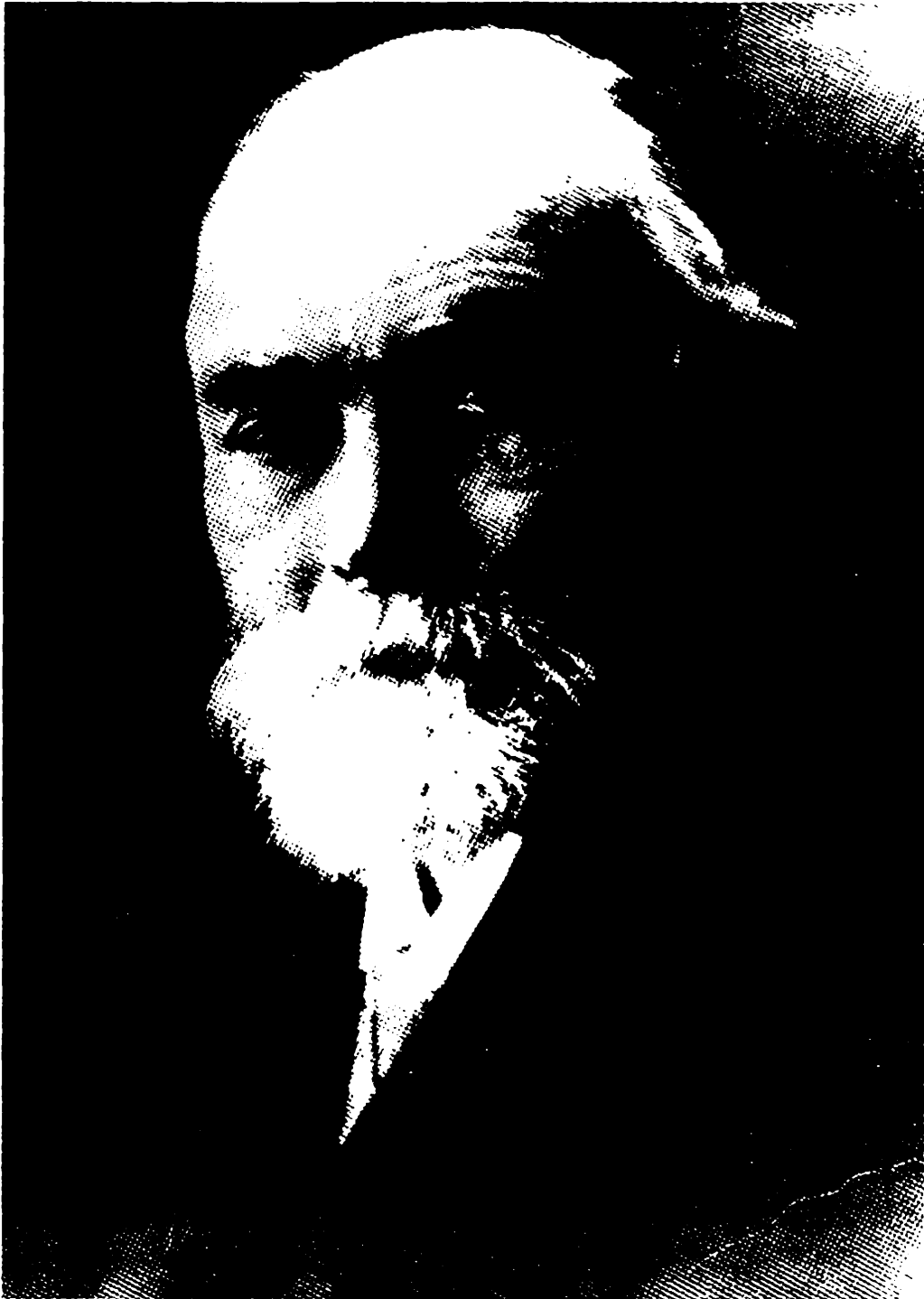

2. Gottlob Frege (1848-1925), one of the founders of modern logic

If  $a$  has the truth value given in the column under it,  $\neg a$  has the corresponding value to its right.

What of disjunction,  $\vee$ ? As I have already noted, a natural assumption is that a disjunction,  $a \vee b$ , is true if one or other (or maybe both) of  $a$  and  $b$  are true, and false otherwise. We can record this in the truth conditions for disjunction:

$a \vee b$  has the value  $T$  just if at least one of  $a$  and  $b$  has the value  $T$ .

$a \vee b$  has the value  $F$  just if both of  $a$  and  $b$  have the value  $F$ .

These conditions can be depicted in the following truth table:

| $a$ | $b$ | $a \vee b$ |
|-----|-----|------------|
| $T$ | $T$ | $T$        |
| $T$ | $F$ | $T$        |
| $F$ | $T$ | $T$        |
| $F$ | $F$ | $F$        |

Truth Functions - or Not?

Each row - except the first, which is the header - now records a possible combination of the values for  $a$  (first column) and  $b$  (second column). There are four such possible combinations, and so four rows. For each combination, the corresponding value of  $a \vee b$  is given to its right (third column).

Again, while we are about it, what is the connection between the truth values of  $a$  and  $b$ , and that of  $a \& b$ ? A natural assumption is that  $a \& b$  is true if both  $a$  and  $b$  are true, and false otherwise. Thus, for example, 'John is 35 and has brown hair' is true just if 'John is 35' and 'John has brown hair' are both true. We can record this in the truth conditions for conjunction:

$a \& b$  has the value  $T$  just if both of  $a$  and  $b$  have the value  $T$ .

$a \& b$  has the value  $F$  just if at least one of  $a$  and  $b$  has the value  $F$ .

These conditions can be depicted in the following truth table:

| <i>a</i> | <i>b</i> | <i>a &amp; b</i> |
|----------|----------|------------------|
| <i>T</i> | <i>T</i> | <i>T</i>         |
| <i>T</i> | <i>F</i> | <i>F</i>         |
| <i>F</i> | <i>T</i> | <i>F</i>         |
| <i>F</i> | <i>F</i> | <i>F</i>         |

Logic

Now, how does all this bear on the problem we started with? Let us come back to the question I raised at the end of the last chapter: what is a situation? A natural thought is that whatever a situation is, it determines a truth value for every sentence. So, for example, in one particular situation, it might be true that the Queen is rich and false that pigs can fly. In another it might be false that the Queen is rich, and true that pigs can fly. (Note that these situations may be purely hypothetical!) In other words, a situation determines each relevant sentence to be either *T* or *F*. The relevant sentences here do not contain any occurrences of 'and', 'or' or 'not'. Given the basic information about a situation, we can use truth tables to work out the truth values of the sentences that do.

For example, suppose we have the following situation:

|                     |
|---------------------|
| <i>p</i> : <i>T</i> |
| <i>q</i> : <i>F</i> |
| <i>r</i> : <i>T</i> |

(*r* might be the sentence 'Rhubarb is nutritious', and '*p* : *T*' means that *p* is assigned the truth value *T*, etc.) What is the truth value of, say,  $p \& (\neg r \vee q)$ ? We work out the truth value of this in exactly the same way that we would work out the numerical value of  $3 \times (-6 + 2)$  using tables for multiplication and addition. The truth value of *r* is *T*. So the

truth table for  $\neg$  tells us that the truth value of  $\neg r$  is  $F$ . But since the value of  $q$  is  $F$ , the truth table for  $\vee$  tells us that the value of  $\neg r \vee q$  is  $F$ . And since the truth value of  $p$  is  $T$ , the truth table for  $\&$  tells us that the value of  $p \& (\neg r \vee q)$  is  $F$ . In this step-by-step way, we can work out the truth value of any formula containing occurrences of  $\&$ ,  $\vee$ , and  $\neg$ .

Now, recall from the last chapter that an inference is valid provided that there is no situation which makes all the premisses true, and the conclusion untrue (false). That is, it is valid if there is no way of assigning  $T$ s and  $F$ s to the relevant sentences, which results in all the premisses having the value  $T$  and the conclusion having the value  $F$ . Consider, for example, the inference that we have already met,  $q/q \vee p$ . (I write this on a single line to save Oxford University Press money.) The relevant sentences are  $q$  and  $p$ . There are four combinations of truth values, and for each of these we can work out the truth values for the premiss and conclusion. We can represent the result as follows:

Truth Functions - or Not?

| $q$ | $p$ | $q$ | $q \vee p$ |
|-----|-----|-----|------------|
| $T$ | $T$ | $T$ | $T$        |
| $T$ | $F$ | $T$ | $T$        |
| $F$ | $T$ | $F$ | $T$        |
| $F$ | $F$ | $F$ | $F$        |

The first two columns give us all the possible combinations of truth values for  $q$  and  $p$ . The last two columns give us the corresponding truth values for the premiss and the conclusion. The third column is the same as the first. This is an accident of this example, due to the fact that, in this particular case, the premiss happens to be one of the relevant sentences. The fourth column can be read off from the truth table for disjunction. Given this information, we can see that the inference is valid. For there is no row where the premiss,  $q$ , is true and the conclusion,  $q \vee p$ , is not.

What about the inference  $q \vee p, \neg q/p$ ? Proceeding in the same way, we obtain:

| $q$ | $p$ | $q \vee p$ | $\neg q$ | $p$ |
|-----|-----|------------|----------|-----|
| $T$ | $T$ | $T$        | $F$      | $T$ |
| $T$ | $F$ | $T$        | $F$      | $F$ |
| $F$ | $T$ | $T$        | $T$      | $T$ |
| $F$ | $F$ | $F$        | $T$      | $F$ |

This time, there are five columns, because there are two premisses. The truth values of the premisses and conclusion can be read off from the truth tables for disjunction and negation. And again, there is no row where both of the premisses are true and the conclusion is not. Hence, the inference is valid.

Logic

What about the inference with which we started:  $q, \neg q/p$ ? Proceeding as before, we get:

| $q$ | $p$ | $q$ | $\neg q$ | $p$ |
|-----|-----|-----|----------|-----|
| $T$ | $T$ | $T$ | $F$      | $T$ |
| $T$ | $F$ | $T$ | $F$      | $F$ |
| $F$ | $T$ | $F$ | $T$      | $T$ |
| $F$ | $F$ | $F$ | $T$      | $F$ |

Again, the inference is valid; and now we see why. There is no row in which both of the premisses are true and the conclusion is false. Indeed, there is no row in which both of the premisses are true. The conclusion doesn't really matter at all! Sometimes, logicians describe this situation by saying that the inference is *vacuously* valid, just because the premisses could never be true together.

Here, then, is a solution to the problem with which we started. According to this account, our original intuitions about this inference were wrong. After all, people's intuitions can often be misleading. It seems obvious to everyone that the earth is motionless – until they take a course in physics, and find out that it is really hurtling through space. We can even offer an explanation as to why our logical intuitions go wrong. Most of the inferences we meet in practice are not of the vacuous kind. Our intuitions develop in this sort of context, and don't apply generally – just as the habits you build up learning to walk (for example, not to lean to the side) don't always work in other contexts (for example, when you to learn to ride a bike).

We will come back to this matter in a later chapter. But let us end this one with a brief look at the adequacy of the machinery we have used. Things here are not as straightforward as one might have hoped. According to this account, the truth value of a sentence  $\neg a$  is completely determined by the truth value of the sentence  $a$ . In a similar way, the truth values of the sentences  $a \vee b$  and  $a \& b$  are completely determined by the truth values of  $a$  and  $b$ . Logicians call operations that work like this *truth functions*. But there are good reasons to suppose that 'or' and 'and', as they occur in English, are not truth functions – at least, not always.

For example, according to the truth table for  $\&$ , ' $a$  and  $b$ ' always has the same truth value as ' $b$  and  $a$ ': namely, they are both true if  $a$  and  $b$  are both true, and false otherwise. But consider the sentences:

1. John hit his head and fell down.
2. John fell down and hit his head.

The first says that John hit his head *and then* fell down. The second says that John fell down *and then* hit his head. Clearly, the first could be true whilst the second is false, and vice versa. Thus, it is not just the truth

values of the conjuncts that are important, but which conjunct caused which.

Similar problems beset 'or'. According to the account we had, ' $a$  or  $b$ ' is true if one or other of  $a$  and  $b$  is true. But suppose a friend says:

Either you come now or we will be late;

and so you come. Given the truth table for  $\vee$ , the disjunction is true. But suppose you discover that your friend had been tricking you: you could have left half an hour later and still been on time. Under these circumstances, you would surely say that your friend had lied: what he had said was false. Again, it is not merely the truth values of the disjuncts that are important, but the existence of a connection of a certain kind between them.

Logic

I will leave you to think about these matters. The material we have been looking at gives us at least a working account of how certain logical machinery functions; and we will draw on this in succeeding chapters, unless the ideas in those chapters explicitly override it – which they will sometimes.

The machinery in question deals only with certain kinds of inferences: there are many others. We have only just started.

### Main Ideas of the Chapter

- In a situation, a unique truth value ( $T$  or  $F$ ) is assigned to each relevant sentence.
- $\neg a$  is  $T$  just if  $a$  is  $F$ .
- $a \vee b$  is  $T$  just if at least one of  $a$  and  $b$  is  $T$ .
- $a \& b$  is  $T$  just if both of  $a$  and  $b$  are  $T$ .

## Chapter 3

### Names and Quantifiers:

### Is Nothing Something?

The inferences that we looked at in the last chapter involved phrases like 'or' and 'it is not the case that', words that add to, or join, whole sentences to make other whole sentences; but there are lots of inferences that appear to work in a quite different way. Consider, for example, the inference:

Marcus gave me a book.  
Someone gave me a book.

Neither the premiss nor the conclusion has a part which is itself a whole sentence. If this inference is valid, it is so because of what is going on *within* whole sentences.

Traditional grammar tells us that the simplest whole sentences are composed of a *subject* and a *predicate*. Thus, consider the examples:

1. Marcus saw the elephant.
2. Annika fell asleep.
3. Someone hit me.
4. Nobody came to my party.

The first word, in each case, is the subject of the sentence: it tells us what the sentence is about. The rest is the predicate: this tells us what is





3. Nobody

said about it. Now, when is such a sentence true? Take the second example. It is true if the object referred to by the subject 'Annika' has the property expressed by the predicate, that is, fell asleep.

All well and good. But what does the subject of sentence 3 refer to? The person who hit me? But maybe nobody hit me. No one said that this was a true sentence. The case with sentence 4 is even worse. To whom does 'nobody' refer? In *Through the Looking Glass*, just before her encounter with the Lion and the Unicorn, Alice comes across the White King, who is waiting for a messenger. (For some reason, when the messenger turns up, it looks disconcertingly like a rabbit.) When the King meets Alice, he says:

'Just look along the road, and tell me if you can see . . . [the Messenger].'

'I see nobody on the road,' said Alice.

'I only wish I had such eyes,' the King remarked in a fretful tone. 'To be able to see Nobody! And at that distance too! Why, it's as much as I can do to see real people, by this light!'

Carroll is making a logical joke, as he often does. When Alice says that she can see nobody, she is not saying that she can see a person – real or otherwise. 'Nobody' does not refer to a person – or to anything else.

Words like 'nobody', 'someone', 'everyone' are called by modern logicians *quantifiers*, and they are distinguished from names like 'Marcus' and 'Annika'. What we have just seen is that, even if both quantifiers and names can be the grammatical subjects of sentences, they must function in quite different ways. So, how do quantifiers work?

Here is a standard modern answer. A situation comes furnished with a stock of objects. In our case, the relevant objects are all people. All the names which occur in our reasoning about this situation refer to one of the objects in this collection. Thus, if we write  $m$  for 'Marcus',  $m$  refers

to one of these objects. And if we write  $H$  for 'is happy', then the sentence  $mH$  is true in the situation just if the object referred to by  $m$  has the property expressed by  $H$ . (For perverse reasons of their own, logicians usually reverse the order, and write  $Hm$ , instead of  $mH$ . This is just a matter of convention.)

Now consider the sentence 'Someone is happy'. This is true in the situation just if there is *some* object or other, in the collection of objects, that is happy – that is, some object in the collection, call it  $x$ , is such that  $x$  is happy. Let us write 'Some object,  $x$ , is such that' as  $\exists x$ . Then we may write the sentence as: ' $\exists x$   $x$  is happy'; or remembering that we are writing 'is happy' as  $H$ , as:  $\exists x xH$ . Logicians sometimes call  $\exists x$  a *particular quantifier*.

Logic

What about 'Everyone is happy'? This is true in a situation if *every* object in the relevant collection is happy. That is, every object,  $x$ , in the collection is such that  $x$  is happy. If we write 'Every object,  $x$ , is such that' as  $\forall x$ , then we can write this as  $\forall x xH$ . Logicians usually call  $\forall x$  a *universal quantifier*.

There are now no prizes for guessing how we are to understand 'Nobody is happy'. This just means that there is no object,  $x$ , in the relevant collection, such that  $x$  is happy. We could have a special symbol meaning 'No object,  $x$ , is such that', but as a matter of fact, logicians don't normally bother with one. For to say that no one is happy is to say it is not the case that somebody is happy. So we may write this as  $\neg \exists x xH$ .

This analysis of quantifiers shows us that names and quantifiers work quite differently. In particular, the fact that 'Marcus is happy' and 'Someone is happy' get written, very differently, as  $mH$  and  $\exists x xH$ , respectively, shows us this. It shows us, moreover, that apparently simple grammatical form may be misleading. Not all grammatical subjects are equal. The account, incidentally, shows us why the

inference with which we started is valid. Let us write  $G$  for 'gave me the book'. Then the inference is:

$$\frac{mG}{\exists x xG}$$

It is clear that if, in some situation, the object referred to by the name  $m$  gave me the book, then some object in the relevant collection gave me the book. By contrast, the White King is inferring from the fact that Alice saw nobody that she saw somebody (viz., Nobody). If we write 'is seen by Alice' as  $A$  then the King's inference is:

$$\frac{\neg \exists x xA}{\exists x xA}$$

This is clearly invalid. If there is no object in the relevant domain that was seen by Alice, it is obviously *not* true that there is some object in the relevant domain that was seen by her.

You might think that this is all a lot of fuss about nothing – in fact, just a way of spoiling a good joke. But it's a lot more serious than that. For quantifiers play a central role in many important arguments in mathematics and philosophy. Here is one philosophical example. It's a natural assumption that nothing happens without an explanation: people don't get ill for no reason; cars don't break down without a fault. Everything, then, has a cause. But what could the cause of everything be? Obviously it can't be anything physical, like a person; or even something like the Big Bang of cosmology. Such things must themselves have causes. So it must be something metaphysical. God is the obvious candidate.

This is one version of an argument for the existence of God, often called the *Cosmological Argument*. One might object to the argument in various ways. But at its heart, there is an enormous logical fallacy. The sentence 'Everything has a cause' is ambiguous. It can mean that

everything that happens has some cause or other – that is, for every  $x$ , there is a  $y$ , such that  $x$  is caused by  $y$ ; or it can mean that there is something which is the cause of everything – that is, there is some  $y$  such that for every  $x$ ,  $x$  is caused by  $y$ . Suppose we think of the relevant domain of objects as causes and effects, and write ‘ $x$  is caused by  $y$ ’ as  $xCy$ . Then we can write these two meanings as, respectively:

1.  $\forall x \exists y xCy$
2.  $\exists y \forall x xCy$

Now, these are not logically equivalent. The first follows from the second. If there is a thing which is the cause of *everything*, then certainly, everything that happens has *some cause or other*. But if everything has some cause or other, it does not follow that there is one and the same thing which is the cause of everything. (Compare: Everyone has a mother; it does not follow that there is someone who is the mother of everyone.)

Logic

This version of the Cosmological Argument trades on this ambiguity. What is established by talk of illnesses and cars is 1. But immediately, the argument goes on to ask what that cause is, assuming that it is 2 that has been established. Moreover, this slide is hidden because, in English, ‘Everything has a cause’ can be used to express either 1 or 2. Notice, also, that there is no ambiguity if the quantifiers are replaced by names. ‘The background radiation of the cosmos is caused by the Big Bang’ is not at all ambiguous. It may well be that a failure to distinguish between names and quantifiers is a further reason why one may fail to see the ambiguity.

So a correct understanding of quantifiers is important – and not just for logic. The words ‘something’, ‘nothing’, etc., do not stand for objects, but function in a completely different way. Or at least, they can do: things are not quite that simple. Consider the cosmos again. Either it stretches back infinitely into time past, or at some particular time it

came into existence. In the first case, it had no beginning, but was always there; in the second, it began at some particular time. At different times, physics has, in fact, told us different things about the truth of this matter. Never mind this, however; just consider the second possibility. In this case, the cosmos came into existence out of nothing – or nothing physical, anyway, the cosmos being the totality of everything physical. Now consider that sentence, ‘The cosmos came into existence out of nothing’. Let  $c$  be the cosmos, and let us write ‘ $x$  came into existence out of  $y$ ’ as  $xEy$ . Then given our understanding of quantifiers, this sentence should mean  $\neg\exists x cEx$ . But it does not mean this; for this is equally true in the first alternative cosmology. In this, the cosmos, being infinite in time past, did not come into being at all. In particular, then, it is not the case that it came into being *from* something or other. When we say that in the second cosmology the cosmos came into existence out of nothing, we mean that it came into being from *nothingness*. So nothing *can* be a thing. The White King was not so foolish after all.

### Main Ideas of the Chapter

- The sentence  $nP$  is true in a situation if the object referred to by  $n$  has the property expressed by  $P$  in that situation.
- $\exists x xP$  is true in a situation just if some object in the situation,  $x$ , is such that  $xP$ .
- $\forall x xP$  is true in a situation just if every object in the situation,  $x$ , is such that  $xP$ .

## Chapter 4

### Descriptions and Existence:

### Did the Greeks Worship

### Zeus?

While we are on the topic of subjects and predicates, there is a certain kind of phrase that can be the subject of sentences, which we haven't talked about yet. Logicians usually call them *definite descriptions*, or sometimes just *descriptions* – though be warned that this is a technical term. Descriptions are phrases like 'the man who first landed on the Moon' and 'the only man-made object on the Earth that is visible from space'. In general, descriptions have the form: *the thing satisfying such and such a condition*. Following the English philosopher/mathematician, Bertrand Russell, one of the founders of modern logic, we can write them as follows. Rewrite 'the man who first landed on the Moon' as 'the object,  $x$ , such that  $x$  is a man and  $x$  landed first on the Moon'. Now write  $\iota x$  for 'the object,  $x$ , such that', and this becomes ' $\iota x(x$  is a man and  $x$  landed first on the Moon)'. If we write  $M$  for 'is a man' and  $F$  for 'landed first on the Moon', we then get:  $\iota x(xM \ \& \ xF)$ . In general, a description is something of the form  $\iota x c_x$ , where  $c_x$  is some condition containing occurrences of  $x$ . (That's what the little subscript  $x$  is there to remind you of.)

Since descriptions are subjects, they can be combined with predicates to make whole sentences. Thus, if we write  $U$  for 'was born in the USA', then 'the man who first landed on the Moon was born in the USA' is:  $\iota x(xM \ \& \ xF)U$ . Let us write  $\mu$  as a shorthand for  $\iota x(xM \ \& \ xF)$ . (I use a Greek



4. Bertrand Russell (1872–1970), another of the founders of modern logic



letter to remind you that it is really a description.) Then this is  $\mu U$ . Similarly, 'The first man to land on the Moon is a man and he landed first on the Moon' is  $\mu M \& \mu F$ .

In terms of the division of the last chapter, descriptions are names, not quantifiers. That is, they refer to objects – if we are lucky: we'll come back to that. Thus, 'The man who first landed on the Moon was born in the USA',  $\mu U$ , is true just if the particular person referred to by the phrase  $\mu$  has the property expressed by  $U$ .

But descriptions are a special kind of name. Unlike what we might call *proper names*, like 'Annika' and 'the Big Bang', they carry information about the object referred to. Thus, for example, 'the man who first landed on the Moon' carries the information that the object referred to has the property of being a man and being first on the Moon. This might all seem banal and obvious, but things are not as simple as they appear. Because descriptions carry information in this way, they are often central to important arguments in mathematics and philosophy; and one way to appreciate some of these complexities is to look at an example of such an argument. This is another argument for the existence of God, often called the *Ontological Argument*. The argument comes in a number of versions, but here is a simple form of it:

God is the being with all the perfections.

But existence is a perfection.

So God possesses existence.

i.e., God exists. If you haven't met this argument before, it will appear rather puzzling. For a start, what is a perfection? Loosely, a perfection is something like omniscience (knowing everything that there is to know), omnipotence (being able to do everything that can be done), and being morally perfect (acting always in the best possible way). In general, the perfections are all those properties that it is a jolly good thing to have. Now, the second premiss says that existence is a perfection. Why on

earth should this be so? The reason one might suppose this to be so is a rather complex one, with its roots in the philosophy of one of the two most influential ancient Greek philosophers, Plato. Fortunately, we can work around this issue. We can make a list of properties like omniscience, omnipotence, etc., include existence in the list, and simply let 'perfection' mean any property on the list. Moreover, we can take 'God' to be synonymous with a certain description, namely, 'the being which has all the perfections (i.e., those properties on the list)'. In the Ontological Argument, both premisses are now true by definition, and so drop out of the picture. The Argument then reduces to a one-liner:

The object which is omniscient, omnipotent, morally perfect, . . . and exists, exists

– and, we might add, is omnipotent, omniscient, morally perfect, and so on. This certainly looks to be true. To make things more perspicuous, suppose we write the list of God's properties as  $P_1, P_2, \dots, P_n$ . So the last one,  $P_n$ , is existence. The definition of 'God' is:  $\exists x(xP_1 \& \dots \& xP_n)$ . Let us write this as  $\gamma$ . Then the one-liner is  $\gamma P_1 \& \dots \& \gamma P_n$  (from which  $\gamma P_n$  follows).

This is a special case of something more general, namely: *the thing satisfying such and such a condition, satisfies that very condition*. This is often called the *Characterization Principle* (a thing has those properties by which it is characterized). We'll abbreviate this as CP. We have already met an example of the CP, with 'The first man to land on the Moon is a man and he landed first on the moon',  $\mu M \& \mu F$ . In general, we obtain a case of the CP if we take some description,  $\exists x c_x$ , and substitute it for every occurrence of  $x$  in the condition  $c_x$ .

Now, for all the world, the CP looks to be true by definition. Of course things have those properties that they are characterized as having. Unfortunately, in general, it is false. For many things follow from it that are indisputably untrue.

For a start, we can use it to deduce the existence of all kinds of things that do not really exist. Consider the (non-negative) integers: 0, 1, 2, 3, . . . There is no greatest. But using the CP, we can show the existence of a greatest. Let  $c_x$  be the condition 'x is the greatest integer & x exists'. Let  $\delta$  be  $\lambda x.c_x$ . Then the CP gives us ' $\delta$  is the greatest integer, and  $\delta$  exists'. The absurdities do not end there. Consider some unmarried person, say the Pope. We can prove that he is married. Let  $c_x$  be the condition 'x married the Pope'. Let  $\delta$  be the description  $\lambda x.c_x$ . The CP gives us ' $\delta$  married the Pope'. So someone married the Pope, i.e., the Pope is married.

Logic

What is to be said about all this? A fairly standard modern answer goes as follows. Consider the description  $\lambda x.c_x$ . If there is a unique object that satisfies the condition  $c_x$  in some situation, then the description refers to it. Otherwise, it refers to nothing: it is an 'empty name'. Thus, there is a unique  $x$ , such that  $x$  is a man and  $x$  landed first on the moon, Armstrong. So 'the  $x$  such that  $x$  is a man and  $x$  landed first on the moon' refers to Armstrong. Similarly, there is a unique least integer, namely 0; hence, the description 'the object which is the least integer' denotes 0. But since there is no greatest integer, 'the object which is the greatest integer' fails to refer to anything. Similarly, the description 'the city in Australia which has more than a million people' also fails to refer. Not, this time, because there are no such cities, but because there are several of them.

What has this to do with the CP? Well, if there is a unique object satisfying  $c_x$  in some situation, then  $\lambda x.c_x$  refers to it. So the instance of the CP concerning  $c_x$  is true:  $\lambda x.c_x$  is one of the things – in fact, the only thing – that satisfies  $c_x$ . In particular, the least integer is (indeed) the least integer; the city which is the federal capital of Australia, is indeed, the federal capital of Australia, etc. So some instances of the CP hold.

But what if there is no unique object satisfying  $c_x$ ? If  $n$  is a name and  $P$  is a predicate, the sentence  $nP$  is true just if there is an object that  $n$  refers

to, and it has the property expressed by  $P$ . Hence, if  $n$  denotes no object,  $nP$  must be false. Thus, if there is no unique thing having the property  $P$ , (if, for example,  $P$  is 'is a winged horse')  $(\exists x xP)P$  is false. As is to be expected, under these conditions, the CP may fail.

Now, how does all this bear on the Ontological Argument? Recall that the instance of the CP invoked there is  $\gamma P_1 \& \dots \& \gamma P_n$ , where  $\gamma$  is the description  $\exists x(xP_1 \& \dots \& xP_n)$ . Either there is something satisfying  $xP_1 \& \dots \& xP_n$ , or there is not. If there is, it must be unique. (There cannot be two omnipotent objects: if I am omnipotent, I can stop you doing things, so you cannot be omnipotent.) So  $\gamma$  refers to this thing, and  $\gamma P_1 \& \dots \& \gamma P_n$  is true. If there is not, then  $\gamma$  refers to nothing; so each conjunct of  $\gamma P_1 \& \dots \& \gamma P_n$  is false; as, therefore, is the whole conjunction. In other words, the instance of the CP used in the argument is true enough if God exists; but it is false if God does not exist. So if one is arguing for the existence of God, one cannot simply invoke this instance of the CP: that would just be *assuming* what one is supposed to be proving. Philosophers say that such an argument *begs the question*; that is, begs to be granted exactly what is in question. And an argument that begs the question clearly does not work.

So much for the Ontological Argument. Let us finish this chapter by seeing that the account of descriptions that I have explained is itself problematic in certain ways. According to this account, if  $\delta P$  is a sentence where  $\delta$  is a description that does not refer to anything, it is false. But this does not always seem to be right. For example, it would seem to be true that the most powerful of the ancient Greek gods was called 'Zeus', lived on Mount Olympus, was worshipped by the Greeks, and so on. Yet there were, in reality, no ancient Greek gods. They did not, in fact, exist. If this is right, then the description 'the most powerful of the ancient Greek gods' does not refer to anything. But in that case, there are true subject/predicate sentences in which the subject term fails to refer to anything, such as 'The most

powerful of the ancient Greek gods was worshipped by the Greeks'.  
To put it tendentiously, there are truths about non-existent objects,  
after all.

### Main Idea of the Chapter

- $\exists! x c_x P$  is true in a situation just if, in that situation, there is a unique object,  $a$ , satisfying  $c_x$ , and  $aP$ .

## Chapter 5

# **Self-Reference: What is this Chapter About?**

Often, things seem simple when one thinks about normal cases; but this can be deceptive. When one considers more unusual cases, the simplicity may well disappear. So it is with reference. We saw in the last chapter that things are not as straightforward as one might have supposed, once one takes into account the fact that some names may not refer to anything. Further complexities arise when we consider another kind of unusual case: self-reference.

It is quite possible for a name to refer to something of which it, itself, is part. For example, consider the sentence 'This sentence contains five words'. The name which is the subject of this sentence, 'this sentence', refers to the whole sentence, of which that name is a part. Similar things happen in a set of regulations which contain the clause 'These regulations may be revised by a majority decision of the Department of Philosophy', or by a person who thinks 'If I am thinking this thought, then I must be conscious'.

These are all relatively unproblematic cases of self-reference. There are other cases which are quite different. For example, suppose someone says:

This very sentence that I am now uttering is false.

Call this sentence  $\lambda$ . Is  $\lambda$  true or false? Well, if it is true, then what it says is the case, so  $\lambda$  is false. But if it is false, then, since this is exactly what it claims, it is true. In either case,  $\lambda$  would seem to be both true and false. The sentence is like a Möbius strip, a topological configuration where, because of a twist, the inside is the outside, and the outside is the inside: truth is falsity, and falsity is truth.

Or suppose someone says:

This very sentence that I am now uttering is true.

Is that true or false? Well, if it is true, it is true, since that is what it says. And if it is false, then it is false, since it says that it is true. Hence, both the assumption that it is true and the assumption that it is false appear to be consistent. Moreover, there would seem to be no other fact that settles the matter of what truth value it has. It's not just that it has some value which we don't, or even can't, know. Rather, there would seem to be nothing that determines it as either true or false at all. It would seem to be neither true nor false.

Logic

These paradoxes are very ancient. The first of them appears to have been discovered by the ancient Greek philosopher Eubulides, and is often called the *liar paradox*. There are many more, and more recent, paradoxes of the same kind, some of which play a crucial role in central parts of mathematical reasoning. Here is another example. A set is a collection of objects. Thus, for example, one may have the set of all people, the set of all numbers, the set of all abstract ideas. Sets can be members of other sets. Thus, for example, the set of all the people in a room is a set, and hence is a member of the set of all sets. Some sets can even be members of themselves: the set of all the objects mentioned on this page is an object mentioned on this page (I have just mentioned it), and so a member of itself; the set of all sets is a set, and so a member of itself. And some sets are certainly not members of themselves: the set

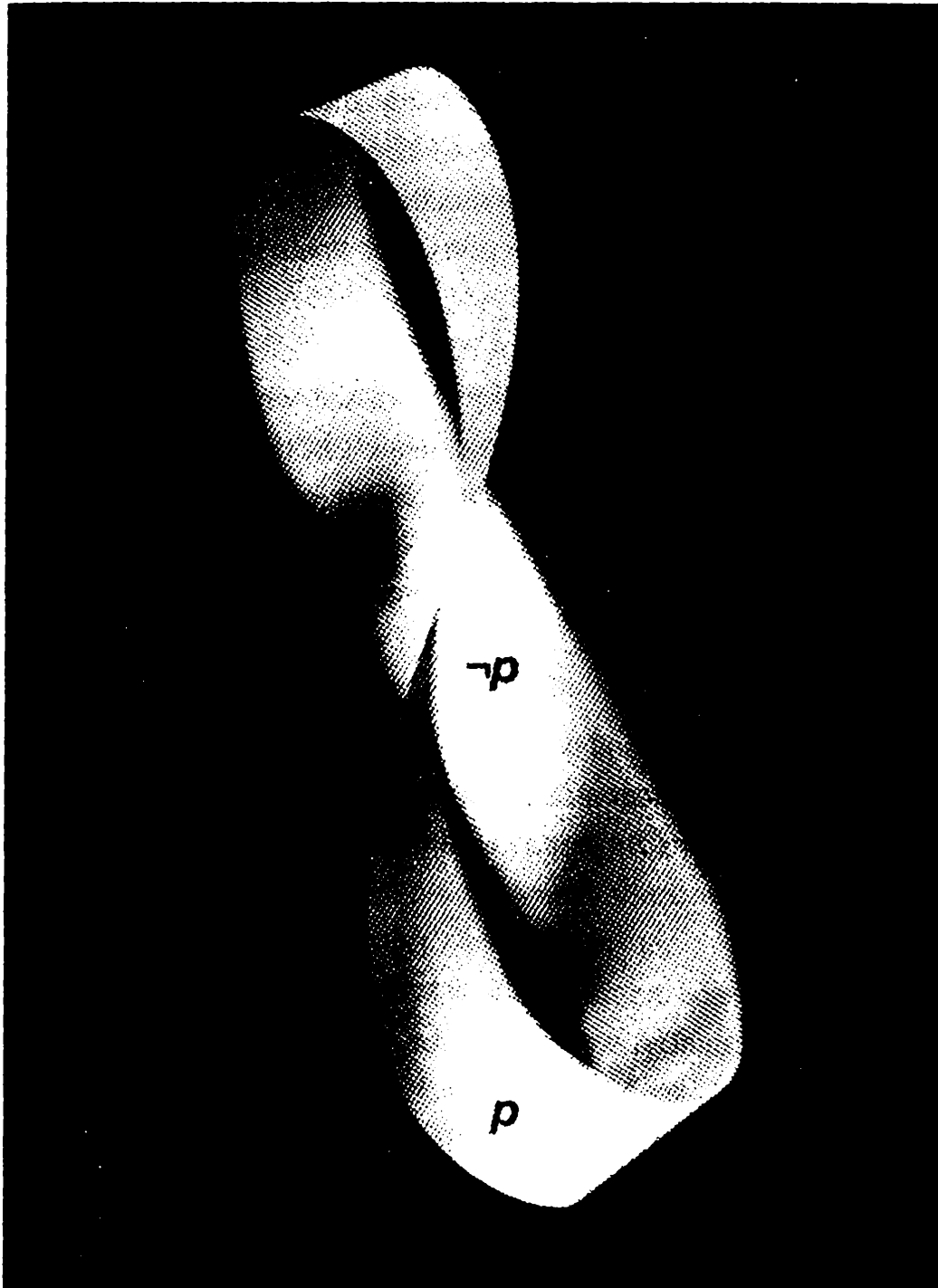

5. A Möbius strip. Inside is outside, and outside in. Truth is falsity, and falsity truth



of all people is not a person, and so not a member of the set of all people.

Now, consider the set of all those sets that are not members of themselves. Call this  $R$ . Is  $R$  a member of itself, or is it not? If it is a member of itself, then it is one of the things that is not a member of itself, and so it is not a member of itself. If, on the other hand, it is not a member of itself, it is one of those sets that are not members of themselves, and so it *is* a member of itself. It would seem that  $R$  both is and is not a member of itself.

This paradox was discovered by Bertrand Russell, whom we met in the last chapter, and so is called *Russell's paradox*. Like the liar paradox, it has a cousin. What about the set of all sets that *are* members of themselves. Is this a member of itself, or is it not? Well, if it is, it is; and if it is not, it is not. Again, there would seem to be nothing to determine the matter either way.

Logic

What examples of this kind do, is challenge the assumption we made in Chapter 2, that every sentence is either true or false, but not both. 'This sentence is false', and ' $R$  is not a member of itself' seem to be both true and false; and their cousins seem to be neither true nor false.

How can this idea be accommodated? Simply by taking these other possibilities into account. Assume that in any situation, every sentence is true but not false, false but not true, both true and false, or neither true nor false. Recall from Chapter 2 that the truth conditions for negation, conjunction and disjunction are the following. In any situation:

$\neg a$  has the value  $T$  just if  $a$  has the value  $F$ .

$\neg a$  has the value  $F$  just if  $a$  has the value  $T$ .

$a \& b$  has the value  $T$  just if both  $a$  and  $b$  have the value  $T$ .

$a \& b$  has the value  $F$  just if at least one of  $a$  and  $b$  has the value  $F$ .

$a \vee b$  has the value  $T$  just if at least one of  $a$  and  $b$  has the value  $T$ .  
 $a \vee b$  has the value  $F$  just if both  $a$  and  $b$  have the value  $F$ .

Using this information, it is easy to work out the truth values of sentences under the new regime. For example:

- Suppose that  $a$  is  $F$  but not  $T$ . Then, since  $a$  is  $F$ ,  $\neg a$  is  $T$  (by the first clause for negation). And since  $a$  is not  $T$ ,  $\neg a$  is not  $F$  (by the second clause for negation). Hence,  $\neg a$  is  $T$  but not  $F$ .
- Suppose that  $a$  is  $T$  and  $F$ , and that  $b$  is just  $T$ . Then both  $a$  and  $b$  are  $T$ , so  $a \& b$  is  $T$  (by the first clause for conjunction). But, because  $a$  is  $F$ , at least one of  $a$  and  $b$  is  $F$ , so  $a \& b$  is  $F$  (by the second clause for conjunction). So  $a \& b$  is both  $T$  and  $F$ .
- Suppose that  $a$  is just  $T$ , and that  $b$  is neither  $T$  nor  $F$ . Then since  $a$  is  $T$ , at least one of  $a$  and  $b$  is  $T$ , and hence  $a \vee b$  is  $T$  (by the first clause for disjunction). But since  $a$  is not  $F$ , then it is not the case that  $a$  and  $b$  are both  $F$ . So  $a \vee b$  is not  $F$  (by the second clause for disjunction). Hence,  $a \vee b$  is just  $T$ .

Self-Reference

What does this tell us about validity? A valid argument is still one where there is no situation where the premisses are true, and the conclusion is not true. And a situation is still something that gives a truth value to each relevant sentence. Only now, the situation may give a sentence one truth value, two, or none. So consider the inference  $q/q \vee p$ . In any situation where  $q$  has the value  $T$ , the conditions for  $\vee$  assure us that  $q \vee p$  also has the value  $T$ . (It may have the value  $F$  also, but no matter.) Thus, if the premiss has the value  $T$ , so does the conclusion. The inference is valid.

At this point, it is worth returning to the inference with which we started in Chapter 2:  $q, \neg q/p$ . As we saw in that chapter, given the assumptions made there, this inference is valid. But given the new assumptions, things are different. To see why, just take a situation where  $q$  has the values  $T$  and  $F$ , but  $p$  has just the value  $F$ . Since  $q$  is both  $T$  and  $F$ ,  $\neg q$  is also both

$T$  and  $F$ . Hence, both premisses are  $T$  (and  $F$  as well, but that is not relevant), and the conclusion,  $p$ , is *not*  $T$ . This gives us another diagnosis of why we find the inference intuitively invalid. It *is* invalid.

That's not the end of the matter, though. As we saw in Chapter 2, this inference follows from two other inferences. The first of these ( $q/q \vee p$ ) we have just seen to be valid on the present account. The other must therefore be invalid; and so it is. The other inference is:

$$\frac{q \vee p, \neg q}{p}$$

Now consider a situation where  $q$  gets the values  $T$  and  $F$ , and  $p$  gets just the value  $F$ . It is easy enough to check that both premisses get the value  $T$  (as well as  $F$ ). But the conclusion does not get the value  $T$ . Hence, the inference is invalid.

Logic

In Chapter 2, I said that this inference does seem intuitively valid. So, given the new account, our intuitions about this must be wrong. One can offer an explanation of this fact, however. The inference appears to be valid because, if  $\neg q$  is true, this seems to rule out the truth of  $q$ , leaving us with  $p$ . But on the present account, the truth of  $\neg q$  does not rule out that of  $q$ . It would do so only if something could not be both true and false. When we think the inference to be valid, we are perhaps forgetting such possibilities, which can arise in unusual cases, like those which are provided by self-reference.

Which explanation of the situation is better, the one that we ended up with in Chapter 2, or the one we now have? That is a question which I will leave you to think about. Let us end, instead, by noting that, as always, one may challenge some of the ideas on which the new account rests. Consider the liar paradox and its cousin. Take the latter first. The sentence 'This sentence is true' was supposed to be an example of something that is neither true nor false. Let us suppose that this is so.

Then, in particular, it is not true. But it, itself, says that it *is* true. So it must be false, contrary to our supposition that it is neither true nor false. We seem to have ended up in a contradiction. Or take the liar sentence, 'This sentence is false'. This was supposed to be an example of a sentence that is both true and false. Let's tweak it a bit. Consider, instead, the sentence 'This sentence is not true'. What is the truth value of this? If it is true, then what it says is the case; so it is not true. But if it's not true, then, since that is what it says, it is true. Either way, it would seem to be both true and not true. Again, we have a contradiction on our hands. It's not just that a sentence may take the values *T* and *F*; rather, a sentence can both be *T* and not be *T*.

It is situations of this kind that have made the subject of self-reference a contentious one, ever since Eubulides. It is, indeed, a very tangled issue.

### Main Idea of the Chapter

- Sentences may be true, false, both, or neither.

## Chapter 6

### Necessity and Possibility

#### What Will be Must be?

We often claim not just that something *is* so, but that it *must be* so. We say: 'It must be going to rain', 'It can't fail to rain', 'Necessarily, it's going to rain'. We also have many ways of saying that, though something may, in fact, not be the case, it *could* be. We say: 'It could rain tomorrow', 'It is possible that it will rain tomorrow', 'It's not impossible that it will rain tomorrow'. If  $a$  is any sentence, logicians usually write the claim that  $a$  must be true as  $\Box a$ , and the claim that  $a$  could be true as  $\Diamond a$ .

$\Box$  and  $\Diamond$  are called *modal operators*, since they express the modes with which things are true or false (necessarily, possibly). The two operators are, in fact, connected. To say that something must be the case is to say that it is not possible for it not to be the case. That is,  $\Box a$  means the same as  $\neg \Diamond \neg a$ . Similarly, to say that it is possible for something to be the case is to say that it is not necessarily the case that it is false. That is,  $\Diamond a$  means the same as  $\neg \Box \neg a$ . For good measure, we can express the fact that it is impossible for  $a$  to be true, indifferently, as  $\neg \Diamond a$  (it is not possible that  $a$ ), or as  $\Box \neg a$  ( $a$  is necessarily false).

Unlike the operators we have met so far,  $\Box$  and  $\Diamond$  are not truth functions. As we saw in Chapter 2, when you know the truth value of  $a$ , you can work out the truth value of  $\neg a$ . Similarly, when you know the truth values of  $a$  and  $b$ , you can work out the truth values of  $a \vee b$  and

$a$  &  $b$ . But you cannot infer the truth value of  $\diamond a$  simply from knowledge of the truth value of  $a$ . For example, let  $r$  be the sentence 'I will rise before 7 a.m. tomorrow'.  $r$  is, as a matter of fact, false. But it certainly could be true: I could set my alarm clock and rise early. Hence,  $\diamond r$  is true. By contrast, let  $j$  be the sentence 'I will jump out of bed and hover 2m above the ground'. Like  $r$ , this is false too. But unlike  $r$ , it is not even possible that it is true. That would violate the laws of gravity. Hence,  $\diamond j$  is false. So the truth value of a sentence,  $a$ , does not determine that of  $\diamond a$ :  $r$  and  $j$  are both false, but  $\diamond r$  is true and  $\diamond j$  is false. Similarly, the truth value of  $a$  does not determine the truth value of  $\Box a$ . Let  $r$  now be the sentence 'I will rise before 8 a.m. tomorrow'. This is, in fact, true; but it is not necessarily true. I could stay in bed. Let  $j$  now be the sentence 'If I jump out of bed tomorrow morning, I will have moved'. That is also true, but there is no way that *that* could be false. It's necessarily true. Hence,  $r$  and  $j$  are both true, but one is necessarily true, and the other is not.

Modal operators are therefore operators of a kind quite different from anything that we have met so far. They are also important and often puzzling operators. To illustrate this, here is an argument for fatalism, given by the other of the two most influential ancient Greek philosophers, Aristotle.

Fatalism is the view that whatever happens *must* happen: it could not have been avoided. When an accident occurs, or a person dies, there is nothing that could have been done to prevent it. Fatalism is a view that has appealed to some. When something goes wrong, there is a certain amount of comfort to be derived from the thought that it could not have been otherwise. None the less, fatalism entails that I am powerless to alter what happens, and this seems plainly false. If I am involved in a traffic accident today, I could have avoided it simply by taking a different route. So what is Aristotle's argument? It goes like this. (Ignore the boldface for the present; we will come back to this.)



6. Aristotle (384-322 BCE), the founder of formal logic

Take any claim you like – say, for the sake of illustration, that I will be involved in a traffic accident tomorrow. Now, we may not know yet whether or not this is true, but we know that either I will be involved in an accident or I won't. Suppose the first of these. Then, as a matter of fact, I will be involved in a traffic accident. And **if it is true to say that I will be involved in an accident then it cannot fail to be the case that I will be involved**. That is, it must be the case that I will be involved. Suppose, on the other hand, that I will not, as a matter of fact, be involved in a traffic accident tomorrow. Then it is true to say that I will not be involved in an accident; and if this is so, it cannot fail to be the case that I won't be in an accident. That is, it must be the case that I am not involved in an accident. Whichever of these two *does* happen, then, it *must* happen. This is fatalism.

What is one to say about this? To answer this, let us look at a standard modern understanding of modal operators. We suppose that every situation,  $s$ , comes furnished with a bunch of possibilities, that is, situations that are possible as far as  $s$  goes – to be definite, let us say situations that could arise without violating the laws of physics. Thus, if  $s$  is the situation that I am presently in (being in Australia), my being in London in a week's time is a possible situation; whilst my being on Alpha Centauri (over four light-years away) is not. Following the 17th-century philosopher and logician Leibniz, logicians often call these possible situations, colourfully, *possible worlds*. Now, to say that  $\diamond a$  (it is possibly the case that  $a$ ) is true in  $s$ , is just to say that  $a$  is in fact true in *at least one* of the possible worlds associated with  $s$ . And to say that  $\square a$  (it is necessarily the case that  $a$ ) is true in  $s$ , is just to say that  $a$  is true in *all* the possible worlds associated with  $s$ . This is why  $\square$  and  $\diamond$  are not truth functions. For  $a$  and  $b$  may have the same truth value in  $s$ , say  $F$ , but may have different truth values in the worlds associated with  $s$ . For example,  $a$  may be true in one of them (say,  $s'$ ), but  $b$  may be true in none, like this:



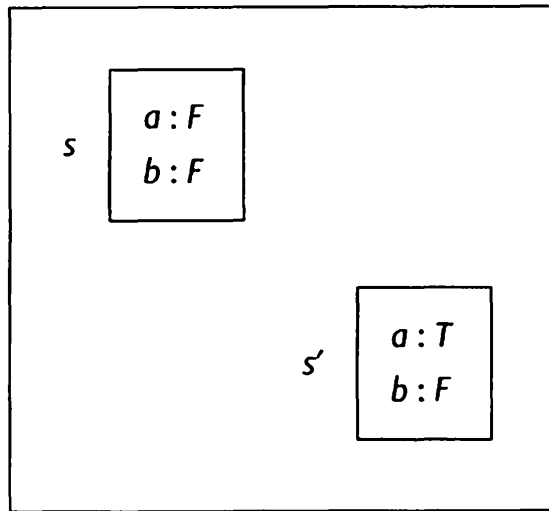

This account gives us a way of analysing inferences employing modal operators. For example, consider the inference:

$$\frac{\diamond a \quad \diamond b}{\diamond(a \& b)}$$

Logic

This is invalid. To see why, suppose that the situations associated with  $s$  are  $s_1$  and  $s_2$ , and that truth values are as follows:

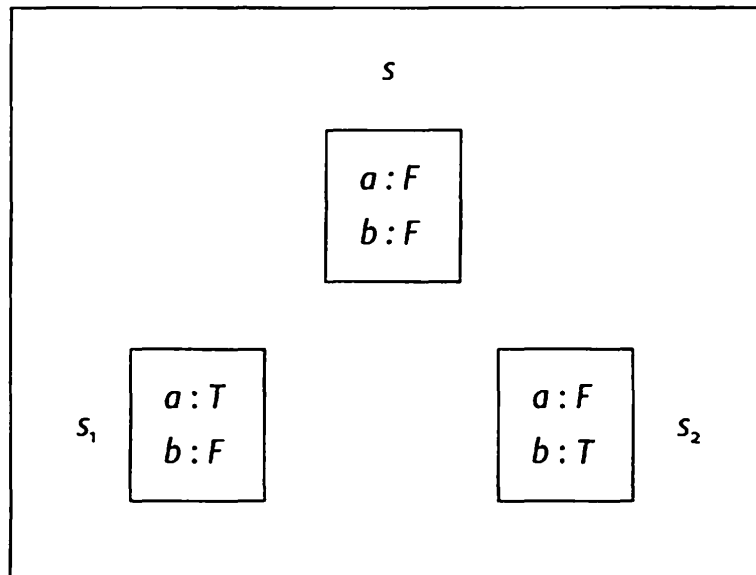

$a$  is  $T$  at  $s_1$ ; hence,  $\diamond a$  is true in  $s$ . Similarly,  $b$  is true in  $s_2$ ; hence,  $\diamond b$  is true in  $s$ . But  $a \& b$  is true in no associated world; hence,  $\diamond(a \& b)$  is not true in  $s$ .

By contrast, the following inference is valid:

$$\frac{\Box a \quad \Box b}{\Box(a \& b)}$$

For if the premisses are true in a situation  $s$ , then  $a$  and  $b$  are true in all the worlds associated with  $s$ . But then  $a \& b$  is true in all those worlds. That is,  $\Box(a \& b)$  is true in  $s$ .

Before we can get back to the question as to how this bears on Aristotle's argument, we need to talk briefly about another logical operator that we have not yet met. Let us write 'if  $a$  then  $b$ ' as  $a \rightarrow b$ . Sentences of this form are called *conditionals*, and will concern us a good deal in the next chapter. All we need to note for the present is that the major inference that conditionals seem to be involved in is this:

$$\frac{a \quad a \rightarrow b}{b}$$

(For example: 'If she works out regularly then she is fit. She does work out regularly; so she is fit'.) Modern logicians usually call this inference by the name with which it was tagged by medieval logicians: *modus ponens*. Literally, this means 'the method of positing'. (Don't ask.)

Now, for Aristotle's argument, we need to think a little about conditionals of the form:

if  $a$  then it cannot fail to be the case that  $b$ .

Such sentences are, in fact, ambiguous. One thing they can mean is that if  $a$  is, as a matter of fact, true, then  $b$  is necessarily true. That is, if  $a$  is true in the situation we are talking about,  $s$ , then  $b$  is true in all the possible situations associated with  $s$ . We can write this as  $a \rightarrow \Box b$ . The

sentence is being used like this when we say things like: 'You can't change the past. If something is true of the past, it cannot now fail to be true. There is nothing you can do to make it otherwise: it's irrevocable.'

The second meaning of a conditional of the form 'If  $a$  then it cannot fail to be the case that  $b$ ', is quite different. We often use this form of words to express the fact that  $b$  follows from  $a$ . We would be using the sentence like this if we said something like 'If Fred is going to be divorced then he cannot fail to be married'. We are not saying that if Fred is going to be divorced, his marriage is irrevocable. We are saying that you can't get a divorce unless you are married. There is no possible situation in which you have the one, but not the other. That is, in any possible situation, if one is true, so is the other. That is,  $\Box(a \rightarrow b)$  is true.

**Logic** Now,  $a \rightarrow \Box b$  and  $\Box(a \rightarrow b)$  mean quite different things. And certainly, the first does not follow from the second. The mere fact that  $a \rightarrow b$  is true in every situation associated with  $s$ , does not mean that  $a \rightarrow \Box b$  is true in  $s$ .  $a$  could be true in  $s$ , whilst  $\Box b$  is not: both  $b$  and  $a$  may fail to be true in some associated world. Or, to give a concrete counter-example: it is necessarily true that if John is getting a divorce, he is married; but it is certainly not true that if John is getting a divorce he is necessarily (irrevocably) married.

To come back to Aristotle's argument at last, consider the sentence that I put in boldface: 'If it is true to say that I will be involved in an accident then it cannot fail to be the case that I will be involved'. This is exactly of the form we have just been talking about. It is therefore ambiguous. Moreover, the argument trades on this ambiguity. If  $a$  is the sentence 'It is true to say that I will be involved in a traffic accident', and  $b$  is the sentence 'I will be involved (in a traffic accident)', then the boldface conditional is true in the sense:

1.  $\Box(a \rightarrow b)$

Necessarily, if it is true to say something, then that something is indeed the case. But what needs to be established is:

2.  $a \rightarrow \Box b$

After all, the next step of the argument is precisely to infer  $\Box b$  from  $a$  by *modus ponens*. But as we have seen, 2 does not follow from 1 at all. Hence, Aristotle's argument is invalid. For good measure, exactly the same problem arises in the second part of the argument, with the conditional 'If it is true to say that I will not be involved in an accident then it cannot fail to be the case that I won't be involved in an accident'.

This seems a satisfactory reply to Aristotle's argument. But there is a closely related argument that cannot be answered so easily. Come back to the example we had about changing the past. It does seem to be true that if some statement about the past is true, it is now necessarily true. It is impossible, now, to render it false. The Battle of Hastings was fought in 1066, and there is now nothing that one can do to make it have been fought in 1067. Thus, if  $p$  is some statement about the past,  $p \rightarrow \Box p$ .

Now consider some statement about the future. Again, for example, let it be the claim that I will be involved in a traffic accident tomorrow. Suppose this is true. Then if someone uttered this sentence 100 years ago, they spoke truly. And even if no one actually uttered it, if anyone had uttered it, they would have spoken truly. Thus, that I will be involved in a traffic accident tomorrow was true 100 years ago. This statement ( $p$ ) is certainly a statement about the past, and so, since true, necessarily true ( $\Box p$ ). So it must necessarily be true that I will be involved in a traffic accident tomorrow. But that was just an example; the same reasoning could be applied to anything. Thus, anything that

happens, must happen. This argument for fatalism does not commit the same fallacy (that is, use the same invalid argument) as the first one that I gave. So is fatalism true after all?

### **Main Ideas of the Chapter**

- **Each situation comes with a collection of associated possible situations.**
- **$\Box a$  is true in a situation,  $s$ , if  $a$  is true in every situation associated with  $s$ .**
- **$\Diamond a$  is true in a situation,  $s$ , if  $a$  is true in some situation associated with  $s$ .**

# Chapter 7

## Conditionals: What's in an 'if'?

In this chapter we'll turn to the logical operator that I introduced in passing in the last chapter, the conditional. Recall that a conditional is a sentence of the form 'if  $a$  then  $c$ ', which we are writing as  $a \rightarrow c$ . Logicians call  $a$  the *antecedent* of the conditional, and  $c$  the *consequent*. We also noted that one of the most fundamental inferences concerning the conditional is *modus ponens*:  $a, a \rightarrow c / c$ . Conditionals are fundamental to much of our reasoning. The previous chapter showed just one example of this. Yet they are deeply puzzling. They have been studied in logic ever since its earliest times. In fact, it was reported by one ancient commentator (Callimachus) that at one time even the crows on the rooftops were cawing about conditionals.

Let us see why – or, at least, one reason why – conditionals are puzzling. If you know that  $a \rightarrow c$ , it would seem that you can infer that  $\neg(a \ \& \ \neg c)$  (it is not the case that  $a$  and not  $c$ ). Suppose, for example, that someone informs you that if you miss the bus, you will be late. You can infer from this that it is false that you will miss the bus and not be late. Conversely, if you know that  $\neg(a \ \& \ \neg c)$ , it would seem that you can infer  $a \rightarrow c$  from this. Suppose, for example, that someone tells you that you won't go to the movies without spending money (it's not the case that you go to the movies and do not spend money). You can infer that if you go to the movies, you will spend money.

$\neg(a \ \& \ \neg c)$  is often written as  $a \supset c$ , and called the *material conditional*. Thus, it would appear that  $a \rightarrow c$  and  $a \supset c$  mean much the same thing. In particular, assuming the machinery of Chapter 2, they must have the same truth table. It is a simple exercise, which I leave to you, to show that this is as follows:

| $a$ | $c$ | $a \supset c$ |
|-----|-----|---------------|
| $T$ | $T$ | $T$           |
| $T$ | $F$ | $F$           |
| $F$ | $T$ | $T$           |
| $F$ | $F$ | $T$           |

Logic

But this is odd. It means that if  $c$  is true in a situation (first and third rows), so is  $a \rightarrow c$ . This hardly seems right. It is true, for example, that Canberra is the federal capital of Australia, but the conditional 'If Canberra is not the federal capital of Australia, Canberra is the federal capital of Australia' seems plainly false. Similarly, the truth table shows us that if  $a$  is false (third and fourth rows),  $a \rightarrow c$  is true. But this hardly seems right either. The conditional 'If Sydney is the federal capital of Australia, then Brisbane is the federal capital' also appears patently false. What has gone wrong?

What these examples seem to show is that  $\rightarrow$  is not a truth function: the truth value of  $a \rightarrow c$  is not determined by the truth values of  $a$  and  $c$ . Both of 'Rome is in France' and 'Beijing is in France' are false; but it's true that:

If Italy is part of France, Rome is in France.

While it's false that:

If Italy is part of France, Beijing is in France.

So how do conditionals work?

One answer can be given using the machinery of possible worlds of the last chapter. Consider the last two conditionals. In any possible situation in which Italy had become incorporated into France, Rome would indeed have been in France. But there are possible situations in which Italy was incorporated in France, but this had no effect on China at all. So Beijing was still not in France. This suggests that the conditional  $a \rightarrow c$  is true in some situation,  $s$ , just if  $c$  is true in every one of the possible situations associated with  $s$  in which  $a$  is true; and it is false in  $s$  if  $c$  is false in some possible situation associated with  $s$  in which  $a$  is true.

This gives a plausible account of  $\rightarrow$ . For example, it shows why *modus ponens* is valid – at least on one assumption. The assumption is that we count  $s$  itself as one of the possible situations associated with  $s$ . This seems reasonable: anything that is *actually* the case in  $s$  is surely *possible*. Now, suppose that  $a$  and  $a \rightarrow c$  are true in some situation,  $s$ . Then  $c$  is true in all situations associated with  $s$  in which  $a$  is true. But  $s$  is one of those situations, and  $a$  is true in it. Hence, so is  $c$ , as required.

Going back to the argument with which we started, we can now see where it fails. The inference on which the argument depends is:

$$\frac{\neg(a \ \& \ \neg c)}{a \rightarrow c}$$

And this is not valid. For example, if  $a$  is  $F$  in some situation,  $s$ , this suffices to make the premiss true in  $s$ . But this tells us nothing about how  $a$  and  $c$  behave in the possible situations associated with  $s$ . It could well be that in one of these, say  $s'$ ,  $a$  is true and  $c$  is not, like this:



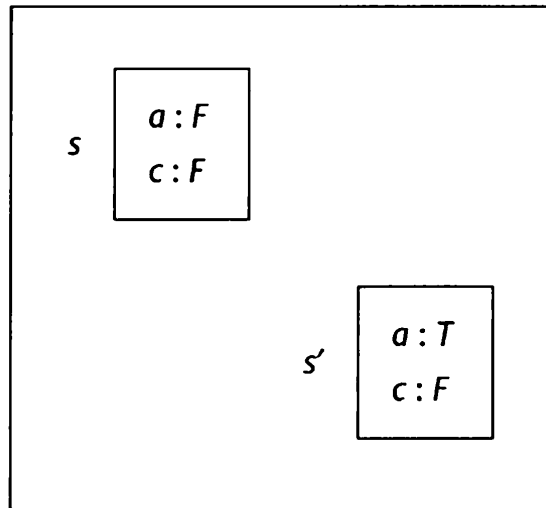

So  $a \rightarrow c$  is not true at  $s$ .

Logic

What about the example we had earlier, where you are informed that you won't go to the movies without spending money. Didn't the inference seem valid in this case? Suppose you know that you won't go to the movies without spending money:  $\neg(g \ \& \ \neg m)$ . Are you really entitled to conclude that if you go to the movies you will spend money:  $g \rightarrow m$ ? Not necessarily. Suppose you are not going to go to the movies, come what may, even if admission is free that night. (There is a programme on the television that is much more interesting.) Then you know that it is not true that you will go ( $\neg g$ ), and so that it is not true that you will go *and* not spend money:  $\neg(g \ \& \ \neg m)$ . Are you then entitled to infer that if you go you will spend money? Certainly not: it may be a free night.

It is important to note that in the kind of situation where you learn that the premiss is true by being informed of it, other factors are usually operating. When someone tells you something like  $\neg(g \ \& \ \neg m)$ , they do not normally do this on the basis that they know that  $\neg g$  is true. (If they knew this, there wouldn't normally be a point in telling you anything much about the situation.) If they tell you this, it is on the basis that there is some connection between  $g$  and  $m$ : that you *can't* have  $g$  true without  $m$  being true – and that is exactly what it takes for the



## 7. Jumping to conclusions

conditional to be true. So in the case where you are informed of the premiss, it would normally be reasonable to infer  $g \rightarrow m$ ; but not from the content of what was said – rather, from the fact *that it was said*.

In fact, we often correctly make inferences of this kind without thinking. Suppose, for example that I ask someone how to get my computer to do something or other, and they reply 'There is a manual on the shelf'. I infer that it is a computer manual. This does not follow from what was actually said, but the remark would not have been relevant unless the

manual was a computer manual, and people are normally relevant in what they say. Hence, I can conclude that it is a computer manual from the fact that they said what they did. The inference is not a deductive one. After all, the person could have said this, and it not be a computer manual. But the inference is still an excellent inductive inference. It is of a kind usually called *conversational implicature*.

The account of the conditional that we have just been looking at seems to fare well – at least as far as we have looked. It faces a number of problems, though. Here is one. Consider the following inferences:

If you go to Rome you will be in Italy.  
If you are in Italy, you are in Europe.  
Hence, if you go to Rome, you will be in Europe.

If  $x$  is greater than 10 then  $x$  is greater than 5.  
Hence, if  $x$  is greater than 10 and less than 100, then  $x$  is greater than 5.

Logic

These inferences seem perfectly valid, and so they are on the present account. We can write the first inference as:

$$1. \frac{a \rightarrow b \quad b \rightarrow c}{a \rightarrow c}$$

To see that this comes out valid, suppose the premisses are true in some situation,  $s$ . Then  $b$  is true in every possible situation associated with  $s$  where  $a$  is true; and likewise,  $c$  is true in every associated situation where  $b$  is. So  $c$  is true in every such situation where  $a$  is true. That is,  $a \rightarrow c$  is true in  $s$ .

We can write the second inference as:

$$2. \frac{a \rightarrow c}{(a \& b) \rightarrow c}$$

To see that this comes out valid, suppose the premiss is true in some situation,  $s$ . Then  $c$  is true in every possible situation associated with  $s$  where  $a$  is true. Now, suppose  $a \& b$  is true in an associated situation; then  $a$  is certainly true in that situation, and hence  $c$  is. Hence,  $(a \& b) \rightarrow c$  is true in  $s$ .

So far so good. The problem is that there are inferences that are exactly of these forms, but which appear to be *invalid*. For example, suppose that there is an election for Prime Minister with only two candidates, Smith, the present Prime Minister, and Jones. Now consider the following inference:

If Smith dies before the election, Jones will win. If Jones wins the election, Smith will retire and take her pension. Hence, if Smith dies before the election, she will retire and take her pension.

This is exactly an inference of the form 1. But it seems clear that there could be a situation in which both premisses are true. But not the conclusion – unless we are considering a bizarre situation in which the government can effect pension payments in the after-life!

Or consider the following inference concerning said Smith:

If Smith jumps from the top of tall precipice, she will die from the fall. Hence, if Smith jumps from the top of a tall precipice and wears a parachute, she will die from the fall.

This is an inference of the form 2. Yet, again, it would seem clear that there could be situations where the premiss is true and the conclusion is not.

What is one to say about this state of affairs? I'll leave you to think about that. Despite the fact that conditionals are central to how we reason

about most things, they are still one of the most contentious areas of logic. If birds are no longer crowing about conditionals, logicians certainly are.

### Main Idea of the Chapter

- $a \rightarrow b$  is true in a situation,  $s$ , just if  $b$  is true in every situation associated with  $s$  where  $a$  is true.

## Chapter 8

# The Future and the Past: Is Time Real?

Time is something that we are all very familiar with. We plan to do things in the future; we remember things in the past; and sometimes we enjoy just being in the present. And part of our finding our way around in time is making inferences that concern time. For example, the two following inferences are intuitively valid:

|                            |   |
|----------------------------|---|
| <u>It is raining.</u>      | <u>It will be true that it has always been raining.</u> |
| It will have been raining. | It is raining.  |

All this seems elementary.

But as soon as one starts to think about time, one seems to get tangled in knots. As Augustine said, if no one asks me what time is, then I know very well; but when someone asks me, I cease to know. One of the most puzzling things about time is that it seems to flow. The present seems to move: first it is today; then it is tomorrow; and so on. But how can time change? Time is what measures the rate at which *everything else* changes. This problem is at the heart of several conundrums concerning time. One such was put forward, early in the 20th century, by the British philosopher John McTaggart Ellis McTaggart. (That's right.) Like many philosophers, McTaggart was tempted by the view that time is unreal – that, in the ultimate order of things, time is an illusion.

To explain McTaggart's argument for this, it will help to have a little symbolism. Take a past-tense sentence, such as 'The sun was shining'. We can express this equivalently, if a little awkwardly, as 'It was the case that the sun is shining'. Let us write 'It was the case that' as **P** (for 'past'). Then we can write this sentence as '**P** the sun is shining', or, writing *s* for 'The sun is shining', simply **Ps**. Similarly, take any future tense sentence, say, 'The sun will be shining'. (Strictly speaking, grammarians will tell you, English has no proper future tense, unlike French or Latin. But you know what I mean.) We can write this as 'It will be the case that the sun is shining'. If we write 'It will be the case that' as **F** (for 'future'), then we can write this as **Fs**. (Don't confuse this **F** with the truth value *F*.)

Logic

**P** and **F** are operators, like  $\square$  and  $\diamond$ , that affix to whole sentences to make whole sentences. Moreover, like  $\square$  and  $\diamond$ , they are not truth functions. 'It is 4 p.m.' and 'It is 4 p.m. on August 2nd, 1999' are both true (at the instant I write); 'It *will be* 4 p.m.' is also true (at the present instant) – it is 4 p.m. once every day – though 'It *will be* 4 p.m. August 2nd, 1999' is not. Logicians call **P** and **F** *tense operators*. Tense operators can be iterated, or compounded. For example, we can say 'The sun *will have been* shining', that is, 'It will be the case that it was the case that the sun is shining': **FPs**. Or we can say 'The sun *had been* shining', that is, 'It was the case that it was the case that the sun is shining': **PPs**. (The modal operators that we met in the last chapter can also be iterated in this way, though we did not consider this there.) Not all iterations of tense operators have snappy English expressions. For example, there is not a much better way to express **FPFs** than as the rather lame 'It will be the case that it was the case that the sun will be shining'. The iterations, though, make perfectly good grammatical sense. We can call iterations of **P** and **F**, like **FP**, **PP**, **FFP**, *compound tenses*.

Now, back to McTaggart. McTaggart reasoned that there would be no time if there were no past and future: these are of its essence. Yet pastness and futurity, he argued, are inherently contradictory; so

nothing in reality can correspond to them. Well, maybe. But why are past and future contradictory? For a start, past and future are incompatible. If some instantaneous event is past, it is not future, and vice versa. Let  $e$  be some instantaneous event. It can be anything you like, but let us suppose that it is the passing of the first bullet through the heart of Czar Nicholas in the Russian Revolution. Let  $h$  be the sentence 'e is occurring'. Then we have:

$$\neg(\mathbf{Ph} \ \& \ \mathbf{Fh})$$

But  $e$ , like all events, is past and future. Because time flows, all events have the property of being future (before they happen) *and* the property of being past (after they happen):

$$\mathbf{Ph} \ \& \ \mathbf{Fh}$$

So we have a contradiction.

This argument isn't likely to persuade anyone for very long. An event can't be past and future *at the same time*. The instant the bullet passed through the Czar's heart was past and future *at different times*. It started off as future; became present for a painful instant; and then was past. But now – and this is the cunning part of McTaggart's argument – what are we saying here? We are applying compound tenses to  $h$ . We are saying that it was the case that the event was future,  $\mathbf{PFh}$ ; then it was the case that it was past,  $\mathbf{PPh}$ . Now, many compound tenses, like simple tenses, are incompatible. For example, if any event *will be* future, it is not the case that it *was* past:

$$\neg(\mathbf{PPh} \ \& \ \mathbf{FFh})$$

But, just as with the simple tenses, the flow of time suffices to ensure that all events have all compound tenses too. In the past,  $\mathbf{Fh}$ ; so in the distant past  $\mathbf{FFh}$ . In the future,  $\mathbf{Ph}$ ; so in the distant future,  $\mathbf{PPh}$ :



## PPh & FFh

And we are back with a contradiction.

Those who have kept their wits about them will reply, just as before, that *h* has its compound tenses at different times. It was the case that **FFh**; then, *later on*, it was the case that **PPh**. But what are we saying here? We are applying more complex compound tenses to *h*: **PFFh** and **PPPh**; and we can run exactly the same argument again with these. These compound tenses are not all consistent with each other, but the flow of time ensures that *h* possesses all of them. We may make the same reply *again*, but it, too, is open to the same counter-reply. Whenever we try to get out of the contradiction with one set of tenses, we do so only by describing things in terms of other tenses that are equally contradictory; so we never escape contradiction. That is McTaggart's argument.

Logic

What is one to say about this? To answer this, let us look at the validity of inferences concerning tenses. To account for this, we suppose that every situation,  $s_0$ , comes together with a bunch of other situations – not, this time, situations that represent possibilities associated with  $s_0$  (as with modal operators), but situations that are either before  $s_0$  or after  $s_0$ . Assuming, as we normally do, that time is one-dimensional and infinite in both directions, past and future, we can represent the situations in a familiar way:

...  $s_{-3}$     $s_{-2}$     $s_{-1}$     $s_0$     $s_1$     $s_2$     $s_3$  ...

Left is earlier; right is later. As usual, each  $s$  provides a truth value,  $T$  or  $F$ , for every sentence without tense operators. What about sentences with tense operators? Well, **Pa** is  $T$  in any situation,  $s$ , just if  $a$  is true in some situation to the left of  $s$ ; and **Fa** is true in  $s$  just if  $a$  is true in some situation to the right of  $s$ .

While we are doing all this, we can add two new tense operators, **G** and **H**. **G** can be read ‘It is always **G**oing to be the case that’, and **G** $a$  is true in any situation,  $s$ , just if  $a$  is true in *all* situations to the right of  $s$ . **H** can be read as ‘It **H**as always been the case that’, and **H** $a$  is true in any situation,  $s$ , just if  $a$  is true in all situations to the left of  $s$ . (**G** and **H** correspond to **F** and **P**, respectively, in just the way that  $\Box$  corresponds to  $\Diamond$ .)

This machinery shows us why the two inferences with which we started the chapter are valid. Employing tense operators, these inferences can be written, respectively, as:

$$\frac{r}{\mathbf{FPr}} \quad \frac{\mathbf{F Hr}}{r}$$

The first inference is valid, since if  $r$  is true in some situation,  $s_0$ , then in any situation to the right of  $s_0$ , say  $s_1$ , **P** $r$  is true (since  $s_0$  is to its left). But then, **FPr** is true in  $s_0$ , since  $s_1$  is to its right. We can depict things like this:

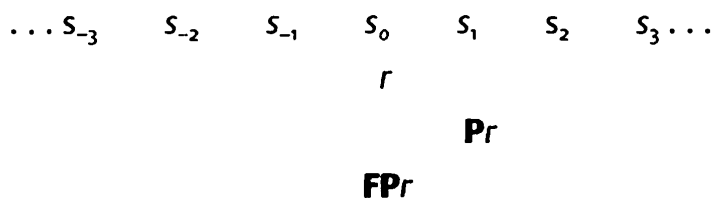

The second inference is valid, since if **F Hr** is true in  $s_0$ , then in some situation to the right of  $s_0$ , say  $s_2$ , **H** $r$  is true. But then in all situations to the left of  $s_2$ , and so in particular  $s_0$ ,  $r$  is true:

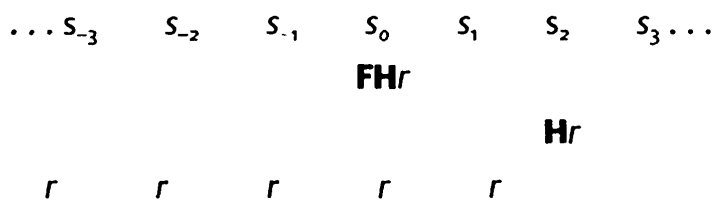

Moreover, certain combinations of tenses are impossible, as one would

expect. Thus, if  $h$  is a sentence that is true in just one situation, say  $s_0$ , then  $\mathbf{P}h \ \& \ \mathbf{F}h$  is false in every  $s$ . Both conjuncts are false in  $s_0$ ; the first conjunct is false to the left of  $s_0$ ; the second conjunct is false to the right. Similarly, e.g.,  $\mathbf{P}h \ \& \ \mathbf{F}h$  is false in every  $s$ . I leave you to check the details.

Now, how does all this bear on McTaggart's argument? The upshot of McTaggart's argument, recall, was that, given that  $h$  has every possible tense, it is never possible to avoid contradiction. Resolving contradictions in one level of complexity for compound tenses only creates them in another. The account of the tense operators that I have just given, shows this to be false. Suppose that  $h$  is true in just  $s_0$ . Then any statement with a compound tense concerning  $h$  is true *somewhere*. For example, consider  $\mathbf{FPPF}h$ . This is true in  $s_{-2}$ , as the following diagram shows:

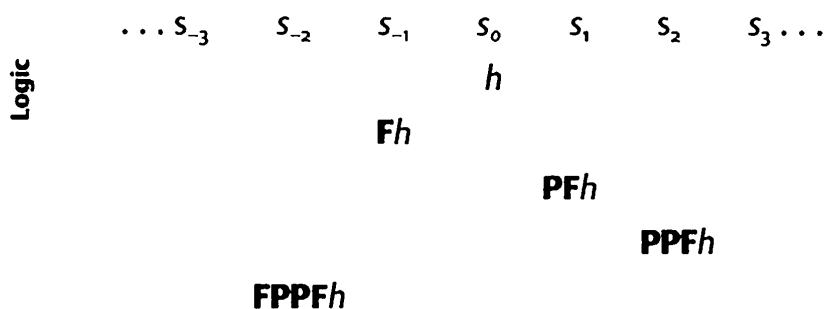

Clearly, we can do the same for every compound tense composed of  $\mathbf{F}$  and  $\mathbf{P}$ , zigzagging left or right, as required. And all this is perfectly consistent. The infinitude of different situations allows us to assign  $h$  all its compound tenses in appropriate places without violating the various incompatibilities between them, e.g., by having  $\mathbf{F}h$  and  $\mathbf{P}h$  true in the same situation. McTaggart's argument, therefore, fails.

This is a happy outcome for those who wish to believe in the reality of time. But those who agree with McTaggart might yet not be persuaded by our considerations. Suppose I give you a set of specifications for constructing a house: the front door goes here; a window here . . . How do you know that all the specifications are consistent? How do you

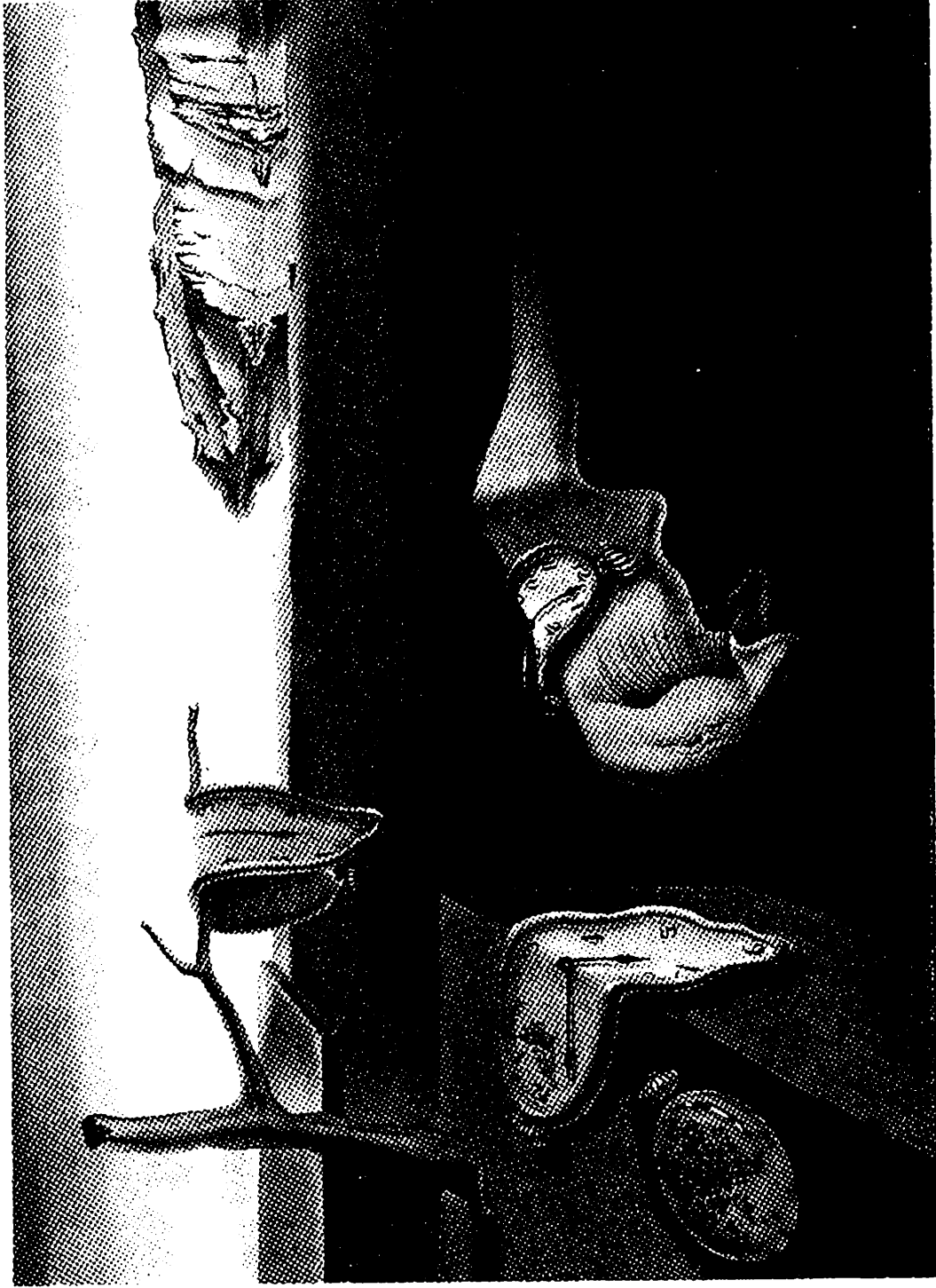

8. Space does not flow. Salvador Dalí's *The Persistence of Memory*

know that, when you perform the construction, everything will work out, and that you will not be required, for example, to put the door in incompatible positions? One way to determine this is to build a scale model in accordance with all the specifications. If such a model can be built, the specifications are consistent. That is exactly what we have done with our tensed talk. The model is the sequence of situations, together with the way of assigning  $T$  and  $F$  to tensed sentences. It is a little more abstract than a model of a house, but the principle is essentially the same.

It may be possible to object to a model, though. Sometimes a model will ignore important things. For example in a scale model of a house, a beam may not collapse, because it bears a lot less stress than the corresponding beam would in a full-scale construction. The full-scale beam may be required to take an impossible load, making the full-scale building impossible – the model notwithstanding. Similarly, it may be suggested that our model of time ignores important things. After all, what we have done is give a *spatial* model of time (left, right, etc.). But space and time are quite different things. Space does not flow in the way that time does (whatever, indeed, that might mean). Now, it is exactly the flow of time that produces the supposed contradiction that McTaggart was pointing to. No wonder this does not show up in the model! Exactly what, then, is missing from the model? And once that is taken into account, does the contradiction reappear?

Logic

## Main Ideas of the Chapter

- Every situation comes with an associated collection of earlier and later situations.
- $Fa$  is true in a situation if  $a$  is true in some later situation.
- $Pa$  is true in a situation if  $a$  is true in some earlier situation.
- $Ga$  is true in a situation if  $a$  is true in every later situation.
- $Ha$  is true in a situation if  $a$  is true in every earlier situation.

## Chapter 9

# Identity and Change: Is Anything Ever the Same?

We have not finished with time yet. Time is involved in various other conundrums, one kind of which we will look at in this chapter. This kind concerns problems that arise when things change; and specifically, the question of what is to be said about the identity of objects that change through time.

Here is an example. We all think that objects can survive through change. For example, when I paint a cupboard, although its colour may change, it is still the same cupboard. Or when you change your hair style, or if you are unfortunate enough to lose a limb, you are still *you*. But how can anything survive change? After all, when you change your hairstyle, the person that results is different, not the same at all. And if the person is different, it is a different person; so the old you has gone out of existence. In exactly the same way, it may be argued, no object persists through any change whatsoever. For any change means that the old object goes out of existence, and is replaced by a quite different object.

Arguments like this appear at various places in the history of philosophy, but it would be generally agreed by logicians, now, that they are mistaken, and rest on a simple ambiguity. We must distinguish between an object and its properties. When we say that you, with a different hairstyle, are different, we are saying that you have different

properties. It does not follow that you are literally a different person, in the way that I am a different person from you.

One reason why one may fail to distinguish between being a certain object and having certain properties is that, in English, the verb 'to be' and its various grammatical forms – 'is', 'am', and so on – can be used to express both of these things. (And the same goes for similar words in other languages.) If we say 'The table is red', 'Your hair is now short', and similar things, we are attributing a property to an object. But if someone says 'I am Graham Priest', 'The person who won the race is the same person who won it last year', and so on, then they are identifying an object in a certain way. That is, they are stating its identity.

Logic

Logicians call the first use of 'is' the '*is*' of *predication*; they call the second use of 'is' the '*is*' of *identity*. And because these have somewhat different properties, they write them in different ways. The 'is' of predication we have already met in Chapter 3. 'John is red' is typically written in the form  $jR$ . (Actually, as I noted in Chapter 3, it is more common to write this the other way round, as  $Rj$ .) The 'is' of identity is written with  $=$ , familiar from school mathematics. Thus, 'John is the person who won the race' is written:  $j = w$ . (The name  $w$  is a description here; but this is of no significance in the present matter.) Sentences like this are called *identities*.

What properties does identity have? First, it is a relation. A relation is something that relates two objects. For example, *seeing* is a relation. If we say 'John sees Mary' we are stating a relation between them. The objects related by a relation do not necessarily have to be different. If we say 'John sees himself' (maybe in a mirror), we are stating a relation that John bears to John. Now, identity is a very special relation. It is a relation that every object bears to itself and to nothing else.

You might think that this would make identity a rather useless relation, but, in fact, this is not so. For example, if I say 'John is the person who

won the race', I am saying that the relation of identity holds between the object referred to by 'John' and the object referred to by 'the person who won the race' – in other words, that these two names refer to one and the same person. This can be a highly significant piece of information.

The most important things about identity, though, are the inferences that it is involved in. Here is an example:

John is the person who won the race.  
The person who won the race got a prize.  
So John got a prize.

We can write this as:

$$\frac{j = w \quad wP}{jP}$$

This inference is valid in virtue of the fact that, for any objects,  $x$  and  $y$ , if  $x = y$ , then  $x$  has any properties that  $y$  has, and vice versa. One and the same object either has the property in question, or it doesn't. This is usually called *Leibniz's Law*, after Leibniz, whom we met in Chapter 6. In an application of Leibniz's Law, one premiss is an identity statement, say  $m = n$ ; the second premiss is a sentence containing one of the names that flanks the identity sign, say  $m$ ; and the conclusion is obtained by substituting  $n$  for  $m$  in this.

Leibniz's Law is a very important one, and has many quite unproblematic applications. For example, high school algebra assures us that  $(x + y)(x - y) = x^2 - y^2$ . So if you are solving a problem, and establish that, say,  $x^2 - y^2 = 3$ , you can apply Leibniz's Law to infer that  $(x + y)(x - y) = 3$ . Its deceptive simplicity hides a multitude of problems, though. In particular, there seem to be many counter-examples to it. Consider, for example, the following inference:



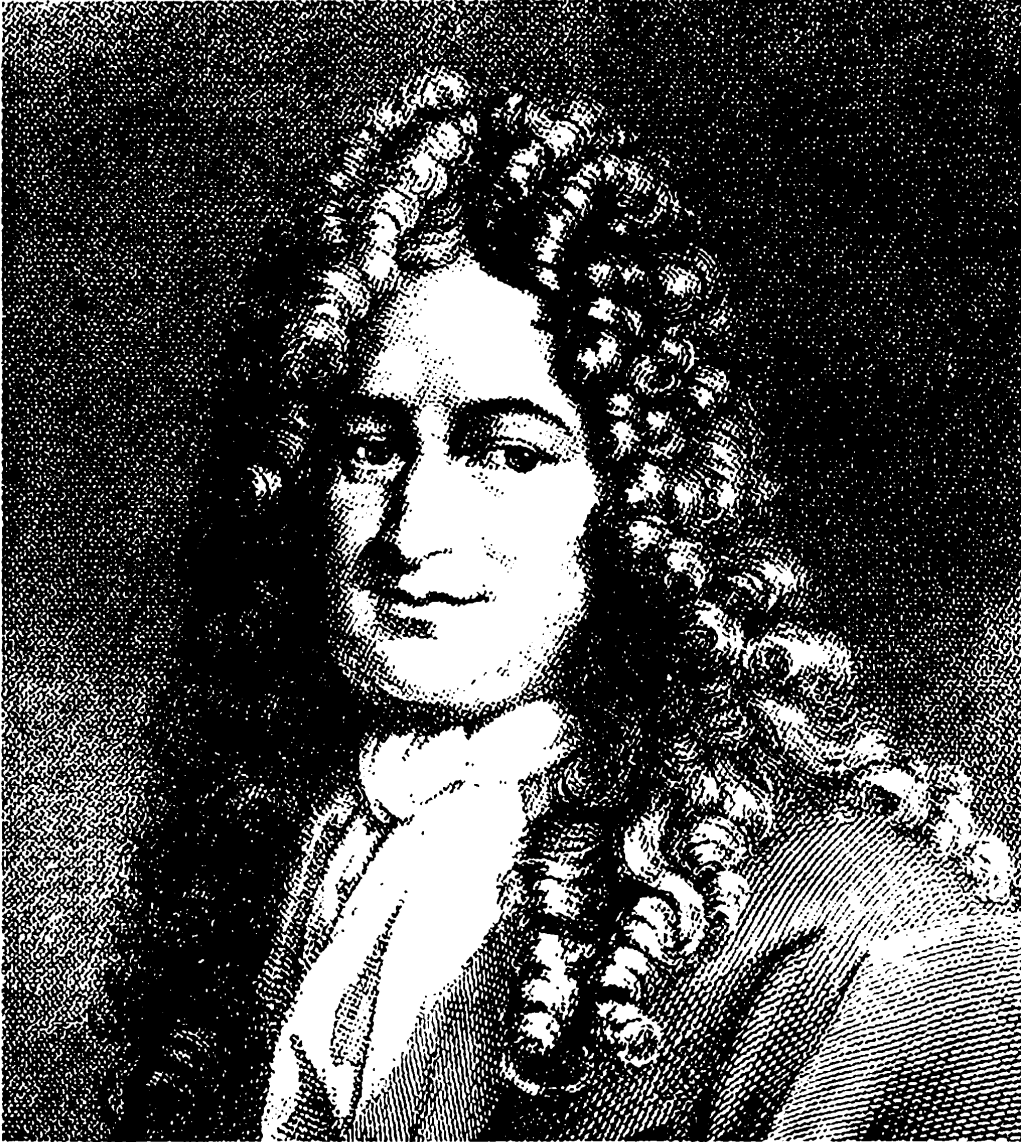

9. Gottfried Wilhelm Leibniz (1646-1716), the last notable logician before the modern period

John is the person who won the race.

Mary knows that the person who won the race got a prize.

So Mary knows that John got a prize.

This looks like an application of Leibniz's Law since the conclusion is obtained by substituting 'John' for 'the person who won the race' in the second premiss. Yet it is clear that the premisses could well be true without the conclusion being true: Mary might not know that John is the person who won the race. Is this a violation of Leibniz's Law? Not

necessarily. The Law says that if  $x = y$  then any property of  $x$  is a property of  $y$ . Now, does the condition ‘Mary knows that  $x$  got a prize’ express a property of  $x$ ? Not really: it would seem, rather, to express a property of Mary. If Mary were suddenly to go out of existence, this would not change  $x$  at all! (The logic of phrases such as ‘knows that’ is still very much *sub judice* in logic.)

Another sort of problem is as follows. Here is a road; it is a tarmac road; call it  $t$ . And here is a road; it is a dirt road; call it  $d$ . The two roads, though, are the same road,  $t = d$ . It is just that the tarmac runs out towards the end of the road. So Leibniz’s Law tells us that  $t$  is a dirt road, and  $d$  is a tarmac road – which they are not. What has gone wrong here? We cannot say that being dirt or tarmac are not really properties of the road. They certainly are. What has gone wrong (arguably) is this: we are not being precise enough in our specification of properties. The relevant properties are *being tarmac at such and such a point*, and *being dirt at such and such a point*. Since  $t$  and  $d$  are the same road, they have both properties, and we do not have a violation of Leibniz’s Law.

So far so good. These problems are relatively easy. Let’s now have one that isn’t. And here, time comes back into the issue. To explain what the problem is, it will be useful to employ the tense operators of the last chapter, and specifically, **G** (‘it is always going to be the case that’). Let  $x$  be anything you like, a tree, a person; and consider the statement  $x = x$ . This says that  $x$  has the property of being identical to  $x$  – which is obviously true: it’s part of the very meaning of identity. And this is so, regardless of time. It is true now, true at all times future, and true at all times past. In particular, then, **G**  $x = x$  is true. Now, here is an instance of Leibniz’s Law:

$$\frac{x = y \quad \mathbf{G} x = x}{\mathbf{G} x = y}$$

(Don’t let the fact that we have substituted  $y$  for only one of the

occurrences of  $x$  in the second premiss throw you. Such applications of Leibniz's Law make perfectly good sense. Just consider: 'John is the person who won the race; John sees John; so John sees the person who won the race'.) What the inference shows is that if  $x$  is identical to  $y$ , and  $x$  has the property of being identical to  $x$  at all future times, so does  $y$ . And since the second premiss is true, as we have just noted, it follows that if two things are identical, they will always be identical.

And what of that? Simply, it doesn't always seem to be true. For example, consider an amoeba. Amoebas are single-celled water creatures that multiply by fission: an amoeba will split down the middle to become two amoebas. Now, take some amoeba,  $A$ , that divides to become two amoebas,  $B$  and  $C$ . Before the split, both  $B$  and  $C$  were  $A$ . So before the split,  $B = C$ . After the split, though,  $B$  and  $C$  are distinct amoebas,  $\neg B = C$ . So if two things are the same, it does not necessarily follow that they are always going to be the same.

Logic

We can't get out of this problem in the same way that we got out of the previous ones. The property of being identical to  $x$  at all future times is certainly a property of  $x$ . And it doesn't appear to be the case that the property is insufficiently fine-grained. There seems to be no way to make it more precise to avoid the problem.

What else can one say? A natural thought is this. Before the split,  $B$  wasn't  $A$ : it was only *part of*  $A$ . But  $B$  is an amoeba, and  $A$  is a single-celled creature: it has no parts that are amoebas. So  $B$  can't be part of  $A$ .

More radically, one might suggest that  $B$  and  $C$  did not really exist before the split, that they came into existence then. If they did not exist before the split, then they were not  $A$  before the split. So it's not the case that  $B = C$  before the split. But that seems wrong too.  $B$  is not a new amoeba; it is simply  $A$ , though some of its properties have changed. If this is not clear, just imagine that  $C$  were to die at the split. In this case, we would have no hesitation in saying that  $B$  is  $A$ . (It would just be like a

snake shedding its skin.) Now, the identity of something can't be affected by whether there are *other* things around. So *A* is *B*. Likewise, *A* is *C*.

Of course, one might insist that just because *A* takes on new properties, it is, strictly speaking, a new object; not merely an old object with new properties. So *B* is not really *A*. Likewise *C*. But now we are back with the problem with which we started the chapter.

### Main Ideas of the Chapter

- $m = n$  is true just if the names  $m$  and  $n$  refer to the same object.
- If two objects are the same, any property of one is a property of the other (Leibniz's Law).

## Chapter 10

# Vagueness: How do you Stop Sliding down a Slippery Slope?

While we are on the subject of identity, here is another problem about it. Everything wears out in time. Sometimes, parts get replaced. Motor bikes and cars get new clutches; houses get new roofs; and even the individual cells in people's bodies are replaced over time. Changes like this do not affect the identity of the object in question. When I replace the clutch on my bike, it remains the same bike. Now suppose that over a period of a few years, I replace every part of the bike, Black Thunder. Being a careful fellow, I keep all the old parts. When everything has been replaced, I put all the old parts back together to recreate the original bike. But I started off with Black Thunder; and changing one part on a bike does not affect its identity: it is still the same bike. So at each replacement, the machine is still Black Thunder; until, at the end, it is – Black Thunder. But we know that that can't be right. Black Thunder now stands next to it in the garage.

Here is another example of the same problem. A person who is 5 years old is a (biological) child. If someone is a child, they are still a child one second later. In which case, they are still a child one second after that, and one second after that, and one second after that, . . . So after 630,720,000 seconds, they are still a child. But then they are 25 years old!

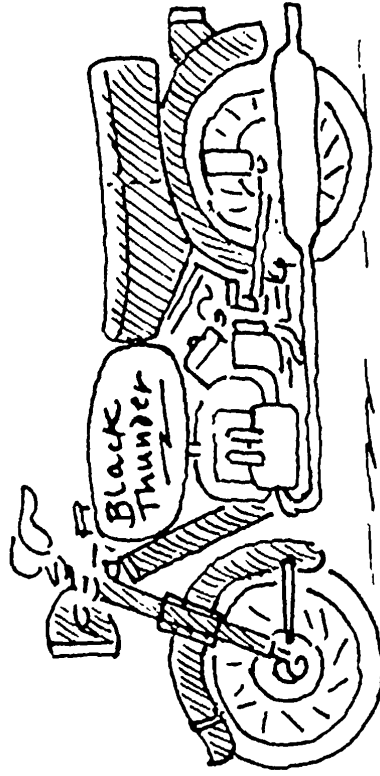
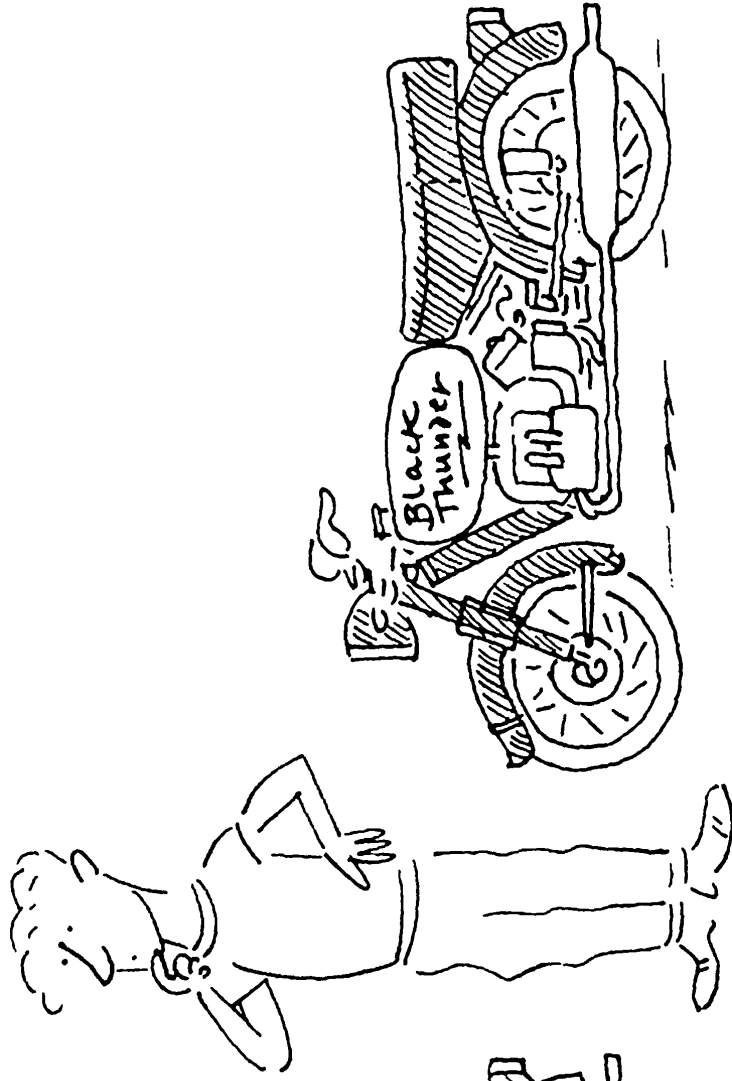

10. A bike-rider's dilemma

Arguments like this are reputed to have been invented by Eubulides, the same Eubulides who invented the liar paradox of Chapter 5. They are now called *sorites paradoxes*. (A standard form of the argument is to the effect that by adding one grain of sand at a time, one can never form a heap; 'sorites' comes from 'soros', the Greek for *heap*.) These are some of the most annoying paradoxes in logic. They arise when the predicate employed ('is Black Thunder', 'is a child') is *vague*, in a certain sense; that is, when its applicability is tolerant with respect to very small changes: if it applies to an object, then a very small change in the object will not alter this fact. Virtually all of the predicates that we employ in normal discourse are vague in this sense: 'is red', 'is awake', 'is happy', 'is drunk' – even 'is dead' (dying takes time). Thus, slippery slope arguments of the sorites kind are potentially endemic in our reasoning.

Logic

To focus the issue concerning them, let us look at one of these arguments in more detail. Let Jack be the five year old child. Let  $a_0$  be the sentence 'Jack is a child after 0 seconds'. Let  $a_1$  be the sentence 'Jack is a child after 1 second', and so on. If  $n$  is any number,  $a_n$  is the sentence 'Jack is a child after  $n$  seconds'. Let  $k$  be some enormous number, at least as great as 630,720,000. We know that  $a_0$  is true. (After 0 seconds have elapsed, Jack is still 5.) And for each number,  $n$ , we know that  $a_n \rightarrow a_{n+1}$ . (If Jack is a child at any time, he is a child one second later.) We can chain all these premisses together by a sequence of *modus ponens* inferences, like this:

$$\begin{array}{r} \frac{a_0 \quad a_0 \rightarrow a_1}{a_1} \quad \frac{a_1 \quad a_1 \rightarrow a_2}{a_2} \\ \vdots \\ \frac{a_{k-1} \quad a_{k-1} \rightarrow a_k}{a_k} \end{array}$$

The final conclusion is  $a_k$ , which we know not to be true. Something has gone wrong, and there doesn't seem much scope to manoeuvre.

So what are we to say? Here is one answer, which is sometimes called *fuzzy logic*. Being a child seems to fade out, gradually, just as being a (biological) adult seems to fade in gradually. It seems natural to suppose that the truth value of 'Jack is a child' also fades from true to false. Truth, then, comes by degrees. Suppose we measure these degrees by numbers between 1 and 0, 1 being complete truth, 0 complete falsity. Every situation, then, assigns each basic sentence such a number.

What about sentences containing operators like negation and conjunction? As Jack gets older, the truth value of 'Jack is a child' goes down. The truth value of 'Jack is not a child' would seem to go up correspondingly. This suggests that the truth value of  $\neg a$  is 1 minus the truth value of  $a$ . Suppose we write the truth value of  $a$  as  $|a|$ ; then we have:

$$|\neg a| = 1 - |a|$$

Here is a table of some sample values:

| $a$  | $\neg a$ |
|------|----------|
| 1    | 0        |
| 0.75 | 0.25     |
| 0.5  | 0.5      |
| 0.25 | 0.75     |
| 0    | 1        |

What about the truth value of conjunctions? A conjunction can only be as good as its worst bit. So it's natural to suppose that the truth value of  $a \& b$  is the *minimum* (lesser) of  $|a|$  and  $|b|$ :

$$|a \& b| = \text{Min}(|a|, |b|)$$



Here is a table of some sample values. Values of  $a$  are down the left hand column; values of  $b$  are along the top row. The corresponding values of  $a \& b$  are where the appropriate row and column meet. For example, if we want to find  $|a \& b|$ , where  $|a| = 0.25$  and  $|b| = 0.5$ , we see where the italicized row and column meet. The result is in boldface.

| $a \& b$ | 1    | 0.75 | 0.5         | 0.25 | 0 |
|----------|------|------|-------------|------|---|
| 1        | 1    | 0.75 | 0.5         | 0.25 | 0 |
| 0.75     | 0.75 | 0.75 | 0.5         | 0.25 | 0 |
| 0.5      | 0.5  | 0.5  | 0.5         | 0.25 | 0 |
| 0.25     | 0.25 | 0.25 | <b>0.25</b> | 0.25 | 0 |
| 0        | 0    | 0    | 0           | 0    | 0 |

Logic Similarly, the value of a disjunction is the *maximum* (greater) of the values of the disjuncts:

$$|a \vee b| = \text{Max}(|a|, |b|)$$

I leave it to you to construct a table of some sample values. Notice that, according to the above,  $\neg$ ,  $\&$ , and  $\vee$  are still truth functions. That is, for example, the truth value of  $a \& b$  is determined by the truth values of  $a$  and  $b$ . It is just that those values are now numbers between 0 and 1, instead of  $T$  and  $F$ . (It is perhaps worth noting, though, that if we think of 1 as  $T$ , and 0 as  $F$ , the results where only 1 and 0 are involved are the same as for the truth functions of Chapter 2, as you can check for yourself.)

What of conditionals? We saw in Chapter 7 that there are good reasons to suppose that  $\rightarrow$  is not a truth function, but let us set those worries aside for the present. If it is a truth function, which one is it, now that we have to take into account degrees of truth? No answer seems

terribly obvious. Here is one (fairly standard) suggestion, which at least seems to give the right sorts of results.

$$\text{If } |a| \leq |b|: |a \rightarrow b| = 1$$

$$\text{If } |b| < |a|: |a \rightarrow b| = 1 - (|a| - |b|)$$

(< means 'is less than'; ≤ means 'is less than or equal to'.) Thus, if the antecedent is less true than the consequent, the conditional is completely true. If the antecedent is more true than the consequent, then the conditional is less than the maximal truth by the difference between their values. Here is a table of some sample values. (Recall that the values of *a* are down the left-hand column and those of *b* are along the top row.)

| $a \rightarrow b$ | 1 | 0.75 | 0.5  | 0.25 | 0    |
|-------------------|---|------|------|------|------|
| 1                 | 1 | 0.75 | 0.5  | 0.25 | 0    |
| 0.75              | 1 | 1    | 0.75 | 0.5  | 0.25 |
| 0.5               | 1 | 1    | 1    | 0.75 | 0.5  |
| 0.25              | 1 | 1    | 1    | 1    | 0.75 |
| 0                 | 1 | 1    | 1    | 1    | 1    |

Vagueness

What of validity? An inference is valid if the conclusion holds in every situation where the premisses hold. But what is it now for something to hold in a situation? When it is true enough. But how true is true enough? That will just depend on the context. For example, 'is a new bike' is a vague predicate. If you go to a bike dealer who tells you that a certain bike is new, you expect it never to have been used before. That is, you expect 'This is a new bike' to have value 1. Suppose, on the other hand, that you go to a bike rally, and are asked to pick out the new bikes. You will pick out the bikes that are less than a year or so old. In other words, your criterion for what is acceptable as a new bike is more lax. 'This is a new bike' need have value only, say, 0.9 or greater.

So we suppose that there is some level of acceptability, fixed by the context. This will be a number somewhere between 0 and 1 – maybe 1 itself in extreme cases. Let us write this number as  $\epsilon$ . Then an inference is valid for that context just if the conclusion has a value at least as great as  $\epsilon$  in every situation where the premisses all have values at least as great as  $\epsilon$ .

Now, how does all this bear on the sorites paradox? Suppose we have a sorites sequence. As above, let  $a_n$  be the sentence 'Jack is a child after  $n$  seconds'; but to keep things manageable, let us suppose that Jack grows up in four seconds! Then a record of truth values might be:

| $a_0$ | $a_1$ | $a_2$ | $a_3$ | $a_4$ |
|-------|-------|-------|-------|-------|
| 1     | 0.75  | 0.5   | 0.25  | 0     |

Logic

$a_0 \rightarrow a_1$  has value 0.75 ( $= (1 - (1 - 0.75))$ ); so does  $a_1 \rightarrow a_2$ ; in fact, every conditional of the form  $a_n \rightarrow a_{n+1}$  has the value 0.75.

What this tells us about the sorites paradox depends on the level of acceptability,  $\epsilon$ , that is in force here. Suppose the context is one that imposes the highest level of acceptability;  $\epsilon$  is 1. In this case, *modus ponens* is valid. For suppose that  $|a| = 1$  and  $|a \rightarrow b| = 1$ . Since  $|a \rightarrow b| = 1$ , we must have  $|a| \leq |b|$ . It follows that  $|b| = 1$ . Thus the sorites argument is valid. In this case, though, each conditional premiss, having value 0.75, is unacceptable.

If, on the other hand, we set the level of acceptability lower than 1, then *modus ponens* turns out to be invalid. Suppose, for the sake of illustration, that  $\epsilon$  is 0.75. As we have already seen,  $a_1$  and  $a_1 \rightarrow a_2$  both have value 0.75, but  $a_2$  has value 0.5, which is less than 0.75.

Either way you look at it, then, the argument fails. Either some of the

premisses aren't acceptable; or, if they are, the conclusions don't follow validly. Why are we taken in by sorites arguments so easily? Maybe because we confuse complete truth with near-complete truth. A failure to draw the distinction doesn't make much difference normally. But if you do it again, and again, and again, . . . it does.

That's one diagnosis of the problem. But with vagueness, nothing is straightforward. What was the problem about saying that 'Jack is a child' is simply true, until a particular point in time, when it becomes simply false? Just that there seems to be no such point. Any place one chooses to draw the line is completely arbitrary; it can be, at best, a matter of convention. But now, at what point in Jack's growing up does he cease to be 100% a child; that is, at what point does 'Jack is a child' change from having the value of exactly 1, to a value below 1? Any place one chooses to draw this line would seem to be just as arbitrary as before. (This is sometimes called the problem of *higher-order vagueness*.) If that is right, we haven't really solved the most fundamental problem about vagueness: we have just relocated it.

Vagueness

## Main Ideas of the Chapter

- Truth values are numbers between 0 and 1 (inclusive).
- $|\neg a| = 1 - |a|$
- $|a \vee b| = \text{Max}(|a|, |b|)$
- $|a \& b| = \text{Min}(|a|, |b|)$
- $|a \rightarrow b| = 1$  if  $|a| \leq |b|$ ;  
 $|a \rightarrow b| = 1 - (|a| - |b|)$  otherwise.
- A sentence is true in a situation just if its truth value is at least as great as the (contextually determined) level of acceptability.

# Chapter 11

## Probability: The Strange Case of the Missing Reference Class

The preceding chapters have given us at least some feel for which inferences are deductively valid, and why. It's now time to come back to the question of inductive validity: that is, the validity of those inferences where the premisses give some ground for the conclusion; yet where, even if the premisses are true in some situation, the conclusion could still turn out to be false.

As I noted in Chapter 1, Sherlock Holmes was very good at this kind of inference. Let us start with an example from him. The mystery of *The Red-Headed League* commences when Holmes and Dr. Watson receive a visit from a certain Mr. Jabez Wilson. When Wilson enters, Watson looks to see what Holmes has inferred about him:

'Beyond the obvious fact that he has at some time done manual labour, that he takes snuff, that he is a Freemason, that he has been in China, and that he has done a considerable amount of writing lately, I can deduce nothing else.'

Mr. Jabez Wilson started up in his chair with his forefinger upon the paper, but his eyes upon my companion.

'How, in the name of good fortune, did you know all that, Mr. Holmes?' he asked.



## 11. Holmes displays his logical prowess

Holmes is pleased to explain. For example, concerning the writing:

'What else can be indicated by that right cuff so very shiny for five inches, and the left one with the smooth patch near the elbow where you rest it upon the desk.'

Despite the fact that Holmes is wont to call this kind of inference a deduction, the inference is, in fact, an inductive one. It is entirely possible that Wilson's coat should have shown these patterns without his having done much writing. He could, for example, have stolen it from someone who had. None the less, the inference is clearly a pretty good one. What makes it, and inferences like it, good? One plausible answer is in terms of probability. So let's talk about this, and then we can return to the question.

A probability is a number assigned to a sentence, which measures how likely it is, in some sense, that the sentence is true. Let us write  $pr(a)$  for

the probability of  $a$ . Conventionally, we measure probabilities on a scale between 0 and 1. If  $pr(a) = 0$ ,  $a$  is certainly false; then as  $pr(a)$  increases, it gets more likely that  $a$  is true; until when  $pr(a) = 1$ ,  $a$  is certainly true.

What else can one say about these numbers? Let me illustrate with a simple example. Suppose we consider the days of any one particular week. Let  $w$  be a sentence that is either true or false every day – say, ‘It is warm’ – and let  $r$  be another – say, ‘It is raining’. Let the relevant information be given by the following table:

|     | Mon | Tue | Wed | Thu | Fri | Sat | Sun |
|-----|-----|-----|-----|-----|-----|-----|-----|
| $w$ |     |     | ✓   | ✓   |     | ✓   | ✓   |
| $r$ |     | ✓   | ✓   |     |     | ✓   |     |

**Logic** A tick indicates that the sentence is true that day; a blank that it is not.

Now, if we are talking about this particular week, what is the probability that on any day, chosen at random, it was warm? There were four warm days, and seven days in total. So the probability is  $4/7$ . Similarly, there were three days where it rained, so the probability that it rained is  $3/7$ :

$$pr(w) = 4/7$$

$$pr(r) = 3/7$$

In general, if we write  $\#a$  to mean the number of days at which the sentence  $a$  is true, and  $N$  for the total number of days:

$$pr(a) = \#a/N$$

How does probability relate to negation, conjunction and disjunction? Negation first. What is the probability of  $\neg w$ ? Well, there were three

days on which it was not warm, so  $pr(\neg w) = 3/7$ . Notice that  $pr(w)$  and  $pr(\neg w)$  add up to 1. This is no accident. We have:

$$\#w + \#\neg w = N$$

Dividing both sides by  $N$ , we get:

$$\frac{\#w}{N} + \frac{\#\neg w}{N} = 1$$

That is,  $pr(w) + pr(\neg w) = 1$ .

For conjunction and disjunction: there are two days on which it was both warm and rainy, so  $pr(w \& r) = \#(w \& r)/N = 2/7$ . And there are five days on which it was either warm or rainy, so  $pr(w \vee r) = \#(w \vee r)/N = 5/7$ . What is the relation between these two numbers? To find the number of days when  $w \vee r$  is true, we can start by adding up the days when  $w$  is true, then add the number of days where  $r$  is true. This won't quite do, since some days will have been counted twice: Wednesday and Saturday. These are the days when it was both rainy and warm. So to get the correct figure, we have to subtract the number of days when it was both:

Probability

$$\#(w \vee r) = \#w + \#r - \#(w \& r)$$

Dividing both sides by  $N$ , we get:

$$\frac{\#(w \vee r)}{N} = \frac{\#w}{N} + \frac{\#r}{N} - \frac{\#(w \& r)}{N}$$

That is:

$$pr(w \vee r) = pr(w) + pr(r) - pr(w \& r)$$

This is the general relationship between probabilities of conjunctions and of disjunctions.



In the last chapter, we saw that degrees of truth can also be measured by numbers between 0 and 1, and it might be natural to suppose that degrees of truth and probabilities are the same. They are not. In particular, conjunction and disjunction work quite differently. For degrees of truth, disjunction is a truth function. Specifically,  $|w \vee r|$  is the maximum of  $|w|$  and  $|r|$ . But  $pr(w \vee r)$  is not determined by  $pr(w)$  and  $pr(r)$  alone, as we have just seen. In particular, for our  $w$  and  $r$ ,  $pr(w) = 4/7$ ,  $pr(r) = 3/7$ , and  $pr(w \vee r) = 5/7$ . But if  $|w| = 4/7$  and  $|r| = 3/7$ ,  $|w \vee r| = 4/7$ , not  $5/7$ .

Logic

Before we can get back to inductive inferences, there is one more bit of information about probability that we need. Given our sample week, the probability that it was raining on some day, chosen at random, is  $3/7$ . But suppose you know that the day in question was a warm one. What is the probability now that it rained? Well, there were four warm days, but only two of those were rainy, so the probability is  $2/4$ . This figure is called a *conditional probability*, and written like this:  $pr(r|w)$ , the probability of  $r$  given  $w$ . If we think about it a little, we can give a general formula for calculating conditional probabilities. How did we arrive at the figure  $2/4$ ? First, we restricted ourselves to those days when  $w$  is true; then we divided this into the number of those days when  $r$  is true, that is, the number of days when both  $w$  and  $r$  are true. In other words:

$$pr(r|w) = \#(w \& r) \div \#w$$

A little algebra tells us that this is equal to:

$$\frac{\#(w \& r)}{N} \div \frac{\#w}{N}$$

And this is  $pr(w \& r) \div pr(w)$ .

So here is our general formula for conditional probability:

$$\text{CP: } pr(w|r) = pr(w \& r)/pr(w)$$

A modicum of care is required in applying this formula. Dividing by the number 0 makes no sense.  $3/0$ , for example, has no value.

Mathematicians call this ratio *undefined*. In the formula for  $pr(w|r)$ , we have divided by  $pr(w)$ , which makes sense only if this is not zero, that is, only if  $w$  is true at least sometimes. Otherwise, the conditional probability is undefined.

Now, at last, we can come back to inductive inferences. What is it for an inference to be inductively valid? Simply that the premisses make the conclusion more probable than not. That is, the conditional probability of  $c$ , the conclusion, given  $p$ , the premiss (or the conjunction of the premisses if there are more than one) is greater than that of the negation of  $c$ :

$$pr(c|p) > pr(\neg c|p)$$

Thus, if we are reasoning about the week of our illustration, the inference:

It was a rainy day; so it was a warm day;

is inductively valid. As is easy to check,  $pr(w|r) = 2/3$ , and  $pr(\neg w|r) = 1/3$ .

The analysis can be applied to show why the inference of Holmes with which we started is valid. Holmes concluded that Jabez Wilson had been doing a lot of writing ( $c$ ). His premiss was to the effect that there were certain marks of wear on Wilson's jacket ( $p$ ). Now, had we gone around the London of Holmes's day, and collected all those people with worn cuffs of the kind in question, then the majority of those would have been clerks, people who spent their working lives writing – or so we may suppose. Thus, the probability that Jabez had been doing a lot of writing, given that his coat bore those marks, is greater than the

probability that he had not. Holmes's inference is indeed inductively valid.

Let me finish by noting one puzzle to which the machinery we have just deployed gives rise. As we have seen, a probability can be calculated as a ratio: we take a certain *reference class*; then we calculate the numbers of various groups within it; then we do some dividing. But which reference class do we use? In the illustrative example concerning the weather, I started by specifying the reference class in question: the days of that particular week. But real-life problems are not posed in this way.

Come back to Jabez Wilson. To work out the probabilities relevant in this case, I suggested that we take the reference class to comprise the people living in London in Holmes's day. But why this? Why not the people living in the whole of England then, or in Europe, or just the males in London, or just the people who could afford to come and see Holmes? Maybe, in some of these cases, it wouldn't make much difference. But certainly in others it would. For example, the people who came to see Holmes were all relatively well off, and not likely to wear second-hand coats. Things would be quite different with a wider population. So what should the appropriate reference class have been? This is the sort of question that keeps actuaries (the people who try to figure out risk-factors for insurance companies) awake at night.

In the last analysis, the most accurate reference class would seem to be the one comprising just Wilson himself. After all, what do facts about *other* people ultimately have to do with him? But in that case, he had either been doing a lot of writing, or he had not. In the first case, the probability that he has been writing given that he has a shiny cuff, is 1, and the inference is valid; in the second, it is 0, and the inference is not valid. In other words, the validity of the inference depends entirely on the truth of the conclusion. So you can't employ the inference in order to *determine* whether or not the conclusion is true. If we go this far, the notion of validity delivered is entirely useless.

## Main Ideas of the Chapter

- The probability of a statement is the number of cases in which it is true, divided by the number of cases in the reference class.
- $pr(\neg a) = 1 - pr(a)$
- $pr(a \vee b) = pr(a) + pr(b) - pr(a \& b)$
- $pr(a | b) = pr(a \& b) / pr(b)$
- An inference is inductively valid just if the conditional probability of the conclusion given the (conjunction of the) premiss(es) is greater than that of its negation given the premisses.

## Chapter 12

# Inverse Probability: You can't be Indifferent About it!

The previous chapter gave us a basic understanding of probability and the role it may have in inductive inferences. In this chapter, we'll look at some further aspects of this. Let's start by considering a very famous inductive inference.

The physical cosmos is not a purely random mess. It shows very distinctive patterns: matter is structured into galaxies, which are structured, in turn, into stars and planetary systems, and on some of those planetary systems, matter is structured in such a way as to produce living creatures like you and me. What is the explanation for this? You might say that the explanation is provided by the laws of physics and biology. And so it may be. But why are the laws of physics and biology the way they are? After all, they could have been quite different. For example, gravity could have been a force of *repulsion*, not attraction. In that case, there would never have been stable chunks of matter, and life as we know it would have been impossible anywhere in the cosmos. Does this not give us excellent reason to believe in the existence of a creator of the cosmos: an intelligent being who brought into existence the cosmos, together with its physical and biological laws, for some purpose or other? In short, does not the fact that the physical cosmos is ordered in the way that it is give us reason to believe in the existence of a god of a certain kind?



Inverse Probability

12. Matter has a distinctive structure. A whirlpool galaxy

This argument is often called the 'Argument from Design' (for the existence of god). It might better be called the Argument to Design; but never mind that. Let us think about it more closely. The premiss of the argument,  $o$ , is a statement to the effect that the cosmos is ordered in a certain way. The conclusion,  $g$ , asserts the existence of a creator-god. Unless  $g$  were true,  $o$  would be most unlikely; so, the argument goes, given that  $o$ ,  $g$  is likely.

Now, it is certainly true that the conditional probability of  $o$  given that  $g$  is true, is much higher than that of  $o$  given that  $g$  is false:

$$1. \quad pr(o|g) > pr(o|\neg g)$$

But this does not give us what we want. For  $o$  to be a good inductive

reason for  $g$ , we need the probability of  $g$ , given  $o$ , to be greater than that of its negation:

$$2. \quad pr(g|o) > pr(\neg g|o)$$

And the fact that  $pr(o|g)$  is high does not necessarily mean that  $pr(g|o)$  is high. For example, the probability that you are in Australia, given that you see a kangaroo in the wild, is very high. (Everywhere else, it would have to have escaped from a zoo.) But the probability that you will see a kangaroo in the wild, given that you are in Australia, is very low. (I lived in Australia for about 10 years before I saw one.)

$pr(o|g)$  and  $pr(g|o)$  are called *inverse probabilities*, and what we have seen is that for the design argument to work, the relationship between them must be such as to get us from 1 to 2. Is it? There is, in fact, a very simple relationship between inverse probabilities. Recall from the equation **CP** of the last chapter that, by definition:

Logic

$$pr(a|b) = pr(a \& b)/pr(b)$$

So:

$$3. \quad pr(a|b) \times pr(b) = pr(a \& b)$$

Similarly:

$$pr(b|a) = pr(b \& a)/pr(a)$$

So:

$$4. \quad pr(b|a) \times pr(a) = pr(b \& a).$$

But  $pr(a \& b) = pr(b \& a)$  (since  $a \& b$  and  $b \& a$  are true in exactly the same situations). Thus, 3 and 4 give us:

$$pr(a|b) \times pr(b) = pr(b|a) \times pr(a)$$

Assuming that  $pr(b)$  is not 0 - I shall make assumptions of this kind without further mention - we can rearrange this equation to get:

**Inv:**  $pr(a|b) = pr(b|a) \times pr(a)/pr(b)$

This is the relationship between inverse probabilities. (To remember this, it may help to note that on the right hand side, it's first a  $b$  followed by an  $a$ , and then an  $a$  followed by a  $b$ .)

Using **Inv** to rewrite the inverse probabilities in 1, we get:

$$pr(g|o) \times \frac{pr(o)}{pr(g)} > pr(\neg g|o) \times \frac{pr(o)}{pr(\neg g)}$$

And cancelling the  $pr(o)$  on both sides gives:

$$\frac{pr(g|o)}{pr(g)} > \frac{pr(\neg g|o)}{pr(\neg g)}$$

Or, rearranging the equation:

5.  $\frac{pr(g|o)}{pr(\neg g|o)} > \frac{pr(g)}{pr(\neg g)}$

Recall that for the Argument to Design to work, we have to get to 2, which is equivalent to:

$$\frac{pr(g|o)}{pr(\neg g|o)} > 1$$

It would appear that the only plausible thing that will take us to this

from 5 is  $\frac{pr(g)}{pr(\neg g)} \geq 1$ , that is:



$$pr(g) \geq pr(\neg g)$$

The values  $pr(g)$  and  $pr(\neg g)$  are called *prior probabilities*; that is, the probabilities of  $g$  and  $\neg g$  prior to the application of any evidence, such as  $o$ . Hence, what we seem to need to make the Argument go through is that the prior probability that there is a creator-god is greater than (or equal to) the prior probability that there is not.

Is it? Unfortunately, there is no reason to believe so. In fact, it would seem that it is the other way around. Suppose you don't know what day of the week it is. Let  $m$  be the hypothesis that it is Monday. Then  $\neg m$  is the hypothesis that it is not Monday. Which is more likely,  $m$  or  $\neg m$ ? Surely,  $\neg m$ : because there are lots more ways for it not to be Monday than there are for it to be Monday. (It could be Tuesday, Wednesday, Thursday . . .) Similarly with god. Conceivably, there are many different ways that the cosmos could have been. And intuitively, relatively few of those are significantly ordered: order is something *special*. That, after all, is what gives the Argument to Design its bite. But then there are relatively few possible cosmoses in which there is an *orderer*. So *a priori*, it is much more likely that there is no creator than that there is.

Logic

What we see, then, is that the Argument to Design fails. It is seductive because people often confuse probabilities with their inverses, and so slide over a crucial part of the argument.

Many inductive arguments require us to reason about inverse probabilities. The Argument to Design is not special in this regard. But many arguments are more successful in doing this. Let me illustrate. Suppose you visit the local casino. They have two roulette wheels. Call them  $A$  and  $B$ . You have been told by a friend that one of them is fixed – though the friend couldn't tell you which one. Instead of coming up red half of the time, and black half of the time, as a fair wheel should, it comes up red  $3/4$  of the time, and black  $1/4$  of the time. (Strictly speaking, real roulette wheels come up green occasionally as well; but

let's ignore this fact to keep things simple.) Now, suppose you watch one of the wheels, say wheel A, and on five successive spins it comes up with the results:

R, R, R, R, B

(R is red, B is black). Are you justified in inferring that this is the wheel that is fixed? In other words, let  $c$  be a statement to the effect that this particular sequence came up, and  $f$  be the statement that wheel A is fixed. Is the inference from  $c$  to  $f$  a good inductive inference?

We need to know whether  $pr(f|c) > pr(\neg f|c)$ . Using the equation **Inv** to convert this into a relationship between inverse probabilities, what this means is that:

$$pr(c|f) \times \frac{pr(f)}{pr(c)} > pr(c|\neg f) \times \frac{pr(\neg f)}{pr(c)}$$

Multiplying both sides by  $pr(c)$  gives:

$$pr(c|f) \times pr(f) > pr(c|\neg f) \times pr(\neg f)$$

Is this true? For a start, what are the prior probabilities of  $f$  and  $\neg f$ ? We know that either A or B is fixed (but not both). We have no more reason to believe that it is wheel A, rather than wheel B, or vice versa. So the probability that it is wheel A is  $1/2$ , and the probability that it is wheel B is also  $1/2$ . In other words,  $pr(f) = 1/2$ , and  $pr(\neg f) = 1/2$ . So we can cancel these out so that the relevant condition becomes:

$$pr(c|f) > pr(c|\neg f)$$

The probability of observing the sequence stated by  $c$ , given that the wheel is fixed in the way described,  $pr(c|f)$ , is  $(3/4)^4 \times (1/4)$ . (Never mind if you don't know why: you can take my word for it.) This is  $81/4^5$ , which

works out to 0.079. The probability that the sequence is observed, given that the wheel is not fixed, and so fair,  $pr(c|\neg f)$ , is  $(\frac{1}{2})^5$  (again, take my word for this if you wish), which works out to 0.031. This is less than 0.079. So the inference is valid.

The way that we worked out prior probabilities here is worth noting. We have two possibilities: either wheel A is fixed, or wheel B is. And we have no information that distinguishes between these two possibilities. So we assign them the same probability. This is an application of something called the *Principle of Indifference*. The Principle tells us that when we have a number of possibilities, with no relevant difference between any of them, they all have the same probability. Thus, if there are  $N$  possibilities in all, each has probability  $1/N$ . The Principle of Indifference is a sort of *symmetry* principle.

Notice that we could not apply the Principle in the Argument to Design.

Logic

In the roulette case, there are two possible situations which are completely symmetric: wheel A is fixed; wheel B is fixed. In the Argument to Design, there are two situations: a creator-god exists; a creator-god does not exist. But these two situations are no more symmetric than: today is Monday; today is not Monday. As we saw, intuitively, there are lots more possibilities in which there is no creator than possibilities in which there is.

The Principle of Indifference is an important part of intuitive reasoning about probability. Let us end this chapter by noting that it is not without its problems. It is well known that it leads to paradoxes in certain applications. Here is one.

Suppose a car leaves Brisbane at noon, travelling to a town 300km away. The car averages a constant velocity somewhere between 50km/h and 100km/h. What can we say about the probability of the time of its arrival? Well, if it is going at 100km/h it will arrive at 3 p.m.; and if it is going at 50km/h, it will arrive at 6 p.m. Hence, it will arrive between

these two times. The mid-point between these times is 4.30 p.m. So by the Principle of Indifference, the car is as likely to arrive before 4.30 p.m. as after it. But now, half way between 50km/h and 100km/h is 75km/h. So again by the Principle of Indifference, the car is as likely to be travelling over 75km/h as under 75 km/h. If it is travelling at 75 km/h, it will arrive at 4 p.m. So it is as likely to arrive before 4 p.m. as after it. In particular, then, it is *more* likely to arrive before 4.30 p.m. than after it. (That gives it an *extra* half an hour.)

I'll leave you to think about this. We have had quite enough about probability for one chapter!

### Main Ideas of the Chapter

- $pr(a|b) = pr(b|a) \times \frac{pr(a)}{pr(b)}$
- Given a number of possibilities, with no relevant difference between them, they all have the same probability (Principle of Indifference).

Inverse Probability

## Chapter 13

### Decision Theory:

### Great Expectations

Let us look at one final issue concerning inductive reasoning. This topic is sometimes called *practical reasoning*, since it is reasoning about how one should act. Here is a famous piece of practical reasoning.

You can choose to believe in the existence of (a Christian) God; you can choose not to. Let us suppose that you choose to believe. Either God exists or God does not. If God exists, all well and good. If not, then your belief is a minor inconvenience: it means that you will have wasted a bit of time in church, and maybe done a few other things that you would not otherwise have wanted to do; but none of this is disastrous. Now suppose, on the other hand, that you choose not to believe in the existence of God. Again, either God exists or not. If God does not exist, all well and good. But if God *does* exist, boy are you in trouble! You are in for a lot of suffering in the afterlife; maybe for all eternity if a bit of mercy isn't thrown in. So any wise person ought to believe in the existence of God. It's the only prudent course of action.

The argument is now usually called *Pascal's Wager*, after the 17th-century philosopher Blaise Pascal, who first put it forward. What is one to say about the Wager?

Let us think a little about how this kind of reasoning works, starting with a slightly less contentious example. When we perform actions, we

often cannot be sure of the results, which may not be entirely under our control. But we can usually estimate how likely the various possible results are; and, just as importantly, we can estimate the *value* to ourselves of the various results. Conventionally, we can measure the value of an outcome by assigning it a number on the following scale, open ended in both directions:

. . . , -4, -3, -2, -1, 0, +1, +2, +3, +4, . . .

Positive numbers are good, and the further to the right, the better. Negative numbers are bad, and the further to the left, the worse. 0 is a point of indifference: we don't care either way.

Now, suppose there is some action we may perform, say going for a bike ride. It may, however, rain. A bike ride when it is not raining is great fun, so we would value that at, say, +10. But a bike ride when it is raining can be pretty miserable, so we would value that at, say, -5. What value should be put on the only thing that is under our control: going on the ride? We could just add the two figures, -5 and 10, together, but that would be missing an important part of the picture. It may be that it is most unlikely to rain, so although the possibility of rain is bad, we do not want to give it too much weight. Suppose the probability of rain is, say, 0.1; correspondingly, the probability of no rain is 0.9. Then we can weight the values with the appropriate probabilities to arrive at an overall value:

$$0.1 \times (-5) + 0.9 \times 10$$

This is equal to 8.5, and is called the *expectation* of the action in question, going for a ride. ('Expectation', here, is a technical term; it has virtually nothing to do with the meaning of the word as used normally in English.)

In general, let *a* be the statement that we perform some action or other.

Suppose, for simplicity, that there are two possible outcomes; let  $o_1$  state that one of these occurs, and let  $o_2$  state that the other occurs. Finally, let  $V(o)$  be the value we attach to  $o$  being true. Then the expectation of  $a$ ,  $E(a)$ , is the number defined by:

$$pr(o_1) \times V(o_1) + pr(o_2) \times V(o_2)$$

(Strictly speaking, the probabilities in question should be conditional probabilities,  $pr(o_1 | a)$  and  $pr(o_2 | a)$ , respectively. But in the example, going for a ride has no effect on the probability of rain. The same is true in all the other examples we will look at. So we can stick with the simple prior probabilities here.)

So far so good. But how does this help me to decide whether or not to go for the bike ride? I know the overall value of my going for a ride. Its expectation is 8.5, as we have just seen. What is the expectation of not going for a ride? Again, either it will rain or it will not – with the same probabilities. The two outcomes now are (i) that it will rain and I stay at home; and (ii) that it will not rain and I stay at home. In each of these cases, I derive no pleasure from a bike ride. It might be slightly worse if it doesn't rain. In that case I might be annoyed that I didn't go. But in neither case is it as bad as getting soaked. So the values might be 0 if it rains, and  $-1$  if it does not. I can now calculate the expectation of staying at home:

$$0.1 \times 0 + 0.9 \times (-1)$$

This comes to  $-0.9$ , and gives me the information I need; for I should choose that action which has the highest overall value, that is, expectation. In this case, going has expectation 8.5, whilst staying at home has value  $-0.9$ . So I should go for a ride.

Thus, given a choice between  $a$  and  $\neg a$ , I should choose whichever has the greater expectation. (If they are the same, I can simply choose at

random, say by tossing a coin.) In the previous case, there are only two possibilities. In general, there might be more (say, going for a ride, going to the movies, and staying at home). The principle is the same, though: I calculate the expectation of each possibility, and choose whichever has the greatest expectation. This sort of reasoning is a simple example from the branch of logic called *decision theory*.

Now let's come back to Pascal's Wager. In this case, there are two possible actions: believing or not; and there are two relevant possibilities: God exists or does not. We can represent the relevant information in the form of the following table.

|                              | God exists    | God doesn't exist |
|------------------------------|---------------|-------------------|
| I believe ( $b$ )            | 0.1   $+10^2$ | 0.9   $-10$       |
| I don't believe ( $\neg b$ ) | 0.1   $-10^6$ | 0.9   $+10^2$     |

Decision Theory

The figures to the left of the backward slashes are the relevant probabilities, 0.1 that God exists, say, and 0.9 that God doesn't exist. (Whether or not I believe has no effect on whether or not God exists, so the probabilities are the same in both rows.) The figures to the right of the slashes are the relevant values. I don't much mind whether or not God exists; the important thing is that I get it right; so the value in each of these cases is  $+10^2$ . (Perhaps one's preferences here might not be exactly the same, but it doesn't matter too much, as we shall see.) Believing, when God doesn't exist, is a minor inconvenience, so gets the value  $-10$ . Not believing, when God does exist, is really bad, though. It gets the value  $-10^6$ .

Given these values, we can compute the relevant expectations:

$$E(b) = 0.1 \times 10^2 + 0.9 \times (-10) \approx 0$$

$$E(\neg b) = 0.1 \times (-10^6) + 0.9 \times 10^2 \approx -10^5$$



( $\approx$  means 'is approximately equal to'.) I should choose whichever action has the greater expectation, which is to believe.

You may think that the precise values I have chosen are somewhat artificial; and so they are. But in fact, the precise values don't really matter too much. The important one is the  $-10^6$ . This figure represents something that is really bad. (Sometimes, a decision theorist might write this as  $-\infty$ .) It is so bad that it will swamp all the other figures, even if the probability of God's existence is very low. That is the punch in Pascal's Wager.

Logic

The Wager might look fairly persuasive, but in fact it makes a rather simple decision-theoretic error. It omits some relevant possibilities. There is not just one possible god, there are many: a Christian god (God), Islam's Allah, Hinduism's Brahman, and lots more that various minor religions worship. And a number of these are very jealous gods. If God exists, and you don't believe, you are in trouble; but if Allah exists and you don't believe, you are equally in trouble; and so on. Moreover, if God exists, and you believe in Allah – or vice versa – this is even worse. For in both Christianity and Islam, believing in false gods is worse than being a simple non-believer.

Let's draw up a table with some more realistic information.

|                          | No God exists | God exists     | Allah exists   | ... |
|--------------------------|---------------|----------------|----------------|-----|
| No belief ( $n$ )        | 0.9   $+10^2$ | 0.01   $-10^6$ | 0.01   $-10^6$ | ... |
| Believe in God ( $g$ )   | 0.9   $-10$   | 0.01   $+10^2$ | 0.01   $-10^9$ | ... |
| Believe in Allah ( $a$ ) | 0.9   $-10$   | 0.01   $-10^9$ | 0.01   $+10^2$ | ... |
| ⋮                        | ⋮             | ⋮              | ⋮              |     |

If we compute the expectations on even this limited amount of information, we get:

$$E(n) = 0.9 \times 10^2 + 0.01 \times (-10^6) + 0.01 \times (-10^6) \approx -2 \times 10^4$$

$$E(g) = 0.9 \times (-10) + 0.01 \times 10^2 + 0.01 \times (-10^9) \approx -10^7$$

$$E(a) = 0.9 \times (-10) + 0.01 \times (-10^9) + 0.01 \times 10^2 \approx -10^7$$

Things are looking pretty bleak all round. But it is clear that theistic beliefs are coming off worst. You shouldn't have any of them.

Let me end, as I have ended all the chapters, with some reasons as to why one might be worried about the general framework deployed — specifically, in this case, the policy of deciding according to the greatest expectation. There are situations where this definitely seems to give the wrong results.

Let's suppose you take the wrong gamble on Pascal's Wager, and end up in Hell. After a few days, the Devil appears with an offer. God has commanded that you be shown some mercy. So the Devil has hatched a plan. He will give you one chance to get out of Hell. You can toss a coin; if it comes down heads, you are out and go to Heaven. If it comes down tails, you stay in Hell forever. The coin is not a fair one, however, and the Devil has control of the odds. If you toss it today, the chance of heads is  $1/2$  (i.e.,  $1-1/2$ ). If you wait till tomorrow, the chances go up to  $3/4$  (i.e.,  $1-1/2^2$ ). You sum up the information:

|                       | Escape                 | Stay in Hell           |
|-----------------------|------------------------|------------------------|
| Toss today ( $d$ )    | $0.5 \setminus +10^6$  | $0.5 \setminus -10^6$  |
| Toss tomorrow ( $m$ ) | $0.75 \setminus +10^6$ | $0.25 \setminus -10^6$ |

Escaping has a very large positive value; staying in Hell has a very large negative value. Moreover, these values are the same today as tomorrow. It is true that if you wait till tomorrow, you might have to spend an *extra* day in Hell, but one day is negligible compared with the infinite number of days that are to follow. Then you do the calculations:

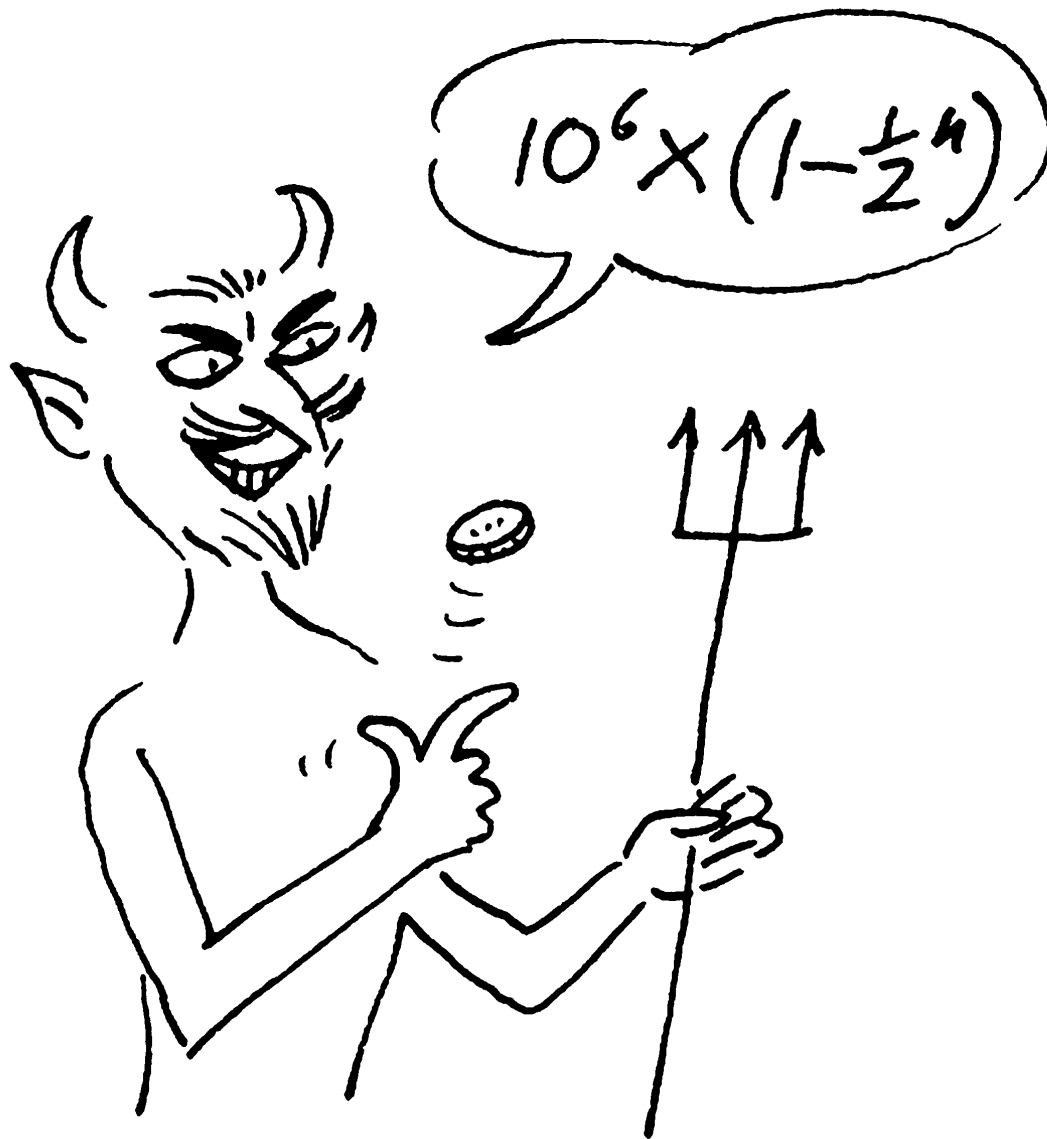

13. A devilish plan: never do today what you should put off until tomorrow

$$E(d) = 0.5 \times 10^6 + 0.5 \times (-10^6) = 0$$

$$E(m) = 0.75 \times 10^6 + 0.25 \times (-10^6) = 0.5 \times 10^6$$

So you decide to wait till tomorrow.

But tomorrow the Devil comes to you and says that if you wait one more day, the odds will get even better: they will go up to  $7/8$  (i.e.,  $1 - 1/2^3$ ). I will let you do the calculations: you should decide to wait till the next day. The trouble is that every day the Devil comes to you and offers you

better odds if you will wait till the next day. The odds get better, day by day, as follows:

$$1 - 1/2, 1 - 1/2^2, 1 - 1/2^3, 1 - 1/2^4, \dots, 1 - 1/2^n, \dots$$

Every day you do the calculation. The expectation of tossing on the  $n$ th day is:

$$(1 - 1/2^n) \times 10^6 + 1/2^n \times (-10^6)$$

A little arithmetic tells us that this is  $10^6 \times (1 - 2/2^n) = 10^6 \times (1 - 1/2^{n-1})$ . The expectation for waiting till the next,  $n + 1$ st, day is the same, with  $n$  replaced by  $n + 1$ . That is,  $10^6 \times (1 - 1/2^n)$  - which is larger. ( $1/2^n$  is smaller than  $1/2^{n-1}$ .) Every day, the expectation goes up.

Hence, every day you do the rational thing and wait till the next day. The result is that you never toss the coin at all, so you stay in Hell for ever! Tossing on *any* day has to be better than that. So it looks as though the only rational thing to do is to be irrational!

## Main Ideas of the Chapter

- $E(a) = pr(o_1) \times V(o_1) + \dots + pr(o_n) \times V(o_n)$ , where  $o_1, \dots, o_n$  state all the possible outcomes that might result from  $a$  being true.
- The rational action is the one which makes true the statement with the greatest expectation.

# Chapter 14

## A Little History and

## Some Further Reading

The ideas that we have been looking at in this book were developed at various different times and places. In this chapter I will describe the history of logic, and locate the ideas in their historical context. I will first outline briefly the history of logic in general; then I will go through, chapter by chapter, and explain how the details fit into the bigger picture.

As we go along, I will also give some further reading, where you can follow up a number of the issues if you wish. This is not as easy as might be thought. By and large, logicians, philosophers, and mathematicians prefer to write for each other. Finding things written for relative beginners is not easy, but I have done my best.

In Western intellectual history, there have been three great periods of development in logic, with somewhat barren periods sandwiched between them. The first great period was ancient Greece between about 400 BCE and 200 BCE. The most influential figure here is Aristotle (384–322), whom we met in Chapter 6. Aristotle developed a systematic theory of inferences called 'syllogisms', which have the form:

All [some] *As* are [are not] *Bs*.

All [some] *Bs* are [are not] *Cs*.

So, all [some] *As* are [are not] *Cs*.

Aristotle lived in Athens much of his life, founded a school of philosophy called the Lyceum, and is usually reckoned to be the founder of logic. But at about the same time, there was another flourishing school of logic in Megara, about 50km west of Athens. Less is known about the Megarian logicians, but they seem to have been particularly interested in conditionals, and also in logical paradoxes. Eubulides (whom we met in Chapters 5 and 10) was a Megarian. Another important philosophical movement started in Athens around 300 BCE. It was called Stoicism, after the porch (Greek, 'stoa') where early meetings were held. Though the philosophical concerns of Stoicism were much wider than logic, logic was an important one of them. It is generally supposed that Megarian logic exerted an influence on the Stoic logicians. At any rate, a major concern of Stoic logicians was the investigation of the behaviour of negation, conjunction, disjunction, and the conditional.

It should also be mentioned that at around the same time as all this was happening in Greece, theories of logic were being developed in India, principally by Buddhist logicians. Important as these theories are, though, they never developed to the sophisticated levels to which logic developed in the West.

The second growth period in Western logic was in the medieval European universities, such as Paris and Oxford, from the 12th to the 14th centuries. The medieval logicians included such notables as Duns Scotus (1266–1308) and William of Ockham (1285–1349), and they systematized and greatly developed the logic that they inherited from ancient Greece. After this period, logic largely stagnated till the second half of the 19th century, the only bright spot on the horizon during this period being Leibniz (1646–1716), whom we met in Chapters 6 and 9. Leibniz anticipated some of the modern developments in logic, but the mathematics of his day was just not up to allowing his ideas to take off.

The development of abstract algebra in the 19th century provided just

what was required, and triggered the start of the third, and possibly the greatest, of the three periods. Radically new logical ideas were developed by thinkers such as Frege (1848–1925) and Russell (1872–1970), whom we met in Chapters 2 and 4, respectively. The logical theories developing from this work are normally referred to as *modern logic*, as opposed to the *traditional logic* that preceded it. Developments in logic continued apace throughout the 20th century, and show no sign of slowing down yet.

A standard history of logic is Kneale and Kneale (1975). This is a little dated now, and is characterized by more optimism than is perhaps justified, in its attitude that early modern logicians had finally got everything pretty much right; but it is still an excellent reference work.

\* \* \*

Logic

**Chapter 1.** The distinction between deductive and inductive validity goes back to Aristotle. Theories of deductive validity have been articulated since that time. The view described in Chapter 1 — that an inference is deductively valid just if the conclusion is true in any situation where its premisses are true — can be traced back, arguably, to medieval logic; but its articulation is a central part of modern logic. A warning: what I have called a *situation* is more commonly called an *interpretation*, *structure*, or sometimes, *model*. The word ‘situation’ itself has a different, and technical, sense in one area of logic. Lewis Carroll (whose real name was Charles Dodgson) was no mean logician himself, and published a number of works on traditional logic.

**Chapter 2.** The argument to the effect that contradictions imply everything is a medieval invention. Exactly who invented it is unclear, but it is certainly to be found in Scotus. The truth-functional understanding of negation, conjunction and disjunction itself seems to have arisen in the Middle Ages. (The Stoic account was not truth-

functional in the modern sense.) In its fully articulated form, it appears in the founders of modern logic, Frege and Russell. A modern dissident is Strawson (1952, ch. 3).

**Chapter 3.** The distinction between names and quantifiers is largely a creature of modern logic. Indeed, the analysis of quantifiers is often reckoned to be a defining moment in modern logic. It was provided by Frege, and later taken up by Russell. At around the same time, the US philosopher and logician, C. S. Peirce, was developing similar ideas.  $\exists x$  is often called the *existential* quantifier; but this terminology smuggles in a somewhat contentious theory of existence. Lewis Carroll's works on *Alice* are replete with philosophical jokes. For an excellent commentary on them, see Heath (1974). For many of Heath's own jokes about nothing, see Heath (1967).

The theories explained in Chapters 1–3 can be found in any standard modern logic text. Hodges (1977) is one that is not pitched at too formidable a level; neither is Lemmon (1971).

**Chapter 4.** The isolation of descriptions as an important logical category is also something to be found only in modern logic. Perhaps the most famous analysis of them was given by Russell in 1905. The account given in this chapter is not Russell's, but it is very close in spirit. Descriptions are discussed in some, but not all, standard modern logic texts. Hodges (1977) has a good clear account.

**Chapter 5.** Various different versions of the liar paradox can be found in ancient Greek philosophy. More paradoxes of self-reference were invented and discussed throughout medieval logic. Even more were discovered around the turn of the 20th century — and this time at the very core of mathematics itself. Since then, they have become a very central issue in logic. Suggestions for solving them are legion. The idea that there might be some sentences that are neither true nor false goes back to Aristotle (*De Interpretatione*, ch. 9); however, he would have had



no sympathy with the symmetric idea that some sentences might be both true and false. That there might be such sentences, and that paradoxical sentences might be amongst them, is an unorthodox view that has been advanced by some logicians in the last 40 years. Discussions of the paradoxes of self-reference tend to get very technical very fast. Good introductory discussions can be found in Read (1994, ch. 6) and Sainsbury (1995, chs. 5, 6). The whole area remains highly contentious.

**Chapter 6.** The study of inferences involving modal operators goes back to Aristotle, and was continued in the Middle Ages. The modern investigations were started by the US philosopher C. I. Lewis, roughly between 1915 and 1930. The notion of a possible world is to be found in Leibniz, but the way it is applied in this chapter is due largely to another US philosopher, Saul Kripke, who produced the ideas in the 1960s. A standard introduction to the area is Hughes and Cresswell (1968); but you are unlikely to get much out of this before you have mastered an introductory logic book of a more standard kind. Aristotle's argument for fatalism comes from *De Interpretatione*, ch. 9. He thought it fallacious, though not for the reasons given in this chapter. A reasonably accessible discussion of it can be found in Haack (1974, ch. 3). The argument with which the chapter finishes is a version of the 'Master Argument' put forward by the Megarian logician Diodorus Cronus.

**Chapter 7.** Debate about the nature of conditionals goes back to the Megarians and Stoics, who produced a number of different theories. The issue was also widely discussed in the Middle Ages. The idea that the conditional is truth-functional is one of the Megarian views. It was endorsed in early modern logic by Frege and Russell. The account given in this chapter can certainly be found in medieval logic; in its modern form, it is due to C. I. Lewis, who developed modal logic around it. The notion of conversational implicature is due to the British philosopher Paul Grice in the 1970s (though he used it in defence of the material

conditional). The nature of conditionals remains highly contentious. Read (1994, ch. 3) is a readable introduction, as is Part 1 of Sanford (1989).

**Chapter 8.** Temporal reasoning is discussed by a number of medieval logicians. The approach described in this chapter was invented largely by the New Zealand logician Arthur Prior in the 1960s, inspired by developments in modal logic. A readable account of the subject can be found in Øhrstrøm and Hasle (1995). McTaggart's argument appeared originally in 1908, though his presentation is somewhat different from mine. My presentation follows Mellor (1981, ch. 7).

**Chapter 9.** The distinction between the *is of identity* and the *is of predication* goes back to Plato (Aristotle's teacher) in ancient Greek philosophy. The origin of the account of identity I have given here is uncertain. The thought that you can substitute equals for equals is to be found in Euclid (c. 300 BCE). Something like the account given here can be found in Ockham, and certainly in Leibniz. In its modern form, it is to be found in Frege and Russell. There are presentations in most standard modern logic texts, such as Hodges (1977) and Lemmon (1971). Puzzles about identity are legion in philosophy. The one with which the chapter ends is due, as far as I know, to Prior.

**Chapter 10.** Sorites problems go back to Megarian logic. The problem with which the chapter starts is a version of one called the *Ship of Theseus*, a ship which was, supposedly, rebuilt plank by plank. As far as I know, the example is first used by the 17th-century English philosopher, Thomas Hobbes, in the section *De Corpore* of his *Elements of Philosophy*. Intense investigation of problems of this kind is largely a feature of the last 30 years. The logical details described in this chapter were developed initially by the Polish logician Jan Łukasiewicz (pronounced *Woo/ka/zye/vitz*) in the 1920s, quite independently of worries about vagueness. (He was motivated initially by Aristotle's argument about fatalism.) Good discussions of vagueness can be found in Read (1994,

ch. 7) and Sainsbury (1995, ch. 2). A much lengthier introduction is Williamson (1994).

**Chapter 11.** Historically, inductive validity is quite under-developed, compared with deductive validity. Probability theory was developed in the 18th century, in connection with games of chance, largely by French-speaking mathematicians, such as Pierre de Laplace and members of the prodigious Bernoulli family. The idea of applying it to inductive inference is due mainly to the German logician Rudolph Carnap in the 1950s. There are many notions of probability. The one described in this chapter is usually called the *frequency interpretation*. A good introduction to the whole area is Skyrms (1975).

**Chapter 12.** Investigations of the connection between inverse probabilities go back to the 18th-century British mathematician, Thomas Bayes. The connection described in this chapter is often (incorrectly) called Bayes' Theorem. Problems concerning the Principle of Indifference also go back to the origins of probability theory. A standard introduction to reasoning of this kind is Howson and Urbach (1989); but this is not a book for those with a fear of mathematics.

**Chapter 13.** Decision theory also has its roots in the investigations of probability theory of the 18th century, but became a serious business in the 20th century, with many important applications being found in economics and game theory. A good introduction is Jeffrey (1985), though, again, this book is not for those with a fear of mathematics. The problem with which the chapter ends comes from Gracely (1988).

Many of the arguments we have met in this book concern God, one way or another. This is not because God is a particularly logical topic. It is just that philosophers have had a long time to come up with interesting arguments concerning God. In Chapter 3, we met the Cosmological Argument. Perhaps the most famous version of this was proposed by the medieval philosopher Thomas Aquinas. (His version is much more

sophisticated than the argument of Chapter 3, and does not suffer from the problem pointed out there.) The Ontological Argument for the existence of God was proposed by the medieval philosopher Anselm of Canterbury. The version given in Chapter 4 is essentially due to the 17th-century philosopher René Descartes in his *Fifth Meditation*. Biological versions of the Argument to Design were popular in the 19th century, but were destroyed by the Theory of Evolution. Cosmological versions, of the kind given in Chapter 12, became very popular in the 20th century. A good little reference work on arguments for the existence of God is Hick (1964).

\* \* \*

There is, of course, much more to the history of logic than the above details tell. Likewise, there is much to logic itself that is entirely absent from this book. We have been skating over the surface of logic. It has great depths and beauty that one could not even begin to convey in a book of this kind. But many of the great logicians of the past became engaged with the subject because of exactly the sorts of considerations and problems that this book discusses. If they have engaged you too, I can ask no more.

History and Further Reading



# Glossary

The following glossary contains the terms of art and logical symbols that are employed in this book. The entries are not meant to be precise definitions, but are meant to convey the main idea for quick reference. By and large, the terms and symbols are reasonably standard, though there are several other sets of symbols that are also in common use.

*antecedent*: what follows the 'if' in a conditional.

*conclusion*: the part of an inference for which reasons are given.

*conditional*: if . . . then . . .

*conditional probability*: the probability of some statement, given some other information.

*conjunction*: . . . and . . .

*conjuncts*: the two sentences involved in a conjunction.

*consequent*: what follows the 'then' in a conditional.

*conversational implicature*: an inference, not from what is said, but from the fact that it is said.

*decision theory*: the theory of how to make decisions under conditions of uncertain information.

*deductive validity*: an inference is deductively valid when the premisses cannot be true without the conclusion also being true.

*(definite) description*: a name of the form 'the thing with such and such properties'.

*disjunction*: either . . . or . . .

*disjuncts*: the two sentences involved in a disjunction.

*expectation*: the result of taking each possible outcome, multiplying its value by its probability, and adding all the results together.

*fuzzy logic*: a kind of logic in which sentences take truth values that may be any number between 0 and 1.

*inductive validity*: an inference is inductively valid when the premisses provide some reasonable ground for the conclusion, though not necessarily a conclusive one.

*inference*: a piece of reasoning, where premisses are given as reasons for a conclusion.

*inverse probability*: the relationship between the conditional probability of  $a$  given  $b$ , and of  $b$  given  $a$ .

'*is*' of identity: . . . is the same object as . . .

'*is*' of predication: part of a predicate indicating the application of the property expressed by the rest of it.

*Leibniz's Law*: if two objects are identical, any property of one is a property of the other.

*liar paradox*: 'This sentence is false'.

*material conditional*: not both (. . . and not . . .).

*modal operator*: a phrase attaching to a sentence, to form another sentence expressing the way in which the first sentence is true or false (possibly, necessarily, etc.).

*modern logic*: the logical theories and techniques arising out of the revolution in logic around the turn of the 20th century.

*modus ponens*: the form of inference  $a, a \rightarrow c / c$ .

*name*: grammatical category for a word that refers to an object (all being well).

*necessity*: it must be the case that . . .

*negation*: it is not the case that . . .

*particular quantifier*: something is such that . . .

*possibility*: it may be the case that . . .

*possible world*: a situation associated with another,  $s$ , where things actually are as they merely might be in  $s$ .

*predicate*: for the grammatically simplest kind of sentence, the part

which expresses whatever is said about what the sentence is about.

*premisses*: the part of an inference that gives reasons.

*Principle of Indifference*: given a number of possibilities, with no relevant difference between them, they all have the same probability.

*prior probability*: the probability of some statement before any evidence is taken into account.

*probability*: a number between 0 and 1, measuring how likely something is.

*proper name*: a name that is not a description.

*quantifier*: a word or phrase that can be the subject of a sentence, but which does not refer to an object.

*reference class*: the group of objects from which probability ratios are computed.

*Russell's paradox*: concerns the set of all sets that are not members of themselves.

*self-reference*: a sentence about a situation which reflects back on itself.

*situation*: a state of affairs, maybe hypothetical, in which premisses and conclusions may be true or false.

*sorites paradox*: a kind of paradox involving repeated applications of a vague predicate.

*subject*: for the grammatically simplest kind of sentence, the part which tells you what the sentence is about.

*syllogism*: a form of inference with two premisses and a conclusion, a theory of which was first produced by Aristotle.

*tense*: past, present or future.

*tense operator*: a phrase attaching to a sentence, to form another sentence expressing when the first sentence is true or false (past or future).

*traditional logic*: logical theories and techniques that were employed before the 20th century.

*truth conditions*: sentences that spell out how the truth value(s) of a sentence depend(s) on the truth values of its components.

*truth function*: a logical symbol which, when applied to sentences to



give a more complex sentence, is such that the truth value of the compound is completely determined by the truth value(s) of its component(s).

*truth table*: a diagram depicting truth conditions.

*truth value*: true (*T*) or false (*F*).

*universal quantifier*: everything is such that . . .

*vagueness*: a property of a predicate expressing the idea that small changes in an object make no difference to the applicability of the predicate.

*valid*: applies to an inference in which the premisses really do provide a reason of some kind for the conclusion.

| Symbol              | Meaning  | Name                    |
|---------------------|--|-------------------------|
| $T$                 | true (in a situation)                            | } truth values          |
| $F$                 | false (in a situation)                           |                         |
| $\vee$              | either . . . or . . .                            | disjunction             |
| $\&$                | . . . and . . .                                  | conjunction             |
| $\neg$              | it's not the case that . . .                     | negation                |
| $\exists x$         | some object, $x$ , is such that . . .            | particular quantifier   |
| $\forall x$         | every object, $x$ , is such that . . .           | universal quantifier    |
| $\iota x$           | the object, $x$ , such that . . .                | description operator    |
| $\Box$              | it must be the case that . . .                   | } modal operators       |
| $\Diamond$          | it may be the case that . . .                    |                         |
| $\rightarrow$       | if . . . then . . .                              | conditional             |
| $\supset$           | not both ( . . . and not . . . )                 | material conditional    |
| <b>P</b>            | it was the case that . . .                       | } tense operators       |
| <b>F</b>            | it will be the case that . . .                   |                         |
| <b>H</b>            | it has always been the case that . . .           |                         |
| <b>G</b>            | it will always be the case that . . .            |                         |
| $=$                 | . . . is the same object as . . .                | identity                |
| $<$                 | . . . is less than . . .                         |                         |
| $\leq$              | . . . is less than or equal to . . .             |                         |
| $ \dots $           | the number which is the truth value of . . .     |                         |
| <i>Max</i>          | the greater of . . . and . . .                   |                         |
| <i>Min</i>          | the lesser of . . . and . . .                    |                         |
| <i>pr</i>           | the probability that . . .                       |                         |
| $pr(\dots   \dots)$ | the probability that . . . given that . . .      | conditional probability |
| $E$                 | the expectation of its being the case that . . . |                         |
| $V$                 | the value of its being the case that . . .       |                         |
| $\approx$           | . . . is approximately equal to . . .            |                         |



# Problems

For each of the main chapters of the book, the following gives an exercise whereby you can test your understanding of the contents of that chapter. Solutions to the problems can be found at the website with the following address:

[www.oup.co.uk/vsi/logic](http://www.oup.co.uk/vsi/logic)

**Chapter 1** Is the following inference deductively valid, inductively valid, or neither? Why? *José is Spanish; most Spanish people are Catholics; so José is Catholic.*

**Chapter 2** Symbolize the following inference, and evaluate its validity. *Either Jones is a knave or he is a fool; but he is certainly a knave; so he is not a fool.*

**Chapter 3** Symbolize the following inference, and evaluate its validity. *Someone either saw the shooting or heard it; so either someone saw the shooting or someone heard it.*

**Chapter 4** Symbolize the following inference, and evaluate its validity. *Everyone wanted to win the prize; so the person who won the race wanted to win the prize.*

**Chapter 5** Symbolize the following inference, and evaluate its validity. *You made an omelette, and you don't make an omelette and not break an egg; so you broke an egg.*

**Chapter 6** Symbolize the following inference, and evaluate its validity.

*It's impossible for pigs to fly, and it's impossible for pigs to breathe under water; so it must be the case that pigs neither fly nor breathe under water.*

**Chapter 7** Symbolize the following inference, and evaluate its validity.

*If you believe in God, then you go to church; but you go to church; so you believe in God.*

**Chapter 8** Symbolize the following inference, and evaluate its validity.

*It has always rained, and it always will rain; so it's raining now.*

**Chapter 9** Symbolize the following inference, and evaluate its validity.

*Pat is a woman, and the person who cleaned the windows is not a woman; so Pat is not the person who cleaned the windows.*

**Chapter 10** Symbolize the following inference, and evaluate its validity,

where the level of acceptability is 0.5. *Jenny is clever; and either Jenny is not clever or she is beautiful; so Jenny is beautiful.*

**Chapter 11** The following set of statistics was collected from ten people (called 1–10).

Logic

|         | 1 | 2 | 3 | 4 | 5 | 6 | 7 | 8 | 9 | 10 |
|---------|---|---|---|---|---|---|---|---|---|----|
| Tall    | ✓ |   | ✓ |   | ✓ |   |   |   |   | ✓  |
| Wealthy | ✓ |   | ✓ |   | ✓ |   | ✓ | ✓ |   |    |
| Happy   | ✓ | ✓ |   | ✓ | ✓ |   |   | ✓ | ✓ |    |

If  $r$  is a randomly chosen person in this collection, assess the inductive validity of the following inference.  *$r$  is tall and rich; so  $r$  is happy.*

**Chapter 12** Suppose there are two illnesses,  $A$  and  $B$ , that have exactly the same observable symptoms. 90% of those who present with the symptoms have illness  $A$ ; the other 10% have illness  $B$ . Suppose, also, that there is a pathology test to distinguish between  $A$  and  $B$ . The test gives the correct answer 9 times out of 10.

1. What is the probability that the test, when applied to a randomly chosen person with the symptoms, will say that they have illness  $B$ ? (Hint: consider a typical sample of 100 people with the symptoms, and work out how many the test will say to have illness  $B$ .)

2. What is the probability that someone with the symptoms has illness  $B$ , given that the test says that they do? (Hint: you have to use the first question.)

**Chapter 13** You hire a car. If you do not take out insurance, and you have an accident, it will cost you \$1,500. If you take out insurance, and have an accident, it will cost you \$300. The insurance costs \$90, and you estimate that the probability of an accident is 0.05. Assuming that the only considerations are financial ones, should you take out the insurance?



# Bibliography

- Gracely, E. J. 'Playing Games with Eternity: the Devil's Offer', *Analysis* 48 (1988), p. 113.
- Haack, S. *Deviant Logic* (Cambridge: Cambridge University Press, 1974).
- Heath, P. 'Nothing', pp. 524–5, Vol. 5, of P. Edwards (ed.), *Encyclopedia of Philosophy* (London: Macmillan, 1967).
- Heath, P. *The Philosopher's Alice* (New York, NY: St. Martin's Press, 1974).
- Hick, J. *Arguments for the Existence of God* (London: Collier-Macmillan Ltd., 1964).
- Hodges, W. *Logic* (London: Penguin Books, 1977).
- Howson, C. and Urbach, P. *Scientific Reasoning: the Bayesean Approach* (La Salle, IL: Open Court, 1989).
- Hughes, G. E. and Cresswell, M. *A New Introduction to Modal Logic* (London: Routledge, 1968).
- Jeffrey, R. *The Logic of Decision* (Chicago: University of Chicago Press, 2nd edition, 1983).
- Lemmon, E. J. *Beginning Logic* (London: Thomas Nelson and Sons Ltd., 1971).
- Kneale, W. and M. *The Development of Logic* (Oxford: Clarendon Press, 1975).
- Mellor, D. H. *Real Time* (Cambridge: Cambridge University Press, 1981. 2nd edition, London: Routledge, 1998).
- Øhrstrøm, P. and Hasle, P. F. V. *Temporal Logic: from Ancient Ideas to Artificial Intelligence* (Dordrecht: Kluwer Academic Publishers, 1995).



- Read, S. *Thinking about Logic: an Introduction to the Philosophy of Logic* (Oxford: Oxford University Press, 1994).
- Sainsbury, R. M. *Paradoxes* (Cambridge: Cambridge University Press, 2nd edition, 1995).
- Sanford, D. H. *If P then Q: Conditionals and the Foundations of Reasoning* (London: Routledge, 1989).
- Skyrms, B. *Choice and Chance* (Encino, CA: Dickenson Publishing Co., 1975).
- Strawson, P. *Introduction to Logical Theory* (London: Methuen & Co., 1952).
- Williamson, T. *Vagueness* (London: Routledge, 1994).

# General Index

References are to pages unless preceded by 'ch.', in which case they are to whole chapters. Principal references, in cases where there is more than one reference, are printed in bold.

## A

acceptability, level of 76ff  
*Alice (in Wonderland and Through the Looking Glass)* 1f, 18f, 21  
antecedent **47**, 75, 111

## B

begging the question 29

## C

change 63ff  
Characterization Principle (CP) 27ff  
conclusion, *see* premiss(es)  
conditional 43, **ch. 7**, 74ff, 103, 106, 111, 115  
material c. **48**, 112, 115  
conjunction **9**, 11f, 15, 16, 34f, 73, 77, 81f, 85, 103, 104, 111, 115  
consequent **47**, 75, 111  
conversational implicature **50ff**, 106, 111

## D

decision theory **ch. 13**, 108, 111

description (definite) **ch. 4**, 105, 111, 115  
disjunction **8**, 11, 16, 34f, 74, 77, 81f, 85, 103, 104, 111, 115

## E

existence 27ff  
expectation **95ff**, 101, 112, 115

## F

fatalism **39**, 45f  
Aristotle's argument for f. **39ff**, 106f  
'Master Argument' for f. **45f**, 106  
future, *see* past

## G

God:  
Argument to (from) Design for the existence of G. **86ff**, 92, 109  
Cosmological Argument for the existence of G. **21f**, 108  
Ontological Argument for the existence of G. **26ff**, 109  
Pascal's Wager for belief in the existence of G. **94ff**, 97ff  
grammar 6, 20, 56

## I

identity **ch. 9**, 70, 107, 115  
inference **1ff**, 6, 7f, 13ff, 17, 75ff, 78ff, 83ff, 86, 102, 104, 106, 107, 112  
interpretation 104

is (of identity or predication) **64**,  
107, 112

## L

Leibniz's Law **65ff**, 112

logic:

ancient Greek l. **102f**, 105, 106,  
107

fuzzy l. **ch. 10**, 112

Indian l. **103**

medieval l. 43, **103**, 104ff

Megarian l. **103**, 106, 107

modal l. **ch. 6**, 106, 107

modern l. **104**, 105ff, 112

Stoic l. **103**, 104, 106

traditional l. **104**, 113

## Logic

## M

Möbius strip 32f

model 104

*modus ponens* **43**, 45, 47, 72, 76,  
112

## N

name **ch. 3**, 26, 105, 112

empty n. 28ff

proper n. **26**, 113

necessity **ch. 6**, 112

negation **9**, 16, 34f, 73f, 77, 80f,  
85, 103, 104, 112, 115

nothing(ness) **ch. 4**

## O

object **19ff**, 26, 28f, 30, 63ff

operator:

modal o. **ch. 6**, 56, 59, 106,  
112, 115

tense o. **ch. 8**, 67, 113,  
115

## P

paradox 103

liar p. **ch. 5**, 105, 112

Russell's p. **ch. 5**, 113

sorites p. **ch. 10**, 107, 113

past and future **ch. 8**, 113

possibility **ch. 6**, 112

possible world **41ff**, 49f, 112

predicate **17ff**, 24, 112

premiss(es) and conclusion **3**,  
4ff, 13ff, 35ff, 75, 78, 83,  
113

Principle of Indifference **92f**, 108,  
113

probability **ch. 11**, **ch. 12**, **ch. 13**,  
108

conditional p. **82ff**, **ch. 12**, 96,  
111, 115

frequency interpretation of p.  
108

inverse p. **ch. 12**, 108, 112

prior p. **93**, 113

property **19ff**, 23, 26, 63ff

## Q

quantifier **ch. 3**, 26, 105, 113

particular (existential) q. **20**,  
23, 105, 112, 115

universal q. **20**, 23, 105, 113,  
115

## R

reasoning 1ff  
practical r. 94  
reference class **84**, 113

## S

self-reference **ch. 5**, 105f, 113  
Sherlock Holmes 4, 78ff, 83ff  
Ship of Theseus 107  
situation **5f**, 12, 16, 19ff, 23, 28ff,  
34f, 41ff, 46, 49, 52ff, 58f,  
62, 73, 75, 77 104, 113  
structure 104  
subject **17ff**, 24, 113  
syllogism **102**, 113

## T

tense 56  
compound t. **56ff**, 60  
time **55ff**, 63, 67, 76  
flow of t. **55**, 57f, 61f  
McTaggart's argument against  
the reality of t. **55ff**, 60ff

## truth 5

t. conditions **9ff**, 34, 113  
t. and context. 75ff  
degrees of t. **73ff**, 82  
t. and falsity 9, 31ff, 105f  
t. function **ch. 2**, 38, 56, 74,  
104, 106, 113  
t. table **9ff**, 48, 113  
t. value **9ff**, 34f, 37, 58, 73f, 77,  
113–14, 115  
*see also* situation

## V

vagueness **ch. 10**, 113  
higher order v. 77  
validity **ch. 1**, 104, 113  
deductive v. **4ff**, 13, 35, 75,  
104, 108, 111  
inductive v. 4, 52, **ch. 11**, 91,  
104, 108, 112  
vacuous v. 14f  
value (of a state of affairs) **95ff**,  
115

t

.

.

,

# Index of Names

## A

Anselm (of Canterbury) 109  
Aquinas (Thomas) 108  
Aristotle 39, 40, 102f, 105, 106,  
107  
Augustine 55

## B

Bayes, T. 108  
Bernoullis, the 108

## C

Callimachus 47  
Carnap, R. 108  
Carroll, L. 1, 108, 109, 104,  
105  
Chomsky, N. 6  
Cresswell, M. 106

## D

Dali, S. 61  
Descartes, R. 109  
Diodorus Cronus 106  
Dodgson C., see Carroll, L.

## E

Eubulides 32, 37, 72, 103  
Euclid 107

## F

Frege, G. 9, 10, 104, 105, 106, 107

## G

Gracely, E. 108  
Grice, P. 106

## H

Haack, S. 106  
Hasle, P. 107  
Heath, P. 105  
Hick, J. 109  
Hobbes, T. 107  
Hodges, W. 105, 106  
Howson, C. 108  
Hughes, G. 106

## J

Jeffrey, R. 108

## K

Kneale, W. & M. 104  
Kripke, S. 106

## L

Laplace, P. de 108  
Leibniz, G. 41, 65, 66, 103, 106,  
107  
Lemmon, E. 105, 107  
Lewis, C. 106  
Łukasiewicz, J. 107

## M

McTaggart, J. 55, 107  
Mellor, D. 107

## O

Ockham (William of) 103, 107  
Øhrstrøm, P. 107

## P

Pascal, B. 94  
Peirce, C. 105  
Plato 27, 107  
Prior, A. 107

## R

Read, S. 106, 107  
Russell, B. 24, 25, 34, 104, 105,  
106, 107

## S

Sainsbury, M. 106, 108  
Sanford, D. 107  
Scotus (Duns) 103, 104  
Skyrms, B. 108  
Strawson, P. 105

## U

Urbach, P. 108

## W

Williamson, T. 108

Visit the

# VERY SHORT INTRODUCTIONS

Web site

**[www.oup.co.uk/vsi](http://www.oup.co.uk/vsi)**

- **Information** about all published titles
- News of **forthcoming books**
- **Extracts** from the books, including titles not yet published
- **Reviews** and views
- **Links** to other **web sites** and main OUP web page
- Information about **VSIs in translation**
- **Contact** the editors
- **Order** other **VSIs** on-line



# ANCIENT PHILOSOPHY

## A Very Short Introduction

Julia Annas

The tradition of ancient philosophy is a long, rich and varied one, in which a constant note is that of discussion and argument. This book aims to introduce readers to some ancient debates and to get them to engage with the ancient developments of philosophical themes. Getting away from the presentation of ancient philosophy as a succession of Great Thinkers, the book aims to give readers a sense of the freshness and liveliness of ancient philosophy, and of its wide variety of themes and styles.

Logic

'Incisive, elegant, and full of the excitement of doing philosophy, Julia Annas's Short Introduction boldly steps outside of conventional chronological ways of organizing material about the Greeks and Romans to get right to the heart of the human problems that exercised them, problems ranging from the relation between reason and emotion to the objectivity of truth. I can't think of a better way to begin.'

**Martha Nussbaum, University of Chicago**

[www.oup.co.uk/vsi/ancientphilosophy](http://www.oup.co.uk/vsi/ancientphilosophy)

Graham Priest

# LOGIC

A Very Short Introduction

'This book is terrific. . . . It covers a lot of ground, but in a wonderfully relaxed and interesting way.'

Simon Blackburn, University of Cambridge (author of *Think*)

VERY SHORT INTRODUCTIONS  
stimulating ways in to new subjects

**OXFORD**  
UNIVERSITY PRESS

[www.oup.com](http://www.oup.com)  
[www.oup.co.uk/vsi](http://www.oup.co.uk/vsi)

ISBN 0-19-568262-9



9 780195 682625

Rs 150